



**HAL**  
open science

# Investigations on the synthesis and reactivity of 1-C-stannylated aminoalditols and iminosugars

Justyna Jaszczyk

► **To cite this version:**

Justyna Jaszczyk. Investigations on the synthesis and reactivity of 1-C-stannylated aminoalditols and iminosugars. Organic chemistry. Université d'Orléans, 2019. English. NNT : 2019ORLE3217 . tel-04624797

**HAL Id: tel-04624797**

**<https://theses.hal.science/tel-04624797>**

Submitted on 25 Jun 2024

**HAL** is a multi-disciplinary open access archive for the deposit and dissemination of scientific research documents, whether they are published or not. The documents may come from teaching and research institutions in France or abroad, or from public or private research centers.

L'archive ouverte pluridisciplinaire **HAL**, est destinée au dépôt et à la diffusion de documents scientifiques de niveau recherche, publiés ou non, émanant des établissements d'enseignement et de recherche français ou étrangers, des laboratoires publics ou privés.

**ÉCOLE DOCTORALE SANTE, SCIENCES BIOLOGIQUES ET CHIMIE DU VIVANT**

INSTITUT DE CHIMIE ORGANIQUE ET ANALITIQUE

**THÈSE** présentée par :  
**Justyna Anna JASZCZYK**

soutenue le : **10 Décembre 2019**

pour obtenir le grade de : **Docteur de l'université d'Orléans**

Discipline/ Spécialité : Chimie Organique

**Etude sur la synthèse et la réactivité de  
dérivés 1-C-stannylés d'aminoalditols  
et d'iminosucres**

Investigations on the synthesis and reactivity of  
1-C-stannylated aminoalditols and iminosugars

**THÈSE dirigée par :**

**Olivier R. MARTIN** (Directeur de thèse)

**Cyril NICOLAS** (Encadrant)

Professeur, Université d'Orléans

Chargé de Recherche, CNRS

**RAPPORTEURS :**

**Jean-Bernard BEHR**

**Thomas LECOURT**

Professeur, Université de Reims

Professeur, INSA de Rouen

**JURY:**

**Stéphanie NORSIKIAN** HDR, Chargée de Recherche, CNRS, ICSN

**Jean-Bernard BEHR** Professeur, Université de Reims

**Thomas LECOURT** Professeur, INSA de Rouen

**Olivier R. MARTIN** Professeur, Université d'Orléans

**Cyril NICOLAS** Chargé de Recherche CNRS, ICOA

*Ever tried.  
Ever failed.  
No matter.  
Try again.  
Fail again.  
Fail better.*

**Samuel Beckett**





## Acknowledgements

First of all, for giving me the opportunity to develop this interesting subject, I would like to express my sincere gratitude to the director of the thesis Prof. Olivier Martin. Your kindness, acceptance, patience, support helped me greatly during the realisation of the project and writing this report.

I want to thank Cyril Nicolas for everything he has done for me while overseeing the project. You helped me to grow not only as a chemist and scientist but also as a person. I am grateful for that.

I would like to thank Prof. Thomas Lecourt and Prof. Jean-Bernard Behr for accepting the manuscript for the review, as well as the position in the jury. My thanks are also sent towards Stéphanie Norsikian for accepting the invitation as a part of the jury.

I would like to express my gratitude towards Sizhe Li for the collaboration in the Stille coupling project and the optimisation of the Stille reaction and giving input in case of the elimination process. Also, I want to thank Maxime Neuville as well as his supervisors (S. Routier and F. Buron) for the collaboration in flow chemistry.

To my colleagues from Labo7: Chloé, Samir, Alice S., Louis, Sizhe, Sophie, Anne-Gäelle, Alice W., Marta, Agata and Salia, I am grateful for the opportunity to work with all of you. You supported me greatly during your stay in the lab and even after. I am even more grateful for the time outside in your company. I sincerely hope, we will have a chance to make another Escape together!

I am grateful to the EDIFICE for giving me an opportunity participate in this project and develop new skills in teaching, as well as allow me to meet a group of wonderful students, which accompanied me through three years of this project.

I also extend my thanks to my friends Weronika, Maciej, Paweł and Bartek, as well as Morgan. For listening to my complaints, sharing both my pain and my happiness, spending evenings together and encouraging my dreams.

I also thank my parents and my family, for the constant support and confidence. You are always there for me no matter how far from home I am. Dziękuję i kocham Was bardzo.



## Abbreviations List

2-AImS	2-AminoIminoSugars
<b>A</b>	
Ac	acetyl
ACN	acetonitrile
<b>B</b>	
BINAP	2,2'-bis(diphenylphosphino)-1,1'-binaphthyl
Bn	benzyl
Boc	<i>tert</i> -butyloxycarbonyl
bs	broad singlet
Bu	butyl
Bus	butanesulfonyl
Bz	benzoyl
<b>C</b>	
CHART	Chaperone-Advanced Replacement Therapy
CIP	Cahn-Ingold-Prelog
CMT	chaperone-mediated therapy
COSY	Correlation Spectroscopy
<b>D</b>	
d	doublet
DAB	1,4-dideoxy-1,4-imino-d-arabinitol
DAG	diacetone glucose
DAST	(diethylamino)sulfur trifluoride
DCE	dichloroethane
DCM	dichloromethane
dd	doublet of doublets
ddd	doublet of doublet of doublets
DEAD	diethyl azodicarboxylate
DFT	Density Functional Theory
DGJ	1-deoxygalactonojirimycin
DIAD	diisopropyl azodicarboxylate
DMDP	2,5-dideoxy-2,5-imino-d-mannitol
DMF	dimethylformamide
DMJ	1-deoxymannojirimycin
DMSO	dimethylsulfoxide
DNJ	1-deoxynojirimycin
DPPA	Diphenyl phosphoryl azide
DPPE	1,2-bis(diphenylphosphino)ethane
DPPF	1,1'-bis(diphenylphosphino)ferrocene
dr	diastereoisomeric ration
dt	doublet of triplets

<b>E</b>	
ERT	Enzyme Replacement Therapy
Et	ethyl
ETH	Eidgenössische Technische Hochschule
<b>F</b>	
FGI	functional group interconversion
Fmoc	fluorenylmethyloxycarbonyl
<b>F</b>	
GC	gas chromatography
<b>H</b>	
HCV	Hepatitis C virus
HFIP	hexafluoroisopropanol
HIV	human immunodeficiency virus
HPLC	High-Performance Liquid Chromatography
HR-MS	High-Resolution Mass Spectrometry
HSQC	Heteronuclear Single Quantum Coherence
<b>I</b>	
ImmG	Immucillin G
ImmH	immucillin H
<b>J</b>	
<i>J</i>	coupling constant
<b>L</b>	
LC-MS	Liquid Chromatography-Mass Spectrometry
LDA	Lithium diisopropyl amide
LG	leaving group
LHMDS	hexamethyldisilazane lithium
LR-MS	Low-Resolution Mass Spectrometry
LSD	Lysosomal Storage Disorder
<b>M</b>	
<i>m</i>	multiplet
<i>m</i> -CPBA	<i>meta</i> -chloroperoxybenzoic acid
Me	methyl
MOM	methoxymethyl
Ms	mesyl
MS	Mass Spectrometry
<b>N</b>	
NFPA	National Fire Protection Association
NIS	<i>N</i> -iodosuccinimide
NJ	nojirimycin
NJ-B	nojirimycin B
NMR	Nuclear Magnetic Resonance
NOESY	Nuclear Overhauser Effect Spectroscopy
<b>P</b>	
Ph	phenyl

PMP	<i>p</i> -methoxyphenyl
PNP	purine nucleoside phosphorylase
PPTS	<i>p</i> -toluenesulfonate
Pr	propyl
	<b>Q</b>
q	quartet
	<b>S</b>
s	singlet
SL	Sizhe Li
SM	starting material
SnAP	Tin-Amine Protocol
SP	side product
SRBC	sheep red blood cells
	<b>T</b>
t	triplet
TBAHS	tetrabutylammonium bisulfite
TBAI	tetrabutylammonium iodide
TEMPO	2,2,6,6,-tetramethyl-1-piperidine-1-oxyl
Tf	trifluoromethanesulfonate
THF	tetrahydrofuran
TLC	Thin Layer Chromatography
TLC-MS	Thin Layer Chromatography-Mass Spectrometry
TMS	trimethylsilyl
TPP	triphenylphosphine
Trs	tresyl
TS	transition state



## Table of Contents

Acknowledgements.....	3
Abbreviations List.....	5
Table of Contents.....	9
List of figures.....	13
List of tables.....	15
List of schemes .....	17
General Introduction .....	21
I. Iminosugars.....	23
1. Where do they come from? .....	23
2. Medical applications and current trials.....	30
II. Iminosugar-C-glycosides .....	33
1. First synthesis and isolation from natural sources.....	33
2. The medical interest behind iminosugar-C-glycosides .....	35
3. Synthetic approaches to iminosugar-C-glycosides.....	38
III. Glycosylamines.....	41
IV. Objectives .....	44
V. Summary of the introduction and objectives <i>in french</i> .....	46
Chapter 1.....	49
I. Introduction.....	51
1. <i>Tert</i> -butanesulfinamides – properties and applications.....	52
2. Research performed in our team.....	60
3. Addition of tin to the imines.....	66
II. Synthesis of <i>N-tert</i> -butanesulfinylglycosylamines .....	69
1. Microwave-assisted and flow chemistry-facilitated synthesis .....	69
2. Crystal structure of ( <i>S</i> <sub>S</sub> )- <i>N-tert</i> -butanesulfinyl-D-xylopyranosylamine 13.....	76
3. Applications to the synthesis of 1-deoxyiminosugars .....	78

III. Synthesis of iminosugar-1-stannanes.....	81
1. Application to <i>N-tert</i> -butanesulfinylglycosylamines.....	81
2. Oxidation of the sulfinyl group to a sulfonyl group.....	83
3. Proposed transition state for the addition of tributyltin lithium .....	85
IV. Conclusions.....	87
V. Summary of Chapter 1 <i>en français</i> .....	88
Chapter 2.....	91
I. Introduction.....	93
1. History of the Stille coupling.....	94
2. Application of the Stille coupling in the field of glycochemistry .....	98
3. <i>Tert</i> -butanesulfinyl group in the Stille reaction.....	103
II. Stille coupling using open-chain 1-stannylated aminoalditols .....	105
1. Preliminary results .....	105
2. Stille coupling for oxidised compounds.....	106
III. Synthesis of 2-aminoiminosugars (2-AImS) .....	109
IV. Conclusions.....	117
V. Summary of Chapter 2 <i>en français</i> .....	118
Chapter 3.....	121
I. Cyclisation of open-chain 1-stannylated aminoalditols.....	123
II. Cyclisation of oxidised stanannes .....	127
1. Results of the cyclisation.....	127
2. Determination of the configuration via NMR studies .....	128
3. Pattern for the results of the addition.....	132
III. Exploitation of heteronuclear coupling constants.....	133
1. Literature data.....	133
2. 1-stannylated iminosugars .....	135
IV. Stille cross-coupling of 1-stannylated iminosugars .....	137
1. Results of the cross-coupling reaction.....	137
2. Determination of the configuration via NMR studies .....	140



V. Conclusions.....	144
VI. Summary of Chapter 3 <i>en français</i> .....	146
Chapter 4.....	149
I. Introduction.....	151
1. Known pathways for the preparation of 2-AImS .....	151
2. SnAP chemistry .....	155
II. Application of the SnAP in the synthesis of 2-AImS .....	161
1. Intermolecular SnAP .....	161
2. Preparation of the starting material for intramolecular SnAP .....	162
3. Application of intramolecular SnAP methodology .....	165
III. Conclusions.....	170
IV. Summary of Chapter 4 <i>en français</i> .....	171
General conclusions and perspectives .....	173
Appendices.....	179
I. List of the publications.....	181
II. List of the communications.....	181
1. Oral presentations .....	181
2. Posters.....	182
Experimental part.....	185
GENERAL REMARKS .....	187
ADDITIONAL NOTES .....	189
GENERAL PROCEDURES .....	192
Bibliography .....	203



## List of figures

Figure 1. Structures of first isolated and synthesised iminosugars.....	24
Figure 2. Structures of NJ-B <b>A5</b> and galactostatin <b>A7</b> . ....	24
Figure 3. Structure of siastatin B. ....	25
Figure 4. Structures of monocyclic iminosugars found in nature. ....	25
Figure 5. Structure of acarbose, a potent, carbocyclic $\alpha$ -glucosidase inhibitor. ....	27
Figure 6. Bicyclic iminosugars. ....	28
Figure 7. Iminosugars available on the market. ....	31
Figure 8. Molecules which are undergoing or failed clinical trials. ....	32
Figure 9. Broussonetines, broussonetinines, radicamines and batzellasides. ....	34
Figure 10. $\beta$ -GalCer <b>A43</b> and its analogues. ....	36
Figure 11. Immucillins. ....	36
Figure 12. <i>Tert</i> -butanesulfinamides. ....	52
Figure 13. <i>N-tert</i> -butanesulfinylglycosylamines. ....	63
Figure 14. Pattern for the addition of M-CF <sub>2</sub> P(O)(OEt) <sub>2</sub> . ....	65
Figure 15. Synthesis of <b>5</b> via flow chemistry. ....	71
Figure 16. Crystallisation by the vapour diffusion method. ....	76
Figure 17. X-ray structure of compound <b>13</b> . ....	77
Figure 18. <sup>1</sup> H NMR of the compounds <b>32</b> and <b>33</b> . ....	84
Figure 19. Comparison of the <sup>1</sup> H NMR spectra of compounds <b>36</b> and <b>37</b> . ....	108
Figure 20. Results of TLC-MS after double reductive amination. ....	113
Figure 21. Potential correlations in the NOESY spectra of compounds <b>57</b> and <b>58</b> . ....	129
Figure 22. NOESY spectra of compound <b>57</b> . ....	130
Figure 23. NOESY spectra of compound <b>58</b> . ....	130
Figure 24. Potential configuration and conformations of compound <b>62</b> . ....	131
Figure 25. Pattern of the absolute configuration of 1-stannylated iminosugars. ....	132
Figure 26. Compounds prepared by Vasella and coworkers. ....	134
Figure 27. Values of the coupling constants measured by Walczak and coworkers. ....	135
Figure 28. Heteronuclear coupling constants for <b>62</b> and <b>67</b> . ....	135
Figure 29. Correlation of <i>J</i> values and relative configuration in pyrrolidine series. ....	136
Figure 30. NOESY spectra of compound <b>73</b> . ....	140
Figure 31. NOESY spectra of compound <b>74</b> . ....	141
Figure 32. Potential configurations and conformations of compound <b>72</b> . ....	142
Figure 33. Potential configurations and conformations of compound <b>75</b> . ....	143
Figure 34. Substructure search on SciFinder <sup>®</sup> . ....	151
Figure 35. Commercially available SnAP reagents. ....	159
Figure 36. Change of the colour during the reaction. ....	167
Figure 37. Results of MS analysis of the fraction containing <b>87</b> . ....	169
Figure 38. Low-Resolution MS of stannylated compound. ....	189
Figure 39. High-Resolution MS of stannylated compound. ....	190
Figure 40. Part of <sup>1</sup> H NMR for stannylated compound. ....	191

Figure 41. Part of $^{13}\text{C}$ NMR for stannylated compound. ....	191
Figure 42. ORTEP of compound <b>13</b> . ....	201

## List of tables

Table 1. Synthesis of $\alpha$ -amino organostannanes according to Kells. ....	67
Table 2. Optimisation of the formation of <b>5</b> under microwave irradiation.....	70
Table 3. Optimisation of the synthesis of <b>5</b> via flow chemistry. ....	71
Table 4. Conditions tested for the formation of <b>15</b> .....	75
Table 5. Isotopes of tin and their abundance. ....	133
Table 6. Optimisation table for the Stille coupling.....	138
Table 7. Bond distances (Angstroms).....	201
Table 8. Dihedral angles (degrees). ....	202



## List of schemes

Scheme 1. First synthesis of iminosugar- <i>C</i> -glycosides. ....	33
Scheme 2. General approaches for the synthesis of imino- <i>C</i> -glycosides. ....	38
Scheme 3. Intramolecular cyclisation. ....	39
Scheme 4. Iminosugar acting as electrophiles. ....	39
Scheme 5. Addition of nucleophile to glycosylamines. ....	41
Scheme 6. Methodology of Nicotra. ....	42
Scheme 7. Addition of Grignard's reagents with the 1,2- <i>anti</i> outcome. ....	43
Scheme 8. General objectives. ....	44
Scheme 9. Synthesis of amines via Ellman's base. ....	52
Scheme 10. First synthesis of <b>2</b> . ....	53
Scheme 11. Industrial synthesis of <b>2</b> . ....	54
Scheme 12. Synthesis of a racemic mixture. ....	55
Scheme 13. Synthesis of <i>N</i> - <i>tert</i> -butanesulfinyl imines through direct condensation. ....	56
Scheme 14. Asymmetric aziridination. ....	57
Scheme 15. Addition of nucleophiles to sugar-derived <i>tert</i> -butanesulfinyl imines. ....	58
Scheme 16. Models of the transition state for the stereoselective addition. ....	59
Scheme 17. Addition of RMgBr to <i>N</i> - <i>tert</i> -butanesulfinyl imines. ....	61
Scheme 18. Iminosugars as analogues of <i>C</i> -glycosides and glycosyl phosphates. ....	62
Scheme 19. Synthesis of <i>N</i> - <i>tert</i> -butanesulfinylglycosylamines in D- <i>araf</i> series. ....	63
Scheme 20. Addition of Grignard reagents to <i>N</i> - <i>tert</i> -butanesulfinylglycosylamines. ....	64
Scheme 21. Addition of M-CF <sub>2</sub> P(O)(OEt) <sub>2</sub> . ....	64
Scheme 22. Synthesis of α-amino organostannanes. ....	66
Scheme 23. Transition state for the addition of LiSnBu <sub>3</sub> . ....	67
Scheme 24. Synthesis of 1-stannylated aminoalditols. ....	68
Scheme 25. Synthesis of ( <i>S</i> <sub>R</sub> )- <i>N</i> - <i>tert</i> -butanesulfinyl arabinofuranosylamine <b>5</b> . ....	69
Scheme 26. Proposed mechanism for the formation of glycosylamine <b>5</b> . ....	72
Scheme 27. Synthesis of ( <i>S</i> <sub>S</sub> )- <i>N</i> - <i>tert</i> -butanesulfinylglycosylamine <b>6</b> . ....	72
Scheme 28. Synthesis of tri- <i>O</i> -benzyl-D-xylopyranose <b>11</b> . ....	73
Scheme 29. Synthesis of ( <i>S</i> <sub>R</sub> )- <i>N</i> - <i>tert</i> -butanesulfinyl xylopyranosylamine <b>12</b> . ....	74
Scheme 30. Synthesis of ( <i>S</i> <sub>S</sub> )- <i>N</i> - <i>tert</i> -butanesulfinyl xylopyranosylamine <b>13</b> . ....	74
Scheme 31. Synthesis of ( <i>S</i> <sub>R</sub> )- <i>N</i> - <i>tert</i> -butanesulfinyl-D-glucopyranosylamine <b>15</b> . ....	75
Scheme 32. Retrosynthetic plan for 1-deoxyiminosugars. ....	78
Scheme 33. Synthesis of 1-deoxyiminosugars <b>22</b> and <b>23</b> . ....	79
Scheme 34. Application of the methodology to L-lyxopyranose <b>23</b> . ....	80
Scheme 35. Addition of LiSnBu <sub>3</sub> to glycosylamine <b>5</b> . ....	81
Scheme 36. Addition of LiBuSn <sub>3</sub> to glycosylamine <b>6</b> . ....	82
Scheme 37. Addition of LiSnBu <sub>3</sub> in the pentopyranose series. ....	82
Scheme 38. Oxidation of the <i>tert</i> -butanesulfinyl group. ....	83
Scheme 39. Deprotection of the <i>tert</i> -butanesulfinyl group. ....	85
Scheme 40. Proposed TS for the addition of LiSnBu <sub>3</sub> . ....	85

Scheme 41. Definition of cross-coupling reactions. ....	93
Scheme 42. General scheme of Stille coupling. ....	94
Scheme 43. Cross-coupling by Eaborn. ....	95
Scheme 44. Cross-coupling by Kosugi and Migita. ....	95
Scheme 45. Cross-coupling by Milstein and Stille. ....	96
Scheme 46. Simplified mechanism vs more complex one. ....	97
Scheme 47. The total synthesis of (+)-goniofufurone <b>C60</b> . ....	98
Scheme 48. The Stille cross-coupling of pyranosides. ....	99
Scheme 49. Synthesis of 1-stannylated glycosides from glucals. ....	100
Scheme 50. Application of the 1-stannylated glycosides in synthesis (Walczak's group)...	101
Scheme 51. Stille coupling of alkenylated glucal derivatives. ....	101
Scheme 52. Analogue of (-)-dinemasone B ( <b>C88</b> ) and (-)-dinemasone C ( <b>C89</b> ). ....	102
Scheme 53. The Stille cross-coupling with <i>tert</i> -butanesulfonyl imines. ....	104
Scheme 54. Aim of Chapter 2. ....	104
Scheme 55. First trials of Stille coupling with stannylated aminoalditols. ....	105
Scheme 56. Degradation of compound <b>30</b> . ....	106
Scheme 57. Protection of compounds <b>32</b> and <b>33</b> with benzoyl group. ....	106
Scheme 58. Stille cross-coupling of the compounds <b>34</b> and <b>35</b> . ....	107
Scheme 59. Stille cross-coupling of the compound <b>35</b> with <i>p</i> -anisoyl chloride. ....	108
Scheme 60. Different approaches to the cyclic iminosugar. ....	109
Scheme 61. Deprotection of benzoyl group in compound <b>37</b> . ....	110
Scheme 62. Oxidation of the mixture with Dess-Martin reagent. ....	111
Scheme 63. Double reductive amination to obtain 2-AImS. ....	112
Scheme 64. Alternative strategy for the cyclisation. ....	114
Scheme 65. Reduction followed by the deprotection of the benzoyl group. ....	114
Scheme 66. Double oxidation and double reductive amination sequence. ....	115
Scheme 67. Double oxidation with Dess-Martin reagent and double reductive amination..	115
Scheme 68. Reductive amination of <b>37</b> . ....	116
Scheme 69. Cyclisation of compounds <b>29</b> and <b>30</b> . ....	123
Scheme 70. Proposed mechanisms for the formation of compound <b>52</b> . ....	124
Scheme 71. S <sub>N</sub> 2 cyclisation at lower temperatures. ....	125
Scheme 72. Cyclisation in the D-xylofuranose series. ....	126
Scheme 73. Cyclisation of oxidised compounds <b>32</b> and <b>33</b> . ....	127
Scheme 74. Oxidation and cyclisation of compound <b>31</b> . ....	128
Scheme 75. Optimal conditions for the Stille cross-coupling. ....	137
Scheme 76. Stille cross-coupling of compounds <b>57</b> , <b>58</b> and <b>62</b> . ....	139
Scheme 77. Synthesis and transformations of <b>D1</b> reported by Vasella. ....	152
Scheme 78. Synthesis of analogues of $\alpha$ -D-GlcNAc-1-phosphate. ....	152
Scheme 79. Synthesis of 2-AImS using azepane derivatives. ....	153
Scheme 80. Synthesis of 2-AImS by regioselective debenzoylation. ....	154
Scheme 81. Approaches for the synthesis of saturated nitrogen-heterocycles. ....	155
Scheme 82. Preparation of SnAP reagent <b>D23</b> . ....	156
Scheme 83. Formation of thiomorpholines starting from <b>D23</b> . ....	156



Scheme 84. Proposed mechanism for the formation of thiomorpholines and related heterocycles through SnAP chemistry. ....	157
Scheme 85. Intermolecular reaction developed by the group of Kagoshima. ....	157
Scheme 86. Diverse N-heterocycles available through SnAP chemistry. ....	158
Scheme 87. Preparation of 2-AImS via SnAP chemistry. ....	160
Scheme 88. Strategy to obtain 2-AImS through intermolecular SnAP. ....	161
Scheme 89. Attempt of intermolecular SnAP. ....	161
Scheme 90. Mesylation and displacement with NaN <sub>3</sub> . ....	162
Scheme 91. Results of the Mitsunobu reaction. ....	163
Scheme 92. Preparation of N-methylated open-chain aminoalditols <b>79</b> and <b>80</b> . ....	163
Scheme 93. Mitsunobu reaction performed on <b>79</b> . ....	164
Scheme 94. Formation of the azide <b>81</b> . ....	164
Scheme 95. Reaction with triflic anhydride. ....	164
Scheme 96. Introduction of the azide via tresylate intermediate. ....	165
Scheme 97. Selective reduction of azide. ....	166
Scheme 98. First attempt of the SnAP using 84 as the starting material. ....	167
Scheme 99. Second SnAP reaction. ....	168
Scheme 100. SnAP chemistry with <b>85</b> as the starting material. ....	169



# **General Introduction**

---



## I. Iminosugars

Iminosugars form a class of glycomimetic compounds, in which nitrogen replaces the endocyclic oxygen atom. These molecules have activity against a wide range of enzymes which operate on carbohydrates. Their potency is the result of the structure, in which at physiological pH the nitrogen is protonated and forms the ammonium cation. This cation resembles the oxocarbenium ion, the intermediate or transition state (TS) in many enzymatic processes acting on glycosides. Thanks to that, these small mimics of carbohydrates can occupy the active site of the enzyme and compete against the natural substrate.

### 1. Where do they come from?

In folklore medicine, many plants were used for the treatment of various predicaments, even though it was unknown what makes these plants unique. With progress in science, now we can identify the structures of the biologically active compounds. Usually, they are secondary metabolites. Iminosugars belong to this group and can also be found in microorganisms and fungi or prepared by reactions in the organic chemistry laboratory. Because of their biological activity and great potential applications in medicine, they gained much interest from research teams.

The first iminosugar was isolated as an antibiotic from *Streptomyces rosechromogens* R-468 by the group of Ishida in 1965.<sup>1</sup> After isolation from *Streptomycesnojiriensis* and structural characterisation, the molecule was named nojirimycin (NJ, **A1**).<sup>2,3,4</sup> The synthesis of **A1** was published around three years later.<sup>5</sup> As an analogue of D-glucose (**A2**), **A1** exhibits inhibitory activity against  $\alpha$ - and  $\beta$ -glucosidases.

However, it was not the first iminosugar structure ever published. In 1962 two groups (Paulsen and Jones) launched the synthesis of *N*-acetyl-1,5-dideoxy-1,5-imino-D-xylitol (**A3**) and *N*-acetyl-1,5-dideoxy-1,5-imino-L-arabinitol (**A4**).<sup>6,7</sup> This type of compounds is characterized by a limited stability (Figure 1).

---

<sup>1</sup> T. Nishikawa, N. Ishida, *J. Antibiot.* **1965**, *18*, 132–133.

<sup>2</sup> S. Inouye, T. Tsuruoka, T. Niida, *J. Antibiot.* **1966**, *19*, 288–292.

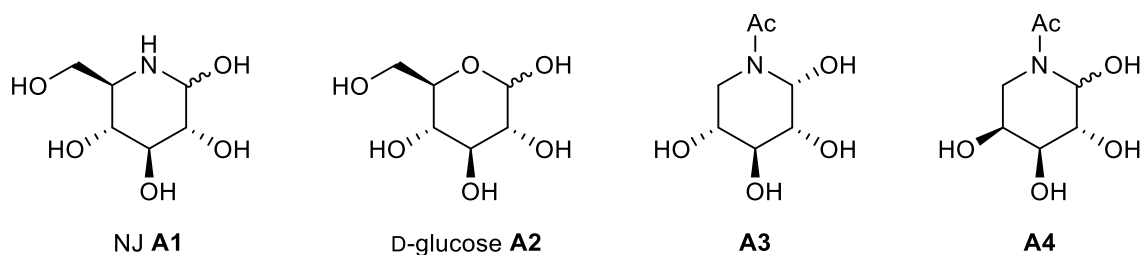
<sup>3</sup> N. Ishida, K. Kumagai, T. Niida, K. Hamamoto, T. Shomura, *J. Antibiot.* **1967**, *20*, 62–65.

<sup>4</sup> N. Ishida, K. Kumagai, T. Niida, T. Shomura, H. Yumoto, *J. Antibiot.* **1967**, *20*, 66–71.

<sup>5</sup> S. Inouye, T. Tsuruoka, T. Ito, T. Niida, *Tetrahedron* **1968**, *24*, 2125–2144.

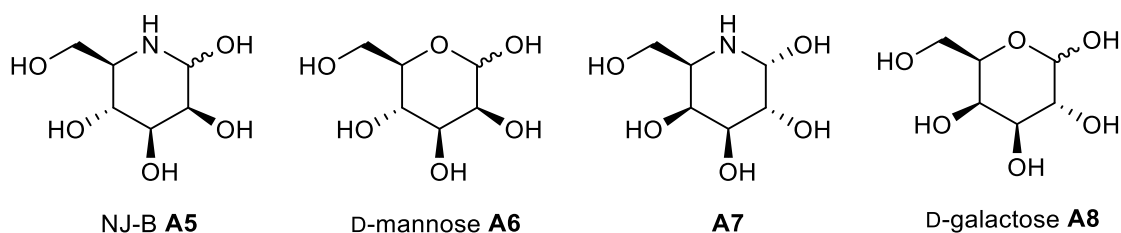
<sup>6</sup> H. Paulsen, *Angew. Chem.* **1962** *74*, 901–918.

<sup>7</sup> J. K. N. Jones, J. C. Turner, *J. Chem. Soc.* **1962**, 4699–4703.



**Figure 1.** Structures of first isolated and synthesised iminosugars.

Further examination of *Streptomyces* strains yielded to two other iminosugars: nojirimycin B (NJ-B, mannojirimycin, **A5**) and galactostatin (**A7**) (Figure 2).<sup>8,9</sup> **A5** is C-2 epimer of **A1** and analogue of D-mannose (**A6**). It was isolated from *Streptomyces lavendulae* and is a potent inhibitor of rat epididymal  $\alpha$ -mannosidase and apricot  $\beta$ -glucosidase. On the other hand, **A7** is an epimer of **A1** at C-4 and an analogue of D-galactose (**A8**), it was isolated from a strain of *Streptomyces lydicus*. The biological activity of **A7** was evaluated on  $\beta$ -galactosidases from different sources over various pH values.



**Figure 2.** Structures of NJ-B **A5** and galactostatin **A7**.

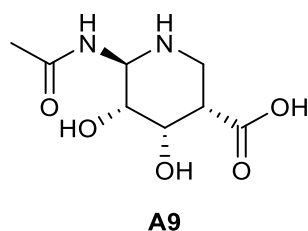
Another two new molecules were found in search for new inhibitors of sialidases in culture filtrates of microorganisms; they were named siastatin A and siastatin B (**A9**) (Figure 3).<sup>10</sup> The structure for siastatin B differs from classical iminosugar structures. The usual hydroxyl moiety at position C-4 is replaced by the carboxylic acid function, and the position C-1 is occupied by a *N*-acetyl group. The structure of siastatin A remains unknown. Biological activity was measured against several sialidases from different sources, as well as  $\beta$ -glucuronidase and *N*-acetyl- $\beta$ -D-glucosaminidase. There is a significant difference of biological activity between those two molecules. Siastatin A is more potent towards sialidases prepared from *Clostridium*

<sup>8</sup> T. Niwa, T. Tsuruoka, H. Goi, Y. Kodama, J. Itoh, S. Inouye, Y. Yamada, T. Niida, M. Nobe, Y. Ogawa, *J. Antibiot.* **1984**, *37*, 1579–1586.

<sup>9</sup> Y. Miyake, M. Ebata, *J. Antibiot.* **1987**, *40*, 122–123.

<sup>10</sup> H. Umezawa, T. Aoyagi, T. Komiyama, H. Morishima, M. Hamada, T. Takeuchi, *J. Antibiot.* **1974**, *27*, 963–969.

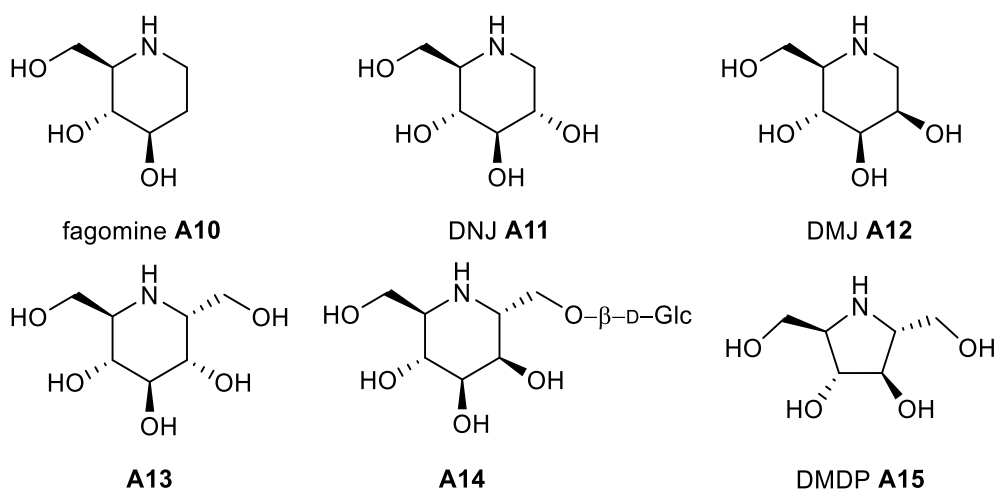
*perfringens* and chorioallantoic membrane; on the other hand, **A9** possess moderate activity against sialidases from *Streptomyces*. Neither of these compounds inhibited the enzymes originating from two viruses and *Vibrio cholerae*. In 1988, the team of Umezawa performed the total synthesis of **A9**.<sup>11</sup> The entire synthetic pathway consists of 14 steps starting from L-ribose with a global yield of around 10%.



**Figure 3.** Structure of siastatin B.

Unfortunately, the *N,O*-acetal function is labile in neutral and acidic conditions, which complicates the synthesis and isolation, as well as dramatically limits potential applications of those molecules as drugs.

Further examples of iminosugars were isolated from plants (Figure 4). What is typical for all those polyhydroxylated alkaloids is the lack of hydroxyl group in position C-1. Those structures proved to be more stable than their corresponding parent iminosugar.



**Figure 4.** Structures of monocyclic iminosugars found in nature.

<sup>11</sup> Y. Nishimura, W. Wang, S. Kondo, T. Aoyagi, H. Umezawa, *J. Am. Chem. Soc.* **1988**, *110*, 7249–7250.

Fagomine (**A10**) and 1-deoxynojirimycin (DNJ, **A11**) were among the very first examples isolated from Buckwheat Seeds (*Fagopyrum esculentum* Moench)<sup>12</sup> and root bark of *Morus* species.<sup>13</sup> **A11** exists as well under the name of moranoline, an indication of the isolation's source, but later, this name was abandoned. It is one of the most prominent analogues of **A1**. In comparison to **A1**, **A11** is much more potent and selective towards  $\alpha$ -glucosidase. The synthesis of DNJ was developed long before isolation from plants, by Paulsen et al. in 1967.<sup>14</sup> It was also isolated from the culture filtrates of *Bacillus* species<sup>15</sup> and *Streptomyces* species.<sup>16</sup> A few years later Asano and coworkers performed a more in-depth analysis of extracts from the mulberry tree (*Morus alba* L.), as well as from silkworms (*Bombyx mori* L.) because of their specific diet consisting exclusively of leaves of the mulberry tree.<sup>17,18,19</sup> They also examined different parts of the tree, focusing on root bark, fruits and leaves. As a result, they isolated a small library of 18 iminosugars from all four sources. Interestingly, root bark contains 16 out of 18 compounds, and some molecules were found exclusively in the root bark. **A11** was found in all examined materials. Moreover, the yield of isolation of **A11** given in mg per 1 kg of dry material was the highest in silkworms (1880 mg).

Another specimen of these type of structures was found in *Lonchocarpus sericeus* and *L. constaricensis*; it is the epimer at position C-2 of **A11** and an analogue of D-mannose – 1-deoxymannojirimycin (DMJ, **A12**).<sup>20</sup> In contrast to the potent inhibition shown by **A11** against  $\alpha$ -glucosidase, **A12**, despite structural analogy to mannose, does not exhibit similar properties when tested on  $\alpha$ -mannosidase.<sup>21</sup>

*Commelina communis* is a wild plant native to eastern parts of China but also was introduced to some parts of Europe and eastern North America. Interestingly, the flowers of this plant bloom for only one day. Also, parts exposed to the air were used in folklore medicine for the treatment of diabetes and influenza. Analysis of the methanolic extract from those aerial parts

---

<sup>12</sup> M. Koyama, S. Sakamura, *Agric. Biol. Chem.* **1974**, *38*, 1111–1112.

<sup>13</sup> M. Yagi, T. Kouno, Y. Acyagi, H. Murai, *Nippon Nogei Kagaku Kaishi* **1976**, *50*, 571–572.

<sup>14</sup> H. Paulsen, I. Sangster, K. Heyns, *Chem. Ber.* **1967**, *100*, 802–815.

<sup>15</sup> D. D. Schmidt, W. Frommer, L. Müller, E. Truscheit, *Naturwissenschaften* **1979**, *66*, 584–585.

<sup>16</sup> S. Murao, S. Miyata, *Agric. Biol. Chem.* **1980**, *44*, 219–221.

<sup>17</sup> N. Asano, E. Tomioka, H. Kizu, K. Matsui, *Carbohydr. Res.* **1994**, *253*, 235–245.

<sup>18</sup> N. Asano, K. Oseki, E. Tomioka, H. Kizu, K. Matsui, *Carbohydr. Res.* **1994**, *259*, 243–255.

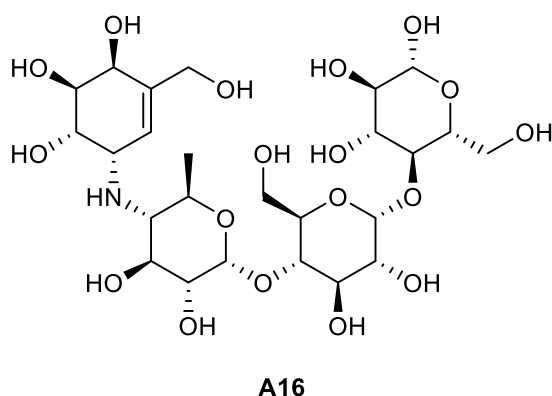
<sup>19</sup> N. Asano, T. Yamashita, K. Yasuda, K. Ikeda, H. Kizu, Y. Kameda, A. Kato, R. J. Nash, H. S. Lee, K. S. Ryu, *J. Agric. Food Chem.* **2001**, *49*, 4208–4213.

<sup>20</sup> L. E. Fellows, E. A. Bell, D. G. Lynn, F. Pilkiewicz, I. Miura, K. Nakanishi, *J. Chem. Soc. Chem. Commun.* **1979**, 977–978.

<sup>21</sup> S. V. Evans, L. E. Fellows, E. A. Bell, *Phytochemistry* **1983**, *22*, 768–770.



revealed the presence of 5 different iminosugars.<sup>22</sup> Four of them belong to the group of pyranose analogues; they are described before, DNJ (A11) and DMJ (A12), as well as compounds such as  $\alpha$ -homonojirimycin (A13) and 7-*O*- $\beta$ -D-glucopyranosyl  $\alpha$ -homonojirimycin (A14). The structure of the last one is analogue of a furanose ring. It is 2,5-dideoxy-2,5-imino-D-mannitol (DMDP, A15). Together with acarbose (A16, Figure 5) as the model, all separated compounds were tested for biological activity against a variety of commercially available  $\alpha$ -glucosidases. Among them, DMDP and  $\alpha$ -homonojirimycin were especially potent against  $\alpha$ -glucosidase originating from Brewer's yeast.



**Figure 5.** Structure of acarbose, a potent, carbocyclic  $\alpha$ -glucosidase inhibitor.

Iminosugars found in natural sources can also exist in the form of bicyclic structures (Figure 6). Their high and specific inhibitory activity is the result of a particular structure, that is somewhat “rigid”, as a consequence of the locked conformation. Most of them were found in plants. However, some microorganisms also produce them.

In 1979, Colegate and coworkers isolated from *Swainsona canescens*, a plant native to Australia, and characterised the very first example of bicyclic iminosugar named swainsonine (A17).<sup>23</sup> They aimed to obtain the molecule responsible for the inhibition of  $\alpha$ -mannosidase, thereby inducing disease in livestock, very similar to mannosidosis – one of the lysosomal storage disease.<sup>24</sup>

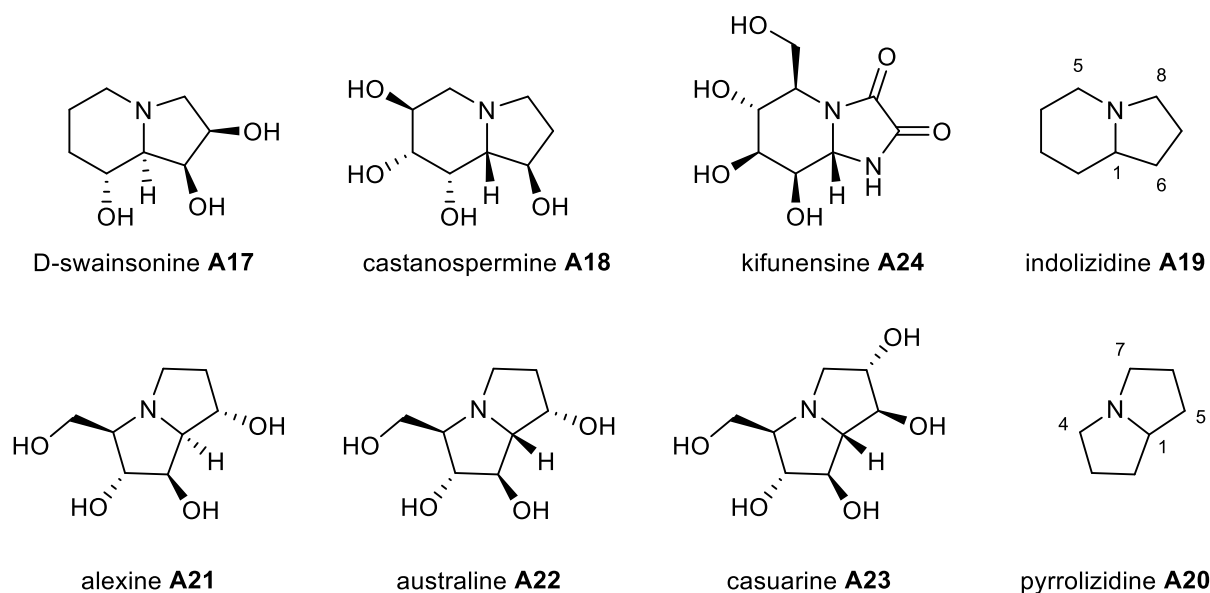
Around two years later, another plant from Australia (this time a tree *Castanospermum australe*) was examined. Interestingly, the seeds of that tree, when consumed unripe by

<sup>22</sup> H. Kim, Y. Kim, Y. Hong, N. Paek, H. Lee, T. Kim, K. Kim, J. Lee, *Planta Med.* **1999**, *65*, 437–439.

<sup>23</sup> S. M. Colegate, P. R. Dorling, C. R. Huxtable, *Aust. J. Chem.* **1979**, *32*, 2257–2264.

<sup>24</sup> P. R. Dorling, C. R. Huxtable, P. Vogel, *Neuropathol. Appl. Neurobiol.* **1978**, *4*, 285–295.

animals, caused severe gastrointestinal irritation or, in some cases, even death.<sup>25</sup> Hohenschutz *et al.* solved this mystery.<sup>26</sup> Using various methods, they isolated, described the structure and named the new molecule castanospermine (**A18**). Since the beginning, this molecule has shown enormous potential. **A18** inhibits replication of the human immunodeficiency virus (HIV)<sup>27</sup> and other retroviruses.<sup>28</sup> Moreover, it also reduces tumour growth in mice.<sup>29</sup>



**Figure 6.** Bicyclic iminosugars.

The core of both molecules **A17** and **A18** is an indolizidine (**A19**). This structure consists of two fused rings – a piperidine and a pyrrolidine sharing a nitrogen atom. If another pyrrolidine ring replaces the piperidine from **A19**, then this structure is a polyhydroxylated pyrrolizidine (**A20**) – the central scaffold for a variety of alkaloids including iminosugars. I want to focus on the description of three of them: alexine (**A21**), australine (**A22**) and casuarine (**A23**).

<sup>25</sup> S. L. Selwyn L. Everist, *Poisonous Plants of Australia*, Angus & Robertson, **1974**.

<sup>26</sup> L. D. Hohenschutz, E. A. Bell, P. J. Jewess, D. P. Leworthy, R. J. Pryce, E. Arnold, J. Clardy, *Phytochemistry* **1981**, *20*, 811–814.

<sup>27</sup> B. D. Walker, M. Kowalski, W. C. Goh, K. Kozarsky, M. Krieger, C. Rosen, L. Rohrschneider, W. A. Haseltine, J. Sodroski, *Proc. Natl. Acad. Sci. U. S. A.* **1987**, *84*, 8120–8124.

<sup>28</sup> P. S. Sunkara, T. L. Bowlin, P. S. Liu, A. Sjoerdsma, *Biochem. Biophys. Res. Commun.* **1987**, *148*, 206–210.

<sup>29</sup> G. K. Ostrander, N. K. Scribner, L. R. Rohrschneider, *Cancer Res.* **1988**, *48*, 1091–1094.

**A21** was isolated in 1988 from *Alexa leiopetala*, and its structure resembles **A15** (DMDP).<sup>30</sup> They also tested the activity of this molecule in comparison with literature data for **A15**. In all cases, **A21** was less potent. The resemblance between those two is not reflected in the biological activity.

In the same year as alexine, the results of reexamination of the seeds of *Castanospermum australe* were released in the press. Beside fagomine (**A10**), castanospermine (**A18**) and its epimer at position 6, one more compound was isolated and fully characterised – **A22** (australine).<sup>31</sup> It is an epimer of **A21** and an inhibitor of  $\alpha$ -glucosidase.

Besides obvious similarities between casuarine (**A23**), **A21**, and **A22**, there is one more hydroxyl group in this structure. Additionally, there is one more chiral centre. The molecule **A23** was isolated from the bark of *Casuarina equisetifolia* L.<sup>32</sup> In the past, the bark, wood, and leaves were applied in folklore medicine for the treatment of diarrhea, dysentery, and colic.<sup>33</sup>

Last bicyclic molecule, which will be described here, was published in 1987 as a result of the screening program for a new type of immunoactive compounds. It was isolated from microorganism *Kitasatosporia kifunense*.<sup>34</sup> In the beginning, it was given only an identification code – FR-900494. In the same article, multiple factors were characterised like isolation process, physicochemical properties and biological activity. They have examined the impact of the molecule on immuno-deficient mice, which were treated with an immunosuppressive agent. The active compound was able to restore the formation of antibodies to sheep red blood cells (SRBC). Unfortunately, the structure of the active compound remained unknown until two years later. In 1989, Kayakiri and coworkers, thanks to the NMR and X-ray analysis, were able to identify the structure accurately.<sup>35</sup> The molecule also received the name – kifunensine (**A24**). Its structure looks similar to the analogues of indolizine described before. However, it

---

<sup>30</sup> R. J. Nash, L. E. Fellows, J. V Dring, G. W. J. Fleet, A. E. Derome, T. A. Hamor, A. M. Scofield, D. J. Watkin, *Tetrahedron Lett.* **1988**, 29, 2487–2490.

<sup>31</sup> R. J. Molyneux, M. Benson, R. Y. Wong, J. E. Tropea, A. D. Elbein, *J. Nat. Prod.* **1988**, 51, 1198–1206.

<sup>32</sup> R. J. Nash, P. I. Thomas, R. D. Waigh, G. W. J. Fleet, M. R. Wormald, P. M. de Q. Lilley, D. J. Watkin, *Tetrahedron Lett.* **1994**, 35, 7849–7852.

<sup>33</sup> R. N. Chopra, S. L. Nayar, I. C. Chopra, *Glossary of Indian Medicinal Plants*, Council Of Scientific And Industrial Research, **1956**.

<sup>34</sup> M. Iwami, O. Nakayama, H. Terano, M. Kohsaka, H. Aoki, H. Imanaka, *J. Antibiot.* **1987**, 40, 612–622.

<sup>35</sup> H. Kayakiri, S. Takase, T. Shibata, M. Okamoto, H. Terano, M. Hashimoto, T. Tada, S. Koda, *J. Org. Chem.* **1989**, 54, 4015–4016.

has an extra heterocyclic nitrogen atom in the pyrrolidine ring and two amide functions (oxalodiamide), next to each other, which cause the pyrrolidine ring to be completely flat. The same team published the synthesis of **A24**, a few months after the structure of **A24** was solved.<sup>36</sup>

## 2. Medical applications and current trials

Iminosugars have many attractive biological properties, which increase their potential as candidates for drugs. They are chemically and metabolically stable, as well as they are not processed by carbohydrate-modifying enzymes. Usually, they are eliminated from the organism in unchanged form. In contrast to many aromatic heterocyclic compounds, they benefit from the presence of multiple hydroxyl groups, and their solubility in water is enough. They can be easily transformed into prodrugs to modulate their polarity. Their similarity to sugars allows them to profit from transport mechanisms dedicated to carbohydrates.

Although the biological activity expressed by iminosugars is remarkable, sometimes it is not enough. There are many requirements for the molecule to be even considered as a candidate in clinical trials – selectivity is one of them. Lack of selectivity in inhibition will disturb the balance of biological processes, and the more the balance is disturbed, the more side effects the molecule will present. The aglycone part of the natural substrates is generally crucial for the recognition by the enzymes acting on carbohydrates; it is not present in 1-deoxyiminosugars. That is why their potential remains quite limited.

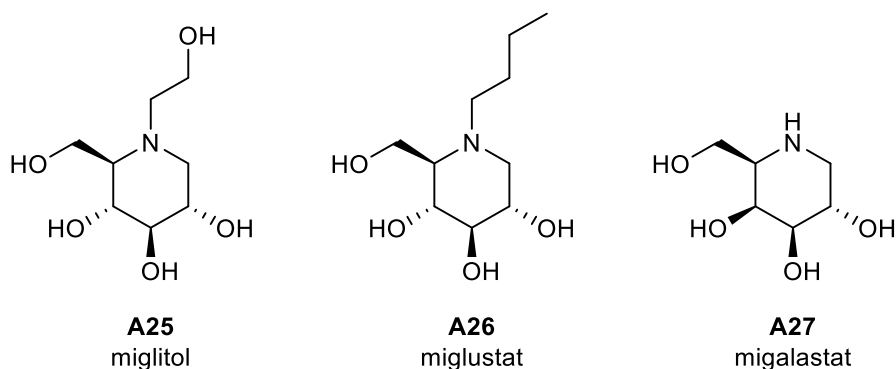
Nevertheless, the role of the aglycone can be partially restored if it is shifted to the endocyclic nitrogen. In this group of molecules, there are two marketed drugs – miglitol produced by Bayer (**A25**) and miglustat by Actelion (**A26**) (Figure 7). They are both analogues of **A11**.

**A25**, under trade name Glyset, is used in the treatment of type II diabetes. Miglitol works in the intestines to slow down the metabolism and absorption of carbohydrates (glucose) through the inhibition of intestinal  $\alpha$ -1,4-glucosidases. It is taken orally, usually three times per day at the beginning of the meal.

---

<sup>36</sup> H. Kayakiri, C. Kasahara, T. Oku, M. Hashimoto, *Tetrahedron Lett.* **1990**, *31*, 225–226.

Zavesca – trade name for **A26**, is an auxiliary therapy used for type I Gaucher disease in cases where Enzyme Replacement Therapy (ERT) is not suitable.<sup>37</sup> It inhibits the glucosyl transferase responsible for the synthesis of glycosphingolipids – glucosylceramide synthase. In the beginning, the aim of this compound was to inhibit  $\alpha$ -glucosidases associated with the human immunodeficiency virus (HIV). A few years ago, it was also approved in Europe, Canada and Japan as the first treatment for Niemann–Pick type C disease but soon after it was replaced by another compound – arimoclomol.



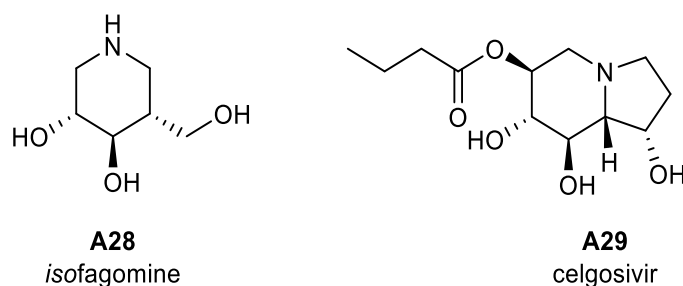
**Figure 7.** Iminosugars available on the market.

The last one from the group of 1-deoxyiminosugar, which is approved for a treatment, is migalastat (DGJ, **A27**), developed by Amicus Therapeutics and sold under the name of Galafold. It is the epimer of **A11** at position C-4 (analogue of D-galactose). Like **A26**, it is used for the treatment of a disease from the group of Lysosomal Storage Disorder (LSD) – Fabry’s disease. This disorder is characterised by a mutation in  $\alpha$ -galactosidase A, the enzyme responsible for the degradation of the lipid globotriaosylceramide in lysosomes. In 1999 Fan *et al.* used iminosugars to prevent misfolding and too fast degradation of mutant enzymes in the endoplasmic reticulum and put forward the idea of chaperone-mediated therapy (CMT).<sup>38</sup> They proved that sub-inhibitory concentration of **A27** increased the activity of the (mutant) enzyme in lymphoblasts, which provided the basis for a cure for patients suffering from the deficiency in  $\alpha$ -galactosidase.

Those are the most successful compounds, other (Figure 8) are still undergoing clinical trials or their trials were suspended due to various reasons.

<sup>37</sup> T. M. Cox, J. M. F. G. Aerts, G. Andria, M. Beck, N. Belmatoug, B. Bembi, R. Chertkoff, S. Vom Dahl, D. Elstein, A. Erikson, et al., *J. Inherit. Metab. Dis.* **2003**, *26*, 513–526.

<sup>38</sup> J.-Q. Fan, S. Ishii, N. Asano, Y. Suzuki, *Nat. Med.* **1999**, *5*, 112–115.



**Figure 8.** Molecules which are undergoing or failed clinical trials.

**A11** (DNJ) has been a candidate for the treatment of Pompe disease. Unfortunately, due to side effects, the trials were suspended. At this moment, Amicus Therapeutics is performing phase III of trials using **A26** as a chaperone in combination with ERT.<sup>39</sup> They call this protocol Chaperone-Advanced Replacement Therapy (CHART®).

Isfagomine (**A28**) was another project of Amicus Therapeutics for Gaucher disease. The project was abandoned after failure at phase II of clinical trials.

Bicyclic compounds also got their chances in clinical trials. **A17** was tested as an anti-cancer drug. It gave positive results, but unfortunately, lack of selectivity in mannosidase inhibition caused severe hepatotoxicity, which completely excluded **A17** as a potential drug.

Another bicyclic compound celgosivir (**A29**), an analogue of **A18**, was examined for antiviral activity. It is supposed to act as a prodrug and release castanospermine after enzyme-promoted ester hydrolysis. It was the objective of two major clinical trials for Hepatitis C virus (HCV)<sup>40</sup> and Dengue fever.<sup>41,42,43</sup>

<sup>39</sup> <https://clinicaltrials.gov/ct2/show/NCT03729362> PROPEL Study - A Study Comparing ATB200/AT2221 With Alglucosidase/Placebo in Adult Subjects With LOPD

<sup>40</sup> <https://clinicaltrials.gov/ct2/show/NCT00157534> A Study to Evaluate the Safety and Efficacy of Celgosivir in Patients With Chronic Hepatitis C Genotype 1 Infection

<sup>41</sup> <https://clinicaltrials.gov/ct2/show/NCT01619969> Celgosivir as a Treatment Against Dengue (CELADEN)

<sup>42</sup> J. G. Low, C. Sung, L. Wijaya, Y. Wei, A. P. S. Rathore, S. Watanabe, B. H. Tan, L. Toh, L. T. Chua, Y. Hou, et al., *Lancet Infect. Dis.* **2014**, *14*, 706–715.

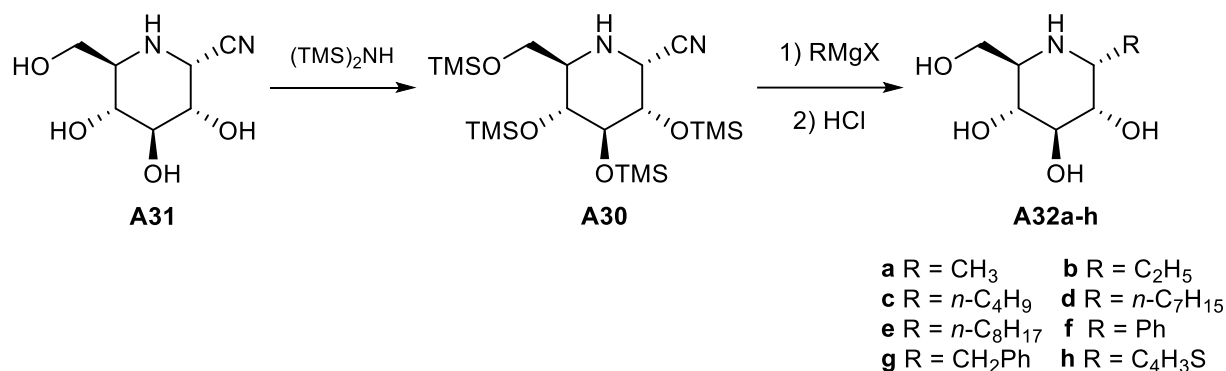
<sup>43</sup> C. Sung, Y. Wei, S. Watanabe, H. S. Lee, Y. M. Khoo, L. Fan, A. P. S. Rathore, K. W.-K. Chan, M. M. Choy, U. S. Kamaraj, et al., *PLoS Negl. Trop. Dis.* **2016**, *10*, e0004851.

## II. Iminosugar-C-glycosides

Another solution to stabilising the structure of hypothetical iminoglycosides is to create a C–C bond connecting the iminosugar scaffold and the aglycone part. This particular group of iminosugars is named “iminosugar-C-glycosides”. They are attractive synthetic targets, but also, some of them can be found in nature.

### 1. First synthesis and isolation from natural sources

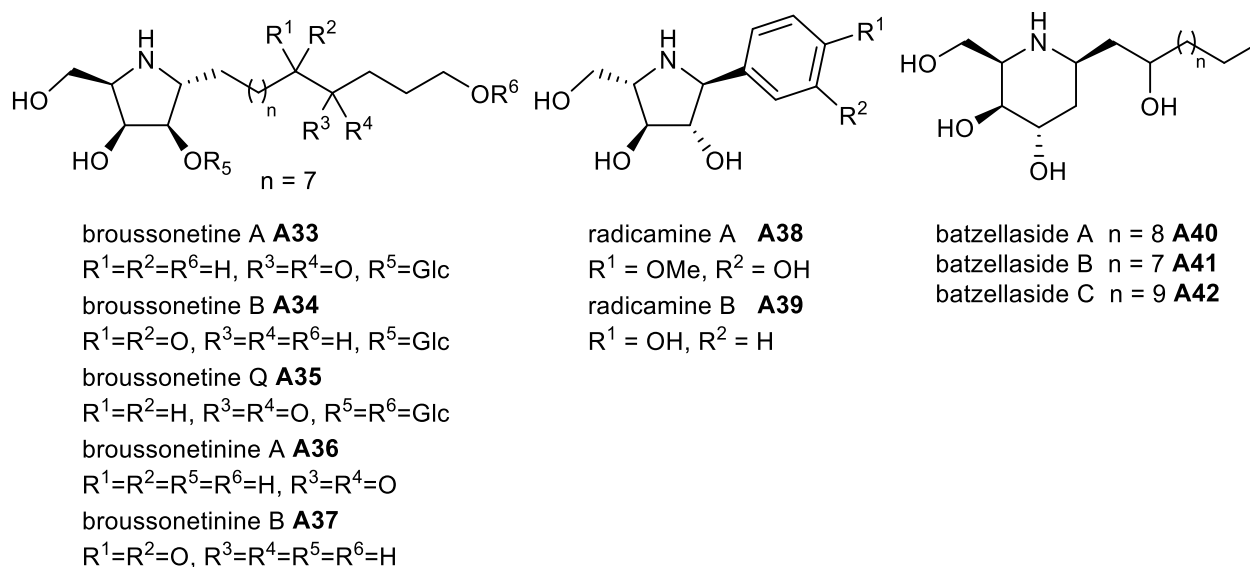
Just like in case of iminosugars, this type of molecules was for the first time prepared via organic synthesis. It was performed by Böshagen *et al.* at Bayer in 1981.<sup>44</sup> Their strategy was based on the addition of various Grignard reagents to protected **A30** – a derivative of NJ with CN group installed at position C-1 (**A31**). As a result, the CN group was eliminated and replaced by R. The addition product was deprotected to yield a small library of iminosugar-C-glycosides (**A32a-h**).



**Scheme 1.** First synthesis of iminosugar-C-glycosides.

A few iminosugar-C-glycosides were isolated among other iminosugar structures from natural sources (Structures **A13**, **A14**, **A15**). A handful more structures of naturally occurring compounds are presented in Figure 9. Usually, they are secondary metabolites.

<sup>44</sup> H. Böshagen, W. Geiger, B. Junge, *Angew. Chem. Int. Ed. Eng.* **1981**, *20*, 806–807.



**Figure 9.** Broussonetines, broussonetinines, radicamines and batzellasides.

There are many groups of such molecules. Usually, their names are centred around the source of isolation, to name a few of them: radicamines, broussonetines and broussonetinines, as well as batzellasides.

The team of Kusano significantly contributed to increasing the library of iminosugar-C-glycosides from natural sources. They published structures of many broussonetines (**A33**, **A34**, **A35**) and broussonetinines (**A36**, **A37**) isolated from dried branches of *Broussonita kazinoki*,<sup>45,46,47,48,49,50,51,52</sup> a tree native to eastern parts of Asia, as well as radicamines (**A38**, **A39**) found in *Lobelia chinensis*.<sup>53</sup> Both plants found many applications in folk medicine. Broussonetines and broussonetinines are a group of around 30 compounds. There is an enormous variety of structures, but they share some similarities. Almost all of them are based

<sup>45</sup> M. Shibano, S. Kitagawa, G. Kusano, *Chem. Pharm. Bull. (Tokyo)*. **1997**, *45*, 505–508.

<sup>46</sup> M. Shibano, S. Kitagawa, S. Nakamura, N. Akazawa, G. Kusano, *Chem. Pharm. Bull. (Tokyo)*. **1997**, *45*, 700–705.

<sup>47</sup> M. Shibano, S. Nakamura, N. Akazawa, G. Kusano, *Chem. Pharm. Bull. (Tokyo)*. **1998**, *46*, 1048–1050.

<sup>48</sup> M. Shibano, S. Nakamura, N. Motoya, G. Kusano, *Chem. Pharm. Bull. (Tokyo)*. **1999**, *47*, 472–476.

<sup>49</sup> M. Shibano, D. Tsukamoto, G. Kusano, *Chem. Pharm. Bull. (Tokyo)*. **1999**, *47*, 907–908.

<sup>50</sup> M. Shibano, D. Tsukamoto, R. Fujimoto, Y. Masui, H. Sugimoto, G. Kusano, *Chem. Pharm. Bull. (Tokyo)*. **2000**, *48*, 1281–1285.

<sup>51</sup> D. Tsukamoto, M. Shibano, R. Okamoto, G. Kusano, *Chem. Pharm. Bull. (Tokyo)*. **2001**, *49*, 492–496.

<sup>52</sup> D. Tsukamoto, M. Shibano, G. Kusano, *Chem. Pharm. Bull. (Tokyo)*. **2001**, *49*, 1487–1491.

<sup>53</sup> M. Shibano, D. Tsukamoto, A. Masuda, Y. Tanaka, G. Kusano, *Chem. Pharm. Bull. (Tokyo)*. **2001**, *49*, 1362–1365.



on a pyrrolidine ring, with a long alkyl chain at position C-1 with different groups exhibited along the chain, like single or multiple hydroxyl groups, ketones and other heterocycles. On the other hand, radicamines do not contain a long aliphatic chain, but an aromatic group is directly connected to the pyrrolidine scaffold. The inhibitory activity of many of those compounds was examined against various glycosidases in comparison to **A11** (DNJ), **A12** (DMJ) and **A27** (DGJ).<sup>54</sup> While some of them are not active at all, many possess similar or higher activity than tested 1-deoxyiminosugars.

Batzellasides (**A40**, **A41**, **A42**) were isolated from a Madagascar *Batzella* sponge.<sup>55</sup> In contrast to previously mentioned compounds, their iminosugar scaffold is a piperidine, and due to their configuration, they are analogues of D-gulose or D-idose. It is impossible to distinguish any further, because of lacking hydroxyl group at position C-2. The only difference between those three molecules is the number of CH<sub>2</sub> group in alkyl chain at position C-1.

## 2. The medical interest behind iminosugar-C-glycosides

The diversity of iminosugar-C-glycosides is opening new possibilities for the discovery of selective inhibitors of carbohydrate-processing enzymes. Their potential applications are centred around an antiviral activity, LSD, cancer and control of glucose absorption.

In many reported cases, it is possible to compare the activity of iminosugar-C-glycosides with *N*-substituted 1-deoxyiminosugars or other glycosyl analogues. One of the best examples are the analogues of galactosphingolipid  $\beta$ -GalCer (**A43**) modulating its interactions with gp120, which is very important for HIV infectivity (Figure 10).<sup>56,57</sup> Several analogues of **A43** with simplified side-chain were prepared: *N*-alkylated iminosugars (**A44**, **A45**), C-glycosyl compound (**A46**) and iminosugar-C-glycoside (**A47**). The binding between those molecules and gp120 was measured as the change in the surface pressure ( $\Delta\pi_i$ ) versus initial surface pressure ( $\pi_i$ ) at the air-water interface of the glycolipid monolayer, on the exposure to an aqueous solution of recombinant gp120. **A44**, which is *N*-heptadecyl DNJ, and **A46** showed

---

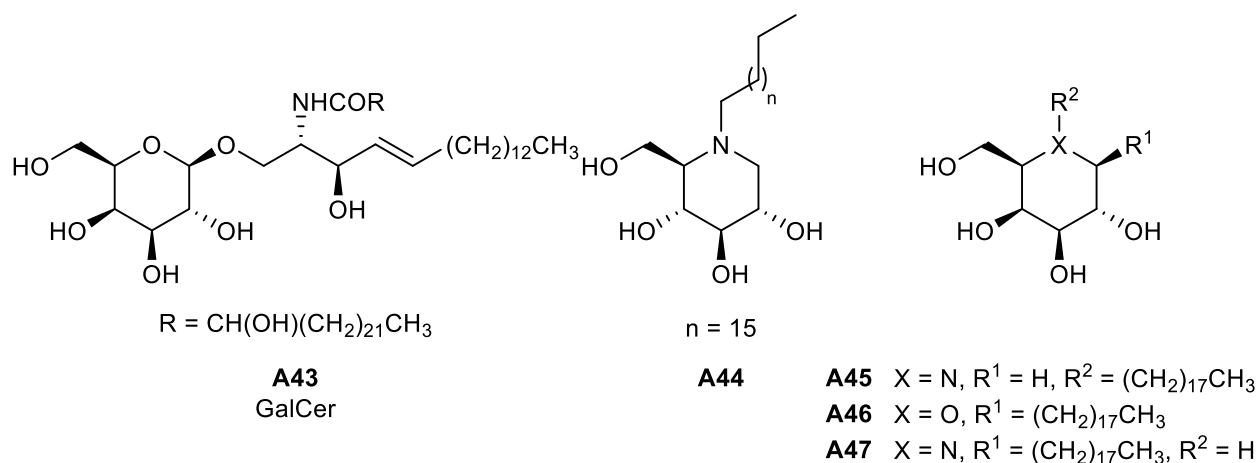
<sup>54</sup> M. Shibano, D. Tsukamoto, G. Kusano, *Heterocycles* **2002**, *57*, 1539–1553.

<sup>55</sup> N. L. Graves, P. Crews, *J. Nat. Prod.* **2005**, *68*, 118–121.

<sup>56</sup> K. T. Weber, D. Hammache, J. Fantini, B. Ganem, *Bioorg. Med. Chem. Lett.* **2000**, *10*, 1011–1014.

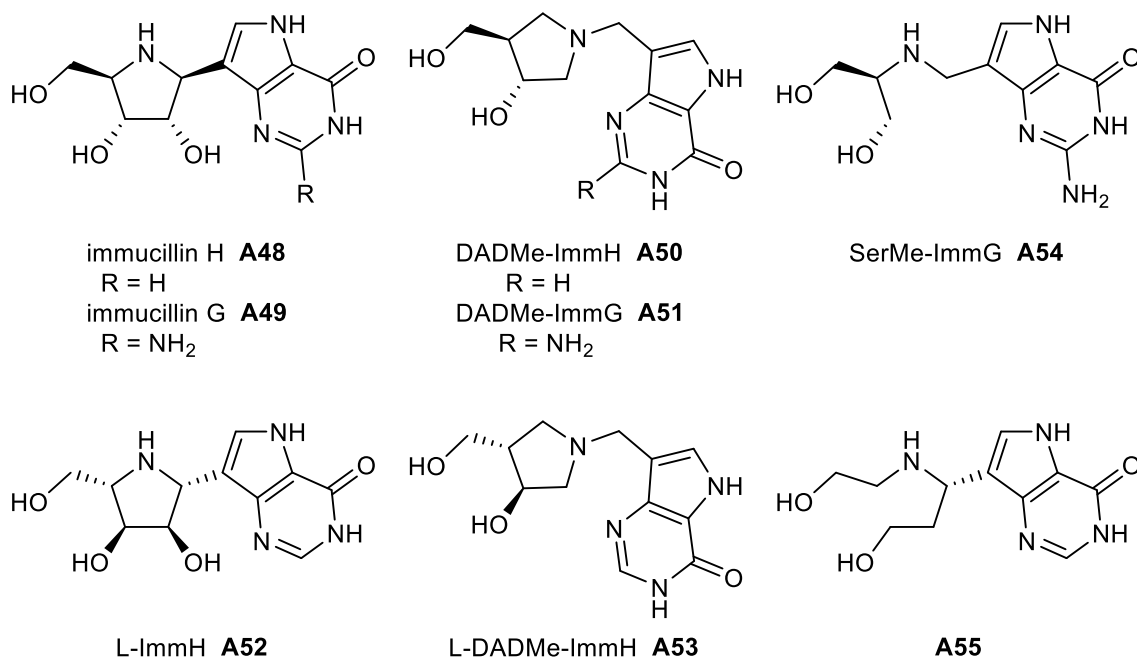
<sup>57</sup> L. A. Augustin, J. Fantini, D. R. Mootoo, *Bioorg. Med. Chem.* **2006**, *14*, 1182–1188.

specific affinity to gp120 similar to **A43**. On the other hand, **A45** displayed less affinity than native galactosphingolipid. In contrast to **A45**, the results for  $\beta$ -1-C-heptadecyl DGJ **A47** were even better than for **A43**.



**Figure 10.**  $\beta$ -GalCer **A43** and its analogues.

Another group of molecules, called immucillins, was vastly investigated. They are not only imino-C-glycosides but also belong to the purine nucleoside analogues. Looking at the structures, they can be divided into three generations (Figure 11).



**Figure 11.** Immucillins.

Among all the compounds, immucillin H (ImmH, Forodesine, **A48**) shines the most. It is a very potent inhibitor of purine nucleoside phosphorylase (PNP) with a picomolar range of activity.

It was conceived by the extensive studies of the PNP transition state structure (Schramm *et al.*) and synthesised for the first time in 1998 by Tyler and coworkers (application for the patent in 1998, patent release in 1999); its remarkable activity against PNP was also published in 1998.<sup>58,59</sup> In the beginning, **A48** was developed and introduced by BioCryst Pharmaceuticals. Recently, in the form of Forodesine hydrochloride, it successfully passed the clinical trials and now is applied to the treatment of relapsed/refractory peripheral T-cell lymphoma. It is available in Japan under trade name Mundesine® produced by Mundipharma K.K. The 9-deaza guanine analogue of **A48** (Immucillin G, ImmG, **A49**) was prepared at the same time. Both molecules belong to the first generation of immucillins.

**A50** and **A51** were prepared as analogues of **A48** and **A49**.<sup>60</sup> In both cases, the  $K_i$  values for human PNP are lower than for parent immucillins.<sup>61</sup> Also, L-analogues **A52** and **A53** were prepared and examined.<sup>62</sup> For both molecules, the values of  $K_i$  were much higher than D-enantiomers. All those molecules are part of the second generation of immucillins.

The third generation consists of the highest number of molecules with most diversified structures; they lack pyrrolidine as the iminosugar scaffold (like **A54** and **A55**).<sup>63</sup> They are either secondary or tertiary amines with various number of hydroxyl groups (starting from one up to four) with 9-deazaguanine or 9-deazahypoxanthine moieties. A few examples can be found in Figure 11.

This further highlights the importance of these molecules as potential therapeutic agents, as well as the need for stereoselective and stereocontrolled synthetic pathways.

---

<sup>58</sup> R. W. Miles, P. C. Tyler, R. H. Furneaux, C. K. Bagdassarian, V. L. Schramm, *Biochemistry* **1998**, *37*, 8615–8621.

<sup>59</sup> R. H. Furneaux, P. C. Tyler, V. L. Schramm **1999-2000**, WO 00/61783

<sup>60</sup> G. B. Evans, R. H. Furneaux, A. Lewandowicz, V. L. Schramm, P. C. Tyler, *J. Med. Chem.* **2003**, *46*, 5271–5276.

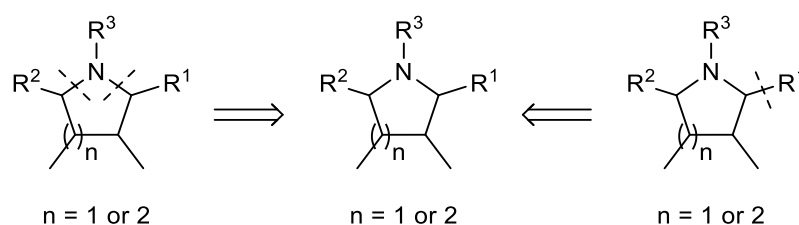
<sup>61</sup> E. A. Taylor, K. Clinch, P. M. Kelly, L. Li, G. B. Evans, P. C. Tyler, V. L. Schramm, *J. Am. Chem. Soc.* **2007**, *129*, 1126–1143.

<sup>62</sup> K. Clinch, G. B. Evans, G. W. J. Fleet, R. H. Furneaux, S. W. Johnson, D. H. Lenz, S. P. H. Mee, P. R. Rands, V. L. Schramm, E. A. Taylor Ringia, et al., *Org. Biomol. Chem.* **2006**, *4*, 1131–1139.

<sup>63</sup> K. Clinch, G. B. Evans, R. F. G. Fröhlich, R. H. Furneaux, P. M. Kelly, L. Legentil, A. S. Murkin, L. Li, V. L. Schramm, P. C. Tyler, et al., *J. Med. Chem.* **2009**, *52*, 1126–1143.

### 3. Synthetic approaches to iminosugar-C-glycosides

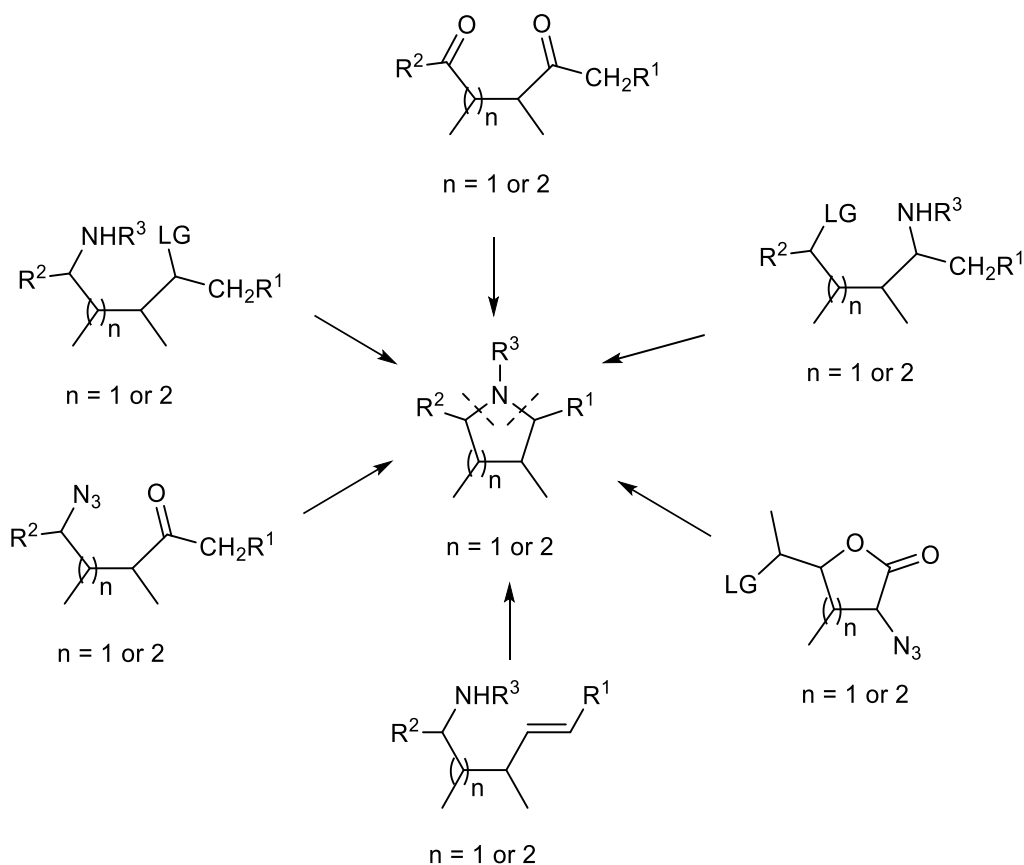
It is almost 40 years since the first publication launched the synthesis of iminosugar-C-glycosides and that time was not wasted. Thanks to creative thinking, many methodologies for the synthesis of these molecules were developed (Scheme 2).<sup>64</sup> Almost all the available synthetic pathways can be divided into two groups, which are centred on an intramolecular cyclisation (Scheme 3) or an electrophilic iminosugar donor (Scheme 4). Many methods from those two groups can be applied to both pyrrolidine and piperidine series. However, there are some methodologies unique to either of them. There are also quite a few examples of total synthesis of iminosugar-C-glycosides from non-sugar starting materials.



**Scheme 2.** General approaches for the synthesis of imino-C-glycosides.

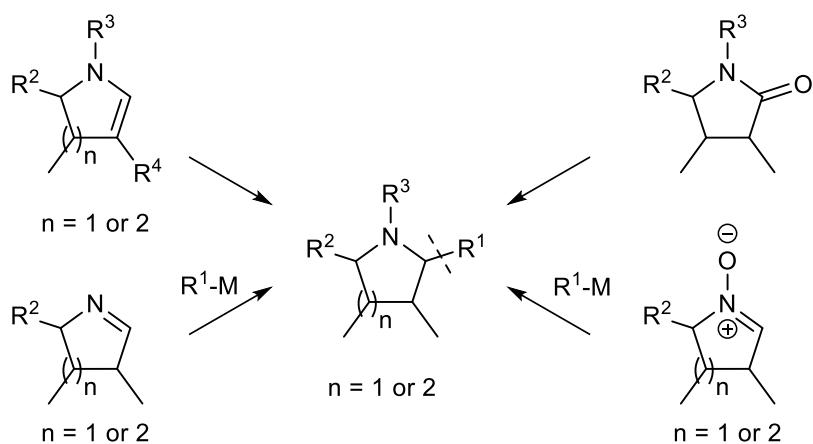
In the group of intramolecular cyclisation, several types of reaction exist. There are methods focused on cyclisation of C-1 to nitrogen or C-4/C-5 to nitrogen – this is dependent on which ring is formed. In case of pyrrolidine it is C-4 to N, and for the piperidine – C-5 to N. The methodologies are based on the prior introduction of nitrogen through amine or azide followed by cyclisation. There is also a particular case of cyclisation – double reductive amination. For this approach, both functions at C-1 and C-4/C-5 are used; it is applied when the starting compound is a diketone. The nitrogen atom needed to close the ring is introduced during the reaction as an external amine (for example, *N*-benzylamine).

<sup>64</sup> P. Compain, V. Chagnault, O. R. Martin, *Tetrahedron: Asymmetry* **2009**, *20*, 672–711.



**Scheme 3.** Intramolecular cyclisation.

The second group of reaction is focused around the creation of a C–C bond between the iminosugar scaffold and the aglycone part. It can be achieved through different types of addition of a nucleophile to an electrophile, like for example an imine, nitron, a double bond and many more. The great challenge of this type of methodologies is the stereochemical control of freshly formed chiral centre at C-1.



**Scheme 4.** Iminosugar acting as electrophiles.

In the beginning, the synthetic approach described in this thesis is related to the strategy developed by Nicotra<sup>65,66</sup>, which will be described in more details in the next part of my general introduction. However, instead of directly forming a C-C bond by the addition of organometallic reagents to glycosylamines, we introduce the tributyltin group at C-1. After cyclisation, it yields very interesting intermediates – 1-C-stannylated iminosugars, which act as nucleophilic species in transition-metal catalyzed C-C bond formation; this constitutes a novel methodology for the preparation of iminosugar-C-glycosides.

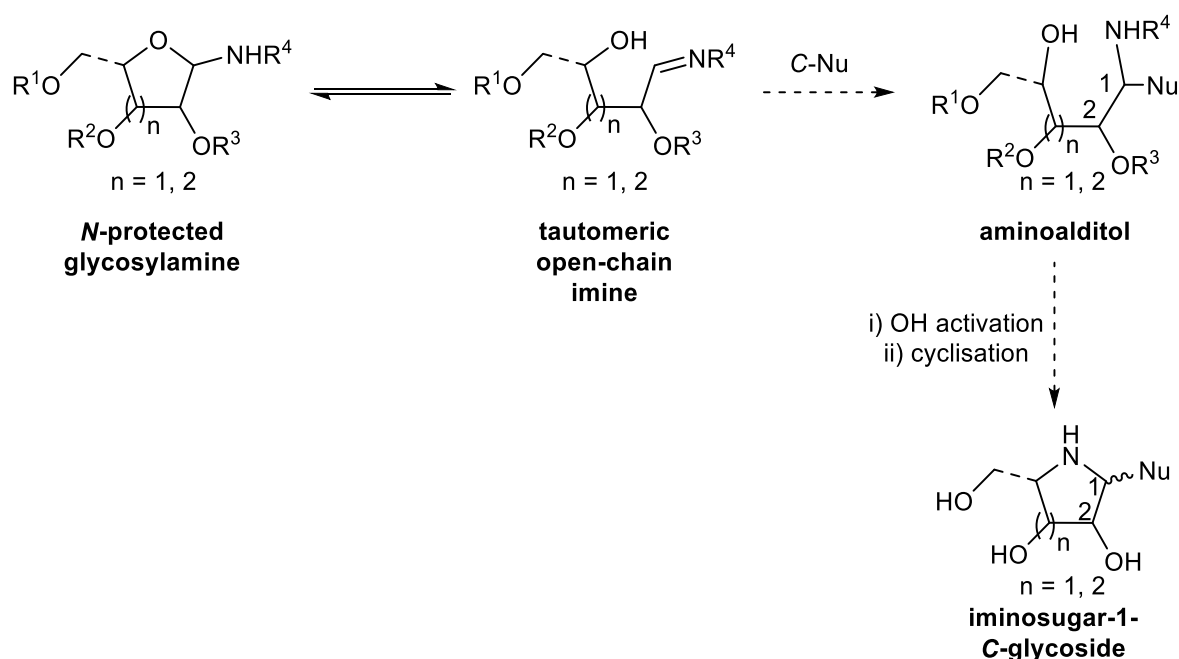
---

<sup>65</sup> L. Lay, F. Nicotra, A. Paganini, C. Pangrazio, L. Panza, *Tetrahedron Lett.* **1993**, *34*, 4555–4558.

<sup>66</sup> L. Cipolla, L. Lay, F. Nicotra, C. Pangrazio, L. Panza, *Tetrahedron* **1995**, *51*, 4679–4690.

### III. Glycosylamines

Glycosylamine is the name of sugars carrying an amino group at C-1. They are *N*-analogues of *O*-glycosides. They exhibit properties similar to the sugars, like mutarotation.<sup>67</sup> The tautomeric form between pseudo- $\alpha$  and pseudo- $\beta$  cyclic furanosylamine or pyranosylamine is an open-chain imine, and this gives an excellent opportunity for the addition of a nucleophile to form an aminoalditol, which can be further cyclised and deprotected to furnish iminosugar-*C*-glycosides (Scheme 5). The most challenging part of this methodology is the control of the stereochemistry of the newly formed chiral centre. Fortunately, some factors allow manipulating the levels of stereoselectivity; also, in general, the addition step is characterised by excellent yields.



**Scheme 5.** Addition of nucleophile to glycosylamines.

This methodology was developed for the first time by Nicotra and coworkers.<sup>65,66</sup> They presented the addition of Grignard reagents to *N*-benzylated and *N*-alkylated glycosylamines in furanose and pyranose series followed by simple cyclisation upon treatment with triflic anhydride to afford 1-*C*-substituted pyrrolidines and piperidines respectively (Scheme 6).

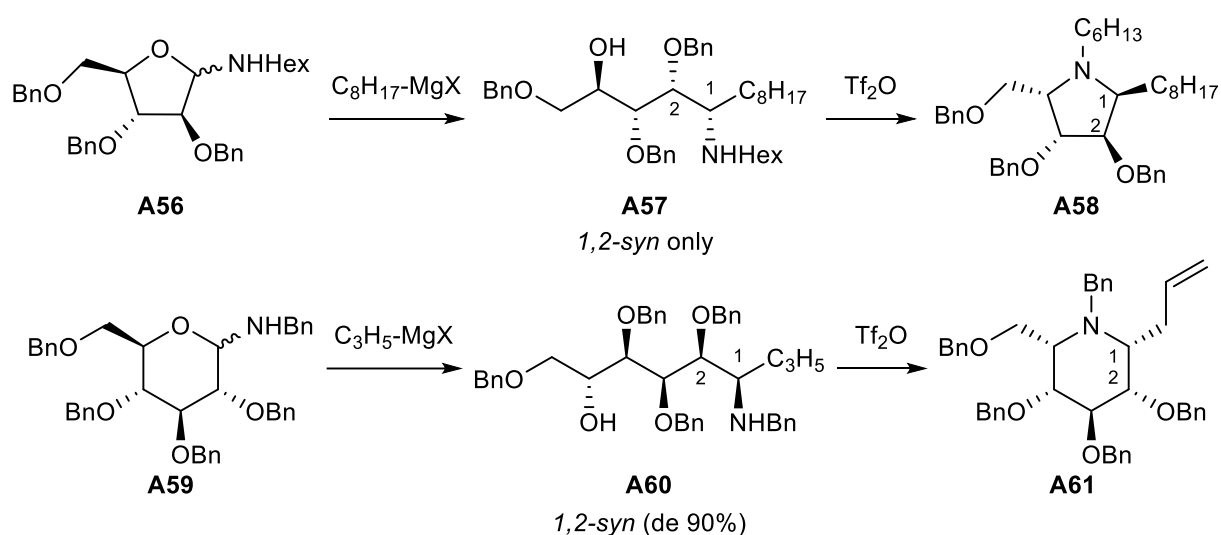
<sup>65</sup> L. Lay, F. Nicotra, A. Paganini, C. Pangrazio, L. Panza, *Tetrahedron Lett.* **1993**, 34, 4555–4558.

<sup>66</sup> L. Cipolla, L. Lay, F. Nicotra, C. Pangrazio, L. Panza, *Tetrahedron* **1995**, 51, 4679–4690.

<sup>67</sup> H. S. Isbell, H. L. Frush, *J. Org. Chem.* **1958**, 23, 1309–1319.

The cyclisation of secondary alcohol by way of a triflate leads to the inversion of the configuration at this position. Hence, the D-arabinofuranose yields L-xylofuranose and by default – D-glucopyranose becomes L-idopyranose after cyclisation. One always has to be mindful about the configuration of the starting material and desired compound. Alternative cyclisation methods might be applied to avoid inversion of the configuration at position C-4 or C-5, like oxidation to the ketone followed by intramolecular reductive amination, which in most cases highly favours axial hydride delivery.

The addition of *n*-hexylmagnesium bromide and allylmagnesium bromide is giving exclusively or principally 1,2-*syn* configuration, which becomes 1,2-*cis* after the cyclisation. It seems that C-2 configuration and the protecting group at this position has a large impact on the mechanism and therefore, the stereochemistry of the addition step. The explanation of this behaviour is the formation of a Cram chelate<sup>68</sup> that leads to the formation of a 1,2-*syn* configuration.



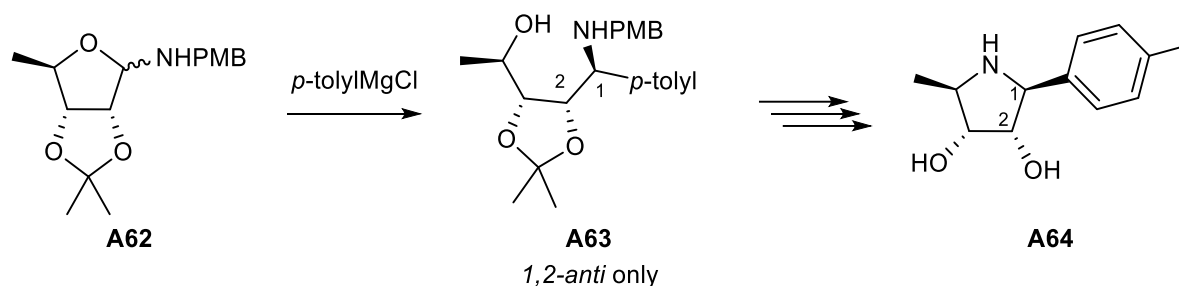
**Scheme 6.** Methodology of Nicotra.

There were a few published reactions of Grignard reagents that gave the 1,2-*anti* configuration.<sup>69</sup> This outcome is mostly observed when the starting material is protected by a 2,3-*O*-isopropylidene, instead of *O*-benzyl group like in previous cases (Scheme 7). Unfortunately, since this protection group requires relative configuration of C-2 and C-3 to be *cis*, so it is not a universal method.

<sup>68</sup> D. J. Cram, F. A. A. Elhafez, *J. Am. Chem. Soc.* **1952**, *74*, 5828–5835.

<sup>69</sup> A. Kotland, F. Accadbled, K. Robeyns, J.-B. Behr, *J. Org. Chem.* **2011**, *76*, 4094–4098.





**Scheme 7.** Addition of Grignard's reagents with the 1,2-*anti* outcome.

The Grignard reagents are not the only type of nucleophiles that were added to glycosylamines, many more were tested, like various organolithium reagents, alkynyl anions through copper, silicon, zinc reagents.<sup>70,71</sup> Also, different protecting groups for the imine were tested, as well as the formation of glycosylamine *in situ* followed by direct addition. The possibilities offered by glycosylamines were in-depth reviewed by Behr and Plantier-Royon in 2006<sup>70</sup> and later, by Nicolas and Martin in 2018.<sup>71</sup>

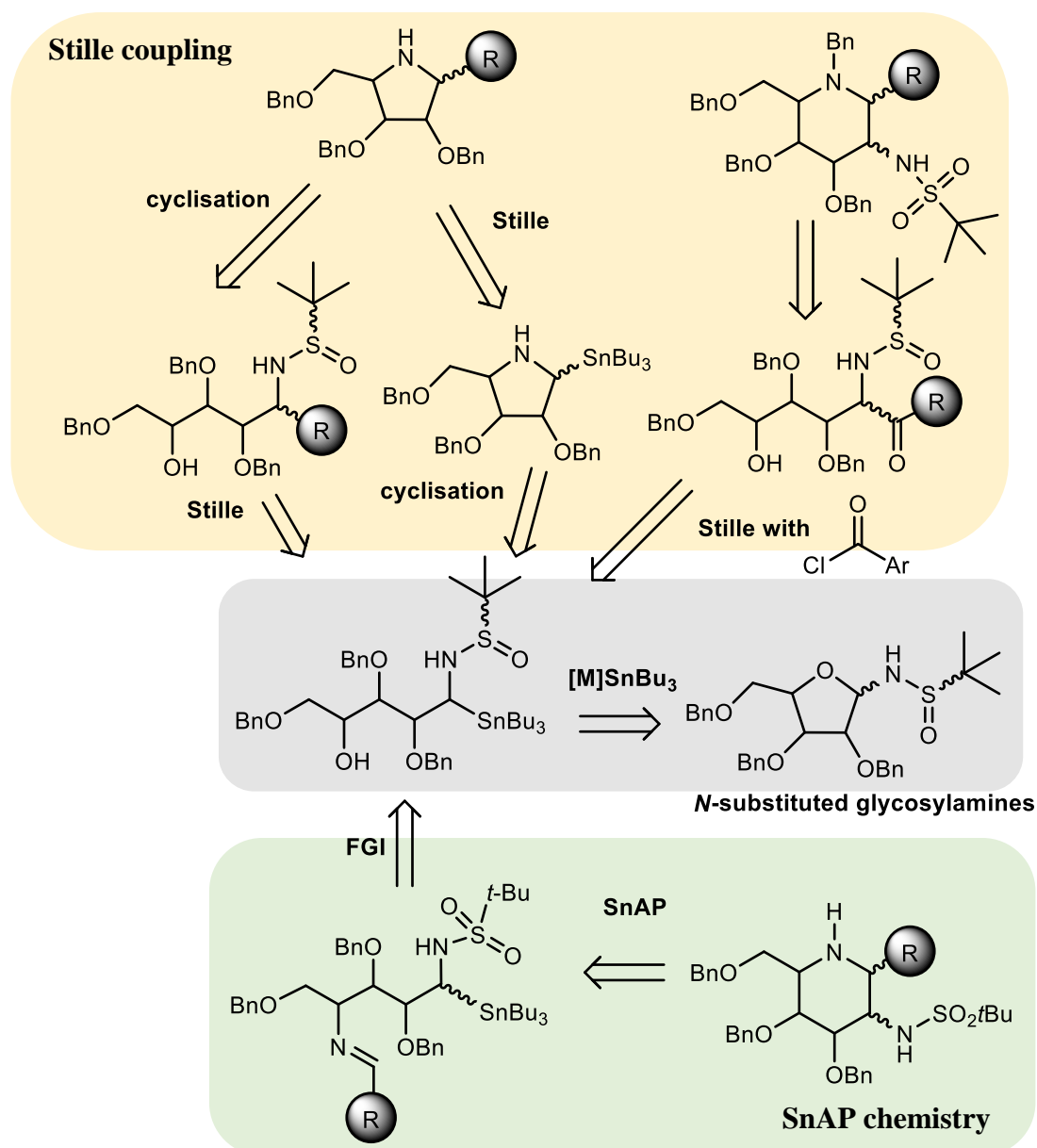
Overall, the synthesis of imino-*C*-glycosides via the glycosylamines is a very effective method. Most of the time, the stereochemical outcome of addition to the imine is directed by the sugar. However, could we take control over the addition step to gain access to both stereoisomers by introducing a chiral auxiliary in the starting material? This obstacle to tuneable synthesis was one of the goals in our team. The progress in this field will be further described in the introduction of Chapter 1.

<sup>70</sup> J.-B. Behr, R. Plantier-Royon, *Recent Res. Dev. Org. Chem.* **2006**, *10*, 1–30.

<sup>71</sup> C. Nicolas, O. R. Martin, *Molecules* **2018**, *23*, 1612–1642.

## IV. Objectives

The purpose of this work is thus to develop an efficient, tuneable and stereocontrolled methodology to access imino-*C*-glycosides with precisely defined configuration by way of stannylated aminoalditols. The latter are very interesting intermediates providing opportunities for the application of Stille coupling and the implementation of SnAP chemistry (Scheme 8). The entire project can be divided into the focused goals listed below.



**Scheme 8.** General objectives.

(**FGI** – functional group interconversion)

The entire work is concentrated on *N-tert*-butanesulfinylglycosylamines as the key substrates. Their synthesis, developed in our team, is characterised by good yields, but there is still room for improvements. That is why the first objective will be to optimise the preparation of *N-tert*-butanesulfinylglycosylamines and to develop an efficient protocol for the synthesis of the stannylated aminoalditols (Chapter 1).

The second aim is to explore the possibility of performing the Stille coupling on the open-chain compounds, followed by the cyclisation of the molecules to obtain iminosugar-*C*-glycosides or 2-aminoiminosugars (2-AminoIminoSugars, 2-AImS), in case the carbohydrate chain is prolonged by one or more carbon atom (case of acyl groups) (Chapter 2).

The third objective will be the cyclisation of the stannylated aminoalditols into 1-stannylated iminosugar, perform extensive NMR studies of their configuration and determine the mechanism of the addition of tributyltin lithium, as well as investigate the Stille coupling and analyse the final compounds (Chapter 3).

“SnAP” stands for Tin-Amine Protocol, and it is a handy methodology developed by the group of Prof. Jeffrey W. Bode from ETH Zürich to synthesise pharmaceutically valuable *N*-heterocycles. Our fourth goal is to apply their copper-mediated cyclisation of organotin compounds into piperidine derivatives to our highly chiral system. It would result in yet another way to obtain iminosugars substituted with an amino group at the position C-2 (2-AminoIminoSugars, 2-AImS) and carrying a 1-*C*-substituent (Chapter 4).

## V. Summary of the introduction and objectives *in french*

Les iminosucres sont une classe de glycomimétiques dans lesquels un azote remplace l'atome d'oxygène endocyclique. Ces molécules ont une activité envers un large éventail d'enzymes qui agissent sur les glucides et leur puissance en tant qu'inhibiteur est le résultat de leur structure. En effet, aux pH physiologiques, l'azote est protoné et forme le cation ammonium qui ressemble à l'ion oxocarbénium, intermédiaire dans de nombreux processus enzymatiques affectant les glycosides. Grâce à cela, ces petits mimétiques de glucides peuvent occuper le site actif de l'enzyme et rivaliser avec le substrat naturel.

Malheureusement, la fonction *N,O*-acétal des iminoglycosides est labile aux pH neutres et acides, ce qui complique leur synthèse et leur isolement, tout en limitant considérablement les applications potentielles de ces molécules en tant que médicaments.

Une façon de stabiliser la structure des iminoglycosides consiste à créer une liaison C–C reliant l'iminosucre et la partie aglycone en remplaçant l'atome d'oxygène glycosidique par un groupement méthylène. Ce groupe particulier d'iminosucres s'appelle les iminosucre-*C*-glycosides, ce sont des cibles synthétiques attrayantes qui peuvent néanmoins être présente dans la nature.

La préparation de ces molécules procède suivant différentes approches. L'approche synthétique choisie dans cette thèse est similaire à la stratégie développée par Nicotra. Elle est basée sur l'ajout d'un réactif organolithien sur des glycosylamines, suivie d'une cyclisation pour obtenir un iminosucre-*C*-glycoside.

L'objectif de ce travail est de développer une méthodologie efficace, paramétrable et stéréocontrôlée, permettant d'accéder facilement aux imino-*C*-glycosides de configuration définie ainsi que des iminosucres et aminoalditols stannylés, comme intermédiaires très intéressants pour l'application au couplage de Stille et à la chimie SnAP (Schéma 8). L'ensemble du projet peut être divisé en plusieurs objectifs qui sont énumérés ci-dessous.

Le projet est centré autour des *N-tert*-butanesulfinylglycosylamines et l'ajout de *n*-Bu<sub>3</sub>SnLi. La réaction de préparation des *N-tert*-butanesulfinylglycosylamines développée dans notre équipe est caractérisée par de bons rendements, mais des améliorations sont encore possibles. C'est pourquoi le premier objectif sera d'optimiser la synthèse de ces substrats et de développer un protocole efficace pour la synthèse des aminoalditols stannylés (Chapitre 1).

Le deuxième objectif est d'explorer la possibilité d'effectuer un couplage de Stille des composés à chaîne ouverte, suivi de la cyclisation des molécules pour obtenir des C-glycosides de 2-amino-imosucres (2-AImS), lorsque la chaîne glucidique est prolongée d'au moins un carbone. (Chapitre 2).

Le troisième objectif est la cyclisation des aminoalditols stannylés en iminosucre-1-tributylstannanes, la réalisation d'études approfondies en RMN de leur configuration et du mécanisme d'addition de  $\text{Bu}_3\text{SnLi}$ , ainsi que la caractérisation des composés finaux obtenus lors du couplage de Stille (Chapitre 3).

SnAP signifie Tin-Amine Protocol. Il s'agit d'une méthodologie pratique mise au point par le groupe du professeur Jeffrey W. Bode de l'ETH Zürich pour la synthèse de N-hétérocycles présentant un intérêt pharmaceutique. Notre quatrième objectif est d'appliquer cette méthode de cyclisation à nos composés et ainsi synthétiser des 2-AImS par une autre voie (Chapitre 4).



# Chapter 1

---





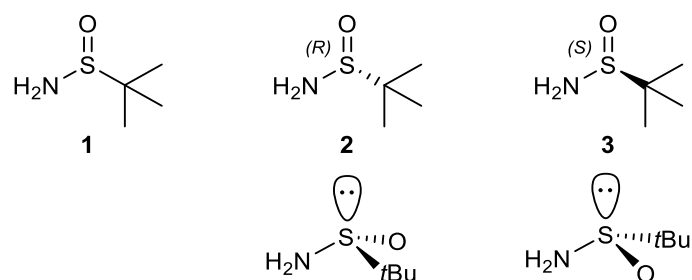
## I. Introduction

Stereoselective methods can be divided into asymmetric organic synthesis, chiral pool and chiral resolution methods. They have provided potent tools in obtaining stereoisomerically pure compounds, be it natural products or potential or marketed drugs. Because the biological activity of stereoisomers is different, the role of stereoselective synthesis is vital in the field of pharmaceuticals. The addition of the Grignard reagents to sulfinylglycosylamines mentioned in the general introduction (Scheme 6 and Scheme 7) is an example of the application of the chiral pool methodology.

In past years, our team made significant progress in the field of stereocontrolled addition. The technique is based on the use of chiral auxiliaries. These are chiral groups incorporated into the starting material to affect the stereochemistry of the reaction directly. They also exist under a different name – chiral handles. After the handle has served its purpose, it is cleaved. The primary drawback of auxiliaries is the additional two steps to the synthesis – installation and removal of the chiral handle. In the ideal case, both of those reactions should be simple and give high yields.

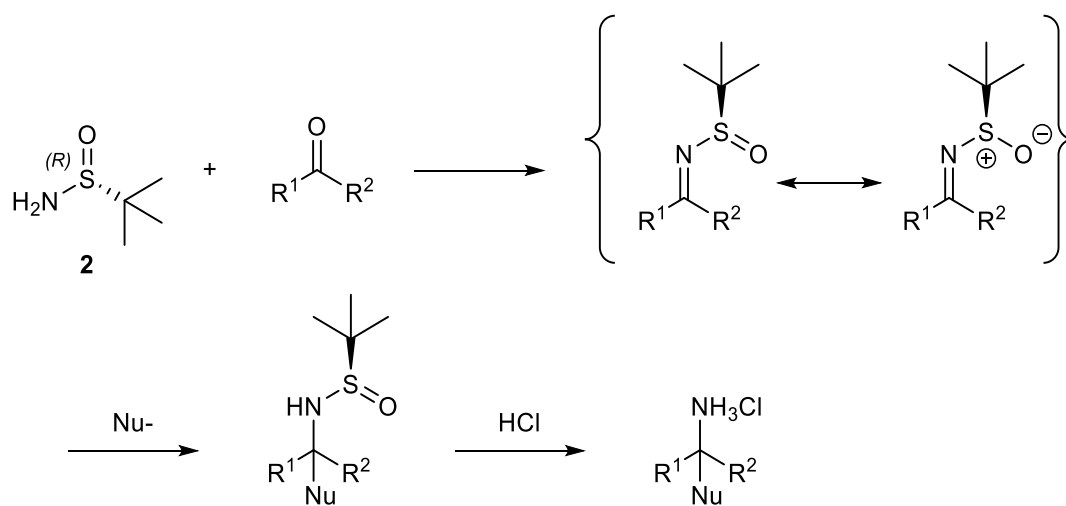
At the same time, because every starting material used is a carbohydrate characterised with multiple chiral centres, our approach is also subjected to chiral substrate control. Introducing the chiral auxiliary creates double stereodifferentiating conditions, and, as a result, match and mismatch situations are generated. ‘Match’ is happening when both factors – chiral auxiliary and the sugar – are directing the nucleophile into the same orientation, leading to the same configuration. This usually results in high dr values of the reaction. On the other hand, when these two elements are guiding the nucleophile towards opposite configurations, we call it ‘mismatch’. Our goal is to find conditions in which the effect of the chiral auxiliary would be dominant, in such a way as to overcome the stereodirecting effect of the sugar moiety and identify conditions permitting the control of either configuration or the newly generated chiral centre.

## 1. *Tert*-butanesulfinamides – properties and applications



**Figure 12.** *Tert*-butanesulfinamides.

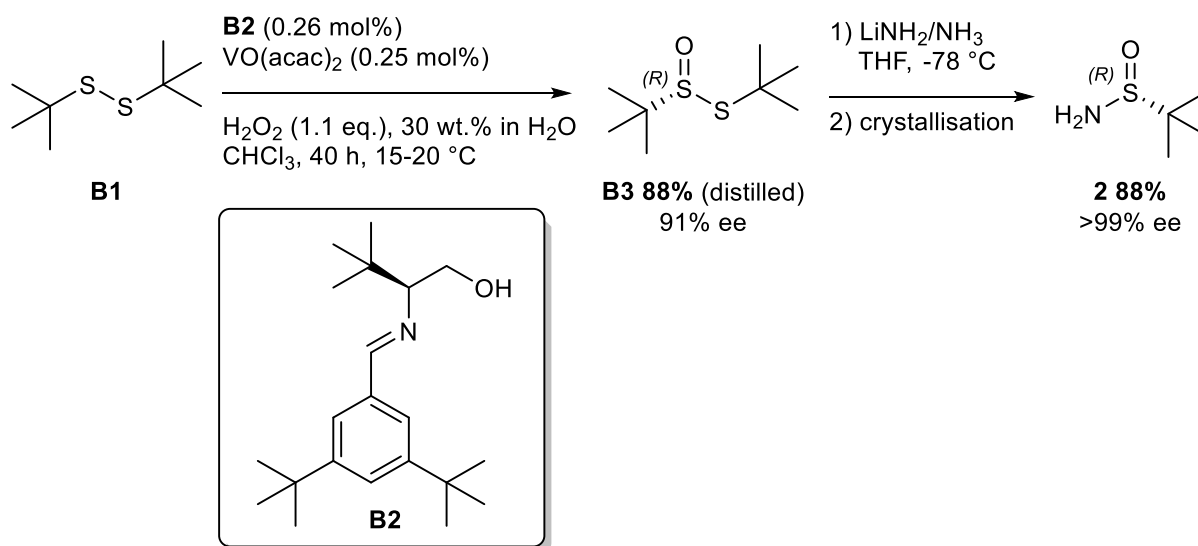
They are small chiral molecules, otherwise known as Ellman's bases (Figure 12) and it is our choice as the chiral auxiliary. The chirality is the result of the tetrahedral structure of the sulphur atom, with four different substituents including the free electron pair located on the sulphur atom. This structure is stereostable and allow the isolation of enantiomers of a trivalent atom. *Tert*-butanesulfinamides possess several advantages and fill many criteria for the perfect chiral handle. Also, they facilitate the synthesis of amines from molecules containing carbonyl function (Scheme 9). The most critical steps are the formation of the imine and the addition of the nucleophile.



**Scheme 9.** Synthesis of amines via Ellman's base.

For starters, let us begin with the production procedure and the costs. The racemic mixture **1** is mentioned in the patent submitted by Chambers, Matassa and Fletcher in the year 1994.<sup>72</sup> For the first time, the synthesis of enantiopure compound **2** was presented by Ellman and coworkers in the year 1997.<sup>73</sup> They were inspired by the work of Davis on the reactivity of *p*-toluenesulfinimines.<sup>74</sup> The properties of this type of compounds are similar; they activate imine for the nucleophilic addition, provide diastereoselectivity and can be easily removed under acidic conditions. Moreover, it was shown before that a *tert*-butyl group in the synthesis of aziridines is more diastereoselective than a *p*-tolyl substituent. It will be discussed in greater detail later in this introduction.

The original synthesis consists of just two steps, and the great advantage of this method is the low cost of starting material **B1** (Scheme 10). *Tert*-butyl disulfide (**B1**) is an oil waste product. The first step is asymmetric oxidation of **B1** using low catalyst loading of Schiff base (**B2**)–vanadium catalyst complex. The reaction works with 98% of conversion (determined by GC) and 91% of enantiomeric excess (ee, determined by HPLC) and the product **B3** is distilled. The second step of the synthesis is the addition of lithium amide in ammonia. What is important is the inversion of the configuration of the final product **2**. Afterwards, **2** is purified by single recrystallisation (99% ee). Overall, the global yield of this synthesis is 68%.

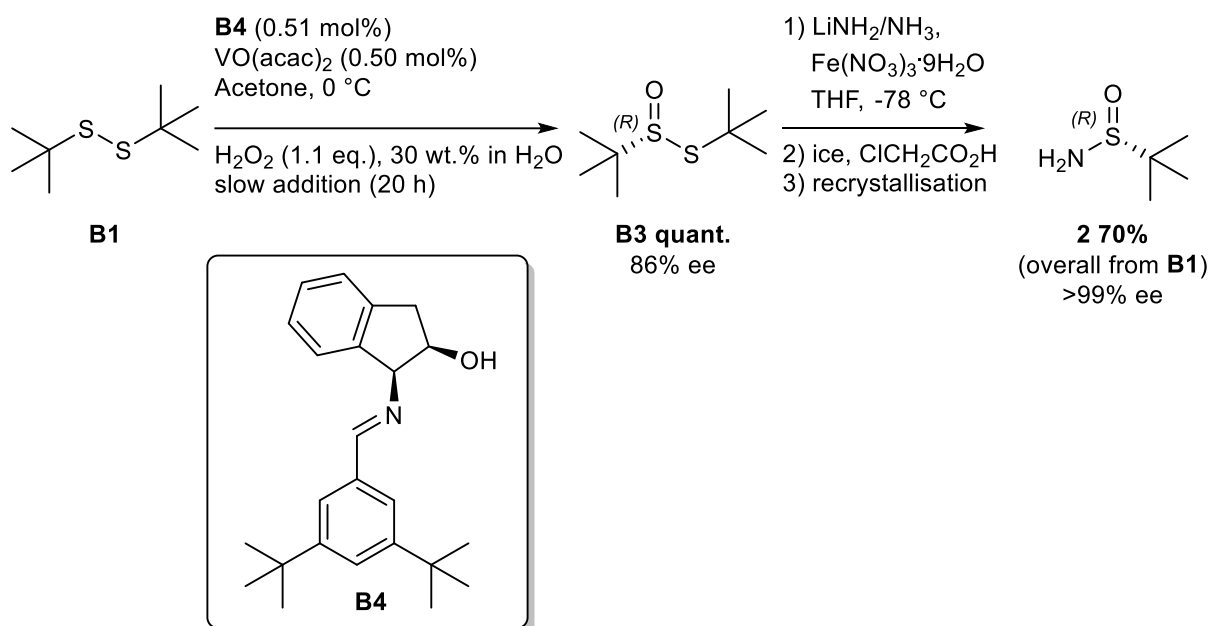


**Scheme 10.** First synthesis of **2**.

<sup>72</sup> M. S. Chambers, V. G. Matassa, S. R. Fletcher **1994** U.S. Patent Number 5,360,802.

<sup>73</sup> G. Liu, D. A. Cogan, J. A. Ellman, *J. Am. Chem. Soc.* **1997**, *119*, 9913–9914.

<sup>74</sup> F. A. Davis, R. E. Reddy, J. M. Szewczyk, P. S. Portonovo, *Tetrahedron Lett.* **1993**, *34*, 6229–6232.



**Scheme 11.** Industrial synthesis of **2**.

The synthesis of **2** was further optimised (Scheme 11).<sup>75</sup> One of the obstacles was using biphasic solvent (a mixture of H<sub>2</sub>O and CHCl<sub>3</sub>); it was quickly replaced by acetone. Also, the ligand for the oxidation was replaced by **B4**, thanks to this change the yield of the first step increased from 88% to quantitative value and, at the same time, maintaining similar levels of ee. High conversion value allowed the removal of the distillation process from the procedure – the second step is performed directly on the crude material. Overall, the global yield for this procedure is slightly higher (70%), but it is more customised for the industrial production of **2** on large scale, like ton scale synthesis (by Allychem Co.).

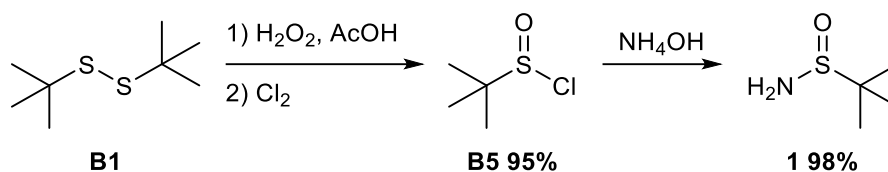
On the market, it can be bought as the racemic mixture or single enantiomer. One may think that the enantiomerically pure compound will be expensive, and this may hinder the application to large scale synthesis, but it is not the case with *tert*-butanesulfinamide due to the low price of starting material **B1**. Those reactions can be run on a multigram scale, and both enantiomers are accessible. Of course, not every synthesis needs the chiral reagent, that is why there is also an effective method (93% overall yield) to prepare the racemic mixture (Scheme 12).<sup>76</sup> The procedure used was developed by Netscher and Prinzbach<sup>77</sup> in 1987 to obtain compound **B5** and then followed by substitution with ammonium hydroxide to furnish racemic mixture **1**.

<sup>75</sup> D. J. Weix, J. A. Ellman, X. Wang, D. P. Curran, *Org. Synth.* **2005**, *82*, 157–165.

<sup>76</sup> D. A. Cogan, G. Liu, K. Kim, B. J. Backes, J. A. Ellman, *J. Am. Chem. Soc.* **1998**, *120*, 8011–8019.

<sup>77</sup> T. Netscher, H. Prinzbach, *Synthesis* **1987**, *8*, 683–688.

Usually, the price for **2** and **3** is around 1€ per 1 g of the compound, when buying in bulk. Besides, you should verify which enantiomer is inside the container by yourself. The best parameter is optical activity and measurement of specific rotation.

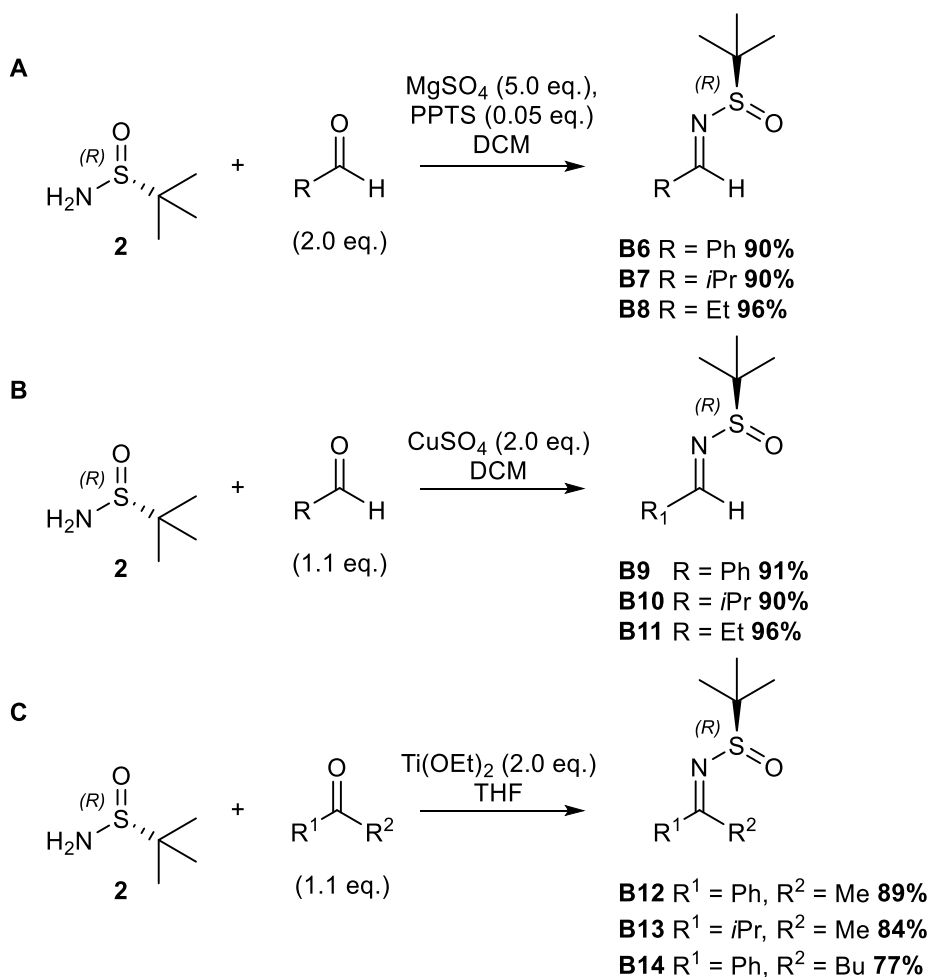


**Scheme 12.** Synthesis of a racemic mixture.

The *tert*-butanesulfinamides have more advantages than just low price. One of the crucial steps in the synthesis of amine is the formation of the imine. The methodology tolerates a wide variety of starting materials, be it simple aldehyde or ketone to more complicated molecules with different substituents and protecting groups. Most of the time, the imine might be formed through the direct condensation of the starting material with one of the *tert*-butanesulfinamides. In the first synthesis of this type, aldehyde (2-3 eq.) and MgSO<sub>4</sub> were used in excess in the presence of the acidic catalyst pyridinium *p*-toluenesulfonate (PPTS) in DCM (Scheme 13 A).<sup>73,78</sup> Moreover, there was no racemisation of the chiral auxiliary. Further studies have shown the positive impact of Lewis acid like CuSO<sub>4</sub> (Scheme 13 B) or in case of the synthesis of ketimines, Ti(OEt)<sub>4</sub> which acts as both Lewis acid and water scavenger (Scheme 13 C).<sup>78</sup> Formed imines are stable and less inclined to tautomerization than N-alkyl, N-aryl, N-acyl and N-carbonyl imines. Also, they are less prone to hydrolysis and most of the imines can be purified by silica flash gel column chromatography.

<sup>73</sup> G. Liu, D. A. Cogan, J. A. Ellman, *J. Am. Chem. Soc.* **1997**, *119*, 9913–9914.

<sup>78</sup> G. Liu, D. A. Cogan, T. D. Owens, T. P. Tang, J. A. Ellman, *J. Org. Chem.* **1999**, *64*, 1278–1284.



**Scheme 13.** Synthesis of *N*-*tert*-butanesulfinyl imines through direct condensation.

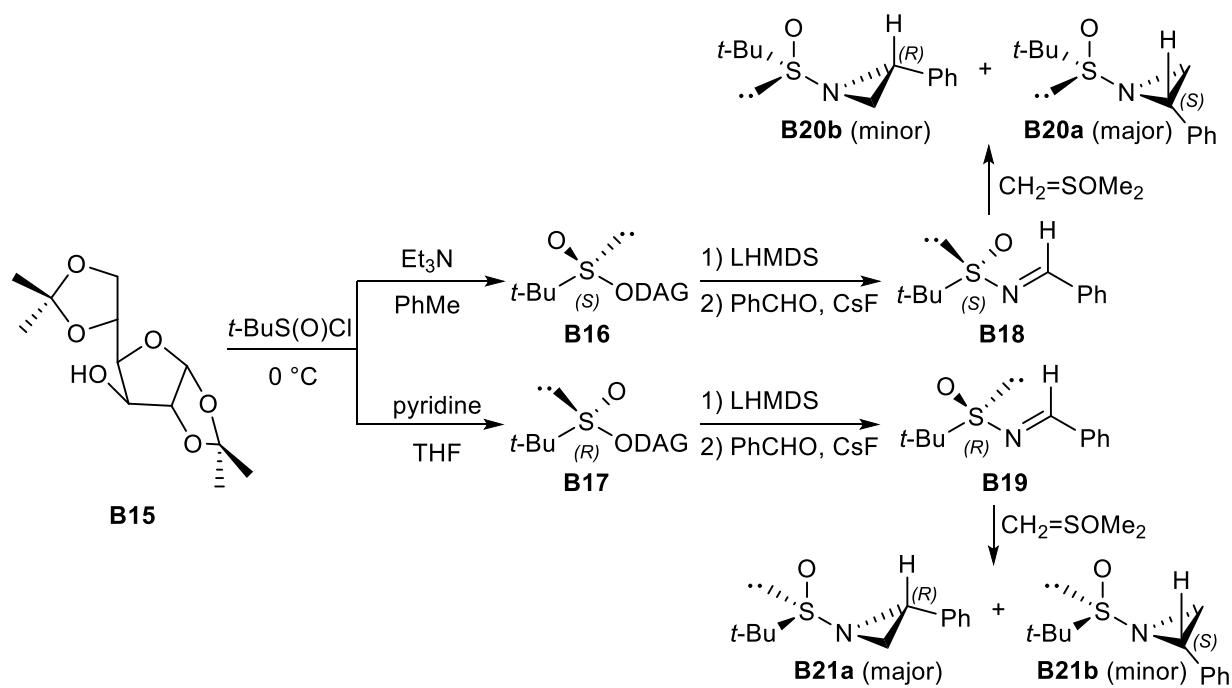
Since the first report by Ruano *et al.*<sup>79</sup> about the selectivity of *tert*-butanesulfinyl imine in the asymmetric aziridination (Scheme 14), the *tert*-butanesulfinyl group gained much interest as a directing group in stereoselective synthesis, but first let us see how all of this started. For the synthesis of the imine, the “DAG methodology” was applied. It was used before in the synthesis of optically pure sulfoxides.<sup>80</sup> In this procedure, diacetone glucose (DAG) **B15** reacts with *tert*-butanesulfinyl chloride to obtain *tert*-butanesulfinyl ester (**B16** and **B17**). Both epimers **B16** and **B17** can be formed depending on the solvent and the base used for the reaction. Afterwards, the methodology of Davis<sup>74</sup> was applied, the compounds were treated with lithium bis(trimethylsilyl)amide (hexamethyldisilazane lithium, LHMDS) to produce an amide *in situ*, which further reacted with an aldehyde resulting in the desired imines **B18** and **B19**. The

<sup>79</sup> J. García Ruano, I. Fernández, M. del Prado Catalina, A. A. Cruz, *Tetrahedron: Asymmetry* **1996**, *7*, 3407–3414.

<sup>80</sup> N. Khair, I. Fernández, F. Alcludia, *Tetrahedron Lett.* **1994**, *35*, 5719–5722.

<sup>74</sup> F. A. Davis, R. E. Reddy, J. M. Szewczyk, P. S. Portonovo, *Tetrahedron Lett.* **1993**, *34*, 6229–6232.

synthesis of desired aziridines (**B20** and **B21**) was achieved with dimethyloxosulphonium methylide. They compared the diastereomeric ratio measured for both epimers with a large *tert*-butanesulfinyl group (configuration of the aziridine carbon 2*S*:2*R* for **B20** 95:5, for **B21** 5:95) and, for derivative containing a *p*-toluene moiety (dr 2*S*:2*R* 73:27).<sup>77</sup>

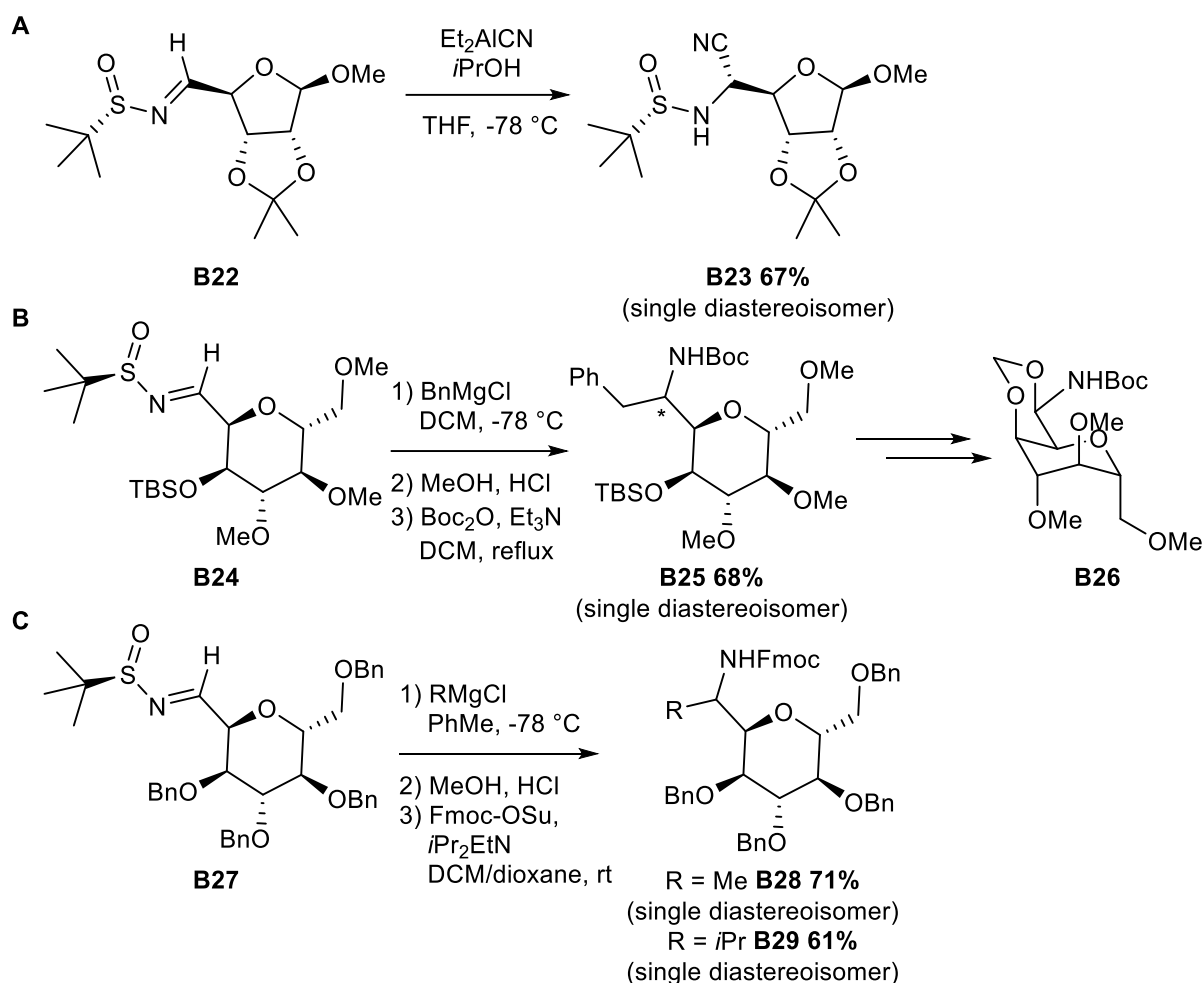


**Scheme 14.** Asymmetric aziridination.

All the facts mentioned above confirm the superiority of the *tert*-butanesulfinyl group as a perfect handle for stereoselective synthesis and up to now, there is an immense number of applications, which demonstrate the utility of this group. I would like to focus on the nucleophilic addition to imines and give a few examples illustrating the applications to the stereoselective addition in carbohydrates derivatives, as well as explain the proposed mechanisms for the addition step.

The *N-tert*-butanesulfinyl imines are very interesting intermediates due to the increased electrophilic character of the carbon-nitrogen double bond. It is activated, thanks to the partial positive charge on the sulphur. There are reports confirming the universal character of this auxiliary group in the addition reactions. The list of all the reported nucleophiles is long and diversified and include several carbon nucleophiles such as organo-magnesium, lithium, zinc and silicon reagents, as well as noncarbon nucleophiles derived from silicon, phosphorus and

tin derivatives. A few examples, where carbohydrates were used as the starting material, are listed below (Scheme 15).<sup>81,82,83</sup>



**Scheme 15.** Addition of nucleophiles to sugar-derived *tert*-butanesulfinyl imines.

In one instance (Scheme 15 A), the *tert*-butanesulfinyl group was used as the chiral auxiliary in the intermediate of the Strecker reaction to introduce a nitrile function.<sup>79</sup> The reaction worked well, and a single diastereoisomer was formed. The team aimed for the acidic hydrolysis of the nitrile and deprotection of two groups at the same time; unfortunately, the desired amino acid was not obtained.

The second presented reaction was published by Rech and Florencig (Scheme 15 B).<sup>80</sup> They proposed a new approach for the synthesis of an amido trioxadecalin ring, which is essential

<sup>81</sup> Y.-C. Luo, H.-H. Zhang, P.-F. Xu, *Synlett* **2009**, 2009, 833–837.

<sup>82</sup> J. C. Rech, P. E. Florencig, *Org. Lett.* **2003**, 5, 1495–1498.

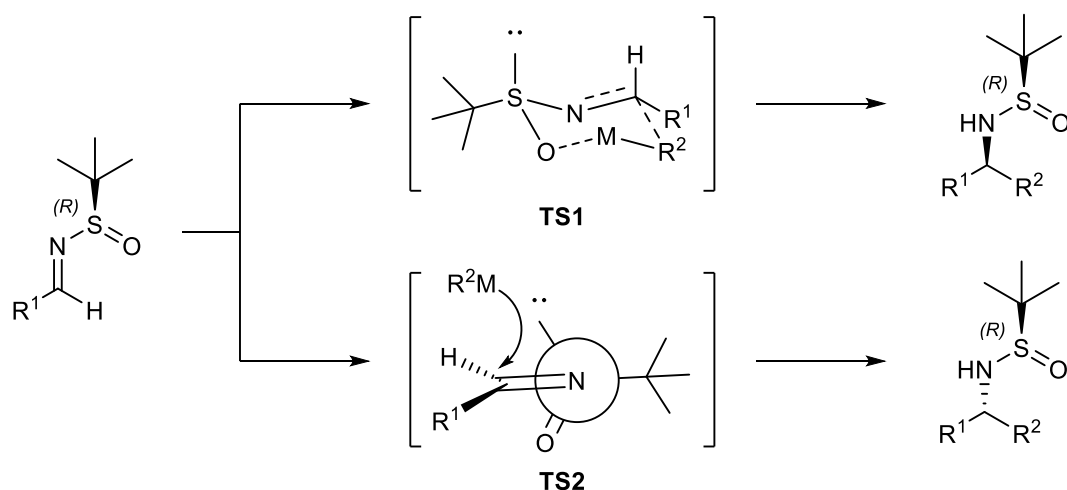
<sup>83</sup> M. Raunkjær, F. El Oualid, G. A. van der Marel, H. S. Overkleeft, M. Overhand, *Org. Lett.* **2004**, 6, 3167–3170.



part of anticancer and immunosuppressive agents isolated from natural sources, like mycalamides, theopederins or onnamides. They briefly commented on the addition of benzylmagnesium chloride: a single diastereoisomer was formed, followed by cleavage of the handle and re-protection with a carbamate. Regrettably, the configuration of the new centre was not determined.

The last but not least example of the utilisation of the *tert*-butanesulfinyl group within a carbohydrate moiety is given in Scheme 15 C.<sup>81</sup> The team of Overhand et al. presented the application of the addition of Grignard reagents towards the synthesis of alkylated sugar amino acids. All described reactions were diastereoselective. Compounds **B28** and **B29** were obtained in good yield after a sequence of three reactions: addition, cleavage and protection.

Unfortunately, in all these cases, either **2** or **3** was investigated, never both to evaluate the impact of the chiral auxiliary and the chiral substrate on the reaction.



**Scheme 16.** Models of the transition state for the stereoselective addition.

In order to explain the configuration of the final compounds, many studies were conducted. Most of the contribution to that field was work of Ellman,<sup>84</sup> Davis,<sup>85</sup> Pflum<sup>86</sup> and Plobeck.<sup>87</sup>

<sup>83</sup> M. Raunkjær, F. El Oualid, G. A. van der Marel, H. S. Overkleeft, M. Overhand, *Org. Lett.* **2004**, *6*, 3167–3170.

<sup>84</sup> D. A. Cogan, G. Liu, J. Ellman, *Tetrahedron* **1999**, *55*, 8883–8904.

<sup>85</sup> F. A. Davis, W. McCoull, *J. Org. Chem.* **1999**, *64*, 3396–3397.

<sup>86</sup> D. A. Pflum, D. Krishnamurthy, Z. Han, S. A. Wald, C. H. Senanayake, *Tetrahedron Lett.* **2002**, *43*, 923–926.

<sup>87</sup> N. Plobeck, D. Powell, *Tetrahedron: Asymmetry* **2002**, *13*, 303–310.

Multiple factors are affecting the addition step: nonetheless, two transition states were proposed to explain the outcome of the reaction: **TS1** and **TS2** (Scheme 16).

In the vast majority of the reaction, the addition of Grignard reagents is going through a six-membered ring transition state due to the chelation of magnesium – **TS1**. It was observed that this reaction is highly dependent on the solvent used. Diastereoisomeric ratio (dr) was high in the case of non-coordinating solvents, like DCM or toluene. On the contrary, dr values for the reaction performed in well-coordinating solvents (THF, Et<sub>2</sub>O) were rather low. The reason is that the solvent might compete for the coordination place and thus prevent the formation of **TS1**.

On the other hand, the addition of organolithium reagents to the same imine usually leads to another diastereoisomer. This result suggests that the addition of the lithium compounds goes through a different mechanism, and the open-chain **TS2** was proposed as an explanation of the configuration at the newly formed chiral centre. Also, the impact of numerous additives, mostly Lewis acids, was examined with different results; in some cases, their presence improves the conversion rates and dr, in others, the dr values and conversion are lower.

In addition to all the advantages mentioned above, the *tert*-butanesulfinamide group is very easy to cleave. This ‘protecting group’ will be removed rapidly under acidic conditions (MeOH-HCl). If the group is removed just right after the addition reaction, the cleavage is easy and straightforward with high yield. On the other hand, sometimes protection of the amine must be retained for several steps, and, in this case, one must be mindful of the nature of the steps following the addition, to avoid removing the group before the time is right.

For more information about the reactivity of *tert*-butanesulfinamides, I highly recommend the review by Robak, Herbage and Ellman from 2010.<sup>88</sup> It is a pervasive analysis of the applications of this chiral handle to organic synthesis.

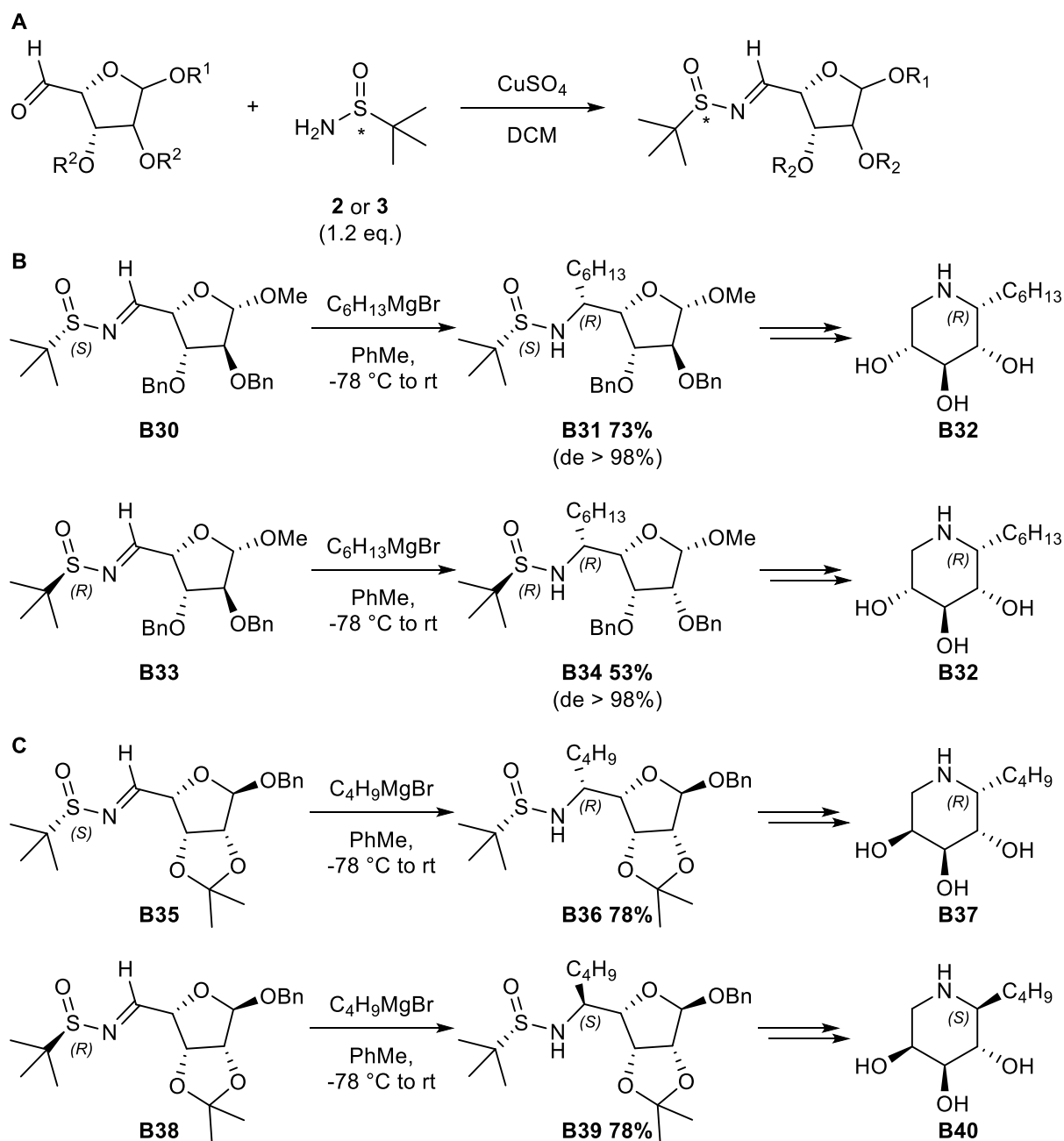
## 2. Research performed in our team

The main interest and research focus of our team has been since many years the synthesis of iminosugars. The adventure of our team with *tert*-butanesulfinamides started during the thesis

---

<sup>88</sup> M. T. Robak, M. A. Herbage, J. A. Ellman, *Chem. Rev.* **2010**, *110*, 3600–3740.

of Farah Oulaïdi. Her project was to develop efficient synthetic routes to access iminosugar-C-glycosides in order to evaluate them as potential pharmacological chaperones. To achieve this goal and make the synthesis stereoselective, she used *N-tert*-butanesulfinyl imines as the intermediates.<sup>89</sup>



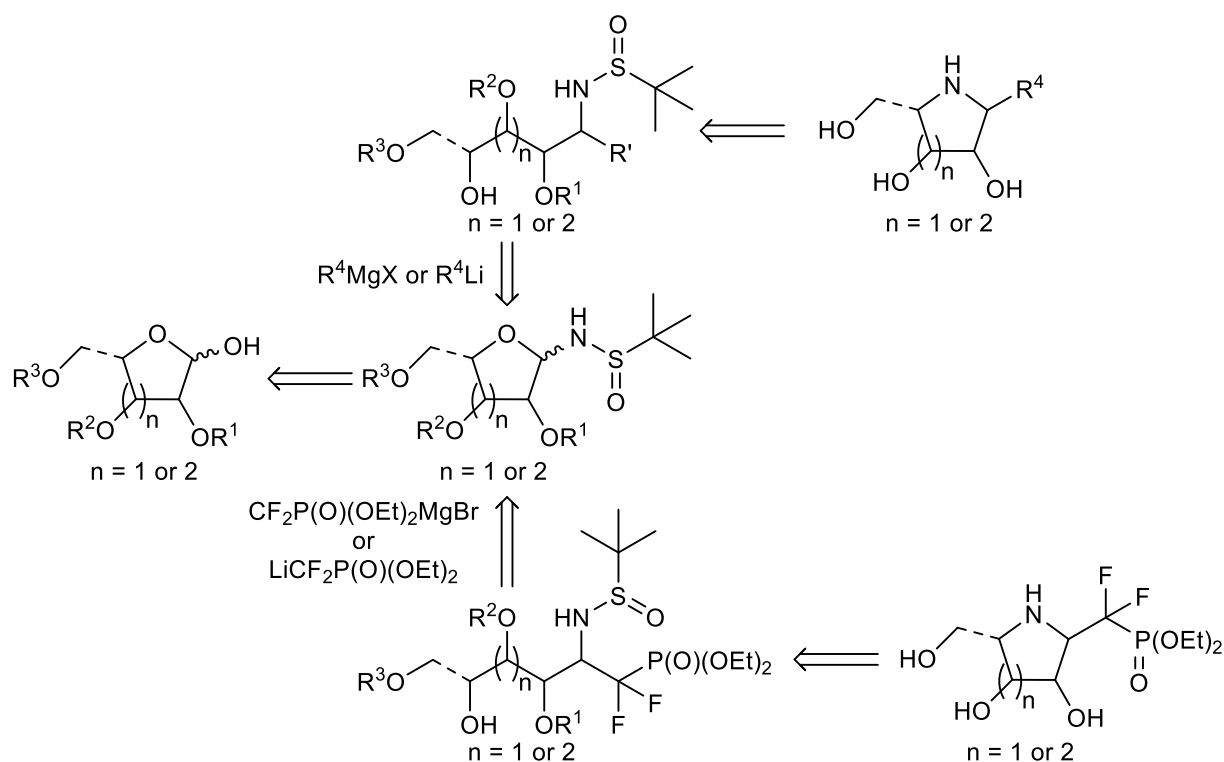
**Scheme 17.** Addition of RMgBr to *N-tert*-butanesulfinyl imines.

The primary objective was the installation of the *tert*-butanesulfinyl group at the position C-5 in pentofuranoses; it was achieved by the direct condensation of the corresponding aldehyde

<sup>89</sup> F. Oulaïdi, E. Gallienne, P. Compain, O. R. Martin, *Tetrahedron: Asymmetry* **2011**, 22, 609–612.

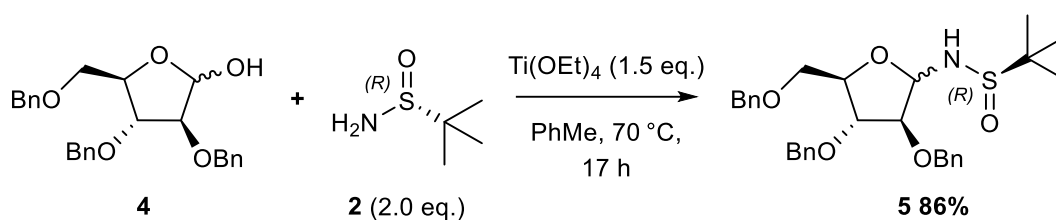
and the auxiliary in the presence of anhydrous  $\text{CuSO}_4$  in DCM with moderate to excellent yields (from 48% up to 77%) (Scheme 17 A).

The addition of Grignard reagents gave different results depending on the starting carbohydrate. In both cases, the reaction was performed with an excess of Grignard reagent (4.0 eq.) in toluene starting from  $-78\text{ }^\circ\text{C}$  to room temperature. In case of the L-xylofuranose carrying Bn groups (Scheme 17 B), for both configurations of the chiral handle (**B30** and **B33**), the same configuration was formed at the new chiral centre (**B31** and **B34**). After cyclisation to a piperidine, the same compound was obtained (**B32**). The sugar moiety is completely controlling the addition step. The same methodology was applied to L-xylofuranose carrying an isopropylidene protecting group (Scheme 17 C). In this case, the addition of butylmagnesium bromide was controlled by the auxiliary group and not by the sugar and two different diastereoisomers were formed. Both compounds **B36** and **B39** were cyclised in three steps to form unprotected, epimeric iminosugar-C-glycosides **B37** and **B40** respectively. The stereochemical outcome of the addition is difficult to predict due to the nature of the sugar substrates. Just by looking at those examples, more questions were posed. Does increasing the number of chiral centres in the molecule, which already possess multiple chiral centres, have an impact on the addition reaction? How to predict the outcome? How we can control it?



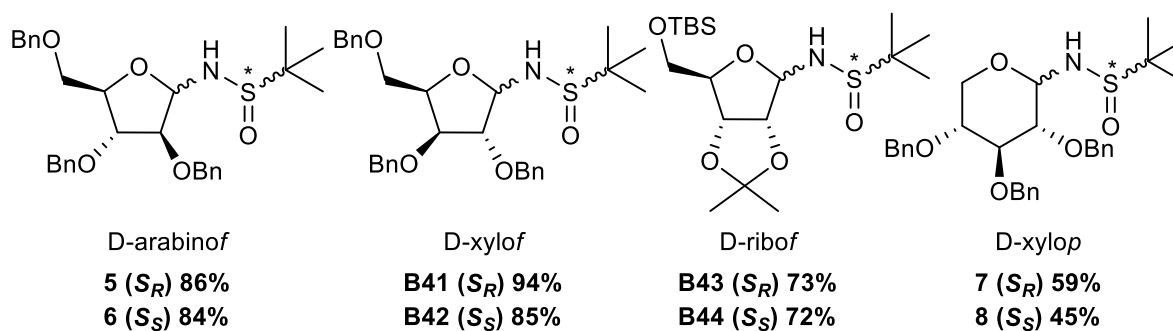
**Scheme 18.** Iminosugars as analogues of C-glycosides and glycosyl phosphates.

The importance of the *tert*-butanesulfinyl group was increased even further with the next PhD student and now dr Chloé Cocard. The thesis aimed to develop and evaluate the iminosugar analogues of *C*-glycosides and glycosyl phosphates (Scheme 18) starting from unprecedented *tert*-butanesulfinylglycosylamines. It was based on the methodology of Nicotra described in the General Introduction. The crucial step of this methodology is the formation of the *N*-*tert*-butanesulfinylglycosylamines. The reaction of tri-*O*-benzyl-D-arabinofuranose **4** with **2** was significantly optimised in terms of solvents, duration, temperature, stoichiometry and additives (Scheme 19).<sup>90</sup>



**Scheme 19.** Synthesis of *N*-*tert*-butanesulfinylglycosylamines in D-araf series.

The same conditions were applied to the synthesis with another epimer – (*S<sub>S</sub>*)-*tert*-butanesulfinamide **3** in the D-arabinofuranose series to give **6** in an excellent yield (84%) and also, different starting materials, like D-xylofuranose and D-ribofuranose (Figure 13). The yields for the pyranose series (**7** and **8**) were slightly lower than in furanose series.

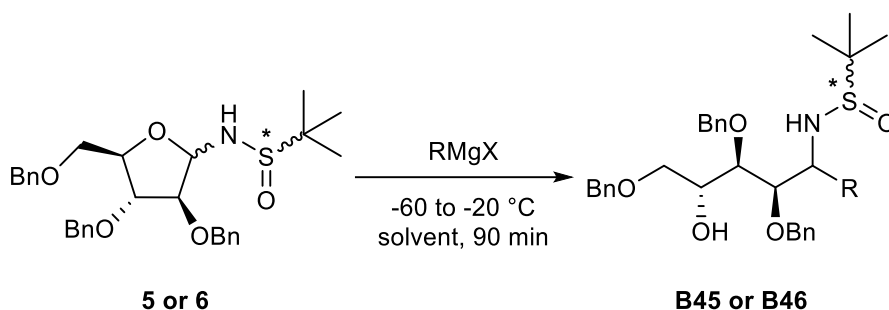


**Figure 13.** *N*-*tert*-butanesulfinylglycosylamines.

Another step of the exploration of the utility of those molecules was the addition of the Grignard reagents and further cyclisation – quick and convenient methodology to access iminosugar-*C*-glycosides (Scheme 20). To summarise the published results, the addition of organomagnesium reagents, in most cases, gave high yield with good dr values. It is possible

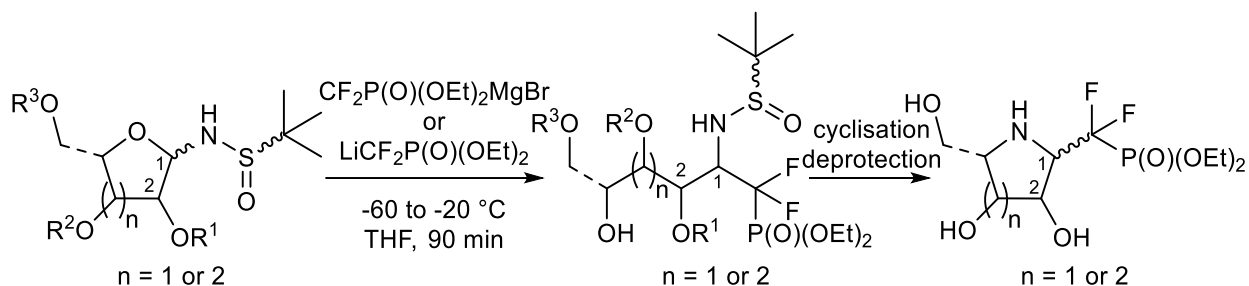
<sup>90</sup> C. Cocard, C. Nicolas, A. Bayle, T. Poisson, X. Pannecoucke, O. R. Martin, *Eur. J. Org. Chem.* **2015**, 2015, 4330–4334.

to further manipulate the dr values by the changes of additives and solvents. Unfortunately, there was little match and mismatch effects, and dr values for the addition to **5** and **6** were retained. It appears here that the stereodirecting effect of the sugar overrides that of the sulfinyl group.



**Scheme 20.** Addition of Grignard reagents to *N-tert*-butanesulfinylglycosylamines.

Another application for the *N-tert*-butanesulfinylglycosylamines was the synthesis of analogues of glycosyl phosphates with iminosugar scaffold by the addition of a difluoromethylphosphonate group as either lithium or magnesium reagents (Scheme 21).<sup>91</sup>



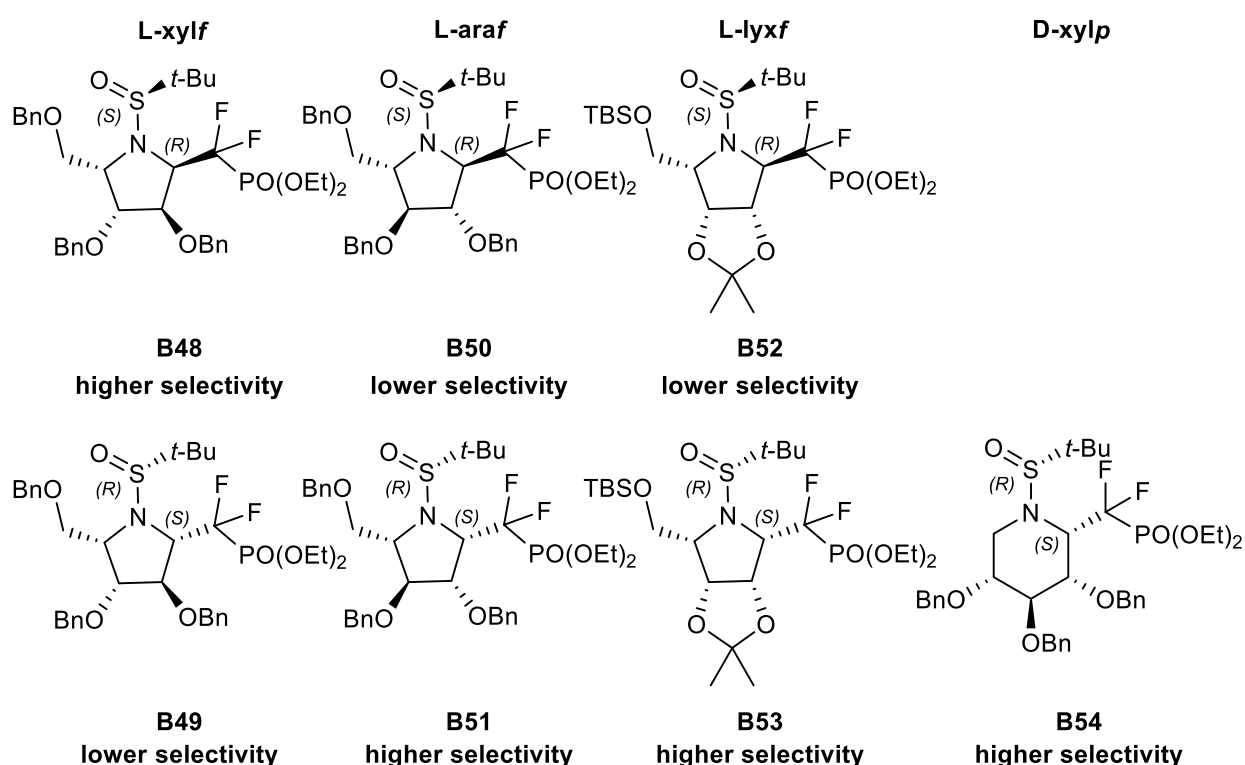
**Scheme 21.** Addition of  $M\text{-CF}_2\text{P(O)(OEt)}_2$ .

For some molecules, one procedure is better than the other in terms of dr values and yields (between 44% and 88%). It is worth to mention that in the case of organomagnesium reagent, it must be used in significant excess due to the lack of stability. In all cases, the configuration of the newly formed chiral centre is controlled mostly by the chiral handle. Inversion of dr is observed when the configuration of the auxiliary is changed, which shows the importance of the chiral handle for the addition process. As a rule, (*S<sub>S</sub>*)-glycosylamines give (*IR*)-(*S<sub>S</sub>*)-iminosugars and the reverse for (*S<sub>R</sub>*) derivatives. The dr values are ranging from 6:4 in the

<sup>91</sup> C. Cocard, C. Nicolas, T. Poisson, X. Pannecoucke, C. Y. Legault, O. R. Martin, *J. Org. Chem.* **2017**, *82*, 2753–2763.

worst case, up to utterly diastereoselective addition (dr 10:0). It is proof that both the *tert*-butanesulfinyl group and the sugar influence the addition.

After the cyclisation of open-chain aminoalditols, a simple but effective pattern emerged (Figure 14). When the C-2 of the molecule and configuration of the chiral handle are matching (in the representation shown), then favoured product of the addition is going to match them too with superior dr values. On the other hand, if those two configurations do not match, the configuration of the preferred product is going to match with the *tert*-butanesulfinyl group, but at the cost of selectivity – only moderate.

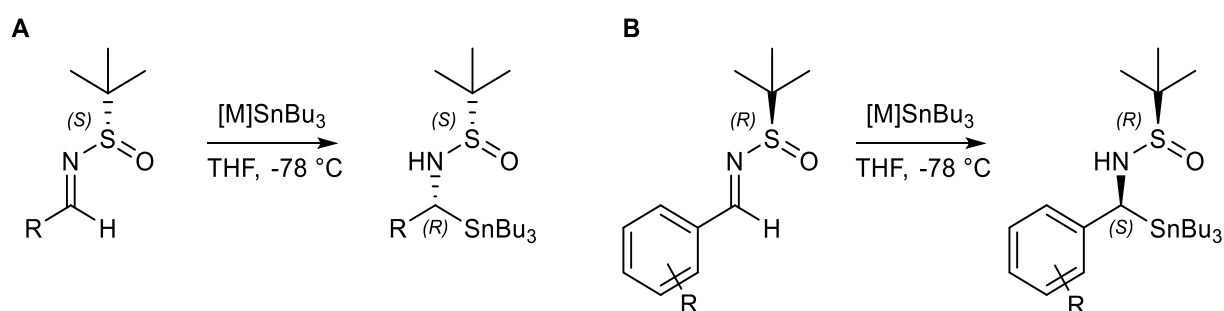


**Figure 14.** Pattern for the addition of  $M\text{-CF}_2\text{P(O)(OEt)}_2$ .

This methodology proved even further the great utility of *tert*-butanesulfinamides as chiral handles for the asymmetric/stereoselective synthesis. They are providing the selectivity for the nucleophilic addition and are compatible with many protecting groups. Their influence on the outcome of the reaction can be further modified with additives.

### 3. Addition of tin to the imines

One of the objectives of this thesis is the stereoselective synthesis of organotin derivatives starting from *N-tert*-butanesulfinylglycosylamines. This reaction was never performed on highly chiral starting materials, like glycosylamines. However, there are a few examples of addition of tributyltin lithium or tributyltin zinc reagents to simple, *N-tert*-butanesulfinyl imines (Scheme 22).<sup>92,93</sup>



**Scheme 22.** Synthesis of  $\alpha$ -amino organostannanes.

All the compounds were obtained as single diastereoisomers with excellent yields (Table 1). The addition works well with aliphatic imines (Entry 1 – 6) and electron-rich aromatic imines (Entry 7 – 10). For the aromatic imines with electron-withdrawing groups present in the ring (Entry 11 – 16), the dr values were lower. However, upon replacement of tributyltin lithium reagent with the organozinc derivative, the reactions gave only one diastereoisomer. It could suggest different mechanisms for the addition of those two organometallic reagents. In cases of both organometallic reagents, the same stereoisomer is formed as major or only product. Kells and Chong recommend the six-membered chair transition state (**TS3**), proposed by Ellman for the addition of the Grignard reagents, as the explanation of the stereochemistry of the addition process. However, perhaps with  $\text{LiSnBu}_3$  and substrate which possess electron-withdrawing groups competing single electron transfer reactions to give low stereoselectivity, no stereoselectivity or side reactions, while with substrates with electron-donating substituents or with  $\text{ZnEt}_2\text{LiSnBu}_3$  reactions occur exclusively via the ionic six-membered ring pathway. So, high diastereoselectivities are observed. They also presented that, after the addition of the tin, the *tert*-butanesulfinyl group might be easily replaced by a *N*-Boc group.

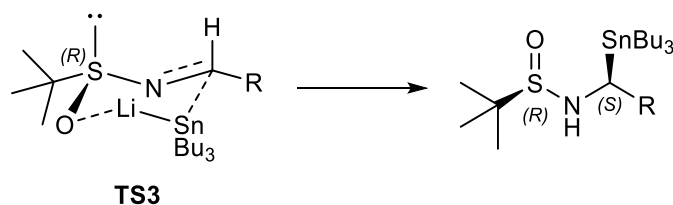
<sup>92</sup> K. W. Kells, J. M. Chong, *Org. Lett.* **2003**, *5*, 4215–4218.

<sup>93</sup> K. W. Kells, J. M. Chong, *J. Am. Chem. Soc.* **2004**, *126*, 15666–15667.

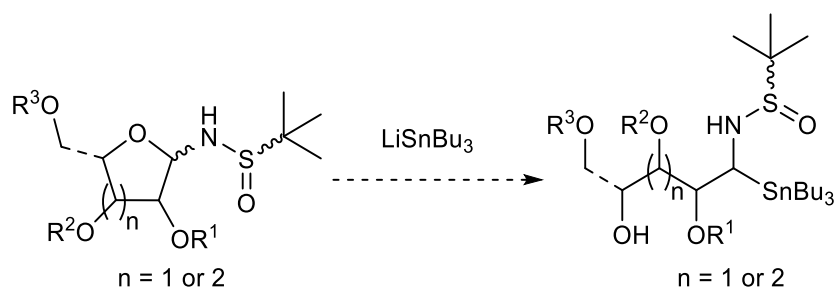


**Table 1.** Synthesis of  $\alpha$ -amino organostannanes according to Kells.<sup>92,93</sup>

Entry	Scheme 22	Auxiliary	R	[M]	Yield [%]	dr (R:S)
1	A	$S_S$	Me	Li	83	98.7:1.3
2	A	$S_S$	Et	Li	92	99.2:0.8
3	A	$S_S$	<i>i</i> -Pr	Li	96	99.3:0.7
4	A	$S_S$	<i>t</i> -Bu	Li	94	>99:1
5	A	$S_S$	C <sub>5</sub> H <sub>11</sub>	Li	84	>200:1
6	A	$S_S$	<i>c</i> -C <sub>6</sub> H <sub>11</sub>	Li	89	99.5:0.5
7	B	$S_R$	H	Li	73	1:>99
8	B	$S_R$	<i>p</i> -Me	Li	77	1:>99
9	B	$S_R$	<i>p</i> -OMe	Li	84	1:>99
10	B	$S_R$	<i>p</i> -NMe <sub>2</sub>	Li	91	1:>99
11	B	$S_R$	<i>p</i> -Cl	Li	80	27:73
12	B	$S_R$		ZnEt <sub>2</sub> Li	94	1:>99
13	B	$S_R$	<i>p</i> -Br	Li	25	50:50
14	B	$S_R$		ZnEt <sub>2</sub> Li	59	1:>99
15	B	$S_R$	<i>p</i> -CF <sub>3</sub>	Li	0	
16	B	$S_R$		ZnEt <sub>2</sub> Li	80	1:>99

**Scheme 23.** Transition state for the addition of LiSnBu<sub>3</sub>.

The first part of my project aims to combine those two highly useful methodologies: the synthesis of *N-tert*-butanesulfinylglycosylamines and the addition of tributyltin lithium reagent, to access very interesting intermediates – 1-stannylated aminoalditols (Scheme 24).

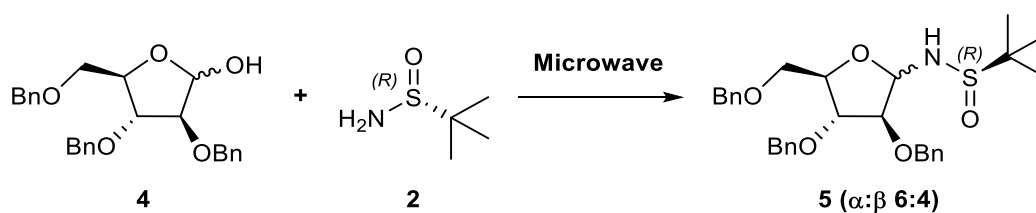


**Scheme 24.** Synthesis of 1-stannylated aminoalditols.

## II. Synthesis of *N-tert*-butanesulfinylglycosylamines

### 1. Microwave-assisted and flow chemistry-facilitated synthesis

The first step in the challenge set for Chapter 1 is the formation of *N-tert*-butanesulfinylglycosylamines. Although the reaction was developed and vastly optimised by Chloé Cocard (Scheme 19), we felt there is a room for more improvements in terms of yield, the reaction time and the number of equivalents of used compounds. With classical methods of organic synthesis essentially exhausted, our attention turned to innovative means. We considered that microwave-assisted organic synthesis with Biotage® Initiator+ and flow chemistry might significantly improve the method; both techniques are available just next door in one of the other teams working in the Institute.



**Scheme 25.** Synthesis of (*S<sub>R</sub>*)-*N-tert*-butanesulfinyl arabinofuranosylamine **5**.

Let us start with the microwave-assisted synthesis. Entire optimisation was performed using tri-*O*-benzyl-D-arabinofuranose **4** and enantiomerically pure (*S<sub>R</sub>*)-*tert*-butanesulfinamide **2** (Scheme 25, Table 2). Both compounds are commercially available and were purchased from Carbosynth. The optical activity of **2** was verified by measuring the specific rotation.

The first attempt was to try direct condensation between aldose **4** and chiral auxiliary **2** (Entry 1). It failed; the presence of Lewis acid is necessary for the formation of relevant glycosylamine.

Optimisation of reaction parameters: time – the optimal time is 90 min; for 45 minutes, starting material **4** was still present in the reaction mixture. Solvents; toluene gives better results than THF. The optimal temperature is 110 °C. Reactions run at 140 °C may be completed faster – in 10 or 20 minutes, depending on which drying reagent is used, but at the cost of the yield. It is almost 20% lower than the optimal conditions (Entry 5). The time of the reaction can be significantly reduced, but longer reaction time at higher temperature reduces the yield.

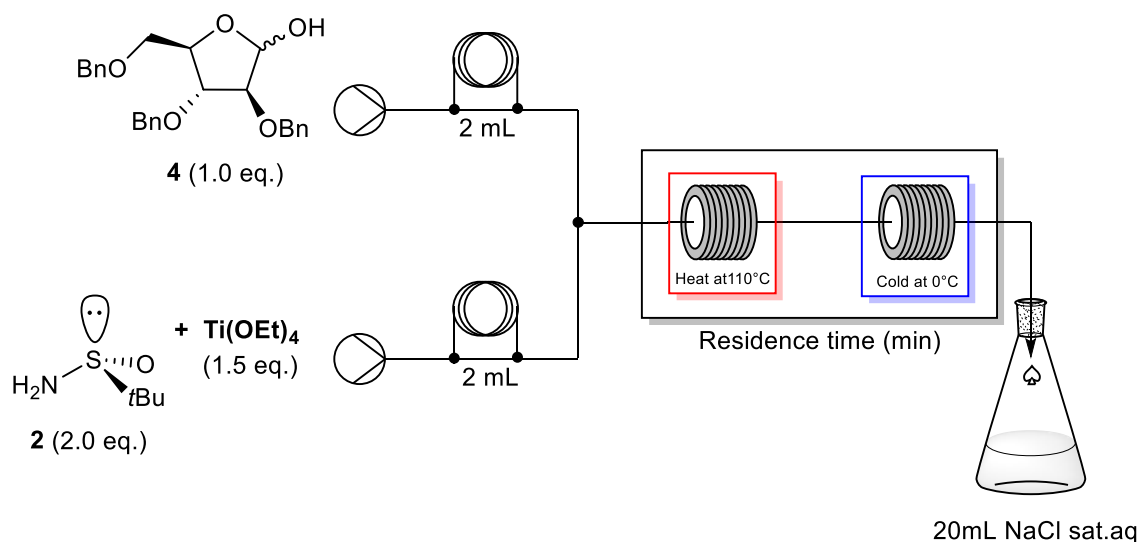
**Table 2.** Optimisation of the formation of **5** under microwave irradiation.

Entry	<b>1</b> (eq.)	Ti(OEt) <sub>4</sub> (eq.)	Drying reagent	Solvent	Temp. (°C)	Time (min)	Yield of <b>5</b> (%)
<b>1</b>	2.0	-	MS 4Å	PhMe	110	60	-
<b>2</b>	2.0	1.5	MS 4Å	PhMe	110	60	77
<b>3</b>	1.1	1.5	MS 4Å	PhMe	110	60	60
<b>4</b>	2.0	1.5	MS 4Å	PhMe	110	45	82
<b>5</b>	<b>2.0</b>	<b>1.5</b>	<b>MS 4Å</b>	<b>PhMe</b>	<b>110</b>	<b>90</b>	<b>93</b>
<b>6</b>	2.0	1.5	MS 4Å	THF	140	20	76
<b>7</b>	2.0	1.5	MgSO <sub>4</sub>	THF	140	10	74
<b>8</b>	2.0	1.5	MS 4Å	THF	140	10	62

After the optimisation, we can obtain the desired compound with better yield and in a much shorter time (90 min vs 17 h). The only downside of using microwave-assisted synthesis is the amount of material on which we can perform the reaction. It is limited to 2.5 g of **4** per tube in 15.0 mL of anhydrous toluene. This obstacle can be overcome by the application of an automatic sampler. It is an extension to the Biotage® Initiator+, which allows programming of several reactions one after another. Toluene is not the most receptive solvent for heating by the microwaves. For small quantities (up to 1 g), heating is not an issue, but for bigger loads (like a maximum of 2.5 g in 15.0 mL of toluene), it becomes a problem. The solution is simple and requires programming the gradual heating procedure (more details in the Experimental Part – General Procedures). After all reactions are finished, the contents of the tubes are combined for the work-up procedure followed by the silica gel flash column chromatography.

In collaboration with Maxime Neuville (Master student in S. Routier and F. Buron's team), the synthesis of **5** was performed with the application of flow chemistry (Figure 15). The reaction was optimised in terms of temperature and time in the reactor (Table 3). Nevertheless, the yields were inferior to both the classical and microwave-assisted syntheses, the best result being a yield of 65% while heating at 140 °C. One of the possible explanations might be that reaction in the flow set-up is performed in a semi-open environment. This reaction requires anhydrous conditions, but in the optimisation via flow chemistry, THF used was anhydrous

only at the beginning. It was placed in an open Erlenmeyer, and it readily absorbs water from the atmosphere. There is a possibility of precipitation of the titanium(IV) ethoxide in the tubing because of the presence of water in the solvent. In the system used, it was not possible to apply molecular sieves to keep the solvent anhydrous. One of the possible improvements would be to use THF over molecular sieves from a sealed bottle under argon atmosphere via syringe.

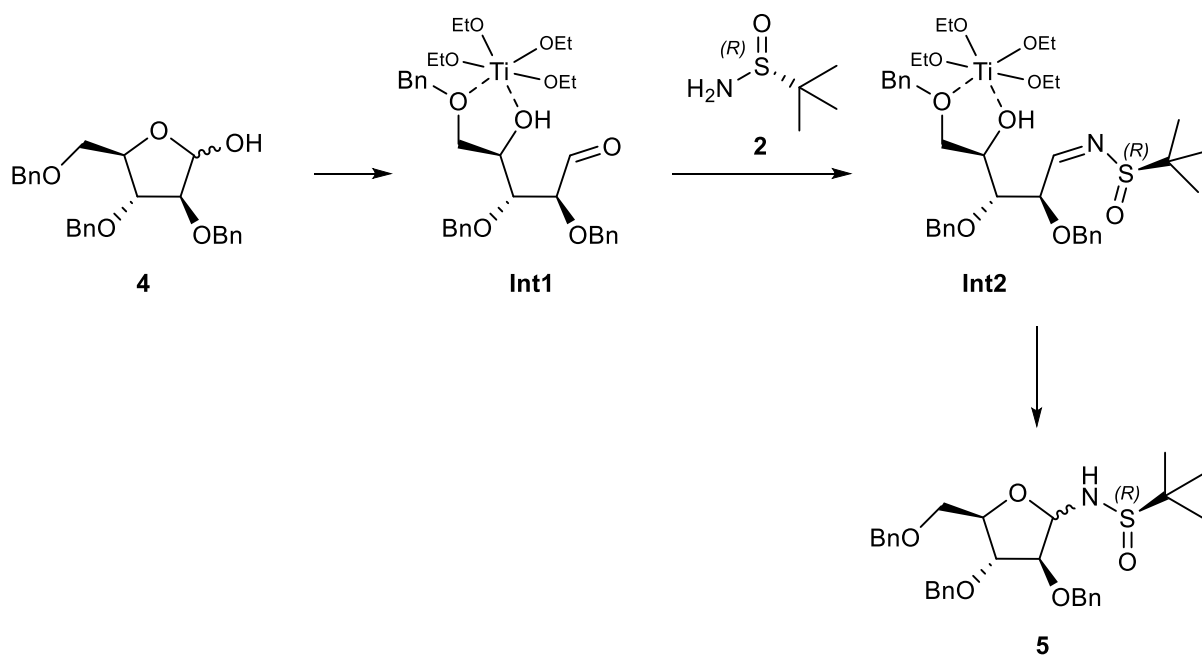


**Figure 15.** Synthesis of **5** via flow chemistry.

**Table 3.** Optimisation of the synthesis of **5** via flow chemistry.

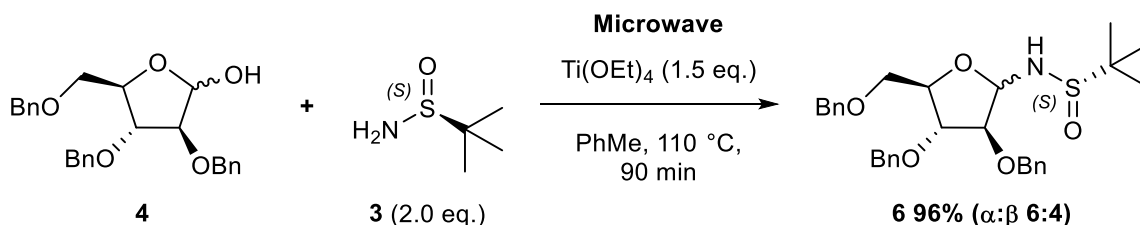
Entry	Temperature (°C)	Residence time (min)	Yield of <b>5</b> (%)
<b>1</b>	110	22.5	48
<b>2</b>	110	40	52
<b>3</b>	140	20	65
<b>4</b>	140	10	52

Since the Lewis acid, in this case, titanium(IV) ethoxide, is essential for the synthesis of (*S<sub>R</sub>*)-*N*-*tert*-butanesulfinyl arabinofuranosylamine **5**, the mechanism presented below (Scheme 26) might explain the reaction. The titanium catalyses the opening of the hemiacetal ring due to the formation of the chelate with the endocyclic oxygen and O-5 (**Int1**). It allows the formation of the arabinose-imine **Int2** through the direct condensation of **2** with the aldehyde **Int1**. Afterwards, the open-chain arabinose-imine (**Int2**) undergoes cyclisation to form the final compound **5**.



**Scheme 26.** Proposed mechanism for the formation of glycosylamine **5**.

The optimised conditions were applied to the other epimer **3** for the synthesis of (*S*<sub>S</sub>)-*tert*-butanesulfinylglycosylamine **6** (Scheme 27). In this case, the yield (isolated 96%) was also superior to the one published before.

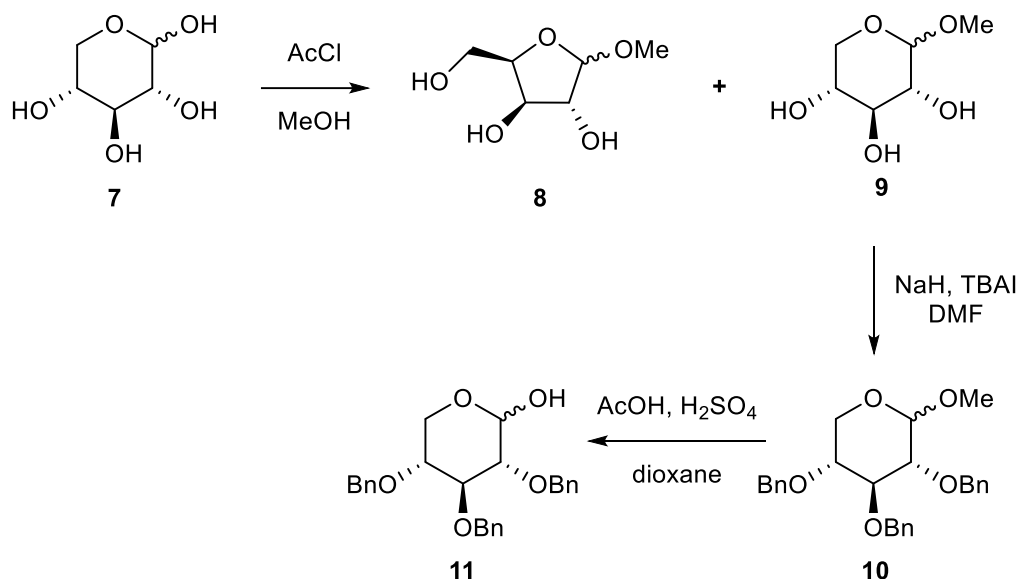


**Scheme 27.** Synthesis of (*S*<sub>S</sub>)-*N-tert*-butanesulfinylglycosylamine **6**.

The optimised conditions were also applied to another sugar series – D-xylopyranose. The starting material **11** was prepared from unprotected D-xylose following the procedure of Fletcher (Scheme 28).<sup>94</sup> The first part in the synthesis is the formation of the methyl glycoside; this reaction may form two compounds: furanoside **8** and pyranoside **9**. Furanoside **8** is formed faster than **9**, but with time, the (*s*) outcome of the reaction is controlled by the thermodynamics and product **9** is favoured in this case. Another step is the protection of three free hydroxyl group with benzyl bromide in the presence of sodium hydride to give compound **10**. The last

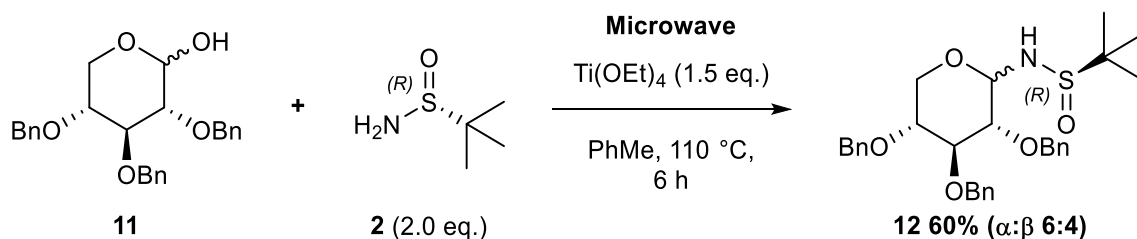
<sup>94</sup> S. Tejima, R. K. Ness, R. L. Kaufman, H. G. Fletcher, *Carbohydr. Res.* **1968**, 7, 485–490.

step is hydrolysis of the methyl glycoside under acidic conditions. Compound **11** is obtained after the recrystallisation from ethanol as a white solid.



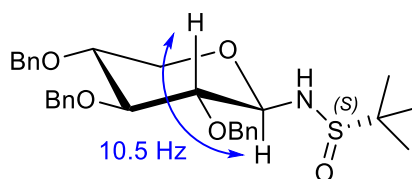
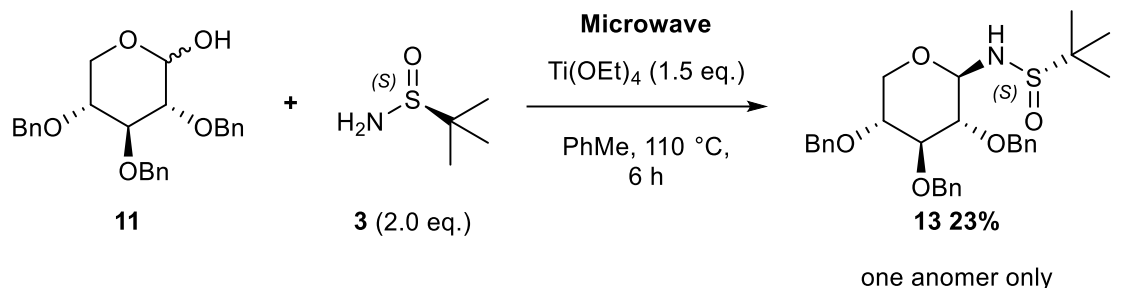
**Scheme 28.** Synthesis of tri-*O*-benzyl-D-xylopyranose **11**.<sup>94</sup>

The optimised conditions for the D-arabinofuranose series were directly applied to the synthesis of the (*S<sub>R</sub>*)-*N*-*tert*-butanesulfinyl xylopyranosylamine **12** (Scheme 29). Unfortunately, after 90 minutes, the reaction was not complete. The reaction was not complete even after 2 or 4 hours; it required 6 hours in the Biotage® Initiator+. Moreover, the yield was way inferior to the one obtained for both epimers in the D-arabinofuranose series (Scheme 25 and Scheme 27). One possible explanation for the longer reaction time is the starting material itself. It is the most thermodynamically stable structure. It is possible that, even with the assistance of the Lewis acid, the opening of the hemiacetal ring is not favoured. It requires a longer reaction time to reach equilibrium towards the formation of compound **12**. Also, it is worth to mention that pyranosylamine **12** (a mixture of anomers) is much more prone to hydrolysis in comparison to furanosylamines **5** and **6**. The purification of **12** via silica gel column chromatography requires the addition of triethylamine both in the preparation of the silica gel and later in the eluent. Otherwise, the yield might be lowered by up to 20%. By taking all the precautions during the purification, the yield of the reaction via microwave-assisted synthesis is comparable to the classical method. The only gain is the time of the reaction, 6 hours vs 48 hours.



**Scheme 29.** Synthesis of (*S<sub>R</sub>*)-*N*-*tert*-butanesulfinyl xylopyranosylamine **12**.

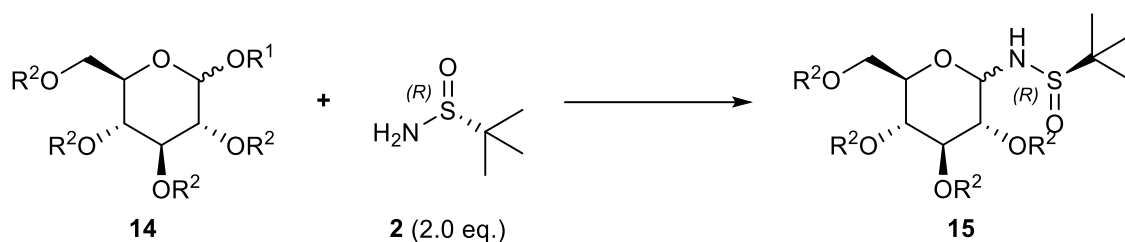
The same procedure was applied to the synthesis of the other epimer – (*S<sub>S</sub>*)-*N*-*tert*-butanesulfinyl xylopyranosylamine **13** (Scheme 30). A single anomer was obtained. The only reaction performed in this series gave **13** in 23% yield. Although the reaction was heated for 6 hours, the starting material **11** was still detected. It was almost impossible to separate appropriately compound **13** from the mixture, not even when the silica gel column chromatography was repeated twice. I suspect that part of **13** was also hydrolysed during the purification. Finally, the pure compound was obtained after the precipitation from pentane in the form of pale yellow crystals. The structure was confirmed by the comparison of the <sup>1</sup>H NMR spectra with published data.<sup>90</sup>



**Scheme 30.** Synthesis of (*S<sub>S</sub>*)-*N*-*tert*-butanesulfinylxylopyranosylamine **13**.

Moreover, we attempted to prepare the *N*-*tert*-butanesulfinylglycosylamine in hexose (D-glucose) series (Scheme 31). The selected conditions for the reaction are listed below (Table 4).





**Scheme 31.** Synthesis of (*S<sub>R</sub>*)-*N*-*tert*-butanesulfinyl-D-glucopyranosylamine **15**.

**Table 4.** Conditions tested for the formation of **15**.

Entry	R <sup>1</sup>	R <sup>2</sup>	Additive	Solvent	Temp. (°C)	Time	Results /comments
1	H	Bn	Ti(OEt) <sub>4</sub> (1.5 eq)	PhMe	70	18 h	Recovered SM
2	H	Bn	Ti(OEt) <sub>4</sub> (1.5 eq)	PhMe	70	24 h	3% yield (3 columns)
3 <sup>1,2</sup>	H	Bn	Ti(OEt) <sub>4</sub> (1.5 eq)	Dioxane	130	45 min	20% product, 20% SM
4 <sup>1,2</sup>	H	Bn	Ti(OEt) <sub>4</sub> (1.5 eq)	ACN	130	45 min	25% product, 50% SM
5	H	Bn	Cs <sub>2</sub> CO <sub>3</sub> (1.5 eq)	DCE	60	18 h	Recovered SM
6	H	Bn	TMSOTf (1.5 eq)	DCM	rt	16 h	Recovered SM
7	Ac	Bn	BF <sub>3</sub> ·OEt <sub>2</sub> (2 eq)	DCM	rt	16 h	Degradation
8	Ac	Bn	BF <sub>3</sub> ·OEt <sub>2</sub> (2 eq)	DCM	rt	36 h	Degradation
9	Ac	Bn	BF <sub>3</sub> ·OEt <sub>2</sub> (2 eq)	ACN	rt	16 h	Degradation
10	Ac	Ac	BF <sub>3</sub> ·OEt <sub>2</sub> (2 eq)	ACN	rt	72 h	Degradation

<sup>1</sup> Microwave-assisted synthesis; <sup>2</sup> Yields of the product were determined by <sup>1</sup>H NMR spectroscopy with mesitylene as an internal standard.

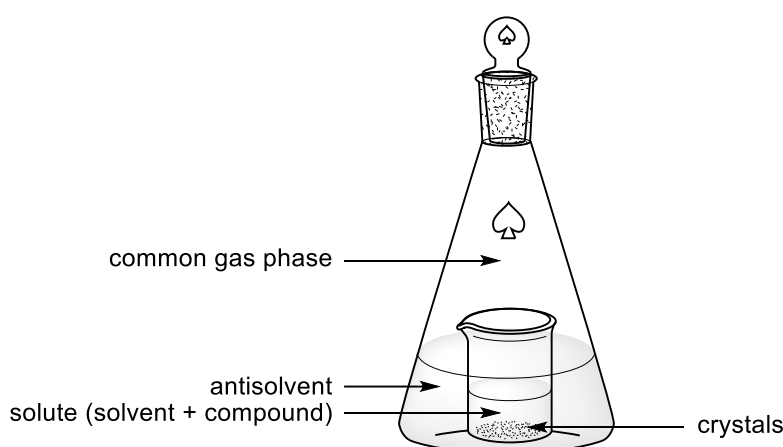
Various conditions were tested. Unfortunately, the reaction does not seem to work well at all. Moreover, the product is challenging to separate from the starting material, and it requires multiple silica gel flash columns. At the same time, it is unstable, and it hydrolyses easily. Performing the purification does not help with the yield of the reaction. The microwave-assisted synthesis (Entry 3 and 4) gives results superior to the methods of classical organic synthesis. Even changing the protecting group R<sup>1</sup> and R<sup>2</sup> to acetates does not change the outcome of the reaction. The same with additives, for most of the reaction either does not work, and the starting material is recovered, or the starting material or products are degraded. Work in this series was discontinued.

## 2. Crystal structure of (*S*<sub>S</sub>)-*N*-*tert*-butanesulfinyl-*D*-xylopyranosylamine **13**

For the first time, we were able to obtain one of the *N*-*tert*-butanesulfinylglycosylamines (**13**) in the form of a solid. Usually, all of them were acquired as oils. However, possessing a crystalline sample opens the possibility of performing X-ray diffraction studies. Unfortunately, the crystals precipitated from pentane were not suitable for the analysis. It required more trials to obtain better quality crystals.

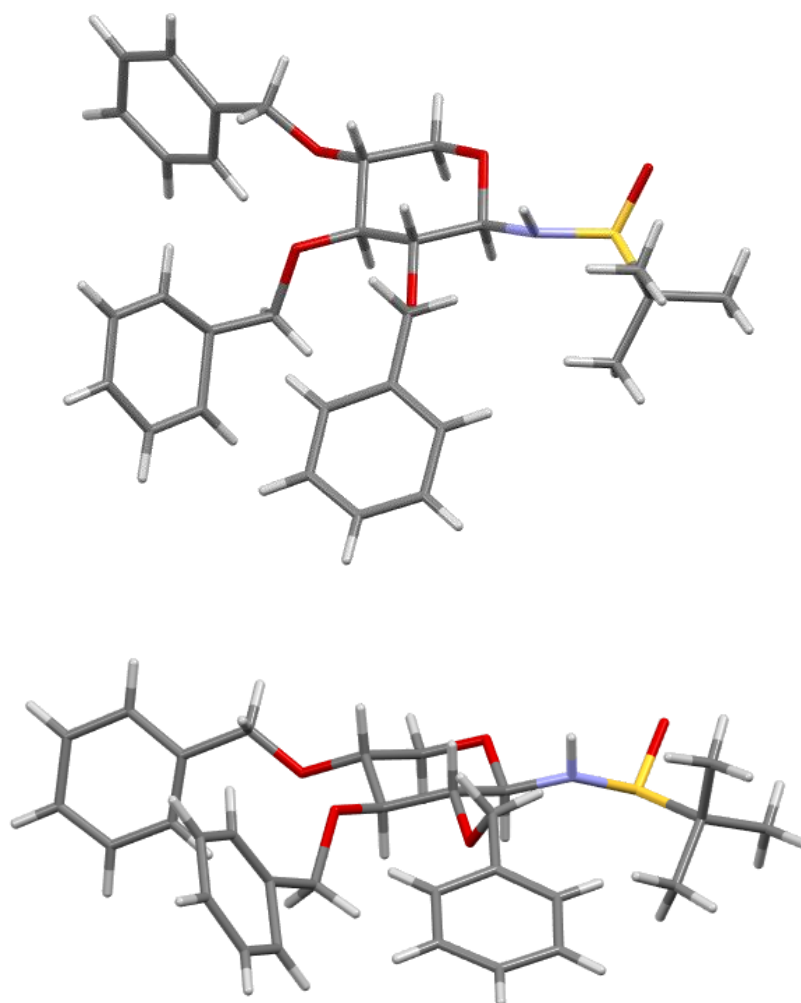
Many methods of crystallisation were examined: thermal recrystallisation and cooling the solvents, solvent evaporation, solvent layering and vapour diffusion, which gave the best results in our case.

The latter method is quite straightforward and easy to set up. Two containers are needed: inner and outer. The inner one must fit inside the other container. In the beginning, it contains the compound in solution in the solvent (this mixture is known as solute). The outer container is filled with an antisolvent and also, a lid is needed to close the setup. Once it is closed, the two liquids share a common gas phase and start to equilibrate via vapour diffusion, which hopefully will result in single crystals suitable for the X-ray. In most cases, it is preferable for the antisolvent to have a higher boiling point than the solvent. The solvent will evaporate into the antisolvent at the same time increasing the concentration of the compound in the solute. There is also a secondary effect which takes place; it is the antisolvent slowly diffusing into the solute, also decreasing the solubility. Both effects are synergic.



**Figure 16.** Crystallisation by the vapour diffusion method.

Two sets of solvent and antisolvent were tested: ethanol and THF as respective solvents, and in both cases, pentane was chosen as antisolvent: (1) THF and pentane, and (2) ethanol and pentane. For both sets, the antisolvent is more volatile. In this case, the antisolvent will diffuse into the solvent. After four days, the formation of the crystals was observed in the THF/pentane combination. On the other hand, no crystallisation was visible in the ethanol/pentane combination even after one month. The crystals were in the shape of needles. They were sent to the group of prof. Krzysztof Lewiński (Fac. of Chemistry, Jagiellonian University, Kraków) for the X-ray analysis. The information which we received was that most of the crystals existed as intertwined crystals. It might be caused by the fast diffusion of the antisolvent to the solvent. Fortunately, they were able to find the right candidate for the X-Ray and obtain a structure with proper resolution. Details on the structural data (bond angles and bond lengths) are given in the Experimental section.

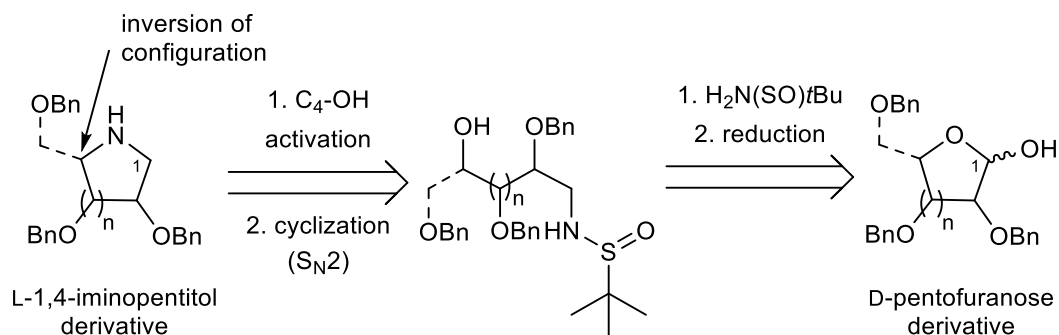


**Figure 17.** X-ray structure of compound 13.

The X-ray structure confirmed the  $\beta$ -configuration of **13** determined by  $^1\text{H}$  NMR (Scheme 30). Also, the sense of chirality of the sulphur atom is visible. We can see that nitrogen, oxygen and carbon atoms are not in the same plane as sulphur (pyramidal arrangement), which indicates the tetrahedral structure (if we include the invisible pair of the electrons). It is also interesting to observe that the N-H bond is antiparallel to C(1)-H bond, allowing the lone pair at nitrogen to be antiparallel with the endocyclic C–O bond, a conformation that is favoured by the exoanomeric effect.

### 3. Applications to the synthesis of 1-deoxyiminosugars

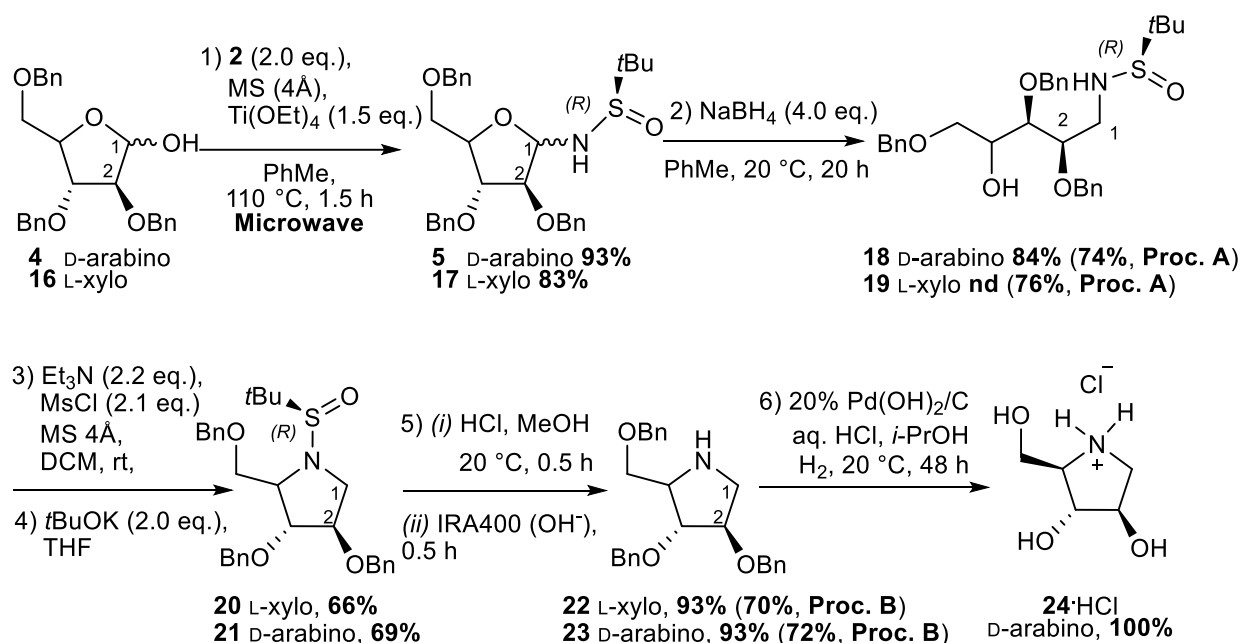
Thanks to the shortening of the time of the glycosylamine formation under microwave conditions, we could develop a short, general and convenient synthetic route to 1-deoxyiminoalditols (Scheme 32). The hydride was used as the nucleophile to reduce the formed glycosylamine without intermediate purification. It was combined with the cyclisation of the resulting open-chain aminoalditols. The route leads in very few steps and short reaction times to protected or deprotected cyclic iminopentitols.



**Scheme 32.** Retrosynthetic plan for 1-deoxyiminosugars.

Starting from commercially available tri-*O*-benzyl pentofuranoses (**4**, **16**), the formation of the sulfinyl glycosylamines (**5**, **17**) was executed under the optimised conditions for microwave-assisted synthesis. Further, the addition of NaBH<sub>4</sub> (4.0 eq.) was performed at room temperature (ca. 20 °C) in toluene with the D-arabinofuranosylamine **4** to obtain compound **18** in good yield (84%, 72% over two steps) after a reaction time of 20 h. Alternatively, for the synthetic utility of the proposed study, the glycosylamines were not isolated. Instead, step (1) was carried out, and the crude reaction mixture was directly treated with NaBH<sub>4</sub> (4.0 eq.) at 110 °C for 1 h to afford the corresponding iminoalditols (**18** and **19**) in high yields (e.g., 74 and 76% respectively

over the two-step sequence **Procedure A**). Additionally, the reaction sequence could also be realised using the (*S*)-(-)-chiral sulfinyl auxiliary **3**. Subsequent reduction at 110 °C for 1 h could then be carried out at the bench (Scheme 33). The synthesis of the aminoalditol compounds **18** and **19** could not be fully accomplished under microwave irradiation as a dramatic yield decrease was observed for the reduction step (e.g., 58% for **18**). The free OH position was next activated as a mesylate, and the crude mesylate treated with *t*-BuOK (0 °C or 20 °C, 0.5-1.5 h) to perform the cyclisation, thus giving pyrrolidine derivatives **20** and **21** in moderate yields (66–69%).



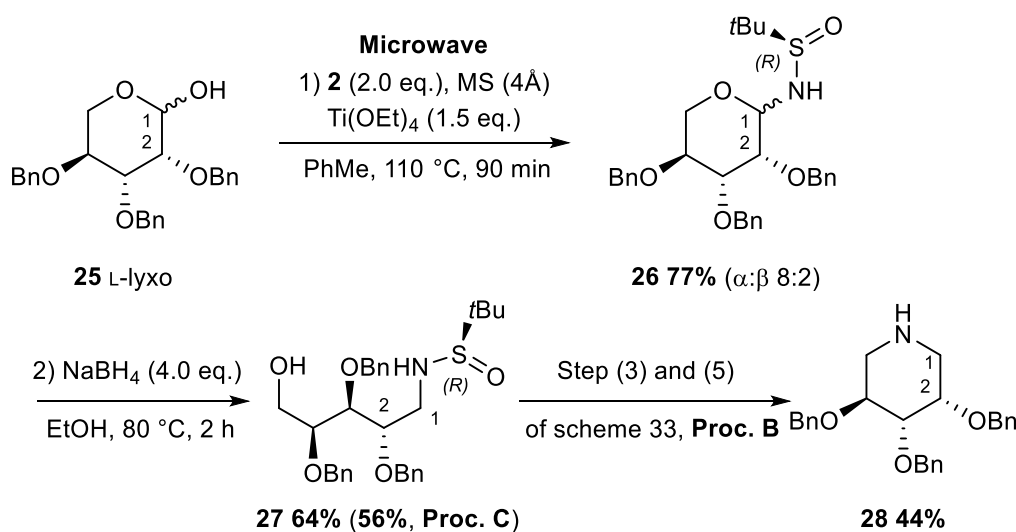
**Scheme 33.** Synthesis of 1-deoxyiminosugars **22** and **23**.

**Procedure A:** step (1), then the addition of NaBH<sub>4</sub> (4 eq.), 110 °C, 1 h (compounds **5** and **17** not isolated); **Procedure B:** step (3) and (5) (use of crude **20** and **21**).

The sulfinyl group was cleaved by simple treatment with acidic methanol to give **22** and **23** in good yield (93%). Once again, instead of two separate steps, the cyclisation could be completed in a single sequence (**Procedure B**). The sulfinyl group can be cleaved from the not isolated intermediate mesylate and subsequently cyclized upon acidification and neutralisation of the reaction mixture with a basic anion exchange resin (step (3) and (5)) – hence giving directly **22** and **23** from **18** and **19** in 70 and 72% yield respectively. Starting from D-arabinofuranose **4**, the corresponding 1,4-imino-L-xylofuranose derivative **22** was obtained, and from L-xylofuranose derivative **16**, the sequence gave the O-benzylated 1,4-imino-D-arabinitol **23**. As a result of the cyclisation method, there is an inversion of the configuration at the position C-4. Furthermore,

**23** was then deprotected by catalytic hydrogenolysis to afford the known D-DAB **24** as its hydrochloride salt.

To prepare a 1,5-dideoxy-1,5-iminopentitol derivative, the same methodology was then applied to the tri-*O*-benzylated pentopyranose. The known tri-*O*-benzyl-L-lyxopyranose **25**,<sup>95</sup> was prepared in three steps from L-lyxose in the sequence similar to the one presented at Scheme 28. The condensation with **2** was performed at 110 °C to give the desired glycosylamine **26** readily (Scheme 34). The L-lyxopyranosylamine derivative was not soluble in toluene. It could be isolated (77%) and characterized. Importantly, heating under microwave irradiation was mandatory to allow the formation of **26** in good yield over a short period of time. Afterwards, the toluene was evaporated, and the crude compound **26** was reduced to the corresponding aminopentitol derivative **27** (64%) upon addition of NaBH<sub>4</sub> (4 equiv.) in EtOH at 80 °C for 2 h (49% over two steps). Step (1) and (2) could obviously be performed without isolation of **26** to give **27** in good overall yield (56%, **Procedure C**). The open-chain compound was thereafter cyclized by way of the mesylate under the conditions described for the pyrrolidines (**Procedure B**), thus affording the 1,5-dideoxy-1,5-imino-L-lyxitol **28** in moderate yield (44%).



**Scheme 34.** Application of the methodology to L-lyxopyranose **23**.

**Procedure C:** Step (1), followed by the evaporation of the solvent and then, step (2).

This short and convenient method might be applied to a broad diversity of sugar hemiacetals to prepare the corresponding cyclic iminoalditols in good overall yields. This work is *in press* in *Carbohydr Res.*

<sup>95</sup> M. S. Schmidt, V. Wittmann, *Carbohydr. Res.* **2008**, *343*, 1612–1623.

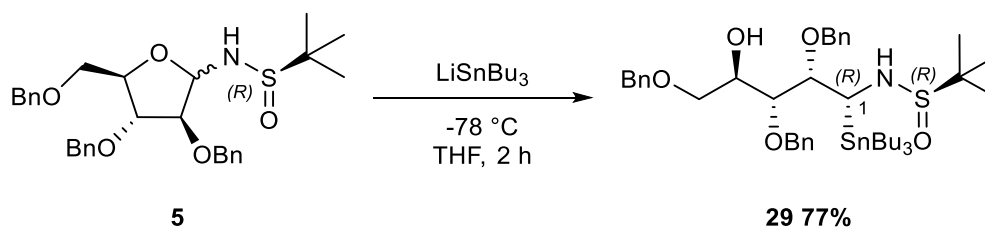
### III. Synthesis of iminosugar-1-stannanes

#### 1. Application to *N*-*tert*-butanesulfinylglycosylamines

With all the *N*-*tert*-butanesulfinylamines ready, we started the studies of the addition of the tributyltin lithium reagent. Usually, the organometallic reagents do not have a long shelf life; tributyltin lithium is so unstable that it is not available as a commercial reagent, nor can it be stored. It must be generated directly before the reaction from tributyltin hydride and lithium diisopropylamide (LDA), which is also generated just before the reaction from *n*-butyl lithium and diisopropylamine. The outcome of the reaction also depends on the quality of the chemicals used, even if only one of the compounds is a miss, the reaction will fail. Before reaction, some of the compounds must be distilled (diisopropylamine) or titrated (*n*-BuLi). It also requires anhydrous THF, which can be either dried by passage through an alumina column or distilled over metallic sodium in the presence of benzophenone.

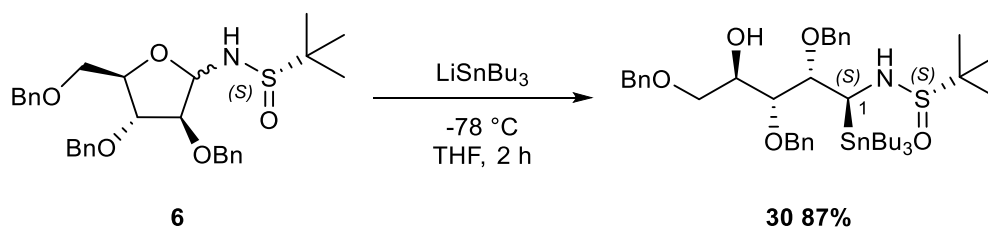
The procedure was applied to compound **5** to obtain the open-chain aminoalditol **29** with an excellent yield (77%) (Scheme 35). After the examination of the crude  $^1\text{H}$  NMR, we established that only one diastereoisomer was formed. Noteworthy, it is possible to scale-up the reaction up to 6 g of starting material. Also, even in these conditions, it was highly stereoselective (dr > 95:5).

Please note that the absolute configuration at C-1 is assigned in Scheme 35, but at this stage, it was not possible to determine it (see Chapter 3 for more details about the assignment of configuration).



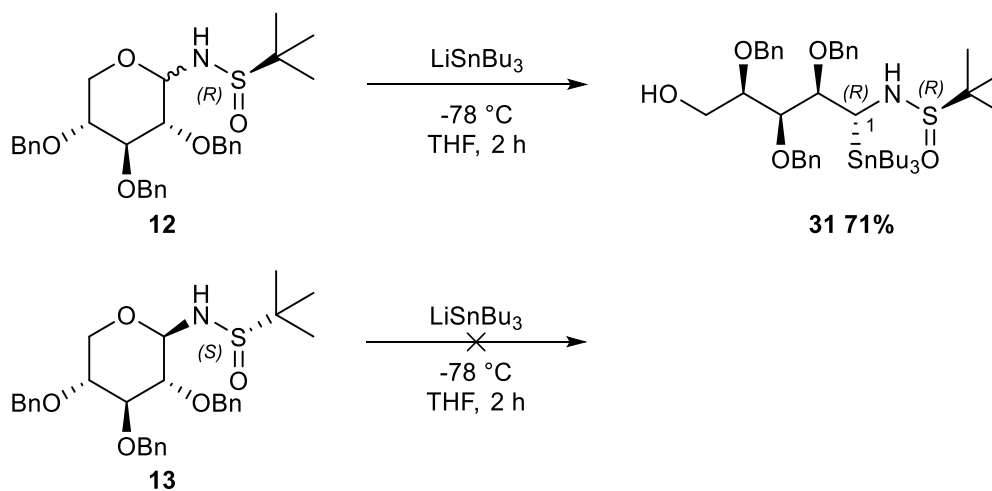
**Scheme 35.** Addition of  $\text{LiSnBu}_3$  to glycosylamine **5**.

The same conditions were applied to glycosylamine **6** (Scheme 36). The result was similar: excellent yield (87%) and a single diastereomer formed.



**Scheme 36.** Addition of  $\text{LiSnBu}_3$  to glycosylamine **6**.

The same protocol was also applied to the compounds from the pentopyranose series – **12** and **13**, with various results (Scheme 37). It works in case of the mixture of anomers with (*S<sub>R</sub>*)-*tert*-butanesulfinyl group with good yield (71%). Also, a single diastereoisomer **31** was formed. On the other hand, the reaction performed on compound **13**, which contains only  $\beta$  anomer, failed. We are not able to pinpoint the exact cause of this failure. The most reasonable source of the problem seems to be the structure of the starting material itself. My guess would be, that opening of the ring, and thus, formation of the imine is not favoured; hence, the nucleophilic addition does not work. It is worth to mention that the reaction with lithium difluorophosphonate also was unsuccessful in this series.



**Scheme 37.** Addition of  $\text{LiSnBu}_3$  in the pentopyranose series.

At this point, we knew that reaction is entirely stereoselective, but we could not determine whether **29** and **30** were diastereoisomers at S only or at S and C-1, and what factor controlled the addition. A first simplification is possible by oxidation of the sulfur atom: if the chiral auxiliary is oxidised to a sulfonyl group, then the only difference between compound **29** and **30** would arise from a different configuration at position C-1. Then just by a simple comparison of the  $^1\text{H}$  NMR spectra, the conclusion might be drawn. In case that  $^1\text{H}$  NMR data for the oxidised compounds are different, the two compounds are diastereoisomers, and hence the

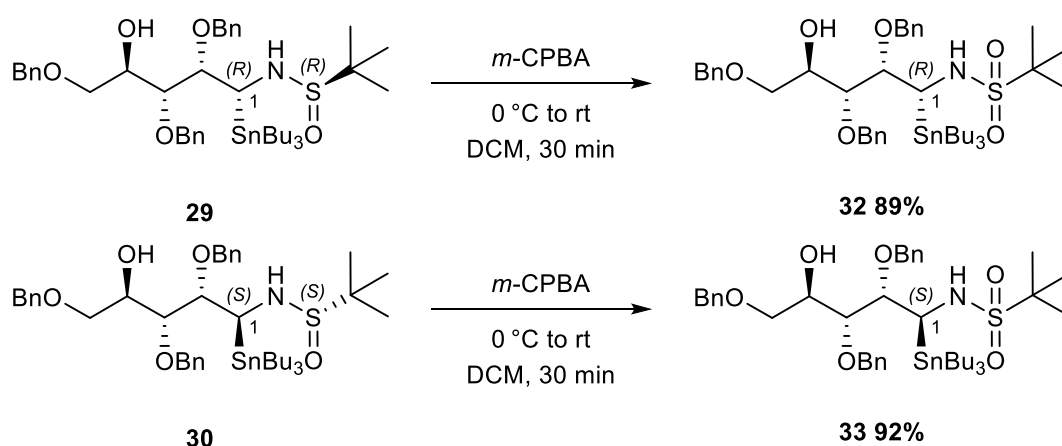


addition step is entirely controlled by the *tert*-butanesulfinyl group. On the other hand, if the spectra are the same, the two adducts have the same configuration at C-1, and the addition is controlled by the carbohydrate moiety.

The same protocol for the addition of the tributyltin lithium reagent to *N*-*tert*-butanesulfinylglycosylamines was used by dr Sizhe Li (SL) in the preparation of the open-chain 1-stannylated aminoalditols in other series (e.g. 2,3,5-tri-*O*-benzyl-D-xylofuranose, 5-*O*-*tert*-butyldimethylsilyl-2,3-*O*-isopropylidene-D-ribofuranose and 2,3,5-tri-*O*-benzyl-L-lyxopyranose). The nucleophilic addition was performed with both configurations of the chiral auxiliary. Interestingly, the outcome of the reaction with *S<sub>S</sub>* derivative in the L-lyxopyranose series was similar to the result for the D-xylopyranose *S<sub>S</sub>* derivative (Scheme 37); reaction failed. Otherwise, the other reactions worked extremely well (yields between 81 and 91%). In all cases, the formation of only one diastereoisomer was observed.

## 2. Oxidation of the sulfinyl group to a sulfonyl group.

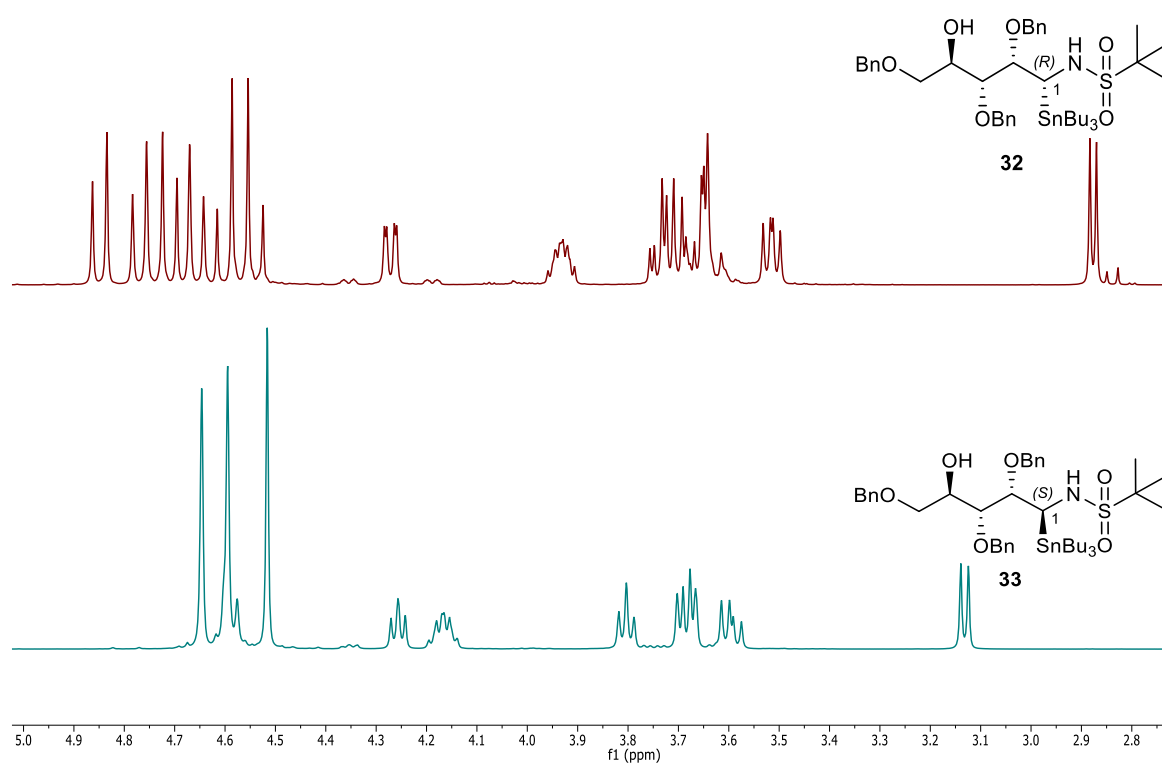
For the transformation of the *tert*-butanesulfinyl to the *tert*-butanesulfonyl group, efficient yet straightforward oxidation with *meta*-chloroperoxybenzoic acid (*m*-CPBA) was chosen (Scheme 38). The reaction is swift and convenient. It requires only starting material, *m*-CPBA and DCM. After 30 min it was complete.



**Scheme 38.** Oxidation of the *tert*-butanesulfinyl group.

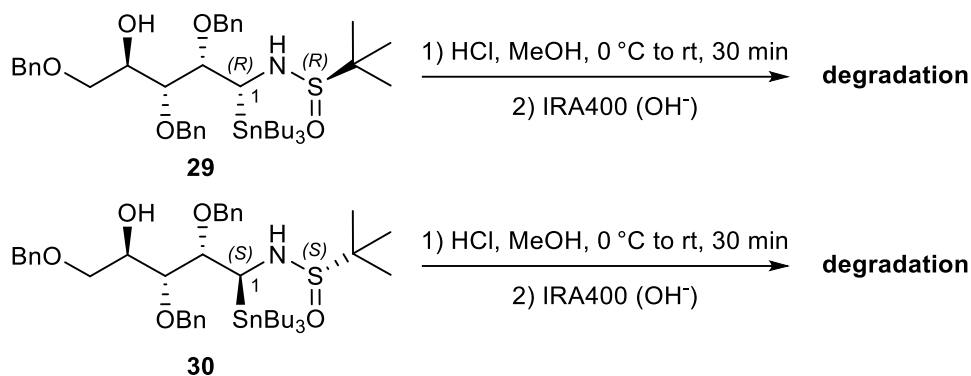
Through the direct comparison of the <sup>1</sup>H NMR spectra (Figure 18) of **32** and **33**, we can see that they are entirely different. It is a direct evidence about complete control of the nucleophilic

addition by the chiral handle. Our reaction appears to be not only highly stereoselective but also tuneable.



**Figure 18.** <sup>1</sup>H NMR of the compounds **32** and **33**.

Oxidation of the sulphur was not the only method, which we considered to verify if compounds **29** and **30** were epimers at C-1. Another approach was the removal of the chiral auxiliary and then, investigation of the <sup>1</sup>H NMR spectra of free aminostannanes. One of the advantages of the *tert*-butanesulfinyl group is that it is easily cleaved. We decided to remove it by treatment with acidic methanol followed by neutralisation with basic anion exchange resin (Scheme 39). Unfortunately, as a result, the starting material was degraded. We are not certain about the structure of the byproduct or byproducts, but for sure, the tin was removed from the molecule or molecules.

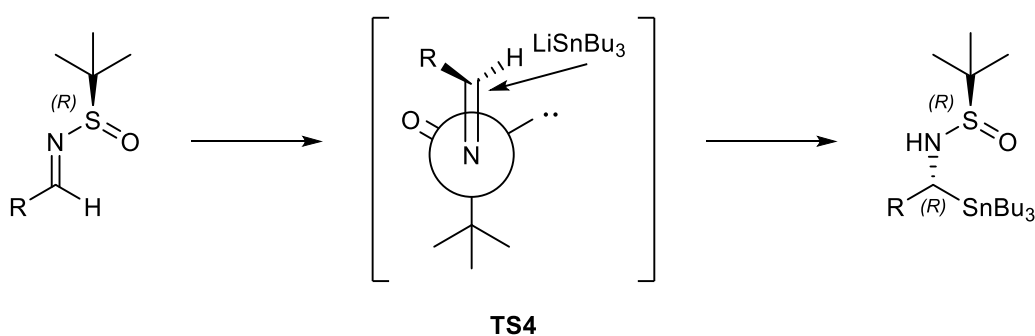


**Scheme 39.** Deprotection of the *tert*-butanesulfinyl group.

### 3. Proposed transition state for the addition of tributyltin lithium

Taking into account the later established absolute configuration at C-1, we can propose the transition state for the nucleophilic addition of the tributyltin lithium reagent to *N-tert*-butanesulfinylglycosylamines (Scheme 40).

We wanted to rationalise the results of the addition step. Based on the absolute configuration of products **29** and **30**, we could see the trend emerging. Application of the handle with configuration  $S_R$  results in the addition product with configuration  $R$  at C-1. On the other hand, using the opposite epimer –  $S_S$  gives the opposite configuration at C-1 ( $S$ ). It is different from the results presented by Kells and Chong. In their case, the auxiliary with the configuration  $S_R$  gave the stannane with  $S$  configuration at C-1 (Scheme 22). They rationalised the outcome with the chelation effect and the formation of a six-membered ring transition state **TS3** (Scheme 23).



**Scheme 40.** Proposed TS for the addition of  $\text{LiSnBu}_3$ .

However, in our case, the open nonchelating addition model proposed by Davis and coworkers<sup>85</sup> is more appropriate in explaining the configuration of formed products. In this model, the Felkin-Ahn approach, where the nucleophile attacks from the least hindered side, which is the side occupied by the free electron pair, is favoured (**TS4**).

It is hard to explain why in similar reactions, the proposed transition states are very unlike. Of course, the main difference is the character of the starting materials. In our case, it is highly chiral sugar moiety, while for Kells and Chong, the chirality comes from the auxiliary group.

## IV. Conclusions

The aim of this part of the project was to optimise the conditions of the synthesis of *N-tert*-butanesulfinylglycosylamines. The goal was achieved with the use of microwave-assisted synthesis and flow chemistry. The application of the microwave irradiation gave the best results; not only the yield was improved, but also the reaction time was significantly decreased. The reaction is around ten times shorter than the one previously reported by our team. Also, the flow chemistry has enormous potential; however, in my personal opinion, there is still room for more improvements. On the other hand, any attempts to synthesise the *N-tert*-butanesulfinylglycosylamines in the hexopyranose series were unsuccessful. Moreover, for the first time, we managed to crystallise an *N-tert*-butanesulfinylglycosylamine, and we have presented the X-ray results.

Besides, a brief synthesis of protected or free 1,4-imino or 1,5-iminopentitol derivatives using a sulfinyl glycosylamine as an aldose imine equivalent was presented. Reducing the latent imine provides an open-chain aminoalditol, which can be easily cyclized by an S<sub>N</sub>2 reaction. This method could be applicable to a broad diversity of protected sugar hemiacetals to prepare the corresponding cyclic iminoalditols in good overall yields in a convenient way.

The second goal of this chapter was to successfully develop the nucleophilic addition of the tributyltin lithium reagent to the *N-tert*-butanesulfinylglycosylamines and the investigation of the stereoselectivity of the reaction. This part of the project was achieved at 100%. The developed reaction is completely diastereoselective and gives very high yields. Moreover, the stereochemistry of the newly formed chiral centre at the C-1 is entirely controlled by the chiral auxiliary. The change of the auxiliary results in the formation of the other diastereoisomer, thus the reaction is tuneable.

In the following chapters, I will describe the application of these very interesting intermediates in organic synthesis. We applied two different types of reaction: Stille coupling (Chapters 2 and 3) and SnAP chemistry (Chapter 4).

## V. Summary of Chapter 1 *en français*

Le premier chapitre du présent rapport porte sur les *N-tert*-butanesulfinamides (Figure 12). Ce sont de petites fonctions chirales, qui peuvent être utilisées comme groupe auxiliaire dans la synthèse asymétrique. La chiralité est le résultat de la structure tétraédrique de l'atome de soufre, avec quatre substituants différents dont la paire d'électrons libres. Les méthodes peu coûteuses et évolutives de préparation de cet auxiliaire chiral ont été présentées dans l'introduction de ce chapitre (Schémas 10 et 11), ainsi que les méthodes connues pour la synthèse des *N-tert*-butanesulfinylimines (Schéma 13). Quelques exemples d'application dans le domaine de la chimie des sucres ont également été décrits (Schéma 15).

L'aventure de notre équipe avec les *tert*-butanesulfinamides a commencé lors de la thèse de Farah Oulaïdi (Schéma 17) impliquant l'addition des réactifs de Grignard sur des *N-tert*-butanesulfinyl imines portés par des pentofuranoses, montrant la forte influence de la fraction sucre sur la stéréochimie de l'addition. Plus tard, l'intérêt pour ce groupe chiral s'est poursuivi avec la thèse de Chloé Cocard (Schéma 18). Elle a mis au point une méthodologie efficace pour la synthèse des *N-tert*-butanesulfinylglycosylamines - des intermédiaires intéressants dans la préparation des analogues des phosphates de glycosyle. Dans ce cas, on a observé un double effet de différenciation stéréochimique, ce qui a conduit à des situations de "match" et de "mismatch" (Figure 14).

L'un des objectifs de cette partie du projet était d'optimiser la synthèse par l'application de la synthèse assistée par micro-ondes (Schéma 25) et de la chimie en flux (Figure 15). L'application de l'irradiation par micro-ondes a donné le meilleur résultat (Tableau 2), non seulement le rendement a été amélioré, mais aussi le temps de réaction a été considérablement réduit (la réaction est environ dix fois plus rapide que celle rapportée précédemment par notre équipe). Cependant, la chimie en flux continu a un énorme potentiel (Tableau 3). Les rendements ne sont pas plus élevés que ceux rapportés précédemment, mais le temps de réaction est encore plus court. Par contre, toutes les tentatives de synthèse de *N-tert*-butanesulfinylglycosylamines dans la série de l'hexopyranose ont échoué, alors que la réaction fonctionne en série pentopyranose. De plus, nous avons réussi pour la première fois à cristalliser une *N-tert*-butanesulfinyl-glycosylamine, en série xylopyranose, par diffusion de vapeur (Figure 16), et nous avons présenté les résultats de la structure déterminée par diffraction des rayons X (Figure 17).

Grâce au raccourcissement du temps de formation de la glycosylamine dans des conditions de microondes, nous avons pu mettre au point une voie synthétique courte, générale et pratique pour obtenir des 1-désoxyiminoalditols (Schéma 32). Le procédé consiste en la formation de *N-tert*-butanesulfinylglycosylamines, suivie d'une réduction directe par le borohydrure de sodium. Ensuite, la molécule a été cyclisée par méthylation du groupe hydroxyle libre, déprotection du groupe sulfinyle en milieu acide et neutralisation. Par conséquent, la configuration en position C-4 est inversée. Cette méthode courte et pratique pourrait être appliquée à une grande diversité d'hémiacétals de sucre pour préparer les iminoalditols cycliques correspondants avec un bon rendement global. Ce travail est sous presse dans *Carbohydr Res.*

Le deuxième objectif de ce chapitre était de mettre au point l'addition nucléophile du réactif tributylstannylolithium aux *N-tert*-butanesulfinylglycosylamines (Schémas 35 à 37) et l'étude de la stéréosélectivité de la réaction. Cette partie du projet a été réalisée à 100%. La réaction développée a été complètement diastéréosélective et a donné des rendements très élevés. De plus, en comparant la <sup>1</sup>H RMN des composés oxydés en sulfonamides (Figure 18), nous avons déterminé que la stéréochimie du centre chiral nouvellement formé en position C-1 était entièrement contrôlée par l'auxiliaire chiral. Le changement de l'auxiliaire entraîne la formation de l'autre diastéréoisomère, donc la réaction est 'tunable'.

Dans les chapitres suivants, je décrirai l'application de ces intermédiaires très intéressants en synthèse organique. Nous avons appliqué deux types de réaction différents à nos organostannanes : le couplage Stille (Chapitres 2 et 3) et la chimie SnAP (Chapitre 4).





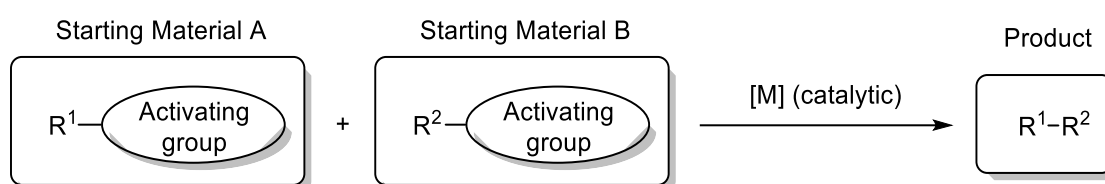
# Chapter 2

---



## I. Introduction

“Cross-coupling reactions are those in which two different starting materials, each of which is usually endowed with an activating group, are reacted together with the aid of a metal catalyst. The result is the loss of the two activating groups and the formation of a new covalent bond between the remaining fragments.”<sup>96</sup> This definition of cross-coupling reaction can be easily demonstrated in Scheme 41, but in essence, it allows the formation of carbon-carbon bonds thanks to the nature of the starting materials and the metal catalyst.



**Scheme 41.** Definition of cross-coupling reactions.

As for the metal catalyst required for this type of reaction, among all the elements of the periodic table, the group of transition metals found vast application in this area, and between them, palladium shines the most. The application of this precious metal to the cross-coupling reactions revolutionised the field of organic synthesis. The importance of the cross-coupling reaction catalysed by palladium was further highlighted by the assignment of the Nobel Prize in Chemistry in 2010 to Richard F. Heck, Ei-ichi Negishi and Akira Suzuki.

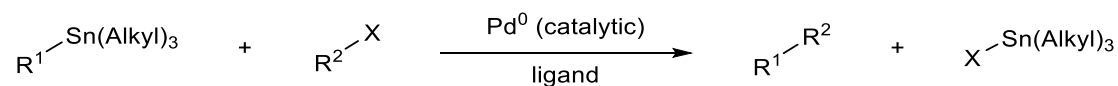
Up-to-date, there are many different types of reactions; most of them named after their inventors. However, we are interested in particular, in one of the reactions involving organostannanes as the starting material, existing under the name of Stille coupling.

---

<sup>96</sup> <https://www.nature.com/subjects/cross-coupling-reactions>

## 1. History of the Stille coupling

Stille cross-coupling, otherwise known as the Stille reaction, is the reaction between organostannanes and electrophiles catalysed by palladium. The simple scheme of this reaction is presented below (Scheme 42).



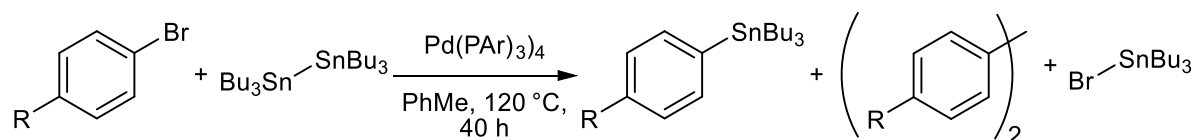
**Scheme 42.** General scheme of Stille coupling.

First reports about the reaction between an aryl halide and stannanes catalysed by palladium came from Colin Eaborn *et al.* in 1976 (Scheme 43).<sup>97</sup> The presented reaction is particular; one of the starting materials – bis(tributyltin) **C3** – contains an Sn-Sn bond. As a result, bromine from **C1** or **C2** is replaced by tributyltin to form compounds containing tin (**C4** or **C5**). At the same time, dimers (**C6** and **C7**) of the starting material (**C1** or **C2**) are formed. Also, side product **C8** was observed for all the reactions. The results from coupling reactions with hexaethyldigermane **C10** and hexamethyldisilane **C18** were also presented. Overall yields of the reactions with three different nucleophiles were between 5 and 57%. However, for the hexamethyldisilane, the yields were soaring, when the catalyst was changed (up to 98% for **C20**, Conditions A to B).

In 1977, two reports were submitted by a Japanese team from Gunma University. In the first statement, Kosugi and Migita described the reaction of aromatic halides with allyltributyltin **C33** to produce allyl derivatives **C34** – **C36** (Scheme 44 A).<sup>98</sup> As the source of palladium, the complex Pd(0) – tetrakis(triphenylphosphine)palladium was chosen. The best results in terms of conversion of the starting material and yield of the product were produced with aryl bromides, the yields being between 72 and 100%. In the case of aryl chlorides, the substituents in the aromatic ring played a significant role. The reaction ultimately failed for **C25**, while for an electron-donating group like in **C27**, the conversion rate was 100% and the yield – 59%. In all cases, the yields for iodo-derivatives **C31** and **C32** were lower, than for corresponding bromides.

<sup>97</sup> D. Azarian, S. S. Dua, C. Eaborn, D. R. M. Walton, *J. Organomet. Chem.* **1976**, *117*, C55–C57.

<sup>98</sup> M. Kosugi, K. Sasazawa, Y. Shimizu, T. Migita, *Chem. Lett.* **1977**, *6*, 301–302.



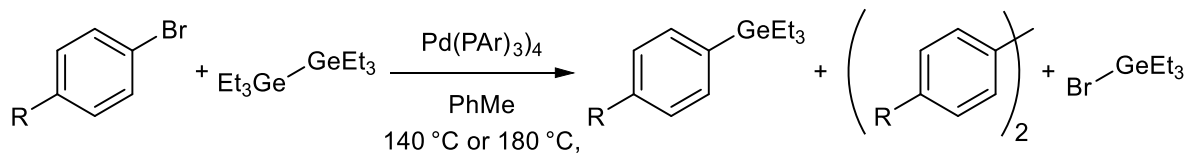
**C1** R = H  
**C2** R = OMe

**C3**

**C4** R = H 28%  
**C5** R = OMe 55%

**C6** R = H 31%  
**C7** R = OMe 8%

**C8**



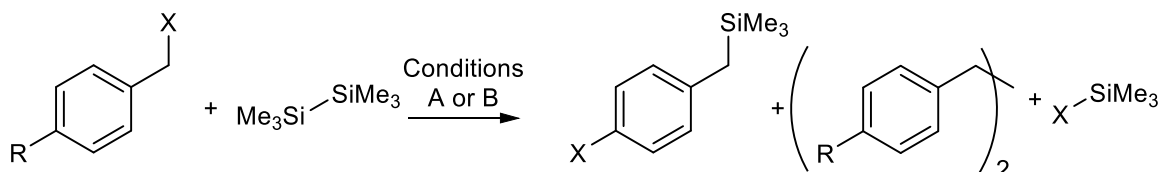
**C1** R = H  
**C9** R = Me

**C10**

**C11** R = H 28%  
**C12** R = Me 35%

**C13** R = H  
**C14** R = Me 60%

**C15**



**C16** R = H, X = Cl  
**C17** R = CN, X = Br

**C18**

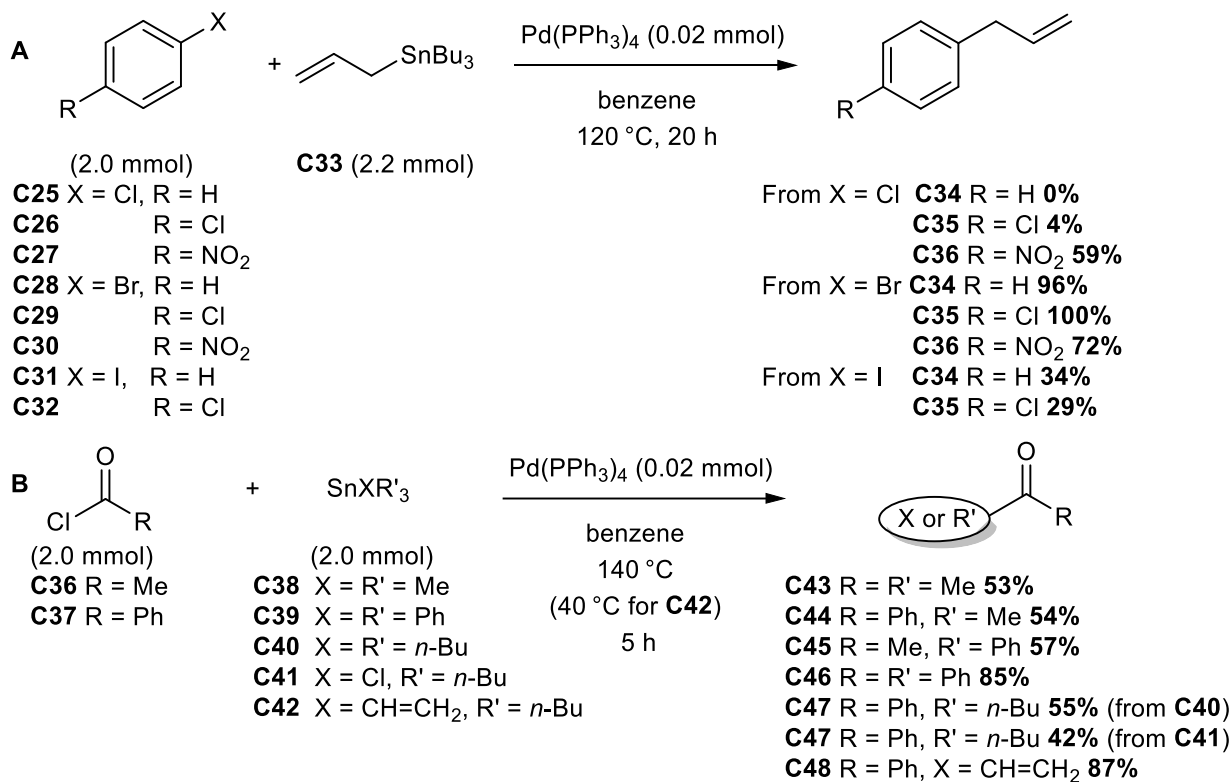
**A:** **C19** R = H 25%  
**B:** **C20** R = CN 98%

**C21** R = H  
**C22** R = CN

**C23** X = Cl  
**C24** X = Br

Conditions A: Pd(PAr<sub>3</sub>)<sub>4</sub>, 140 °C, 60 h  
Conditions B: Pd[P(*p*-OMeC<sub>6</sub>H<sub>4</sub>)<sub>3</sub>]<sub>4</sub>, 140 °C, 10 h

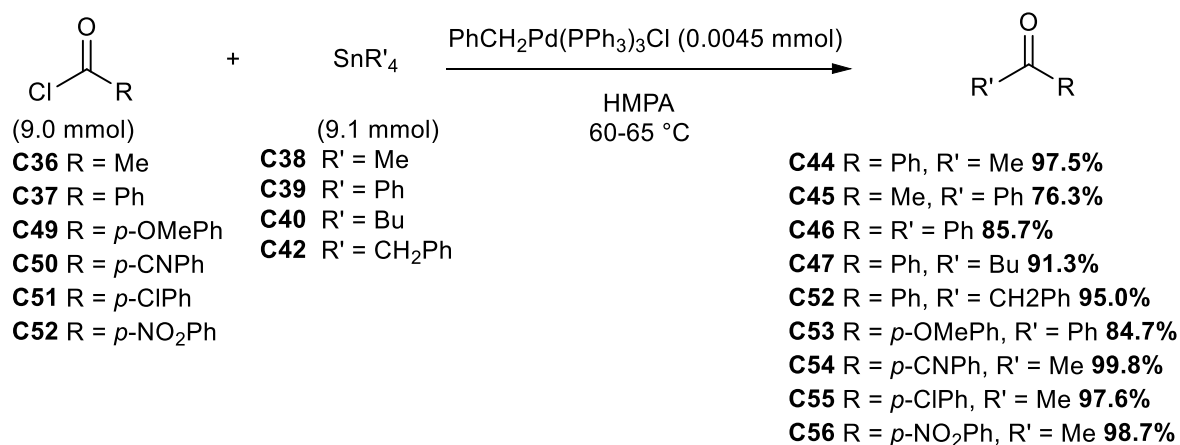
### Scheme 43. Cross-coupling by Eaborn.



### Scheme 44. Cross-coupling by Kosugi and Migita.

The second article focused on the alkylation, arylation and vinylation of acyl chlorides (Scheme 44 B).<sup>99</sup> In comparison to the previous report, the temperature was increased (140 °C instead of 120 °C). Only in the case of vinyl derivative **C42**, the reaction was performed at a lower temperature (40 °C). Also, the time of the reaction was shorter (5 h vs 20 h). The source of palladium remained the same. The yield of the reaction ranged from 42 to 87%. There was not much difference in terms of yield between **C43**, **C44**, **C45** and **C47**. However, the yield was much higher when both substituents were a phenyl group (**C46**, 85%). The highest yield (87%) was achieved for the reaction of vinyltributyltin (**C42**) with benzoyl chloride.

In 1978, another report was published by David Milstein and John K. Stille.<sup>100</sup> They presented a general and selective method for the synthesis of ketones from organostannanes and acyl chlorides catalysed by palladium (Scheme 45). Not only did they try different acyl chlorides, but also different sources of tin, such as tetramethyl, tetraphenyl, tetrabutyl or tetrabenzyltin. The majority of the yields were above 90%. Moreover, the reaction tolerated many different protecting groups. In contrast to the report by Migita,<sup>97</sup> the required temperature was between 60 and 65 °C and the reaction time 10-15 min. Also, the source of palladium was different – PhCH<sub>2</sub>Pd(PPh<sub>3</sub>)<sub>2</sub>Cl. In the same report, a simplified reaction mechanism was proposed with oxidative addition and reductive elimination as the main parts of the catalytic cycle. It was further evaluated by Stille, in the review published in 1986 (Scheme 46 A).<sup>101</sup>



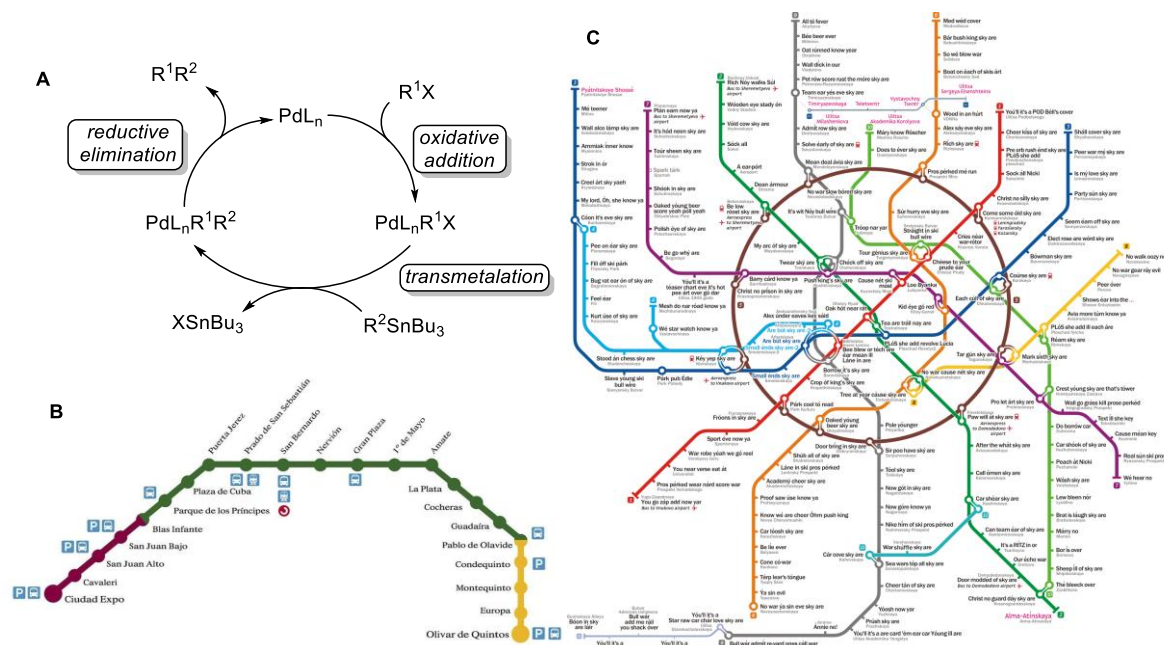
**Scheme 45.** Cross-coupling by Milstein and Stille.

<sup>99</sup> M. Kosugi, Y. Shimizu, T. Migita, *Chem. Lett.* **1977**, 6, 1423–1424.

<sup>100</sup> D. Milstein, J. K. Stille, *J. Am. Chem. Soc.* **1978**, 100, 3636–3638.

<sup>101</sup> J. K. Stille, *Angew. Chemie Int. Ed. English* **1986**, 25, 508–524.

Even though Stille was not the first person to discover this coupling process, his immense input towards understanding the mechanism of the reaction resulted in the reaction being named after him. Unfortunately, sometimes, simple representation does not reflect the real situation. I genuinely admire the comparison of the Stille coupling mechanism to the map of subway transport presented by Espinet *et al.* in the review about Stille reaction (Scheme 46 A).<sup>102</sup> Using their words, the most commonly presented and accepted mechanism of this reaction is simple; there is hardly any place for side reactions; just like the map of the subway in Sevilla – one line (Scheme 46 B). However, in reality, what is really happening is much more complicated, like for example, the subway in Moscow (Scheme 46 C). Going from point A to point B can be achieved in more than one way, and also A and B are not the only points of the exit on the route – this mimics possible side products.



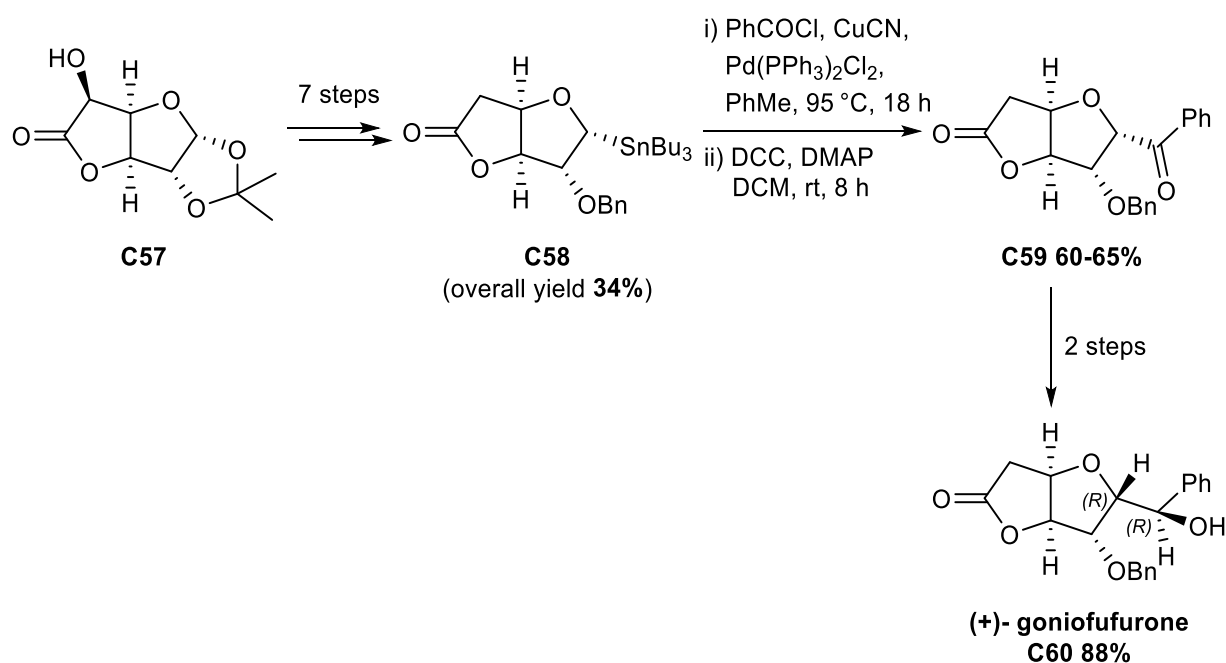
**Scheme 46.** Simplified mechanism vs more complex one.

<sup>102</sup> C. Cordovilla, C. Bartolomé, J. M. Martínez-Ilarduya, P. Espinet, *ACS Catal.* **2015**, *5*, 3040–3053.

## 2. Application of the Stille coupling in the field of glycochemistry

Although the majority of cross-coupling reactions were all invented using aromatic compounds as starting materials, nothing prevents chemists working in the field of glycochemistry to adapt these methodologies to employ them in the domain of carbohydrates.

One of the first implementation of the Stille coupling was presented in 1993 by the team of Falck in the total synthesis of (+)-goniofufurone **C60**.<sup>103</sup> The cross-coupling was performed between compound **C58** and benzoyl chloride (Scheme 47). It required two metals in catalytic amounts – palladium(II) and copper(I) cyanide. Lack of either metal caused the failure of the reaction or significantly reduced the yield of the product. Overall, the yield of this step was between 60 and 65%. It is interesting that, they observed the complete retention of the configuration of the newly formed C–C bond, in contrast to results reported by Stille – a complete inversion of the configuration in the reaction between tetraallylstannanes with benzoyl chloride.<sup>104</sup>



**Scheme 47.** The total synthesis of (+)-goniofufurone **C60**.

Two years later, in 1995, the same team presented the reactivity of the 1-stannylated pyranosides (Scheme 48).<sup>105</sup> The reaction with phenyl chlorothionoformate **C64** (**C67**, nearly

<sup>103</sup> J. Ye, R. K. Bhatt, J. R. Falck, *Tetrahedron Lett.* **1993**, 34, 8007–8010.

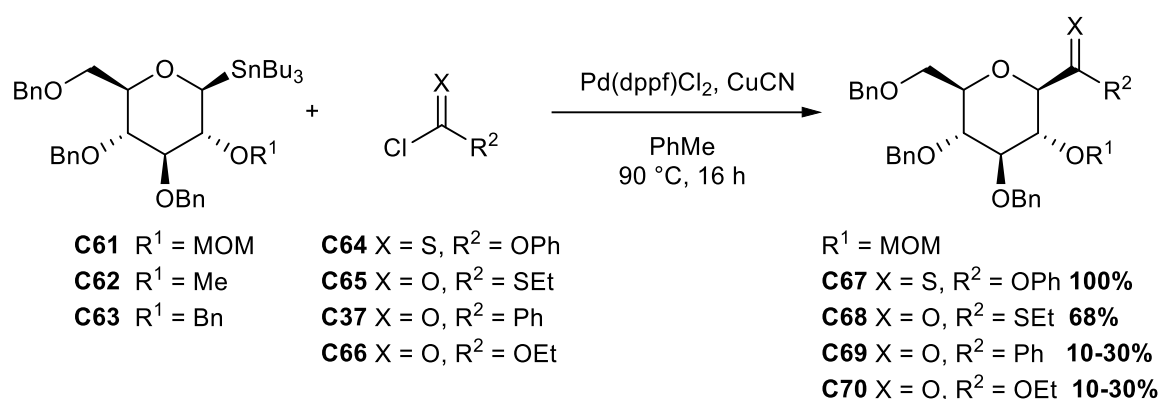
<sup>104</sup> J. W. Labadie, J. K. Stille, *J. Am. Chem. Soc.* **1983**, 105, 6129–6137.

<sup>105</sup> Y. Y. Belosludtsev, R. K. Bhatt, J. R. Falck, *Tetrahedron Lett.* **1995**, 36, 5881–5882.



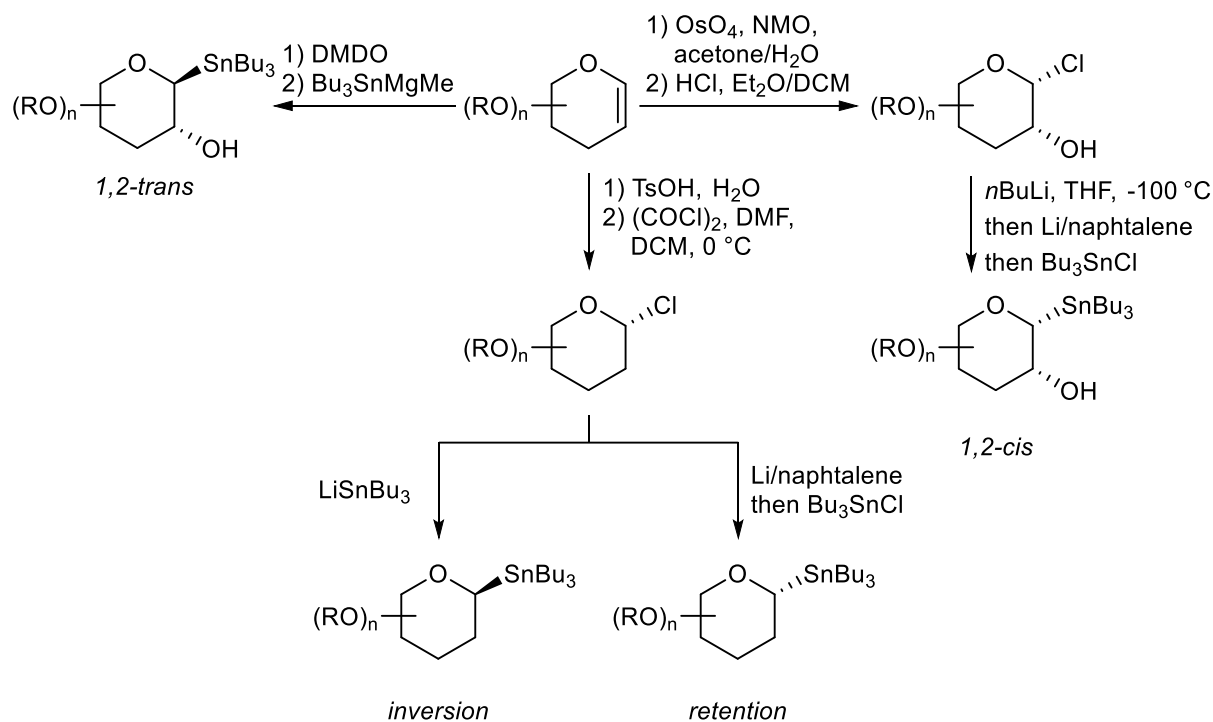
quantitative) and ethyl chlorothioformate **C65** (**C68**, 68%) gave far better results than with benzoyl chloride **C37** or ethyl chloroformate **C66**.

They also evaluated the influence of the substituent at C-2; three protecting groups were investigated – MOM (**C61**), Me (**C62**) and Bn (**C63**). The superior results for **C61** are explained by the existence of organocopper species generated during the reactions, which are stabilised by the highly coordinating group at C-2. For **C62** and **C63**, low yields or decomposition of the starting material were observed.



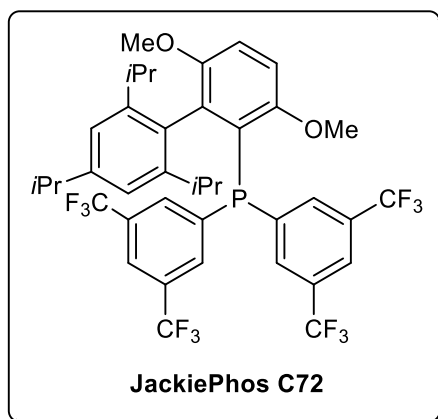
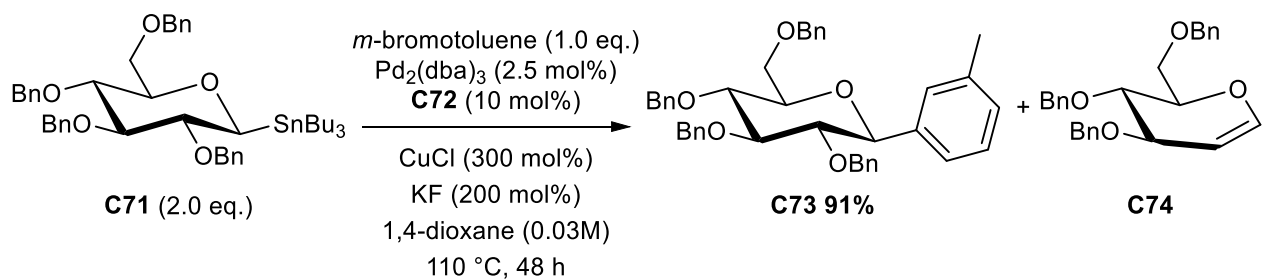
**Scheme 48.** The Stille cross-coupling of pyranosides.

Recently, the group of Maciej Walczak from the University of Colorado in the USA launched a series of articles about the application of 1-stannylated glycosides in organic synthesis. They found many applications for such anomeric stannanes; they were used not only for the synthesis of C-glycosides but also in preparation of selenoglycosides, stereoselective oxidative glycosylation and others. Nonetheless, all the reactions require the introduction of the tin to the sugar moiety (Scheme 49). As the starting material, they used a glycol and then, to obtain specific configuration, followed different protocols. For the 1,2-trans configuration, the reaction sequence goes first through the formation of the epoxide and the selective opening of the epoxide with a Bu<sub>3</sub>SnMgMe. On the other hand, to obtain the 1,2-cis configuration, the reaction proceeded through the formation of a 1,2-cis 1-chloro intermediate and then, replacement with the stannane. Another route was designed for the formation of 2-deoxyglycosylstannanes. At the beginning the glycol was transformed to an anomeric alcohol, then replaced with chloride, which was further submitted to reaction with either tributyltin lithium reagent (with inversion of the configuration at C-1) or lithium/naphthalene followed by tributyltin chloride (with retention of configuration at C-1).

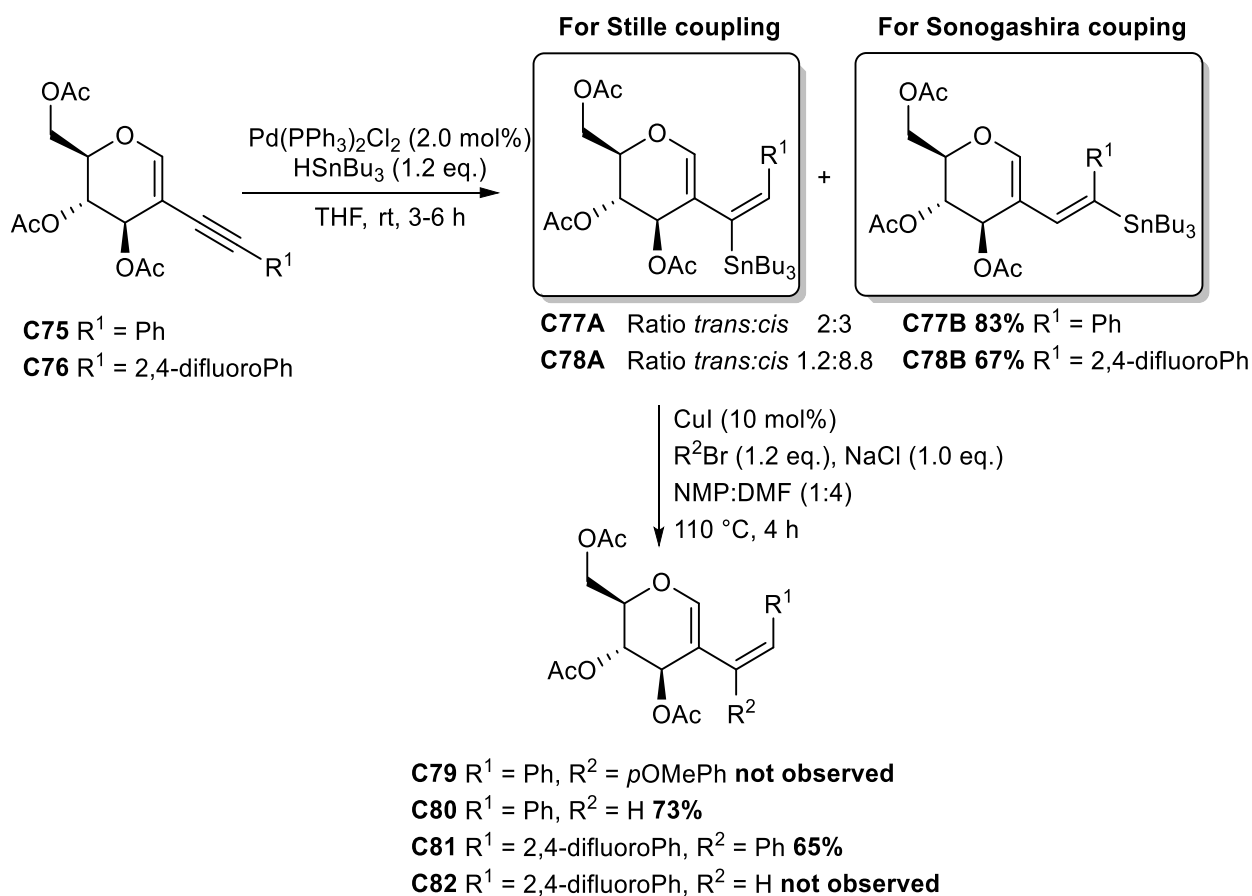


**Scheme 49.** Synthesis of 1-stannylated glycosides from glucals.

The coupling reaction required optimisation in terms of used ligand, which is an essential part of the process (Scheme 50). With suitable ligand **C72** with a beautiful name – JackiePhos, they increased the percentage of compound **C73**, at the same time, decreasing the amount of side product **C74**. This extremely bulky phosphine ligand reduced the possibility of  $\beta$ -elimination. As a result, a single anomer was formed starting from an anomericly pure 1-stannylated glycoside. The configuration of the product was retained from the starting material. Optimised conditions of the reaction were applied to a wide range of aromatic or heteroaromatic iodides or bromides, and also to polycyclic molecules and/or molecules containing amino acids or peptides. The reaction is also compatible with different monosaccharides, not only fully protected ones but also with free hydroxyl groups. In every case, the product is formed as single anomer with a configuration depending on the starting stannane. It is worth to mention that the yield was calculated based on the limiting agent used – the aromatic halides.

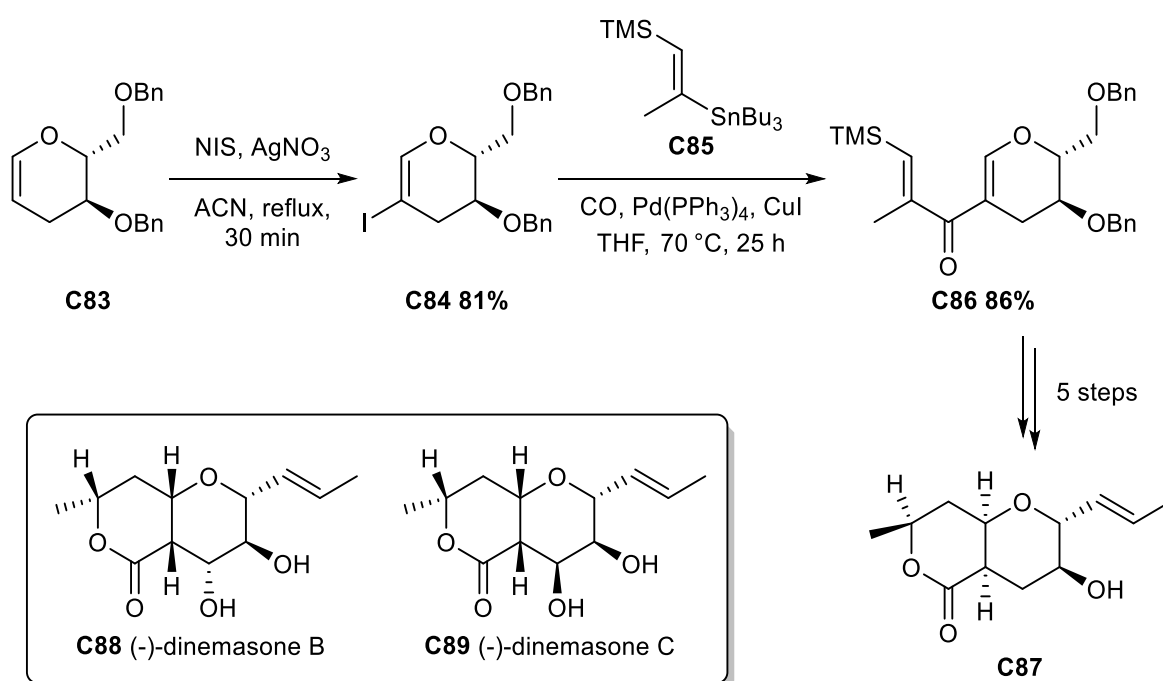


**Scheme 50.** Application of the 1-stannylated glycosides in synthesis (Walczak's group).



**Scheme 51.** Stille coupling of alkenylated glucal derivatives.

There are also some reports with the application of glucals as starting materials in the Stille coupling. One example was presented by Stefani *et al.* (Scheme 51).<sup>106</sup> As the starting material for the Stille coupling, they used glucal-derived vinyl stannanes **C77A** and **C78A**. They were respectively prepared from 2-alkynyl glucal derivatives **C75** and **C76**. In this case, two regioisomers might be created (series **A** and **B**). Afterwards, **A** regioisomers were applied to the Stille coupling with aryl halides, while the **B** – to Sonogashira coupling. The reaction was much more favourable when the aryl substituent was equipped with electron-withdrawing groups (**C81**). Otherwise, the elimination product **C80** was observed as a primary compound. What is also interesting, the reaction worked better when copper(I) iodide was used as the catalyst.



**Scheme 52.** Analogue of (-)-dinemasone B (**C88**) and (-)-dinemasone C (**C89**).

Interestingly, an article submitted by Li *et al.*<sup>107</sup> propose a concise and direct synthesis of an analogue of (-)-dinemasone B (**C88**) and (-)-dinemasone C (**C89**); both compounds were isolated from endophytic fungus *Dinemasporium strigosum* by Krohn and co-workers (Scheme 52).<sup>108</sup> One of the pivotal steps was Stille coupling. However, this time, the tin did not come from the sugar moiety, but from vinylstannane **C85**. The glucal **C84** was assigned in the role

<sup>106</sup> A. Shamim, C. S. Barbeiro, B. Ali, H. A. Stefani, *ChemistrySelect* **2016**, *1*, 5653–5659.

<sup>107</sup> X. Xue, W. Li, Z. Yin, X. Meng, Z. Li, *Tetrahedron Lett.* **2015**, *56*, 5228–5230.

<sup>108</sup> K. Krohn, M. H. Sohrab, T. van Ree, S. Draeger, B. Schulz, S. Antus, T. Kurtán, *European J. Org. Chem.* **2008**, *2008*, 5638–5646.

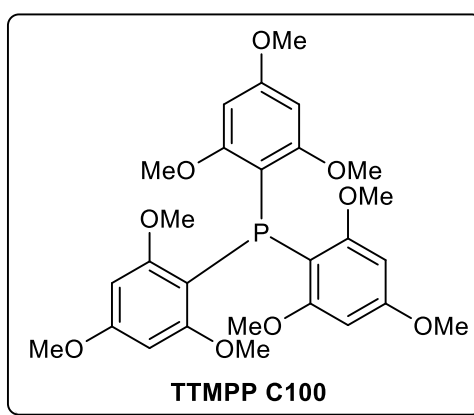
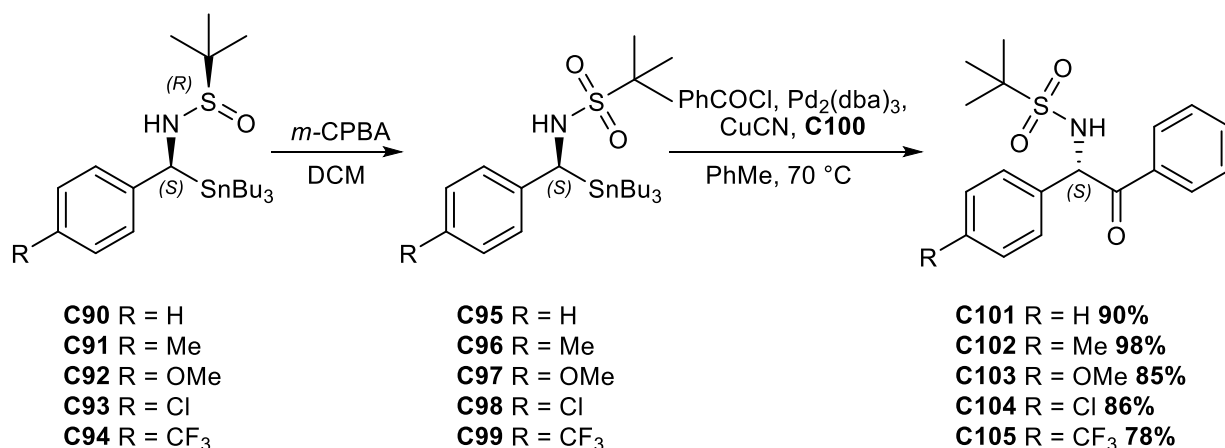
of the electrophile. Remarkable, the Stille carbonylative cross-coupling reaction required the addition of copper to the catalytic palladium under the atmosphere of carbon monoxide to work, but it worked very well (**C86**, yield 86%).

Up-to-date there is no example of the Stille cross-coupling applied to the synthesis of imino-C-glycosides. Most of the work was done in the field of glycals and glycosides. It is also the reason we wanted to pursue this direction – to unlock the straightforward synthesis of very important mimics of glycosides.

### 3. *Tert*-butanesulfinyl group in the Stille reaction

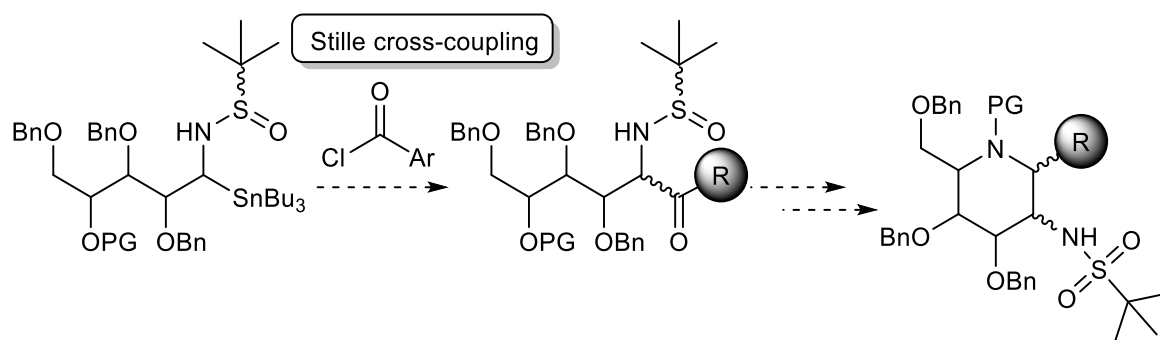
In the literature, there is only one example of the Stille cross-coupling performed on a starting material containing the *tert*-butanesulfinyl group. It was published by Kells and Chong together with the synthesis of *tert*-butanesulfinylorganostannanes (Scheme 22B, Table 1).<sup>91</sup>

Unfortunately, the coupling reaction with various electrophiles under Stille-type conditions failed. They did not identify the cause of the failure, but they found that once the *tert*-butanesulfinyl group is oxidised to *tert*-butanesulfonyl, the Stille coupling with benzoyl chloride was possible (Scheme 53). For the oxidation method, they used *meta*-chloroperoxybenzoic acid in dichloromethane. As the source of the palladium, the complex with dibenzylidene acetone was used. Also, copper was required, this time in the form of copper(I) cyanide. The best results were obtained with the application of bulky tris(2,4,6-trimethoxyphenyl)phosphine (TTMPP, **C100**) as the ligand. The yield of the reaction was between 78 and 98%, depending on the substituents present on the aryl moiety. In all cases, the inversion of the configuration at the benzylic carbon was observed.



**Scheme 53.** The Stille cross-coupling with *tert*-butanesulfonyl imines.

The second part of my project is centred around the application of the Stille cross-coupling with aroyl chlorides to prepare 1-stannylated aminoalditols and cyclise the molecules to obtain 2-AImS (Scheme 54).

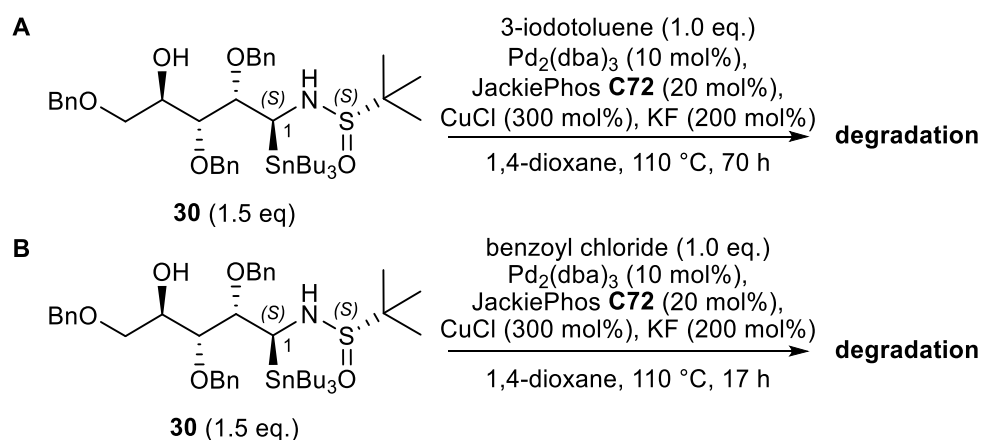


**Scheme 54.** Aim of Chapter 2.

## II. Stille coupling using open-chain 1-stannylated aminoalditols

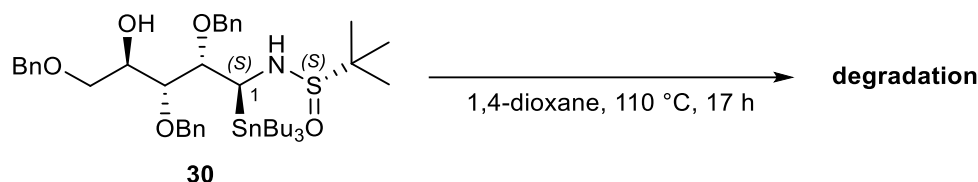
### 1. Preliminary results

With the open-chain stannanes (prepared in Chapter 1) at our disposal, we decided to start with the first trials of cross-coupling reactions. The conditions for the preliminary trials were inspired by the work of Walczak. As the electrophile, we decided to use 3-iodotoluene (Scheme 55 A) and benzoyl chloride (Scheme 55 B). Unfortunately, both reactions failed.



**Scheme 55.** First trials of Stille coupling with stannylated aminoalditols.

We tried to identify the cause of the failure and we realised that the starting material is not stable at elevated temperatures. To verify its thermostability, a simple “degradation” experiment was set (Scheme 56): a small sample of compound **30** was dissolved in 1,4-dioxane and then heated at 110 °C for 17 h. Afterwards, TLC (Thin Layer Chromatography) analysis confirmed the lack of the starting material inside. Also, <sup>1</sup>H NMR of the crude material showed significant changes in the structure of **30** due to prolonged exposure at high temperature. Unfortunately, even after separation using preparative TLC, we were not able to identify the exact structure of the degradation product, but for sure, there was no more tin nor *tert*-butanesulfinyl group in the main compound.

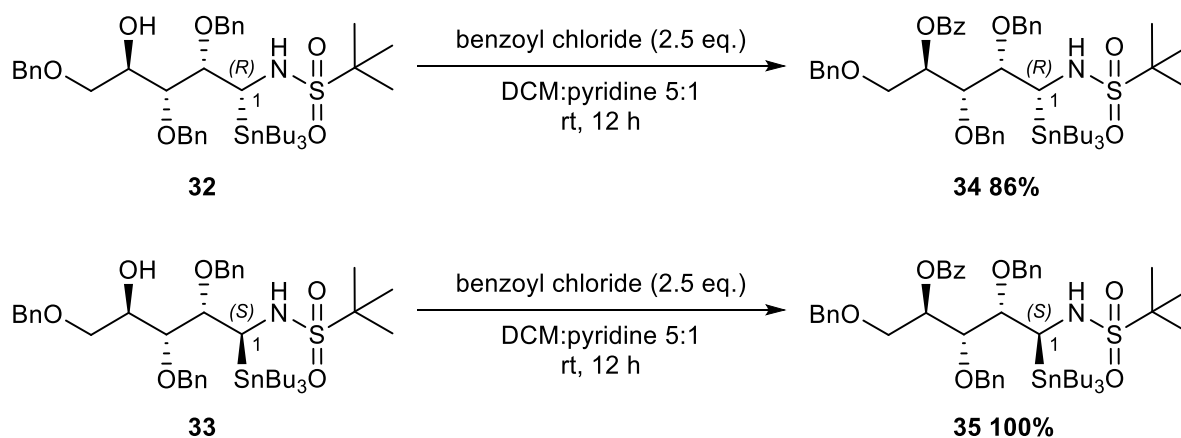


**Scheme 56.** Degradation of compound **30**.

Although the reaction failed, we were not totally surprised: the same result was presented in the publication of Kells and Chong.<sup>93</sup> So, we decided to apply the same solution, namely oxidation of the *tert*-butanesulfinyl group to *tert*-butanesulfonyl.

## 2. Stille coupling for oxidised compounds.

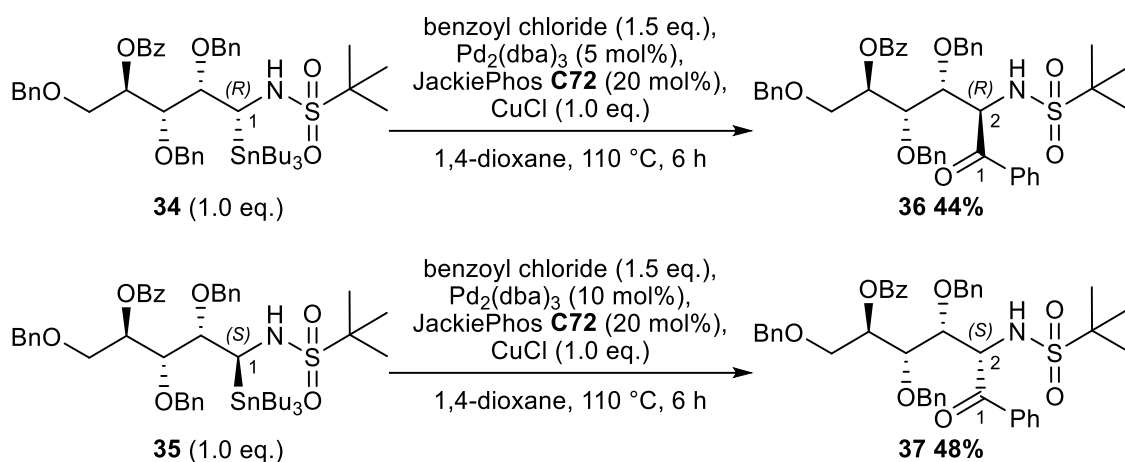
Fortunately, we already were in possession of the oxidised compounds (See Scheme 38). However, before the Stille cross-coupling, we decided to protect the free hydroxyl moiety at C-4 with a benzoyl group (Scheme 57). One of the advantages of this group is that it can be cleaved selectively. Altogether, the reaction worked well, with high yields and the products were easily purified.



**Scheme 57.** Protection of compounds **32** and **33** with benzoyl group.

Then, I did not further optimize the conditions for the coupling reaction. Indeed, in the project run in parallel and realised in close collaboration with dr. Li – the Stille cross-coupling performed on cyclic iminosugar-1-stannanes (Chapter 3), the Stille reaction was already largely optimised by dr. Li and the same conditions were applied to the coupling of the open-chain stannylated aminoalditols.

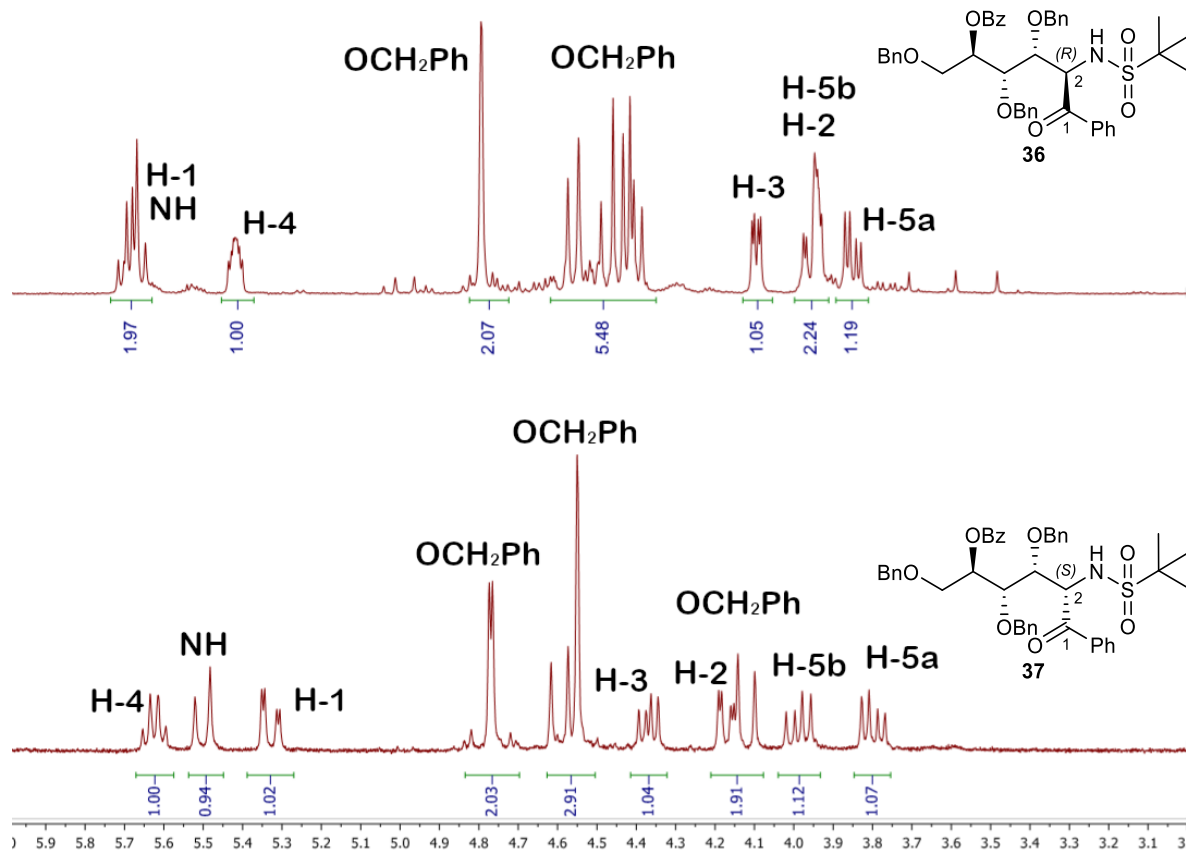




**Scheme 58.** Stille cross-coupling of the compounds **34** and **35**.

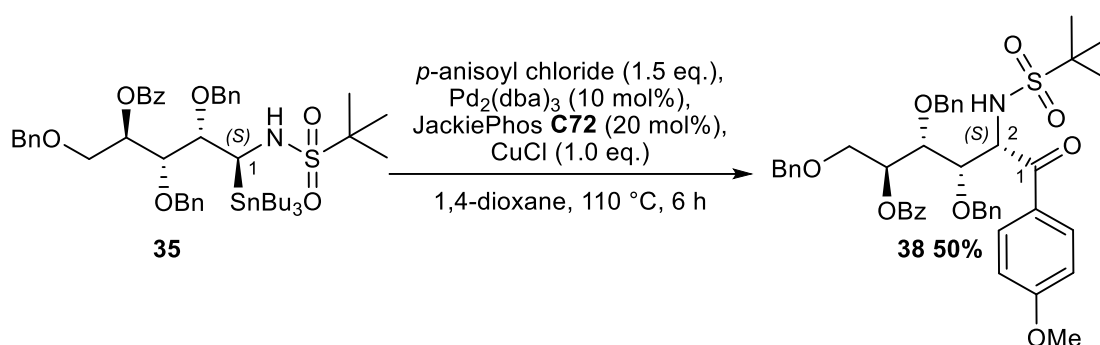
As a result, for both compounds, the reaction worked with moderate yields. We were not able to determine the configuration at C-2 (previously C-1) at this stage, but it is presumed to follow the same trend as in the work of Kells and Chong, which was also observed in the iminosugar series (see Chapter 3 for more details), namely inversion of the configuration in relation with the starting material (but remains *R* or *S* because of an inversion of substituent priority). One of the methods to determine the configuration would be the cyclisation of the molecule and measurements of the coupling constants in  $^1\text{H}$  NMR. All the cyclisation trials will be described in the following section of Chapter 2.

Despite not knowing the absolute configuration, we can compare  $^1\text{H}$  NMR spectra for both compounds (Figure 19). Although it will not solve the question of configuration, it will show if these compounds are different. And yes, indeed, they are vastly different from each other.



**Figure 19.** Comparison of the <sup>1</sup>H NMR spectra of compounds **36** and **37**.

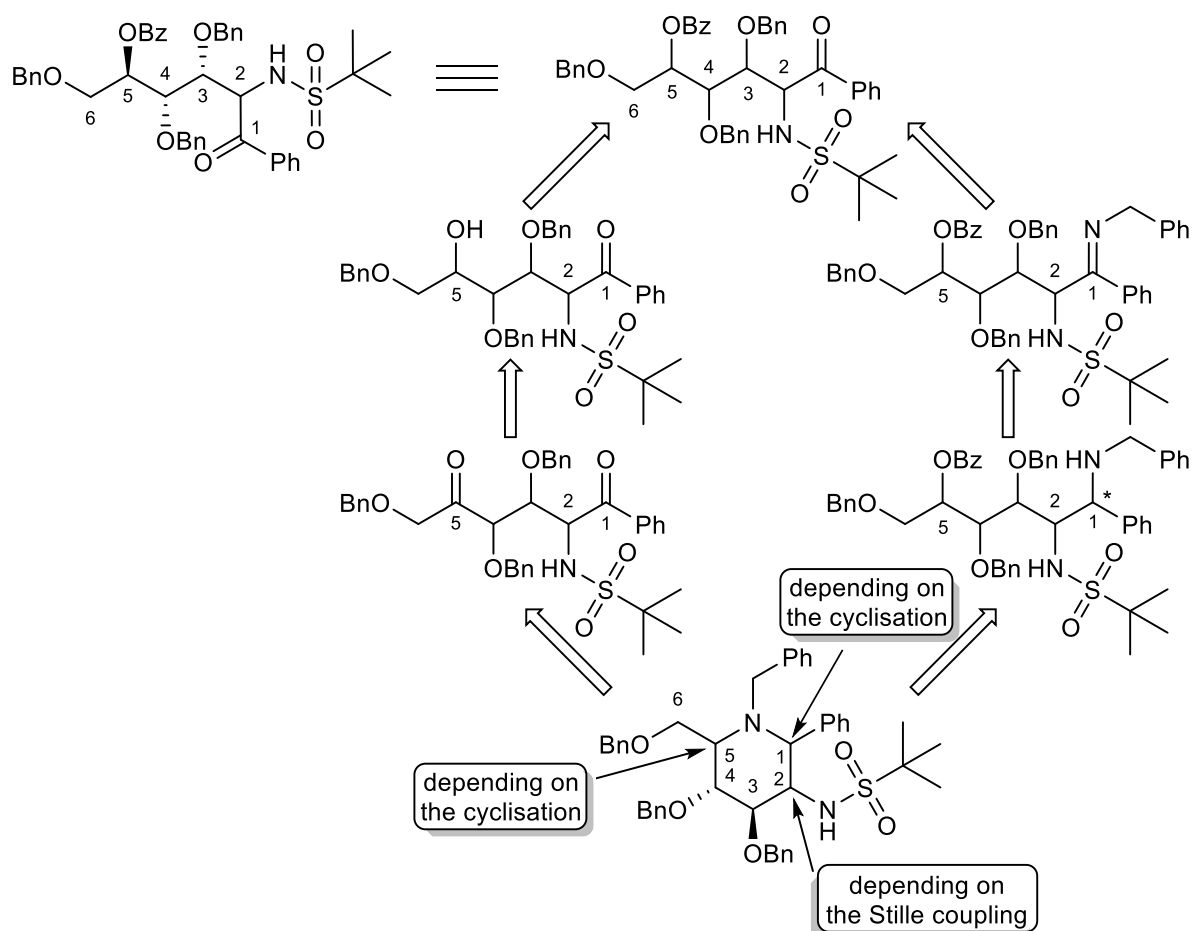
Similar results were obtained with *p*-anisoyl chloride (Scheme 59). The yield of this reaction was slightly better (50%). Like in previous reactions only one diastereoisomer was detected and isolated.



**Scheme 59.** Stille cross-coupling of the compound **35** with *p*-anisoyl chloride.

### III. Synthesis of 2-aminoiminosugars (2-AImS)

Contrary to our predictions, the cyclisation proved to be more challenging than we thought. In this section, I will describe all the pathways of cyclisation we tried. Moreover, we had to find out the way to introduce a second nitrogen atom into the molecule to obtain an iminosugar structure with another amino group at C-2. We thought of two different means to achieve this goal (Scheme 60). Depending on the method applied, various configurations of the final compound might be achieved.



**Scheme 60.** Different approaches to the cyclic iminosugar.

The route on the left side of the scheme via a 1,5-diketone derivative is the most straightforward. It also consists of the least number of steps. It would begin with the deprotection of the hydroxyl group at C-5, followed by oxidation and then – double reductive amination. Due to the stereochemical course of the double reductive amination,<sup>109</sup> we expected

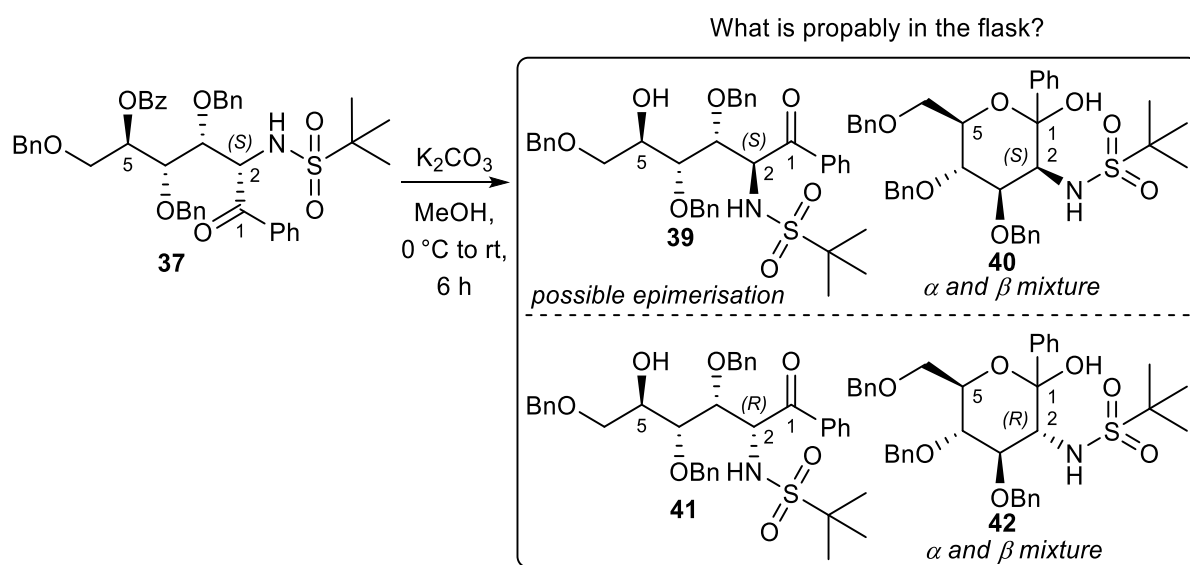
<sup>109</sup> O. M. Saavedra, O. R. Martin, *J. Org. Chem.* **1996**, *61*, 6987–6993.

to obtain the pseudo- $\beta$ -D-*gluco* or pseudo- $\beta$ -D-*manno* configuration predominantly, the configuration at C-2 depending on the stereochemistry of the previous step – Stille cross-coupling.

In the second pathway (right side), the nitrogen would be introduced earlier through the direct condensation of either of the starting materials, **36** or **37**, with an amine, quickly followed by reduction. As the next steps, we planned the cleavage of the benzoyl group and then the activation of the free hydroxyl at position C-5 and  $S_N2$  cyclisation. The sequence might be longer, but it would give an opportunity to access iminosugars in rare configurations – *L-ido* or *L-gulo* (again depending on the result of the Stille coupling).

For the first step of the first route, I decided to use potassium carbonate in methanol (Scheme 61). Deprotection of the benzoate was expected to provide a 5-hydroxy ketone, a structure that might exist as an equilibrium between an open chain form and cyclic hemiketals. The resulting mixture gave a complex  $^1\text{H}$  NMR, most likely containing some percentage of **39** and  $\alpha$ - and  $\beta$ -anomers of **40**. In addition, we cannot exclude the possibility of an epimerisation at position C-2 due to the application of a base in the reaction. In the best case, the mixture would consist of three compounds; in the worse scenario – six compounds.

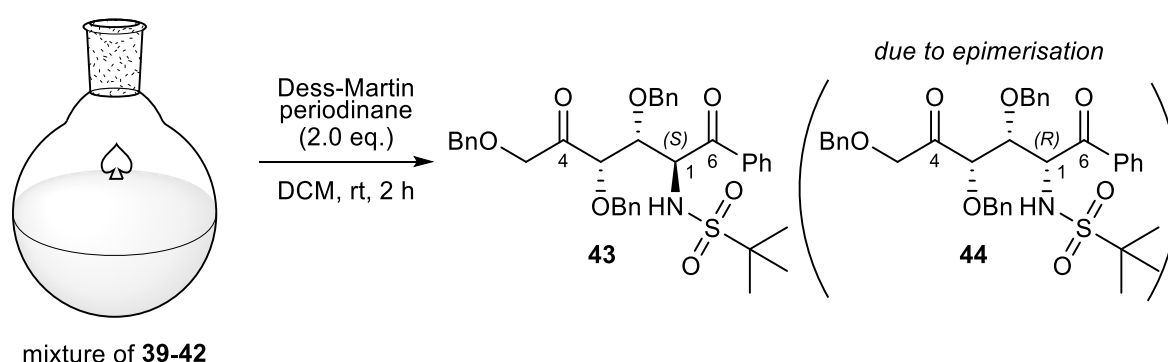
Moreover, the mixture was utterly inseparable using silica gel flash column chromatography. The only solution left was to progress further with this mixture and hope that, the situation will become better.



**Scheme 61.** Deprotection of benzoyl group in compound **37**.

Next reaction was the oxidation to obtain a diketone (Scheme 62). The Dess-Martin periodinane was applied as an oxidant. After the reaction, the  $^1\text{H}$  NMR spectra of the new compound and starting material were compared. Small changes were visible. An attempt of purification was undertaken, but it did not change  $^1\text{H}$  NMR radically and did not help identify the content. Surprisingly, the TLC was relatively clean.

Besides, usually, structures like the 1,5-diketone are somewhat unstable, and it is preferable to use them directly in the next reaction – in this case, double reductive amination. A small sample was taken to verify the presence of a diketone in the sample by High-Resolution Mass Spectrometry (HRMS), and indeed, it was the case.



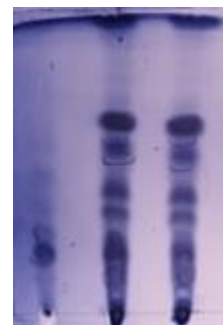
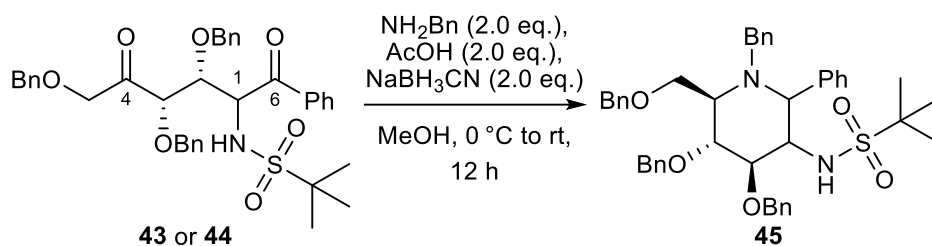
**Scheme 62.** Oxidation of the mixture with Dess-Martin reagent.

The classical conditions of reductive amination were applied (Scheme 63).<sup>110,111</sup> We were still not sure about the possible epimerisation at C-2, so as a result, both configurations mentioned before were possible.

Surprisingly, from something nearly clean (based on the TLC), the TLC analysis after the reaction was much more complicated. Like someone mentioned (here direct quote) “Your TLC looks like the sunset in California”. It was quite accurate statement, it really looked like the sun and its reflection in the water, one more bright spot and countless smaller and slightly less intense spots just below. To be honest, I was not even sure how to tackle a purification like this.

<sup>110</sup> G. Godin, P. Compain, G. Masson, O. R. Martin, *J. Org. Chem.* **2002**, *67*, 6960–6970.

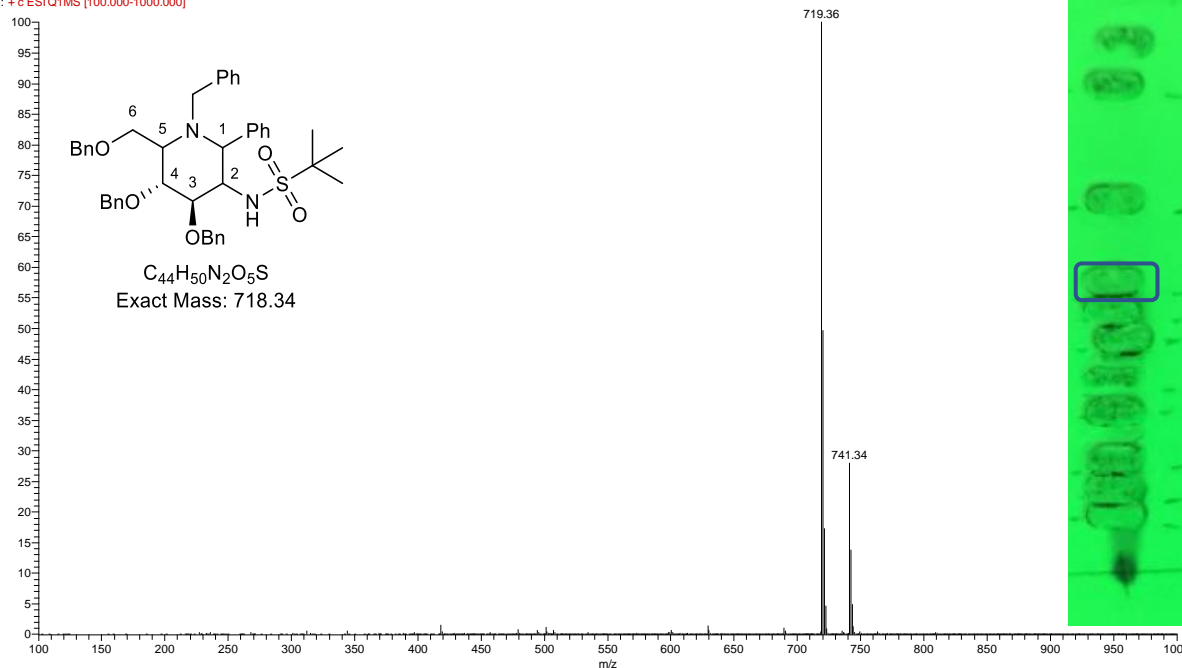
<sup>111</sup> L. E. Overman, *Organic Reactions*. Vol. 59, Wiley, **2002**.



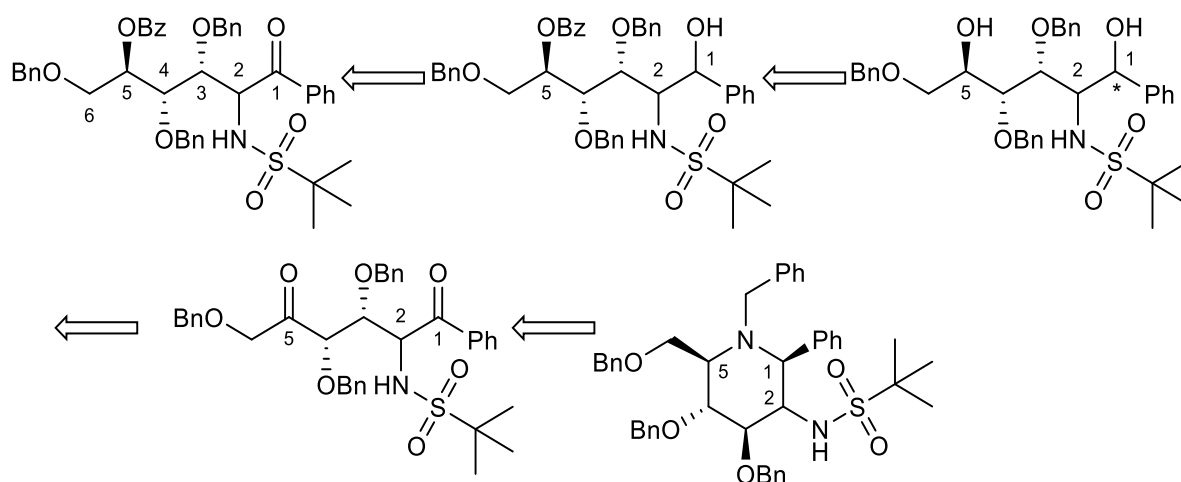
**Scheme 63.** Double reductive amination to obtain 2-AImS.

Fortunately, our Institute is equipped with a TLC-MS device. In essence, this technique allows obtaining the mass spectra of every single spot of the TLC. Small parts of TLC are extracted and then passed through the mass detector. It allows determining if the desired compound is present after the reaction mixture or not. Three spots gave the result corresponding to the mass of the desired compound (Figure 20, three spectra are presented here; the rest can be found in the Experimental section). Because of the side reaction, the formation of multiple isomers was possible; the isomers might migrate differently on the TLC, which would also explain three spots exhibiting the same mass. These three spots are one after the other; we cannot exclude the probability of the trailing of the compound on the TLC plate. Due to the scale of the reaction (8.7 mg) and the multitude of side compounds formed the purification, was not attempted. The <sup>1</sup>H NMR of the mixture was taken, but it was too complicated and unclear to draw any conclusions.

2018113-JAJ343-7 #32-46 RT: 0.47-0.68 AV: 15 SB: 33 0.03-0.23 , 1.27-1.54 NL: 1.44E8  
F: +c ESI QIMS [100.000-1000.000]



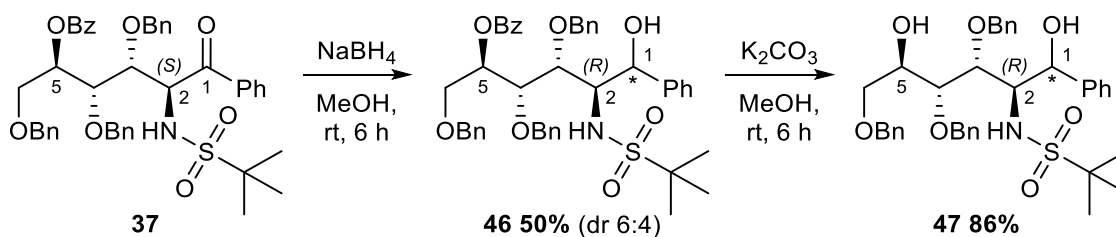




**Scheme 64.** Alternative strategy for the cyclisation.

Compound **37** was treated with sodium borohydride in methanol at room temperature (Scheme 65). Unfortunately, the yield of the recovered compound was just moderate (50%). After careful analysis of the  $^1\text{H}$  NMR spectra, we confirmed the presence of two compounds. In particular, there were two signals in the aliphatic range, two singlets coming from the *tert*-butyl group of two epimers (dr 6:4).

Afterwards, the mixture was submitted to the debenzoylation reaction (Scheme 65). Again, potassium carbonate was used. However, this time, there was no risk of potential epimerisation. The reaction worked quite well (yield 83%). Judging from the  $^1\text{H}$  NMR, two compounds were present inside.



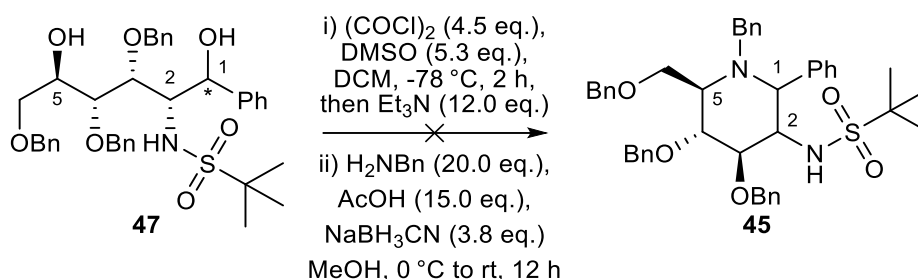
**Scheme 65.** Reduction followed by the deprotection of the benzoyl group.

Subsequently, the mixture of the C-1 epimers **47** was engaged into the two steps – one-pot sequence: double oxidation under Swern conditions directly followed by double reductive amination (Scheme 66).<sup>112</sup> After the work-up, the reaction mixture was purified on preparative TLC; five fractions were isolated, and every one of them was subjected to the MS analysis.

<sup>112</sup> B. Liu, J. van Mechelen, R. J. B. H. N. van den Berg, A. M. C. H. van den Nieuwendijk, J. M. F. G. Aerts, G. A. van der Marel, J. D. C. Codée, H. S. Overkleeft, *Eur. J. Org. Chem.* **2019**, 2019, 118–129.

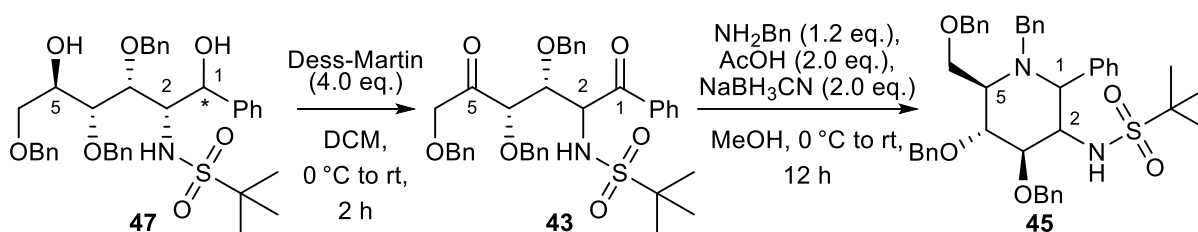


Unfortunately, the signal coming from the desired compound **45** was not found in any of the fractions. Since in previous attempt of cyclisation the reductive amination worked, and this time it was unsuccessful, I suppose that either the Swern oxidation failed or the diketone decomposed.



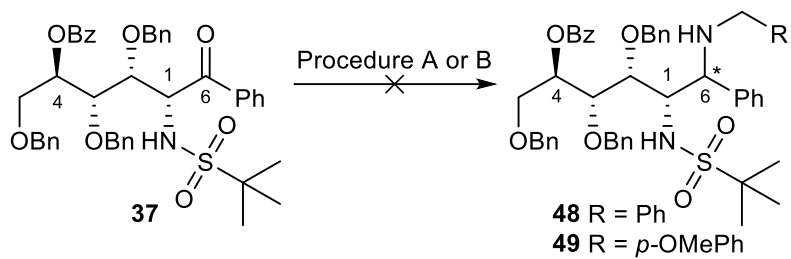
**Scheme 66.** Double oxidation and double reductive amination sequence.

To solve this problem, we decided to repeat the oxidation with Dess-Martin reagent followed by a quick work-up and then double reductive amination (Scheme 67). The reaction mixture was purified via preparative TLC. Seven fractions were isolated and then analysed by LR-MS. Three fractions contained signals showing the correct mass. They were mixed and then given for the HPLC separation. Unfortunately, even with the help of HPLC, we were not able to recover the compound and separate it from the impurities to perform decent  $^1\text{H}$  NMR.



**Scheme 67.** Double oxidation with Dess-Martin reagent and double reductive amination.

Our last attempt of cyclisation was the early introduction of the second nitrogen atom, as described before (Scheme 60). Because the first step was the formation of the imine, which usually lacks stability, we decided to combine condensation and reduction in one sequence and achieve a reductive amination (Scheme 68). The reaction with either of the amines (benzyl and 4-methoxybenzyl) was monitored via TLC, and there were no changes visible. The situation did not change even after the addition of more equivalents of the compounds nor heating the reaction mixture at  $40\text{ }^\circ\text{C}$ .  $^1\text{H}$  NMR analysis confirmed that, in both cases, only the starting material was recovered.



Procedure A: i) H<sub>2</sub>NBn (1.2 eq.), AcOH (2.0 eq.), MeOH, 0 °C, 10 min  
 ii) NaBH<sub>3</sub>CN (2.0 eq.), MeOH, 0 °C, 3 h  
 Procedure B: i) *p*-OMePhCH<sub>2</sub>PhNH<sub>2</sub> (1.0 eq.), DCE, rt, 1 h  
 ii) NaBH<sub>4</sub> (2.0 eq.), MeOH, rt, 16 h

**Scheme 68.** Reductive amination of **37**.

In view of these difficulties, this approach was not further investigated.

## IV. Conclusions

In this part of the project, I wanted to focus on the development of the linear Stille cross-coupling and cyclisation of the obtained molecules to furnish iminosugar-*C*-glycosides.

Despite the failures in the primary results, the first goal of this part of the thesis was achieved. The Stille cross-coupling of the linear stannylated aminoalditols was successful. Although the reaction works with moderate yield, it is stereospecific. Also, the yield of the reaction is comparable with the one presented in the literature for the reaction involving cyclic *C*-glycosyl stannanes. Unfortunately, we were not able to determine the configuration at C-1 after the reaction. The conditions applied to the reaction were not optimised for this type of starting material; they are the result of the direct application of the method developed in Chapter 3. I suppose the yield of the reaction might be increased with correct optimisation.

The elongation of the main carbon chain enables the synthesis of 2-aminoiminosugar scaffolds. However, the cyclisation of the Stille cross-coupling product proved to be much more complicated than we initially assumed. Different ways were tested, some more fortunate, than others. We were able to identify the desired compound, but never pure enough or in sufficient quantity to perform full NMR analysis and determine the configuration of the final compound.

## V. Summary of Chapter 2 *en français*

L'introduction du Chapitre 2 est centrée sur les réactions de couplage, qui permettent la formation d'une liaison C–C (Schéma 41). L'application du palladium comme catalyseur des réactions de couplage a révolutionné le domaine de la synthèse organique. L'importance de la réaction de couplage catalysée par le palladium a été encore soulignée par l'attribution du prix Nobel de chimie en 2010 à Richard F. Heck, Ei-ichi Negishi et Akira Suzuki. Parmi toutes les réactions de couplage développées à ce jour, nous nous sommes particulièrement intéressés au couplage Stille (Schéma 42).

Le premier rapport sur la réaction entre les stannanes et les halogénures d'aryle catalysés par le palladium a été publié en 1976 par Eaborn et ses collaborateurs (Schéma 43). Un an plus tard, deux rapports ont été soumis par Kosugi et Migita. Dans un premier temps, la synthèse de composés allylés utilisant de l'allyltributylétain et divers halogénures a été présentée (Schéma 44 A). Le deuxième rapport concernait la synthèse de cétones par alkylation, arylation et vinylation de chlorures d'acyle (Schéma 44 B). En 1978, David Milstein et John K. Stille (Schéma 45) ont publié un autre rapport sur la synthèse des cétones par réaction de couplage incluant l'étain. Contrairement au rapport de Kosugi et Migita, la température requise était plus basse (entre 60 et 65 °C) et le temps de réaction 10-15 min. Même si Stille n'a pas été la première personne à découvrir ce processus de couplage, son immense contribution à la compréhension du mécanisme de la réaction a fait que la réaction porte son nom. Le mécanisme simplifié a également été présenté (Schéma 46).

La réaction de Stille telle qu'adaptée au domaine de la chimie des sucres, est présentée, y compris les travaux de Falck, Walczak, Stefani, Li et Kurtán. Il existe également un rapport sur le couplage Stille utilisant un produit de départ stannylé portant le groupe *N-tert*-butanesulfinyl, décrit par Kells et Chong. La réaction avec cet auxiliaire chiral a échoué ; cependant, le groupe sulfinyle a été oxydé en sulfonyle et la réaction a bien fonctionné avec d'excellents rendements (Schéma 53). La configuration du centre chiral est inversée dans ce système.

La deuxième partie de mon projet était centrée sur l'application du couplage croisé de Stille avec des chlorures d'aryle pour préparer des aminoalditols portant un group acyle et cycliser

les molécules pour obtenir du 2-AImS (Schéma 54). Les premiers essais du couplage de Stille ont été réalisés avec des composés sulfinylés non oxydés et ont échoué (Schéma 55). Nous nous sommes rendu compte que le produit de départ était instable aux températures élevées (Schéma 56). Heureusement, la réaction a fonctionné avec les composés oxydés (Schémas 58 et 59). Bien que la réaction donne le produit attendu avec un rendement modéré, elle est stéréospécifique. De plus, le rendement de la réaction est comparable à celui présenté dans la littérature pour la réaction avec les 1-glycosylstannanes. A ce stade, nous n'avons pas été en mesure de déterminer la configuration en C-1 après la réaction. Les conditions appliquées à la réaction n'ont pas été optimisées pour ce type de produit de départ ; elles résultent de l'application directe de la méthode développée au Chapitre 3. Je suppose que le rendement de la réaction pourrait être augmenté avec une optimisation correcte.

L'allongement de la chaîne principale de carbone permet la synthèse de scaffolds de type 2-aminoiminosucre (Schéma 60). Cependant, la cyclisation du produit de couplage croisé de Stille s'est avérée beaucoup plus compliquée qu'on ne l'avait d'abord pensé. Différentes méthodes, y compris l'introduction précoce ou tardive du deuxième atome d'azote, ont été testées, certaines plus heureuses que d'autres. Nous avons pu identifier le composé désiré par spectrométrie de masse, mais nous n'avons jamais pu l'obtenir assez pur ou en quantité suffisante pour effectuer une analyse RMN complète et déterminer la configuration du composé final.



# Chapter 3

---

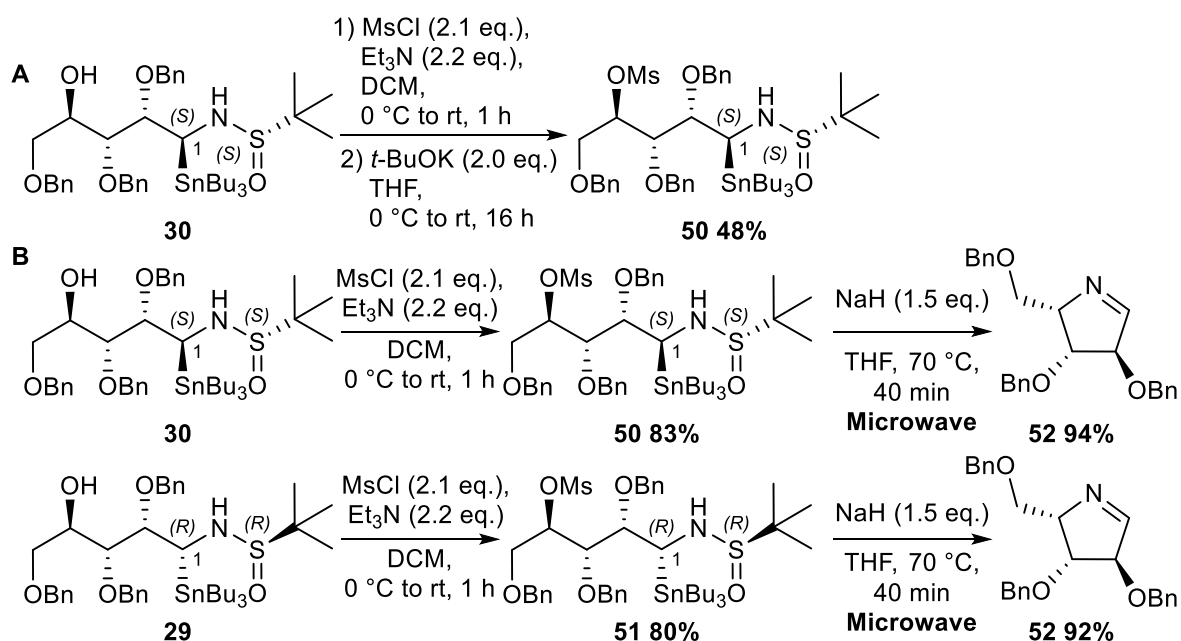




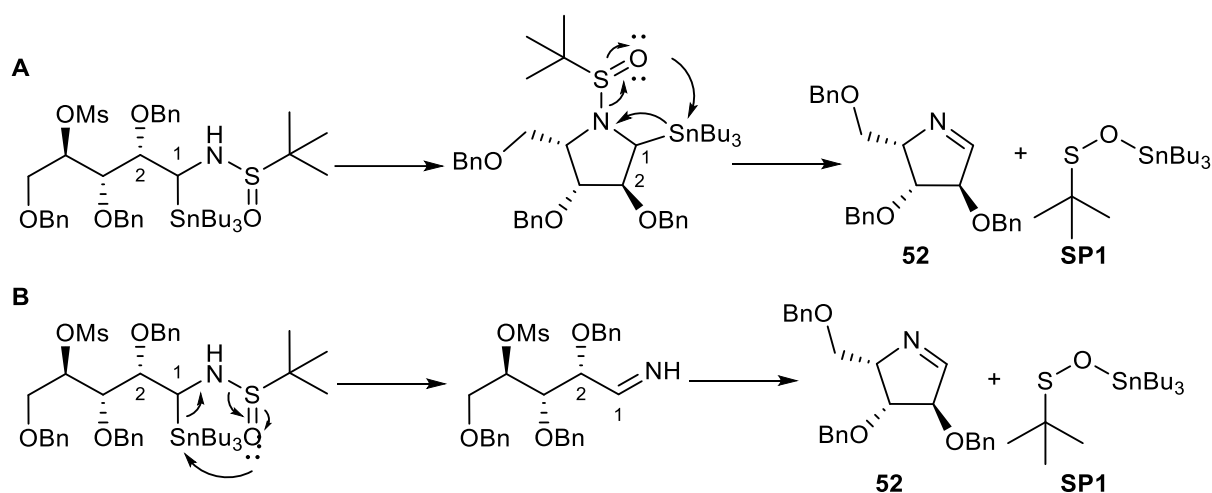
In this part of my report, I would like to speak about the Stille cross-coupling reaction of cyclic iminosugar-1-tributylstannanes. This project was realised in close collaboration with dr Sizhe Li (SL) and in parallel with the Stille reaction of open-chain stannylated compounds (Chapter 2). To fully explain the discovered patterns, I will have to combine the results obtained during this PhD, as well as those obtained by the post-doctoral fellow SL. A clear distinction will be made between my contribution and that of SL.

## I. Cyclisation of open-chain 1-stannylated aminoalditols

For the cyclisation of open-chain stannylated compounds, we decided to use the method mentioned previously for the synthesis of the 1,4- and 1,5-dideoxyiminopentitol derivatives (Scheme 33 and 34), which consists of activating C-4 via formation of a mesylated derivative followed by  $S_N2$  cyclisation using potassium *tert*-butoxide, which will lead to inversion of the configuration at C-4. At the start, we decided to try the cyclisation directly with sulfinylamino compounds **29** and **30** (Scheme 69 A). The reaction was monitored by TLC. At 0 °C or even allowing the reaction to warm up to room temperature overnight (16 h) no changes were observed and the mesylated intermediate **50** was recovered. We decided to replace the hindered base with sodium hydride (Scheme 69 B).



**Scheme 69.** Cyclisation of compounds **29** and **30**.



**Scheme 70.** Proposed mechanisms for the formation of compound **52**.

Again, the mesylation worked well for both starting materials. However, the S<sub>N</sub>2 reaction did not work at room temperature and the starting material was recovered. Then, when heating the reaction mixture at 70 °C for 40 min under microwave irradiation, instead of isolating the cyclic 1-stannylated *N*-sulfinylated iminosugars, in both cases we obtained a degradation compound **52** (analogue of nectrisine). Noteworthy, during the reaction, two groups (i.e. sulfinyl and tributyltin) were eliminated. Two mechanisms are proposed to rationalise this elimination process and structure of possible side product (**SP1**) (Scheme 70).

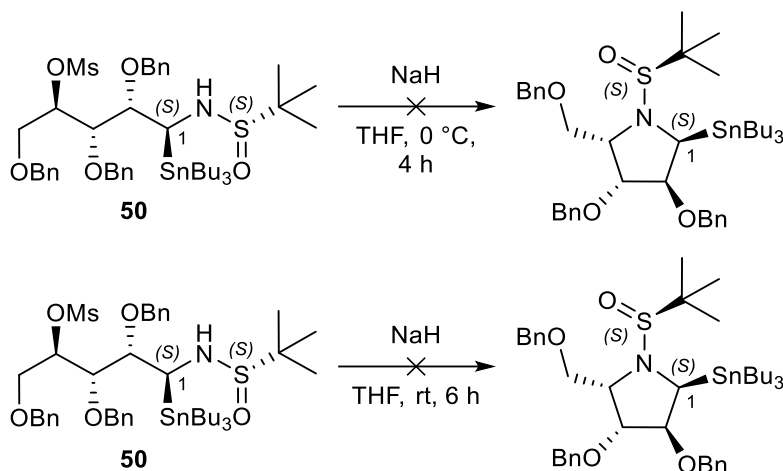
In the first proposed case (Scheme 70 A), the elimination pathway would take place after the cyclisation. Possible reasons favouring this process might be the steric proximity and *cis*-relation of these two groups – electron-rich oxygen and electron-deficient tin, with a possible concerted β-elimination similar to that of selenoxides<sup>113</sup> leading to alkenes; this new type of elimination might be facilitated by the formation of an energetically favourable Sn–O bond.

Furthermore, the S<sub>N</sub>2 cyclisation was performed at elevated temperature thus possibly favouring the elimination process in the open-chain stannylated compound **30**. The increased temperature might allow the early elimination of both functional groups, but thanks to the presence of the mesylate at C-4, the resulting imine could cyclize to give the dihydropyrrole **52** (Scheme 70 B).

One possible way of excluding the second proposed mechanism would be trying to cyclise the compounds at low temperature. Unfortunately, as noted previously (Scheme 69 A) the S<sub>N</sub>2

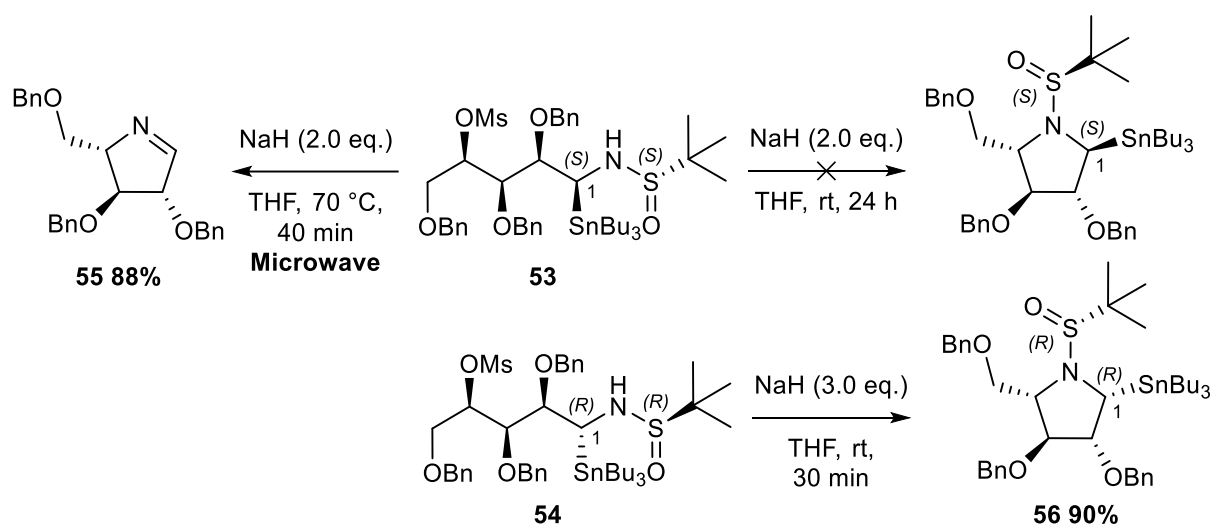
<sup>113</sup> H. J. Reich, S. Wollowitz, in *Org. React.*, John Wiley & Sons, Inc., Hoboken, NJ, USA, **1993**, pp. 1–296.

cyclisation performed at 0 °C or room temperature failed, and the starting mesylate **50** was recovered (Scheme 71).



**Scheme 71.** S<sub>N</sub>2 cyclisation at lower temperatures.

Similar experiments were done by SL from a different sugar scaffold – D-xylofuranose (open-chain stannylated **53** and **54**) (Scheme 72). He observed the same behaviour for compound **53** and when the reaction mixture was heated at 70 °C, compound **55** was isolated. Of course, cyclisation of the *S<sub>S</sub>* derivative **53** at room temperature was unsuccessful and the starting material was recovered. Surprisingly, with **54**, SL was able to isolate the cyclic *N*-sulfinyl 1-stannylated iminosugar **56**, when performing the reaction at room temperature. This remarkable difference may be due to the fact that in **56**, the tributylstannyl at C-1 and the benzyloxymethyl at C-4 are in *cis*-relation and, for the elimination to take place, the *tert*-butylsulfinyl group should occupy a highly unfavourable *cis* position with respect to both of these hindered groups; hence elimination is not favourable in this configuration. Only in this series, the desired *N*-sulfinylated cyclic iminosugar was stable. Taking advantage of the easy cleavage of the sulfinyl group, it was possible to exchange it in **56** for carbamates (i.e. *N*-Boc and *N*-CBz by treatment of **56** with HCl in methanol followed by neutralisation with a basic anion exchange resin, and subsequent reaction with Boc<sub>2</sub>O and CBzCl respectively).



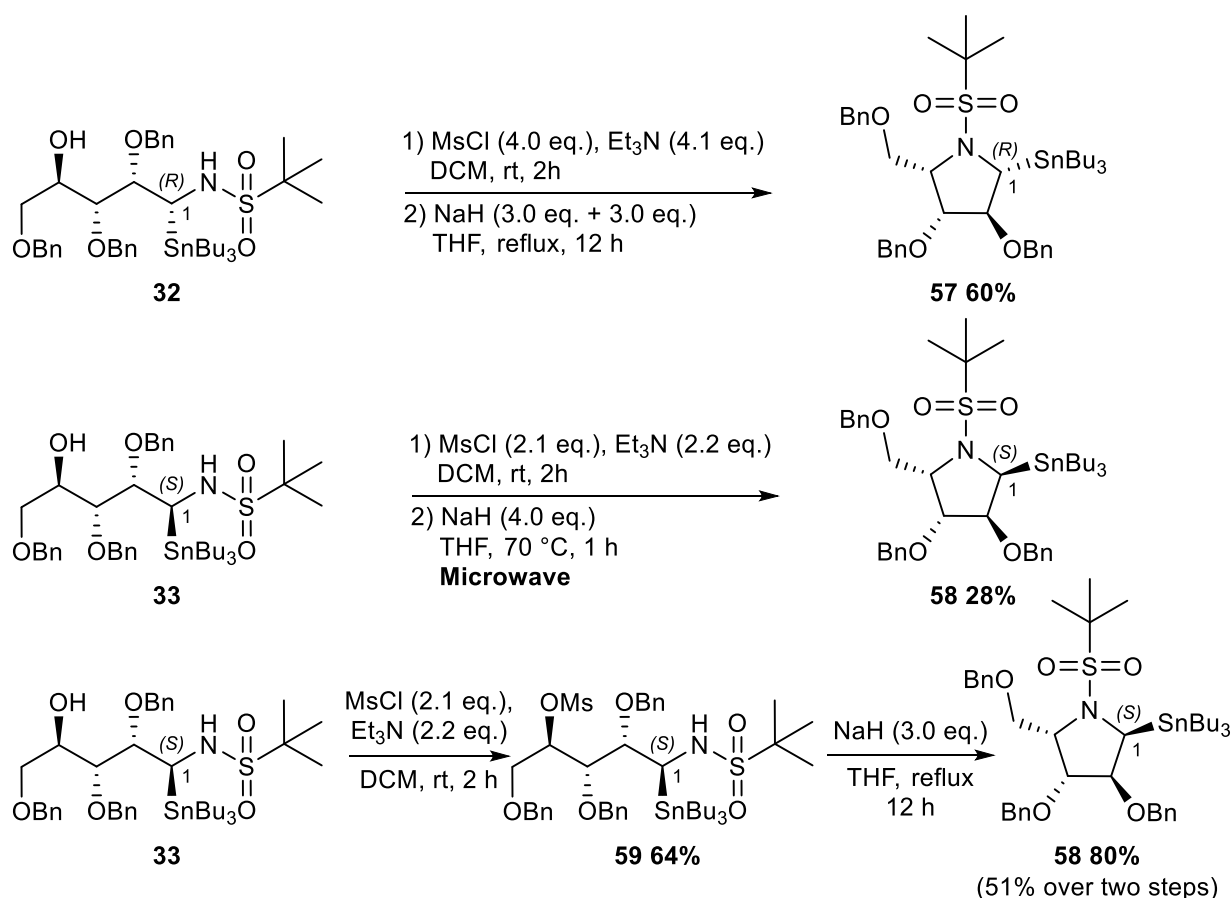
**Scheme 72.** Cyclisation in the D-xylofuranose series.

At this part, we were intrigued by the specific reactivity of compounds **50**, **51**, **53** and **54**. What are the sterics and electronic parameters that make the cyclic iminoglycosylstannane derivatives stable or not? In the collaboration with prof. Claude Legault from the University of Sherbrooke, DFT calculations are currently under investigations.

## II. Cyclisation of oxidised stanannes

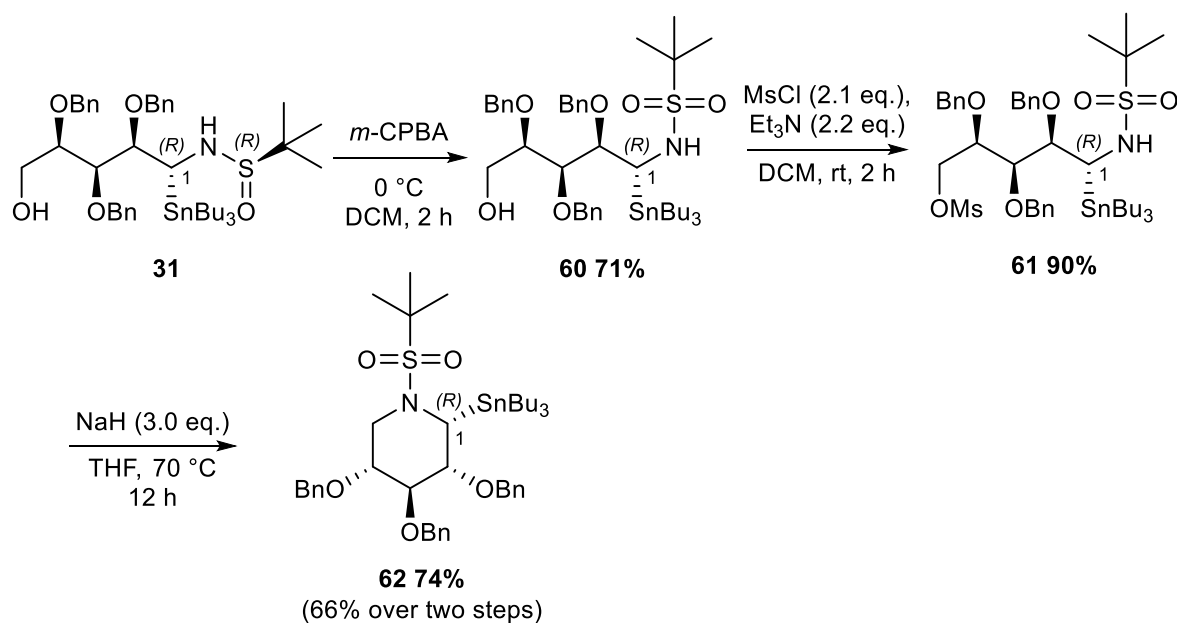
### 1. Results of the cyclisation

From the experiments with the Stille cross-coupling of open-chain aminoalditols, we knew that derivatives oxidised to the sulfonylamine possessed much higher stability. As a result, when the cyclisation of non-oxidised compounds (**29** and **30**) failed, we decided to switch to oxidised derivatives (**32** and **33**) and use the same strategy (Scheme 73). The sequence worked in moderate yield for compound **32** to furnish **57** (60%), but not for **33**; the yield over two steps to obtain **58** was only 28%. Surprisingly, much better results (e.g. 51%) were achieved when the mesylated intermediate **59** was isolated through quick silica gel flash column chromatography. Interestingly, it was possible to perform the cyclisation step at the bench with regular heating or under microwave irradiation with same efficacy. After the cyclisation, both compounds were in *L-xylo* configuration.



**Scheme 73.** Cyclisation of oxidised compounds **32** and **33**.

For the open-chain 1-stannylated aminoalditol **31** prepared from protected D-xylopyranose **11**, we settled on the oxidation followed by the cyclisation sequence with the isolation of the intermediate product (Scheme 74). In comparison with D-*arabino* series (Scheme 38), the oxidation gave lower yields. However, the yields of the mesylation and the cyclisation were slightly higher (90% and 73% respectively). In this case, the cyclisation does not affect the configuration; therefore, it remains D-*xylo*.



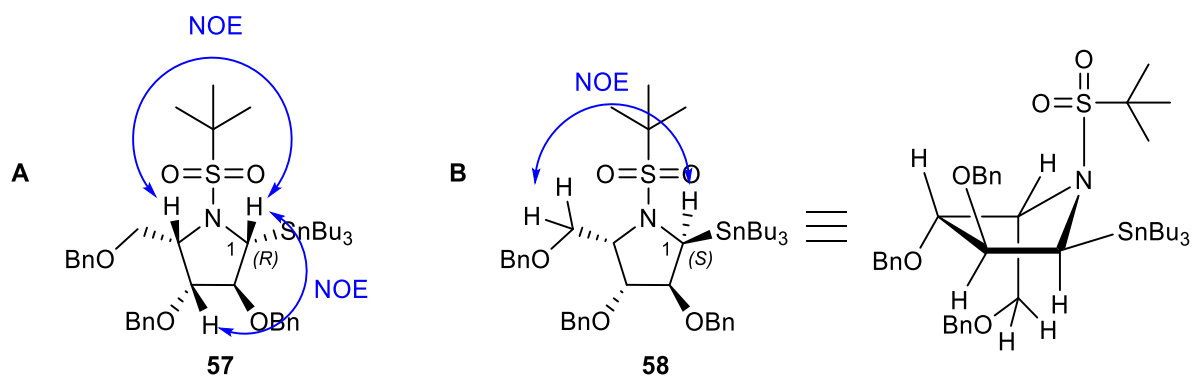
**Scheme 74.** Oxidation and cyclisation of compound **31**.

## 2. Determination of the configuration via NMR studies

1D and 2D NMR techniques are very convenient methods to determine chemical structures and configurations. NOESY (Nuclear Overhauser Effect Spectroscopy) belongs to the group of 2D NMR experiments and, as the name suggests, allows the observation of NOE (Nuclear Overhauser Effect), which is very useful in structural determination. It allows the observation of through-space correlation signals arising from protons in close proximity (up to 5 Å), even if they are not bonded to each other, via spin-lattice relaxation.

Direct comparison of the  $^1\text{H}$  NMR spectra of cyclic compounds **57** and **58** proved that they were different from each other, but 1D- $^1\text{H}$ -NMR itself was not helpful in terms of determining the configuration, due to overlapping of signals in **57** and **58**. Moreover, because of the

flexibility of the pyrrolidine ring and rapid changes of conformation, we cannot rely on the values of the coupling constants, like in the piperidine series. The NOESY spectra were thus irreplaceable in the pyrrolidine series because we could observe NOE effects, which would allow the assignment of configuration. There are a few possibilities to observe the NOE in these compounds (Figure 21). Moreover, knowing that **57** and **58** are epimers at C-1, if we identify the configuration of one of the compounds, we can assume that the other possesses the opposite configuration.



**Figure 21.** Potential correlations in the NOESY spectra of compounds **57** and **58**.

All the potential interactions were listed above. However, the lack of signal does not equal lack of interaction; it could also mean weak intensity, and it was not registered. For compound **57**, there is a small signal from the correlation between H-C-1 and H-C-4 which confirms that the protons are in close spatial proximity (Figure 22). It is possible that due to the sulfonyl group present at the nitrogen atom the correlation appears to be weak. Other possible interactions like between H-C-1 and H-C-3 did not give any signal.

There are not many possibilities to determine the configuration of the second epimer. There are no potential interactions between H-C-1 and H-C-4 nor between H-C-1 and H-C-3. However, we do observe signals coming from H-C-1 and H-C-5 (Figure 23), indicating close proximity of these groups in a favourable conformation (Figure 21 B).

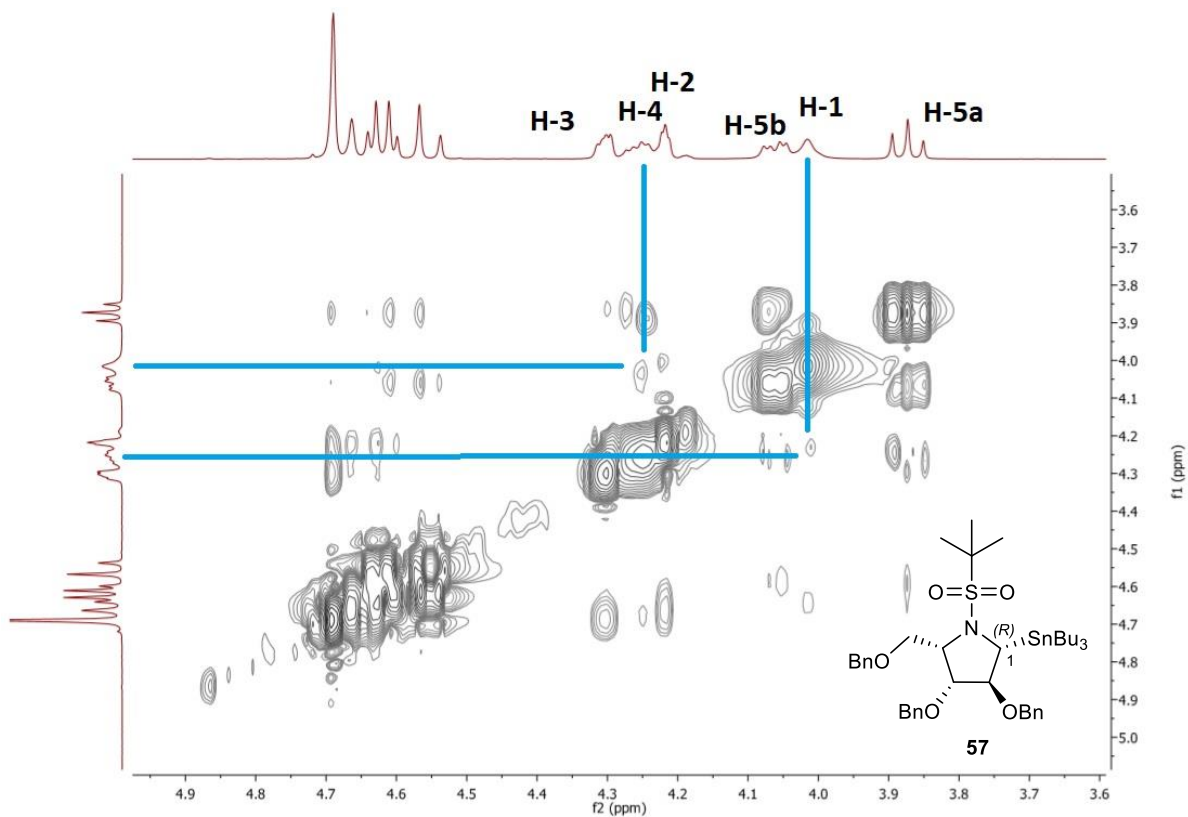


Figure 22. NOESY spectra of compound **57**.

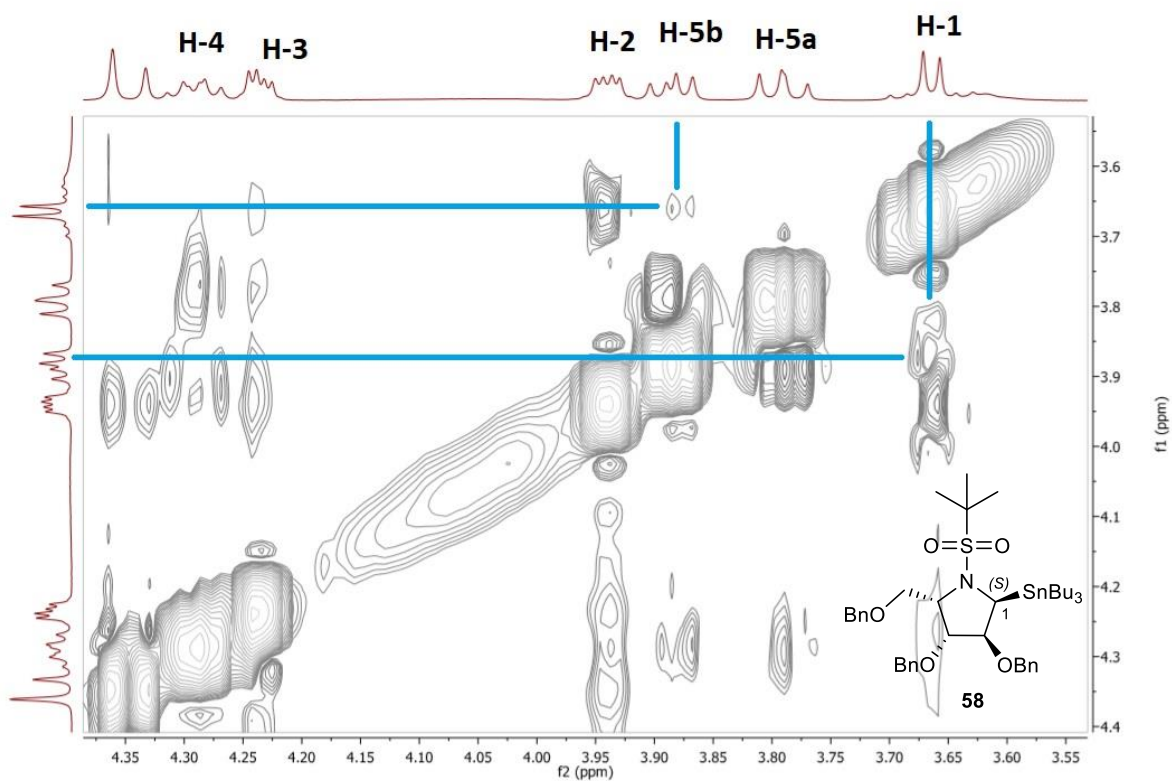
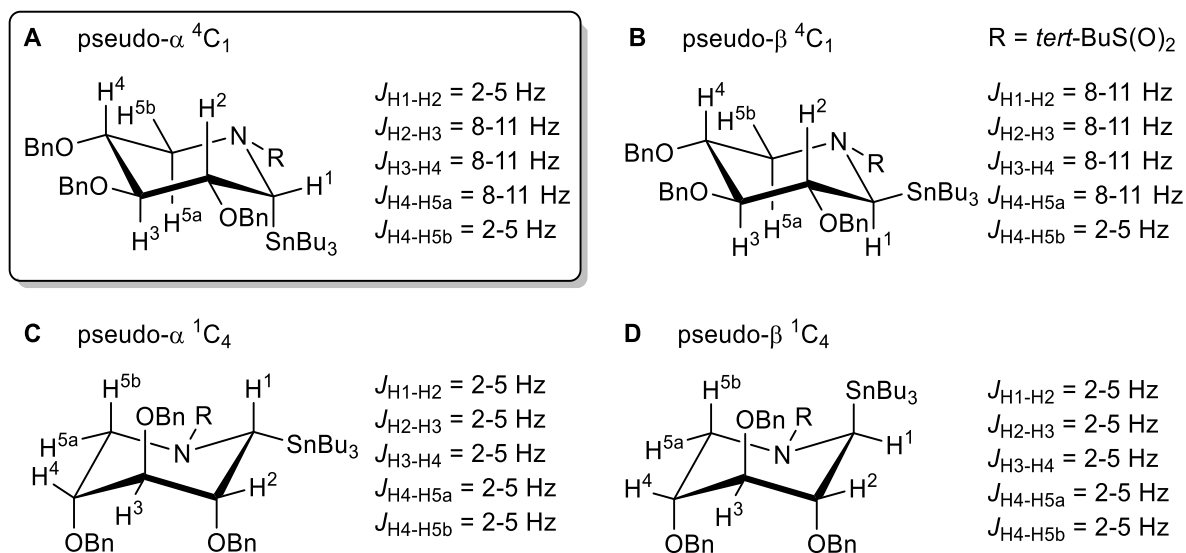


Figure 23. NOESY spectra of compound **58**.



For compound **62**, as it is a piperidine, we were able not only to determine the configuration but also its conformational arrangement using the values of the coupling constants in the  $^1\text{H}$  NMR spectra (Figure 24).

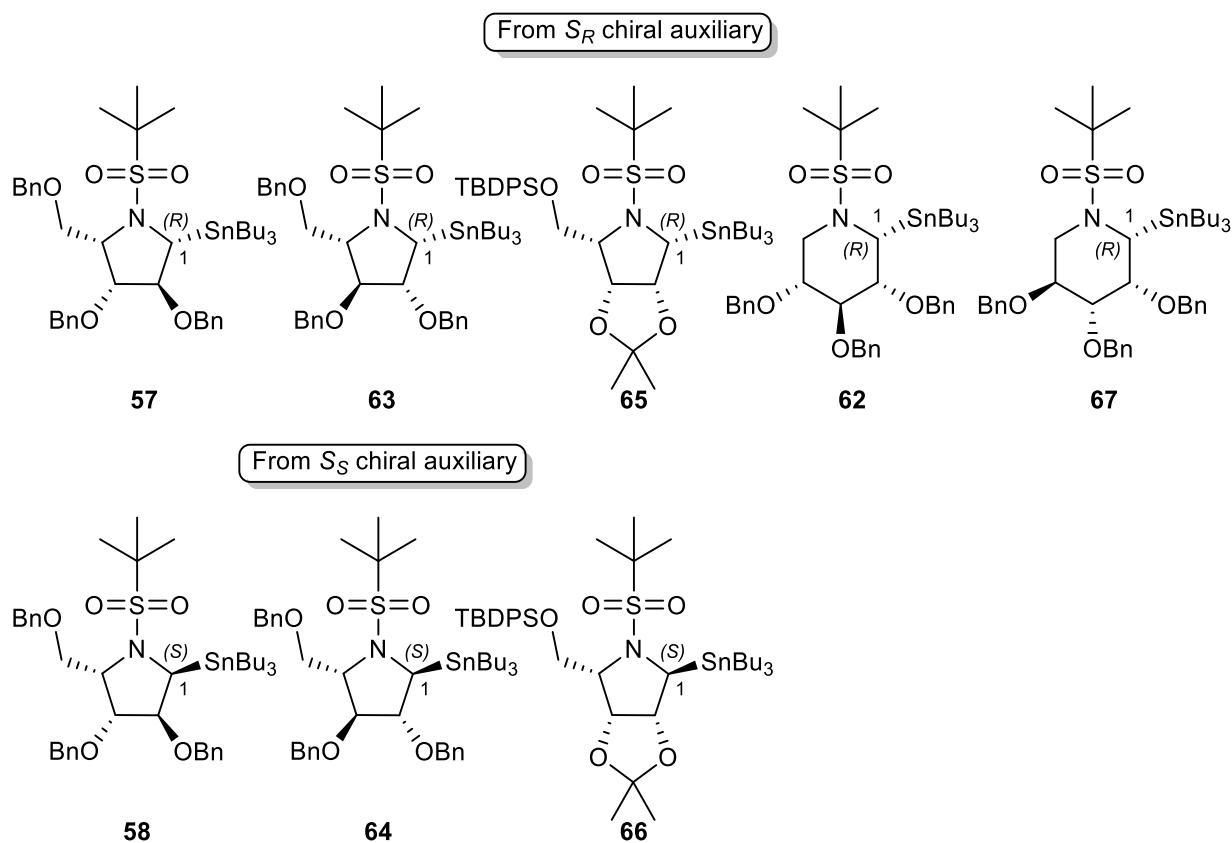


**Figure 24.** Potential configuration and conformations of compound **62**.

Structure **A** (tin is axial, pseudo- $\alpha$ ) and **B** (tin is equatorial, pseudo- $\beta$ ) represent the conformation  $^4\text{C}_1$ , while **C** (tin is equatorial, pseudo- $\alpha$ ) and **D** (tin is axial, pseudo- $\beta$ ) illustrate the  $^1\text{C}_4$  conformation. We were not able to measure the values of all coupling constants; nevertheless, the obtained values allowed for precise identification. We can directly reject both  $^1\text{C}_4$  conformers (**C** and **D**), because all the values are expected to be in range 2 – 5 Hz, while we found a value of 10.9 Hz for one of the coupling constants between protons H-4 and H-5 (either  $J_{\text{H4-H5a}}$  or  $J_{\text{H4-H5b}}$ ) and 8.9 Hz for H-3 (either  $J_{\text{H2-H3}}$  or  $J_{\text{H3-H4}}$ ). The value of the coupling constant for H-1 can distinguish between options **A** and **B**; there are two values 2.3 and 6.7 Hz; the second value comes from the coupling between proton and the tin, while the smaller is  $J_{\text{H1-H2}}$ , which means the correct absolute configuration and conformation are presented as option **A** (pseudo- $\alpha$  with tin axial).

### 3. Pattern for the results of the addition

During the project, several iminosugar-1-tributylstannanes were prepared. For every single one of them, the full analysis was performed, and the configuration at C-1 determined (Figure 25). What we realised is that the configuration of final cyclic stannanes corresponds with the configuration of the chiral handles used for the addition of the tributyltin lithium reagent: the *R*-configuration at C-1 is obtained using an *S<sub>R</sub>* auxiliary, while the *S*-configuration is obtained using an *S<sub>S</sub>* auxiliary. Also, the stereochemical outcome does not depend on the configuration of the starting sugar. Hence the configuration at C-1 is **predictable and tuneable**, which is of great advantage for further synthetic applications of these stannanes.



**Figure 25.** Pattern of the absolute configuration of 1-stannylated iminosugars.

### III. Exploitation of heteronuclear coupling constants

#### 1. Literature data

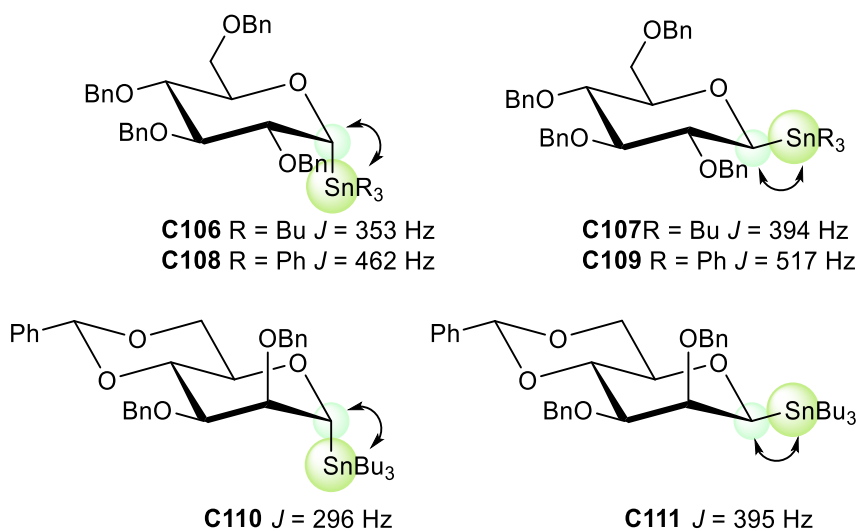
Out of all the elements from the periodic table, tin possesses the highest number of stable isotopes. Below, in Table 5 are listed all stable isotopes and their abundance. Slightly more than a third of tin exists as  $^{120}\text{Sn}$ , other most common isotopes are  $^{118}\text{Sn}$  and  $^{116}\text{Sn}$ . Moreover, tin is also unique in the fact that three of its isotopes have spin  $\frac{1}{2}$  nuclei and therefore are active in NMR. Those are  $^{115}\text{Sn}$ ,  $^{117}\text{Sn}$  and  $^{119}\text{Sn}$ . All of them can couple with other nuclei like  $^1\text{H}$ ,  $^{13}\text{C}$ ,  $^{19}\text{F}$  and  $^{31}\text{P}$ . Because of low abundance,  $^{115}\text{Sn}$  is least useful isotope. On the other hand, both  $^{117}\text{Sn}$  and  $^{119}\text{Sn}$  have a similar percentage (7.68 and 8.59 respectively). It leads to exciting observations in both  $^1\text{H}$  and  $^{13}\text{C}$  NMR.

**Table 5.** Isotopes of tin and their abundance.

Isotope	Abundance
$^{112}\text{Sn}$	0.97%
$^{114}\text{Sn}$	0.66%
$^{115}\text{Sn}$	0.34%
$^{116}\text{Sn}$	14.54%
$^{117}\text{Sn}$	7.68%
$^{118}\text{Sn}$	24.22%
$^{119}\text{Sn}$	8.59%
$^{120}\text{Sn}$	34.58%
$^{122}\text{Sn}$	4.63%
$^{124}\text{Sn}$	5.79%

We decided to investigate the values of the coupling constant published in the literature for related compounds. We found out two very intriguing reports about these values. One came

from the team of prof. Andrea Vasella.<sup>114</sup> This group was one of the first to present the synthesis of 1-C-stannylated glycosides. They prepared and separated compounds listed below (Figure 26): four compounds with *D-gluco* configuration (series of  $\alpha$  and  $\beta$  anomers with tributyl or triphenyltin) and two in *D-manno* configuration ( $\alpha$  and  $\beta$  anomers with a tributyltin substituent).



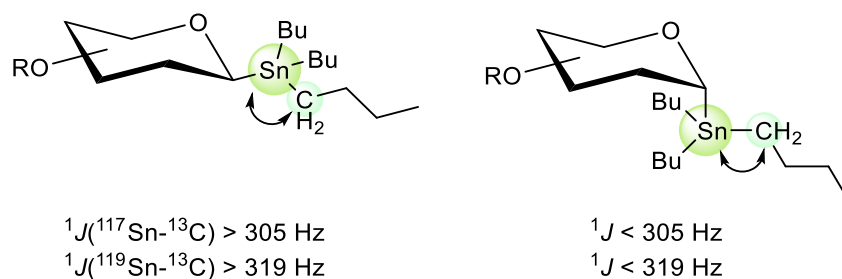
**Figure 26.** Compounds prepared by Vasella and coworkers.<sup>113</sup>

First interesting fact, all molecules without exception were in the conformation  ${}^4C_1$ . Moreover, there was a correlation between the value of the heteronuclear coupling constant  $J(\text{Sn}-{}^{13}\text{C})$  and the configuration at C-1. The values for  $\alpha$  derivatives were always smaller than the ones for the  $\beta$  counterparts. The values were given as the average between  $J({}^{117}\text{Sn}-{}^{13}\text{C})$  and  $J({}^{119}\text{Sn}-{}^{13}\text{C})$ .

The second report is more recent; it was released in 2017 by the team of Walczak (Figure 27).<sup>115</sup> They reported a trend similar to that discovered by Vasella and his team. However, they did not focus on the coupling constant between tin and C-1, but between tin and the carbon in the  $\alpha$ -position in the *n*-butyl chain. Similar to the previous report, all the prepared molecules were in the  ${}^4C_1$  conformation. They observed different values for the compounds having tin in axial position compared to the ones with tin equatorial. They went even further and proposed exact values allowing the compounds to be distinguished: for tin in equatorial position the  $J({}^{117}\text{Sn}-{}^{13}\text{C})$  values are above 305 Hz (319 Hz for  $J({}^{119}\text{Sn}-{}^{13}\text{C})$ ), and they are below this limit when the tin occupies the axial position.

<sup>114</sup> P. Uhlmann, D. Nanz, E. Bozó, A. Vasella, *Helv. Chim. Acta* **1994**, 77, 1430–1440.

<sup>115</sup> F. Zhu, J. Rodriguez, T. Yang, I. Kevlishvili, E. Miller, D. Yi, S. O'Neill, M. J. Rourke, P. Liu, M. A. Walczak, *J. Am. Chem. Soc.* **2017**, 139, 17908–17922.

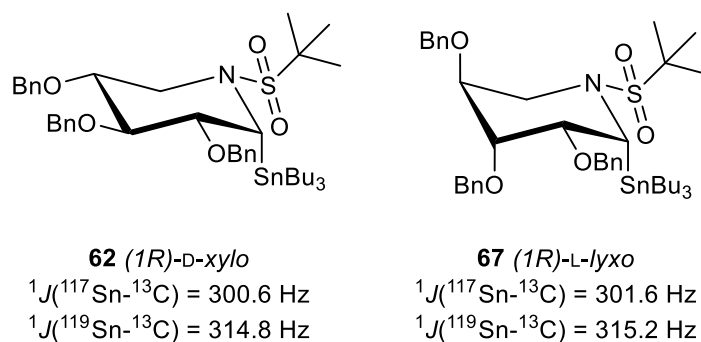


**Figure 27.** Values of the coupling constants measured by Walczak and coworkers.<sup>114</sup>

## 2. 1-stannylated iminosugars

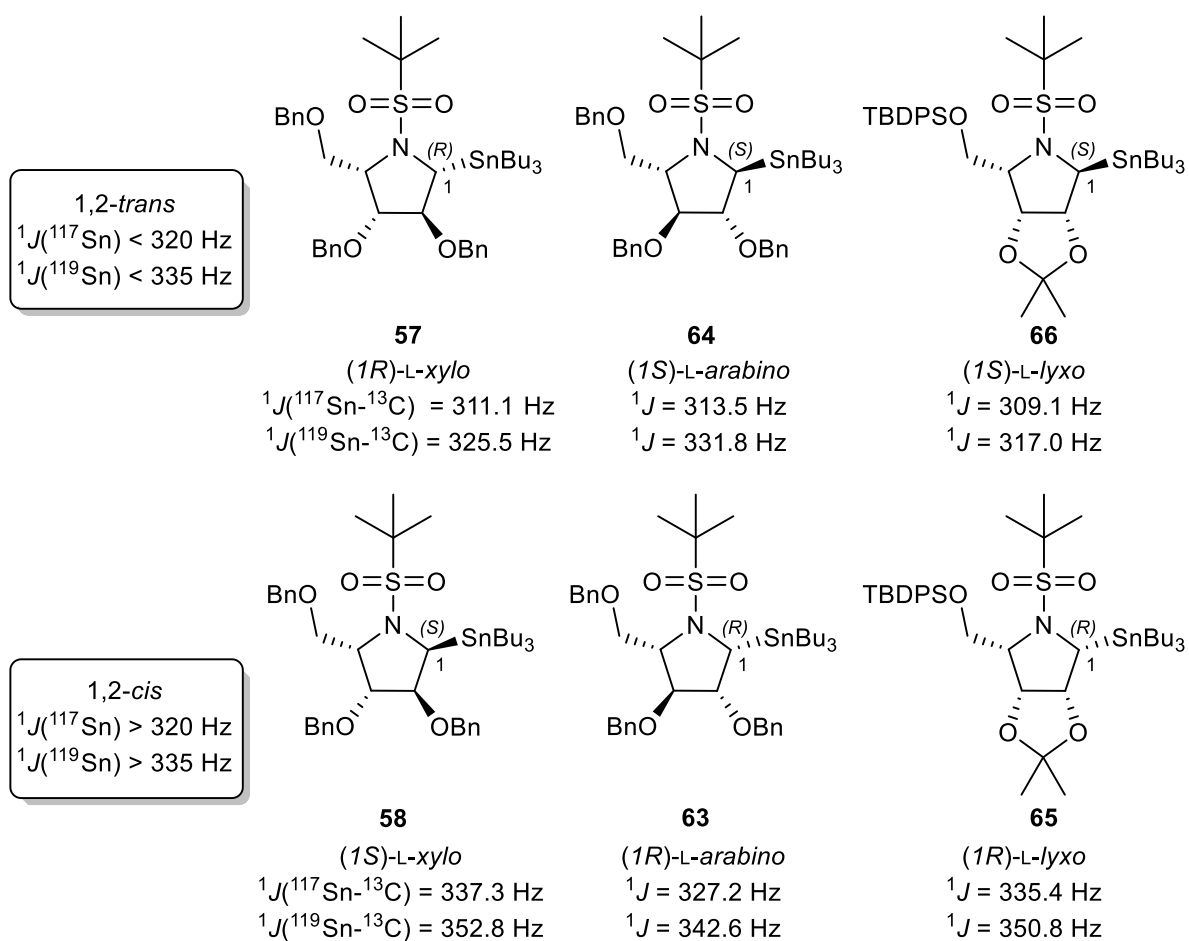
In almost every compound, we could observe the heteronuclear coupling constants between tin and protons in position C-1 and C-2 in  ${}^1\text{H}$  NMR, and the coupling between tin and carbon atoms in positions  $\alpha$ ,  $\beta$  and  $\gamma$  in the *n*-butyl chain as well as at C-1 (depending on the number of scans) in  ${}^{13}\text{C}$  NMR. We wanted to determine if the rule determined by Walczak would also apply to six-membered iminosugar-1-stannanes.

First of all, we determined the configuration and conformation of molecules **62** and **67**. The conformation of both was  ${}^4\text{C}_1$ . Furthermore, the tin occupies the axial position (Figure 28). The values of the coupling constants  ${}^1J(\text{Sn}-{}^{13}\text{C})$  were then calculated in the same way as Walczak, and they were 300.6 and 301.6 Hz, respectively for the  ${}^1J({}^{117}\text{Sn}-{}^{13}\text{C})$  in **62** and **67** and 314.8 and 315.2 Hz for the  ${}^1J({}^{119}\text{Sn}-{}^{13}\text{C})$ . The two compounds thus clearly respect the rule and this observation thus widens the application of this prediction tool to the iminosugar-1-tributylstannanes.



**Figure 28.** Heteronuclear coupling constants for **62** and **67**.

In the literature, there are no such rules for the 5-membered ring series. In our work, we did not find out any direct relations between the values of the coupling constant and the absolute configurations at C-1. However, we found a useful correlation between  $J$  values and the relative configuration of positions C-1 and C-2. This correlation is outlined in Figure 29: as a rule, 1,2-*trans* compounds have  $^1J(^{117}\text{Sn}-^{13}\text{C})$  coupling constants smaller than 320 Hz (335 Hz for coupling with  $^{119}\text{Sn}$ ), and 1,2-*cis* compounds have coupling constants  $^1J(^{117}\text{Sn}-^{13}\text{C})$  larger than 320 Hz (335 Hz for coupling with  $^{119}\text{Sn}$ ).



**Figure 29.** Correlation of  $J$  values and relative configuration in pyrrolidine series.

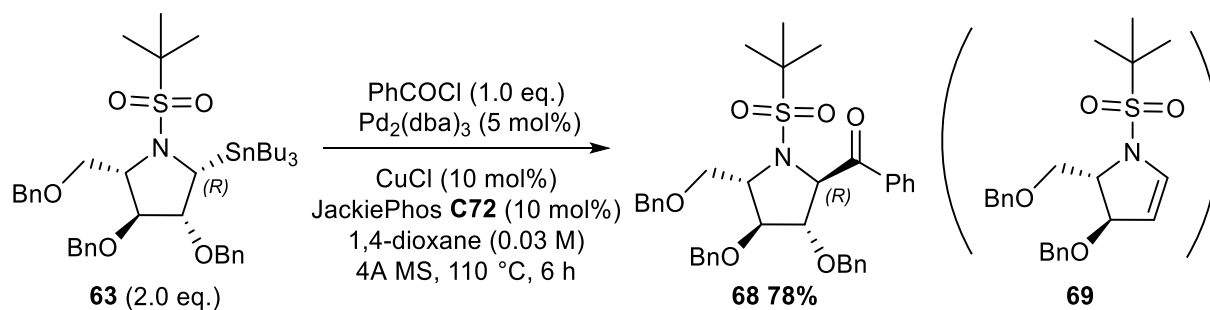
Knowing the configuration at C-2 and the values of the coupling constants, we can thus determine the absolute configuration at C-1. This new tool is quite useful to determine configuration of stannylated derivatives of pyrrolidine iminosugars; it will also possibly allow the determination of 1-C-stannylated furanoses in the sugar series (no examples reported so far with *n*-butyl chain as a substituent on the tin in furanose series).

## IV. Stille cross-coupling of 1-stannylated iminosugars

### 1. Results of the cross-coupling reaction

After the successful preparation of the stannylated iminosugars, the next step in the synthesis of iminosugar-C-glycosides was the Stille cross-coupling. The theoretical aspect of this reaction, as well as a few applications in the field of glycochemistry was described in the introduction of Chapter 2. Here, I would like to focus on the description of the results obtained using cyclic iminosugar-1-stannanes as starting materials.

The reaction was optimised by SL using *L-arabino* compound **63**. It was optimised in terms of catalyst, phosphine ligand, solvent, temperature, time, source of copper, presence of fluoride anions and stoichiometry. Also, the formation of the side product **69** was taken into account as to favour oxidative addition and reductive elimination vs the  $\beta$ -elimination. Below, I present the optimal conditions for the Stille coupling (Scheme 75) and a few alternative conditions tested (Table 6).



**Scheme 75.** Optimal conditions for the Stille cross-coupling.

One of the most crucial parameters in the cross-coupling reactions is the phosphine ligand. The outcome of the reaction varies from 0% to good yields depending on the ligand used. In our case, 11 different phosphines, including mono- and biphosphine ligands, as well as triphenylarsine were tested. Most of the biphosphines gave low yields (less than 16% for DPPE and DPPF) or failed (*R*-(+)-BINAP). The best result was achieved with JackiePhos **C72**, a bulky phosphine ligand which prevents anomerisation of intermediate organocopper and ensures substrate compatibility with coordinating solvents.<sup>116</sup> Also, the copper(I) proved to be

<sup>116</sup> F. Zhu, E. Miller, S. Zhang, D. Yi, S. O'Neill, X. Hong, M. A. Walczak, *J. Am. Chem. Soc.* **2018**, *140*, 18140–18150.

necessary for the reaction, otherwise, the formation of the desired product was not observed. In addition, any reaction with copper replaced by other transition metal (Zn, Fe) failed. The starting material was recovered. Among different sources of copper(I), the best results were obtained with copper(I) chloride and copper(I) cyanide (yield around 50%). For safety reasons, determined by NFPA 704 (in Health: level 3 and 4 for CuCl and CuCN, respectively), we decided to proceed with copper(I) chloride. Interestingly, the worst result was obtained with copper(I) iodide.

**Table 6.** Optimisation table for the Stille coupling.

Entry	Ligand	Co-catalyst	Yield (%)
1	TPP	CuCl	33
2	DPPE	CuCl	7
3	DPPF	CuCl	16
4	R-(+)-BINAP	CuCl	0
5	AsPh <sub>3</sub>	CuCl	18
6	JackiePhos	CuCl	51
7	JackiePhos	CuBr	42
8	JackiePhos	CuI	3
9	JackiePhos	CuCN	50
10	JackiePhos	ZnCl <sub>2</sub>	0
11	JackiePhos	FeCl <sub>3</sub>	0

The requirement for the copper(I) is not so uncommon occurrence. In the general introduction to Chapter 2, I listed a few examples of Stille cross-couplings in which the copper(I) was applied (Schemes 47, 48, 50, 52 and 53). The impact of the copper(I) as co-catalyst in the Stille cross-coupling reaction is well-documented and its occurrence is named “copper effect”.<sup>102,117,118,119,120,121</sup> This effect can be explained by the synergy of two components. The

<sup>102</sup> C. Cordovilla, C. Bartolomé, J. M. Martínez-Ilarduya, P. Espinet, *ACS Catal.* **2015**, *5*, 3040–3053.

<sup>117</sup> L. S. Liebeskind, R. W. Fengl, *J. Org. Chem.* **1990**, *55*, 5359–5364.

<sup>118</sup> V. Farina, S. Kapadia, B. Krishnan, C. Wang, L. S. Liebeskind, *J. Org. Chem.* **1994**, *59*, 5905–5911.

<sup>119</sup> X. Han, B. M. Stoltz, E. J. Corey, *J. Am. Chem. Soc.* **1999**, *121*, 7600–7605.

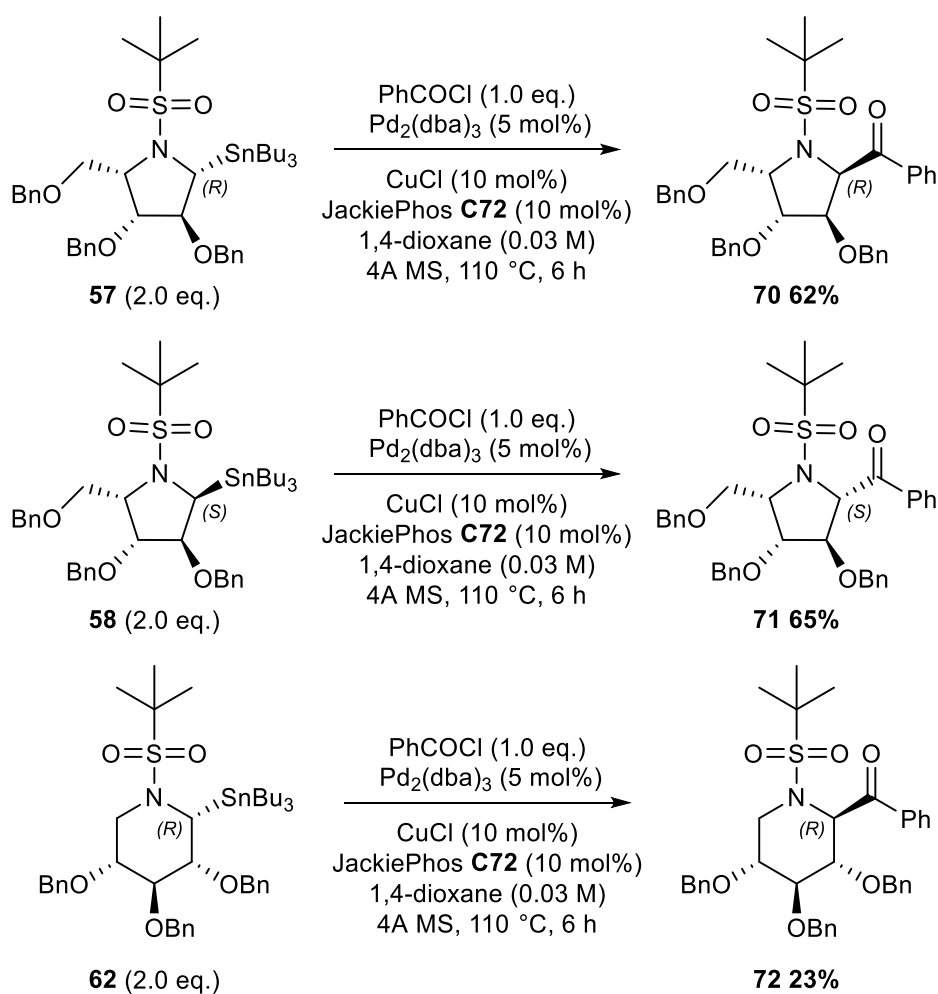
<sup>120</sup> A. L. Casado, P. Espinet, *Organometallics* **2003**, *22*, 1305–1309.

<sup>121</sup> S. P. H. Mee, V. Lee, J. E. Baldwin, *Angew. Chemie Int. Ed.* **2004**, *43*, 1132–1136.



first component: the copper(I) can act as ligand scavenger, mitigating the autoretardation by free phosphine of the rate-determining associative transmetalation (it does not participate in the catalytic cycle). In addition, it participates in the Sn/Cu transmetalation process. Due to the transmetalation, the stannane is replaced by the more reactive organocopper, which enters the catalytic cycle with palladium.

The reaction was found to be highly stereoselective as a single diastereoisomer was observed and isolated. Moreover, the same reaction was performed with the scope of different acyl chlorides (*para*-anisoyl, *para*-nitrobenzoyl, *para*-bromobenzoyl, *para*-, *meta*- and *ortho*-chlorobenzoyl). Interestingly, it worked also with an aliphatic acyl chloride (hexanoyl). The yields were in the range between 39 and 78% depending on the acyl group. Unfortunately, these conditions were not suitable for the cross-coupling with aryl iodides or bromides – common electrophiles in Stille reactions.



**Scheme 76.** Stille cross-coupling of compounds **57**, **58** and **62**.

I applied the same conditions to the prepared compounds **57**, **58** and **62** (Scheme 76). The yields of compounds **70** and **71** were comparable (62% and 65% respectively); however, for compound **72** it was rather low, only 23%. The optimisation was performed in the pyrrolidine series; possibly the conditions were not suitable for the piperidine series. It would require more optimisation work using compound **62** as the starting material. Remarkably, like for the previous reaction (Scheme 75), single diastereoisomers were observed in every Stille couplings.

## 2. Determination of the configuration via NMR studies

After the cross-couplings, the same method was employed to determine the configuration at C-1 position. Unfortunately, no relevant signals were observed on the NOESY spectra of products **70** and **71**. Within the small library of the products formed from 1-stannylated iminosugars (Figure 25), we could observe the NOE signals for compounds **73** and **74** prepared from D-ribofuranosylamine **65** and **66** by SL (Figure 30 and 31).

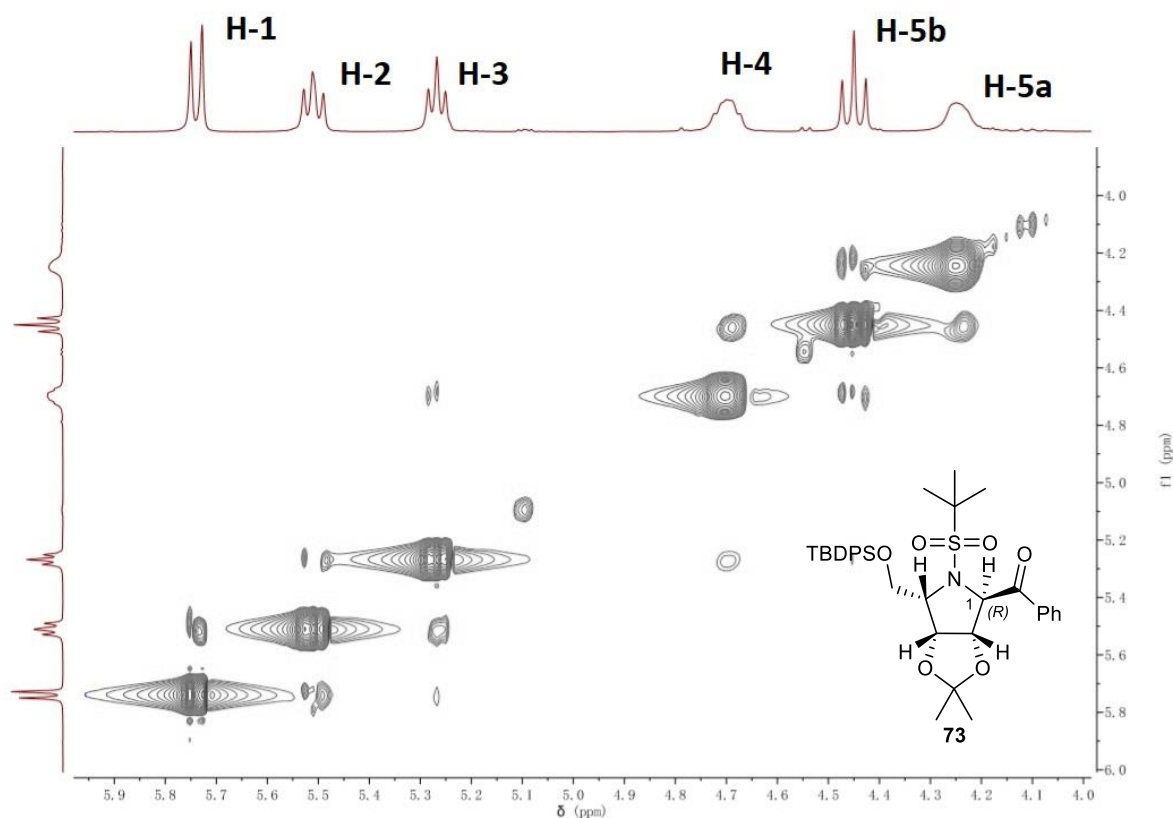
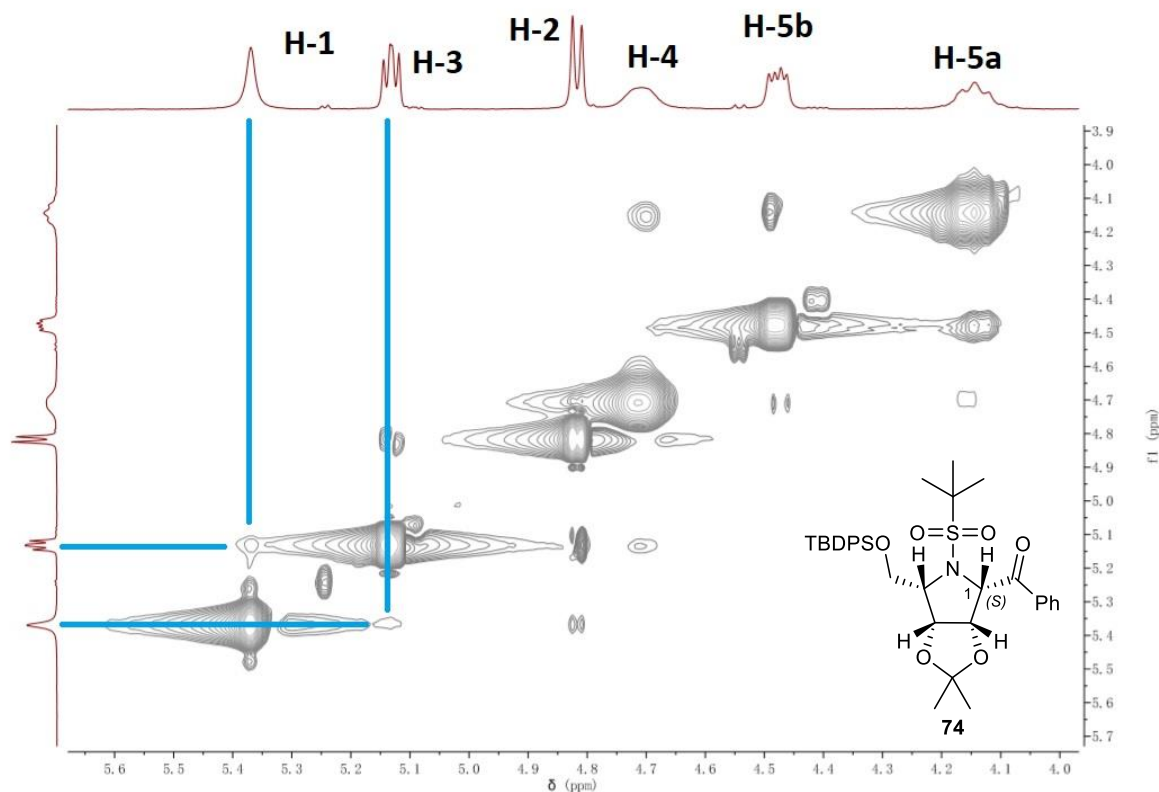


Figure 30. NOESY spectra of compound **73**.



**Figure 31.** NOESY spectra of compound **74**.

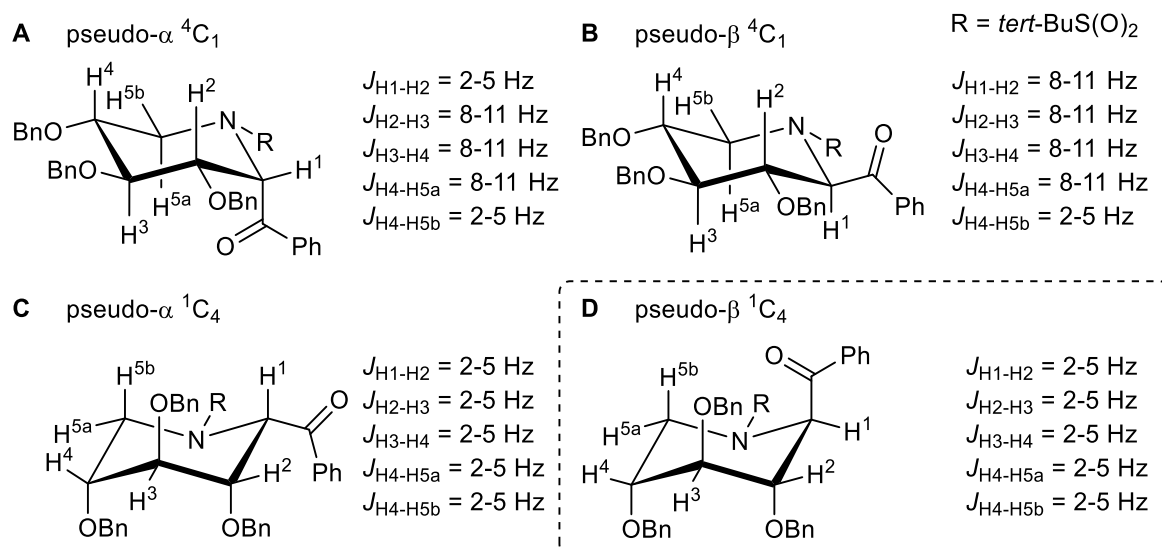
For compound **73**, there are not many interactions which potentially could be observed. The only option would be possible interactions between H–C-1 and H–C-5, but there is no such signal. For the epimer **74**, there is more potential NOE interactions: H–C-1 and H–C-4 or H–C-1 and H–C-3. We observe signals coming from H–C-1 and H–C-3 (Figure 31), which indicates the inversion of the configuration during the Stille cross-coupling reaction. Nonetheless, the absolute configuration remains the same due to the shift in the priority of the substituents (CIP rules).<sup>122,123</sup> For all other derivatives (**70**, **71**, as well as products of the Stille cross-coupling of **63** and **64**) in the pyrrolidine series, we assume the same trend to be retained during the cross-coupling reaction that is a stereoinverting Stille mechanism.

Usually, the identification of the compounds in the piperidine series would be easier, thanks to the values of coupling constant in <sup>1</sup>H NMR. Nevertheless, for compound **72**, it was difficult to determine the configuration at C-1 and conformation (Figure 32). Many signals (H-2, H-3, H-4 and H-5a) are overlapping. However, the signal from H-1 is a broad singlet, which would suggest a small value of the coupling constant. It can only rule out pseudo-β in the <sup>4</sup>C<sub>1</sub>

<sup>122</sup> R. S. Cahn, C. Ingold, V. Prelog, *Angew. Chemie Int. Ed. English* **1966**, *5*, 385–415.

<sup>123</sup> V. Prelog, G. Helmchen, *Angew. Chemie Int. Ed. English* **1982**, *21*, 567–583.

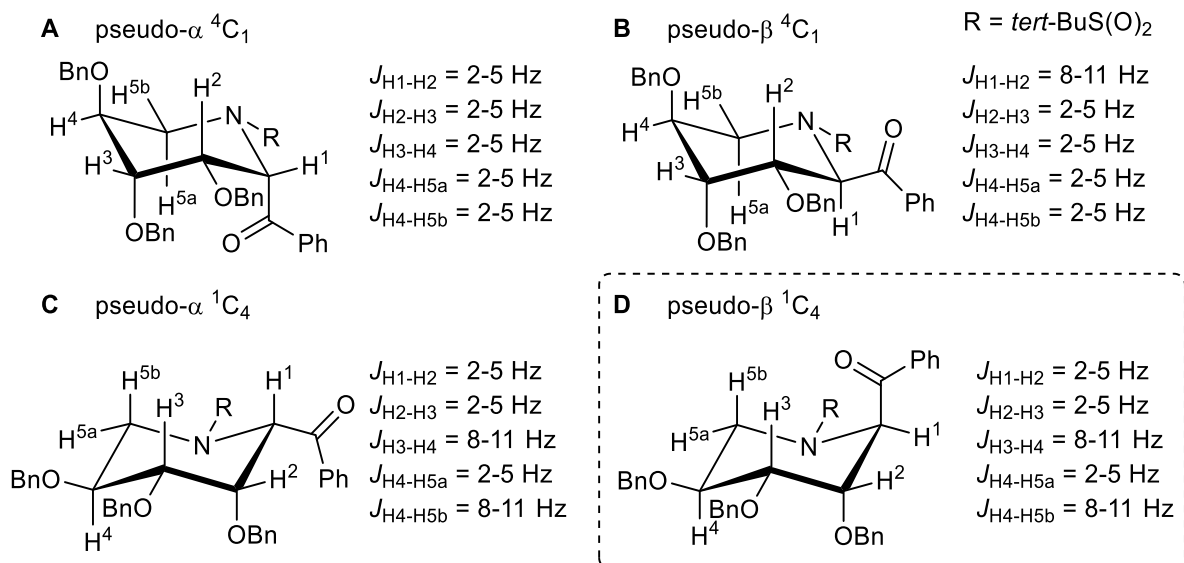
conformation (option **B**) because the value of  $J_{H1-H2}$  would be between 8 and 11 Hz, leaving three other options available. However, combining the NMR data with the result of the Stille cross-coupling in pyrrolidine series, we strongly suggest option **D** as the configuration and conformation for compound **72**.



**Figure 32.** Potential configurations and conformations of compound **72**.

For compound **75** (product of the Stille performed on compound **67** by SL), the  ${}^1\text{H}$  NMR signals were well separated, which allowed the verification of the configuration and conformations (Figure 33). Due to the shape of the signal coming from C-1 (broad singlet), option **B** was rejected. After the analysis of other signals, we established that compound **75** is most likely presented as option **D**.

The inversion of the configuration is not an unusual outcome of the Stille cross-coupling reaction. The same trend was observed by Kells and Chong<sup>93</sup> in their Stille reaction with *tert*-butanesulfonyl group (Scheme 53) and by the group of Walczak in the synthesis of *C*-glycosides (Scheme 50).<sup>114</sup> Taking into account our own result and mentioned before reports, as the outcome of the Stille coupling performed on the open-chain stannylated aminoalditols (Chapter 2), we assumed that the products were following the same trend and they were presented with the inverted configuration at C-1 (Scheme 58 and 59).



**Figure 33.** Potential configurations and conformations of compound **75**.

## V. Conclusions

In this chapter, I have described in detail the project realised in collaboration with a post-doctoral fellow – dr Sizhe Li. This project is centred around the cyclisation methods to obtain 1-tributylstannylated iminosugars and their Stille reaction with aryl chlorides.

From the cyclisation of the sulfinyl derivatives, we observed the elimination of two functional groups leading to cyclic imines **52** and **55**. Two mechanisms were proposed as a possible explanation of this phenomenon. Interestingly, the elimination did not occur for compound **54**, (precursor in *D-xyl*o series) and iminosugar **56**, carrying a *N*-sulfinyl group was isolated.

The problem of elimination was solved by performing the cyclisation step from oxidised substrates carrying a *tert*-butanesulfonyl group. All prepared iminosugar-1-stannanes were carefully characterised, and their configuration at C-1 was determined by in-depth NMR analysis. From all prepared compounds a pattern emerged. There was a direct correlation between the absolute configuration at C-1 and the chirality of the sulfinyl auxiliary present during the addition of the tributyltin lithium reagent. The application of *tert*-butanesulfinamide **2** in the synthesis resulted in 1-(*R*) derivatives, and the opposite (1-(*S*) configuration) was obtained when the chiral auxiliary **3** was implemented in the synthesis.

Interestingly, the presence of the tin in the molecule was reflected in the NMR spectra, as we could observe the heteronuclear coupling between NMR active isotopes of tin ( $^{117}\text{Sn}$  and  $^{119}\text{Sn}$ ) and nearby protons and carbon atoms ( $^{13}\text{C}$ ). Notably, the values of the coupling constants between tin and carbon atoms proved to be extremely useful. We examined values presented by Vasella and Walczak in the literature. Hence, our compounds prepared in the piperidine series (**62** and **67**) followed the rule proposed by Walczak for 1-*C*-stannylated glycosides. Moreover, we suggested a model for the prediction of the configuration at C-1 based on the configuration at position C-2 and the coupling constant values between tin and the carbon atom in  $\alpha$  position in *n*-butyl chain in the pyrrolidine derivatives.

Lastly, the iminosugar-1-tributylstannanes were submitted for the Stille cross-coupling. The reaction was optimised by SL. The same conditions were applied to all prepared stannylated compounds. The yields were good in the pyrrolidine series, however rather low in the piperidine series. Remarkable, each time a single diastereoisomer was observed and isolated. Establishing the configuration at the ex-C-1 was more complicated than for the iminosugar-1-

tributylstannanes, due to the overlapping of the signals in  $^1\text{H}$  NMR. However, in the small library of prepared 1-benzoylated iminosugars, we managed to confirm the configuration of **73** and **74** using NOESY experiments, which indicate the inversion of the configuration during the cross-coupling reaction. For the other compounds we can assume that they are following the same trend.

In conclusion, the goal set for this part of the thesis was completely achieved, however, there are still many aspects to investigate. I will highlight future possibilities in the perspectives section. In the next chapter, I will present yet another application for open-chain stannylated aminoalditols – SnAP chemistry.

## VI. Summary of Chapter 3 *en français*

Dans cette partie de mon rapport, je présenterai le projet réalisé en parallèle avec le couplage croisé de Stille décrit précédemment. Il concerne également le couplage Stille, mais sur les iminosucres-1-stannylés cycliques comme produits de départ. Ce projet a été réalisé en étroite collaboration avec le Dr Sizhe Li. Pour expliquer en détail les modèles découverts, je devrai combiner les résultats obtenus au cours de cette thèse avec ceux du Dr. Li, postdoc dans notre équipe.

Au début, il a fallu étudier la cyclisation des aminoalditols à chaîne ouverte. Pour la cyclisation, nous avons décidé d'utiliser la méthode mentionnée précédemment dans la synthèse des iminopentitols cycliques (Schéma 33 et 34), qui consiste en l'activation de la position C-4 par transformation en dérivé mésylé puis cyclisation  $S_N2$  avec hydrure de sodium, ce qui conduira à l'inversion de la configuration en position C-4. Cependant, l'élimination des deux groupes fonctionnels a été observée ( $R_3Sn$  et sulfinyle) et une imine cyclique a été isolée (Schéma 69). Deux mécanismes ont été présentés comme solution possible pour cette élimination (Schéma 70). Par ailleurs, des protocoles alternatifs à basse température pour la cyclisation ont été testés ; malheureusement, ils n'ont pas été couronnés de succès (Schéma 71). Des résultats similaires ont été observés pour la cyclisation effectuée par le Dr Li dans la série du D-xylofuranose (Schéma 72). Cependant, il a été possible d'observer et d'isoler l'iminosucre 1-stannylé dans cette série. De plus, il a été possible d'échanger le groupe sulfinyle dans le produit cyclique contre un groupe protecteur de type carbamate (comme N-Boc et N-CBz).

Le problème de l'élimination a été résolu par l'application des composés oxydés (Schéma 73). Chaque iminosucre-1-stannane préparé a été soigneusement caractérisé et sa configuration en position C-1 a été déterminée par une analyse RMN approfondie. De tous les composés préparés, un modèle a émergé, permettant une corrélation directe entre la configuration absolue en C-1 et la chiralité de l'auxiliaire présent lors de l'addition du réactif tributylstannyllithium (Figure 25). L'application de l'auxiliaire chiral ( $S_R$ ) dans la synthèse a donné des dérivés 1-( $R$ ), et la configuration inverse (1-( $S$ )) a été obtenue lorsque l'auxiliaire chiral de configuration opposée a été implanté dans la molécule.

La présence de l'étain dans la molécule est notée dans les spectres RMN ; nous avons pu observer le couplage hétéronucléaire entre les isotopes actifs RMN de l'étain ( $^{117}Sn$  et  $^{119}Sn$ ) et les protons et atomes de carbone voisins ( $^{13}C$ ). Notamment, les valeurs de la constante de



couplage entre les atomes d'étain et de carbone se sont révélées extrêmement utiles. Nous avons examiné les valeurs présentées dans la littérature par Vasella (Figure 26) et Walczak (Figure 27). Nos composés préparés en série pseudopyranose suivent la règle proposée par Walczak pour les glycosides 1-stannylés (Figure 28). De plus, nous avons proposé un modèle pour la prédiction de la configuration en C-1 sur la base de la configuration en C-2 et de la valeur de la constante de couplage entre l'étain et l'atome de carbone à en position  $\alpha$  dans la chaîne *n*-butyle (Figure 29). Il existe une différence significative entre les valeurs des configurations 1,2-*cis* et 1,2-*trans*.

Enfin, les iminosucre-1-stannanes ont été soumis au couplage de Stille. La réaction a été optimisée par le Dr Li dans tous ses aspects (Schéma 75). Les mêmes conditions ont été appliquées aux composés stannylés préparés (Schéma 76). Les rendements ont été bons en série pyrrolidine, mais plutôt faibles en série pipéridine. Néanmoins, chaque fois qu'un diastéréoisomère a été observé et isolé, la configuration en position C-1 a été déterminée par l'analyse RMN, et dans tous les cas l'inversion de la configuration a été observée (la même configuration absolue due au changement de priorité des substituants).

En conclusion, l'objectif fixé pour cette partie de la thèse a été entièrement atteint. Dans le prochain chapitre, je présenterai une autre application pour les aminoalditols stannylés à chaîne ouverte - la chimie SnAP.



# Chapter 4

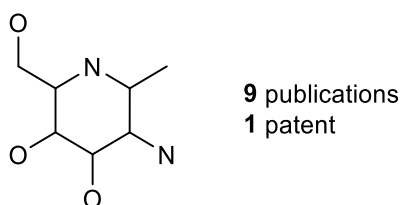
---



## I. Introduction

Before I explain in detail the concept behind the SnAP chemistry, I would like to focus on the interest in 2-AImS (2-AminoIminoSugar) derivatives and known ways for the preparation of this type of compounds.

The 2-amino glycosides and C-glycosides are well-known structures with a well-documented history and known biological activity (e.g. glycosidase and glycosyltransferase inhibitors or parts of antibiotics).<sup>124,125,126</sup> However, the 2-amino-iminosugar-C-glycosides are not common structures. How rare they are was verified by the search performed using the SciFinder<sup>®</sup> database. For the chemical structure search, 2-aminoiminosugar skeleton related to a hexose was chosen as a substructure (Figure 34). Only nine articles and a single patent were found. The biological activity of a few 2-AImS derivatives was measured against various enzymes.



**Figure 34.** Substructure search on SciFinder<sup>®</sup>.

### 1. Known pathways for the preparation of 2-AImS

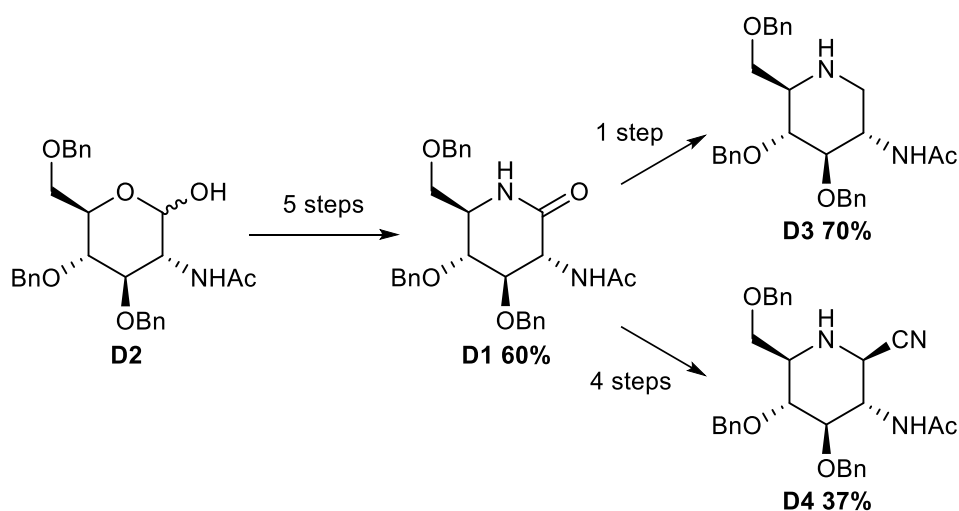
The first article came from the group of Vasella in 1998.<sup>127</sup> They presented the synthesis and further modification of lactam **D1** (Scheme 77). Notably, the starting material **D2** already contained an acetamido group at C-2 (e.g., GlcNAc). The synthetic route consisted of introducing the intracyclic nitrogen by the formation of a lactam. Compound **D1** was obtained in 5 steps with an overall yield of 60%. Afterwards, it was converted into 2-acetamido-1,2-dideoxynojirimycin **D3** in one step (70%) or the amino nitrile derivative **D4** in 4 steps (37%).

<sup>124</sup> W. Zou, *Curr. Top. Med. Chem.* **2005**, *5*, 1363–1391.

<sup>125</sup> M. Chittapragada, S. Roberts, Y. W. Ham, *Perspect. Medicin. Chem.* **2009**, *3*, 21–37

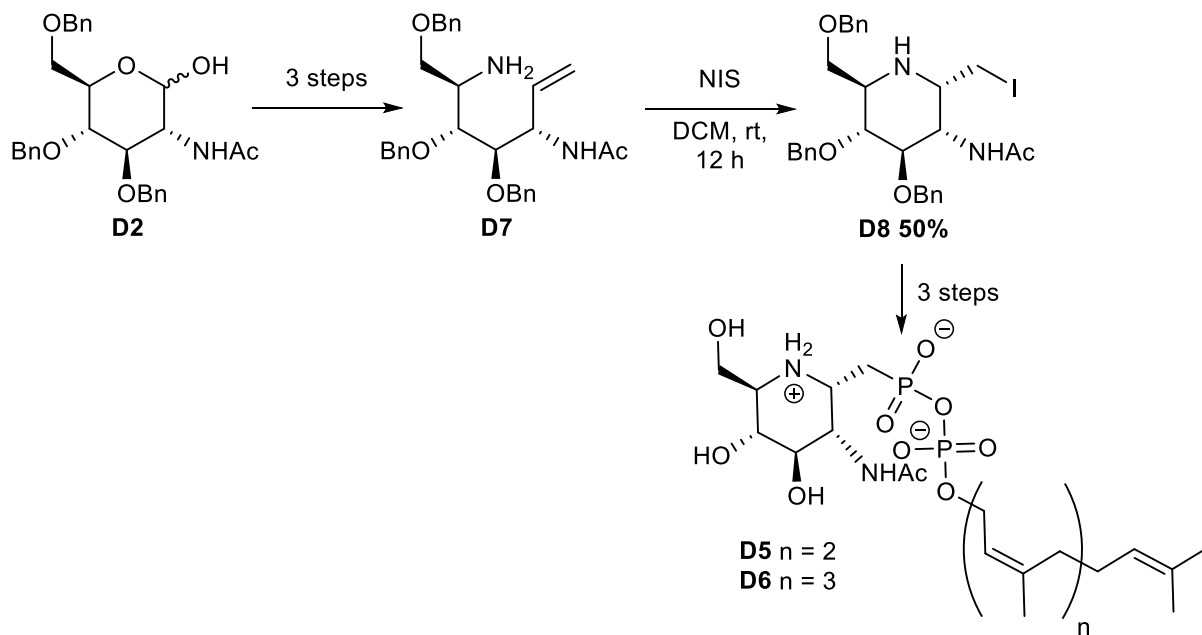
<sup>126</sup> K. M. Krause, A. W. Serio, T. R. Kane, L. E. Connolly, *Cold Spring Harb. Perspect. Med.* **2016**, *6*.

<sup>127</sup> T. Granier, A. Vasella, *Helv. Chim. Acta* **1998**, *81*, 865–880.



**Scheme 77.** Synthesis and transformations of **D1** reported by Vasella.

After a 16 years break, in 2014, three reports were published: containing the synthesis of analogues of  $\alpha$ -D-GlcNAc-1-phosphate by Cheng *et al.* (Scheme 78)<sup>128</sup> and two articles from Yves Blériot and co-workers detailing the synthesis of 1,2-*cis*-homoiminosugars derivatives of GlcNAc and GalNAc (Scheme 79)<sup>129,130</sup>.



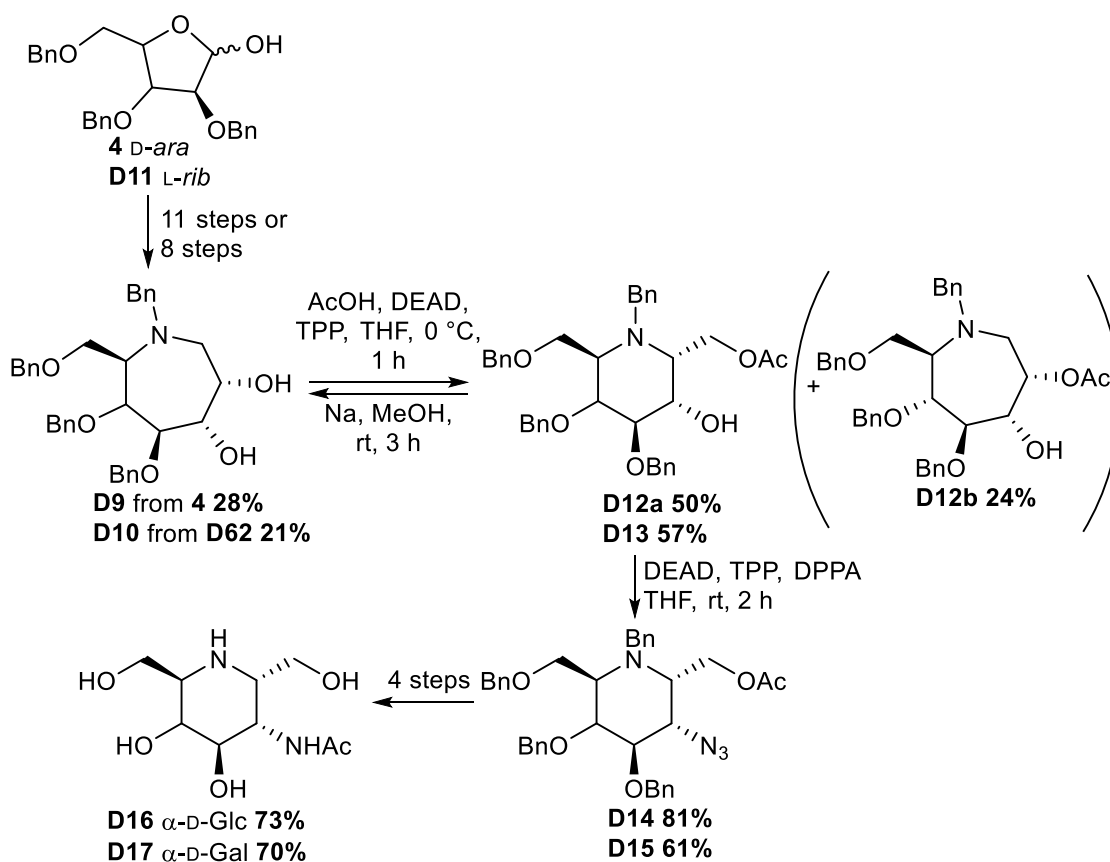
**Scheme 78.** Synthesis of analogues of  $\alpha$ -D-GlcNAc-1-phosphate.

<sup>128</sup> C.-H. Hsu, M. Schelwies, S. Enck, L.-Y. Huang, S.-H. Huang, Y.-F. Chang, T.-J. R. Cheng, W.-C. Cheng, C.-H. Wong, *J. Org. Chem.* **2014**, *79*, 8629–8637.

<sup>129</sup> Y. Blériot, N. Auberger, Y. Jagadeesh, C. Gauthier, G. Prencipe, A. T. Tran, J. Marrot, J. Désiré, A. Yamamoto, A. Kato, *et al.*, *Org. Lett.* **2014**, *16*, 5512–5515.

<sup>130</sup> Y. Blériot, A. T. Tran, G. Prencipe, Y. Jagadeesh, N. Auberger, S. Zhu, C. Gauthier, Y. Zhang, J. Désiré, I. Adachi, *et al.*, *Org. Lett.* **2014**, *16*, 5516–5519.

The synthesis of three iminosugar-based lipid mimetics of GlcNAc-P-P-polyprenol (**D5** and **D6**) was performed in 7 to 10 steps starting from **D2**. The applied strategy consisted of a ring-opening Wittig reaction, amination and cyclisation. One of the crucial steps was the diastereoselective intramolecular iodoamination – cyclisation of **D7** to obtain key intermediate **D8** (50%). Afterwards, it was engaged in the synthesis of phosphonate analogues **D5** and **D6**. The biological activity of each analogue was evaluated against the *Clostridium difficile* peptidoglycan transglycosylase. Compound **D6** gave the best results (100% of inhibition at a concentration of 100  $\mu$ M,  $K_i$  ( $\mu$ M)  $6.3 \pm 1.4$ ).

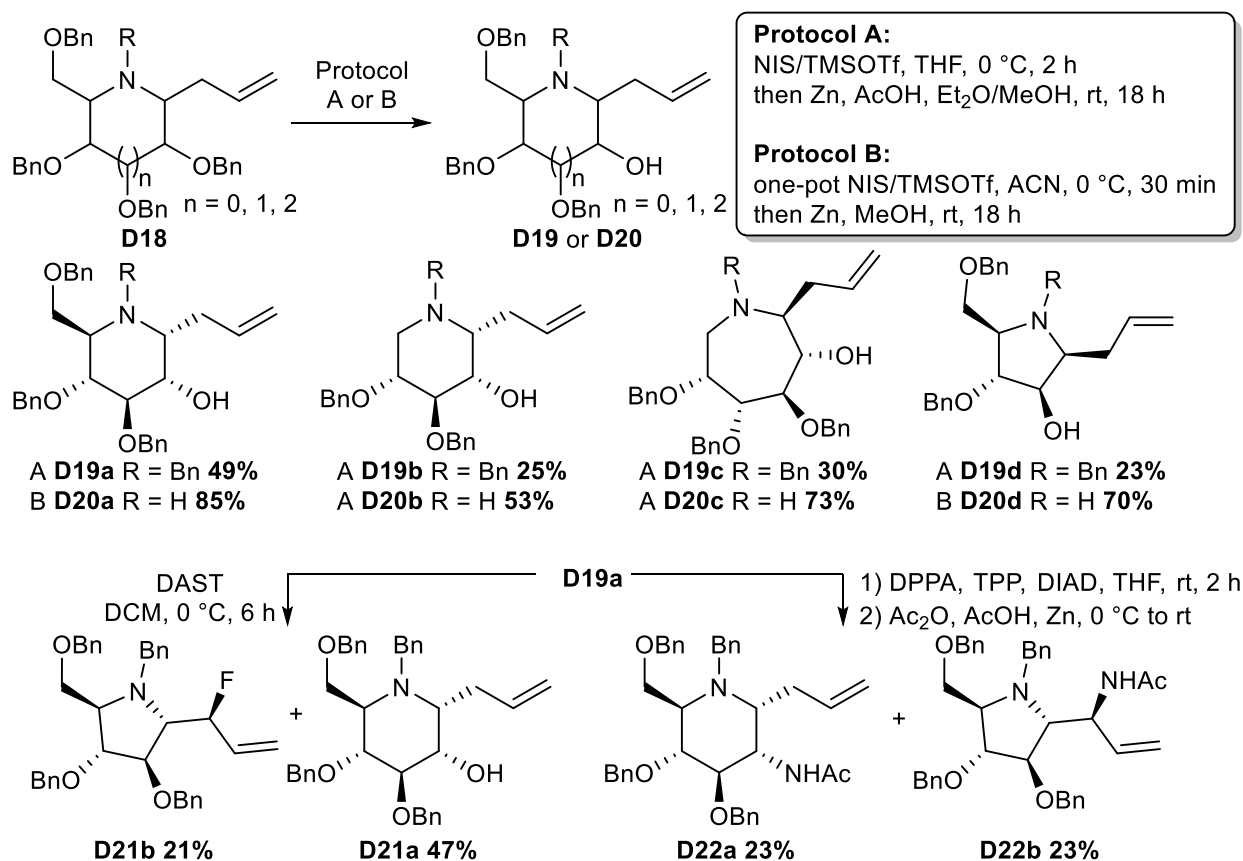


**Scheme 79.** Synthesis of 2-AImS using azepane derivatives.

The methodology described by Yves Blériot and co-workers (Scheme 79) was different. Their work on azepane iminosugars was extended to the synthesis of 2-AImS. They passed through polyhydroxylated azepanes **D9** and **D10** as substrates, which were prepared in 11 steps from **4** or 8 steps from **D11**. The key step was the ring contraction from an azepane to a piperidine skeleton by way of a regioselective  $\beta$ -aminoalcohol activation and aziridium ion formation to give piperidines **D12a** and **D13**.<sup>129</sup> These derivatives were transformed to 1,2-cis-homoiminosugars **D16** and **D17** respectively through deprotection and further reactions. The second article describes the synthesis of 1,2-*trans*-derivatives  $\beta$ -D-GlcNAc and  $\alpha$ -D-ManNAc

analogues using similar methodology.<sup>130</sup> The critical step in both synthetic pathways was a  $\beta$ -amino alcohol skeletal rearrangement applied to an azepane precursor. In both cases, the second amino group was obtained from the introduction of an azido group at C-2 followed by its reduction.

The strategy presented in the most recent article containing substructure from Figure 35 was centered on the regioselective debenzoylation at C-2 of 1-allylated iminosugars (Scheme 80),<sup>131</sup> which was inspired by the work of Nicotra in the glycoside series.<sup>132</sup> The method was tested on various five-, six-, and seven-membered perbenzoylated C-allyl iminosugars. Interestingly, the reaction worked more efficiently when the endocyclic nitrogen was unprotected and the reaction was performed in one pot (e.g. 23% for **D19d** vs 70% for **D20d**). Then, for compound **D19a**, the free hydroxyl group was further functionalised to give 2-fluoro or 2-acetamido iminosugars.



**Scheme 80.** Synthesis of 2-AImS by regioselective debenzoylation.

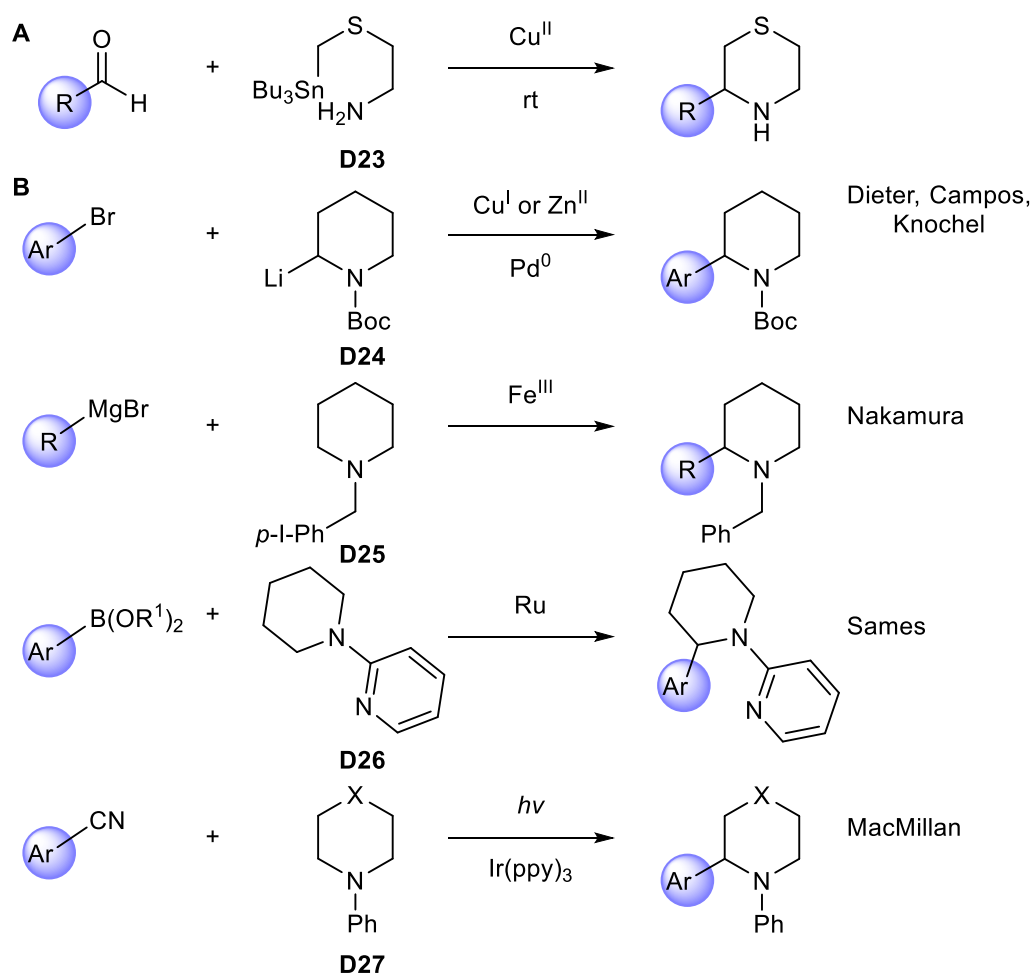
<sup>131</sup> Q. Foucart, J. Marrot, J. Désiré, Y. Blériot, *Org. Lett.* **2019**, *21*, 4821–4825.

<sup>132</sup> L. Cipolla, L. Lay, F. Nicotra, *J. Org. Chem.* **1997**, *62*, 6678–6681.



## 2. SnAP chemistry

SnAP stands for tin (Sn) Amine Protocol. This term was introduced by the team of Jeffrey Bode from the Eidgenössische Technische Hochschule (ETH) Zürich in 2013.<sup>133</sup> They presented an alternative strategy for the synthesis of substituted heterocycles, involving the transformation of aldehydes through the reaction of SnAP reagent of type **D23** (Scheme 81 A), rather than cross-coupling reactions (Scheme 81 B).<sup>134, 135</sup> The first examples were presented for the synthesis of thiomorpholines.



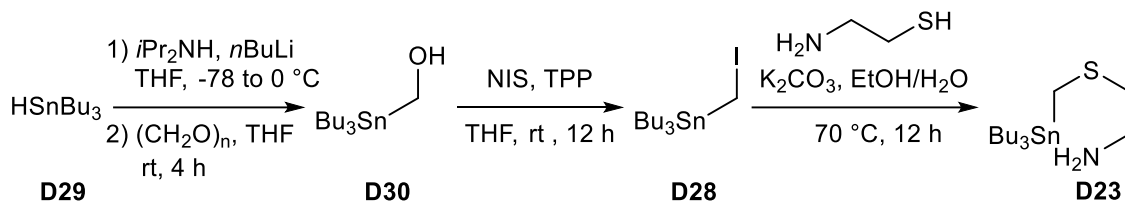
**Scheme 81.** Approaches for the synthesis of saturated nitrogen-heterocycles.

<sup>133</sup> C.-V. T. Vo, G. Mikutis, J. W. Bode, *Angew. Chemie Int. Ed.* **2013**, 52, 1705–1708.

<sup>134</sup> K. R. Campos, *Chem. Soc. Rev.* **2007**, 36, 1069–1084.

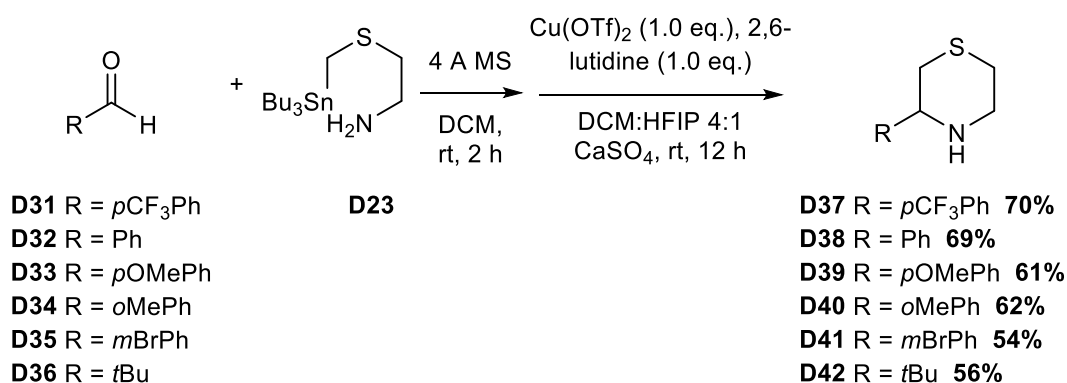
<sup>135</sup> E. A. Mitchell, A. Peschiulli, N. Lefevre, L. Meerpoel, B. U. W. Maes, *Chem. - A Eur. J.* **2012**, 18, 10092–10142.

The amino tributylstannane (**D23**) used as the starting material could be prepared: in one step from commercially available tributyl(iodomethyl)-stannane (**D28**) by S-alkylation of 2-aminoethanethiol. Alternatively, **D28** could be obtained in two steps from tributyltin hydride **D29** via transformation to alcohol **D30** and then substitution with NIS in the presence of triphenylphosphine (TPP) (Scheme 82).



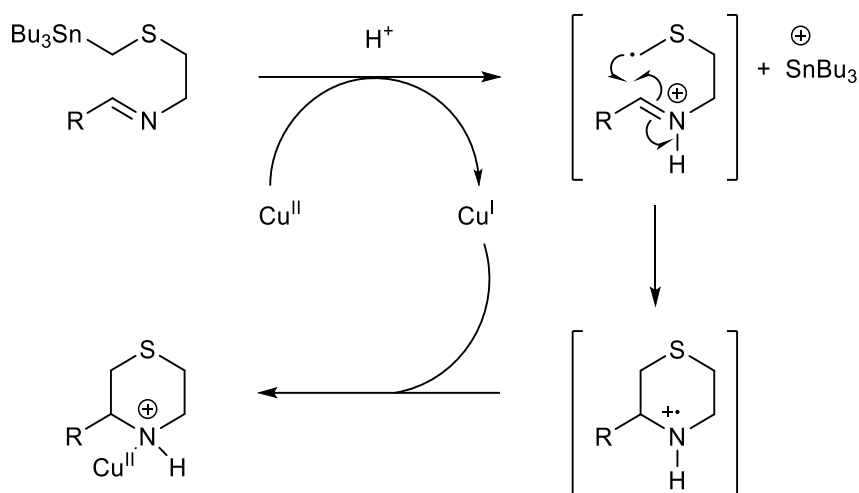
**Scheme 82.** Preparation of SnAP reagent **D23**.

Afterwards, the SnAP reagent **D23** was submitted to a sequence of two reactions, without isolation of the intermediate. The first step was the direct condensation of **D23** with an aldehyde in the presence of molecular sieves. The subsequent reaction was vastly optimised; the best results were obtained when the imine was added directly to the mixture containing copper(II) triflate, 2,6-lutidine and calcium sulfate in hexafluoroisopropanol (HFIP) (Scheme 83). The reaction tolerated a variety of aldehydes with good to moderate results.

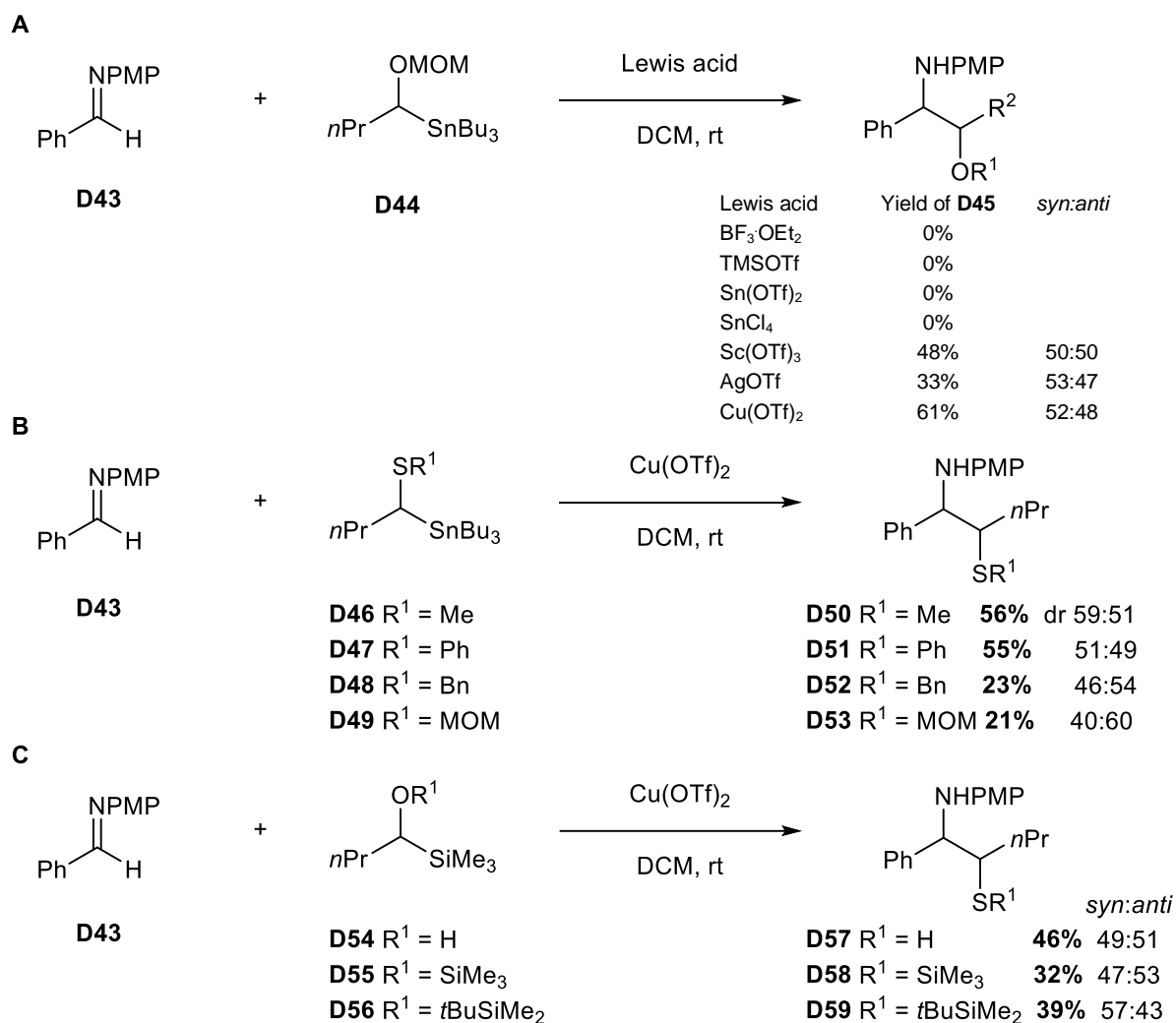


**Scheme 83.** Formation of thiomorpholines starting from **D23**.

In the same article, the reaction mechanism for the SnAP was proposed (Scheme 84). Based on the results with 2-pyridylaldehyde and related substrates, as well as tests performed with TEMPO, the authors attributed the role of oxidant to the copper. Therefore, the proposed mechanism involved the formation of an  $\alpha$ -thioalkyl radical, which cyclise onto the imine resulting in the formation of a cation radical: the latter is reduced by Cu<sup>I</sup> and assemble the complex between Cu<sup>II</sup> and the product. Afterwards, the desired compound can be released by treatment with a solution of 10% aq NH<sub>4</sub>OH.



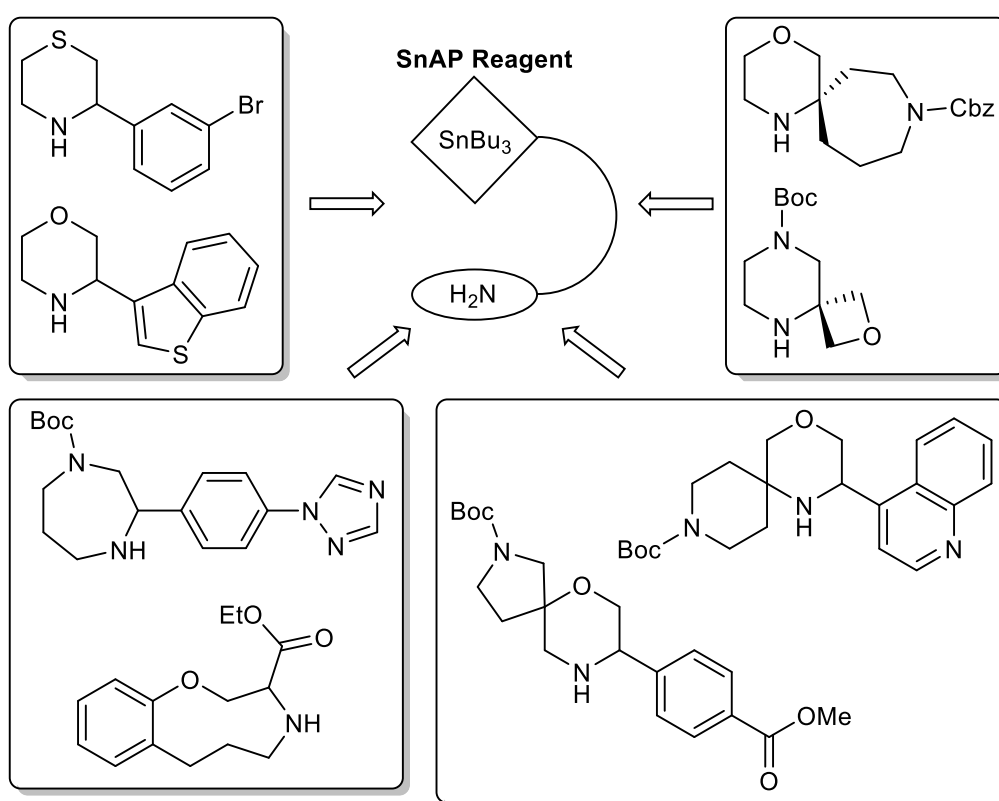
**Scheme 84.** Proposed mechanism for the formation of thiomorpholines and related heterocycles through SnAP chemistry.



**Scheme 85.** Intermolecular reaction developed by the group of Kagoshima.

Noteworthy, this reaction was inspired by the investigation of the team of Kagoshima in 2003 on the intermolecular addition of  $\alpha$ -oxygenated (Scheme 85 A), and  $\alpha$ -sulfurated alkylstannanes (Scheme 85 B), as well as  $\alpha$ -oxygenated alkylsilanes onto imines using various Lewis acids as promoters. It resulted from these studies that the best promoter was  $\text{Cu}(\text{OTf})_2$  (Scheme 85 C).<sup>136, 137, 138</sup>

The yields for the presented reactions were in the range of 21 to 61%, while the *syn* to *anti* ratios were close to 1:1. The copper(II) was used as a stoichiometric amount. In this case, the role of the copper was attributed to be as Lewis acid. Other tested Lewis acids either ultimately failed or gave inferior or similar results.



**Scheme 86.** Diverse N-heterocycles available through SnAP chemistry.

The SnAP chemistry was successfully developed by the group of Bode, as an elegant tool to create multiple types of saturated heterocycles. The diversity of the SnAP reagents was increased, enabling the synthesis of piperazines and morpholines,<sup>139</sup> as well as numerous

<sup>136</sup> H. Kagoshima, K. Shimada, *Chem. Lett.* **2003**, 32, 514–515.

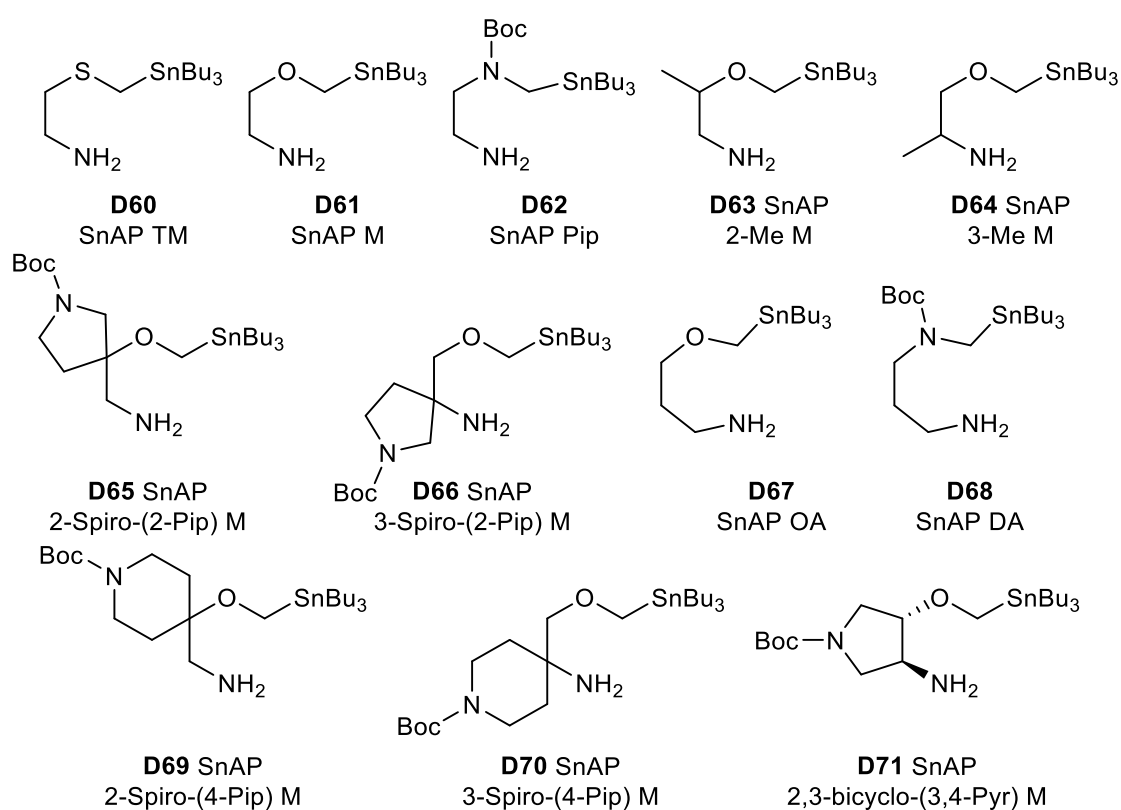
<sup>137</sup> H. Kagoshima, N. Takahashi, *Chem. Lett.* **2004**, 33, 962–963.

<sup>138</sup> H. Kagoshima, K. Yonezawa, *Synth. Commun.* **2006**, 36, 2427–2432.

<sup>139</sup> M. U. Luescher, C.-V. T. Vo, J. W. Bode, *Org. Lett.* **2014**, 16, 1236–1239.

medium-ring saturated N-heterocycles (diazepanes, oxazepanes, diazocanes, oxazocanes and hexahydrobenzoxa-zonines),<sup>140</sup> saturated spirocyclic N-heterocycles,<sup>141</sup> C-substituted spirocyclic and bicyclic saturated N-heterocycles<sup>142</sup> and exocyclic 3-amino- and 3-alkoxypyrrolidines and piperidines<sup>143</sup> (Scheme 86). They also proved that the synthetic process can be performed using a catalytic amount of copper(II) triflate (lowering the amount of copper and 2,6-lutidine to 5 – 20% or change of the ligand to (±)-PhBox 5 – 20%, as well as change of the solvent to pure HFIP or mixture of HFIP and ACN).<sup>144</sup>

To prepare most of the structures described above, specific SnAP reagents are required. A variety of them is commercially available at Merck Sigma-Aldrich (Figure 35).



**Figure 35.** Commercially available SnAP reagents.

Due to the resemblance of open-chain aminostannanes **32** and **33** to one of the SnAP-eX (eX stands for the external heterocycle atom) reagents (**D72**), we decided to try to implement the

<sup>140</sup> C.-V. T. Vo, M. U. Luescher, J. W. Bode, *Nat. Chem.* **2014**, *6*, 310–314.

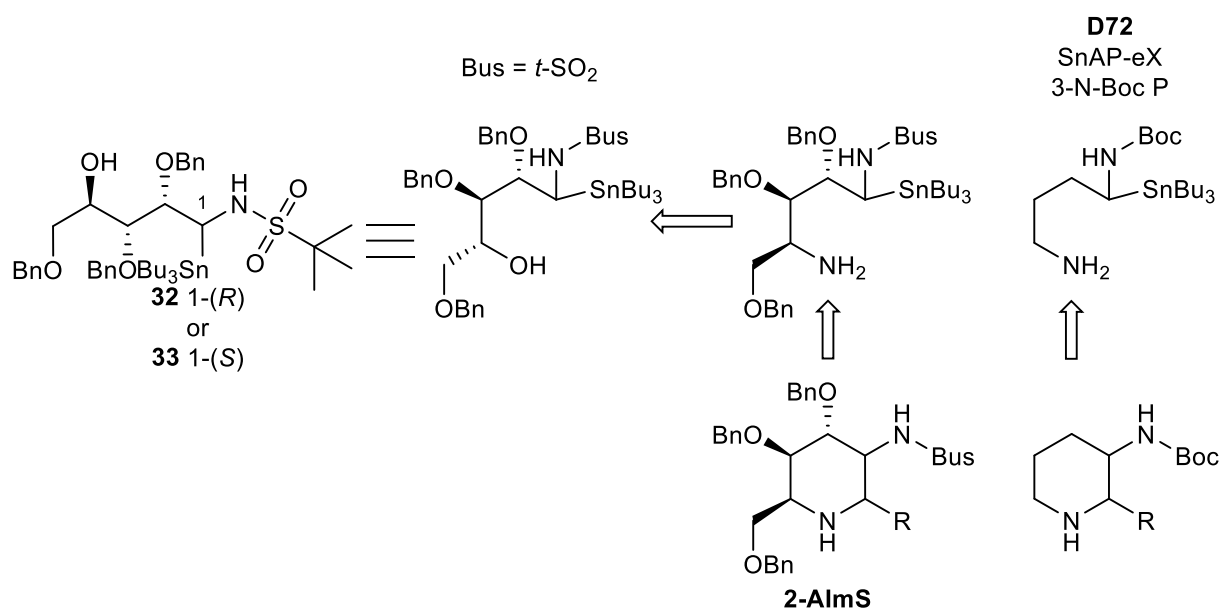
<sup>141</sup> W.-Y. Siau, J. W. Bode, *J. Am. Chem. Soc.* **2014**, *136*, 17726–17729.

<sup>142</sup> K. Geoghegan, J. W. Bode, *Org. Lett.* **2015**, *17*, 1934–1937.

<sup>143</sup> M. U. Luescher, J. W. Bode, *Org. Lett.* **2016**, *18*, 2652–2655.

<sup>144</sup> M. U. Luescher, J. W. Bode, *Angew. Chemie Int. Ed.* **2015**, *54*, 10884–10888.

SnAP chemistry to be able to obtain 2-aminoiminosugar-C-glycosides. As outlined in the scheme below (Scheme 87), that was the goal of the last part of my thesis.



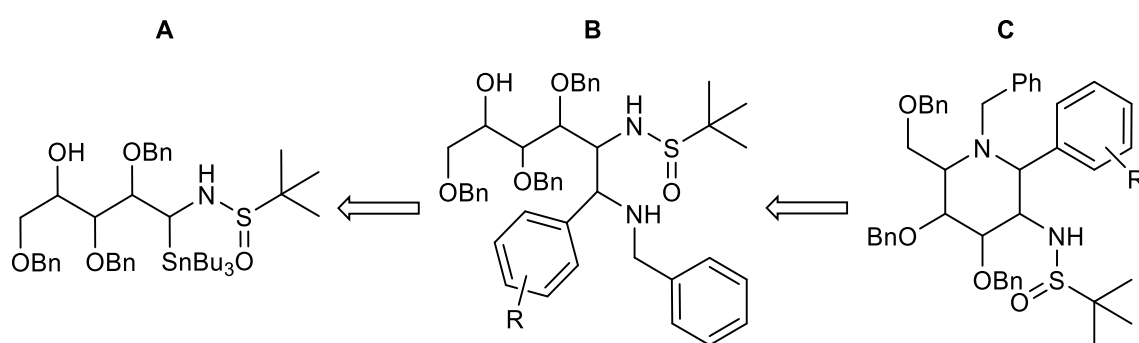
**Scheme 87.** Preparation of 2-AImS via SnAP chemistry.

We expected to meet a few difficulties with this project. Even though the main skeleton of the compound resembles the SnAP reagent, our starting material possesses three additional chiral centres. Will it help the cyclisation or rather undermine it? In addition, the substituents on the main carbon chain are much bigger than protons in case of SnAP-eX reagent **D72**, which also may hinder the cyclisation process due to sterics. Moreover, the proposed mechanism of the reaction (Scheme 84) goes through the radical formation. It could be possible that the radical will be quenched by the transfer of the hydrogen from one of *O*-benzyl group. Also, because of the presence of a good leaving group at C-2, the  $\beta$ -elimination is still an option as a side reaction.

## II. Application of the SnAP in the synthesis of 2-AImS

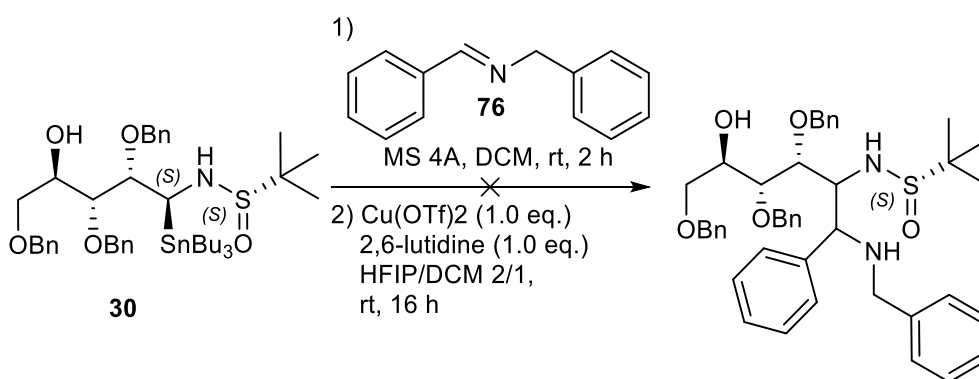
### 1. Intermolecular SnAP

The first attempts to implement the copper-mediated C–C bond formation were performed on the stannylated aminoalditols **A** through the intermolecular version of SnAP reaction. If the reaction was successful, it would lead to 1,2-diamino structures of type **B** (Scheme 88), which could be further cyclised to furnish 2-AImS compounds **C**.



**Scheme 88.** Strategy to obtain 2-AImS through intermolecular SnAP.

Thus, the conditions developed by Bode *et al.* were used directly on compound **30** and *N*-benzylidenebenzylamine **76** (Scheme 89). The reaction did not work, however, during the LC-MS analysis, many signals were observed possibly corresponding to elimination of benzyloxy moiety and/or sulfinyl group in compound **30**.

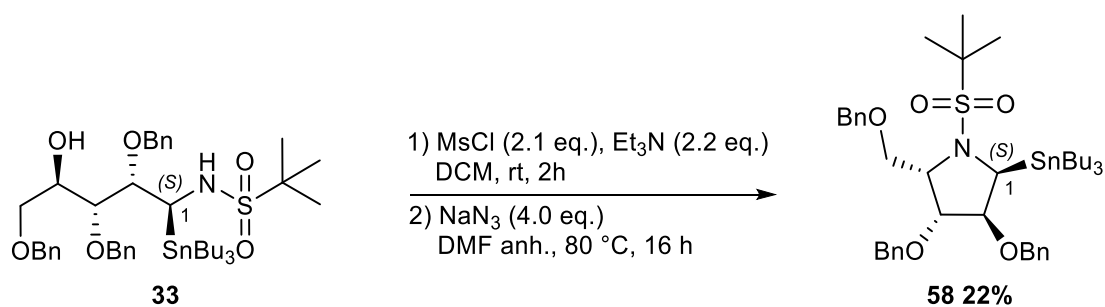


**Scheme 89.** Attempt of intermolecular SnAP.

Alternatively, we thought that an intramolecular version of this transformation could possibly be much more entropically favoured. Thus, we swiftly changed strategy and decided to transform the starting material to accommodate the intramolecular SnAP, which would require the introduction of a second amino group into the open-chain aminoalditol as outlined in Scheme 87.

## 2. Preparation of the starting material for intramolecular SnAP

The first tested method to introduce the azido group was the mesylation at O-4 followed by the displacement with sodium azide in anhydrous DMF (Scheme 90). However, the azido derivative was not isolated. Instead, the sulfonamide **33** cyclised, not unexpectedly, to yield iminosugar-1-tributylstannane **58** (22%).



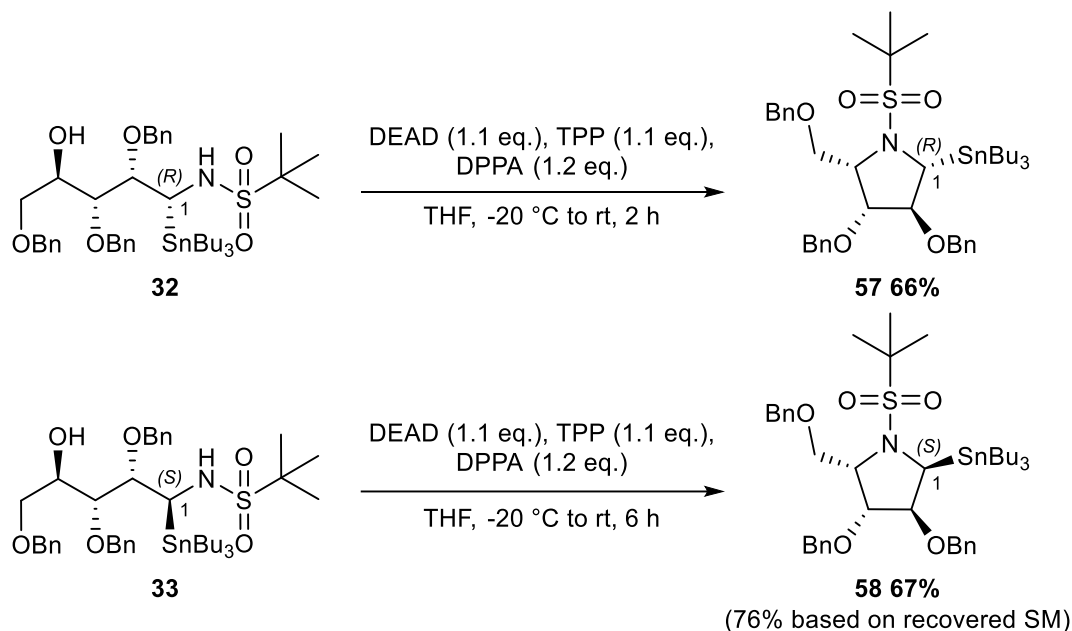
**Scheme 90.** Mesylation and displacement with  $\text{NaN}_3$ .

An alternative method to introduce an azido or an amino group at the place of primary and secondary alcohols is the Mitsunobu reaction. The amine at C-4 could thus be obtained by subsequent Staudinger reduction. The reaction was performed from both epimers **32** and **33** (Scheme 91). But, like for the previous reaction, rather than the azido derivative, the cyclic iminosugar-1-stannanes **57** and **58** were isolated (66 and 67% respectively). Interestingly, the Mitsunobu reaction could have replaced the mesylation and  $\text{S}_{\text{N}}2$  reaction (Schemes 73 and 74) and be an alternative to the synthesis of cyclic iminosugar-1-stannanes, thus shortening the entire process by one step.

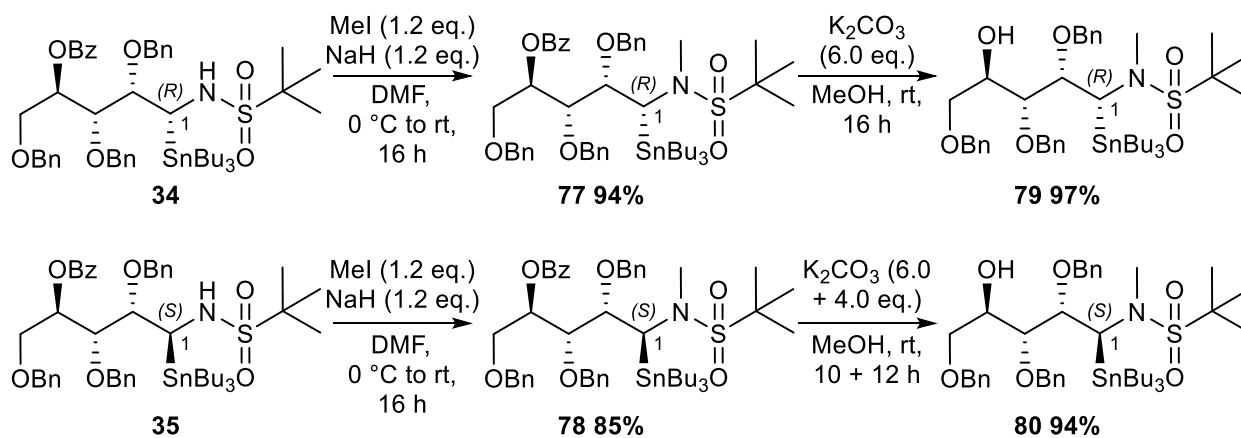
To introduce the azido group, we then decided to deactivate the cyclisation process by alkylating the nitrogen atom with methyl iodide (Scheme 92). As the starting materials, the compounds **34** and **35** with a benzoyl group at O-4 were used (preparation in Chapter 2, Scheme 57). The reaction worked extremely well in both cases. However, it had to be monitored carefully. If it was allowed to react longer, the partial deprotection of the benzoyl group and



the formation 4-*O*-methylated compound was observed. Afterwards, the protecting group at *O*-4 was removed to yield open-chain aminoalditols **79** and **80** with excellent yields.

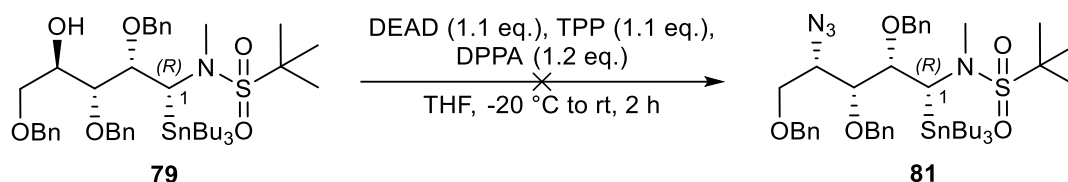


**Scheme 91.** Results of the Mitsunobu reaction.

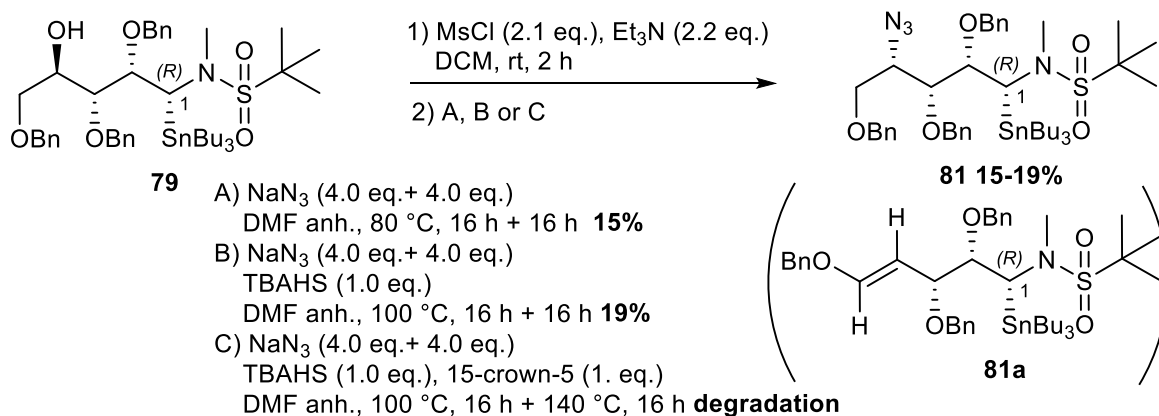


**Scheme 92.** Preparation of N-methylated open-chain aminoalditols **79** and **80**.

Once we blocked out the possibility of the cyclisation, we repeated the Mitsunobu reaction using **79** to introduce the azido group (Scheme 93). Unfortunately, the reaction did not work, and the starting material was recovered. Because it failed, we returned to the mesylation and displacement with sodium azide in DMF (Scheme 94). It worked with rather low yield (15%). In the presence of additive tetrabutylammonium bisulphate, the yield was increased to 19%. We also observed the formation of an elimination product as a result.

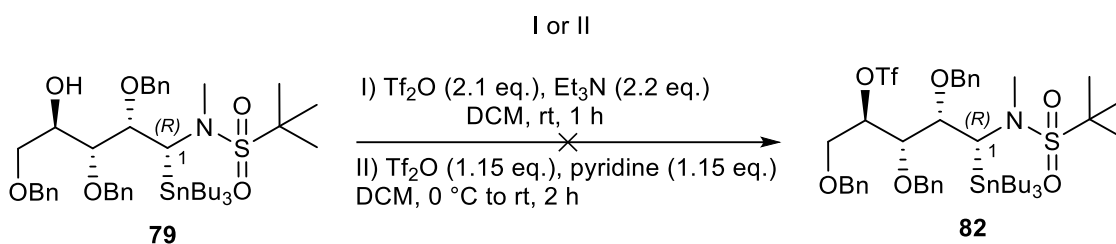


**Scheme 93.** Mitsunobu reaction performed on **79**.



**Scheme 94.** Formation of the azide **81**.

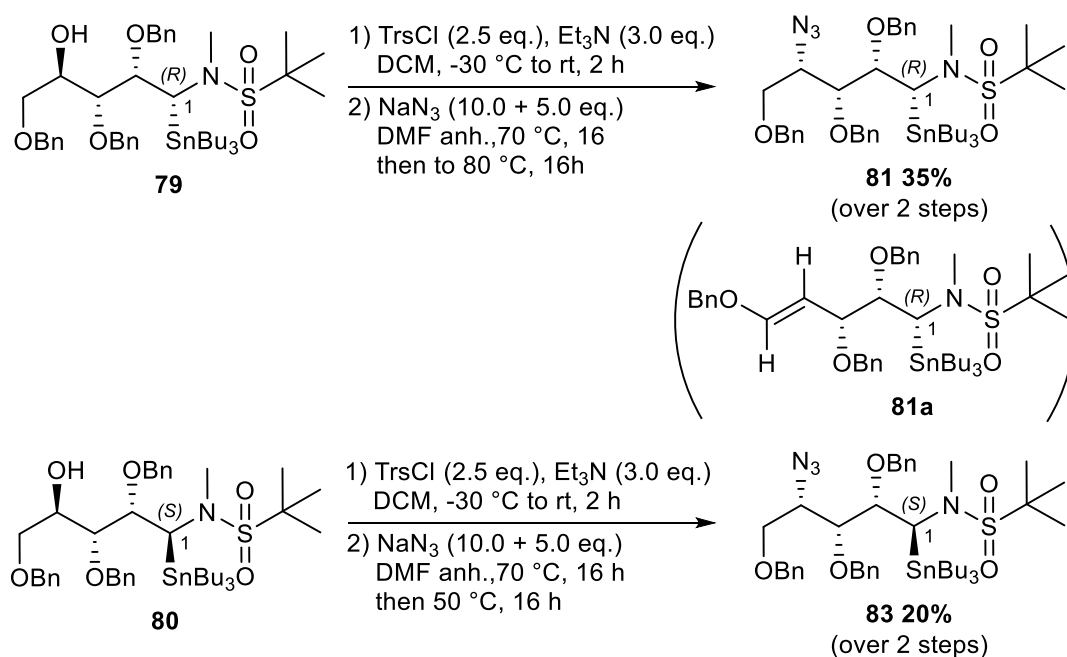
We tried to improve the outcome of the reaction and thus the yield of the azide by switching to a more reactive leaving group like a triflate (Scheme 95). However, the reaction performed at 0 °C resulted in the recovery of the starting material. At room temperature, degradation was observed.



**Scheme 95.** Reaction with triflic anhydride.

Another possibility was to use a leaving group with intermediate reactivity higher than mesylate, but lower than the triflate. We decided to investigate the reaction using a tresyl (tresyl = 2,2,2-trifluoroethanesulfonyl,  $\text{CF}_3\text{CH}_2\text{SO}_2$ ) group. With the application of tresyl chloride followed by the displacement with sodium azide, we managed to increase the yield of the substitution up to 40% (Scheme 96). However, it required additional equivalents of sodium azide and prolonged reaction time. In addition, the formation of an elimination side product **81a** was observed. Furthermore, the reaction was not complete and the starting material **79** was

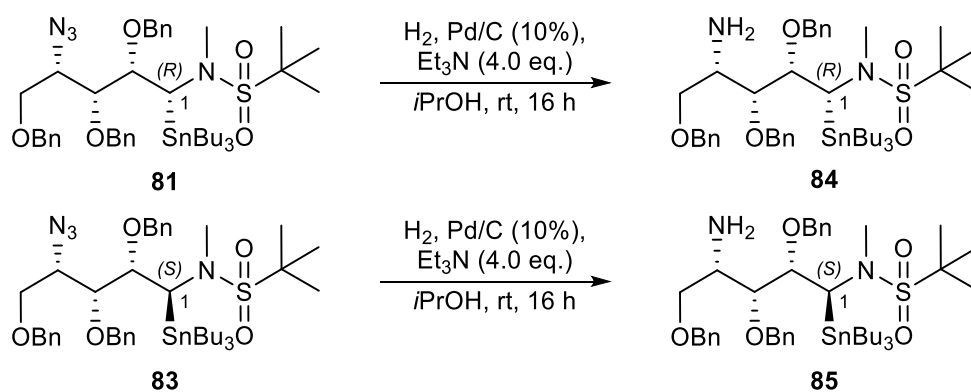
still observed on TLC. Compound **79** was separated during the purification process along with product **81** (yield over two steps based on the recovered starting material was 51%). The same conditions were applied to the epimer **80** and a similar result was obtained, the reaction was incomplete, formation of a side compound was observed and additional equivalents of sodium azide were supplied. In the end, residual starting material was recovered (yield over two steps based on the recovered starting material was 25%). Overall, the result of the azide formation was better than previously, however still not satisfactory. We decided to store the compound in the form of azide.



**Scheme 96.** Introduction of the azide via tresylate intermediate.

### 3. Application of intramolecular SnAP methodology

The azide group was selectively reduced to an amino group via catalytic hydrogenation in the presence of triethylamine (Scheme 97). The compounds were not purified, instead, the products were directly engaged to the SnAP chemistry. However, we could observe the signals from the amine on  $^1\text{H}$  NMR spectra of the products.



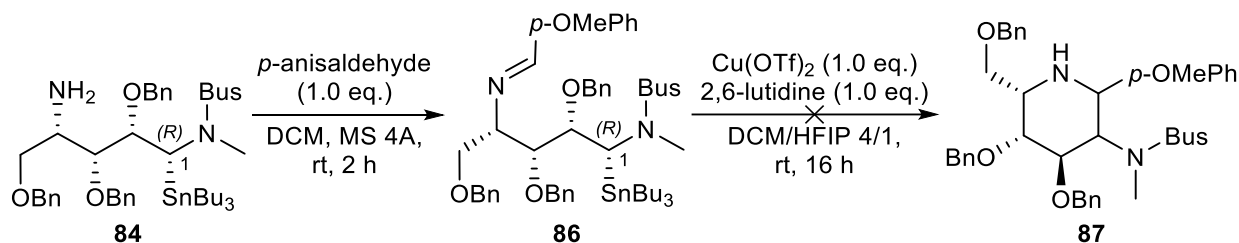
**Scheme 97.** Selective reduction of azide.

Before I will speak about the application of the SnAP to compounds **84** and **85**, I would like to explain the importance of the quality of the copper(II) triflate. It was stressed multiple times in the supporting information for the articles published by the group of Bode. They tested the copper(II) triflate from many suppliers and the best results were achieved with the one provided from STREM Chemicals, Inc. Otherwise, the reaction failed or yield was much lower. They demonstrate the difference by preparation of the mixture of copper(II) with 2,6-lutidine in HFIP. After around one hour the mixture was dark green if the copper salt was from STREM and blue in case of other suppliers.

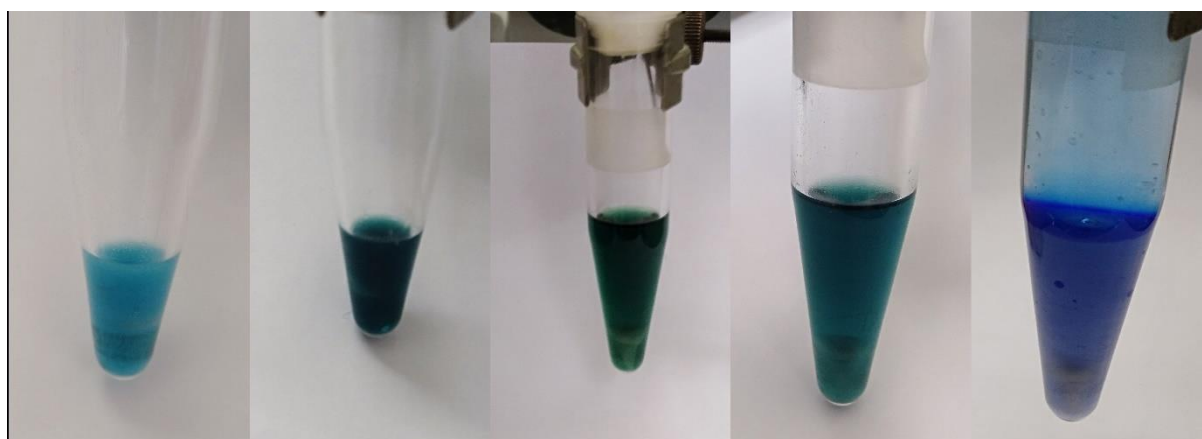
To give our SnAP the best chance to succeed, we diligently followed the advice given in the supporting information and prepared the copper(II) triflate from STREM accordingly. We also performed a model reaction described by Bode (with SnAP Pip reagent **D62** and *p*-anisaldehyde) and confirmed that we were able to reproduce the results reported in their paper using our copper triflate and other reagents.

The amines **84** was allowed to react with *para*-anisaldehyde in the presence of molecular sieves in DCM for two hours, then it was filtered through a short pad of Celite® and concentrated. In a separated flask, the suspension of copper and 2,6-lutidine in HFIP was prepared (Scheme 98). The imine was dissolved and added in one portion to the prepared mixture. Through the course of the reaction, we observed changes in the colour of the reaction mixture (Figure 36). The white-bluish suspension (copper and HFIP) became blue after the addition of 2,6-lutidine. However, after one hour, the suspension became homogeneous and dark green. After the addition of the imine, the mixture did not change colour drastically, the small difference was seen after the reaction was left overnight to react (a dark mixture of green and blue). Upon releasing potential product from the complex with copper by treatment with 10% aqueous

NH<sub>4</sub>OH, the colour changed to cobalt blue. The mass spectrometry analysis and <sup>1</sup>H NMR revealed that the sample did not contain the desired compound. Instead, the mixture of imine and 2,6-lutidine was recovered. It was used for the next attempt.



**Scheme 98.** First attempt of the SnAP using **84** as the starting material.

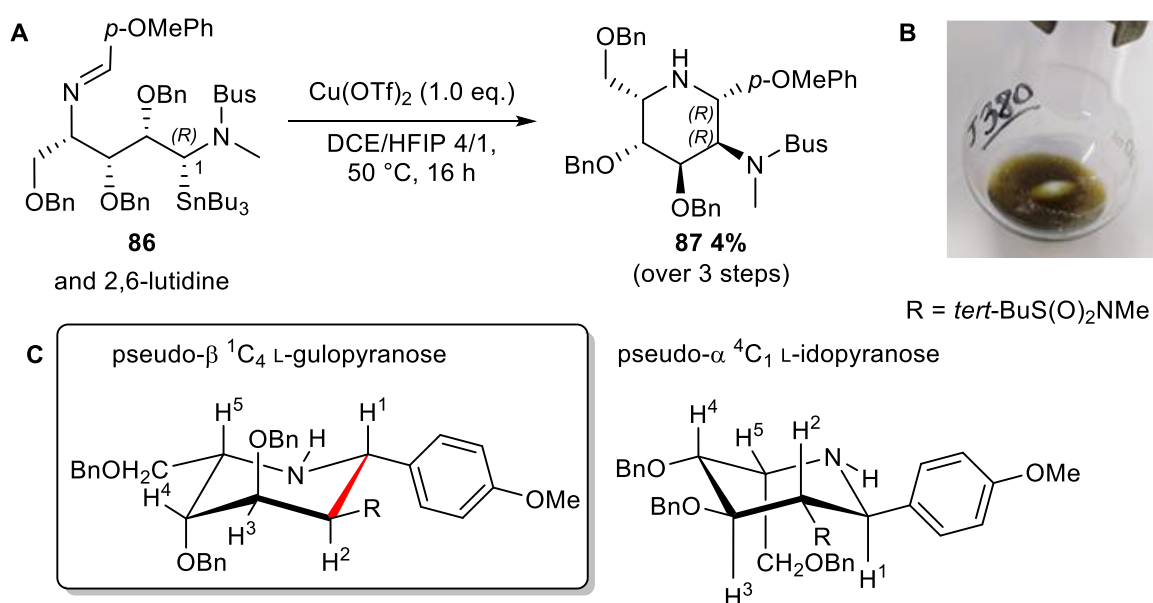


**Figure 36.** Change of the colour during the reaction.

Next attempt (Scheme 99 A), we decided to perform the reaction at higher temperature (50 °C), for that we changed the solvent from DCM to 1,2-dichloroethane (DCE). The mixture of imine **86** and 2,6-lutidine was dissolved in DCE and added to the prepared suspension (HFIP + Cu(OTf)<sub>2</sub>). Unexpectedly, after heating overnight, the colour of the mixture turned from dark green to brown (Scheme 99 B). The TLC analysis revealed the formation of a new spot. When no more changes on the TLC were observed, the reaction was quenched with 10% aqueous NH<sub>4</sub>OH. After the work-up, the concentrated residue was purified via preparative TLC and each fraction was submitted to mass spectrometry analysis. One of them unambiguously contained the mass of the desired compound **87** (Figure 37).

Isolation of the fraction led to a 6 mg sample of this product (yield = 4% over three steps and two preparative TLC). The <sup>1</sup>H NMR spectrum of the product was recorded at 600 MHz (total analysis). The NMR data clearly established that the compound had the expected constitution (i.e., *tert*-butyl, *N*-methyl, *O*-methoxy three *O*-benzyl groups). Moreover, besides an aromatic

impurity, only a single compound was observed, which suggests that the copper-mediated cyclisation was diastereoselective. Assignment of the signals on the basis of 2D NMR spectra, including H,H-COSY and HSQC led to the observation of a very large coupling constants between H-C-1 and H-C-2 ( $J = 10.5$  Hz): we can propose two possible configurations for compound **87**, both of which in a conformation with these two protons in axial positions (Scheme 99 C): either an *L-ido* or an *L-gulo* configuration. Further analysis of the NMR data indicated that all the other intracyclic  $J_{H,H}$  coupling constants are very small; this strongly suggests that the SnAP reaction product has the pseudo- $\beta$ -*L-gulo* configuration, in a favourable conformation with the two large groups equatorial.

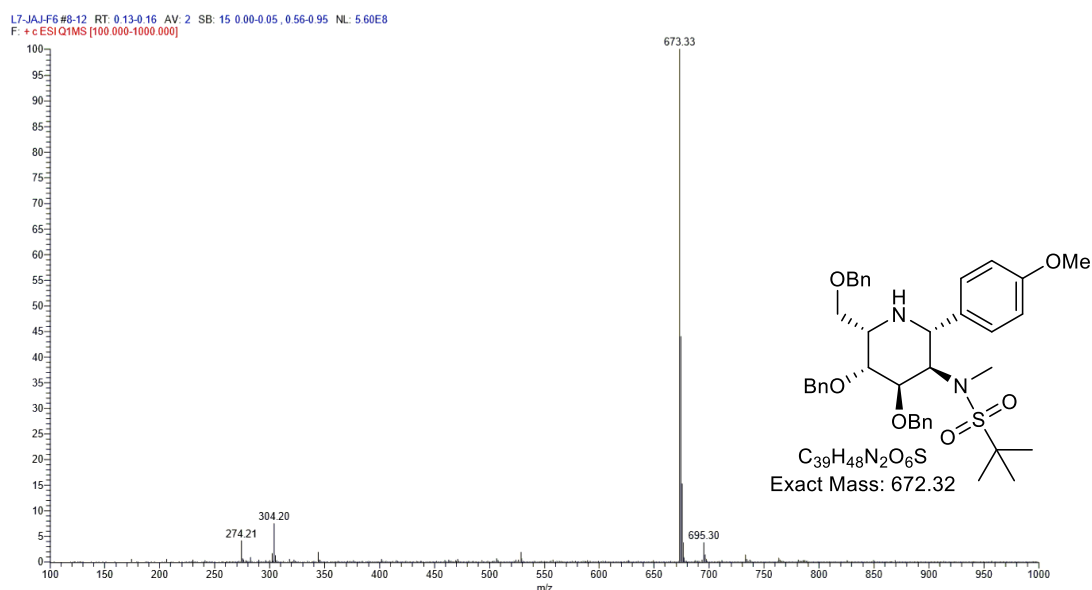


**Scheme 99.** Second SnAP reaction.

Thus, the process leads to a structure in which the two groups at the reacting sites are *trans*, and with a *cis* relation between the substituents at C-2 and C-3. There is also a change in the relation in comparison to the starting material. Previously *O*-benzyl and amine carrying sulfinyl group were in *anti* relation. However, after the cyclisation, these substituents are in relative *cis* configuration. This indicates inversion of configuration at the carbon carrying the stannyl group.

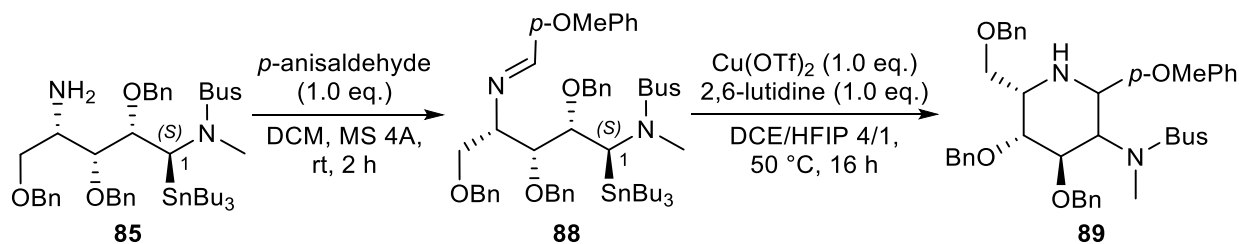
Even though the yield of the reaction was low, we have proven that it was working; this is a highly significant result in that it shows that the SnAP strategy can be applied to more complex structures. Amino-iminosugars are thus accessible via an unusual connexion between the C-1 and C-2 carbon atoms, and the process appears to be highly stereoselective. The optimisation should now be undertaken in order to make the reaction useful in a synthetic sequence.

Positif :



**Figure 37.** Results of MS analysis of the fraction containing **87**.

A similar experiment was performed for the second amine **85** (60 mg of **83**). The reaction performed at room temperature failed, as only signals coming from starting material **85** intermediate imine **88** were detected. Once heated at 50 °C (Scheme 100), the presence of compound **89** was detected by mass spectrometry in the crude mixture. The purification was not attempted, due to the small scale of the reaction.



**Scheme 100.** SnAP chemistry with **85** as the starting material.

Although the yield of the cyclisation through SnAP chemistry was low, we proved it is working and it is selective. It encourages further the research on the application of this process to the synthesis of iminosugar derivatives and other complex molecules.

### III. Conclusions

In this Chapter, the main goal was to apply the SnAP chemistry to our developed stannylated derivatives. If successful, it would enable the synthesis of 1-*C*-substituted 2-aminoiminosugars. The procedure itself is straightforward and possesses advantages like the fact that it is mediated by copper (less expensive than palladium) and allows late-stage functionalisation (different variations are possible with the change of an aldehyde).

Of not, the first attempt in recreating the intermolecular reaction between stannylated aminoalditol and an external imine, inspired by the work of Kagoshima, failed. The formation of the desired compound was not observed, and the starting material was not recovered.

We changed the strategy for the intramolecular version proposed by Bode in the synthesis of various saturated heterocycles: SnAP chemistry. The first challenge was to introduce the azido group at C-4. The tested methods (mesylation followed by substitution with sodium azide and Mitsunobu reaction) led to the cyclisation and isolation of 1-stannylated iminosugars. Introducing the azido group required the protection of the amine at C-1 by methylation and the activation of hydroxyl group at C-4. Afterward, the Mitsunobu reaction failed and the mesylation followed by cyclisation gave the desired product in low yield. We managed to increase the yield of the substitution to about 35% by switching the leaving group from mesylate to a tresyl moiety. The selective reduction of the azide to an amine was performed without any problems. The SnAP reaction consisted of two steps: formation of the imine and cyclisation via a radical intermediate. The challenge appeared with the second step. The classical conditions did not work. However, changing the solvent and increasing the temperature led to the formation of the desired compound. Its presence was confirmed by NMR, MS and LC-MS analysis, and its structure proven to be 1-*C*-substituted 2-aminoiminosugar.

This project is in very early stage of progress and the presented results are preliminary. We demonstrated that the formation of the desired products was possible by SnaAP chemistry; however, to fully take advantage of this methodology extensive optimisation will be required.



#### IV. Summary of Chapter 4 *en français*

Dans l'introduction du chapitre 4, j'ai expliqué ce que sont les 2-aminoiminosucres ainsi que leur rareté. A l'heure actuelle, il n'existe que neuf articles et un brevet décrivant la synthèse de ces types de sucres. La plupart des stratégies commencent avec un composé contenant le groupe amino en C-2 et se concentrent sur l'introduction d'un atome d'azote intracyclique ou inversement, le matériau de départ est l'iminosucre et la méthodologie permet l'introduction d'un deuxième groupe amino. Quelques-uns d'entre eux ont été expliqués plus en détail, comme la synthèse des analogues du  $\alpha$ -D-GlcNAc-1-phosphate par Cheng *et al.* et la synthèse des analogues 1,2-*cis*-homoiminosucres de GlcNAc et GalNAc par contraction de l'anneau azépane par l'équipe d'Yves Blériot.

Par la suite, une explication détaillée de SnAP et de son application a été effectuée. SnAP signifie protocole étain (Sn) amine. Ce terme a été introduit par l'équipe de Jeffrey Bode de l'Eidgenössische Technische Hochschule (ETH) Zürich en 2013. Depuis le début, il a été présenté comme une stratégie alternative pour la synthèse de N-hétérocycles saturés. En général, la méthodologie consiste en deux étapes effectuées l'une après l'autre sans purification. La première étape est la condensation de l'amine portant le groupe tributylétain (appelé réactif SnAP) avec un aldéhyde ou une cétone pour former une imine, qui est ensuite soumise pour la cyclisation en présence d'un sel de cuivre (II).

La simplicité et la polyvalence de cette réaction ont permis la synthèse de petites banques de molécules avec différents supports N-hétérocycliques, comme les pipérazines et les morpholines, ainsi que de nombreux supports N-hétérocycles saturés à cycle moyen ainsi que des supports 3-amino- et 3-alkoxy-pyrrolidines et piperidines exocycliques. Actuellement, plusieurs réactifs SnAP sont disponibles sur le marché.

L'objectif principal du chapitre 4 était d'appliquer la chimie SnAP aux dérivés stannylés développés. En cas de succès, elle permettrait la synthèse de 2-aminoiminosucres C-glycosylés.

Après l'échec des tentatives de réaction intermoléculaire basées sur l'approche de Kagoshima, nous avons changé la stratégie pour celle proposée par Bode - un processus intramoléculaire passant par la formation d'espèces radicalaires.

Le premier défi a été l'introduction de l'azide en position C-4. Les méthodes testées (méthylation suivie d'une substitution par l'azoture de sodium ou une réaction de Mitsunobu) conduisent à

la cyclisation et à l'isolement des iminosucres 1-stannylés. Pour introduire le groupe azido, il a fallu protéger l'amine par sa transformation en amine tertiaire avant l'activation du groupe hydroxyle en C-4. Par la suite, la réaction de Mitsunobu a échoué et l'autre méthode a donné un faible rendement. Nous avons réussi à augmenter le rendement en changeant le groupe partant du mésylate au trésylate. La réduction sélective de l'azide a ensuite été réalisée sans problème.

Le SnAP se compose de deux étapes : la formation de l'imine et la cyclisation par l'intermédiaire radicalaire. Le défi est apparu avec la deuxième étape. Les conditions classiques n'ont pas fonctionné. Cependant, le changement du solvant et l'augmentation de la température ont permis d'observer la formation du composé désiré, de l'isoler et de confirmer sa configuration et sa conformation par des analyses RMN, MS et LC-MS approfondies.

Même si le rendement de la réaction a été faible, nous avons prouvé qu'elle fonctionnait ; c'est un résultat très significatif dans la mesure où il montre que la stratégie SnAP peut être appliquée à des structures plus complexes. Les dérivés d'amino-iminosucres sont donc accessibles par une connexion inhabituelle entre les atomes de carbone C-1 et C-2, et le procédé semble très stéréosélectif. L'optimisation doit maintenant être entreprise afin de rendre la réaction utile dans une séquence synthétique.

# **General conclusions and perspectives**

---



In this part, I would like to summarise the objective for each chapter, as well as comment on what was achieved. Also, I will give perspective in the short and medium term, how the developed reactions might be further refined and in which field they may find applications.

In the first chapter, the objectives were: the optimisation of the synthesis of *N*-tert-butanesulfinylglycosylamines and the development of the preparation of 1-stannylated aminoalditols. To achieve the first goal, the microwave-assisted synthesis and flow chemistry techniques were applied. With the first technique, we managed to increase the yield and at the same time, shortening the reaction time. In case of flow chemistry, we proposed various improvements which could be implemented to improve the outcome.

The synthesis of 1-stannylated aminoalditols was successful, the developed reaction was highly diastereoselective and gave excellent yield. Moreover, it was found to be tuneable, the outcome of the addition depending on the configuration of the chiral auxiliary used in the synthesis, which was confirmed by later studies. The synthesis of stannylated intermediates is pivotal and enables the application of the Stille cross-coupling and SnAP chemistry.

The precious intermediate 1-stannylated aminoalditols were engaged in two different methodologies involving tin, namely Stille cross-coupling (Chapter 2 and 3) and SnAP chemistry (Chapter 4). While the Stille reaction applied to cyclic 1-stannylated iminosugar derivatives would yield iminosugar-*C*-glycosides, both the Stille cross-coupling of stannylated aminoalditols and the SnAP chemistry would result in the formation of the same type of scaffold but in the 2-aminoglycosides series – *C*-glycosylated 2-aminoiminosugar (2-AImS).

In terms of realisation, the two projects proved to be difficult and generated multiple problems. The main obstacle in the Stille reaction of open-chain intermediates was the formation of a cyclic hemiacetal after deprotection of the 4-OH group. The solution could be selective reduction of introduced carbonyl group followed by deprotection of the benzoyl group at O-4. The diol formed could be cyclised using double oxidation and double reductive amination procedure, or alternatively, double mesylation and S<sub>N</sub>2 cyclisation, but this could not be achieved.

For the SnAP chemistry, two versions were tested, namely the intermolecular one with an external imine, and, secondly, the intramolecular cyclisation (a more entropically favoured solution). The intermolecular reaction did not work. The intramolecular approach required the introduction of the second amino group via an azide followed by its reduction, subsequent condensation with an aldehyde and copper-mediated cyclisation. The reaction was successful

with modest yield. However, the formation of a single compound was observed, which suggest that the reaction is diastereoselective. To be able to profit from this methodology, both formation of the azido intermediate and the cyclisation step will require extensive optimisation.

The biological activity of these molecules (after deprotection) could be evaluated on various enzymes processing the glycosides of GlcNAc, GalNAc and MurNAc. We could imagine some of these molecules as inhibitors of enzymes responsible for the formation of peptidoglycan in bacteria or chitin.

Taking into account the number of steps needed to reach the final product, the methodology involving Stille reaction is shorter than SnAP approach. Notably, the SnAP chemistry where the aldehyde is replaced by a cyclic ketone would enable access to 1-spiroiminosugars. The existing methodologies of the synthesis of such scaffolds were summarised recently in one of the chapters of *Topics in Heterocyclic Chemistry*.<sup>145</sup>

On the other hand, the execution of the Stille reaction of 1-tributylstannyl iminosugars was successful. The reaction provided 1-C-acylated iminosugar derivatives, which can be converted in a diversity of significant glycoside mimics. The precursors, cyclic 1-C-stannylated iminosugars, provided evidence for the stereochemistry of the addition of the tributyltin lithium reagent and the remarkable influence of the chiral handle in the formation of either epimer. Importantly, we proposed a new tool for the determination of the configuration of 1-stannylated pyrrolidines derivatives, complementary to NOESY data. We demonstrated the existence of a relationship between the value of the heteronuclear coupling constant of tin and the carbon atom in  $\alpha$ -position of the *n*-butyl chain and the relative configuration at C-1 vs C-2 substituent.

We would like to increase the scope of the electrophiles applicable to the Stille coupling reaction, in particular, aromatic halides; however, this will require extended optimisation. Alternatively, we could apply bimetallic catalysis involving two metals in two catalytic cycles, usually connected by a transmetalation step. In this respect, one of the most remarkable examples involving the Stille reaction is its application with gold and palladium.<sup>146</sup> Both metals were added as fully coordinated complexes with the same ligand, thus the possibility of ligand scavenging process by gold was ruled out. The reactions gave excellent yields even with bulky

---

<sup>145</sup> D. Hazelard, R. Hensienne, J.-B. Behr, P. Compain, in *Top. Heterocycl. Chem.*, Springer, Berlin, Heidelberg, **2019**, pp. 1–30.

<sup>146</sup> J. DelPozo, D. Carrasco, M. H. Pérez-Temprano, M. García-Melchor, R. Álvarez, J. A. Casares, P. Espinet, *Angew. Chemie Int. Ed.* **2013**, *52*, 2189–2193.

groups, which usually make the Stille reaction less effective. Moreover, due to values of the activation energy calculated via DFT methods, the two transmetalations (Sn/Au and Au/Pd) seems to be more energetically favoured than single one (Sn/Pd).<sup>147</sup> Maybe with the application of this bimetallic system, we could overcome the restrictions in the scope of electrophiles used with our substrates, as well as increase the yield of the reaction. In addition, the improvement of our methodology could allow the preparation of library of immucilins-like compounds and many other iminosugar-C-glycosides of biological interest.

---

<sup>147</sup> M. H. Pérez-Temprano, J. A. Casares, Á. R. de Lera, R. Álvarez, P. Espinet, *Angew. Chemie Int. Ed.* **2012**, *51*, 4917–4920.





# Appendices

---



## I. List of the publications

*A Practical Approach to Dideoxy-1,4- and 1,5-iminopentitols from Protected Sugar Hemiacetals.*

Jaszczyk, J. ; Li, S. ; Cocaud, C. ; Nicolas, C. ; Martin, O. R.

*Carbohydrate Research* **2019**, *in press*

*The synthesis and reactivity of 1-stannylated iminosugars.*

Jaszczyk, J. ; Li, S. ; Nicolas, C. ; Martin, O. R. , in preparation for a high impact journal

## II. List of the communications

### 1. Oral presentations

Jaszczyk, J. ; Nicolas, C. ; Martin, O. R.

*Innovative approach to iminosugar-C-glycosides through Stille cross-coupling reaction*  
(Flash communication)

27<sup>èmes</sup> Journées du Groupe Français des Glycosciences, GFG2018

**May 2018** – Nouan-le-Fuzelier (France).

Jaszczyk, J. ; Li, S. ; Nicolas, C. ; Martin, O. R.

*Tunable synthesis of glycoside mimics through cross-coupling reactions of acyl chlorides and stereochemically defined iminosugar-1-tributylstannanes*

Colloque Biotechnocentre

**Oct 2018** – Seillac (France).

Jaszczyk, J. ; Li, S. ; Nicolas, C. ; Martin, O. R.

*New approaches to iminoglycoside mimics by way of organotin intermediates*

20<sup>th</sup> European Carbohydrate Symposium

**Jul 2019** – Leiden (Netherlands).

## 2. Posters

Jaszczyk, J. ; Nicolas, C. ; Martin, O. R.

*Inhibitors of GGL (glycoglycerolipids) biosynthesis in enterococci: synthesis and biological evaluation*

Colloque Biotechnocentre

**October 2017** – Seillac (France).

Jaszczyk, J. ; Nicolas, C. ; Martin, O. R.

*Studies towards the synthesis of inhibitors of glycoglycerolipids biosynthesis in Enterococci*

Journée Scientifique de la Fédération Physique et Chimie du Vivant- FR2708

**January 2018** – Orléans (France).

Jaszczyk, J. ; Nicolas, C. ; Martin, O. R.

*Studies towards the synthesis of inhibitors of glycoglycerolipids biosynthesis in Enterococci*

25<sup>th</sup> Young Research Fellow Meeting

**March 2018** – Orléans (France).

Li, S. ; Jaszczyk, J. ; Nicolas, C. ; Martin, O. R.

*Innovative approach to iminosugar-C-glycosides through stille cross-coupling reaction*

27<sup>èmes</sup> Journées du Groupe Français des Glycosciences

**May 2018** – Nouan-le-Fuzelier (France).

Li, S. ; Jaszczyk, J. ; Pannecouke, X. ; Poisson, T. ; Nicolas, C. ; Martin, O. R.

*Tunable Synthesis of Glycoside Mimics Through Cross-Coupling Reactions of Benzoyl Chlorides and Stereochemically Defined Iminosugar-1-tributylstannanes*

17<sup>th</sup> meeting of the French-American Chemical Society (FACS XVII )

**Jun 2018** – Orléans (France).

Li, S. ; Jaszczyk, J. ; Pannecouke, X. ; Poisson, T. ; Nicolas, C. ; Martin, O. R.

*Tunable approach for the stereoselective synthesis of iminosugar-C-glycosides as glycosyl mimics*

16<sup>th</sup> Belgian Organic Synthesis Symposium (BOSS)

**July 2018** – Bruxelles (Belgium).

Goldman, M. ; Jaszczyk, J. ; Nicolas, C. ; Martin, O. R.

*Synthesis of (fluorescent) 1-(phosphonomethyl)-1,5-dideoxy-1,5-imino-d-xylitol derivatives as glucose-1-phosphate mimics*

Journée Scientifique de la Fédération Physique et Chimie du Vivant- FR2708

**April 2019** – Orléans (France).

Li, S. ; Jaszczyk, J. ; Poisson, T. ; Pannecouke, X. ; Nicolas, C. ; Martin, O. R.

*Tunable synthesis of glycoside mimics through cross-coupling reactions of benzoyl and acyloyl chlorides and stereochemically defined iminosugar-1-tributylstannanes*

Journée Scientifique de la Fédération Physique et Chimie du Vivant- FR2708

**April 2019** – Orléans (France).

Li, S. ; Jaszczyk, J. ; Roy, V. ; Agrofoglio, L. A. ; Pannecouke, X. ; Poisson, T. ; Martin, O.

R. ; Nicolas, C.

*New approaches to iminoglycoside mimics by way of organotin intermediates*

47<sup>th</sup> International Union of Pure And Applied Chemistry – IUPAC 2019

**July 2019** – Paris (France).



# **Experimental part**

---





## GENERAL REMARKS

Unless otherwise stated, all reagents were purchased from commercial sources and used as received. 2,3,5-tri-*O*-benzyl-D-arabinofuranose, (*S*)-(-)- and (*R*)-(+)-2-methyl-2-propanesulfonamide were purchased from Carbosynth. D-Xylose was purchased from Fischer Scientific and following reported procedures, 2,3,4-tri-*O*-benzyl-D-xylopyranose was prepared. Ti(OEt)<sub>4</sub> (50 mL in glass bottle), 4 Å activated molecular sieves (powder and pellets, 1.6 mm diameter), toluene (puriss. p.a., ACS reagent, ≥ 99.7% (GC)), THF (99.9% GC) with 2,6-di-*tert*-butyl-4-methylphenol (250 mg/L) as stabilizer, *n*-BuLi solution (2.5 M in hexanes), diisopropylamine (puriss. p.a., ≥99.5% (GC)) and tributyltin hydride (10 g in glass bottle, 97%, contains 0.05% BHT as stabilizer) were purchased from Sigma-Aldrich (Merck). Utilization of tributyltin hydride provided from other suppliers than Sigma-Aldrich (Merck), resulted in unsuccessful addition to the glycosylamines. MsCl (99.5%) and mesitylene (97%, pure) were purchased from Acros Organics. Et<sub>3</sub>N (technical grade) was purchased from VWR. Ethyl acetate (EtOAc) (99.8% GC, tech. grade, pure for synthesis), petroleum ether (PE) (tech. grade, pure for synthesis, bp 40-65 °C) and dichloromethane (99.95% GC, tech. grade, pure for synthesis, stab. with ethanol) were purchased from Carlo Erba. Diisopropylamine was distilled over calcium hydride prior to use. *n*-BuLi was titrated using salicylaldehyde phenylhydrazone as an indicator. Toluene (puriss. p.a., ACS reagent, ≥ 99.7% (GC)) and THF (99.9% GC) with 2,6-di-*tert*-butyl-4-methylphenol (250 mg/L) as stabilizer were purified by passage through a column containing activated alumina under nitrogen pressure (Dry Solvent Station GT S100, GlassTechnology, Geneva, CH). Dichloromethane (99.99% GC) was distilled from calcium hydride. 4 Å MS (powder and pellets) were activated by drying in an oven at 500 °C (48 h). They were allowed to reach room temperature and kept over CaCl<sub>2</sub> in a desiccator prior to use.

NMR spectra were recorded at 298 K with a Bruker (250 MHz) and Bruker Avance III HD nanobay 400 MHz spectrometers equipped with a BBO probe. Some spectra were recorded at CBM on Bruker (600 MHz) and Bruker (700 MHz) spectrometers. The nuclei-signal assignments were done with the aid of 1 D [<sup>1</sup>H NMR, <sup>13</sup>C NMR, Distortionless Enhancement by Polarization Transfer (DEPT)] and 2 D [<sup>1</sup>H-<sup>1</sup>H Correlation Spectroscopy (COSY) and <sup>1</sup>H-<sup>13</sup>C Heteronuclear Single Quantum Coherence (HSQC)] experiments. When appropriate or in case of ambiguous proton and carbon, assignments were established using Heteronuclear Multiple-bond Correlation (HMBC) and Nuclear Overhauser Effect Spectroscopy (NOESY). <sup>1</sup>H NMR chemical shift values are listed in parts per million (ppm) downfield from TMS as the internal standard or relative to the corresponding non-deuterated solvent. Data are reported as follows: chemical shift (ppm on the δ scale), multiplicity (s = singlet, bs = broad singlet, d = doublet, bd = broad doublet, dd = doublet of doublet, ddd = doublet of doublet of doublet, t = triplet and m = multiplet), coupling constant *J* (Hz), integration and assignment. <sup>13</sup>C NMR chemical shifts are given in ppm relative to the corresponding non-deuterated solvent or TMS as the internal standard.

High-resolution mass spectra (HRMS) were recorded with a MaXis ESI qTOF ultrahigh-resolution mass spectrometer (FR2708, Orléans).

Infrared spectra (IR) were recorded with a Thermo Scientific Nicolet IS10 FTIR spectrometer using diamond ATR golden gate sampling and are reported in wave numbers ( $\text{cm}^{-1}$ ).

Specific optical rotations were measured with a Perkin–Elmer 341 polarimeter or a Jasco P-2000 polarimeter in a thermostated ( $20\text{ }^{\circ}\text{C}$ ) 1 dm long cell with high-pressure sodium lamp and are reported as follow:  $[\alpha]_D^{20} = (\text{solvent}, c (\text{g}/100 \text{ mL}))$ .

Analytical thin-layer chromatography (TLC) was performed with Merck Silica Gel 60 F254 pre-coated plates or with Macherey-Nagel pre-coated sheets ALUGRAM® silica gel 60 (layer 0.20 mm) with fluorescent indicator UV<sub>254</sub>. Visualization of the developed chromatogram was performed under ultraviolet light (254 nm) and on staining by immersion in aqueous, acidic ceric ammonium molybdate (CAM; 470 mL H<sub>2</sub>O, 28 mL H<sub>2</sub>SO<sub>4</sub>, 24 g ammonium molybdate, 0.5 g cerium ammonium nitrate) followed by heating on a hot plate.

Preparative thin-layer chromatography (prep TLC) was performed with Macherey-Nagel pre-coated glass plates SIL G-100 UV<sub>254</sub> silica gel 60 (layer 1.00 mm) with fluorescent indicator UV<sub>254</sub>. Visualization of the developed chromatogram was performed under ultraviolet light (254 nm). Visible bands were circled with a pencil, scraped with a metal spatula and extracted with ethyl acetate (EtOAc).

Normal phase flash chromatography was performed in the air on Silica Gel 60 (230–400 mesh) with petroleum ether (PE, bp  $40\text{--}65\text{ }^{\circ}\text{C}$ ), ethyl acetate (EtOAc), dichloromethane (DCM) or acetone as eluents unless otherwise stated. Organic solutions were concentrated under reduced pressure with a Buchi rotary evaporator.

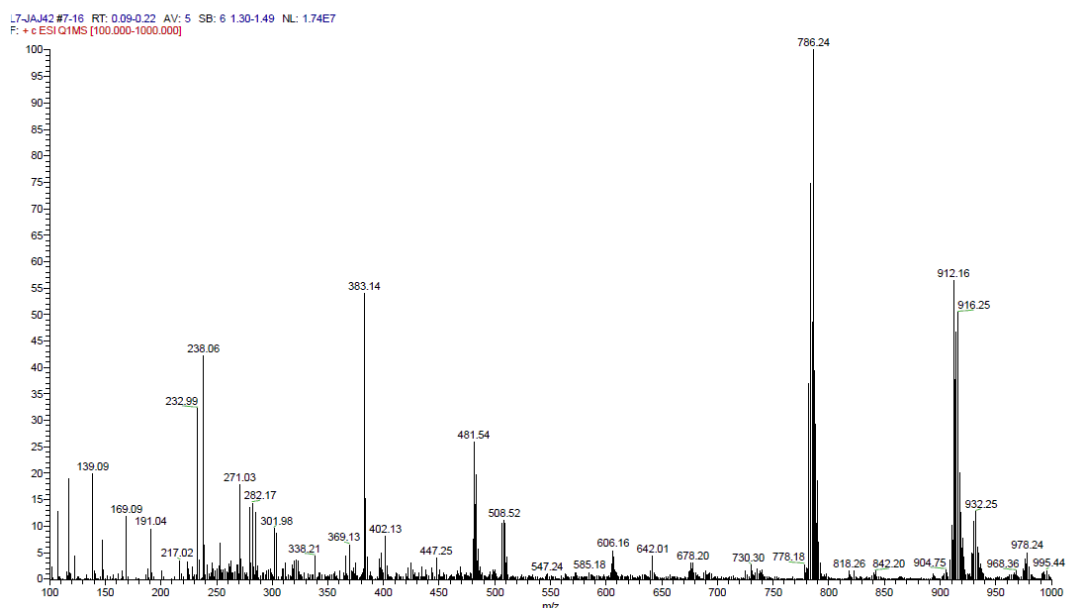
## ADDITIONAL NOTES

Tin possesses the highest number of stable isotopes. Together with the abundance, they were listed in Table 5. Due to so many stable isotopes, there are interesting effects concerning Mass Spectrometry as well as  $^1\text{H}$  and  $^{13}\text{C}$  NMR.

### LRMS and HRMS data of tin-containing compounds

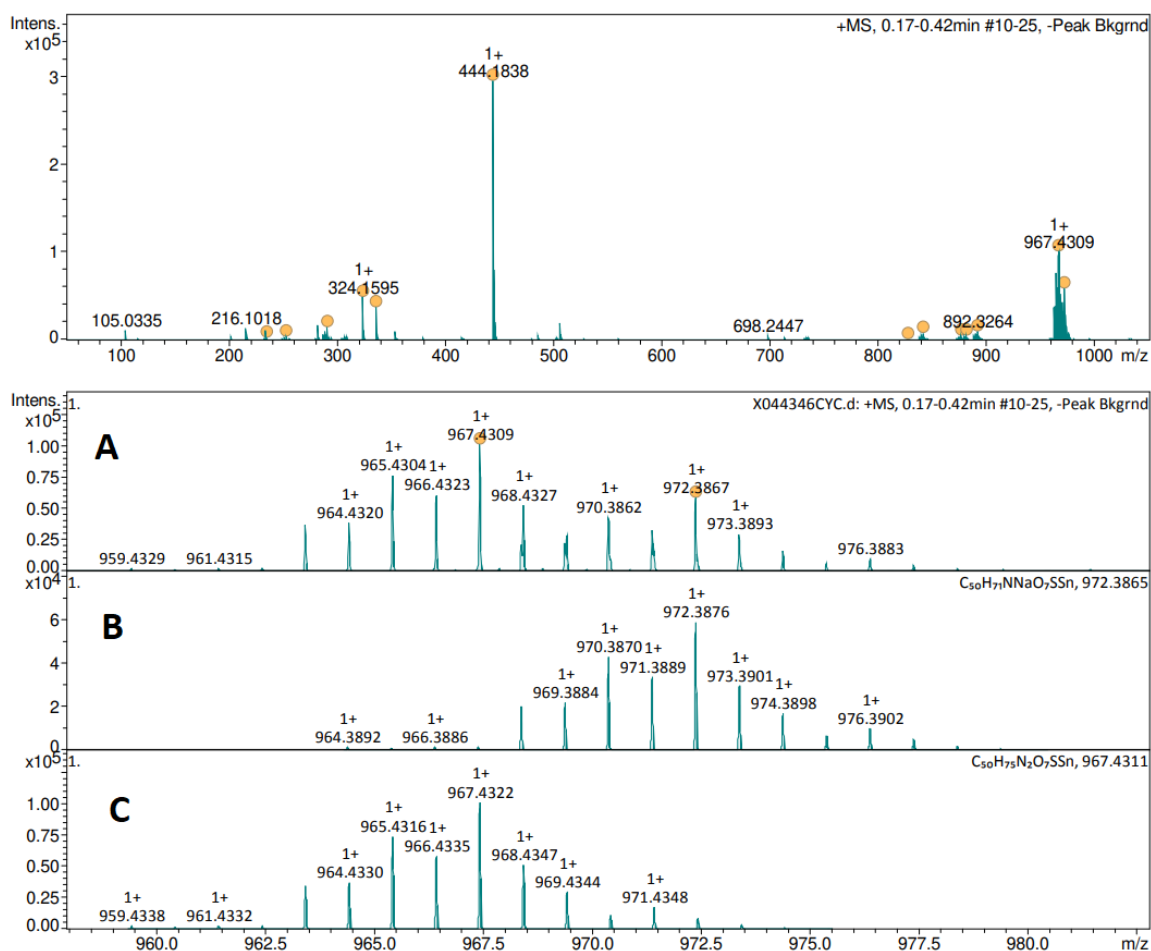
We can confirm the presence of the tin in the molecule just by looking at the MS results. The signal is a bunch of peaks close to each other (Figure 38).

Positif :



**Figure 38.** Low-Resolution MS of stannylated compound.

In High-Resolution MS (e.g. Figure 39 for compound of formula  $\text{C}_{50}\text{H}_{71}\text{NO}_7\text{SSn}$ ), the isotope pattern is clearly identified, and the relative intensity of signals. Besides tin, there are also present isotopes of other elements, which complicates the results even more. Part A illustrate detected signals, the two other parts represent the calculated values for  $[\text{M}+\text{Na}]^+$  (part B) and  $[\text{M}+\text{NH}_4]^+$  (part C). Superposition of B and C would give us detected values. The values given in the description of HRMS data for the stannylated molecules were obtained for  $^{120}\text{Sn}$ .



**Figure 39.** High-Resolution MS of stannylated compound.

### $^1\text{H}$ and $^{13}\text{C}$ NMR spectra of tin-containing compounds

Due to the presence of NMR-active isotopes, we can observe the heteronuclear coupling between  $^1\text{H}$  and  $^{117}\text{Sn}/^{119}\text{Sn}$  (Figure 40), as well as between  $^{13}\text{C}$  and  $^{117}\text{Sn}/^{119}\text{Sn}$  (Figure 41) as satellites.

For  $^1\text{H}$  NMR the coupling was observed for the protons at positions C-1 and C-2. Nevertheless, these signals were assigned as multiplets in the description for each compound.

In case of  $^{13}\text{C}$  NMR, we could observe satellite coupling on both substituents of tin (i.e., amino- or iminoalditol moiety and *n*-butyl chains). In contrast to  $^1\text{H}$  NMR spectra, no additional signals were observed for C-2. Moreover, the signals for C-1 were sometimes difficult to detect because of a low sample concentration. On the other hand, in *n*-butyl chain, we could clearly report distinguishable signals from carbons in position  $\alpha$  and  $\beta$  (set of four satellites given). For the  $\gamma$ -carbon, the difference between  $^{13}\text{C}$ - $^{117}\text{Sn}$  and  $^{13}\text{C}$ - $^{119}\text{Sn}$  was lost and only chemical shift of two merged signals was disclosed. Coupling constants are in the order of  $^1J_{\text{Sn,C}} = 300$  Hz,  $^2J_{\text{Sn,C}} = 60$  Hz,  $^3J_{\text{Sn,C}} = 20$  Hz.

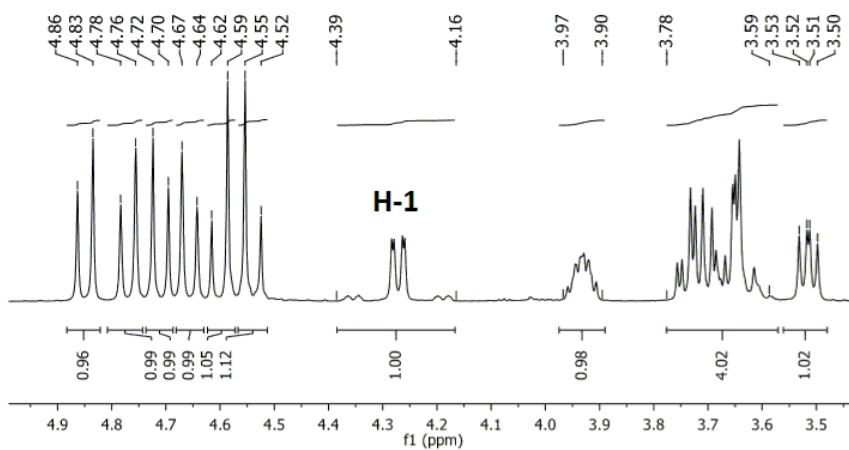


Figure 40. Part of  $^1\text{H}$  NMR for stannylated compound.

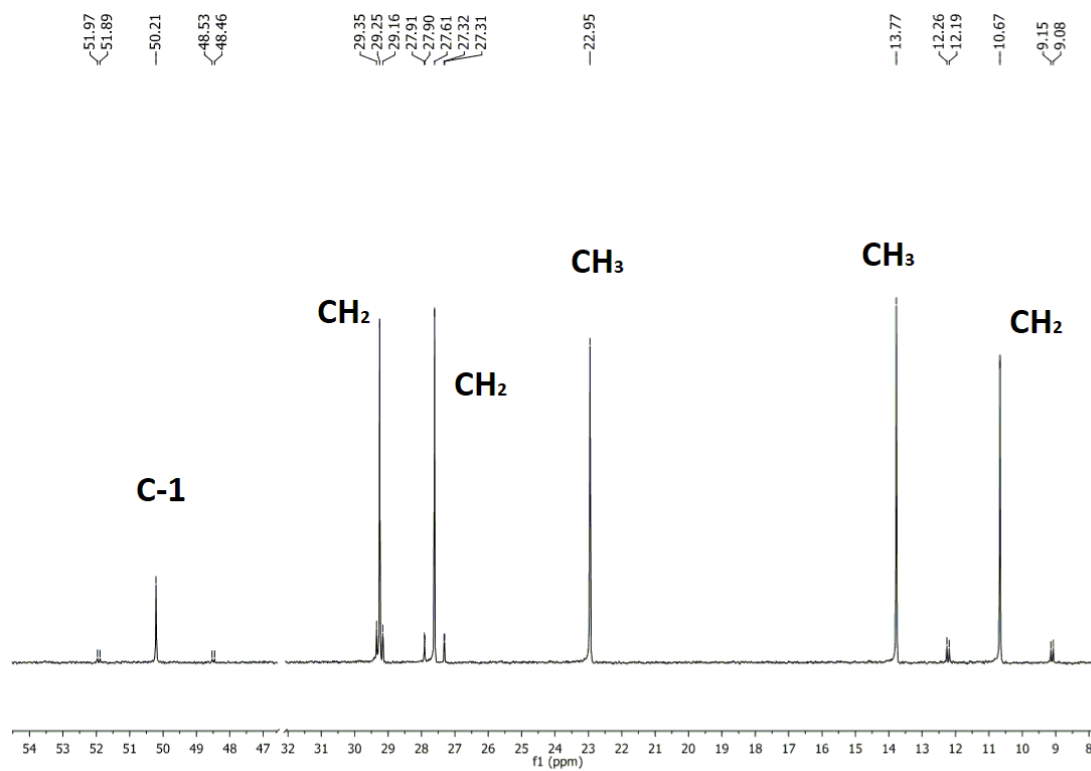


Figure 41. Part of  $^{13}\text{C}$  NMR for stannylated compound.

## GENERAL PROCEDURES

### General procedure A: Synthesis of *N-tert*-butanesulfinylglycosylamines under conventional heating

The related aldose was dissolved in dry toluene (0.27 M) under argon atmosphere. (*S*)- or (*R*)-2-methyl-2-propanesulfinamide (2.0 eq.), titanium (IV) ethoxide (1.5 eq.) and activated 4 Å molecular sieves were added. The reaction mixture was stirred for 16 h at 70 °C. The mixture was diluted with EtOAc (50.0 mL/1.0 g of SM) and was stirred with a saturated aqueous solution of NaCl (50.0 mL/1.0 g of SM) for 10 min, then filtered through Celite®; the cake was washed with EtOAc (50.0 mL/1.0 g of SM). The phases were separated; the organic phase was washed three times with a saturated aqueous solution of NaCl (3 × 50.0 mL) and then dried over MgSO<sub>4</sub>, filtered through a cotton plug and concentrated under reduced pressure. The residue was purified by silica gel flash column chromatography.

### General procedure B: Synthesis of *N-tert*-butanesulfinylglycosylamines under microwave irradiation

Into a Biotage® Microwave Reaction Vial (size 10 – 20 mL), flushed with argon, was charged with: the related aldose (1.0 eq.), (*S*)- or (*R*)-2-methyl-2-propanesulfinamide (2.0 eq.), titanium (IV) ethoxide (1.5 eq.), activated 4 Å molecular sieves and dry toluene (15.0 mL) under argon atmosphere. The Biotage® vial was closed with a septum cap and was placed into a Biotage® Initiator+. Due to the nature of the solvent and the scale of the reaction, the mixture was heated up gradually: 5 min at 50 °C, 1 min at 60 °C, 1 min at 70 °C, 1 min at 80 °C, 1 min at 90 °C, 1 min at 100 °C, and the time required for the total conversion at 110 °C (furanose – 5 h, pyranose – 6 h). Afterwards, the cap was unsealed and the mixture was transferred into a beaker, and then it was diluted with EtOAc (50.0 mL/1.0 g of SM). The mixture was stirred with a saturated aqueous solution of NaCl (50.0 mL/1.0 g of SM) for 10 min and then filtered through Celite®. The cake was washed with EtOAc (50.0 mL/1.0 g of SM). The phases were separated; the organic phase was washed three times with a saturated aqueous solution of NaCl (3 × 100.0 mL) and then dried over MgSO<sub>4</sub>, filtered through a cotton plug and concentrated under reduced pressure. The residue was purified by silica gel flash column chromatography.

### General procedure C: Preparation of 1-*N-tert*-butanesulfinylamino-1-deoxy-pentitol derivatives from protected sugar hemiacetals

A single-necked flask equipped with a reflux condenser and an argon inlet system was charged with related tri-*O*-benzyl-pentofuranose, 4 Å activated molecular sieves (0.4 g per mmol of substrate) and (*S*)- or (*R*)-2-methyl-2-propanesulfinamide (2.0 equiv.). Dry toluene (4 mL per mmol of substrate) was inserted and the mixture was stirred for 5 min at room temperature (~20 °C). Titanium(IV) ethoxide (Ti(OEt)<sub>4</sub>, 1.5 equiv.) was then added and the reaction mixture was stirred at 110 °C until no more starting material was observed by TLC analysis (generally, 1.5 h). The content was next allowed to reach 20 °C and NaBH<sub>4</sub> (4.0 equiv.) was added. The resulting suspension was stirred at 110 °C until no more sulfinyl glycosylamine intermediate remained in the reaction mixture (1 h). The suspension was then allowed to cool down to room

temperature and sat. aqueous NaCl was added. The mixture was stirred at 20 °C for 10 min and the precipitate and molecular sieves were filtered through a pad of Celite®. The cake was rinsed (EtOAc 50 mL/1 g of SM) and the aqueous layer was discarded. The organic phase was washed with saturated aqueous solution of NH<sub>4</sub>Cl (30.0 mL) and then dried over MgSO<sub>4</sub>, filtered through a cotton plug and concentrated under reduced pressure. The residue was purified by silica gel flash column chromatography.

#### **General procedure D: Synthesis of 1,4-Dideoxy-1,4-iminopentitol derivatives from corresponding *N*-*tert*-butanesulfinylamino-1-deoxy-pentitols**

To a solution of starting material in anhydrous DCM (0.08 M), under argon atmosphere, were added Et<sub>3</sub>N (2.2 equiv.) and MsCl (2.0 equiv.) and the reaction mixture was stirred at room temperature until no more starting material was present (30–60 min). The mixture was then diluted (50.0 mL/1.0 g of SM) and the organic phase was washed with saturated aqueous solution of NH<sub>4</sub>Cl (50.0 mL/1.0 g of SM). The aqueous phase was extracted three times with DCM (2 × 30.0 mL) and the combined organic phases were dried over MgSO<sub>4</sub> and concentrated under reduced pressure. The crude mesylated intermediate was used in the next cyclization step without further purification.

A single-necked flask under argon atmosphere was charged with AcCl (5 equiv., 0.4 M) and dry MeOH and the mixture was stirred at 20 °C for 30 min (solution A). Another flask under argon atmosphere (flask B) was charged with dry MeOH and crude mesylated intermediate (0.4 M), and solution A was added through syringe to flask B. The reaction mixture was stirred for 1 h; Amberlite IRA-400 (OH<sup>-</sup> form) ion-exchange resin was then added until pH 8. The mixture was stirred further for 1 h at the same temperature and the suspension was filtered through a cotton plug. The solvents were evaporated under reduced pressure and the residue was purified by silica gel flash column chromatography.

#### **General procedure E: Addition of tributyltin lithium reagent to glycosylamines**

Flask A under argon atmosphere was charged with diisopropylamine (3.5 eq.) and anhydrous THF (0.18 M). The solution was cooled down to 0 °C and freshly titrated *n*-BuLi<sup>148</sup> (solution in THF, 3.5 eq.) was added dropwise. The reaction mixture was stirred for 30 min and then was cooled down to -78 °C. Afterwards, tributyltin hydride (3.5 eq.) was added dropwise via a syringe. The mixture was stirred for 15 min. Flask B under argon atmosphere was charged with *N*-*tert*-butanesulfinylglycosylamine (1.0 eq.) and anhydrous THF (1.3 M) and then it was cooled down to -78 °C. The content of flask B was added dropwise into flask A by syringe. The mixture was stirred for 2 h at -78 °C. The reaction was quenched with MeOH (20.0 mL/1.0 g of SM) and a saturated aqueous solution of NH<sub>4</sub>Cl (10.0 mL/1.0 g of SM) and was diluted with Et<sub>2</sub>O (50.0 mL/1.0 g of SM). The phases were separated; the organic phase was washed two times with a saturated aqueous solution of NaCl (2 × 50.0 mL) and then dried over MgSO<sub>4</sub>, filtered through a cotton plug and concentrated under reduced pressure. The residue was purified by silica gel flash column chromatography.

---

<sup>148</sup> B. E. Love, E. G. Jones, *J. Org. Chem.* **1999**, *64*, 3755–3756.

### General procedure F: Oxidation with *m*-CPBA

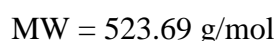
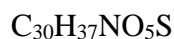
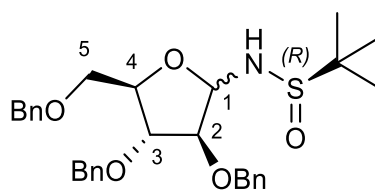
A solution of the open-chain stannane in anhydrous DCM (0.05 M) under argon atmosphere was cooled down to 0 °C. Afterwards, *meta*-chloroperoxybenzoic acid (2.0 eq.) was added. The mixture was monitored by TLC. When the reaction was complete (30 min to 2 h), it was quenched with a saturated aqueous solution of Na<sub>2</sub>S<sub>2</sub>O<sub>3</sub> (30.0 mL/1.0 g of SM) and was diluted with DCM (50.0 mL/1.0 g of SM). The phases were separated; the organic phase was washed three times with a saturated aqueous solution of Na<sub>2</sub>S<sub>2</sub>O<sub>3</sub> (3 × 50.0 mL) and then dried over MgSO<sub>4</sub>, filtered through a cotton plug and concentrated under reduced pressure. The residue was purified by silica gel flash column chromatography.

### General procedure G: Stille coupling with acyl chlorides

An oven-dried Biotage® Microwave Reaction Vial (size 2 – 5 mL) with a magnetic stir bar was charged with the stannylated iminosugar (2.0 eq.). Pd<sub>2</sub>(dba)<sub>3</sub> (10% mol), phosphine ligand (JackiePhos, 10% mol), CuCl (1.0 eq. or 10% mol) and 4 Å molecular sieves (125.0 mg/100.0 mg of SM) were added. Then the septum screw-top tube was evacuated and backfilled three times with argon using a needle attached to a vacuum manifold (5 min of vacuum followed by 2 min of argon). The anhydrous 1,4-dioxane (0.1 M) and the desired acyl chloride (1.0 eq.) were added via syringe. The sealed tube was heated in an oil bath for 6 h at 110 °C under argon. The completion of the reaction was confirmed by TLC analysis, and then the reaction was cooled to room temperature, diluted with DCM (10.0 mL/100.0 mg of SM) and filtered through Celite®. The cake was washed multiple times with DCM (4-6 × 10.0 mL). The filtrate was concentrated under reduced pressure. The residue was then purified by preparative TLC followed by silica gel flash column chromatography.



2,3,5-Tri-*O*-benzyl-*(S<sub>R</sub>)*-*N*-*tert*-butanesulfinyl- $\alpha/\beta$ -D-arabinofuranosylamine **5**



**Procedure 1:** According to the general procedure A, the reaction was performed with commercial 2,3,5-tri-*O*-benzyl-D-arabinofuranose **4** (0.525 g, 1.25 mmol, 1.0 eq.), (*R*)-2-methyl-2-propanesulfinamide **2** (0.30 g, 2.50 mmol, 2.0 eq.), titanium (IV) ethoxide (0.39 mL, 1.87 mmol, 1.5 eq.), activated 4 Å molecular sieves and dry toluene (5.0 mL). The mixture was stirred for 14 h at 70 °C. An extra amount of **2** (76 mg, 0.62 mmol, 0.5 eq.) and titanium (IV) ethoxide (0.13 mL, 0.62 mmol, 0.5 eq.) were added. The mixture was stirred for 14 h at 70 °C. The crude compound was purified by silica gel column chromatography ( $\varnothing = 2.0$  cm, L = 20 cm) using PE:EtOAc (8:2 to 6:4) as the eluent to afford compound **5** as a mixture of anomers in form of a yellow oil (0.54 g, 83%).

**Procedure 2:** According to the general procedure B, the reaction was performed with commercial 2,3,5-tri-*O*-benzyl-D-arabinofuranose **4** (2.50 g, 5.95 mmol, 1.0 eq.), (*R*)-2-methyl-2-propanesulfinamide **2** (1.44 g, 11.89 mmol, 2.0 eq.), titanium (IV) ethoxide (2.03 g, 8.92 mmol, 1.5 eq.), activated 4 Å molecular sieves and dry toluene (15.0 mL). After heating up, the mixture was stirred for 80 min at 110 °C. The crude compound was purified by silica gel column chromatography ( $\varnothing = 3.0$  cm, L = 25 cm) using PE:EtOAc (7:3 to 5:5) as the eluent to afford compound **5** as a mixture of anomers (ratio ~1:1) in form of a yellow oil (2.81 g, 90%).

$R_f = 0.3$  and  $0.2$  (PE:EtOAc 6:4)

**IR (neat):**  $\nu = 3030, 2865, 1454, 1363, 1207, 1075, 1027, 750 \text{ cm}^{-1}$

**HRMS (ESI):**  $m/z$  calc. for  $\text{C}_{30}\text{H}_{38}\text{NO}_5\text{S}$   $[\text{M} + \text{H}]^+$  524.246521, found 524.246530

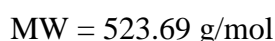
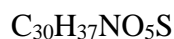
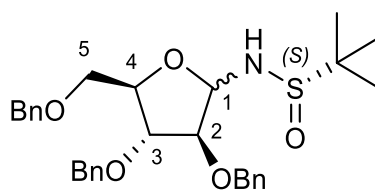
NMR data are consistent with that of the literature.<sup>90</sup>

**<sup>1</sup>H NMR (250 MHz, CDCl<sub>3</sub>):**  $\delta = 1.14$  (s, 4.6H, CH<sub>3</sub>), 1.20 (s, 4.5H, CH<sub>3</sub>), 3.36 – 3.51 (m, 1.6H, H-5A, H-5B, H-5a), 3.55 (dd,  $J = 4.9, 9.8$  Hz, 0.4H, H-5b<sub>min</sub>), 3.81 – 3.89 (m, 1H, H-2<sub>min</sub>, H-3<sub>maj</sub>), 3.89 – 4.01 (m, 1.6H, H-2<sub>maj</sub>, H-3<sub>min</sub>, H-4<sub>maj</sub>), 4.33 – 4.56 (m, 6.8H, OCH<sub>2</sub>Ph<sub>maj</sub>, OCH<sub>2</sub>Ph<sub>min</sub>, H-4<sub>min</sub>, NH<sub>min</sub>), 4.72 (d,  $J = 8.9$  Hz, 0.6H, NH<sub>maj</sub>), 5.16 (bd,  $J = 10.8$  Hz, 0.4H, H-1<sub>min</sub>), 5.26 (dd,  $J = 4.5, 8.9$  Hz, 0.6H, H-1<sub>maj</sub>), 7.09 – 7.35 (m, 15H, H<sub>Ar</sub> maj, H<sub>Ar</sub> min)

**<sup>13</sup>C NMR (101 MHz, CDCl<sub>3</sub>):**  $\delta = 22.5$  (CH<sub>3</sub> *t*-Bu maj), 22.6 (CH<sub>3</sub> *t*-Bu min), 56.1 (C<sup>IV</sup> *t*-Bu maj + C<sup>IV</sup> *t*-Bu min), 70.1 (C-5<sub>min</sub>), 70.5 (C-5<sub>maj</sub>), 71.9 (OCH<sub>2</sub>Ph<sub>min</sub>), 71.9 (OCH<sub>2</sub>Ph<sub>maj</sub>), 71.9 (OCH<sub>2</sub>Ph<sub>maj</sub>), 72.5 (OCH<sub>2</sub>Ph<sub>min</sub>), 73.4 (OCH<sub>2</sub>Ph<sub>min</sub>), 73.4 (OCH<sub>2</sub>Ph<sub>maj</sub>), 80.0 (C-4<sub>maj</sub>), 81.9 (C-4<sub>min</sub>), 82.7 (C-2<sub>maj</sub> + C-3<sub>maj</sub>), 82.9 (C-3<sub>min</sub>), 86.6 (C-2<sub>min</sub>), 87.5 (C-1<sub>maj</sub>), 91.8 (C-1<sub>min</sub>), 127.7– 128.6 (C<sub>Ar</sub> maj +

$C_{Ar \text{ min}}$ , 137.1  $C_{Ar \text{ maj}}^{IV}$ , 137.3 ( $C_{Ar \text{ min}}^{IV}$ ), 137.4 ( $C_{Ar \text{ min}}^{IV}$ ), 137.7 ( $C_{Ar \text{ maj}}^{IV}$ ), 138.1 ( $C_{Ar \text{ maj}}^{IV}$ ),  
138.2 ( $C_{Ar \text{ min}}^{IV}$ )

2,3,5-Tri-*O*-benzyl-(*S,S*)-*N*-*tert*-butanesulfinyl- $\alpha/\beta$ -D-arabinofuranosylamine **6**



**Procedure 1:** According to the general procedure A, the reaction was performed with commercial 2,3,5-tri-*O*-benzyl-D-arabinofuranose **4** (0.80 g, 1.90 mmol, 1.0 eq.), (*S*)-2-methyl-2-propanesulfinamide **3** (0.46 g, 3.80 mmol, 2.0 eq.), titanium (IV) ethoxide (0.60 mL, 2.85 mmol, 1.5 eq.), activated 4 Å molecular sieves and dry toluene (7.0 mL). The mixture was stirred for 20 h at 70 °C. The crude compound was purified by silica gel column chromatography ( $\varnothing = 2.0$  cm, L = 25 cm) using PE:EtOAc (7:3 to 5:5) as the eluent to afford compound **6** as a mixture of anomers in form of a yellow oil (0.86 g, 86%).

**Procedure 2:** According to the general procedure B, the reaction was performed with commercial 2,3,5-tri-*O*-benzyl-D-arabinofuranose **4** (2.50 g, 5.95 mmol, 1.0 eq.), (*S*)-2-methyl-2-propanesulfinamide **3** (1.44 g, 11.89 mmol, 2.0 eq.), titanium (IV) ethoxide (2.03 g, 8.92 mmol, 1.5 eq.), activated 4 Å molecular sieves and dry toluene (15.0 mL). After heating up, the mixture was stirred for 80 min at 110 °C. The crude compound was purified by silica gel column chromatography ( $\varnothing = 4.0$  cm, L = 30 cm) using PE:EtOAc (6:4 to 5:5) as the eluent to afford compound **6** as a mixture of anomers in form of a yellow oil (3.01 g, 96%).

$R_f = 0.3$  (PE:EtOAc 5:5)

**IR (neat):**  $\nu = 3245, 3031, 2866, 1454, 1364, 1266, 1206, 1072, 1027, 733 \text{ cm}^{-1}$

**HRMS (ESI):**  $m/z$  calc. for  $\text{C}_{30}\text{H}_{38}\text{NO}_5\text{S}$   $[\text{M} + \text{H}]^+$  524.246521, found 524.246347

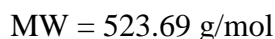
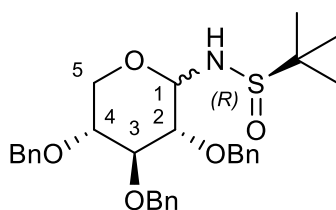
NMR data are consistent with that of the literature.<sup>90</sup>

**$^1\text{H}$  NMR (400 MHz,  $\text{CDCl}_3$ ):**  $\delta = 1.14$  (bs, 9H,  $\text{CH}_3_{\text{maj}}$ ,  $\text{CH}_3_{\text{min}}$ ), 3.47 – 3.64 (m, 2H, H-5 $_{\text{maj}}$ , H-5 $_{\text{b}_{\text{maj}}}$ , H-5 $_{\text{a}_{\text{min}}}$ , H-5 $_{\text{b}_{\text{min}}}$ ), 3.89 (dd,  $J = 2.4, 4.2$  Hz, 0.4H, H-2 $_{\text{min}}$ ), 3.95 – 3.98 (m, 0.6H, H-3 $_{\text{maj}}$ ), 4.02 – 4.06 (m, 0.4H, H-3 $_{\text{min}}$ ), 4.06 – 4.11 (m, 0.4H, H-4 $_{\text{min}}$ ), 4.11 – 4.14 (m, 0.6H, H-2 $_{\text{maj}}$ ), 4.35 – 4.30 (m, 0.6H, H-4 $_{\text{maj}}$ ), 4.42 (d,  $J = 11.9$  Hz, 0.4H,  $\text{OCH}_2\text{Ph}_{\text{min}}$ ), 4.46 – 4.63 (m, 6H,  $\text{OCH}_2\text{Ph}_{\text{maj}}$ ,  $\text{OCH}_2\text{Ph}_{\text{min}}$ ,  $\text{NH}_{\text{min}}$ ), 4.81 (d,  $J = 9.9$  Hz, 0.6H,  $\text{NH}_{\text{maj}}$ ), 5.26 (dd,  $J = 4.2, 11.0$  Hz, 0.4H, H-1 $_{\text{min}}$ ), 5.33 (bd,  $J = 9.9$  Hz, 0.6H, H-1 $_{\text{maj}}$ ), 7.20 – 7.38 (m, 15H,  $\text{H}_{\text{Ar}_{\text{maj}}}$ ,  $\text{H}_{\text{Ar}_{\text{min}}}$ )

**$^{13}\text{C}$  NMR (101 MHz,  $\text{CDCl}_3$ ):**  $\delta = 22.4$  ( $\text{CH}_3_{t\text{-Bu}_{\text{maj}}}$ ), 22.6 ( $\text{CH}_3_{t\text{-Bu}_{\text{min}}}$ ), 56.1 ( $\text{C}^{\text{IV}}_{t\text{-Bu}_{\text{maj}}}$ ), 56.2 ( $\text{C}^{\text{IV}}_{t\text{-Bu}_{\text{min}}}$ ), 70.1 (C-5 $_{\text{min}}$ ), 70.3 (C-5 $_{\text{maj}}$ ), 71.7 ( $\text{OCH}_2\text{Ph}_{\text{min}}$ ), 71.9 ( $\text{OCH}_2\text{Ph}_{\text{min}}$ ), 71.9 ( $\text{OCH}_2\text{Ph}_{\text{maj}}$ ), 72.0 ( $\text{OCH}_2\text{Ph}_{\text{maj}}$ ), 73.4 ( $\text{OCH}_2\text{Ph}_{\text{min}}$ ), 73.4 ( $\text{OCH}_2\text{Ph}_{\text{maj}}$ ), 80.8 (C-4 $_{\text{min}}$ ), 81.6 (C-3 $_{\text{min}}$ ), 82.6 (C-2 $_{\text{min}}$ ), 82.7 (C-4 $_{\text{maj}}$ ), 82.9 (C-3 $_{\text{maj}}$ ), 85.8 (C-2 $_{\text{maj}}$ ), 87.6 (C-1 $_{\text{min}}$ ), 91.2 (C-1 $_{\text{maj}}$ ),

127.7–128.6 ( $C_{\text{Ar maj}} + C_{\text{Ar min}}$ ), 137.1  $C_{\text{Ar maj}}^{\text{IV}}$ , 137.2 ( $C_{\text{Ar min}}^{\text{IV}}$ ), 137.3 ( $C_{\text{Ar maj}}^{\text{IV}}$ ), 137.7 ( $C_{\text{Ar min}}^{\text{IV}}$ ), 138.1 ( $C_{\text{Ar maj}}^{\text{IV}}$ ), 138.2 ( $C_{\text{Ar min}}^{\text{IV}}$ )

2,3,4-Tri-*O*-benzyl-(*S<sub>R</sub>*)-*N*-*tert*-butanesulfinyl- $\alpha/\beta$ -D-xylopyranosylamine **12**



According to the general procedure B, the reaction was performed with 2,3,4-tri-*O*-benzyl-D-xylopyranose **11** (2.00 g, 4.75 mmol, 1.0 eq.), (*R*)-2-methyl-2-propanesulfinamide **2** (1.15 g, 9.51 mmol, 2.0 eq.), titanium (IV) ethoxide (1.63 g, 7.13 mmol, 1.5 eq.), activated 4 Å molecular sieves and dry toluene (12.0 mL). After heating up, the mixture was stirred for 140 min at 110 °C. The crude compound was purified by silica gel column chromatography ( $\emptyset = 3.0$  cm, L = 30 cm) using PE:EtOAc (8:2 to 7:3) with 3% of Et<sub>3</sub>N as the eluent to afford compound **12** as a mixture of anomers in form of a colorless oil (1.84 g, 74%).

**R<sub>f</sub>** = 0.5 (PE:EtOAc 5:5)

**IR (neat):**  $\nu = 3223, 3030, 2869, 1454, 1363, 1313, 1207, 1071, 1028, 735 \text{ cm}^{-1}$

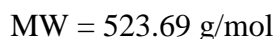
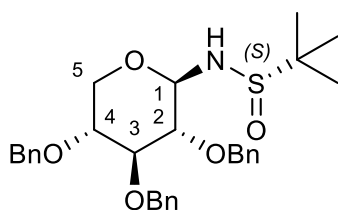
**HRMS (ESI):**  $m/z$  calc. for C<sub>30</sub>H<sub>38</sub>NO<sub>5</sub>S [M + H]<sup>+</sup> 524.246521, found 524.246471

NMR data are consistent with that of the literature.<sup>90</sup>

**<sup>1</sup>H NMR (400 MHz, CDCl<sub>3</sub>):**  $\delta = 1.11$  (s, 5.4H, CH<sub>3</sub> maj), 1.18 (s, 3.6H, CH<sub>3</sub> min), 3.27 (dd,  $J = 10.0, 11.5$  Hz, 0.6H, H-5a<sub>maj</sub>), 3.33 (t,  $J = 8.3$  Hz, 0.6H, H-2<sub>maj</sub>), 3.44 – 3.50 (m, 0.4H, H-4<sub>min</sub>), 3.54 (dd,  $J = 4.0, 6.7$  Hz, 0.4H, H-2<sub>min</sub>), 3.57 – 3.73 (m, 1.6H, H-3<sub>maj</sub>, H-3<sub>min</sub>, H-4<sub>maj</sub>), 3.76 (dd,  $J = 4.1, 12.1$  Hz, 0.4H, H-5a<sub>min</sub>), 3.85 (dd,  $J = 7.0, 12.1$  Hz, 0.4H, H-5b<sub>min</sub>), 3.90 – 3.97 (m, 1.2H, H-5b<sub>maj</sub>, NH<sub>maj</sub>), 4.48 (dd,  $J = 5.1, 8.2$  Hz, 0.6H, H-1<sub>maj</sub>), 4.53 – 4.72 (m, 4H, OCH<sub>2</sub>Ph<sub>maj</sub>, OCH<sub>2</sub>Ph<sub>min</sub>, NH<sub>min</sub>), 4.75 (d,  $J = 11.3$  Hz, 0.6H, OCH<sub>2</sub>Ph<sub>maj</sub>), 4.82 (d,  $J = 7.6$  Hz, 0.6H, OCH<sub>2</sub>Ph<sub>maj</sub>), 4.84 (d,  $J = 7.9$  Hz, 0.6H, OCH<sub>2</sub>Ph<sub>maj</sub>), 4.93 (d,  $J = 11.0$  Hz, 0.6H, OCH<sub>2</sub>Ph<sub>maj</sub>), 5.07 (dd,  $J = 4.0, 8.1$  Hz, 0.4H, H-1<sub>min</sub>), 7.22 – 7.38 (m, 15H, H<sub>Ar</sub> maj, H<sub>Ar</sub> min)

**<sup>13</sup>C NMR (101 MHz, CDCl<sub>3</sub>):**  $\delta = 22.4$  (CH<sub>3</sub> *t*-Bu maj), 22.6 (CH<sub>3</sub> *t*-Bu min), 55.9 (C<sup>IV</sup><sub>*t*-Bu</sub> maj), 56.4 (C<sup>IV</sup><sub>*t*-Bu</sub> min), 62.1 (C-5<sub>min</sub>), 65.1 (C-5<sub>maj</sub>), 72.4 (OCH<sub>2</sub>Ph<sub>min</sub>), 72.5 (OCH<sub>2</sub>Ph<sub>min</sub>), 73.2 (OCH<sub>2</sub>Ph<sub>maj</sub>), 74.3 (OCH<sub>2</sub>Ph<sub>min</sub>), 74.5 (OCH<sub>2</sub>Ph<sub>maj</sub>), 75.1 (C-4<sub>min</sub>), 75.5 (OCH<sub>2</sub>Ph<sub>maj</sub>), 76.9 (C-2<sub>min</sub>), 77.4 (C-3<sub>min</sub>), 77.8 (C-4<sub>maj</sub>), 79.4 (C-2<sub>maj</sub>), 79.6 (C-1<sub>min</sub>), 84.5 (C-3<sub>maj</sub>), 86.1 (C-1<sub>maj</sub>), 127.9 – 128.8 (C<sub>Ar</sub> maj + C<sub>Ar</sub> min), 137.5 (C<sup>IV</sup><sub>Ar</sub> min), 137.8 (C<sup>IV</sup><sub>Ar</sub> maj), 138.1 (C<sup>IV</sup><sub>Ar</sub> maj), 138.2 (C<sup>IV</sup><sub>Ar</sub> min), 138.2 (C<sup>IV</sup><sub>Ar</sub> min), 138.4 (C<sup>IV</sup><sub>Ar</sub> maj)

2,3,4-Tri-*O*-benzyl-(*S*)-*N*-*tert*-butanesulfinyl- $\beta$ -D-xylopyranosylamine **13**



According to the general procedure B, the reaction was performed with 2,3,4-tri-*O*-benzyl-D-xylopyranose **11** (2.50 g, 5.95 mmol, 1.0 eq.), (*S*)-2-methyl-2-propanesulfinamide **3** (1.44 g, 11.89 mmol, 2.0 eq.), titanium (IV) ethoxide (1.87 mL, 8.92 mmol, 1.5 eq.), activated 4 Å molecular sieves and dry toluene (15.0 mL). After heating up, the mixture was stirred for 5 h at 110 °C. The crude compound was recrystallized from *n*-pentane to afford compound **13** as a single anomer in the form of pale yellow crystals (0.71 g, 23%).

**R<sub>f</sub>** = 0.5 (PE:EtOAc 5:5)

**mp** = 135.0 – 137.0 °C

**IR (neat):**  $\nu$  = 3166, 3031, 2869, 1454, 1363, 1209, 1071, 907, 728  $\text{cm}^{-1}$

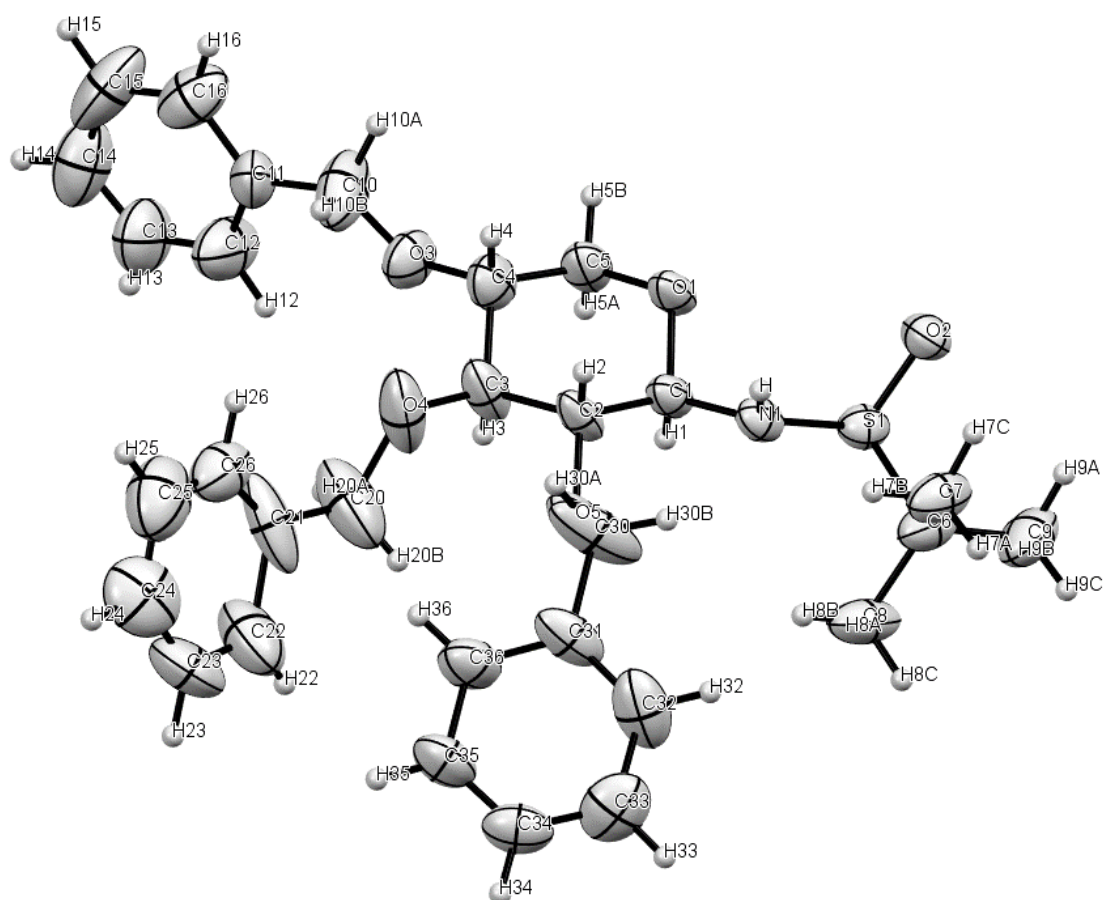
**HRMS (ESI):**  $m/z$  calc. for  $\text{C}_{30}\text{H}_{38}\text{NO}_5\text{S}$  [ $\text{M} + \text{H}$ ]<sup>+</sup> 524.246521, found 524.246209

NMR data are consistent with that of the literature.<sup>90</sup>

**<sup>1</sup>H NMR (400 MHz, CDCl<sub>3</sub>):**  $\delta$  = 1.18 (s, 9H, CH<sub>3</sub>), 3.22 – 3.31 (m, 2H, H-2, H-5a), 3.53 – 3.65 (m, 2H, H-3, H-4), 3.71 (d,  $J$  = 11.0 Hz, NH), 3.99 (dd,  $J$  = 4.4, 11.5 Hz, 1H, H-5b), 4.42 (dd,  $J$  = 8.8, 10.5 Hz, 1H, H-1), 4.61 (d,  $J$  = 11.7 Hz, 1H, OCH<sub>2</sub>Ph), 5.70 (d,  $J$  = 11.7 Hz, 1H, OCH<sub>2</sub>Ph), 4.77 (s, 2H, OCH<sub>2</sub>Ph), 4.81 (d,  $J$  = 10.9 Hz, 1H, OCH<sub>2</sub>Ph), 4.91 (d,  $J$  = 10.9 Hz, 1H, OCH<sub>2</sub>Ph), 7.26 – 7.38 (m, 15H, H<sub>Ar</sub>)

**<sup>13</sup>C NMR (101 MHz, CDCl<sub>3</sub>):**  $\delta$  = 22.50 (CH<sub>3</sub> *t*-Bu), 56.48 (C<sup>IV</sup> *t*-Bu), 65.38 (C-5), 73.41 (OCH<sub>2</sub>Ph), 75.33 (OCH<sub>2</sub>Ph), 75.80 (OCH<sub>2</sub>Ph), 77.70 (C-3 or C-4), 81.56 (C-2), 84.66 (C-3 or C-4), 88.88 (C-1), 127.88 – 128.64 (C<sub>Ar</sub>), 137.91 (C<sup>IV</sup> <sub>Ar</sub>), 138.12 (C<sup>IV</sup> <sub>Ar</sub>), 138.49 (C<sup>IV</sup> <sub>Ar</sub>)

### X-Ray Data:



**Figure 42.** ORTEP of compound 13.

**Table 7.** Bond distances (Angstroms).

Entry	Atom1	Atom2	Length	Entry	Atom1	Atom2	Length
1	S1	N1	1.656(5)	40	C11	C16	1.38(1)
2	S1	O2	1.494(4)	41	C12	H12	0.95
3	S1	C6	1.840(6)	42	C12	C13	1.38(1)
4	N1	H	0.93(6)	43	C13	H13	0.95
5	N1	C1	1.431(7)	44	C13	C14	1.29(2)
6	O1	C1	1.439(6)	45	C14	H14	0.95
7	O1	C5	1.432(7)	46	C14	C15	1.39(2)
8	O3	C4	1.431(7)	47	C15	H15	0.95
9	O3	C10	1.36(1)	48	C15	C16	1.41(2)
10	O4	C3	1.404(9)	49	C16	H16	0.95
11	O4	C20	1.52(1)	50	C20	H20A	0.99
12	O5	C2	1.428(7)	51	C20	H20B	0.99
13	O5	C30	1.42(1)	52	C20	C21	1.47(2)
14	C1	H1	1	53	C21	C22	1.56(2)
15	C1	C2	1.511(8)	54	C21	C26	1.33(1)
16	C2	H2	1	55	C22	H22	0.95
17	C2	C3	1.527(9)	56	C22	C23	1.31(2)
18	C3	H3	1	57	C23	H23	0.95
19	C3	C4	1.53(1)	58	C23	C24	1.35(2)
20	C4	H4	1	59	C24	H24	0.95
21	C4	C5	1.51(1)	60	C24	C25	1.33(2)
22	C5	H5A	0.99	61	C25	H25	0.95

Entry	Atom1	Atom2	Length	Entry	Atom1	Atom2	Length
23	C5	H5B	0.99	62	C25	C26	1.22(2)
24	C6	C7	1.53(1)	63	C26	H26	0.95
25	C6	C8	1.533(9)	64	C30	H30A	0.99
26	C6	C9	1.52(1)	65	C30	H30B	0.99
27	C7	H7A	0.98	66	C30	C31	1.50(1)
28	C7	H7B	0.98	67	C31	C32	1.38(1)
29	C7	H7C	0.98	68	C31	C36	1.40(1)
30	C8	H8A	0.98	69	C32	H32	0.949
31	C8	H8B	0.98	70	C32	C33	1.43(1)
32	C8	H8C	0.98	71	C33	H33	0.95
33	C9	H9A	0.981	72	C33	C34	1.35(1)
34	C9	H9B	0.98	73	C34	H34	0.95
35	C9	H9C	0.979	74	C34	C35	1.35(1)
36	C10	H10A	0.991	75	C35	H35	0.949
37	C10	H10B	0.99	76	C35	C36	1.39(1)
38	C10	C11	1.50(1)	77	C36	H36	0.951
39	C11	C12	1.37(1)				

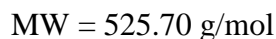
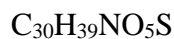
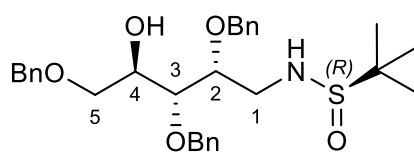
**Table 8.** Dihedral angles (degrees).

Entry	Atom1	Atom2	Atom3	Angle	Entry	Atom1	Atom2	Atom3	Angle
1	N1	S1	O2	109.3(2)	69	H10A	C10	C11	108.9
2	N1	S1	C6	99.2(3)	70	H10B	C10	C11	108.8
3	O2	S1	C6	104.1(3)	71	C10	C11	C12	123.1(8)
4	S1	N1	H	121(3)	72	C10	C11	C16	120.1(7)
5	S1	N1	C1	117.1(3)	73	C12	C11	C16	116.8(8)
6	H	N1	C1	111(3)	74	C11	C12	H12	118.7
7	C1	O1	C5	111.2(4)	75	C11	C12	C13	122.4(9)
8	C4	O3	C10	116.4(6)	76	H12	C12	C13	119
9	C3	O4	C20	108.9(7)	77	C12	C13	H13	119
10	C2	O5	C30	113.2(5)	78	C12	C13	C14	122(1)
11	N1	C1	O1	108.9(4)	79	H13	C13	C14	119
12	N1	C1	H1	109.3	80	C13	C14	H14	121
13	N1	C1	C2	110.6(4)	81	C13	C14	C15	118(1)
14	O1	C1	H1	109.3	82	H14	C14	C15	121
15	O1	C1	C2	109.6(4)	83	C14	C15	H15	119
16	H1	C1	C2	109.2	84	C14	C15	C16	121(1)
17	O5	C2	C1	111.0(5)	85	H15	C15	C16	119
18	O5	C2	H2	109.4	86	C11	C16	C15	119.0(9)
19	O5	C2	C3	108.9(5)	87	C11	C16	H16	120.4
20	C1	C2	H2	109.5	88	C15	C16	H16	120.5
21	C1	C2	C3	108.7(5)	89	O4	C20	H20A	111
22	H2	C2	C3	109.4	90	O4	C20	H20B	111
23	O4	C3	C2	108.6(5)	91	O4	C20	C21	104.1(9)
24	O4	C3	H3	108.4	92	H20A	C20	H20B	109
25	O4	C3	C4	113.7(6)	93	H20A	C20	C21	111
26	C2	C3	H3	108.4	94	H20B	C20	C21	111
27	C2	C3	C4	109.2(5)	95	C20	C21	C22	109.7(9)
28	H3	C3	C4	108.4	96	C20	C21	C26	137(1)
29	O3	C4	C3	110.3(5)	97	C22	C21	C26	112.5(9)
30	O3	C4	H4	109.7	98	C21	C22	H22	122
31	O3	C4	C5	108.3(5)	99	C21	C22	C23	117(1)
32	C3	C4	H4	109.6	100	H22	C22	C23	122
33	C3	C4	C5	109.2(5)	101	C22	C23	H23	121
34	H4	C4	C5	109.6	102	C22	C23	C24	118(1)
35	O1	C5	C4	111.1(5)	103	H23	C23	C24	121
36	O1	C5	H5A	109.5	104	C23	C24	H24	116
37	O1	C5	H5B	109.4	105	C23	C24	C25	128(1)



Entry	Atom1	Atom2	Atom3	Angle	Entry	Atom1	Atom2	Atom3	Angle
38	C4	C5	H5A	109.4	106	H24	C24	C25	116
39	C4	C5	H5B	109.4	107	C24	C25	H25	123
40	H5A	C5	H5B	108.1	108	C24	C25	C26	114(1)
41	S1	C6	C7	109.8(5)	109	H25	C25	C26	123
42	S1	C6	C8	106.9(5)	110	C21	C26	C25	131(1)
43	S1	C6	C9	104.8(5)	111	C21	C26	H26	114.7
44	C7	C6	C8	112.2(6)	112	C25	C26	H26	115
45	C7	C6	C9	110.9(6)	113	O5	C30	H30A	109.7
46	C8	C6	C9	111.8(6)	114	O5	C30	H30B	109.7
47	C6	C7	H7A	109.4	115	O5	C30	C31	109.9(7)
48	C6	C7	H7B	109.5	116	H30A	C30	H30B	108.2
49	C6	C7	H7C	109.4	117	H30A	C30	C31	109.7
50	H7A	C7	H7B	109.5	118	H30B	C30	C31	109.7
51	H7A	C7	H7C	109.6	119	C30	C31	C32	121.4(7)
52	H7B	C7	H7C	109.5	120	C30	C31	C36	120.1(7)
53	C6	C8	H8A	109.5	121	C32	C31	C36	118.5(7)
54	C6	C8	H8B	109.5	122	C31	C32	H32	120
55	C6	C8	H8C	109.4	123	C31	C32	C33	120.1(8)
56	H8A	C8	H8B	109.4	124	H32	C32	C33	120
57	H8A	C8	H8C	109.5	125	C32	C33	H33	120.5
58	H8B	C8	H8C	109.5	126	C32	C33	C34	119.1(8)
59	C6	C9	H9A	109.5	127	H33	C33	C34	120.4
60	C6	C9	H9B	109.4	128	C33	C34	H34	119
61	C6	C9	H9C	109.5	129	C33	C34	C35	122.0(7)
62	H9A	C9	H9B	109.4	130	H34	C34	C35	119
63	H9A	C9	H9C	109.5	131	C34	C35	H35	120.2
64	H9B	C9	H9C	109.5	132	C34	C35	C36	119.6(7)
65	O3	C10	H10A	108.8	133	H35	C35	C36	120.1
66	O3	C10	H10B	108.9	134	C31	C36	C35	120.6(7)
67	O3	C10	C11	113.5(7)	135	C31	C36	H36	119.7
68	H10A	C10	H10B	107.7	136	C35	C36	H36	119.7

2,3,5-Tri-*O*-benzyl-1-*(S<sub>R</sub>)*-*N*-*tert*-butanesulfinylamino-1-deoxy-D-arabinitol **18**



According to general procedure C, the reaction was performed with commercial 2,3,5-tri-*O*-benzyl-D-arabinofuranose **4** to afford **18** as yellowish syrup (277 mg, 74%).

Alternatively, it could be prepared by reduction of the isolated glycosylamine derived from **4**, compound **5**. An oven-dried 5-mL single-necked round-bottomed flask was charged with **5** (50 mg, 0.095 mmol, 1.0 eq.) and flushed with argon. Dry THF (0.5 mL) was inserted via a syringe and NaBH<sub>4</sub> (7 mg, 0.19 mmol, 2.0 eq.) was added in one portion. The reaction mixture was then allowed to stir at 20 °C for 20 h under argon atmosphere. The mixture was quenched by the addition of aq. NH<sub>4</sub>Cl (10 mL), and it was extracted twice with EtOAc (2 × 10.0 mL). The combined organic phases were dried over Na<sub>2</sub>SO<sub>4</sub>, filtered through a cotton plug and the solvents were evaporated under reduced pressure. The crude product was purified by silica gel column chromatography (PE:EtOAc 5:5 to 3:7) to afford **18** in good yield (42 mg, 84%).

$R_f = 0.1$  (PE:EtOAc 5:5)

$[\alpha]_D^{20} = -34.5$  (CHCl<sub>3</sub>,  $c = 0.78$  g/100 mL)

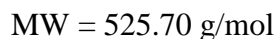
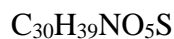
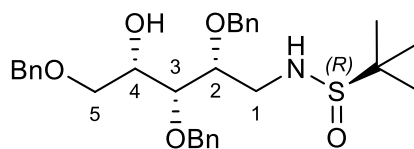
**IR** (neat):  $\nu = 3309, 3062, 3030, 2865, 1454, 1068, 735, 697 \text{ cm}^{-1}$

**HRMS (ESI):**  $m/z$  calc. for C<sub>30</sub>H<sub>40</sub>NO<sub>5</sub>S [M + H]<sup>+</sup> 526.2622, found 526.2622

**<sup>1</sup>H NMR (400 MHz, CDCl<sub>3</sub>):**  $\delta = 1.13$  (s, 9H, CH<sub>3</sub>), 2.92 (bs, 1H, OH), 3.25 – 3.46 (m, 3H, H-1a, H-1b, NH), 3.59 – 3.71 (m, 3H, H-3, H-5a, H-5b), 3.86 – 3.92 (m, 1H, H-2), 3.94 – 4.02 (m, 1H, H-4), 4.48 – 4.70 (m, 6H, OCH<sub>2</sub>Ph), 7.22 – 7.39 (m, 15H, H<sub>Ar</sub>),

**<sup>13</sup>C NMR (101 MHz, CDCl<sub>3</sub>):**  $\delta = 22.7$  (CH<sub>3</sub> *t*-Bu), 45.6 (C-1), 55.9 (C<sup>IV</sup> *t*-Bu), 70.7 (C-4), 71.2 (C-5), 73.3 (OCH<sub>2</sub>Ph), 73.6 (OCH<sub>2</sub>Ph), 73.7 (OCH<sub>2</sub>Ph), 77.4 (C-3), 79.4 (C-2), 127.9 – 128.7 (C<sub>Ar</sub>), 137.8 (C<sup>IV</sup> <sub>Ar</sub>), 138.0 (C<sup>IV</sup> <sub>Ar</sub>), 138.1 (C<sup>IV</sup> <sub>Ar</sub>)

2,3,5-Tri-*O*-benzyl-1-(*S<sub>R</sub>*)-*N*-*tert*-butanesulfinylamino-1-deoxy-L-xylitol **19**



According to general procedure C, the reaction was performed with commercial 2,3,5-tri-*O*-benzyl-L-xylofuranose **16** to afford **19** as a colourless oil (1.9 g, 76%).

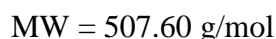
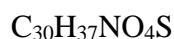
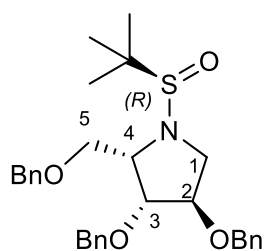
$R_f = 0.2$  (PE:EtOAc 5:5)

**HRMS (ESI):**  $m/z$  calc. for  $\text{C}_{30}\text{H}_{40}\text{NO}_5\text{S}$   $[\text{M} + \text{H}]^+$  526.2627, found 526.2621

**$^1\text{H}$  NMR (400 MHz,  $\text{CDCl}_3$ ):**  $\delta = 1.16$  (s, 9H,  $\text{CH}_3$ ), 2.48 (d,  $J = 7.5$  Hz, 1H, OH), 3.27 (dt,  $J = 6.2, 12.7$  Hz, 1H, H-1a), 3.39 (dd,  $J = 6.4, 9.3$  Hz, 1H, H-5a), 3.43 – 3.60 (m, 3H, H-1b, H-5b, NH), 3.70 (dd,  $J = 2.2, 6.1$  Hz, 1H, H-3), 3.87 – 4.00 (m, 2H, H-2, H-4), 4.38 – 4.78 (m, 6H,  $\text{OCH}_2\text{Ph}$ ), 7.21 – 7.36 (m, 15H,  $\text{H}_{\text{Ar}}$ ),

**$^{13}\text{C}$  NMR (101 MHz,  $\text{CDCl}_3$ ):**  $\delta = 22.6$  ( $\text{CH}_3$   $t\text{-Bu}$ ), 45.7 (C-1), 55.8 ( $\text{C}^{\text{IV}}$   $t\text{-Bu}$ ), 68.9 (C-4), 71.3 (C-5), 72.8 ( $\text{OCH}_2\text{Ph}$ ), 73.3 ( $\text{OCH}_2\text{Ph}$ ), 74.3 ( $\text{OCH}_2\text{Ph}$ ), 77.3 (C-3), 79.3 (C-2), 127.7 – 128.5 ( $\text{C}_{\text{Ar}}$ ), 137.9 ( $\text{C}^{\text{IV}}_{\text{Ar}}$ ), 138.0 ( $\text{C}^{\text{IV}}_{\text{Ar}}$ ), 138.0 ( $\text{C}^{\text{IV}}_{\text{Ar}}$ )

2,3,5-Tri-*O*-benzyl-(*S<sub>R</sub>*)-*N*-*tert*-butanesulfinyl-1,4-dideoxy-1,4-imino-L-xylitol **20**



To a solution of compound **18** (96 mg, 0.18 mmol, 1.0 eq.) in anhydrous DCM (3.5 mL), in the presence of 4Å MS, under argon atmosphere were added Et<sub>3</sub>N (100 μL, 0.73 mmol, 4.0 eq.) and MsCl (57 μL, 0.73 mmol, 4.0 eq.) and the reaction mixture was stirred at 20 °C for 30 min. The molecular sieves were filtered through Celite®, the cake rinsed with DCM (5.0 mL) and the organic solution washed with aq. NH<sub>4</sub>Cl (10.0 mL). Next, the aqueous phase was extracted once with DCM (5.0 mL) combined organic phases were dried over MgSO<sub>4</sub> and filtered over a cotton plug. Solvent evaporation gave the crude mesylated intermediate which was used in the cyclisation step without further purification.

To a solution of the just generated mesylated intermediate in anhydrous THF (3.5 mL) under argon atmosphere was added *tert*-BuOK (40 mg, 0.36 mmol, 2.0 eq.) and the reaction mixture was stirred at 0 °C for 1 h. Extra *t*-BuOK (20 mg, 0.18 mmol, 1.0 eq.) was added and stirring was pursued for another 30 min. Aqueous NH<sub>4</sub>Cl (10.0 mL) was then added and the mixture was extracted twice with EtOAc (2 × 5.0 mL). The combined organic phases were then washed with saturated aqueous solution of NaCl, dried over MgSO<sub>4</sub>, filtered over a cotton plug and concentrated under reduced pressure. The crude product was purified by silica gel column chromatography (PE:EtOAc 7:3) to give **20** (60 mg, 66%) as a pale yellow oil.

**R<sub>f</sub>** = 0.4 (PE:EtOAc 7:3)  $[\alpha]_D^{20} = -36.1$  (CHCl<sub>3</sub>, *c* = 1.06 g/100 mL)

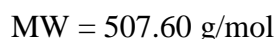
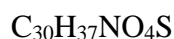
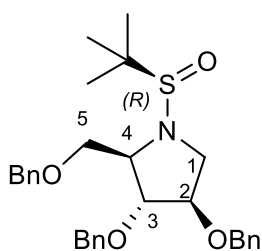
**IR (neat):**  $\nu = 3029, 2924, 2865, 1454, 1362, 1074, 1028, 753 \text{ cm}^{-1}$

**HRMS (ESI):** *m/z* calc. for C<sub>30</sub>H<sub>38</sub>NO<sub>4</sub>S [M + H]<sup>+</sup> 508.2516, found 505.2515

**<sup>1</sup>H NMR (400 MHz, CDCl<sub>3</sub>):**  $\delta = 1.16$  (s, 9H, CH<sub>3</sub>), 3.02 (dd, *J* = 3.7, 11.5 Hz, 1H, H-1a), 3.74 (d, *J* = 4.8 Hz, 2H, H-5), 3.87 (dd, *J* = 6.9, 11.5 Hz, 1H, H-1b), 3.94 – 4.01 (m, 1H, H-4), 4.06 (dd, *J* = 4.6, 6.0 Hz, 1H, H-3), 4.17 (dt, *J* = 4.3, 6.9 Hz, 1H, H-2), 4.42 – 4.64 (m, 6H, OCH<sub>2</sub>Ph), 7.19 – 7.40 (m, 15H, H<sub>Ar</sub>)

**<sup>13</sup>C NMR (101 MHz, CDCl<sub>3</sub>):**  $\delta = 23.1$  (CH<sub>3</sub> *t*-Bu), 51.2 (C-1), 57.7 (C<sup>IV</sup> *t*-Bu), 59.7 (C-4), 68.2 (C-5), 71.8 (OCH<sub>2</sub>Ph), 72.5 (OCH<sub>2</sub>Ph), 73.5 (OCH<sub>2</sub>Ph), 81.5 (C-2), 83.2 (C-3), 127.5 – 128.4 (C<sub>Ar</sub>), 138.1 (C<sup>IV</sup> <sub>Ar</sub>), 138.1 (C<sup>IV</sup> <sub>Ar</sub>), 138.3 (C<sup>IV</sup> <sub>Ar</sub>)

2,3,5-Tri-*O*-benzyl-*(S<sub>R</sub>)*-*N*-*tert*-butanesulfinyl-1,4-dideoxy-1,4-imino-D-arabinitol **21**



To a solution of compound **19** (200 mg, 0.38 mmol, 1.0 eq.) in anhydrous DCM (5.0 mL), under argon atmosphere were added triethylamine (113  $\mu\text{L}$ , 0.84 mmol, 2.2 eq.) and MsCl (59  $\mu\text{L}$ , 0.76 mmol, 2.0 eq.) and the reaction mixture was stirred at room temperature for 1 h. The mixture was diluted by addition of DCM (20.0 mL) and the organic solution was washed with saturated aqueous solution of NaCl (30.0 mL). Next, the aqueous phase was extracted twice with DCM ( $2 \times 20.0$  mL). The combined organic phases were dried over  $\text{MgSO}_4$ , filtered over a cotton plug and concentrated under reduced pressure. The crude mesylated intermediate which was used for the cyclisation step without further purification.

To a solution of the just generated mesylated intermediate in anhydrous THF (5.0 mL) under argon atmosphere was added *tert*-BuOK (85 mg, 0.76 mmol, 2.0 eq.) and the reaction mixture was stirred at 20  $^\circ\text{C}$  for 30 min. Saturated aqueous solution of  $\text{NH}_4\text{Cl}$  (10.0 mL) was then added and the mixture was extracted three times with EtOAc ( $3 \times 15.0$  mL). Next, the combined organic phases were washed with saturated aqueous solution of NaCl (20.0 mL), dried over  $\text{MgSO}_4$ , filtered over a cotton plug and concentrated under reduced pressure. The crude product was purified by silica gel column chromatography (PE:EtOAc 2:1) to give **21** (132 mg, 69%) as colorless oil.

$R_f = 0.3$  (PE:EtOAc 2:1)

$[\alpha]_D^{20} = -9.6$  ( $\text{CHCl}_3$ ,  $c = 1.0$  g/100 mL)

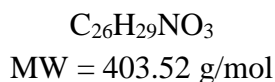
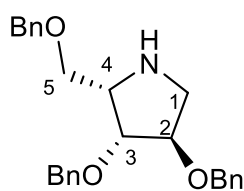
**IR** (neat):  $\nu = 3021, 2929, 2857, 1714, 1451, 1064, 739, 694 \text{ cm}^{-1}$

**HRMS** (ESI):  $m/z$  calc. for  $\text{C}_{30}\text{H}_{38}\text{NO}_4\text{S}$   $[\text{M} + \text{H}]^+$  508.2522, found 505.2519

**$^1\text{H}$  NMR** (400 MHz,  $\text{CDCl}_3$ ):  $\delta = 1.15$  (s, 9H,  $\text{CH}_3$ ), 2.79 (dd,  $J = 4.3, 10.2$  Hz, 1H, H-1a), 3.46 – 3.57 (m, 2H, H-5), 3.77 – 3.86 (m, 1H, H-4), 3.97 – 4.08 (m, 3H, H-1b, H-2, H-3), 4.40 – 4.51 (m, 4H,  $\text{OCH}_2\text{Ph}$ ), 4.60 (s, 2H,  $\text{OCH}_2\text{Ph}$ ), 7.20 – 7.37 (m, 15H,  $\text{H}_{\text{Ar}}$ )

**$^{13}\text{C}$  NMR** (101 MHz,  $\text{CDCl}_3$ ):  $\delta = 23.6$  ( $\text{CH}_3$  *t*-Bu), 44.8 (C-1), 57.6 ( $\text{C}^{\text{IV}}$  *t*-Bu), 68.26 (C-4), 71.2 (C-5), 71.6 ( $\text{OCH}_2\text{Ph}$ ), 72.1 ( $\text{OCH}_2\text{Ph}$ ), 73.1 ( $\text{OCH}_2\text{Ph}$ ), 82.1 (C-3 or C-2), 83.1 (C-2 or C-3), 127.6 – 128.5 ( $\text{C}_{\text{Ar}}$ ), 138.2 ( $\text{C}^{\text{IV}}$   $\text{Ar}$ ), 138.1 ( $\text{C}^{\text{IV}}$   $\text{Ar}$ ), 137.9 ( $\text{C}^{\text{IV}}$   $\text{Ar}$ )

2,3,5-Tri-*O*-benzyl-1,4-dideoxy-1,4-imino-L-xylitol **22**



According to general procedure D, the reaction was performed with **18** to afford **22** as a yellow oil (51 mg, 70%).

Alternatively, compound **22** could be obtained from imino-L-xylitol **20**. In a 10-mL single-necked round-bottomed flask under argon atmosphere was inserted AcCl (37  $\mu$ L, 0.52 mmol, 5.0 eq.) and dry MeOH (3.0 mL) and the solution was stirred at 20 °C for 30 min (solution A). In parallel, another 10-mL flask under argon atmosphere was charged with imino-L-xylitol (*S<sub>R</sub>*)-**20** (53 mg, 0.104 mmol, 1.0 eq.) and solution A was added through syringe. The reaction mixture was stirred for 15 min and neutralized by addition of resin Amberlite IRA-400 (OH<sup>-</sup> form) until pH 8. The solution was filtered through a cotton plug and concentrated under vacuum to afford **22** in good yield (39 mg, 93%).

$R_f = 0.4$  (DCM:MeOH 9:1)  $[\alpha]_D^{20} = 7.9$  (CHCl<sub>3</sub>,  $c = 0.96$  g/100 mL)

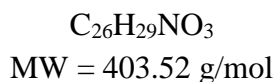
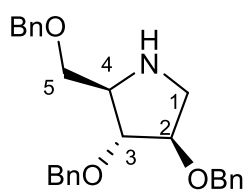
**IR (neat):**  $\nu = 3062, 3029, 2914, 2861, 1453, 1094, 1027, 735, 697$  cm<sup>-1</sup>

**HRMS (ESI):**  $m/z$  calc. for C<sub>26</sub>H<sub>30</sub>NO<sub>3</sub> [M + H]<sup>+</sup> 404.2220, found 404.2220

**<sup>1</sup>H NMR (400 MHz, CDCl<sub>3</sub>):**  $\delta = 2.25$  (bs, 1H, NH), 2.90 (d,  $J = 12.0$  Hz, 1H, H-1a), 3.35 (dd,  $J = 5.6, 11.8$  Hz, 1H, H-1b), 3.49 (dd,  $J = 5.5, 11.5$  Hz, 1H, H-4), 3.58 – 3.66 (m, 1H, H-5a), 3.69 – 3.73 (m, 1H, H-5b), 3.93 – 4.05 (m, 2H, H-2, H-3), 4.42 – 4.60 (m, 6H, OCH<sub>2</sub>Ph), 7.20 – 7.39 (m, 15H, H<sub>Ar</sub>),

**<sup>13</sup>C NMR (101 MHz, CDCl<sub>3</sub>):**  $\delta = 50.9$  (C-1), 60.5 (C-4), 69.3 (C-5), 71.5 (OCH<sub>2</sub>Ph), 71.9 (OCH<sub>2</sub>Ph), 73.5 (OCH<sub>2</sub>Ph), 82.9 (C-3 or C-2), 83.2 (C-2 or C-3), 127.7 – 128.5 (C<sub>Ar</sub>), 138.2 (C<sup>IV</sup><sub>Ar</sub>), 138.3 (C<sup>IV</sup><sub>Ar</sub>), 138.5 (C<sup>IV</sup><sub>Ar</sub>)

2,3,5-Tri-*O*-benzyl-1,4-dideoxy-1,4-imino-D-arabinitol **23**



According to general procedure D, the reaction was performed with **19** to afford **23** as a colourless oil (110 mg, 72%).

Alternatively, compound **23** could be obtained from imino-D-arabinitol **21**. In a 2-mL single-necked round-bottomed flask under argon atmosphere was inserted AcCl (17  $\mu$ L, 0.24 mmol, 4.0 eq.) and dry MeOH (0.5 mL) and the solution was stirred at 20 °C for 30 min (solution A). In parallel, another 2-mL flask under argon atmosphere was charged with imino-D-arabinitol **21** (30 mg, 0.06 mmol, 1.0 eq.) and solution A was added through syringe. The reaction mixture was stirred for 15 min and neutralized by addition of resin Amberlite IRA-400 (OH<sup>-</sup> form) until pH 8. The solution was filtered through a cotton plug and concentrated under vacuum to afford **23** in good yield (23 mg, 93%).

$R_f = 0.45$  (DCM:MeOH 15:1)                       $[\alpha]_D^{20} = -1.0$  (CHCl<sub>3</sub>,  $c = 1.0$  g/100 mL)

**IR (neat):**  $\nu = 3034, 2917, 2863, 1739, 1451, 1087, 736, 688$  cm<sup>-1</sup>

**HRMS (ESI):**  $m/z$  calc.            for C<sub>26</sub>H<sub>30</sub>NO<sub>3</sub> [M + H]<sup>+</sup> 404.2226, found 404.2218

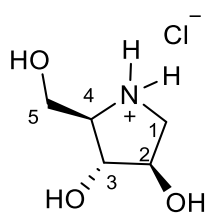
NMR data are consistent with that of the literature.<sup>149</sup>

**<sup>1</sup>H NMR (400 MHz, CDCl<sub>3</sub>):**  $\delta = 2.24$  (bs, 1H, NH), 3.09 (d,  $J = 3.6$  Hz, 2H, H-1), 3.24 (q,  $J = 4.8$  Hz, 1H, H-4), 3.55 (dd,  $J = 5.6, 9.5$  Hz, 1H, H-5a), 3.61 (dd,  $J = 5.1, 9.5$  Hz, 1H, H-5b), 3.87 (dd,  $J = 1.9, 4.8$  Hz, 1H, H-3), 3.97 – 4.05 (m, 1H, H-2), 4.39 – 4.59 (m, 6H, OCH<sub>2</sub>Ph), 7.21 – 7.31 (m, 15H, H<sub>Ar</sub>)

**<sup>13</sup>C NMR (101 MHz, CDCl<sub>3</sub>):**  $\delta = 51.1$  (C-1), 64.2 (C-4), 70.4 (C-5), 71.1 (OCH<sub>2</sub>Ph), 71.9 (OCH<sub>2</sub>Ph), 73.2 (OCH<sub>2</sub>Ph), 84.6 (C-2), 85.8 (C-3), 127.6 – 128.4 (C<sub>Ar</sub>), 138.2 (C<sup>IV</sup><sub>Ar</sub>), 138.2 (C<sup>IV</sup><sub>Ar</sub>), 138.3 (C<sup>IV</sup><sub>Ar</sub>)

<sup>149</sup> H. S. Overkleeft, J. van Wiltenburg, U. K. Pandit, *Tetrahedron* **1994**, *50*, 4215–4224.

1,4-Dideoxy-1,4-imino-D-arabinitol·HCl **24**



MW = 113.15 g/mol

A vigorously stirred suspension of **23** (70 mg, 0.173 mmol, 1.0 eq.), 20% Pd(OH)<sub>2</sub>-C (40 mg), and aq. HCl (1 N, 0.6 mmol, 600 μL) in *i*PrOH (5.0 mL) was degassed under vacuum and saturated with hydrogen (3 ×). The reaction mixture was stirred at 20 °C for 48 h under hydrogen atmosphere (balloon of H<sub>2</sub>). The mixture was filtered over a pad of Celite® and the solid residue was rinsed with MeOH (5.0 mL). The solvents were evaporated under reduced pressure to give **24**·HCl as colorless syrup in quantitative yield (29 mg).

$[\alpha]_D^{20} = 24.5$  (CHCl<sub>3</sub>, *c* = 0.47 g/100 mL)

**HRMS (ESI):** *m/z* calc. for C<sub>5</sub>H<sub>12</sub>NO<sub>3</sub> [M + H]<sup>+</sup> 134.0817, found 134.0812

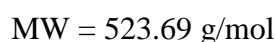
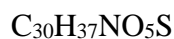
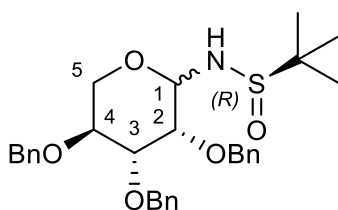
Characterization data are consistent with those reported in the literature.<sup>149</sup>

**<sup>1</sup>H NMR (400 MHz, CDCl<sub>3</sub>):** δ = 3.37 (d, *J* = 12.6 Hz, 1H, H-1a), 3.54 – 3.67 (m, 2H, H-4, H-1b), 3.84 (dd, *J* = 8.2, 12.2 Hz, 1H, H-5a), 3.96 (dd, *J* = 4.6, 12.2 Hz, 1H, H-5b), 4.06 – 4.15 (m, 1H, H-3), 4.31 – 4.37 (m, 1H, H-2)

**<sup>13</sup>C NMR (101 MHz, CDCl<sub>3</sub>):** δ = 50.0 (C-1), 58.9 (C-5), 66.6 (C-4), 74.2 (C-2), 75.6 (C-3)



2,3,4-Tri-*O*-benzyl-*(S<sub>R</sub>)*-*N*-*tert*-butanesulfinyl- $\alpha/\beta$ -L-lyxopyranosylamine **26**



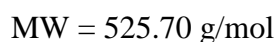
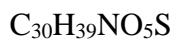
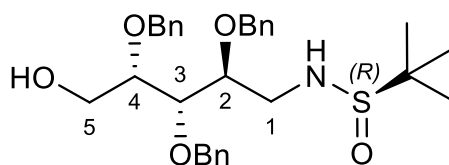
According to the general procedure B, the reaction was performed with 2,3,4-tri-*O*-benzyl-L-lyxopyranose **25** (0.5 g, 1.19 mmol, 1.0 eq.), *(R)*-2-methyl-2-propanesulfinamide **2** (0.288 g, 2.30 mmol, 2.0 eq.), titanium (IV) ethoxide (0.41 g, 1.78 mmol, 1.5 eq.), activated 4 Å molecular sieves (0.5 g) and dry toluene (5.0 mL). After heating up, the mixture was stirred for 90 min at 110 °C. The crude compound was purified by silica gel column chromatography ( $\emptyset$  = 3.0 cm, L = 30 cm) using PE:EtOAc (5:5) as the eluent to afford compound **26** as a mixture of anomers (8:2, not assigned) in form of a colorless oil (0.48 g, 77%).

$R_f$  = 0.4 (PE:EtOAc 5:5)

**HRMS (ESI):**  $m/z$  calc. for  $\text{C}_{30}\text{H}_{38}\text{NO}_5\text{S}$   $[\text{M} + \text{H}]^+$  524.2471, found 524.2465

**$^1\text{H}$  NMR (400 MHz,  $\text{CDCl}_3$ ):**  $\delta$  = 1.08 (s, 7.6 H,  $\text{CH}_3$  maj), 1.18 (s, 1.8 H,  $\text{CH}_3$  min), 3.50 – 3.63 (m, 1.2H, H-3<sub>min</sub>, H-4<sub>min</sub>, H-5<sub>amaj</sub>,  $\text{NH}_{\text{min}}$ ), 3.65 – 3.72 (m, 0.8H, H-4<sub>maj</sub>), 3.37 – 3.90 (m, 1.6H, H-2<sub>min</sub>, H-3<sub>maj</sub>, H-5<sub>a</sub><sub>min</sub>, H-5<sub>b</sub><sub>min</sub>), 3.94 (t,  $J$  = 3.2 Hz, 0.8H, H-2<sub>maj</sub>), 4.07 (dd,  $J$  = 2.0, 12.8 Hz, 0.8H, H-5<sub>b</sub><sub>maj</sub>), 4.42 – 4.70 (m, 6H,  $\text{OCH}_2\text{Ph}_{\text{maj}}$ ,  $\text{OCH}_2\text{Ph}_{\text{min}}$ ), 4.97 (dd,  $J$  = 5.4, 8.0 Hz, 0.2H, H-1<sub>min</sub>), 5.05 (d,  $J$  = 7.8 Hz, 0.8H, H-1<sub>maj</sub>), 5.64 (bs, 0.7 H,  $\text{NH}_{\text{maj}}$ ), 7.40 – 7.19 (m, 15H,  $\text{H}_{\text{Ar}}$ ),

**$^{13}\text{C}$  NMR (101 MHz,  $\text{CDCl}_3$ ):**  $\delta$  = 22.4 ( $\text{CH}_3$  *t*-Bu min), 22.4 ( $\text{CH}_3$  *t*-Bu maj), 55.9 ( $\text{C}^{\text{IV}}$  *t*-Bu min), 56.1 ( $\text{C}^{\text{IV}}$  *t*-Bu maj), 58.7 (C-5<sub>maj</sub>), 64.0 (C-5<sub>min</sub>), 71.5 ( $\text{OCH}_2\text{Ph}_{\text{min}}$ ), 71.5 ( $\text{OCH}_2\text{Ph}_{\text{min}}$ ), 71.7 ( $\text{OCH}_2\text{Ph}_{\text{maj}}$ ), 71.7 ( $\text{OCH}_2\text{Ph}_{\text{maj}}$ ), 73.0 ( $\text{OCH}_2\text{Ph}_{\text{min}}$ ), 73.4 (C-2<sub>min</sub>), 73.5 (C-2<sub>maj</sub>), 73.9 ( $\text{OCH}_2\text{Ph}_{\text{maj}}$ ), 74.7 (C-4<sub>maj</sub>), 74.8 (C-4<sub>min</sub>), 76.2 (C-3<sub>min</sub>), 77.3 (C-3<sub>maj</sub>), 82.6 (C-1<sub>min</sub>), 82.9 (C-1<sub>maj</sub>), 127.7 – 128.5 ( $\text{C}_{\text{Ar}}$  maj +  $\text{C}_{\text{Ar}}$  min), 137.6 ( $\text{C}^{\text{IV}}$   $\text{Ar}$  maj), 137.8 ( $\text{C}^{\text{IV}}$   $\text{Ar}$  min), 137.9 ( $\text{C}^{\text{IV}}$   $\text{Ar}$  maj), 138.0 ( $\text{C}^{\text{IV}}$   $\text{Ar}$  min), 138.0 ( $\text{C}^{\text{IV}}$   $\text{Ar}$  maj), 138.2 ( $\text{C}^{\text{IV}}$   $\text{Ar}$  min)

2,3,4-Tri-*O*-benzyl-1-(*S<sub>R</sub>*)-*N*-*tert*-butanesulfinylamino-1-deoxy-*L*-lyxitol **27**

(Procedure C referred at Scheme 34). A 5-mL microwave vial under argon atmosphere was charged with 2,3,4-tri-*O*-benzyl-*L*-lyxopyranose **25**<sup>95</sup> (0.1 g, 0.24 mmol, 1.0 eq.), 4 Å activated molecular sieves (0.2 g), (*R*)-(+)-2-methyl-2-propanesulfonamide **2** (58 mg, 0.48 mmol, 2.0 eq.) and a microwave magnetic stir bar. Dry toluene (2.0 mL) was inserted and the mixture was stirred during 10 min at 20 °C. Ti(OEt)<sub>4</sub> (82 mg, 0.36 mmol, 1.5 eq.) was added, the vial was sealed and the reaction mixture was heated at 110 °C for 1.5 h under microwave irradiation. After cooling to room temperature, the cap was removed and the solvent was evaporated under reduced pressure (septum pierced by a needle).

The crude 2,3,4-tri-*O*-benzyl-(*S<sub>R</sub>*)-*N*-*tert*-butanesulfinyl- $\alpha/\beta$ -*L*-lyxopyranosylamine **26** was then dissolved by adding 5.0 mL of absolute ethanol, the mixture was flushed with argon and NaBH<sub>4</sub> (36 mg, 0.95 mmol, 4.0 eq.) was added. The reaction mixture was subsequently heated at 80 °C under argon atmosphere, until no more of the sulfinyl intermediate was observed (2 h). Next, the suspension was allowed to cool down to room temperature and the solvent was evaporated. The residue was dissolved in DCM (20.0 mL) and molecular sieves were eliminated by filtration through a cotton plug. The organic phase was washed with saturated aqueous solution of NH<sub>4</sub>Cl (20.0 mL) and the aqueous phase was extracted three times with DCM (3 × 10.0 mL). Combined organic layers were dried over MgSO<sub>4</sub>, filtered through a cotton plug and the solvent was evaporated under reduced pressure. The crude product was purified by silica gel column chromatography (PE:EtOAc 1:2 to 1:3) to afford **27** in moderate yield (71 mg, 56%).

Alternatively, compound **27** could be obtained from the reduction of isolated 2,3,4-tri-*O*-benzyl-(*S<sub>R</sub>*)-*N*-*tert*-butanesulfinyl- $\alpha/\beta$ -*L*-lyxopyranosylamine **26**. An oven-dried 5-mL single-necked round-bottomed flask under argon atmosphere, was charged with compound **26** (90 mg, 0.17 mmol, 1.0 eq.), and absolute ethanol (5.0 mL). Afterwards, NaBH<sub>4</sub> (26 mg, 0.69 mmol, 4.0 eq.) was added, portionwise, and the reaction mixture was stirred at 80 °C for 2 h. The suspension was allowed to cool down to room temperature and the solvent was removed by evaporation under reduced pressure. The crude residue was dissolved in EtOAc (20.0 mL) and the organic phase was washed with saturated aqueous solution of NaCl (20.0 mL). Next, the aqueous layer was discarded, and the organic phase was dried over MgSO<sub>4</sub>, filtered through a cotton plug and evaporated under reduced pressure. The crude product was purified by silica gel column chromatography (PE:EtOAc 1:2 to 1:3) to afford compound **27** in moderate yield (58 mg, 64%).

$R_f = 0.25$  (PE:EtOAc 1:2)

$[\alpha]_D^{20} = -59.4$  (CHCl<sub>3</sub>,  $c = 1.5$  g/100 mL)

**IR (neat):**  $\nu = 3392, 3031, 2930, 2876, 1707, 1454, 1043, 736, 691$  cm<sup>-1</sup>

**HRMS (ESI):**  $m/z$  calc. for C<sub>30</sub>H<sub>40</sub>NO<sub>5</sub>S [M + H]<sup>+</sup> 526.2627, found 526.2632

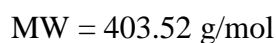
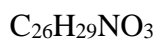
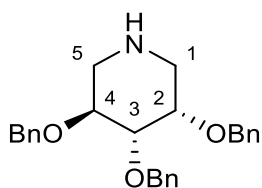
**<sup>1</sup>H NMR (400 MHz, CDCl<sub>3</sub>):**  $\delta = 1.08$  (s, 9H, CH<sub>3</sub>), 2.45 (t,  $J = 6.1$  Hz, 1H, OH), 3.29 – 3.52 (m, 2H, H-1), 3.63 – 3.75 (m, 3H, H-4, H-5a, NH), 3.76 – 3.85 (m, 2H, H-2, H-5b), 3.86–3.93 (dd,  $J = 3.8, 5.2$ , Hz, 1H, H-3), 4.49 – 4.77 (m, 6H, OCH<sub>2</sub>Ph), 7.23 – 7.39 (m, 15H, H<sub>Ar</sub>)

**<sup>1</sup>H NMR (400 MHz, C<sub>6</sub>D<sub>6</sub>):**  $\delta = 0.80$  (s, 9H, CH<sub>3</sub>), 3.30 – 3.41 (m, 2H, H-1), 3.56 (q,  $J = 4.9$  Hz, 1H, H-4), 3.62 – 3.72 (m, 2H, H-5), 3.83 (q,  $J = 5.0$  Hz, 1H, H-3), 3.87 (dd,  $J = 3.8, 5.5$  Hz, 1H, H-2), 3.94 (t,  $J = 6.3$  Hz, 1H, OH), 4.31 – 4.58 (m, 6H, OCH<sub>2</sub>Ph), 6.92 – 7.03 (m, 9H, H<sub>Ar</sub>), 7.14 – 7.22 (m, 6H, H<sub>Ar</sub>)

**<sup>13</sup>C NMR (101 MHz, CDCl<sub>3</sub>):**  $\delta = 22.6$  (CH<sub>3</sub> *t*-Bu), 45.6 (C-1), 55.7 (C<sup>IV</sup> *t*-Bu), 61.2 (C-5), 72.1 (OCH<sub>2</sub>Ph), 72.7 (OCH<sub>2</sub>Ph), 74.2 (OCH<sub>2</sub>Ph), 79.4 (C-2 or C-3 or C-4), 79.4 (C-2 or C-3 or C-4), 79.8 (C-2 or C-3 or C-4), 127.9 – 128.6 (C<sub>Ar</sub>), 137.8 (C<sup>IV</sup> <sub>Ar</sub>), 138.1 (C<sup>IV</sup> <sub>Ar</sub>), 138.1 (C<sup>IV</sup> <sub>Ar</sub>)

**<sup>13</sup>C NMR (101 MHz, C<sub>6</sub>D<sub>6</sub>):**  $\delta = 22.7$  (CH<sub>3</sub> *t*-Bu), 45.7 (C-1), 55.6 (C<sup>IV</sup> *t*-Bu), 61.5 (C-5), 72.1 (OCH<sub>2</sub>Ph), 72.9 (OCH<sub>2</sub>Ph), 74.7 (OCH<sub>2</sub>Ph), 79.4 (C-3), 80.6 (C-2), 80.8 (C-4), 127.8 – 128.7 (C<sub>Ar</sub>), 138.9 (C<sup>IV</sup> <sub>Ar</sub>), 139.2 (C<sup>IV</sup> <sub>Ar</sub>), 139.3 (C<sup>IV</sup> <sub>Ar</sub>)

2,3,4-Tri-*O*-benzyl-1,5-dideoxy-1,5-imino-L-lyxitol **28**



According to general procedure D, the reaction was performed with amino-L-lyxitol **27** to afford after purification through silica gel column chromatography (DCM:MeOH 100:1 to 30:1) imino-L-lyxitol **28** as a colourless oil (18 mg, 44% over two steps).

$R_f = 0.4$  (DCM:MeOH 15:1)       $[\alpha]_D^{20} = 33.0$  ( $\text{CHCl}_3$ ,  $c = 1.0$  g/100 mL)

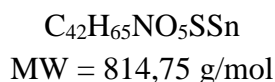
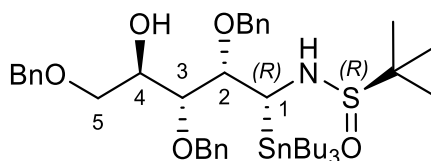
**IR (neat):**  $\nu = 3310, 3028, 2923, 2866, 1717, 1448, 1097, 729, 694 \text{ cm}^{-1}$

**HRMS (ESI):**  $m/z$  calc. for  $\text{C}_{26}\text{H}_{30}\text{NO}_3$   $[\text{M} + \text{H}]^+$  404.2226, found 404.2218

**$^1\text{H}$  NMR (400 MHz,  $\text{CDCl}_3$ ):**  $\delta = 2.57$  (dd,  $J = 7.3, 13.6$  Hz, 1H, H-5b or H-1b), 2.64 (d,  $J = 13.8$  Hz, 1H, H-1b or H-5b), 3.05 (dd,  $J = 6.0, 13.6$  Hz, 1H, H-1a or H-5a), 3.13 (dd,  $J = 2.8, 13.4$  Hz, 1H, H-5a or H-1a), 3.61 (d,  $J = 5.3$  Hz, 1H), 3.68 – 3.79 (m, 2H), 4.53 – 4.77 (m, 6H,  $\text{OCH}_2\text{Ph}$ ), 7.22 – 7.43 (m, 15 H,  $\text{H}_{\text{Ar}}$ )

**$^{13}\text{C}$  NMR (101 MHz,  $\text{CDCl}_3$ ):**  $\delta = 46.8$  (C-1), 47.7 (C-5), 71.4 ( $\text{OCH}_2\text{Ph}$ ), 72.4 ( $\text{OCH}_2\text{Ph}$ ), 72.5 ( $\text{OCH}_2\text{Ph}$ ), 74.7 (C-2 or C-3 or C-4), 76.6 (C-2 or C-3 or C-4), 79.8 (C-2 or C-3 or C-4), 127.5 – 128.4 ( $\text{C}_{\text{Ar}}$ ), 138.7 ( $\text{C}^{\text{IV}}_{\text{Ar}}$ ), 138.7 ( $\text{C}^{\text{IV}}_{\text{Ar}}$ ), 138.9 ( $\text{C}^{\text{IV}}_{\text{Ar}}$ )

(1*R*)-2,3,5-Tri-*O*-benzyl-1-(*S<sub>R</sub>*)-*N*-*tert*-butanesulfinylamino-1-deoxy-1-tributylstannyl-D-arabinitol **29**



According to the general procedure E, flask A under, argon atmosphere, was charged with diisopropylamine (2.6 mL, 18.47 mmol, 3.5 eq.) in anhydrous THF (30.0 mL), and *n*-BuLi (1.915 M in THF, 9.6 mL, 18.47 mmol, 3.5 eq.) and tributyltin hydride (5.0 mL, 18.47 mmol, 3.5 eq.) were added. In parallel, in flask B, *N*-*tert*-butanesulfinylglycosylamine **5** (2.76 g, 5.28 mmol, 1.0 eq.) was dissolved in anhydrous THF (15.0 mL). The content of the flask B was added dropwise into flask A via syringe. The mixture was stirred for 2 h at  $-78$  °C. The crude compound was purified by silica gel column chromatography ( $\varnothing = 4.0$  cm, L = 40 cm) using DCM:Acetone (40:1) as the eluent to afford compound **29** as a single diastereoisomer in form of a colourless oil (3.30 g, 77%).

$R_f = 0.3$  (DCM:Acetone 20:1)  $[\alpha]_D^{20} = +2.5$  ( $CHCl_3$ ,  $c = 1.05$  g/100 mL)

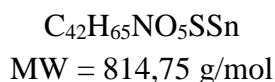
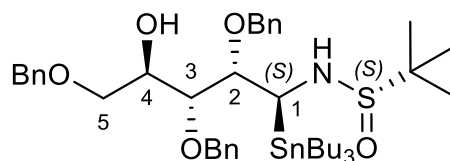
**IR (neat):**  $\nu = 3398, 3088, 3066, 3030, 2955, 2922, 2869, 1454, 1042, 732, 696$   $cm^{-1}$

**HRMS (ESI):**  $m/z$  calc. for  $C_{42}H_{65}NNaO_5SSn$   $[M + Na]^+$  838.349761, found 838.350255

**$^1H$  NMR (400 MHz,  $CDCl_3$ ):**  $\delta = 0.80 - 0.96$  (m, 15H,  $CH_3 + CH_2$ ), 1.12 (s, 9H,  $CH_3$ ), 1.18 – 1.54 (m, 12H,  $CH_2$ ), 2.88 (d,  $J = 5.2$  Hz, 1H, OH), 3.51 (dd,  $J = 5.8, 7.8$  Hz, 1H, H-3), 3.64 – 3.73 (m, 4H, H-1, H-5a, H-5b, NH), 3.91 – 3.96 (m, 1H, H-4), 4.18 – 4.36 (m, 1H, H-2), 4.53 (d,  $J = 11.8$  Hz, 1H,  $OCH_2Ph$ ), 4.60 (d,  $J = 11.8$  Hz, 1H,  $OCH_2Ph$ ), 4.65 (d,  $J = 11.1$  Hz, 1H,  $OCH_2Ph$ ), 4.71 (d,  $J = 11.4$  Hz, 1H,  $OCH_2Ph$ ), 4.77 (d,  $J = 11.1$  Hz, 1H,  $OCH_2Ph$ ), 4.84 (d,  $J = 11.4$  Hz, 1H,  $OCH_2Ph$ ), 7.22 – 7.36 (m, 15H,  $H_{Ar}$ )

**$^{13}C$  NMR (101 MHz,  $CDCl_3$ ):**  $\delta = 10.72$  ( $SnCH_2CH_2CH_2CH_3$ , satellites: 9.12, 9.19, 12.24, 12.31), 13.78 ( $SnCH_2CH_2CH_2CH_3$ ), 22.74 ( $CH_3$  *t*-Bu), 27.63 ( $SnCH_2CH_2CH_2CH_3$ , satellites: 27.32, 27.34, 27.92, 27.93), 29.28 ( $SnCH_2CH_2CH_2CH_3$ , satellites: 29.18, 29.38), 52.75 (C-1, satellites: 51.07, 51.15, 54.35, 54.42), 55.95 ( $C^{IV}$  *t*-Bu), 71.09 (C-5), 71.73 (C-4), 73.56 ( $OCH_2Ph$ ), 74.49 ( $OCH_2Ph$ ), 74.87 ( $OCH_2Ph$ ), 82.70 (C-3), 86.55 (C-2), 127.56 – 128.54 ( $C_{Ar}$ ), 138.17 ( $C^{IV}$   $_{Ar}$ ), 138.56 ( $C^{IV}$   $_{Ar}$ ), 139.02 ( $C^{IV}$   $_{Ar}$ )

(1*S*)-2,3,5-Tri-*O*-benzyl-1-(*S*<sub>S</sub>)-*N*-*tert*-butanesulfinylamino-1-deoxy-1-tributylstannyl-D-arabinitol **30**



According to the general procedure E, flask A, under argon atmosphere, was charged with diisopropylamine (2.7 mL, 19.27 mmol, 3.5 eq.) in anhydrous THF (30.0 mL), and *n*-BuLi (1.915 M in THF, 10.1 mL, 19.27 mmol, 3.5 eq.) and tributyltin hydride (5.2 mL, 19.27 mmol, 3.5 eq.) were added. In parallel, in flask B, *N*-*tert*-butanesulfinylglycosylamine **6** (2.88 g, 5.50 mmol, 1.0 eq.) was dissolved in anhydrous THF (15.0 mL). The content of the flask B was added dropwise into flask A via syringe. The mixture was stirred for 2 h at  $-78\text{ }^{\circ}\text{C}$ . The crude compound was purified by silica gel column chromatography ( $\varnothing = 4.0\text{ cm}$ ,  $L = 40\text{ cm}$ ) using DCM:Acetone (40:1 to 10:1) as the eluent to afford compound **30** as a single diastereoisomer in form of a colourless oil (3.93 g, 87%).

$R_f = 0.1$  (DCM:Acetone 40:1)  $[\alpha]_D^{20} = -19.0$  (CHCl<sub>3</sub>,  $c = 1.06\text{ g}/100\text{ mL}$ )

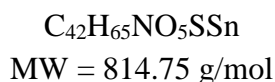
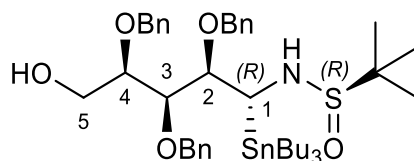
**IR (neat):**  $\nu = 3333, 3088, 3063, 3030, 2953, 2921, 2869, 1454, 1059, 1027, 731, 695\text{ cm}^{-1}$

**HRMS (ESI):**  $m/z$  calc. for C<sub>42</sub>H<sub>65</sub>NNaO<sub>5</sub>SSn  $[M + Na]^+$  838.349761, found 838.349962

**<sup>1</sup>H NMR (250 MHz, CDCl<sub>3</sub>):**  $\delta = 0.66 - 0.95$  (m, 15H, CH<sub>3</sub> + CH<sub>2</sub>), 1.12 – 1.50 (m, 21H, CH<sub>2</sub> + CH<sub>3</sub>), 3.49 (d,  $J = 5.7\text{ Hz}$ , 1H, OH), 3.59 – 3.78 (m, 3H, H-1, H-5a, H-5b), 3.89 – 4.07 (m, 1H, H-2, H-3, NH), 4.18 – 4.27 (m, 1H, H-4), 4.48 – 4.58 (m, 3H, OCH<sub>2</sub>Ph), 4.62 (d,  $J = 11.1\text{ Hz}$ , 1H, OCH<sub>2</sub>Ph), 4.75 (d,  $J = 11.1\text{ Hz}$ , 1H, OCH<sub>2</sub>Ph), 4.77 (d,  $J = 11.1\text{ Hz}$ , 1H, OCH<sub>2</sub>Ph), 7.19 – 7.40 (m, 15H, H<sub>Ar</sub>)

**<sup>13</sup>C NMR (101 MHz, CDCl<sub>3</sub>):**  $\delta = 10.67$  (SnCH<sub>2</sub>CH<sub>2</sub>CH<sub>2</sub>CH<sub>3</sub>, satellites: 9.08, 9.15, 12.19, 12.26), 13.77 (SnCH<sub>2</sub>CH<sub>2</sub>CH<sub>2</sub>CH<sub>3</sub>), 22.95 (CH<sub>3</sub> *t*-Bu), 27.61 (SnCH<sub>2</sub>CH<sub>2</sub>CH<sub>2</sub>CH<sub>3</sub>, satellites: 27.31, 27.32, 27.90, 27.91), 29.25 (SnCH<sub>2</sub>CH<sub>2</sub>CH<sub>2</sub>CH<sub>3</sub>, satellites: 29.16, 29.35), 50.21 (C-1, satellites: 48.46, 48.53, 51.89, 51.97), 56.25 (C<sup>IV</sup><sub>*t*-Bu</sub>), 71.30 (C-4), 71.42 (C-5), 73.57 (OCH<sub>2</sub>Ph), 73.82 (OCH<sub>2</sub>Ph), 73.98 (OCH<sub>2</sub>Ph), 81.66 (C-2 or C-3), 83.73 (C-2 or C-3), 127.67 – 128.50 (C<sub>Ar</sub>), 138.31 (C<sup>IV</sup><sub>Ar</sub>), 138.41 (C<sup>IV</sup><sub>Ar</sub>)

(1*R*)-2,3,4-Tri-*O*-benzyl-1-(*S<sub>R</sub>*)-*N*-*tert*-butanesulfinylamino-1-deoxy-1-tributylstannyl-D-xylitol **31**



According to the general procedure E, flask A under argon atmosphere was charged with diisopropylamine (1.7 mL, 11.98 mmol, 3.5 eq.) in anhydrous THF (20.0 mL), and then *n*-BuLi (2.18 M in THF, 5.5 mL, 11.98 mmol, 3.5 eq.) and tributyltin hydride (3.2 mL, 11.98 mmol, 3.5 eq.) were added. In parallel, in flask B, *N*-*tert*-butanesulfinylglycosylamine **12** (1.80 g, 3.42 mmol, 1.0 eq.) was dissolved in anhydrous THF (10.0 mL). The content of the flask B was added dropwise into flask A via syringe. The mixture was stirred for 150 min at  $-78$  °C. The crude compound was purified by silica gel column chromatography ( $\varnothing = 4.0$  cm,  $L = 25$  cm) using PE:EtOAc (8:2) as the eluent to afford compound **31** as a single diastereoisomer in form of a colourless oil (1.99 g, 71%).

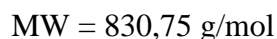
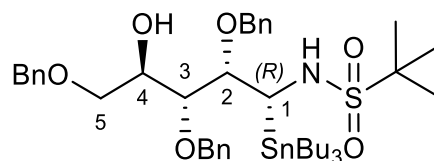
$R_f = 0.36$  (DCM:Acetone 40:1)

**IR (neat):**  $\nu = 3408, 3085, 3059, 3028, 2961, 2920, 2866, 1451, 1055, 1024, 726, 691$   $cm^{-1}$

**$^1H$  NMR (400 MHz,  $CDCl_3$ ):**  $\delta = 0.71 - 0.92$  (m, 15H,  $CH_2 + CH_3$ ),  $1.15 - 1.46$  (m, 21H,  $CH_2 + CH_3$ ),  $3.09 - 3.28$  (m, 1H, H-1),  $3.45$  (s, 1H, OH),  $3.73$  (d,  $J = 10.4$  Hz, 1H, NH),  $3.84 - 3.99$  (m, 4H, H-2, H-4, H-5a, H-5b),  $4.32$  (bd,  $J = 8.0$  Hz, 1H, H-3),  $4.53 - 4.59$  (m, 2H,  $OCH_2Ph$ ),  $4.70 - 4.74$  (m, 2H,  $OCH_2Ph$ ),  $4.79$  (d,  $J = 11.0$  Hz, 1H,  $OCH_2Ph$ ),  $5.03$  (d,  $J = 11.6$  Hz, 1H,  $OCH_2Ph$ ),  $7.19 - 7.41$  (m, 15H,  $H_{Ar}$ )

**$^{13}C$  NMR (101 MHz,  $CDCl_3$ ):**  $\delta = 10.29$  ( $SnCH_2CH_2CH_2CH_3$ , satellites: 8.71, 8.79, 11.79, 11.86),  $13.74$  ( $SnCH_2CH_2CH_2CH_3$ ),  $23.04$  ( $CH_3$  *t*-Bu),  $27.65$  ( $SnCH_2CH_2CH_2CH_3$ , satellites: 27.35, 27.36, 27.94, 27.95),  $29.35$  ( $SnCH_2CH_2CH_2CH_3$ , satellites: 29.25, 29.45),  $50.65$  (C-1),  $56.52$  ( $C^{IV}_{t-Bu}$ ),  $60.61$  (C-5),  $71.70$  ( $OCH_2Ph$ ),  $74.28$  ( $OCH_2Ph$ ),  $75.53$  ( $OCH_2Ph$ ),  $77.67$  (C-4),  $81.05$  (C-3),  $81.84$  (C-2),  $127.08 - 128.63$  ( $C_{Ar}$ ),  $138.21$  ( $C^{IV}_{Ar}$ ),  $138.43$  ( $C^{IV}_{Ar}$ ),  $138.94$  ( $C^{IV}_{Ar}$ )

(1*R*)-2,3,5-Tri-*O*-benzyl-1-*N*-*tert*-butanesulfonylamino-1-deoxy-1-tributylstannyl-D-arabinitol **32**



According to the general procedure F, the reaction was performed with 1-stannylated sulfinyl compound **29** (2.71 g, 3.34 mmol, 1.0 eq.), *meta*-chloroperoxybenzoic acid (1.50 g, 6.65 mmol, 2.0 eq.) and anhydrous DCM (50.0 mL). The mixture was stirred for 30 min at 0 °C. The crude compound was purified by silica gel column chromatography ( $\varnothing = 3.0$  cm, L = 20 cm) using PE:EtOAc (10:1) as the eluent to afford compound **32** in form of a colourless oil (2.45 g, 89%).

$R_f = 0.24$  (PE:EtOAc 9:1)

$[\alpha]_D^{20} = 9.7$  ( $\text{CHCl}_3$ ,  $c = 1.30$  g/100 mL)

**IR (neat):**  $\nu = 3493, 3294, 3088, 3069, 3034, 2955, 2926, 2866, 1457, 1321, 1128, 1087, 1071, 1023, 868, 735, 697 \text{ cm}^{-1}$

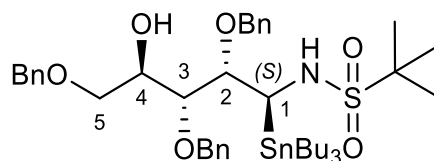
**HRMS (ESI):**  $m/z$  calc. for  $\text{C}_{42}\text{H}_{65}\text{NNaO}_6\text{SSn}$   $[\text{M} + \text{Na}]^+$  854.344675, found 854.344667

**$^1\text{H}$  NMR (400 MHz,  $\text{CDCl}_3$ ):**  $\delta = 0.78 - 1.02$  (m, 15H,  $\text{CH}_3 + \text{CH}_2$ ), 1.20 – 1.58 (m, 21H,  $\text{CH}_3 + \text{CH}_2$ ), 2.95 (d,  $J = 5.0$  Hz, 1H, OH), 3.73 (dd,  $J = 5.6$  Hz, 7.8 Hz, 1H, H-3), 3.70 – 3.81 (m, 3H, H-1, H-5a, H-5b), 3.97 – 4.5 (m, 1H, H-4), 4.10 – 4.20 (m, 2H, H-2, NH), 4.52 (d,  $J = 11.9$  Hz, 1H,  $\text{OCH}_2\text{Ph}$ ), 4.57 (d,  $J = 11.9$  Hz, 1H,  $\text{OCH}_2\text{Ph}$ ), 4.68 – 4.74 (m, 3H,  $\text{OCH}_2\text{Ph}$ ), 4.87 (d,  $J = 11.3$  Hz, 1H,  $\text{OCH}_2\text{Ph}$ ), 7.18 – 7.43 (m, 15H,  $\text{H}_{\text{Ar}}$ )

**$^{13}\text{C}$  NMR (101 MHz,  $\text{CDCl}_3$ ):**  $\delta = 10.67$  ( $\text{SnCH}_2\text{CH}_2\text{CH}_2\text{CH}_3$ , satellites: 9.06, 9.13, 12.20, 12.27), 13.62 ( $\text{CH}_3$ ), 24.14 ( $\text{CH}_3$ ), 27.47 ( $\text{SnCH}_2\text{CH}_2\text{CH}_2\text{CH}_3$ , satellites: 27.16, 27.17, 27.77, 27.78), 29.07 ( $\text{SnCH}_2\text{CH}_2\text{CH}_2\text{CH}_3$ , satellites: 28.98, 29.16), 49.89 (C-1, satellites: 48.35, 48.41, 51.37, 51.43), 59.81 ( $\text{C}^{\text{IV}}_{t\text{-Bu}}$ ), 70.90 (C-5), 71.47 (C-4), 73.39 ( $\text{OCH}_2\text{Ph}$ ), 74.64 ( $\text{OCH}_2\text{Ph}$ ), 75.07 ( $\text{OCH}_2\text{Ph}$ ), 82.64 (C-3), 87.67 (C-2), 127.58 – 128.40 ( $\text{C}_{\text{Ar}}$ ), 138.02 ( $\text{C}^{\text{IV}}_{\text{Ar}}$ ), 138.32 ( $\text{C}^{\text{IV}}_{\text{Ar}}$ ), 138.67 ( $\text{C}^{\text{IV}}_{\text{Ar}}$ )



(1*S*)-2,3,5-Tri-*O*-benzyl-1-*N*-*tert*-butanesulfonylamino-1-deoxy-1-tributylstannyl-D-arabinitol **33**



$C_{42}H_{65}NO_6SSn$   
MW = 830,75 g/mol

According to the general procedure F, the reaction was performed with 1-stannylated sulfinyl compound **30** (2.91 g, 3.57 mmol, 1.0 eq.), *meta*-chloroperoxybenzoic acid (1.50 g, 7.14 mmol, 2.0 eq.) and anhydrous DCM (50.0 mL). The mixture was stirred for 30 min at 0 °C. The crude compound was purified by silica gel column chromatography ( $\varnothing = 3.0$  cm, L = 20 cm) using PE:EtOAc (9:1) as the eluent to afford compound **33** in form of a colourless oil (2.72 g, 92%).

$R_f = 0.31$  (PE:EtOAc 9/1)

$[\alpha]_D^{20} = -12.1$  (CHCl<sub>3</sub>,  $c = 1.03$  g/100 mL)

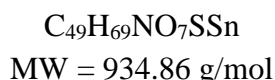
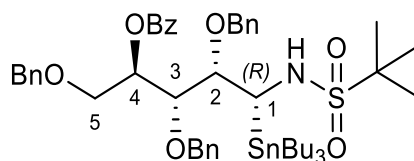
**IR (neat):**  $\nu = 3483, 3363, 3300, 3087, 3066, 3028, 2955, 2917, 2869, 2847, 1454, 1312, 1125, 1084, 1055, 1023, 735, 694$  cm<sup>-1</sup>

**HRMS (ESI):**  $m/z$  calc. for  $C_{42}H_{65}NNaO_6SSn$   $[M + Na]^+$  854.344675, found 854.344925

**<sup>1</sup>H NMR (400 MHz, CDCl<sub>3</sub>):**  $\delta = 0.76 - 0.97$  (m, 15H, CH<sub>3</sub> + CH<sub>2</sub>), 1.21 – 1.50 (m, 21H, CH<sub>3</sub> + CH<sub>2</sub>), 3.17 (d,  $J = 6.1$  Hz, 1H, OH), 3.63 (dd,  $J = 6.4$  Hz, 9.5 Hz, 1H, H-5a), 3.67 – 3.80 (m, 2H, H-1, H-5b), 3.84 (t,  $J = 6.1$  Hz, 1H, H-3), 4.17 – 4.24 (m, 1H, H-4), 4.26 – 4.41 (m, 1H, H-2), 4.55 (s, 2H, OCH<sub>2</sub>Ph), 4.59 – 4.65 (m, 3H, OCH<sub>2</sub>Ph, NH), 4.68 (s, 2H, OCH<sub>2</sub>Ph), 7.24 – 7.41 (m, 15H, H<sub>Ar</sub>)

**<sup>13</sup>C NMR (101 MHz, CDCl<sub>3</sub>):**  $\delta = 11.08$  (SnCH<sub>2</sub>CH<sub>2</sub>CH<sub>2</sub>CH<sub>3</sub>, satellites: 9.47, 9.54, 12.62, 12.69), 13.74 (CH<sub>3</sub>), 24.39 (CH<sub>3</sub>), 27.63 (SnCH<sub>2</sub>CH<sub>2</sub>CH<sub>2</sub>CH<sub>3</sub>, satellites: 27.32, 27.33, 27.94, 27.95), 29.17 (SnCH<sub>2</sub>CH<sub>2</sub>CH<sub>2</sub>CH<sub>3</sub>, satellites: 29.08, 29.27), 46.03 (C-1, satellites: 44.35, 44.43, 47.63, 47.70), 59.79 (C<sup>IV</sup><sub>*t*-Bu</sub>), 70.80 (C-4), 71.45 (C-5), 73.54 (OCH<sub>2</sub>Ph), 73.70 (OCH<sub>2</sub>Ph), 73.81 (OCH<sub>2</sub>Ph), 80.06 (C-3), 84.92 (C-2), 127.81 – 128.60 (C<sub>Ar</sub>), 137.95 (C<sup>IV</sup><sub>Ar</sub>), 138.00 (C<sup>IV</sup><sub>Ar</sub>), 138.12 (C<sup>IV</sup><sub>Ar</sub>)

(1*R*)-4-*O*-Benzoyl-2,3,5-tri-*O*-benzyl-1-*N*-*tert*-butanesulfonylamino-1-deoxy-1-tributylstannyl-*D*-arabinitol **34**



The 1-stannylated aminoalditol **32** (5.57 g, 8.71 mmol, 1.0 eq.) was dissolved in anhydrous DCM (100.0 mL) under argon atmosphere, and pyridine (20.0 mL) was added. After 10 min, benzoyl chloride (2.0 mL, 16.77 mmol, 2.5 eq.) was added. The mixture was stirred for 12 h at room temperature. The reaction was quenched with a saturated aqueous solution of  $Na_2CO_3$  (50 mL) and was diluted with DCM (50 mL). The phases were separated; the organic phase was washed twice with a saturated aqueous solution of  $Na_2CO_3$  ( $2 \times 50$  mL) and then dried over  $MgSO_4$ , filtered through a cotton plug and concentrated under reduced pressure. The crude compound was purified by silica gel column chromatography ( $\varnothing = 4.0$  cm,  $L = 25$  cm) using PE:Et<sub>2</sub>O (9:1) as the eluent to afford compound **34** as a colourless oil (5.39 g, 86%).

$R_f = 0.63$  (PE:AcOEt 9:1)       $[\alpha]_D^{20} = 48.1$  ( $CHCl_3$ ,  $c = 1.03$  g/100 mL)

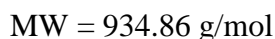
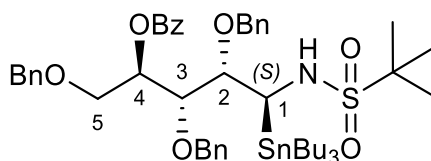
**IR (neat):**  $\nu = 3277, 3088, 3063, 3031, 2954, 2923, 2870, 2854, 1713, 1453, 1316, 1270, 1124, 1093, 1068, 1046, 1026, 874, 734, 710, 696$   $cm^{-1}$

**HRMS (ESI):**  $m/z$  calc.      for  $C_{49}H_{73}N_2O_7SSn$  [ $M + NH_4$ ]<sup>+</sup> 953.415495, found 953.415140  
for  $C_{49}H_{69}NNaO_7SSn$  [ $M + Na$ ]<sup>+</sup> 958.370890, found 958.370720

**<sup>1</sup>H NMR (400 MHz, CDCl<sub>3</sub>):**  $\delta = 0.77 - 0.85$  (m, 9H, CH<sub>3</sub>), 0.87 – 1.03 (m, 6H, CH<sub>2</sub>), 1.18 – 1.28 (m, 6H, CH<sub>2</sub>), 1.31 – 1.51 (m, 15H, CH<sub>2</sub> + CH<sub>3</sub>), 3.86 (dd,  $J = 2.0, 9.0$  Hz, 1H, H-3), 3.71 – 3.86 (m, 1H, H-1), 4.01 – 4.11 (m, 3H, H-5a, H-5b, NH), 4.12 – 4.30 (m, 1H, H-2), 4.56 (d,  $J = 12.2$  Hz, 1H, OCH<sub>2</sub>Ph), 4.59 – 4.70 (m, 3H, OCH<sub>2</sub>Ph), 4.77 (d,  $J = 11.1$  Hz, 1H, OCH<sub>2</sub>Ph), 4.88 (d,  $J = 11.1$  Hz, 1H, OCH<sub>2</sub>Ph), 5.55 – 5.58 (m, 1H, H-4), 7.21 – 7.37 (m, 15H, H<sub>Ar</sub>), 7.41 – (m, 2H, H<sub>Ph</sub>), 7.56 (t,  $J = 7.4$  Hz, 1H, H<sub>Ph</sub>), 8.03 (d,  $J = 7.1$  Hz, 2H, H<sub>Ph</sub>)

**<sup>13</sup>C NMR (101 MHz, CDCl<sub>3</sub>):**  $\delta = 10.80$  (SnCH<sub>2</sub>CH<sub>2</sub>CH<sub>2</sub>CH<sub>3</sub>, satellites: 9.18, 9.25, 12.34, 12.41), 13.71 (CH<sub>3</sub>), 24.35 (CH<sub>3</sub>), 27.61 (SnCH<sub>2</sub>CH<sub>2</sub>CH<sub>2</sub>CH<sub>3</sub>, satellites: 27.29, 27.30, 27.91, 27.92), 29.17 (SnCH<sub>2</sub>CH<sub>2</sub>CH<sub>2</sub>CH<sub>3</sub>, satellites: 29.08, 29.26), 50.69 (C-1), 60.10 (C<sup>IV</sup><sub>t-Bu</sub>), 68.16 (C-5), 73.03 (OCH<sub>2</sub>Ph), 74.90 (C-4), 75.27 (OCH<sub>2</sub>Ph), 75.61 (OCH<sub>2</sub>Ph), 83.31 (C-3), 86.61 (C-2), 127.53 – 128.48 (C<sub>Ar</sub>), 129.91 (C<sub>Ar</sub>), 130.39 (C<sup>IV</sup><sub>Ar</sub>), 133.10 (C<sub>Ph</sub>), 138.36 (C<sup>IV</sup><sub>Ar</sub>), 138.61 (C<sup>IV</sup><sub>Ar</sub>), 138.81 (C<sup>IV</sup><sub>Ar</sub>), 166.03 (C<sup>IV</sup>=O)

(1*S*)-4-*O*-Benzoyl-2,3,5-tri-*O*-benzyl-1-*N*-*tert*-butanesulfonylamino-1-deoxy-1-tributylstannyl-D-arabinitol **35**



The 1-stannylated aminoalditol **33** (3.00 g, 3.61 mmol, 1.0 eq.) was dissolved in anhydrous DCM (50.0 mL) under argon atmosphere, and pyridine (10.0 mL) was added. After 10 min, benzoyl chloride (1.0 mL, 9.03 mmol, 2.5 eq.) was added. The mixture was stirred for 12 h at room temperature. The reaction was quenched with a saturated aqueous solution of  $\text{Na}_2\text{CO}_3$  (20.0 mL) and it was diluted with DCM (30.0 mL). The phases were separated; the organic phase was washed twice with a saturated aqueous solution of  $\text{Na}_2\text{CO}_3$  ( $2 \times 30.0$  mL) and then dried over  $\text{MgSO}_4$ . It was filtered through a cotton plug and concentrated under reduced pressure. The crude compound was purified by silica gel column chromatography ( $\varnothing = 4.0$  cm,  $L = 20$  cm) using PE:Et<sub>2</sub>O (9:1 to 8:2) as the eluent to afford compound **35** as a colorless oil (3.37 g, 100%).

**R<sub>f</sub>** = 0.36 (PE:Et<sub>2</sub>O 8:2)

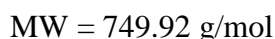
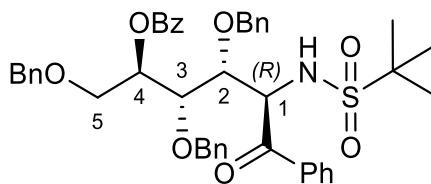
**IR (neat):**  $\nu = 3088, 3059, 3028, 2955, 2923, 2870, 2851, 1717, 1454, 1312, 1271, 1125, 1093, 1065, 1024, 869, 736, 710, 698 \text{ cm}^{-1}$

**HRMS (ESI):**  $m/z$  calc. for  $\text{C}_{49}\text{H}_{73}\text{N}_2\text{O}_7\text{SSn} [\text{M} + \text{NH}_4]^+$  953.415495, found 953.415186  
for  $\text{C}_{49}\text{H}_{69}\text{NNaO}_7\text{SSn} [\text{M} + \text{Na}]^+$  958.370890, found 958.370720

**<sup>1</sup>H NMR (400 MHz, CDCl<sub>3</sub>):**  $\delta = 0.61 - 0.85$  (m, 15H, CH<sub>2</sub> + CH<sub>3</sub>), 1.11 – 1.39 (m, 15H, CH<sub>2</sub> + CH<sub>3</sub>), 3.59 – 3.78 (m, 1H, H-1), 3.92 (dd,  $J = 7.0, 10.9$  Hz, 1H, H-5a), 4.03 – 4.15 (m, 2H, H-5b, NH), 4.16 – 4.38 (m, 2H, H-2, H-3), 4.45 (d,  $J = 12.1$  Hz, 1H, OCH<sub>2</sub>Ph), 4.53 (d,  $J = 10.9$  Hz, 1H, OCH<sub>2</sub>Ph), 4.56 – 4.62 (m, 2H, OCH<sub>2</sub>Ph), 4.70 (d,  $J = 10.9$  Hz, 1H, OCH<sub>2</sub>Ph), 4.88 (d,  $J = 11.2$  Hz, 1H, OCH<sub>2</sub>Ph), 5.67 – 5.70 (m, 1H, H-4), 7.19 – 7.33 (m, 15H, H<sub>Ar</sub>), 7.42 (t,  $J = 7.7$  Hz, 2H, H<sub>Ph</sub>), 7.56 (t,  $J = 7.4$  Hz, 1H, H<sub>Ph</sub>), 8.04 (d,  $J = 7.5$  Hz, 2H, H<sub>Ph</sub>)

**<sup>13</sup>C NMR (101 MHz, CDCl<sub>3</sub>):**  $\delta = 10.89$  (SnCH<sub>2</sub>CH<sub>2</sub>CH<sub>2</sub>CH<sub>3</sub>, satellites: 9.28, 9.35, 12.43, 12.50), 13.72 (CH<sub>3</sub>), 24.45 (CH<sub>3</sub>), 27.61 (SnCH<sub>2</sub>CH<sub>2</sub>CH<sub>2</sub>CH<sub>3</sub>, satellites: 27.29, 27.30, 27.91, 27.93), 29.12 (SnCH<sub>2</sub>CH<sub>2</sub>CH<sub>2</sub>CH<sub>3</sub>, satellites: 29.02, 29.21), 46.93 (C-1), 59.96 (C<sup>IV</sup><sub>t-Bu</sub>), 68.93 (C-5), 73.17 (OCH<sub>2</sub>Ph), 74.63 (OCH<sub>2</sub>Ph), 74.66 (OCH<sub>2</sub>Ph), 75.06 (C-4), 80.36 (C-2 or C-3), 82.07 (C-2 or C-3), 127.64 – 128.70 (C<sub>Ar</sub>), 129.99 (C<sub>Ar</sub>), 130.27 (C<sup>IV</sup><sub>Ph</sub>), 133.17 (C<sub>Ar</sub>), 137.91 (C<sup>IV</sup><sub>Ar</sub>), 137.99 (C<sup>IV</sup><sub>Ar</sub>), 138.27 (C<sup>IV</sup><sub>Ar</sub>), 166.10 (C<sup>IV</sup>=O)

(1*R*)-1-Benzoyl-4-*O*-benzoyl-2,3,5-tri-*O*-benzyl-1-*N*-*tert*-butanesulfonylamino-1-deoxy-D-arabinitol **36**



According to the general procedure G, an oven-dired Biotage® microwave reaction vial (size 2 – 5 mL) was charged with benzoylated stannane **34** (20 mg, 21.4  $\mu\text{mol}$ , 1.0 eq.), benzoyl chloride (3.7  $\mu\text{L}$ , 32.1  $\mu\text{mol}$ , 1.5 eq.),  $\text{Pd}_2(\text{dba})_3$  (1.0 mg, 1.1  $\mu\text{mol}$ , 5% mol), JackiePhos (3.4 mg, 4.28  $\mu\text{mol}$ , 20% mol),  $\text{CuCl}$  (2.0 mg, 21.4  $\mu\text{mol}$ , 1.0 eq.), 4 Å molecular sieves (50 mg) and 1,4-dioxane (1.0 mL). The mixture was stirred for 6 h at 110 °C. The crude compound was purified by preparative TLC followed by silica gel column chromatography ( $\emptyset = 1.0 \text{ cm}$ ,  $L = 15 \text{ cm}$ ) using PE:EtOAc (8:2) as the eluent to afford compound **36** as a single diastereoisomer in form of a colourless oil (7.2 mg, 44%).

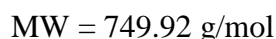
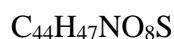
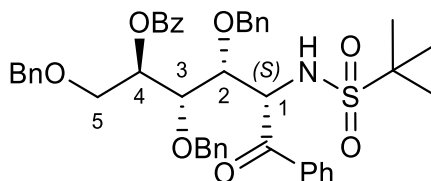
$R_f = 0.4$  (PE:EtOAc 8:2)

**HRMS (ESI):**  $m/z$  calc. for  $\text{C}_{44}\text{H}_{47}\text{NNaO}_8\text{S}$   $[\text{M} + \text{Na}]^+$  772.2920, found 772.2916

**$^1\text{H}$  NMR (400 MHz,  $\text{CDCl}_3$ ):**  $\delta = 1.27$  (s, 9H,  $\text{CH}_3$ ), 3.85 (dd,  $J = 4.8, 11.3 \text{ Hz}$ , 1H, H-5a), 3.91 – 4.00 (m, 2H, H-2, H-5b), 4.09 (dd,  $J = 2.5, 6.3 \text{ Hz}$ , 1H, H-3), 4.35 – 4.61 (m, 4H,  $\text{OCH}_2\text{Ph}$ ), 4.72 – 4.82 (m, 2H,  $\text{OCH}_2\text{Ph}$ ), 5.37 – 5.45 (m, 1H, H-4), 5.63 – 5.73 (m, 2H, H-1, NH), 6.94 – 7.06 (m, 2H,  $\text{H}_{\text{Ar}}$ ), 7.06 – 7.16 (m, 3H,  $\text{H}_{\text{Ar}}$ ), 7.17 – 7.43 (m, 15H,  $\text{H}_{\text{Ar}}$ ), 7.52 – 7.62 (m, 2H,  $\text{H}_{\text{Ar}}$ ), 8.80 – 7.85 (m, 2H,  $\text{H}_{\text{Ar}}$ )

**$^{13}\text{C}$  NMR (101 MHz,  $\text{CDCl}_3$ ):**  $\delta = 24.15$  ( $\text{CH}_3$   $t\text{-Bu}$ ), 58.56 (C-1), 60.00 ( $\text{C}^{\text{IV}}_{t\text{-Bu}}$ ), 67.96 (C-5), 73.01 ( $\text{OCH}_2\text{Ph}$ ), 73.07 ( $\text{OCH}_2\text{Ph}$ ), 73.18 (C-4), 74.54 ( $\text{OCH}_2\text{Ph}$ ), 78.34 (C-3), 78.39 (C-2), 127.57 – 128.83 ( $\text{C}_{\text{Ar}}$ ), 129.71 ( $\text{C}_{\text{Ar}}$ ), 133.10 ( $\text{C}_{\text{Ar}}$ ), 133.87 ( $\text{C}_{\text{Ar}}$ ), 135.68 ( $\text{C}^{\text{IV}}_{\text{Ar}}$ ), 136.40 ( $\text{C}^{\text{IV}}_{\text{Ar}}$ ), 137.78 ( $\text{C}^{\text{IV}}_{\text{Ar}}$ ), 137.87 ( $\text{C}^{\text{IV}}_{\text{Ar}}$ ), 165.53 ( $\text{C}^{\text{IV}}=\text{O}$ ), 198.83 ( $\text{C}^{\text{IV}}=\text{O}$ )

(1*S*)-1-Benzoyl-4-*O*-benzoyl-2,3,5-tri-*O*-benzyl-1-*N*-*tert*-butanesulfonylamino-1-deoxy-D-arabinitol **37**



According to the general procedure G, an oven-dried Biotage® microwave reaction vial (size 10 – 20 mL) was charged with benzoylated stannane **35** (750 mg, 0.802 mmol, 1.0 eq.), benzoyl chloride (140  $\mu\text{L}$ , 1.203 mmol, 1.5 eq.),  $\text{Pd}_2(\text{dba})_3$  (37 mg, 0.0401 mmol, 5% mol), JackiePhos (64 mg, 0.0802 mmol, 10% mol),  $\text{CuCl}$  (80 mg, 0.802 mmol, 1.0 eq.), 4 Å molecular sieves (1.6 g) and 1,4-dioxane (20.0 mL). The mixture was stirred for 6 h at 110 °C. The crude compound was purified by silica gel column chromatography ( $\varnothing = 3.0 \text{ cm}$ ,  $L = 25 \text{ cm}$ ) using PE:EtOAc (8:2) as the eluent to afford compound **36** as a single diastereoisomer in form of a colourless oil (288 mg, 48%).

$R_f = 0.4$  (PE:EtOAc 8:2)

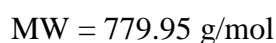
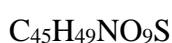
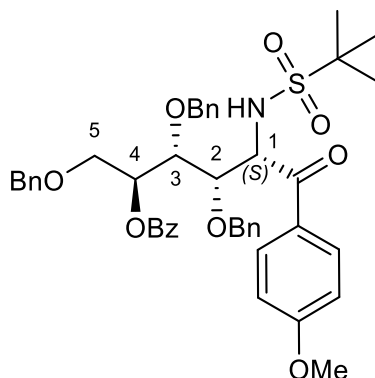
$[\alpha]_D^{20} = 4.5$  ( $\text{CHCl}_3$ ,  $c = 1.01 \text{ g/100 mL}$ )

**IR (neat):**  $\nu = 3088, 3062, 3031, 2955, 2923, 2870, 1717, 1689, 1603, 1581, 1451, 1321, 1290, 1268, 1128, 1100, 1071, 1027, 929, 729, 704 \text{ cm}^{-1}$

**$^1\text{H NMR}$  (400 MHz,  $(\text{CD}_3)_2\text{CO}$ ):**  $\delta = 1.34$  (s, 3H, NMe), 3.84 (dd,  $J = 4.8, 10.3 \text{ Hz}$ , 1H, H-5a), 4.00 (dd,  $J = 4.7, 10.3 \text{ Hz}$ , 1H, H-5b), 4.27 (dd,  $J = 3.0, 6.7 \text{ Hz}$ , 1H, H-2), 4.31 (d,  $J = 10.8 \text{ Hz}$ , 1H,  $\text{OCH}_2\text{Ph}$ ), 4.38 – 4.44 (m, 1H, H-3), 4.57 (s, 2H,  $\text{OCH}_2\text{Ph}$ ), 4.66 (d,  $J = 10.8 \text{ Hz}$ , 1H,  $\text{OCH}_2\text{Ph}$ ), 4.76 (s, 2H,  $\text{OCH}_2\text{Ph}$ ), 5.39 – 5.56 (m, 1H, H-1), 5.61 (dd,  $J = 4.8, 9.7 \text{ Hz}$ , 1H, H-4), 6.36 (d,  $J = 9.6 \text{ Hz}$ , NH), 7.13 – 7.37 (m, 15H,  $\text{H}_{\text{Ar}}$ ), 7.44 – 7.71 (m, 5H,  $\text{H}_{\text{Ar}}$ ), 7.82 – 7.84 (m, 2H,  $\text{H}_{\text{Ar}}$ ), 8.04 – 8.09 (m, 3H,  $\text{H}_{\text{Ar}}$ )

**$^{13}\text{C NMR}$  (101 MHz,  $(\text{CD}_3)_2\text{CO}$ ):**  $\delta = 24.52$  ( $\text{CH}_3$   $t\text{-Bu}$ ), 60.61 ( $\text{C}^{\text{IV}}_{t\text{-Bu}}$ ), 61.60 (C-1), 68.80 (C-5), 73.64 ( $\text{OCH}_2\text{Ph}$ ), 74.65 (C-4), 75.08 ( $\text{OCH}_2\text{Ph}$ ), 75.65 ( $\text{OCH}_2\text{Ph}$ ), 79.15 (C-3), 81.13 (C-2), 128.22 – 130.52 ( $\text{C}_{\text{Ar}}$ ), 131.16 ( $\text{C}^{\text{IV}}_{\text{Ar}}$ ), 133.75 ( $\text{C}_{\text{Ar}}$ ), 134.19 ( $\text{C}_{\text{Ar}}$ ), 134.25 ( $\text{C}_{\text{Ar}}$ ), 136.41 ( $\text{C}^{\text{IV}}_{\text{Ar}}$ ), 138.67 ( $\text{C}^{\text{IV}}_{\text{Ar}}$ ), 139.13 ( $\text{C}^{\text{IV}}_{\text{Ar}}$ ), 139.47 ( $\text{C}^{\text{IV}}_{\text{Ar}}$ ), 166.01 ( $\text{C}^{\text{IV}}=\text{O}$ ), 197.84 ( $\text{C}^{\text{IV}}=\text{O}$ )

(1*S*)-4-*O*-Benzoyl-2,3,5-tri-*O*-benzyl-1-*N*-*tert*-butanesulfonylamino-1-deoxy-1-*p*-methoxybenzoyl-D-arabinitol **38**



According to the general procedure G, an oven-dired Biotage® Microwave Reaction Vial (size 2 – 5 mL) was charged with benzoylated stannane **35** (100 mg, 0.107 mmol, 1.0 eq.), benzoyl chloride (17  $\mu\text{L}$ , 0.150 mmol, 1.5 eq.),  $\text{Pd}_2(\text{dba})_3$  (10 mg, 10.7  $\mu\text{mol}$ , 10% mol), JackiePhos (17 mg, 21.4  $\mu\text{mol}$ , 20% mol),  $\text{CuCl}$  (11 mg, 0.107 mmol, 1.0 eq.), 4 Å molecular sieves (150 mg) and 1,4-dioxane (2.0 mL). The mixture was stirred for 6 h at 110 °C. The crude compound was purified by silica gel column chromatography ( $\varnothing = 1.5 \text{ cm}$ ,  $L = 25 \text{ cm}$ ) using PE:EtOAc (8:2) as the eluent to afford compound **38** as a single diastereoisomer in form of a yellow oil (41 mg, 50%).

$R_f = 0.2$  (PE:EtOAc 8:2)

$[\alpha]_D^{20} = 13.5$  ( $\text{CHCl}_3$ ,  $c = 1.0 \text{ g}/100 \text{ mL}$ )

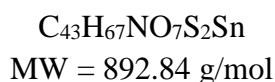
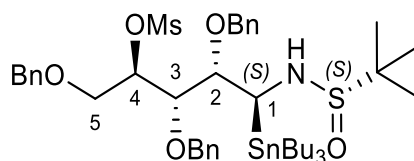
**IR (neat):**  $\nu = 3293, 3062, 3024, 2958, 2926, 2875, 2856, 1723, 1600, 1448, 1258, 691 \text{ cm}^{-1}$

**HRMS (ESI):**  $m/z$  calc. for  $\text{C}_{45}\text{H}_{53}\text{N}_2\text{O}_9\text{S}$   $[\text{M} + \text{NH}_4]^+$  797.346629, found 797.345567  
for  $\text{C}_{45}\text{H}_{49}\text{NNaO}_9\text{S}$   $[\text{M} + \text{Na}]^+$  802.302024, found 802.300839

**$^1\text{H}$  NMR (400 MHz,  $\text{CDCl}_3$ ):**  $\delta = 1.25$  (s, 9H,  $\text{CH}_3$  *t*-Bu), 3.68 (s, 3H, OMe), 3.73 (dd,  $J = 4.8, 10.2 \text{ Hz}$ , 1H, H-5a), 3.95 (dd,  $J = 5.0, 10.2 \text{ Hz}$ , 1H, H-5b), 4.05 – 4.15 (m, 2H, H-2,  $\text{OCH}_2\text{Ph}$ ), 4.28 (dd,  $J = 4.5, 7.4 \text{ Hz}$ , 1H, H-3), 4.46 – 4.56 (m, 3H,  $\text{OCH}_2\text{Ph}$ ), 4.68 (d,  $J = 11.3 \text{ Hz}$ , 1H,  $\text{OCH}_2\text{Ph}$ ), 4.72 (d,  $J = 11.3 \text{ Hz}$ , 1H,  $\text{OCH}_2\text{Ph}$ ), 5.19 (d,  $J = 9.3 \text{ Hz}$ , 1H, H-1), 5.45 (d,  $J = 9.3 \text{ Hz}$ , 1H, NH), 5.58 (q,  $J = 4.6 \text{ Hz}$ , 1H, H-4), 6.52 (d,  $J = 8.6 \text{ Hz}$ , 2H,  $\text{H}_{\text{PhOMe}}$ ), 7.13-7.19 (m, 15H,  $\text{H}_{\text{Ar}}$ ), 7.35 (dd,  $J = 7.5 \text{ Hz}$ , 2H,  $\text{H}_{\text{Ar}}$ ), 7.43 (dd,  $J = 7.4 \text{ Hz}$ , 1H,  $\text{H}_{\text{Ar}}$ ), 7.67 (d,  $J = 8.6 \text{ Hz}$ , 2H,  $\text{H}_{\text{PhOMe}}$ ), 7.98 (d,  $J = 7.65 \text{ Hz}$ , 2H,  $\text{H}_{\text{Ar}}$ )

**$^{13}\text{C}$  NMR (101 MHz,  $\text{CDCl}_3$ ):**  $\delta = 24.40$  ( $\text{CH}_3$ ), 55.59 ( $\text{OCH}_3$ ), 60.60 ( $\text{C}^{\text{IV}}_{t\text{-Bu}}$ ), 60.65 (C-1), 68.20 (C-5), 73.39 ( $\text{OCH}_2\text{Ph}$ ), 73.76 (C-4), 75.16 ( $\text{OCH}_2\text{Ph}$ ), 75.37 ( $\text{OCH}_2\text{Ph}$ ), 79.27 (C-3), 80.24 (C-2), 114.09 ( $\text{C}_{\text{Ar}}$ ), 127.23 ( $\text{C}^{\text{IV}}_{\text{Ar}}$ ), 127.87 – 133.31 ( $\text{C}_{\text{Ar}}$ ), 137.50 ( $\text{C}^{\text{IV}}_{\text{Ar}}$ ), 137.98 ( $\text{C}^{\text{IV}}_{\text{Ar}}$ ), 138.59 ( $\text{C}^{\text{IV}}_{\text{Ar}}$ ), 164.06 ( $\text{C}^{\text{IV}}_{\text{Ar}}$ ), 165.65 ( $\text{C}^{\text{IV}}_{\text{Ar}}$ ), 194.76 ( $\text{C}^{\text{IV}}_{\text{Ar}}$ )

(1*S*)-2,3,5-Tri-*O*-benzyl-1-(*S*<sub>S</sub>)-*N*-*tert*-butanesulfinylamino-1-deoxy-1-tributylstannyl-4-methanesulfonyl-D-arabinitol **50**



The sulfinylated stannane **30** (110.0 mg, 0.135 mmol, 1.0 eq.) was dissolved in anhydrous DCM (2.0 mL) under an argon atmosphere, and then triethylamine (41  $\mu$ L, 0.297 mmol, 2.2 eq.) and activated 4 Å molecular sieves were added. The mixture was cooled down to 0 °C. After 10 min, methanesulfonyl chloride (21  $\mu$ L, 0.27 mmol, 2.0 eq.) was added. The mixture was allowed to warm up to room temperature and overall it was stirred for 1 h. The reaction was quenched with a saturated aqueous solution of NaCl (5.0 mL) and it was diluted with DCM (10.0 mL). The phases were separated; the aqueous phase was extracted twice with DCM (2  $\times$  10.0 mL). The combined organic phases were washed twice with a saturated aqueous solution of NaCl (2  $\times$  20.0 mL) and then they were dried over MgSO<sub>4</sub>, filtered through a cotton plug and concentrated under reduced pressure. The crude compound was purified by silica gel column chromatography ( $\varnothing$  = 1.0 cm, L = 10 cm) using PE:EtOAc (5:2) as the eluent to afford compound **50** as a colourless oil (100 mg, 83%).

$R_f$  = 0.4 (PE:EtOAc 5:2)                       $[\alpha]_D^{20} = 2.8$  (CHCl<sub>3</sub>,  $c = 1.0$  g/100 mL)

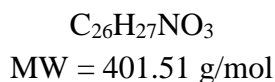
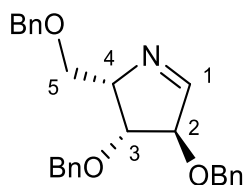
**IR (neat):**  $\nu = 3303, 3059, 3031, 2955, 2923, 2869, 2851, 1492, 1451, 1350, 1173, 1097, 1055, 1030, 957, 907, 736, 691, 593$  cm<sup>-1</sup>

**HRMS (ESI):**  $m/z$  calc.                      for C<sub>43</sub>H<sub>67</sub>NNaO<sub>7</sub>S<sub>2</sub>Sn [M + Na]<sup>+</sup> 916.3279, found 916.3276

**<sup>1</sup>H NMR (400 MHz, CDCl<sub>3</sub>):**  $\delta = 0.78 - 0.94$  (m, 15H, CH<sub>2</sub> + CH<sub>3</sub>), 1.12 – 1.48 (m, 21H, CH<sub>2</sub> + CH<sub>3</sub>), 3.10 (s, 3H, OMs), 3.45 – 3.64 (m, 1H, H-1), 3.79 – 3.87 (m, 2H, H-5a, NH), 3.91 (dd,  $J = 3.4, 7.2$  Hz, 1H, H-2), 3.95 (dd,  $J = 3.5, 11.0$  Hz, 1H, H-5b), 4.40 (dd,  $J = 2.2, 7.2$  Hz, 1H, H-3), 4.48 – 4.58 (m, 3H, OCH<sub>2</sub>Ph), 4.63 (d,  $J = 11.0$  Hz, 1H, OCH<sub>2</sub>Ph), 4.80 (d,  $J = 10.8$  Hz, 1H, OCH<sub>2</sub>Ph), 4.83 (d,  $J = 11.0$  Hz, 1H, OCH<sub>2</sub>Ph), 5.08 – 5.13 (m, 1H, H-4), 7.20 – 7.38 (m, 15H, H<sub>Ar</sub>)

**<sup>13</sup>C NMR (101 MHz, CDCl<sub>3</sub>):**  $\delta = 10.67$  (SnCH<sub>2</sub>CH<sub>2</sub>CH<sub>2</sub>CH<sub>3</sub>, satellites: 9.07, 9.17, 12.20, 12.27), 13.74 (CH<sub>3</sub>), 22.95 (CH<sub>3</sub>), 27.56 (SnCH<sub>2</sub>CH<sub>2</sub>CH<sub>2</sub>CH<sub>3</sub>, satellites: 27.25, 27.27, 27.86, 27.87), 29.19 (SnCH<sub>2</sub>CH<sub>2</sub>CH<sub>2</sub>CH<sub>3</sub>, satellites: 29.09, 29.28), 38.71 (SCH<sub>3</sub>), 50.07 (C-1), 56.52 (C<sup>IV</sup><sub>*t*-Bu</sub>), 68.97 (C-5), 73.53 (OCH<sub>2</sub>Ph), 74.35 (OCH<sub>2</sub>Ph), 75.13 (OCH<sub>2</sub>Ph), 81.73 (C-2), 82.36 (C-3), 83.67 (C-4), 127.48 – 128.58 (C<sub>Ar</sub>), 137.67 (C<sup>IV</sup><sub>Ar</sub>), 137.86 (C<sup>IV</sup><sub>Ar</sub>), 138.41 (C<sup>IV</sup><sub>Ar</sub>)

2,3,5-Tri-*O*-benzyl-1,*N*-dehydro-1,4-dideoxy-1,4-imino-D-arabinitol **52**



The mesylated stannyl intermediate **50** was dissolved in anhydrous THF (1.0 mL) under argon atmosphere, and sodium hydride (30.0 mg, 0.72 mmol, 6.0 eq.) was added. The mixture was stirred for 8 h at 68 °C. The reaction was quenched with MeOH (5.0 mL), diluted with EtOAc (30 mL) and extracted with a saturated aqueous solution of NaCl (20.0 mL). The phases were separated; the organic phase was washed once with a saturated aqueous solution of NaCl (20.0 mL) and then dried over MgSO<sub>4</sub>, filtered through a cotton plug and concentrated under reduced pressure. The crude compound was purified by silica gel column chromatography (Ø = 1.0 cm, L = 10 cm) using PE:EtOAc (8:2) as the eluent to afford compound **57** as a colourless oil (58.6 mg, 60%).

**R<sub>f</sub>** = 0.45 (DCM:Acetone 40:1)                       $[\alpha]_D^{20} = -52.0$  (CHCl<sub>3</sub>, *c* = 1.0 g/100 mL)

**IR** (neat):  $\nu = 3088, 3060, 3032, 2927, 2864, 1727, 1610, 1582, 1492, 1452, 1363, 1200, 1095, 1072, 1027, 910, 729, 694, 598$  cm<sup>-1</sup>

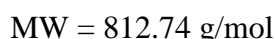
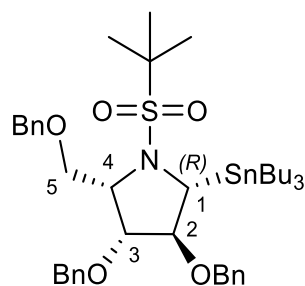
**HRMS** (ESI): *m/z* calc.            for C<sub>26</sub>H<sub>28</sub>NO<sub>3</sub> [M + H]<sup>+</sup> 402.2069, found 402.2059

**<sup>1</sup>H NMR** (400 MHz, CDCl<sub>3</sub>):  $\delta = 3.75$  (dd, *J* = 1.8, 4.6 Hz, 2H, H-5a), 3.79 (dd, *J* = 1.8, 4.6 Hz, 2H, H-5b), 4.18 (dd, *J* = 4.4, 6.6 Hz, 1H, H-3), 4.34 – 4.40 (m, 1H, H-4), 4.48 – 4.64 (m, 6H, OCH<sub>2</sub>Ph), 4.67 (d, *J* = 4.4 Hz, 1H, H-2), 7.26 – 7.38 (m, 15H, H<sub>Ar</sub>), 7.69 (d, *J* = 1.8 Hz, 1H, H-1)

**<sup>13</sup>C NMR** (101 MHz, CDCl<sub>3</sub>):  $\delta = 68.05$  (C-5), 72.67 (OCH<sub>2</sub>Ph), 72.71 (C-4), 72.88 (OCH<sub>2</sub>Ph), 73.57 (OCH<sub>2</sub>Ph), 83.22 (C-3), 88.67 (C-2), 127.58 – 128.69 (C<sub>Ar</sub>), 137.79 (C<sup>IV</sup><sub>Ar</sub>), 138.10 (C<sup>IV</sup><sub>Ar</sub>), 138.58 (C<sup>IV</sup><sub>Ar</sub>)



(1*R*)-2,3,5-Tri-*O*-benzyl-1-*N*-*tert*-butanesulfonyl-1-tributylstannyl-1,4-dideoxy-1,4-imino-L-xylitol **37**



**Procedure 1:** The open-chain sulfonamide **32** (100.0 mg, 0.12 mmol, 1.0 eq.) was dissolved in anhydrous DCM (1.0 mL) under an argon atmosphere, and then triethylamine (69  $\mu\text{L}$ , 0.49 mmol, 4.1 eq.) and activated 4 Å molecular sieves were added. After 10 min, methanesulfonyl chloride (37  $\mu\text{L}$ , 0.48 mmol, 4.0 eq.) was added. The mixture was stirred for 30 min at room temperature. The reaction was quenched with a saturated aqueous solution of  $\text{NH}_4\text{Cl}$  (10 mL) and was diluted with DCM (30.0 mL) and then was filtered through Celite®; the cake was washed with DCM ( $2 \times 10.0$  mL). The phases were separated; the aqueous phase was extracted twice with DCM ( $2 \times 15.0$  mL). The combined organic phases were washed twice with a saturated aqueous solution of  $\text{NH}_4\text{Cl}$  ( $2 \times 30.0$  mL) and then were dried over  $\text{MgSO}_4$ , filtered through a cotton plug and concentrated under reduced pressure. The product was used without further purification in the next step.

The crude intermediate product was dissolved in anhydrous THF (1.0 mL) under argon atmosphere, and sodium hydride (30.0 mg, 0.72 mmol, 6.0 eq.) was added. The mixture was stirred for 8 h at 68 °C. The reaction was quenched with MeOH (5.0 mL), diluted with EtOAc (30.0 mL) and extracted with a saturated aqueous solution of NaCl (20.0 mL). The phases were separated. The organic phase was washed once with a saturated aqueous solution of NaCl (20.0 mL) and then dried over  $\text{MgSO}_4$ , filtered through a cotton plug and concentrated under reduced pressure. The crude compound was purified by silica gel column chromatography ( $\varnothing = 1.0$  cm,  $L = 10$  cm) using PE:EtOAc (8:2) as the eluent to afford compound **57** as a colourless oil (58.6 mg, 60%).

**Procedure 2:** In flask A, triphenylphosphine (174.0 mg, 0.66 mmol, 1.1 eq.) was dissolved in anhydrous THF (10.0 mL) under argon atmosphere, and it was cooled down to  $-20$  °C ( $\text{CaCl}_2$ -ice bath). Afterwards, diethyl azodicarboxylate (0.10 mL, 0.66 mmol, 1.1 eq.) was added dropwise. In parallel, open-chain sulfonamide **32** (500.0 mg, 0.60 mmol, 1.0 eq.) was dissolved in anhydrous THF (5.0 mL) under argon atmosphere. The content of flask B was added dropwise into flask A by a syringe. The mixture was stirred for 30 min at  $-20$  °C and another 30 min at room temperature. The reaction was quenched with  $\text{H}_2\text{O}$  (10.0 mL) and it was diluted with EtOAc (30.0 mL). The phases were separated, and the aqueous phase was extracted with EtOAc (15.0 mL). Combined organic phases were washed two times with a saturated aqueous

solution of NaCl (2 × 30.0 mL) and then they were dried over MgSO<sub>4</sub>, filtered through a cotton plug and concentrated under reduced pressure. The crude compound was purified by silica gel column chromatography (Ø = 1.5 cm, L = 15 cm) using PE:EtOAc (15:1) as the eluent to afford compound **57** as a colourless oil (325.1 mg, 66%).

**R<sub>f</sub>** = 0.63 (PE:EtOAc 9:1) **[α]<sub>D</sub><sup>20</sup>** = -10.9 (CHCl<sub>3</sub>, *c* = 1.03 g/100 mL)

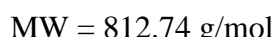
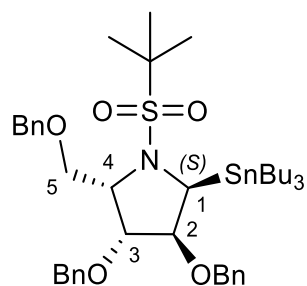
**IR (neat):**  $\nu$  = 3088, 3059, 3025, 2952, 2914, 2866, 2847, 1752, 1717, 1454, 1315, 1128, 1071, 1043, 1030, 732, 694, 678 cm<sup>-1</sup>

**HRMS (ESI):** *m/z* calc. for C<sub>42</sub>H<sub>64</sub>NO<sub>5</sub>SSn [M + H]<sup>+</sup> 814.352166, found 814.352336  
for C<sub>42</sub>H<sub>67</sub>N<sub>2</sub>O<sub>5</sub>SSn [M + NH<sub>4</sub>]<sup>+</sup> 831.378715, found 831.378897  
for C<sub>42</sub>H<sub>63</sub>NNaO<sub>5</sub>SSn [M + Na]<sup>+</sup> 836.334111, found 836.334357

**<sup>1</sup>H NMR (700MHz, (CD<sub>3</sub>)<sub>2</sub>CO):**  $\delta$  = 0.78 – 0.92 (m, 15H, CH<sub>3</sub> + CH<sub>2</sub>), 1.21 – 1.28 (m, 6H, CH<sub>2</sub>), 1.36 – 1.48 (m, 15H, CH<sub>3</sub> + CH<sub>2</sub>), 3.87 (t, *J* = 8.9 Hz, 1H, H-5a), 4.01 (bs, 1H, H-1), 4.04 – 4.09 (m, 1H, H-5b), 4.19 – 4.28 (m, 2H, H-2, H-4), 4.29 – 4.32 (m, 1H, H-3), 4.55 (d, *J* = 12.0 Hz, 1H, OCH<sub>2</sub>Ph), 4.61 – 4.63 (m, 2H, OCH<sub>2</sub>Ph), 4.65 – 4.72 (m, 3H, OCH<sub>2</sub>Ph), 7.23 – 7.41 (m, 15H, H<sub>Ar</sub>)

**<sup>13</sup>C NMR (176 MHz, (CD<sub>3</sub>)<sub>2</sub>CO):**  $\delta$  = 11.29 (SnCH<sub>2</sub>CH<sub>2</sub>CH<sub>2</sub>CH<sub>3</sub>, satellites: 10.36, 10.40, 12.17, 12.21), 14.03 (CH<sub>3</sub>), 25.85 (CH<sub>3</sub>), 28.19 (SnCH<sub>2</sub>CH<sub>2</sub>CH<sub>2</sub>CH<sub>3</sub>, satellites: 28.02, 28.03, 28.35, 28.36), 29.73 (SnCH<sub>2</sub>CH<sub>2</sub>CH<sub>2</sub>CH<sub>3</sub>, satellites: 29.68, 29.79), 57.62 (C-1, satellites: 56.62, 58.65), 62.30 (C-4), 64.15 (C<sup>IV</sup><sub>*t*-Bu</sub>), 69.31 (C-5), 71.34 (OCH<sub>2</sub>Ph), 74.04 (OCH<sub>2</sub>Ph), 74.50 (OCH<sub>2</sub>Ph), 83.92 (C-2 or C-3), 83.94 (C-2 or C-3), 128.29 – 129.25 (C<sub>Ar</sub>), 138.87 (C<sup>IV</sup><sub>Ar</sub>), 138.47 (C<sup>IV</sup><sub>Ar</sub>), 138.53 (C<sup>IV</sup><sub>Ar</sub>)

(1*S*)-2,3,5-Tri-*O*-benzyl-1-*N*-*tert*-butanesulfonyl-1-tributylstannyl-1,4-dideoxy-1,4-imino-L-xylitol **58**



The mesylated compound **59** (334.0 mg, 0.37 mmol, 1.0 eq.) was dissolved in anhydrous THF (10.0 mL) under argon atmosphere, and sodium hydride (45 mg, 1.12 mmol, 3.0 eq.) was added. The mixture was stirred for 10 h at 70 °C. The reaction was quenched with a saturated aqueous solution of Na<sub>2</sub>CO<sub>3</sub> (10.0 mL), and it was diluted with EtOAc (40.0 mL). The phases were separated, and the organic phase was washed once with a saturated aqueous solution of Na<sub>2</sub>CO<sub>3</sub> (20.0 mL), once with a saturated aqueous solution of NaCl (20.0 mL). The organic phase was dried over MgSO<sub>4</sub>, filtered through a cotton plug and concentrated under reduced pressure. The crude compound was purified by silica gel column chromatography (Ø = 1.5 cm, L = 15 cm) using PE:EtOAc (10:1) as the eluent to afford compound **58** as a colourless oil (243.7 mg, 80%).

$R_f = 0.33$  (PE:EtOAc 10:1)

$[\alpha]_D^{20} = 44.4$  (CHCl<sub>3</sub>,  $c = 1.11$  g/100 mL)

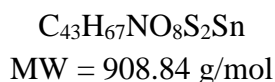
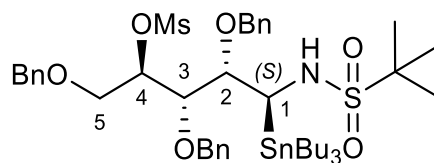
**IR (neat):**  $\nu = 3082, 3066, 3037, 2941, 2917, 2873, 2867, 1454, 1305, 1118, 1087, 1071, 1024, 1014, 735, 691 \text{ cm}^{-1}$

**HRMS (ESI):**  $m/z$  calc. for C<sub>42</sub>H<sub>64</sub>NO<sub>5</sub>SSn [M + H]<sup>+</sup> 814.352166, found 814.352849  
for C<sub>42</sub>H<sub>67</sub>N<sub>2</sub>O<sub>5</sub>SSn [M + NH<sub>4</sub>]<sup>+</sup> 831.378715, found 831.379173  
for C<sub>42</sub>H<sub>63</sub>NNaO<sub>5</sub>SSn [M + Na]<sup>+</sup> 836.334111, found 836.334814

**<sup>1</sup>H NMR (400 MHz, CDCl<sub>3</sub>):**  $\delta = 0.71 - 0.90$  (m, 15H, CH<sub>3</sub> + CH<sub>2</sub>), 1.14 – 1.43 (m, 21H, CH<sub>3</sub> + CH<sub>2</sub>), 3.60 – 3.67 (m, 1H, H-1), 3.73 – 3.80 (m, 1H, H-5a), 3.86 (dd,  $J = 5.6$  Hz, 8.9 Hz, 1H, H-5b), 3.91 (dd,  $J = 2.6$  Hz, 5.6 Hz, 1H, H-2), 4.21 (dd,  $J = 2.6$  Hz, 5.2 Hz, 1H, H-3), 4.23 – 4.29 (m, 1H, H-4), 4.32 (d,  $J = 11.3$  Hz, 1H, OCH<sub>2</sub>Ph), 4.43 (d,  $J = 11.3$  Hz, 1H, OCH<sub>2</sub>Ph), 4.49 (d,  $J = 11.6$  Hz, 1H, OCH<sub>2</sub>Ph), 4.52 (s, 2H, OCH<sub>2</sub>Ph), 4.59 (d,  $J = 11.6$  Hz, 1H, OCH<sub>2</sub>Ph), 7.21 – 7.36 (m, 15H, H<sub>Ar</sub>)

**<sup>13</sup>C NMR (101 MHz, CDCl<sub>3</sub>):**  $\delta = 13.16$  (SnCH<sub>2</sub>CH<sub>2</sub>CH<sub>2</sub>CH<sub>3</sub>, satellites: 11.40, 11.48, 14.83, 14.91), 13.87 (CH<sub>3</sub>), 25.11 (CH<sub>3</sub>), 27.75 (SnCH<sub>2</sub>CH<sub>2</sub>CH<sub>2</sub>CH<sub>3</sub>, satellites: 27.41, 27.43, 28.08, 28.09), 29.29 (SnCH<sub>2</sub>CH<sub>2</sub>CH<sub>2</sub>CH<sub>3</sub>, satellites: 29.20, 29.38), 57.18 (C-1), 61.42 (C<sup>IV</sup><sub>t-Bu</sub>), 62.42 (C-4), 67.79 (C-5), 71.79 (OCH<sub>2</sub>Ph), 73.15 (OCH<sub>2</sub>Ph), 73.58 (OCH<sub>2</sub>Ph), 83.34 (C-3), 85.21 (C-2), 127.76 – 128.60 (C<sub>Ar</sub>), 137.89 (C<sup>IV</sup><sub>Ar</sub>), 138.05 (C<sup>IV</sup><sub>Ar</sub>), 138.33 (C<sup>IV</sup><sub>Ar</sub>)

(1*S*)-2,3,5-Tri-*O*-benzyl-1-*N*-*tert*-butanesulfonylamino-1-deoxy-4-*O*-methanesulfonyl-1-tributylstannyl-D-arabinitol **59**



The open-chain sulphonamide **33** (500.0 mg, 0.60 mmol, 1.0 eq.) was dissolved in anhydrous DCM (50.0 mL) under argon atmosphere, and triethylamine (0.10 mL, 1.20 mmol, 2.0 eq.) was added. After 10 min, methanesulfonyl chloride (0.18 mL, 1.32 mmol, 2.2 eq.) was added, and the mixture was stirred for 30 min at room temperature. The reaction was quenched with a saturated aqueous solution of  $NH_4Cl$  (30.0 mL) and it was diluted with DCM (30.0 mL). The phases were separated; the organic phase was washed two times with a saturated aqueous solution of  $NH_4Cl$  ( $2 \times 50.0$  mL) and then it was dried over  $MgSO_4$ , filtered through a cotton plug and concentrated under reduced pressure. The crude compound was purified by silica gel column chromatography ( $\varnothing = 1.5$  cm,  $L = 15$  cm) using PE:EtOAc (8:2) as the eluent to afford compound **59** as a pale-yellow oil (346.1 mg, 64%).

$R_f = 0.18$  (PE:EtOAc 9:1)  $[\alpha]_D^{20} = -2.0$  ( $CHCl_3$ ,  $c = 1.08$  g/100 mL)

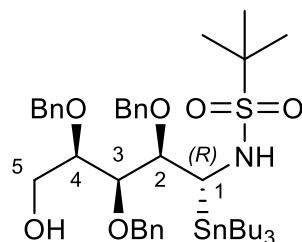
**IR** (neat):  $\nu = 3339, 3031, 2954, 2921, 2870, 1454, 1351, 1312, 1174, 1124, 1027, 909, 811, 735, 697$   $cm^{-1}$

**HRMS** (ESI):  $m/z$  calc. for  $C_{43}H_{71}N_2O_8S_2Sn$   $[M + NH_4]^+$  927.366830, found 927.366400  
for  $C_{43}H_{67}NNaO_8S_2Sn$   $[M + Na]^+$  932.322226, found 932.322187

**$^1H$  NMR** (400 MHz,  $CDCl_3$ ):  $\delta = 0.71 - 0.92$  (m, 15H,  $CH_3 + CH_2$ ), 1.19 – 1.41 (m, 21H,  $CH_3 + CH_2$ ), 3.03 (s, 3H,  $CH_3SO_2$ ), 3.60 – 3.78 (m, 1H, H-1), 3.82 (dd,  $J = 8.1$  Hz, 11.2 Hz, 1H, H-5a), 3.99 – 4.09 (m, 2H, H-5b, NH), 4.11 – 4.16 (m, 1H, H-2), 4.19 (dd,  $J = 1.6, 6.4$  Hz, 1H, H-3), 4.46 – 4.57 (m, 3H,  $OCH_2Ph$ ), 4.63 (d,  $J = 11.2$  Hz, 1H,  $OCH_2Ph$ ), 4.66 (d,  $J = 11.1$  Hz, 1H,  $OCH_2Ph$ ), 4.79 (d,  $J = 11.2$  Hz, 1H,  $OCH_2Ph$ ), 5.06 (dt,  $J = 2.1, 8.0$  Hz, 1H, H-4), 7.22 – 7.38 (m, 15H,  $H_{Ar}$ )

**$^{13}C$  NMR** (101 MHz,  $CDCl_3$ ):  $\delta = 10.87$  ( $SnCH_2CH_2CH_2CH_3$ ), 13.74 ( $CH_3$ ), 24.42 ( $CH_3$ ), 27.63 ( $SnCH_2CH_2CH_2CH_3$ ), 29.13 ( $SnCH_2CH_2CH_2CH_3$ ), 38.43 ( $CH_3SO_2$ ), 46.71 (C-1), 60.00 ( $C^{IV}$  of *t*-Bu), 69.30 (C-5), 73.48 ( $OCH_2Ph$ ), 74.56 ( $OCH_2Ph$ ), 74.75 ( $OCH_2Ph$ ), 81.33 (C-2 or C-3), 83.38 (C-3 or C-2), 84.67 (C-4), 127.85 – 128.77 ( $C_{Ar}$ ), 137.49 ( $C^{IV}_{Ar}$ ), 137.82 ( $C^{IV}_{Ar}$ )

(1*R*)-2,3,4-Tri-*O*-benzyl-1-*N*-*tert*-butanesulfonylamino-1-deoxy-1-tributylstannyl-D-xylitol  
**60**



C<sub>42</sub>H<sub>65</sub>NO<sub>6</sub>SSn  
MW = 830,75 g/mol

According to the general procedure F, the reaction was performed with the open-chain stannane **31** (1.88 g, 2.30 mmol, 1.0 eq.), *meta*-chloroperoxybenzoic acid (1.06 g, 4.61 mmol, 2.0 eq.) and anhydrous DCM (20.0 mL). The mixture was stirred for 30 min at 0 °C. The crude compound was purified by silica gel column chromatography (Ø = 2.0 cm, L = 20 cm) using PE:EtOAc (8:2) as the eluent to afford compound **60** in form of a colourless oil (1.10 g, 57%).

R<sub>f</sub> = 0.31 (PE:EtOAc 9:1)  $[\alpha]_D^{20} = 5.9$  (CHCl<sub>3</sub>, *c* = 1.27 g/100 mL)

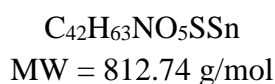
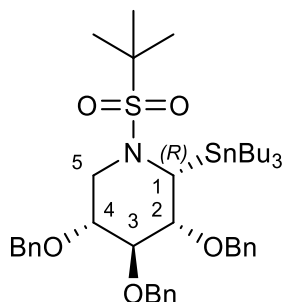
**IR (neat):**  $\nu = 3523, 3366, 3281, 3091, 3063, 3028, 2955, 2923, 2869, 2847, 1457, 1308, 1122, 1068, 1049, 1020, 732, 694$  cm<sup>-1</sup>

**HRMS (ESI):** *m/z* cal. for C<sub>42</sub>H<sub>69</sub>N<sub>2</sub>O<sub>6</sub>SSn [M + NH<sub>4</sub>]<sup>+</sup> 849.389280, found 849.388983  
for C<sub>42</sub>H<sub>65</sub>NNaO<sub>6</sub>SSn [M + Na]<sup>+</sup> 854.344675, found 854.344536

**<sup>1</sup>H NMR (400 MHz, CDCl<sub>3</sub>):**  $\delta = 0.73 - 0.89$  (m, 15H, CH<sub>3</sub> + CH<sub>2</sub>), 1.17 – 1.40 (m, 21H, CH<sub>3</sub> + CH<sub>2</sub>), 2.24 (dd, *J* = 5.3, 6.8 Hz, 1H, OH), 3.47 – 3.64 (m, 1H, H-1), 3.81 – 3.98 (m, 3H, H-4, H-5a, H-5b), 4.12 (dd, *J* = 4.4, 6.8 Hz, 1H, H-3), 4.19 (dd, *J* = 3.8, 6.8 Hz, 1H, H-2), 4.24 – 4.33 (m, 1H, NH), 4.58 (d, *J* = 11.4 Hz, 1H, OCH<sub>2</sub>Ph), 4.63 (d, *J* = 11.5 Hz, 1H, OCH<sub>2</sub>Ph), 4.67 – 4.77 (m, 3H, OCH<sub>2</sub>Ph), 4.87 (d, *J* = 11.4 Hz, 1H, OCH<sub>2</sub>Ph), 7.22 – 7.38 (m, 15H, H<sub>Ar</sub>)

**<sup>13</sup>C NMR (101 MHz, CDCl<sub>3</sub>):**  $\delta = 10.77$  (SnCH<sub>2</sub>CH<sub>2</sub>CH<sub>2</sub>CH<sub>3</sub>, satellites: 9.17, 9.24, 12.29, 12.36), 13.70 (CH<sub>3</sub>), 24.40 (CH<sub>3</sub>), 27.61 (SnCH<sub>2</sub>CH<sub>2</sub>CH<sub>2</sub>CH<sub>3</sub>, satellites: 27.29, 27.31, 27.91, 27.92), 29.17 (SnCH<sub>2</sub>CH<sub>2</sub>CH<sub>2</sub>CH<sub>3</sub>, satellites: 29.08, 29.26), 46.48 (C-1, satellites: 44.80, 44.87, 48.08, 48.16), 59.90 (C<sup>IV</sup><sub>*t*-Bu</sub>), 61.97 (C-5), 72.66 (OCH<sub>2</sub>Ph), 74.22 (OCH<sub>2</sub>Ph), 74.90 (OCH<sub>2</sub>Ph), 78.54 (C-4), 80.26 (C-3), 81.53 (C-2), 127.60 – 128.63 (C<sub>Ar</sub>), 138.04 (C<sup>IV</sup><sub>Ar</sub>), 138.13 (C<sup>IV</sup><sub>Ar</sub>), 138.41 (C<sup>IV</sup><sub>Ar</sub>)

(1*R*)-2,3,4-Tri-*O*-benzyl-1-*N*-*tert*-butanesulfonyl-1-tributylstannyl-1,5-dideoxy-1,5-imino-D-xylitol **62**



The open-chain sulfonamide **60** (400.0 mg, 0.48 mmol, 1.0 eq.) was dissolved in anhydrous DCM (20.0 mL) under argon atmosphere, and triethylamine (0.147  $\mu$ L, 1.06 mmol, 2.2 eq.) was added. After 10 min, methanesulfonyl chloride (78  $\mu$ L, 1.01 mmol, 2.1 eq.) was added. The mixture was subsequently stirred for 30 min at room temperature. The reaction was quenched with a saturated aqueous solution of NaCl (30.0 mL) and it was diluted with DCM (40.0 mL). The phases were separated, the organic phase was washed twice with a saturated aqueous solution of NaCl ( $2 \times 30.0$  mL) and it was dried over  $MgSO_4$ , filtered through a cotton plug and concentrated under reduced pressure. The crude compound was purified by silica gel column chromatography ( $\varnothing = 1.5$  cm,  $L = 15$  cm) using PE:EtOAc (6:1) as the eluent to afford compound **61** as a pale-yellow oil (392.7 mg, 90%).

The mesylated compound **61** (392.7 mg, 0.43 mmol, 1.0 eq.) was dissolved in anhydrous THF (20.0 mL) under argon atmosphere, and sodium hydride (52.0 mg, 1.12 mmol, 3.0 eq.) was added. The mixture was stirred at room temperature and it was monitored by TLC analysis. After 10 h, the reaction was complete. Additional 2.0 eq. of sodium hydride were added (34.5 mg, 0.86 mmol) and after it was stirred for 2 h at room temperature. MeOH (5.0 mL) was added and the content was concentrated. The residue was diluted with DCM (30.0 mL) and it was washed with a saturated aqueous solution of NaCl (20.0 mL). The phases were separated, the organic phase was washed once with a saturated aqueous solution of NaCl (20.0 mL), dried over  $MgSO_4$ , filtered through a cotton plug and concentrated under reduced pressure. The crude compound was purified by silica gel column chromatography using PE:EtOAc (12:1 to 10:1) as the eluent to afford compound **62** as a colourless oil (256.8 mg, 73%).

$R_f = 0.62$  (PE:EtOAc 9:1)  $[\alpha]_D^{20} = 7.1$  ( $CHCl_3$ ,  $c = 1.08$  g/100 mL)

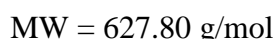
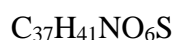
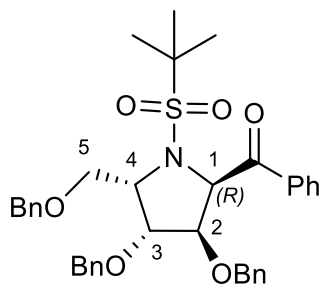
**IR (neat):**  $\nu = 3088, 3066, 3031, 2955, 2923, 2869, 2850, 1454, 1318, 1125, 1109, 1064, 1027, 729, 694$   $cm^{-1}$

**HRMS (ESI):**  $m/z$  calc. for  $C_{42}H_{63}NNaO_5SSn$   $[M + Na]^+$  836.334111, found 836.334285

**<sup>1</sup>H NMR (400 MHz, CDCl<sub>3</sub>):**  $\delta$  = 0.82 – 1.07 (m, 15H, CH<sub>3</sub> + CH<sub>2</sub>), 1.20 – 1.53 (m, 21H, CH<sub>3</sub> + CH<sub>2</sub>), 2.53 (dd,  $J$  = 10.9, 13.6 Hz, 1H, H-5a), 3.42 (t,  $J$  = 8.9 Hz, 1H, H-3), 3.54 – 3.65 (m, 1H, H-4), 3.74 – 4.03 (m, 2H, H-2, H-5b), 4.05 – 4.20 (m, 1H, H-1), 4.63 – 4.77 (m, 4H, OCH<sub>2</sub>Ph), 4.85 – 4.90 (m, 2H, OCH<sub>2</sub>Ph), 7.19 – 7.49 (m, 15H, H<sub>Ar</sub>)

**<sup>13</sup>C NMR (101 MHz, CDCl<sub>3</sub>):**  $\delta$  = 11.06 (SnCH<sub>2</sub>CH<sub>2</sub>CH<sub>2</sub>CH<sub>3</sub>, satellites: 9.49, 9.56, 12.55, 12.62), 13.61 (CH<sub>3</sub>), 24.18 (CH<sub>3</sub>), 27.48 (SnCH<sub>2</sub>CH<sub>2</sub>CH<sub>2</sub>CH<sub>3</sub>, satellites: 27.17, 27.18, 27.78, 27.80), 29.00 (SnCH<sub>2</sub>CH<sub>2</sub>CH<sub>2</sub>CH<sub>3</sub>, satellites: 28.91, 29.10), 50.05 (C-5), 53.47 (C-1), 61.30 (C<sup>IV</sup><sub>*t*-Bu</sub>), 73.09 (OCH<sub>2</sub>Ph), 73.60 (OCH<sub>2</sub>Ph), 75.72 (OCH<sub>2</sub>Ph), 78.62 (C-4), 81.35 (C-2), 85.74 (C-3), 127.59 – 128.42 (C<sub>Ar</sub>), 138.11(C<sup>IV</sup><sub>Ar</sub>), 138.68 (C<sup>IV</sup><sub>Ar</sub>)

(1*R*)-2,3,5-Tri-*O*-benzyl-1-*N*-*tert*-butanesulfonyl-1-*C*-benzoyl-1,4-dideoxy-1,4-imino-L-xylitol **70**



According to the general procedure G, the reaction was performed with: cyclic stannane **57** (75 mg, 92.3  $\mu\text{mol}$ , 2.0 eq.), benzoyl chloride (6.5 mg, 4.61  $\mu\text{mol}$ , 1.0 eq.),  $\text{Pd}_2(\text{dba})_3$  (2.1 mg, 2.3  $\mu\text{mol}$ , 10% mol), JackiePhos (3.7 mg, 4.61  $\mu\text{mol}$ , 10% mol),  $\text{CuCl}$  (0.46 mg, 4.61  $\mu\text{mol}$ , 10% mol), 4 Å molecular sieves (200 mg) and anhydrous 1,4-dioxane (1.5 mL). The mixture was stirred under a positive argon atmosphere (argon balloon) for 6 h at 110 °C. The crude compound was purified by preparative TLC using PE:EtOAc (5:1) as the eluent, followed by silica gel column chromatography ( $\varnothing = 1.0 \text{ cm}$ ,  $L = 20 \text{ cm}$ ) using DCM:MeOH (400:1) as the eluent to afford compound **70** as a single diastereoisomer in form of a colourless oil (18 mg, 62%).

$R_f = 0.46$  (PE:EtOAc 5:1)

$[\alpha]_D^{20} = 23.4$  ( $\text{CHCl}_3$ ,  $c = 1.00 \text{ g/100 mL}$ )

**IR (neat):**  $\nu = 3063, 3028, 2927, 2863, 1698, 1597, 1451, 1309, 1116, 1087, 992, 739, 698 \text{ cm}^{-1}$

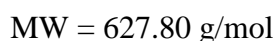
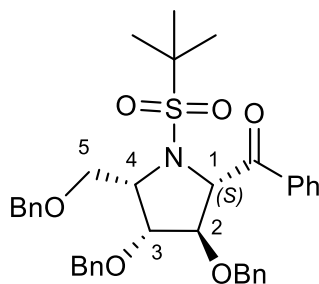
**HRMS (ESI):**  $m/z$  calc. for  $\text{C}_{37}\text{H}_{41}\text{NNaO}_6\text{S}$   $[\text{M} + \text{Na}]^+ 650.254680$ , found 650.254441

**$^1\text{H}$  NMR (400 MHz,  $(\text{CD}_3)_2\text{CO}$ ):**  $\delta = 1.38$  (s, 9H,  $\text{CH}_3$  *t*-Bu), 3.97 (d,  $J = 6.8 \text{ Hz}$ , 2H, H-5a, H-5b), 4.24 – 4.26 (m, 1H, H-3), 4.32 (t,  $J = 2.4 \text{ Hz}$ , 1H, H-2), 4.41 (d,  $J = 11.7 \text{ Hz}$ , 1H,  $\text{OCH}_2\text{Ph}$ ), 4.49 – 4.66 (m, 4H, H-4,  $\text{OCH}_2\text{Ph}$ ), 4.71 (s, 2H,  $\text{OCH}_2\text{Ph}$ ), 5.61 (s, 1H, H-1), 7.13 (m, 15H,  $\text{H}_{\text{Ar}}$ ), 7.45 – 7.63 (m, 2H,  $\text{H}_{\text{Ph}}$ ), 7.61 – 7.64 (m, 1H,  $\text{H}_{\text{Ar}}$ ), 7.86 (d,  $J = 7.8 \text{ Hz}$ , 2H,  $\text{H}_{\text{Ar}}$ )

**$^{13}\text{C}$  NMR (101 MHz,  $(\text{CD}_3)_2\text{CO}$ ):**  $\delta = 24.72$  ( $\text{CH}_3$  *t*-Bu), 61.90 ( $\text{C}^{\text{IV}}_{t\text{-Bu}}$ ), 63.09 (C-4), 69.42 (C-5), 70.59 (C-1), 72.04 ( $\text{OCH}_2\text{Ph}$ ), 73.59 ( $\text{OCH}_2\text{Ph}$ ), 73.78 ( $\text{OCH}_2\text{Ph}$ ), 83.38 (C-3), 84.60 (C-2), 128.16 – 129.63 ( $\text{C}_{\text{Ar}}$ ), 134.01 ( $\text{C}_{\text{Ar}}$ ), 136.78 ( $\text{C}^{\text{IV}}_{\text{Ar}}$ ), 138.78 ( $\text{C}^{\text{IV}}_{\text{Ar}}$ ), 138.91 ( $\text{C}^{\text{IV}}_{\text{Ar}}$ ), 139.66 ( $\text{C}^{\text{IV}}_{\text{Ar}}$ ), 195.81 ( $\text{C}^{\text{IV}}=\text{O}$ )



(1*S*)-2,3,5-Tri-*O*-benzyl-1-*N*-*tert*-butanesulfonyl-1-*C*-benzoyl-1,4-dideoxy-1,4-imino-L-xylitol **71**



According to the general procedure G, the reaction was performed with: cyclic stannane **58** (100 mg, 0.123 mmol, 2.0 eq.), benzoyl chloride (8.7 mg, 6.15  $\mu\text{mol}$ , 1.0 eq.),  $\text{Pd}_2(\text{dba})_3$  (2.8 mg, 3.075  $\mu\text{mol}$ , 10% mol), JackiePhos (5.0 mg, 6.15  $\mu\text{mol}$ , 10% mol),  $\text{CuCl}$  (0.6 mg, 6.15  $\mu\text{mol}$ , 10% mol), 4 Å molecular sieves (200 mg) and anhydrous 1,4-dioxane (1.5 mL). The mixture was stirred under a positive argon atmosphere (argon balloon) for 6 h at 110 °C. The crude compound was purified by preparative TLC using PE:EtOAc (5:1) as the eluent, followed by silica gel column chromatography ( $\varnothing = 1.0 \text{ cm}$ ,  $L = 20 \text{ cm}$ ) using DCM:MeOH (700:1) as the eluent to afford compound **71** as a single diastereoisomer in form of a colourless oil (25 mg, 65%).

$R_f = 0.42$  (PE:EtOAc 5:1)

$[\alpha]_D^{20} = -24.1$  ( $\text{CHCl}_3$ ,  $c = 1.00 \text{ g/100 mL}$ )

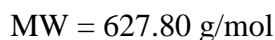
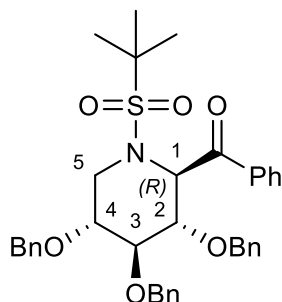
**IR (neat):**  $\nu = 3059, 3028, 2920, 2869, 1692, 1597, 1448, 1321, 1110, 1052, 726, 688 \text{ cm}^{-1}$

**HRMS (ESI):**  $m/z$  calc. for  $\text{C}_{37}\text{H}_{42}\text{NO}_6\text{S}$   $[\text{M} + \text{H}]^+$  628.272735, found 628.272781  
for  $\text{C}_{37}\text{H}_{41}\text{NNaO}_6\text{S}$   $[\text{M} + \text{Na}]^+$  650.254680, found 650.254534

**$^1\text{H}$  NMR (400 MHz,  $(\text{CD}_3)_2\text{CO}$ ):**  $\delta = 1.40$  (s, 9H,  $\text{CH}_3$  *t*-Bu), 3.69 (d,  $J = 10.1 \text{ Hz}$ , 1H, H-5a), 3.81 (bs, 1H, H-5b), 4.42 (d,  $J = 11.7 \text{ Hz}$ , 1H,  $\text{OCH}_2\text{Ph}$ ), 4.46 – 4.63 (m, 4H, H-4,  $\text{OCH}_2\text{Ph}$ ), 4.65 – 4.83 (m, 4H, H-2, H-3,  $\text{OCH}_2\text{Ph}$ ), 5.70 (bs, 1H, H-1), 6.89 (d,  $J = 7.1 \text{ Hz}$ , 2H,  $\text{H}_{\text{Ar}}$ ), 7.07 – 7.43 (m, 13 H,  $\text{H}_{\text{Ar}}$ ), 7.49 – 7.53 (m, 2H,  $\text{H}_{\text{Ar}}$ ), 7.60 – 7.63 (m, 1H,  $\text{H}_{\text{Ar}}$ ), 8.02 (d,  $J = 7.8 \text{ Hz}$ , 2H,  $\text{H}_{\text{Ar}}$ )

**$^{13}\text{C}$  NMR (101 MHz,  $(\text{CD}_3)_2\text{CO}$ ):**  $\delta = 24.79$  ( $\text{CH}_3$  *t*-Bu), 59.79 (C-4), 62.18 (C-1), 62.56 ( $\text{C}^{\text{IV}}_{t\text{-Bu}}$ ), 68.02 (C-5), 73.56 ( $\text{OCH}_2\text{Ph}$ ), 73.87 ( $\text{OCH}_2\text{Ph}$ ), 74.30 ( $\text{OCH}_2\text{Ph}$ ), 81.01 (C-3 or C-2), 83.57 (C-2 or C-3), 128.15 – 129.32 ( $\text{C}_{\text{Ar}}$ ), 133.51 ( $\text{C}_{\text{Ar}}$ ), 138.73 ( $\text{C}^{\text{IV}}_{\text{Ar}}$ ), 138.76 ( $\text{C}^{\text{IV}}_{\text{Ar}}$ ), 139.63 ( $\text{C}^{\text{IV}}_{\text{Ar}}$ ), 200.51 ( $\text{C}^{\text{IV}}=\text{O}$ )

(1*R*)-2,3,4-Tri-*O*-benzyl-1-*N*-*tert*-butanesulfonyl-1-*C*-benzoyl-1,5-dideoxy-1,5-imino-D-xylitol **72**



According to the general procedure G, the reaction was performed with: cyclic stannane **62** (80 mg, 98.4  $\mu\text{mol}$ , 2.0 eq.), benzoyl chloride (7.0 mg, 49.2  $\mu\text{mol}$ , 1.0 eq.),  $\text{Pd}_2(\text{dba})_3$  (2.3 mg, 2.46  $\mu\text{mol}$ , 10% mol), JackiePhos (4.0 mg, 4.92  $\mu\text{mol}$ , 10% mol),  $\text{CuCl}$  (0.5 mg, 4.92 mmol, 10% mol), 4 Å molecular sieves (150 mg) and anhydrous 1,4-dioxane (1.5 mL). The mixture was stirred under a positive argon atmosphere (argon balloon) for 6 h at 110 °C. The crude compound was purified by silica gel column chromatography ( $\varnothing = 1.0 \text{ cm}$ ,  $L = 25 \text{ cm}$ ) using PE:EtOAc (15:1) as the eluent to afford compound **72** as single diastereoisomer in form of a colorless oil (7 mg, 26%).

$R_f = 0.48$  (PE:EtOAc 5:1)

$[\alpha]_D^{20} = -11.3$  ( $\text{CHCl}_3$ ,  $c = 0.50 \text{ g/100 mL}$ )

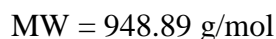
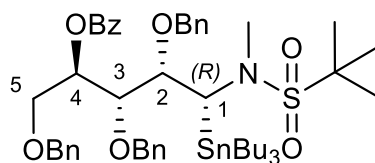
**IR (neat):**  $\nu = 3063, 3028, 2926, 2869, 1723, 1682, 1593, 1457, 1328, 1270, 1115, 1074, 1027, 739, 691 \text{ cm}^{-1}$

**HRMS (ESI):**  $m/z$  calc. for  $\text{C}_{37}\text{H}_{42}\text{NO}_6\text{S}$   $[\text{M} + \text{H}]^+$  628.272735, found 628.271990  
for  $\text{C}_{37}\text{H}_{41}\text{NNaO}_6\text{S}$   $[\text{M} + \text{Na}]^+$  650.254680, found 650.254557

**$^1\text{H}$  NMR (400 MHz,  $(\text{CH}_3)_2\text{CO}$ ):**  $\delta = 1.28$  (s, 9H,  $\text{CH}_3$ ), 3.66 (dt,  $J = 7.7, 11.2$ , Hz, 1H, H-5a), 3.82 – 4.03 (m, 4H, H-2, H-3, H-4, H-5b), 4.65 (s, 2H,  $\text{OCH}_2\text{Ph}$ ), 4.72 – 4.80 (m, 3H,  $\text{OCH}_2\text{Ph}$ ), 4.88 (d,  $J = 11.1$  Hz, 1H,  $\text{OCH}_2\text{Ph}$ ), 5.80 (s, 1H, H-1), 6.88 (d,  $J = 7.1$  Hz, 2H,  $\text{H}_{\text{Ar}}$ ), 7.10 – 7.22 (m, 2H,  $\text{H}_{\text{Ar}}$ ), 7.24 – 7.45 (m, 6H,  $\text{H}_{\text{Ar}}$ ), 7.52 (dt,  $J = 3.8, 7.7$  Hz, 4H,  $\text{H}_{\text{Ar}}$ ), 7.63 (dd,  $J = 4.6, 7.2$  Hz, 2H, ArH), 7.93– 8.10 (m, 4H,  $\text{H}_{\text{Ar}}$ )

**$^{13}\text{C}$  NMR (101 MHz,  $(\text{CH}_3)_2\text{CO}$ ):**  $\delta = 23.64$  ( $\text{CH}_3$ ), 46.73 (C-5), 55.67 ( $\text{C}^{\text{IV}}_{t\text{-Bu}}$ ), 61.26 (C-1), 69.68 (C-4), 72.46 ( $\text{OCH}_2\text{Ph}$ ), 74.03 ( $\text{OCH}_2\text{Ph}$ ), 75.08 ( $\text{OCH}_2\text{Ph}$ ), 79.48 (C-3), 81.74 (C-2), 127.22 – 133.19 ( $\text{C}_{\text{Ar}}$ ), 137.66 ( $\text{C}^{\text{IV}}_{\text{Ar}}$ ), 138.04 ( $\text{C}^{\text{IV}}_{\text{Ar}}$ ), 138.68 ( $\text{C}^{\text{IV}}_{\text{Ar}}$ ), 139.21 ( $\text{C}^{\text{IV}}_{\text{Ar}}$ ), 190.73 ( $\text{C}^{\text{IV}}_{=\text{O}}$ )

(1*R*)-4-*O*-Benzoyl-2,3,5-tri-*O*-benzyl-1-*N*-*tert*-butanesulfonylamino-1-deoxy-*N*-methyl-1-tributylstannyl-*D*-arabinitol **77**



The *O*-benzoylated stannane **34** (2.0 g, 2.14 mmol, 1.0 eq.) was dissolved in anhydrous DMF (10.0 mL) under argon atmosphere, and then was cooled down to 0 °C. Afterwards, sodium hydride (103 mg, 2.57 mmol, 1.2 eq.) was added. After 10 min, iodomethane (0.16 mL, 2.57 mmol, 1.2 eq.) was added dropwise. The mixture was allowed to reach room temperature and it was stirred for 16 h at the same temperature. The reaction mixture was quenched with a mixture of ice and water (10.0 mL) and extracted twice with EtOAc (2 × 20.0 mL). The combined organic phases were washed three times with a saturated aqueous solution of NaCl (3 × 20.0 mL), dried over MgSO<sub>4</sub>, filtered through a cotton plug and concentrated under reduced pressure. The crude compound was purified by silica gel column chromatography using PE:EtOAc (9:1) as the eluent to afford compound **77** as a colourless oil (1.90 g, 94%).

**R<sub>f</sub>** = 0.6 (PE:EtOAc 9:1)

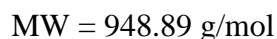
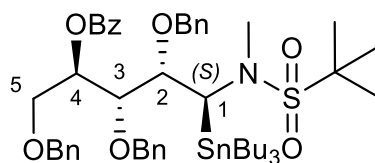
**IR (neat):**  $\nu = 3088, 3063, 3031, 2961, 2920, 2866, 2851, 1717, 1448, 1309, 1271, 1119, 1100, 1071, 1024, 938, 732, 717, 694 \text{ cm}^{-1}$

**HRMS (ESI):**  $m/z$  cal. for C<sub>50</sub>H<sub>75</sub>N<sub>2</sub>O<sub>7</sub>SSn [M + NH<sub>4</sub>]<sup>+</sup> 967.431145, found 967.432296  
for C<sub>50</sub>H<sub>71</sub>NNaO<sub>7</sub>SSn [M + Na]<sup>+</sup> 972.386540, found 972.387840

**<sup>1</sup>H NMR (250 MHz, CDCl<sub>3</sub>):**  $\delta = 0.70 - 0.95$  (m, 15H, CH<sub>3</sub> + CH<sub>2</sub>), 1.08 – 1.21 (m, 6H, CH<sub>2</sub>), 1.29 – 1.45 (m, 15H, CH<sub>3</sub> + CH<sub>2</sub>), 2.97 (s, 3H, NMe), 3.57 (dd,  $J = 1.7, 9.9$  Hz, 1H, H-3), 3.98 – 4.08 (m, 2H, H-5a, H-5b), 4.09 – 4.29 (m, 2H, H-1, H-2), 4.44 (d,  $J = 10.5$  Hz, 1H, OCH<sub>2</sub>Ph), 4.57 (d,  $J = 12.2$  Hz, 1H, OCH<sub>2</sub>Ph), 4.63 – 4.78 (m, 3H, OCH<sub>2</sub>Ph), 4.88 (d,  $J = 10.5$  Hz, 1H, OCH<sub>2</sub>Ph), 5.74 – 5.83 (m, 1H, H-4), 7.14 – 7.44 (m, 17H, H<sub>Ar</sub>, H<sub>Ph</sub>), 7.49 – 7.58 (m, 1H, H<sub>Ph</sub>), 7.96 – 8.04 (m, 2H, H<sub>Ph</sub>)

**<sup>13</sup>C NMR (101 MHz, CDCl<sub>3</sub>):**  $\delta = 12.03$  (SnCH<sub>2</sub>CH<sub>2</sub>CH<sub>2</sub>CH<sub>3</sub>, satellites: 10.45, 10.52, 13.54, 13.64), 13.64 (CH<sub>3</sub>), 24.74 (CH<sub>3</sub>), 27.60 (SnCH<sub>2</sub>CH<sub>2</sub>CH<sub>2</sub>CH<sub>3</sub>, satellites: 27.27, 27.28, 27.92, 27.94), 29.14 (SnCH<sub>2</sub>CH<sub>2</sub>CH<sub>2</sub>CH<sub>3</sub>, satellites: 29.05, 29.23), 39.66 (NCH<sub>3</sub>), 58.95 (C-1), 61.91 (C<sup>IV</sup><sub>*t*-Bu</sub>), 68.18 (C-5), 72.89 (OCH<sub>2</sub>Ph), 74.68 (C-4), 74.96 (OCH<sub>2</sub>Ph), 75.39 (OCH<sub>2</sub>Ph), 83.42 (C-3), 87.00 (C-2), 127.48 – 133.01 (C<sub>Ar</sub>), 138.45 (C<sup>IV</sup><sub>Ar</sub>), 138.53 (C<sup>IV</sup><sub>Ar</sub>), 138.75 (C<sup>IV</sup><sub>Ar</sub>), 166.03 (C<sup>IV</sup><sub>=O</sub>)

(1*S*)-4-*O*-Benzoyl-2,3,5-tri-*O*-benzyl-1-*N*-*tert*-butanesulfonylamino-1-deoxy-*N*-methyl-1-tributylstannyl-*D*-arabinitol **78**



The *O*-benzoylated stannane **35** (810 mg, 0.867 mmol, 1.0 eq.) was dissolved in anhydrous DMF (10.0 mL) under an argon atmosphere, and then it was cooled down to 0 °C. Afterwards, sodium hydride (42 mg, 1.04 mmol, 1.2 eq.) was added. After 10 min, iodomethane (65  $\mu\text{L}$ , 1.04 mmol, 1.2 eq.) was added dropwise. The mixture was allowed to reach room temperature and it was stirred for 16 h. The reaction mixture was quenched with a mixture of ice and water (10.0 mL) and it extracted twice with EtOAc (2  $\times$  20.0 mL). The combined organic phases were washed three times with a saturated aqueous solution of NaCl (3  $\times$  20.0 mL), dried over  $\text{MgSO}_4$ , filtered through a cotton plug and concentrated under reduced pressure. The crude compound was purified by silica gel column chromatography using PE:EtOAc (9:1) as the eluent to afford compound **78** as pale yellow oil (700 mg, 85%).

$R_f = 0.5$  (PE:EtOAc 9:1)

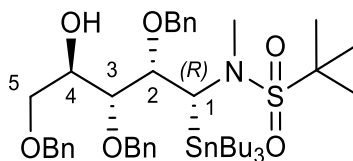
**IR** (neat):  $\nu = 3088, 3066, 3028, 2961, 2920, 2866, 2851, 1720, 1448, 1312, 1264, 1207, 1169, 1119, 1093, 1065, 1027, 945, 739, 713, 698, 666 \text{ cm}^{-1}$

**HRMS** (ESI):  $m/z$  cal. for  $\text{C}_{50}\text{H}_{75}\text{N}_2\text{O}_7\text{SSn} [\text{M} + \text{NH}_4]^+$  967.431145, found 967.431969  
for  $\text{C}_{50}\text{H}_{71}\text{NNaO}_7\text{SSn} [\text{M} + \text{Na}]^+$  972.386540, found 972.387550

**$^1\text{H}$  NMR** (400 MHz,  $\text{CDCl}_3$ ):  $\delta = 0.80 - 1.05$  (m, 15H,  $\text{CH}_3 + \text{CH}_2$ ), 1.19 – 1.50 (m, 21H,  $\text{CH}_3 + \text{CH}_2$ ), 2.87 (s, 3H, NMe), 3.85 – 3.96 (m, 2H, H-5a, H-5b), 4.02 – 4.14 (m, 1H, H-2), 4.23 (dd,  $J = 2.8, 7.0 \text{ Hz}$ , 1H, H-3), 4.34 – 4.49 (m, 3H, H-1,  $\text{OCH}_2\text{Ph}$ ), 4.55 (d,  $J = 12.1 \text{ Hz}$ , 1H,  $\text{OCH}_2\text{Ph}$ ), 4.68 (d,  $J = 11.3 \text{ Hz}$ , 1H,  $\text{OCH}_2\text{Ph}$ ), 4.69 (d,  $J = 10.7 \text{ Hz}$ , 1H,  $\text{OCH}_2\text{Ph}$ ), 4.85 (d,  $J = 11.3 \text{ Hz}$ , 1H,  $\text{OCH}_2\text{Ph}$ ), 5.64 – 5.67 (m, 1H, H-4), 7.19 – 7.36 (m, 15H,  $\text{H}_{\text{Ar}}$ ), 7.75 (t,  $J = 7.6 \text{ Hz}$ , 2H,  $\text{H}_{\text{Ph}}$ ), 7.59 (t,  $J = 7.1 \text{ Hz}$ , 1H,  $\text{H}_{\text{Ph}}$ ), 8.08 (d,  $J = 8.0 \text{ Hz}$ , 2H,  $\text{H}_{\text{Ph}}$ )

**$^{13}\text{C}$  NMR** (101 MHz,  $\text{CDCl}_3$ ):  $\delta = 11.04$  ( $\text{SnCH}_2\text{CH}_2\text{CH}_2\text{CH}_3$ , satellites: 9.50, 9.57, 12.51, 12.58), 13.75 ( $\text{CH}_3$ ), 24.60 ( $\text{CH}_3$ ), 27.66 27.60 ( $\text{SnCH}_2\text{CH}_2\text{CH}_2\text{CH}_3$ , satellites: 27.35, 27.36, 27.97, 27.99), 29.20 ( $\text{SnCH}_2\text{CH}_2\text{CH}_2\text{CH}_3$ , satellites: 29.11, 29.30), 36.84 (N $\text{CH}_3$ ), 55.08 (C-1), 62.48 ( $\text{C}^{\text{IV}}_{t\text{-Bu}}$ ), 68.81 (C-5), 72.97 ( $\text{OCH}_2\text{Ph}$ ), 73.04 (C-4), 73.28 ( $\text{OCH}_2\text{Ph}$ ), 74.41 ( $\text{OCH}_2\text{Ph}$ ), 76.29 (C-3), 80.85 (C-2), 127.65 – 128.58 ( $\text{C}_{\text{Ar}}$ ), 130.06 ( $\text{C}_{\text{Ar}}$ ), 130.26 ( $\text{C}^{\text{IV}}_{\text{Ar}}$ ), 133.32 ( $\text{C}_{\text{Ar}}$ ), 137.96 ( $\text{C}^{\text{IV}}_{\text{Ar}}$ ), 138.18 ( $\text{C}^{\text{IV}}_{\text{Ar}}$ ), 165.82 ( $\text{C}^{\text{IV}}=\text{O}$ )

(1*R*)-2,3,5-Tri-*O*-benzyl-1-*N*-*tert*-butanesulfonylamino-1-deoxy-*N*-methyl-1-tributylstannyl-*D*-arabinitol **79**



The *N*-methylated stannane **77** (638 mg, 0.672 mmol, 1.0 eq.) was dissolved in anhydrous methanol (15.0 mL), and potassium carbonate (548 mg, 4.03 mmol, 6.0 eq.) was added portionwise. The mixture was allowed to react at room temperature for 16 h. The solvent was evaporated under reduced pressure and the residue was dissolved in Et<sub>2</sub>O (30.0 mL). The organic phase was washed three times with a saturated aqueous solution of NaCl (3 × 20.0 mL), dried over MgSO<sub>4</sub>, filtered through a cotton plug and concentrated under reduced pressure. The crude compound was purified by silica gel column chromatography using PE:EtOAc (9:1) as the eluent to afford compound **80** as pale yellow oil (552 mg, 97%).

**R<sub>f</sub>** = 0.3 (PE:EtOAc 9:1)

**IR (neat):**  $\nu = 3500, 3085, 3063, 3028, 2952, 2929, 2870, 2851, 1454, 1312, 1116, 1093, 1068, 1027, 932, 748, 732, 694 \text{ cm}^{-1}$

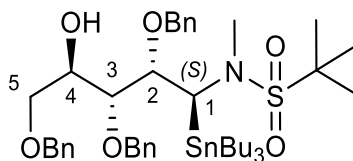
**HRMS (ESI):**  $m/z$  cal. for C<sub>43</sub>H<sub>71</sub>N<sub>2</sub>O<sub>6</sub>SSn [M + NH<sub>4</sub>]<sup>+</sup> 863.404930, found 863.404938  
for C<sub>43</sub>H<sub>67</sub>NNaO<sub>6</sub>SSn [M + Na]<sup>+</sup> 868.360325, found 868.360180

**<sup>1</sup>H NMR (400 MHz, CDCl<sub>3</sub>):**  $\delta =$

0.77 – 1.09 (m, 15H, CH<sub>3</sub> + CH<sub>2</sub>), 1.19 – 1.53 (m, 21H, CH<sub>3</sub> + CH<sub>2</sub>), 3.00 (s, 3H, NMe), 3.05 (bs, 1H, OH), 3.52 (dd,  $J = 6.9, 7.1 \text{ Hz}$ , 1H, H-3), 3.69 – 3.82 (m, 2H, H-5a, H-5b), 3.99 (bs, 1H, H-4), 4.05 – 4.25 (m, 2H, H-1, H-2), 4.48 – 4.60 (m, 3H, OCH<sub>2</sub>Ph), 4.64 (d,  $J = 11.3 \text{ Hz}$ , 1H, OCH<sub>2</sub>Ph), 4.81 (d,  $J = 11.0 \text{ Hz}$ , 1H, OCH<sub>2</sub>Ph), 4.96 (d,  $J = 10.8 \text{ Hz}$ , 1H, OCH<sub>2</sub>Ph), 7.16 – 7.39 (m, 15H, H<sub>Ar</sub>)

**<sup>13</sup>C NMR (101 MHz, CDCl<sub>3</sub>):**  $\delta = 11.95$  (SnCH<sub>2</sub>CH<sub>2</sub>CH<sub>2</sub>CH<sub>3</sub>, satellites: 10.38, 10.45, 13.46, 13.53), 13.72 (CH<sub>3</sub>), 24.74 (CH<sub>3</sub>), 27.62 (SnCH<sub>2</sub>CH<sub>2</sub>CH<sub>2</sub>CH<sub>3</sub>, satellites: 27.30, 27.31, 27.94, 27.95), 29.18 (SnCH<sub>2</sub>CH<sub>2</sub>CH<sub>2</sub>CH<sub>3</sub>, satellites: 29.09, 29.28), 39.84 (NCH<sub>3</sub>), 58.57 (C-1), 62.01 (C<sup>IV</sup><sub>*t*-Bu</sub>), 71.28 (C-5), 72.42 (C-4), 73.52 (OCH<sub>2</sub>Ph), 74.90 (OCH<sub>2</sub>Ph), 75.40 (OCH<sub>2</sub>Ph), 81.99 (C-3), 88.52 (C-2), 127.54 – 128.51 (C<sub>Ar</sub>), 138.35 (C<sup>IV</sup><sub>Ar</sub>), 138.61 (C<sup>IV</sup><sub>Ar</sub>), 138.68 (C<sup>IV</sup><sub>Ar</sub>)

(1S)-2,3,5-Tri-*O*-benzyl-1-*N*-*tert*-butanesulfonylamino-1-deoxy-*N*-methyl-1-tributylstannyl-*D*-arabinitol **80**



The *N*-methylated stannane **78** (666 mg, 0.702 mmol, 1.0 eq.) was dissolved in anhydrous methanol (15.0 mL) and potassium carbonate (582 mg, 4.21 mmol, 6.0 eq.) was added portionwise. The mixture was allowed to react at room temperature and following the reaction progress by TLC analysis. After 10 h, the reaction was not complete. Additional 4.0 eq. of potassium carbonate were added (388 mg, 2.80 mmol) and the reaction mixture was stirred further at the same temperature. After 16 h, the reaction was complete. The solvent was evaporated under reduced pressure and the residue was dissolved in Et<sub>2</sub>O (30.0 mL). The organic phase was washed three times with a saturated aqueous solution of NaCl (3 × 20.0 mL), dried over MgSO<sub>4</sub>, filtered through a cotton plug and concentrated under reduced pressure. The crude compound was purified by silica gel column chromatography using PE:EtOAc (9:1) as the eluent to afford compound **80** as pale yellow oil (559 mg, 94%).

$R_f = 0.35$  (PE:EtOAc 9:1)

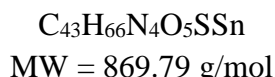
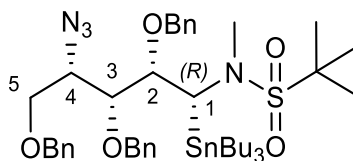
**IR (neat):**  $\nu = 3512, 3091, 3063, 3034, 2955, 2917, 2866, 1454, 1296, 1201, 1106, 1059, 1030, 951, 751, 698, 669 \text{ cm}^{-1}$

**HRMS (ESI):**  $m/z$  cal. for C<sub>43</sub>H<sub>71</sub>N<sub>2</sub>O<sub>6</sub>SSn [M + NH<sub>4</sub>]<sup>+</sup> 863.404930, found 863.405631  
for C<sub>43</sub>H<sub>67</sub>NNaO<sub>6</sub>SSn [M + Na]<sup>+</sup> 868.360325, found 868.361207

**<sup>1</sup>H NMR (400 MHz, CDCl<sub>3</sub>):**  $\delta = 0.81 - 0.88$  (m, 9H, CH<sub>3</sub>), 0.90 – 1.03 (m, 6H, CH<sub>2</sub>), 1.21 – 1.33 (m, 15H, CH<sub>2</sub> + CH<sub>3</sub>), 1.34 – 1.52 (m, 6H, CH<sub>2</sub>), 2.87 (s, 3H, NMe), 2.93 (d,  $J = 5.2$  Hz, 1H, OH), 3.65 (dd,  $J = 4.6, 9.8$  Hz, 1H, H-5a), 3.71 (dd,  $J = 2.1, 9.8$  Hz, 1H, H-5b), 3.78 (d,  $J = 8.2$  Hz, 1H, H-3), 4.03 – 4.10 (m, 1H, H-4), 4.11 – 4.21 (m, 1H, H-2), 4.26 – 4.43 (m, 1H, H-1), 4.49 – 4.62 (m, 4H, OCH<sub>2</sub>Ph), 4.66 (d,  $J = 11.2$  Hz, 1H, OCH<sub>2</sub>Ph), 4.85 (d,  $J = 11.2$  Hz, 1H, OCH<sub>2</sub>Ph), 7.20 – 7.35 (m, 15H, H<sub>Ar</sub>)

**<sup>13</sup>C NMR (101 MHz, CDCl<sub>3</sub>):**  $\delta = 11.05$  (SnCH<sub>2</sub>CH<sub>2</sub>CH<sub>2</sub>CH<sub>3</sub>, satellites: 9.50, 9.57, 12.53, 12.60), 13.76 (CH<sub>3</sub>), 24.66 (CH<sub>3</sub>), 27.65 (SnCH<sub>2</sub>CH<sub>2</sub>CH<sub>2</sub>CH<sub>3</sub>, satellites: 27.33, 27.35, 27.96, 27.97), 29.19 (SnCH<sub>2</sub>CH<sub>2</sub>CH<sub>2</sub>CH<sub>3</sub>, satellites: 29.10, 29.29), 36.77 (NCH<sub>3</sub>), 54.76 (C-1), 62.54 (C<sup>IV</sup><sub>*t*-Bu</sub>), 70.35 (C-4), 71.29 (C-5), 72.93 (OCH<sub>2</sub>Ph), 73.67 (OCH<sub>2</sub>Ph), 73.89 (OCH<sub>2</sub>Ph), 77.36 (C-3), 80.19 (C-2), 127.71 – 128.56 (C<sub>Ar</sub>), 138.06 (C<sup>IV</sup><sub>Ar</sub>), 138.08 (C<sup>IV</sup><sub>Ar</sub>), 138.31 (C<sup>IV</sup><sub>Ar</sub>)

(1*R*)-4-azido-2,3,5-Tri-*O*-benzyl-1-*N*-*tert*-butanesulfonylamino-1,4-dideoxy-*N*-methyl-1-tributylstannyl-L-xylitol **81**



**Procedure 1:** The *N*-methylated stannane **79** (134.0 mg, 0.158 mmol, 1.0 eq.) was dissolved in freshly distilled DCM (5.0 mL) under argon atmosphere, and triethylamine (88  $\mu$ L, 0.635 mmol, 4.0 eq.) was added. After 10 min, methanesulfonyl chloride (50  $\mu$ L, 0.635 mmol, 4.0 eq.) was added and the mixture was stirred for 2 h at room temperature. The reaction was quenched with a saturated aqueous solution of  $NH_4Cl$  (10.0 mL) and it was diluted with DCM (30.0 mL). The phases were separated; the aqueous phase was extracted twice with DCM (2  $\times$  15.0 mL). The combined organic phases were washed two times with a saturated aqueous solution of  $NH_4Cl$  (2  $\times$  30.0 mL) and then were dried over  $MgSO_4$ , filtered through a cotton plug and concentrated under reduced pressure. The product was used without further purification in the next step.

The crude intermediate mesylate was dissolved in anhydrous DMF (3.0 mL) under an argon atmosphere, and sodium azide (41.0 mg, 0.634 mmol, 4.0 eq.) and tetrabutylammonium bisulfate (53.0 mg, 0.158 mmol, 1.0 eq.) were added. The mixture was stirred for 16 h at 100  $^{\circ}C$ . Additional equivalents of sodium azide (41.0 mg, 0.634 mmol, 4.0 eq.) were added and the mixture was stirred for another 16 h at 100  $^{\circ}C$ . Afterwards, the reaction was quenched with MeOH (5.0 mL), diluted with EtOAc (20.0 mL) and extracted with a saturated aqueous solution of NaCl (10.0 mL). The phases were separated; the organic phase was washed four times with a saturated aqueous solution of NaCl (4  $\times$  10.0 mL) and then dried over  $MgSO_4$ , filtered through a cotton plug and concentrated under reduced pressure. The crude compound was purified by preparative TLC using PE:EtOAc (9:1) as the eluent to afford compound **81** as a white solid (26.3 mg, 19%).

**Procedure 2:** The *N*-methylated stannane **79** (500 mg, 0.592 mmol, 1.0 eq.) was dissolved in freshly distilled DCM (15.0 mL) under an argon atmosphere, and then triethylamine (0.25 mL, 1.77 mmol, 3.0 eq.) was added and the mixture was cooled down to  $-30^{\circ}C$ . After 10 min, tresylchloride (170  $\mu$ L, 1.48 mmol, 2.5 eq.) was added. The mixture was stirred for 2 h at 0  $^{\circ}C$ . The reaction was quenched with a saturated aqueous solution of  $NH_4Cl$  (10.0 mL). The phases were separated, and the aqueous phase was extracted once with DCM (15.0 mL). The combined organic phases were dried over  $MgSO_4$ , filtered through a cotton plug and concentrated under reduced pressure. The product was used subsequently, in the next step without further purification.

The crude intermediate tresylate was dissolved in anhydrous DMF (10.0 mL) under argon atmosphere, and sodium azide (385 mg, 5.92 mmol, 10.0 eq.) was added. The mixture was

stirred for 16 h at 70 °C. Additional equivalents of sodium azide (192 mg, 2.46 mmol, 5.0 eq.) were added and the mixture was stirred for 16 h at 80 °C. The reaction was quenched with MeOH (5.0 mL), diluted with EtOAc (30.0 mL) and washed with a saturated aqueous solution of NaCl (20.0 mL). The phases were separated; the organic phase was washed four times with a saturated aqueous solution of NaCl (4 × 20.0 mL) and then it was dried over MgSO<sub>4</sub>, filtered through a cotton plug and concentrated under reduced pressure. The crude compound was purified by silica gel column chromatography (Ø = 2.0 cm, L = 20 cm) using PE:EtOAc (9:1 to 5:5) as the eluent to afford compound **81** in form of a white solid (181 mg, 35%). In addition, starting material **79** was recovered (155 mg).

**R<sub>f</sub>** = 0.5 (PE:EtOAc 9:1)

**IR (neat):**  $\nu$  = 3056, 3018, 2955, 2923, 2873, 2854, 2100, 1638, 1594, 1489, 1435, 1302, 1230, 1198, 1109, 1068, 957, 926, 780, 755, 723, 691 cm<sup>-1</sup>

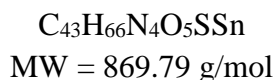
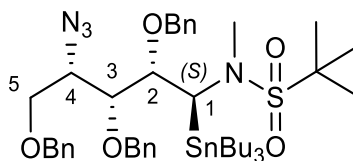
**HRMS (ESI):**  $m/z$  cal. for C<sub>43</sub>H<sub>70</sub>N<sub>5</sub>O<sub>5</sub>SSn [M + NH<sub>4</sub>]<sup>+</sup> 888.411412, found 888.711979  
for C<sub>43</sub>H<sub>66</sub>N<sub>4</sub>NaO<sub>5</sub>SSn [M + Na]<sup>+</sup> 893.366808, found 893.366940

**<sup>1</sup>H NMR (400 MHz, CDCl<sub>3</sub>):**  $\delta$  = 0.78 – 1.10 (m, 15H, CH<sub>2</sub> + CH<sub>3</sub>), 1.18 – 1.56 (m, 21H, CH<sub>2</sub> + CH<sub>3</sub>), 2.96 (s, 3H, NMe), 3.45 (d,  $J$  = 9.5 Hz, 1H, H-3), 3.54 – 3.62 (m, 2H, H-4, H-5a), 3.69 (t,  $J$  = 10.4 Hz, 1H, H-5b), 3.76 – 3.93 (m, 1H, H-1), 4.18 – 4.39 (m, 1H, H-2), 4.43 – 4.50 (m, 3H, OCH<sub>2</sub>Ph), 4.62 (d,  $J$  = 11.3 Hz, 1H, OCH<sub>2</sub>Ph), 4.90 (d,  $J$  = 11.3 Hz, 1H, OCH<sub>2</sub>Ph), 4.99 (d,  $J$  = 11.0 Hz, 1H, OCH<sub>2</sub>Ph), 7.16 – 7.39 (m, 15H, H<sub>Ar</sub>)

**<sup>13</sup>C NMR (101 MHz, CDCl<sub>3</sub>):**  $\delta$  = 11.87 (SnCH<sub>2</sub>CH<sub>2</sub>CH<sub>2</sub>CH<sub>3</sub>, satellites: 10.31, 10.38, 13.36, 13.42), 13.74 (CH<sub>3</sub>), 24.81 (CH<sub>3</sub>), 27.60 (SnCH<sub>2</sub>CH<sub>2</sub>CH<sub>2</sub>CH<sub>3</sub>, satellites: 27.28, 27.29, 27.91, 27.93), 29.22 (SnCH<sub>2</sub>CH<sub>2</sub>CH<sub>2</sub>CH<sub>3</sub>, satellites: 29.13, 29.32), 39.29 (NCH<sub>3</sub>), 57.45 (C-1), 60.65 (C-4), 61.78 (C<sup>IV</sup><sub>*t*-Bu</sub>), 69.08 (C-5), 73.57 (OCH<sub>2</sub>Ph), 74.92 (OCH<sub>2</sub>Ph), 75.72 (OCH<sub>2</sub>Ph), 80.24 (C-3), 87.11 (C-2), 127.65 – 128.57 (C<sub>Ar</sub>), 137.59 (C<sup>IV</sup><sub>Ar</sub>), 138.04 (C<sup>IV</sup><sub>Ar</sub>), 138.29 (C<sup>IV</sup><sub>Ar</sub>)



(1*S*)-4-azido-2,3,5-Tri-*O*-benzyl-1-*N*-*tert*-butanesulfonylamino-1,4-dideoxy-*N*-methyl-1-tributylstannyl-L-xylitol **83**



The *N*-methylated stannane **80** (519 mg, 0.614 mmol, 1.0 eq.) was dissolved in freshly distilled DCM (15.0 mL) under an argon atmosphere, and triethylamine (0.26 mL, 1.84 mmol, 3.0 eq.) was added. The mixture was cooled down to  $-30$  °C. After 10 min, tresyl chloride (0.17 mL, 1.65 mmol, 2.5 eq.) was added. The mixture was stirred for 2 h at 0 °C. The reaction was quenched with a saturated aqueous solution of  $NH_4Cl$  (10.0 mL). The phases were separated; the aqueous phase was extracted once with DCM (15.0 mL). The combined organic phases were dried over  $MgSO_4$ , filtered through a cotton plug and concentrated under reduced pressure. The product was used subsequently in the next without further purification.

The crude intermediate tresylate was dissolved in anhydrous DMF (10.0 mL) under an argon atmosphere, and sodium azide (400 mg, 6.14 mmol, 10.0 eq.) was added. The mixture was stirred for 16 h at 70 °C. Additional equivalents of sodium azide (192 mg, 2.46 mmol, 5.0 eq.) were added and the mixture was stirred for 16 h at 50 °C. The reaction was quenched with MeOH (5.0 mL), it was diluted with EtOAc (30.0 mL) and washed with a saturated aqueous solution of NaCl (20.0 mL). The phases were separated; the organic phase was washed four times with a saturated aqueous solution of NaCl ( $4 \times 20.0$  mL) and then it was dried over  $MgSO_4$ , filtered through a cotton plug and concentrated under reduced pressure. The crude compound was purified by silica gel column chromatography ( $\varnothing = 2.0$  cm,  $L = 20$  cm) using PE:EtOAc (9:1 to 5:5) as the eluent to afford compound **83** in form of a white solid (104 mg, 20%). In addition, starting material **80** was recovered (92 mg).

$R_f = 0.6$  (PE:EtOAc 9:1)

**IR (neat):**  $\nu = 3060, 3017, 2953, 2926, 2871, 2853, 2105, 1639, 1594, 1487, 1196, 1110, 959, 926, 752, 690$   $cm^{-1}$

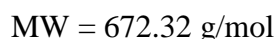
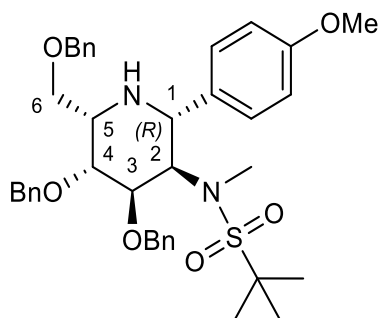
**HRMS (ESI):**  $m/z$  cal. for  $C_{43}H_{66}N_4NaO_5SSn$   $[M + Na]^+$  893.366808, found 893.367138

**$^1H$  NMR (400 MHz,  $CDCl_3$ ):**  $\delta = 0.80 - 1.06$  (m, 15H,  $CH_2 + CH_3$ ), 1.16 – 1.52 (m, 21H,  $CH_2 + CH_3$ ), 3.05 (s, 3H, NMe), 3.59 – 3.69 (m, 2H, H-5a, H-5b), 3.78 – 3.85 (m, 1H, H-4), 3.86 – 3.91 (m, 1H, H-2), 3.92 – 3.98 (m, 1H, H-3), 3.99 – 4.15 (m, 1H, H-1), 4.44 – 4.57 (m, 4H,  $OCH_2Ph$ ), 4.72 (d,  $J = 11.3$  Hz, 1H,  $OCH_2Ph$ ), 4.97 (d,  $J = 11.5$  Hz, 1H,  $OCH_2Ph$ ), 7.16 – 7.38 (m, 15H,  $H_{Ar}$ )

**$^{13}C$  NMR (101 MHz,  $CDCl_3$ ):**  $\delta = 11.32$  ( $SnCH_2CH_2CH_2CH_3$ , satellites: 9.77, 9.84, 12.80, 12.87), 13.71 ( $CH_3$ ), 25.06 ( $CH_3$ ), 27.60 ( $SnCH_2CH_2CH_2CH_3$ , satellites: 27.28, 27.30, 27.91,

27.92), 29.21 ( $\text{SnCH}_2\text{CH}_2\text{CH}_2\text{CH}_3$ , satellites: 29.11, 29.30), 39.09 ( $\text{NCH}_3$ ), 54.27 (C-1), 61.92 (C-4), 62.47 ( $\text{C}^{\text{IV}}_{t\text{-Bu}}$ ), 70.54 (C-5), 73.31 ( $\text{OCH}_2\text{Ph}$ ), 74.53 ( $\text{OCH}_2\text{Ph}$ ), 75.16 ( $\text{OCH}_2\text{Ph}$ ), 78.19 (C-3), 82.62 (C-2), 127.18 – 128.47 ( $\text{C}_{\text{Ar}}$ ), 137.64 ( $\text{C}^{\text{IV}}_{\text{Ar}}$ ), 138.04 ( $\text{C}^{\text{IV}}_{\text{Ar}}$ ), 138.60 ( $\text{C}^{\text{IV}}_{\text{Ar}}$ )

(1*R*)-2-(*N*-*tert*-Butanesulfonyl-*N*-methylamino)-3,4,6-tri-*O*-benzyl-1,2,5-trideoxy-1,5-imino-1-*C*-*p*-methoxyphenyl-L-gulitol **87**



The stannylated azide **81** (178 mg, 0.205 mmol, 1.0 eq.) was dissolved in *i*-PrOH (10.0 mL) under argon atmosphere, and triethylamine (112  $\mu$ L) and palladium on charcoal (10%, 45 mg) were added. Then, the septum screw-top flask was evacuated and backfilled three times with hydrogen using a needle attached to a vacuum manifold (5 min of vacuum followed by 2 min of hydrogen). The mixture was stirred for 16 h at room temperature under a positive pressure of hydrogen (hydrogen filled balloon). Afterwards, the reaction mixture was filtered through membrane filter, rinsed with DCM (10.0 mL) and concentrated under reduced pressure. The product was used without further purification in the next step.

The crude intermediate amine was dissolved in freshly distilled DCM (5.0 mL) under argon atmosphere, and *para*-anisaldehyde (25  $\mu$ L, 0.205 mmol, 1.0 eq.) and molecular sieves 4 $\text{\AA}$  (50.0 mg) were added. The mixture was stirred for 3 h at room temperature. Afterwards, the reaction mixture was filtered through membrane filter, rinsed with DCM and concentrated under reduced pressure to give **86** which was used without further purification.

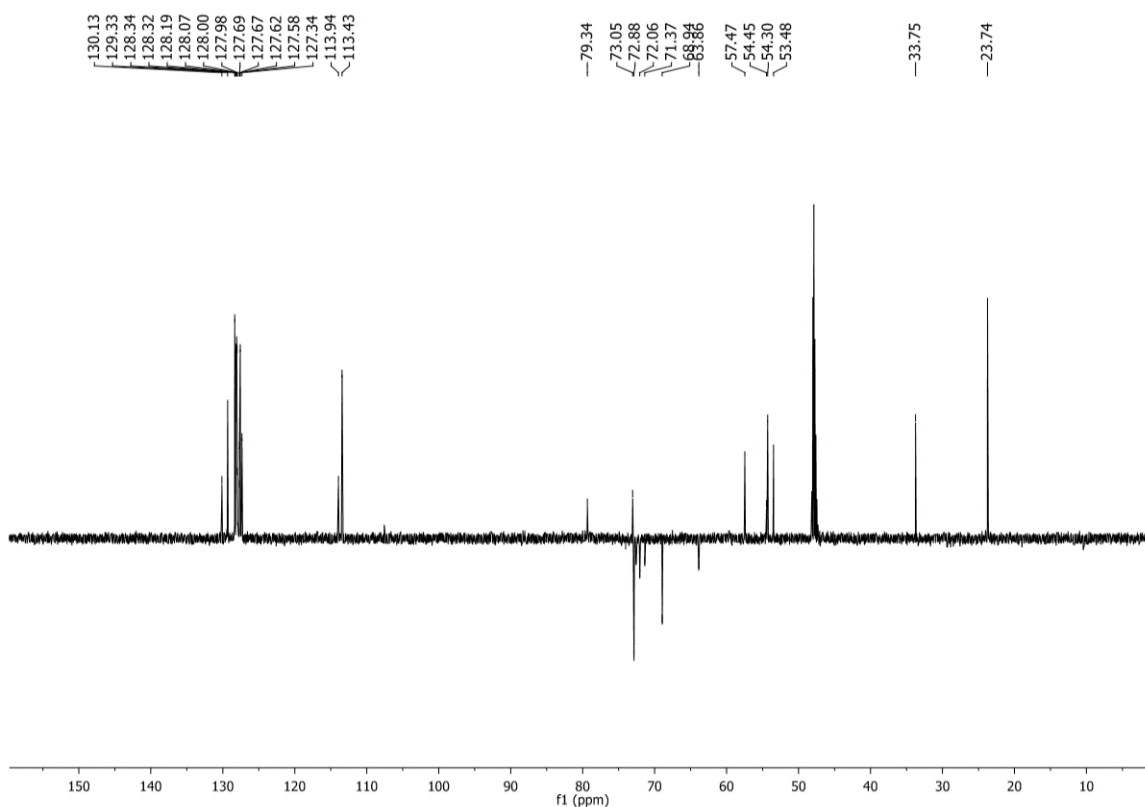
Flask A was charged with  $\text{Cu}(\text{OTf})_2$  (74 mg, 0.205 mmol, 1.0 eq., STREM), 2,6-lutidine (24  $\mu$ L, 0.205 mmol, 1.0 eq.) and HFIP (1.0 mL), and the mixture was stirred for 1 h at room temperature (the colour changed from blue to dark green). Afterwards, in flask B, the crude intermediate imine **86** was dissolved in DCE (4.0 mL). The content of flask B was added to flask A via syringe. The mixture was stirred for 16 h at 50  $^\circ\text{C}$  (the reaction mixture changed colour to brown). The reaction was quenched with a 10% aqueous solution of  $\text{NH}_4\text{OH}$  (5.0 mL) and it was stirred for 20 min. Afterwards, it was diluted with DCM (20.0 mL). The phases were separated; the aqueous phase was extracted twice with DCM ( $2 \times 10.0$  mL). The combined organic phases were washed twice with a 10% aqueous solution of  $\text{NH}_4\text{OH}$  ( $2 \times 10.0$  mL) and twice with a saturated aqueous solution of NaCl ( $2 \times 20.0$  mL). It dried over  $\text{MgSO}_4$ , filtered through a cotton plug and concentrated under reduced pressure. The crude compound was purified by preparative TLC using PE:EtOAc (7:3) as the eluent. The obtained fractions were analysed by LR-MS; fraction containing compound product were combined and purified by preparative TLC using PE:EtOAc (7:3) as the eluent to afford compound **87** in form of a colourless oil (6 mg, 4%).

**R<sub>f</sub>** = 0.3 (PE:EtOAc 7:3)

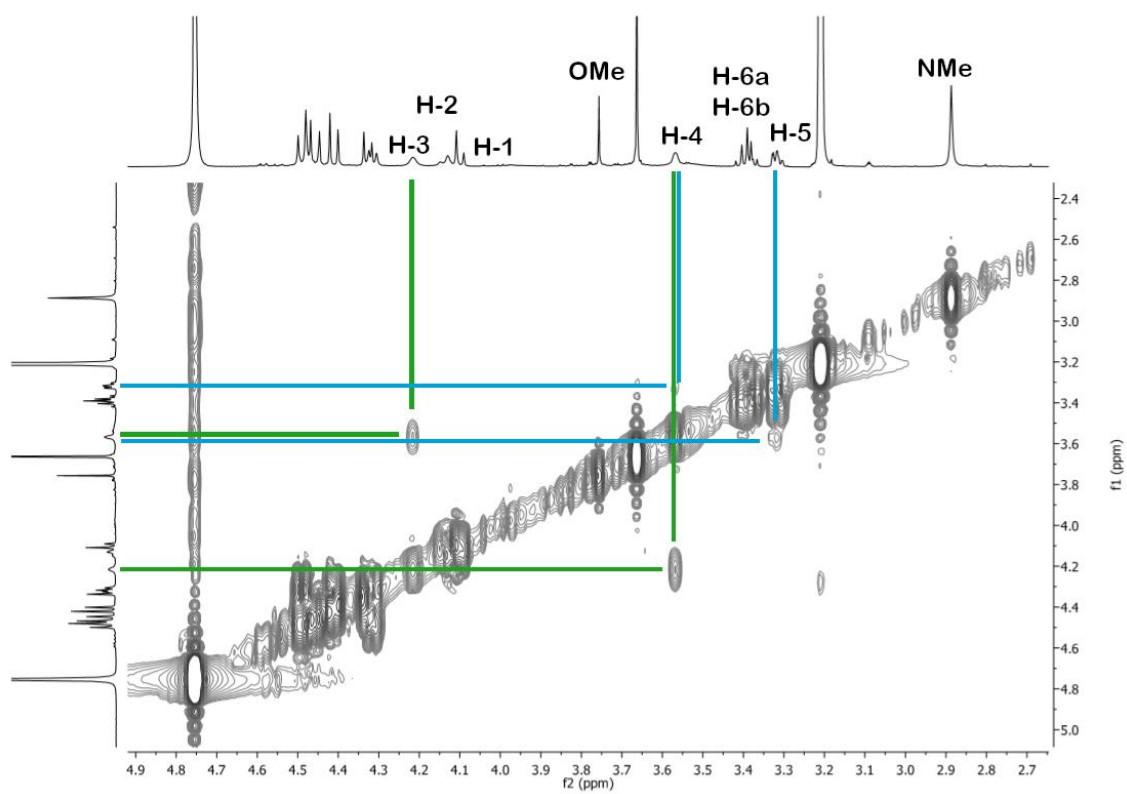
**<sup>1</sup>H NMR (600 MHz, CD<sub>3</sub>OD):** δ = 0.93 (s, 9H, CH<sub>3</sub>), 2.89 (s, 3H, NMe), 3.28 – 3.34 (m, 1H, H-5), 3.35 – 3.43 (m, 2H, H-6a, H-6b), 3.57 (bs, 1H, H-4), 3.66 (s, 3H, OMe), 4.10 (d, *J* = 10.5 Hz, 1H, H-1), 4.14 (d, *J* = 10.5 Hz, 1H, H-2), 4.22 (bs, 1H, H-3), 4.29 – 4.35 (m, 2H, OCH<sub>2</sub>Ph), 4.38 – 4.52 (m, 5H, OCH<sub>2</sub>Ph), 6.78 (d, *J* = 8.7 Hz, 2H, H<sub>Ar</sub>), 6.96 (d, *J* = 8.7 Hz, 1H, H<sub>Ar</sub>), 7.09 – 7.33 (m, 20H, H<sub>Ar</sub>), 7.40 (d, *J* = 8.7 Hz, 1H, H<sub>Ar</sub>)

**<sup>13</sup>C DEPT NMR (151 MHz, CD<sub>3</sub>OD):** δ = 23.74 (CH<sub>3</sub> *t*-Bu), 33.75 (NCH<sub>3</sub>), 53.48 (C-5), 54.30 (OCH<sub>3</sub>), 54.45, 57.47 (C-1 or C-2), 60.0 (very broad, C-1 or C-2), 63.86, 68.94 (C-6), 71.37 (OCH<sub>2</sub>Ph), 72.06 (OCH<sub>2</sub>Ph), 72.88 (OCH<sub>2</sub>Ph), 73.05 (C-4), 79.34 (C-3), 113.43, 113.94, 127.34 – 130.13 (C<sub>Ar</sub>)

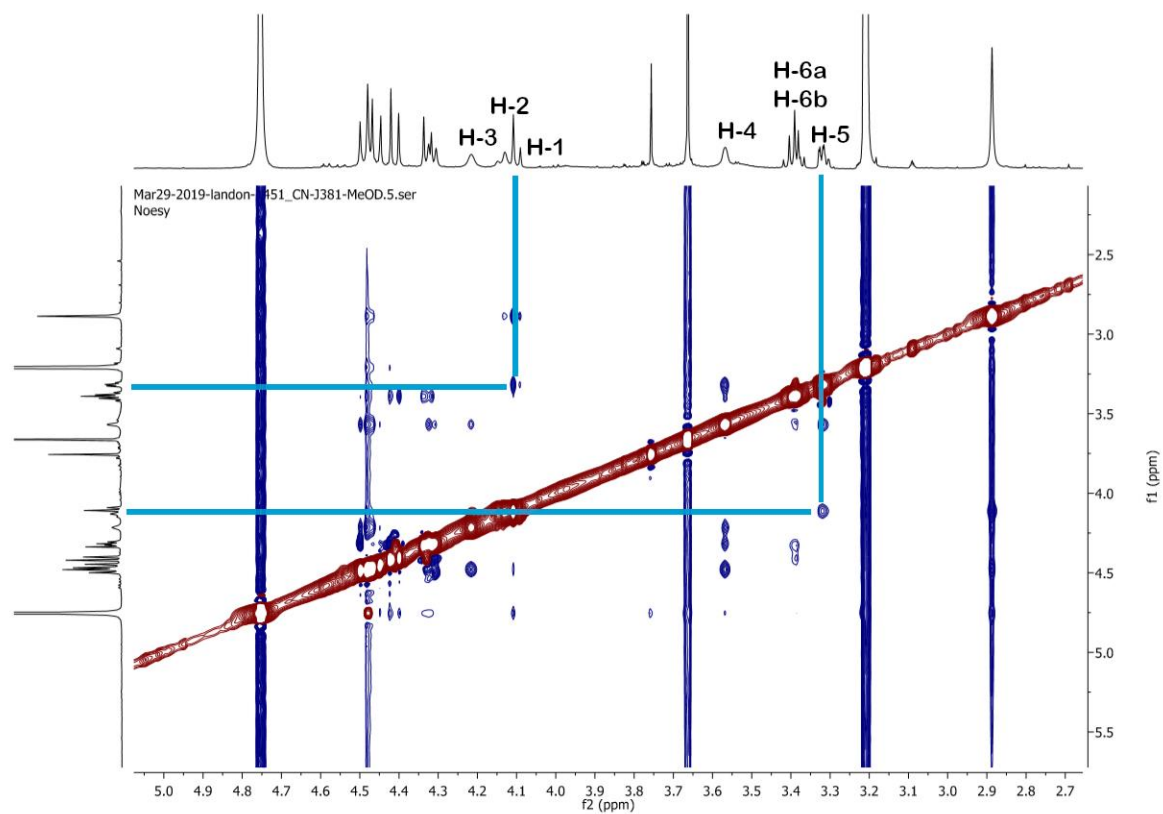
**<sup>13</sup>C DEPT NMR (151 MHz, CD<sub>3</sub>OD):**



**COSY (CD<sub>3</sub>OD):**

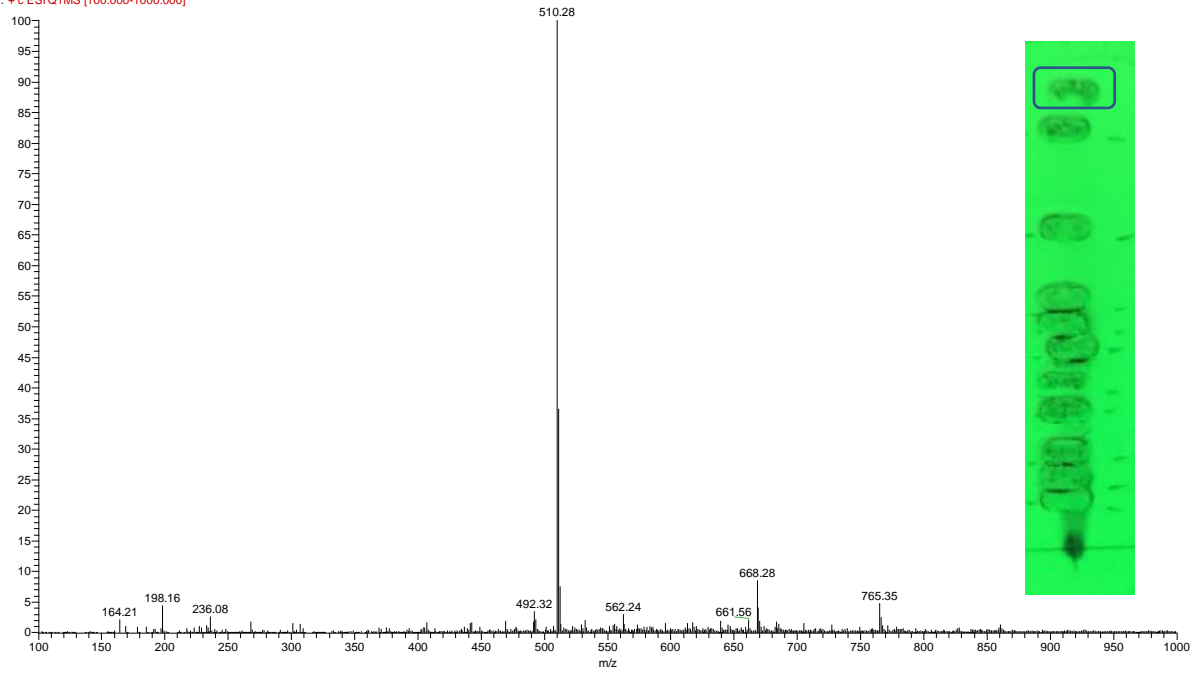


**NOESY (CD<sub>3</sub>OD):**

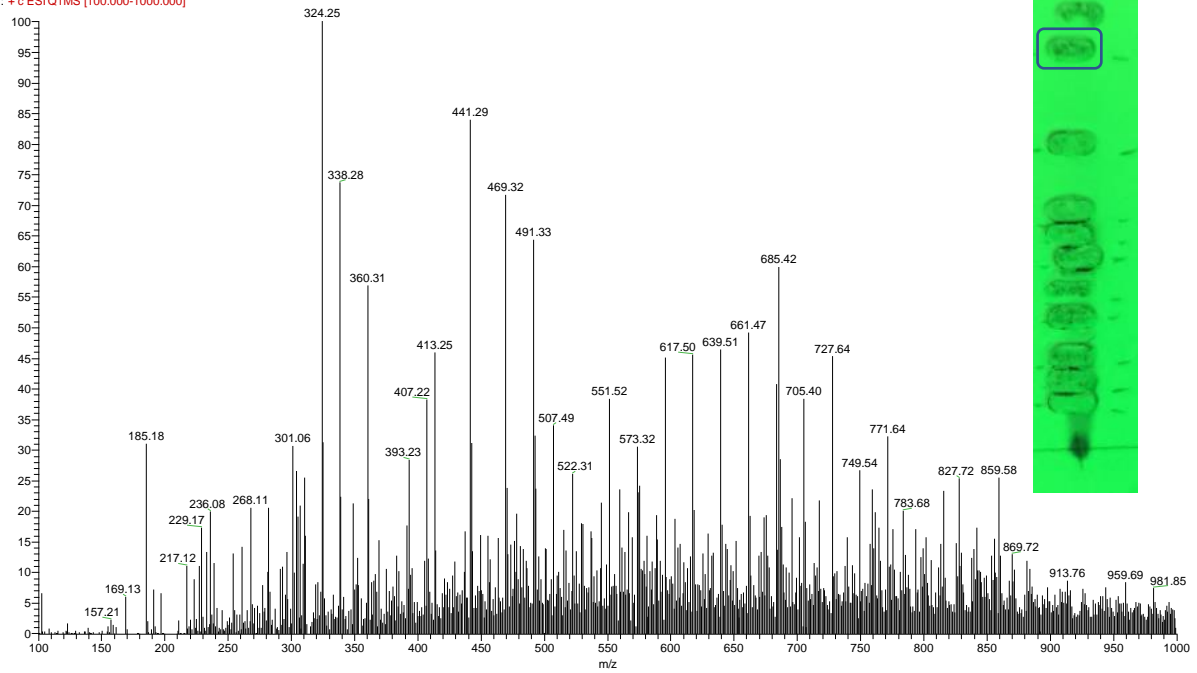


# TLC-MS afted double reductive amination – remaining fractions

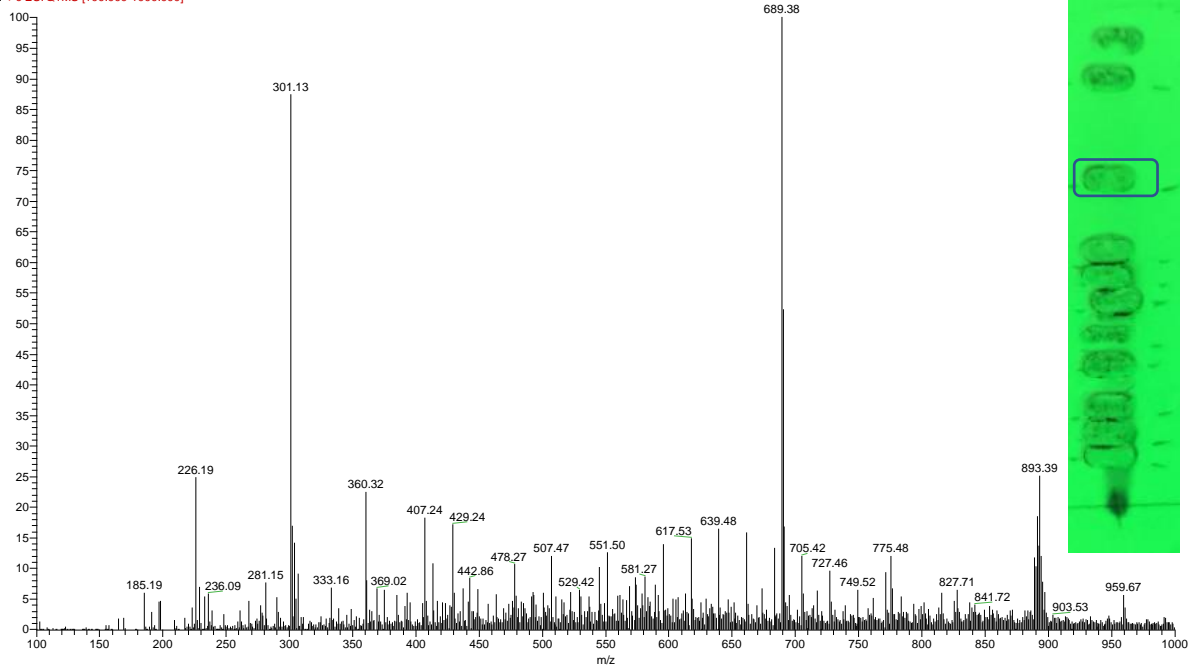
2018113-JAJ343-11 #33-41 RT: 0.50-0.62 AV: 9 SB: 40 0.08-0.34 ,1.14-1.45 NL: 4.64E7  
F: + c ESI Q1MS [100.000-1000.000]



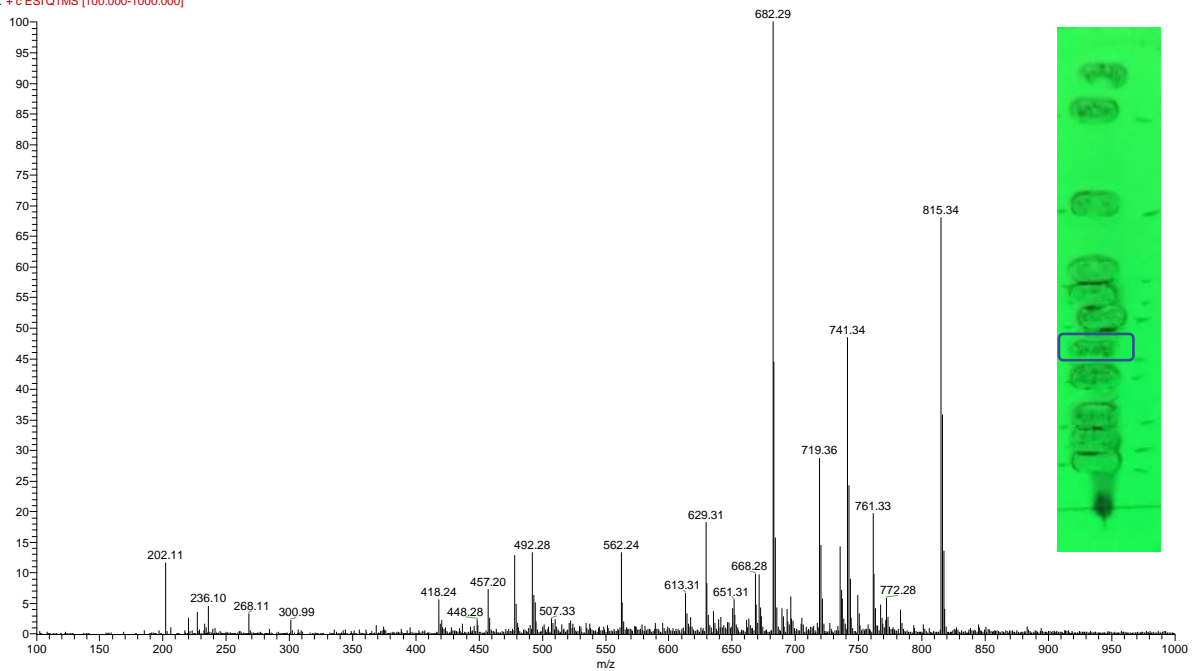
2018113-JAJ343-10 #31-38 RT: 0.48-0.58 AV: 8 SB: 22 0.19-0.34 ,0.90-1.05 NL: 2.32E6  
F: + c ESI Q1MS [100.000-1000.000]



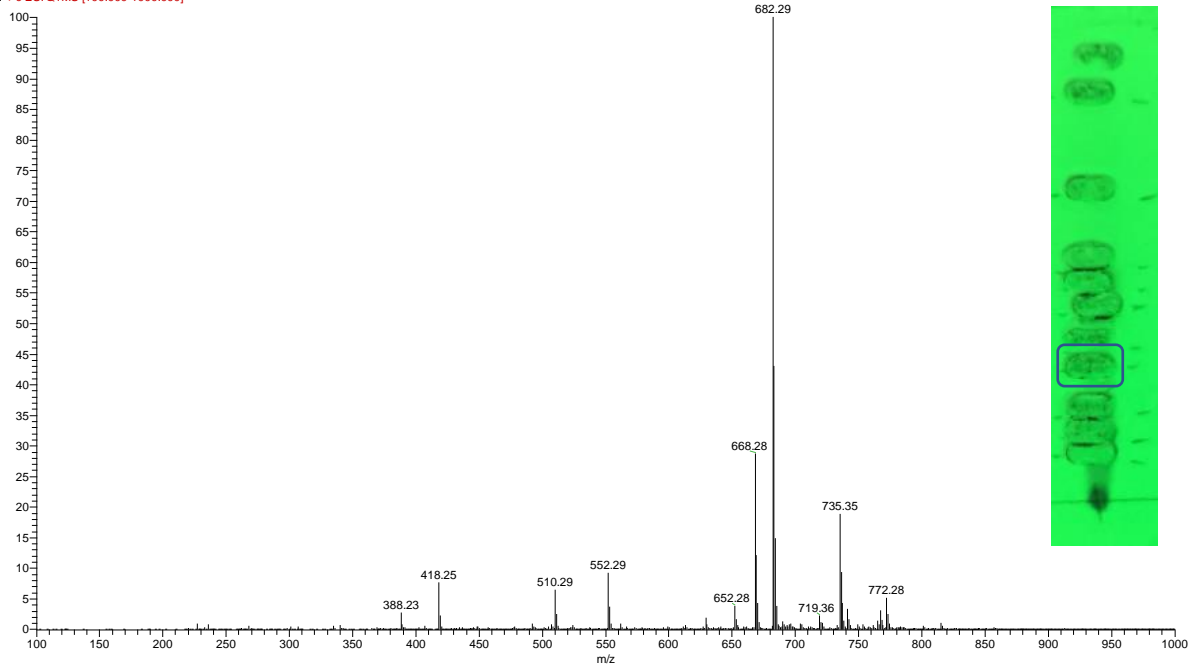
2018113-JAJ343-9 #33-40 RT: 0.49-0.60 AV: 8 SB: 18 0.21-0.33, 0.84-0.96 NL: 6.53E6  
F: + c ESI Q1MS [100.000-1000.000]



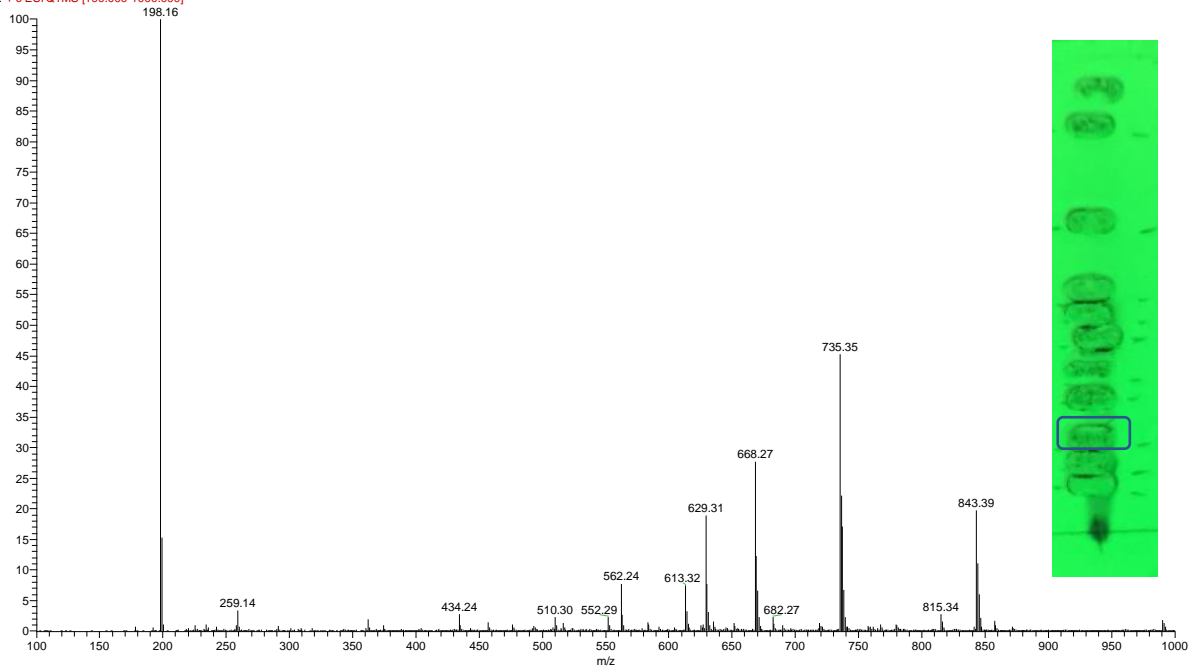
2018113-JAJ343-5 #29-41 RT: 0.44-0.63 AV: 13 SB: 84 0.08-0.35, 1.56-2.52 NL: 1.82E7  
F: + c ESI Q1MS [100.000-1000.000]



2018113-JAJ343-4 #32-44 RT: 0.47-0.65 AV: 13 SB: 40 0.08-0.30, 1.24-1.58 NL: 7.38E7  
F: + c ESI Q1MS [100.000-1000.000]

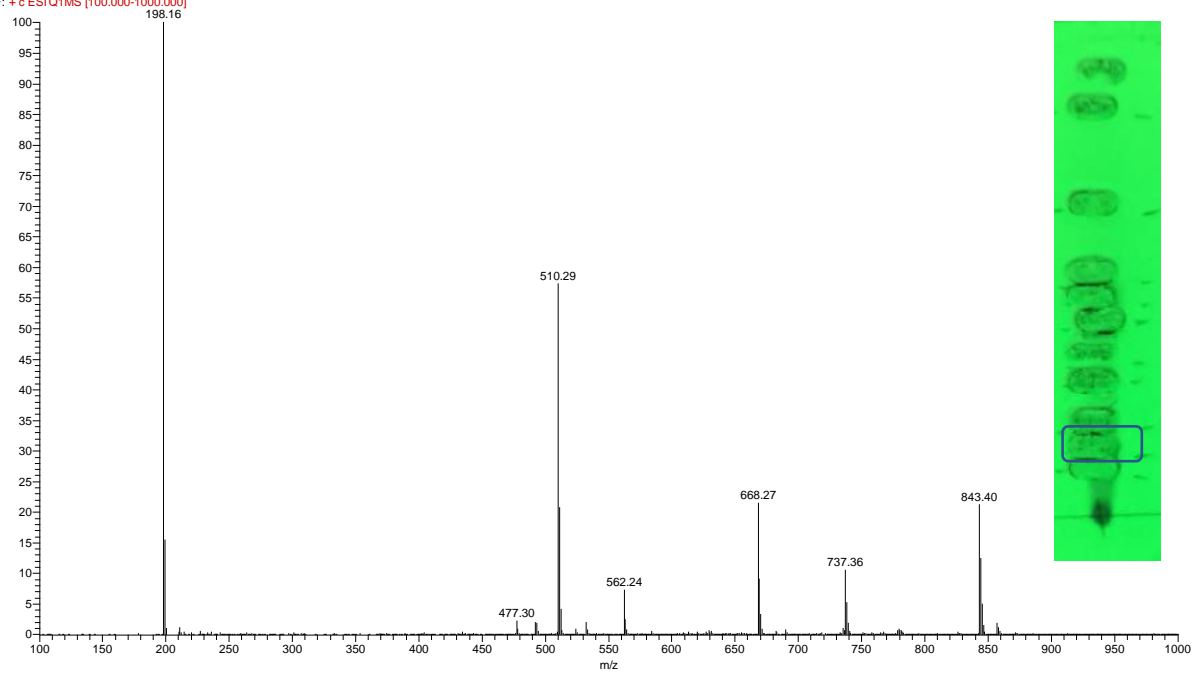


2018113-JAJ343-3 #33-41 RT: 0.48-0.60 AV: 9 SB: 44 0.08-0.32, 1.27-1.66 NL: 6.69E7  
F: + c ESI Q1MS [100.000-1000.000]

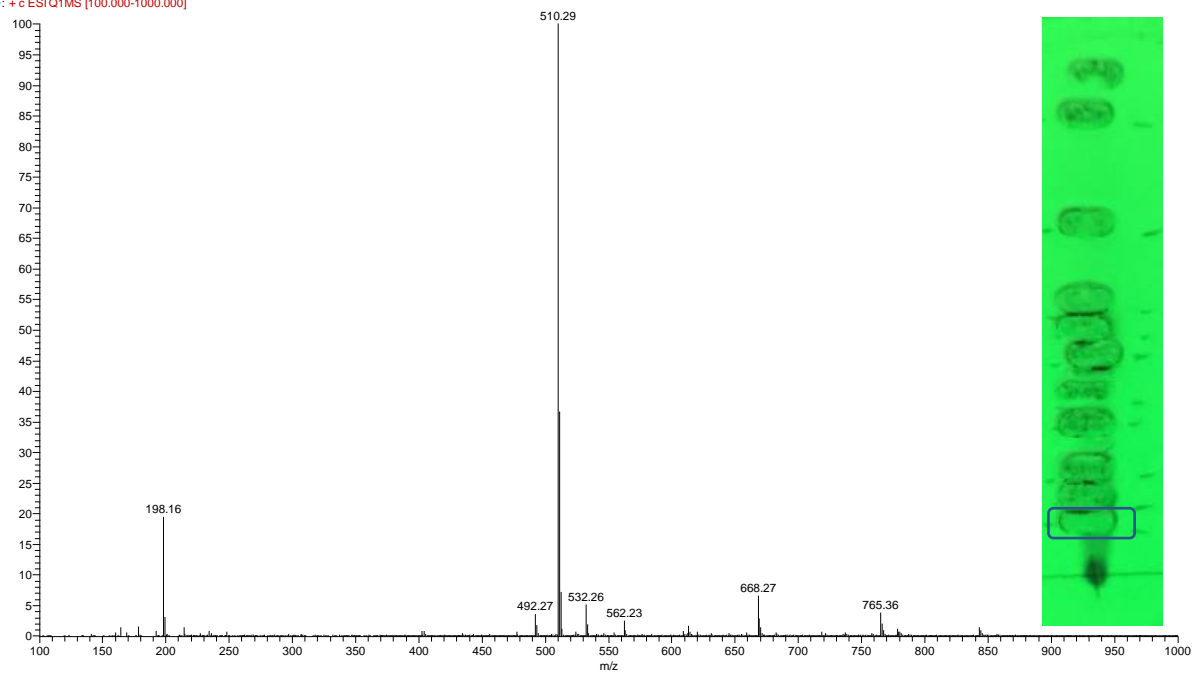




2018113-JAJ343-2 #32-47 RT: 0.47-0.69 AV: 16 SB: 63 0.00-0.32 , 1.25-1.85 NL: 8.42E7  
F: + c ESI Q1MS [100.000-1000.000]



2018113-JAJ343-1 #32-47 RT: 0.47-0.69 AV: 16 SB: 93 0.05-0.30 , 1.42-2.53 NL: 1.37E8  
F: + c ESI Q1MS [100.000-1000.000]





# **Bibliography**

---



- (1) T. Nishikawa, N. Ishida, *J. Antibiot.* **1965**, *18*, 132–133.
- (2) S. Inouye, T. Tsuruoka, T. Niida, *J. Antibiot.* **1966**, *19*, 288–292.
- (3) N. Ishida, K. Kumagai, T. Niida, K. Hamamoto, T. Shomura, *J. Antibiot.* **1967**, *20*, 62–65.
- (4) N. Ishida, K. Kumagai, T. Niida, T. Shomura, H. Yumoto, *J. Antibiot.* **1967**, *20*, 66–71.
- (5) S. Inouye, T. Tsuruoka, T. Ito, T. Niida, *Tetrahedron* **1968**, *24*, 2125–2144.
- (6) H. Paulsen, *Angew. Chem.* **1962** *74*, 901–918.
- (7) J. K. N. Jones, J. C. Turner, *J. Chem. Soc.* **1962**, 4699–4703.
- (8) T. Niwa, T. Tsuruoka, H. Goi, Y. Kodama, J. Itoh, S. Inouye, Y. Yamada, T. Niida, M. Nobe, Y. Ogawa, *J. Antibiot.* **1984**, *37*, 1579–1586.
- (9) Y. Miyake, M. Ebata, *J. Antibiot.* **1987**, *40*, 122–123.
- (10) H. Umezawa, T. Aoyagi, T. Komiyama, H. Morishima, M. Hamada, T. Takeuchi, *J. Antibiot.* **1974**, *27*, 963–969.
- (11) Y. Nishimura, W. Wang, S. Kondo, T. Aoyagi, H. Umezawa, *J. Am. Chem. Soc.* **1988**, *110*, 7249–7250.
- (12) M. Koyama, S. Sakamura, *Agric. Biol. Chem.* **1974**, *38*, 1111–1112.
- (13) M. Yagi, T. Kouno, Y. Aoyagi, H. Murai, *Nippon Nogei Kagaku Kaishi* **1976**, *50*, 571–572.
- (14) H. Paulsen, I. Sangster, K. Heyns, *Chem. Ber.* **1967**, *100*, 802–815.
- (15) D. D. Schmidt, W. Frommer, L. Müller, E. Truscheit, *Naturwissenschaften* **1979**, *66*, 584–585.
- (16) S. Murao, S. Miyata, *Agric. Biol. Chem.* **1980**, *44*, 219–221.
- (17) N. Asano, E. Tomioka, H. Kizu, K. Matsui, *Carbohydr. Res.* **1994**, *253*, 235–245.
- (18) N. Asano, K. Oseki, E. Tomioka, H. Kizu, K. Matsui, *Carbohydr. Res.* **1994**, *259*, 243–255.
- (19) N. Asano, T. Yamashita, K. Yasuda, K. Ikeda, H. Kizu, Y. Kameda, A. Kato, R. J. Nash, H. S. Lee, K. S. Ryu, *J. Agric. Food Chem.* **2001**, *49*, 4208–4213.

- (20) L. E. Fellows, E. A. Bell, D. G. Lynn, F. Pilkiewicz, I. Miura, K. Nakanishi, *J. Chem. Soc. Chem. Commun.* **1979**, 977–978.
- (21) S. V. Evans, L. E. Fellows, E. A. Bell, *Phytochemistry* **1983**, *22*, 768–770.
- (22) H. Kim, Y. Kim, Y. Hong, N. Paek, H. Lee, T. Kim, K. Kim, J. Lee, *Planta Med.* **1999**, *65*, 437–439.
- (23) S. M. Colegate, P. R. Dorling, C. R. Huxtable, *Aust. J. Chem.* **1979**, *32*, 2257–2264.
- (24) P. R. Dorling, C. R. Huxtable, P. Vogel, *Neuropathol. Appl. Neurobiol.* **1978**, *4*, 285–295.
- (25) S. L. Selwyn L. Everist, *Poisonous Plants of Australia*, Angus & Robertson, **1974**.
- (26) L. D. Hohenschutz, E. A. Bell, P. J. Jewess, D. P. Leworthy, R. J. Pryce, E. Arnold, J. Clardy, *Phytochemistry* **1981**, *20*, 811–814.
- (27) B. D. Walker, M. Kowalski, W. C. Goh, K. Kozarsky, M. Krieger, C. Rosen, L. Rohrschneider, W. A. Haseltine, J. Sodroski, *Proc. Natl. Acad. Sci. U. S. A.* **1987**, *84*, 8120–8124.
- (28) P. S. Sunkara, T. L. Bowlin, P. S. Liu, A. Sjoerdsma, *Biochem. Biophys. Res. Commun.* **1987**, *148*, 206–210.
- (29) G. K. Ostrander, N. K. Scribner, L. R. Rohrschneider, *Cancer Res.* **1988**, *48*, 1091–1094.
- (30) R. J. Nash, L. E. Fellows, J. V Dring, G. W. J. Fleet, A. E. Derome, T. A. Hamor, A. M. Scofield, D. J. Watkin, *Tetrahedron Lett.* **1988**, *29*, 2487–2490.
- (31) R. J. Molyneux, M. Benson, R. Y. Wong, J. E. Tropea, A. D. Elbein, *J. Nat. Prod.* **1988**, *51*, 1198–1206.
- (32) R. J. Nash, P. I. Thomas, R. D. Waigh, G. W. J. Fleet, M. R. Wormald, P. M. de Q. Lilley, D. J. Watkin, *Tetrahedron Lett.* **1994**, *35*, 7849–7852.
- (33) R. N. Chopra, S. L. Nayar, I. C. Chopra, *Glossary of Indian Medicinal Plants*, Council Of Scientific And Industrial Research, **1956**.
- (34) M. Iwami, O. Nakayama, H. Terano, M. Kohsaka, H. Aoki, H. Imanaka, *J. Antibiot.* **1987**, *40*, 612–622.
- (35) H. Kayakiri, S. Takase, T. Shibata, M. Okamoto, H. Terano, M. Hashimoto, T. Tada, S. Koda, *J. Org. Chem.* **1989**, *54*, 4015–4016.

- (36) H. Kayakiri, C. Kasahara, T. Oku, M. Hashimoto, *Tetrahedron Lett.* **1990**, *31*, 225–226.
- (37) T. M. Cox, J. M. F. G. Aerts, G. Andria, M. Beck, N. Belmatoug, B. Bembi, R. Chertkoff, S. Vom Dahl, D. Elstein, A. Erikson, et al., *J. Inherit. Metab. Dis.* **2003**, *26*, 513–526.
- (38) J.-Q. Fan, S. Ishii, N. Asano, Y. Suzuki, *Nat. Med.* **1999**, *5*, 112–115.
- (39) <https://clinicaltrials.gov/ct2/show/NCT03729362> PROPEL Study - A Study Comparing ATB200/AT2221 With Alglucosidase/Placebo in Adult Subjects With LOPD
- (40) <https://clinicaltrials.gov/ct2/show/NCT00157534> A Study to Evaluate the Safety and Efficacy of Celgosivir in Patients With Chronic Hepatitis C Genotype 1 Infection
- (41) <https://clinicaltrials.gov/ct2/show/NCT01619969> Celgosivir as a Treatment Against Dengue (CELADEN)
- (42) J. G. Low, C. Sung, L. Wijaya, Y. Wei, A. P. S. Rathore, S. Watanabe, B. H. Tan, L. Toh, L. T. Chua, Y. Hou, et al., *Lancet Infect. Dis.* **2014**, *14*, 706–715.
- (43) C. Sung, Y. Wei, S. Watanabe, H. S. Lee, Y. M. Khoo, L. Fan, A. P. S. Rathore, K. W.-K. Chan, M. M. Choy, U. S. Kamaraj, et al., *PLoS Negl. Trop. Dis.* **2016**, *10*, e0004851.
- (44) H. Böshagen, W. Geiger, B. Junge, *Angew. Chem. Int. Ed. Eng.* **1981**, *20*, 806–807.
- (45) M. Shibano, S. Kitagawa, G. Kusano, *Chem. Pharm. Bull. (Tokyo)*. **1997**, *45*, 505–508.
- (46) M. Shibano, S. Kitagawa, S. Nakamura, N. Akazawa, G. Kusano, *Chem. Pharm. Bull. (Tokyo)*. **1997**, *45*, 700–705.
- (47) M. Shibano, S. Nakamura, N. Akazawa, G. Kusano, *Chem. Pharm. Bull. (Tokyo)*. **1998**, *46*, 1048–1050.
- (48) M. Shibano, S. Nakamura, N. Motoya, G. Kusano, *Chem. Pharm. Bull. (Tokyo)*. **1999**, *47*, 472–476.
- (49) M. Shibano, D. Tsukamoto, G. Kusano, *Chem. Pharm. Bull. (Tokyo)*. **1999**, *47*, 907–908.
- (50) M. Shibano, D. Tsukamoto, R. Fujimoto, Y. Masui, H. Sugimoto, G. Kusano, *Chem. Pharm. Bull. (Tokyo)*. **2000**, *48*, 1281–1285.
- (51) D. Tsukamoto, M. Shibano, R. Okamoto, G. Kusano, *Chem. Pharm. Bull. (Tokyo)*. **2001**, *49*, 492–496.

- (52) D. Tsukamoto, M. Shibano, G. Kusano, *Chem. Pharm. Bull. (Tokyo)*. **2001**, *49*, 1487–1491.
- (53) M. Shibano, D. Tsukamoto, A. Masuda, Y. Tanaka, G. Kusano, *Chem. Pharm. Bull. (Tokyo)*. **2001**, *49*, 1362–1365.
- (54) M. Shibano, D. Tsukamoto, G. Kusano, *Heterocycles* **2002**, *57*, 1539–1553.
- (55) N. L. Segraves, P. Crews, *J. Nat. Prod.* **2005**, *68*, 118–121.
- (56) K. T. Weber, D. Hammache, J. Fantini, B. Ganem, *Bioorg. Med. Chem. Lett.* **2000**, *10*, 1011–1014.
- (57) L. A. Augustin, J. Fantini, D. R. Mootoo, *Bioorg. Med. Chem.* **2006**, *14*, 1182–1188.
- (58) R. W. Miles, P. C. Tyler, R. H. Furneaux, C. K. Bagdassarian, V. L. Schramm, *Biochemistry* **1998**, *37*, 8615–8621.
- (59) R. H. Furneaux, P. C. Tyler, V. L. Schramm **1999-2000**, WO 00/61783
- (60) G. B. Evans, R. H. Furneaux, A. Lewandowicz, V. L. Schramm, P. C. Tyler, *J. Med. Chem.* **2003**, *46*, 5271–5276.
- (61) E. A. Taylor, K. Clinch, P. M. Kelly, L. Li, G. B. Evans, P. C. Tyler, V. L. Schramm, *J. Am. Chem. Soc.* **2007**, *129*, 1126–1143.
- (62) K. Clinch, G. B. Evans, G. W. J. Fleet, R. H. Furneaux, S. W. Johnson, D. H. Lenz, S. P. H. Mee, P. R. Rands, V. L. Schramm, E. A. Taylor Ringia, et al., *Org. Biomol. Chem.* **2006**, *4*, 1131–1139.
- (63) K. Clinch, G. B. Evans, R. F. G. Fröhlich, R. H. Furneaux, P. M. Kelly, L. Legentil, A. S. Murkin, L. Li, V. L. Schramm, P. C. Tyler, et al., *J. Med. Chem.* **2009**, *52*, 1126–1143.
- (64) P. Compain, V. Chagnault, O. R. Martin, *Tetrahedron: Asymmetry* **2009**, *20*, 672–711.
- (65) L. Lay, F. Nicotra, A. Paganini, C. Pangrazio, L. Panza, *Tetrahedron Lett.* **1993**, *34*, 4555–4558.
- (66) L. Cipolla, L. Lay, F. Nicotra, C. Pangrazio, L. Panza, *Tetrahedron* **1995**, *51*, 4679–4690.
- (67) H. S. Isbell, H. L. Frush, *J. Org. Chem.* **1958**, *23*, 1309–1319.
- (68) D. J. Cram, F. A. A. Elhafez, *J. Am. Chem. Soc.* **1952**, *74*, 5828–5835.



- (69) A. Kotland, F. Accadbled, K. Robeyns, J.-B. Behr, *J. Org. Chem.* **2011**, *76*, 4094–4098.
- (70) J.-B. Behr, R. Plantier-Royon, *Recent Res. Dev. Org. Chem.* **2006**, *10*, 1–30.
- (71) C. Nicolas, O. R. Martin, *Molecules* **2018**, *23*, 1612–1642.
- (72) M. S. Chambers, V. G. Matassa, S. R. Fletcher **1994** U.S. Patent Number 5,360,802.
- (73) G. Liu, D. A. Cogan, J. A. Ellman, *J. Am. Chem. Soc.* **1997**, *119*, 9913–9914.
- (74) F. A. Davis, R. E. Reddy, J. M. Szewczyk, P. S. Portonovo, *Tetrahedron Lett.* **1993**, *34*, 6229–6232.
- (75) D. J. Weix, J. A. Ellman, X. Wang, D. P. Curran, *Org. Synth.* **2005**, *82*, 157–165.
- (76) D. A. Cogan, G. Liu, K. Kim, B. J. Backes, J. A. Ellman, *J. Am. Chem. Soc.* **1998**, *120*, 8011–8019.
- (77) T. Netscher, H. Prinzbach, *Synthesis* **1987**, *8*, 683–688.
- (78) G. Liu, D. A. Cogan, T. D. Owens, T. P. Tang, J. A. Ellman, *J. Org. Chem.* **1999**, *64*, 1278–1284.
- (79) J. García Ruano, I. Fernández, M. del Prado Catalina, A. A. Cruz, *Tetrahedron: Asymmetry* **1996**, *7*, 3407–3414.
- (80) N. Khair, I. Fernández, F. Alcudia, *Tetrahedron Lett.* **1994**, *35*, 5719–5722.
- (81) Y.-C. Luo, H.-H. Zhang, P.-F. Xu, *Synlett* **2009**, *2009*, 833–837.
- (82) J. C. Rech, P. E. Floreancig, *Org. Lett.* **2003**, *5*, 1495–1498.
- (83) M. Raunkjær, F. El Oualid, G. A. van der Marel, H. S. Overkleeft, M. Overhand, *Org. Lett.* **2004**, *6*, 3167–3170.
- (84) D. A. Cogan, G. Liu, J. Ellman, *Tetrahedron* **1999**, *55*, 8883–8904.
- (85) F. A. Davis, W. McCoull, *J. Org. Chem.* **1999**, *64*, 3396–3397.
- (86) D. A. Pflum, D. Krishnamurthy, Z. Han, S. A. Wald, C. H. Senanayake, *Tetrahedron Lett.* **2002**, *43*, 923–926.
- (87) N. Plobeck, D. Powell, *Tetrahedron: Asymmetry* **2002**, *13*, 303–310.
- (88) M. T. Robak, M. A. Herbage, J. A. Ellman, *Chem. Rev.* **2010**, *110*, 3600–3740.

- (89) F. Oulaïdi, E. Gallienne, P. Compain, O. R. Martin, *Tetrahedron: Asymmetry* **2011**, *22*, 609–612.
- (90) C. Cocard, C. Nicolas, A. Bayle, T. Poisson, X. Pannecoucke, O. R. Martin, *Eur. J. Org. Chem.* **2015**, *2015*, 4330–4334.
- (91) C. Cocard, C. Nicolas, T. Poisson, X. Pannecoucke, C. Y. Legault, O. R. Martin, *J. Org. Chem.* **2017**, *82*, 2753–2763.
- (92) K. W. Kells, J. M. Chong, *Org. Lett.* **2003**, *5*, 4215–4218.
- (93) K. W. Kells, J. M. Chong, *J. Am. Chem. Soc.* **2004**, *126*, 15666–15667.
- (94) S. Tejima, R. K. Ness, R. L. Kaufman, H. G. Fletcher, *Carbohydr. Res.* **1968**, *7*, 485–490.
- (95) M. S. Schmidt, V. Wittmann, *Carbohydr. Res.* **2008**, *343*, 1612–1623.
- (96) <https://www.nature.com/subjects/cross-coupling-reactions>
- (97) D. Azarian, S. S. Dua, C. Eaborn, D. R. M. Walton, *J. Organomet. Chem.* **1976**, *117*, C55–C57.
- (98) M. Kosugi, K. Sasazawa, Y. Shimizu, T. Migita, *Chem. Lett.* **1977**, *6*, 301–302.
- (99) M. Kosugi, Y. Shimizu, T. Migita, *Chem. Lett.* **1977**, *6*, 1423–1424.
- (100) D. Milstein, J. K. Stille, *J. Am. Chem. Soc.* **1978**, *100*, 3636–3638.
- (101) J. K. Stille, *Angew. Chemie Int. Ed. English* **1986**, *25*, 508–524.
- (102) C. Cordovilla, C. Bartolomé, J. M. Martínez-Illarduya, P. Espinet, *ACS Catal.* **2015**, *5*, 3040–3053.
- (103) J. Ye, R. K. Bhatt, J. R. Falck, *Tetrahedron Lett.* **1993**, *34*, 8007–8010.
- (104) J. W. Labadie, J. K. Stille, *J. Am. Chem. Soc.* **1983**, *105*, 6129–6137.
- (105) Y. Y. Belosludtsev, R. K. Bhatt, J. R. Falck, *Tetrahedron Lett.* **1995**, *36*, 5881–5882.
- (106) A. Shamim, C. S. Barbeiro, B. Ali, H. A. Stefani, *ChemistrySelect* **2016**, *1*, 5653–5659.
- (107) X. Xue, W. Li, Z. Yin, X. Meng, Z. Li, *Tetrahedron Lett.* **2015**, *56*, 5228–5230.
- (108) K. Krohn, M. H. Sohrab, T. van Ree, S. Draeger, B. Schulz, S. Antus, T. Kurtán, *European J. Org. Chem.* **2008**, *2008*, 5638–5646.

- (109) O. M. Saavedra, O. R. Martin, *J. Org. Chem.* **1996**, *61*, 6987–6993.
- (110) G. Godin, P. Compain, G. Masson, O. R. Martin, *J. Org. Chem.* **2002**, *67*, 6960–6970.
- (111) L. E. Overman, *Organic Reactions. Vol. 59*, Wiley, **2002**.
- (112) B. Liu, J. van Mechelen, R. J. B. H. N. van den Berg, A. M. C. H. van den Nieuwendijk, J. M. F. G. Aerts, G. A. van der Marel, J. D. C. Codée, H. S. Overkleeft, *Eur. J. Org. Chem.* **2019**, *2019*, 118–129.
- (113) H. J. Reich, S. Wollowitz, in *Org. React.*, John Wiley & Sons, Inc., Hoboken, NJ, USA, **1993**, pp. 1–296.
- (114) P. Uhlmann, D. Nanz, E. Bozó, A. Vasella, *Helv. Chim. Acta* **1994**, *77*, 1430–1440.
- (115) F. Zhu, J. Rodriguez, T. Yang, I. Kevlishvili, E. Miller, D. Yi, S. O’Neill, M. J. Rourke, P. Liu, M. A. Walczak, *J. Am. Chem. Soc.* **2017**, *139*, 17908–17922.
- (116) F. Zhu, E. Miller, S. Zhang, D. Yi, S. O’Neill, X. Hong, M. A. Walczak, *J. Am. Chem. Soc.* **2018**, *140*, 18140–18150.
- (117) L. S. Liebeskind, R. W. Fengl, *J. Org. Chem.* **1990**, *55*, 5359–5364.
- (118) V. Farina, S. Kapadia, B. Krishnan, C. Wang, L. S. Liebeskind, *J. Org. Chem.* **1994**, *59*, 5905–5911.
- (119) X. Han, B. M. Stoltz, E. J. Corey, *J. Am. Chem. Soc.* **1999**, *121*, 7600–7605.
- (120) A. L. Casado, P. Espinet, *Organometallics* **2003**, *22*, 1305–1309.
- (121) S. P. H. Mee, V. Lee, J. E. Baldwin, *Angew. Chemie Int. Ed.* **2004**, *43*, 1132–1136.
- (122) R. S. Cahn, C. Ingold, V. Prelog, *Angew. Chemie Int. Ed. English* **1966**, *5*, 385–415.
- (123) V. Prelog, G. Helmchen, *Angew. Chemie Int. Ed. English* **1982**, *21*, 567–583.
- (124) W. Zou, *Curr. Top. Med. Chem.* **2005**, *5*, 1363–1391.
- (125) M. Chittapragada, S. Roberts, Y. W. Ham, *Perspect. Medicin. Chem.* **2009**, *3*, 21–37
- (126) K. M. Krause, A. W. Serio, T. R. Kane, L. E. Connolly, *Cold Spring Harb. Perspect. Med.* **2016**, *6*.
- (127) T. Granier, A. Vasella, *Helv. Chim. Acta* **1998**, *81*, 865–880.

- (128) C.-H. Hsu, M. Schelwies, S. Enck, L.-Y. Huang, S.-H. Huang, Y.-F. Chang, T.-J. R. Cheng, W.-C. Cheng, C.-H. Wong, *J. Org. Chem.* **2014**, *79*, 8629–8637.
- (129) Y. Blériot, N. Auberger, Y. Jagadeesh, C. Gauthier, G. Prencipe, A. T. Tran, J. Marrot, J. Désiré, A. Yamamoto, A. Kato, et al., *Org. Lett.* **2014**, *16*, 5512–5515.
- (130) Y. Blériot, A. T. Tran, G. Prencipe, Y. Jagadeesh, N. Auberger, S. Zhu, C. Gauthier, Y. Zhang, J. Désiré, I. Adachi, et al., *Org. Lett.* **2014**, *16*, 5516–5519.
- (131) Q. Foucart, J. Marrot, J. Désiré, Y. Blériot, *Org. Lett.* **2019**, *21*, 4821–4825.
- (132) L. Cipolla, L. Lay, F. Nicotra, *J. Org. Chem.* **1997**, *62*, 6678–6681.
- (133) C.-V. T. Vo, G. Mikutis, J. W. Bode, *Angew. Chemie Int. Ed.* **2013**, *52*, 1705–1708.
- (134) K. R. Campos, *Chem. Soc. Rev.* **2007**, *36*, 1069–1084.
- (135) E. A. Mitchell, A. Pesciulli, N. Lefevre, L. Meerpoel, B. U. W. Maes, *Chem. - A Eur. J.* **2012**, *18*, 10092–10142.
- (136) H. Kagoshima, K. Shimada, *Chem. Lett.* **2003**, *32*, 514–515.
- (137) H. Kagoshima, N. Takahashi, *Chem. Lett.* **2004**, *33*, 962–963.
- (138) H. Kagoshima, K. Yonezawa, *Synth. Commun.* **2006**, *36*, 2427–2432.
- (139) M. U. Luescher, C.-V. T. Vo, J. W. Bode, *Org. Lett.* **2014**, *16*, 1236–1239.
- (140) C.-V. T. Vo, M. U. Luescher, J. W. Bode, *Nat. Chem.* **2014**, *6*, 310–314.
- (141) W.-Y. Siau, J. W. Bode, *J. Am. Chem. Soc.* **2014**, *136*, 17726–17729.
- (142) K. Geoghegan, J. W. Bode, *Org. Lett.* **2015**, *17*, 1934–1937.
- (143) M. U. Luescher, J. W. Bode, *Org. Lett.* **2016**, *18*, 2652–2655.
- (144) M. U. Luescher, J. W. Bode, *Angew. Chemie Int. Ed.* **2015**, *54*, 10884–10888.
- (145) D. Hazelard, R. Hensienne, J.-B. Behr, P. Compain, in *Top. Heterocycl. Chem.*, Springer, Berlin, Heidelberg, **2019**, pp. 1–30.
- (146) J. DelPozo, D. Carrasco, M. H. Pérez-Temprano, M. García-Melchor, R. Álvarez, J. A. Casares, P. Espinet, *Angew. Chemie Int. Ed.* **2013**, *52*, 2189–2193.

- (147) M. H. Pérez-Temprano, J. A. Casares, Á. R. de Lera, R. Álvarez, P. Espinet, *Angew. Chemie Int. Ed.* **2012**, *51*, 4917–4920.
- (148) B. E. Love, E. G. Jones, *J. Org. Chem.* **1999**, *64*, 3755–3756.
- (149) H. S. Overkleeft, J. van Wiltenburg, U. K. Pandit, *Tetrahedron* **1994**, *50*, 4215–4224.

**Justyna Anna JASZCZYK**

## **Etude sur la synthèse et la réactivité de dérivés 1-C-stannylés d'aminoditols et d'iminosucres**

Les iminosucres sont des molécules polyhydroxylées naturelles dans lesquelles l'oxygène endocyclique des sucres est remplacé par un atome d'azote. Ces molécules sont actives contre un large éventail d'enzymes qui traitent les glucides, notamment les glycosidases et les glycosyltransférases. Les C-glycosides d'iminosucres sont des analogues de glycosides dans lesquels l'aglycone est connectée au scaffold iminosucre par une liaison C-C. Ce sont des mimétiques de glycosides hautement souhaitables, car ils incorporent des éléments de la structure de l'aglycone des glycosides. Contrôler la stéréochimie en C-1 dans de tels composés pour produire des anomères pseudo- $\alpha$  ou pseudo- $\beta$  s'est révélé être un défi majeur en synthèse organique.

Dans ce rapport, nous présentons une nouvelle approche pour la synthèse d'iminosucre-C-glycosylés à l'aide de dérivés innovants d'iminosucres 1-stannylés combinés au couplage de Stille avec des chlorures d'acyle. La synthèse des molécules stannylées est efficace et diastéréosélective. De plus, les deux diastéréoisomères possibles sont facilement accessibles en utilisant un auxiliaire chiral de type *N-tert*-butanesulfinylamide pendant la séquence, et le procédé est donc 'tunable'. De plus, nous avons détaillé deux applications ingénieuses d'intermédiaires 1-C-stannylés, qui conduiraient à des C-glycosides de 2-aminoiminosucres (analogues des glycosamines en série iminosucres). L'une d'entre elles est centrée sur la cyclisation diastéréosélective sur une imine en présence d'un sel de cuivre (la chimie SnAP). Ce travail fournit des méthodologies de synthèse innovantes dans le domaine des mimétiques glucidiques, une source importante de composés biologiquement et thérapeutiquement actifs.

Mots clés: Iminosucre-C-glycosides, Iminosucres 1-C-stannylés, couplage de Stille, *N-tert*-butanesulfinyl-glycosylamines, chimie SnAP

## **Investigations on the synthesis and reactivity of 1-C-stannylated aminoalditols and iminosugars**

Iminosugars are naturally occurring polyhydroxylated molecules in which the endocyclic oxygen of sugars has been replaced by a nitrogen atom. These molecules are active against a wide range of enzymes which process carbohydrates, most prominently glycosidases and glycosyltransferases. Iminosugar-C-glycosides are analogues of glycosides in which the aglycone is connected to the iminosugar scaffold by a C-C bond. These are highly desirable glycoside mimics, as they incorporate elements of the structure of the aglycone of glycosides. Controlling the stereochemistry at C-1 in such compounds, to make pseudo- $\alpha$  or pseudo- $\beta$  anomers, proved to be a major challenge in organic synthesis.

In this report, we describe a new approach for the synthesis of iminosugar-C-glycosides through innovative 1-C-stannylated iminosugars, by way of the Stille cross-coupling with acyl chlorides. The synthesis of the stannylated molecules is efficient and diastereoselective. Moreover, the procedure proved to be tunable, as the two possible diastereoisomers were easily accessible selectively using a chiral auxiliary (*N-tert*-butanesulfinylamide) during the reaction sequence. In addition, we detail two ingenious applications of 1-C-stannylated intermediates which could lead to imino-C-glycosides in the 2-aminosugar series (analogues of glucosamines). One of these takes advantage of a diastereoselective copper-mediated cyclisation onto an imine (SnAP chemistry). This work provides innovative synthetic methodologies in the field of carbohydrate mimetics, a significant source of biologically and therapeutically active compounds.

Keywords: Iminosugar-C-glycosides, 1-C-stannylated iminosugars, Stille cross-coupling reactions, *N-tert*-butanesulfinyl-glycosylamines, SnAP chemistry



**Institut de Chimie Organique et Analytique –  
ICOA UMR 7311**

Université d'Orléans - Pôle de chimie  
Rue de Chartres - BP 6759  
45067 Orléans Cedex 2

