



HAL
open science

Correspondance classique-quantique et application au contrôle d'équations d'ondes et de Schrödinger dans l'espace euclidien

Antoine Prouff

► **To cite this version:**

Antoine Prouff. Correspondance classique-quantique et application au contrôle d'équations d'ondes et de Schrödinger dans l'espace euclidien. Equations aux dérivées partielles [math.AP]. Université Paris-Saclay, 2024. Français. NNT : 2024UPASM011 . tel-04634673

HAL Id: tel-04634673

<https://theses.hal.science/tel-04634673>

Submitted on 4 Jul 2024

HAL is a multi-disciplinary open access archive for the deposit and dissemination of scientific research documents, whether they are published or not. The documents may come from teaching and research institutions in France or abroad, or from public or private research centers.

L'archive ouverte pluridisciplinaire **HAL**, est destinée au dépôt et à la diffusion de documents scientifiques de niveau recherche, publiés ou non, émanant des établissements d'enseignement et de recherche français ou étrangers, des laboratoires publics ou privés.

Correspondance classique-quantique et application au contrôle d'équations d'ondes et de Schrödinger dans l'espace euclidien

*Quantum-classical correspondence principle and application
to the control of wave and Schrödinger equations in the
Euclidean space*

Thèse de doctorat de l'université Paris-Saclay

École doctorale n°574 : mathématiques Hadamard (EDMH)
Spécialité de doctorat: Mathématiques fondamentales
Graduate School : Mathématiques. Référent : Faculté des sciences d'Orsay

Thèse préparée dans l'unité de recherche **Laboratoire de mathématiques d'Orsay (Université Paris-Saclay, CNRS)**, sous la direction de **Matthieu LÉAUTAUD**, Professeur

Thèse soutenue à Paris-Saclay, le 11 juin 2024, par

Antoine PROUFF

Composition du jury

Membres du jury avec voix délibérative

Gabriel RIVIÈRE Professeur des Universités, Université de Nantes	Président
Clotilde FERMANIAN KAMMERER Professeure des Universités, Université d'Angers	Rapporteur & Examinatrice
Jared WUNSCH Professeur, Northwestern University	Rapporteur
Karine BEAUCHARD Professeure des Universités, École normale supérieure de Rennes	Examinatrice
Jean-Marc BOUCLET Professeur des Universités, Université Paul Sabatier	Examineur
Nicolas BURQ Professeur des Universités, Université Paris-Saclay	Examineur
Fabricio MACIÀ Professeur, Universidad Politécnica de Madrid	Examineur

Titre : Correspondance classique-quantique et application au contrôle d'équations d'ondes et de Schrödinger dans l'espace euclidien

Mots clés: Analyse microlocale et semi-classique, Correspondance classique-quantique, Contrôle des EDP, Stabilisation, Observabilité

Résumé : Les équations des ondes et de Schrödinger modélisent une grande variété de phénomènes ondulatoires, tels que la propagation de la lumière, les vibrations d'un objet ou l'évolution temporelle d'une particule quantique. Dans ces modèles, l'asymptotique des hautes énergies peut être décrite par des équations de la mécanique classique, comme l'optique géométrique. Dans cette thèse, nous étudions plusieurs applications de la correspondance classique-quantique à des problèmes de contrôle des équations des ondes et de Schrödinger dans l'espace euclidien, en utilisant des méthodes d'analyse microlocale.

Dans les deux premières parties, nous étudions l'équation des ondes amorties et l'équation de Schrödinger avec un potentiel confinant dans l'espace euclidien. Nous don-

ons des conditions nécessaires et suffisantes de stabilité uniforme pour la première, et d'observabilité pour la seconde. Ces conditions font intervenir la dynamique classique sous-jacente qui consiste en une optique géométrique tordue par la présence du potentiel.

Nous analysons ensuite dans une troisième partie la correspondance classique-quantique dans un cadre général qui contient les deux problèmes mentionnés ci-dessus. Nous démontrons une version du théorème d'Egorov dans le formalisme des métriques sur l'espace des phases et du calcul de Weyl-Hörmander. On présente différents cadres d'application de ce théorème pour des équations de Schrödinger, de demi-ondes et de transport.

Title: Quantum-classical correspondence principle and application to the control of wave and Schrödinger equations in the Euclidean space

Keywords: Microlocal and semiclassical analysis, Quantum-classical correspondence principle, Control of PDEs, Stabilization, Observability

Abstract: Wave and Schrödinger equations model a variety of phenomena, such as propagation of light, vibrating structures or the time evolution of a quantum particle. In these models, the high-energy asymptotics can be approximated by classical mechanics, as geometric optics. In this thesis, we study several applications of this principle to control problems for wave and Schrödinger equations in the Euclidean space, using microlocal analysis.

In the first two chapters, we study the damped wave equation and the Schrödinger equation with a confining potential in the euclidean space. We provide necessary and sufficient conditions for uniform stability in the

first case, or observability in the second one. These conditions involve the underlying classical dynamics which consists in a distorted version of geometric optics, due to the presence of the potential.

Then in the third part, we analyze the quantum-classical correspondence principle in an abstract setting that encompasses the two aforementioned problems. We prove a version of Egorov's theorem in the Weyl-Hörmander framework of metrics on the phase space. We provide with various examples of application of this theorem for Schrödinger, half-wave and transport equations.

Remerciements

Ces trois années de thèse m'auront laissé de merveilleux souvenirs. Mes premiers remerciements vont naturellement à mon directeur de thèse, Matthieu Léautaud. Je me suis souvent félicité d'avoir choisi de faire ma thèse avec lui, et j'avoue que c'est avec un peu d'appréhension que je m'apprête à présent à « quitter le nid ». Ses encouragements ont été mon moteur et ses conseils ma boussole. Je me suis senti incroyablement libre dans mon itinéraire scientifique et je lui en suis extrêmement reconnaissant. Je suis très heureux et fier d'avoir été son étudiant.

Je remercie mes rapporteurs de thèse, Clotilde Fermanian Kammerer et Jared Wunsch, pour leur lecture minutieuse de mon manuscrit, leur appréciation de mon travail et l'intérêt qu'ils ont manifesté pour mes contributions mathématiques. Un grand merci également à Karine Beauchard, Jean-Marc Bouclet, Nicolas Burq, Fabricio Macià et Gabriel Rivière d'avoir accepté d'examiner ma thèse, j'en suis très honoré.

Je souhaite témoigner ma sincère gratitude à Maria Colombo et Paul Pegon. J'ai eu le privilège de travailler avec eux lors d'un stage de recherche à Lausanne d'avril à juillet 2019. Ce fut un des épisodes les plus marquants de mon parcours universitaire. Cette expérience m'a mis le pied à l'étrier et m'a donné beaucoup de confiance en moi. Je leur dois beaucoup. De même, j'adresse de chaleureux remerciements à Fabricio Macià pour son hospitalité lors de mes visites pendant l'année universitaire 2020-2021 et en mars 2022. J'attends avec impatience la prochaine occasion de retourner à Madrid.

Je salue mes fidèles amis de l'ENS Paris-Saclay. Leur compagnie a été un solide repère tout au long de ma thèse. C'est toujours un immense plaisir de passer du temps avec eux et de les battre sèchement au tarot en leur montrant ma façon de « transcender mon jeu ». Je salue également les choristes du groupe Achor, qui ont rendu mes mercredis soirs si pétillants.

Quant à mes formidables camarades du LMO, je leur dois évidemment des remerciements très spéciaux. Ce fut un bonheur quotidien de partager le bureau 3A20 « de l'ambiance » avec mes quatre co-bureaux. Je suis reconnaissant envers tous les doctorants et post-doctorants avec qui j'ai passé tant de bons moments, en particulier lors de cette dernière année de thèse, qui fut si intense qu'elle en devint parfois éprouvante. Les pauses café très allongées, les goûters du mardi, les goûters du jeudi, notre petit club piscine + restau, notre groupe de tennis... ou tout simplement les repas délicieusement saupoudrés de rires et de complicité que nous avons partagés au CESFO. Ce sont autant de souvenirs que je m'efforcerai de conserver précieusement.

Enfin je remercie ma famille, et tout spécialement mon père pour ses encouragements constants, et aussi ma sœur qui n'y est pas pour rien dans mon appétit pour les sciences. Et bien sûr, chaque fois que je me trouve sous un beau ciel étoilé, je pense à ma chère maman, qui veille sur moi, j'en suis certain, quelque part au milieu de ces éclats de lumière. *

C'est avec un petit pincement au cœur que je me prépare à quitter Orsay. Mais je suis plus motivé que jamais pour me lancer dans la nouvelle aventure qui m'attend outre-Atlantique à l'Université Purdue. Je ne manquerai pas de revenir au bercail de temps en temps.

Orsay, bureau 3A20,
le vendredi 24 mai 2024.

*Lumière dont je m'acharne passionnément à comprendre la mystérieuse propagation dans la poignée de pages qui suit...

Contents

1	Introduction	9
1.1	Correspondance classique-quantique et théorie du contrôle des équations aux dérivées partielles	9
1.1.1	La lumière, onde et corpuscule...	9
1.1.2	Trois problèmes de mathématiques	10
1.1.3	Estimées de résolvante et théorie du contrôle	15
1.1.4	Quantification et analyse microlocale	20
1.1.5	Dynamique quantique et dynamique classique	23
1.1.6	Objectifs de la thèse	27
1.2	Stabilité uniforme de l'équation des ondes avec potentiel confinant sous-quartique	27
1.2.1	Principaux résultats	28
1.2.2	Conditions géométriques et condition dynamique	30
1.2.3	Eléments de preuve	31
1.2.4	Perspectives	32
1.3	Observabilité de l'équation de Schrödinger avec potentiel confinant sous-quadratique	32
1.3.1	Résultat principal	34
1.3.2	Observabilité des oscillateurs harmoniques en dimension 2	35
1.3.3	Autres applications	40
1.3.4	Idée de preuve du théorème 1.3.2	42
1.3.5	Perspectives	43
1.4	Le théorème d'Egorov dans le calcul de Weyl–Hörmander	44
1.4.1	Retour sur les dynamiques quantique et classique	45
1.4.2	Le théorème d'Egorov comme une série de Dyson	45
1.4.3	Classes de symboles de Weyl–Hörmander et résultat principal	46
1.4.4	Exemples d'application	50
1.4.5	Idée de preuve du théorème 1.4.7	55
1.4.6	Perspectives	56
2	Energy decay for the damped wave equation with a confining potential in the Euclidean space	59
2.1	Introduction	59
2.1.1	Setting of the problem	59
2.1.2	Main results	60
2.1.3	Geometric and dynamical stabilization conditions	62
2.1.4	Strategy of proof and plan of the paper	64
2.2	Background and preliminary results	65
2.2.1	Well-posedness	65
2.2.2	Spectrum of the damped wave operator	66
2.2.3	Weyl quantization and semiclassical defect measures	66
2.2.4	Weyl-Heisenberg translation operators	67
2.3	Resolvent estimate	67
2.4	A priori conditions of stabilization: Proof of Proposition 2.1.2	69
2.4.1	A priori necessary condition	69
2.4.2	A priori sufficient condition	71
2.5	Proof of Theorem 2.1.6	74
2.6	Stabilization condition	76
2.A	Pseudo-differential operators	78
2.B	Miscellaneous results on classical averages	80

3	Observability of the Schrödinger equation with subquadratic confining potential in the Euclidean space	85
3.1	Introduction and main results	85
3.1.1	Main result	87
3.1.2	Idea of proof and comments	89
3.1.3	Examples in dimension 1	90
3.1.4	Observability of two-dimensional harmonic oscillators	92
3.1.5	Other applications	101
3.1.6	Link with the Kato smoothing effect	102
3.1.7	Natural semiclassical scaling for homogeneous potentials	103
3.1.8	Plan of the article	103
3.2	Study of the classical dynamics	104
3.2.1	Invariance of classical observability under subprincipal perturbation	104
3.2.2	Quantitative estimates of classical (non-)observability	107
3.2.3	Continuity of the composition by the flow in symbol classes	112
3.3	Proof of the main theorem	113
3.4	Proofs of observability results from conical sets	118
3.4.1	Proof of Proposition 3.1.4	118
3.4.2	Proof of Proposition 3.1.5	119
3.4.3	Proof of Proposition 3.1.6	127
3.5	Proofs of observability results from spherical sets	130
3.5.1	Proof of Proposition 3.1.8	130
3.5.2	Proof of Lemma 3.1.11	132
3.5.3	Proof of Proposition 3.1.10	136
3.A	Reduction to a weaker observability inequality	145
3.B	Pseudo-differential operators	147
3.B.1	Weyl quantization	147
3.B.2	Symbol classes	147
3.B.3	L^2 -boundedness of pseudo-differential operators	148
3.B.4	Refined estimate in the pseudo-differential calculus	148
3.B.5	Positivity	149
4	Egorov's theorem in the Weyl–Hörmander calculus	151
4.1	Introduction and results	151
4.1.1	The classical and quantum dynamics	153
4.1.2	Notation and conventions	156
4.1.3	Metrics on the phase space	158
4.1.4	Assumptions and main result	159
4.1.5	Comments	161
4.1.6	Egorov's theorem as a Dyson series	163
4.1.7	Examples of application	164
4.1.8	More on admissibility of phase space metrics	170
4.1.9	Propagation of quantum partitions of unity	172
4.1.10	Related works: the contributions of Jean-Michel Bony	174
4.1.11	Strategy of the proof and plan of the article	175
4.2	The Weyl–Hörmander calculus	176
4.2.1	Functional framework	176
4.2.2	Pseudodifferential calculus	177
4.3	Classical and quantum well-posedness	179
4.3.1	Proof of Proposition 4.1.16: global-in-time existence of the Hamiltonian flow	180
4.3.2	Proof of Proposition 4.1.16: essential self-adjointness	181
4.3.3	The quantum and classical dynamics as an evolution group on L^2 symbols	182
4.4	The classical dynamics	183
4.4.1	Norms with respect to a metric	183
4.4.2	A general estimate	185
4.4.3	Exponentially expanding flows	189
4.4.4	Lipschitz-type properties of the flow	191

4.5	Mapping properties of the Egorov expansion operators	193
4.5.1	Mapping properties in symbol classes	193
4.5.2	Mapping properties in spaces of confined symbols	196
4.6	The quantum dynamics	199
4.6.1	Egorov expansion for a specific class of symbols	199
4.6.2	Preliminary lemmata	202
4.6.3	Two commutator lemmata	203
4.7	Quantum evolution of confined symbols: proof of Theorem 4.1.40	208
4.7.1	Control of the terms of the Dyson expansion	208
4.7.2	Confinement estimate of the remainder	209
4.7.3	End of the proof of Theorem 4.1.40	212
4.8	Quantum evolution in symbol classes: proof of the main theorem and applications	215
4.8.1	Continuity on the Schwartz class: proof of Corollary 4.1.44	215
4.8.2	Proof of Theorem 4.1.15	216
4.9	Examples of application: proofs of statements in Section 4.1.7	220
4.9.1	Schrödinger operator: proofs of statements in Subsection 4.1.7.1	220
4.9.2	Half-wave operator: proofs of statements in Subsection 4.1.7.2	221
4.9.3	Vector fields: proofs of statements in Subsection 4.1.7.3	225
4.A	Refined estimates for the Weyl–Hörmander calculus	227
4.A.1	Symplectic Fourier transform	227
4.A.2	Poisson operator	227
4.A.3	Moyal operator	229
4.A.4	Bi-confinement estimate	229
4.A.5	Pseudodifferential calculus	231
4.B	Continuity properties of pseudodifferential operators	235
4.B.1	Distributional continuity	235
4.B.2	L^2 boundedness	236
4.B.3	Trace class and Hilbert–Schmidt operators	236
4.C	Technical lemmata on phase space metrics	236
4.C.1	Temperate growth of the Hamiltonian	236
4.C.2	Properties of the temperance weight	237
4.C.3	Slow variation radius	237
4.C.4	Improved admissibility	238
4.C.5	Equivalent seminorms on spaces of confined symbols	239
4.D	Faà di Bruno formula	239

1 - Introduction

1.1. Correspondance classique-quantique et théorie du contrôle des équations aux dérivées partielles

Le principe de correspondance entre la mécanique quantique ou la mécanique ondulatoire et la mécanique classique dans l'asymptotique des hautes fréquences ou des hautes énergies s'est révélé être un outil puissant dans l'étude de bon nombre de problèmes mathématiques. Nous en présentons dans cette thèse deux applications à la théorie du contrôle des équations de type ondes et Schrödinger dans l'espace euclidien. Nous développons aussi une forme de ce principe de correspondance (un théorème d'Egorov) dans un cadre assez général.

1.1.1. La lumière, onde et corpuscule...

Les prémices du concept de correspondance classique-quantique émergent déjà dans les deux théories concurrentes de Huygens et Newton sur la propagation de la lumière au XVIIe siècle. En effet, une série d'expériences en apparence contradictoires semble indiquer que la lumière se comporte tantôt comme une onde, dont la description mathématique implique la théorie des équations aux dérivées partielles (EDP), tantôt comme une particule suivant une trajectoire calculable en résolvant une équation différentielle ordinaire (EDO). De nombreuses contributions ont permis de clarifier ce paradoxe. En 1828, Hamilton publie dans sa *Théorie des systèmes de rayons* [Ham28] une nouvelle formulation de l'optique qui établit une analogie entre trajectoires balistiques et propagation des ondes de la façon suivante : ce que l'on interprète comme les « rayons de l'optique géométrique » sont les lignes orthogonales aux fronts d'onde (les ensembles « d'iso-amplitude » d'une onde). Il introduit également l'équation d'Hamilton–Jacobi, qui donne une formulation EDP de la mécanique classique, par opposition au principe fondamental de la dynamique de Newton qui consiste en une EDO. Il faudra ensuite attendre plusieurs décennies avant que soit construite une théorie en mesure d'expliquer le caractère en apparence contradictoire de la lumière. Une étape importante est la compréhension du fait que l'optique géométrique est contenue dans l'équation des ondes, au sens où l'on peut l'obtenir comme limite à haute fréquence des solutions de cette dernière (voir par exemple Sommerfeld et Runge [SR11]). Un autre jalon dans la construction de la mécanique quantique est la contribution de de Broglie qui postule que les particules de matière peuvent elles aussi présenter un comportement ondulatoire [dB24]. Le lien entre classique et quantique se manifeste dans une formule étonnante de simplicité :

$$\lambda = \frac{h}{p},$$

où λ est une grandeur « ondulatoire » (la longueur d'onde de de Broglie) associée à une particule de quantité de mouvement p (une grandeur familière en mécanique classique), et h est la constante de Planck. Ce principe est illustré de façon frappante par la diffraction d'électrons ou de petites molécules dans l'expérience des fentes d'Young [You04, TEM⁺89] : après avoir envoyé un grand nombre de particules, on observe sur l'écran une figure d'interférence typique des ondes. Cette observation aboutira aux fondements de la mécanique ondulatoire avec les travaux de Schrödinger [Sch26b].

Qu'il soit question de lumière ou de matière, l'intuition de la correspondance classique-quantique est la même : dans une certaine asymptotique (petite longueur l'onde, c'est-à-dire haute fréquence, pour la lumière, ou grande quantité de mouvement pour une particule de matière), le comportement ondulatoire s'efface et laisse la place à une évolution temporelle qui s'apparente à celle d'un système mécanique classique (optique géométrique, dynamique de billard, etc.).

Un des exemples les plus simples de correspondance classique-quantique est la découverte par Schrödinger en 1926 des états cohérents de l'oscillateur harmonique quantique [Sch26a]. On peut vérifier par un calcul explicite que la fonction d'onde

$$\varphi(t, x) = \frac{e^{-\frac{i}{2}td}}{\pi^{d/4}} \exp\left(-\frac{|x - x_t|^2}{2}\right) e^{-\frac{i}{2}\xi_t \cdot x_t + i\xi_t \cdot x}, \quad (t, x) \in \mathbf{R} \times \mathbf{R}^d, \quad (1.1.1)$$

est solution de l'équation de Schrödinger

$$D_t\varphi + \frac{1}{2}(-\Delta + |x|^2)\varphi = 0, \quad D_t = \frac{1}{i}\partial_t, \quad (1.1.2)$$

si $t \mapsto (x_t, \xi_t)$ satisfait la seconde loi de Newton de la mécanique classique $\ddot{x} = F(x)$ avec un champ de force $F(x) = -\nabla \frac{1}{2}|x|^2 = -x$ dérivant d'un potentiel harmonique :

$$\begin{cases} \dot{x}_t = \xi_t \\ \dot{\xi}_t = -x_t \end{cases}.$$

On peut reformuler ce fait en disant qu'un paquet d'ondes gaussien initialement centré en x_0 avec moment ξ_0 se propage, sous l'évolution quantique (1.1.2) le long de la trajectoire classique d'un point-masse avec position et moment initiaux (x_0, ξ_0) . Cet exemple est très particulier puisque cette correspondance apparaît en dehors de tout régime asymptotique. C'est en fait un cas de correspondance *exacte* entre classique et quantique, liée au fait que le hamiltonien en question (l'oscillateur harmonique) est quadratique.

1.1.2. Trois problèmes de mathématiques

Dans le contexte évoqué ci-dessus, de nombreux problèmes mathématiques sont motivés par des questions issues de la physique. On expose trois de ces problèmes portant sur des équations d'ondes ou de la mécanique quantique, dans lesquels la correspondance classique-quantique joue un rôle crucial. Les deux premiers concernent la stabilité uniforme de l'équation des ondes amorties et l'observabilité de l'équation de Schrödinger, pour lesquels on se contente pour l'instant de présenter quelques résultats historiques (nous détaillerons davantage la littérature dans les paragraphes suivants). Le troisième problème concerne l'observation des fonctions propres. Ces trois questions sont liées entre elles via les estimées de résolvente décrites au paragraphe 1.1.3, et sont introduites dans un ordre qui sera clarifié par la proposition 1.1.6.

1.1.2.1. Stabilité uniforme des ondes amorties

Dans la communauté mathématique, l'obtention de l'optique géométrique dans la limite haute fréquence de l'équation des ondes apparaît dans les travaux fondateurs d'Egorov [Ego69], de Hörmander [Hör71b, Hör71a] et Duistermaat–Hörmander [DH72]. Rauch et Taylor, dans l'article [RT74], appliquent ces résultats à l'étude de l'équation des ondes amorties dans une variété riemannienne compact (M, g) (disons sans bord) :

$$\partial_t^2\psi - \Delta_g\psi + b(x)\partial_t\psi = 0,$$

où Δ_g est l'opérateur de Laplace–Beltrami associé à la métrique g et $b \in L^\infty(M)$ est une fonction à valeurs réelles positives appelée coefficient d'amortissement. En prenant une réalisation auto-adjointe de Δ_g dans l'espace de Hilbert $L^2 = L^2(M, d\text{Vol}_g)$, l'équation se reformule comme un problème d'évolution d'ordre 1 :

$$\partial_t\Psi = \mathcal{A}_b\Psi \quad \text{avec} \quad \mathcal{A}_b = \begin{pmatrix} 0 & 1 \\ \Delta_g & -b \end{pmatrix}, \quad \Psi = \begin{pmatrix} \psi \\ \partial_t\psi \end{pmatrix}, \quad (1.1.3)$$

qui est bien posé dans l'espace de Hilbert $\mathfrak{H} := H^1(M) \times L^2$ par la théorie des semi-groupes [Paz83]. Les solutions satisfont formellement le bilan d'énergie

$$\frac{d}{dt} \left(\frac{1}{2} \|\partial_t\psi\|_{L^2}^2 + \frac{1}{2} \|\nabla_g\psi\|_{L^2}^2 \right) = - \left\| \sqrt{b}\partial_t\psi \right\|_{L^2}^2.$$

En particulier, pour une donnée initiale $U \in \mathfrak{H}$ du problème d'évolution (1.1.3), l'énergie

$$\mathcal{E}(U, t) = \frac{1}{2} \|\partial_t\psi(t)\|_{L^2}^2 + \frac{1}{2} \|\nabla_g\psi(t)\|_{L^2}^2 \quad (1.1.4)$$

décroit au cours du temps. L'action du coefficient d'amortissement $b \geq 0$ sur le système est donc de dissiper l'énergie. L'opérateur des ondes amorties \mathcal{A}_b est en fait une perturbation de l'opérateur des ondes \mathcal{A}_0 , qui lui, est conservatif. La question que se posent Rauch et Taylor est celle de la *stabilité uniforme* : on se demande pour quels coefficients d'amortissement b l'énergie décroît exponentiellement et uniformément, i.e. il existe $\tau, c > 0$ tels que pour tout $U \in \mathfrak{H}$, on ait

$$\forall t \geq 0, \quad \mathcal{E}(U, t) \leq C e^{-t/\tau} \mathcal{E}(U, 0) \quad (1.1.5)$$

La réponse fait intervenir le flot géodésique g^t , c'est-à-dire l'optique géométrique sur la variété (M, g) .

Théorème 1.1.1 (Rauch-Taylor – [RT74, Ral69]). *Soit $b \geq 0$ continue sur M . Alors on a stabilité uniforme (1.1.5) si et seulement si b vérifie la Condition de Contrôle Géométrique, i.e. toute géodésique paramétrée par longueur d'arc entre dans l'ensemble amorti $\{b > 0\}$, ou de façon équivalente*

$$\exists T > 0, \exists c > 0 : \forall v \in SM, \quad \frac{1}{T} \int_0^T b(\pi \circ g^t(v)) dt \geq c. \quad (1.1.6)$$

Ici SM est le fibré unitaire tangent au-dessus de M , $\pi : SM \rightarrow M$ est la projection canonique et $g^t : SM \rightarrow SM$ est le flot géodésique de (M, g) .

La signification de ce théorème est la suivante : pour stabiliser les « vibrations » sur toute la variété M , il suffit de contrôler les « fréquences infinies » en disposant l'amortissement de sorte qu'il capture toutes les géodésiques. L'heuristique sous-jacente est que les basses fréquences sont suffisamment délocalisées pour qu'elles soient amorties dès lors que l'amortissement est non trivial.

Ce résultat, et sa généralisation à des problèmes à bord par Bardos, Lebeau et Rauch [BLR92], ont eu une influence considérable sur les développements mathématiques ultérieurs et ont ouvert tout une branche de recherche. Cette dernière a également bénéficié et stimulé de nombreuses avancées dans le domaine de l'analyse microlocale, dont on introduit les rudiments dans le paragraphe 1.1.4. Ainsi les travaux de Rauch et Taylor, puis Bardos, Lebeau et Rauch, ont soulevé de nombreuses questions, dont certaines sont évoquées ci-après.

Une question naturelle est de se demander si l'on peut quantifier le taux de décroissance exponentiel, c'est-à-dire le paramètre τ , dans (1.1.5). Dans un article fondateur [Leb96] calcule explicitement ce taux optimal. Celui-ci est lié au minimum de deux valeurs : l'une spectrale (l'abscisse spectrale de l'opérateur des ondes amorties) et l'autre dynamique (la meilleure constante c dans l'asymptotique $T \rightarrow +\infty$ de (1.1.6)). L'article de Sjöstrand [Sjö00] décrit très précisément le spectre de l'opérateur des ondes amorties \mathcal{A}_b (voir aussi Anantharaman [Ana10]), celui d'Hitrik [Hit03] prouve un développement asymptotique du propagateur en terme des états propres amortis, et la série d'articles [HS04, HS05, HS08a, HS08b] généralise et précise ces résultats.

Dans l'article [Leb96], Lebeau prouve une décroissance logarithmique de l'énergie dès lors que l'amortissement b est non trivial, pour des données initiales dans le domaine de l'opérateur des ondes amorties. Ce résultat repose sur un argument de prolongement unique quantitatif pour l'opérateur de Laplace–Beltrami, valable dans n'importe quelle variété riemannienne compacte connexe : l'effet tunnel inhérent à la mécanique quantique implique une délocalisation des solutions de l'équation des ondes, qui nécessairement rencontrent la zone d'amortissement. La décroissance logarithmique est la manifestation d'une version quantitative de cette propriété.

Il est donc naturel de s'interroger sur les taux de décroissance intermédiaires de l'énergie pour des données plus régulières, lorsque la Condition de Contrôle Géométrique (1.1.6) n'est pas satisfaite. De nombreux paramètres entrent alors en jeu, en particulier le comportement en temps long de l'optique géométrique (plus précisément la dynamique du flot géodésique), la régularité ou le taux d'annulation de l'amortissement, etc. On peut regrouper les résultats existants à ce sujet en deux grandes familles.

Lorsque l'optique géométrique a un comportement *chaotique*, où plus généralement lorsque l'ensemble des trajectoires non amorties possède des propriétés d'hyperbolicité, on montre un taux de décroissance exponentiel pour des données régulières (ou du moins une décroissance du type $e^{-c\sqrt{t}}$ dans certaines situations). Citons en particulier les travaux de Christianson [Chr07, Chr10, Chr11], Burq et Christianson [BC15], Nonnenmacher et Rivière [Riv14], ainsi que l'article de Christianson, Schenck, Vasy et Wunsch [CSVW14]. Les travaux de Schenck [Sch10, Sch11] traitent des cas où la décroissance est même exponentielle, tout comme l'article de Jin [Jin20] où l'amortissement est simplement supposé non identiquement nul. Notons toutefois qu'il ne s'agit pas de stabilité uniforme puisqu'elle n'est valable que pour des données initiales régulières (dans le domaine de l'opérateur \mathcal{A}_b).

L'autre famille de résultats concerne les situations dites *intégrables*, qui présentent en général plus de symétries et une optique géométrique plus prévisible. Une situation très étudiée est celle d'un domaine de dimension 2 ou 3 dont le bord contient deux faces parallèles, avec un cylindre de trajectoires périodiques non amorties rebondissantes entre ces deux faces. Voir dans l'ordre chronologique Liu et Rao [LR05], Burq et Hitrik [BH07] ainsi que Phung [Phu07, Phu08]. Dans ces

travaux, les taux de décroissance observés sont polynômiaux, en raison du fait que les trajectoires non amorties sont relativement stables (la divergence entre deux trajectoires voisines est linéaire). Une étude approfondie du 2-tore carré a été initiée par Anantharaman et Léautaud [AL14], où l'influence de l'ordre d'annulation de l'amortissement au bord de l'ensemble amorti est étudiée. Ce résultat a donné lieu par la suite à des études raffinées sur la géométrie de l'ensemble non amorti et la régularité du coefficient d'amortissement. Voir Léautaud–Lerner [LL17] ou encore Sun [Sun23]. Une liste de références plus complète se trouve dans l'introduction de [Lé23].

1.1.2.2. Observabilité de l'équation de Schrödinger

On présente maintenant une question d'observabilité pour l'équation de Schrödinger

$$D_t \psi = \Delta_g \psi, \quad \psi(0) = u, \quad D_t = \frac{1}{i} \partial_t. \quad (1.1.7)$$

Etant donné $T > 0$ et un ouvert $\omega \subset M$, on se demande sous quelle condition l'ensemble $(0, T) \times \omega$ observe l'équation de Schrödinger, au sens où

$$\exists C > 0 : \forall u \in L^2, \quad \|u\|_{L^2(M)}^2 \leq C \int_0^T \|e^{it\Delta_g} u\|_{L^2(\omega)}^2 dt, \quad (1.1.8)$$

où $t \mapsto \psi(t) = e^{it\Delta_g} u$ désigne la solution de (1.1.7). Du point de vue de la physique quantique, si on interprète la solution $t \mapsto e^{it\Delta_g} u$ comme l'évolution temporelle de la fonction d'onde d'une particule quantique vivant sur la variété (M, g) , on cherche donc à déterminer des conditions sur le couple (ω, T) telles que l'on puisse borner une fraction de la masse de la donnée initiale u en observant la solution dans ω sur un laps de temps T . Notons que pour ce problème, l'observabilité est équivalente à la contrôlabilité exacte de l'équation (1.1.7), via la méthode H.U.M. (voir [DR77, Lio88]). Un résultat de Lebeau [Leb92b] (énoncé dans le cas plus compliqué du contrôle depuis le bord, mais dont la démonstration s'adapte à (1.1.8)) stipule que la Condition de Contrôle Géométrique¹ (1.1.6) pour $b = \mathbf{1}_\omega$ en un certain temps $T > 0$ est suffisante pour avoir une telle inégalité pour tout temps $T > 0$.

Théorème 1.1.2 ([Leb92b]). *Si la fonction indicatrice de ω satisfait la Condition de Contrôle Géométrique (1.1.6) pour un $T > 0$, alors l'assertion (1.1.8) est vraie pour tout $T > 0$.*

Si la Condition de Contrôle Géométrique est suffisante pour avoir observabilité, on connaît maintenant de nombreux exemples indiquant qu'elle n'est absolument pas nécessaire en général. Ceci avait déjà été remarqué par Haraux [Har89] et Jaffard [Jaf90] dans leurs travaux sur l'équation des plaques (leurs résultats s'appliquent au cas de l'équation de Schrödinger sur le tore). La question de l'observabilité pour l'équation de Schrödinger est bien souvent étroitement liée à celle de l'étude des propriétés de concentration ou de délocalisation des fonctions propres du laplacien, que l'on détaille dans le paragraphe suivant.

Il s'avère que, comme pour l'étude de la décroissance de l'énergie pour les ondes amorties, la propriété (1.1.8) dépend en premier lieu de la dynamique du flot géodésique. Deux situations ont principalement été étudiées dans la littérature. D'un côté, les contextes intégrables caractérisés par l'existence de quantités conservées par la dynamique classique sous-jacente, vont souvent de paire avec de la multiplicité dans le spectre au niveau quantique, ce qui permet parfois de produire des fonctions propres très concentrées. C'est le cas de la sphère par exemple ou du disque. D'un autre côté, on a les systèmes avec une limite classique chaotique, dont le principal exemple est le flot géodésique sur une variété riemannienne de courbure négative. On collecte ci-après une liste non exhaustive de références illustrant cette diversité de situations.

A la suite des travaux [Har89, Jaf90], l'observabilité de l'équation de Schrödinger sur le tore a été étudiée par de nombreux auteurs, tels que Burq–Zworski [BZ12, BZ19], Bourgain–Burq–Zworski [BBZ13], Macià [Mac10] en dimension 2 et Komornik [Kom92] ainsi que Anantharaman, Macià et Fermanian Kammerer [AM14, AFKM15] en dimension quelconque. Ces résultats énoncent en particulier que (1.1.8) est satisfaite sur le tore \mathbf{T}^d pour tout ouvert $\omega \neq \emptyset$ et tout $T > 0$. Il est donc clair que la Condition de Contrôle Géométrique est loin d'être nécessaire dans ce cas. Le cas de la sphère ronde \mathbf{S}^d est radicalement différent. En effet, l'expression explicite des fonctions propres, les harmoniques sphériques, permet de construire des suites se concentrant sur n'importe

¹Notons que l'intégrale (1.1.6) avec $b = \mathbf{1}_\omega$ a bien un sens lorsque ω est ouvert, puisque l'application $t \mapsto b(\pi \circ g^t(v))$ est alors semi-continue inférieurement quel que soit $v \in SM$.

quelle géodésique fermée, ce qui force donc $\bar{\omega}$ à intersecter tout équateur. Ainsi dans cet exemple, la Condition de Contrôle géométrique est également nécessaire (plus rigoureusement, il est nécessaire qu'elle soit vérifiée par n'importe quel ouvert épaissi de rayon $\varepsilon > 0$). Quant au disque avec condition de Dirichlet, la question de caractériser les ouverts observant l'équation de Schrödinger a été résolue par Anantharaman–Léautaud–Macià [ALM16b, ALM16a] : l'observabilité (1.1.8) en un certain temps $T > 0$ est satisfaite si et seulement si l'ouvert ω intersecte le bord du disque, et dans ce cas, on a (1.1.8) en tout temps $T > 0$. En particulier, il n'est pas nécessaire d'observer les diamètres. Ceux-ci sont suffisamment « instables » pour que l'énergie se disperse dans tout le disque. Mentionnons également les articles de Macià et Rivière sur les variétés de Zoll [MR16, MR19] d'où l'on peut déduire des résultats sur l'observabilité de Schrödinger.

Enfin dans le cadre chaotique, on renvoie vers les travaux d'Anantharaman–Rivière [AR12]. Pour les surfaces à courbure sectionnelle négative, la situation, bien que très différente d'un point de vue dynamique, ressemble à celle du tore : tout ouvert non-vide observe l'équation de Schrödinger. Le résultat est peut-être plus intuitif : les propriétés mélangeantes du flot géodésique impliquent qu'il suffit d'observer une toute petite portion de la variété. Voir Dyatlov–Jin [DJ18], Jin [Jin20] et enfin Dyatlov–Jin–Nonnenmacher [DJN22].

L'enseignement que l'on peut tirer de ces divers exemples est que l'observabilité de l'équation de Schrödinger est liée à la dynamique en temps long du flot géodésique sous-jacent. Plus le flot géodésique est stable (le cas extrême étant celui des variétés de Zoll où le flot est périodique), plus la contrainte sur l'ouvert d'observation ω sera forte pour que celui-ci observe l'équation de Schrödinger. À l'inverse, si le flot classique est très instable et qu'il présente des propriétés de mélange suffisantes (cas des surfaces à courbure négative par exemple), alors une observation depuis n'importe quel ouvert non trivial suffira. On constate donc que la propagation à vitesse infinie de l'énergie pour l'équation de Schrödinger implique une très grande richesse dans le problème de caractériser l'observabilité. C'est en opposition avec le cas des ondes pour lequel un critère universel, la Condition de Contrôle Géométrique, régit les propriétés de stabilité uniforme (et d'observabilité) de l'équation quelle que soit la géométrie de (M, g) .

1.1.2.3. Caractérisation des limites quantiques

Dans le prolongement des deux précédents paragraphes sur la stabilisation des ondes et l'observabilité de l'équation de Schrödinger, on discute maintenant de la question de l'observation des états propres d'un opérateur auto-adjoint P à résolvante compacte sur une variété compacte M , typiquement l'opérateur de Laplace–Beltrami associé à une métrique riemannienne g sur M . L'objectif de ce paragraphe est d'illustrer l'apport de la correspondance classique quantique dans le domaine de la géométrie spectrale, de se forger quelques intuitions, mais aussi de comprendre les limites de l'analogie classique-quantique. Ce sujet sera relativement peu abordé dans la suite de ce manuscrit. On en reparlera cependant dans le chapitre 3, où notre résultat sur l'observabilité de l'équation de Schrödinger implique des résultats d'observation des fonctions propres de certains opérateurs de Schrödinger dans l'espace euclidien.

On se donne un opérateur auto-adjoint P non-borné, positif et à résolvante compacte, agissant sur l'espace de Hilbert $L^2(M)$. En pratique on considère spécifiquement $P = -\Delta_g$ dans la limite des hautes énergies, ou des opérateurs de Schrödinger $P = -\hbar^2 \Delta_g + V(x)$ où $V \in C^\infty(M)$ dans la limite semi-classique $\hbar \rightarrow 0$. La théorie spectrale nous dit alors que le spectre de P est discret, et composé d'une suite croissante de réels positifs

$$0 \leq \lambda_0 \leq \lambda_1 \leq \lambda_2 \leq \dots \leq \lambda_n \longrightarrow +\infty.$$

À chaque valeur propre $\lambda \in \text{Spec } P$ est associé un espace propre non trivial E_λ de dimension finie. Les éléments non nuls de E_λ sont appelés états propres, modes propres ou fonctions propres. On définit un objet qui encode les propriétés de concentration (spatiale) des états propres dans l'asymptotique des hautes énergies $\lambda_n \rightarrow +\infty$.

Définition 1.1.3 (Limite quantique). Fixons $(u_n)_{n \in \mathbf{N}}$ une base hilbertienne orthonormée d'états propres et introduisons les mesures de probabilité $\mu_n = |u_n(x)|^2 d\text{Vol}_g(x)$, qui correspondent à probabilité de présence d'une particule quantique dans l'état u_n . On appelle limite quantique (associée à la base $(u_n)_{n \in \mathbf{N}}$) toute mesure de probabilité μ obtenue comme valeur d'adhérence de cette suite $(\mu_n)_{n \in \mathbf{N}}$ pour la topologie faible-étoile.

Notons que dans cette définition, les limites quantiques dépendent a priori de la base hilbertienne choisie. On peut donc aussi bien chercher à caractériser l'ensemble des limites quantiques associées à toutes les bases possibles, que s'intéresser aux limites quantiques associées à des bases particulières.

Les limites quantiques sont généralement étudiées en les relevant à l'espace des phases (ou plutôt au fibré unitaire cotangent S^*M). Ces mesures relevées sont parfois appelées *mesures semi-classiques*. Il est connu que l'ensemble des mesures semi-classiques est contenu dans l'ensemble (convexe) des mesures de probabilité invariantes par le flot géodésique. La question de caractériser l'ensemble des limites quantiques (ou des mesures semi-classiques) est en général très difficile. On donne ici un panorama de quelques résultats connus à ce sujet dans des contextes géométriques variés (essentiellement des variétés riemanniennes compactes). Comme pour l'observabilité de l'équation de Schrödinger, la distribution asymptotique des fonctions propres dépend des propriétés globales du flot géodésique sous-jacent. La compréhension fine des limites quantiques exige parfois de prendre en compte les phénomènes délicats d'interférences qui apparaissent en temps très long dans la dynamique du propagateur associé à l'opérateur P considéré.

La première famille d'exemples relève du chaos quantique, où l'on s'intéresse à des systèmes dont la limite classique est chaotique. On renvoie aux articles de revue [AN09b, AN09a, Non13] pour plus de références. Pour $P = -\Delta_g$, sur une variété riemannienne compacte dont le flot géodésique est ergodique par rapport à la mesure de Liouville sur S^*M , on sait d'après les travaux de Šnirel'man [Šni74], Zelditch [Zel87] et Colin de Verdière [CdV85] que la propriété d'*ergodicité quantique* est satisfaite, c'est-à-dire que pour toute base orthonormée de vecteurs propres fixée $(u_n)_{n \in \mathbf{N}}$, il existe un sous-ensemble $S \subset \mathbf{N}$ de densité 1 tel que

$$\mu_n \xrightarrow[n \in S]{*} \frac{1}{\text{Vol}_g(M)} d\text{Vol}_g. \quad (1.1.9)$$

Ceci signifie que la plupart des états propres s'équi-distribuent sur la variété dans la limite des hautes énergies et est en accord avec l'heuristique classique-quantique : les solutions stationnaires de l'EDP $D_t \psi = -P\psi$ doivent moralement se délocaliser lorsque la dynamique classique sous-jacente est ergodique, i.e. ses sous-ensembles invariants stricts sont de mesure nulle. D'autres généralisations ont été donnée ultérieurement ; voir par exemple le cas des billards convexes traité par Gérard et Leichtnam [GL93], ou des variétés à bord par Zelditch et Zworski [ZZ96]. Plus tard, Rudnick et Sarnak formulent la conjecture d'*unique ergodicité quantique* [RS94], selon laquelle sur toute variété de courbure sectionnelle négative, la convergence (1.1.9) est vraie pour toute la suite $(\mu_n)_{n \in \mathbf{N}}$, i.e. $S = \mathbf{N}$. Cette conjecture a été prouvée dans des cas très particuliers, notamment celui des surfaces arithmétiques compactes, et pour des bases hilbertiennes particulières ; voir Lindenstrauss [Lin06]. Dans le cas des surfaces d'Anosov, les résultats de Dyatlov–Jin [DJ18] et récemment de Dyatlov–Jin–Nonnenmacher [DJN22] énoncent que les limites quantiques ont un support égal à toute la variété : pour tout ouvert non-vide $\omega \subset M$, il existe une constante $c_\omega > 0$ telle que

$$-\Delta_g u = \lambda u \quad \implies \quad \|u\|_{L^2(\omega)} \geq c_\omega \|u\|_{L^2(M)}. \quad (1.1.10)$$

La preuve repose entre autre sur un théorème d'Egorov (qui formalise l'équivalence classique-quantique et sur lequel nous reviendrons au chapitre 4) et un principe d'incertitude fractal [Dya19]. Dans le contexte des variétés d'Anosov, les travaux d'Anantharaman [Ana08], Anantharaman–Nonnenmacher [AN07] et Rivière [Riv10b] donnent des bornes inférieures de l'entropie de Kolmogorov–Sinai des mesures semi-classiques, qui interdisent en particulier la concentration de toute l'énergie sur une géodésique fermée. Elles n'excluent cependant pas l'apparition de *cicatrices*, i.e. la concentration partielle de sous-suites d'états propres sur des géodésiques fermées. Il existe en fait des modèles jouets de chaos quantique qui présentent ce phénomène de cicatrices. Ainsi, pour des applications de type chat d'Arnold quantique, Faure, Nonnenmacher et de Bièvre prouvent l'existence de sous-suites de modes propres dont la moitié de la masse se concentre sur des trajectoires fermées de l'application chat classique sous-jacente [FNDB03, FN04], l'autre moitié étant équirépartie. Ce résultat montre que le théorème de Šnirel man ne peut pas être amélioré en général, et infirme l'unique ergodicité quantique dans ce cas très particulier. Pour terminer avec ce tour d'horizon dans le contexte du chaos quantique, citons le résultat de Hassell [Has10] qui concerne le stade de Bunimovitch, un des exemples les plus importants de billards ergodiques. Pour des billards « génériques », Hassell prouve l'existence de modes propres du Laplacien de Dirichlet produisant des cicatrices sur les trajectoires périodiques rebondissant sur les côtés de la partie rectangulaire du billard. C'est un autre exemple

de modes propres exceptionnels autorisés par le théorème de Šnirel'man contrevenant à l'unique ergodicité quantique. Dans les billards polygonaux, Hassell, Hillairet et Marzuola [HHM09] montrent que les fonctions propres du laplacien de Dirichlet ou de Neumann ne peuvent pas se concentrer loin des coins du billard : pour tout voisinage ω de l'ensemble des sommets du bord polygonal on a l'inégalité d'observabilité (1.1.10).

L'autre famille de systèmes dynamiques particulièrement étudiée est celle des systèmes complètement intégrables, caractérisés par un nombre maximal de quantités préservées. L'exemple le plus simple est peut-être le tore $\mathbf{T}^d = \mathbf{R}^d/\mathbf{Z}^d$. L'un des principaux résultats existants, dû à Jakobson [Jak97], d'après une idée de Bourgain, énonce que les limites quantiques du tore sont absolument continues par rapport à la mesure de Lebesgue, en dimension arbitraire. En dimension 2, Jakobson obtient de surcroît une description explicite des limites quantiques, établissant que leurs densités par rapport à la mesure de Lebesgue sont des polynômes trigonométriques. Les travaux [BZ12, BBZ13, BZ19] sur l'observabilité de l'équation de Schrödinger impliquent également que (1.1.10) est satisfaite sur \mathbf{T}^d pour tout ouvert ω non vide. Voir également les travaux de Anantharaman–Macià [AM14] et Macià–Rivière [MR18] pour des opérateurs de Schrödinger. Dans le cas de la sphère ronde de dimension arbitraire, Jakobson et Zelditch [JZ99] prouvent que l'ensemble des mesures semi-classiques (i.e. les relevés des limites quantiques sur S^*M) associées à une certaine base de fonctions propres coïncide avec l'ensemble des mesures invariantes par le flot géodésique, dont les points extrémaux se projettent, via la projection canonique $\pi : S^*M \rightarrow M$, sur les mesures de Dirac sur les équateurs. C'est en quelque sorte la situation opposée à celle de l'unique ergodicité quantique.² La concentration de modes propres sur des géodésiques apparaît comme un phénomène lié à la grande dégénérescence du spectre du laplacien sur la sphère. Le résultat de Jakobson–Zelditch a été généralisé par Macià aux espaces symétriques compacts de rang 1 [Mac08], ou encore aux variétés compactes de courbure sectionnelle constante strictement positive [AM10]. En revanche, Macià et Rivière [MR16] montrent que cette propriété n'est plus satisfaite sur la sphère \mathbf{S}^d lorsque le laplacien est remplacé par un opérateur de Schrödinger $P = -\Delta + V(x)$ avec un potentiel lisse générique. De même, l'ensemble des mesures semi-classiques pour l'opérateur de Laplace–Beltrami sur certaines surfaces de Zoll ne coïncide pas avec l'ensemble des mesures invariantes par le flot géodésique [MR16]. Dans le disque, les travaux d'Anantharaman, Léautaud et Macià donnent une description fine des limites quantiques d'opérateurs du type $-\Delta_D + V(x)$ (Δ_D est le laplacien de Dirichlet) : elles peuvent s'écrire comme une combinaison convexe d'une mesure absolument continue par rapport à la mesure de Lebesgue dans l'intérieur du disque et de la mesure uniforme sur le cercle (cette dernière s'obtient aussi comme limite quantique d'une suite de modes propres du disque appelée « galerie des chuchotements »). On renvoie vers l'article d'Anantharaman–Fermanian Kammerer–Macià [AFKM15] pour un traitement général des mesures semi-classiques pour les systèmes complètement intégrables. On mentionne pour terminer les récents travaux d'Arnaiz et Macià [AM22a, AM22b], qui donnent une description complète des limites quantiques pour des oscillateurs harmoniques généraux et des perturbations de ceux-ci, selon les propriétés diophantiennes des fréquences caractéristiques de l'oscillateur. Nous en reparlerons brièvement au chapitre 3.

1.1.3. Estimées de résolvante et théorie du contrôle

L'étude mathématique des problèmes de stabilité uniforme des ondes amorties et d'observabilité de l'équation de Schrödinger décrits dans les paragraphes 1.1.2.1 et 1.1.2.2 peut souvent être réalisée via une réduction à un problème stationnaire, à savoir une estimée de résolvante sur le générateur de l'évolution. On donne ici deux énoncés dont nous ébauchons les preuves.

Ondes amorties

Revenons tout d'abord sur la stabilité uniforme des ondes amorties. On formule le problème dans un cadre un peu plus abstrait. On considère l'équation des ondes amorties

$$\partial_t \Psi = \mathcal{A}_B \Psi \quad \text{avec} \quad \mathcal{A}_B = \begin{pmatrix} 0 & 1 \\ -P & -B^*B \end{pmatrix}, \quad (1.1.11)$$

²Notons que pour une base aléatoire de fonctions propres sur la 2-sphère, on a tout de même unique ergodicité quantique, c'est-à-dire que pour presque toute base hilbertienne orthonormale de fonctions propres du laplacien (par rapport à une mesure de probabilité naturelle sur l'ensemble de ces bases), la probabilité uniforme sur \mathbf{S}^2 est la seule limite quantique associée à cette base au sens de la définition 1.1.3 [Zel92, Van97, Van98].

où P est un opérateur auto-adjoint à résolvante compacte³ tel que $P \geq c > 0$ sur un espace de Hilbert \mathcal{H} , et B est un opérateur auto-adjoint borné sur \mathcal{H} . L'exemple que nous avons en tête pour le paragraphe 1.2 est $\mathcal{H} = L^2(\mathbf{R}^d)$ avec $P = V(x) - \Delta$ (où le potentiel est positif et confinant) et B est l'opérateur de multiplication par \sqrt{b} , où $b \in L^\infty(\mathbf{R}^d)$, $b \geq 0$. La théorie de Hille-Yosida [Paz83] permet de vérifier que l'opérateur des ondes amorties \mathcal{A}_B défini dans (1.1.11) engendre un semi-groupe de contractions $(e^{t\mathcal{A}_B})_{t \in \mathbf{R}}$ sur l'espace de Hilbert $\mathfrak{H} = \text{dom } P^{1/2} \times \mathcal{H}$ muni du produit scalaire

$$\left(\begin{pmatrix} u_1 \\ v_1 \end{pmatrix}, \begin{pmatrix} u_2 \\ v_2 \end{pmatrix} \right)_{\mathfrak{H}} := \left(P^{1/2}u_1, P^{1/2}u_2 \right)_{\mathcal{H}} + (v_1, v_2)_{\mathcal{H}}, \quad \begin{pmatrix} u_1 \\ v_1 \end{pmatrix}, \begin{pmatrix} u_2 \\ v_2 \end{pmatrix} \in \mathfrak{H}.$$

Pour une donnée initiale $U \in \mathfrak{H}$ de (1.1.11), l'énergie associée est définie par

$$\mathcal{E}(U, t) := \frac{1}{2} \left\| e^{\mathcal{A}_B t} U \right\|_{\mathfrak{H}}^2, \quad t \geq 0,$$

de sorte qu'en écrivant $\Psi = (\psi(t), \partial_t \psi(t))$ la solution de (1.1.11) issue de U , on ait

$$\mathcal{E}(U, t) = \frac{1}{2} \left(\left\| \partial_t \psi(t) \right\|_{\mathcal{H}}^2 + \left\| \sqrt{P} \psi(t) \right\|_{\mathcal{H}}^2 \right).$$

On a alors le résultat suivant dont on ébauche une preuve.

Proposition 1.1.4 (Estimée de résolvante pour la stabilité uniforme des ondes). *On a*

$$\exists \tau, C > 0 : \forall t \in \mathbf{R}, \quad \left\| e^{t\mathcal{A}_B} \right\|_{\mathcal{L}(\mathfrak{H})} \leq C e^{-t/\tau} \quad (1.1.12)$$

\Updownarrow

$$\text{Spec } \mathcal{A}_B \cap i\mathbf{R} = \emptyset \quad \text{et} \quad \sup_{\lambda \in \mathbf{R}} \left\| (\mathcal{A}_B - i\lambda)^{-1} \right\|_{\mathcal{L}(\mathfrak{H})} < \infty. \quad (1.1.13)$$

Démonstration. On suppose d'abord que l'on a décroissance exponentielle de la norme d'opérateur du semi-groupe. En vertu de la formule

$$(\mathcal{A}_B - i\lambda)^{-1} = - \int_0^{+\infty} e^{t(\mathcal{A}_B - i\lambda)} dt,$$

l'inégalité triangulaire et (1.1.12) impliquent pour $\lambda \in \mathbf{R}$:

$$\left\| (\mathcal{A}_B - i\lambda)^{-1} \right\|_{\mathcal{L}(\mathfrak{H})} \leq \int_0^{+\infty} C e^{-t/\tau} dt = C\tau.$$

Réciproquement, on suppose que la résolvante de \mathcal{A}_B est bornée sur l'axe des imaginaires purs. On se donne $U \in \mathfrak{H}$ et on fixe $\chi \in C^\infty(\mathbf{R}; [0, 1])$ telle que $\chi \equiv 1$ au voisinage de l'infini et $\chi \equiv 0$ sur \mathbf{R}_- . On pose $V(t) := \chi(t) e^{t\mathcal{A}_B} U$ pour un certain $U \in \mathfrak{H}$. On a

$$\partial_t V(t) = \chi'(t) e^{t\mathcal{A}_B} U + \mathcal{A}_B V(t).$$

On prend la transformée de Fourier par rapport au temps pour obtenir

$$iz \widehat{V}(z) = \mathcal{F}_{t \rightarrow z} \left(\chi'(t) e^{t\mathcal{A}_B} U \right) (z) + \mathcal{A}_B \widehat{V}(z),$$

d'où l'on tire, en supposant que $z \in \mathbf{R}$ (et en utilisant que $\text{Spec } \mathcal{A}_B \cap i\mathbf{R} = \emptyset$) :

$$\widehat{V}(z) = -(\mathcal{A}_B - iz)^{-1} \mathcal{F}_{t \rightarrow z} \left(\chi'(t) e^{t\mathcal{A}_B} U \right) (z). \quad (1.1.14)$$

En utilisant le théorème de Plancherel⁴ puis (1.1.14), on en déduit que

$$\int_{\mathbf{R}} \|V(t)\|_{\mathfrak{H}}^2 dt = c \int_{\mathbf{R}} \left\| \widehat{V}(z) \right\|_{\mathfrak{H}}^2 dz \leq cC \int_{\mathbf{R}} \left\| \mathcal{F}_{t \rightarrow z} \left(\chi'(t) e^{t\mathcal{A}_B} U \right) (z) \right\|_{\mathfrak{H}}^2 dz.$$

³La compacité de la résolvante et la stricte positivité de l'opérateur simplifient un certain nombre d'arguments dans l'étude de la stabilité uniforme des ondes. Notons que l'hypothèse $P \geq c > 0$ n'est pas satisfaite pour $P = -\Delta_g$ sur une variété riemannienne (M, g) compacte, mais l'argument peut être adapté; voir [AL14].

⁴Notons que pour être rigoureux, il faudrait montrer auparavant que $t \mapsto V(t)$ est bien dans $L^2(\mathbf{R}; \mathfrak{H})$.

Le théorème de Plancherel de nouveau, puis le fait que $(e^{t\mathcal{A}_B})_{t \in \mathbf{R}_+}$ est un semi-groupe de contractions impliquent

$$\int_{\mathbf{R}} \|V(t)\|_{\mathfrak{H}}^2 dt \leq C \int_{\mathbf{R}} \left\| \chi'(t) e^{t\mathcal{A}_B} U \right\|_{\mathfrak{H}}^2 dt \leq C \|\chi'\|_{L^2(\mathbf{R})}^2 \|U\|_{\mathfrak{H}}^2.$$

En utilisant que $\|e^{t\mathcal{A}_B}\|_{\mathcal{L}(\mathfrak{H})} \leq 1$ pour tout $t \geq 0$, on obtient en particulier que

$$\int_{\mathbf{R}_+} \left\| e^{t\mathcal{A}_B} U \right\|_{\mathfrak{H}}^2 dt \leq \int_{\mathbf{R}_+} \left\| (1 - \chi(t)) e^{t\mathcal{A}_B} U + V(t) \right\|_{\mathfrak{H}}^2 dt \leq 2 \left(\|1 - \chi\|_{L^2(\mathbf{R}_+)}^2 + C \|\chi'\|_{L^2(\mathbf{R})}^2 \right) \|U\|_{\mathfrak{H}}^2.$$

Enfin, la propriété de semi-groupe conduit à

$$\begin{aligned} \forall t \in \mathbf{R}_+^*, \quad \left\| e^{t\mathcal{A}_B} U \right\|_{\mathfrak{H}}^2 &\leq \frac{1}{t} \int_0^t \left\| e^{(t-s)\mathcal{A}_B} e^{s\mathcal{A}_B} U \right\|_{\mathfrak{H}}^2 ds \leq \frac{1}{t} \int_0^t \left\| e^{s\mathcal{A}_B} U \right\|_{\mathfrak{H}}^2 ds \\ &\leq \frac{2}{t} \left(\|1 - \chi\|_{L^2(\mathbf{R}_+)}^2 + C \|\chi'\|_{L^2(\mathbf{R})}^2 \right) \|U\|_{\mathfrak{H}}^2. \end{aligned}$$

Ceci est valable pour tout $U \in \mathfrak{H}$. En particulier, pour t assez grand, on obtient $\|e^{t\mathcal{A}_B}\|_{\mathcal{L}(\mathfrak{H})} < 1$, et la propriété de semi-groupe implique donc la décroissance exponentielle uniforme (1.1.12). \square

L'estimée de résolvante (1.1.13) porte sur un opérateur qu'on peut qualifier de vectoriel, au sens où il agit sur l'espace de Hilbert $\mathfrak{H} \subset \mathcal{H} \oplus \mathcal{H}$. Il existe plusieurs façons de se ramener à une estimée de résolvante « scalaire » plus facilement manipulable. D'une part on peut montrer qu'il existe une constante $C > 0$ telle que pour tout $\lambda \in \mathbf{R}$:

$$C^{-1} \langle \lambda \rangle \left\| (P - \lambda^2 + i\lambda B^* B)^{-1} \right\|_{\mathcal{L}(\mathcal{H})} \leq \left\| (\mathcal{A}_B - i\lambda)^{-1} \right\|_{\mathcal{L}(\mathfrak{H})} \leq C \langle \lambda \rangle \left\| (P - \lambda^2 + i\lambda B^* B)^{-1} \right\|_{\mathcal{L}(\mathcal{H})}.$$

On renvoie à [Leb96] ou encore à [AL14, Lemma 4.6] pour une preuve (l'idée générale est d'utiliser la formule du complément de Schur pour exprimer les composantes de $(\mathcal{A}_B - i\lambda)^{-1}$). On peut donc montrer (en séparant les parties réelle et imaginaire de l'opérateur $P - \lambda^2 + i\lambda B^* B$ et en utilisant le fait que B est borné) que

$$\begin{aligned} \text{Spec } \mathcal{A}_B \cap i\mathbf{R} = \emptyset \quad &\text{et} \quad \sup_{\lambda \in \mathbf{R}} \left\| (\mathcal{A}_B - i\lambda)^{-1} \right\|_{\mathcal{L}(\mathfrak{H})} < \infty \\ &\Downarrow \\ \exists C > 0 : \forall \lambda \in \mathbf{R}, \forall u \in \text{dom } P, \quad &\|u\|_{\mathcal{H}} \leq \frac{C}{\langle \lambda \rangle} \left\| (P - \lambda^2)u \right\|_{\mathcal{H}} + C \|Bu\|_{\mathcal{H}}. \end{aligned} \quad (1.1.15)$$

Une seconde manière de se ramener à une estimée de résolvante scalaire est d'utiliser la factorisation de l'opérateur des ondes

$$-\partial_t^2 - P = (D_t + \sqrt{P})(D_t - \sqrt{P}).$$

Un travail semblable à celui de la preuve de (1.1.15) peut être réalisé après avoir diagonalisé la partie principale (sans amortissement) de l'équation des ondes amorties (1.1.3) vue comme système hyperbolique ; voir [Lé23]. On aboutit ainsi à l'énoncé suivant :

$$\begin{aligned} \text{Spec } \mathcal{A}_B \cap i\mathbf{R} = \emptyset \quad &\text{et} \quad \sup_{\lambda \in \mathbf{R}} \left\| (\mathcal{A}_B - i\lambda)^{-1} \right\|_{\mathcal{L}(\mathfrak{H})} < \infty \\ &\Downarrow \\ \exists C > 0 : \forall \lambda \in \mathbf{R}, \forall u \in \text{dom } \sqrt{P}, \quad &\|u\|_{\mathcal{H}} \leq C \left\| (\sqrt{P} - \lambda)u \right\|_{\mathcal{H}} + C \|Bu\|_{\mathcal{H}}. \end{aligned} \quad (1.1.16)$$

En particulier, les estimées de résolvante sur les opérateur P et \sqrt{P} en (1.1.15) et (1.1.16) sont équivalentes (ce que l'on peut aussi vérifier directement). Cela dit, elles ont chacune leurs avantages et leurs inconvénients.

- L'estimée (1.1.15) est pratique car elle porte sur l'opérateur P , qui sera dans notre étude un opérateur de Schrödinger (en particulier un opérateur *différentiel*) ; voir le paragraphe 1.2. En revanche, étudier l'évolution quantique e^{-itP} dans ce cadre peut s'avérer plus compliqué. En effet, dans le cas $P = -\Delta_g$ sur une variété Riemannienne compacte (M, g) , le propagateur

$e^{it\Delta_g}$ correspond à l'équation de Schrödinger (1.1.7), pour laquelle on a propagation de l'énergie à vitesse infinie. On n'a alors a priori pas de description *globale* sur l'espace des phases pour l'évolution $e^{it\Delta_g}$ en termes de correspondance classique-quantique, et il est en général nécessaire de tronquer le hamiltonien P au voisinage d'une couche d'énergie pour étudier l'évolution. On reparlera de ces questions en lien avec le théorème d'Egorov dans le paragraphe 1.4.

- L'estimée de résolvante en (1.1.16) implique un opérateur « plus petit », à savoir \sqrt{P} , qui correspond à l'opérateur de demi-ondes dans le cas $P = -\Delta_g$ (c'est en particulier un opérateur d'ordre 1). L'évolution associée correspond à l'équation des ondes, pour laquelle on a propagation de l'énergie à vitesse finie, et on dispose alors d'un principe de correspondance classique-quantique global permettant de décrire l'action du propagateur $e^{-it\sqrt{-\Delta_g}}$ sur tout l'espace des phases. La contrepartie est que la racine carrée \sqrt{P} (définie par le calcul fonctionnel pour les opérateurs auto-adjoints) n'est pas vraiment explicite, et on perd le caractère différentiel de l'opérateur lorsque l'on part d'un opérateur différentiel P .

Dans le chapitre 2 sur la stabilité uniforme des ondes avec potentiel confinant, on utilisera la première option, c'est-à-dire l'estimée de résolvante (1.1.15) sur P . L'une des applications du chapitre 4 sur le théorème d'Egorov dans le calcul de Weyl–Hörmander pourra être utilisée pour prouver l'estimée de résolvante (1.1.16) sur \sqrt{P} .

Schrödinger

On donne maintenant un analogue de la proposition 1.1.4 pour le problème de l'observabilité de l'équation de Schrödinger introduit dans le paragraphe 1.1.2.2. Là encore, on peut reformuler le problème dans un cadre abstrait. On considère l'équation de Schrödinger

$$D_t\psi = -P\psi, \quad (1.1.17)$$

où P est un opérateur auto-adjoint à résolvante compacte agissant sur un espace de Hilbert \mathcal{H} . On fixe également un opérateur d'observation B borné et auto-adjoint sur \mathcal{H} . L'exemple que l'on a en tête consiste à prendre $\mathcal{H} = L^2(\mathbf{R}^d)$, $P = V(x) - \frac{1}{2}\Delta$ un opérateur de Schrödinger (avec potentiel confinant, i.e. $V(x) \rightarrow +\infty$ lorsque $x \rightarrow \infty$) et $B = \mathbb{1}_\omega$ où $\omega \subset \mathbf{R}^d$ est un ouvert d'observation. Le résultat suivant, dont on ébauche la preuve, est dû à Burq et Zworski [BZ04], Ramdani–Takahashi–Tenenbaum–Tucsnak [RTTT05] et Miller [Mil05] (voir aussi [TW09, Mil12]).

Proposition 1.1.5 (Estimée de résolvante pour l'observabilité de Schrödinger). *On a l'inégalité d'observabilité*

$$\exists T, C > 0 : \forall u \in \mathcal{H}, \quad \|u\|_{\mathcal{H}}^2 \leq C \int_0^T \|Be^{-itP}u\|_{\mathcal{H}}^2 dt \quad (1.1.18)$$

si et seulement si

$$\exists C > 0 : \forall \lambda \in \mathbf{R}, \forall u \in \text{dom } P, \quad \|u\|_{\mathcal{H}} \leq C\|(P - \lambda)u\|_{\mathcal{H}} + C\|Bu\|_{\mathcal{H}}. \quad (1.1.19)$$

Démonstration. On commence par supposer que l'estimée de résolvante (1.1.19) est fautive. Alors il existe des suites $(\lambda_n)_{n \in \mathbf{N}}$ dans \mathbf{R} et $(u_n)_{n \in \mathbf{N}}$ dans $\text{dom } P$ telles que $\|u_n\|_{L^2(\mathbf{R}^d)} = 1$ pour tout $n \in \mathbf{N}$ et

$$(P - \lambda_n)u_n \xrightarrow[n \rightarrow \infty]{\mathcal{H}} 0 \quad \text{et} \quad Bu_n \xrightarrow[n \rightarrow \infty]{\mathcal{H}} 0.$$

On déduit de l'inégalité des accroissements finis que pour tout $T > 0$, on a uniformément en $t \in [0, T]$:

$$\left\| e^{-it(P - \lambda_n)}u_n - u_n \right\|_{\mathcal{H}} \leq \int_0^t \|e^{-itP}(P - \lambda_n)u_n\|_{\mathcal{H}} dt = o(1)$$

lorsque $n \rightarrow \infty$, et donc

$$\|Be^{-itP}u_n\|_{\mathcal{H}} \leq \|Bu_n\|_{\mathcal{H}} + \|B\|_{\mathcal{L}(\mathcal{H})} \left\| e^{-it(P - \lambda_n)}u_n - u_n \right\|_{\mathcal{H}} = o(1)$$

lorsque $n \rightarrow \infty$ (uniformément en $t \in [0, T]$). On obtient donc

$$\int_0^T \|Be^{-itP}u_n\|_{\mathcal{H}}^2 dt \xrightarrow[n \rightarrow \infty]{} 0,$$

ce qui contredit l'observabilité (1.1.18).

Réciproquement, on suppose que l'estimée de résolvante (1.1.19) est vraie. On fixe $\chi_1, \chi_2 \in C^\infty(\mathbf{R}; [0, 1])$ telles que $\chi_1 \equiv 1$ sur $] -\infty, 1]$ et $\text{supp } \chi_1 \subset] -\infty, 2]$, et $\chi_2 \equiv 1$ sur $[1, +\infty[$ et $\text{supp } \chi_2 \subset [0, +\infty[$. Soit $u \in L^2(\mathbf{R}^d)$ et posons $v(t) := \chi_R(t)e^{-itP}u$ où $\chi = \chi_R = \chi_1(\bullet - R)\chi_2$ pour $R > 0$. On observe que χ est supportée dans $[0, 2 + R]$ et qu'elle vaut 1 sur $[1, 1 + R]$. On a

$$D_t v(t) = (D_t \chi_R)(t)e^{-itP}u - Pv(t).$$

On prend la transformée de Fourier par rapport au temps pour obtenir

$$(P + z)\hat{v}(z) = \mathcal{F}_{t \rightarrow z} \left(\frac{1}{i} \chi'(t) e^{-itP} u \right) (z).$$

On applique l'estimée de résolvante (1.1.19) avec $\lambda = z \in \mathbf{R}$ et $\hat{v}(z)$ à la place de u pour aboutir à

$$\|\hat{v}(z)\|_{\mathcal{H}} \leq C \left\| \mathcal{F}_{t \rightarrow z} \left(\chi'(t) e^{-itP} u \right) (z) \right\|_{\mathcal{H}} + C \left\| \widehat{Bv}(z) \right\|_{\mathcal{H}}.$$

On prend le carré de cette inégalité, on intègre sur $z \in \mathbf{R}$ et on utilise le théorème de Plancherel pour en déduire

$$\int_{\mathbf{R}} \|v(t)\|_{\mathcal{H}}^2 dt \leq 2C^2 \int_{\mathbf{R}} \|\chi'(t) e^{-itP} u\|_{\mathcal{H}}^2 dt + 2C^2 \int_{\mathbf{R}} \|Bv(t)\|_{\mathcal{H}}^2 dt.$$

En se rappelant que $(e^{-itP})_{t \in \mathbf{R}}$ est un groupe unitaire et en utilisant la définition de $v(t)$, on peut borner le membre de gauche par en-dessous et le membre de droite par au-dessus de sorte à obtenir

$$R\|u\|_{\mathcal{H}}^2 \leq 4C^2 \|\chi'\|_{L^\infty}^2 \|u\|_{\mathcal{H}}^2 + 2C^2 \int_0^{2+R} \|Be^{-itP}u\|_{\mathcal{H}}^2 dt.$$

On a utilisé le fait que χ' est bornée indépendamment du paramètre R et que la mesure de Lebesgue de son support est bornée par 2, et aussi que $\chi = \chi_R$ est supportée dans $[0, 2 + R]$. On obtient donc pour R assez grand :

$$\|u\|_{\mathcal{H}}^2 \leq \frac{2C^2}{R - 4C^2 \|\chi'\|_{L^\infty}^2} \int_0^{2+R} \|Be^{-itP}u\|_{\mathcal{H}}^2 dt,$$

ce qui correspond bien à (1.1.18). \square

Pour résumer cette partie, on a mis en évidence l'importance des estimées de résolvante du type

$$\exists C > 0 : \forall \lambda \in \mathbf{R}, \forall u \in \mathcal{H}, \quad \|u\|_{\mathcal{H}} \leq C \|(P^s - \lambda)u\|_{\mathcal{H}} + C \|Bu\|_{\mathcal{H}}. \quad (1.1.20)$$

Les cas qui nous intéressent sont $s = 1/2$ pour la stabilité uniforme des ondes (B est alors la multiplication par la racine carrée du coefficient d'amortissement), et $s = 1$ pour l'observabilité de l'équation de Schrödinger (B est alors la multiplication par la fonction l'indicatrice de l'ensemble d'observation). L'analogie pour le problème de l'observation uniforme des fonctions propres tel que (1.1.10) est une estimée du type

$$\exists C > 0 : \quad (Pu = \lambda u \implies \|u\|_{\mathcal{H}} \leq C \|Bu\|_{\mathcal{H}}). \quad (1.1.21)$$

La preuve d'une estimée de résolvante comme (1.1.20) se déroule généralement en deux étapes. Premièrement, on vérifie que l'estimée (1.1.20) est vraie sur tout compact $\lambda \in [-\lambda_0, \lambda_0]$ (avec une constante $C = C(\lambda_0)$ dépendant de $\lambda_0 > 0$), pourvu que le couple d'opérateurs (P^s, B) satisfasse des propriétés de prolongement unique [LRLR22a, LRLR22b]. Deuxièmement, on vérifie que la constante C est en fait uniforme en $\lambda_0 > 0$ à haute énergie $\lambda \gg 1$. Par la contraposée, si cette constante $C(\lambda_0)$ explose lorsque $\lambda_0 \rightarrow +\infty$, alors il existe une suite $(\lambda_n)_{n \in \mathbf{N}}$ telle que $\lambda_n \rightarrow +\infty$ et une suite $(u_n)_{n \in \mathbf{N}}$ dans le domaine de P^s telles que

$$\left\{ \begin{array}{l} (P^s - \lambda_n)u_n = o_{\mathcal{H}}(1), \\ Bu_n = o_{\mathcal{H}}(1), \end{array} \right. \quad \|u_n\|_{\mathcal{H}} = 1, \quad (1.1.22)$$

$$\left\{ \begin{array}{l} (P^s - \lambda_n)u_n = o_{\mathcal{H}}(1), \\ Bu_n = o_{\mathcal{H}}(1), \end{array} \right. \quad (1.1.23)$$

lorsque $n \rightarrow \infty$. Une famille de fonctions satisfaisant (1.1.22) est qualifiée de *quasi-mode* de l'opérateur P^s de précision $o(1)$, ou encore de $o(1)$ -quasi-mode de P^s . On interprète (1.1.23) comme le

fait que ce quasi-mode échappe à l'amortissement ou à l'observation. Ainsi, la négation de l'estimée de résolvante (1.1.20) donne lieu à des quasi-modes échappant à l'amortissement ou à l'observation, qu'il convient donc d'étudier.

On termine ce paragraphe par un énoncé permettant de relier les trois problèmes évoqués dans le paragraphe 1.1.2, à savoir la stabilisation des ondes, l'observabilité de Schrödinger et l'étude des fonctions propres.

Proposition 1.1.6. *Soit P un opérateur auto-adjoint à résolvante compacte tel que $P \geq c > 0$ sur un espace de Hilbert \mathcal{H} , et soit B un opérateur auto-adjoint borné sur \mathcal{H} . Alors on a les implications*

$$(1.1.15) \iff (1.1.16) \implies (1.1.19) \implies (1.1.21).$$

Démonstration. On rappelle que les estimées de résolvante (1.1.15) et (1.1.16) sont équivalentes à (1.1.13). Il reste donc à montrer les implications. Notons tout d'abord que l'on a pour tout $s \geq 0$:

$$\forall \lambda \leq 0, \forall u \in \text{dom } P^s, \quad \|u\|_{\mathcal{H}} \leq c^{-s} \|P^s u\|_{\mathcal{H}} \leq c^{-s} \|(P^s - \lambda)u\|_{\mathcal{H}} + \|Bu\|_{\mathcal{H}},$$

étant donné que $P \geq c > 0$ par hypothèse. Vérifions l'implication (1.1.16) \Rightarrow (1.1.19). Si l'on suppose que (1.1.16) est vraie, il suffit donc de prouver (1.1.19) pour $\lambda \geq 0$. Cela découle directement du fait que pour tout $\lambda \geq 0$ et pour tout $u \in \text{dom } P$, on a

$$\begin{aligned} \|(P^{1/2} - \lambda)u\|_{\mathcal{H}} &= \|(P^{1/2} + \lambda)^{-1}(P - \lambda^2)u\|_{\mathcal{H}} \leq \|(P^{1/2} + \lambda)^{-1}\|_{\mathcal{L}(\mathcal{H})} \|(P - \lambda^2)u\|_{\mathcal{H}} \\ &\leq c^{-1/2} \|(P - \lambda^2)u\|_{\mathcal{H}}. \end{aligned}$$

En injectant cette inégalité dans (1.1.16) pour $\lambda \geq 0$, on obtient bien (1.1.19) avec λ^2 à la place de λ . Cela prouve donc (1.1.16) \Rightarrow (1.1.19). La deuxième implication consiste à appliquer (1.1.19) aux fonctions propres, ce qui termine la preuve de la proposition. \square

1.1.4. Quantification et analyse microlocale

L'évolution associée à une équation aux dérivées partielles telle que l'équation des ondes ou l'équation de Schrödinger a lieu dans un espace de Hilbert, généralement de dimension infinie, comme l'espace des fonctions de carré intégrable $L^2(M, d\text{Vol}_g)$ sur une variété riemannienne (M, g) . La dynamique classique sous-jacente (e.g. l'optique géométrique) est en revanche naturellement définie sur l'espace des phases T^*M , c'est-à-dire le fibré cotangent au-dessus de la variété M , qui est de dimension $2 \dim M$ (voir le paragraphe 1.1.5.1 pour des définitions plus précises). La quantification est le procédé mathématique qui permet de relever les *observables classiques* (les fonctions sur l'espace des phases T^*M) en *observables quantiques* (les opérateurs agissant sur $L^2(M)$), et ainsi comparer dynamique quantique et dynamique classique. Dans ce paragraphe, on considère $M = \mathbf{R}^d$ et la quantification de Weyl Op^w que l'on introduit à présent (il en existe beaucoup d'autres mais on se restreindra à celle-ci dans ce manuscrit). On renvoie à [Zwo12, Ler10, Hör85, DS99, Mar02] pour plus de détails et des présentations alternatives de la théorie.

1.1.4.1. Quantification de Weyl

Etant donné un symbol $a \in \mathcal{S}(T^*M)$, on définit la quantification de Weyl de a comme étant l'opérateur $\text{Op}^w(a)$ agissant sur l'espace de Schwartz $\mathcal{S}(M)$ donné par

$$[\text{Op}^w(a)u](x) = \int_{T^*M} e^{i\xi \cdot (x-y)} a\left(\frac{x+y}{2}, \xi\right) u(y) dy d\xi, \quad x \in M, u \in \mathcal{S}(M). \quad (1.1.24)$$

On vérifie alors que $\text{Op}^w(a) : \mathcal{S}(M) \rightarrow \mathcal{S}(M)$ est continu. Notons que cette formule ne nécessite qu'une structure affine sur M (pour donner un sens à $x - y$ et $\frac{x+y}{2}$); la structure euclidienne est superflue.⁵ C'est la raison pour laquelle on conserve la notation M (au lieu de \mathbf{R}^d), pour laquelle il n'y a pas d'origine et la distinction entre point et vecteur tangent est claire. On remarque que la quantification Op^w envoie les symboles ne dépendant que de la variable x sur les opérateurs de multiplication et ceux ne dépendant que de la variable ξ sur les multiplicateurs de Fourier :

$$\text{Op}^w(a(x)) = a(x), \quad \text{and} \quad \text{Op}^w(a(\xi)) = \mathcal{F}^{-1} a(\xi) \mathcal{F},$$

⁵On travaille ici avec une normalisation fixée de la mesure de Lebesgue dx sur \mathbf{R}^d , telle que produit scalaire sur $L^2(M)$ s'écrive $(u, v)_{L^2} := \int_M \bar{u}(x)v(x) dx$. On normalise la mesure « duale » $d\xi$ sur les espaces cotangents $T_x^*M \simeq \mathbf{R}^d$ de sorte que la mesure $dx d\xi$ sur T^*M vérifie $\text{Op}^w(1) = \text{Id}$ dans (1.1.24).

où \mathcal{F} est la transformée de Fourier. Pour des symboles plus généraux, on attend de l'opérateur correspondant qu'il « interpole » entre ces deux cas particuliers, et qu'il agisse de façon consistante avec les valeurs prises par a dans les différentes régions de l'espace des phases. Ces opérateurs $\text{Op}^{\text{w}}(a)$ sont appelés opérateurs pseudo-différentiels, ou observables quantiques. On parlera de symbole ou d'observable classique pour a .

En introduisant la transformée de Wigner [Wig32] de $u_1, u_2 \in \mathcal{S}(M)$:

$$(u_1 \otimes u_2)(x, \xi) := \int_{\mathbf{R}^d} \bar{u}_2\left(x + \frac{v}{2}\right) u_1\left(x - \frac{v}{2}\right) e^{i\xi \cdot v} dv, \quad (x, \xi) \in T^*M, \quad (1.1.25)$$

qui envoie continûment $\mathcal{S}(M) \times \mathcal{S}(M)$ dans $\mathcal{S}(T^*M)$, on obtient une formulation faible

$$\int_M \bar{u}_2 \text{Op}^{\text{w}}(a) u_1 dx = \int_{T^*M} a(u_1 \otimes u_2) dx d\xi$$

permettant d'étendre la définition de la quantification de Weyl aux distributions tempérées :

$$\langle \text{Op}^{\text{w}}(a) u_1, u_2 \rangle_{\mathcal{S}', \mathcal{S}(M)} := \langle a, u_1 \otimes \bar{u}_2 \rangle_{\mathcal{S}', \mathcal{S}(T^*M)}, \quad a \in \mathcal{S}'(T^*M), u_1, u_2 \in \mathcal{S}(M).$$

On obtient alors un opérateur $\text{Op}^{\text{w}}(a) : \mathcal{S}(M) \rightarrow \mathcal{S}'(M)$ continu. Réciproquement, tout opérateur $A : \mathcal{S}(M) \rightarrow \mathcal{S}'(M)$ continu peut s'écrire de façon unique $A = \text{Op}^{\text{w}}(a)$ avec $a \in \mathcal{S}'(T^*M)$ en vertu du théorème du noyau de Schwartz [Trè67, Corollaire du Théorème 51.7]. La transformée de Wigner s'étend en une application sesquilinéaire $L^2(M) \times L^2(M) \rightarrow L^2(T^*M)$. On lui donne maintenant une première interprétation. Lorsque $u_1 = u_2 = u \in L^2(M)$ est de norme 1, on la voit souvent comme une distribution de « quasi-probabilité » qui relève la densité $|u(x)|^2 dx$ à l'espace des phases et en indique la localisation spatiale et fréquentielle simultanée, aussi appelée *microlocalisation*. Cette interprétation est justifiée en particulier par l'observation que

$$\int_{T_x^*M} (u \otimes u)(x, \xi) d\xi = |u(x)|^2 \quad \text{et} \quad \int_M (u \otimes u)(x, \xi) dx = |\mathcal{F} u(\xi)|^2.$$

L'importance des produits scalaires du type

$$(u, \text{Op}^{\text{w}}(a)u)_{L^2} = \int_{T^*M} a(u \otimes u) dx d\xi$$

apparaît donc clairement : ces quantités permettent d'évaluer, ou de mesurer, la microlocalisation de u , d'où la terminologie d'observable quantique et classique.

1.1.4.2. Calcul pseudo-différentiel

L'outil de base de l'analyse microlocale est le calcul pseudo-différentiel, qui permet de décrire la composition d'opérateurs de la forme $\text{Op}^{\text{w}}(a)$ en fonction de leurs symboles. Si l'on se donne deux symboles a_1, a_2 tels que la composition $\text{Op}^{\text{w}}(a_1)\text{Op}^{\text{w}}(a_2) : \mathcal{S}(M) \rightarrow \mathcal{S}'(M)$ ait un sens et soit continue, alors on peut définir le produit de Moyal de a_1 et a_2 , noté $a_1 \# a_2$, par l'identité

$$\text{Op}^{\text{w}}(a_1)\text{Op}^{\text{w}}(a_2) = \text{Op}^{\text{w}}(a_1 \# a_2). \quad (1.1.26)$$

Sous certaines hypothèses sur a_1 et a_2 , le calcul pseudo-différentiel consiste à donner un développement asymptotique du produit de Moyal qui prend la forme

$$\text{Op}^{\text{w}}(a_1)\text{Op}^{\text{w}}(a_2) = \text{Op}^{\text{w}}(a_1 \# a_2) = \text{Op}^{\text{w}}(a_1 a_2) + \text{Op}^{\text{w}}\left(\frac{1}{2i}\{a_1, a_2\}\right) + \text{termes de reste}. \quad (1.1.27)$$

Cette formule est remarquable à plusieurs égards : le terme « d'ordre 0 » correspond au produit des symboles, ce qui est très raisonnable si l'on songe aux cas particuliers de symboles ne dépendant que d'une des deux variables. Le terme « d'ordre 1 » quant à lui implique le crochet de Poisson des observables classiques, défini par

$$\{a_1, a_2\} = \sigma(H_{a_1}, H_{a_2}) = \partial_\xi a_1 \cdot \partial_x a_2 - \partial_x a_1 \cdot \partial_\xi a_2,$$

où $\sigma = d\xi \wedge dx$ est la forme symplectique canonique sur T^*M et H_a est le champ de vecteurs hamiltonien associé à a selon (1.1.33). Le terme de reste ne dépend que des dérivées d'ordre plus grand

que 2 de a_1 et a_2 . On a en fait un développement asymptotique pour lequel le terme d'ordre j fait intervenir uniquement les dérivées d'ordre j des symboles en question. Pour que ce développement asymptotique soit pertinent, il est donc naturel de demander que l'on gagne de la petitesse à chaque dérivée des symboles impliqués. Les deux façons les plus communément utilisées pour obtenir ce gain sont les suivantes. La première, qualifiée de *semi-classique*, consiste à considérer des symboles $a = a_h$ dépendant d'un petit paramètre $h \in]0, 1]$ pour lesquels

$$\forall \alpha, \beta \in \mathbf{N}^d, \exists C_{\alpha, \beta} > 0 : \forall h \in]0, 1], \forall \rho \in T^*M, \quad \left| \partial_x^\alpha \partial_\xi^\beta a_h(\rho) \right| \leq C_{\alpha, \beta} h^{|\beta|}. \quad (1.1.28)$$

On obtient alors la classe standard de symboles semi-classiques $S_{\text{scl}}(1)$, et le terme d'ordre j du calcul pseudo-différentiel (1.1.27) est d'ordre h^j . Un exemple de tel symbole est donné par $a_h(x, \xi) = a(x, h\xi)$ où $a \in C_b^\infty(T^*M)$ est un symbole fixé. La seconde, qualifiée de *microlocale*, implique des symboles de la forme

$$\forall \alpha, \beta \in \mathbf{N}^d, \exists C_{\alpha, \beta} > 0 : \forall (x, \xi) \in T^*M, \quad \left| \partial_x^\alpha \partial_\xi^\beta a(x, \xi) \right| \leq \frac{C_{\alpha, \beta}}{\langle \xi \rangle^{|\beta|}}, \quad (1.1.29)$$

où $\langle \bullet \rangle = (1 + |\bullet|^2)^{1/2}$. On obtient la classe standard de symboles notée $S_{1,0}^0$. Un exemple de tels symboles est donné par $a(x, \xi) = a_0(x, \frac{\xi}{\langle \xi \rangle})$ avec $a_0 \in C_b^\infty(T^*M)$. Dans ce cadre, les termes successifs dans le développement asymptotique (1.1.27) gagnent de la décroissance à l'infini en ξ : le j -ième terme de (1.1.27) se comporte comme $\langle \xi \rangle^{-j}$.

Ces deux cadres peuvent être unifiés et généralisés au sein de la théorie des métriques sur l'espace des phases et du calcul de Weyl–Hörmander (voir le paragraphe 1.4).

1.1.4.3. Vers les métriques sur l'espace des phases et le calcul de Weyl–Hörmander

Une autre interprétation de la transformée de Wigner est la suivante

$$\text{Op}^{\text{W}}(u_1 \otimes u_2) = |u_1\rangle\langle u_2|,$$

où l'on utilise la notation bra-ket pour l'opérateur de rang 1 donné par $|u_1\rangle\langle u_2| : u \mapsto (u_2, u)_{L^2} u_1$. Cette observation permet de mieux comprendre l'action d'un opérateur pseudo-différentiel général a . Dans la droite ligne de (1.1.1), on définit le paquet d'ondes centré en $\rho_0 = (x_0, \xi_0) \in T^*M$ par

$$\varphi_{\rho_0}(x) = \pi^{-d/4} \exp\left(-\frac{|x - x_0|^2}{2}\right) e^{i\xi_0 \cdot (x - x_0)}, \quad x \in \mathbf{R}^d.$$

On vérifie par un calcul de transformée de Fourier de gaussienne que la transformée de Wigner de φ_{ρ_0} avec lui-même est donnée par

$$(\varphi_{\rho_0} \otimes \varphi_{\rho_0})(\rho) = \pi^{-d} \exp\left(-|\rho - \rho_0|^2\right), \quad \forall \rho \in T^*M.$$

En intégrant par rapport à ρ_0 , on obtient

$$\int_{T^*M} (\varphi_{\rho_0} \otimes \varphi_{\rho_0})(\rho) d\rho_0 = 1, \quad \forall \rho \in T^*M$$

(avec une normalisation correcte de la mesure $d\rho_0$) et la famille de fonctions $(\varphi_{\rho_0} \otimes \varphi_{\rho_0})_{\rho_0 \in T^*M}$ forme ainsi une partition de l'unité de T^*M . Si l'on considère un symbole a variant lentement de sorte que $a \times (\varphi_{\rho_0} \otimes \varphi_{\rho_0}) \approx a(\rho_0) \times (\varphi_{\rho_0} \otimes \varphi_{\rho_0})$, on peut alors écrire formellement,⁶ après quantification

$$\begin{aligned} \text{Op}^{\text{W}}(a) &= \int_{T^*M} \text{Op}^{\text{W}}(a \times (\varphi_{\rho_0} \otimes \varphi_{\rho_0})) d\rho_0 \approx \int_{T^*M} a(\rho_0) \text{Op}^{\text{W}}(\varphi_{\rho_0} \otimes \varphi_{\rho_0}) d\rho_0 \\ &= \int_{T^*M} a(\rho_0) |\varphi_{\rho_0}\rangle\langle \varphi_{\rho_0}| d\rho_0. \end{aligned} \quad (1.1.30)$$

Ainsi l'opérateur $\text{Op}^{\text{W}}(a)$ peut s'interpréter comme une superposition de projecteurs orthogonaux sur les paquets d'ondes φ_{ρ_0} , pondérée par a . Ici, nos paquets d'ondes φ_{ρ_0} sont moralement concentrés

⁶L'approximation (1.1.30), liée à la différence entre la quantification de Weyl et la quantification de Wick, peut être décrite de façon quantitative; voir [Ler10, Proposition 2.4.3].

dans des boîtes de l'espace des phases de taille 1×1 . Ces paquets d'ondes sont en quelques sortes les « atomes » de l'espace des phases : ils saturent le principe d'incertitude de Heisenberg

$$\forall(x_0, \xi_0) \in T^*M, \forall u \in L^2(M), \quad \frac{1}{2}\|u\|_{L^2}^2 \leq \|(x - x_0)u\|_{L^2} \left\| \left(\frac{1}{i} \nabla - \xi_0 \right) u \right\|_{L^2}, \quad (1.1.31)$$

qui peut s'interpréter comme le fait que la transformée de Wigner de tout état $u \in L^2(M)$ occupe dans l'espace des phases T^*M un volume plus grand qu'une constante universelle. Cela dit, on a une certaine flexibilité sur la forme de la boîte élémentaire qui contient le paquet d'onde, du moment qu'elle est compatible avec le principe d'incertitude (1.1.31). On verra au paragraphe 1.4 que dans certains problèmes, il est naturel de considérer une famille de paquets d'ondes dont le rapport d'aspect dans l'espace des phases dépend du point ρ_0 . La forme des boîtes sera essentiellement donnée par les boules unité d'une certaine métrique g sur T^*M . Cette vision des opérateurs pseudo-différentiels prend tout son sens dans la théorie des métriques sur l'espace des phases développée par Hörmander, et que l'on abordera dans le paragraphe 1.4.

1.1.5. Dynamique quantique et dynamique classique

Dans ce paragraphe, on décrit plus précisément la formalisation mathématique de la correspondance classique-quantique à l'aide des outils d'analyse microlocale introduits dans le paragraphe 1.1.4.

1.1.5.1. Propagateur quantique et flot hamiltonien

Les problèmes de stabilité uniforme des ondes (paragraphe 1.1.2.1) et d'observabilité de l'équation de Schrödinger (paragraphe 1.1.2.2), peuvent se ramener à l'étude de quasi-modes (1.1.22) de l'opérateur $Q := P^s$ via des estimées de résolvante. Pour étudier ces quasi-modes, on analyse le groupe unitaire fortement continu $(e^{-itQ})_{t \in \mathbf{R}}$ construit via le théorème de Stone [RS80, VIII.4] et qui résout l'équation

$$D_t \psi = -Q \psi. \quad (1.1.32)$$

Le modèle dont nous avons particulièrement discuté dans le paragraphe 1.1.2 correspond à $P = -\Delta_g$ sur une variété riemannienne compacte sans bord (M, g) . On rappelle alors que les valeurs $s = 1/2$ et $s = 1$ correspondent respectivement aux demi-ondes ($Q = \sqrt{-\Delta_g}$) et à Schrödinger ($Q = -\Delta_g$). L'heuristique classique-quantique nous indique dans ce cas que le propagateur est lié, dans un certain régime, au flot géodésique $(g^t)_{t \in \mathbf{R}}$ de la variété.

Pour des opérateurs Q plus généraux, ce flot est remplacé par une généralisation naturelle : le flot hamiltonien associé au symbole principal de cet opérateur. Ce dernier est une fonction lisse sur l'espace des phases T^*M , qui est le cadre naturel de la mécanique classique [Arn89]. Dans tout ce manuscrit, un point typique de l'espace des phases sera noté $\rho = (x, \xi)$ en coordonnée canoniques, où $x \in M$ est la variable de position, ξ est la variable de moment, appartenant à la fibre T_x^*M au-dessus de x . On rappelle que T^*M est muni d'une structure symplectique canonique (indépendante de toute structure riemannienne sur M), donnée par une forme symplectique $\sigma = d\alpha$, obtenue comme la différentielle extérieure de la 1-forme de Liouville définie par

$$\alpha_\rho(X) = \rho(d\pi.X), \quad \rho \in T^*M, X \in T_\rho(T^*M),$$

avec $\pi : T^*M \rightarrow M$ la projection canonique du fibré cotangent. En coordonnées canoniques (x, ξ) , on écrit souvent $\alpha = \xi dx$, si bien que $\sigma = d\xi \wedge dx$. Cette 2-forme alternée est non-dégénérée, de sorte que toute 1-forme sur T^*M peut se représenter par un unique champ de vecteurs. Ainsi, étant donné une fonction $q \in C^\infty(T^*M)$, on peut lui associer son champ de vecteurs hamiltonien H_q comme étant son « gradient symplectique » :

$$\sigma(H_q, X) = -dq.X, \quad (1.1.33)$$

pour tout champ de vecteurs X sur T^*M . Ce champ de vecteurs sur T^*M engendre un flot $(\phi^t)_{t \in \mathbf{R}}$ agissant sur T^*M dit flot hamiltonien (qui sous des hypothèses raisonnables est le plus souvent complet), que l'on obtient en intégrant l'équation différentielle :

$$\frac{d}{dt} \phi^t = H_q \circ \phi^t. \quad (1.1.34)$$

Ce flot correspond à la mécanique classique naturellement associée à la dynamique quantique e^{-itQ} . Notons qu'il préserve par construction la fonction q , c'est-à-dire

$$\forall t \in \mathbf{R}, \quad q \circ \phi^t = q. \quad (1.1.35)$$

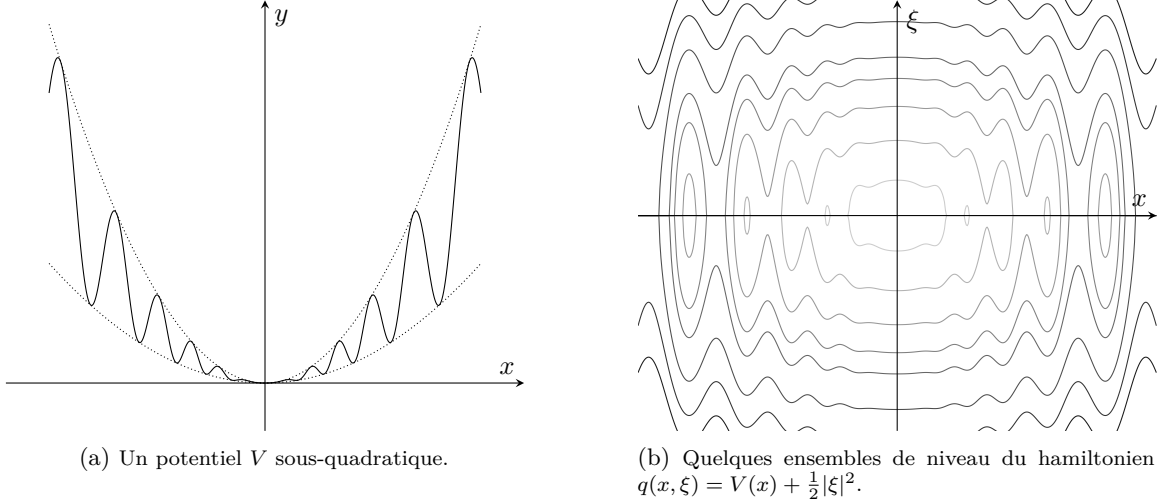

FIG. 1.1 – Mécanique classique avec un potentiel sous-quadratique.

Cette égalité s'interprète comme la conservation de l'énergie mécanique du système. Dans le cas des demi-ondes sur (M, g) compacte sans bord (i.e. $Q = \sqrt{-\Delta_g}$), le symbole principal est donné par $q(x, \xi) = |\xi|_{g_x^{-1}}$ où g^{-1} est la métrique duale⁷ de g . Le flot Hamiltonien associé correspond alors au flot géodésique de (M, g) .

Un autre exemple important, et que l'on étudie dans les contributions de cette thèse, est celui d'un opérateur de Schrödinger $Q = V(x) - \frac{1}{2}\Delta$ dans l'espace euclidien $M = \mathbf{R}^d$ avec laplacien plat (associé à la structure euclidienne standard sur \mathbf{R}^d) et un potentiel $V \in C^\infty(M)$. La définition rigoureuse de symbole principal est plus délicate puisque l'espace des phases a un infini à la fois en la variable x et en la variable ξ . Cela dit, étant donné que l'on dispose sur l'espace euclidien de la quantification de Weyl (1.1.24), on peut considérer le symbole total de l'opérateur Q , à savoir $q(x, \xi) = V(x) + \frac{1}{2}|\xi|^2$, où $|\bullet|$ est la norme euclidienne. En coordonnées, le champ de vecteurs associé à q est donné par

$$H_q(x, \xi) = \xi \cdot \partial_x - \partial_x V(x) \cdot \partial_\xi.$$

En écrivant les composantes du flot $\phi^t(x, \xi) = (x^t, \xi^t)$, l'EDO (1.1.34) se réécrit

$$\begin{cases} \dot{x}^t = \xi^t \\ \dot{\xi}^t = -\partial_x V(x^t) \end{cases}, \quad (1.1.36)$$

ce qui correspond au mouvement d'un point matériel dans un potentiel V , régi par la seconde loi de Newton. Voir la Figure 1.1 pour une illustration.

Hormis pour des opérateurs Q très particuliers, comme le cas $M = \mathbf{T}^d$, $Q = -\Delta$, $q(x, \xi) = |\xi|^2$, pour lequel la transformée de Fourier permet de diagonaliser explicitement Q , on ne dispose pas en général de formule explicite pour obtenir des informations sur le propagateur, au delà de la simple conservation de l'énergie

$$\forall u \in L^2(M), \forall t \in \mathbf{R}, \quad \|e^{-itQ}u\|_{L^2} = \|u\|_{L^2}$$

(l'analogie quantique de (1.1.35)). Ainsi pour étudier le propagateur e^{-itQ} , on va le comparer dans certain régimes à la mécanique classique sous-jacente $(\phi^t)_{t \in \mathbf{R}}$ via la notion de quantification introduite dans le paragraphe 1.1.4.

1.1.5.2. Formulation de Heisenberg de la mécanique quantique

Nous avons à présent tous les outils nécessaire pour présenter de façon plus formelle le dénominateur commun aux problèmes de stabilisation des ondes et d'observabilité de Schrödinger introduits dans le paragraphe 1.1.2, à savoir la correspondance classique-quantique. Nous allons faire apparaître l'analogie entre classique et quantique via la formulation de Heisenberg de la mécanique quantique.

⁷La métrique g au point $x \in M$ prend en argument des vecteurs tangents, c'est-à-dire des éléments de $T_x M$, tandis que la métrique g^{-1} prend en argument des covecteurs, c'est-à-dire des éléments de $T_x^* M$.

Cette dernière consiste à s'intéresser à l'évolution des observables plutôt qu'à l'évolution des états. Soit $t \mapsto \psi(t)$ une solution de l'équation de Schrödinger abstraite (1.1.32) posée sur $M = \mathbf{R}^d$ avec un hamiltonien P de symbole total p , de sorte que $P = \text{Op}^w(p)$. On se donne également $A_0 = \text{Op}^w(a_0)$ une observable quantique, que l'on suppose bornée sur $L^2(M)$. En écrivant $u = \psi(0)$ la donnée initiale et $\psi(t) = e^{-itP}u$, on a

$$(\psi(t), A_0\psi(t))_{L^2} = (u, e^{itP} \text{Op}^w(a_0) e^{-itP} u)_{L^2}, \quad \forall t \in \mathbf{R},$$

en utilisant l'unitarité du propagateur. L'opérateur conjugué $A(t) := e^{itP} \text{Op}^w(a_0) e^{-itP}$ correspond à l'évolution quantique de l'observable A_0 . Il satisfait l'équation

$$\partial_t A(t) = i[A(t), P]. \quad (1.1.37)$$

Le parallèle avec la mécanique classique apparaît clairement suivant l'observation que l'évolution d'une observable classique $a_0 \in C^\infty(T^*M)$, donnée par $a(t) := a_0 \circ \phi^t$, satisfait l'équation

$$\partial_t a(t) = \{a(t), p\} \quad (1.1.38)$$

(on rappelle que ϕ^t est le flot hamiltonien associé au symbole p , défini par (1.1.34)). Le lien entre les deux équations (1.1.37) et (1.1.38) se manifeste via la quantification de Weyl ($A(t) = \text{Op}^w(a(t))$) et le calcul pseudo-différentiel (1.1.27), étant donné que

$$[P, A(t)] = \text{Op}^w\left(\frac{1}{i}\{p, a(t)\}\right) + \text{reste}.$$

Cette observation permet d'établir le théorème d'Egorov, qui énonce que

$$e^{itP} \text{Op}^w(a_0) e^{-itP} = \text{Op}^w(a_0 \circ \phi^t) + \text{reste}.$$

En d'autres termes, l'évolution quantique d'une observable est approchée par la quantification de l'évolution classique du symbole correspondant. Sous de bonnes hypothèses, le reste est « petit » dans un certain régime asymptotique. Par exemple dans le cadre semi-classique introduit dans le paragraphe 1.1.4, il tend vers zéro lorsque $h \rightarrow 0$; dans le cas microlocal le reste est un opérateur régularisant, i.e. un opérateur pseudo-différentiel avec un symbole présentant de la décroissance à l'infini en ξ . Pour un hamiltonien quadratique tel que l'oscillateur harmonique $P = \frac{1}{2}(-\Delta + |x|^2)$, les termes de reste sont exactement nuls, ce qui est lié à la propriété d'état cohérent de la solution (1.1.1) de l'équation de Schrödinger harmonique.

1.1.5.3. Mesures de défaut

Une façon élégante de formaliser le concept de correspondance classique quantique est d'utiliser les mesures de défaut (microlocales ou semi-classiques). Cette notion a été introduite indépendamment par Gérard [Gér91b] et Tartar [Tar90] au début des années 1990 (dans le cadre microlocal) et a donné lieu à des développements très riches depuis (elle préexistait sous une forme semi-classique dans les travaux de Šnirel'man [Šni74], Zelditch [Zel87] et Colin de Verdière [CdV85] sur l'ergodicité quantique). On présente ici la variante semi-classique des mesures de défaut dans l'espace euclidien; voir [Gér91a, LP93] ou encore [Zwo12, Chapitre 5]. Plus précisément, on considère dans ce paragraphe un opérateur de Schrödinger avec laplacien plat et potentiel homogène $P = |x|^{2m} - \Delta$, $m \in [0, +\infty[$. Cet exemple permet de décrire les propriétés des mesures de défaut semi-classique et par la même occasion de discuter de leurs limitations et des obstructions à leur utilisation dans les problèmes qui vont nous intéresser au paragraphe 1.3.

Notre motivation, en lien avec la discussion du paragraphe 1.1.3 sur les estimées de résolvante, est la suivante : on souhaite étudier les propriétés de microlocalisation d'un quasi-mode de P , c'est-à-dire une suite $(u_\lambda)_\lambda$ dans $\text{dom } P$, où λ vit dans un sous-ensemble non-borné de \mathbf{R}_+ , satisfaisant

$$\|(P - \lambda^2)u_\lambda\|_{L^2} \leq \epsilon_\lambda, \quad \|u_\lambda\| = 1, \quad (1.1.39)$$

pour une certaine suite $(\epsilon_\lambda)_\lambda$ de réels positifs. En général, cette suite est de la forme $\epsilon_\lambda = O(\lambda^\delta)$ ou $o(\lambda^\delta)$ lorsque $\lambda \rightarrow +\infty$, pour une puissance $\delta \leq 2$. Cette étude peut se ramener à un cadre semi-classique plus standard en introduisant un paramètre de Planck $h = \lambda^{-1-1/m}$, qui tend bien vers zéro dans l'asymptotique des hautes énergies $\lambda \rightarrow +\infty$. On écrit dorénavant u_h au lieu de u_λ . En divisant l'équation (1.1.39) par λ^2 , on obtient (disons dans le cas $\epsilon_\lambda = o(\lambda^\delta)$) :

$$(P_h - 1)u_h = o\left(h^{(2-\delta)\frac{m}{m+1}}\right), \quad \text{avec } P_h = h^{\frac{2m}{m+1}} P. \quad (1.1.40)$$

On peut exprimer l'opérateur P_h à l'aide d'une quantification semi-classique $P_h = \widetilde{\text{Op}}_h(p)$ avec $p(x, \xi) = |x|^{2m} + |\xi|^2$, où l'on a posé

$$\widetilde{\text{Op}}_h(a) := \text{Op}^w\left(a\left(h^{\frac{1}{m+1}}x, h^{\frac{m}{m+1}}\xi\right)\right), \quad a \in \mathcal{S}'(T^*M), h \in]0, 1]. \quad (1.1.41)$$

Ce choix d'échelle, bien que différent de la quantification semi-classique habituelle Op_h (obtenue ici pour $m = \infty$), est imposé par l'homogénéité du potentiel. Cette quantification est unitairement équivalente à la quantification semi-classique standard, et satisfait donc les mêmes propriétés, notamment un calcul pseudo-différentiel de gain h (par exemple dans le développement asymptotique (1.1.27), chaque terme gagne une puissance de h).

Adaptée à cette quantification, on a une nouvelle transformée de Wigner dépendant de h :

$$(u \otimes_h v)(x, \xi) := (u \otimes v)\left(h^{-\frac{1}{1+m}}x, h^{-\frac{m}{m+1}}\xi\right), \quad \forall (x, \xi) \in T^*M, \forall u, v \in \mathcal{S}(M),$$

définie de sorte que

$$\widetilde{\text{Op}}_h(u \otimes_h v) = \text{Op}^w(u \otimes v) = |u\rangle\langle v|.$$

Etant donnée une suite bornée $(u_h)_{h \in]0, 1]}$ dans $L^2(M)$, on appelle mesure de défaut demi-classique toute mesure de Radon μ obtenue comme valeur d'adhérence de la suite $(u_h \otimes_h u_h)_{h \in]0, 1]}$ pour la topologie faible-étoile. On a donc en particulier

$$\left(u_{h_n}, \widetilde{\text{Op}}_{h_n}(a)u_{h_n}\right)_{L^2} \xrightarrow{h_n \rightarrow 0} \int_{T^*M} a d\mu, \quad \forall a \in C_c^\infty(T^*M),$$

le long d'une sous-suite $h_n \rightarrow 0$. On peut montrer que les mesures de défaut semi-classiques sont positives [Zwo12, Théorème 5.2] et existent toujours. Ces mesures encodent la microlocalisation asymptotique de la fonction u_h dans la limite semi-classique (à des échelles en espace et moment dictées par la puissance m dans (1.1.41)), comme l'illustre le résultat classique suivant (voir par exemple [Zwo12, Théorèmes 5.3 et 5.4]).

Proposition 1.1.7. *On considère l'opérateur $P_h = \widetilde{\text{Op}}_h(p)$ défini selon (1.1.41) avec $p(x, \xi) = |x|^{2m} + |\xi|^2$. Soit $(u_h)_h$ une suite bornée de $L^2(M)$, et soit μ une mesure de défaut semi-classique. On suppose que $(u_h)_h$ est un quasi-mode, c'est-à-dire*

$$(P_h - 1)u_h = o_{L^2}(h^\varepsilon), \quad \|u_h\|_{L^2} = 1,$$

pour un certain $\varepsilon \geq 0$. Alors on a les propriétés suivantes.

1. Si $\varepsilon = 0$, alors $\text{supp } \mu \subset \{p = 1\}$.
2. Si $\varepsilon = 1$, alors $H_p \mu = 0$, soit encore $(\phi^t)_* \mu = \mu$ pour tout $t \in \mathbf{R}$, où $(\phi^t)_{t \in \mathbf{R}}$ est le flot hamiltonien associé à p .

L'interprétation de ce résultat est la suivante : lorsque u_h est un vecteur propre approché de P_h d'énergie 1, au sens où $P_h u_h = u_h + o_{L^2}(1)$, l'essentiel de l'énergie se concentre dans la limite $h \rightarrow 0$ sur l'ensemble de niveau $\{p = 1\}$. Lorsque la précision du quasi-mode est suffisante, en l'occurrence $o(h)$, la mesure μ est de plus invariante par le flot hamiltonien associé à p , ce qui implique en général une forme de délocalisation des quasi-modes.

Voyons à titre d'illustration comment ce résultat se décline pour le problème des ondes amorties (1.1.11) dans $M = \mathbf{R}^d$ avec $P = |x|^{2m} - \Delta$. La proposition 1.1.4 combinée avec (1.1.15) permet de ramener la question de la stabilité uniforme des ondes amorties à l'étude des $o(\lambda)$ -quasi-modes de l'opérateur $P = |x|^{2m} - \Delta$, c'est-à-dire les suites $(u_\lambda)_\lambda$ bornées dans $L^2(M)$ telles que

$$(P - \lambda^2)u_\lambda = o_{L^2}(\lambda) \quad \|u_\lambda\|_{L^2} = 1. \quad (1.1.42)$$

On obtient alors la reformulation semi-classique (1.1.40) avec $\delta = 1$. On observe que la précision du quasi-mode, ici $o(h^{\frac{m}{m+1}})$, n'est pas suffisante pour appliquer l'item (2) de la proposition 1.1.7 et avoir l'invariance des mesures de défaut semi-classiques par le flot, car $\varepsilon = \frac{m}{m+1} < 1$. On ne dispose donc a priori que de l'information de l'item (1), i.e. $\text{supp } \mu \subset \{p = 1\}$. La mesure μ peut donc en principe être égale à n'importe quelle mesure positive supportée sur la couche d'énergie $\{p = 1\}$. Des solutions existent pour extraire plus d'information de cette mesure, notamment les mesures de défaut

2-microlocales (on renvoie à Nier [Nie96], Miller [Mil96, Mil97], Fermanian Kammerer [FK00, FK05] ainsi qu'au travail de Fermanian Kammerer et Gérard [FKG02] pour une introduction de cette notion et des exemples d'application). L'idée est de zoomer autour du support de la mesure de défaut semi-classique et de désintégrer celle-ci selon une échelle raffinée, afin de détecter des phénomènes de concentration et d'oscillation qui échappent à la mesure de défaut initiale. Cette approche s'est révélée être très puissante pour l'analyse des quasi-modes dans des variétés compactes telles que le tore ou le disque ; voir par exemple Macià [Mac10], Anantharaman–Macià [AM14], Anantharaman–Léautaud [AL14], ou encore Anantharaman–Léautaud–Macià [ALM16b].

Dans le cas qui nous intéresse, la précision $o(h^{\frac{m}{m+1}})$ dans la reformulation semi-classique (1.1.40) est suffisamment mauvaise pour permettre au quasi-mode de se concentrer à une vitesse relativement lente sur la variété caractéristique $\{p = 1\}$. Dans ce contexte, les outils de seconde microlocalisation ne semblent pas donner d'information suffisante pour l'étude de la stabilité uniforme des ondes amorties.

1.1.6. Objectifs de la thèse

Comme nous l'avons expliqué dans le paragraphe 1.1.2, les travaux de Rauch et Taylor, et plus tard Bardos, Lebeau et Rauch, sur les équations des ondes et de Schrödinger, ont donné lieu à un champ de recherche très riche et une vaste littérature, allant de paire avec le développement des techniques d'analyse microlocale. Une grande partie des travaux existants concerne le cas de géométries compactes. Dans cette thèse, on étudie plusieurs déclinaisons de ces problèmes de contrôle à l'espace euclidien $M = \mathbf{R}^d$ avec un potentiel confinant. Une difficulté nouvelle réside dans le fait que l'espace des phases T^*M possède un double infini (à la fois en x et en ξ) avec lequel il faut composer pour établir une forme de correspondance classique-quantique et répondre à des questions telles que la stabilité uniforme des ondes ou l'observabilité de l'équation de Schrödinger.

Dans le paragraphe 1.2 de cette introduction, qui résume le chapitre 2 on présente les résultats obtenus sur le problème de la stabilité uniforme des ondes amorties dans l'espace euclidien avec potentiel confinant. On donne des conditions nécessaires et suffisantes de stabilité uniforme portant sur le coefficient d'amortissement, dans l'esprit de la Condition de Contrôle Géométrique.

Le paragraphe 1.3 expose nos contributions, détaillées dans le chapitre 3, sur problème de l'observabilité de l'équation de Schrödinger dans l'espace euclidien avec potentiel confinant sous-quadratique. On donne une caractérisation partielle des ouverts de \mathbf{R}^d qui observent l'équation de Schrödinger, sous forme d'une condition de type « contrôle géométrique » également.

Dans le paragraphe 1.4, qui synthétise le chapitre 4, on développe une version du théorème d'Egorov. Motivée par le cadre géométrique du paragraphe 1.2, elle permet d'étudier la correspondance classique-quantique dans le formalisme général des métriques sur l'espace des phases et du calcul de Weyl–Hörmander. On donne trois contextes d'application pour des équations de Schrödinger, de demi-ondes et de transport.

1.2. Stabilité uniforme de l'équation des ondes avec potentiel confinant sous-quartique

Dans le chapitre 2 de ce manuscrit, nous étudions l'équation des ondes amorties avec un potentiel confinant dans l'espace euclidien :

$$\partial_t^2 \psi + P\psi + b\partial_t \psi = 0, \quad (\psi, \partial_t \psi)|_{t=0} = U. \quad (1.2.1)$$

Ici, le coefficient d'amortissement $b \in L^\infty(\mathbf{R}^d)$ est supposé positif, $P = V(x) - \frac{1}{2}\Delta$ est un opérateur de Schrödinger auto-adjoint avec Laplacien plat (euclidien), et on fait les hypothèses suivantes sur le potentiel V :

$$V \in L_{\text{loc}}^\infty(\mathbf{R}^d), \quad V \geq 0 \quad \text{et} \quad V(x) \xrightarrow{x \rightarrow \infty} +\infty. \quad (1.2.2)$$

Le formalisme développé au paragraphe 1.1.3 s'applique ici pour toute donnée initiale $U \in \mathfrak{H} = \text{dom } P^{1/2} \oplus L^2(\mathbf{R}^d)$. La solution de (1.2.1) associée vérifie le bilan d'énergie

$$\mathcal{E}(U, t) = \mathcal{E}(U, 0) - \int_0^t \left\| \sqrt{b} \partial_t \psi(s) \right\|_{L^2(\mathbf{R}^d)}^2 ds, \quad \forall t \geq 0,$$

où

$$\mathcal{E}(U, t) = \frac{1}{2} \left(\left\| P^{1/2} \psi(t) \right\|_{L^2(\mathbf{R}^d)}^2 + \left\| \partial_t \psi(t) \right\|_{L^2(\mathbf{R}^d)}^2 \right). \quad (1.2.3)$$

Comme au paragraphe 1.1.2.1 dans le cas d'une géométrie bornée, on souhaite déterminer une condition sur b pour que l'on ait stabilité uniforme.

Définition 1.2.1 (Décroissance uniforme de l'énergie). On dit que l'équation des ondes amorties (1.2.1) est uniformément stable si

$$\exists C > 0, \exists \tau > 0 : \forall U \in \mathfrak{H}, \forall t \geq 0, \quad \mathcal{E}(U, t) \leq C e^{-t/\tau} \mathcal{E}(U, 0).$$

On a vu dans le paragraphe 1.1.3 que cette propriété se reformule de manière équivalente en termes de résolvente ou de quasi-modes.

1.2.1. Principaux résultats

On donne maintenant une première condition nécessaire de stabilité uniforme. Notons

$$\kappa := \frac{1}{|B_1(0)|} \mathbb{1}_{B_1(0)},$$

où $B_1(0) \subset \mathbf{R}^d$ est la boule unité ouverte et $|\bullet|$ la mesure de Lebesgue. On pose également $\kappa_r = r^{-d} \kappa(\bullet/r)$ pour tout $r > 0$.

Proposition 1.2.2. Soit V satisfaisant (1.2.2) et soit $b \in L^\infty(\mathbf{R}^d)$ positif tels que l'équation des ondes amorties (1.2.1) soit uniformément stable au sens de la définition 1.2.1. Alors b satisfait la Condition de Contrôle Géométrique Uniforme

$$\exists T > 0, \exists c > 0 : \forall (x, v) \in \mathbf{SR}^d, \quad \liminf_{r \rightarrow 0} \frac{1}{T} \int_0^T (b * \kappa_r)(x + tv) dt \geq c. \quad (\text{CCGU})$$

Les hypothèses de ce résultat sur la régularité de V et b sont peu contraignantes. La Condition de Contrôle Géométrique Uniforme (CCGU) que l'on introduit ici est la généralisation naturelle de celle de Rauch et Taylor (1.1.6) à un cadre non-compact avec amortissement L^∞ . Elle consiste à intégrer, le long du flot géodésique de \mathbf{R}^d (i.e. des lignes droites) la fonction b convoluée à une échelle $r > 0$ arbitrairement petite. Notons que cette étape de convolution est indispensable pour donner un sens à l'intégrale dès lors que la dimension d est plus grande que 2. Une formulation similaire a déjà été proposée par Burq et Gérard dans [BG20]. On aurait également pu penser à considérer la limite inférieure quand $T \rightarrow +\infty$ de la moyenne en temps, au lieu de prendre T fixé. Il s'avère que (CCGU) est la bonne généralisation de (1.1.6), car elle implique l'uniformité de T par rapport à $(x, v) \in \mathbf{SR}^d$, qui vit dans un ensemble non-compact. Cette observation a déjà été faite dans le travail de Burq et Joly [BJ16].

On montre aussi la condition suffisante de stabilité uniforme suivante.

Proposition 1.2.3. Soit V satisfaisant (1.2.2) et soit $b \in L^\infty(\mathbf{R}^d)$ positif tel que

$$\exists R > 0, \exists c > 0 : \quad b(x) \geq c \text{ pour presque tout } |x| \geq R. \quad (1.2.4)$$

Alors l'équation des ondes amorties (1.2.1) est uniformément stable.

Cette proposition repose sur un argument de mesure de défaut semi-classique impliquant uniquement le Laplacien. La condition (1.2.4) apparaît déjà comme une condition suffisante de stabilité uniforme pour une équation des ondes amorties non-linéaire dans les travaux de Zuazua [Zua91]. On insiste encore une fois sur le fait que les propositions 1.2.2 et 1.2.3 ne nécessitent quasiment aucune hypothèse sur le potentiel et exploitent seulement la partie « cinétique » de l'opérateur de Schrödinger P , à savoir le laplacien.

Remarque 1.2.4. Les Propositions 1.2.2 et 1.2.3 n'exploitent pas le caractère confinant du potentiel supposé dans (1.2.2), et qui pourrait être relaxé. Ceci nécessiterait quelques adaptations dans l'étape de réduction de la stabilité uniforme à une estimée de résolvente du type (1.1.15). Il s'avère que pour des potentiels bornés satisfaisant $V(x) \geq \epsilon > 0, \forall x \in \mathbf{R}^d$, la proposition 1.2.3 est un cas particulier de [BJ16, Theorem 1.1].

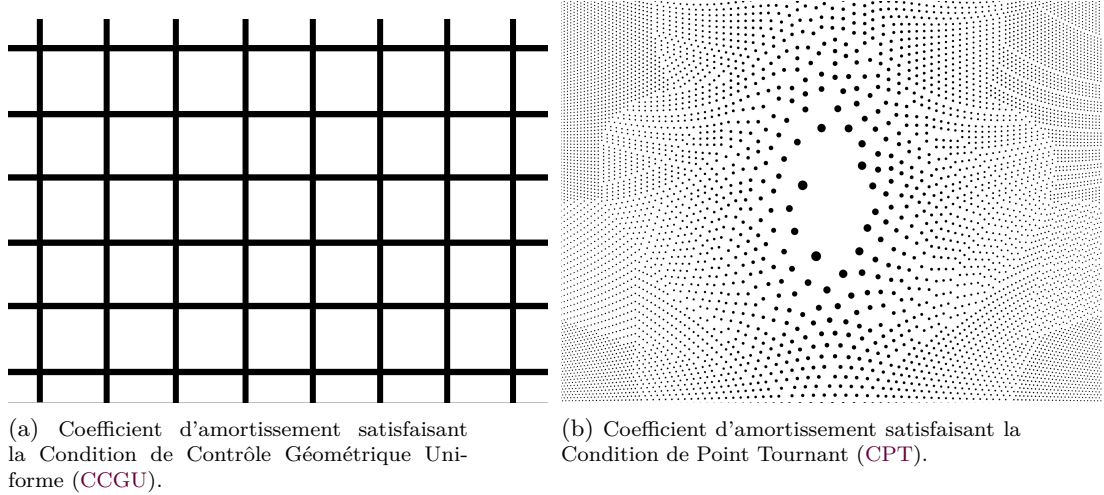

FIG. 1.2 – L'amortissement est l'indicatrice de l'ensemble dessiné en noir.

A présent, on souhaite refermer l'écart entre les conditions nécessaire et suffisante obtenues dans les propositions 1.2.2 et 1.2.3 en étudiant le régime « potentiel » où $V(x)$ domine sur le laplacien dans l'opérateur de Schrödinger P . Dorénavant, en plus de (1.2.2), on fait l'hypothèse suivante sur le potentiel :

$$V \in C^2(\mathbf{R}^d) \quad \text{et} \quad \nabla V(x) = o\left(V(x)^{3/4}\right) \quad \text{lorsque } x \rightarrow \infty. \quad (1.2.5)$$

Par un argument de type Grönwall, cette hypothèse impose en particulier que le potentiel soit strictement sous-quartique, à savoir $|V(x)| \ll \langle x \rangle^4$ lorsque $x \rightarrow \infty$. en particulier, elle est satisfaite avec tout potentiel de la forme $V(x) = \langle x \rangle^s$ pour $s < 4$.

Proposition 1.2.5 (Conditions nécessaires de stabilité uniforme). *Soit V satisfaisant (1.2.2) et (1.2.5), et soit $b \in L^\infty(\mathbf{R}^d)$ positif tel que l'équation des ondes amorties (1.2.1) soit uniformément stable. Alors b satisfait (CCGU) ainsi que la Condition de Point Tournant*

$$\exists R > 0, \exists c > 0 : \quad \liminf_{x \rightarrow \infty} \frac{1}{|B_{R/V(x)^{1/4}}(x)|} \int_{B_{R/V(x)^{1/4}}(x)} b(y) dy \geq c. \quad (\text{CPT})$$

Notons que l'intégrale intervenant dans (CPT) ci-dessus s'interprète comme la convolution $(k_x * b)(x)$ où

$$k_x(y) = \frac{1}{|B_{R/V(x)^{1/4}}(0)|} \mathbb{1}_{B_{R/V(x)^{1/4}}(0)}(y), \quad y \in \mathbf{R}^d.$$

Au voisinage d'un point x , on moyenne l'amortissement dans une boule de rayon $R/V(x)^{1/4}$, et on demande que la fonction ainsi obtenue soit bornée par en-dessous par une constante strictement positive en dehors d'un compact. Notons que puisque le potentiel est confinant, à savoir $V(x) \rightarrow +\infty$ pour $x \rightarrow \infty$, le rayon des boules en question tend vers zéro. Ainsi, l'amortissement doit remplir l'espace à une échelle de plus en plus petite à mesure que l'on s'approche de l'infini. On donne une illustration de cette condition sur la Figure 1.2, où l'on fait également une comparaison avec la Condition de Contrôle Géométrique Uniforme (CCGU).

On remarque que la Condition de Point Tournant (CPT) est une condition nécessaire de stabilité uniforme assez contraignante. En particulier, si l'on fait une certaine hypothèse de continuité uniforme sur le coefficient d'amortissement, elle force celui-ci à être borné inférieurement par une constante strictement positive en dehors d'un compact. En vertu de la proposition 1.2.3, on en déduit directement le résultat suivant.

Corollaire 1.2.6 (Caractérisation de la stabilité uniforme sous hypothèse d'uniforme continuité). *Soit V satisfaisant (1.2.2) et (1.2.5) et soit $b \in L^\infty(\mathbf{R}^d)$ positif et uniformément continu. Alors l'équation des ondes amorties (1.2.1) est uniformément stable si et seulement si*

$$\liminf_{x \rightarrow \infty} b > 0. \quad (1.2.6)$$

Le problème de la stabilité uniforme des ondes dans l'espace euclidien a déjà été étudié par Burq et Joly dans [BJ16] avec un opérateur sous forme divergence $-\operatorname{div} K \nabla$ au lieu du laplacien (sous l'hypothèse que le champ de matrices K est uniformément borné et elliptique sur \mathbf{R}^d) et un potentiel V constant égal à 1. Dans ce cadre, ces auteurs montrent que la stabilité uniforme a lieu dès lors que la version suivante de la Condition de Contrôle Géométrique Uniforme est satisfaite :

$$\exists T > 0, \exists c > 0 : \inf_{v \cdot K(x)v=1} \frac{1}{T} \int_0^T b(\varphi_t(x, v)) dt \geq c, \quad (1.2.7)$$

où $(\varphi_t)_{t \in \mathbf{R}}$ est le flot hamiltonien associé au symbole $(x, \xi) \mapsto \xi \cdot K(x) \xi$ et b est supposé uniformément continu. Dans cet article, l'hypothèse d'uniforme continuité est utile non seulement pour donner un sens à la Condition de Contrôle Géométrique Uniforme, mais aussi et surtout pour construire une fonction $0 \leq \underline{b} \leq b$ telle que $\underline{b} \in C_b^\infty(\mathbf{R}^d)$ et qui vérifie la condition (1.2.7). Le fait que les dérivées successives soient uniformément bornées sur tout l'espace est crucial pour appliquer les outils de l'analyse semi-classique. On renvoie également à la généralisation du résultat de Burq et Joly au cas des variétés asymptotiquement coniques ou cylindriques par Wang [Wan24]. Voir aussi l'étude des coefficients d'amortissement oscillant rapidement par Royer [Roy18]. On mentionne également l'étude de Wunsch sur la décroissance polynomiale de l'énergie dans le cas des amortissements périodiques ne satisfaisant pas nécessairement la Condition de Contrôle Géométrique Uniforme [Wun17].

1.2.2. Conditions géométriques et condition dynamique

On peut en fait unifier les deux conditions géométriques (CCGU) et (CPT) en une condition dynamique faisant intervenir le flot hamiltonien $(\phi^t)_{t \in \mathbf{R}}$ associé au symbole $p(x, \xi) := V(x) + \frac{1}{2}|\xi|^2$ de l'opérateur P , défini par (1.1.34) (pour $q = p$). La régularité C^2 de l'hypothèse (1.2.5) permet d'appliquer le théorème de Cauchy–Lipschitz, et le caractère confinant du potentiel (1.2.2) assure la complétude du flot.

Définition 1.2.7 (Condition Dynamique de Stabilisation). Soit V satisfaisant (1.2.2) et (1.2.5). On dit qu'une fonction $b \in L^\infty(\mathbf{R}^d)$ satisfait la Condition Dynamique de Stabilisation si

$$\exists T, R > 0 : \liminf_{\lambda \rightarrow +\infty} \inf_{\rho \in \{p=\lambda^2\}} \frac{1}{T} \int_0^T (b * \kappa_{R/\sqrt{\lambda}})(\phi^{t/\lambda}(\rho)) dt > 0. \quad (\text{CDS})$$

Proposition 1.2.8. Soit V satisfaisant (1.2.2) et (1.2.5). Une fonction positive $b \in L^\infty(\mathbf{R}^d)$ satisfait la Condition Dynamique de Stabilisation (CDS) si et seulement si elle satisfait la Condition de Contrôle de Géométrie Uniforme (CCGU) et la Condition de Point Tournant (CPT) :

$$(\text{CDS}) \quad \iff \quad (\text{CCGU}) + (\text{CPT}).$$

Commentons cette Condition Dynamique de Stabilisation (CDS). On remarque tout d'abord qu'elle fait intervenir la dynamique classique sous-jacente à notre équation des ondes dans la limite des hautes énergies $\lambda \rightarrow +\infty$ uniquement. C'est en effet le régime asymptotique dans lequel la correspondance classique-quantique est valide ici. Par ailleurs, l'équivalence dans la proposition 1.2.8 met en évidence la présence de deux échelles spécifiques. Autour de la couche d'énergie $\{p = \lambda^2\}$, on a en effet une échelle spatiale typique qui apparaît, à savoir l'échelle $R/\sqrt{\lambda}$ du noyau de convolution, et une échelle temporelle typique t/λ sur laquelle on moyenne l'amortissement. Ces échelles apparaissent naturellement lorsque l'on étudie les $o(\lambda)$ -quasimodes de l'opérateur P , i.e. les familles de fonctions $(u_\lambda)_\lambda$ normalisées dans $L^2(\mathbf{R}^d)$ telles que

$$(P - \lambda^2)u_\lambda = o_{L^2}(\lambda), \quad \|u_\lambda\|_{L^2} = 1. \quad (1.2.8)$$

On rappelle l'on a expliqué l'intérêt d'étudier de tels quasi-modes dans le cadre de la stabilité uniforme des ondes amorties dans le paragraphe 1.1.3. On voit l'apparition de l'échelle typique temporelle de la façon suivante : les quasimodes (1.2.8) sont invariants par la dynamique quantique sur des temps de l'ordre t/λ . En effet, si u_λ satisfait (1.2.8), alors

$$e^{i\frac{t}{\lambda}(P-\lambda^2)}u_\lambda - u_\lambda = \frac{i}{\lambda} \int_0^t e^{i\frac{s}{\lambda}(P-\lambda^2)}(P - \lambda^2)u_\lambda ds = o_{L^2}(tu_\lambda). \quad (1.2.9)$$

L'échelle $R/\sqrt{\lambda}$ de localisation en espace apparaît lorsque l'on cherche à construire des quasimodes par la méthode WKB [DS99, Chapitre 2]. On retrouvera cette échelle particulière dans le paragraphe 1.4.4.2 comme échelle naturelle de « seconde microlocalisation ».

L'intérêt de la formulation géométrique (CCGU) + (CPT) est qu'elle est beaucoup plus simple à vérifier en pratique sur des exemples concrets de coefficients d'amortissement. Les conditions de Contrôle Géométrique Uniforme et de Point Tournant sont liées à la Condition Dynamique de Stabilisation (CDS) dans des régions particulières de l'espace des phases. La première (CCGU) correspond à (CDS) dans un régime cinétique où le laplacien domine : on fixe un point $x_0 \in \mathbf{R}^d$ dans l'espace physique et on considère une suite de points de l'espace des phases dans $\{p = \lambda^2\}$ se projetant sur x_0 . Les trajectoires du flot hamiltonien passant par ces points ressemblent de plus en plus à des droites à mesure que $\lambda \rightarrow +\infty$, qui se projettent sur des lignes droites dans l'espace physique, d'où la condition (CCGU). La condition (CPT) quant à elle est obtenue en se plaçant dans le régime potentiel : au voisinage de la section nulle $\{\xi = 0\}$ de l'espace des phases (pour des ξ bornés), les trajectoires du flot hamiltonien sont transverses à l'espace physique et se projettent de façon singulière sur celui-ci. L'énergie est concentrée dans une boule de rayon $R/\sqrt{\lambda}$ centrée en un point x_λ tel que $V(x_\lambda) \approx \lambda^2$. La proposition 1.2.8 nous dit essentiellement qu'il suffit de contrôler les régimes cinétique et potentiel pour observer toute la couche d'énergie $\{p = \lambda^2\}$.

1.2.3. Eléments de preuve

On décrit ici brièvement la preuve de la proposition 1.2.5 qui établit que la Condition de Contrôle Géométrique Uniforme (CCGU) et la Condition de Point Tournant (CPT) sont nécessaires pour avoir stabilité uniforme, dans le cas d'un potentiel V satisfaisant (1.2.2) et (1.2.5). On a vu dans le paragraphe 1.1.3 que la stabilité uniforme de l'équation des ondes, au sens de la définition 1.2.1, est équivalente à l'estimée de résolvente (1.1.15) avec B l'opérateur de multiplication par \sqrt{b} (voir aussi la proposition 1.1.4). En niant l'estimée (1.1.15), on peut donc caractériser l'absence de stabilité uniforme par l'existence de quasi-modes $(u_\lambda)_\lambda$ non amortis, c'est-à-dire une famille de fonctions $u_\lambda \in \text{dom } P$ satisfaisant

$$\|u_\lambda\|_{L^2(\mathbf{R}^d)} = 1, \quad (P - \lambda^2)u_\lambda = o_{L^2}(\lambda) \quad \text{and} \quad (u_\lambda, bu_\lambda)_{L^2} = o_{L^2}(1), \quad (1.2.10)$$

dans la limite $\lambda \rightarrow +\infty$.

Pour montrer que (CCGU) est nécessaire, on construit de tels quasi-modes concentrés autour de n'importe quel segment dans \mathbf{R}^d . Fixons $x_0 \in \mathbf{R}^d$ le centre d'un segment et $\nu \in \mathbf{S}^{d-1}$ sa direction. Le quasi-mode en question est de la forme

$$u_\lambda(x) = c_\lambda k \left(M_\lambda^{-1}(x - x_0) \right) e^{i\lambda\nu \cdot (x - x_0)}, \quad x \in \mathbf{R}^d. \quad (1.2.11)$$

Ici $k \in C_c^\infty(\mathbf{R}^d)$ est une fonction « bosse » positive supportée dans la boule unité de \mathbf{R}^d non-identiquement nulle, M_λ est l'application linéaire

$$M_\lambda = T|\nu\rangle\langle\nu| + \frac{R_\lambda}{\sqrt{\lambda}} (\text{Id} - |\nu\rangle\langle\nu|),$$

où $|\nu\rangle\langle\nu|$ désigne le projecteur orthogonal sur $\text{Vect } \nu$ dans \mathbf{R}^d , $T > 0$ est fixé et R_λ tend vers $+\infty$ lorsque $\lambda \rightarrow +\infty$ (mais pas trop rapidement). La constante $c_\lambda > 0$ dans (1.2.11) sert uniquement à normaliser u_λ . On vérifie par un calcul explicite que la famille $(u_\lambda)_\lambda$ définie en (1.2.11) satisfait (1.2.10). Ce quasi-mode se concentre dans un voisinage tubulaire du segment $x_0 + [-T, T]\nu$ de section $R_\lambda/\sqrt{\lambda} \rightarrow 0$. Notons que cette échelle de concentration spatiale réapparaîtra dans l'exemple présenté dans le paragraphe 1.4.4.2 sur le théorème d'Egorov pour l'équation de demi-ondes. La concentration en fréquence est assurée par la présence de l'exponentielle imaginaire dans (1.2.11). Ainsi, ce quasi-mode $(u_\lambda)_\lambda$ de (1.2.11) vérifiant $(u_\lambda, bu_\lambda)_{L^2} \rightarrow 0$ lorsque $\lambda \rightarrow \infty$ implique que la Condition de Contrôle Géométrique Uniforme (CCGU) est nécessaire pour la stabilité uniforme.

Pour montrer la nécessité de la Condition de Point Tournant, on construit des quasi-modes dans un régime potentiel, c'est-à-dire des quasi-modes oscillant relativement peu mais très concentrés autour des points tournants de la dynamique classique. Ceux-ci prennent la forme suivante. Etant donnée une suite de points $(x_\lambda)_\lambda$ dans \mathbf{R}^d telle que $V(x_\lambda) = \lambda^2$ et $x_\lambda \rightarrow \infty$ lorsque $\lambda \rightarrow +\infty$ (rappelons que le potentiel est supposé confinant). On pose

$$u_\lambda(x) = cr^{-d/2} k \left(\frac{x - x_\lambda}{r} \right), \quad \text{avec } r = \frac{R_\lambda}{V(x_\lambda)^{1/4}} = \frac{R_\lambda}{\sqrt{\lambda}}, \quad x \in \mathbf{R}^d,$$

où R_λ tend vers $+\infty$ lorsque $\lambda \rightarrow +\infty$ (mais pas trop rapidement). La constante c sert à assurer une bonne normalisation. Ces quasi-modes se concentrent dans des boules de plus en plus petites à mesure que $x_\lambda \rightarrow \infty$. On retrouve encore une fois l'échelle de concentration spatiale $R_\lambda/\sqrt{\lambda}$. Cette échelle est choisie de sorte que $\Delta u_\lambda = O_{L^2}(\lambda/R_\lambda^2) = o_{L^2}(\lambda)$, c'est-à-dire que l'énergie cinétique du quasi-mode est de la taille du reste. Une plus forte concentration, par exemple à une échelle $r = \lambda^{-1/2-\epsilon}$ avec $\epsilon > 0$, impliquerait une contribution de l'énergie cinétique non négligeable, qu'il faudrait donc corriger en raffinant la construction du quasi-mode (choix de l'enveloppe k , multiplication par un facteur de phase...). Ainsi ce quasi-mode donne que la Condition de Point Tournant (CPT) est nécessaire pour la stabilité uniforme.

1.2.4. Perspectives

Le corollaire 1.2.6 est finalement un peu décevant car la condition (1.2.6) masque complètement la richesse contenue dans la Condition de Point Tournant (CPT) issue du potentiel confinant. On peut penser que la Condition Dynamique de Stabilisation (CDS) est la bonne formulation pour prouver une condition suffisante de stabilité uniforme pour un $b \in L^\infty(\mathbf{R}^d)$ (ou même $C_b^0(\mathbf{R}^d)$) quelconque, via un théorème d'Egorov. Il est donc raisonnable de conjecturer que cette condition caractérise la stabilité uniforme.

Conjecture 1.2.9. *Soit $V \in C^\infty(\mathbf{R}^d)$ satisfaisant (1.2.2) et (1.2.5) et soit $b \in L^\infty(\mathbf{R}^d)$ positif. L'équation (1.2.1) est uniformément stable si et seulement si b satisfait la Condition de Contrôle Géométrique Uniforme (CCGU) et la Condition de Point Tournant (CPT).*

A l'avenir, on souhaiterait donc démontrer la conjecture 1.2.9 pour des amortissements b pouvant osciller au moins à l'échelle caractéristique $R/V(x)^{1/4}$ de la condition (CPT). Des hypothèses « symboliques » supplémentaires sur le potentiel (concernant la décroissance des dérivées de V) seront certainement nécessaire pour utiliser les outils d'analyse microlocale.

Prouver ce résultat semble représenter un défi important. En effet, déjà dans les variétés compactes, l'étude de la stabilité uniforme de l'équation des ondes amorties avec des amortissements présentant des discontinuités est délicate, et les résultats dans cette direction reposent sur des outils fins de seconde microlocalisation. C'est par exemple le cas dans la sphère de dimension d munie de la métrique canonique d'après un résultat de Lebeau [Leb92a] (plus tard généralisé aux surfaces de révolution de Zoll par Zhu [Zhu18]), ainsi que dans le tore plat de dimension 2 avec un amortissement égal à l'indicatrice d'un polygone ; voir [BG20] ou plus récemment [Rou23] en dimension supérieure. Cette question est l'une des motivations pour l'étude des théorèmes d'Egorov dans le formalisme de Weyl–Hörmander développée dans le chapitre 4.

On peut aussi s'interroger sur le rôle du potentiel quartique dans ce problème. Pour un potentiel de la forme $V(x) = \langle x \rangle^s$ avec $s \geq 4$, on peut se demander si la condition (CCGU) est nécessaire, voire suffisante, ou si de nouveaux phénomènes apparaissent.

1.3. Observabilité de l'équation de Schrödinger avec potentiel confinant sous-quadratique

On présente ici les résultats du chapitre 3. On se place dans l'espace euclidien $M = \mathbf{R}^d$ et on considère l'équation de Schrödinger

$$D_t \psi = -P\psi, \quad P = V(x) - \frac{1}{2}\Delta, \quad t \in \mathbf{R}, x \in \mathbf{R}^d, \quad (1.3.1)$$

où V est un potentiel à valeurs réelles minoré. On cherche à caractériser les ouverts $\omega \subset \mathbf{R}^d$ et les temps $T > 0$ tels que

$$\exists C > 0 : \forall u \in L^2(\mathbf{R}^d), \quad \|u\|_{L^2(\mathbf{R}^d)}^2 \leq C \int_0^T \|e^{-itP}u\|_{L^2(\omega)}^2 dt. \quad \text{Obs}(\omega, T)$$

Lorsque $\text{Obs}(\omega, T)$ est vérifiée, on dit que l'équation de Schrödinger (1.3.1) est observable depuis ω en temps T , ou que (ω, T) observe l'équation de Schrödinger. On appellera ω l'ensemble d'observation et T le temps d'observation. Quant à la constante C dans l'inégalité, on l'appellera coût de l'observation. Lorsqu'un ensemble d'observation ω est fixé, l'infimum des $T > 0$ tels que $\text{Obs}(\omega, T)$ soit satisfaite est

appelé temps d'observation optimal et noté $T_\star = T_\star(\omega)$. Il est clair que cette inégalité d'observabilité est vérifiée pour $\omega = \mathbf{R}^d$ en tout temps $T > 0$, puisque le propagateur e^{-itP} est une isométrie sur $L^2(\mathbf{R}^d)$. Mais en vue des applications, on souhaite trouver les plus petits ensembles d'observation possibles et estimer le temps d'observation optimal correspondant.

Comme expliqué dans le paragraphe 1.3, l'observabilité de l'équation de Schrödinger a été très étudiée dans les variétés riemanniennes compactes. Plus récemment, la question a suscité un intérêt grandissant dans l'espace euclidien, pour lequel de nouvelles difficultés apparaissent en raison de la présence d'un infini en espace. Täufer [Tä22] étudie l'équation de Schrödinger libre dans \mathbf{R}^d , et montre qu'elle est observable depuis tout ensemble ouvert périodique non vide en tout temps strictement positif. La preuve repose sur la transformée de Floquet–Bloch et la théorie des séries de Fourier lacunaires. Ce résultat a ensuite été généralisé par Le Bal'h et Martin [LBM23] au cas d'un ensemble d'observation périodique et mesurable, avec un potentiel périodique L^∞ en dimension 2.

Dans [HWW22], Huang, Wang and Wang caractérisent les ensembles mesurables pour lesquels l'équation de Schrödinger (1.3.1) est observable en dimension 1 avec $V(x) = |x|^{2m}$, $m \in \mathbf{N}$. Ils prouvent que dans le cas $m = 1$ (resp. $m \geq 2$), on a observabilité depuis $\omega \subset \mathbf{R}$ en un certain temps (resp. en tout temps) si et seulement si

$$\liminf_{x \rightarrow +\infty} \frac{|\omega \cap [-x, x]|}{|[-x, x]|} > 0,$$

où $|\bullet|$ est la mesure de Lebesgue. Un tel ensemble est qualifié de « faiblement épais ». Simultanément, Martin et Pravda-Starov [MPS21] proposent une généralisation de cette condition en dimension d , qui s'avère être nécessaire si $d \geq 1$ et suffisante si $d = 1$, dans le cas de l'équation de Schrödinger harmonique fractionnaire, c'est-à-dire l'équation (1.3.1) avec $P = (-\Delta + |x|^2)^s$, où $s \geq 1$.

Dans les cas particuliers des potentiels ou opérateurs discutés ci-dessus, les techniques utilisées reposent principalement sur des outils d'analyse harmonique abstraits et donnent des résultats très forts. Cela dit, il semble que ces arguments requièrent la connaissance d'estimées spectrales précises sur les valeurs propres et les fonctions propres, des asymptotiques explicites et des symétries. De plus, dans le cas de l'oscillateur harmonique, les résultats existants [HWW22, MPS21] se concentrent sur les propriétés géométriques des ensembles observant l'équation de Schrödinger, mais étant donné un tel ensemble, ils ne donnent pas le temps d'observation optimal associé. De fait, ils fournissent une borne supérieure de ce temps optimal indépendamment de l'ensemble d'observation, correspondant à une demi-période de l'oscillateur harmonique. Mais il est raisonnable de penser que cette borne supérieure peut être améliorée en prenant en compte la géométrie de l'ensemble d'observation.

Pour compléter ce panorama, on mentionne l'étude de l'observabilité pour des hamiltoniens quadratiques dépendant du temps par Waters [Wat23]. Par ailleurs, pour des potentiels bornés en dimension 1, un résultat quantitatif d'observabilité a été obtenu récemment par Su, Sun et Yuan [SSY23]. Voir aussi [WDX23] sur la demi-droite.

Motivations, hypothèses et notations

Nos objectifs dans ce paragraphe sont les suivants :

- a) trouver une méthode robuste pour prouver que l'équation de Schrödinger est observable depuis un certain ensemble, sous des hypothèses souples sur le potentiel (valable par exemple pour des perturbations du potentiel harmonique telles que $x \cdot Ax$ avec A une matrice $d \times d$ réelle symétrique définie positive, ou des potentiels de la forme $\langle x \rangle^{2m}$ avec $m > 0$ un nombre réel) ;
- b) fournir une borne plus précise sur le temps d'observation optimal $T_\star(\omega)$ dépendant de la forme de l'ensemble d'observation ω .

On travaille sous les hypothèses suivantes sur le potentiel.

Hypothèse 1.3.1. *Le potentiel V est de classe C^∞ et satisfait pour un certain $m \in]0, 1]$:*

$$\begin{aligned} \exists C, r > 0 : \forall |x| \geq r \quad \frac{1}{C} \langle x \rangle^{2m} \leq V(x) \leq C \langle x \rangle^{2m}, \\ \forall \alpha \in \mathbf{N}^d, \exists C_\alpha > 0 : \forall x \in \mathbf{R}^d, \quad |\partial^\alpha V(x)| \leq C_\alpha \langle x \rangle^{2m-|\alpha|}. \end{aligned}$$

La théorie spectrale classique assure que l'opérateur $V(x) - \frac{1}{2}\Delta$ avec domaine $C_c^\infty(\mathbf{R}^d)$ admet une unique extension auto-adjointe, toujours notée P , et que le problème d'évolution (1.3.1) est bien

posé sur $L^2(\mathbf{R}^d)$. On introduit le symbole de l'opérateur P comme la fonction

$$p(x, \xi) := V(x) + \frac{|\xi|^2}{2}, \quad (x, \xi) \in \mathbf{R}^{2d}.$$

On rappelle que les points typiques de l'espace des phases $T^*M = T^*\mathbf{R}^d \simeq \mathbf{R}^{2d}$ sont notés $\rho = (x, \xi)$, et que $\pi : \mathbf{R}^{2d} \rightarrow \mathbf{R}^d$ fait référence à la projection canonique $(x, \xi) \mapsto x$. On rappelle également que le flot hamiltonien $(\phi^t)_{t \in \mathbf{R}}$ agissant sur \mathbf{R}^{2d} est défini comme solution des équations de Hamilton (1.1.36). Dans la suite, on appelle *trajectoire projetée* la composante de position $t \mapsto x^t = \pi \circ \phi^t$ de toute trajectoire du flot hamiltonien.

1.3.1. Résultat principal

Notre résultat principal dans ce cadre est le théorème 1.3.2 ci-dessous, valable pour des potentiels confinants sous-quadratiques ($m \in]0, 1]$). On note $B_r(x)$ la boule ouvert de rayon r centrée en $x \in \mathbf{R}^d$.

Théorème 1.3.2. *On suppose que V satisfait l'hypothèse 1.3.1. Pour tout borélien $\omega \subset \mathbf{R}^d$, on définit pour $R > 0$ l'ensemble épaissi*

$$\omega_R = \bigcup_{x \in \omega} B_R(x),$$

et on introduit pour $T > 0$ la moyenne classique

$$\mathfrak{K}^\infty(\omega, T) = \liminf_{\rho \rightarrow \infty} \int_0^T \mathbf{1}_{\omega \times \mathbf{R}^d}(\phi^t(\rho)) dt = \liminf_{\rho \rightarrow \infty} |\{t \in (0, T) : (\pi \circ \phi^t)(\rho) \in \omega\}|. \quad (1.3.2)$$

Fixons un borélien $\omega \subset \mathbf{R}^d$. Alors les deux affirmations suivantes sont vraies.

(i) (Condition suffisante) Supposons qu'il existe $T_0 > 0$ tel que

$$\mathfrak{K}^\infty := \mathfrak{K}^\infty(\omega, T_0) > 0.$$

Alors il existe une constante $L = L(d, T_0, p) > 0$ telle que pour $R = \frac{L}{\mathfrak{K}^\infty}$, et pour tout $T > T_0$, on ait $\text{Obs}(\omega_R, T)$, à savoir :

$$\exists C > 0 : \forall u \in L^2(\mathbf{R}^d), \quad \|u\|_{L^2(\mathbf{R}^d)}^2 \leq C \int_0^T \|e^{-itP}u\|_{L^2(\omega_R)}^2 dt.$$

(ii) (Condition nécessaire) Supposons qu'il existe un temps $T > 0$ tel que $\text{Obs}(\omega, T)$ soit vraie avec coût $C_{\text{obs}} > 0$, c'est-à-dire

$$\forall u \in L^2(\mathbf{R}^d), \quad \|u\|_{L^2(\mathbf{R}^d)}^2 \leq C_{\text{obs}} \int_0^T \|e^{-itP}u\|_{L^2(\omega)}^2 dt.$$

Alors il existe une constante $c = c(d, T, p)$ telle que pour tout $R \geq 1$ on ait :

$$\mathfrak{K}^\infty(\omega_R, T) \geq \frac{1}{C_{\text{obs}}} - c \frac{\langle \log R \rangle^{1/2}}{R}.$$

Remarque 1.3.3. Une version plus précise du théorème est énoncée au chapitre 3 : les conditions nécessaire et suffisante faisant intervenir les moyennes classiques sont exprimées uniquement en termes du « symbol principal de P » qui dépend uniquement du comportement asymptotique de V à l'infini, et on peut également retirer n'importe quel ensemble compact de l'ensemble d'observation ω sans en changer les propriétés d'observabilité.

Le cœur de la preuve consiste à établir une version du théorème d'Egorov pour relier l'évolution quantique e^{-itP} et l'évolution classique ϕ^t . Cette stratégie s'inscrit dans la lignée de l'article de Laurent et Léautaud [LL16], ainsi que des travaux plus anciens de Dehman et Lebeau [DL09]. Une étape cruciale est d'approcher la fonction indicatrice de ω par une fonction de troncature variant suffisamment lentement. C'est ce qui explique l'apparition de l'épaississement ω_R , et $R \gg 1$ joue

ici le rôle d'un paramètre semi-classique. Notons que la quantité dynamique $\mathfrak{R}^\infty(\omega, T)$ rappelle des moyennes classiques semblables définies par Lebeau [Leb96] ou Laurent-Léautaud [LL16] dans le cadre des ondes. La différence notable de notre travail avec ces travaux sur l'équation des ondes est la suivante : dans (1.3.2), on compte le temps passé dans ω par des trajectoires qui sont de plus en plus longues à mesure que l'on prend une donnée initiale $\rho = (x, \xi)$ de haute énergie. En particulier, ces trajectoires ne sont pas paramétrées par longueur d'arc mais sont au contraire de plus en plus rapides à l'infini dans l'espace des phases, ce qui est cohérent avec la vitesse de propagation infinie de l'énergie pour l'équation de Schrödinger. Enfin la quantité $\mathfrak{R}^\infty(\omega, T)$ encode la dynamique à l'infini dans l'espace des phases et ne voit pas ce qui se passe à basse énergie. Le fait que l'observabilité soit caractérisée par un critère à « haute énergie » est lié à un argument de prolongement unique, qui permet d'affirmer que les basses énergies sont suffisamment délocalisées pour être observées depuis tout ouvert non vide.

Bien que le théorème 1.3.2 ne donne pas une caractérisation complète des ensembles observant l'équation de Schrödinger, il donne une condition presque nécessaire et suffisante, modulo épaississement de ω . Il fournit des résultats optimaux dans beaucoup de situations concrètes comme on l'illustre dans deux exemples dans le paragraphe 1.3.2.

1.3.2. Observabilité des oscillateurs harmoniques en dimension 2

En guise d'application du théorème 1.3.2, on étudie l'observabilité de l'équation de Schrödinger avec potentiel harmonique en dimension 2, depuis un ensemble d'observation conique ou invariant par rotation. Ces résultats sont en fait valides dans le cadre plus général de potentiels dont le « symbol principal » est harmonique (voir le chapitre 3 pour de plus amples détails). On caractérise l'observabilité en des termes purement géométriques sur l'ensemble d'observation.

Rappelons tout d'abord quelques généralités à propos des oscillateurs harmoniques. Soit A une matrice 2×2 réelle symétrique définie positive, et introduisons le hamiltonien $P_A := \frac{1}{2}(x \cdot Ax - \Delta)$. Quitte à réaliser un changement orthogonal de coordonnées, on peut supposer que A est diagonale, de sorte que le potentiel puisse s'écrire

$$V_A(x) = \frac{1}{2}x \cdot Ax = \frac{1}{2}(\nu_1^2 x_1^2 + \nu_2^2 x_2^2).$$

On appelle *fréquences caractéristiques* de P_A les nombres ν_1, ν_2 , que l'on suppose strictement positifs. Le flot hamiltonien associé est explicite : en notant $x_1(t), x_2(t)$ et $\xi_1(t), \xi_2(t)$ les composantes de ϕ^t , on peut résoudre les équations de Hamilton (1.1.36) :

$$\begin{cases} x_j(t) = \cos(\nu_j t)x_j(0) + \frac{1}{\nu_j} \sin(\nu_j t)\xi_j(0) \\ \xi_j(t) = -\nu_j \sin(\nu_j t)x_j(0) + \cos(\nu_j t)\xi_j(0) \end{cases}, \quad \forall j \in \{1, 2\}. \quad (1.3.3)$$

De cette expression, on déduit que chaque coordonnée est périodique, de sorte que pour $j_0 = 1$ ou 2 , les trajectoires avec données initiales de la forme $x_j(0) = x_0 \delta_{j=j_0}, \xi_j(0) = \xi_0 \delta_{j=j_0}$ avec $x_0, \xi_0 \in \mathbf{R}$ sont périodiques, de période $2\pi/\nu_{j_0}$ (à moins que x_0 et ξ_0 soient nuls tous les deux, auquel cas la trajectoire est un point). On peut classer les oscillateurs harmoniques en trois catégories. Voir la Figure 1.3 pour une illustration.

- L'oscillateur harmonique est *isotrope* si $\nu_1 = \nu_2 = \nu$. Dans cette situation, les ensembles de niveau du hamiltonien sont des sphères concentriques dans l'espace des phases (à un changement de coordonnées symplectiques près). Les trajectoires du flot parcourent ces cercles, de sorte que leurs projections sur l'espace physique forment des ellipses. Le flot est $\frac{2\pi}{\nu}$ -périodique. Cf. Figure 1.3a.
- L'oscillateur harmonique est *anisotrope rationnel* lorsque $\frac{\nu_2}{\nu_1}$ est un nombre rationnel différent de 1. Les trajectoires, bien que toutes fermées, présentent un comportement plus compliqué. En écrivant $\frac{\nu_2}{\nu_1} = \frac{p}{q}$ avec p et q des entiers positifs premiers entre-eux, la période du flot est $p\frac{2\pi}{\nu_2} = q\frac{2\pi}{\nu_1}$. Cf. Figure 1.3b.
- L'oscillateur harmonique est *anisotrope irrationnel* lorsque $\frac{\nu_2}{\nu_1} \in \mathbf{R} \setminus \mathbf{Q}$. Dans ce cas, le flot hamiltonien est apériodique. Les trajectoires sont denses dans les tores invariants de la dynamique, donnant lieu à des trajectoires projetées qui remplissent des rectangles parallèles aux espaces propres de la matrice A . Cf. Figure 1.3c.

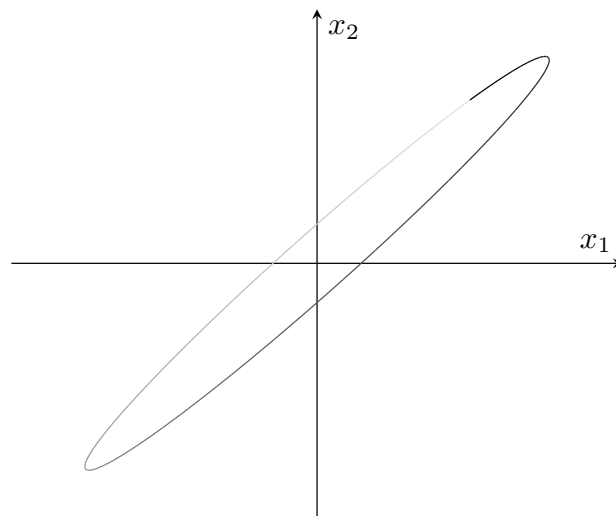

(a) Un oscillateur harmonique isotrope : $\frac{\nu_2}{\nu_1} = 1$.

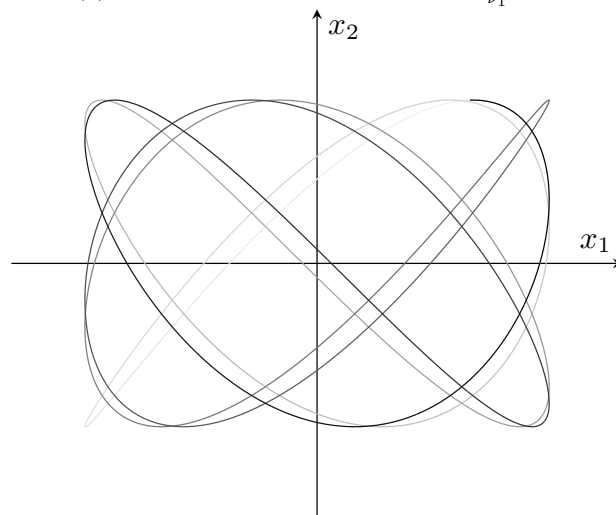

(b) Un oscillateur harmonique anisotrope rationnel : $\frac{\nu_2}{\nu_1} = \frac{7}{5}$.

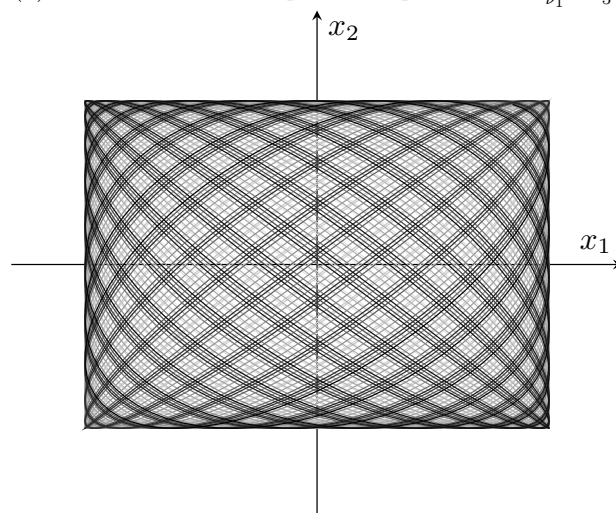

(c) Un oscillateur harmonique anisotrope irrationnel : $\frac{\nu_2}{\nu_1} = \frac{\pi}{3}$.

FIG. 1.3 – Trajectoires projetées typiques de différents oscillateurs harmoniques. Le dégradé de gris indique le sens de parcours des trajectoires.

Dans les deux exemples présentés ci-dessous, on va mettre en évidence le fait que les oscillateurs isotropes et anisotropes se comportent très différemment vis-à-vis de la question de l'observabilité : les ouverts observant l'équation de Schrödinger ne sont pas les mêmes. On peut d'ores et déjà anticiper ce fait en observant que les trajectoires des oscillateurs isotropes sont très simples et n'explorent qu'une petite partie de la région classiquement autorisée. À l'inverse, les trajectoires des oscillateurs anisotropes visitent l'espace des phases de façon beaucoup plus exhaustive, ce qui devrait faciliter l'observabilité depuis un ensemble petit.

1.3.2.1. Observation depuis des ensembles coniques

On étudie dans un premier lieu le cas où l'ensemble d'observation est conique, c'est-à-dire invariant par homothétie de rapport positif :

$$\forall x \in \mathbf{R}^d, \forall \lambda > 0, \quad (x \in \omega \iff \lambda x \in \omega).$$

Dans la proposition ci-dessous, on étudie un ensemble d'observation conique, illustré sur la Figure 1.4. Comme application du théorème 1.3.2, on montre des propriétés d'observabilité différentes selon que l'oscillateur est isotrope ou non.

Proposition 1.3.4 (Ensembles coniques et anisotropie). *Notons $\nu_+ \geq \nu_- > 0$ les fréquences caractéristiques de l'oscillateur harmonique et choisissons une base orthonormée (e_+, e_-) de vecteurs propres de la matrice A , de sorte que $Ae_{\pm} = \nu_{\pm}^2 e_{\pm}$. Pour tout $\varepsilon \in (0, \pi/2)$, on définit les deux cônes d'ouverture ε :*

$$C_{\varepsilon}^{\pm} = \left\{ x \in \mathbf{R}^2 : |x \cdot e_{\mp}| < \tan\left(\frac{\varepsilon}{2}\right) x \cdot e_{\pm} \right\}.$$

L'ensemble $\omega(\varepsilon) = C_{\varepsilon}^+ \cup C_{\varepsilon}^-$ observe l'équation de Schrödinger si et seulement si l'oscillateur est anisotrope, à savoir $\nu_- < \nu_+$. Dans ce cas, il existe des constantes $C, c > 0$, dépendant éventuellement de ν_+, ν_- , telles que pour tout $\varepsilon \in (0, \pi/2)$,

$$T_0 - C\varepsilon^2 \leq T_{\star}(\omega(\varepsilon)) \leq T_0 - c\varepsilon^2, \quad \text{où } T_0 = \frac{\pi}{\nu_+} \left(2 + \left\lfloor \frac{\nu_+}{\nu_-} \right\rfloor \right). \quad (1.3.4)$$

Notons que dans ce résultat, il n'y a pas de distinction entre oscillateur anisotrope rationnel ou irrationnel : on ne peut pas deviner à partir des propriétés d'observabilité de $\omega(\varepsilon)$ si l'oscillateur en question est rationnel ou pas. On note également que le temps d'observation optimal dans la limite $\varepsilon \rightarrow 0$ est donné par $T_0 = T_0(\nu_+, \nu_-)$. Il présente un comportement discontinu lorsque l'on fait varier ν_+ et ν_- .

On illustre ce fait sur l'exemple donné dans la Figure 1.4. Si l'on considère un oscillateur dont les fréquences caractéristiques sont telles que $\frac{\nu_+}{\nu_-} = 4$, on peut choisir la donnée initiale de la trajectoire de sorte que la courbe retourne dans le quadrant Nord-Ouest en passant par l'origine, sans rentrer dans l'union de deux cônes. On obtient par conséquent une borne inférieure plus grande sur le temps d'observation optimal que dans le cas $\frac{\nu_+}{\nu_-} = 3,9$ illustré sur la Figure 1.4, correspondant au saut de $[3,9] = 3$ à $[4] = 4$ dans la formule (1.3.4).

De l'expression explicite du flot (1.3.3), on peut déduire que la dynamique restreinte à $\text{Vect } e_+$ (resp. $\text{Vect } e_-$) possède des trajectoires d'énergie arbitrairement grande contenues dans $\text{Vect } e_+$ (resp. $\text{Vect } e_-$). En particulier, si l'on veut avoir observabilité, il est nécessaire d'observer les deux directions $\text{Vect } e_{\pm}$. Dans le cas isotrope, la matrice est diagonale, si bien que tous les vecteurs de \mathbf{R}^2 sont des vecteurs propres de A , ce qui explique pourquoi l'ensemble $\omega(\varepsilon)$ n'observe pas les oscillateurs isotropes.

1.3.2.2. Observabilité depuis des ensembles invariants par rotation

Notre deuxième exemple concerne les propriétés d'observabilité lorsque l'ouvert ω consiste en une réunion d'anneaux. Un ensemble ω invariant par rotation est déterminé par la donnée d'un ensemble $I \subset \mathbf{R}_+$ tel que

$$\omega = \omega(I) = \{x \in \mathbf{R}^d : |x| \in I\}. \quad (1.3.5)$$

En raison de l'épaississement de l'ensemble d'observation que l'on fait lorsqu'on applique le théorème 1.3.2, on fera dans la suite des hypothèses supplémentaires sur l'ensemble I assurant que $\omega(I)$ et sa version épaissie sont en quelque sorte équivalents.

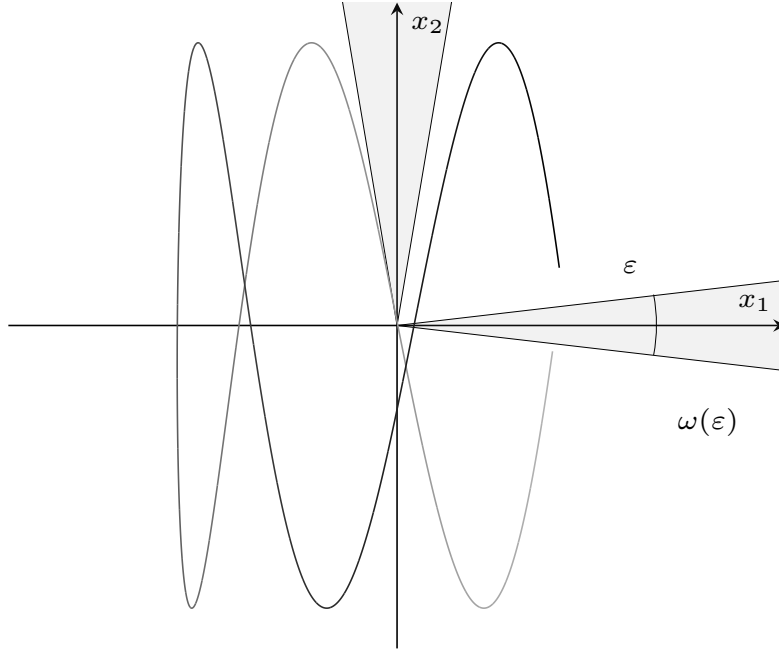

FIG. 1.4 – La trajectoire projetée ci-dessus est responsable de la borne inférieure sur le temps d’observation optimal (1.3.4). Elle est obtenue avec un oscillateur tel que $\frac{\nu_+}{\nu_-} = 3,9$.

En dimension 2, l’existence de trajectoires projetées circulaires pour les oscillateurs isotropes implique que l’ensemble I ne peut pas contenir beaucoup de trous si l’on veut avoir observabilité depuis $\omega(I)$. En effet, si on a $]r_1, r_2[\cap I = \emptyset$ pour $0 < r_1 < r_2$, alors les orbites circulaires de rayon $r \in]r_1, r_2[$ ne seront pas observées par $\omega(I)$. Si I contient une suite de tels trous partant à l’infini, la quantité dynamique (1.3.2) vaut $\mathfrak{K}^\infty(\omega(I), T) = 0$ quel que soit $T > 0$. Dans le cas où ces trous sont de plus en plus grands à mesure que l’on s’approche de l’infini, on a même $\mathfrak{K}^\infty(\omega(I)_R, T) = 0$ quels que soient $R \geq 1$ et $T > 0$, et on déduit alors de la condition nécessaire du théorème 1.3.2 que $(\omega(I), T)$ n’observe l’équation de Schrödinger pour aucun temps $T > 0$.

Dans la suite, on écarte donc les oscillateurs isotropes pour se focaliser sur les oscillateurs anisotropes. On s’intéresse plus particulièrement aux effets de l’irrationalité sur les propriétés d’observabilité des ensembles invariants par rotation. Dans la proposition ci-dessous, on considère un ensemble d’observation de la forme $\omega(I)$ où $I = \bigcup I_n$ est une réunion au plus dénombrable d’intervalles ouverts de \mathbf{R}_+ . On suppose de plus que $|I_n| \rightarrow +\infty$ (on ignore cette hypothèse si on n’a qu’un nombre fini de I_n). On a donc une réunion d’anneaux $\omega(I) = \bigcup \omega(I_n)$ de plus en plus épais.

On associe à un tel ensemble un nombre compris entre 0 et 1 qui quantifie la distribution des anneaux à l’infini :

$$\kappa_\star(I) = \min \left\{ \kappa \in [0, 1] : \liminf_{r \rightarrow +\infty} \frac{1}{r} |I \cap [\kappa r, r]| = 0 \right\} \in [0, 1]. \quad (1.3.6)$$

Nous allons voir qu’il convient de comparer cette quantité géométrique à une quantité dynamique qui encode des propriétés du flot hamiltonien pertinentes dans ce problème. Cette dernière est exprimée à partir de la fonction $\Lambda : \mathbf{R}_+^\star \rightarrow [0, 1]$ définie par

$$\Lambda(\mu) = \begin{cases} \tan\left(\frac{\pi/2}{p+q}\right) & \text{si } \mu = \frac{p}{q}, \text{ pgcd}(p, q) = 1, \ p - q \equiv 0 \pmod{2}, \\ \sin\left(\frac{\pi/2}{p+q}\right) & \text{si } \mu = \frac{p}{q}, \text{ pgcd}(p, q) = 1, \ p - q \equiv 1 \pmod{2}, \\ 0 & \text{si } \mu \in \mathbf{R} \setminus \mathbf{Q}. \end{cases} \quad (1.3.7)$$

Quant au temps optimal d’observation T_\star , nous allons le quantifier à partir des propriétés diophantiennes des fréquences caractéristiques de l’oscillateur harmonique considéré lorsque celui-ci est

irrationnel. On introduit l'exposant d'irrationalité d'un irrationnel μ , défini par

$$\tau(\mu) = \sup \left\{ s \in \mathbf{R} : \left| \mu - \frac{p}{q} \right| < \frac{1}{q^s} \text{ pour une infinité de couples } (p, q) \text{ premiers entre-eux} \right\}. \quad (1.3.8)$$

Le théorème d'approximation de Dirichlet nous dit que $\tau(\mu) \in [2, +\infty]$ pour tout irrationnel. Gardons également à l'esprit que $\tau(\mu) = 2$ pour Lebesgue-presque tout irrationnel (voir les notes de cours [Dur] ou les livres [EW11, Sch91] pour plus de détails).

Proposition 1.3.5 (Ensembles invariants par rotation et anisotropie). *Considérons un oscillateur harmonique de fréquences caractéristiques ν_1 et ν_2 avec $\nu_1 \neq \nu_2$. On fixe $I = \bigcup I_n$ une réunion d'intervalles ouverts de \mathbf{R}_+ tels que $|I_n| \rightarrow +\infty$. On note $\omega(I)$ le sous-ensemble de \mathbf{R}^2 invariant par rotation correspondant, défini par (1.3.5). Alors on a observabilité depuis $\omega(I)$ en un certain temps $T > 0$ si et seulement si*

$$\kappa_*(I) > \Lambda \left(\frac{\nu_2}{\nu_1} \right). \quad (1.3.9)$$

Par ailleurs, le temps d'observation optimal $T_* = T_*(\omega(I))$ peut être estimé comme suit :

- si $\frac{\nu_2}{\nu_1} \in \mathbf{Q}$, en écrivant $\frac{\nu_2}{\nu_1} = \frac{p}{q}$ sous forme de fraction irréductible, on a

$$T_* < \frac{\pi}{\nu_2} p = \frac{\pi}{\nu_1} q;$$

- si $\frac{\nu_2}{\nu_1} \in \mathbf{R} \setminus \mathbf{Q}$ est diophantien, c'est-à-dire si $\tau = \tau(\frac{\nu_2}{\nu_1}) < \infty$, alors on a

$$\forall \varepsilon > 0, \exists c_\varepsilon, C_\varepsilon > 0 : \quad c_\varepsilon \left(\frac{1}{\kappa_*(I)} \right)^{\frac{1}{\tau-1+\varepsilon}} \leq T_* \leq C_\varepsilon \left(\frac{1}{\kappa_*(I)} \right)^{\tau-1+\varepsilon}. \quad (1.3.10)$$

Les constantes c_ε et C_ε dépendent éventuellement de ν_1, ν_2 mais pas de I .

Commentons le sens des différentes quantités apparaissant dans cet énoncé.

Le nombre $\kappa_*(I)$ introduit dans (1.3.6) correspond à une certaine notion de densité⁸ de l'ensemble I , et ne dépend que de celui-ci. Par exemple, $\kappa_*(I) = 1$ signifie que I a une densité positive dans toute fenêtre $[\kappa r, r]$ avec $\kappa < 1$ lorsque $r \rightarrow +\infty$. A l'inverse, $\kappa_*(I)$ proche de zéro signifie que les anneaux sont extrêmement épars à l'infini.

Etant donné $\mu \in \mathbf{R}_+^*$, la constante $\Lambda(\mu)$ définie en (1.3.7) est liée au flot des oscillateurs harmoniques dont les fréquences caractéristiques ν_1, ν_2 satisfont $\frac{\nu_1}{\nu_2} = \mu$, et ne dépend que de cette valeur μ . Plus précisément, elle correspond au ratio maximal entre la distance minimale et la distance maximale des trajectoires projetées à l'origine. C'est le contenu du lemme ci-dessous.

Lemme 1.3.6. *Pour tous $\nu_1, \nu_2 > 0$, on a*

$$\Lambda \left(\frac{\nu_2}{\nu_1} \right) = \sup_{\rho_0 \in \mathbf{R}^4 \setminus \{0\}} \frac{\inf_{t \in \mathbf{R}} |(\pi \circ \phi^t)(\rho_0)|}{\sup_{t \in \mathbf{R}} |(\pi \circ \phi^t)(\rho_0)|}, \quad (1.3.11)$$

où $(\phi^t)_{t \in \mathbf{R}}$ est le flot hamiltonien d'un oscillateur harmonique avec fréquences caractéristiques ν_1, ν_2 .

Ainsi on peut qualifier $\Lambda(\frac{\nu_2}{\nu_1})$ de rapport d'aspect radial optimal des trajectoires projetées. L'observabilité depuis $\omega(I)$ va dépendre de la possibilité d'observer les trajectoires du flot qui sont les plus confinées dans la direction radiale. Pour que ces courbes passent suffisamment de temps dans l'ensemble d'observation, il faut donc que I charge toute fenêtre radiale de l'ordre de ce ratio critique, d'où le critère $\kappa_*(I) > \Lambda(\frac{\nu_2}{\nu_1})$. Voir la Figure 1.5 pour une illustration d'un cas où de telles trajectoires ne sont pas capturées par l'ensemble d'observation. Notons que maximiser le ratio (1.3.11) par rapport à toutes les données initiales $\rho_0 \neq 0$ revient à prendre la limite supérieure quand $\rho_0 \rightarrow \infty$,

⁸On notera que $\kappa_*(I)$ ne coïncide pas en général avec la densité inférieure de I définie par

$$\Theta_\infty(I) = \liminf_{r \rightarrow +\infty} \frac{|I \cap [0, r]|}{|[0, r]|}.$$

On a en fait $\Theta_\infty(I) \leq \kappa_*(I)$ et $\kappa_*(I) = 0 \Leftrightarrow \Theta_\infty(I) = 0$. L'égalité $\Theta_\infty(I) = \kappa_*(I)$ n'est pas toujours vraie comme on peut le voir sur l'exemple $I = \bigcup_{n \in \mathbf{N}} (n, n + \frac{1}{2})$, pour lequel on a $\Theta_\infty(I) = \frac{1}{2}$ mais $\kappa_*(I) = 1$.

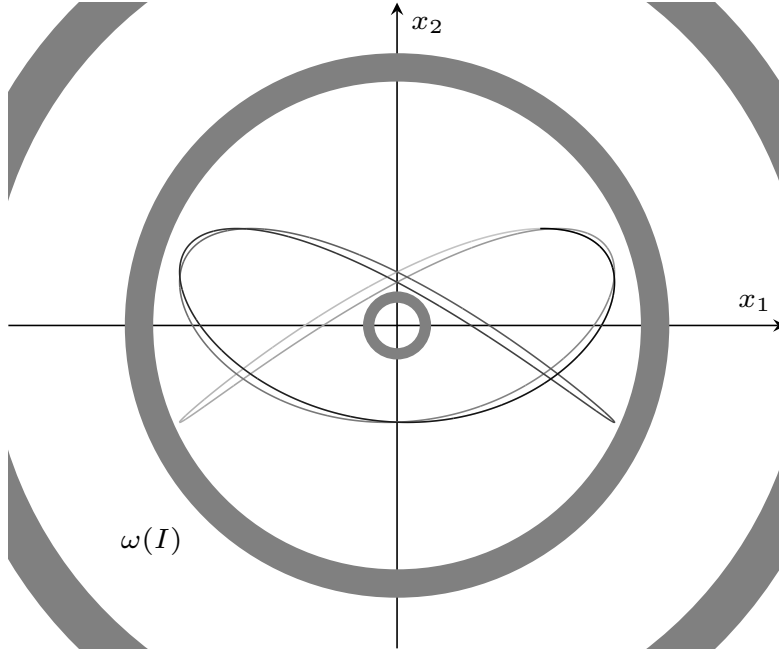

FIG. 1.5 – Trajectoire projetée pour un oscillateur harmonique tel que $\frac{\nu_2}{\nu_1} = \frac{4}{3}$, qui n'intersecte pas l'ensemble d'observation $\omega(I)$.

par homogénéité du flot hamiltonien. Ainsi $\Lambda(\mu)$ peut être vue comme une quantité qui capture le comportement du flot à l'infini. Par ailleurs, on remarque que $\Lambda(\mu) = \Lambda(1/\mu)$, ce qui signifie que cette valeur ne dépend que du spectre de la matrice A et non d'un choix spécifique de coordonnées. En outre, le maximum de Λ est atteint exactement à 1 où elle est égale à $\tan(\frac{\pi}{4}) = 1$. Cette observation est cohérente avec le fait qu'en dimension 2, les oscillateurs harmoniques isotropes sont les seuls à posséder des orbites circulaires. Remarquons également que la fonction Λ s'annule exactement sur les irrationnels, ce qui correspond au fait que toutes les trajectoires passent à une distance arbitrairement petite de l'origine, quitte à attendre très longtemps, comme on l'a observé sur la Figure 1.3c.

Dans le cas irrationnel, l'estimée du temps d'observation optimal (1.3.10) donne une information dans le régime asymptotique où l'ensemble d'observation est très épars, à savoir $\kappa_*(I) \ll 1$. Notons également que pour presque tout irrationnel μ , on a $\tau(\mu) = 2$, de sorte que la minoration et la majoration dans (1.3.10) sont du même ordre, et on a alors $T_*(\omega(I)) \asymp \kappa_*(I)^{-1}$. Enfin, on a représenté sur la Figure 1.6 des trajectoires projetées avec rapport d'aspect radial optimal pour différents oscillateurs harmoniques anisotropes rationnels.

Remarque 1.3.7. Il peut sembler surprenant que la proposition 1.3.5 nous donne une caractérisation exacte des ensembles invariants par rotation depuis lesquels l'observabilité est vraie, alors que le théorème 1.3.2 ne donne qu'une caractérisation modulo épaisseur de l'ensemble d'observation. Ceci est dû à l'hypothèse supplémentaire $|I_n| \rightarrow +\infty$ qui permet en quelque sorte d'absorber l'épaisseur (celui-ci devient négligeable à l'infini devant le rayon des anneaux).

1.3.3. Autres applications

On discute rapidement deux conséquences du théorème 1.3.2.

1.3.3.1. Observabilité uniforme des fonctions propres

Sous l'hypothèse 1.3.1, l'opérateur P est auto-adjoint à résolvante compacte. Ainsi son spectre est constitué de valeurs propres, de multiplicité finie. Une conséquence directe de l'inégalité d'observabilité $\text{Obs}(\omega, T)$ dans un ensemble d'observation ω est que les fonctions propres de P sont uniformément observables depuis ω :

$$\exists c > 0 : \forall u \in L^2(\mathbf{R}^d), \quad \left(\exists \lambda \in \mathbf{R} : Pu = \lambda u \implies \|u\|_{L^2(\omega)} \geq c \|u\|_{L^2(\mathbf{R}^d)} \right). \quad (1.3.12)$$

En particulier, on déduit des deux exemples présentés dans le paragraphe 1.3.2 qu'on a observabilité uniforme des fonctions propres depuis les deux cônes de la proposition 1.3.4 pour tout oscillateur

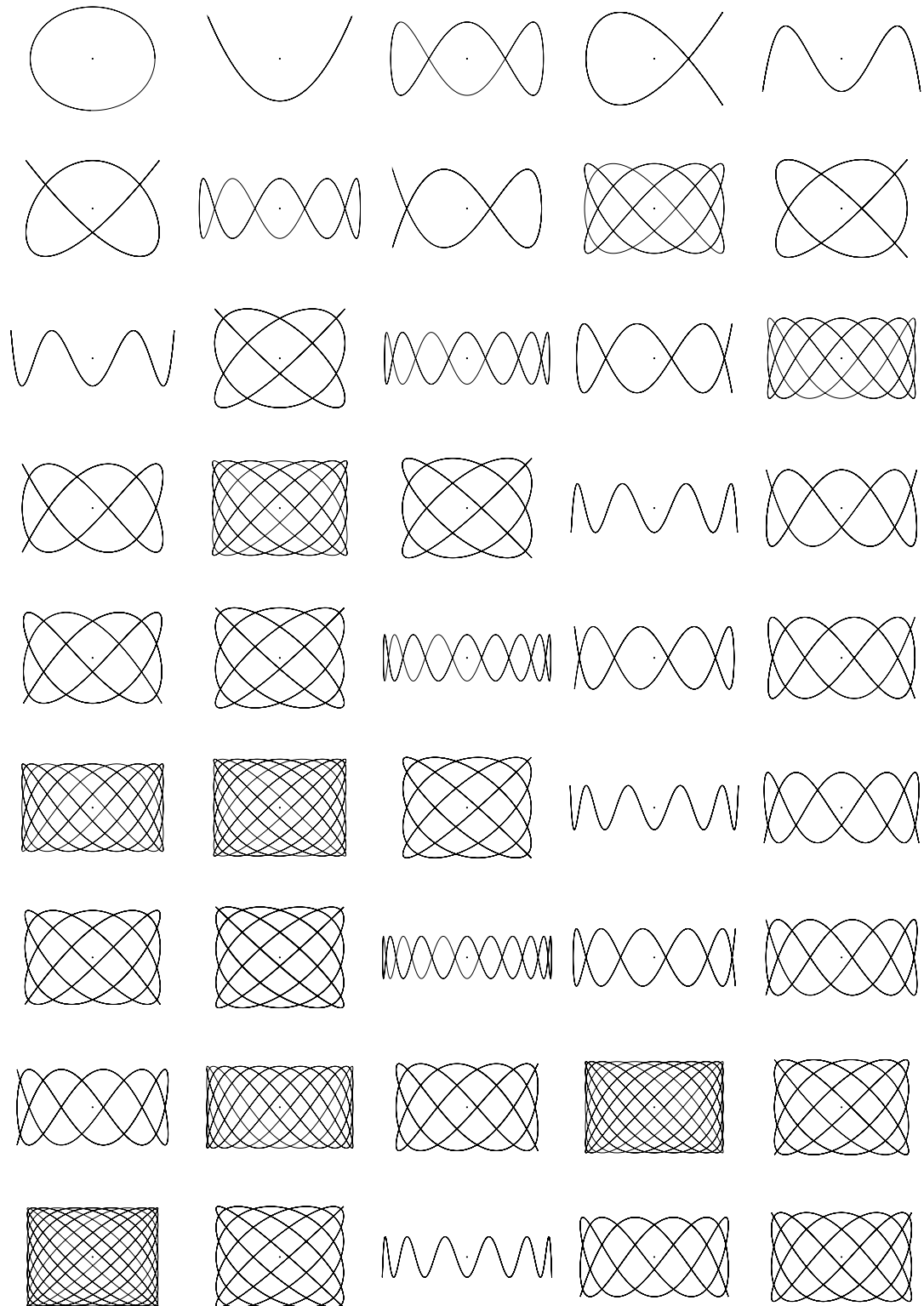

FIG. 1.6 – Trajectoires projetées ayant un rapport d'aspect radial optimal. La petite croix indique le point d'équilibre de chaque l'oscillateur (là où le potentiel harmonique est nul). Certaines courbent rebroussement chemin, de sorte que leur image apparait comme singulière. Les oscillateurs harmoniques considérés ont le ratio $\frac{\omega_2}{\omega_1}$ suivant, de gauche à droite et de haut en bas : $\frac{1}{1}, \frac{2}{1}, \frac{3}{1}, \frac{3}{2}, \frac{4}{1}, \frac{4}{3}, \frac{5}{1}, \frac{5}{2}, \frac{5}{3}, \frac{5}{4}, \frac{6}{1}, \frac{6}{5}, \frac{7}{1}, \frac{7}{2}, \dots$

harmonique anisotrope (ce résultat est stable par perturbation « sous-principale » du potentiel ; voir la remarque 1.3.3). Noter que ce résultat peut en principe être déduit des travaux d’Arnaiz et Macià [AM22a] qui caractérisent les limites quantiques des oscillateurs harmoniques. On déduit également de la proposition 1.3.5 que (1.3.12) est vraie dans les ensembles invariants par rotation satisfaisant les hypothèses de la proposition et le critère (1.3.9). Il n’est pas clair que l’on puisse déduire ce résultat de la connaissance des limites quantiques [AM22a]. En effet, ces dernières sont définies comme dans le paragraphe 1.1.5.3 à partir d’une remise à l’échelle prenant en compte l’infini en espace. Puisque les fonctions test pour ces mesures de défaut sont définies à l’échelle semi-classique, on est limité à des ensembles d’observation invariants par cette remise à l’échelle, c’est-à-dire des ensembles coniques.

1.3.3.2. Décroissance polynomiale de l’énergie pour l’équation des ondes amorties

On termine ce paragraphe par une présentation des conséquences du théorème 1.3.2 sur l’équation des ondes amorties

$$\begin{cases} \partial_t^2 \psi + P\psi + \mathbb{1}_\omega \partial_t \psi = 0 \\ (\psi, \partial_t \psi)|_{t=0} = U_0 \in \text{dom } P^{1/2} \times L^2 \end{cases} \quad (1.3.13)$$

avec amortissement dans $\omega \subset \mathbf{R}^d$, pourvu que $P \geq 0$ (on suppose par exemple que le potentiel V est positif). On rappelle que l’observabilité pour l’équation de Schrödinger $\text{Obs}(\omega, T)$ implique une décroissance à un taux t^{-1} pour l’énergie (définie en (1.2.3)) de l’équation des ondes amorties (1.3.13) (on renvoie à l’article d’Anantharaman et Léautaud [AL14, Théorème 2.3] pour une preuve). Cela signifie qu’il existe une constante $C > 0$ telle que

$$\mathcal{E}(U_0, t) \leq \frac{C}{t} \left(\|Pu_0\|_{L^2}^2 + \|P^{1/2}u_1\|_{L^2}^2 \right), \quad \forall t > 0, \quad (1.3.14)$$

pour toute donnée initiale $U_0 = (u_0, u_1) \in \text{dom } P \times \text{dom } P^{1/2}$ dans le domaine de l’opérateur des ondes amorties. Ce résultat s’applique ici et les exemples présentés dans le paragraphe 1.3.2 fournissent des situations concrètes dans lesquelles la décroissance de l’énergie (1.3.14) a lieu. Ces exemples incluent des cas où la Condition de Contrôle Géométrique Uniforme (CCGU) ou la Condition de Point Tournant (CPT) du paragraphe 1.2 ne sont pas vérifiées. La proposition 1.2.5 implique donc que l’on n’a pas stabilité uniforme au sens de la définition 1.2.1, ce qui rend la décroissance de l’énergie (1.3.14) pertinente dans ce contexte.

1.3.4. Idée de preuve du théorème 1.3.2

La preuve du théorème 1.3.2 repose sur un théorème d’Egorov (dont on a décrit brièvement le principe dans le paragraphe 1.1.5.2). On présente ici seulement la stratégie de la preuve de la condition suffisante du théorème 1.3.2. On se donne donc un ouvert $\omega \subset \mathbf{R}^d$ satisfaisant la condition dynamique $\mathfrak{R}^\infty(\omega, T) > 0$ pour un certain $T > 0$.

Etant donné $R \geq 1$, la première étape consiste à construire une fonction de troncature $\chi_R \in C_b^\infty(\mathbf{R}^{2d})$ telle que

$$\mathbb{1}_\omega \leq \chi_R \leq \mathbb{1}_{\omega_R}. \quad (1.3.15)$$

Il s’avère qu’on peut construire cette fonction de sorte à avoir les estimées suivantes sur les dérivées :

$$\forall \alpha \in \mathbf{N}^{2d}, \exists C_\alpha > 0 : \quad \|\partial^\alpha \chi_R\|_\infty \leq \frac{C_\alpha}{R^{|\alpha|}}. \quad (1.3.16)$$

Ensuite, pour des symboles satisfaisant (1.3.16), on montre un théorème d’Egorov qui établit que

$$e^{itP} \text{Op}^w(\chi_R) e^{-itP} = \text{Op}^w(\chi_R \circ \phi^t) + O_{\mathcal{L}(L^2)}\left(\frac{1}{R}\right),$$

où la constante impliquée dans le reste est uniforme en $t \in [-T, T]$. Le paramètre $1/R$ fait ici office

de paramètre semi-classique. En utilisant (1.3.15), on obtient donc, quel que soit $u \in L^2(\mathbf{R}^d)$,

$$\begin{aligned} \int_0^T \|e^{-itP}u\|_{L^2(\omega_R)}^2 dt &= \int_0^T (e^{-itP}u, \mathbb{1}_{\omega_R} e^{-itP}u)_{L^2} dt \\ &\geq \int_0^T (e^{-itP}u, \chi_R e^{-itP}u)_{L^2} dt \\ &= \int_0^T (u, e^{itP} \text{Op}^w(\chi_R) e^{-itP}u)_{L^2} dt \\ &= \left(u, \text{Op}^w \left(\int_0^T \chi_R \circ \phi^t dt \right) u \right)_{L^2} + O\left(\frac{T}{R}\right) \|u\|_{L^2}^2. \end{aligned} \quad (1.3.17)$$

On utilise maintenant une inégalité de Gårding adaptée aux propriétés des symboles qu'on considère. L'hypothèse $\mathfrak{K}^\infty(\omega, T) > 0$ permet d'écrire que

$$\int_0^T \chi_R \circ \phi^t dt \geq \frac{\mathfrak{K}^\infty(\omega, T)}{2}$$

en dehors d'un compact de l'espace des phases. Ainsi, pour une fonction de troncature $\psi \in C_c^\infty(\mathbf{R}^{2d})$ telle que $1 - \psi$ localise en-dehors du compact en question, on a

$$a_R := \frac{\mathfrak{K}^\infty(\omega, T)}{2} \psi + (1 - \psi) \int_0^T \chi_R \circ \phi^t dt \geq \frac{\mathfrak{K}^\infty(\omega, T)}{2}$$

uniformément sur tout l'espace des phases. On peut choisir ψ dépendant de R de sorte qu'elle satisfasse aussi (1.3.16), et alors l'inégalité de Gårding donne dans notre contexte

$$\begin{aligned} \text{Op}^w \left(\int_0^T \chi_R \circ \phi^t dt \right) &= \text{Op}^w \left(a_R + \psi \left(\int_0^T \chi_R \circ \phi^t dt - \frac{\mathfrak{K}^\infty(\omega, T)}{2} \right) \right) \\ &\geq \frac{\mathfrak{K}^\infty(\omega, T)}{2} \text{Id} - K - O_{\mathcal{L}(L^2)} \left(\frac{1}{R} \right), \end{aligned} \quad (1.3.18)$$

où K est un opérateur compact, contenant les contributions impliquant la fonction de troncature ψ . Etablir ce résultat demande un soin particulier, notamment dans l'estimation des dérivées du symbol moyenné $\int_0^T \chi_R \circ \phi^t dt$. En insérant (1.3.18) dans (1.3.17), on obtient ainsi (pour T fixé) :

$$\int_0^T \|e^{-itP}u\|_{L^2(\omega_R)}^2 dt \geq \left(\frac{\mathfrak{K}^\infty(\omega, T)}{2} - O\left(\frac{1}{R}\right) \right) \|u\|_{L^2}^2 - (u, Ku)_{L^2}.$$

Pour terminer, il suffit de prendre $R \gg \mathfrak{K}^\infty(\omega, T)^{-1}$. On obtient donc l'inégalité d'observabilité souhaitée depuis ω_R , modulo l'opérateur compact K . On se débarrasse de ce dernier par un argument de compacité-unicité dû à Bardos, Lebeau et Rauch [BLR92] utilisant en boîte noire une propriété de prolongement unique des fonctions propres de l'opérateur de Schrödinger P [LRLR22a]. Voir l'Annexe 3.A du chapitre 3 pour une présentation détaillée.

1.3.5. Perspectives

Le théorème 1.3.2 donne une caractérisation partielle des ouverts observant l'équation de Schrödinger (1.3.1), au sens où les conditions nécessaire et suffisante fournies dans ce théorème coïncident modulo épaissement de l'ensemble d'observation. Dans l'esprit de la Condition Dynamique de Stabilisation (CDS) introduite dans le paragraphe 1.2 sur la stabilité uniforme des ondes avec potentiel confinant, on peut conjecturer qu'un bon candidat pour caractériser l'observabilité de (1.3.1) depuis $\omega \subset \mathbf{R}^d$ en temps T est que

$$\exists R > 0 : \quad \tilde{\mathfrak{K}}^\infty(\omega, T) := \liminf_{\rho \rightarrow \infty} \int_0^T (\mathbb{1}_\omega * \kappa_R) (\pi \circ \phi^t(\rho)) dt > 0, \quad (1.3.19)$$

où $\kappa = |B_1(0)|^{-1} \mathbb{1}_{B_1(0)}$ et $\kappa_R = R^{-d} \kappa(\bullet/R)$, $R > 0$. La quantité (1.3.19) s'interprète comme une moyenne classique de l'indicatrice de l'ensemble d'observation à une échelle $R > 0$ (potentiellement

grande). On note au passage que la condition (1.3.19) a du sens pour un ensemble d'observation ω Lebesgue mesurable.

Une autre piste de recherche dans le prolongement du théorème 1.3.2 est de relaxer l'hypothèse de sous-quadraticité sur le potentiel (i.e. $m \leq 1$ dans l'hypothèse 1.3.1). On pourrait par exemple étudier le cas particulier $V(x) = |x|^4$ (on parle alors d'oscillateur anharmonique). En dimension 2, la complète intégrabilité de la dynamique classique sous-jacente [BLR22] pourrait alors être mise à profit pour étudier l'observabilité de l'équation de Schrödinger correspondante dans l'esprit des travaux [AFKM15, ALM16b].

1.4. Le théorème d'Egorov dans le calcul de Weyl–Hörmander

Dans l'article [Ego69], Egorov prouve que tout symplectomorphisme local χ peut être quantifié, au sens où il existe un opérateur U_χ (microlocalement unitaire) tel que $U_\chi^* \text{Op}^w(a) U_\chi \approx \text{Op}^w(a \circ \chi)$. Ce type d'énoncé, qui porte maintenant le nom de théorème d'Egorov, est une façon de formaliser mathématiquement la correspondance classique-quantique. Dans le chapitre 4, plutôt que de quantifier un symplectomorphisme (c'est-à-dire aller du classique au quantique), on souhaite au contraire décrire l'évolution quantique d'une observable à partir de données classiques. Etant donné un opérateur auto-ajoint $P = \text{Op}^w(p)$ et le propagateur associé e^{-itP} , on veut montrer un énoncé du type

$$e^{itP} \text{Op}^w(a) e^{-itP} \approx \text{Op}^w(a \circ \phi^t),$$

où $(\phi^t)_{t \in \mathbf{R}}$ est le flot hamiltonien associé au symbole p . Cette déclinaison du théorème d'Egorov a été très étudiée et appliquée dans de nombreux contextes (on renvoie par exemple aux livres de Taylor [Tay91, Chapter 6] dans le cadre microlocal et de Zworski [Zwo12, Chapter 11] dans le cadre semi-classique). Listons quelques applications.

- En géométrie spectrale, des outils de type « théorème d'Egorov » permettent d'établir des liens entre la trace du groupe des ondes et le spectre des longueurs d'une variété riemannienne compacte [Cha74, DG75].
- Les théorèmes d'Egorov permettent d'analyser les propriétés de concentration et de délocalisation des fonctions propres du laplacien sur des variétés riemanniennes compactes dans le contexte du chaos quantique, en lien avec la notion d'ergodicité quantique [CdV85, Ana08, AN07, Riv10b, Riv10a, AR12, Riv14, DG14, DJN22].
- En théorie du contrôle des équations aux dérivées partielles, les théorèmes d'Egorov peuvent être utilisés pour établir des inégalités d'observabilité [DL09, DLRL14, LL16, Pro23].
- Les théorèmes d'Egorov ont aussi des applications en théorie des résonances de diffusion [NZ09, NZ15, Dya15, DG17], et plus généralement dans l'étude des estimées de résolvante [BBR10, AR20, Lé23].
- Des idées liées au théorème d'Egorov ont été utilisées récemment dans l'étude des flots d'Anosov [FT23a, FT23b].

Dans le chapitre 4, on développe un théorème d'Egorov dans le cadre général des métriques sur l'espace des phases, en vue d'applications à la théorie du contrôle (stabilisation des ondes et observabilité de l'équation de Schrödinger). Avant d'introduire les rudiments du formalisme de Weyl–Hörmander dans le paragraphe 1.4.3, on précise le cadre géométrique du chapitre 4.

On rappelle que l'espace de phases T^*M n'est muni a priori que d'une structure symplectique, et que la structure riemannienne qu'on va lui ajouter est un objet extrinsèque qu'il convient de voir comme un outil de travail. Pour cette raison, on s'efforcera dans ce paragraphe de voir $M = \mathbf{R}^d$ comme un espace affine, sans origine privilégiée et sans produit scalaire spécifique, i.e. sans structure euclidienne. L'espace des phases T^*M hérite naturellement de cette structure affine : il existe un espace vectoriel réel de dimension finie $W = V \oplus V^*$ qui agit librement transitivement sur T^*M par translation :

$$\begin{aligned} W \times T^*M &\longrightarrow T^*M, \\ (\zeta, \rho) &\longmapsto \rho + \zeta. \end{aligned} \tag{1.4.1}$$

Cet espace vectoriel W s'identifie aux espaces tangents $T_\rho(T^*M)$ au-dessus de chaque point $\rho \in T^*M$. On rappelle que cette structure affine suffit pour définir la quantification de Weyl. Elle suffit également pour dériver les fonctions $a \in C^\infty(T^*M)$. Les dérivées successives $\nabla^k a$ sont vues

comme des tenseurs symétriques, où ∇ est la connexion naturelle sur T^*M donnée par la structure affine (1.4.1).⁹

Dans la suite, on travaille dans l'espace de Hilbert $L^2(M)$, c'est-à-dire l'espace des fonctions de carré intégrable par rapport à une mesure de Lebesgue sur M . Rigoureusement, il serait plus naturel de travailler avec l'espace des demi-densités de carré intégrable, pour lequel on n'a pas à se poser la question de la normalisation de la mesure de Lebesgue. Cela dit, ces deux espaces sont naturellement isomorphes (via le choix d'une certaine normalisation de la mesure de Lebesgue) et il est plus commode de travailler avec des fonctions plutôt qu'avec des densités.

1.4.1. Retour sur les dynamiques quantique et classique

Nous avons vu dans le paragraphe 1.1.5.2 qu'étant donné une observable classique $a_0 \in \mathcal{S}'(T^*M)$ et $A_0 = \text{Op}^w(a_0)$ sa quantification de Weyl, l'évolution quantique $A(t) := e^{itP}A_0e^{-itP}$ selon la formulation de Heisenberg satisfait l'équation

$$D_t A = [P, A].$$

Au niveau symbolique, on peut montrer qu'il existe toujours $a(t, \bullet) \in \mathcal{S}'(T^*M)$ tel que $A(t) = \text{Op}^w(a(t))$, et on a donc

$$D_t \text{Op}^w(a(t)) = \text{Op}^w(p \# a(t) - a(t) \# p), \quad a(0) = a_0,$$

où $\#$ désigne le produit de Moyal (1.1.26). Ainsi $t \mapsto a(t)$ est solution de l'équation

$$\partial_t a = \mathcal{H}_p a, \tag{1.4.2}$$

où \mathcal{H}_p est l'opérateur

$$\mathcal{H}_p a := i(p \# a - a \# p), \quad a \in \mathcal{S}'(T^*M). \tag{1.4.3}$$

Sous des hypothèses relativement faibles sur p , on montre dans le chapitre 4 que l'on peut définir une famille d'opérateurs $(\mathcal{U}(t))_{t \in \mathbf{R}}$ sur $L^2(T^*M)$ telle que

$$\forall a_0 \in L^2(T^*M), \quad e^{itP} \text{Op}^w(a_0) e^{-itP} = \text{Op}^w(\mathcal{U}(t)a_0), \tag{1.4.4}$$

i.e. $a(t) = \mathcal{U}(t)a_0$ (c'est essentiellement une conséquence du théorème du noyau de Schwartz [Trè67, Corollaire du Théorème 51.7]), et que $(\mathcal{U}(t))_{t \in \mathbf{R}}$ est un groupe unitaire fortement continu sur $L^2(T^*M)$, dont le générateur infinitésimal est une extension auto-adjointe de \mathcal{H}_p . Dans la suite, on note ce groupe unitaire $(e^{t\mathcal{H}_p})_{t \in \mathbf{R}}$ et on l'appelle la *dynamique quantique*.

On peut faire un travail similaire au niveau classique. On fait agir le flot hamiltonien, engendré par le champ de vecteurs hamiltonien défini par (1.1.33) (avec $q = p$), sur les fonctions par pré-composition : $U(t) : a_0 \mapsto a_0 \circ \phi^t$ pour $a_0 \in \mathcal{S}'(T^*M)$. On remarque alors que l'application $t \mapsto U(t)a_0$ satisfait l'équation

$$\partial_t a = H_p a, \tag{1.4.5}$$

où l'on voit le champ de vecteur H_p comme opérateur différentiel d'ordre 1. Il s'avère que sous des hypothèses assez faibles sur p , la famille d'opérateurs $(U(t))_{t \in \mathbf{R}}$ est un groupe unitaire fortement continu sur $L^2(T^*M)$, engendré par une extension auto-adjointe de H_p . On note ce groupe $(e^{tH_p})_{t \in \mathbf{R}}$ et on l'appelle la *dynamique classique*.

1.4.2. Le théorème d'Egorov comme une série de Dyson

Avec cette formalisation, comparer classique et quantique revient à comparer $\mathcal{U}(t)a_0$ solution de (1.4.2) et $U(t)a_0$ solution de (1.4.5). Ceci se ramène d'un point de vue algébrique à la comparaison des générateurs \mathcal{H}_p et H_p , qui sont reliés via le calcul pseudo-différentiel (1.1.27) par la formule

$$\mathcal{H}_p = H_p + \mathcal{H}_p^{(3)}, \tag{1.4.6}$$

Ici, l'opérateur $\mathcal{H}_p^{(3)}$ correspond au reste d'ordre 3 dans le calcul pseudo-différentiel avec le symbole p (le terme d'ordre 2 s'annule pour une raison de symétrie grâce à la quantification de Weyl). La correspondance classique-quantique se manifeste lorsque ce terme est petit dans un certain régime

⁹L'action (1.4.1) donne naturellement une notion de transport parallèle et donc une connexion à partir de laquelle on définit les dérivées successive, sans recours à une quelconque structure euclidienne sur T^*M .

asymptotique, par exemple d'ordre h^3 dans le formalisme semi-classique, ou d'ordre $\langle \xi \rangle^{-3}$ dans le formalisme microlocal.

Lorsque les générateurs de deux évolutions diffèrent d'une perturbation « petite » comme dans (1.4.6), en appliquant le théorème fondamental de l'analyse à la fonction $s \mapsto e^{s\mathcal{H}_p} e^{(t-s)H_p}$, on obtient formellement

$$e^{t\mathcal{H}_p} - e^{tH_p} = \int_0^t e^{s\mathcal{H}_p} (\mathcal{H}_p - H_p) e^{(t-s)H_p} ds = \int_0^t e^{(t-s)\mathcal{H}_p} \mathcal{H}_p^{(3)} e^{sH_p} ds.$$

On peut ensuite itérer cette procédure pour obtenir une série de Dyson :

$$e^{t\mathcal{H}_p} = \sum_{j=0}^{j_0} \mathcal{E}_j(t) + \widehat{\mathcal{E}}_{j_0+1}(t), \quad j_0 \in \mathbf{N}, \quad (1.4.7)$$

où $\mathcal{E}_0(t) := e^{tH_p}$, et pour tout $j \geq 1$:

$$\mathcal{E}_j(t) := \int_{t\Delta_j} e^{(t-s_j)H_p} \mathcal{H}_p^{(3)} e^{(s_j-s_{j-1})H_p} \mathcal{H}_p^{(3)} \dots \mathcal{H}_p^{(3)} e^{s_1 H_p} ds, \quad (1.4.8)$$

$$\widehat{\mathcal{E}}_j(t) := \int_{t\Delta_j} e^{(t-s_j)\mathcal{H}_p} \mathcal{H}_p^{(3)} e^{(s_j-s_{j-1})H_p} \mathcal{H}_p^{(3)} \dots \mathcal{H}_p^{(3)} e^{s_1 H_p} ds. \quad (1.4.9)$$

Ici on a noté $\mathbf{s} = (s_1, s_2, \dots, s_j)$ et le k -simplexe

$$\Delta_k = \{(s_1, s_2, \dots, s_k) \in \mathbf{R}^k : 0 \leq s_1 \leq s_2 \leq \dots \leq s_k \leq 1\},$$

et on a posé

$$t\Delta_k = \{ts' \in \mathbf{R}^k : s' \in \Delta_k\}, \quad t \in \mathbf{R}.$$

Notons que les opérateurs $\mathcal{E}_j(t)$ et $\widehat{\mathcal{E}}_j(t)$ peuvent, de façon équivalente à (1.4.8) et (1.4.9), être définis par récurrence par $\mathcal{E}_0(t) = e^{tH_p}$ et pour $j \geq 1$:

$$\mathcal{E}_{j+1}(t) = \int_0^t e^{(t-s)H_p} \mathcal{H}_p^{(3)} \mathcal{E}_j(s) ds \quad \text{et} \quad \widehat{\mathcal{E}}_{j+1}(t) = \int_0^t e^{(t-s)\mathcal{H}_p} \mathcal{H}_p^{(3)} \mathcal{E}_j(s) ds. \quad (1.4.10)$$

L'identité (1.4.7) constitue ainsi une expression concise et explicite (bien que formelle à ce stade) du développement asymptotique qui intervient dans le théorème d'Egorov (notons que cette structure avait déjà été remarquée par Bambusi, Graffi et Paul [BGP99]). On va maintenant donner un cadre analytique général dans lequel cette identité algébrique a un sens précis.

1.4.3. Classes de symboles de Weyl–Hörmander et résultat principal

Le formalisme de Weyl–Hörmander consiste à considérer une certaine métrique riemannienne sur l'espace des phases, adaptée au problème étudié (dans notre cas, cette métrique sera adaptée à la dynamique classique sous-jacente). Cette théorie, qui sous sa forme « définitive » présentée ci-dessous est essentiellement due à Hörmander [Hör79], a été bâtie au fil des contributions de Kohn et Nirenberg [KN65], de Hörmander [Hör67] ainsi que de Beals et Fefferman [BF73, BF74, Bea75] et Dencker [Den86]. On va considérer les classes de symboles $S(m, g)$ (voir le livre de Hörmander [Hör85, Chapitre XVIII] ou celui de Lerner [Ler10]), qui généralisent les classes de symboles semi-classiques (1.1.28) ou microlocales (1.1.29) évoquées dans le paragraphe 1.1.4. Notre objectif est de montrer que la dynamique quantique $(e^{t\mathcal{H}_p})_{t \in \mathbf{R}}$ s'étend à de telles classes de symboles et de décrire son action sur ces classes générales à partir de la dynamique classique $(e^{tH_p})_{t \in \mathbf{R}}$. L'objet central du calcul de Weyl–Hörmander est une métrique riemannienne g sur T^*M , qui permet de mesurer les dérivées successives des observables classiques sur l'espace des phases.

Définition 1.4.1 (Classes de symboles de Weyl–Hörmander). Soit g une métrique riemannienne sur T^*M et $m : T^*M \rightarrow \mathbf{R}_+^*$ une fonction strictement positive. La classe de symboles $S(m, g)$ est l'espace vectoriel de fonctions $a : T^*M \rightarrow \mathbf{C}$ de classe C^∞ telles que

$$\forall j \in \mathbf{N}, \exists C_j > 0 : \quad |\nabla^j a|_g \leq C_j m \quad \text{sur } T^*M.$$

La famille dénombrable de semi-normes

$$|a|_{S(m,g)}^{(\ell)} = \max_{0 \leq j \leq \ell} \sup_{\rho \in T^*M} \frac{|\nabla^j a|_g(\rho)}{m(\rho)}, \quad \ell \in \mathbf{N},$$

munit $S(m, g)$ d'une structure d'espace de Fréchet.

Dans cette définition, on a noté $|\nabla^j a|_g(\rho)$ la norme du tenseur symétrique $\nabla^j a$ au point ρ par rapport à la métrique g , définie par

$$|\nabla^j a|_g(\rho) = \sup_{|X_k|_g(\rho) \leq 1} |\nabla^j a.(X_1, X_2, \dots, X_j)|,$$

où le supremum porte sur les champs de vecteurs de norme plus petite que 1 en ρ . On donne deux exemples importants de classes de symboles.

Exemple 1.4.2. Les classes de symboles semi-classiques et microlocales évoquées dans le paragraphe 1.1.4 sont de la forme $S(1, g)$ pour les métriques suivantes.

- Si l'on se donne $dx^2 + d\xi^2$ une certaine métrique euclidienne sur T^*M , alors la classe $S(1, g_h)$ avec $g_h = dx^2 + h^2 d\xi^2$, $h \in]0, 1]$, coïncide avec la classe de symboles semi-classique $S_{\text{scl}}(1)$ définie en (1.1.28).
- Si l'on pose $g = dx^2 + \langle \xi \rangle^{-2} d\xi^2$, alors la classe $S(1, g)$ coïncide avec la classe de symboles microlocale $S_{1,0}^0$ définie en (1.1.29).

Pour avoir un calcul pseudo-différentiel avec de bonnes propriétés dans ces classes de symboles, on a besoin de quelques hypothèses techniques sur la métrique g et le poids m . Pour alléger la présentation, on ne donne pas ici la définition exacte de métrique et de poids admissibles. On mentionne simplement que g et m doivent être à variation lente (ils doivent rester du même ordre de grandeur dans les boules unité de g) et tempérées (leur croissance à l'infini est au plus polynomiale). L'hypothèse la plus importante que g doit satisfaire est le principe d'incertitude, c'est-à-dire que « sa fonction de gain » h_g doit être plus petite que 1. Pour définir cette fonction de gain, on définit tout d'abord la métrique σ -duale associée à g .

Etant donnée une métrique riemannienne g sur T^*M , on peut la voir alternativement comme un 2-tenseur bilinéaire symétrique ou comme un champ d'applications linéaires inversibles :

$$g_\rho : T_\rho T^*M \longrightarrow T_\rho^* T^*M, \quad \rho \in T^*M.$$

Ainsi on peut voir g^{-1} comme un 2-tenseur prenant en argument des 1-formes (plutôt que des champs de vecteurs).¹⁰ On définit alors la métrique σ -duale associée à g comme

$$g^\sigma = -\sigma g^{-1} \sigma \tag{1.4.11}$$

(on rappelle que la forme symplectique σ a été introduite au paragraphe 1.1.5.1). C'est une métrique riemannienne sur T^*M . On peut alors introduire la définition suivante.

Définition 1.4.3 (Fonction de gain). Soit g une métrique riemannienne sur T^*M . On définit la fonction de gain associée à g par

$$h_g(\rho) := \sup_{\zeta \in W \setminus \{0\}} \frac{|\zeta|_g(\rho)}{|\zeta|_{g^\sigma}(\rho)}.$$

On définit le gain maximal de g par $\underline{h}_g := \sup_{T^*M} h_g$. On dit que g satisfait le principe d'incertitude si $h_g \leq 1$, ou de façon équivalente, si $g \leq g^\sigma$.

Pour les métriques de l'exemple 1.4.2, la fonction de gain se calcule de la façon suivante.

- Pour la métrique $g_h = dx^2 + h^2 d\xi^2$, on a $g_h^\sigma = h^{-2} dx^2 + d\xi^2$ et donc $h_{g_h} = h$ est constante sur T^*M . On a alors $\underline{h}_{g_h} = h$.
- Pour la métrique $g = dx^2 + \langle \xi \rangle^{-2} d\xi^2$, on a $g^\sigma = \langle \xi \rangle^2 dx^2 + d\xi^2$ et donc $h_g(x, \xi) = \langle \xi \rangle^{-1}$ pour tout $(x, \xi) \in T^*M$. Dans ce cas, on remarque que le gain maximal vaut $\underline{h}_g = 1$.

¹⁰En géométrie riemannienne, les applications g et g^{-1} sont souvent appelées les isomorphismes musicaux [Lee09, Section 12.8].

On aura également besoin d'une autre fonction associée à g , qui n'est pas définie de façon intrinsèque mais permet de quantifier la propriété de tempérance de la métrique, c'est-à-dire la potentielle explosion de la métrique à l'infini dans l'espace des phases.

Définition 1.4.4 (Poids de tempérance). On définit le poids de tempérance associé à g par

$$\theta_g(\rho) := \sup_{\zeta \in T_\rho T^*M \setminus \{0\}} \frac{|\zeta|_{g^\sigma}(\rho)}{|\zeta|_{\mathbf{g}}(\rho)} = \sup_{\zeta \in T_\rho T^*M \setminus \{0\}} \frac{|\zeta|_{\mathbf{g}^\sigma}(\rho)}{|\zeta|_g(\rho)},$$

où \mathbf{g} est une métrique euclidienne fixée telle que $\mathbf{g} = \mathbf{g}^\sigma$.

Les résultats présentés ci-dessous sont valables sous deux hypothèses principales. La première assure que les dynamiques classique et quantique ont un sens, et ne dépend que du hamiltonien p .

Hypothèse 1.4.5. *Le hamiltonien classique $p \in \mathcal{S}'(T^*M)$ est de classe C^∞ et*

- (i) *le flot hamiltonien $(\phi^t)_{t \in \mathbf{R}}$ est complet;*
- (ii) *l'opérateur $\text{Op}^w(p)$ avec domaine $\mathcal{S}(M)$ est essentiellement auto-adjoint sur $L^2(M)$. On note P son unique extension auto-adjointe.*

La deuxième hypothèse est spécifique au théorème d'Egorov, et consiste en une condition de compatibilité du hamiltonien classique p et de la métrique g . On donnera au paragraphe 1.4.4 ci-dessous des exemples dans lesquels les hypothèses 1.4.5 et 1.4.6 sont vérifiées et notre résultat principal (le théorème 1.4.7) s'applique.

Hypothèse 1.4.6. *La métrique g sur T^*M est admissible et le couple (p, g) satisfait les conditions suivantes.*

- (i) *(Expansion du flot :) L'exposant de Lyapunov suivant est fini :*

$$\Lambda := \frac{1}{2} \sup_{T^*M} |\mathcal{L}_{H_p} g|_g < \infty.$$

Ici, \mathcal{L}_{H_p} désigne la dérivée de Lie par rapport au champ de vecteurs hamiltonien.

- (ii) *(Sous-quadraticité forte :) Il existe $\epsilon \in]0, 1/2]$ tel que*

$$\nabla^3 p \in S \left((\theta_g \underline{h}_g^{1/2})^{-\epsilon} (h_g / \underline{h}_g)^{-3}, g \right) \cap S \left((h_g / \underline{h}_g)^{-1}, g \right).$$

- (iii) *(Contrôle de la métrique le long du flot :) Il existe $\Upsilon \geq 0$ et $C_\Upsilon > 0$ tels que*

$$\forall \rho \in T^*M, \forall t \in \mathbf{R}, \quad g_{\phi^t(\rho)} \leq C_\Upsilon^2 e^{2\Upsilon|t|} g_\rho.$$

Pour énoncer notre résultat principal, on introduit maintenant la métrique

$$g(t) := e^{2(\Lambda+2\Upsilon)|t|} g, \quad t \in \mathbf{R}, \tag{1.4.12}$$

et le temps d'Ehrenfest associé

$$T_E = T_E(p, g) := \frac{1/2}{\Lambda + 2\Upsilon} \log \left(\frac{1}{\underline{h}_g} \right). \tag{1.4.13}$$

On remarque que

$$h_{g(t)} = e^{2(\Lambda+2\Upsilon)|t|} h_g, \tag{1.4.14}$$

de sorte que T_E apparait comme le temps limite jusqu'auquel la métrique $g(t)$ satisfait le principe d'incertitude $h_{g(t)} \leq 1$.

Notre résultat principal est le suivant.

Théorème 1.4.7. *Soit p et g satisfaisant les hypothèses 1.4.5 et 1.4.6 et soit $T \in [0, \frac{1}{6}T_E]$. Soit m un poids admissible tel que $m(t) = e^{tH_p} m$ soit uniformément admissible¹¹ sur l'intervalle de temps $[0, T]$. Alors pour tout $a \in S(m, g)$, l'opérateur $\text{Op}^w(a)$ conjugué par le propagateur s'écrit*

$$e^{itP} \text{Op}^w(a) e^{-itP} = \text{Op}^w \left(e^{t\mathcal{H}_p} a \right),$$

¹¹On renvoie au chapitre 4 pour des explications sur l'uniforme admissibilité du poids $m(t)$.

où $e^{t\mathcal{H}_p}a \in S(m(t), g(t))$. Pour tout $\ell \in \mathbf{N}$, il existe $k \in \mathbf{N}$ et une constante $C_\ell > 0$ tels que

$$\forall a \in S(m, g), \forall t \in [-T, T], \quad \left| e^{t\mathcal{H}_p}a \right|_{S(m(t), g(t))}^{(\ell)} \leq C_\ell |a|_{S(m, g)}^{(k)}.$$

De plus, pour tout $j_0 \in \mathbf{N}$, on a le développement asymptotique

$$e^{t\mathcal{H}_p}a \sim e^{tH_p}a + \sum_{j=1}^{j_0} \mathcal{E}_j(t)a + \widehat{\mathcal{E}}_{j_0+1}(t)a, \quad (1.4.15)$$

où $\mathcal{E}_j(t)$ et $\widehat{\mathcal{E}}_j(t)$ sont définis en (1.4.8) et (1.4.9) et vérifient : pour tout $\ell \in \mathbf{N}$, il existe des entiers $(k_{j_0, \ell})_{j_0 \in \mathbf{N}}$ et des constantes $(C_{j_0, \ell})_{j_0 \in \mathbf{N}}$, $(C'_{j_0, \ell})_{j_0 \in \mathbf{N}}$ tels que pour tout $a \in S(m, g)$ et tout $t \in [-T, T]$, on ait

$$\left\{ \begin{array}{l} |e^{tH_p}a|_{S(m(t), g(t))}^{(\ell)} \leq C_{0, \ell} |a|_{S(m, g)}^{(k)}, \\ |\mathcal{E}_{j_0}(t)a|_{S(h_{g(t)}^{2j_0} m(t), g(t))}^{(\ell)} \leq C'_{j_0, \ell} |\nabla a|_{S(m, g)}^{(k)}, \\ |\widehat{\mathcal{E}}_j(t)a|_{S(h_{g(t)}^{2(j_0+1)} m(t), g(t))}^{(\ell)} \leq C'_{j_0+1, \ell} |\nabla a|_{S(m, g)}^{(k)}, \end{array} \right. \quad \begin{array}{l} \\ j_0 \geq 1 \\ j_0 \geq 1. \end{array} \quad \begin{array}{l} (1.4.16) \\ (1.4.17) \\ (1.4.18) \end{array}$$

Les estimées (1.4.16), (1.4.17) et (1.4.18) donnent un sens précis à l'identité (1.4.7). On a bien un développement asymptotique puisque chaque terme gagne $h_{g(t)}^2$ (le fait qu'on gagne deux puissances de la fonction de gain au lieu d'une à chaque étape du développement est lié au fait que l'on utilise la quantification de Weyl).

Remarque 1.4.8 (Cas $\underline{h}_g = 1$). On observe que dans le cas d'une métrique g avec gain maximal $\underline{h}_g = 1$ (e.g. la métrique $g = dx^2 + \langle \xi \rangle^{-2} d\xi^2$ de l'exemple 1.4.2), on a $T_E(g) = 0$. Pour remédier à ce problème et pouvoir appliquer le théorème 1.4.7 dans un intervalle de temps $[-T_0, T_0]$ non trivial, on peut considérer la métrique $e^{-T_0}g$ pour $T_0 > 0$ à la place de g , et on a alors $T_E(e^{-T_0}g) = T_E(g) + \frac{1/2}{\Lambda + 2\Upsilon} T_0$. Si la multiplication de la métrique par e^{-T_0} ne change pas Λ et Υ (ces quantités sont homogènes de degré 0 par rapport à g), elle augmente en revanche la valeur des semi-normes de p (et donc les constantes dans (1.4.16), (1.4.17) et (1.4.18) dépendent de T_0). Ce n'est pas un problème tant que l'on ne cherche pas à faire tendre T_0 vers l'infini.

La théorie des opérateurs intégraux de Fourier, dont les propagateurs e^{-itP} sont des exemples paradigmatiques, a déjà fait l'objet de travaux dans le formalisme de Weyl–Hörmander, comme ceux de Beals [Bea74] et de Hörmander [Hör79], qui s'inscrivent plutôt dans la continuité de l'article d'Egorov sur la quantification des symplectomorphismes. Concernant les propagateurs et les problèmes d'évolution, on mentionne la série d'articles de Bony [Bon94, Bon96, Bon97, Bon03, Bon07, Bon09]. L'approche de ces travaux est relativement algébrique et semble difficile à appliquer dans des situations concrètes pour étudier des problèmes de contrôle d'équations aux dérivées partielles par exemple. Notre résultat est conçu spécialement pour ce type d'applications, et fournit des estimées précises qui ouvrent la voie à une étude quantitative de la correspondance classique-quantique.

Le théorème 1.4.7 ci-dessus est valable dans une grande généralité, et peut s'appliquer dans beaucoup de contextes différents comme nous allons l'illustrer dans les exemples du paragraphe 1.4.4 ci-dessous. Commentons d'abord les principaux atouts de ce résultat.

- Par un argument de type Grönwall, on peut vérifier que par définition de Λ , on a

$$(\phi^t)^*g \leq e^{2\Lambda|t|}g, \quad \forall t \in \mathbf{R}$$

(le membre de gauche est la métrique g tirée en arrière par le flot), ce qui équivaut en fait à

$$|d\phi^t|_g \leq e^{\Lambda|t|}, \quad \forall t \in \mathbf{R}.$$

Pour estimer grossièrement Λ , on peut vérifier que par définition de la dérivée de Lie,

$$\Lambda \leq \sup_{T^*M} \left(h_g |\nabla^2 p|_g + \frac{1}{2} |\nabla_{H_p} g|_g \right). \quad (1.4.19)$$

On constate alors que l'hypothèse (i) de finitude de l'exposant de Lyapunov est liée au fait de contrôler la hessienne du hamiltonien p , ce que l'on interprète comme de la « sous-quadraticité ». Demander que le hamiltonien soit sous-quadratique est usuel dans l'étude de propriétés d'Egorov (voir par exemple Bouzouina–Robert [BR02] ou Robert [Rob87, Théorème (IV-10)]). C'est cette hypothèse qui permet de formuler un résultat global dans l'espace des phases, qui traite donc l'infini, sans nécessité de tronquer le hamiltonien au voisinage d'une couche d'énergie particulière. Par ailleurs, on ne fait pas d'hypothèse d'ellipticité sur le hamiltonien, ce qui permet de considérer des opérateurs un peu plus exotiques tels que des laplaciens magnétiques ou des champs de vecteurs.

- L'hypothèse (ii) de sous-quadraticité forte permet de donner un sens précis à l'assertion « $\mathcal{H}_p^{(3)}$ est petit » en tant qu'opérateur agissant sur des classes de symboles. L'hypothèse $\nabla^3 p \in S((h_g/\underline{h}_g)^{-1}, g)$ permet en particulier d'obtenir le développement asymptotique (1.4.15) en puissances de $h_{g(t)}^2$, en plus d'un contrôle des dérivées du flot hamiltonien.
- Les conditions de l'hypothèse 1.4.6 sont homogènes de degré 0 par rapport à la métrique g , c'est-à-dire que si elles sont vérifiées pour g , elles le sont aussi pour $g(t)$ (du moment que $|t| \leq T_E$). C'est pour avoir cette propriété que l'on considère le poids h_g/\underline{h}_g au lieu de h_g seul dans la condition de sous-quadraticité forte par exemple.
- Le théorème 1.4.7 s'applique dans un cadre semi-classique : si l'on considère une suite $(g_{\hbar}, p_{\hbar})_{\hbar \in]0,1]}$ dépendant de \hbar et satisfaisant l'hypothèse 1.4.6 (en particulier la condition de sous-quadraticité forte (ii)) uniformément en \hbar , avec fonction de gain $h_{g_{\hbar}} = \hbar$, alors les estimées du théorème sont vraies uniformément en $\hbar \in]0,1]$. Notons que dans ce cas, il convient de se placer dans une échelle de temps semi-classique en considérant l'évolution $e^{-itP_{\hbar}} = e^{-i\frac{\tau}{\hbar}P_{\hbar}}$ après avoir posé $\tau = \hbar t$. On retrouve alors dans ce contexte un temps d'Ehrenfest d'ordre $\log \hbar^{-1}$. On renvoie au paragraphe 1.4.4.1 pour plus de détails sur un exemple d'application du théorème 1.4.7 dans un cadre semi-classique.
- La définition de la métrique $g(t)$ en (1.4.12), et donc celle du temps d'Ehrenfest (1.4.13), font intervenir $\Lambda + 2\Upsilon$ et non Λ comme on aurait pu s'y attendre. Le paramètre Υ apparaît pour des raisons techniques liées à l'utilisation du poids de tempérance θ_g dans l'hypothèse de sous-quadraticité forte (ii). Cependant en pratique, on aura souvent $\Upsilon = 0$ (voir les deux premiers exemples présentés dans le paragraphe 1.4.4).

Pour terminer ces commentaires, mentionnons que le théorème 1.4.7 découle d'un résultat plus fort sur la propagation de partitions de l'unité quantiques adaptées à la métrique g . C'est en fait le résultat qui nous intéresse le plus pour l'étude de la stabilité uniforme des ondes (en vue de la conjecture 1.2.9 mentionnée au paragraphe 1.2). Cependant, nous avons choisi de ne pas présenter ce résultat dans cette introduction pour des raisons de concision. On renvoie donc au chapitre 4 pour des définitions et un énoncé précis. On discute de quelques perspectives d'applications de ce résultat plus fin dans le paragraphe 1.4.6.

1.4.4. Exemples d'application

On donne trois contextes dans lesquels le théorème 1.4.7 s'applique. Dans chacune de ces trois situations, on fournit des exemples de métriques pertinentes pour étudier les groupes d'évolution considérés, et on explique les liens avec les travaux présentés dans les paragraphes 1.2 et 1.3. Notons que l'espace de Hilbert naturel dans lequel les problèmes suivants sont posés ne coïncide pas toujours avec $L^2(M)$. On expliquera alors comment se ramener à notre cadre d'étude.

1.4.4.1. Opérateur de Schrödinger dans l'espace euclidien plat

On munit $M = \mathbf{R}^d$ d'une structure euclidienne γ fixée (i.e. invariante par translation). Considérons un opérateur de Schrödinger avec laplacien plat et potentiels électrique et magnétique $V : M \rightarrow \mathbf{R}$ et $\beta : M \rightarrow TM$:

$$P = P_{\hbar} = \frac{1}{2} \left| \frac{\hbar}{i} \partial - \beta \right|_{\gamma}^2 + V = -\frac{\hbar^2}{2} \Delta - \frac{1}{i} \beta \cdot \partial - \frac{\hbar}{2i} \operatorname{div} \beta + \frac{1}{2} |\beta|_{\gamma}^2 + V, \quad (1.4.20)$$

agissant sur l'espace de Schwartz, avec un paramètre semi-classique $\hbar \in (0,1]$. Ici $\Delta = \Delta_{\gamma}$ est le laplacien plat associé à γ .

Proposition 1.4.9. *Lorsque V et β ont une croissance tempérée, on a*

$$P = \text{Op}^w(p) \quad \text{avec} \quad p(x, \xi) = \frac{\hbar^2}{2} |\xi|_{\gamma^{-1}}^2 - \hbar \xi \cdot \beta + \frac{1}{2} |\beta|_{\gamma}^2 + V(x). \quad (1.4.21)$$

De plus, supposons que

- Le potentiel vecteur $\beta : M \rightarrow TM$ est un champ de vecteurs affine, à savoir $\nabla^2 \beta = 0$.
- Le potentiel électrique $V : M \rightarrow \mathbf{R}$ est borné inférieurement et sous-quadratique, au sens où

$$\forall k \geq 0, \quad \sup_{T^*M} |\nabla^{2+k} V|_{\gamma} < \infty.$$

Alors les Hypothèses 1.4.5 et 1.4.6 sont satisfaites avec la métrique

$$g = g_{\hbar} = \gamma \oplus \hbar^2 \gamma^{-1}, \quad (1.4.22)$$

uniformément par rapport à $\hbar \in (0, 1]$.

L'uniformité par rapport à \hbar dans la conclusion de la proposition 1.4.9 permet d'utiliser le théorème 1.4.7 dans un cadre semi-classique $\hbar \rightarrow 0$. En effet, dans le cadre de la proposition 1.4.9, l'exposant de Lyapunov est d'ordre $\Lambda = \Lambda_{\hbar} \approx \hbar$ (et $\Upsilon = 0$), ce qui donne un temps d'Ehrenfest $T_E \approx \hbar^{-1} \log \hbar^{-1}$. Dans la variable de temps semi-classique $\tau = \hbar t$, ceci revient donc à considérer des temps $|\tau| = O(\log \hbar^{-1})$, ce qui correspond bien au temps d'Ehrenfest usuel dans le contexte de l'opérateur semi-classique (1.4.20) (voir [BR02]). A titre d'illustration, le théorème 1.3.2 donne le résultat suivant : pour tout $a \in S(1, g_{\hbar})$, on a

$$e^{i\frac{\tau}{\hbar} P} \text{Op}^w(a) e^{-i\frac{\tau}{\hbar} P} = \text{Op}^w(a(\tau)), \quad (1.4.23)$$

où $a(\tau)$ appartient à un sous-ensemble borné de $S(1, \bar{g}_{\hbar}(\tau))$ pour $|\tau| \leq \varepsilon \log \hbar^{-1}$ pour un certain $\varepsilon > 0$, avec $\bar{g}_{\hbar}(\tau) = e^{2\frac{\Lambda}{\hbar} \tau} g_{\hbar}$ (on rappelle que Λ est d'ordre \hbar dans cet exemple). On a également le développement asymptotique (1.4.15) avec les estimées (1.4.16), (1.4.17) et (1.4.18) uniformes par rapport à \hbar et τ satisfaisant la condition $|\tau| \leq \varepsilon \log \hbar^{-1}$. Noter qu'avec $\hbar = 1$, on retrouve la version du théorème d'Egorov utilisée dans le chapitre 3 pour l'observabilité de l'équation de Schrödinger.

La déclinaison du théorème 1.4.7 que l'on obtient dans ce contexte permet de retrouver les résultats de Bouzouina et Robert [BR02] (voir également Robert [Rob87, Theorem (IV-10)]). Dans ces travaux, on retrouve l'hypothèse de sous-quadraticité du hamiltonien classique (i.e. les dérivées d'ordre plus grand que 2 sont bornées), que l'on utilise dans la preuve de la proposition 1.4.9 pour vérifier la condition (i) de l'hypothèse 1.4.6, à savoir $\Lambda < \infty$. Par ailleurs, l'énoncé [BR02, Theorem 1.2 (11)] s'applique à des symboles a tels que $\nabla a \in S(1, g_{\hbar})$. Notre théorème généralise ce résultat à des classes de symboles associées à des poids m généraux. Enfin, le théorème 1.4.7 fournit non seulement un développement asymptotique en puissances de \hbar de l'opérateur conjugué dans le membre de gauche de (1.4.23), mais montre aussi que cet opérateur est pseudo-différentiel, avec des estimées précises sur son symbole.

La métrique g introduite en (1.4.22) semble être celle qui détecte l'échelle de concentration maximale en la variable x . Pour voir cela, on peut raisonner de la façon suivante, disons dans le cadre non semi-classique $\hbar = 1$ pour simplifier. Un moyen simple de vérifier qu'une métrique \tilde{g} vérifie l'hypothèse 1.4.6, et en particulier l'hypothèse $\Lambda < \infty$, consiste à montrer que $|\nabla^2 p|_{\tilde{g}}$ est bornée sur T^*M (en vertu de (1.4.19)). Si l'on cherche \tilde{g} sous la forme

$$\tilde{g} = \frac{dx^2}{\Phi^2} + \frac{d\xi^2}{\Psi^2}, \quad (1.4.24)$$

avec Φ, Ψ deux fonctions sur T^*M , le fait que $(\nabla^2 p)_{\xi\xi} = \gamma^{-1}$ soit constante sur l'espace des phases impose alors que le coefficient de \tilde{g} dans la direction ξ , à savoir Ψ^{-1} , doit être borné inférieurement, i.e. $\Psi \leq C$ uniformément sur T^*M . Pour que le principe d'incertitude soit vérifié, c'est-à-dire $h_{\tilde{g}} = \Phi^{-1} \Psi^{-1} \leq 1$, on doit donc avoir $\Phi \geq C^{-1}$. Cet argument indique qu'il semble difficile de construire des métriques \tilde{g} vérifiant l'hypothèse 1.4.6 détectant des échelles plus petites que 1 en espace. C'est une conséquence du fait que le laplacien dans l'opérateur de Schrödinger $P = V(x) - \frac{1}{2} \Delta$ sature la sous-quadraticité dans la variable ξ . Voir la Figure 1.7 pour une illustration des boîtes unités de la métrique g définie en (1.4.22) dans l'espace des phases (pour $\hbar = 1$).

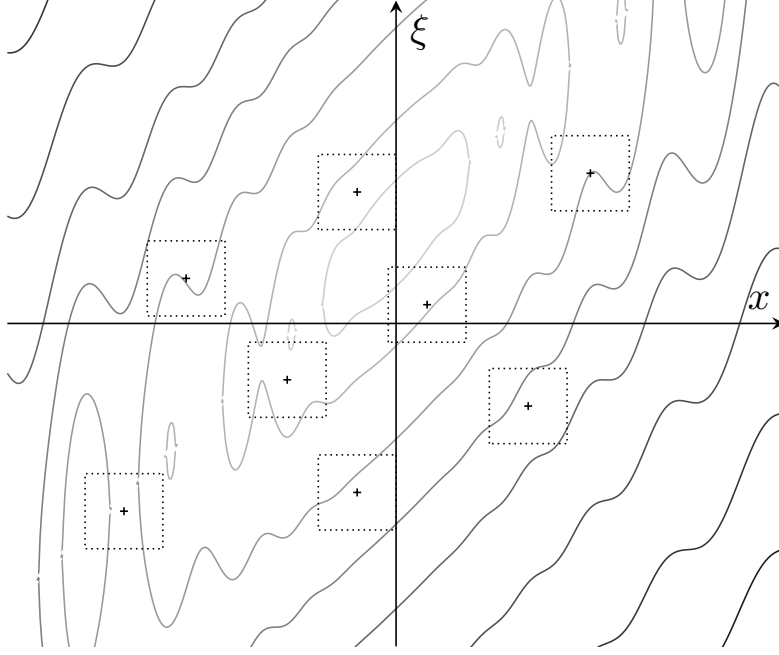

FIG. 1.7 – Ensembles de niveau du hamiltonien classique p défini en dimension 1 par (1.4.21), avec V donné par la Figure 1.1a et $\nabla\beta$ constant. On a tracé en pointillés les boîtes de la métrique introduite en (1.4.22) $g_1 = \gamma \oplus \gamma^{-1}$ (i.e. les produits de boules unité de γ et de γ^{-1}). Ce sont des carrés de côté ≈ 1 , saturant ainsi le principe d'incertitude $h_{g_1} \leq 1$.

1.4.4.2. Opérateur de demi-ondes dans un espace courbe

Comme on l'a expliqué dans l'exemple du paragraphe 1.4.4.1 ci-dessus, le fait que le laplacien soit parfaitement plat est important si l'on veut que le théorème d'Egorov soit valide pour l'opérateur de Schrödinger (1.4.20). On va voir que la situation est très différente pour l'opérateur des ondes.

On considère une métrique riemannienne γ sur M . On suppose qu'elle satisfait

$$\exists C_\gamma > 0 : \forall x_1, x_2 \in M, \quad \gamma_{x_1} \leq C_\gamma^2 \gamma_{x_2} \quad \text{et} \quad \forall k \in \mathbf{N}, \quad \sup_M |\nabla^k \gamma|_\gamma < \infty. \quad (1.4.25)$$

(Noter que (1.4.25) est équivalent à l'existence d'une constante $c > 0$ telle que $c^{-2}I \leq \gamma \leq c^2I$ et $\gamma \in C_b^\infty(M)$.) On ne prescrit pas ici de comportement spécifique à l'infini.

La variété riemannienne (M, γ) possède une forme volume naturelle Vol_γ , ainsi qu'un opérateur de Laplace–Beltrami Δ_γ agissant sur les fonctions test. On le voit comme un opérateur symétrique non borné sur l'espace de Hilbert $L^2(M, d\text{Vol}_\gamma)$. En fixant des coordonnées euclidiennes sur M , celui-ci s'écrit

$$\Delta_\gamma = |\gamma|^{-1/2} \partial_j \gamma^{ij} |\gamma|^{1/2} \partial_i, \quad \text{avec} \quad d\text{Vol}_\gamma = |\gamma|^{1/2} dx.$$

A titre préliminaire, on conjugue Δ_γ à un opérateur symétrique sur $L^2(M, dx)$, où dx est une normalisation arbitraire de la mesure de Lebesgue (cet espace est mieux adapté à la quantification de Weyl). On identifie les éléments $v \in L^2(M, d\text{Vol}_\gamma)$ aux fonctions $u \in L^2(M)$ via l'isométrie

$$\begin{aligned} L^2(M, d\text{Vol}_\gamma) &\longrightarrow L^2(M) \\ v &\longmapsto v|\gamma|^{1/4} = u. \end{aligned} \quad (1.4.26)$$

L'opérateur de Laplace–Beltrami se retrouve conjugué à

$$\tilde{\Delta}_\gamma = |\gamma|^{1/4} \Delta_\gamma |\gamma|^{-1/4} = |\gamma|^{-1/4} \partial_j \gamma^{ij} |\gamma|^{1/2} \partial_i |\gamma|^{-1/4}, \quad (1.4.27)$$

qui est symétrique par rapport au produit scalaire de $L^2(M)$.

On peut calculer le symbole de Weyl de l'opérateur $-\tilde{\Delta}_\gamma$ (cf. le chapitre 4 pour une expression explicite) : il existe $R_\gamma \in C_b^\infty(T^*M)$ tel que

$$-\tilde{\Delta}_\gamma = \text{Op}^w \left(|\xi|_{\gamma^{-1}}^2 + R_\gamma \right). \quad (1.4.28)$$

La factorisation formelle

$$\partial_t^2 - \Delta_\gamma = \left(\partial_t - i\sqrt{-\Delta_\gamma} \right) \left(\partial_t + i\sqrt{-\Delta_\gamma} \right)$$

réduit l'étude de l'équation des ondes dans ce contexte aux équations d'évolution

$$\left(\partial_t \pm i\sqrt{-\Delta_\gamma} \right) v_\pm = 0,$$

qui après conjugaison (1.4.26) deviennent

$$\left(\partial_t \pm i\sqrt{-\tilde{\Delta}_\gamma} \right) u_\pm = 0.$$

Étant donné (1.4.28), l'opérateur $\text{Op}^w(\langle \xi \rangle_{\gamma^{-1}})$ est une bonne approximation de $\sqrt{-\tilde{\Delta}_\gamma}$, et le symbole $\langle \xi \rangle_{\gamma^{-1}}$ a l'avantage d'être C^∞ sur l'espace des phases. On considère ainsi l'opérateur

$$P := \text{Op}^w(p) \quad \text{avec} \quad p(x, \xi) := \langle \xi \rangle_{\gamma_x^{-1}}. \quad (1.4.29)$$

Proposition 1.4.10. *Sous les hypothèses (1.4.25) sur la métrique γ , le symbole p défini dans (1.4.29) satisfait les Hypothèses 1.4.5 et 1.4.6 pour la famille de métriques admissibles*

$$g_{(x, \xi)} = \langle \xi \rangle_{\gamma_x^{-1}}^{1-\alpha} \gamma_x \oplus \langle \xi \rangle_{\gamma_x^{-1}}^{-(1+\alpha)} \gamma_x^{-1} = \frac{1}{p^\alpha} (p\gamma_x \oplus p^{-1}\gamma_x^{-1}), \quad \alpha \in [0, 1]. \quad (1.4.30)$$

Le théorème 1.3.2 s'applique donc pour ces métriques et fournit à titre d'illustration l'énoncé suivant : étant donné $\alpha \in [0, 1]$ fixé, pour tout $a \in S(\langle \xi \rangle^n, g)$ ($n \in \mathbf{R}$), on a

$$e^{itP} \text{Op}^w(a) e^{-itP} = \text{Op}^w(a(t)),$$

où la famille de symboles $a(t)$ est contenue dans un sous-ensemble borné de $S(\langle \xi \rangle^n, g)$ pour tout $t \in [-T, T]$ avec $T > 0$ fixé. On retrouve le résultat énoncé par Taylor [Tay91, Section 6, Proposition 6.3.B]) dans les classes de symboles

$$S_{\rho, \delta}^n(\mathbf{R}^{2d}) := \left\{ a \in C^\infty(\mathbf{R}^{2d}) : \forall \beta_1, \beta_2 \in \mathbf{N}^d, \exists C_{\beta_1, \beta_2} > 0 : \left| \partial_x^{\beta_2} \partial_\xi^{\beta_1} a(x, \xi) \right| \leq C_{\beta_1, \beta_2} \langle \xi \rangle^{n - \rho|\beta_1| + \delta|\beta_2|} \right\}.$$

Notre résultat clarifie la condition d'admissibilité $\rho = 1 - \delta > 1/2$ sous laquelle [Tay91, Section 6, Proposition 6.3.B] s'applique (on peut même traiter le cas $\rho = 1 - \delta = 1/2$, à savoir $\alpha = 0$ dans la proposition 1.4.10, pour lequel on n'a pas de gain). Il fournit également un développement asymptotique explicite de $a(t, \bullet)$.

Les cas extrémaux $\alpha = 1$ et $\alpha = 0$ sont d'un intérêt particulier.

- La métrique g pour $\alpha = 1$:

$$g = \gamma \oplus \frac{1}{\langle \xi \rangle_{\gamma^{-1}}^2} \gamma^{-1}$$

est la plus commune en analyse microlocale et la plus naturelle à introduire sur l'espace des phases lorsqu'on étudie l'équation des ondes. Elle correspond à « l'échelle microlocale principale », i.e. à des symboles dans des classes de la forme $S_{1,0}^m(\mathbf{R}^{2d})$ (cf. (1.1.29) ou [Tay91]). Voir la Figure 1.8a.

- Le cas $\alpha = 0$, i.e.

$$g = \langle \xi \rangle_{\gamma^{-1}} \gamma \oplus \frac{1}{\langle \xi \rangle_{\gamma^{-1}}} \gamma^{-1}$$

correspond à une *seconde échelle microlocale* de propagation des ondes, qui apparaît déjà de façon implicite dans plusieurs travaux liés à l'équation des ondes (amorties), surtout dans le cadre semi-classique, dans des arguments impliquant des mesures de défaut [BZ16, BG20, Rou23]. Voir la Figure 1.8b.

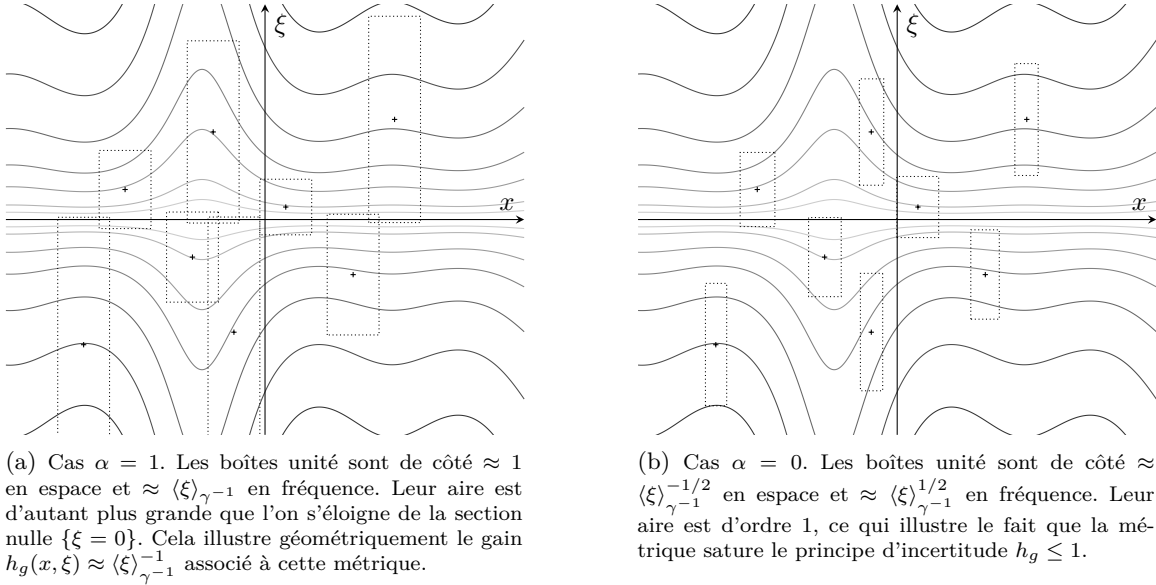

FIG. 1.8 – On a tracé quelques lignes de niveau du hamiltonien $p(x, \xi) = \langle \xi \rangle_{\gamma-1}$. Les boîtes unité associées à la métrique g définie en (1.4.30) sont représentées en pointillés. Elles correspondent au produit des boules unité de γ_1 et γ_2 associées à la décomposition $g = \gamma_1 \oplus \gamma_2$ dans (1.4.30).

Comparons la proposition 1.4.10 à la proposition 1.4.9 du paragraphe précédent. On remarque deux différences principales. La première est que le cadre géométrique de la proposition 1.4.10 est plus flexible : on peut considérer une géométrie avec de la courbure, contrairement au cas de la proposition 1.4.9 où nous sommes limités au laplacien plat (associé à une structure euclidienne sur M). La deuxième est que la proposition 1.4.10 introduit une famille de métriques qui vérifient les Hypothèses 1.4.5 et 1.4.6 et encodent des échelles différentes de propagation de l'énergie. Cela contraste avec la proposition 1.4.9 qui paraît plus rigide et nous impose de considérer une métrique constante sur tout l'espace des phases. On peut attribuer ces différences au fait que l'équation de Schrödinger propage l'énergie à vitesse infinie, tandis que l'équation des ondes la propage à vitesse finie.

1.4.4.3. Champs de vecteurs

Notre dernière application concerne les opérateurs différentiels d'ordre 1, à savoir les champs de vecteurs. Ces opérateurs sont relativement différents de ceux étudiés aux paragraphes 1.4.4.1 et 1.4.4.2, notamment parce qu'ils ne sont pas semi-bornés.

On considère un champ de vecteurs X sur M , borné par rapport à une métrique euclidienne fixée. On suppose qu'il préserve une densité lisse $\mu = |\mu| dx$, de sorte que l'opérateur de dérivation $\frac{1}{i}X$ agissant sur les fonctions lisses à support compact soit symétrique en tant qu'opérateur non borné sur $L^2(M, \mu)$ (on suppose que X et $|\mu|$ ne s'annulent pas). Pour se ramener à un cadre où nos résultats s'appliquent, on identifie à nouveau $L^2(M, \mu)$ à $L^2(M)$ via l'isométrie

$$\begin{aligned} L^2(M, \mu) &\longrightarrow L^2(M) \\ u &\longmapsto u|\mu|^{1/2}. \end{aligned}$$

L'opérateur $\frac{1}{i}X$ s'en trouve donc conjugué par $|\mu|^{1/2}$, de sorte que l'opérateur obtenu agissant sur $L^2(M)$ s'écrit

$$\frac{1}{i}|\mu|^{1/2}X|\mu|^{-1/2} = \frac{1}{i}X - \frac{1}{2i}(X \log |\mu|).$$

Un argument d'intégrations par parties permet de calculer la dérivée logarithmique, et on se ramène ainsi à l'étude sur $L^2(M)$ de l'opérateur

$$P = \frac{1}{i}X + \frac{1}{2i} \operatorname{div} X, \quad (1.4.31)$$

qui est bien symétrique sur $L^2(M)$. On va en fait considérer cet opérateur pour un champ de vecteurs X arbitraire (pouvant éventuellement s'annuler), sans introduire de densité invariante. Notre seule

hypothèse est que

$$\forall k \in \mathbf{N}, \quad \sup_M |\nabla^k X|_\gamma < \infty \quad (1.4.32)$$

pour une certaine métrique euclidienne γ sur M .

Proposition 1.4.11. *Sous l'hypothèse (1.4.32) sur X , on a*

$$P = \text{Op}^w(p) \quad \text{avec} \quad p(x, \xi) = \xi \cdot X(x),$$

et l'hypothèse 1.4.5 est satisfaite, ainsi que l'hypothèse 1.4.6 pour la métrique

$$g_{(x,\xi)} = \langle \xi \rangle_{\gamma^{-1}}^{2\alpha_1} \gamma \oplus \langle \xi \rangle_{\gamma^{-1}}^{-2\alpha_2} \gamma^{-1}, \quad (1.4.33)$$

où les paramètres α_1 et α_2 vérifient

$$0 \leq \alpha_1 \leq \alpha_2 \leq 1, \quad \alpha_1 + \alpha_2 \geq 1 \quad \text{and} \quad \alpha_1 < 1. \quad (1.4.34)$$

On peut comparer la proposition 1.4.11 avec un résultat récent sur les flots d'Anosov sur les variétés compactes. Bien que l'analyse des champs de vecteurs puisse sembler relever de la mécanique classique, les techniques microlocales se sont révélées très utiles dans ce domaine; voir par exemple [FS11, DZ16, FT23a, FT23b]. Récemment, Faure et Tsujii [FT23a, FT23b] ont introduit une famille de métriques sur l'espace des phases pour étudier la dynamique en temps long des flots d'Anosov. Ces métriques sont de la forme

$$g_{(x,\xi)} = \langle \xi \rangle^{2\alpha^\perp} dx_\perp^2 + \frac{1}{\langle \xi \rangle^{2\alpha^\perp}} d\xi_\perp^2 + \langle \xi \rangle^{2\alpha^\parallel} dx_\parallel^2 + \frac{1}{\langle \xi \rangle^{2\alpha^\parallel}} d\xi_\parallel^2, \quad (1.4.35)$$

en coordonnées (locales) « flot-boîte » : les variables de position et de moment sont séparées en deux composantes dites perpendiculaire et parallèle

$$x = (x_\perp, x_\parallel) \in \mathbf{R}^{d-1} \times \mathbf{R}, \quad \xi = (\xi_\perp, \xi_\parallel) \in \mathbf{R}^{d-1} \times \mathbf{R},$$

de sorte que le champ de vecteurs X s'écrive $-X = \partial_{x_\parallel}$. Les paramètres $\alpha_\perp, \alpha_\parallel$ satisfont

$$0 \leq \alpha^\parallel \leq \alpha^\perp < 1 \quad \text{et} \quad \frac{1}{2} \leq \alpha_\perp < 1.$$

Des choix particuliers de ces paramètres permettent à Faure et Tsujii de décrire le spectre de Ruelle du flot et d'analyser les états résonants associés. Dans notre résultat, on retrouve la métrique (1.4.35) en prenant $\alpha_1 = \alpha_2 = \alpha_\parallel = \alpha_\perp$.

1.4.5. Idée de preuve du théorème 1.4.7

Le cœur de la preuve consiste à décrire l'action sur les classes de symboles $S(m, g)$ de e^{tH_p} et $\mathcal{H}_p^{(3)}$ intervenant dans la définition des opérateurs $\mathcal{E}_j(t)$ et $\widehat{\mathcal{E}}_j(t)$ (définis en (1.4.8) et (1.4.9)) de la série de Dyson (1.4.7). D'une part, on montre que le flot hamiltonien e^{tH_p} agit continument sur les classes de symboles de la façon suivante :

$$e^{tH_p} : S(m, g) \longrightarrow S(m(t), g(t)), \quad (1.4.36)$$

où $m(t) = e^{tH_p} m$ et $g(t)$ est définie en (1.4.12). Les estimées de continuité portant sur les semi-normes dans ces espaces sont uniformes par rapport à $t \in \mathbf{R}$: pour tout symbole $a \in S(m, g)$, on a

$$\forall \ell \in \mathbf{N}, \exists C_\ell > 0 : \forall t \in \mathbf{R}, \forall \rho \in T^*M,$$

$$|\nabla^\ell e^{tH_p} a|_{g(t)}(\rho) = |\nabla^\ell e^{tH_p} a|_g(\rho) e^{-\ell(\Lambda+2\Upsilon)|t|} \leq C_\ell m(t; \rho) \max_{0 \leq j \leq \ell} \sup_{T^*M} \frac{|\nabla^j a|_g}{m}.$$

La continuité de l'opérateur e^{tH_p} en (1.4.36) est une façon synthétique de décrire la croissance exponentielle des dérivées du flot :

$$\forall k \in \mathbf{N}^*, \exists C_k > 0 : \quad |\nabla^k \phi^t|_g \leq C_k e^{k\Lambda|t|},$$

où Λ est l'exposant de Lyapunov défini dans l'item (i). De même, on prouve que l'opérateur $\mathcal{H}_p^{(3)}$ agit continument sur les classes de symboles de la façon suivante :

$$\mathcal{H}_p^{(3)} : S(m, g(s)) \longrightarrow S\left(h_{g(s)}^2 \underline{h}_g e^{-(\Lambda+2\Upsilon)|s|} m, g(s)\right), \quad (1.4.37)$$

uniformément en $|s| \leq T_E$. La limitation sur s vient du fait que l'on utilise le calcul pseudo-différentiel pour prouver les estimées de semi-normes allant avec (1.4.37). Précisons la raison pour laquelle on a (1.4.37). L'opérateur $\mathcal{H}_p^{(3)}$ est lié au reste d'ordre 3 dans le calcul pseudo-différentiel avec p (on rappelle que la définition de $\mathcal{H}_p^{(3)}$ en (1.4.6) fait intervenir \mathcal{H}_p défini en (1.4.3), et donc des produits de Moyal avec p). Puisque $\nabla^3 p \in S((h_g/\underline{h}_g)^{-1}, g)$ (item (ii) de l'hypothèse 1.4.6) et $a \in S(m, g(s))$, le gain du calcul pseudo-différentiel associé correspond moralement à

$$\sqrt{h_g h_{g(s)}} = \sqrt{h_g^2 e^{2(\Lambda+2\Upsilon)|s|}} = h_g e^{(\Lambda+2\Upsilon)|s|}$$

(on a utilisé (1.4.14)). A l'ordre 3, on « gagne » donc

$$h_g^3 e^{3(\Lambda+2\Upsilon)|s|} = h_{g(s)}^2 h_g e^{-(\Lambda+2\Upsilon)|s|}.$$

En multipliant par les poids $(h_g/\underline{h}_g)^{-1}$ et m associés à $\nabla^3 p$ et a respectivement, le calcul pseudo-différentiel donne donc que $\mathcal{H}_p^{(3)} a$ appartient à la classe $S(m', g(s))$ où

$$m' = h_{g(s)}^2 h_g e^{-(\Lambda+2\Upsilon)|s|} \left(\frac{h_g}{\underline{h}_g}\right)^{-1} m = h_{g(s)}^2 e^{-(\Lambda+2\Upsilon)|s|} \underline{h}_g m.$$

On montre ensuite l'estimée (1.4.17) sur l'opérateur $\mathcal{E}_j(t)$ défini en (1.4.8) par récurrence sur j , en exploitant la relation de récurrence (1.4.10). Si on suppose (1.4.17) sur $\mathcal{E}_j(t)$, on compose cette estimée avec celles obtenues sur e^{tH_p} en (1.4.36) et sur $\mathcal{H}_p^{(3)}$ en (1.4.37) pour obtenir

$$e^{(t-s)H_p} \mathcal{H}_p^{(3)} \mathcal{E}_j(s) : S(m, g) \longrightarrow S\left(m(t) h_{g(t)}^{2(j+1)} \underline{h}_g e^{-(\Lambda+2\Upsilon)|s|}, g(t)\right).$$

Le facteur $\underline{h}_g e^{-(\Lambda+2\Upsilon)|s|}$ disparaît lors de l'intégration sur $s \in [0, t]$ et on obtient l'estimée (1.4.17) sur $\mathcal{E}_{j+1}(t)$.

La partie la plus délicate de la preuve du théorème 1.4.7 consiste à montrer l'estimée (1.4.18) sur le reste, i.e. l'opérateur $\widehat{\mathcal{E}}_j(t)$ défini en (1.4.9). La difficulté additionnelle provient du fait que l'opérateur $e^{t\mathcal{H}_p}$, qui intervient dans la définition de $\widehat{\mathcal{E}}_j(t)$, n'est défini qu'implicitement par (1.4.4) (tandis que l'opérateur e^{tH_p} qui intervient dans la définition de $\mathcal{E}_j(t)$ est une opération explicite sur les symboles). Cette étape repose sur la caractérisation des opérateurs pseudo-différentiels donnée par Beals [Bea77]. C'est au cours de cette démonstration que l'on utilise l'hypothèse sur $\nabla^3 p$ faisant intervenir le poids de tempérance θ_g (item (ii) de l'hypothèse 1.4.6), ainsi que l'item (iii).

1.4.6. Perspectives

Notre étude des théorèmes de type Egorov dans le formalisme de Weyl–Hörmander est motivée par la conjecture 1.2.9, et plus particulièrement par les petites échelles apparaissant sur la Figure 1.2b en lien avec la Condition de Point Tournant (CPT). La discussion du paragraphe 1.2 sur les ondes amorties met en évidence une échelle critique 2-microlocale à laquelle se propagent les ondes de façon cohérentes. Pour capturer cette échelle, on démontre dans le chapitre 4, un résultat (dont le théorème 1.4.7 est une conséquence) de propagation de « partitions de l'unité quantiques » adaptées à une métrique g satisfaisant les Hypothèses 1.4.5 et 1.4.6. On espère pouvoir utiliser ce résultat pour décrire l'évolution quantique d'observables singulières. Plus précisément, on souhaite analyser l'opérateur $e^{itP} b(x) e^{-itP}$, pour une fonction b n'appartenant pas nécessairement à une bonne classe de symboles (par exemples le coefficient d'amortissement dans l'équation des ondes amorties (1.2.1)), via une décomposition en paquets d'ondes de b (vue comme fonction sur l'espace des phases) adaptée à une métrique g bien choisie. Notre théorème d'Egorov pour les partitions de l'unité quantiques devrait permettre de décrire l'évolution des paquets d'ondes issues de cette décomposition.

Une autre question, en lien avec l'exemple du paragraphe 1.4.4.1, consiste à se demander si l'on peut étendre le cadre d'application du théorème 1.4.7 à un propagateur du type $e^{it\Delta_\gamma}$ avec γ une

métrique euclidienne en dehors d'un compact, voire asymptotiquement euclidienne. Etant donné la propriété de propagation à vitesse infinie de l'énergie pour l'équation de Schrödinger, il semble naturel de demander que cette métrique soit non-captante, de sorte à pouvoir garder un contrôle uniforme sur le flot hamiltonien dans le régime haute fréquence $\xi \rightarrow \infty$. Cette approche donnerait alors probablement un point de vue alternatif sur l'effet régularisant de Kato [Doi05, Rob13, RZ08, RZ09, Bur04].

2 - Energy decay for the damped wave equation with a confining potential in the Euclidean space

We investigate trend to equilibrium of the damped wave equation with a confining potential in the Euclidean space. We provide with necessary and sufficient conditions for the energy to decay exponentially, uniformly with respect to all initial data. Our motivation is to understand the geometric conditions on the damping coefficient ensuring such an exponential decay, in the particular situation where waves are trapped in a confining potential. Our work relies on tools from semiclassical analysis.

2.1. Introduction

2.1.1. Setting of the problem

We study the energy decay of damped waves in the Euclidean space of dimension $d \geq 1$, that is to say the trend to equilibrium for solutions to the equation

$$\partial_t^2 u + Pu + b(x)\partial_t u = 0, \quad x \in \mathbf{R}^d, t > 0, \quad (2.1.1)$$

In (2.1.1), $b \in L^\infty(\mathbf{R}^d)$ is the non-negative *damping coefficient* and the operator P is assumed to be of the form

$$P = V(x) - \frac{1}{2}\Delta, \quad (2.1.2)$$

where V is a non-negative locally bounded confining potential on \mathbf{R}^d :

$$V \in L_{\text{loc}}^\infty(\mathbf{R}^d; \mathbf{R}), \quad V \geq 0 \quad \text{and} \quad V(x) \xrightarrow{x \rightarrow \infty} +\infty. \quad (2.1.3)$$

A further growth condition on V will be stated later. In the present work, we investigate necessary and sufficient conditions under which uniform exponential decay for Equation (2.1.1) holds. As a first observation, we mention that the energy balance corresponding to this equation, obtained by multiplying (2.1.1) by $\partial_t \bar{u}$ and performing integration by parts, is simply

$$\frac{d}{dt} \mathcal{E}(u(t)) = - \int_{\mathbf{R}^d} b |\partial_t u|^2 dx, \quad (2.1.4)$$

where the energy \mathcal{E} is defined formally by

$$\mathcal{E}(v(t)) = \frac{1}{2} \left(\left\| P^{1/2} v \right\|_{L^2(\mathbf{R}^d)}^2 + \left\| \partial_t v \right\|_{L^2(\mathbf{R}^d)}^2 \right),$$

provided P is a non-negative operator. This a priori estimate indicates that the equation (2.1.1) is non-conservative wherever b is positive. The question of the uniform exponential decay of the energy of solutions to (2.1.1) amounts to the existence of constants $C > 0, \tau > 0$ such that

$$\forall U_0 \in \mathcal{H}, \quad \mathcal{E}(U_0, t) \leq C e^{-t/\tau} \mathcal{E}(U_0, 0), \quad \forall t \geq 0. \quad (2.1.5)$$

The study of decay rates for the damped wave equation dates back to the 70s with the celebrated works of Rauch and Taylor, and later of Bardos, Lebeau and Rauch [RT74, BLR88, BLR92], in the setting of compact Riemannian manifolds. They prove a sharp sufficient condition for having uniform exponential decay of the energy of solutions to the damped wave equation. The latter can be expressed in broad terms as follows: any speed-one geodesic enters the so-called damped set, where the damping is effective (this is merely $\{b > 0\}$ when b is continuous). This is called the *Geometric Control Condition* (GCC). The idea behind this result is that the energy of high frequency solutions is largely carried by the rays of geometric optics. This phenomenon echoes the fact that high-frequency waves propagate according to the laws of geometric optics.

In comparison, few is understood in unbounded geometries, partly because it is unclear how to handle properly the presence of infinity in space. In this respect, the main landmark paper is the

work of Burq and Joly [BJ16]. One of their results is a sufficient condition for having uniform decay of the energy for the Klein–Gordon equation in \mathbf{R}^d , that is to say the same equation as (2.1.1) with the operator $P = -\frac{1}{2}\Delta + 1$. It reads: uniform exponential decay holds if there exists $L > 0$ such that the average of b on any segment of length L is uniformly bounded from below by a constant $c > 0$. This uniform version of the GCC appears to be a fairly natural generalization of the GCC to unbounded domains. Note that their proof requires b to be uniformly continuous on \mathbf{R}^d , which in particular prevents b from being more and more oscillatory near infinity. Their result has been recently generalized to asymptotically cylindrical and conic manifolds by Wang in [Wan24].

In the sequel, we may rewrite (2.1.1) in the form of an order one evolution PDE:

$$\partial_t U = \mathcal{A}_b U, \quad t > 0, \quad (2.1.6)$$

where we wrote $U = (u, \partial_t u)$, and the infinitesimal generator is the so-called *damped wave operator*:

$$\mathcal{A}_b = \begin{pmatrix} 0 & 1 \\ -P & -b \end{pmatrix}.$$

The energy of the solution $(U(t))_{t \in \mathbf{R}_+}$ of (2.1.6) with initial datum U_0 corresponds to:

$$\mathcal{E}(U_0, t) = \frac{1}{2} \left\| e^{t\mathcal{A}_b} U_0 \right\|_{\mathcal{H}}^2, \quad t \in \mathbf{R}_+,$$

where $\mathcal{H} = \text{dom } P^{1/2} \times L^2(\mathbf{R}^d)$, normed by $\|(u, v)\|_{\mathcal{H}}^2 = \|P^{1/2}u\|_{L^2}^2 + \|v\|_{L^2}^2$, is the natural Hilbert space on which the evolution problem (2.1.6) is well-posed. The exponential decay, defined in (2.1.5), can be expressed in a simple way by saying that the norm of the semigroup decay exponentially over time.

Definition 2.1.1 (Uniform stabilization). The equation (2.1.1) is said to be uniformly stable if there exist $C > 0, \tau > 0$ such that

$$\left\| e^{t\mathcal{A}_b} \right\|_{\mathcal{L}(\mathcal{H})} \leq C e^{-t/\tau}, \quad \forall t \geq 0.$$

Note that by the semigroup property, uniform stability is equivalent to the fact that $\|e^{t\mathcal{A}_b}\|_{\mathcal{L}(\mathcal{H})} < 1$ for some $t > 0$ (see [EN00, Chapter V, Proposition 1.7]).

A motivation to study (2.1.1) in the setting (2.1.2) and (2.1.3) is that waves should be essentially trapped in a bounded region of \mathbf{R}^d when V is confining. Then we can expect the analysis to share similarities with what has already been done for damped waves in compact domains. Actually, the situation will turn out to be rather different, due to the underlying classical dynamics possessing turning points, as we shall explain further.

2.1.2. Main results

We present two types of results here. We refer to the first one as “a priori conditions of stabilization” since it does not rely on any particular feature of the potential. These results are based on constructions of geometrical optics and semiclassical defect measures for the flat Laplacian in \mathbf{R}^d . Thus the following proposition has to be seen as a variation of classical results in control theory.

Throughout this paper, we denote by $|A|$ the d -dimensional Lebesgue measure of the measurable set $A \subset \mathbf{R}^d$. Given a finite measure space (X, \mathcal{B}, μ) , we also use the notation

$$\int_X f d\mu := \frac{1}{\mu(X)} \int_X f d\mu.$$

We also write $\mathbf{SR}^d = \mathbf{R}^d \times \mathbf{S}^{d-1}$.

Proposition 2.1.2 (A priori necessary and sufficient conditions for uniform stability). *Assume V is subject to (2.1.3) and $b \in L^\infty(\mathbf{R}^d)$ is a non-negative damping coefficient. Then if (2.1.1) is uniformly stable, b satisfies the Uniform Geometric Control Condition*

$$\exists T > 0, \exists c > 0 : \forall (x_0, \nu_0) \in \mathbf{SR}^d, \forall r > 0, \quad \int_{-T}^T (b * \kappa_r)(x_0 + \tau \nu_0) d\tau \geq c, \quad (\text{UGCC})$$

where

$$\kappa_r = r^{-d} \kappa(\bullet/r) \quad \text{with} \quad \kappa(x) = \frac{1}{|B_1(0)|} \mathbb{1}_{B_1(0)}(x). \quad (2.1.7)$$

Conversely, if b is essentially bounded from below by a positive constant outside some compact set, that is

$$\exists R > 0, \exists c > 0 : \quad b(x) \geq c \quad \text{for a.e. } x \in \mathbf{R}^d \setminus B_R(0), \quad (2.1.8)$$

then (2.1.1) is uniformly stable.

Remark 2.1.3. The condition (UGCC) is equivalent to the following statement:

$$\exists T > 0, \exists c > 0 : \forall (x_0, \nu_0) \in S\mathbf{R}^d, \quad \liminf_{r \rightarrow 0} \int_{-T}^T (b * \kappa_r)(x_0 + \tau \nu_0) d\tau \geq c. \quad (2.1.9)$$

This is proved in Lemma 2.B.1 in Appendix 2.B.

The version of the Geometric Control Condition appearing in the proposition generalizes the one known for continuous damping coefficients to the case where b is merely L^∞ . It has already been formulated (in an equivalent way) by Burq and Gérard in [BG20], and has been shown to be necessary for uniform stability to occur for the damped-wave equation on compact Riemannian manifolds. Notice that for $b \in C^0(\mathbf{R}^d)$, the condition (UGCC) is equivalent to

$$\exists T > 0, \exists c > 0 : \forall (x_0, \nu_0) \in S\mathbf{R}^d, \quad \int_{-T}^T b(x_0 + \tau \nu_0) d\tau \geq c.$$

It is also the natural way of generalizing GCC to non-compact geometries—see Burq and Joly [BJ16]. We will discuss later different useful reformulations of (UGCC) (see Remark 2.1.3). As for the sufficient condition, it already appeared in [Zua91]. Although we assume in Proposition 2.1.2 that V is a confining potential, the conditions (UGCC) and (2.1.8) are unrelated to this confinement property, so that the Proposition should be true also for non-negative $L^\infty_{\text{loc}}(\mathbf{R}^d)$ potentials. In Actually, the assumption that V is confining is convenient when reducing the problem of uniform stability to a resolvent estimate (see Proposition 2.2.1).

We now aim at understanding the effect of the presence of a *confining* potential. New interesting geometric control conditions appear in this context. We are going to require additional assumptions on the potential from now on.

Assumption 2.1.4 (Growth condition on the potential). *The potential V is sub-quartic, that is to say*

$$V \in C^2(\mathbf{R}^d) \quad \text{and} \quad \nabla V(x) = o\left(V(x)^{3/4}\right) \quad \text{as } x \rightarrow \infty.$$

Remark 2.1.5. One can check that the strict sub-quarticity condition implies the (weaker) property $V(x) \ll |x|^4$ as $x \rightarrow \infty$. In fact, every potential of the form $|x|^s$ with $0 < s < 4$ outside a compact set satisfies the sub-quarticity assumption.

Our main result is the following necessary condition.

Theorem 2.1.6 (Necessary condition for uniform stability). *Assume the potential V is subject to (2.1.3) and Assumption 2.1.4, and the damping coefficient $b \in L^\infty(\mathbf{R}^d)$ is such that the damped wave equation (2.1.1) is uniformly stable. Then b satisfies the Uniform Geometric Control Condition (UGCC) and the Turning Point Condition:*

$$\exists R > 0 : \quad \liminf_{x \rightarrow \infty} \int_{B_{R/V(x)^{1/4}}(x)} b(y) dy > 0. \quad (\text{TPC})$$

Examples of damping coefficients satisfying conditions (UGCC) and (TPC) are shown on Figures 2.1a and 2.1b respectively.

Restricting the scope of our investigation to a class of nice damping coefficients, we prove the following characterization of uniform stabilization, as a consequence of the necessary condition in Theorem 2.1.6 and the a priori sufficient condition obtained in Proposition 2.1.2.

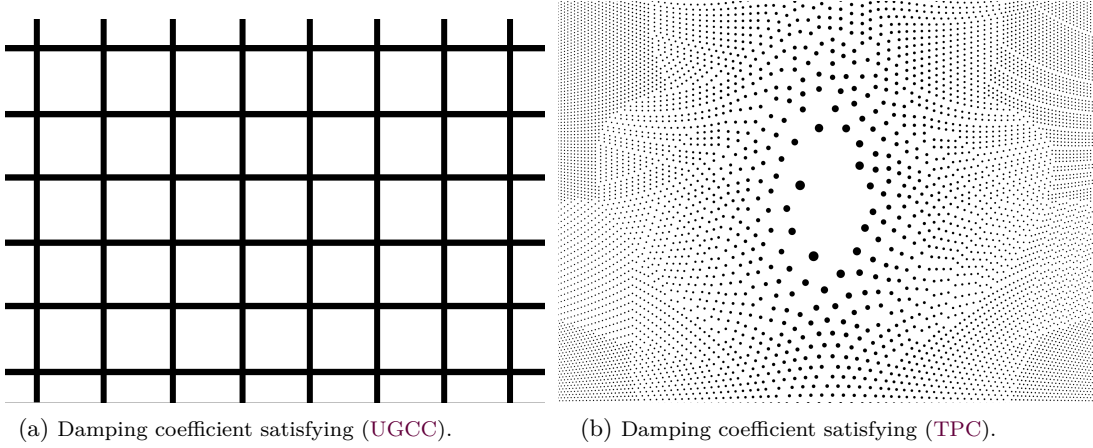

Figure 2.1 – Black and white indicate the points where b is equal to 1 or 0 respectively.

Corollary 2.1.7 (Characterization of uniform stability for uniformly continuous damping coefficients). *Let V be a potential on \mathbf{R}^d satisfying (2.1.3) and Assumption 2.1.4, and suppose b is a uniformly continuous non-negative damping coefficient. Then equation (2.1.1) is uniformly stable if and only if b is bounded from below outside a compact set, that is to say*

$$\liminf_{x \rightarrow \infty} b(x) > 0.$$

The point of Corollary (2.1.7) is to show that the necessary condition TPC together with uniform continuity of b forces the latter to be bounded from below in a neighborhood of infinity.

2.1.3. Geometric and dynamical stabilization conditions

Proposition 2.1.2 and Theorem 2.1.6 above provide geometric necessary conditions of stabilization. To understand completely the picture, it is relevant to unify the two conditions (UGCC) and (TPC) into a single dynamical condition, accounting for the underlying classical dynamics (here a distorted geometric optics).

2.1.3.1. Classical dynamics

We briefly introduce the Hamiltonian flow associated with P and recall the basic definitions that will be needed thereafter. Throughout this chapter, a typical point of \mathbf{R}^d will be denoted by x or y , whereas the points of the cotangent space $T_x^*\mathbf{R}^d$ will be denoted by ξ or η . We will also often use the notation ρ or ζ to denote a running point (x, ξ) or (y, η) in $T^*\mathbf{R}^d$. The cotangent space $T^*\mathbf{R}^d$ equipped with the symplectic form $\sigma = d\xi \wedge dx$, the so-called *phase space*, will be frequently identified with \mathbf{R}^{2d} . The operator P can be written as $P = \text{Op}^w(p)$, that is to say the Weyl quantization of the real-valued symbol $p(x, \xi) = V(x) + \frac{1}{2}|\xi|^2$ (see [Hör85, Ler10, Zwo12]). Under Assumption 2.1.4, the potential V is C^2 , so we can define the Hamiltonian vector field¹ associated with p by

$$H_p = \xi \cdot \partial_x - \nabla V(x) \cdot \partial_\xi.$$

The Hamiltonian flow associated with p , which we denote by $(\varphi^t)_{t \in \mathbf{R}}$, is the flow generated by H_p , namely

$$\frac{d}{dt} \varphi^t(\rho) = H_p(\varphi^t(\rho)).$$

Writing $\varphi^t(\rho) = (x^t, \xi^t)$ the position and momentum components of the flow, we can rewrite this as

$$\begin{cases} \dot{x}^t = \xi^t \\ \dot{\xi}^t = -\nabla V(x^t) \end{cases}, \quad (2.1.10)$$

which corresponds to Newton's second law of classical mechanics with a force field $\vec{F} = -\nabla V$. In the setting of a confining potential (2.1.3), which is our case throughout this paper, classical o.d.e. theory ensures that the integral curves of H_p are well-defined for all times (the level sets of p are compact). Notice that p is preserved by the Hamiltonian flow by construction.

1. In fact, $V \in W_{\text{loc}}^{2,\infty}(\mathbf{R}^d)$ would be sufficient to define the Hamiltonian vector field.

2.1.3.2. Dynamical stabilization condition

Given a continuous function K on $T^*\mathbf{R}^d$, a real number $T > 0$ and $\rho \in T^*\mathbf{R}^d$, we denote by $\langle K \rangle_T$ the function on $T^*\mathbf{R}^d$ consisting in averaging K along the trajectories of the Hamiltonian flow, namely

$$\langle K \rangle_T(\rho) := \frac{1}{2T} \int_{-T}^T K(\varphi^t(\rho)) dt.$$

If K is a continuous function on \mathbf{R}^d , we write $\langle K \rangle_T(\rho) := \langle K \circ \pi \rangle_T(\rho)$ (with a slight abuse of notation), where $\pi : T^*\mathbf{R}^d \rightarrow \mathbf{R}^d$ is the cotangent bundle projection.

Definition 2.1.8 (Stabilization condition – Dynamical formulation). Let V be a C^2 potential such that the Hamiltonian flow $(\varphi^t)_{t \in \mathbf{R}}$ associated with $p(x, \xi) = V(x) + \frac{1}{2}|\xi|^2$ introduced in (2.1.10) is globally well-defined. We say a function $b \in L^\infty(\mathbf{R}^d)$ satisfies the *Dynamical Stabilization Condition* if

$$\exists T > 0, \exists R > 0 : \quad \liminf_{\lambda \rightarrow +\infty} \inf_{\rho \in \{p=\lambda^2\}} \left\langle b * \kappa_{R/\sqrt{\lambda}} \right\rangle_{T/\lambda}(\rho) > 0, \quad (\text{DSC})$$

where $\kappa_{R/\sqrt{\lambda}}$ is given by (2.1.7).

We refer to Subsection 2.1.3.3 below for a discussion of the relative scales appearing in this definition, namely the energy scale $\{p = \lambda^2\}$, the regularization scale $R/\sqrt{\lambda}$ and the time scale $T/\sqrt{\lambda}$.

Proposition 2.1.9. *Suppose V is subject to (2.1.3) and Assumption 2.1.4. Then a non-negative function $b \in L^\infty(\mathbf{R}^d)$ satisfies the Dynamical Stabilization Condition (DSC) if and only if it satisfies the Uniform Geometric Control Condition (UGCC) and the Turning Point Condition (TPC):*

$$(\text{DSC}) \iff (\text{UGCC}) + (\text{TPC}).$$

The Dynamical Stabilization Condition (DSC) is the natural candidate for characterizing the uniform stabilization of the damped wave equation (2.1.1). Indeed, it follows directly from the quantum-classical correspondence heuristics that the damping coefficient should capture all the high energy rays of geometric optics (modulo the non-obvious space-time scales $R/\sqrt{\lambda}$ and T/λ described below in Subsection 2.1.3.3). Proposition 2.1.9 above gives us a very practical way to check that (DSC) is verified on concrete examples.

The Geometric Control Condition and the Turning Point Condition are related to the Dynamical Stabilization Condition in distinct phase space regions. Condition (UGCC) concerns the kinetic regime where the Laplace operator rules over the potential. It is obtained by considering a fixed point $x_0 \in \mathbf{R}^d$ and looking at points over x_0 in the energy shell $\{p = \lambda^2\}$ with $\lambda \gg 1$. In a $O(1)$ neighborhood of x_0 on the energy layer $\{p = \lambda^2\}$, the Hamiltonian p is well-approximated by $|\xi|^2$, so that the flow lines look more and more like straight lines and project to rays onto the physical space (this corresponds to taking x fixed and letting $\xi \rightarrow \infty$ on $V(x) + \frac{1}{2}|\xi|^2 = \lambda^2$). In contrast, condition (TPC) comes from the potential regime, where states have a large potential energy compared to their oscillation rate, i.e. V prevails over the Laplacian (this corresponds to taking ξ fixed and letting $x \rightarrow \infty$ on $V(x) + \frac{1}{2}|\xi|^2 = \lambda^2$). This regime arises in phase space regions close to the null section but also close to infinity in space, where the classical dynamics has turning points: trajectories are transversal to the null section and project singularly onto the physical space. Proposition 2.1.9 that controlling only kinetic quasimodes through (UGCC) and potential quasimodes through (TPC) is sufficient to control any state on the energy shell $\{p = \lambda^2\}$.

Proposition 2.1.9 suggest that the condition (UGCC) + (TPC) is sharp. This motivates the following statement.

Conjecture 2.1.10. *Consider V satisfying (2.1.3) and Assumption 2.1.4, and $b \in L^\infty(\mathbf{R}^d)$ non-negative. Then equation (2.1.1) is uniformly stabilized if and only if b satisfies the Geometric Control Condition (UGCC) and the Turning Point Condition (TPC).*

The dynamical viewpoint of (DSC) seems to be the best one to quantify the decay rate, namely the optimal rate τ in (2.1.5) (at least for high energy initial data), as Lebeau did in compact manifolds [Leb96]. We give in Appendix 2.B a good candidate for the value of this optimal decay rate.

2.1.3.3. Typical space-time scales

In view of the quantum-classical correspondence principle (or Egorov's theorem), one can guess that a sharp geometric condition on b to ensure stabilization would be that the average of b along any high-energy bicharacteristic of the classical Hamiltonian $p = \lambda^2$ should be bounded from below. More precisely, assuming that b is continuous, these averages should be of the form

$$\int_{-t}^t b((\pi \circ \varphi_s)(x, \xi)) ds$$

where $\pi : T^*\mathbf{R}^d \rightarrow \mathbf{R}^d$ is the cotangent bundle projection, $(x, \xi) \in \{p = \lambda^2\}$ for λ large, and $t > 0$ may depend on λ . In the case of rough damping coefficients, as for the Geometric Control Condition, it is natural to regularize the damping coefficient b by convolution and hence consider quantities of the type

$$\int_{-t}^t (b * \kappa_r)((\pi \circ \varphi_s)(x, \xi)) ds,$$

where κ_r is given by (2.1.7), with a scaling factor $r > 0$ possibly depending on λ . See [BG20, Pro23, Lé23] for discussions on this question. To figure out the relevant scale for t as a parameter depending on λ , we can investigate the dynamical consequence of being a $o(\lambda)$ -quasimode of P , namely a family $(u_\lambda)_\lambda$ in $\text{dom } P$ such that

$$(P - \lambda^2)u_\lambda = o_{L^2}(\lambda), \quad \|u_\lambda\|_{L^2} = 1$$

(the relevance of the latter is given by Proposition 2.3.2). Since e^{isP} is an isometry for any s , using the mean-value inequality, we obtain

$$e^{it(P-\lambda^2)}u_\lambda - u_\lambda = \int_0^t ie^{is(P-\lambda^2)}(P - \lambda^2)u_\lambda ds = o_{L^2}(t\lambda), \quad \|u_\lambda\|_{L^3} = 1. \quad (2.1.11)$$

That means that u_λ is nearly invariant under the action of the propagator e^{itP} (up to a phase factor) on a time scale of order $t \approx T/\lambda$:

$$e^{itP}u_\lambda = e^{it\lambda^2}u_\lambda + o_{L^2}(1), \quad \text{uniformly for } t \in [0, T/\lambda].$$

Here T a fixed constant. As for the parameter r , the point is to understand what is the critical concentration scale of $o(\lambda)$ -quasimodes. This can be done roughly through the following observation. Assume a quasimode concentrates in a tubular neighborhood of radius r of a bicharacteristic projected onto the physical space (namely the x^t component of a trajectory of the Hamiltonian flow; see (2.1.10)). Thinking of this quasimode u_λ as a wave packet $u_\lambda = f_\lambda e^{i\lambda\psi_\lambda}$, with envelope f_λ (which localizes the quasimode in space) and phase $e^{i\lambda\psi_\lambda}$ (which localizes in frequency), that means the gradient of f_λ is of order $1/r$, or in other words, its Fourier transform is mainly supported in a window of size $1/r$. In order to have a $o(\lambda)$ -quasimode, this frequency contribution of the envelope function should fit in the remainder $o(\lambda)$ so that it does not disrupt the microlocalization of the wave packet. Thus the amount of kinetic energy carried by the envelope f_λ , which is of order $\nabla f_\lambda \approx 1/r^2$, should actually be $o(\lambda)$, and therefore the critical concentration scale appears to be $r \approx R/\sqrt{\lambda}$, where R can be as large as one wishes.

2.1.4. Strategy of proof and plan of the paper

After recalling some basic results on the topic of the damped wave equation in Section 2.2, we prove that the uniform exponential decay of the energy is equivalent to a particular resolvent estimate for the damped wave operator (Section 2.3).

In Section 2.4, we prove Proposition 2.1.2, i.e. the a priori necessary and sufficient conditions that do not take into account the potential. The scheme of the proof is classical: for the necessary condition, we construct quasimodes (in fact wave packets) concentrating around any segment in \mathbf{R}^d . For the sufficient condition, we prove that the energy of $o(h)$ -quasimodes of the semiclassical Laplacian escapes at infinity in space by a defect measure argument. We then deduce that the same holds for the quasimodes of the operator P relevant in this problem.

Section 2.5 discusses the finer necessary condition of Theorem 2.1.6. The proof is based on the construction of suitable quasimodes with an optimal space concentration near the turning points of

the classical dynamics. Then we prove Corollary 2.1.7 (concerning uniformly continuous damping coefficients) as a direct application. The main ingredient is a relatively simple instance of the WKB method that we adapt to our setting. We find an approximate solution to $(V - \frac{1}{2}\Delta - \lambda^2)u_\lambda = 0$ under the form $u_\lambda = f_\lambda e^{i\psi_\lambda}$, where we assume $f_\lambda : \mathbf{R}^d \rightarrow \mathbf{R}$ is L^2 and has compact support and $\psi_\lambda : \mathbf{R}^d \rightarrow \mathbf{R}$ is defined in a neighborhood of the support of f_λ . In practice, the shape of the envelope f_λ is arbitrary and the phase function ψ_λ is linear. Notice that our setting is quite different from the original WKB method for two reasons: on the one hand, we do not need a pointwise approximation of solutions to the equation $(P - \lambda^2)u_\lambda = 0$ but only an L^2 approximation, and the remainder is allowed to be fairly large; on the other hand, we are not focusing on a fixed energy layer of a semiclassical Schrödinger operator $-h^2\Delta + V$ as it is usually the case, but rather consider the high energy régime for $-\Delta + V$, which means we will have to handle the fact that not only the Laplacian but also the potential scales as $\lambda \rightarrow \infty$.

Finally, we deal with Proposition 2.1.9 in Section 2.6, by roughly showing that the Hamiltonian flow is well approximated by its linearization on the time scale under consideration.

We recall in Appendix 2.A classical results on the Weyl quantization and the pseudo-differential calculus that we need throughout the paper. Technical remarks and lemmata on conditions (UGCC) and (DSC) are collected in Appendix 2.B.

Acknowledgments

This project partly conducted while visiting Universidad Politécnica de Madrid during the academic year 2020-2021. I thank this institution for its hospitality. I am grateful to Matthieu Léautaud for his encouragements and his helpful comments on a preliminary version of this paper. I also thank Fabricio Macià for many discussions on this topic. This work has been partially supported by FMJH's "Junior scientific visibility program" (France) and grant MTM2017-85934-C3-3-P (MINECO, Spain).

2.2. Background and preliminary results

Let us recall basic definitions and well-known results that will be needed afterwards. We recall that the potential is assumed to be non-negative and confining (2.1.3) throughout this article.

2.2.1. Well-posedness

Under (2.1.3), the operator $V(x) - \frac{1}{2}\Delta$ with domain $C_c^\infty(\mathbf{R}^d)$ is nonnegative and symmetric. Therefore, it admits a unique self-adjoint extension denoted by P , the Friedrichs extension (see [RS75, Theorem X.23]), associated with the closure \bar{q} of the quadratic form

$$q : C_c^\infty(\mathbf{R}^d) \times C_c^\infty(\mathbf{R}^d) \ni (u, v) \mapsto (u, (V - \frac{1}{2}\Delta)v)_{L^2}.$$

Moreover, the lower bound of the spectrum of P is the same as the lower bound of q , and the domain of P denoted by $\text{dom } P$, is contained in its form domain (that is to say the domain of \bar{q}) which will be denoted by $Q(P)$. An integration by parts yields,

$$q(u, u) = \left\| V^{1/2}u \right\|_{L^2}^2 + \frac{1}{2} \|\nabla u\|_{L^2}^2, \quad \forall u \in C_c^\infty(\mathbf{R}^d). \quad (2.2.1)$$

If we equip the spaces $\text{dom } P$ with the graph norm $u \mapsto \|Pu\|_{L^2} + \|u\|_{L^2}$ and $Q(P)$ with the norm $u \mapsto \left(q(u, u) + \|u\|_{L^2}^2 \right)^{1/2}$ respectively, classical arguments show that the embeddings $\text{dom } P \hookrightarrow Q(P)$ and $Q(P) \hookrightarrow L^2(\mathbf{R}^d)$ are compact, since V is confining (2.1.3) (use for example the Riesz-Fréchet-Kolmogorov characterization of relatively compact subsets of $L^2(\mathbf{R}^d)$). As a consequence, the resolvent of P is compact. Then the spectrum of P is classically made of a sequence of nonnegative eigenvalues with finite multiplicity tending to infinity. Besides, P is invertible since 0 is not an eigenvalue, and therefore is not in the spectrum of P . We conclude that P is a positive operator, meaning that there exists $\lambda_0 > 0$ such that $P \geq \lambda_0 \text{Id}$ (this is an instance of the uncertainty principle). Thus, the form \bar{q} is a well-defined inner product which endows $Q(P)$ with a Hilbert space structure. In the sequel, we will use the Hilbert space $\mathcal{H} = Q(P) \times L^2(\mathbf{R}^d)$ whose inner product is

$$(U, V)_{\mathcal{H}} := \bar{q}(u_1, v_1) + (u_2, v_2)_{L^2(\mathbf{R}^d)}, \quad \forall U = (u_1, u_2), V = (v_1, v_2) \in \mathcal{H}.$$

The damped wave operator \mathcal{A}_b , defined in (2.1.1), with domain $\text{dom } \mathcal{A}_b = \text{dom } P \times Q(P)$ is a closed operator, which can be seen as a bounded perturbation of the skew-adjoint operator \mathcal{A}_0 :

$$\mathcal{A}_b = \mathcal{A}_0 - \mathcal{B}_b, \quad \text{with } \mathcal{B}_b = \begin{pmatrix} 0 & 0 \\ 0 & b \end{pmatrix} \text{ satisfying } \|\mathcal{B}_b\|_{\mathcal{L}(\mathcal{H})} = \|b\|_{L^\infty}.$$

The energy balance (2.1.4) can be reformulated rigorously as the fact that \mathcal{A}_b is dissipative, that is to say:

$$\Re(U, \mathcal{A}_b U)_{\mathcal{H}} = -(u_2, bu_2)_{L^2} \leq 0, \quad \forall U = (u_1, u_2) \in \text{dom } \mathcal{A}_b.$$

Besides, it is maximal-dissipative (Proposition 2.2.1 below ensures that $\mathcal{A}_b - \lambda$ is surjective for $\lambda > 0$). Thus the Lumer-Philips Theorem [Paz83, Theorem 4.3] ensures that \mathcal{A}_b generates a contraction semigroup $(e^{t\mathcal{A}_b})_{t \in \mathbf{R}_+}$.

2.2.2. Spectrum of the damped wave operator

Let us now describe the spectrum of \mathcal{A}_b . According to [AL14, Lemma 4.2], one could get a bit more precise localization of the spectrum than the one we present below, but this will not be of interest for us.

Proposition 2.2.1 (Basic localization properties of the spectrum of the damped wave operator – [AL14, Lemma 4.2]). *Let $b \in L^\infty(\mathbf{R}^d)$ be nonnegative and assume b is not identically zero. Then the spectrum of \mathcal{A}_b is made of a complex sequence of eigenvalues with finite multiplicity tending to infinity and*

$$\text{Spec } \mathcal{A}_b \subset \{z \in \mathbf{C} : -\|b\|_{L^\infty} \leq \Re z < 0\}.$$

2.2.3. Weyl quantization and semiclassical defect measures

To any function $a \in \mathcal{S}(T^*\mathbf{R}^d)$, we associate an operator on $\mathcal{S}(\mathbf{R}^d)$, denoted by $\text{Op}^w(a)$ and defined by

$$\text{Op}^w(a)u(x) = (2\pi)^{-d} \int_{\mathbf{R}^d \times \mathbf{R}^d} e^{i\xi \cdot (x-y)} a\left(\frac{x+y}{2}, \xi\right) u(y) dy d\xi, \quad \forall u \in \mathcal{S}(\mathbf{R}^d). \quad (2.2.2)$$

This operator is called a pseudo-differential operator and it maps $\mathcal{S}(\mathbf{R}^d)$ to itself (see for instance [Zwo12, Theorem 4.16]). The function a is called the symbol of $\text{Op}^w(a)$. See Appendix 2.A for an account of the classical properties of pseudo-differential operators.

We also introduce the semiclassical rescaling of the Weyl quantization:

$$\text{Op}_h^w(a) = \text{Op}^w(a(x, h\xi)), \quad h \in (0, 1]. \quad (2.2.3)$$

When studying particular sequences of L^2 functions in the semiclassical limit, semiclassical defect measures are a good tool to record their microlocalization, that is the asymptotic localization in phase-space when $h \rightarrow 0^+$. For any bounded sequence $(u_h)_{h>0}$ in $L^2(\mathbf{R}^d)$, the Calderón-Vaillancourt Theorem (Theorem 2.A.4), together with a diagonal extraction and the Gårding inequality, allows to prove that there exists a subsequence $(h_n)_{n \in \mathbf{N}}$ and a non-negative Radon measure μ on $T^*\mathbf{R}^d$ with finite mass, which is called a *semiclassical defect measure*, such that $h_n \rightarrow 0^+$ and

$$\forall a \in C_c^\infty(T^*\mathbf{R}^d), \quad (u_{h_n}, \text{Op}_{h_n}^w(a)u_{h_n})_{L^2} \xrightarrow{n \rightarrow \infty} \int_{T^*\mathbf{R}^d} a(x, \xi) d\mu(x, \xi)$$

(we refer to [Zwo12, Theorem 5.2] for more details about this construction; see also [Gér91b, LP93]). When $(u_h)_{h>0}$ has additional properties, more can be said about the limiting measure μ , using pseudo-differential calculus (Theorem 2.A.5).

Proposition 2.2.2 (Property of semiclassical defect measures – [Zwo12, Theorems 5.3-5.4]). *Assume $(u_h)_{h>0}$ is a bounded sequence in $L^2(\mathbf{R}^d)$ and let μ be a semiclassical defect measure. Then*

- if $(-h^2 \frac{1}{2} \Delta - 1)u_h = o_{L^2}(1)$, then $\text{supp } \mu \subset \{|\xi| = 1\}$;
- if $(-h^2 \frac{1}{2} \Delta - 1)u_h = o_{L^2}(h)$, then μ is invariant by the flow $\phi^t(x, \xi) = (x + t\xi, \xi)$, namely $(\phi^t)_* \mu = \mu, \forall t \in \mathbf{R}$.

2.2.4. Weyl-Heisenberg translation operators

Given a point $\rho_0 = (x_0, \xi_0) \in T^*\mathbf{R}^d$, we define T_{ρ_0} to be the operator acting as

$$T_{\rho_0} u(x) = e^{-\frac{i}{2}\xi_0 \cdot x_0} e^{i\xi_0 \cdot x} u(x - x_0), \quad \forall u \in \mathcal{S}(\mathbf{R}^d).$$

This is clearly a continuous operator mapping $\mathcal{S}(\mathbf{R}^d)$ to itself, and it can be extended to a continuous operator $\mathcal{S}'(\mathbf{R}^d) \rightarrow \mathcal{S}'(\mathbf{R}^d)$. Moreover, it is unitary on $L^2(\mathbf{R}^d)$ with inverse $T_{-\rho_0}$. Note that we have the following identity:

$$T_{\rho_0} T_{\rho_1} = e^{\frac{i}{2}\sigma(\rho_0, \rho_1)} T_{\rho_0 + \rho_1}, \quad \forall \rho_0, \rho_1 \in T^*\mathbf{R}^d.$$

These operators allow to perform translations at the level of symbols via the equality

$$T_{\rho_0} \text{Op}^w(a) T_{-\rho_0} = \text{Op}^w(a(\rho - \rho_0)), \quad \forall a \in \mathcal{S}'(T^*\mathbf{R}^d), \forall \rho_0 \in T^*\mathbf{R}^d,$$

which is a particular case of Egorov's Theorem (see [Zwo12] for instance). In addition, we have the noteworthy intertwining relation with the Fourier transform \mathcal{F} :

$$T_{J\rho_0} \mathcal{F} = \mathcal{F} T_{\rho_0}, \quad J = \begin{pmatrix} 0 & \text{Id} \\ -\text{Id} & 0 \end{pmatrix} \quad (2.2.4)$$

(J is the usual symplectic matrix here; in particular $\sigma(\rho_0, \rho_1) = \rho_0 \cdot J\rho_1$).

2.3. Resolvent estimate

The first step in our study is to reformulate the question of uniform stability as a stationary problem, under the form of a resolvent estimate. This is a common method to study the damped wave equation, see e.g. [Leb96, AL14, BJ16]. In the context of uniform stability (Definition 2.1.1, a useful link between the evolution problem and the resolvent estimate is given by the following fundamental result, whose proof can be found in [EN00, Chapter V, Theorem 1.11].

Theorem 2.3.1 (Gearhart, Prüss, Huang, Greiner – [Gea78, Hua85, Prü84]). *A strongly continuous semigroup $(T(t))_{t \in \mathbf{R}_+}$ on a Hilbert space H is uniformly exponentially stable if and only if the half plane $\{z \in \mathbf{C} : \Re z > 0\}$ is contained in the resolvent set of the generator A , with the resolvent satisfying*

$$\sup_{\lambda \in \mathbf{R}} \|(A - i\lambda)^{-1}\|_{\mathcal{L}(H)} < \infty.$$

Applying this theorem to the damped wave operator \mathcal{A}_b , we deduce a characterization of the uniform stability of (2.1.1). In fact, it is more convenient to work with the converse statement, characterizing the failure of uniform stability.

Proposition 2.3.2. *Assume V is subject to (2.1.3) and that the non-negative damping coefficient $b \in L^\infty(\mathbf{R}^d)$ does not identically vanish. The equation (2.1.1) is not uniformly stable if and only if there exists a sequence $(u_n)_{n \in \mathbf{N}}$ in $\text{dom } P$ with $\|u_n\|_{L^2} = 1, \forall n \in \mathbf{N}$, and a sequence of real numbers $\lambda_n \rightarrow +\infty$, such that*

1. $(u_n)_{n \in \mathbf{N}}$ is a $o(\lambda_n)$ -quasimode of P , namely $(P - \lambda_n^2)u_n = o_{L^2}(\lambda_n)$ in $L^2(\mathbf{R}^d)$ as $n \rightarrow \infty$;
2. $(u_n, bu_n)_{L^2} \rightarrow 0$ in $L^2(\mathbf{R}^d)$ as $n \rightarrow \infty$ (the u_n 's are ‘‘asymptotically undamped’’).

Proof. By [AL14, Lemma 4.6], the resolvent of \mathcal{A}_b can be controlled by the resolvent of the operator

$$P_b(z) = P + z^2 + zb \quad \text{dom } P_b(z) = \text{dom } P,$$

near infinity on the imaginary axis: there exist $C \geq 1$ and $\lambda_0 > 0$ such that

$$\forall \lambda \in \mathbf{R}, |\lambda| \geq \lambda_0, \quad C^{-1}|\lambda| \|P_b(i\lambda)^{-1}\|_{\mathcal{L}(L^2)} \leq \|(\mathcal{A}_b - i\lambda)^{-1}\|_{\mathcal{L}(\mathcal{H})} \leq C(1 + |\lambda|) \|P_b(i\lambda)^{-1}\|_{\mathcal{L}(L^2)}.$$

In addition, since the norm of the resolvent is a continuous function, we know that $\|(\mathcal{A}_b - i\lambda)^{-1}\|_{\mathcal{L}(\mathcal{H})}$ is bounded for any λ in a fixed compact set. Therefore Theorem 2.3.1 implies that the equation (2.1.1) is not uniformly stable if and only if there exist a sequence $(\lambda_n)_{n \in \mathbf{N}}$ tending to $\pm\infty$

such that $|\lambda_n| \|P_b(i\lambda_n)^{-1}\|_{\mathcal{L}(\mathcal{H})} \rightarrow +\infty$ as $n \rightarrow \infty$. Without loss of generality, one can assume that $\lambda_n \rightarrow +\infty$ since $P_b(i\lambda)^* = P_b(-i\lambda)$ for all $\lambda \in \mathbf{R}$. We infer that there exists a sequence $(u_n)_{n \in \mathbf{N}}$ in $\text{dom } P$ such that $\|u_n\|_{L^2} = 1, \forall n \in \mathbf{N}$ and $P_b(i\lambda_n)u_n = o(\lambda_n)$. Then we compute:

$$o(\lambda_n) = \Im(u_n, P_b(i\lambda_n)u_n)_{L^2} = \Im((u_n, (P - \lambda_n^2)u_n)_{L^2} + i\lambda_n(u_n, bu_n)_{L^2}) = \lambda_n(u_n, bu_n)_{L^2},$$

which yields $(u_n, bu_n)_{L^2} = \left\| \sqrt{b}u_n \right\|_{L^2}^2 \rightarrow 0$ in $L^2(\mathbf{R}^d)$. Since b is L^∞ , we deduce that $bu_n \rightarrow 0$ in L^2 , and from

$$(P - \lambda_n^2)u_n = P_b(i\lambda_n)u_n - i\lambda_n bu_n,$$

we deduce that

$$\left((P - \lambda_n^2)u_n = o_{L^2}(\lambda_n) \quad \text{and} \quad \sqrt{b}u_n = o_{L^2}(1) \right) \iff P_b(i\lambda_n)u_n = o_{L^2}(\lambda_n)$$

as $n \rightarrow \infty$, which completes the proof. \square

In view of this characterization, our goal is to study the properties of localization and oscillation of $o(\lambda)$ -quasimodes and see under which conditions on the damping coefficient they are ‘‘asymptotically undamped’’ in the sense of Item 2 of Proposition 2.3.2. For simplicity, we will drop the subscript n and call $o(\lambda)$ -quasimode of P any sequence of functions $(u_\lambda)_\lambda$ lying in $\text{dom } P$, indexed by a subset of \mathbf{R}_+ whose closure contains $+\infty$, and normalized in $L^2(\mathbf{R}^d)$, such that

$$(P - \lambda^2)u_\lambda = o_{L^2}(\lambda), \quad \lambda \rightarrow +\infty. \quad (2.3.1)$$

Comments on the natural semiclassical setting for homogeneous potentials.

Note that $o(\lambda)$ -quasimodes can be recast in a semiclassical framework if the potential V is homogeneous, by choosing an appropriate scaling of the phase space. More specifically, if $V(x) = |x|^{2m}$ where $m \geq 0$ is a real number, one may introduce the unitary dilation operator Λ_h mapping $u \in L^2(\mathbf{R}^d)$ to the function $x \mapsto h^{d\gamma/2}u(h^\gamma x)$ with $\gamma = 1/(m+1)$, and then define a quantization Op_h by

$$\widetilde{\text{Op}}_h(a) := \text{Op}_1^w(a(h^\gamma x, h^{1-\gamma}\xi)) = \Lambda_h \text{Op}_h^w(a)\Lambda_h^*, \quad \forall a \in \mathcal{S}(T^*\mathbf{R}^d), \quad (2.3.2)$$

where $\text{Op}_h^w(a)$ denotes the standard semiclassical Weyl quantization of the symbol a recalled in (2.2.3). In this framework, substituting $1/\lambda$ for $h^{1-\gamma}$ and relabeling $u_{1/h^{1-\gamma}}$ as u_h , (2.3.1) becomes:

$$\left(h^{\frac{2m}{m+1}}P - 1 \right) u_h = \widetilde{\text{Op}}_h p - 1u_h = o_{L^2}(h^{1-\gamma}), \quad h \rightarrow 0^+, \quad (2.3.3)$$

namely $(u_h)_{h>0}$ is a semiclassical quasimode with precision $o(h^{1-\gamma})$. Notice that this formulation is commonly used to study the high-frequency limit for the operator $P = -\frac{1}{2}\Delta + 1$; see [AL14, BJ16, Zw012]. Since the potential V is bounded, it fits into the $o(\lambda)$ remainder, so that setting $h = 1/\lambda$, we obtain

$$(-h^2\frac{1}{2}\Delta - 1)u_h = o_{L^2}(h). \quad (2.3.4)$$

Thus we observe that the case $P = -\frac{1}{2}\Delta + 1$ yields ‘‘good quasimodes’’, since a precision $o(h)$ allows to provides a fairly accurate description of the asymptotic behavior of u_h as $h \rightarrow 0$ (Proposition 2.2.2). Quasimodes of the form (2.3.4) are related to geometric conditions of the form (UGCC), since the Hamiltonian flow associated with the Laplacian is the geodesic flow. In comparison, in the presence of a confining potential, quasimodes are coarser since their precision is $o(h^{1-\gamma})$ with $\gamma \in (0, 1)$. This phenomenon highlights one of the difficulties of the study of stabilization in the presence of a confining potential: the asymptotic invariance properties of u_λ as $\lambda \rightarrow \infty$ will be slightly more difficult to exhibit than in the ‘‘free case’’ $V(x) = 1$ where the dynamics is driven by the Laplacian only. Sharp concentration properties of quasimodes appear at *second-microlocal* scales. Another difficulty arising from the presence of a confining potential is the fact that the trajectories of the classical dynamics may have ‘‘turning points’’ at which the classical particles’ momentum vanishes. These points are those at which the classical energy equals the potential energy, that is to say $p(x, \xi) = V(x)$.² This situation occurs typically at points where the trajectories of the Hamiltonian flow $(\varphi^t)_{t \in \mathbf{R}}$ are transversal to the zero section $\mathbf{R}^d \times \{0\} \subset T^*\mathbf{R}^d$.

2. To be more specific, observe that in the case of $p(x, \xi) = |x|^{2m} + \frac{1}{2}|\xi|^2$ with $m > 0$, turning points are the phase space points $(x, 0)$ with $|x| = 1$ on the energy shell $\{p = 1\}$ where the energy of quasimodes concentrate.

2.4. A priori conditions of stabilization: Proof of Proposition 2.1.2

This section is devoted to the proof of Proposition 2.1.2. In Subsection 2.4.1, we give a quasi-mode construction which allows to prove the necessary condition of Proposition 2.1.2. Then in Subsection 2.4.2, we show that the energy of quasimodes escapes from any compact set and we prove the sufficient condition of Proposition 2.1.2.

2.4.1. A priori necessary condition

In order to investigate the necessary condition of uniform stability, we construct $o(\lambda)$ -quasimodes for P by constructing quasi-modes for the Laplacian, whose potential energy fits in the remainder term. This is done by using wave-packets concentrating along straight lines, giving rise to the necessity of (UGCC).

Proposition 2.4.1 (Construction of kinetic quasimodes). *Let P be the operator defined in (2.1.2) with a potential V subject to (2.1.3). Let $(x_n, \nu_n)_{n \in \mathbf{N}}$ be a sequence in \mathbf{SR}^d , and let $(t_n)_{n \in \mathbf{N}}$ and $(r_n)_{n \in \mathbf{N}}$ be sequences of real positive numbers such that $t_n \rightarrow +\infty$ and $r_n \rightarrow 0$ as $n \rightarrow \infty$. Define a sequence $(\lambda_n)_{n \in \mathbf{N}}$ by*

$$\lambda_n = \max \left\{ \frac{(n+1)^2}{r_n^2}, n \|V\|_{L^\infty(B_{t_n}(x_n))} \right\}, \quad \forall n \in \mathbf{N}.$$

Note that $\lambda_n \rightarrow +\infty$ as $n \rightarrow \infty$. Set $\rho_n = (x_n, \lambda_n \nu_n)$, and denote by Σ_n the automorphism of \mathbf{R}^d defined by

$$\Sigma_n = t_n |\nu_n\rangle \langle \nu_n| + \frac{n+1}{\sqrt{\lambda_n}} (1 - |\nu_n\rangle \langle \nu_n|),$$

where $|\nu_n\rangle \langle \nu_n|$ (resp. $1 - |\nu_n\rangle \langle \nu_n|$) is the orthogonal projection onto $\text{span } \nu_n$ (resp. $\text{span } \nu_n^\perp$). Further denote by M_n the dilation operator acting on $L^2(\mathbf{R}^d)$ as $(M_n f)(x) = |\det \Sigma_n|^{-1/2} f(\Sigma_n^{-1} x)$, and recall that T_{ρ_n} is the phase-space translation operator associated with ρ_n . Then if we fix $k \in C_c^\infty(\mathbf{R}^d)$ satisfying $\|k\|_{L^2} = 1$ and $\text{supp } k \subset B_1(0)$, the functions

$$u_n := T_{\rho_n} M_n k, \quad n \in \mathbf{N},$$

form a $o(\lambda_n)$ -quasimode of P , that is $\|u_n\|_{L^2} = 1, \forall n \in \mathbf{N}$ and $(P - \lambda_n^2)u_n = o_{L^2}(\lambda_n)$ as $n \rightarrow \infty$.

Proof. First note that since T_{ρ_n} and M_n are unitary, the u_n 's are normalized in L^2 , and they are also C_c^∞ , so that they belong to the domain of P . In the proof, we will use the following observation:

$$\|\Sigma_n\|_{\mathcal{L}(\mathbf{R}^d)} \leq t_n \quad \text{and} \quad \|\Sigma_n^{-1}\|_{\mathcal{L}(\mathbf{R}^d)} \leq \frac{\sqrt{\lambda_n}}{n+1} = o(\sqrt{\lambda_n}) \quad \text{for } n \text{ large enough.} \quad (2.4.1)$$

It essentially comes from the assumption $t_n \rightarrow +\infty$ and the fact that $(n+1)/\sqrt{\lambda_n} \leq r_n \rightarrow 0$ as $n \rightarrow \infty$.

Then notice that the potential term $V u_n$ is negligible. Indeed, the operators T_{ρ_n} and M_n being unitary, we have

$$\begin{aligned} \|V u_n\|_{L^2} &= \|M_n^* T_{\rho_n}^* V u_n\|_{L^2} = \|M_n^* T_{\rho_n}^* V T_{\rho_n} M_n k\|_{L^2} = \|V(x_n + \Sigma_n x) k(x)\|_{L^2_x} \\ &\leq \|V\|_{L^\infty(x_n + \Sigma_n \text{supp } k)} \|k\|_{L^2}. \end{aligned}$$

Yet $\text{supp } k \subset B_1(0)$, so that using (2.4.1), $x_n + \Sigma_n \text{supp } k \subset B_{t_n}(x_n)$. It follows that

$$\|V u_n\|_{L^2} \leq \|V\|_{L^\infty(B_{t_n}(x_n))} \leq \lambda_n/n = o(\lambda_n) \quad (2.4.2)$$

by definition of λ_n . Thus in order to conclude the proof of the proposition, we would like to prove that $(u_n)_{n \in \mathbf{N}}$ is a quasimode of the Laplacian. To do this, it will be more convenient to proceed on the Fourier side, and prove that $(|\xi|^2 - \lambda_n^2) \mathcal{F} u_n = o_{L^2}(\lambda_n)$. Recall from (2.2.4) that the translation

operators enjoy the intertwining relations $\mathcal{F} T_{\rho_n} = T_{J\rho_n} \mathcal{F}$, and also that for dilation operators $\mathcal{F} M_n = M_n^* \mathcal{F}$, so that $\mathcal{F} u_n = T_{J\rho_n} M_n^* \mathcal{F} k$. Accordingly,

$$\begin{aligned} M_n T_{J\rho_n}^* \left(|\xi|^2 - \lambda_n^2 \right) \mathcal{F} u_n(\xi) &= M_n T_{J\rho_n}^* \left(|\xi|^2 - \lambda_n^2 \right) T_{J\rho_n} M_n^* \mathcal{F} k(\xi) = \left(|\lambda_n \nu_n + \Sigma_n^{-1} \xi|^2 - \lambda_n^2 \right) \mathcal{F} k(\xi) \\ &= \left(2\lambda_n \Sigma_n^{-1} \nu_n \cdot \xi + |\Sigma_n^{-1} \xi|^2 \right) \mathcal{F} k(\xi), \end{aligned}$$

where we used the fact that Σ_n^{-1} is symmetric for the last equality. Finally, by definition of Σ_n , it holds $\Sigma_n^{-1} \nu_n = \nu_n / t_n = o(1)$, and as we have seen in (2.4.1), we have $\|\Sigma_n^{-1}\|_{\mathcal{L}(\mathbf{R}^d)} = o(\sqrt{\lambda_n})$. Therefore we get

$$\left\| M_n T_{J\rho_n}^* \left(|\xi|^2 - \lambda_n^2 \right) \mathcal{F} u_n \right\|_{L^2} \leq 2\lambda_n |\Sigma_n^{-1} \nu_n| \|\xi \mathcal{F} k\|_{L^2} + \|\Sigma_n^{-1}\|_{\mathcal{L}(\mathbf{R}^d)}^2 \left\| |\xi|^2 \mathcal{F} k \right\|_{L^2} = o(\lambda_n).$$

Since, again, the translation and dilation operators are unitary, we conclude that $(|\xi|^2 - \lambda_n^2) \mathcal{F} u_n = o_{L^2}(\lambda_n)$. The Plancherel theorem together with (2.4.2) finish the proof. \square

We are now ready to prove that (UGCC) is necessary for stabilization.

Proof of the necessary condition of Proposition 2.1.2. We argue by contradiction: assume (UGCC) is not true. Since (UGCC) is equivalent to (2.1.9) in view of Remark 2.1.3, we deduce that for any $n \in \mathbf{N}^*$, there exist $(x_n, \nu_n) \in S\mathbf{R}^d$ and

$$0 < r_n \leq \min \left\{ \frac{1}{n}, \sqrt{\frac{n}{\|V\|_{L^\infty(B_n(x_n))}}} \right\} \quad (2.4.3)$$

satisfying

$$\int_{-n}^n (b * \kappa_{r_n})(x_n + t\nu_n) dt \leq 2^{-n}. \quad (2.4.4)$$

We will construct a $o(\lambda)$ -quasimode of P concentrating around the rays $\{x_n + t\nu_n : t \in [-n, n]\}$ which is not asymptotically undamped in the sense of Item 2 of Proposition 2.3.2. In \mathbf{R}^d , we define the cylinder with axis $\mathbf{R}\nu_n$, center x_n , length n and radius $\sqrt{3}r_n/2$ by:

$$\mathcal{C}_n = \left\{ y \in \mathbf{R}^d : \text{dist}(y - x_n, \mathbf{R}\nu_n) \leq \frac{\sqrt{3}}{2} r_n, |(y - x_n) \cdot \nu_n| \leq \frac{n}{2} \right\},$$

as well as the (time) interval

$$I_n(y) = \left[(y - x_n) \cdot \nu_n - \frac{r_n}{2}, (y - x_n) \cdot \nu_n + \frac{r_n}{2} \right] \subset \mathbf{R},$$

which depends on $y \in \mathbf{R}^d$. When $y \in \mathcal{C}_n$, we observe that $I_n(y) \subset [-n, n]$ (recall that $r_n \leq 1/n \leq n$ for any $n \in \mathbf{N}^*$). In addition, if $y \in \mathcal{C}_n$ and $t \in I_n(y)$, using the Pythagorean Theorem, it holds

$$\begin{aligned} |x_n - y + t\nu_n|^2 &= |((x_n - y) \cdot \nu_n) + t\nu_n|^2 + |x_n - y - ((x_n - y) \cdot \nu_n) \nu_n|^2 \\ &= |t - (y - x_n) \cdot \nu_n|^2 + \text{dist}(y - x_n, \mathbf{R}\nu_n)^2 \leq \left(\frac{r_n}{2} \right)^2 + \left(\frac{\sqrt{3}}{2} r_n \right)^2 = r_n^2, \end{aligned}$$

which can be reformulated as

$$y \in \mathcal{C}_n, t \in I_n(y) \quad \implies \quad \kappa_{r_n}(x_n - y + t\nu_n) = \frac{1}{r_n^d |B_1(0)|}, \quad (2.4.5)$$

where κ_r is introduced in Proposition 2.1.2. Now from (2.4.4) and the definition of the convolution, we have Therefore, we can prove the following:

$$\begin{aligned} 2^{-n} &\geq \int_{-n}^n (b * \kappa_{r_n})(x_n + t\nu_n) dt = \int_{\mathbf{R}^d} b(y) \int_{-n}^n \kappa_{r_n}(x_n - y + t\nu_n) dt dy \\ &\geq \int_{\mathcal{C}_n} b(y) \frac{1}{2n} \int_{I_n(y)} \kappa_{r_n}(x_n - y + t\nu_n) dt dy. \end{aligned}$$

Then by (2.4.5) we obtain

$$2^{-n} \geq \frac{1}{2nr_n^{d-1}|B_1(0)|} \int_{\mathcal{C}_n} b(y) dy$$

(recall that $I_n(y)$ has length r_n), which yields

$$\int_{\mathcal{C}_n} b(y) dy \leq 2|B_1(0)|nr_n^{d-1}2^{-n}, \quad \forall n \in \mathbf{N}^*.$$

Now we consider $(u_n)_{n \in \mathbf{N}}$ the quasimode of P provided by Proposition 2.4.1 (with $t_n = n/2$ and $r_n/2$ in place of r_n). It comes together with a sequence $(\lambda_n)_{n \in \mathbf{N}}$ so that $(P - \lambda_n^2)u_n = o_{L^2}(\lambda_n)$. Thanks to (2.4.3), the definition of λ_n gives

$$\lambda_n = \left(\frac{n+1}{r_n} \right)^2, \quad \forall n \in \mathbf{N},$$

and recalling the definition of u_n , we see that

$$\text{supp } u_n \subset \mathcal{C}_n \quad \text{and} \quad \|u_n\|_\infty = \frac{\|k\|_\infty}{\sqrt{t_n}} r_n^{-\frac{d-1}{2}}.$$

We conclude that

$$\begin{aligned} |(u_n, bu_n)_{L^2}| &= \int_{\mathcal{C}_n} b(y)|u_n(y)|^2 dy \leq \|u_n\|_\infty^2 \int_{\mathcal{C}_n} b(y) dy \leq \frac{\|k\|_\infty^2}{t_n} \times 2|B_1(0)|n2^{-n} \\ &= 4\|k\|_\infty^2|B_1(0)|2^{-n} \xrightarrow{n \rightarrow \infty} 0. \end{aligned}$$

Therefore by Proposition 2.3.2, (2.1.1) is not uniformly stable, which is the sought result. \square

2.4.2. A priori sufficient condition

We now prepare for the proof of the a priori sufficient condition, which involves semiclassical defect measures associated with quasimodes of the Laplacian. We recall that $\phi^t(x, \xi) = (x + t\xi, \xi)$ is the Hamiltonian flow associated with the function $(x, \xi) \mapsto \frac{1}{2}|\xi|^2$.

Lemma 2.4.2. *Let μ be a nonnegative Radon measure on $T^*\mathbf{R}^d$ having finite mass and satisfying*

$$\text{supp } \mu \subset \{|\xi| = 1\} \quad \text{and} \quad (\phi^t)_* \mu = \mu, \quad \forall t \in \mathbf{R}.$$

Then $\mu = 0$.

Proof. Fix $a \in C_c^\infty(T^*\mathbf{R}^d)$, and let us show that $\int_{T^*\mathbf{R}^d} a d\mu = 0$. Let $\chi \in C_c^\infty(\mathbf{R}_+^*)$ satisfy $\chi(s) = 1$ in a neighborhood of 1, in order that $\chi(|\xi|) = 1$ on the support of μ . Then we have

$$\int_{T^*\mathbf{R}^d} a d\mu = \int_{T^*\mathbf{R}^d} a(x, \xi) \chi(|\xi|) d\mu(x, \xi) = \int_{T^*\mathbf{R}^d} a(x + t\xi, \xi) \chi(|\xi|) d\mu(x, \xi),$$

where we used the flow invariance of μ and $|\xi|$ in the last equality, for any $t \in \mathbf{R}$. By averaging this on $[-T, T]$, for some $T > 0$, we obtain

$$\int_{T^*\mathbf{R}^d} a d\mu = \int_{T^*\mathbf{R}^d} \left(\int_{-T}^T a(x + t\xi, \xi) dt \right) \chi(|\xi|) d\mu(x, \xi). \quad (2.4.6)$$

Since a is compactly supported, there exists $R > 0$ such that $|x| \geq R$ implies $a(x, \xi) = 0$ for all $\xi \in (\mathbf{R}^d)^*$. Also introduce $r := \inf \text{supp } \chi > 0$. Then one can restrict the integration domain in (2.4.6) to the set if $(x, \xi, t) \in T^*\mathbf{R}^d \times \mathbf{R}$ such that

$$|\xi| \geq r \quad \text{and} \quad |x + t\xi| \leq R.$$

Thanks to the reverse triangle inequality, we have for such (x, ξ, t) :

$$\left| |t| - \frac{|x|}{|\xi|} \right| = \frac{1}{|\xi|} \left| |t\xi| - |x| \right| \leq \frac{R}{r}. \quad (2.4.7)$$

For fixed (x, ξ) , the Lebesgue measure of the set of t 's satisfying the constraint (2.4.7) is less than $2R/r$. Therefore

$$\left| \int_{T^*\mathbf{R}^d} a d\mu \right| \leq \frac{1}{2T} \int_{T^*\mathbf{R}^d} \frac{R}{r} \|a\|_\infty |\chi(|\xi|)| d\mu(x, \xi) \leq \frac{R}{2Tr} \|a\|_\infty \|\chi\|_\infty \mu(T^*\mathbf{R}^d).$$

The constants R and r depend only on a and χ respectively, so we obtain the desired conclusion by letting $T \rightarrow \infty$. \square

The next step towards the sufficient condition is to prove that the energy of a semiclassical $o(h)$ -quasimode of the Laplacian always escapes from any compact set in the limit $h \rightarrow 0$.

Proposition 2.4.3. *Let $(u_h)_{h>0}$ be a bounded family in $L^2(\mathbf{R}^d)$ satisfying $(-h^2\Delta - 1)u_h = o_{L^2}(h)$. Then*

$$\int_{\mathbf{R}^d} a |u_h|^2 dx \xrightarrow{h \rightarrow 0} 0, \quad \forall a \in C_c^\infty(\mathbf{R}^d).$$

Proof. Thanks to Proposition 2.2.2, we know that any semiclassical defect measure associated with $(u_h)_{h>0}$ satisfies the hypotheses of Lemma 2.4.2, and therefore is the zero measure. This means that

$$(u_h, \text{Op}_h^w(a)u_h)_{L^2} \xrightarrow{h \rightarrow 0} 0, \quad \forall a \in C_c^\infty(T^*\mathbf{R}^d) \quad (2.4.8)$$

(notice that this limit holds for the whole family $(u_h)_{h>0}$, and not only along a subsequence, by uniqueness of the semiclassical defect measure). Now fix $a \in C_c^\infty(\mathbf{R}^d)$. To finish the proof, we will use a cut-off function in the ξ variable in order to reduce to a compactly supported symbol on $T^*\mathbf{R}^d$ and be able to apply (2.4.8). Let $\chi \in C^\infty(T^*\mathbf{R}^d)$ be a cut-off function that depends only on the ξ variable, has compact support in ξ and equals 1 in a neighborhood of $\{|\xi| = 1\}$. Then we have

$$\text{Op}_h^w((1 - \chi)a)u_h = \text{Op}_h^w\left(\frac{(1 - \chi)a}{|\xi|^2 - 1}\right) \text{Op}_h^w(|\xi|^2 - 1)u_h + O_{L^2}(h) = o_{L^2}(h) + O_{L^2}(h) = o_{L^2}(1).$$

For the first equality, we have used the pseudo-differential calculus (Theorem 2.A.5) with $a_1 = (1 - \chi)a/(|\xi|^2 - 1)$ which is a well-defined symbol in $S(\langle \xi \rangle^{-2})$ since $1 - \chi$ vanishes in a neighborhood of $\{|\xi| = 1\}$, and $a_2 = |\xi|^2 - 1 \in S(\langle \xi \rangle^2)$. Then we use the assumption on $(u_h)_{h>0}$ together with the Calderón-Vaillancourt Theorem (Theorem 2.A.4) to get the second equality. Finally, combining this with (2.4.8), we obtain

$$\int_{\mathbf{R}^d} a |u_h|^2 dx = (u_h, \text{Op}_h^w(\chi a)u_h)_{L^2} + (u_h, \text{Op}_h^w((1 - \chi)a)u_h)_{L^2} \xrightarrow{h \rightarrow 0} 0,$$

which is the sought result. \square

In the following proposition, we show that the escape at infinity of the energy still occurs for any $o(\lambda)$ -quasimode of P , which will pave the way for the subsequent a priori sufficient condition. The basic idea is to turn a given quasimode of P into a semiclassical quasimode of the Laplacian by means of a suitable space cut-off.

Proposition 2.4.4 (Escape from any compact set). *Let P be the operator defined in (2.1.2) with a potential V subject to (2.1.3). Let $(u_\lambda)_\lambda$ be a $o(\lambda)$ -quasimode of P . Then it holds:*

$$\forall a \in C_c^\infty(\mathbf{R}^d), \quad \int_{\mathbf{R}^d} a(x) |u_\lambda(x)|^2 dx \xrightarrow{\lambda \rightarrow \infty} 0.$$

Proof. Let $(u_\lambda)_\lambda$ be a quasimode of P . We set $h = 1/\lambda$ and $u_h = u_\lambda$ so that³

$$(h^2P - 1)u_h = o_{L^2}(h) \quad \text{as } h \rightarrow 0.$$

3. Notice that this corresponds to the semiclassical scaling associated with the free Laplacian (2.2.3) and not the one involving a homogeneous potential (2.3.2).

Pick a cut-off function $\psi \in C_c^\infty(\mathbf{R}^d)$ which is identically equal to 1 in a neighborhood of the origin, in order that $\psi_R(x) = \psi(x/R)$ is identically 1 on $\text{supp } a$ for all R large enough. Define for any $h > 0$:

$$R_h = \sup \left\{ R > 0 : \|\psi_R V\|_{L^\infty} \leq \frac{1}{\sqrt{h}} \right\},$$

which is a finite positive number for all h sufficiently small. It follows from this definition that $\|\psi_{R_h} V\|_{L^\infty} \leq 1/\sqrt{h}$ and that $R_h \rightarrow \infty$ as $h \rightarrow 0$ (recall that V is a confining potential under (2.1.3)). Therefore, setting $v_h = \psi_{R_h} u_h$, we have

$$\begin{aligned} (-h^2 \Delta - 1)v_h &= (-h^2 \Delta \psi_{R_h})u_h - 2h^2 \nabla \psi_{R_h} \cdot \nabla u_h + \psi_{R_h} (h^2 P - 1)u_h - h^2 \psi_{R_h} V u_h \\ &= O_{L^2} \left(\frac{h^2}{R_h^2} \right) - \frac{2h}{R_h} (\nabla \psi) \left(\frac{x}{R_h} \right) \cdot h \nabla u_h + O_{L^2} (h^2 \|\psi_{R_h} V\|_{L^\infty}) + o_{L^2}(h) \\ &= -\frac{2h}{R_h} (\nabla \psi) \left(\frac{x}{R_h} \right) \cdot h \nabla u_h + o_{L^2}(h). \end{aligned} \quad (2.4.9)$$

Yet recall that

$$\frac{1}{2} \|h \nabla u_h\|_{L^2}^2 \leq h^2 \left(\frac{1}{2} \|\nabla u_h\|_{L^2}^2 + \|V^{1/2} u_h\|_{L^2}^2 \right) = \|u_h\|_{L^2}^2 + ((h^2 P - 1)u_h, u_h)_{L^2} = 1 + o_{L^2}(h)$$

(see (2.2.1)). Together with (2.4.9), this implies that $(v_h)_{h>0}$ (which is a bounded family of L^2 functions) is a semiclassical $o(h)$ -quasimode of the Laplacian, that is to say

$$(-h^2 \Delta - 1)v_h = o_{L^2}(h) \quad \text{as } h \rightarrow 0.$$

Now Proposition 2.4.3 yields

$$\int_{\mathbf{R}^d} a |v_h|^2 dx \xrightarrow{h \rightarrow 0} 0, \quad \forall a \in C_c^\infty(\mathbf{R}^d). \quad (2.4.10)$$

The result follows from the fact that $v_h(x) = u_h(x)$ on $\text{supp } a$ for h small enough. \square

Now we can finish the proof of Proposition 2.1.2.

Proof of the sufficient condition of Proposition 2.1.2. We show the converse statement: suppose the damped wave equation (2.1.1) is not uniformly stable. Then by Proposition 2.3.2 there exists a $o(\lambda)$ quasimode of P (see Item (1)) denoted by $(u_\lambda)_\lambda$, which is ‘‘asymptotically undamped’’ (see Item (1)), that is to say $(u_\lambda, b u_\lambda)_{L^2} \rightarrow 0$ as $\lambda \rightarrow \infty$. Let $R > 0$ and $a \in C_c^\infty(\mathbf{R}^d)$ be such that $0 \leq a(x) \leq 1$ for any $x \in \mathbf{R}^d$ and $a(x) = 1$ on $B_R(0)$. Then applying Proposition 2.4.4 we see that

$$\left| \int_{B_R(0)} b |u_\lambda|^2 dx \right| \leq \|b\|_{L^\infty} \int_{B_R(0)} |u_\lambda|^2 dx \leq \|b\|_{L^\infty} \int_{\mathbf{R}^d} a |u_\lambda|^2 dx \xrightarrow{\lambda \rightarrow \infty} 0,$$

which implies that

$$o(1) = (u_\lambda, b u_\lambda)_{L^2} = o(1) + \int_{\mathbf{R}^d \setminus B_R(0)} b |u_\lambda|^2 dx.$$

Writing $b_R = \text{essinf}_{\mathbf{R}^d \setminus B_R(0)} b$, we have, applying Proposition 2.4.4 once more

$$o(1) = \int_{\mathbf{R}^d \setminus B_R(0)} b |u_\lambda|^2 dx \geq b_R \int_{\mathbf{R}^d \setminus B_R(0)} |u_\lambda|^2 dx = b_R (1 + o(1))$$

as $\lambda \rightarrow \infty$, so that $b_R = 0$. Notice that $R > 0$ is arbitrary. Therefore (2.1.8) is not true, which concludes the proof. \square

2.5. Proof of Theorem 2.1.6

In this section we prove Theorem 2.1.6. The rough idea is to construct quasimodes which concentrate in space as much as possible in order to derive the stronger possible necessary condition on b .

We start with a technical lemma to control the growth of the potential.

Lemma 2.5.1. *Let V satisfy (2.1.3) and Assumption (2.1.4). Then here exists a non-increasing function $\epsilon : \mathbf{R}_+^* \mapsto \mathbf{R}_+^*$ tending to zero at infinity, and depending only on V , such that the following assertion holds: for any $\lambda \geq 1$ and $x_0 \in \mathbf{R}^d$ satisfying $V(x_0) \leq \lambda^2$ we have*

$$\forall x \in \bar{B}_{\sqrt{\lambda}}(x_0), \quad |V(x) - V(x_0)| \leq |x - x_0| \lambda^{3/2} \epsilon(\lambda).$$

Proof. Set

$$C = \sup_{z \in \mathbf{R}^d} \frac{|\nabla V(z)|}{4(1+V(z))^{3/4}} < \infty,$$

which is well-defined under Assumption 2.1.4, and set $C_V := (2^{1/4} + C)^3 \geq 1$, which depends only on V . Fix $A_0 > 0$ such that $V(x) \geq 1$ whenever $|x| \geq A_0$ (it exists since V is confining under (2.1.3)) and set

$$\epsilon(\lambda) = C_V \inf_{A \geq A_0} \left(\frac{\|\nabla V\|_{L^\infty(B_A(0))}}{\lambda^{3/2}} + \sup_{|z| \geq A} \frac{|\nabla V(z)|}{V(z)^{3/4}} \right). \quad (2.5.1)$$

From this definition, it is clear that ϵ is well-defined for any $\lambda > 0$, takes positive values (V cannot vanish identically since it is confining) and that it is indeed non-increasing. To show that $\epsilon(\lambda) \rightarrow 0$ as $\lambda \rightarrow +\infty$, we proceed as follows. Let $\eta > 0$. Then we fix $A \geq A_0$ large enough so that the second term in the right-hand side of (2.5.1) is smaller than $\eta/2$ (recall V satisfies $\nabla V(x) = o(V(x)^{3/4})$ as $x \rightarrow \infty$). Then for any $\lambda \geq \|\nabla V\|_{L^\infty(B_A(0))}^{2/3} (2/\eta)^{2/3}$, the first term is smaller than $\eta/2$, which gives $\epsilon(\lambda) \leq \eta$, and η is arbitrary.

Take $\lambda \geq 1$ and $x_0 \in \mathbf{R}^d$ such that $V(x_0) \leq \lambda^2$ as in the statement. Since $x \mapsto (1+V(x))^{1/4}$ is of class C^1 on \mathbf{R}^d , we can apply the mean value inequality to get

$$\forall x \in \bar{B}_{\sqrt{\lambda}}(x_0), \quad \left| (1+V(x))^{1/4} - (1+V(x_0))^{1/4} \right| \leq C|x - x_0| \leq C\sqrt{\lambda}.$$

Recalling that $\lambda \geq 1$, we deduce that for any $x \in \bar{B}_{\sqrt{\lambda}}(x_0)$, it holds

$$(1+V(x))^{3/4} \leq \left((1+V(x_0))^{1/4} + C\sqrt{\lambda} \right)^3 \leq \left((2\lambda^2)^{1/4} + C\sqrt{\lambda} \right)^3 \leq (2^{1/4} + C)^3 \lambda^{3/2} = C_V \lambda^{3/2}.$$

After using the mean value inequality on V , it allows us to obtain for any $x \in \bar{B}_{\sqrt{\lambda}}(x_0)$ and any $A \geq A_0$:

$$\begin{aligned} |V(x) - V(x_0)| &\leq |x - x_0| \sup_{t \in [0,1]} |\nabla V(x_0 + t(x - x_0))| \\ &\leq |x - x_0| \left(\lambda^{3/2} \frac{\|\nabla V(y)\|_{L^\infty(B_A(0))}}{\lambda^{3/2}} + \sup_{y \in B_{\sqrt{\lambda}}(x_0) \setminus B_A(0)} \frac{|\nabla V(y)|}{V(y)^{3/4}} (1+V(y))^{3/4} \right) \\ &\leq C_V |x - x_0| \lambda^{3/2} \left(\frac{\|\nabla V(y)\|_{L^\infty(B_A(0))}}{\lambda^{3/2}} + \sup_{y \in \mathbf{R}^d \setminus B_A(0)} \frac{|\nabla V(y)|}{V(y)^{3/4}} \right), \end{aligned}$$

and the result follows by taking the infimum over $A \geq A_0$. \square

Lemma 2.5.2 (Construction of potential quasimodes). *Let P be the operator defined in (2.1.2) with a potential V subject to (2.1.3). Let $k \in C_c^\infty(\mathbf{R}^d)$ be non-negative, supported in $B_1(0)$ with $\|k\|_{L^2} = 1$. There exists $C > 0$ and $M > 0$ such that for any $R \geq 1$ and any $x_0 \in \mathbf{R}^d$ with $|x_0| \geq M$, the function u defined by*

$$u(x) = r^{-d/2} k\left(\frac{x - x_0}{r}\right), \quad x \in \mathbf{R}^d, r = \frac{R}{V(x_0)^{1/4}},$$

satisfies

$$\|u\|_{L^2} = 1 \quad \text{and} \quad \|(P - \lambda^2)u\|_{L^2} \leq C\lambda \left(\frac{1}{R^2} + R\epsilon(\lambda) \right) \quad \text{where } \lambda = p(x_0, 0)^{1/2} = V(x_0)^{1/2},$$

Here ϵ is the function from Lemma 2.5.1 associated with V and the constant C depends only on the dimension d and the choice of k .

Proof. The claim that $\|u\|_{L^2} = 1$ follows from the fact that $\|k\|_{L^2} = 1$ and the operator $M_r : f \mapsto r^{-d/2}f(\bullet/r)$ is unitary.

We estimate the Laplacian of u : we have

$$\|\Delta u\|_{L^2} = \left\| \frac{1}{r^2} M_r(\Delta k) \right\|_{L^2} \leq \frac{\lambda}{R^2} \|\Delta k\|_{L^2}.$$

We estimate the potential energy now: using Lemma 2.5.1, we have

$$\|(V - \lambda^2)u\|_{L^2} \leq \lambda^{3/2} \epsilon(\lambda) \| \bullet - x_0 |u \|_{L^2} = \lambda R \epsilon(\lambda) \| M_r \tilde{k} \|_{L^2} = \lambda R \epsilon(\lambda) \|\tilde{k}\|_{L^2},$$

where $\tilde{k}(x) = |x - x_0|k(x - x_0)$. Lemma 2.5.1 works here provided $|x_0| \geq M$ is large enough so that $\lambda = V(x_0)^{1/2} \geq 1$ (recall that V is confining). We obtain the desired estimate. \square

Now we prove Theorem 2.1.6.

Proof of Theorem 2.1.6. We show the converse statement. We know by Proposition 2.1.2 that (UGCC) is necessary. Thus, we assume that (TPC) is violated and prove that uniform stability fails. In virtue of Proposition 2.3.2, it suffices to exhibit a family of normalized L^2 functions $(u_\lambda)_\lambda$ in $\text{dom } P$ such that

$$(P - \lambda^2)u_\lambda = o_{L^2}(\lambda) \quad \text{and} \quad (u_\lambda, bu_\lambda)_{L^2}$$

as $\lambda \rightarrow \infty$.

That (TPC) does not hold implies that

$$\forall n \in \mathbf{N}, \quad \int_{B_{R_n/V(x_{n,k})^{1/4}(x_n)}} b(y) dy \xrightarrow[k \rightarrow \infty]{} 0, \quad R_n := n + 1,$$

along a sequence of points $x_{n,k} \rightarrow \infty$ in \mathbf{R}^d . For all $n \in \mathbf{N}$, we set $x_n := x_{n,k_n}$ where k_n is chosen sufficiently large in such a way that

$$\forall n \in \mathbf{N}, \quad \int_{B_{R_n/V(x_n)^{1/4}(x_n)}} b(y) dy \leq 2^{-n} \quad \text{and} \quad R_n \leq \frac{1}{\sqrt{\epsilon(\sqrt{V(x_n)}})}, \quad (2.5.2)$$

where ϵ is the function associated with V introduced in Lemma 2.5.1. This is possible since V is confining and $\epsilon(\lambda) \rightarrow 0$ as $\lambda \rightarrow +\infty$. Moreover, defining $\lambda_n = V(x_n)^{1/2}$ we can apply Lemma 2.5.2 to obtain a sequence of L^2 normalized functions $(u_n)_{n \in \mathbf{N}}$ satisfying for any n large enough

$$\|(P - \lambda_n^2)u_n\|_{L^2} \leq C\lambda_n \left(\frac{1}{R_n^2} + R_n\epsilon(\lambda_n) \right) = \lambda_n O \left(\frac{1}{(n+1)^2} + \sqrt{\epsilon(\lambda_n)} \right) = o(\lambda_n),$$

since $\epsilon(\lambda) \rightarrow 0$ as $\lambda \rightarrow +\infty$. Therefore $(u_n)_{n \in \mathbf{N}}$ is a $o(\lambda_n)$ -quasimode of P . It remains to prove that it is asymptotically undamped in the sense of Item 2 of Proposition 2.3.2. By definition of u_n in Lemma 2.5.2, we have

$$0 \leq \int_{\mathbf{R}^d} |u_n(x)|^2 b(y) dy \leq \frac{\|k\|_{L^\infty}^2}{(R_n/V(x_n)^{1/4})^d} \int_{B_{R_n/V(x_n)^{1/4}(x_n)}} b(y) dy \leq |B_1(0)| 2^{-n} \|k\|_{L^\infty}^2, \quad \forall n \in \mathbf{N},$$

where we used (2.5.2) in the last inequality. This tends to zero as $n \rightarrow \infty$, and the proof is complete. \square

As an application of Theorem 2.1.6, we have the following.

Proof of Corollary 2.1.7. We already know that b bounded from below outside a compact set is a sufficient condition by Proposition 2.1.2. Conversely, it is necessary that (TPC) holds in virtue of Theorem 2.1.6, namely

$$\exists c > 0, \exists R > 0 : \quad \liminf_{x \rightarrow \infty} \int_{B_{R/V(x)^{1/4}}(x)} b(y) dy \geq c. \quad (2.5.3)$$

Yet since b is uniformly continuous, there exists $\varepsilon > 0$ such that for any $x, y \in \mathbf{R}^d$ such that $|x - y| \leq \varepsilon$, we have $|b(x) - b(y)| \leq c/3$. Now by choosing a parameter $r > 0$ large enough, we can achieve two things: on the one hand, in view of the lower limit in (2.5.3), we can secure

$$\forall |x| \geq r, \quad \int_{B_{R/V(x)^{1/4}}(x)} b(y) dy \geq \frac{2}{3}c;$$

on the other hand, since V is a confining potential, we can ensure that $R/V(x)^{1/4} \leq \varepsilon$ for all $|x| \geq r$. In particular, for any such x , there exists $y \in B_{R/V(x)^{1/4}}(x)$ such that $b(y) \geq 2c/3$. We conclude that $b(x) \geq b(y) - c/3 \geq c/3$ since $|x - y| \leq \varepsilon$, which completes the proof. \square

2.6. Stabilization condition

In this section, we prove Proposition 2.1.9. A noteworthy consequence of Assumption 2.1.4 is that trajectories of the Hamiltonian flow $(\varphi^t)_{t \in \mathbf{R}}$ are well-approximated around a given point by their tangent for small times, as shown below.

For the sequel, it is convenient to introduce new variables adapted to the typical scales of our problem described in (2.1.11). The underlying classical system is ruled by the Hamiltonian flow $(x, \xi) \mapsto \varphi^t(x, \xi) = (x^t, \xi^t)$, i.e. the o.d.e. system (2.1.10). Suppose the trajectory is contained in the energy shell $\{p = \lambda^2\}$. We set $s = t\lambda$ and to consider the reparametrization $s \mapsto (x^{s/\lambda}, \xi^{s/\lambda})$. In doing so, we observe that the fact that $\xi^{s/\lambda}$ is the time derivative of $x^{s/\lambda}$ (with respect to s) is not true anymore. To correct this issue, we set

$$\phi_\lambda^s(x, \xi) := (y_s^\lambda, \eta_s^\lambda) = \left(x_{s/\lambda}, \frac{1}{\lambda} \xi_{s/\lambda} \right), \quad (2.6.1)$$

which in turn satisfies

$$\begin{cases} \dot{y}_s^\lambda = \eta_s^\lambda \\ \dot{\eta}_s^\lambda = -\frac{1}{\lambda^2} \nabla V(y_s^\lambda) \end{cases} \quad \text{and} \quad p(y_s^\lambda, \lambda \eta_s^\lambda) = V(y_s^\lambda) + \frac{\lambda^2}{2} |\eta_s^\lambda|^2 = \lambda^2, \quad \forall s \in \mathbf{R}. \quad (2.6.2)$$

Lemma 2.6.1. *Suppose V is subject to (2.1.3) and Assumption 2.1.4. Recall the function ϵ from Lemma 2.5.1. Then for any fixed $T > 0, \lambda > 0$, given $(x, \xi) \in \{p = \lambda^2\}$, and $(y_s^\lambda, \eta_s^\lambda) = \phi_\lambda^s(x, \xi)$ defined in (2.6.1), we have:*

$$\forall s \in [-T, T], \quad |\eta_s^\lambda - \eta| \leq \frac{T}{\sqrt{\lambda}} \epsilon(\lambda) \quad \text{and} \quad |y_s^\lambda - (y + s\eta)| \leq \frac{T^2}{\sqrt{\lambda}} \epsilon(\lambda).$$

Proof. Recalling the o.d.e. system (2.6.2) satisfied by $s \mapsto (y_s^\lambda, \eta_s^\lambda)$, we have

$$\frac{d}{ds} \eta_s^\lambda = -\frac{1}{\lambda^2} \nabla V(y_s^\lambda). \quad (2.6.3)$$

Therefore, using the mean value inequality, we have for any $s \in [-T, T]$:

$$|\eta_s^\lambda - \eta| = \left| \int_0^s -\frac{1}{\lambda^2} \nabla V(y_\tau^\lambda) d\tau \right| \leq \frac{T}{\lambda^2} \sup_{s \in [-T, T]} |\nabla V(y_s^\lambda)| = \frac{T}{\sqrt{\lambda}} \sup_{s \in [-T, T]} \frac{|\nabla V(y_s^\lambda)|}{\lambda^{3/2}}. \quad (2.6.4)$$

Yet for any $A \geq A_0$, we have

$$\sup_{s \in [-T, T]} \frac{|\nabla V(y_s^\lambda)|}{\lambda^{3/2}} \leq \frac{\|\nabla V\|_{L^\infty(B_A(0))}}{\lambda^{3/2}} + \sup_{\substack{s \in [-T, T] \\ |y_s^\lambda| \geq A}} \frac{|\nabla V(y_s^\lambda)|}{\lambda^{3/2}} \leq \frac{\|\nabla V\|_{L^\infty(B_A(0))}}{\lambda^{3/2}} + \sup_{|z| \geq A} \frac{|\nabla V(z)|}{V(z)^{3/4}},$$

where we used the inequality $V(y_s^\lambda) \leq \lambda^2$, as a consequence of the fact that p is preserved by the Hamiltonian flow, namely $p(y_s^\lambda, \lambda \eta_s^\lambda) = \lambda^2, \forall s \in \mathbf{R}$ with our new variables. Combining this estimate with (2.6.4) and taking the infimum over $A \geq A_0$ yield the sought estimate for $|\eta_s^\lambda - \eta|$. Subsequently, applying the mean value inequality on $y_s^\lambda - (y + s\eta)$, we obtain for any $s \in [-T, T]$:

$$|y_s^\lambda - (y + s\eta)| \leq T \sup_{s \in [-T, T]} |\eta_s^\lambda - \eta| \leq \frac{T^2}{\sqrt{\lambda}} \epsilon(\lambda),$$

which finishes the proof. \square

Proof of Proposition 2.1.9. Assume (DSC) holds for a fixed $b \in L^\infty(\mathbf{R}^d)$ with constants $T, R > 0$. First we prove that (UGCC) holds (in fact we show (2.1.9), see Remark 2.1.3). From (DSC), there exist constants $c, \lambda_0 > 0$ such that, if we pick an arbitrary point $(x_0, \nu_0) \in S\mathbf{R}^d$, considering $\rho_\lambda = (x_0, \lambda \nu_0) \in T^*\mathbf{R}^d$, we have

$$\forall \lambda \geq \lambda_0, \quad \int_{-T}^T \left(b * \kappa_{R/\sqrt{\lambda}} \right) \left(\varphi_{t/\tilde{\lambda}}(\rho_\lambda) \right) dt \geq c, \quad (2.6.5)$$

where $\tilde{\lambda} := p(\rho_\lambda)$. Notice that $\tilde{\lambda} \sim \lambda$ as $\lambda \rightarrow +\infty$. Yet using Lemma 2.6.1, we have $(\pi \circ \varphi_{t/\tilde{\lambda}})(\rho_\lambda) = x_0 + t\nu_0 + o(T^2/\sqrt{\tilde{\lambda}})$ as $\lambda \rightarrow +\infty$ uniformly in $t \in [-T, T]$, so that

$$\begin{aligned} & \left| \int_{-T}^T \left(b * \kappa_{R/\sqrt{\tilde{\lambda}}} \right) (x_0 + t\nu_0) dt - \int_{-T}^T \left(b * \kappa_{R/\sqrt{\tilde{\lambda}}} \right) \left(\varphi_{t/\tilde{\lambda}}(\rho_\lambda) \right) dt \right| \\ & \leq \|b\|_{L^\infty} \left\| \kappa_{R/\sqrt{\tilde{\lambda}}} \left(\bullet + x_0 + t\nu_0 - (\pi \circ \varphi_{t/\tilde{\lambda}})(\rho_\lambda) \right) - \kappa_{R/\sqrt{\tilde{\lambda}}} \right\|_{L^1} \\ & = \|b\|_{L^\infty} \left\| \kappa_{R/\sqrt{\tilde{\lambda}}} \left(\bullet + o\left(\frac{T^2}{R}\right) \right) - \kappa \right\|_{L^1}, \end{aligned}$$

using Young's inequality. The right-hand side goes to zero as $\lambda \rightarrow +\infty$ (by dominated convergence for instance) since R and T are independent of λ . Combining this with (2.6.5) yields

$$\int_{-T}^T \left(b * \kappa_{R/\sqrt{\tilde{\lambda}}} \right) (x_0 + t\nu_0) dt \geq c + o(1)$$

as $\lambda \rightarrow \infty$ (or equivalently $\tilde{\lambda} \rightarrow \infty$). This proves that (UGCC) holds.

Next we prove that (TPC) holds. To this aim, we consider an arbitrary sequence of points $\rho_n = (x_n, 0)$ where $x_n \rightarrow \infty$ as $n \rightarrow \infty$ and we write $\lambda_n = \sqrt{V(x_n)}$ (which goes to $+\infty$ since V is a confining potential). Write for simplicity $\lambda_n = \lambda$, $x_n = x_\lambda$ and $\rho_n = \rho_\lambda$. Then we have from (DSC):

$$\exists c, \lambda_0 > 0 : \forall \lambda \geq \lambda_0, \quad \int_{-T}^T \left(b * \kappa_{R/V(x_\lambda)^{1/4}} \right) \left(\varphi_{t/\lambda}(\rho_\lambda) \right) dt \geq c. \quad (2.6.6)$$

Yet using Lemma 2.6.1 once again, we have $(\pi \circ \varphi_{t/\lambda})(\rho_\lambda) = x_\lambda + o(T^2/\sqrt{\lambda})$ as $\lambda \rightarrow +\infty$ uniformly in $t \in [-T, T]$, so that

$$\begin{aligned} & \left| \int_{B_{R/\sqrt{\tilde{\lambda}}}(x_\lambda)} b(y) dy - \int_{-T}^T \left(b * \kappa_{R/\sqrt{\tilde{\lambda}}} \right) \left(\varphi_{t/\lambda}(\rho_\lambda) \right) dt \right| \\ & \leq \|b\|_{L^\infty} \left\| \kappa_{R/\sqrt{\tilde{\lambda}}} - \kappa_{R/\sqrt{\tilde{\lambda}}} \left(\bullet + (\pi \circ \varphi_{t/\lambda})(\rho_\lambda) - x_\lambda \right) \right\|_{L^1} = \|b\|_{L^\infty} \left\| \kappa - \kappa \left(\bullet + o\left(\frac{T^2}{R}\right) \right) \right\|_{L^1}, \end{aligned}$$

which tends to zero again as $\lambda \rightarrow +\infty$. The parameters T and R are fixed, so combining this with (2.6.6) yields

$$\int_{B_{R/\sqrt{\tilde{\lambda}}}(x_\lambda)} b(y) dy \geq c + o(1)$$

as $\lambda \rightarrow \infty$ (or equivalently $\tilde{\lambda} \rightarrow \infty$). This proves that (TPC) holds.

Conversely, suppose (UGCC) holds with constant $T > 0$ and (TPC) holds with constant $R > 0$, both having lower bound $c > 0$. Choose $\tilde{T} = 2T$ and $\tilde{R} = 2R$ so that

$$\left(\frac{R}{\tilde{R}}\right)^4 \leq 1 - \left(\frac{T}{\tilde{T}}\right)^2. \quad (2.6.7)$$

By Lemma 2.6.1 again, we have

$$\left| \int_{-\tilde{T}}^{\tilde{T}} (b * \kappa_{\tilde{R}/\sqrt{\lambda}})(x + t\xi/\lambda) dt - \int_{-\tilde{T}}^{\tilde{T}} (b * \kappa_{\tilde{R}/\sqrt{\lambda}})(\varphi_{t/\lambda}(x, \xi)) dt \right| \xrightarrow{\lambda \rightarrow +\infty} 0, \quad (2.6.8)$$

uniformly in $(x, \xi) \in \{p = \lambda^2\}$. Let $(x, \xi) \in \{p = \lambda^2\}$. We distinguish two regimes.

- Assume first that $|\xi| \geq \lambda/2$. Then use (2.6.8) and change variables in t ($t \mapsto \frac{\lambda}{|\xi|}t$) to obtain

$$\begin{aligned} \int_{-\tilde{T}}^{\tilde{T}} (b * \kappa_{\tilde{R}/\sqrt{\lambda}})(\varphi_{t/\lambda}(x, \xi)) dt &= \int_{-\tilde{T}|\xi|/\lambda}^{\tilde{T}|\xi|/\lambda} (b * \kappa_{\tilde{R}/\sqrt{\lambda}})\left(x + t\frac{\xi}{|\xi|}\right) dt + o(1) \\ &\geq \frac{T\lambda}{\tilde{T}|\xi|} \int_{-T}^T (b * \kappa_{\tilde{R}/\sqrt{\lambda}})\left(x + t\frac{\xi}{|\xi|}\right) dt + o(1) \geq \frac{T}{\sqrt{2}\tilde{T}}c + o(1) \end{aligned}$$

as $\lambda \rightarrow +\infty$. The inequalities come from the lower bound on $|\xi|$, the fact that $|\xi| \leq \sqrt{2}\lambda$ (the potential is non-negative) and the assumption that (UGCC) holds.

- Else, if $|\xi| \leq \lambda/2$, writing $(x_t^\lambda, \xi_t^\lambda) = \varphi_{t/\lambda}(x, \xi)$, we know by Lemma 2.6.1 that $\xi_t^\lambda = \xi + o(\tilde{T}/\sqrt{\lambda})$ as $\lambda \rightarrow +\infty$, so in particular, $|\xi_t^\lambda| \leq \sqrt{2}\lambda/2$ for any λ large enough. Therefore,

$$V(x_t^\lambda) = \lambda^2 - \frac{|\xi_t^\lambda|^2}{2} \geq \lambda^2 - \left(\frac{1}{2}\right)^2 \lambda^2 \geq \left(\frac{1}{2}\right)^4 \lambda^2,$$

which implies that

$$\frac{V(x_\lambda)^{1/4}}{R} \geq \frac{\sqrt{\lambda}}{\tilde{R}}$$

(recall that $\tilde{R} = 2R$), hence $B_{\tilde{R}/\lambda}(x_t^\lambda) \supset B_{R/V(x_t^\lambda)^{1/4}}(x_t^\lambda)$. We deduce that

$$\int_{-\tilde{T}}^{\tilde{T}} (b * \kappa_{\tilde{R}/\sqrt{\lambda}})(\varphi_{t/\lambda}(x, \xi)) dt \geq \int_{-\tilde{T}}^{\tilde{T}} \frac{|B_{R/V(x_t^\lambda)^{1/4}}(x_t^\lambda)|}{|B_{\tilde{R}/\sqrt{\lambda}}(x_t^\lambda)|} \int_{B_{R/V(x_t^\lambda)^{1/4}}(x_t^\lambda)} b(y) dy dt.$$

Yet since $V(x_t^\lambda) \leq \lambda^2$, we have

$$\frac{|B_{R/V(x_t^\lambda)^{1/4}}(x_t^\lambda)|}{|B_{\tilde{R}/\sqrt{\lambda}}(x_t^\lambda)|} = \frac{R^d \lambda^{d/2}}{\tilde{R}^d V(x_t^\lambda)^{d/4}} \geq \left(\frac{R}{\tilde{R}}\right)^d,$$

so that using (TPC), we finally have

$$\int_{-\tilde{T}}^{\tilde{T}} (b * \kappa_{\tilde{R}/\sqrt{\lambda}})((\pi \circ \varphi_{t/\lambda})(x, \xi)) dt \geq \left(\frac{R}{\tilde{R}}\right)^d c + o(1),$$

as $\lambda \rightarrow +\infty$.

This finishes the proof of Proposition 2.1.9. \square

2.A. Pseudo-differential operators

Let us recall some definitions and classical results that we use throughout this article. The material is taken from [Ler10, Zwo12].

Quantization.

One may extend the quantization procedure (2.2.2) to tempered distributions on phase space: given $a \in \mathcal{S}'(T^*\mathbf{R}^d)$ and a couple of test functions $u, v \in \mathcal{S}(\mathbf{R}^d)$, we have the weak formulation of (2.2.2):

$$\int_{\mathbf{R}^d} v(x) \text{Op}^w(a)u(x) dx = \int_{\mathbf{R}^d \times \mathbf{R}^d} a(x, \xi) W[u, v](x, \xi) dx d\xi,$$

where the *Wigner transform* of u and v by

$$W[u, v](x, \xi) = (2\pi)^{-d} \int_{\mathbf{R}^d} v\left(x + \frac{y}{2}\right) u\left(x - \frac{y}{2}\right) e^{i\xi \cdot y} dy.$$

The Wigner transform is a continuous map $\mathcal{S}(\mathbf{R}^d) \times \mathcal{S}(\mathbf{R}^d) \rightarrow \mathcal{S}(\mathbf{R}^{2d})$, which allows to make sense of $\text{Op}^w(a) : \mathcal{S}(\mathbf{R}^d) \rightarrow \mathcal{S}'(\mathbf{R}^d)$ for a tempered distribution $a \in \mathcal{S}'(T^*\mathbf{R}^d)$.

Symbol classes and L^2 boundedness.

We briefly recall classical definitions about order functions and symbol classes.

Definition 2.A.1 (Order function). A measurable function $m : T^*\mathbf{R}^d \rightarrow \mathbf{R}_+$ is called an order function if there exist constants $C > 0$ and $N \in \mathbf{R}$ such that

$$m(\rho_2) \leq C \langle \rho_2 - \rho_1 \rangle^N m(\rho_1), \forall \rho_1, \rho_2 \in T^*\mathbf{R}^d.$$

Note that the product of two order functions is still an order function. Examples of such functions include $\langle x \rangle^N$, $\langle \xi \rangle^N$, $\langle \rho \rangle^N$ for $N \in \mathbf{R}$, etc. Symbol classes attached to these order functions allow to filter symbols according to their growth and the growth of their derivatives.

Definition 2.A.2 (Symbol class $S(m)$). Let m be an order function. The symbol class $S(m)$ is

$$S(m) = \{a \in C^\infty(T^*\mathbf{R}^d) : \forall \alpha \in \mathbf{N}^d, \exists C_\alpha > 0 : |\partial^\alpha a| \leq C_\alpha m\}.$$

For any multi-index $\alpha \in \mathbf{N}^d$, the best constant C_α provides a seminorm, which endows $S(m)$ with a structure of Fréchet space. Note that $\partial^\alpha S(m) \rightarrow S(m)$ is continuous, and that $(a_1, a_2) \mapsto a_1 a_2$ maps $S(m_1) \times S(m_2) \rightarrow S(m_1 m_2)$ continuously.

Since symbols in $S(m)$ have roughly speaking a polynomial growth, as well as their derivatives, we have:

Proposition 2.A.3 ([Zwo12, Theorem 4.16]). *Let m be an order function. Then for any $a \in S(m)$, the operator $\text{Op}_h^w(a)$ maps $\mathcal{S}(\mathbf{R}^d) \rightarrow \mathcal{S}(\mathbf{R}^d)$ and it extends by duality to a continuous operator $\mathcal{S}'(\mathbf{R}^d) \rightarrow \mathcal{S}'(\mathbf{R}^d)$ too.*

The symbols in $S(1)$ (or in $S(m)$ with m bounded) enjoy a good boundedness property on L^2 :

Theorem 2.A.4 (Calderón-Vaillancourt – [Zwo12, Theorem 4.23]). *Let $a \in S(1)$. Then $\text{Op}^w(a)$ can be uniquely extended to a bounded operator $L^2(\mathbf{R}^d) \rightarrow L^2(\mathbf{R}^d)$ with the estimate*

$$\|\text{Op}^w(a)\|_{\mathcal{L}(L^2(\mathbf{R}^d))} \leq C_d \sum_{|\alpha| \leq M_d} \|\partial^\alpha a\|_\infty,$$

where the constants C_d and M_d depend only on the dimension d .

Semiclassical framework and pseudo-differential calculus.

In the usual semiclassical Weyl quantization setting (2.2.3), composition of pseudo-differential operators behaves as follows.

Theorem 2.A.5 (Pseudo-differential Calculus – [Zwo12, Theorem 4.18]). *Let m_1, m_2 be order functions, and let $a_1 \in S(m_1), a_2 \in S(m_2)$. Then we have*

$$\begin{aligned} \text{Op}_h^w(a_1) \text{Op}_h^w(a_2) &= \text{Op}_h^w(a_1 a_2) + h \text{Op}_h^w(r_1(a_1, a_2; h)) \\ &= \text{Op}_h^w(a_1 a_2) - \frac{i\hbar}{2} \text{Op}_h^w(\{a_1, a_2\}) + h^2 \text{Op}_h^w(r_2(a_1, a_2; h)), \end{aligned}$$

as operators on $\mathcal{S}(\mathbf{R}^d)$, where $r_1(\bullet, \bullet; h)$ and $r_2(\bullet, \bullet; h)$ are bilinear maps from $S(m_1) \times S(m_2)$ to $S(m_1 m_2)$ that are continuous uniformly in $h \in (0, 1]$. Here $\{a_1, a_2\} = \partial_\xi a_1 \cdot \partial_x a_2 - \partial_\xi \cdot a_2 \cdot \partial_x a_1$ is the Poisson bracket. In particular, if $m_1 m_2$ is bounded, we have

$$\begin{aligned} \text{Op}_h^{\text{W}}(a_1) \text{Op}_h^{\text{W}}(a_2) &= \text{Op}_h^{\text{W}}(a_1 a_2) + O_{\mathcal{L}(L^2(\mathbf{R}^d))}(h) \\ &= \text{Op}_h^{\text{W}}(a_1 a_2) - \frac{i\hbar}{2} \text{Op}_h^{\text{W}}(\{a_1, a_2\}) + O_{\mathcal{L}(L^2(\mathbf{R}^d))}(h^2), \end{aligned}$$

as operators on $L^2(\mathbf{R}^d)$.

2.B. Miscellaneous results on classical averages

We start this section with a technical remark about (UGCC).

Lemma 2.B.1. *Let $b \in L^\infty(\mathbf{R}^d)$ be non-negative and κ be as in Proposition 2.1.2. Then the condition (UGCC) is equivalent to the following statement:*

$$\exists T > 0, \exists c > 0 : \forall (x_0, \nu_0) \in \mathbf{SR}^d, \quad \liminf_{r \rightarrow 0} \int_{-T}^T (b * \kappa_r)(x_0 + \tau \nu_0) d\tau \geq c. \quad (2.B.1)$$

Proof. Condition (UGCC) clearly implies the property (2.B.1). For the converse, fix $r_0 > 0$, $(x_0, \nu_0) \in \mathbf{SR}^d$ and assume (2.B.1) holds. Using the associative and commutative properties of the convolution together with Fubini's Theorem, for any $r > 0$ we have

$$\begin{aligned} \int_{-T}^T (\kappa_r * (b * \kappa_{r_0}))(x_0 + t\nu_0) dt &= \int_{-T}^T (\kappa_{r_0} * (b * \kappa_r))(x_0 + t\nu_0) dt \\ &= \int_{\mathbf{R}^d} \kappa_{r_0}(y) \int_{-T}^T (b * \kappa_r)(x_0 + t\nu_0 - y) dt dy. \end{aligned}$$

Now letting $r \rightarrow 0$, we observe that the left-hand side tends to $\int_{-T}^T (b * \kappa_{r_0})(x_0 + t\nu_0) dt$ (by the dominated convergence theorem for example, using that $b * \kappa_{r_0}$ is continuous). As for the right-hand side, Fatou's Lemma yields

$$\begin{aligned} \liminf_{r \rightarrow 0} \int_{\mathbf{R}^d} \kappa_{r_0}(y) \int_{-T}^T (b * \kappa_r)(x_0 + t\nu_0 - y) dt dy &\geq \int_{\mathbf{R}^d} \kappa_{r_0}(y) \liminf_{r \rightarrow 0} \int_{-T}^T (b * \kappa_r)(x_0 - y + t\nu_0) dt dy \\ &\geq c \|\kappa\|_{L^1}, \end{aligned}$$

where we used (2.B.1) for the last inequality. Therefore (UGCC) is proved. \square

Notice that when the damping coefficient b is continuous, (2.B.1) proves that (UGCC) is equivalent to

$$\exists T > 0, \exists c > 0 : \forall (x_0, \nu_0) \in \mathbf{SR}^d, \quad \int_{-T}^T b(x_0 + \tau \nu_0) d\tau \geq c.$$

We finally suggest a way to quantify the fact that a function b satisfies (DSC). The relevant quantity seems to be the limit of (DSC) as $(T, R) \rightarrow \infty$, which turns out to exist.

Proposition 2.B.2. *Suppose V is subject to (2.1.3) and Assumption 2.1.4. For any $b \in L^\infty(\mathbf{R}^d)$ non-negative, the limit*

$$\lim_{(T, R) \rightarrow \infty} \liminf_{\lambda \rightarrow +\infty} \inf_{\{p=\lambda^2\}} \left\langle b * \kappa_{R/\sqrt{\lambda}} \right\rangle_{T/\lambda} \quad (2.B.2)$$

exists. Moreover, b satisfies (DSC) if and only if this limit is positive.

Proof of Proposition 2.B.2. Let (T, R) and (\tilde{T}, \tilde{R}) be two couples of positive numbers. First, for any $\lambda \geq 1$ and any $\rho \in \{p = \lambda^2\}$, we have by Fubini's theorem

$$\begin{aligned} & \left| \left\langle \left\langle b * \kappa_{\tilde{R}/\sqrt{\lambda}} * \kappa_{R/\sqrt{\lambda}} \right\rangle_{T/\lambda} \right\rangle_{\tilde{T}/\lambda}(\rho) - \left\langle b * \kappa_{\tilde{R}/\sqrt{\lambda}} * \kappa_{R/\sqrt{\lambda}} \right\rangle_{\tilde{T}/\lambda}(\rho) \right| \\ &= \left| \int_{-T}^T \left(\int_{-\tilde{T}+s}^{\tilde{T}+s} (b * \kappa_{\tilde{R}/\sqrt{\lambda}} * \kappa_{R/\sqrt{\lambda}})(\varphi_{\tau/\lambda}(\rho)) d\tau - \int_{-\tilde{T}}^{\tilde{T}} (b * \kappa_{\tilde{R}/\sqrt{\lambda}} * \kappa_{R/\sqrt{\lambda}})(\varphi_{\tau/\lambda}(\rho)) d\tau \right) ds \right| \\ &= \left| \int_{-T}^T \left(\int_{-\tilde{T}+s}^{\tilde{T}+s} - \int_{-\tilde{T}}^{\tilde{T}} \right) (b * \kappa_{\tilde{R}/\sqrt{\lambda}} * \kappa_{R/\sqrt{\lambda}})(\varphi_{\tau/\lambda}(\rho)) d\tau ds \right| \\ &\leq \int_{-T}^T 2 \frac{|s|}{T} \|b * \kappa_{\tilde{R}/\sqrt{\lambda}} * \kappa_{R/\sqrt{\lambda}}\|_{L^\infty} d\tau ds \leq 2 \frac{T}{\tilde{T}} \|b\|_{L^\infty} \|\kappa\|_{L^1}^2. \end{aligned}$$

Second, we have for all $\rho \in T^*M$:

$$\begin{aligned} & \left| \left\langle b * \kappa_{\tilde{R}/\sqrt{\lambda}} * \kappa_{R/\sqrt{\lambda}} \right\rangle_{\tilde{T}/\lambda}(\rho) - \left\langle b * \kappa_{\tilde{R}/\sqrt{\lambda}} \right\rangle_{\tilde{T}/\lambda}(\rho) \right| \leq \|b * \kappa_{\tilde{R}/\sqrt{\lambda}} * \kappa_{R/\sqrt{\lambda}} - b * \kappa_{\tilde{R}/\sqrt{\lambda}}\|_{L^\infty} \\ &\leq \int_{\mathbf{R}^d} \kappa_{R/\sqrt{\lambda}}(y) \left\| (b * \kappa_{\tilde{R}/\sqrt{\lambda}})(\bullet - y) - b * \kappa_{\tilde{R}/\sqrt{\lambda}} \right\|_{L^\infty} dy \\ &\leq \|\kappa\|_{L^1} \|b\|_{L^\infty} \sup_{y \in B_{R/\sqrt{\lambda}}(0)} \left\| \kappa_{\tilde{R}/\sqrt{\lambda}}(\bullet - y) - \kappa_{\tilde{R}/\sqrt{\lambda}} \right\|_{L^1} \\ &= \|\kappa\|_{L^1} \|b\|_{L^\infty} \sup_{y \in B_1(0)} \left\| \kappa \left(\bullet - y \frac{R}{\tilde{R}} \right) - \kappa \right\|_{L^1}. \end{aligned}$$

In the first inequality, we use a crude L^∞ bound to get rid of the time average $\langle \bullet \rangle_{\tilde{T}/\lambda}$. Then we expand the convolution with $\kappa_{R/\sqrt{\lambda}}$ and use Young's inequality in L^1-L^∞ . Then we apply Young's inequality again to have the third inequality (this time the L^∞ norm falls on b and the L^1 norm on $\kappa_{\tilde{R}/\sqrt{\lambda}}$. The last equality consists in a change of variables. Therefore combining the two estimates, we obtain

$$\left\langle \left\langle b * \kappa_{\tilde{R}/\sqrt{\lambda}} * \kappa_{R/\sqrt{\lambda}} \right\rangle_{\tilde{T}/\lambda} \right\rangle_{T/\lambda}(\rho) = \left\langle b * \kappa_{\tilde{R}/\sqrt{\lambda}} \right\rangle_{\tilde{T}/\lambda}(\rho) + o(1) \quad (2.B.3)$$

as $(\tilde{T}, \tilde{R}) \rightarrow \infty$, uniformly in $\lambda \geq 1$ and $\rho \in \{p = \lambda^2\}$. Now, \tilde{R} being fixed, we want to take the infimum of (2.B.3) over $\rho \in \{p = \lambda^2\}$. For the left-hand side, there is some additional work. Indeed, take $(x_0, \xi_0) \in \{p = \lambda^2\}$ and $y \in B_{\tilde{R}/\sqrt{\lambda}}(0)$. Using Lemma 2.5.1, we know that $|V(x_0 + y) - V(x_0)| = o(\tilde{R}\lambda)$ as $\lambda \rightarrow +\infty$ so that

$$p(x_0 + y, \xi_0) \sim \lambda^2, \quad \text{as } \lambda \rightarrow +\infty, \quad (2.B.4)$$

and by Lemma 2.6.1, we know that

$$(\pi \circ \varphi_{s/\lambda})(x_0, \xi_0) - y = x_0 - y + \frac{s}{\lambda} \xi_0 + o\left(\frac{T^2}{\sqrt{\lambda}}\right) = (\pi \circ \varphi_{s/\lambda})(x_0 - y, \xi_0) + o\left(\frac{T^2}{\sqrt{\lambda}}\right) \quad (2.B.5)$$

as $\lambda \rightarrow +\infty$, uniformly in $s \in [-T, T]$, $(x_0, \xi_0) \in \{p = \lambda^2\}$ and $y \in B_{R/\sqrt{\lambda}}(0)$. We expand the convolution with $\kappa_{\tilde{R}/\sqrt{\lambda}}$

$$\begin{aligned} I &:= \int_{-\tilde{T}}^{\tilde{T}} \int_{-T}^T (b * \kappa_{\tilde{R}/\sqrt{\lambda}} * \kappa_{R/\sqrt{\lambda}})((\pi \circ \varphi_{(t+s)/\lambda})(\rho)) ds dt \\ &= \int_{-\tilde{T}}^{\tilde{T}} \int_{\mathbf{R}^d} \kappa_{\tilde{R}/\sqrt{\lambda}}(y) \int_{-T}^T (b * \kappa_{R/\sqrt{\lambda}})((\pi \circ \varphi_{s/\lambda})(\varphi_{t/\lambda}(\rho)) - y) ds dy dt. \end{aligned} \quad (2.B.6)$$

Writing for short $x' = \pi \circ \varphi_{s/\lambda}(\varphi_{t/\lambda}(\rho)) - y$ and $\tilde{x} = \pi \circ \varphi_{s/\lambda}(\varphi_{t/\lambda}(\rho) - (y, 0))$, we have

$$\begin{aligned} & \left| I - \int_{-\tilde{T}}^{\tilde{T}} \int_{\mathbf{R}^d} \kappa_{\tilde{R}/\sqrt{\lambda}}(y) \int_{-T}^T (b * \kappa_{R/\sqrt{\lambda}}) (\varphi_{s/\lambda}(\varphi_{t/\lambda}(\rho) - (y, 0))) ds dy dt \right| \\ & \leq \|\kappa\|_{L^1} \sup_{\substack{t \in [-\tilde{T}, \tilde{T}] \\ s \in [-T, T]}} \sup_{\substack{\rho \in \{p=\lambda^2\} \\ y \in B_{R/\sqrt{\lambda}}(0)}} \left| (b * \kappa_{R/\sqrt{\lambda}}) (x') - (b * \kappa_{R/\sqrt{\lambda}}) (\tilde{x}) \right|. \end{aligned}$$

We apply (2.B.5) to $(x_0, \xi_0) = \varphi_{t/\lambda}(\rho)$ to deduce that $|x' - \tilde{x}| = o(T^2/\sqrt{\lambda})$, so that

$$\begin{aligned} & \left| (b * \kappa_{R/\sqrt{\lambda}}) (x') - (b * \kappa_{R/\sqrt{\lambda}}) (\tilde{x}) \right| \\ & = \left| \int_{\mathbf{R}^d} (b(x' - y') \kappa_{R/\sqrt{\lambda}}(y') - b(x' - y') \kappa_{R/\sqrt{\lambda}}(y' + \tilde{x} - x')) dy' \right| \\ & \leq \|b\|_{L^\infty} \left\| \kappa - \kappa \left(\bullet + \frac{\tilde{x} - x'}{R/\sqrt{\lambda}} \right) \right\|_{L^1} \xrightarrow{\lambda \rightarrow +\infty} 0, \end{aligned}$$

by dominated convergence. This is uniform in t, s, ρ and y (recall that x' and \tilde{x} depend on all these variables). So we deduce that

$$I = \int_{-\tilde{T}}^{\tilde{T}} \int_{\mathbf{R}^d} \kappa_{\tilde{R}/\sqrt{\lambda}}(y) \int_{-T}^T (b * \kappa_{R/\sqrt{\lambda}}) (\varphi_{s/\lambda}(\varphi_{t/\lambda}(\rho) - (y, 0))) ds dy dt + o(1) \quad (2.B.7)$$

as $\lambda \rightarrow +\infty$, uniformly in $\rho \in \{p = \lambda^2\}$. Now we write $\tilde{\rho} = \varphi_{t/\lambda}(\rho) - (y, 0)$ and we denote by $\tilde{\lambda}$ the real number such that $\tilde{\lambda}^2 = p(\tilde{\rho})$. Bear in mind that $\tilde{\lambda} \sim \lambda$ as $\lambda \rightarrow +\infty$ from (2.B.4). Now by the triangle inequality, we have

$$\begin{aligned} D & := \left| \int_{-T}^T (b * \kappa_{R/\sqrt{\lambda}}) (\varphi_{s/\lambda}(\tilde{\rho})) ds - \int_{-T}^T (b * \kappa_{R/\sqrt{\tilde{\lambda}}}) (\varphi_{s/\tilde{\lambda}}(\tilde{\rho})) ds \right| \\ & \leq \left| \int_{-T}^T (b * \kappa_{R/\sqrt{\lambda}}) (\varphi_{s/\lambda}(\tilde{\rho})) ds - \int_{-T}^T (b * \kappa_{R/\sqrt{\tilde{\lambda}}}) (\varphi_{s/\lambda}(\tilde{\rho})) ds \right| \\ & \quad + \left| \int_{-T}^T (b * \kappa_{R/\sqrt{\tilde{\lambda}}}) (\varphi_{s/\lambda}(\tilde{\rho})) ds - \int_{-T}^T (b * \kappa_{R/\sqrt{\tilde{\lambda}}}) (\varphi_{s/\tilde{\lambda}}(\tilde{\rho})) ds \right|. \end{aligned}$$

Changing variables in the integral over s and using Young's inequality:

$$\begin{aligned} D & \leq \|b\|_{L^\infty} \left\| \kappa_{R/\sqrt{\lambda}} - \kappa_{R/\sqrt{\tilde{\lambda}}} \right\|_{L^1} + \left| \int_{-T}^T (b * \kappa_{R/\sqrt{\tilde{\lambda}}}) (\varphi_{s/\lambda}(\tilde{\rho})) ds - \int_{-T \frac{\lambda}{\tilde{\lambda}}}^{T \frac{\lambda}{\tilde{\lambda}}} (b * \kappa_{R/\sqrt{\tilde{\lambda}}}) (\varphi_{s/\lambda}(\tilde{\rho})) ds \right| \\ & \leq \|b\|_{L^\infty} \left\| \kappa_{\sqrt{\lambda/\tilde{\lambda}}} - \kappa \right\|_{L^1} + \|b\|_{L^\infty} \|\kappa\|_{L^1} \frac{1}{2T \frac{\lambda}{\tilde{\lambda}}} \times 2T \left| \frac{\lambda}{\tilde{\lambda}} - 1 \right|, \end{aligned}$$

which tends to zero as $\lambda \rightarrow +\infty$ (recall (2.B.4)). Therefore plugging $D \rightarrow 0$ into (2.B.7), we deduce that

$$I = \int_{-\tilde{T}}^{\tilde{T}} \int_{\mathbf{R}^d} \kappa_{\tilde{R}/\sqrt{\lambda}}(y) \left\langle b * \kappa_{R/\sqrt{\lambda}} \right\rangle_{T/\tilde{\lambda}}(\tilde{\rho}) dy dt + o(1),$$

hence recalling the definition of I in (2.B.6):

$$\begin{aligned} I & = \int_{-\tilde{T}}^{\tilde{T}} \int_{-T}^T (b * \kappa_{\tilde{R}/\sqrt{\lambda}} * \kappa_{R/\sqrt{\lambda}}) ((\pi \circ \varphi_{(t+s)/\lambda})(\rho)) ds dt \\ & \geq \inf_{\tilde{\lambda} \geq \lambda/2} \inf_{\tilde{\rho} \in \{p=\lambda^2\}} \left\langle b * \kappa_{R/\sqrt{\tilde{\lambda}}} \right\rangle_{T/\tilde{\lambda}}(\tilde{\rho}) \|\kappa\|_{L^1} + o(1) \end{aligned}$$

as $\lambda \rightarrow +\infty$. Taking the infimum over $\rho \in \{p = \lambda^2\}$ yields

$$\inf_{\rho \in \{p = \lambda^2\}} \left\langle \left\langle b * \kappa_{\tilde{R}/\sqrt{\lambda}} * \kappa_{R/\sqrt{\lambda}} \right\rangle_{\tilde{T}/\lambda} \right\rangle_{T/\lambda}(\rho) \geq \inf_{\tilde{\lambda} \geq \lambda/2} \inf_{\tilde{\rho} \in \{p = \tilde{\lambda}^2\}} \left\langle b * \kappa_{R/\sqrt{\tilde{\lambda}}} \right\rangle_{T/\tilde{\lambda}}(\tilde{\rho}) + o(1)$$

and taking lower limits in λ together with (2.B.3) imply:

$$\liminf_{(\tilde{T}, \tilde{R}) \rightarrow \infty} \liminf_{\lambda \rightarrow +\infty} \inf_{\{p = \lambda^2\}} \left\langle b * \kappa_{\tilde{R}/\sqrt{\lambda}} \right\rangle_{\tilde{T}/\lambda} \geq \liminf_{\lambda \rightarrow +\infty} \inf_{\{p = \lambda^2\}} \left\langle b * \kappa_{R/\sqrt{\lambda}} \right\rangle_{T/\lambda}.$$

This estimate proves that if b satisfies (DSC) with constants (T, R) , then the lower limit in (\tilde{T}, \tilde{R}) above is positive, and the converse is straightforward. Taking the upper limit as $(T, R) \rightarrow \infty$ of the right-hand side provides the existence of the limit in (2.B.2). \square

3 - Observability of the Schrödinger equation with subquadratic confining potential in the Euclidean space

This chapter is a reproduction of the article [Pro23], accepted in Analysis & PDE.

We consider the Schrödinger equation in \mathbf{R}^d , $d \geq 1$, with a confining potential growing at most quadratically. Our main theorem characterizes open sets from which observability holds, provided they are sufficiently regular in a certain sense. The observability condition involves the Hamiltonian flow associated with the Schrödinger operator under consideration. It is obtained using semiclassical analysis techniques. It allows to provide with an accurate estimation of the optimal observation time. We illustrate this result with several examples. In the case of two-dimensional harmonic potentials, focusing on conical or rotation-invariant observation sets, we express our observability condition in terms of arithmetical properties of the characteristic frequencies of the oscillator.

3.1. Introduction and main results

We are concerned with the observability of the Schrödinger equation with a confining potential in the Euclidean space:

$$i\partial_t\psi = P\psi, \quad P = V(x) - \frac{1}{2}\Delta, \quad t \in \mathbf{R}, x \in \mathbf{R}^d, \quad (3.1.1)$$

where V is a real-valued potential, bounded from below. Specific assumptions shall be stated below. The general problem reads as follows: we wonder which measurable sets $\omega \subset \mathbf{R}^d$ and times $T > 0$ satisfy

$$\exists C > 0 : \forall u \in L^2(\mathbf{R}^d), \quad \|u\|_{L^2(\mathbf{R}^d)}^2 \leq C \int_0^T \|e^{-itP}u\|_{L^2(\omega)}^2 dt. \quad \text{Obs}(\omega, T)$$

When this property $\text{Obs}(\omega, T)$ is true, we say that the Schrödinger equation (3.1.1) is observable from ω in time T , or that ω observes the Schrödinger equation. The question consists in finding conditions on the pair (ω, T) ensuring that one can recover a fraction of the mass of the initial data u , by observing the solution $\psi(t) = e^{-itP}u$ of (3.1.1) in ω during a time T . We will often call ω the observation set and T the observation time. As for the constant C in the inequality, we will refer to it as the observation cost throughout the text. When an observation set ω is fixed, the infimum of times $T > 0$ such that $\text{Obs}(\omega, T)$ holds is called the optimal observation time, and is denoted by $T_\star = T_\star(\omega)$. It is clear that this so-called observability inequality holds for $\omega = \mathbf{R}^d$ in any time $T > 0$. This is because the propagator solving the Schrödinger equation e^{-itP} is an isometry on $L^2(\mathbf{R}^d)$.¹ But from the viewpoint of applications, one would like to find the smallest possible observation sets and the corresponding optimal times for which the observability inequality holds.

The observability question for Schrödinger-type equations has been extensively investigated over the past decades, mainly in compact domains of \mathbf{R}^d or compact Riemannian manifolds. See the surveys of Laurent [Lau14] or Macià [Mac15] for an overview. In a compact Riemannian manifold, Lebeau showed that the so-called Geometric Control Condition (introduced for the wave equation in [RT74, BLR92]) is sufficient to get observability of the Schrödinger equation in any time $T > 0$ [Leb92b]. This means that all billiard trajectories have to enter the observation set in finite time. See for instance Phung [Phu01] for later developments in Euclidean domains. However, works by Haraux [Har89] and Jaffard [Jaf90] on the torus show that this condition is not always necessary. Since then, considerable efforts have been made to find the good geometric condition characterizing the observability of the Schrödinger equation, depending on the geometrical context. This question

1. Another consequence of this is that the condition $\text{Obs}(\omega, T)$ is “open” with respect to T : if $\text{Obs}(\omega, T)$ is true with cost $C > 0$, then $\text{Obs}(\omega, T - \varepsilon)$ is true as soon as $\varepsilon < 1/C$. See Lemma 3.A.3 in the appendix for a precise statement.

is closely related to that of understanding the concentration or delocalization of Laplace eigenfunctions or quasimodes, which rule the propagation of states through the Schrödinger evolution; see [BZ04]. The latter properties are linked to the behavior of the underlying classical dynamics, which is supposed to drive the quantum dynamics at high frequency. In the literature, mainly two different dynamical situations have been investigated. On the one hand, complete integrability, meaning existence of many conserved quantities, usually features symmetries that result in high multiplicity in the spectrum at the quantum level. This allows for possible concentration of eigenfunctions. On the other hand, chaotic systems, epitomized by the geodesic flow of negatively curved Riemannian manifolds, go along with strong instability properties. For instance, quantum ergodicity states that most² Laplace eigenfunctions are delocalized on manifolds with ergodic geodesic flow. Here we collect a non-exhaustive list of references illustrating this diversity of situations. On the torus, observability was investigated by several authors. In addition to [Har89, Jaf90], let us mention Burq and Zworski [BZ04, BZ12, BZ19], Bourgain, Burq and Zworski [BBZ13], Macià [Mac10], as well as Anantharaman and Macià [AM12, AM14]. General completely integrable systems were studied by Anantharaman, Fermanian Kammerer and Macià [AFKM15]. As for the disk, the question of characterizing open sets from which observability holds was solved by Anantharaman, Léautaud and Macià [ALM16a, ALM16b]. Macià and Rivière thoroughly described what happens on the sphere and on Zoll manifolds [MR16, MR19]. In the negatively curved setting, we refer to Anantharaman [Ana08], Anantharaman and Rivière [AR12], Eswarathan and Rivière [ER17], Dyatlov and Jin [DJ18], Jin [Jin18] and recently Dyatlov, Jin and Nonnenmacher [DJN22]. See also Privat, Trélat and Zuazua [PTZ16] in connection with quantum ergodicity.

Recently, there has been a growing interest in the question of observability for the Schrödinger equation in the Euclidean space, for which new difficulties arise due to the presence of infinity in space. Täufer [Tä22] deals with the observability of the free Schrödinger equation in \mathbf{R}^d , showing that it is observable from any non-empty periodic open set in any positive time. It relies on the Floquet-Bloch transform and the theory of lacunary Fourier series. It was later generalized by Le Bal'ch and Martin [LBM23] to the case of periodic measurable observation sets with a periodic L^∞ potential, in dimension 2. In [HWW22], Huang, Wang and Wang characterize measurable sets for which the Schrödinger equation (3.1.1) is observable, in dimension $d = 1$ when $V(x) = |x|^{2m}$, $m \in \mathbf{N}$. They prove that, in the case where $m = 1$ (resp. $m \geq 2$), one has observability from $\omega \subset \mathbf{R}$ in some time (resp. in any time) if and only if

$$\liminf_{x \rightarrow +\infty} \frac{|\omega \cap [-x, x]|}{|[-x, x]|} > 0, \quad (3.1.2)$$

where $|\bullet|$ is the one-dimensional Lebesgue measure. Such a set is called “weakly thick”. Simultaneously, Martin and Pravda-Starov [MPS21] provided a generalization of this condition in dimension d which turns out to be necessary if $d \geq 1$ and sufficient if $d = 1$ for observability to hold, in the case of the fractional harmonic Schrödinger equation, namely equation (3.1.1) with $P = (-\Delta + |x|^2)^s$, where $s \geq 1$. In the particular cases of potentials or operators discussed above, the techniques that are used, mainly relying on abstract harmonic analysis tools, provide very strong results. However, it seems that more general potentials remain out of reach, since the arguments involved require the knowledge of precise spectral estimates on eigenvalues and eigenfunctions, explicit asymptotics and symmetry properties. Moreover, regarding the case of the harmonic oscillator, the existing results focus on the properties of the sets for which observability holds, but given such a set, they do not give a hint of what would be the minimal time for which the observability inequality holds. In fact they provide an upper bound for this optimal time independent of the open set, corresponding to half a period of the classical harmonic oscillator. But it is reasonable to think that this upper bound can be improved taking into account the geometry of the observation set.

Motivations, assumptions and notation

The present work aims to address the issues discussed above, namely:

- a) find a robust method to prove that the Schrödinger equation is observable from a given set with less restrictions on the dimension or the potential (e.g. variations of the harmonic potential like $x \cdot Ax$ where A is a real symmetric positive-definite $d \times d$ matrix, or potentials of the form $\langle x \rangle^{2m}$ with $m > 0$ a real number);

² In fact, the situation is more complicated due to the possible existence of a sparse subsequence of eigenmodes concentrating around unstable closed classical trajectories—a phenomenon known as scarring.

- b) provide a more accurate upper bound for the optimal observation time depending on the shape of the observation set.

Throughout this work, we make the following assumptions on the potential:

Assumption 3.1.1. *The potential V is C^∞ smooth and satisfies*

$$\exists m > 0, \exists C, r > 0 : \forall |x| \geq r \quad \frac{1}{C} \langle x \rangle^{2m} \leq V(x) \leq C \langle x \rangle^{2m}, \quad (3.1.3)$$

$$\forall \alpha \in \mathbf{N}^d, \exists C_\alpha > 0 : \forall x \in \mathbf{R}^d, \quad |\partial^\alpha V(x)| \leq C_\alpha \langle x \rangle^{2m-|\alpha|}. \quad (3.1.4)$$

Unless stated otherwise, we assume that the potential is subquadratic, namely $0 < m \leq 1$.

Throughout the article, we shall refer to the left-hand side inequality in (3.1.3) by saying that the potential is *elliptic*. In addition, the notion of *principal symbol* that we will use is made clear below.

Definition 3.1.2 (Principal symbol). Let V_0 and V be two potentials satisfying Assumption 3.1.1 above with a power $m > 0$. We say that V_0 and V have the same principal symbol if

$$\forall \alpha \in \mathbf{N}^d, \exists C_\alpha > 0 : \forall x \in \mathbf{R}^d, \quad |\partial^\alpha (V - V_0)(x)| \leq C_\alpha \langle x \rangle^{2m-1-|\alpha|}.$$

This defines an equivalence relation. The equivalence class of such a potential V is called the principal symbol of V .

Classical spectral theory arguments ensure that the operator $V(x) - \frac{1}{2}\Delta$ with domain $C_c^\infty(\mathbf{R}^d)$ is essentially self-adjoint (from now on, its closure will be denoted by P) and that the evolution problem (3.1.1) on $L^2(\mathbf{R}^d)$ is well-posed. In fact, most of our results will depend only on the principal symbol of V , namely they will not depend on perturbations of the potential of order $\langle x \rangle^{2m-1}$.

Our strategy emphasizes the role of the underlying classical dynamics ruling the evolution of high-energy solutions to the Schrödinger equation (3.1.1), by means of the so-called quantum-classical correspondence principle. This motivates the introduction of the symbol of the operator P , defined by

$$p(x, \xi) := V(x) + \frac{|\xi|^2}{2}, \quad (x, \xi) \in \mathbf{R}^{2d}.$$

This is a smooth function on the phase space $\mathbf{R}^{2d} \simeq \mathbf{R}_x^d \times \mathbf{R}_\xi^d$, tending to $+\infty$ as $(x, \xi) \rightarrow \infty$, since the potential is elliptic. Throughout this text, typical phase space points will be denoted by $\rho = (x, \xi)$, and we will sometimes use the notation $\pi : \mathbf{R}^{2d} \rightarrow \mathbf{R}^d$ for the projection $(x, \xi) \mapsto x$. We will often refer to p as the classical Hamiltonian, and to its quantization P as the quantum Hamiltonian. The Hamiltonian flow $(\phi^t)_{t \in \mathbf{R}}$ on \mathbf{R}^{2d} , which preserves p , is defined as the flow generated by the Hamilton equation:

$$\frac{d}{dt} \phi^t(\rho) = J \nabla p(\phi^t(\rho)), \quad \phi^0(\rho) = \rho. \quad (3.1.5)$$

It is well-defined for all times under our assumptions. Here $J = \begin{pmatrix} 0 & I_d \\ -I_d & 0 \end{pmatrix}$ is the symplectic matrix. Introducing $(x^t, \xi^t) = \phi^t(\rho)$ the position and momentum components of the flow, this can be rewritten as

$$\begin{cases} \frac{d}{dt} x^t = \xi^t \\ \frac{d}{dt} \xi^t = -\nabla V(x^t) \end{cases}, \quad (x^0, \xi^0) = \rho. \quad (3.1.6)$$

In the sequel, we will refer to the x -component of a trajectory of the Hamiltonian flow as a *projected trajectory*.

3.1.1. Main result

Let us insist on the fact that the result below applies for confining potentials having a subquadratic growth, i.e. $0 < m \leq 1$. We will explain later why we restrict ourselves to this case. Throughout the article, the open ball of radius r centered at $x \in \mathbf{R}^d$ is denoted by $B_r(x)$. Our main result reads as follows.

Theorem 3.1.3. *Let V_0 and V be potentials on \mathbf{R}^d satisfying Assumption 3.1.1 with some $m \in (0, 1]$, having the same principal symbol. Set $P = V(x) - \frac{1}{2}\Delta$ and denote by e^{-itP} the propagator solving the Schrödinger equation*

$$i\partial_t\psi = P\psi.$$

Also denote by $(\phi_0^t)_{t \in \mathbf{R}}$ the Hamiltonian flow associated with the symbol $p_0(x, \xi) = V_0(x) + \frac{1}{2}|\xi|^2$. For any Borel set $\omega \subset \mathbf{R}^d$, define for any $R > 0$ the thickened set

$$\omega_R = \bigcup_{x \in \omega} B_R(x),$$

and introduce for any $T > 0$ the classical quantity³

$$\mathfrak{K}_{p_0}^\infty(\omega, T) = \liminf_{\rho \rightarrow \infty} \int_0^T \mathbb{1}_{\omega \times \mathbf{R}^d}(\phi_0^t(\rho)) dt = \liminf_{\rho \rightarrow \infty} |\{t \in (0, T) : (\pi \circ \phi_0^t)(\rho) \in \omega\}|.$$

Fix a Borel set $\omega \subset \mathbf{R}^d$. Then the following two assertions hold:

(i) *(Sufficient condition) Assume there exists $T_0 > 0$ such that*

$$\mathfrak{K}_{p_0}^\infty := \mathfrak{K}_{p_0}^\infty(\omega, T_0) > 0. \quad (3.1.7)$$

Then there exists a constant $L = L(d, T_0, p_0, p) > 0$ such that for $R = \frac{L}{\mathfrak{K}_{p_0}^\infty}$, for any compact set $K \subset \mathbf{R}^d$ and any $T > T_0$, $\text{Obs}(\omega_R \setminus K, T)$ is true, namely:

$$\exists C > 0 : \forall u \in L^2(\mathbf{R}^d), \quad \|u\|_{L^2(\mathbf{R}^d)}^2 \leq C \int_0^T \|e^{-itP}u\|_{L^2(\omega_R \setminus K)}^2 dt.$$

(ii) *(Necessary condition) Assume there exists a time $T > 0$ such that $\text{Obs}(\omega, T)$ is true with cost $C_{\text{obs}} > 0$, that is to say*

$$\forall u \in L^2(\mathbf{R}^d), \quad \|u\|_{L^2(\mathbf{R}^d)}^2 \leq C_{\text{obs}} \int_0^T \|e^{-itP}u\|_{L^2(\omega)}^2 dt. \quad (3.1.8)$$

Then there exists a constant $c = c(d, T, p_0, p)$ such that for any $R \geq 1$ and any compact set $K \subset \mathbf{R}^d$, it holds:

$$\mathfrak{K}_{p_0}^\infty(\omega_R \setminus K, T) \geq \frac{1}{C_{\text{obs}}} - c \frac{(\log R)^{1/2}}{R}.$$

The rest of the introduction is organized as follows: in Subsection 3.1.2, we comment on Theorem 3.1.3 and describe the main ideas of the proof. Then we discuss various examples of application. We begin with examples in dimension 1 in Subsection 3.1.3. In Subsection 3.1.4, we investigate the particular case of harmonic oscillators in two dimensions. We specifically focus on conical and rotation-invariant observation sets in Subsections 3.1.4.1 and 3.1.4.3 respectively. These are cases where one can prove accurate estimates on the optimal observation time—see for instance Proposition 3.1.5. Arithmetical properties of the characteristic frequencies of the harmonic oscillator under consideration also play a key role, as evidenced by Proposition 3.1.10. Then in Subsection 3.1.5, we present other consequences of Theorem 3.1.3 concerning observability of eigenfunctions of the Schrödinger operator P and energy decay of the damped wave equation. Lastly, we discuss the links between our work and the Kato smoothing effect in Subsection 3.1.6, and provide with further explanations regarding the natural semiclassical scaling of the problem and the criticality of quadratic potentials in Subsection 3.1.7.

3. The integral makes sense when ω is Borel. Indeed, the map $(t, \rho) \mapsto \mathbb{1}_{\omega \times \mathbf{R}^d}(\phi_0^t(\rho))$ is then Lebesgue-measurable, so that the same is true for $t \mapsto \mathbb{1}_{\omega \times \mathbf{R}^d}(\phi_0^t(\rho))$ when ρ is fixed. Tonelli's theorem [Ler14, Theorem 4.2.5] then shows that the map $\rho \mapsto \int_0^T \mathbb{1}_{\omega \times \mathbf{R}^d}(\phi_0^t(\rho)) dt$ is Lebesgue-measurable.

3.1.2. Idea of proof and comments

The core of our work consists in establishing a suitable version of Egorov's theorem to relate the evolution through the Schrödinger flow of high-energy initial data on the quantum side, to the action of the associated Hamiltonian flow on the classical side. This is done using semiclassical analysis. To apply this theory, we approximate the indicator function of ω by a smooth and sufficiently flat cut-off function. This is how the larger set ω_R arises. Although Theorem 3.1.3 is not a complete characterization of sets for which observability holds, it provides an almost necessary and sufficient condition of observability, up to thickening the observation set, and it gives sharp results in many concrete situations. See the examples given in Subsections 3.1.3, 3.1.4 and 3.1.5 below. We review remarkable features of this statement.

- The observability condition (3.1.7) we find is reminiscent of the Geometric Control Condition that rules the observability or control of the wave equation in a number of geometrical contexts, especially compact Riemannian manifolds [RT74, BLR88, BLR92]. It reflects the importance of the quantum-classical correspondence in this problem: high-energy solutions to the Schrödinger equation, lifted to phase space, propagate along the trajectories of the Hamiltonian flow. Our constant $\mathfrak{R}_{p_0}^\infty(\omega, T)$ is to some extent different from the one quantifying the Geometric Control Condition for the wave equation (see the constant $C(t)$ of Lebeau [Leb96] or the constant $\mathfrak{R}(T)$ of Laurent and Léautaud [LL16]). Indeed, the latter constant consists in averaging some function (typically the indicator function of ω) along speed-one geodesics in a time interval $[0, T]$. In contrast, our constant $\mathfrak{R}_{p_0}^\infty(\omega, T)$ does the same, except that the length of trajectories tends to infinity as their initial datum ρ goes to infinity in phase space. This is consistent with the infinite speed of propagation of singularities for the Schrödinger equation.
- Let us insist on the fact that the Schrödinger equation (3.1.1) does not contain any semiclassical parameter. Instead, we artificially introduce a semiclassical parameter $R \rightarrow +\infty$, which we use to enlarge the observation set. This is natural in view of the fact that remainders in the quantum-classical correspondence are expressed in terms of derivatives of the symbol under consideration: scaling these symbols by $\frac{1}{R}$ thus produces remainders of the same order.
- On the technical side, the non-compactness of the Euclidean space yields new difficulties. In our problem, the use of semiclassical defect measures seems to be limited to very particular geometries of the observation set: roughly speaking, only homogeneous symbols can be paired with such measures, which would theoretically restrict the scope of the result to conical observation sets. Instead, we use (and prove) a version of Egorov's theorem to study the operator $e^{itP} \mathbb{1}_\omega e^{-itP}$. The idea of using Egorov's theorem was introduced in control theory by Dehman, Lebeau [DL09] and Laurent, Léautaud [LL16]. Of course, we must pay a particular attention to the remainder terms, in connection with the non-compactness of the ambient space. The great advantage of this is that we can describe the evolution of a fairly large class of symbols on the phase space, which in turn allows to study observability for a variety of observation sets.
- Our result is very robust since it is valid for a fairly large class of potentials, with the noteworthy property that the statement only involves the principal symbol of the potential. Indeed, up to enlarging the parameter R , the fact that the dynamical condition (3.1.7) is fulfilled or not in ω_R is independent of the representative of the equivalence class of V_0 (introduced in Definition 3.1.2) chosen to compute $\mathfrak{R}_p^\infty(\omega_R, T)$. This is a consequence of Corollary 3.2.4. This was already evidenced in the context of propagation of singularities for solutions to the perturbed harmonic Schrödinger equation; see Mao and Nakamura [MN09]. The stability under subprincipal perturbation of the potential fails to be true if one considers superquadratic potentials ($m > 1$), as we can see by the examination of the trajectories of the flow. Take V_0 satisfying Assumptions 3.1.1 for some $m > 1$, and perturb this potential with some W behaving like $\langle x \rangle^{2m-1}$. Consider the Hamiltonian flow associated with the potential $V = V_0 + W$. Then the second derivative of a trajectory of the classical flow is given by

$$\frac{d^2}{dx^2} x^t = -\nabla V_0(x^t) - \nabla W(x^t).$$

We remark that the perturbation is of order $\nabla W(x^t) \approx \langle x^t \rangle^{2(m-1)}$, which may blow up when x^t is large. When $m \leq 1$, the perturbation of the trajectory remains bounded, and can

therefore be absorbed by thickening the observation set. See Subsection 3.2.1 and the proof of Theorem 3.1.3 at the end of Section 3.3 for further details.

- At the level of the Hamiltonian flow, the difference between $m \leq 1$ and $m > 1$ can also be understood by looking at the equation solved by the differential of the flow: differentiating the Hamilton equation (3.1.5) yields

$$\frac{d}{dt} d\phi^t(\rho) = J \text{Hess } p(\phi^t(\rho)) d\phi^t(\rho).$$

We deduce that the differential of the flow behaves as

$$|d\phi^t| \lesssim e^{t|\text{Hess } p|},$$

which means that the norm of the Hessian of the Hamiltonian plays the role of a local Lyapunov exponent for the classical dynamics. Yet $\text{Hess } p$ is uniformly bounded on phase space if and only if $m \leq 1$. Incidentally, it is likely that for $m < 1$, one can exploit the decay of $\text{Hess } p$ at infinity in the space variable in order to get small remainders in the proof of Egorov's theorem (see Proposition 3.3.3) instead of taking R large. This might allow to thicken ω by any positive ε rather than by a large parameter R . Since we are mostly interested in quadratic potentials in this work, we chose not to refine our result in this direction.

- It is possible that the necessary condition can be slightly improved by propagating coherent states rather than using Egorov's theorem on quantum observables. This is discussed in more details in Subsection 3.1.4.2.

3.1.3. Examples in dimension 1

The one-dimensional case gives an insight of how the potential can influence the geometry of sets for which observability holds.

3.1.3.1. Harmonic potential

The one-dimensional harmonic oscillator corresponds to $V(x) = \frac{1}{2}x^2$. The Hamiltonian flow reads:

$$\phi^t(x, \xi) = (x \cos t + \xi \sin t, -x \sin t + \xi \cos t), \quad (x, \xi) \in \mathbf{R}^2, t \in \mathbf{R}.$$

Our dynamical condition (3.1.7) can then be written as

$$\liminf_{(x, \xi) \rightarrow \infty} \int_0^T \mathbf{1}_\omega(x \cos t + \xi \sin t) dt > 0.$$

In view of the periodicity of the flow, it is relevant to consider $T = 2\pi$. Under this additional assumption, condition (3.1.7) reduces to

$$\mathfrak{K}^\infty := \liminf_{A \rightarrow \infty} \int_0^{2\pi} \mathbf{1}_\omega(A \sin t) dt > 0, \quad (3.1.9)$$

where A has to be thought as (the square-root of) the energy $p(x, \xi) = \frac{1}{2}(x^2 + \xi^2)$. We claim that this is equivalent to the weak thickness (3.1.2) condition of Huang, Wang and Wang [HWW22]. Suppose that $\mathfrak{K}^\infty > 0$. First, notice that

$$\int_0^{2\pi} \mathbf{1}_\omega(A \sin t) dt = 2 \int_{-\pi/2}^{\pi/2} \mathbf{1}_\omega(A \sin t) dt.$$

Second, fix $c \in (0, \mathfrak{K}^\infty/2)$. Since the integrand is bounded by 1, we can slightly reduce the time interval to $[-\frac{\pi}{2} + \frac{c}{3}, \frac{\pi}{2} - \frac{c}{3}]$ so that $y = A \sin t$ defines a proper change of variables:

$$\begin{aligned} \frac{c}{3} &\leq \liminf_{A \rightarrow \infty} \int_{-\pi/2}^{\pi/2} \mathbf{1}_\omega(A \sin t) dt - \frac{2}{3}c \leq \liminf_{A \rightarrow \infty} \int_{-\frac{\pi}{2} + \frac{c}{3}}^{\frac{\pi}{2} - \frac{c}{3}} \mathbf{1}_\omega(A \sin t) dt \\ &\leq \liminf_{A \rightarrow \infty} \int_{-\frac{\pi}{2} + \frac{c}{3}}^{\frac{\pi}{2} - \frac{c}{3}} \mathbf{1}_\omega(A \sin t) \frac{A|\cos t|}{A \frac{2}{\pi} \times \frac{c}{3}} dt = \frac{3\pi}{2c} \liminf_{A \rightarrow \infty} \frac{1}{A} \int_{-A \sin(\frac{\pi}{2} - \frac{c}{3})}^{A \sin(\frac{\pi}{2} - \frac{c}{3})} \mathbf{1}_\omega(y) dy. \end{aligned}$$

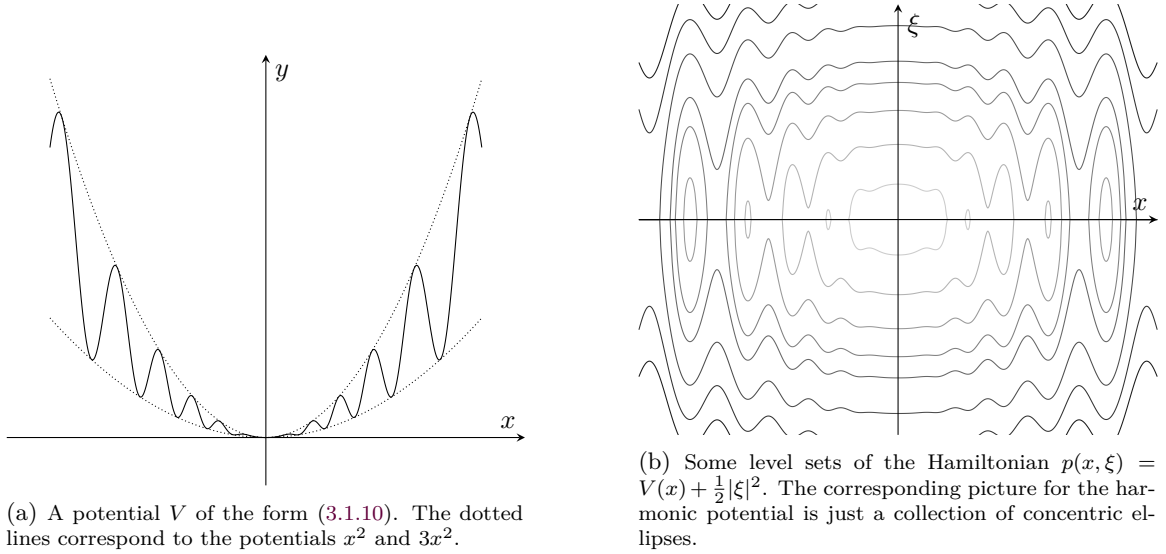

Figure 3.1 – Case of a potential with critical points.

We used the concavity inequality $\cos t \geq 1 - \frac{2}{\pi}|t|$ on $[-\frac{\pi}{2}, \frac{\pi}{2}]$ to get the third inequality. This gives

$$\liminf_{A \rightarrow \infty} \frac{|\omega \cap [-A, A]|}{|[-A, A]|} > 0,$$

namely ω is weakly thick. Conversely, we can follow the same lines, using that the Jacobian $|\cos t|$ is less than 1, to show that any weakly thick set satisfies (3.1.9). Although our main theorem allows to conclude that observability is true only on a slightly larger set, it is more precise than the previous result from [HWW22] with respect to the optimal observation time: we can estimate this optimal time depending on the geometry of the observation set. In addition, our result is stable under subprincipal perturbation of the potential. In particular, weak thickness of ω implies observability from ω_R (for some R given by Theorem 3.1.3) for any potential whose principal symbol is $\frac{1}{2}x^2$ (or any positive multiple of x^2). Anticipating on the next paragraph, observe that a weakly thick set can contain arbitrarily large gaps, hence is not necessarily thick (see [HWW22, Example 4.12]).

3.1.3.2. Potentials having critical points

An interesting phenomenon appears when the potential possesses a sequence of critical points going to infinity. To construct such a potential, we proceed as follows. We set

$$V(x) = (2 + \sin(a \log \langle x \rangle))x^2, \quad x \in \mathbf{R}, \quad (3.1.10)$$

where a is a positive parameter to be chosen properly. See Figure 3.1a for an illustration.

One can check that Assumption 3.1.1 is fulfilled: V is subquadratic, elliptic (bounded from below by x^2) and each derivative yields a gain of $\langle x \rangle^{-1}$. Notice however that this is not a subprincipal perturbation of the harmonic potential. It holds for any $x \in \mathbf{R}$:

$$\begin{aligned} V'(x) &= \frac{x}{\langle x \rangle^2} (2\langle x \rangle^2 (2 + \sin(a \log \langle x \rangle)) + ax^2 \cos(a \log \langle x \rangle)) \\ &= \frac{x}{\langle x \rangle^2} ((4 + 2 \sin(a \log \langle x \rangle)) + x^2 (4 + 2 \sin(a \log \langle x \rangle)) + a \cos(a \log \langle x \rangle)). \end{aligned}$$

Factorizing the last two terms, we can write for a certain angle φ_a :

$$\begin{aligned} V'(x) &= \frac{x}{\langle x \rangle^2} \left((4 + 2 \sin(a \log \langle x \rangle)) + x^2 \left(4 + \sqrt{4 + a^2} \sin(\varphi_a + a \log \langle x \rangle) \right) \right) \\ &= \frac{x}{\langle x \rangle^2} \left((4 + 2 \sin(a \log \langle x \rangle)) + 4x^2 \left(1 + \sqrt{\frac{1}{4} + \left(\frac{a}{4}\right)^2} \sin(\varphi_a + a \log \langle x \rangle) \right) \right). \end{aligned}$$

When $\frac{1}{4} + \left(\frac{a}{4}\right)^2 > 1$, which is true if and only if $a > 2\sqrt{3}$, we can find two sequences $(x_n^+)_{n \in \mathbf{N}}$ and $(x_n^-)_{n \in \mathbf{N}}$ tending to infinity such that

$$\begin{cases} \sqrt{\frac{1}{4} + \left(\frac{a}{4}\right)^2} \sin(\varphi_a + a \log \langle x_n^+ \rangle) \geq -1 + \eta \\ \sqrt{\frac{1}{4} + \left(\frac{a}{4}\right)^2} \sin(\varphi_a + a \log \langle x_n^- \rangle) \leq -1 - \eta \end{cases},$$

for some sufficiently small $\eta > 0$. The intermediate value theorem then implies that there exist infinitely many points x_n^0 , with $|x_n^0|$ tending to infinity, where $V'(x_n^0) = 0$. Now we observe from (3.1.6) that the trajectories of the Hamiltonian flow with initial data $\rho_n = (x_n^0, 0)$ are stationary, that is

$$\phi^t(\rho_n) = \rho_n, \quad \forall t \in \mathbf{R}.$$

We deduce the following: assume that the Schrödinger equation (3.1.1) is observable from $\omega \subset \mathbf{R}$ in some time for this potential. Then, the necessary condition of Theorem 3.1.3 tells us that there exists $R > 0$ such that for any n large enough, $x_n^0 \in \omega_R$. We can rephrase this as

$$\exists n_0 \in \mathbf{N} : \forall n \geq n_0, \quad \omega \cap B_R(x_n^0) \neq \emptyset. \quad (3.1.11)$$

This is consistent with the phase portrait depicted in Figure 3.1b: some energy might be trapped around small closed trajectories encircling stable critical points. Hence, in order to have observability, ω cannot be too far away from those points. In fact, one observes that (3.1.11) concerns all critical points, whatever the sign of $V''(x_n^0)$ is.

In conclusion, the situation of a potential of the form (3.1.10) is in contrast with the previous case of the harmonic potential $\frac{1}{2}x^2$ where the weak thickness condition allowed for large gaps around any sequence of points $x_n \rightarrow \infty$ satisfying $|x_{n+1}| \gg |x_n|$. Notice that ω can still have large gaps away from critical points though.

3.1.3.3. Sublinear potentials

Our last remark in the one-dimensional case concerns potentials having a sublinear growth, namely $m \in (0, 1/2]$. In this situation, the trajectories of the Hamiltonian flow whose initial datum has purely potential energy (namely $\xi = 0$) do not escape far away from their initial location. This is because:

$$\frac{d}{dt} \xi^t = -V'(x^t) = O\left(\langle x^t \rangle^{2m-1}\right),$$

which remains bounded uniformly as soon as $m \leq 1/2$. For the same reason, $m = 1/2$ also appears to be critical in Proposition 3.2.5. If observability from $\omega \subset \mathbf{R}$ holds in some time for such a potential, the necessary condition of Theorem 3.1.3 leads to the conclusion that ω has to intersect any interval of length $2R$, for some $R > 0$. Likewise, in higher dimension, any set from which the Schrödinger equation is observable must satisfy

$$\exists R > 0 : \forall x \in \mathbf{R}^d, \quad \omega \cap B_R(x) \neq \emptyset. \quad (3.1.12)$$

Therefore, sets observing the Schrödinger equation (3.1.1) for a sublinear potential cannot have arbitrarily large holes.⁴ Although the case of bounded potentials (i.e. $m = 0$) is not in the scope of this article, let us mention that this observation is consistent with recent results on the free Schrödinger equation. See Huang, Wang, Wang [HWW22] and Täufer [Tä22], as well as Le Balc'h and Martin [LBM23] for the case of bounded periodic potentials in two dimensions.

3.1.4. Observability of two-dimensional harmonic oscillators

As an application of Theorem 3.1.3, we study the observability of harmonic oscillators in conical or rotation-invariant sets. Our results mainly concern the two-dimensional case. The examples presented in this subsection suggest that there is no general reformulation of our dynamical condition (3.1.7) in purely geometrical terms. That is to say, it seems difficult to find an equivalent

4. Notice that (3.1.12) is much weaker than the usual thickness condition of control theory:

$$\exists R, c > 0 : \forall x \in \mathbf{R}^d, \quad |\omega \cap B_R(x)| \geq c|B_R(x)|.$$

condition that would not involve the Hamiltonian flow (e.g. thickness, weak thickness...). In contrast, by restricting ourselves to a certain class of potentials (harmonic oscillators at the principal level here) and a certain class of observation sets (conical or rotation-invariant), one can indeed transform the dynamical condition into a geometrical one. Along the way, we will see that observability properties are very sensitive to slight modifications of the coefficients of the harmonic oscillator under consideration. This subsection culminates in Proposition 3.1.10, where we show that observability of rotation-invariant sets is governed by Diophantine properties of the oscillator's coefficients.

Let us first recall basics about general harmonic oscillators. Let A be a real symmetric positive-definite $d \times d$ matrix and set $H_A = \frac{1}{2}(x \cdot Ax - \Delta)$. Up to an orthonormal change of coordinates, one can assume that A is diagonal, so that the potential can be written

$$V_A(x) = \frac{1}{2}x \cdot Ax = \frac{1}{2} \sum_{j=1}^d \nu_j^2 x_j^2.$$

The *characteristic frequencies* of H_A are those numbers $\nu_1, \nu_2, \dots, \nu_d$, that we will always assume to be positive. The corresponding Hamiltonian flow is explicit: denoting by $x_1(t), x_2(t), \dots, x_d(t)$ and $\xi_1(t), \xi_2(t), \dots, \xi_d(t)$ the components of ϕ^t , we can solve the Hamilton equations (3.1.6):

$$\begin{cases} x_j(t) = \cos(\nu_j t)x_j(0) + \frac{1}{\nu_j} \sin(\nu_j t)\xi_j(0) \\ \xi_j(t) = -\nu_j \sin(\nu_j t)x_j(0) + \cos(\nu_j t)\xi_j(0) \end{cases}, \quad \forall j \in \{1, 2, \dots, d\}. \quad (3.1.13)$$

From this expression, we see that each coordinate is periodic, so that the trajectories whose initial conditions are of the form $x_j(0) = x_0 \delta_{j=j_0}, \xi_j(0) = \xi_0 \delta_{j=j_0}$ with $x_0, \xi_0 \in \mathbf{R}$, are periodic, with period $2\pi/\nu_{j_0}$ (unless both x_0 and ξ_0 vanish, in which case the trajectory is a point). Assuming $d = 2$, we can classify harmonic oscillators into three categories. See Figure 3.2 for an illustration.

- The oscillator is *isotropic*⁵ if $\nu_1 = \nu_2 = \nu$. In this situation, energy surfaces, that is, level sets of the classical Hamiltonian, are concentric spheres in phase space (up to a symplectic change of coordinates). Trajectories of the Hamiltonian flow are great circles on these spheres, so that their projection on the x -variable “physical space” are ellipses. The flow is periodic, with period $\frac{2\pi}{\nu}$.
- The harmonic oscillator is said to be *anisotropic rational* when $\frac{\nu_2}{\nu_1}$ is a rational number different from 1. Trajectories, although all closed, exhibit a more complicated behavior. Writing $\frac{\nu_2}{\nu_1} = \frac{p}{q}$ with p and q coprime positive integers, the period of the flow is $p\frac{2\pi}{\nu_2} = q\frac{2\pi}{\nu_1}$. Projected trajectories are known in the physics literature as Lissajous curves [Lis57].
- We say a harmonic oscillator is *anisotropic irrational* when $\frac{\nu_2}{\nu_1} \in \mathbf{R} \setminus \mathbf{Q}$. In that case, the Hamiltonian flow is aperiodic. Trajectories are dense in invariant tori (see (3.1.14) below), yielding projected trajectories that fill rectangles parallel to the eigenspaces of the matrix A .

In the multi-dimensional setting, the description of the flow can be achieved by examining the \mathbf{Q} -vector space generated by the characteristic frequencies. The dimension of the latter gives the number of periodic decoupled “sub-oscillators” from which we can reconstruct the dynamics of the whole oscillator. This is thoroughly explained in the article of Arnaiz and Macià [AM22a], who compute the set of quantum limits of general harmonic oscillators, and study their behavior when bounded perturbations of the potential are added [AM22b].

In order to understand well the classical dynamics of the harmonic oscillator, it is convenient to take advantage of the complete integrability of this dynamical system. Here, the classical Hamiltonian is the sum of the one-dimensional Hamiltonians $\frac{1}{2}(\nu_j^2 x_j^2 + \xi_j^2)$, which are conserved by the flow, as one can see from the explicit expression (3.1.13). This property implies that energy levels are foliated in (possibly degenerate) invariant d -dimensional tori of the form:

$$\mathbf{T}_E = \left\{ (x, \xi) \in \mathbf{R}^{2d} : \forall j, \frac{1}{2}(\nu_j^2 x_j^2 + \xi_j^2) = E_j \right\}, \quad E = (E_1, E_2, \dots, E_d) \in \mathbf{R}_+^d. \quad (3.1.14)$$

The projection of these tori on the x -variable space yields rectangles, as in Figure 3.2c.

5. For general dimension, we still call isotropic any harmonic oscillator having all its characteristic frequencies equal.

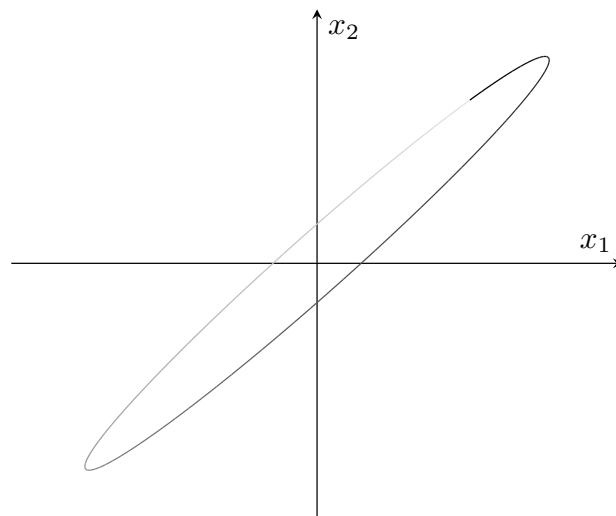

(a) Isotropic harmonic oscillator: $\frac{\nu_2}{\nu_1} = 1$.

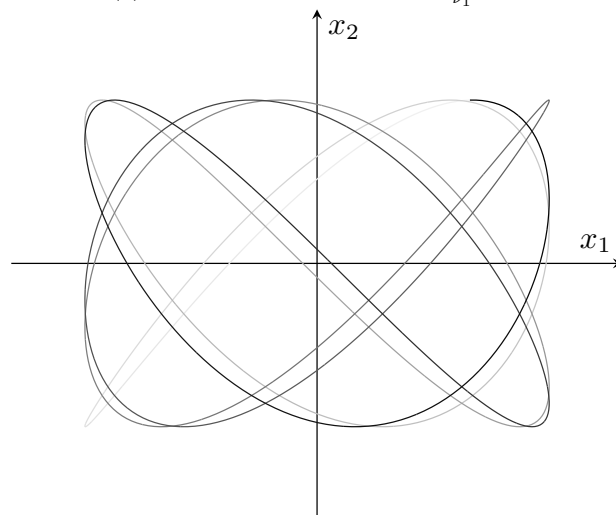

(b) Rational anisotropic harmonic oscillator: $\frac{\nu_2}{\nu_1} = \frac{7}{5}$.

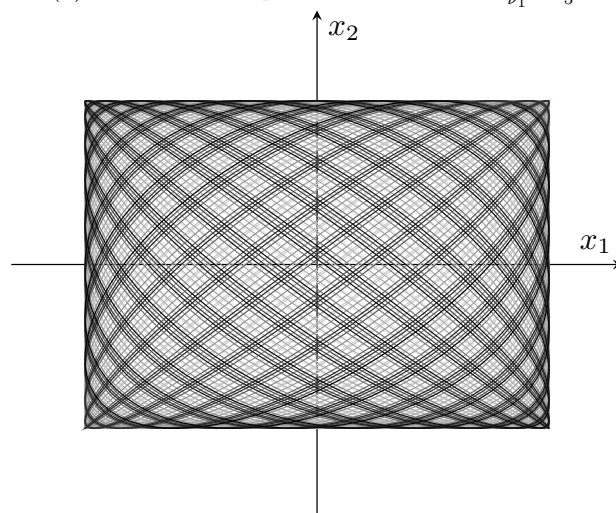

(c) Irrational anisotropic harmonic oscillator: $\frac{\nu_2}{\nu_1} = \frac{\pi}{3}$.

Figure 3.2 – Typical projected trajectories of two-dimensional harmonic oscillators. Shading indicates the course of the trajectory.

The goal of the following examples is to highlight the fact that observability is sensitive to the global properties of the Hamiltonian flow. We will show that isotropic and anisotropic harmonic oscillators behave differently with respect to observability, i.e. the sets that observe the Schrödinger equation are not the same. One can already anticipate that the isotropic oscillator $\nu_1 = \nu_2$ has less such sets since its classical trajectories are all ellipses, that is, they are very simple and only explore a small part of the classically allowed region. It contrasts with the anisotropic situation $\nu_1 \neq \nu_2$, where, in the rational case for instance, trajectories visit more exhaustively the classically allowed region. It makes it harder to find a set that is not reached by any of these trajectories. It is even more the case when ν_1 and ν_2 are rationally independent, since the trajectories are then dense in the invariant torus to which they belong, as we already discussed.

3.1.4.1. Observability from conical sets

We first investigate the case where the observation set ω is conical, namely it is invariant by dilations with positive scaling factor:

$$\forall x \in \mathbf{R}^d, \forall \lambda > 0, \quad (x \in \omega \iff \lambda x \in \omega). \quad (3.1.15)$$

We will see that exploiting the symmetries of harmonic oscillators is sometimes sufficient to obtain satisfactory results, without the need of our main theorem (see Subsection 3.1.4.2). However, Theorem 3.1.3 will prove useful to estimate precisely the optimal observation time in some situations.

As we already noticed, it follows from the expression of the flow (3.1.13) that, whatever the characteristic frequencies, the classical dynamics exhibits periodic trajectories contained in the coordinate axes. Those starting from the origin are of the form

$$x_j(t) = \frac{1}{\nu_j} \sin(\nu_j t) \xi_j(0), \quad \xi_j(t) = \cos(t) \xi_j(0)$$

for one $j \in \{1, 2, \dots, d\}$, and with all the other components being equal to zero. Thus it appears that a general necessary condition for a conical ω to observe the Schrödinger equation (3.1.1), working for any harmonic oscillator, is that it contains at least half of each line spanned by an eigenvector of A . Note that this works in any dimension.

Proposition 3.1.4. *Consider $P = V(x) - \frac{1}{2}\Delta$, where V is a potential fulfilling Assumptions 3.1.1 and having principal symbol $V_A(x) = \frac{1}{2}x \cdot Ax$, A being a real symmetric positive-definite $d \times d$ matrix. Let $\omega \subset \mathbf{R}^d$ be a conical set and assume that it observes the Schrödinger equation in some time $T > 0$. Then for any eigenvector v of A , it holds $v \in \bar{\omega}$ or $-v \in \bar{\omega}$.*

Now we place ourselves in dimension $d = 2$. We know from the above Proposition 3.1.4 that the closure of a conical set which observes the Schrödinger equation has to contain at least half of any line spanned by an eigenvector of the matrix A . Here, we exhibit a conical observation set, illustrated on Figure 3.3, that behaves differently according to whether the harmonic oscillator is isotropic or not.

Proposition 3.1.5 (Conical sets and anisotropy). *Let $d = 2$ and consider a potential V fulfilling Assumption 3.1.1, and with principal symbol*

$$V_A(x) = \frac{1}{2}x \cdot Ax, \quad x \in \mathbf{R}^2,$$

where A is a real symmetric positive-definite matrix. Denote by $\nu_+ \geq \nu_- > 0$ its characteristic frequencies. Choose an orthonormal basis of eigenvectors (e_+, e_-) of A , so that $Ae_{\pm} = \nu_{\pm}^2 e_{\pm}$. For any $\varepsilon \in (0, \pi/2)$, define the two cones with aperture ε :

$$C_{\varepsilon}^{\pm} = \left\{ x \in \mathbf{R}^2 : |x \cdot e_{\mp}| < \tan\left(\frac{\varepsilon}{2}\right) x \cdot e_{\pm} \right\}. \quad (3.1.16)$$

Then the set $\omega(\varepsilon) = C_{\varepsilon}^+ \cup C_{\varepsilon}^-$ observes the Schrödinger equation if and only if the oscillator is anisotropic, that is $\nu_- < \nu_+$. In that case, there exist constants $C, c > 0$, possibly depending on ν_+, ν_- , such that for any $\varepsilon \in (0, \pi/2)$,

$$T_0 - C\varepsilon^2 \leq T_*(\omega(\varepsilon)) \leq T_0 - c\varepsilon^2, \quad \text{where } T_0 = \frac{\pi}{\nu_+} \left(2 + \left\lfloor \frac{\nu_+}{\nu_-} \right\rfloor \right). \quad (3.1.17)$$

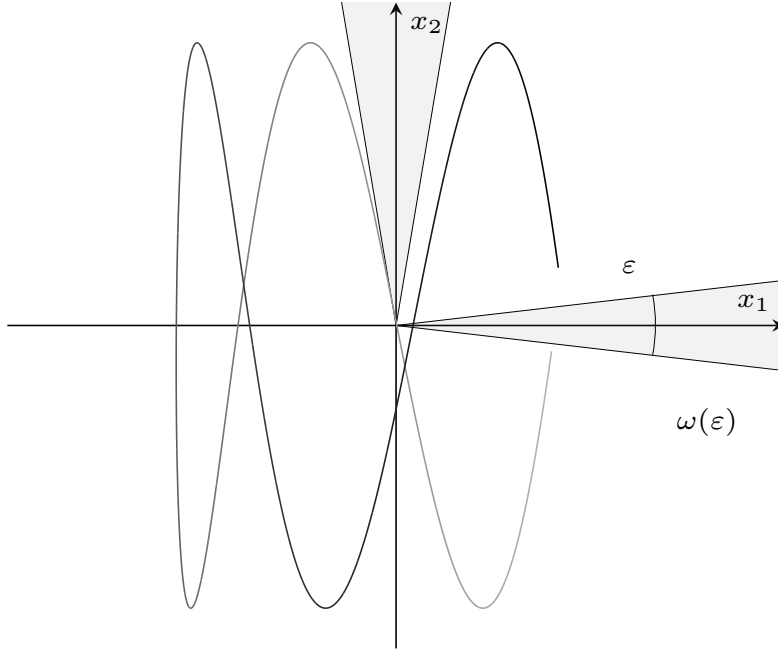

Figure 3.3 – The above projected trajectory is responsible for the lower bound on the optimal observation time in (3.1.17). It is obtained with an oscillator such that $\frac{\nu_2}{\nu_1} = 3.9$. For $\frac{\nu_2}{\nu_1} = 4$, one can choose the initial datum so that the curve goes back to the upper-right quadrant, passing through the origin, without crossing the two cones. This yields a larger lower bound on the optimal time, corresponding to the jump from $\lfloor 3.9 \rfloor = 3$ to $\lfloor 4 \rfloor = 4$ in Formula (3.1.17).

This result leads to several noteworthy observations.

First, it does not distinguish between rational and irrational anisotropic oscillators: one cannot guess, from the knowledge that observability form $\omega(\varepsilon)$ holds, whether the oscillator is rational or irrational.

Second, the time T_0 , obtained formally as the limiting optimal observation time when $\varepsilon \rightarrow 0$, does not vary continuously with respect to ν_+ and ν_- because of the floor function. This is related to special symmetry properties of the Hamiltonian flow that appear when ν_+ is a multiple of ν_- , namely the projected trajectories can go from a quadrant to another one crossing the origin, and thus avoiding to cross the observation cones. See Figure 3.3.

Third, when ε is fixed, our result does not rule out that the optimal observation time is continuous with respect to the characteristic frequencies. This is because the constants C and c can depend on ν_1, ν_2 .

It is interesting to see what happens when $\nu_+, \nu_- \rightarrow \nu$, that is to say when the operator P becomes closer to an isotropic harmonic oscillator. As mentioned earlier, we know from Proposition 3.1.4 that observability is not true for a set of the form $C_\varepsilon^+ \cup C_\varepsilon^-$ for an isotropic oscillator ($\varepsilon < \pi/2$ is important here). Thus it can seem surprising that the optimal observation time for such a set is bounded uniformly in ν_+, ν_- as the frequencies tend to ν . Actually, degeneracy in this limit should be seen on the observation cost, rather than on the optimal observation time. Indeed, computations suggest that the value of the dynamical constant $\mathfrak{R}_p^\infty(\omega(\varepsilon), T)$ tends to zero; see (3.4.13) in the proof. This would imply a blow up of the observation cost as $\nu_1, \nu_2 \rightarrow \nu$, in virtue of the necessary condition part of Theorem 3.1.3.

3.1.4.2. Refinement for the unperturbed isotropic harmonic oscillator

Theorem 3.1.3 allows to conclude about whether an open set ω observes the Schrödinger equation provided this open set is in a sense “regular”: the thickening process yields open sets that are sufficiently close to a cut-off function. But the quest of characterizing general measurable sets seems to be more delicate. To understand the limitation of our main theorem, we investigate the very particular case of the isotropic harmonic oscillator and conical observation sets in dimension $d \geq 1$. In this setting, we can take advantage of symmetries and exact propagation of coherent states.

For the purpose of the statement, let us introduce some notation. A conical set in \mathbf{R}^d is deter-

mined by the subset $\Sigma = \omega \cap \mathbf{S}^{d-1}$ in the unit sphere. When $\Sigma \subset \mathbf{S}^{d-1}$ we denote by $\omega(\Sigma)$ the conical set defined by

$$\omega(\Sigma) = \left\{ x \in \mathbf{R}^d \setminus \{0\} : \frac{x}{|x|} \in \Sigma \right\}. \quad (3.1.18)$$

Moreover, for any subset $\Sigma \subset \mathbf{S}^{d-1}$, we introduce the notation

$$-\Sigma = \{\theta \in \mathbf{S}^{d-1} : -\theta \in \Sigma\}.$$

The lower density of a measurable set $\Sigma \subset \mathbf{S}^{d-1}$, denoted by Θ_{Σ}^- , is the function $\mathbf{S}^{d-1} \rightarrow [0, 1]$ defined by

$$\Theta_{\Sigma}^-(\theta) = \liminf_{r \rightarrow 0} \frac{\sigma(\Sigma \cap B_r(\theta))}{\sigma(B_r(\theta))}, \quad \forall \theta \in \mathbf{S}^{d-1}, \quad (3.1.19)$$

where $B_r(\theta)$ is the ball of radius r centered at θ in \mathbf{R}^d , and σ is the uniform probability measure on the unit sphere \mathbf{S}^{d-1} .

We insist on the fact that the statement below is proved for exact isotropic harmonic oscillators, and not for perturbations of it.

Proposition 3.1.6. *Let $P = \frac{1}{2}(\nu^2|x|^2 - \Delta)$ be an isotropic oscillator with characteristic frequency $\nu > 0$. Let $\Sigma \subset \mathbf{S}^{d-1}$ be measurable, and $\omega(\Sigma)$ be the corresponding conical set. Set $\widehat{\Sigma} = \Sigma \cup -\Sigma$ the symmetrized version of Σ .*

(i) *If the Schrödinger equation is observable from $\omega(\Sigma)$ in some time, then it holds*

$$\inf_{\mathbf{S}^{d-1}} \Theta_{\widehat{\Sigma}}^- > 0.$$

(ii) *If $\widehat{\Sigma} = \Sigma \cup -\Sigma$ has full measure, namely $\sigma(\mathbf{S}^{d-1} \setminus \widehat{\Sigma}) = 0$, or equivalently $\Theta_{\widehat{\Sigma}}^-(\theta) = 1$ for all $\theta \in \mathbf{S}^{d-1}$, then $\omega(\Sigma)$ observes the Schrödinger equation, with optimal observation time $T_* < \frac{2\pi}{\nu}$.*

Remark 3.1.7. The gap between the sufficient and the necessary conditions above can be thought as the difference between Σ being the complement of a Cantor set (thus having full measure) and Σ being the complement of a fat Cantor set; see [Str81, Chapter 2, p. 80]. Regarding the estimate on the optimal observation time, the strict inequality is due to Lemma 3.A.3.

In fact, considering the propagation of coherent state, as investigated for instance by Combescure and Robert (see [CR97]), one could conjecture that observability is characterized by the property

$$\exists R > 0 : \quad \liminf_{\rho \rightarrow \infty} \int_0^T |\omega \cap B_R(x^t(\rho))| dt > 0, \quad (3.1.20)$$

with $x^t(\rho) = (\pi \circ \phi^t)(\rho)$. This type of integral can be rewritten as

$$\int_0^T |\omega \cap B_R(x^t(\rho))| dt = \int_0^T \|\mathbb{1}_{\omega}\|_{L^1(B_R(x^t(\rho)))} dt.$$

The necessary condition of Theorem 3.1.3, namely $\mathfrak{K}_p^\infty(\omega_R, T) > 0$ for some R large enough, involves the quantity

$$\int_0^T \mathbb{1}_{\omega_R}(x^t(\rho)) dt = \int_0^T \|\mathbb{1}_{\omega}\|_{L^\infty(B_R(x^t(\rho)))} dt. \quad (3.1.21)$$

Since the L^1 norm in a ball of radius R is controlled by the L^∞ norm (times a constant of order R^d), we know that the dynamical condition (3.1.20) is stronger than the condition $\mathfrak{K}_p^\infty(\omega_R, T) > 0$, involving the L^∞ norm as written in (3.1.21). In particular, if ω is dense but Lebesgue negligible, the condition $\mathfrak{K}_p^\infty(\omega_R, T) > 0$ will be satisfied, since then $\omega_R = \mathbf{R}^d$ for any $R > 0$, whereas (3.1.20) will not. In this situation, Theorem 3.1.3 would then yield a trivial result, namely that observability holds from the whole space, although it clearly does not hold from ω itself. Thus (3.1.20) seems to be a good guess to free ourselves from thickening the observation set. In addition, this condition would be consistent with the generalized geometric control condition introduced by Burq and Gérard in the context of stabilization of the wave equation [BG20].

3.1.4.3. Observability from spherical sets

In this section, we investigate the observability properties of a set consisting in a union of spherical layers. In the sequel, we refer to rotation-invariant (measurable) sets as *spherical* sets. Such a set ω is completely determined by the data of a measurable set $I \subset \mathbf{R}_+$, such that

$$\omega = \omega(I) = \{x \in \mathbf{R}^d : |x| \in I\} . \quad (3.1.22)$$

Due to the thickening process that occurs when applying Theorem 3.1.3, we shall generally make further assumptions, that ensure that a set and its thickened version are somewhat equivalent.

The existence of many periodic circular orbits of the Hamiltonian flow for radial potentials implies that observability from $\omega(I)$ does not hold for such Hamiltonians if I contains large gaps. In fact, the proposition below works for slightly more general potentials.

Proposition 3.1.8. *Let $d \geq 2$. Suppose the Hamiltonian P is of the form $P = V(x) - \frac{1}{2}\Delta$ with a potential V satisfying Assumption 3.1.1 together with:*

(i) $V(-x) = V(x), \forall x \in \mathbf{R}^d;$

(ii) *there exists an orthogonal change of coordinates M such that*

$$V(MS_\theta M^{-1}x) = V(x), \quad \forall x \in \mathbf{R}^d, \forall \theta \in \mathbf{R},$$

where S_θ is the rotation of angle θ acting on the first two coordinates; in particular, for every $y \in \mathbf{R}^{d-2}$, the map $V_y : (x_1, x_2) \mapsto V(M(x_1, x_2, y))$ is radial;

(iii) *the map \tilde{V}_0 such that $V_{y=0}(x_1, x_2) = \tilde{V}_0(|(x_1, x_2)|)$ is non-decreasing.*

Then for any spherical set $\omega(I)$, if observability holds from $\omega(I)$ in some time $T > 0$, it holds

$$\exists r > 0 : \forall s \in \mathbf{R}_+ : \quad I \cap [s, s+r] \neq \emptyset . \quad (3.1.23)$$

Remark 3.1.9. The hypotheses are fulfilled for harmonic oscillators in d dimensions having at least two identical characteristic frequencies.

In dimension 2, Proposition 3.1.8 allows to conclude that spherical sets observing the Schrödinger equation for isotropic harmonic oscillators have to occupy space somewhat uniformly—they cannot contain arbitrarily large gaps. Therefore, we shall rule out isotropic harmonic oscillators from our study of observability from spherical sets. Instead, we investigate how the anisotropy of a harmonic oscillator can help to get observability from an observation set made of concentric rings. The proposition below investigates, in dimension 2, the observability from spherical sets of the form $\omega(I)$ where $I = \bigcup I_n$ is a countable union of open intervals in \mathbf{R}_+ . We require additionally that $|I_n| \rightarrow +\infty$ (we drop this assumption if there are only finitely many I_n 's). To any such set, we associate a number between 0 and 1 that quantifies the distribution of the annuli $\omega(I_n)$ at infinity:

$$\kappa_*(I) = \min \left\{ \kappa \in [0, 1] : \liminf_{r \rightarrow +\infty} \frac{1}{r} |I \cap [\kappa r, r]| = 0 \right\} \in [0, 1] . \quad (3.1.24)$$

While investigating the observability property from such a set $\omega(I)$, we will see that it is relevant to compare the geometrical quantity $\kappa_*(I)$ with a dynamical quantity that encodes relevant features of the underlying Hamiltonian flow. This dynamical constant is expressed in terms of a function $\Lambda : \mathbf{R}_+^* \rightarrow [0, 1]$ defined by

$$\Lambda(\mu) = \begin{cases} \tan\left(\frac{\pi/2}{p+q}\right) & \text{if } \mu = \frac{p}{q}, \gcd(p, q) = 1, p - q \equiv 0 \pmod{2} \\ \sin\left(\frac{\pi/2}{p+q}\right) & \text{if } \mu = \frac{p}{q}, \gcd(p, q) = 1, p - q \equiv 1 \pmod{2} \\ 0 & \text{if } \mu \in \mathbf{R} \setminus \mathbf{Q} \end{cases} . \quad (3.1.25)$$

As far as the optimal observation time T_* is concerned, we shall use Diophantine properties of μ to approximate irrational oscillators by rational ones, for which we can control T_* by the period of

the flow. This motivates the introduction of the irrationality exponent of an irrational number μ , defined by

$$\tau(\mu) = \sup \left\{ s \in \mathbf{R} : \left| \mu - \frac{p}{q} \right| < \frac{1}{q^s} \text{ for infinitely many coprime couples } (p, q) \right\}. \quad (3.1.26)$$

Dirichlet's approximation theorem tells us that $\tau(\mu) \in [2, +\infty]$, for any irrational number. Also keep in mind that $\tau(\mu) = 2$ is achieved for Lebesgue-almost every irrational. See the lecture notes [Dur] or the books [EW11, Sch91] for further details.

Proposition 3.1.10 (Spherical sets and anisotropy). *Let $d = 2$ and consider a potential V fulfilling Assumption 3.1.1, and with principal symbol*

$$V_A(x) = \frac{1}{2}x \cdot Ax, \quad x \in \mathbf{R}^2,$$

where A is a real symmetric positive-definite matrix. Denote by ν_1 and ν_2 the characteristic frequencies of A , and assume that $\nu_1 \neq \nu_2$. We fix $I = \bigcup I_n$ a union of open intervals in \mathbf{R}_+ , assuming that $|I_n| \rightarrow +\infty$. Denote by $\omega(I)$ the corresponding open spherical set in \mathbf{R}^2 , as defined in (3.1.22). Then observability from $\omega(I)$ holds in some time T if and only if

$$\kappa_\star(I) > \Lambda \left(\frac{\nu_2}{\nu_1} \right). \quad (3.1.27)$$

Moreover, the optimal observation time T_\star can be estimated as follows:

- if $\frac{\nu_2}{\nu_1} \in \mathbf{Q}$, writing $\frac{\nu_2}{\nu_1} = \frac{p}{q}$ with p, q positive coprime integers, it holds

$$T_\star < \frac{\pi}{\nu_2} p = \frac{\pi}{\nu_1} q;$$

- if $\frac{\nu_2}{\nu_1} \in \mathbf{R} \setminus \mathbf{Q}$ is Diophantine, that is $\tau = \tau(\frac{\nu_2}{\nu_1}) < \infty$, then it holds

$$\forall \varepsilon > 0, \exists c_\varepsilon, C_\varepsilon > 0 : \quad c_\varepsilon \left(\frac{1}{\kappa_\star(I)} \right)^{\frac{1}{\tau-1+\varepsilon}} \leq T_\star \leq C_\varepsilon \left(\frac{1}{\kappa_\star(I)} \right)^{\tau-1+\varepsilon}. \quad (3.1.28)$$

The constants c_ε and C_ε may depend on ν_1, ν_2 , but not on I .

Let us review the meaning of the different quantities involved in this statement.

The number $\kappa_\star(I)$ introduced in (3.1.24) encodes some notion of density⁶ of the set I . For instance, $\kappa_\star(I) = 1$ means that I has positive density in any window $[\kappa r, r]$ with $\kappa < 1$ as $r \rightarrow +\infty$. In contrast, $\kappa_\star(I)$ close to zero means that the annuli are extremely sparse at infinity. This quantity is well-defined, for the map

$$\kappa \longmapsto \liminf_{r \rightarrow +\infty} \frac{1}{r} \int_{\kappa r}^r \mathbb{1}_I(s) ds$$

is non-increasing and lower semi-continuous (even Lipschitz-continuous in fact). That it is non-increasing comes from the monotonicity of the integral and of the lower limit, whereas the continuity follows from the fact that

$$\left| \frac{1}{r} \int_{\kappa_2 r}^r \mathbb{1}_I(s) ds - \frac{1}{r} \int_{\kappa_1 r}^r \mathbb{1}_I(s) ds \right| \leq |\kappa_2 - \kappa_1|.$$

6. Beware of the fact that $\kappa_\star(I)$ does not coincide in general with the lower density of I defined by

$$\Theta_\infty(I) = \liminf_{r \rightarrow +\infty} \frac{|I \cap [0, r]|}{|[0, r]|}.$$

In fact, the two quantities satisfy

$$\Theta_\infty(I) \leq \kappa_\star(I) \quad \text{and} \quad \kappa_\star(I) = 0 \iff \Theta_\infty(I) = 0.$$

The second assertion follows from the definition of $\kappa_\star(I)$. To check the first assertion, we write

$$\frac{|I \cap [0, r]|}{|[0, r]|} = \kappa_\star \frac{|I \cap [0, \kappa_\star r]|}{|[0, \kappa_\star r]|} + \frac{1}{r} |I \cap [\kappa_\star r, r]| \leq \kappa_\star + \frac{1}{r} |I \cap [\kappa_\star r, r]|.$$

Then taking lower limits as $r \rightarrow +\infty$ and using the definition of κ_\star yield the desired inequality. Notice that the equality $\Theta_\infty(I) = \kappa_\star(I)$ is not true in general, as one can see from the example $I = \bigcup_{n \in \mathbf{N}} (n, n + \frac{1}{2})$, for which we have $\Theta_\infty(I) = \frac{1}{2}$ but $\kappa_\star(I) = 1$.

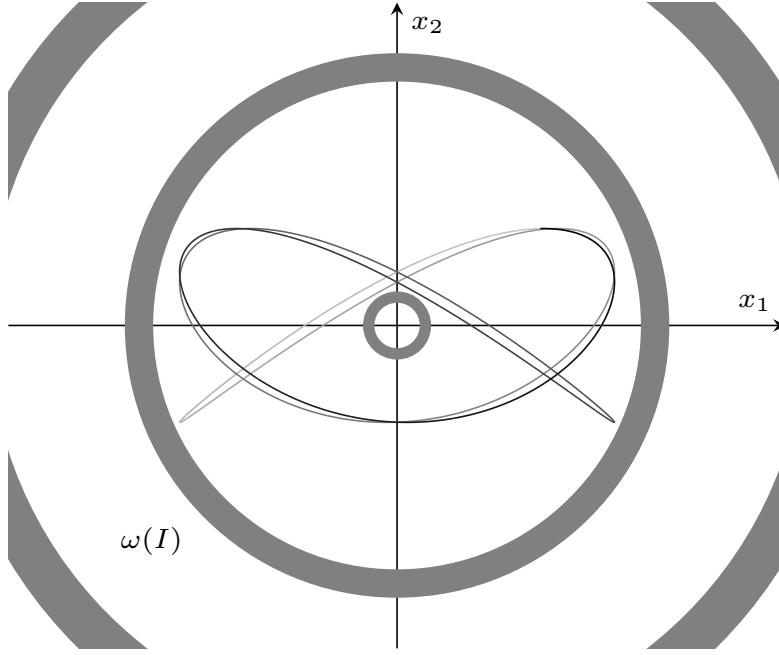

Figure 3.4 – The above curve is a projected trajectory of a harmonic oscillator with $\frac{\nu_2}{\nu_1} = \frac{4}{3}$, that does not intersect the observation set $\omega(I)$. The existence of a sequence of energy layers $\{p = E_n\}$, $E_n \rightarrow +\infty$, containing such curves would imply that observability from $\omega(I)$ fails.

Given $\mu \in \mathbf{R}_+^*$, the constant $\Lambda(\mu)$ defined in (3.1.25) is related to the flow of a harmonic oscillator with characteristic frequencies ν_1, ν_2 such that $\mu = \frac{\nu_2}{\nu_1}$. More precisely, it corresponds to the largest ratio between the minimum and the maximum of the distance to the origin of a projected trajectory. This is the content of the following lemma that we prove in Subsection 3.5.2.

Lemma 3.1.11. *It holds*

$$\Lambda\left(\frac{\nu_2}{\nu_1}\right) = \sup_{\rho_0 \in \mathbf{R}^2 \setminus \{0\}} \frac{\inf_{t \in \mathbf{R}} |(\pi \circ \phi^t)(\rho_0)|}{\sup_{t \in \mathbf{R}} |(\pi \circ \phi^t)(\rho_0)|}. \quad (3.1.29)$$

Thus we can refer to $\Lambda(\mu)$ as the optimal “radial aspect ratio” of projected trajectories. Observability from $\omega(I)$ will depend on whether the critical trajectories that attain this maximal ratio spend sufficient time in $\omega(I)$, hence the criterion $\kappa_*(I) > \Lambda(\frac{\nu_2}{\nu_1})$. See Figure 3.4 for an illustration of the case where such trajectories are not seen by the observation set. Notice that maximizing the ratio in (3.1.29) with respect to any non-zero initial data is the same as taking the upper limit as $\rho_0 \rightarrow \infty$ since the Hamiltonian flow is homogeneous. Thus $\Lambda(\mu)$ can be understood as a quantity that captures the behavior of the flow at infinity. In addition, we remark that $\Lambda(\mu) = \Lambda(1/\mu)$, which means that this value depends only on the spectrum of the matrix A , and not on the choice of a specific basis of \mathbf{R}^2 . The maximum of Λ is reached exactly at 1, where it is equal to $\tan(\frac{\pi}{4}) = 1$. This is consistent with the fact that in two dimensions, isotropic harmonic oscillators are the only ones possessing circular orbits: the norm of the trajectory $|x^t(\rho_0)|$ is constant for well-chosen initial data.

The distinction between rational and irrational values of μ is natural in light of the complete integrability of the flow of harmonic oscillators. When the ratio of characteristic frequencies $\mu = \frac{\nu_2}{\nu_1}$ is rational, writing $\mu = \frac{p}{q}$ with p, q a couple of coprime integers, one can check that the Hamiltonian flow of the corresponding harmonic oscillator is periodic of period $\frac{2\pi}{\nu_2}p = \frac{2\pi}{\nu_1}q$. In that case, there are many orbits of the flow whose projection on the x -variable space stays away from the origin, thus producing a positive $\Lambda(\mu)$, as one can see on Figure 3.2b. When μ is irrational, it is known that (non-degenerate) trajectories are dense in the invariant torus to which they belong. In particular, any projected trajectory can get arbitrarily close to the origin, up to waiting a long enough time, so that $\Lambda(\mu) = 0$; see Figure 3.2c.

Lastly, let us point out that the estimate (3.1.28) of the optimal observation time for

Diophantine irrational does not give any precise information for a given open set I , but is relevant for fixed ν_1, ν_2 in the asymptotics $\kappa_*(I) \ll 1$.

Remark 3.1.12. It can look surprising that Proposition 3.1.10 gives an exact characterization of spherical sets for which observability holds, whereas Theorem 3.1.3 provides a necessary and sufficient condition up to thickening the observation set. This improvement is made possible by the extra assumption that $|I_n| \rightarrow +\infty$. It ensures that thickening the observation set by a radius R is negligible compared to the width of the annulus $\omega(I_n)$, for n large.

Remark 3.1.13 (Non-Diophantine irrationals). When $\mu = \frac{\nu_2}{\nu_1} \in \mathbf{R} \setminus \mathbf{Q}$, one can estimate T_* , even if $\tau = \tau(\mu) = +\infty$, using the so-called convergents of μ . These are the rational numbers arising in the continued fraction expansion algorithm. Denote them in irreducible form by $\mu_j = \frac{p_j}{q_j}$. It is known that this sequence is the most efficient way to approximate an irrational number by rationals (a result known as Lagrange theorem; see [Dur, Theorem 1.3] or [EW11, Sch91]). These convergents satisfy

$$\forall j \in \mathbf{N}, \quad \left| \mu - \frac{p_j}{q_j} \right| < \frac{1}{q_j^2}. \quad (3.1.30)$$

(This is why $\tau(\mu) \geq 2$ holds for any irrational.) We will show in the proof of Proposition 3.1.10 the following: when $\mu \in \mathbf{R} \setminus \mathbf{Q}$, there exist constants $c_1, c_2 > 0$ and $\delta_1, \delta_2 > 0$, possibly depending on ν_1, ν_2 , such that

$$c_1 q_{j_1} \leq T_* \leq c_2 q_{j_2} \quad (3.1.31)$$

(see (3.5.51) in the proof), where j_1 is the largest index for which $q_j \leq \frac{\delta_1}{\kappa_*}$, and j_2 is the smallest index for which $q_j \geq \frac{\delta_2}{\kappa_*}$.

The bounds (3.1.28) are particularly interesting when τ has the smallest possible value, that is $\tau = 2$, which is the case of Lebesgue-almost every irrational. However, we see that the lower and upper bounds (3.1.28) get far apart as τ goes to infinity. This reflects the fact that the gaps between the denominators of consecutive convergents get wider at each step of the continued fraction expansion. Irrationals having an infinite irrationality exponent are known as Liouville numbers. There are many of them: the set of Liouville numbers is an instance of a Lebesgue negligible set having the cardinality of the continuum. This set is also Baire generic, as it can be written as a countable intersection of dense open sets. When $\frac{\nu_2}{\nu_1}$ is a Liouville number, the bounds (3.1.31) on the optimal observation time are very poor, owing to the lacunary behavior of the q_j 's.

3.1.5. Other applications

Let us briefly discuss two other applications of Theorem 3.1.3.

3.1.5.1. Uniform observability of eigenfunctions

Under Assumption 3.1.1, the operator P is self-adjoint with compact resolvent. Thus, its spectrum consists in a collection of eigenvalues with finite multiplicity. A direct consequence of an observability inequality $\text{Obs}(\omega, T)$ in a set ω is the fact that the eigenfunctions of P are uniformly observable from ω :

$$\exists c > 0 : \forall u \in L^2(\mathbf{R}^d), \quad \left(Pu = \lambda u \implies \|u\|_{L^2(\omega)} \geq c \|u\|_{L^2(\mathbf{R}^d)} \right).$$

Theorem 3.1.3 thus furnishes a sufficient condition for this to hold. In particular, for anisotropic oscillators, Proposition 3.1.5 implies that uniform observability of eigenfunctions from the two cones defined in (3.1.16) is true. This can certainly be deduced from the work of Arnaiz and Macià [AM22a] that characterizes quantum limits of harmonic oscillators. From Proposition 3.1.10, we obtain a similar uniform estimate in spherical sets satisfying the assumptions of the proposition together with the condition (3.1.27). This time, it is not clear that one can deduce this result as easily from the knowledge of quantum limits [AM22a]. See also [DSV23] for recent works about spectral inequalities for the Hermite operator, and [Mar22] for anisotropic Shubin operators.

3.1.5.2. Energy decay of the damped wave equation

Lastly, our study leads to stabilization results concerning the damped wave equation

$$\begin{cases} \partial_t^2 \psi + P\psi + \mathbf{1}_\omega \partial_t \psi = 0 \\ (\psi, \partial_t \psi)|_{t=0} = U_0 \in \text{dom } P^{1/2} \times L^2 \end{cases}, \quad (3.1.32)$$

with damping in $\omega \subset \mathbf{R}^d$, provided $P \geq 0$ (assume for instance that the potential V is non-negative). This equation comes with a natural energy

$$\mathcal{E}(U_0, t) = \frac{1}{2} \left(\left\| P^{1/2} \psi(t) \right\|_{L^2}^2 + \left\| \partial_t \psi(t) \right\|_{L^2}^2 \right),$$

which decays over time. Let us recall that Anantharaman and Léautaud proved in [AL14, Theorem 2.3] that an observability inequality $\text{Obs}(\omega, T)$ implies a decay at rate $t^{-1/2}$ for the damped wave equation (3.1.32), meaning that there exists a constant $C > 0$ such that

$$\mathcal{E}(U_0, t) \leq \frac{C}{t} \left(\|P u_0\|_{L^2}^2 + \left\| P^{1/2} u_1 \right\|_{L^2}^2 \right), \quad \forall t > 0,$$

for all initial data in the domain of the damped wave operator, here $U_0 = (u_0, u_1) \in \text{dom } P \times \text{dom } P^{1/2}$. Their result applies in our setting since P has compact resolvent under Assumption 3.1.1. Our examples thus provide concrete situations where such a decay occurs.

3.1.6. Link with the Kato smoothing effect

The dynamical condition (3.1.7) concerns only what happens at infinity in phase space. We will see that trajectories of the Hamiltonian flow escape from any compact set (in the x variable) most of the time provided the initial data has large enough energy, namely $p(\rho)$ is large enough. This is the reason why one can remove any compact set from the observation without losing observability: no energy can be trapped in a compact set. Quantitatively, we will check that, given $T > 0$, there exist a constant $C > 0$ and $E_0 > 0$ such that

$$\forall r \geq 0, \forall \rho \in \{p \geq E_0\}, \quad \left| \{t \in [0, T] : \phi^t(\rho) \in B_r(0) \times \mathbf{R}^d\} \right| = \int_0^T \mathbf{1}_{B_r(x^t)} dt \leq C \frac{r}{\sqrt{p(\rho)}} \quad (3.1.33)$$

(see Corollary 3.2.6). We can rephrase this by saying that compact sets are not *classically observable*. This property is related to the Kato smoothing effect as follows. Writing $(x^t, \xi^t) = \phi^t(\rho)$, for any $\varepsilon > 0$, we compute using Fubini's theorem:

$$\int_0^T \frac{\sqrt{p(\rho)}}{\langle x^t \rangle^{1+\varepsilon}} dt = \int_0^T \left(\int_{\langle x^t \rangle}^{+\infty} (1+\varepsilon) \frac{\sqrt{p(\rho)}}{r^{2+\varepsilon}} dr \right) dt = \int_1^{+\infty} (1+\varepsilon) \frac{\sqrt{p(\rho)}}{r} \left(\int_0^T \mathbf{1}_{B_r(0)}(\langle x^t \rangle) dt \right) \frac{dr}{r^{1+\varepsilon}}.$$

From (3.1.33), we deduce that

$$\int_0^T \frac{\sqrt{p(\rho)}}{\langle x^t \rangle^{1+\varepsilon}} dt \leq C \int_1^{+\infty} (1+\varepsilon) \frac{dr}{r^{1+\varepsilon}},$$

and the latter integral is indeed convergent when $\varepsilon > 0$. This is the classical analogue to the so-called Kato smoothing effect. In our context, the latter says roughly that

$$\int_0^T \left\| \langle x \rangle^{-\frac{1+\varepsilon}{2}} P^{1/4} e^{-itP} u \right\|_{L^2(\mathbf{R}^d)}^2 dt \leq C \|u\|_{L^2(\mathbf{R}^d)}^2.$$

See for instance Doi [Doi05] for a thorough discussion on this topic. See also the survey of Robbiano [Rob13], as well as Robbiano and Zuily [RZ08, RZ09] and Burq [Bur04] for related results. The main phenomenon responsible for this smoothing effect is the fact that P contains a Laplace-Beltrami operator associated with a non-trapping metric (here a flat metric), that is to say all geodesics escape at infinity forward and backward in time. In our case, working with a flat Laplacian enables us to compare the trajectories of the Hamiltonian flow to straight lines, at least for some time near the origin. It would be interesting to see whether our study can be adapted to operators of the form $P = V(x) - \frac{1}{2} \Delta_g$ with a non-trapping metric g on \mathbf{R}^d (sufficiently flat at infinity). See [MN, Lemma 3.1] for an alternative proof that non-trapping implies failure of observability from *bounded* observation sets. The argument relies on semiclassical defect measures.

3.1.7. Natural semiclassical scaling for homogeneous potentials

A way to comprehend what goes wrong when the potential is superquadratic is to introduce the natural semiclassical scales associated to our problem, based on an observation of Macià and Nakamura [MN]. Take for simplicity $p(x, \xi) = |x|^{2m} + |\xi|^2$. Following classical arguments, we recall in Appendix 3.A that the observability inequality reduces to a high-energy observability inequality: roughly speaking, we can restrict ourselves to L^2 functions u that are microlocalized around some level set $\{p = E\}$ with $E \gg 1$. Writing

$$p(x, \xi) = E \quad \iff \quad \left| \frac{x}{E^{1/2m}} \right|^{2m} + \left| \frac{\xi}{E^{1/2}} \right|^2 = 1,$$

we may introduce a small Planck parameter h such that $E = h^{-\gamma}$ for some power $\gamma > 0$. Thus we have

$$|h^{\gamma/2m}x|^{2m} + |h^{\gamma/2}\xi|^2 = 1.$$

This motivates the definition of an h -dependent Weyl quantization (see Appendix 3.B)

$$\text{Op}_h(a) := \text{Op}_1\left(a(h^{\gamma/2m}x, h^{\gamma/2}\xi)\right),$$

for any classical observable a on the phase space. This quantization is properly “normalized” by choosing $\gamma = \frac{2m}{m+1}$: with this choice, the corresponding pseudo-differential calculus is expressed in powers of h , since then $h^{\gamma/2m}h^{\gamma/2} = h$. Therefore the relevant semiclassical Schrödinger operator is

$$P_h = \text{Op}_h(p) = h^\gamma P.$$

If one wants to express the observability inequality in terms of the associated propagator, one is then lead to study

$$e^{-itP}u = e^{-i\frac{th^{1-\gamma}}{h}P_h}u.$$

In other words, running the Schrödinger evolution on a time interval $[0, T]$ amounts to consider a semiclassical time scale of order $h^{1-\gamma} = h^{\frac{1-m}{1+m}}$. It is then clear that this time blows up as $h \rightarrow 0$ when $m > 1$. Yet the analysis of the quantum-classical correspondence, for long times, is much more difficult. In particular, it restricts considerably the amount of classical observables whose evolution can be described through the usual Egorov theorem. For this reason, we will not pursue in this direction and stick to the case $m \leq 1$. An interesting approach to study this would be to consider first particular potentials for which the classical flow is completely integrable, e.g. anharmonic oscillators (see [BLR22]). Indeed, observability of the Schrödinger equation has been successfully investigated taking advantage of the completely integrable nature of the underlying classical dynamics in some particular geometrical contexts (e.g. in the disk [ALM16a, ALM16b] which corresponds morally to $m = \infty$; see also [AM14] on the torus and [AFKM15]).

3.1.8. Plan of the article

Section 3.2 below is devoted to the study of the underlying classical dynamics: we show that the Hamiltonian flow is roughly stable under subprincipal perturbations of the potential, and that high-energy projected trajectories can cross compact sets only on a very short period of time. Then we establish an instance of quantum-classical correspondence adapted to our context in Section 3.3, and subsequently prove Theorem 3.1.3. This is the core of the article. Next, in Sections 3.4 and 3.5, we deal with the examples presented in Subsections 3.1.4.1, 3.1.4.2 and Subsection 3.1.4.3 (observability from conical and spherical sets respectively). Finally, we recall in Appendix 3.A a classical result, related to the notion of unique continuation, that shows that the sought observability inequality is equivalent to a similar high-energy inequality. Appendix 3.B collects reminders about pseudo-differential operators, as well as refined estimates on the pseudo-differential calculus and the Gårding inequality needed for Section 3.3.

Acknowledgments

This project originated and was initially developed while visiting Universidad Politécnica de Madrid during the academic year 2020-2021 and the spring 2022. I thank this institution for its hospitality. I also thank Fabricio Macià for introducing me to this problem and for sharing many

ideas and material, including unpublished works with Shu Nakamura [MN]. I am also grateful to Matthieu Léautaud for countless discussions and for his helpful comments on a preliminary version of this paper. This work has been partially supported by FMJH's "Junior scientific visibility program" (France) and grant MTM2017-85934-C3-3-P (MINECO, Spain).

3.2. Study of the classical dynamics

In this section, we investigate the properties of the Hamiltonian flow $(\phi^t)_{t \in \mathbf{R}}$ associated with p . This study consists essentially in analyzing the ODE system that defines ϕ^t , namely the Hamilton equation (3.1.5). The dynamical condition of Theorem 3.1.3

$$\mathfrak{R}_p^\infty(\omega, T) = \liminf_{\rho \rightarrow \infty} \int_0^T \mathbb{1}_{\omega \times \mathbf{R}^d}(\phi^t(\rho)) dt > 0$$

motivates the study of what can be referred to as "classical observability".

Definition 3.2.1 (Classical observability). Let $q = q(t; \rho)$ be a Borel-measurable⁷ function on $\mathbf{R} \times \mathbf{R}^{2d}$. Then we say that q is classically observable if

$$\mathfrak{R}_p^\infty(q) := \liminf_{\rho \rightarrow \infty} \int_{\mathbf{R}} q(t; \phi^t(\rho)) dt > 0. \quad (3.2.1)$$

Of course, we will be specifically interested in the case where p contains a subquadratic potential and $q = \mathbb{1}_{(0, T) \times \omega \times \mathbf{R}^{2d}}$, but it is interesting to work out this problem in a more general setting in order to understand to what extent quadratic potentials are critical for the Schrödinger equation.

3.2.1. Invariance of classical observability under subprincipal perturbation

In this subsection, we consider a set of classical symbols on \mathbf{R}^{2d} of order n_1 in x and n_2 in ξ , defined by

$$S^{n_1, n_2} = \left\{ a \in C^\infty(\mathbf{R}^{2d}) : \forall \alpha \in \mathbf{N}^{2d}, \sup_{(x, \xi) \in \mathbf{R}^{2d}} \frac{|\partial^\alpha a(x, \xi)|}{\langle x \rangle^{n_1 - |\alpha|} + \langle \xi \rangle^{n_2 - |\alpha|}} < \infty \right\}.$$

A basic example is the classical Hamiltonian $p(x, \xi) = V(x) + \frac{1}{2}|\xi|^2$ that we consider: it belongs to $S^{2m, 2}$. We draw the reader's attention to the fact that this is not a standard symbol class in microlocal analysis. Our aim here is simply to study symbols whose derivatives have similar decay properties as the classical Hamiltonian p . We will not make use of any notion of pseudo-differential calculus in this subsection.

It is clear that these symbol classes are nested in the following way: if $n_1 \leq n'_1$ and $n_2 \leq n'_2$, then $S^{n_1, n_2} \subset S^{n'_1, n'_2}$ (and this inclusion is even continuous with respect to the associated Fréchet structure). Given $n_1, n_2 \in \mathbf{R}$, a real-valued symbol $a \in S^{n_1, n_2}$ is said to be elliptic in S^{n_1, n_2} if $a(x, \xi) \geq c(\langle x \rangle^{n_1} + \langle \xi \rangle^{n_2})$ provided $|(x, \xi)|$ is large enough. In addition, the binary relation

$$\forall f, g \in S^{n_1, n_2}, \quad f = g \pmod{S^{n_1-1, n_2-1}} \iff f - g \in S^{n_1-1, n_2-1} \quad (3.2.2)$$

is an equivalence relation, and the projection on the quotient space $S^{n_1, n_2}/S^{n_1-1, n_2-1}$ is called the principal symbol. Two symbols are said to have the same principal symbol if they belong to the same equivalence class through this projection. In the example of our classical Hamiltonian p , these notions of ellipticity and principal symbol are consistent with the terminology used right after Assumption 3.1.1 regarding the potential V .

The proposition below is essentially an application of Grönwall's Lemma.

Proposition 3.2.2 (Stability estimate). *Fix $n_1, n_2 > 0$ and let $p_1, p_2 \in S^{n_1, n_2}$ be elliptic symbols in S^{n_1, n_2} . Assume they have the same principal symbol in the sense of (3.2.2). Consider the*

⁷ Recall that Borel-measurability is slightly stronger than Lebesgue-measurability. This restriction ensures that $t \mapsto q(t; \phi^t(\rho))$ is Lebesgue-measurable. This is not a problem in our context since we will consider functions q that are continuous, or at worse, indicator functions of Borel sets.

Hamiltonian flows $(\phi_1^t)_{t \in \mathbf{R}}$ and $(\phi_2^t)_{t \in \mathbf{R}}$ associated with p_1 and p_2 respectively. Then there exists a constant $C > 0$ such that

$$|\phi_2^t(\rho) - \phi_1^t(\rho)| \leq e^{Ct(p_1(\rho))^{\max(0, 1 - \frac{2}{n_+})}}, \quad \forall \rho \in \mathbf{R}^{2d}, \forall t \geq 0,$$

where $n_+ = \max(n_1, n_2)$. In particular, when $n_1, n_2 \leq 2$, there exists $C > 0$ such that

$$|\phi_2^t(\rho) - \phi_1^t(\rho)| \leq e^{Ct}, \quad \forall \rho \in \mathbf{R}^{2d}, \forall t \geq 0.$$

Remark 3.2.3. This result ensures that the distance between $\phi_1^t(\rho)$ and $\phi_2^t(\rho)$ is bounded provided $n_+ \leq 2$, on a time interval $[0, T]$ independent of ρ . In our problem, this condition on n_+ means exactly that the potential is subquadratic.

Proof. In this proof, we write $n_+ = \max(n_1, n_2)$ and $n_- = \min(n_1, n_2)$. Set $\tilde{p} = p_2 - p_1$, which belongs to S^{n_1-1, n_2-1} by assumption. The Hamilton equation (3.1.5) gives

$$\begin{aligned} \left| \frac{d}{dt} (\phi_2^t(\rho) - \phi_1^t(\rho)) \right| &= |J(\nabla p_2(\phi_2^t(\rho)) - \nabla p_1(\phi_1^t(\rho)))| \\ &\leq |\nabla p_2(\phi_2^t(\rho)) - \nabla p_2(\phi_1^t(\rho))| + |\nabla \tilde{p}(\phi_1^t(\rho))|. \end{aligned} \quad (3.2.3)$$

By assumption, p_1 and p_2 are elliptic at infinity in S^{n_1, n_2} so that for any $\rho = (x, \xi)$ large enough, one has:

$$\frac{1}{C} (\langle x \rangle^{n_1} + \langle \xi \rangle^{n_2}) \leq |p_j(\rho)| \leq C (\langle x \rangle^{n_1} + \langle \xi \rangle^{n_2}), \quad j \in \{1, 2\}. \quad (3.2.4)$$

From the definition of S^{n_1-1, n_2-1} , which contains \tilde{p} , we have

$$|\nabla \tilde{p}(\rho)| \leq C (\langle x \rangle^{n_1-2} + \langle \xi \rangle^{n_2-2}).$$

The ellipticity of p_2 , that is, the left-hand side of (3.2.4), then yields

$$|\nabla \tilde{p}(\rho)| \leq C \left(|p_1(\rho)|^{\max(0, 1 - \frac{2}{n_1})} + |p_1(\rho)|^{\max(0, 1 - \frac{2}{n_2})} \right) \leq C' |p_1(\rho)|^{\max(0, 1 - \frac{2}{n_+})},$$

provided $|\rho|$ is large enough. We obtain on the whole phase space:

$$|\nabla \tilde{p}(\rho)| \leq C + C |p_1(\rho)|^{\max(0, 1 - \frac{2}{n_+})}, \quad \forall \rho \in \mathbf{R}^{2d}. \quad (3.2.5)$$

Now we deal with the other term in (3.2.3): the mean-value inequality yields

$$|\nabla p_2(\phi_2^t(\rho)) - \nabla p_2(\phi_1^t(\rho))| \leq |\phi_2^t(\rho) - \phi_1^t(\rho)| \times \sup_{s \in [0, 1]} |\text{Hess } p_2((1-s)\phi_1^t(\rho) + s\phi_2^t(\rho))|. \quad (3.2.6)$$

Write for short $\rho_s^t = (1-s)\phi_1^t(\rho) + s\phi_2^t(\rho)$. Using that $p_2 \in S^{n_1, n_2}$, we obtain

$$|\text{Hess } p_2(\rho_s^t)| \leq C \left(\langle (1-s)x_1^t + sx_2^t \rangle^{n_1-2} + \langle (1-s)\xi_1^t + s\xi_2^t \rangle^{n_2-2} \right),$$

where we wrote $\phi_j^t(\rho) = (x_j^t, \xi_j^t)$, $j \in \{1, 2\}$. Then we use the classical inequality $\langle a+b \rangle \leq 2(\langle a \rangle + \langle b \rangle)$ to get

$$\begin{aligned} |\text{Hess } p_2(\rho_s^t)| &\leq C \left((\langle x_1^t \rangle + \langle x_2^t \rangle)^{\max(0, n_1-2)} + (\langle \xi_1^t \rangle + \langle \xi_2^t \rangle)^{\max(0, n_2-2)} \right) \\ &\leq C' \left(\langle x_1^t \rangle^{\max(0, n_1-2)} + \langle \xi_1^t \rangle^{\max(0, n_2-2)} \right) + C' \left(\langle x_2^t \rangle^{\max(0, n_1-2)} + \langle \xi_2^t \rangle^{\max(0, n_2-2)} \right). \end{aligned}$$

Next we use the ellipticity of p_1 and p_2 and the fact that they are conserved by the corresponding flows:

$$\begin{aligned} |\text{Hess } p_2(\rho_s^t)| &\leq C \left(|p_1(\phi_1^t(\rho))|^{\max(0, 1 - \frac{2}{n_+})} + |p_2(\phi_2^t(\rho))|^{\max(0, 1 - \frac{2}{n_+})} \right) \\ &= C \left(|p_1(\rho)|^{\max(0, 1 - \frac{2}{n_+})} + |p_2(\rho)|^{\max(0, 1 - \frac{2}{n_+})} \right), \end{aligned}$$

which holds for $|\rho|$ large enough. Up to adding a constant, this works for all $\rho \in \mathbf{R}^d$. Finally we use the fact that p_1 and p_2 are comparable (a consequence of ellipticity) to obtain

$$|\text{Hess } p_2(\rho_s^t)| \leq C + C|p_1(\rho)|^{\max(0, 1 - \frac{2}{n_+})}, \quad \forall \rho \in \mathbf{R}^{2d}.$$

Plugging this into (3.2.6), that results in

$$|\nabla p_2(\phi_2^t(\rho)) - \nabla p_2(\phi_1^t(\rho))| \leq C|\phi_2^t(\rho) - \phi_1^t(\rho)| \times \left(1 + |p_1(\rho)|^{\max(0, 1 - \frac{2}{n_+})}\right),$$

for all $\rho \in \mathbf{R}^{2d}$. Putting this together with (3.2.5), we estimate the right-hand side of (3.2.3) from above as:

$$\left| \frac{d}{dt} (\phi_2^t(\rho) - \phi_1^t(\rho)) \right| \leq C(1 + |\phi_2^t(\rho) - \phi_1^t(\rho)|) \times \left(1 + |p_1(\rho)|^{\max(0, 1 - \frac{2}{n_+})}\right).$$

We deduce that

$$\begin{aligned} \left| \frac{d}{dt} \langle \phi_2^t(\rho) - \phi_1^t(\rho) \rangle \right| &= \left| \frac{d}{dt} (\phi_2^t(\rho) - \phi_1^t(\rho)) \cdot \frac{\phi_2^t(\rho) - \phi_1^t(\rho)}{\langle \phi_2^t(\rho) - \phi_1^t(\rho) \rangle} \right| \\ &\leq C \langle \phi_2^t(\rho) - \phi_1^t(\rho) \rangle \left(1 + |p_1(\rho)|^{\max(0, 1 - \frac{2}{n_+})}\right), \end{aligned}$$

for any $\rho \in \mathbf{R}^{2d}$. We conclude by Grönwall's Lemma that

$$\langle \phi_2^t(\rho) - \phi_1^t(\rho) \rangle \leq e^{Ct|p_1(\rho)|^{\max(0, 1 - \frac{2}{n_+})}}, \quad \forall \rho \in \mathbf{R}^{2d}, \forall t \geq 0,$$

which gives the sought result. \square

The result below roughly states that our dynamical condition is invariant under sub-principal perturbation of the potential V , under the assumption that V is sub-quadratic.

Corollary 3.2.4. *Fix $0 < n_1, n_2 \leq 2$ and let $p_1, p_2 \in S^{n_1, n_2}$ be elliptic symbols in S^{n_1, n_2} , and assume they have the same principal symbol in the sense of (3.2.2). Consider the Hamiltonian flows $(\phi_1^t)_{t \in \mathbf{R}}$ and $(\phi_2^t)_{t \in \mathbf{R}}$ associated with p_1 and p_2 respectively. For any $T > 0$, there exists a constant $C = C_T > 0$ such that the following holds: for any function $q = q(t; \rho)$, Lipschitz in ρ and such that*

$$\text{supp } q \subset [-T, T] \times \mathbf{R}^{2d},$$

one has

$$\left| \int_{\mathbf{R}} q(t; \phi_2^t(\rho)) dt - \int_{\mathbf{R}} q(t; \phi_1^t(\rho)) dt \right| \leq C \|\nabla_{\rho} q\|_{L^{\infty}(\mathbf{R} \times \mathbf{R}^{2d})}, \quad \forall \rho \in \mathbf{R}^{2d}.$$

In particular, it holds

$$|\mathfrak{R}_{p_2}^{\infty}(q) - \mathfrak{R}_{p_1}^{\infty}(q)| \leq C \|\nabla_{\rho} q\|_{L^{\infty}(\mathbf{R} \times \mathbf{R}^{2d})}.$$

Proof. This is a direct application of the mean-value inequality and Proposition 3.2.2, observing that $n_+ = \max(n_1, n_2) \leq 2$:

$$\begin{aligned} \left| \int_{\mathbf{R}} q(t; \phi_2^t(\rho)) dt - \int_{\mathbf{R}} q(t; \phi_1^t(\rho)) dt \right| \\ \leq \int_{-T}^T \|\nabla_{\rho} q\|_{L^{\infty}(\mathbf{R} \times \mathbf{R}^{2d})} |\phi_2^t(\rho) - \phi_1^t(\rho)| dt \leq 2Te^{CT} \|\nabla_{\rho} q\|_{L^{\infty}(\mathbf{R} \times \mathbf{R}^{2d})}. \end{aligned}$$

Taking lower limits in ρ yields the second claim. \square

3.2.2. Quantitative estimates of classical (non-)observability

In this subsection, we show that $\mathbb{1}_{(0,T) \times B_r(0) \times \mathbf{R}^d}$ is not classically observable in the sense of Definition 3.2.1 when the Hamiltonian is of the form $p(x, \xi) = V(x) + \frac{1}{2}|\xi|^2$. Actually for this class of Hamiltonians, we can prove a more precise result.

Proposition 3.2.5. *Let p be a symbol of the form $p(x, \xi) = V(x) + \frac{1}{2}|\xi|^2$, with V fulfilling Assumption 3.1.1 with an arbitrary $m > 0$.*

- If $m \geq 1/2$, there exists a constant $C > 0$ and $E_0 > 0$ such that for all $E \geq E_0$, one has

$$\forall r \geq 0, \forall \rho \in \{p = E\}, \quad \left| \left\{ t \in \left[0, E^{\frac{1}{2}(\frac{1}{m}-1)}\right] : \phi^t(\rho) \in B_r(0) \times \mathbf{R}^d \right\} \right| \leq C \frac{r}{\sqrt{E}}.$$

- If $m < 1/2$, then for any $\varepsilon > 0$ small enough, there exists a constant $C > 0$ and $E_0 > 0$ such that for all $E \geq E_0$, one has

$$\forall r \geq 0, \forall \rho \in \{p = E\}, \quad \left| \left\{ t \in \left[0, E^{\frac{1}{2}(\frac{1}{m}-1)-\varepsilon}\right] : \phi^t(\rho) \in B_r(0) \times \mathbf{R}^d \right\} \right| \leq C \frac{r}{\sqrt{E}}.$$

Corollary 3.2.6 (Classical non-observability). *Under the assumptions of the proposition above, one has the following:*

- If $m < 1$, then for any $T \geq 0$, there exists a constant $C > 0$ and $E_0 > 0$ such that for all $E \geq E_0$, one has

$$\forall r \geq 0, \forall \rho \in \{p = E\}, \quad \left| \{t \in [0, T] : \phi^t(\rho) \in B_r(0) \times \mathbf{R}^d\} \right| \leq C \frac{r}{\sqrt{E}}.$$

- If $m \geq 1$, there exists a constant $C > 0$ and $E_0 > 0$ such that for all $E \geq E_0$ and for all $T \geq 0$, one has

$$\forall r \geq 0, \forall \rho \in \{p = E\}, \quad \left| \{t \in [0, T] : \phi^t(\rho) \in B_r(0) \times \mathbf{R}^d\} \right| \leq C \frac{r(1+T)}{E^{\frac{1}{2m}}}.$$

Remark 3.2.7. The corollary implies in particular that when r and T are fixed, the function $\mathbb{1}_{(0,T) \times B_r(0) \times \mathbf{R}^d}$ is not classically observable in the sense of Definition 3.2.1.

Let us explain the meaning of the typical scales appearing in Proposition 3.2.5 and the subsequent corollary. When V satisfies Assumption 3.1.1 with an arbitrary $m > 0$, one can single out a typical time scale in the energy layer $\{p(\rho) = E\}$ of order $\tau \approx E^{\frac{1}{2}(\frac{1}{m}-1)}$, which corresponds roughly speaking to the “period” of the trajectories of the flow, or rather, to the time needed to go from one turning point of a projected trajectory to another. We observe that for the harmonic oscillator, one has $m = 1$, hence $\tau \approx 1$ is indeed independent of the energy layer. Following this observation, we understand the criticality of quadratic potentials in our problem: if $m > 1$, the typical time scale of evolution of the flow tends to zero as the energy goes to infinity, which means that the flow mixes the phase space more and more in the high-energy limit in a time interval of the form $[0, T]$ with $T > 0$ fixed. On the contrary, for $m < 1$, the flow gets nicer on such a time interval because $\tau \rightarrow +\infty$ as $E \rightarrow +\infty$. We also have a typical scale with respect to the space variable, which is $r \approx E^{\frac{1}{2m}}$. This is the approximate diameter of the classically allowed region $K_E = \{x \in \mathbf{R}^d : V(x) \leq E\}$. This scale also appears naturally when one looks for a trajectory $t \mapsto \phi^t(\rho) = (x^t(\rho), \xi^t(\rho))$ such that $|x^t(\rho)| = \text{constant}$ (think for instance of the case of radial potentials). Differentiating $|x^t(\rho)|^2$ with respect to time, one gets $x^t(\rho) \cdot \xi^t(\rho) = 0$ for all t , and differentiating again leads to $|\xi^t(\rho)|^2 - x^t(\rho) \cdot \nabla V(x^t(\rho)) = 0$. Yet $|\nabla V(x^t(\rho))| \lesssim |x^t(\rho)|^{2m-1}$, and p is preserved by the flow. From this we can deduce that $|x^t(\rho)| \approx p(\rho)^{\frac{1}{2m}}$. So if r is larger than $p(\rho)^{\frac{1}{2m}}$, such trajectories will always stay in $B_r(0) \times \mathbf{R}^d$. Finally, if $\rho_0 = (x_0, \xi_0) \in \{p(\rho) = E\}$ is such that $|x_0| \leq r$, with $r \leq \varepsilon p(\rho)^{\frac{1}{2m}}$, ε being sufficiently small, the momentum of the trajectory verifies $|\xi_0| \gtrsim \sqrt{p(\rho)}$. Therefore, we can expect that the measure of times $t \in [0, \tau]$ such that $|x^t(\rho)| \lesssim r$ will be of order $r/\sqrt{p(\rho)}$.

The proof of Proposition 3.2.5 relies on the lemma below.

Lemma 3.2.8. *Let $a, b, c > 0$. Let $I \subset \mathbf{R}$ be a measurable set such that*

$$\forall (t_1, t_2) \in I \times I, \quad a|t_2 - t_1|^2 - b|t_2 - t_1| + c \geq 0.$$

Then it holds

$$|I \cap [0, \tau]| \leq \frac{8ac}{b^2} \tau, \quad \forall \tau \geq \frac{b}{2a}. \quad (3.2.7)$$

Remark 3.2.9. Observe that the left-hand side of (3.2.7) is always bounded by τ . Thus, the lemma is mainly relevant in the case where $ac \ll b^2$, in which case the discriminant of the polynomial $aX^2 - bX + c$ is positive.

Proof of Lemma 3.2.8. First assume that the discriminant of the polynomial $aX^2 - bX + c$ is positive. Denote by $z_- \leq z_+$ the (real) roots of the polynomial. Then we have

$$\frac{b}{2a} = \frac{z_+ + z_-}{2} \leq z_+ \leq z_+ + z_- = \frac{b}{a} \quad \text{and} \quad z_- = \frac{z_+ z_-}{z_+} = \frac{c/a}{z_+} \leq \frac{2c}{b}.$$

Since $a > 0$, we deduce that any t such that $at^2 - bt + c \geq 0$ verifies

$$t \leq z_- \leq \frac{2c}{b} \quad \text{or} \quad t \geq z_+ \geq \frac{b}{2a}. \quad (3.2.8)$$

We deduce that

$$\left| I \cap \left[0, \frac{b}{2a} \right] \right| \leq |\{t \in [0, z_+] : at^2 - bt + c \geq 0\}| \leq |[0, z_-]| \leq \frac{2c}{b}. \quad (3.2.9)$$

Now if $\tau \geq b/2a$, we split the interval $[0, \tau]$ as follows:

$$[0, \tau] = \bigcup_{k=1}^n \left[\frac{k-1}{n}\tau, \frac{k}{n}\tau \right], \quad \text{with } n = \left\lceil \frac{\tau}{b/2a} \right\rceil \geq 1.$$

On each piece, we have

$$\left| I \cap \left[\frac{k-1}{n}\tau, \frac{k}{n}\tau \right] \right| = \left| \left(I - \frac{k-1}{n}\tau \right) \cap \left[0, \frac{1}{n}\tau \right] \right| \leq \left| \left(I - \frac{k-1}{n}\tau \right) \cap \left[0, \frac{b}{2a} \right] \right|,$$

where the last inequality is due to the definition of n . We can apply (3.2.9) with $I - \frac{k-1}{n}\tau$ instead of I , since the former set satisfies the assumptions of the lemma. Then, summing over k yields

$$|I \cap [0, \tau]| \leq n \frac{2c}{b} \leq \left(\frac{\tau}{b/2a} + 1 \right) \frac{2c}{b} \leq \frac{8ac}{b^2} \tau,$$

which is the desired estimate. Finally if the discriminant is nonpositive, i.e. $b^2 \leq 4ac$, then

$$|I \cap [0, \tau]| \leq \tau \leq \frac{4ac}{b^2} \tau,$$

which concludes the proof. \square

Proof of Proposition 3.2.5. Let us write for short $E = p(\rho)$, and introduce the components of the flow $(x^t, \xi^t) = \phi^t(\rho)$. Assume $E > 0$. The core of the argument is to compare x^t to the straight trajectory $t \mapsto x^0 + t\xi^0$, which is of course easier to handle. In order to have two distinct points of the initial trajectory to be in the ball $B_r(0)$, its distance to the straight trajectory has to be very small or very large, which is possible in a time interval which is either small or large respectively. Introduce

$$I = I_{\rho, r} = \{t \in \mathbf{R} : x^t \in B_r(0)\}.$$

This set is measurable. Moreover, for any $t_1 \leq t_2$, using the Hamilton equation and the Taylor Formula at order 1 with integral remainder, one has

$$x^{t_2} = x^{t_1} + (t_2 - t_1)\xi^{t_1} - (t_2 - t_1)^2 \int_0^1 (1-s)\nabla V \left(x^{(1-s)t_1 + st_2} \right) ds.$$

Assume now that $t_1, t_2 \in I$. Then the inverse triangle inequality leads to

$$2r \geq |t_2 - t_1| |\xi^{t_1}| - (t_2 - t_1)^2 \sup_{t \in [t_1, t_2]} |\nabla V(x^t)|. \quad (3.2.10)$$

At this stage we have to estimate differently the term involving ∇V , depending on whether m is greater or less than $1/2$ (or roughly speaking on whether the potential is approximately convex or concave).

Case $m \geq 1/2$. Using that V satisfies Assumption 3.1.1, we have

$$|\xi^{t_1}| = \sqrt{2(E - V(x^{t_1}))} \geq \sqrt{\max(0, E - C\langle r \rangle^{2m})},$$

for some constant $C \geq 1$. Moreover, one can roughly estimate the remainder using the triangle inequality:

$$\sup_{t \in [t_1, t_2]} |\nabla V(x^t)| \leq C \sup_{t \in [t_1, t_2]} \langle x^t \rangle^{2m-1}.$$

Now we take advantage of the fact that V is elliptic: up to enlarging the constant C , one has

$$-C + \frac{1}{C} \langle x \rangle^{2m} \leq V(x) \leq V(x) + \frac{1}{2} |\xi|^2, \quad \forall (x, \xi) \in \mathbf{R}^{2d}.$$

Therefore if E is large enough (say larger than C), we obtain $\langle x^t \rangle^{2m-1} \leq CE^{1-\frac{1}{2m}}$, with a possibly larger constant C (we use $m \geq 1/2$ here). Inequality (3.2.10) then becomes

$$2r \geq |t_2 - t_1| \sqrt{\max(0, E - C\langle r \rangle^{2m})} - CE^{1-\frac{1}{2m}} |t_2 - t_1|^2.$$

Set

$$a = CE^{1-\frac{1}{2m}}, \quad b = \sqrt{\max(0, E - C\langle r \rangle^{2m})}, \quad c = 2r \quad \text{and} \quad \tau = E^{\frac{1}{2}(\frac{1}{m}-1)}. \quad (3.2.11)$$

We have $\tau \geq \frac{b}{2a}$ since we can assume that $C \geq 1$:

$$\frac{b}{2a} = \frac{\sqrt{\max(0, E - C\langle r \rangle^{2m})}}{2C} E^{\frac{1}{2m}-1} \leq \frac{1}{2C} E^{\frac{1}{2}(\frac{1}{m}-1)} \leq \tau.$$

With these notation, we have that any $t_1, t_2 \in I$ satisfy

$$a|t_2 - t_1|^2 - b|t_2 - t_1| + c \geq 0.$$

Therefore, assuming first that $C\langle r \rangle^{2m} \leq E/2$, we have $b \geq \sqrt{E/2} > 0$, so that Lemma 3.2.8 applies. We obtain

$$\left| I \cap \left[0, E^{\frac{1}{2}(\frac{1}{m}-1)} \right] \right| \leq \frac{8ac}{b^2} \tau \leq \frac{8CE^{1-\frac{1}{2m}} \times 2r}{E/2} E^{\frac{1}{2}(\frac{1}{m}-1)} = 32C \frac{r}{\sqrt{E}}.$$

If on the contrary we have $\langle r \rangle \geq (E/2C)^{\frac{1}{2m}}$, as soon as $E \geq 2^{2m+1}C$ we have $r \geq \frac{1}{2}(E/2C)^{\frac{1}{2m}}$, and we check that

$$\left| I \cap \left[0, E^{\frac{1}{2}(\frac{1}{m}-1)} \right] \right| \leq E^{\frac{1}{2}(\frac{1}{m}-1)} = \frac{r}{\sqrt{E}} \times \frac{E^{\frac{1}{2m}}}{r} \leq \frac{r}{\sqrt{E}} \times 2^{1+\frac{1}{2m}} C^{\frac{1}{2m}}.$$

This is valid for any $r > 0$, but in fact $r = 0$ works as well since $B_0(0) = \emptyset$. In addition, this is independent of the point $\rho \in \{p = E\}$, whence the result.

Case $m < 1/2$. In the situation where the potential is ‘‘sublinear’’, the inequality $\langle x^t \rangle^{2m-1} \lesssim E^{1-\frac{1}{2m}}$ is false in general since the power $2m - 1$ is nonpositive (such an inequality would require $V(x^t)$ to be controlled from below by E , which is possible near turning points of the trajectory but not in the well). Thus, a priori we can only have $|\nabla V(x^t)| \leq C$, which leads to

$$\begin{aligned} 2r &\geq |t_2 - t_1| |\xi^{t_1}| - C|t_2 - t_1|^2 \geq |t_2 - t_1| \sqrt{\max(0, E - C\langle r \rangle^{2m})} - C|t_2 - t_1|^2 \\ &\geq |t_2 - t_1| \sqrt{\max(0, E - C\langle r \rangle)} - C|t_2 - t_1|^2. \end{aligned} \quad (3.2.12)$$

This coincides with the previous case for the critical value $m = 1/2$: for any $t_1, t_2 \in I$, it holds

$$a|t_2 - t_1|^2 - b|t_2 - t_1| + c \geq 0,$$

where a, b, c are defined in (3.2.11) (with $m = 1/2$). Then, the first step of the proof tells us that there exists $C > 0$ such that for all E large enough, it holds

$$\left| \left\{ t \in [0, \sqrt{E}] : \phi^t(\rho) \in B_r(0) \times \mathbf{R}^d \right\} \right| \leq C \frac{r}{\sqrt{E}}, \quad \forall r \geq 0, \forall \rho \in \{p = E\}. \quad (3.2.13)$$

We shall use this additional information to improve (3.2.12), and then bootstrap this procedure to reach the critical time $E^{\frac{1}{2}(\frac{1}{m}-1)}$. We will work this out by induction, taking (3.2.13) as our basis step. Consider $n \geq 0$ and suppose there exist $\gamma_n \in [\frac{1}{2}, \frac{1}{2}(\frac{1}{m}-1))$ and $C_n \geq 1$ such that when E is large enough, one has

$$\left| \left\{ t \in [0, E^{\gamma_n}] : \phi^t(\rho) \in B_r(0) \times \mathbf{R}^d \right\} \right| \leq C_n \frac{r}{\sqrt{E}}, \quad \forall r \geq 0, \forall \rho \in \{p = E\}. \quad (3.2.14)$$

We first deduce from the Taylor formula a bound slightly more precise than (3.2.10):

$$\begin{aligned} 2r &\geq |t_2 - t_1| |\xi^{t_1}| - |t_2 - t_1| \int_{t_1}^{t_2} |\nabla V(x^t)| dt \\ &\geq |t_2 - t_1| \sqrt{\max(0, E - C\langle r \rangle^{2m})} - |t_2 - t_1| \int_{t_1}^{t_2} |\nabla V(x^t)| dt. \end{aligned} \quad (3.2.15)$$

Take $\delta \in [0, 1]$ to be chosen later. We have

$$\begin{aligned} \int_{t_1}^{t_2} |\nabla V(x^t)| dt &\leq C \int_{t_1}^{t_2} \langle x^t \rangle^{2m-1} dt = C \int_0^{+\infty} \left(\int_{t_1}^{t_2} \mathbb{1}_{u \leq \langle x^t \rangle^{2m-1}} dt \right) du \\ &\leq C \int_0^{+\infty} \left| \left\{ t \in [t_1, t_2] : u \leq |x^t|^{2m-1} \right\} \right| du \\ &\leq C \int_0^{E^{\delta(1-\frac{1}{2m})}} |t_2 - t_1| du + C \int_{E^{\delta(1-\frac{1}{2m})}}^{+\infty} \left| \left\{ t \in [t_1, t_2] : |x^t| \leq u^{-\frac{1}{1-2m}} \right\} \right| du. \end{aligned} \quad (3.2.16)$$

The first inequality follows from our assumptions on V , the equality is a consequence of Fubini's Theorem, then we use that $2m - 1 \leq 0$ to deduce $\langle x^s \rangle^{2m-1} \leq |x^s|^{2m-1}$, and finally we split the integral over u into two pieces. To estimate the second piece, we split the interval $[t_1, t_2]$ into $N = \lceil \frac{|t_2 - t_1|}{E^{\gamma_n}} \rceil$ intervals of length less than E^{γ_n} . On the k -th piece, we use the induction hypothesis (3.2.14), with $\rho_k = \phi^{t_1 + \frac{k-1}{N}|t_2 - t_1|}(\rho)$ instead of ρ , namely setting $\tilde{t}_k = t_1 + \frac{k-1}{N}|t_2 - t_1|$, it holds

$$\left| \left\{ t \in [\tilde{t}_k, \tilde{t}_{k+1}] : |x^t| \leq u^{-\frac{1}{1-2m}} \right\} \right| \leq \left| \left\{ s \in [0, E^{\gamma_n}] : |x^{s+\tilde{t}_k}| \leq u^{-\frac{1}{1-2m}} \right\} \right| \leq \frac{C_n}{\sqrt{E}} u^{-\frac{1}{1-2m}}.$$

Summing over $k \in \{1, 2, \dots, N\}$ yields

$$\left| \left\{ t \in [t_1, t_2] : |x^t| \leq u^{-\frac{1}{1-2m}} \right\} \right| \leq \frac{C_n}{\sqrt{E}} u^{-\frac{1}{1-2m}} \left\lceil \frac{|t_2 - t_1|}{E^{\gamma_n}} \right\rceil,$$

provided E is large enough. Integrating over u , we obtain a bound for the second term in (3.2.16):

$$\begin{aligned} \int_{E^{\delta(1-\frac{1}{2m})}}^{+\infty} \left| \left\{ t \in [t_1, t_2] : |x^t| \leq u^{-\frac{1}{1-2m}} \right\} \right| du &\leq \frac{C_n}{E^{1/2}} \left(\frac{|t_2 - t_1|}{E^{\gamma_n}} + 1 \right) \int_{E^{\delta(1-\frac{1}{2m})}}^{+\infty} u^{-\frac{1}{1-2m}} du \\ &= \frac{C_n}{E^{1/2}} \left(\frac{|t_2 - t_1|}{E^{\gamma_n}} + 1 \right) \times \frac{-1}{1 - \frac{1}{1-2m}} E^{\delta(1-\frac{1}{2m})(1-\frac{1}{1-2m})} \\ &= \left(\frac{1}{m} - 1 \right) \times \frac{C_n}{E^{1/2}} \left(\frac{|t_2 - t_1|}{E^{\gamma_n}} + 1 \right) E^{\delta}. \end{aligned}$$

In the end we obtain

$$\int_{t_1}^{t_2} |\nabla V(x^t)| dt \leq \frac{C}{2} |t_2 - t_1| \left(E^{\delta(1-\frac{1}{2m})} + E^{\delta-\frac{1}{2}-\gamma_n} \right) + CE^{\delta-\frac{1}{2}},$$

for some constant $C > 0$. By choosing $\delta = m(2\gamma_n + 1)$ (we have indeed $\delta \in [2m, 1) \subset [0, 1)$ when $\gamma_n \in [\frac{1}{2}, \frac{1}{2}(\frac{1}{m} - 1))$), we obtain

$$\int_{t_1}^{t_2} |\nabla V(x^t)| dt \leq C|t_2 - t_1|E^{(2m-1)\gamma_n + m - \frac{1}{2}} + CE^{\delta - \frac{1}{2}}.$$

Going back to (3.2.15), if $t_1, t_2 \in I$, i.e. x^{t_1} and x^{t_2} lie in $B_r(0)$, we deduce

$$2r \geq |t_2 - t_1| \left(\sqrt{\max(0, E - C\langle r \rangle^{2m})} - CE^{\delta - \frac{1}{2}} \right) - CE^{\frac{1}{2} - \gamma_{n+1}} |t_2 - t_1|^2,$$

where we set $\gamma_{n+1} = (1 - 2m)\gamma_n + 1 - m$. Now set

$$a = CE^{\frac{1}{2} - \gamma_{n+1}}, \quad b = \sqrt{\max(0, E - C\langle r \rangle^{2m})} - CE^{\delta - \frac{1}{2}} \quad \text{and} \quad c = 2r.$$

Assuming first that $C\langle r \rangle^{2m} \leq E/2$ and recalling that $\delta < 1$, we know that for E large enough, we have $b \geq \sqrt{E/3}$. Any $t_1, t_2 \in I$ satisfy

$$a|t_2 - t_1|^2 - b|t_2 - t_1| + c \geq 0,$$

so we apply Lemma 3.2.8 with $\tau = E^{\gamma_{n+1}} \geq \frac{b}{2a}$ to get

$$|I \cap [0, E^{\gamma_{n+1}}]| \leq \frac{8ac}{b^2} E^{\gamma_{n+1}} \leq \frac{16CE^{1/2}}{E/3} r = \frac{48C}{\sqrt{E}} r.$$

When $C\langle r \rangle^{2m} \geq E/2$, assuming that E is large enough we have $r \geq \frac{1}{2}(E/2C)^{\frac{1}{2m}}$ and we conclude as in the previous step that

$$|\{t \in [0, E^{\gamma_{n+1}}] : x^t \in B_r(0)\}| \leq \frac{r}{\sqrt{E}} \frac{E^{\gamma_{n+1} + \frac{1}{2}}}{r} \leq \frac{r}{\sqrt{E}} 2^{1 + \frac{1}{2m}} C^{\frac{1}{2m}} E^{\gamma_{n+1} - \frac{1}{2}(\frac{1}{m} - 1)}.$$

Since by the induction hypothesis we have $\gamma_n \in [\frac{1}{2}, \frac{1}{2}(\frac{1}{m} - 1))$, then γ_{n+1} belongs to the same interval because by definition, $\gamma_{n+1} \geq 1 - m \geq \frac{1}{2}$, and we have

$$\frac{\gamma - \gamma_{n+1}}{1/2} = (1 - 2m) \frac{\gamma - \gamma_n}{1/2} \quad \text{where} \quad \gamma = \frac{1}{2} \left(\frac{1}{m} - 1 \right). \quad (3.2.17)$$

Therefore we see that $\gamma_{n+1} - \gamma < 0$, so as soon as E is large enough, it holds

$$|\{t \in [0, E^{\gamma_{n+1}}] : x^t \in B_r(0)\}| \leq C_{n+1} \frac{r}{\sqrt{E}}$$

for any $r \geq 0$, and for some constant C_{n+1} . Thus we have constructed by induction a non-decreasing sequence $(\gamma_n)_{n \in \mathbf{N}}$ for which (3.2.14) holds. We deduce from (3.2.17) that it converges to $\gamma = \frac{1}{2}(\frac{1}{m} - 1)$, which yields the final result. \square

Proof of Corollary 3.2.6. Firstly we treat the case where $m < 1$. For ε small enough, $E^{\frac{1}{2}(\frac{1}{m} - 1) - \varepsilon}$ tends to $+\infty$ as $E \rightarrow +\infty$, so we can write using Proposition 3.2.5:

$$|\{t \in [0, T] : \phi^t(\rho) \in B_r(0) \times \mathbf{R}^d\}| \leq \left| \left\{ t \in \left[0, E^{\frac{1}{2}(\frac{1}{m} - 1) - \varepsilon}\right] : \phi^t(\rho) \in B_r(0) \times \mathbf{R}^d \right\} \right| \leq C \frac{r}{\sqrt{E}},$$

provided E is large enough, for all $\rho \in \{p = E\}$ and all $r \geq 0$. Now in the case where $m \geq 1$, we know that $E^{\frac{1}{2}(\frac{1}{m} - 1)}$ remains bounded as $E \rightarrow +\infty$. By Proposition 3.2.5 again, there is a $E_0 > 0$ such that for any $E \geq E_0$, it holds

$$\left| \left\{ t \in \left[0, E^{\frac{1}{2}(\frac{1}{m} - 1)}\right] : \phi^t(\rho) \in B_r(0) \times \mathbf{R}^d \right\} \right| \leq C \frac{r}{\sqrt{E}}, \quad (3.2.18)$$

whenever $r \geq 0$ and $\rho \in \{p(\rho) = E\}$. Let $n = \lceil \frac{T}{E^{\frac{1}{2}(\frac{1}{m}-1)}} \rceil$. Writing $t_k = \frac{k}{n}T$ and $\rho_k = \phi^{t_k}(\rho)$ for any $k \in \{0, 1, \dots, n\}$, we have

$$\begin{aligned} |\{t \in [0, T] : \phi^t(\rho) \in B_r(0) \times \mathbf{R}^d\}| &\leq \sum_{k=1}^n |\{t \in [t_{k-1}, t_k] : \phi^t(\rho) \in B_r(0) \times \mathbf{R}^d\}| \\ &= \sum_{k=1}^n |\{t \in [0, \frac{1}{n}T] : \phi^{t+t_{k-1}}(\rho) \in B_r(0) \times \mathbf{R}^d\}| \\ &\leq \sum_{k=1}^n |\{t \in [0, E^{\frac{1}{2}(\frac{1}{m}-1)}] : \phi^t(\rho_{k-1}) \in B_r(0) \times \mathbf{R}^d\}|. \end{aligned}$$

The last inequality comes from the definition of n . Estimate (3.2.18) applies to each piece of this sum. We conclude that

$$|\{t \in [0, T] : \phi^t(\rho) \in B_r(0) \times \mathbf{R}^d\}| \leq nC \frac{r}{\sqrt{E}} \leq \frac{1+T}{E^{\frac{1}{2}(\frac{1}{m}-1)}} \times C \frac{r}{\sqrt{E}} = C \frac{r(1+T)}{E^{\frac{1}{2m}}}$$

(we can ensure that $n \leq \frac{1+T}{E^{\frac{1}{2}(\frac{1}{m}-1)}}$ in the second equality up to enlarging E_0 so that it is larger than 1, independently of T). This completes the proof. \square

3.2.3. Continuity of the composition by the flow in symbol classes

From now on we go back to a *subquadratic* potential, that is to say we suppose our classical Hamiltonian is of the form $p(x, \xi) = V(x) + \frac{1}{2}|\xi|^2$, with V satisfying Assumption 3.1.1 with $m \in (0, 1]$. In the course of our study, we will need to check that the composition of a symbol with the Hamiltonian flow is still well-behaved in a suitable symbol class, in the sense that its derivatives remain controlled properly. The following lemma is common in the context of the quantum-classical correspondence: see for instance Bouzouina and Robert [BR02, Lemma 2.2]. We reproduce a proof to obtain an estimate adapted to our context and to keep track of the dependence of constants on the parameters of the problem. We recall that a function $a \in C^\infty(\mathbf{R}^{2d})$ is said to be a symbol in the class $S(1)$ if all its derivatives are bounded. The quantities

$$|a|_{S(1)}^\ell = \max_{\substack{\alpha \in \mathbf{N}^{2d} \\ 0 \leq |\alpha| \leq \ell}} \sup_{\rho \in \mathbf{R}^{2d}} |\partial^\alpha a(\rho)|, \quad \ell \in \mathbf{N},$$

endow the vector space $S(1)$ with a Fréchet structure (see Appendix 3.B for further details).

Lemma 3.2.10. *Let a be a symbol in $S(1)$. Then the function $a \circ \phi^t$ still belongs to $S(1)$, and stays in a bounded subset of $S(1)$ locally uniformly with respect to t . More precisely, for any fixed $T > 0$, for any nonzero multi-index $\alpha \in \mathbf{N}^{2d}$, we have the derivative estimate*

$$\|\partial^\alpha (a \circ \phi^t)\|_\infty \leq C_\alpha(T, p) \max_{1 \leq |\beta| \leq |\alpha|} \|\partial^\beta a\|_\infty,$$

uniformly in $t \in [-T, T]$. The constants $C_\alpha(T, p)$ depend only on T and on the sup-norm of derivatives of order $\{2, 3, \dots, |\alpha| + 1\}$ of p .

Proof. In all the proof, t ranges in a compact set, say $[-T, T]$ for some fixed $T > 0$.

Step 1 – Control of differentials of the Hamiltonian flow. Differentiating the Hamilton equation (3.1.5) defining the flow ϕ^t , we get

$$\frac{d}{dt} d\phi^t(\rho) = J \text{Hess } p(\phi^t(\rho)) d\phi^t(\rho).$$

By assumption on the potential V (see (3.1.4)), we observe that the Hessian of p is bounded. Since $d\phi^0(\rho) = \text{Id}$ for any $\rho \in \mathbf{R}^{2d}$, we classically deduce using Grönwall's Lemma that

$$\|d\phi^t(\rho)\| \leq e^{T|J \text{Hess } p|_\infty} \leq e^{T|\text{Hess } p|_\infty}, \quad \forall \rho \in \mathbf{R}^{2d}, \forall t \in [-T, T].$$

For higher order differentials, we proceed by induction. Suppose that for some $k \geq 1$, all the differentials of order $\leq k$ of ϕ^t are bounded uniformly in t on \mathbf{R}^{2d} , with a bound involving derivatives

of order $k + 1$ of p . Differentiating the Hamilton equation $k + 1$ times, the Faà di Bruno formula shows that $\frac{d}{dt} d^{k+1}\phi^t(\rho)$ is a sum of terms of the form:

$$J d^\ell(\nabla p)(\phi^t(\rho)) \cdot (d^{k_1}\phi^t(\rho), d^{k_2}\phi^t(\rho), \dots, d^{k_\ell}\phi^t(\rho)),$$

where $1 \leq \ell \leq k + 1$ and $k_1 + k_2 + \dots + k_\ell = k + 1$. Such terms are bounded uniformly in $t \in [-T, T]$ by the induction hypothesis as soon as $\ell \geq 2$ (note that all the differentials of order ≥ 2 of p are bounded). So in fact the ODE on $d^{k+1}\phi^t(\rho)$ can be written

$$\frac{d}{dt} d^{k+1}\phi^t(\rho) = J \text{Hess } p(\phi^t(\rho)) d^{k+1}\phi^t(\rho) + R(t, \rho),$$

where $R(t, \rho)$ satisfies

$$|R(t, \rho)|_\infty \leq C(T, p), \quad \forall \rho \in \mathbf{R}^{2d}, \forall t \in [-T, T],$$

where the constant $C(T, p)$ depends only on the sup-norm of derivatives of order $\{2, 3, \dots, k + 2\}$ of p . We conclude by Grönwall's Lemma again, together with Duhamel's Formula that $d^{k+1}\phi^t(\rho)$ is bounded similarly: given that $k + 1 \geq 2$, we have $d^{k+1}\phi^0(\rho) = 0$ for every $\rho \in \mathbf{R}^{2d}$, so that

$$\|d^{k+1}\phi^t(\rho)\| \leq \int_0^t C(T, p) e^{|\text{Hess } p|_\infty(t-s)} ds \leq TC'(T, p).$$

This finishes the induction.

Step 2 – Estimates of derivatives of $a \circ \phi^t$. We estimate the derivatives in x or ξ . Let $\alpha \in \mathbf{N}^{2d} \setminus \{0\}$, and denote by $(x_1^t, x_2^t, \dots, x_d^t, \xi_1^t, \xi_2^t, \dots, \xi_d^t)$ the components of the flow. The chain rule together with the Faà di Bruno formula yield that $\partial^\alpha(a \circ \phi^t)$ can be expressed as a sum of terms of the form

$$(\partial_x^{\tilde{\alpha}} \partial_\xi^{\tilde{\beta}} a) \circ \phi^t \times \prod_{j_1 \in \tilde{\alpha}} \partial^{\alpha_{j_1}} x_{j_1} \times \prod_{j_2 \in \tilde{\beta}} \partial^{\beta_{j_2}} \xi_{j_2},$$

where $\tilde{\alpha}, \tilde{\beta} \in \mathbf{N}^d$ are such that $1 \leq |\tilde{\alpha}| + |\tilde{\beta}| \leq |\alpha|$ and $\alpha_{j_1}, \beta_{j_2} \in \mathbf{N}^{2d} \setminus \{0\}$ satisfy $\sum_{j_1} \alpha_{j_1} + \sum_{j_2} \beta_{j_2} = \alpha$. (By $j_1 \in \tilde{\alpha}, j_2 \in \tilde{\beta}$, we mean that $j_1, j_2 \in \{1, 2, \dots, d\}$ are indices for which $\tilde{\alpha}$ and $\tilde{\beta}$ are nonzero.) The claim follows immediately from the bounds on the derivatives of x_j^t and ξ_j^t proved in Step 1. \square

3.3. Proof of the main theorem

We start with a lemma that will enable us to replace $\mathbb{1}_{\omega_R \setminus B_r(0)}$ in the observability inequality with a well-behaved symbol.

Lemma 3.3.1 (Mollifying the observation set). *Let $\omega \subset \mathbf{R}^d$ and denote by ω_R the open set*

$$\omega_R = \bigcup_{x \in \omega} B_R(x), \quad R > 0.$$

There exists a symbol $a = a_R \in S(1)$ depending only on the x variable such that

$$\mathbb{1}_{\omega_{R/2}}(x) \leq a_R(x) \leq \mathbb{1}_{\omega_R}(x), \quad \forall x \in \mathbf{R}^d.$$

In addition, it satisfies the seminorm estimates:

$$\forall \ell \in \mathbf{N}, \exists C_\ell > 0 : \forall R \geq 1, \quad |a_R|_{S(1)}^\ell \leq C_\ell \quad \text{and} \quad |\nabla a_R|_{S(1)}^\ell \leq \frac{C_\ell}{R}.$$

The constants involved do not depend on ω .

Proof. Fix $\kappa \in C_c^\infty(\mathbf{R}^d)$ a mollifier with the following properties:

$$\kappa(x) \geq 0, \quad \forall x \in \mathbf{R}^d, \quad \text{supp } \kappa \subset B_1(0) \quad \text{and} \quad \int_{\mathbf{R}^d} \kappa(x) dx = 1.$$

For any $r > 0$, set $\kappa_r = r^{-d}\kappa(\bullet/r)$, so that $\|\kappa_r\|_{L^1(\mathbf{R}^d)} = 1$. Set for any $R > 0$:

$$a_R(x) = \left(\kappa_{\frac{1}{4}R} * \mathbf{1}_{\omega_{\frac{3}{4}R}} \right) (x), \quad \forall x \in \mathbf{R}^d.$$

We check that a_R defined in this way satisfies the required properties. We first observe that, by definition, a_R is non-negative, and that $a_R \leq 1$ by Young's inequality. Now by standard properties of convolution, the support of a_R is contained in $\omega_{\frac{3}{4}R} + B_{\frac{1}{4}R}(0) \subset \omega_R$ (recall that the support of κ is a compact subset of $B_1(0)$), which proves that $a_R \leq \mathbf{1}_{\omega_R}$. On the other hand, if $x \in \omega_{R/2}$, then $\kappa_{\frac{1}{4}R}(x - \bullet)$ is supported in $\omega_{\frac{3}{4}R}$, so that $a_R(x) = 1$, which proves that $a_R \geq \mathbf{1}_{\omega_{R/2}}$. Differentiating under the integral sign, we see that $\|\partial^\alpha a_R\|_\infty$ is of order $1/R^{|\alpha|}$ for any multi-index $\alpha \in \mathbf{N}^d$, which yields the desired seminorm estimates ($R \geq 1$ is important here). The constants depend only on the supremum norms of derivatives of κ , and not on ω . \square

Remark 3.3.2. The symbol a_R can be considered as a semiclassical symbol, with Planck parameter $1/R^2$, since by construction each derivative yields a gain of $1/R$. However in view of Lemma 3.2.10, this property is not preserved by composition by the Hamiltonian flow, since all the derivatives of $a_R^\circ \phi^t$ of order ≥ 1 behave as $1/R$. This comes from the fact that, when differentiating $a_R \circ \phi^t$ twice or more, the second, third, and higher order derivatives can hit ϕ^t instead of a_R .

We prove a version of Egorov's theorem taking into account the above remark. Our approach is very classical; see [BR02] or [Zwo12, Chapter 11] for refinements. We refer again to Appendix 3.B for an account on the Weyl quantization Op .

Proposition 3.3.3 (Egorov). *Let $a \in S(1)$. Then the symbol $a \circ \phi^t$ lies in $S(1)$ with seminorm estimates*

$$\forall T > 0, \forall \ell \in \mathbf{N}, \exists C_\ell(T, p) > 0: \quad |a \circ \phi^t|_{S(1)}^\ell \leq C_\ell(T, p) |a|_{S(1)}^\ell, \quad \forall t \in [-T, T],$$

and, it holds

$$e^{itP} \text{Op}(a) e^{-itP} = \text{Op}(a \circ \phi^t) + \mathcal{R}_a(t), \quad (3.3.1)$$

where the remainder term $\mathcal{R}_a(t)$ is a bounded operator satisfying

$$\forall T > 0, \exists C(T, p) > 0: \quad \|\mathcal{R}_a(t)\|_{L^2 \rightarrow L^2} \leq C(T, p) |\nabla a|_{S(1)}^{k_d}, \quad \forall t \in [-T, T],$$

for some integer k_d depending only on the dimension.

Proof. The claim that $a \circ \phi^t \in S(1)$ and the subsequent seminorm estimates are provided by Lemma 3.2.10. To prove (3.3.1), we follow the classical method that consists in differentiating the time dependent operator

$$Q(s) = e^{-isP} \text{Op}(a \circ \phi^s) e^{isP},$$

and estimating this derivative. For the sake of simplicity, let us introduce $a_s = a \circ \phi^s$. All the operators in this composition map $\mathcal{S}(\mathbf{R}^d)$ to itself continuously, so that $Q(s)u$ can be differentiated using the chain rule, for any $u \in \mathcal{S}(\mathbf{R}^d)$. From now on, we will omit to write u . Recalling that, by definition of ϕ^s , we have $\frac{d}{ds} a_s = \{p, a_s\}$, it holds

$$\frac{d}{ds} \text{Op}(a_s) = \text{Op}(\{p, a_s\})$$

(rigorously, one may apply the Dominated Convergence Theorem to the pairing $\langle v, \text{Op}(a_s)u \rangle_{\mathcal{S}', \mathcal{S}(\mathbf{R}^d)}$ for two Schwartz functions u and v). Therefore we get

$$\frac{d}{ds} Q(s) = -ie^{-isP} ([P, \text{Op}(a_s)] + i\text{Op}(\{p, a_s\})) e^{isP} = -ie^{-isP} \text{Op}(\mathcal{R}_3(s)) e^{isP}. \quad (3.3.2)$$

The symbol $\mathcal{R}_3(s)$ above is nothing but the remainder of order 3 in the pseudo-differential calculus between p and a_s . Proposition 3.B.5 provides a bound on this remainder in terms of seminorms of a_s . Recall that, in the subcritical case $m \leq 1$, $\partial^\alpha p \in S(1)$ whenever $|\alpha| \geq 2$. Therefore according to Proposition 3.B.5, for any seminorm index $\ell \in \mathbf{N}$, there exist a constant $C_\ell > 0$ as well as an integer $k \geq 0$ such that

$$|\mathcal{R}_3(s)|_{S(1)}^\ell \leq C_\ell |d^3 a_s|_{S(1)}^k |d^3 p|_{S(1)}^k.$$

Then we use Lemma 3.2.10 to obtain

$$|\mathcal{R}_3(s)|_{S(1)}^\ell \leq C_\ell(T, p) |\nabla a|_{S(1)}^k,$$

for any $s \in [-T, T]$. Therefore, the Calderón-Vaillancourt Theorem (Theorem 3.B.2) tells us that the norm of $\text{Op}(\mathcal{R}_3(s))$ is bounded, uniformly in $s \in [-T, T]$, by a seminorm of ∇a , and a constant depending only on T and p . Plugging this into (3.3.2), given that the propagator e^{isP} is an isometry, we obtain the same bound on $\frac{d}{ds}Q(s)$. Integrating this in s , we obtain from the mean-value inequality

$$\forall t \in [-T, T], \quad \|Q(t) - Q(0)\|_{L^2 \rightarrow L^2} \leq 2T \sup_{s \in [-T, T]} \left\| \frac{d}{ds}Q(s) \right\|_{L^2 \rightarrow L^2} \leq C(T, p) |\nabla a|_{S(1)}^{k_d},$$

where the integer k_d depends only on the dimension. Conjugating by the propagator, which is an isometry on L^2 , yields the desired result. \square

We are now in a position to prove our main result.

Proof of Theorem 3.1.3. We fix $\omega \subset \mathbf{R}^d$, a compact set $K \subset \mathbf{R}^d$, and we introduce $\tilde{\omega}(R) = (\omega \setminus K_R)_R$, for $R > 0$. One can verify that $\tilde{\omega}(R) \subset \omega_R \setminus K$. By Lemma 3.3.1, there exists a symbol $a_R \in S(1)$ depending on the parameter $R > 0$ such that

$$\mathbf{1}_{(\omega \setminus K_R) \times \mathbf{R}^d} \leq a_R \leq \mathbf{1}_{\tilde{\omega}(R) \times \mathbf{R}^d}, \quad \forall R > 0, \quad (3.3.3)$$

and $|\nabla a_R|_{S(1)}^\ell \leq c_{d,\ell}/R$ for any $\ell \in \mathbf{N}$, with a constant $c_{d,\ell}$ depending only on the dimension and ℓ , uniformly in $R \geq 1$. Notice that the symbol depends on ω and K but not its seminorms. On the quantum side, one can regard the functions in (3.3.3) as multiplication operators, and understand the inequalities in the sense of self-adjoint operators. Conjugating by the Schrödinger propagator does not change the inequalities, so that:

$$e^{itP} \mathbf{1}_{\omega \setminus K_R} e^{-itP} \leq e^{itP} \text{Op}(a_R) e^{-itP} \leq e^{itP} \mathbf{1}_{\tilde{\omega}(R)} e^{-itP}, \quad \forall t \in \mathbf{R}.$$

Then we use Egorov's theorem (Proposition 3.3.3) and we integrate with respect to t to get

$$\int_0^{T_0} e^{itP} \mathbf{1}_{(\omega \setminus K_R) \times \mathbf{R}^d} e^{-itP} dt \leq \int_0^{T_0} \text{Op}(a_R \circ \phi^t) dt + \mathcal{R}_R \leq \int_0^{T_0} e^{itP} \mathbf{1}_{\tilde{\omega}(R)} e^{-itP} dt, \quad (3.3.4)$$

where the remainder term \mathcal{R}_R is a bounded operator with

$$\|\mathcal{R}_R\|_{L^2 \rightarrow L^2} \leq C |\nabla a_R|_{S(1)}^{k_d} \leq \frac{C'}{R}, \quad \forall R \geq 1. \quad (3.3.5)$$

The constant C' above depends only on p and T_0 (and of course on the dimension d), but not on ω or K . One can check that the quantization and the integral over t in the middle term of (3.3.4) commute.⁸

On the classical side, using the same notation as in (3.2.1), we introduce the quantity

$$\mathfrak{K}_{p_0}^\infty(a_R \mathbf{1}_{(0,T)}) = \liminf_{\rho \rightarrow \infty} \int_0^T a_R(\phi_0^t(\rho)) dt,$$

and similarly for p instead of p_0 , replacing the flow ϕ_0^t by ϕ^t . We claim that for any $T > 0$, there exists a constant $C'' > 0$ depending only on the dimension, on T and on the Hamiltonians p_0 and p , such that for any compact \tilde{K} , and for any $R > 0$:

$$\begin{cases} \mathfrak{K}_{p_0}^\infty(\omega, T) \leq \mathfrak{K}_p^\infty(a_R \mathbf{1}_{(0,T)}) + \frac{C''}{R} \\ \mathfrak{K}_p^\infty(a_R \mathbf{1}_{(0,T)}) \leq \mathfrak{K}_{p_0}^\infty(\omega_R \setminus \tilde{K}, T) + \frac{C''}{R} \end{cases}. \quad (3.3.6)$$

⁸. One can see this by pairing the operator under consideration with two Schwartz functions and use the Dominated Convergence Theorem.

The constant C'' does not depend on ω or K from which we built a_R neither. The proof of the first inequality in (3.3.6) reads as follows: Corollary 3.2.6 shows that the quantity in the left-hand side does not change if we remove a compact set:

$$\mathfrak{K}_{p_0}^\infty(\omega, T) = \mathfrak{K}_{p_0}^\infty(\omega \setminus K_R, T), \quad \forall R > 0. \quad (3.3.7)$$

Now we use that $\mathbb{1}_{(\omega \setminus K_R) \times \mathbf{R}^d} \leq a_R$ to get

$$\mathfrak{K}_{p_0}^\infty(\omega \setminus K_R, T) \leq \mathfrak{K}_{p_0}^\infty(a_R \mathbb{1}_{(0,T)}). \quad (3.3.8)$$

Then we switch from p_0 to p , having the same principal symbol, using Corollary 3.2.4: the function $a_R \mathbb{1}_{(0,T)}$ is compactly supported in time and $\frac{c_{d,1}}{R}$ -Lipschitz in the variable ρ , so that

$$\mathfrak{K}_p^\infty(a_R \mathbb{1}_{(0,T)}) \leq \mathfrak{K}_p^\infty(a_R \mathbb{1}_{(0,T)}) + \frac{C''}{R}, \quad \forall R > 0.$$

Putting this together with (3.3.7) and (3.3.8) yields the first inequality in (3.3.6). The second inequality in (3.3.6) is proved using similar arguments: Corollary 3.2.4 leads to

$$\mathfrak{K}_p^\infty(a_R \mathbb{1}_{(0,T)}) \leq \mathfrak{K}_{p_0}^\infty(a_R \mathbb{1}_{(0,T)}) + \frac{C''}{R}, \quad \forall R > 0.$$

Then we use from the construction of a_R in (3.3.3) that a_R is supported in $\omega_R \times \mathbf{R}^d$, and we apply Corollary 3.2.6 to remove a compact set \tilde{K} . This leads to the sought inequality.

Sufficient condition. We wish to bound the left-hand side of (3.3.4) from below. The high-energy classical observability constant $\mathfrak{K}_{p_0}^\infty := \mathfrak{K}_{p_0}^\infty(\omega, T_0)$ is assumed to be positive. From the first inequality in (3.3.6), with T_0 in place of T , we can write

$$\exists A > 0 : \forall |\rho| \geq A, \quad \int_0^{T_0} (a_R \circ \phi^t)(\rho) dt \geq \frac{1}{2} \mathfrak{K}_{p_0}^\infty - \frac{C''}{R} = c_R. \quad (3.3.9)$$

Take a cut-off function $\chi \in C_c^\infty(\mathbf{R}^{2d})$ such that $\chi \equiv 1$ on the unit ball, and set $\chi_R = \chi(\bullet/(A+R))$. Then χ_R has compact support, equals one on the ball $B_A(0)$, and it satisfies $\|\partial^\alpha \chi_R\|_\infty = O(1/R^{|\alpha|})$, with constants independent of ω again.⁹ We split the symbol in the left-hand side of (3.3.9) using this cut-off function: we write

$$\int_0^{T_0} a_R \circ \phi^t dt = b_0 + b_\infty$$

where we set

$$b_0 = \chi_R \times \left(\int_0^{T_0} a_R \circ \phi^t dt - c_R \right) \quad \text{and} \quad b_\infty = (1 - \chi_R) \int_0^{T_0} a_R \circ \phi^t dt + c_R \chi_R.$$

Using the Leibniz Formula and Lemma 3.2.10, we can prove that $b_0 \in S(1)$. Moreover, b_0 is compactly supported in \mathbf{R}^{2d} , so that $\text{Op}(b_0)$ is a compact operator by [Zwo12, Theorem 4.28]. As for b_∞ , the Leibniz Formula and Lemma 3.2.10 lead to the following estimates on derivatives: for all $\alpha \in \mathbf{N}^{2d}$, one has

$$\|\partial^\alpha b_\infty\|_\infty \leq C_\alpha \max_{\alpha_1 + \alpha_2 = \alpha} \|\partial^{\alpha_1} (1 - \chi_R)\|_\infty \times \int_0^{T_0} \|\partial^{\alpha_2} (a_R \circ \phi^t)\|_\infty dt + c_R \frac{C_\alpha}{R^{|\alpha|}} \leq C_{\alpha, T_0, p} \left(\frac{1}{R^{|\alpha|}} + \frac{1}{R} \right).$$

The last inequality comes from distinguishing the cases $\alpha_2 = 0$ and $\alpha_2 \neq 0$. In the first case, we have $\partial^{\alpha_1} (1 - \chi_R) = O(R^{-|\alpha|})$ and $|a_R \circ \phi^t| \leq 1$. Otherwise, Lemma 3.2.10 tells us that $\partial^{\alpha_2} (a_R \circ \phi^t)$ behaves like $|\nabla a_R|_{S(1)}^{|\alpha|} = O(1/R)$, $R \geq 1$. In particular, $b_\infty \in S(1)$ and it holds $|\text{Hess } b_\infty|_{S(1)}^\ell = O(1/R)$ for any $\ell \in \mathbf{N}$, with a constant independent of ω and K . In addition, we have $b_\infty \geq c_R$ in view of (3.3.9). Therefore, the Gårding inequality (Proposition 3.B.6) yields

$$\text{Op}(b_\infty) \geq \left(c_R - \frac{C_1}{R} \right) \text{Id}.$$

9. The parameter A depends on R , but this will not be a problem in the sequel. The phase space region localized at distance $\leq A$ from the origin will be handled by Proposition 3.A.1.

The constant C_1 is independent of ω and K in view of the seminorm estimates of Hess b_∞ discussed above. Going back to (3.3.4), we have proved

$$\int_0^T e^{itP} \mathbf{1}_{\tilde{\omega}(R)} e^{-itP} dt \geq c_R \text{Id} + \text{Op}(b_0) + \mathcal{R}, \quad \forall R \geq 1.$$

As we have seen in the course of the proof, $\text{Op}(b_0)$ is a compact self-adjoint operator and $\|\mathcal{R}\|_{L^2 \rightarrow L^2} \leq C_2/R$, with a constant C_2 depending only on the dimension, on T_0 and on the Hamiltonians p_0, p . In view of the definition of c_R in (3.3.9), taking $R = 4(C'' + C_2 + T_0)/\mathfrak{K}_{p_0}^\infty$, we obtain the desired observability inequality, up to a compact operator:

$$\int_0^{T_0} e^{itP} \mathbf{1}_{\tilde{\omega}(R)} e^{-itP} dt - \text{Op}(b_0) \geq \frac{1}{4} \mathfrak{K}_{p_0}^\infty \text{Id}.$$

Notice that indeed $R \geq 1$, since $\mathfrak{K}_{p_0}^\infty \leq T_0$. Proposition 3.A.1 then applies (see Remark 3.A.2). It yields the sought observability inequality on $\tilde{\omega}(R) \subset \omega_R \setminus K$, in any time $T > T_0$.

Necessary condition. Consider the symbol a_R from (3.3.3) with $K = \emptyset$. We fix $R \geq 1$ (not necessarily large), \tilde{K} compact, and we estimate the observation cost C_{obs} in (3.1.8) using the quantity $\mathfrak{K}_{p_0}^\infty(\omega_R \setminus \tilde{K}, T)$. We will track carefully the dependence of remainders on the parameter R . Write for short

$$\langle a_R \rangle_T(\rho) = \int_0^T (a_R \circ \phi^t)(\rho) dt, \quad \rho \in \mathbf{R}^{2d},$$

and pick a point $\rho_0 \in \mathbf{R}^{2d}$ such that

$$\langle a_R \rangle_T(\rho_0) \leq \inf_{\rho \in \mathbf{R}^{2d}} \langle a_R \rangle_T(\rho) + \frac{1}{R}.$$

Notice that in virtue of the second inequality of (3.3.6), we have

$$\langle a_R \rangle_T(\rho_0) \leq \mathfrak{K}_p^\infty(a_R \mathbf{1}_{(0,T)}) + \frac{1}{R} \leq \mathfrak{K}_{p_0}^\infty(\omega_R \setminus \tilde{K}, T) + \frac{C'' + 1}{R}. \quad (3.3.10)$$

Differentiating under the integral sign and using Lemma 3.2.10, we check that $\langle a_R \rangle_T$ is Lipschitz as a function of ρ :

$$\forall \rho \in \mathbf{R}^{2d}, \quad |\nabla \langle a_R \rangle_T(\rho)| \leq T \sup_{t \in [0, T]} |\nabla (a_R \circ \phi^t)(\rho)| \leq C(T, p) \|\nabla a_R\|_\infty \leq \frac{c}{R}. \quad (3.3.11)$$

Consider a Gaussian wave packet centered at ρ_0 , namely, writing $\rho_0 = (x_0, \xi_0)$, we define

$$w(x) = \pi^{-d/4} \exp\left(-\frac{|x - x_0|^2}{2}\right) e^{i\xi_0 \cdot x}, \quad x \in \mathbf{R}^d.$$

It is properly normalized: $\|w\|_{L^2} = 1$. A classical computation (cf. [Fol89, Proposition (1.48)]) shows that the Wigner transform of w is the Gaussian in the phase space centered at ρ_0 , defined by $\rho \mapsto \pi^{-d} \exp(-|\rho - \rho_0|^2)$, that is to say

$$(w, \text{Op}(\langle a_{2R} \rangle_T) w)_{L^2} = \pi^{-d} \int_{\mathbf{R}^{2d}} \langle a_{2R} \rangle_T(\rho) \exp(-|\rho - \rho_0|^2) d\rho = \pi^{-d} \int_{\mathbf{R}^{2d}} \langle a_{2R} \rangle_T(\rho_0 + \rho) \exp(-|\rho|^2) d\rho.$$

Note that it is a non-negative quantity. Taking an arbitrary $A > 0$ and splitting the integral over \mathbf{R}^{2d} into two pieces, we obtain

$$\begin{aligned} (w, \text{Op}(\langle a_{2R} \rangle_T) w)_{L^2} &\leq \int_{B_A(0)} (\langle a_{2R} \rangle_T(\rho_0) + A \|\nabla \langle a_{2R} \rangle_T\|_\infty) \pi^{-d} e^{-|\rho|^2} d\rho \\ &\quad + \int_{\mathbf{R}^{2d} \setminus B_A(0)} \|\langle a_{2R} \rangle_T\|_\infty \pi^{-d} e^{-|\rho|^2} d\rho \\ &\leq \langle a_{2R} \rangle_T(\rho_0) + A \frac{c}{R} + T \int_{\mathbf{R}^{2d} \setminus B_A(0)} \pi^{-d} e^{-|\rho|^2} d\rho \\ &\leq \mathfrak{K}_{p_0}^\infty(\omega_R \setminus \tilde{K}, T) + \frac{C'' + 1 + Ac}{R} + T e^{-A^2/2} 2^d. \end{aligned}$$

We used (3.3.11) and (3.3.10) to obtain the last two inequalities. We take $A = |2 \log R|^{1/2}$ to obtain

$$(w, \text{Op}(\langle a_{2R} \rangle_T) w)_{L^2} \leq \mathfrak{K}_{p_0}(\omega_R \setminus \tilde{K}, T) + \tilde{C} \frac{1 + |\log R|^{1/2}}{R}$$

for some constant $\tilde{C} > 0$ independent of R . Going back to the left-hand side of (3.3.4) (recall that we chose $K = \emptyset$ here) with T in place of T_0 , as well as (3.3.5), taking the inner product with w on both sides, we deduce that

$$\int_0^T \|e^{-itP} w\|_{L^2(\omega)}^2 dt \leq \mathfrak{K}_{p_0}(\omega_R \setminus \tilde{K}, T) + \tilde{C} \frac{1 + |\log R|^{1/2}}{R} + \frac{C'}{R}.$$

By assumption, $\text{Obs}(\omega, T)$ is true with a cost $C_{\text{obs}} > 0$. Recalling that $\|w\|_{L^2} = 1$, we can bound the left-hand side from below by C_{obs}^{-1} . We arrive at

$$\mathfrak{K}_{p_0}(\omega_R \setminus \tilde{K}, T) \geq \frac{1}{C_{\text{obs}}} - \tilde{C} \frac{1 + |\log R|^{1/2}}{R} - \frac{C'}{R},$$

which yields the sought result. \square

3.4. Proofs of observability results from conical sets

In this section, we give proofs of the results presented in Subsections 3.1.4.1 and 3.1.4.2, which concern observation sets that are conical in the sense of (3.1.15). Propositions 3.1.4, 3.1.5 and 3.1.6 are proved in Subsections 3.4.1, 3.4.2 and 3.4.3 respectively.

3.4.1. Proof of Proposition 3.1.4

Let us prove the converse statement: assume there exists a normalized eigenvector e of A such that $e \notin \bar{\omega}$ and $-e \notin \bar{\omega}$. Let $\nu > 0$ be such that $Ae = \nu^2 e$. We claim the following.

Lemma 3.4.1. *There exists a constant $c > 0$ such that for any $R > 0$, it holds*

$$\forall s \in \mathbf{R}, \quad (se \in \omega_R \implies |s| \leq cR).$$

Proof. If $s \in \mathbf{R}$ is such that $se \in \omega_R$, then there exists $y \in \omega \setminus \{0\}$ such that $|se - y| \leq R$. Moreover, since e belongs to the complement of the closed set $\bar{\omega} \cup -\bar{\omega}$, there exists $\varepsilon > 0$ such that

$$\forall x \in (\omega \cup -\omega) \setminus \{0\}, \quad \left| e - \frac{x}{|x|} \right| \geq \varepsilon.$$

We apply this to $x = \text{sign}(s)y$ to obtain

$$|s| \leq \frac{1}{\varepsilon} \left| se - \frac{|s|y}{|y|} \right| \leq \frac{1}{\varepsilon} |se - y| + \frac{1}{\varepsilon} |y| \left| 1 - \frac{|s|}{|y|} \right| \leq \frac{1}{\varepsilon} |se - y| + \frac{1}{\varepsilon} |se - y| \leq \frac{2R}{\varepsilon}.$$

We used the inverse triangle inequality to obtain the second to last inequality. \square

Using this lemma, for any $T > 0$ and any $\eta > 0$, we can estimate the quantity

$$\int_0^T \mathbf{1}_{\omega_R \times \mathbf{R}^d}(\phi^t(0, \eta e)) dt = \int_0^T \mathbf{1}_{\omega_R} \left(\frac{\eta}{\nu} \sin(\nu t) e \right) dt \leq \int_0^{2N\pi/\nu} \mathbf{1}_{\omega_R} \left(\frac{\eta}{\nu} \sin(\nu t) e \right) dt,$$

where $N = \lceil \nu T / 2\pi \rceil$. Using the periodicity of the sine and a change of variable, we deduce:

$$\int_0^T \mathbf{1}_{\omega_R \times \mathbf{R}^d}(\phi^t(0, \eta e)) dt \leq \frac{N}{\nu} \int_0^{2\pi} \mathbf{1}_{\omega_R} \left(\frac{\eta}{\nu} \sin(t) e \right) dt = \frac{2N}{\nu} \int_{-\pi/2}^{\pi/2} \mathbf{1}_{\omega_R} \left(\frac{\eta}{\nu} \sin(t) e \right) dt.$$

Provided $\eta \neq 0$, we make the change of variables $s = \eta \sin t$, for which we have $dt = (\eta^2 - s^2)^{-1/2} ds$; this leads to

$$\int_0^T \mathbf{1}_{\omega_R \times \mathbf{R}^d}(\phi^t(0, \eta e)) dt \leq \frac{2N}{\nu} \int_{-|\eta|}^{|\eta|} \mathbf{1}_{\omega_R} \left(\frac{s}{\nu} e \right) \frac{ds}{\sqrt{\eta^2 - s^2}}.$$

From Lemma 3.4.1 above, we conclude that for any η large enough:

$$\int_0^T \mathbf{1}_{\omega_R \times \mathbf{R}^d}(\phi^t(0, \eta e)) dt \leq \frac{2N}{\nu} \int_{-cR\nu}^{cR\nu} \frac{ds}{\sqrt{\eta^2 - s^2}}.$$

An extra change of variables yields

$$\int_0^T \mathbf{1}_{\omega_R \times \mathbf{R}^d}(\phi^t(0, \eta e)) dt \leq \frac{2N}{\nu} \int_{-cR\nu/\eta}^{cR\nu/\eta} \frac{ds}{\sqrt{1 - s^2}} = O\left(\frac{R}{\eta}\right)$$

as η tends to infinity and R is fixed. We deduce that for any $R > 0$, it holds

$$\liminf_{\rho \rightarrow \infty} \int_0^T \mathbf{1}_{\omega_R \times \mathbf{R}^d}(\phi^t(\rho)) dt = 0.$$

The necessary condition of Theorem 3.1.3 then proves that observability cannot hold from ω in time T . \square

3.4.2. Proof of Proposition 3.1.5

We first reduce to the case where the matrix A is diagonal in the canonical basis of \mathbf{R}^2 . Then we investigate the isotropic and anisotropic cases separately.

Step 1 – Reduction to positive cones containing half coordinate axes.

Let $S : \mathbf{R}^2 \rightarrow \mathbf{R}^2$ be a linear symplectic mapping. It holds $\nabla(p \circ S) = S^*(\nabla p) \circ S$, and we observe that

$$\frac{d}{dt} S^{-1} \phi^t(S\rho) = S^{-1} J(S^{-1})^* S^* \nabla p(\phi^t(S\rho)) = J \nabla(p \circ S)(S^{-1} \phi^t(S\rho)).$$

This means that the conjugation of the Hamiltonian flow of p by S is the Hamiltonian flow of $p \circ S$. Thus, for any measurable set $C \subset \mathbf{R}^2 \times \mathbf{R}^2$:

$$\int_0^T \mathbf{1}_C(\phi^t(\rho)) dt = \int_0^T \mathbf{1}_{S^{-1}C}((S^{-1} \phi^t S)(\rho)) dt,$$

and finally, since $S^{-1}\rho \rightarrow \infty$ if and only if $\rho \rightarrow \infty$, we deduce that

$$\liminf_{\rho \rightarrow \infty} \int_0^T \mathbf{1}_C(\phi^t(\rho)) dt = \liminf_{\rho \rightarrow \infty} \int_0^T \mathbf{1}_{S^{-1}C}((S^{-1} \phi^t S)(\rho)) dt. \quad (3.4.1)$$

Denoting by Q the orthogonal matrix that diagonalizes A as follows:

$$Q^{-1} A Q = \begin{pmatrix} \nu_-^2 & 0 \\ 0 & \nu_+^2 \end{pmatrix}, \quad \text{with } Q \begin{pmatrix} 1 \\ 0 \end{pmatrix} = e_- \text{ and } Q \begin{pmatrix} 0 \\ 1 \end{pmatrix} = e_+,$$

we apply the above observation (3.4.1) to the map

$$S = \begin{pmatrix} Q & 0 \\ 0 & Q \end{pmatrix}.$$

It is indeed symplectic since $Q = (Q^{-1})^*$ is an orthogonal matrix. When the subset of the phase space C is of the form $\omega(\varepsilon)$ given in the statement, the resulting set $S^{-1}C$ is $\tilde{\omega}(\varepsilon) = C_\varepsilon^1 \cup C_\varepsilon^2$ where

$$C_\varepsilon^1 = \left\{ (x_1, x_2) \in \mathbf{R}^2 : |x_2| < \tan\left(\frac{\varepsilon}{2}\right) x_1 \right\} \quad \text{and} \quad C_\varepsilon^2 = \left\{ (x_1, x_2) \in \mathbf{R}^2 : |x_1| < \tan\left(\frac{\varepsilon}{2}\right) x_2 \right\}.$$

The corresponding Hamiltonian is

$$(p \circ S)(x, \xi) = \frac{1}{2} (Qx \cdot A Qx + |Q\xi|^2) = \frac{1}{2} (\nu_-^2 x_1^2 + \nu_+^2 x_2^2 + |\xi|^2).$$

That is to say, we have reduced the problem to the study of observability from $\tilde{\omega}(\varepsilon)$ for the above Hamiltonian: the Schrödinger equation is observable from $\omega(\varepsilon)$ in time T for the Hamiltonian p is and only if it is observable from $\tilde{\omega}(\varepsilon)$ in time T for the Hamiltonian $p \circ S$. From now on, we write $\omega(\varepsilon)$ instead of $\tilde{\omega}(\varepsilon)$, p instead of $p \circ S$ respectively, and $(\nu_1, \nu_2) = (\nu_-, \nu_+)$.

Step 2 – Isotropic case.

The case where $\nu_+ = \nu_- = \nu$ follows from Proposition 3.1.4. Indeed, since $\varepsilon < \pi/2$, one has $\omega(\varepsilon) \cap L_\pm = \{0\}$ where $L_\pm = \{x_2 = \pm x_1\}$ are eigenspaces of $A = \nu^2 \text{Id}$. Therefore, isotropic oscillators are not observable from $\omega(\varepsilon)$.

Anisotropic case.

We assume that the harmonic oscillator is anisotropic, i.e. $\nu_1 < \nu_2$, and we want to show that $\omega(\varepsilon)$ observes the Schrödinger equation. Anticipating the use of Theorem 3.1.3 where the observation set has to be enlarged, we will rather prove that the dynamical condition in (3.1.7) is verified by the smaller set $\omega(\frac{\varepsilon}{2}) = C_{\varepsilon/2}^1 \cup C_{\varepsilon/2}^2$. We fix an initial point $\rho^0 = (x_1^0, x_2^0, \xi_1^0, \xi_2^0) \in \mathbf{R}^2 \times \mathbf{R}^2$. We write the space components of the flow as follows:

$$x_j^t = \cos(\nu_j t) x_j^0 + \frac{1}{\nu_j} \sin(\nu_j t) \xi_j^0 = A_j \sin(\nu_j t + \theta_j), \quad j \in \{1, 2\}, t \in \mathbf{R},$$

$$\text{with} \quad A_j = \sqrt{(x_j^0)^2 + \left(\frac{\xi_j^0}{\nu_j}\right)^2} \quad \text{and} \quad \cos \theta_j = \frac{\xi_j^0 / \nu_j}{A_j}, \quad \sin \theta_j = \frac{x_j^0}{A_j}.$$

Our first goal will be to prove that the dynamical condition (3.1.7) is satisfied in the time interval $[0, T_0]$, where T_0 is given in (3.1.17). We can consider ρ^0 to be nonzero since we are interested in what happens at infinity. Therefore $A_1 > 0$ or $A_2 > 0$. Also keep in mind that $\rho^0 \rightarrow \infty$ if and only if $|(A_1, A_2)| \rightarrow +\infty$.

Step 3 – Time spent in $C_{\varepsilon/2}^2$.

First we look at the possibility to be in the cone $C_{\varepsilon/2}^2$. This will certainly be the case provided A_1 is very small compared to A_2 , that is to say the projected trajectory (x_1^t, x_2^t) is almost contained in the ordinate axis. We prove the following:

$$\int_0^{T_0} \mathbb{1}_{C_{\varepsilon/2}^2}(x_1^t, x_2^t) dt \geq \frac{\pi}{\nu_2} \left(1 - \frac{A_1/A_2}{\tan(\frac{\varepsilon}{4})}\right). \quad (3.4.2)$$

Suppose $t \in [0, T_0]$ is such that $\sin(\nu_2 t + \theta_2) \geq \delta$, namely $x_2^t \geq A_2 \delta$. Assuming that $A_2 > 0$, one has

$$|x_1^t| \leq A_1 \leq \frac{A_1}{A_2 \delta} x_2^t. \quad (3.4.3)$$

We want to quantify the amount of t such that this holds. In the following estimate, we use the fact that $T_0 \geq \frac{2\pi}{\nu_2}$ and the classical concavity inequality $\sin x \geq \frac{2}{\pi}x, \forall x \in [0, \frac{\pi}{2}]$:

$$\int_0^{T_0} \mathbb{1}_{\sin(\nu_2 t + \theta_2) \geq \delta} dt \geq \int_0^{2\pi/\nu_2} \mathbb{1}_{\sin(\nu_2 t) \geq \delta} dt \geq \frac{1}{\nu_2} \int_0^{2\pi} \mathbb{1}_{\sin t \geq \delta} dt \geq \frac{2}{\nu_2} \int_0^{\pi/2} \mathbb{1}_{\frac{2}{\pi}t \geq \delta} dt = \frac{\pi}{\nu_2} (1 - \delta).$$

Now in (3.4.3), we wish $\frac{A_1}{A_2 \delta}$ to be strictly less than $\tan(\varepsilon/4)$, that is to say $\delta > A_1/(A_2 \tan(\varepsilon/4))$. Therefore, for any δ satisfying this condition, the time spent by the trajectory in $C_{\varepsilon/2}^2$ can be bounded from below by:

$$\int_0^{T_0} \mathbb{1}_{x_2^t \geq A_2 \delta} dt \geq \int_0^{T_0} \mathbb{1}_{\sin(\nu_2 t + \theta_2) \geq \delta} dt \geq \frac{\pi}{\nu_2} (1 - \delta),$$

so that, maximizing the right-hand side with respect to δ , one obtains (3.4.2). Notice that this inequality is useful only if A_1/A_2 is small enough. In the opposite case where A_1/A_2 is large, we use another argument (ν_1 and ν_2 do not play a symmetric role here).

Step 4 – Time spent in $C_{\varepsilon/2}^1$.

Let us now consider the times when the trajectory is in the other cone $C_{\varepsilon/2}^1$. Set $\eta = \lfloor \frac{\nu_2}{\nu_1} \rfloor + 1 - \frac{\nu_2}{\nu_1} \in (0, 1]$. The main claim in this step of the proof is the following:

$$\exists t_2 \in [0, T_0] : \quad x_2^{t_2} = 0 \quad \text{and} \quad x_1^{t_2} \geq A_1 \delta_1, \quad \text{where} \quad \delta_1 = \min\left(\frac{\nu_1}{\nu_2} \eta, 1 - \frac{\nu_1}{\nu_2}\right). \quad (3.4.4)$$

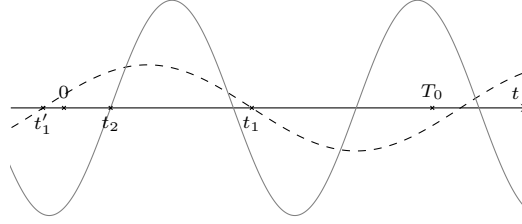

Figure 3.5 – The dashed line is $t \mapsto \sin(\nu_1 t + \theta_1)$, the gray line is $t \mapsto \sin(\nu_2 t + \theta_2)$, with $\frac{\nu_2}{\nu_1} = 1.7$.

Denote by t_1 the first zero of $\sin(\nu_1 t + \theta_1)$ in $[0, T_0]$. It exists since by definition, $T_0 \geq \frac{\pi}{\nu_2}(1 + \frac{\nu_2}{\nu_1}) \geq \frac{\pi}{\nu_1}$. It turns out that t_1 is given by

$$t_1 = \frac{\pi}{\nu_1} \left(\left\lceil \frac{\theta_1}{\pi} \right\rceil - \frac{\theta_1}{\pi} \right).$$

Then $t_1 \in [0, \frac{\pi}{\nu_1})$, and we know that $\sin(\nu_1 t + \theta_1)$ has constant sign on $I_1 := [0, t_1]$, on $I_2 := [t_1, t_1 + \frac{\pi}{\nu_1}] \cap [0, T_0]$ and on $I_3 := [t_1 + \frac{\pi}{\nu_1}, t_1 + \frac{2\pi}{\nu_1}] \cap [0, T_0]$. Observe that I_1 is possibly reduced to a singleton, I_2 is always non trivial, and I_3 is possibly empty. One can check this from the fact that T_0 can be rewritten

$$T_0 = \frac{\pi}{\nu_1} + (1 + \eta) \frac{\pi}{\nu_2}. \quad (3.4.5)$$

Because $T_0 \geq \frac{\pi}{\nu_1}$, we know that $\sin(\nu_1 t + \theta_1)$ vanishes at least once in $[0, T_0]$. We first distinguish cases according to whether there are a single one or more than two of these zeroes in this interval.

- Assume first t_1 is the only zero in $[0, T_0]$. The situation is illustrated in Figure 3.5. In view of (3.4.5), t_1 lies at distance $> (1 + \eta) \frac{\pi}{\nu_2}$ from the boundary of $[0, T_0]$, otherwise $t_1 + \frac{\pi}{\nu_1}$ or $t_1 - \frac{\pi}{\nu_1}$ is another zero in $[0, T_0]$. In particular, the intervals $[0, t_1]$ and $[t_1, T_0]$ have length $\geq (1 + \eta) \frac{\pi}{\nu_2}$. We know that $\sin(\nu_1 t + \theta_1) \geq 0$ on one of these intervals, that we denote by \tilde{I} . Given that \tilde{I} has length $\geq (1 + \eta) \frac{\pi}{\nu_2}$, it contains a zero of $\sin(\nu_2 t + \theta_2)$, lying at distance $\geq \frac{\pi}{\nu_2} \frac{\eta}{2}$ from the boundary of \tilde{I} . We denote such a zero by t_2 . Given that the only zero of $\sin(\nu_1 t + \theta_1)$ in \tilde{I} is t_1 , we deduce that the distance between t_2 and the closest zero t'_1 of $\sin(\nu_1 t + \theta_1)$ is at least $\frac{\pi}{\nu_2} \frac{\eta}{2}$. Then the inequality $\sin x \geq \frac{2}{\pi} x$ on $x \in [0, \frac{\pi}{2}]$ yields

$$\sin(\nu_1 t_2 + \theta_1) = \sin(\nu_1(t_2 - t'_1) + \nu_1 t'_1 + \theta_1) = \sin(\nu_1 |t_2 - t'_1|) \geq \frac{2\nu_1}{\pi} |t_2 - t'_1| \geq \frac{\nu_1}{\nu_2} \eta. \quad (3.4.6)$$

The absolute value resulting from the second inequality is due to the fact that we chose t_2 in an interval where $\sin(\nu_1 t + \theta_1) \geq 0$, or equivalently, $\nu_1 t_1 + \theta_1$ is an even or odd multiple of π according to the sign of $t_2 - t_1$. We conclude that $x_2^{t_2} = 0$ by definition of t_2 and that we have $x_1^{t_2} \geq A_1 \frac{\nu_1}{\nu_2} \eta$ in virtue of (3.4.6), hence the claim (3.4.4).

- Now we treat the case where $t_1 + \frac{\pi}{\nu_1}$ also lies in $[0, T_0]$. The situation is illustrated in Figure 3.6. The interval $J_1 := [t_1, t_1 + \frac{\pi}{\nu_1}]$ is contained in $[0, T_0]$. As we already mentioned, $\sin(\nu_1 t + \theta_1)$ has constant sign on J_1 .
 - If $\sin(\nu_1 t + \theta_1) \geq 0$ on J_1 , since J_1 has length $\frac{\pi}{\nu_1} > \frac{\pi}{\nu_2}$, then $t \mapsto \sin(\nu_2 t + \theta_2)$ vanishes in J_1 , and we can choose a zero t_2 at distance $\geq \frac{\pi}{2} (\frac{1}{\nu_1} - \frac{1}{\nu_2})$ from the boundary of J_1 . This is illustrated in Figure 3.6a. Reproducing the previous argument with the concavity inequality for the sine function, we deduce that

$$\sin(\nu_1 t_2 + \theta_1) \geq \frac{2\nu_1}{\pi} \times \frac{\pi}{2} \left(\frac{1}{\nu_1} - \frac{1}{\nu_2} \right) = 1 - \frac{\nu_1}{\nu_2}.$$

Therefore in this case, there is $t_2 \in [0, T_0]$ with $x_2^{t_2} = 0$ and $x_1^{t_2} \geq (1 - \frac{\nu_1}{\nu_2}) A_1$, hence the claim (3.4.4).

- In the remaining case where $\sin(\nu_1 t + \theta_1) \leq 0$ on J_1 , we introduce some additional notation; see Figure 3.6b. We denote by t_- (resp. t_+) the largest (resp. smallest) zero of $\sin(\nu_2 t + \theta_2)$ which is $< t_1$ (resp. $> t_1 + \frac{\pi}{\nu_1}$), given respectively by

$$t_- = \frac{\pi}{\nu_2} \left(\left\lfloor \frac{\nu_2 t_1 + \theta_2}{\pi} \right\rfloor - 1 - \frac{\theta_2}{\pi} \right) \quad \text{and} \quad t_+ = \frac{\pi}{\nu_2} \left(\left\lceil \frac{\nu_2 (t_1 + \frac{\pi}{\nu_1}) + \theta_2}{\pi} \right\rceil + 1 - \frac{\theta_2}{\pi} \right).$$

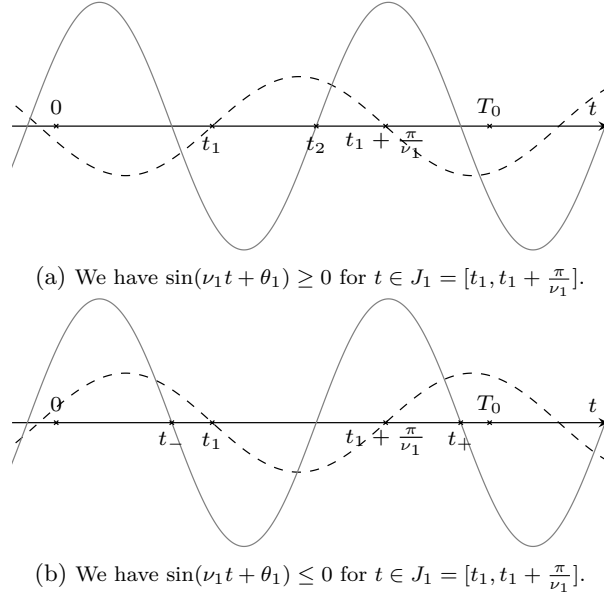

Figure 3.6 – The dashed line is $t \mapsto \sin(\nu_1 t + \theta_1)$, the gray line is $t \mapsto \sin(\nu_2 t + \theta_2)$, with $\frac{\nu_2}{\nu_1} = 1.2$.

They both have the property that $\sin(\nu_1 t_{\pm} + \theta_1) > 0$, but we wish to quantify this statement in order to have a uniform lower bound. We observe that we can write

$$t_+ - t_- = \frac{\pi}{\nu_2} \left(k + 1 + \left\lfloor \frac{\nu_2}{\nu_1} \right\rfloor \right),$$

with $k \in \{0, 1\}$. Indeed, from the definition of t_+ and t_- and the properties of the floor and ceiling functions, we see that

$$k = \left\lfloor \frac{\nu_2(t_1 + \frac{\pi}{\nu_1}) + \theta_2}{\pi} \right\rfloor - \left\lfloor \frac{\nu_2 t_1 + \theta_2}{\pi} \right\rfloor + 1 - \left\lfloor \frac{\nu_2}{\nu_1} \right\rfloor$$

is an integer satisfying

$$-1 \leq \frac{\nu_2}{\nu_1} - 1 - \left\lfloor \frac{\nu_2}{\nu_1} \right\rfloor < k \leq 1 + \frac{\nu_2}{\nu_1} - \left\lfloor \frac{\nu_2}{\nu_1} \right\rfloor < 2,$$

whence $k = 0$ or 1 . In particular, we remark that the distance between t_- and t_+ is always less than T_0 . This implies that either t_- or t_+ belongs to $[0, T_0]$.

- Suppose t_- and t_+ both belong to $[0, T_0]$. We have

$$(t_+ - t_-) - \frac{\pi}{\nu_1} = \frac{\pi}{\nu_2} \left(k + 1 + \left\lfloor \frac{\nu_2}{\nu_1} \right\rfloor - \frac{\nu_2}{\nu_1} \right) = \frac{\pi}{\nu_2} (k + \eta) \geq \frac{\pi}{\nu_2} \eta.$$

Recalling that $t_- < t_1$ and $t_+ > t_1 + \frac{\pi}{\nu_1}$, we deduce that either $t_1 - t_- \geq \frac{\pi}{2\nu_2} \eta$ or $t_+ - (t_1 + \frac{\pi}{\nu_1}) \geq \frac{\pi}{2\nu_2} \eta$. We call t_2 the zero, among t_- and t_+ , that satisfies this property. Then, the concavity inequality for the sine function allows to conclude that $x_1^{t_2} \geq A_1 \frac{\nu_1}{\nu_2} \eta$ again.

- If $t_- \notin [0, T_0]$, so that $t_+ \in [0, T_0]$, we can estimate the distance of t_+ from $t_1 + \frac{\pi}{\nu_1}$ and T_0 as follows:

$$t_+ - \left(t_1 + \frac{\pi}{\nu_1} \right) = t_+ - t_- - \frac{\pi}{\nu_1} - (t_1 - t_-) = \frac{\pi}{\nu_2} (k + \eta) - (t_1 - t_-) \geq \frac{\pi}{\nu_2} \eta - \frac{\pi}{\nu_2} (1 - k), \quad (3.4.7)$$

where we used the fact that $|t_1 - t_-| \leq \frac{\pi}{\nu_2}$ by construction in the last inequality; and

$$T_0 - t_+ = T_0 - (t_+ - t_-) - t_- = \frac{\pi}{\nu_2} (1 - k) - t_- \geq \frac{\pi}{\nu_2} (1 - k), \quad (3.4.8)$$

where this time we have used that $t_- < 0$ by assumption.

Now observe that t_+ satisfies by definition

$$t_1 + \frac{2\pi}{\nu_1} - t_+ = \frac{\pi}{\nu_1} - \left(t_+ - \left(t_1 + \frac{\pi}{\nu_1} \right) \right) \geq \frac{\pi}{\nu_1} - \frac{\pi}{\nu_2}.$$

Thus, if $|t_+ - (t_1 + \frac{\pi}{\nu_1})| \geq \frac{\pi}{2} \min(\frac{\eta}{\nu_2}, \frac{1}{\nu_1} - \frac{1}{\nu_2})$, then $t_2 = t_+$ lies at distance $\geq \frac{\pi}{2} \min(\frac{\eta}{\nu_2}, \frac{1}{\nu_1} - \frac{1}{\nu_2})$ from the boundary of the interval $[t_1 + \frac{\pi}{\nu_1}, t_1 + \frac{2\pi}{\nu_1}]$, to which it belongs. This allows to deduce that $x_1^{t_2} \geq A_1 \delta_1$ using the inequality $\sin x \geq \frac{2}{\pi} x$ on $[0, \frac{\pi}{2}]$ again, and $x_2^{t_2} = 0$ by definition of $t_2 = t_+$. If on the contrary $|t_+ - (t_1 + \frac{\pi}{\nu_1})| \leq \frac{\pi}{2} \min(\frac{\eta}{\nu_2}, \frac{1}{\nu_1} - \frac{1}{\nu_2})$, then from (3.4.7), it follows that $k = 0$, so that $t_2 = t_+ + \frac{\pi}{\nu_2} \leq T_0$ from (3.4.8). Then we have

$$t_1 + \frac{2\pi}{\nu_1} - t_2 = \frac{\pi}{\nu_1} - \frac{\pi}{\nu_2} - \left(t_+ - \left(t_1 + \frac{\pi}{\nu_1} \right) \right) \geq \frac{\pi}{2} \left(\frac{1}{\nu_1} - \frac{1}{\nu_2} \right).$$

In particular, t_2 lies again at large enough distance of the boundary of $[t_1 + \frac{\pi}{\nu_1}, t_1 + \frac{2\pi}{\nu_1}]$. We deduce as before that $x_1^{t_2} \geq A_1 \delta_1$ and $x_2^{t_2} = 0$.

- It remains to deal with the case where $t_+ \notin [0, T_0]$, hence $t_- \in [0, T_0]$, which is symmetrical. We write

$$t_1 - t_- = - \left(t_+ - t_1 - \frac{\pi}{\nu_1} \right) + t_+ - t_- - \frac{\pi}{\nu_1} \geq - \frac{\pi}{\nu_2} + \frac{\pi}{\nu_2} (k + \eta) = \frac{\pi}{\nu_2} \eta - \frac{\pi}{\nu_2} (1 - k), \quad (3.4.9)$$

$$t_- = T_0 - (t_+ - t_-) + t_+ - T_0 \geq \frac{\pi}{\nu_2} (1 - k), \quad (3.4.10)$$

using respectively that $|t_1 + \frac{\pi}{\nu_1} - t_+| \leq \frac{\pi}{\nu_2}$ by construction of t_+ , and $t_+ > T_0$ by assumption. By definition of t_- we have

$$t_- - \left(t_1 - \frac{\pi}{\nu_1} \right) = \frac{\pi}{\nu_1} - (t_1 - t_-) \geq \frac{\pi}{\nu_1} - \frac{\pi}{\nu_2},$$

so that $t_2 = t_-$ satisfies $x_1^{t_2} \geq A_1 \delta_1$ and $x_2^{t_2} = 0$ provided $|t_1 - t_-| \geq \frac{\pi}{2} \min(\frac{\eta}{\nu_2}, \frac{1}{\nu_1} - \frac{1}{\nu_2})$. Otherwise, $k = 0$ in virtue of (3.4.9) so that (3.4.10) ensures that $t_2 = t_- - \frac{\pi}{\nu_2} \geq 0$. Then we check that

$$t_2 - \left(t_1 - \frac{\pi}{\nu_1} \right) = \frac{\pi}{\nu_1} - \frac{\pi}{\nu_2} - (t_1 - t_-) \geq \frac{\pi}{2} \left(\frac{1}{\nu_1} - \frac{1}{\nu_2} \right),$$

and we conclude similarly to the previous case.

The discussion above shows that (3.4.4) is true. In particular, $(x_1^{t_2}, x_2^{t_2})$ is in the cone $C_{\varepsilon/2}^1$. Using that the sine function is 1-Lipschitz, we know that for t in a neighborhood of 0, it holds

$$|x_2^{t_2+t}| \leq A_2 \nu_2 |t| \quad \text{and} \quad x_1^{t_2+t} \geq A_1 (\delta_1 - \nu_1 |t|).$$

So for t small enough, $(x_1^{t_2+t}, x_2^{t_2+t})$ will remain in the cone $C_{\varepsilon/2}^1$. Quantitatively, as soon as t fulfills the condition

$$|t| < \frac{\frac{\delta_1}{\nu_1}}{1 + \frac{\nu_2}{\nu_1} \frac{A_2/A_1}{\tan(\varepsilon/4)}}, \quad (3.4.11)$$

we compute that

$$x_1^{t_2+t} > A_1 \frac{\frac{\delta_1}{\nu_1} \frac{\nu_2}{\tan(\varepsilon/4)} \frac{A_2/A_1}{\tan(\varepsilon/4)}}{1 + \frac{\nu_2}{\nu_1} \frac{A_2/A_1}{\tan(\varepsilon/4)}} > \frac{A_2 \nu_2}{\tan(\varepsilon/4)} |t| \geq \frac{|x_2^{t_2+t}|}{\tan(\varepsilon/4)}.$$

This means that for t satisfying (3.4.11), the point $(x_1^{t_2+t}, x_2^{t_2+t})$ belongs indeed to the cone $C_{\varepsilon/2}^1$. In the case where $t_2 = 0$ or $t_2 = T_0$, we may restrict ourselves to times t satisfying $t \geq 0$ or $t \leq 0$ in addition to (3.4.11), so that in the end, we obtain

$$\int_0^{T_0} \mathbb{1}_{C_{\varepsilon/2}^1}(x_1^t, x_2^t) dt \geq \min \left(T_0, \frac{\frac{\delta_1}{\nu_1}}{1 + \frac{\nu_2}{\nu_1} \frac{A_2/A_1}{\tan(\varepsilon/4)}} \right). \quad (3.4.12)$$

Step 5 – Upper bound on the optimal observation time.

Now that we have (3.4.2) and (3.4.12) at hand, we can obtain a lower bound independent of the values of A_1 and A_2 . If on the one hand $\frac{A_1}{A_2} \leq \frac{\tan(\varepsilon/4)}{2}$, then (3.4.2) yields

$$\int_0^{T_0} \mathbf{1}_{(x_1^t, x_2^t) \in \omega(\frac{\varepsilon}{2})} dt \geq \frac{\pi}{2\nu_2},$$

while on the other hand, if $\frac{A_2}{A_1} \leq \frac{2}{\tan(\varepsilon/4)}$, then (3.4.12) leads to

$$\int_0^{T_0} \mathbf{1}_{(x_1^t, x_2^t) \in \omega(\frac{\varepsilon}{2})} dt \geq \min\left(T_0, \frac{\frac{\delta_1}{\nu_1}}{1 + \frac{\nu_2}{\nu_1} \frac{2}{\tan^2(\varepsilon/4)}}\right) \geq \frac{\varepsilon^2}{16} \min\left(T_0, \frac{\delta_1}{\nu_1 + 2\nu_2}\right) \quad (3.4.13)$$

(to get the second inequality, use that $\frac{\varepsilon}{4} \leq \tan(\frac{\varepsilon}{4}) \leq 1$ since $\varepsilon \leq \pi/2$ by assumption). On the whole, we have

$$\int_0^{T_0} \mathbf{1}_{(x_1^t, x_2^t) \in \omega(\frac{\varepsilon}{2})} dt \geq \frac{\varepsilon^2}{32} \min\left(\frac{\pi}{\nu_2}, \frac{\delta_1}{\nu_1 + \nu_2}\right) = c\varepsilon^2,$$

and setting $T_\varepsilon = T_0 - \frac{c}{2}\varepsilon^2$, we deduce

$$\int_0^{T_\varepsilon} \mathbf{1}_{(x_1^t, x_2^t) \in \omega(\frac{\varepsilon}{2})} dt \geq \int_0^{T_0} \mathbf{1}_{(x_1^t, x_2^t) \in \omega(\frac{\varepsilon}{2})} dt - \frac{c}{2}\varepsilon^2 \geq \frac{c}{2}\varepsilon^2.$$

Therefore the dynamical condition (3.1.7) holds in time T_ε . Setting $T = T_0 - \frac{c}{4}\varepsilon^2 > T_\varepsilon$, we use Theorem 3.1.3 to conclude that observability is true on $[0, T]$ from $\omega(\frac{\varepsilon}{2})_R \setminus K$, for some $R > 0$ and for any compact set K . We can take K to be a ball with radius large enough so that $\omega(\frac{\varepsilon}{2})_R \setminus K \subset \omega(\varepsilon)$ (this can be justified by an argument similar to Lemma 3.4.1). We conclude that observability holds from $\omega(\varepsilon)$ in time T . This proves the upper bound in (3.1.17).

Step 6 – Lower bound on the optimal observation time.

Fix $\varepsilon \in (0, \pi/4)$. We recall that $\nu_2 > \nu_1$. Our objective is to exhibit trajectories (x_1^t, x_2^t) that do not meet the set $\omega(2\varepsilon)$. They typically look like the one shown in Figure 3.3. Take $\delta > 0$ a small parameter to be chosen later. These trajectories we look for are of the form

$$x_1^t = A_1 \sin\left(\pi \frac{\nu_1}{\nu_2} (1 - \delta) - \nu_1 t\right) \quad \text{and} \quad x_2^t = A_2 s \sin(\pi \delta + \nu_2 t), \quad (3.4.14)$$

with $s \in \{+1, -1\}$, and $A_1, A_2 > 0$ to be tuned properly later on as well.

Let us introduce three remarkable times t_0, t_1 and t_2 : provided $\delta < 1/2$, the first zeroes of x_1^t and x_2^t in the interval $[0, T_0]$ coincide and are given by

$$t_0 = \frac{\pi}{\nu_2} (1 - \delta).$$

The next zero of x_1^t is

$$t_1 = t_0 + \frac{\pi}{\nu_1}.$$

As for x_2^t , its first zero that is strictly larger than t_1 is given by

$$t_2 = \frac{\pi}{\nu_2} \left(1 + \left\lfloor \delta + \frac{\nu_2}{\pi} t_1 \right\rfloor - \delta\right) = \frac{\pi}{\nu_2} \left(1 + \left\lfloor 1 + \frac{\nu_2}{\nu_1} \right\rfloor - \delta\right) = T_0 - \frac{\pi}{\nu_2} \delta. \quad (3.4.15)$$

This is illustrated on Figure 3.7. Notice that $t_2 \leq T_0$. By construction, the interval $[t_1, t_2]$ has length $t_2 - t_1 \in (0, \frac{\pi}{\nu_2}]$, and x_2^t has constant sign on this interval. We choose the sign s involved in the definition (3.4.14) of x_2^t in such a way that $x_2^t \leq 0$ on $[t_1, t_2]$. In particular, the projected trajectory (x_1^t, x_2^t) cannot cross $C_{2\varepsilon}^2$ in the time interval $[t_1, t_2]$. Likewise, since $x_1^0 > 0$, it follows that $x_1^t \leq 0$ on $[t_0, t_1]$, by definition of t_0, t_1 . In particular, the curve (x_1^t, x_2^t) cannot be in $C_{2\varepsilon}^1$ for $t \in [t_0, t_1]$.

Set $T = t_2 - \frac{\pi}{\nu_2} \delta$. In each interval $[0, t_0]$, $[t_0, t_1]$ and $[t_1, T]$, we want to exclude the possibility for the trajectory to be in $C_{2\varepsilon}^1$ or $C_{2\varepsilon}^2$ by suitably choosing the parameters δ, A_1, A_2 .

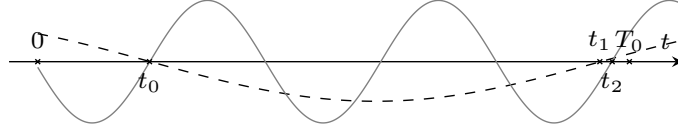

Figure 3.7 – The dashed line is $t \mapsto x_1^t$, the gray line is $t \mapsto x_2^t$, with $\frac{\nu_2}{\nu_1} = 3.9$, as defined in (3.4.14).

To achieve this goal, we are interested in estimating from above and from below x_1^t and x_2^t in these intervals. We first deal with x_1^t . Recalling that the sine function is 1-Lipschitz, we know that

$$|x_1^t| \leq A_1 \nu_1 \min(|t - t_0|, |t - t_1|), \quad \forall t \in \mathbf{R}. \quad (3.4.16)$$

We obtain lower estimates by roughly bounding from below $\sin x$ on $[0, \pi]$ by the “triangle” function $\frac{2}{\pi} \min(x, \pi - x)$. For $t \in [0, t_0]$, that leads to

$$\begin{aligned} |x_1^t| &\geq A_1 \frac{2}{\pi} \min(\nu_1 |t_0 - t|, |\pi - \nu_1(t_0 - t)|) \geq A_1 \frac{2\nu_1}{\pi} \min\left(|t_0 - t|, \left|\frac{\pi}{\nu_1} - \frac{\pi}{\nu_2} + \delta \frac{\pi}{\nu_2} + t\right|\right) \\ &\geq A_1 \frac{2\nu_1}{\pi} \min\left(|t_0 - t|, \frac{\pi}{\nu_1} - \frac{\pi}{\nu_2}\right), \end{aligned} \quad (3.4.17)$$

for $t \in [t_0, t_1]$ we obtain

$$|x_1^t| \geq A_1 \frac{2\nu_1}{\pi} \min(|t - t_0|, |t - t_1|), \quad (3.4.18)$$

while for $t \in [t_1, T]$, we obtain

$$\begin{aligned} |x_1^t| &\geq A_1 \frac{2}{\pi} \min(\nu_1 |t - t_1|, |\pi - \nu_1(t - t_1)|) \geq A_1 \frac{2\nu_1}{\pi} \min\left(|t - t_1|, \left|\frac{\pi}{\nu_1} + t_1 - t\right|\right) \\ &\geq A_1 \frac{2\nu_1}{\pi} \min\left(|t_1 - t|, \frac{\pi}{\nu_1} + t_1 - T\right). \end{aligned}$$

The last inequality rests on the fact that $\frac{\pi}{\nu_1} + t_1 \geq T$. More quantitatively, we have

$$\begin{aligned} \frac{\pi}{\nu_2} + t_1 &= T_0 + \frac{\pi}{\nu_2} \left(1 + \frac{\nu_2}{\nu_1} + 1 - \delta - 2 - \left\lfloor \frac{\nu_2}{\nu_1} \right\rfloor\right) \\ &= T + \frac{\pi}{\nu_2} \delta + \frac{\pi}{\nu_2} \left(\frac{\nu_2}{\nu_1} - \left\lfloor \frac{\nu_2}{\nu_1} \right\rfloor\right). \end{aligned} \quad (3.4.19)$$

In particular, it holds

$$\frac{\pi}{\nu_1} + t_1 - T = \pi \left(\frac{1}{\nu_1} - \frac{1}{\nu_2}\right) + \left(\frac{\pi}{\nu_2} + t_1 - T\right) \geq \pi \left(\frac{1}{\nu_1} - \frac{1}{\nu_2}\right) + \frac{\pi}{\nu_2} \delta, \quad (3.4.20)$$

which leads to

$$|x_1^t| \geq A_1 \frac{2\nu_1}{\pi} \min\left(|t_1 - t|, \pi \left(\frac{1}{\nu_1} - \frac{1}{\nu_2}\right)\right), \quad \forall t \in [t_1, T].$$

We obtain a similar estimate for x_2^t : it vanishes at t_0 and t_2 , so using again that the sine function is 1-Lipschitz we get

$$|x_2^t| \leq A_2 \nu_2 \min(|t_0 - t|, |t_2 - t|), \quad \forall t \in \mathbf{R}. \quad (3.4.21)$$

Near, t_1 , we want an accurate upper bound using the fact that $x_2^{t_1} \leq 0$ (recall that we chose the sign s in (3.4.14) so that this is true): for any $t \in \mathbf{R}$, we have

$$x_2^t \leq x_2^t - x_2^{t_1} \leq A_2 \nu_2 |t - t_1|. \quad (3.4.22)$$

As for a lower bound, we obtain for $t \in [0, t_0]$:

$$\begin{aligned} |x_2^t| &\geq A_2 \frac{2}{\pi} \min(\nu_2 |t_0 - t|, |\pi - \nu_2(t_0 - t)|) \geq A_2 \frac{2\nu_2}{\pi} \min\left(|t_0 - t|, \delta \frac{\pi}{\nu_2} + t\right) \\ &\geq A_2 \frac{2\nu_2}{\pi} \min\left(|t_0 - t|, \delta \frac{\pi}{\nu_2}\right), \end{aligned} \quad (3.4.23)$$

and for $t \in [t_1, T]$:

$$\begin{aligned} |x_2^t| &\geq A_2 \frac{2}{\pi} \min(|\pi - \nu_2(t_2 - t)|, \nu_2|t_2 - t|) \geq A_2 \frac{2\nu_2}{\pi} \min\left(\left|\frac{\pi}{\nu_2} - (t_2 - t)\right|, |t_2 - t|\right) \\ &\geq A_2 \frac{2\nu_2}{\pi} \min\left(|t - t_1|, \frac{\pi}{\nu_2}\delta\right). \end{aligned} \quad (3.4.24)$$

This time, the last inequality holds true since on the one hand, $t_2 - t \geq t_2 - T = \frac{\pi}{\nu_2}\delta$, and on the other hand, thanks to (3.4.19) and (3.4.15), we check that for any $t \in [t_1, T]$:

$$\frac{\pi}{\nu_2} - (t_2 - t) = (t - t_1) + \left(\frac{\pi}{\nu_2} + t_1\right) - t_2 = (t - t_1) + \frac{\pi}{\nu_2} \left(\frac{\nu_2}{\nu_1} - \left\lfloor \frac{\nu_2}{\nu_1} \right\rfloor\right) \geq t - t_1.$$

Now we show that the two conditions

$$2\frac{\nu_1}{\nu_2}\varepsilon \leq \frac{A_2}{A_1}\delta, \quad (3.4.25)$$

$$2\frac{\nu_2}{\nu_1}\varepsilon \leq \frac{A_1}{A_2} \min\left(1, \frac{\nu_2}{\nu_1} - 1\right), \quad (3.4.26)$$

imply that the curve (x_1^t, x_2^t) does not cross the set $\omega(2\varepsilon)$ in the interval $[0, T]$. We study the three intervals $[0, t_0]$, $[t_0, t_1]$ and $[t_1, T]$ separately.

- Let $t \in [0, t_0]$. On the one hand, the condition (3.4.25) implies that

$$A_1\nu_1|t - t_0| \frac{4\varepsilon}{\pi} \leq A_2 \frac{2\nu_2}{\pi} \min\left(|t - t_0|, \delta \frac{\pi}{\nu_2}\right)$$

(recall that $t_0 \leq \frac{\pi}{\nu_2}$ and $\delta \leq 1/2$). Using that $\tan \varepsilon \leq \frac{\varepsilon}{\pi/4}$ for $\varepsilon \in [0, \frac{\pi}{4}]$, we obtain

$$A_1\nu_1|t - t_0| \tan \varepsilon \leq A_2 \frac{2\nu_2}{\pi} \min\left(|t - t_0|, \delta \frac{\pi}{\nu_2}\right),$$

which leads to $\tan(\varepsilon)|x_1^t| \leq |x_2^t|$ in virtue of (3.4.16) and (3.4.23). Therefore $(x_1^t, x_2^t) \notin C_{2\varepsilon}^1$. On the other hand, the condition (3.4.26) implies that

$$A_2\nu_2|t_0 - t| \frac{4\varepsilon}{\pi} \leq A_1 \frac{2\nu_1}{\pi} \min\left(|t_0 - t|, \frac{\pi}{\nu_1} - \frac{\pi}{\nu_2}\right)$$

(recall again that $t_0 \leq \frac{\pi}{\nu_2}$). Using that $\tan \varepsilon \leq \frac{\varepsilon}{\pi/4}$ for $\varepsilon \in [0, \frac{\pi}{4}]$, we obtain

$$A_2\nu_2|t_0 - t| \tan \varepsilon \leq A_1 \frac{2\nu_1}{\pi} \min\left(|t_0 - t|, \frac{\pi}{\nu_1} - \frac{\pi}{\nu_2}\right),$$

which leads to $\tan(\varepsilon)|x_2^t| \leq |x_1^t|$ in virtue of (3.4.21) and (3.4.17). Therefore $(x_1^t, x_2^t) \notin C_{2\varepsilon}^2$.

- On $[t_0, t_1]$, the situation is slightly simpler because we already know that $x_1^t \leq 0$ on this interval, which means that the trajectory does not cross $C_{2\varepsilon}^1$ by construction. In addition, condition (3.4.26) implies that

$$A_2\nu_2 \min(|t_0 - t|, |t_1 - t|) \frac{4\varepsilon}{\pi} \leq A_1 \frac{2\nu_1}{\pi} \min(|t - t_0|, |t_1 - t|).$$

Then (3.4.21), (3.4.22) and (3.4.18) yield $\tan(\varepsilon)x_2^t \leq |x_1^t|$, hence $(x_1^t, x_2^t) \notin C_{2\varepsilon}^2$.

- We finally consider $t \in [t_1, T]$. Notice that by construction, it holds $x_2^t \leq 0$ on $[t_1, T]$, so that the trajectory does not enter $C_{2\varepsilon}^2$. To disprove the fact that it meets $C_{2\varepsilon}^1$, we check that the condition (3.4.25) implies

$$A_1\nu_1|t - t_1| \frac{4\varepsilon}{\pi} \leq A_2 \frac{2\nu_2}{\pi} \min\left(|t - t_1|, \frac{\pi}{\nu_2}\delta\right),$$

owing to the fact that $\frac{\pi}{\nu_2} \geq T - t_1 \geq t - t_1$ (this can be deduced from (3.4.20)). Then (3.4.16) and (3.4.24) lead to $\tan(\varepsilon)|x_1^t| \leq |x_2^t|$, which shows indeed that $(x_1^t, x_2^t) \notin C_{2\varepsilon}^1$.

To sum up, in order to ensure that $t \mapsto (x_1^t, x_2^t)$ does not cross $\omega(2\varepsilon)$, it suffices to choose A_1/A_2 properly, as well as δ , so that (3.4.25) and (3.4.26) are fulfilled. If we set

$$\delta = \frac{4\varepsilon^2}{\min(1, \frac{\nu_2}{\nu_1} - 1)} \quad \text{and} \quad \frac{A_1}{A_2} = 2\varepsilon \frac{\frac{\nu_2}{\nu_1}}{\min(1, \frac{\nu_2}{\nu_1} - 1)}, \quad (3.4.27)$$

we can check that these two conditions are indeed satisfied.

The conclusion is as follows: we consider a sequence of initial data of the form $\rho_n = (A_{1,n} \sin(\pi \frac{\nu_1}{\nu_2} (1 - \delta)), A_{2,n} \sin(\pi \delta))$ with $A_{1,n}/A_{2,n}$ as in (3.4.27) and $A_{1,n}, A_{2,n} \rightarrow \infty$ as $n \rightarrow \infty$. The x component of the trajectory $t \mapsto \phi^t(\rho_n)$ is then of the same form as the projected trajectory (x_1^t, x_2^t) that we studied. Given that these trajectories do not cross $\omega(2\varepsilon)$, we conclude that the observability condition of Theorem 3.1.3 is not true in time T , namely

$$\mathfrak{R}_{p_0}^\infty(\omega(2\varepsilon), T) = 0.$$

Yet for any $R > 0$, as we have already seen earlier, $\omega(\varepsilon)_R$ is contained in $\omega(2\varepsilon)$ modulo a compact set. Thus for any $R > 0$, there exists a compact set $K(R) \subset \mathbf{R}^d$ such that

$$\mathfrak{R}_{p_0}^\infty(\omega(\varepsilon)_R \setminus K(R), T) \leq \mathfrak{R}_{p_0}^\infty(\omega(2\varepsilon), T) = 0.$$

We conclude thanks to the necessary condition in Theorem 3.1.3 that observability cannot hold in $\omega(\varepsilon)$ in time T . It remains to see that by definition (recall (3.4.15) and (3.4.27)), we have

$$T = t_2 - \frac{\pi}{\nu_2} \delta = T_0 - 2 \frac{\pi}{\nu_2} \delta = T_0 - C\varepsilon^2.$$

This ends the proof of the lower bound of the optimal observation time. \square

3.4.3. Proof of Proposition 3.1.6

The aim of this proposition is to study observability from measurable conical sets for the (exact) isotropic harmonic oscillator. We first simplify the situation owing to periodicity properties of the isotropic quantum harmonic oscillator.

Step 1 – Upper bound of the optimal observation time.

First recall that there exists a complex number z of modulus 1 such that

$$e^{i\frac{\pi}{\nu}P} u = zu(-\bullet), \quad \forall u \in L^2(\mathbf{R}^d). \quad (3.4.28)$$

See for instance¹⁰ [Zwo12, Subsection 11.3.1] or [Fol89, (4.26)]. In particular, the propagator e^{-itP} is $\frac{2\pi}{\nu}$ -periodic modulo multiplication by z^2 . This enables us to show that observability holds in some time T if and only if it holds in time $\frac{2\pi}{\nu}$: assume the Schrödinger equation is observable from $\omega \subset \mathbf{R}^d$ in some time T ; let k be an integer such that $k\frac{2\pi}{\nu} \geq T$. The aforementioned $\frac{2\pi}{\nu}$ -periodicity of the harmonic oscillator leads to

$$\begin{aligned} \|u\|_{L^2(\mathbf{R}^d)}^2 &\leq C \int_0^T \|e^{-itP} u\|_{L^2(\omega)}^2 dt \leq C \int_0^{k\frac{2\pi}{\nu}} \|e^{-itP} u\|_{L^2(\omega)}^2 dt \\ &= Ck \int_0^{\frac{2\pi}{\nu}} \|e^{-itP} u\|_{L^2(\omega)}^2 dt, \end{aligned} \quad (3.4.29)$$

for any $u \in L^2$ so that observability holds in ω in time $\frac{2\pi}{\nu}$. In particular, the optimal observation time is always $\leq \frac{2\pi}{\nu}$. We can further reduce the observation time by $(2Ck)^{-1}$ (see Lemma 3.A.3), so that the optimal observation time is in fact $T_\star < \frac{2\pi}{\nu}$. Incidentally, the property (3.4.28) yields

$$\int_0^{\pi/\nu} \|e^{-itP} u\|_{L^2(\omega \cup -\omega)}^2 dt \leq \int_0^{2\pi/\nu} \|e^{-itP} u\|_{L^2(\omega)}^2 dt \leq 2 \int_0^{\pi/\nu} \|e^{-itP} u\|_{L^2(\omega \cup -\omega)}^2 dt, \quad (3.4.30)$$

which will be useful later on.

¹⁰ The property (3.4.28) can be derived from the fact that the spectrum of P is made of half integer multiples of ν , together with parity properties of eigenfunctions.

Step 2 – Necessary condition.

Assume observability holds from $\omega = \omega(\Sigma)$ in some time T . Let k be a positive integer such that $k\frac{2\pi}{\nu} \geq T$. Using (3.4.29) and (3.4.30), we obtain

$$\forall u \in L^2(\mathbf{R}^d), \|u\|_{L^2(\mathbf{R}^d)}^2 \leq C \int_0^T \|e^{-itP}u\|_{L^2(\omega)}^2 dt \leq 2Ck \int_0^{\pi/\nu} \|e^{-itP}u\|_{L^2(\omega \cup -\omega)}^2 dt.$$

We choose for u a particular coherent state. Following Combes and Robert [RC21], for any $\rho_0 = (x_0, \xi_0)$, we set

$$\varphi_{\rho_0}(x) = \left(\frac{\nu}{\pi}\right)^{d/4} e^{-\frac{i}{2}\xi_0 \cdot x_0 + i\xi_0 \cdot x} \exp\left(-\frac{\nu}{2}|x - x_0|^2\right).$$

Then it holds

$$e^{-itP}\varphi_{\rho_0} = e^{-\frac{i}{2}t\nu d}\varphi_{\rho_t}, \quad (3.4.31)$$

where $\rho_t = \phi^t(\rho_0)$ is the evolution of ρ_0 in phase space along the Hamiltonian flow associated with $p(x, \xi) = \frac{1}{2}(\nu^2|x|^2 + |\xi|^2)$, that is to say

$$\rho_t = \left(\cos(\nu t)x_0 + \sin(\nu t)\frac{\xi_0}{\nu}, -\nu \sin(\nu t)x_0 + \cos(\nu t)\xi_0 \right).$$

Equation (3.4.31) can be checked by observing that the derivative of both sides agree, or by applying [RC21, Proposition 3]. Selecting an initial datum of the form $\rho_0 = (0, \xi_0)$ with a non-zero ξ_0 , the observability inequality implies

$$\begin{aligned} 1 &= \|\varphi_{\rho_0}\|_{L^2(\mathbf{R}^d)}^2 \leq C \int_0^T \|\varphi_{\rho_t}\|_{L^2(\omega)}^2 dt \leq 2kC \int_0^{\pi/\nu} \|\varphi_{\rho_t}\|_{L^2(\omega \cup -\omega)}^2 dt \\ &= 2kC \left(\frac{\pi}{\nu}\right)^{d/2} \int_0^{\pi/\nu} \int_{\omega \cup -\omega} \left| \exp\left(-\frac{\nu}{2}\left|x - \sin(\nu t)\frac{\xi_0}{\nu}\right|^2\right) \right|^2 dx dt \\ &= 4k\frac{C}{\nu} \left(\frac{\pi}{\nu}\right)^{d/2} \int_0^{\pi/2} \int_{\omega \cup -\omega} \exp\left(-\nu\left|x - \sin(t)\frac{\xi_0}{\nu}\right|^2\right) dx dt. \end{aligned} \quad (3.4.32)$$

We used a change of variables in the integral over t and the fact that $\sin(x) = \sin(\pi - x)$ to obtain the last equality. Next we truncate the integrals in t and in x using respectively a small parameter $\delta > 0$ and a large parameter $R > 0$:

$$\begin{aligned} &\int_0^{\pi/2} \left(\frac{\pi}{\nu}\right)^{d/2} \int_{\omega \cup -\omega} \exp\left(-\nu\left|x - \sin(t)\frac{\xi_0}{\nu}\right|^2\right) dx dt \\ &\leq \pi\delta + \int_{\frac{\pi}{2}\delta}^{\frac{\pi}{2}(1-\delta)} \left(\frac{\pi}{\nu}\right)^{d/2} \left(\int_{\omega \cup -\omega} \exp\left(-\nu\left|x - \sin(t)\frac{\xi_0}{\nu}\right|^2\right) \mathbb{1}_{B_R(\sin(t)\frac{\xi_0}{\nu})}(x) dx \right. \\ &\quad \left. + \int_{\mathbf{R}^d \setminus B_R(0)} e^{-\nu|x|^2} dx \right) dt. \end{aligned}$$

The rightmost integral is controlled by c/R for some constant $c > 0$. Therefore it holds

$$\begin{aligned} &\int_0^{\pi/2} \left(\frac{\pi}{\nu}\right)^{d/2} \int_{\omega \cup -\omega} \exp\left(-\nu\left|x - \sin(t)\frac{\xi_0}{\nu}\right|^2\right) dx dt \\ &\leq \pi\delta + \frac{c}{R} + \left(\frac{\pi}{\nu}\right)^{d/2} \int_{\frac{\pi}{2}\delta}^{\frac{\pi}{2}(1-\delta)} \left| (\omega \cup -\omega) \cap B_R\left(\sin(t)\frac{\xi_0}{\nu}\right) \right| dt. \end{aligned}$$

We get rid of the sine in the right-hand side by noticing that $\cos t \geq 1 - \frac{2}{\pi}t \geq \delta$ for any $t \in [\frac{\pi}{2}\delta, \frac{\pi}{2}(1-\delta)]$, and changing variables:

$$\begin{aligned} &\int_{\frac{\pi}{2}\delta}^{\frac{\pi}{2}(1-\delta)} \left| (\omega \cup -\omega) \cap B_R\left(\sin(t)\frac{\xi_0}{\nu}\right) \right| dt \leq \int_{\frac{\pi}{2}\delta}^{\frac{\pi}{2}(1-\delta)} \left| (\omega \cup -\omega) \cap B_R\left(\sin(t)\frac{\xi_0}{\nu}\right) \right| \frac{|\cos t|}{\delta} dt \\ &= \frac{1}{\delta} \int_{\sin(\frac{\pi}{2}\delta)}^{\sin(\frac{\pi}{2}(1-\delta))} \left| (\omega \cup -\omega) \cap B_R\left(s\frac{\xi_0}{\nu}\right) \right| ds. \end{aligned}$$

Using that $\sin x \geq \frac{2}{\pi}x$ on $[0, \frac{\pi}{2}]$, we finally deduce that

$$\begin{aligned} & \int_0^{\pi/2} \left(\frac{\pi}{\nu}\right)^{d/2} \int_{\omega \cup -\omega} \exp\left(-\nu \left|x - \sin(t) \frac{\xi_0}{\nu}\right|^2\right) dx dt \\ & \leq \pi\delta + \frac{c}{R} + \frac{1}{\delta} \left(\frac{\pi}{\nu}\right)^{d/2} \int_\delta^1 \left|(\omega \cup -\omega) \cap B_R\left(s \frac{\xi_0}{\nu}\right)\right| ds. \end{aligned} \quad (3.4.33)$$

We plug this into (3.4.32) to obtain

$$\frac{1}{2} = \frac{1}{2} \|\varphi_{\rho_0}\|_{L^2(\mathbf{R}^d)}^2 \leq 4k \frac{C}{\delta\nu} \left(\frac{\pi}{\nu}\right)^{d/2} \int_\delta^1 \left|(\omega \cup -\omega) \cap B_R\left(s \frac{\xi_0}{\nu}\right)\right| ds, \quad (3.4.34)$$

where we absorbed the remainder terms of (3.4.33) in the left-hand side by choosing δ sufficiently small and R sufficiently large. We now use a scaling argument in the right-hand side, which is possible since the set $\omega \cup -\omega$ is conical: for any $s \in [\delta, 1]$, writing

$$\theta_0 = \frac{\xi_0}{|\xi_0|} \quad \text{and} \quad r = \frac{\nu R}{\delta|\xi_0|}, \quad (3.4.35)$$

we have

$$\begin{aligned} \left|(\omega \cup -\omega) \cap B_R\left(s \frac{\xi_0}{\nu}\right)\right| &= \left(s \frac{|\xi_0|}{\nu}\right)^d \left|(\omega \cup -\omega) \cap B_{\frac{\nu R}{s|\xi_0|}}(\theta_0)\right| \\ &\leq \left(\frac{R}{\delta}\right)^d r^{-d} |(\omega \cup -\omega) \cap B_r(\theta_0)|. \end{aligned}$$

After integrating over the s variable, the estimate (3.4.34) becomes

$$1 = \|\varphi_{\rho_0}\|_{L^2(\mathbf{R}^d)}^2 \leq 8k \frac{C}{\delta\nu} \left(\frac{\pi}{\nu}\right)^{d/2} \left(\frac{R}{\delta}\right)^d r^{-d} |(\omega \cup -\omega) \cap B_r(\theta_0)|. \quad (3.4.36)$$

We now reformulate the right-hand side in terms of the lower density Θ_{Σ}^- defined in (3.1.19). To do so, we observe that the triangle inequality yields for $r \in (0, 1)$:

$$\forall x \in B_r(\theta_0), \quad ||x| - 1| \leq |x - \theta_0| \quad \text{and} \quad \left|\frac{x}{|x|} - \theta_0\right| = \left|\frac{x - \theta_0}{|x|} + \frac{\theta_0}{|x|}(1 - |x|)\right| \leq \frac{2r}{1-r},$$

which in turn leads to

$$B_r(\theta_0) \subset \left\{x \in \mathbf{R}^d : 1-r \leq |x| \leq 1+r \quad \text{and} \quad \left|\frac{x}{|x|} - \theta_0\right| \leq \frac{2r}{1-r}\right\}, \quad r \in (0, 1).$$

Recall that if $|\xi_0|$ is large enough, then (3.4.35) implies $r \in (0, 1)$. We conclude by a spherical change of coordinates that

$$\begin{aligned} |(\omega \cup -\omega) \cap B_r(\theta_0)| &\leq \int_{1-r}^{1+r} \int_{\mathbf{S}^{d-1}} \mathbb{1}_{|\theta - \theta_0| \leq \frac{2r}{1-r}} \mathbb{1}_{\omega \cup -\omega}(\tilde{r}\theta) c_d \tilde{r}^{d-1} d\sigma(\theta) d\tilde{r} \\ &\leq \int_{1-r}^{1+r} \int_{\mathbf{S}^{d-1} \cap B_{\frac{2r}{1-r}}(\theta_0)} \mathbb{1}_{\widehat{\Sigma}}(\theta) c_d 2^{d-1} d\sigma(\theta) d\tilde{r} \\ &= c_d 2^{d-1} \times 2r \sigma\left(\widehat{\Sigma} \cap B_{\frac{2r}{1-r}}(\theta_0)\right). \end{aligned} \quad (3.4.37)$$

In addition, one has

$$\sigma(B_r(\theta_0)) \leq c'_d r^{d-1}. \quad (3.4.38)$$

(In the above estimates, c_d and c'_d are constants depending only on the dimension.) Combining (3.4.36), (3.4.37) and (3.4.38), we obtain

$$\begin{aligned} 1 = \|\varphi_{\rho_0}\|_{L^2(\mathbf{R}^d)}^2 &\leq c_d c'_d 2^{d+3} k \frac{C}{\delta\nu} \left(\frac{\pi}{\nu}\right)^{d/2} \left(\frac{R}{\delta}\right)^d \times \left(\frac{2}{1-r}\right)^{d-1} \frac{1}{c'_d \left(\frac{2r}{1-r}\right)^{d-1}} \sigma\left(\widehat{\Sigma} \cap B_{\frac{2r}{1-r}}(\theta_0)\right) \\ &\leq c_d c'_d 2^{d+3} k \frac{C}{\delta\nu} \left(\frac{\pi}{\nu}\right)^{d/2} \left(\frac{R}{\delta}\right)^d \left(\frac{2}{1-r}\right)^d \frac{\sigma\left(\widehat{\Sigma} \cap B_{\frac{2r}{1-r}}(\theta_0)\right)}{\sigma\left(B_{\frac{2r}{1-r}}(\theta_0)\right)}. \end{aligned}$$

Recalling that r behaves as $1/|\xi_0|$, it remains to let $\xi_0 \rightarrow \infty$ with $\frac{\xi_0}{|\xi_0|} = \theta_0$ arbitrary, to deduce that

$$1 \leq c_d c'_d 2^{d+3} k \frac{C}{\delta \nu} \left(\frac{\pi}{\nu}\right)^{d/2} \left(\frac{2R}{\delta}\right)^d \Theta_{\widehat{\Sigma}}(\theta_0), \quad \forall \theta_0 \in \mathbf{S}^{d-1}.$$

This concludes the proof of the necessary condition.

Step 3 – Sufficient condition.

Write for short $\omega = \omega(\Sigma)$ again. The fact that $\widehat{\Sigma} = \Sigma \cup -\Sigma$ has full measure, namely $\sigma(\mathbf{S}^{d-1} \setminus \widehat{\Sigma}) = 0$, implies that $\mathbf{R}^d \setminus (\omega \cup -\omega)$ is Lebesgue negligible (recall the definition of $\omega(\Sigma)$ in (3.1.18)). Therefore the left-hand side of (3.4.30) with $k = 1$ yields

$$\int_0^{2\pi/\nu} \|e^{-itP} u\|_{L^2(\omega)}^2 dt \geq \int_0^{\pi/\nu} \|e^{-itP} u\|_{L^2(\omega \cup -\omega)}^2 dt = \int_0^{\pi/\nu} \|e^{-itP} u\|_{L^2(\mathbf{R}^d)}^2 dt = \frac{\pi}{\nu} \|u\|_{L^2(\mathbf{R}^d)}^2,$$

where we used the fact that the propagator is an isometry. This completes the proof. \square

3.5. Proofs of observability results from spherical sets

In this section, we give proofs of the results presented in Subsection 3.1.4.3, which concern observation sets that are spherical in the sense of (3.1.22). Propositions 3.1.8 and 3.1.10 are proved in Subsections 3.5.1 and 3.5.3 respectively. Subsection 3.5.2 is dedicated to the proof of Lemma 3.1.11.

3.5.1. Proof of Proposition 3.1.8

The rotation S_θ of angle θ reads

$$S_\theta y = (\cos \theta y_1 + \sin \theta y_2, -\sin \theta y_1 + \cos \theta y_2, y_3, \dots, y_d), \quad y = (y_1, y_2, \dots, y_d) \in \mathbf{R}^d.$$

In the sequel, we set L_0 to be the two dimensional plane spanned by the vectors

$$e_1 = M(1, 0, 0, \dots, 0) \quad \text{and} \quad e_2 = M(0, 1, 0, 0, \dots, 0),$$

The two linear maps

$$\Pi_{L_0} = \frac{1}{2} M(\text{Id} - S_\pi) M^{-1} \quad \text{and} \quad \Pi_{L_0^\perp} = \frac{1}{2} M(\text{Id} + S_\pi) M^{-1}$$

are the orthogonal projectors on L_0 and L_0^\perp respectively, since M is orthogonal. With the notation of assumption (iii), we can write, with a slight abuse of notation,

$$V(x_0) = \tilde{V}_0(|M^{-1}x_0|), \quad \forall x_0 \in L_0. \quad (3.5.1)$$

Let us investigate the properties of the gradient of V on L_0 .

Lemma 3.5.1. *Let $x_0 \in L_0$. Then it holds*

$$\nabla V(x_0) \in L_0 \quad \text{and} \quad \exists c = c(|x_0|) \geq 0 : \quad \nabla V(x_0) = cx_0.$$

Proof. Assumptions (i) and (ii) (with $\theta = \pi$) yield for any $x \in \mathbf{R}^d$:

$$-\nabla V(-x) = \nabla V(x) \quad \text{and} \quad MS_{-\pi} M^{-1} \nabla V(MS_\pi M^{-1}x) = \nabla V(x). \quad (3.5.2)$$

Yet since $x_0 \in L_0$, we have $\Pi_{L_0} x_0 = x_0$ so that

$$x_0 = -MS_\pi M^{-1} x_0, \quad (3.5.3)$$

and noticing that $S_\pi = S_{-\pi}$, we obtain combining the two equations (3.5.2):

$$\nabla V(x_0) = -\nabla V(-x_0) = -MS_\pi M^{-1} \nabla V(-MS_\pi M^{-1} x_0) = -MS_\pi M^{-1} \nabla V(x_0).$$

That means exactly that $\Pi_{L_0^\perp} \nabla V(x_0) = 0$, or in other words, $\nabla V(x_0) \in L_0$.

Next we prove that $\nabla V(x_0)$ is collinear with x_0 . We first get rid of the case $x_0 = 0$: the first equation in (3.5.2) implies that $\nabla V(0) = 0$. From now on, we assume that $x_0 \neq 0$. We compute

$$\frac{d}{d\theta} MS_\theta M^{-1} = \frac{d}{d\theta} \left(MS_\theta M^{-1} \Pi_{L_0} + MS_\theta M^{-1} \Pi_{L_0^\perp} \right) = MS_{\theta+\pi/2} M^{-1} \Pi_{L_0}.$$

This is true because $MS_\theta M^{-1} \Pi_{L_0^\perp}$ is independent of θ ($MS_\theta M^{-1}$ is the identity in L_0^\perp). Therefore, differentiating the equality $V(x) = V(MS_\theta M^{-1}x)$ at $\theta = 0$, we obtain

$$\begin{aligned} 0 &= \frac{d}{d\theta} V(x_0)|_{\theta=0} = \frac{d}{d\theta} V(MS_\theta M^{-1}x_0)|_{\theta=0} = \nabla V(x_0) \cdot MS_{\pi/2} M^{-1} \Pi_{L_0} x_0 \\ &= \nabla V(x_0) \cdot MS_{\pi/2} M^{-1} x_0. \end{aligned}$$

This means that $\nabla V(x_0)$ is orthogonal to $MS_{\pi/2} M^{-1} x_0$. Yet the plane L_0 is invariant by $MS_\theta M^{-1}$ and $x_0 \perp MS_{\pi/2} M^{-1} x_0$. Since $\nabla V(x_0) \in L_0$ and L_0 has dimension 2, we deduce that $\nabla V(x_0) = cx_0$ for some $c \in \mathbf{R}$. We claim that $c \geq 0$ as a consequence of assumption (iii) that \tilde{V}_0 is non-decreasing. Indeed for $t > 0$ close to zero, using (3.5.1), the Taylor formula at order one yields

$$0 \leq \tilde{V}_0((1+t)|M^{-1}x_0|) - \tilde{V}_0(|M^{-1}x_0|) = V(x_0 + tx_0) - V(x_0) = t\nabla V(x_0) \cdot x_0 + o(t).$$

Dividing by $t > 0$, we find that $\nabla V(x_0) \cdot x_0 = c|x_0|^2 \geq 0$. Thus $c = \nabla V(x_0) \cdot \frac{x_0}{|x_0|^2}$ depends only on $|x_0|$ since V restricted to L_0 is radial, and the proof is complete. \square

This lemma allows us to exhibit periodic circular orbits of the Hamiltonian flow of p . For any $x_0 \in L_0$, denoting by c the scalar such that $\nabla V(x_0) = cx_0$, the phase space curve

$$x^t = MS_{\sqrt{ct}} M^{-1} x_0, \quad \xi^t = \sqrt{c} MS_{\sqrt{ct}+\pi/2} M^{-1} x_0 \quad (3.5.4)$$

is the trajectory of the Hamiltonian flow with initial data $(x_0, \sqrt{c} MS_{\pi/2} M^{-1} x_0)$. This follows from uniqueness in the Picard-Lindelöf Theorem, since the above curve solves on the one hand:

$$\frac{d}{dt} x^t = \sqrt{c} MS_{\sqrt{ct}+\pi/2} M^{-1} \Pi_{L_0} x_0 = \xi^t,$$

and on the other hand, in view of (3.5.3) and observing that $|x^t| = |x_0|$ for any t ,

$$\frac{d}{dt} \xi^t = c MS_{\sqrt{ct}+\pi} M^{-1} \Pi_{L_0} x_0 = c MS_{\sqrt{ct}} M^{-1} \left(\Pi_{L_0^\perp} - \Pi_{L_0} \right) x_0 = -cx^t = -\nabla V(x^t).$$

To conclude, we argue as follows: since by assumption observability holds from $\omega(I)$ in time $T > 0$, the necessary condition of Theorem 3.1.3 implies that there exists $R > 0$ such that

$$\exists \epsilon > 0, \exists A > 0 : \forall |\rho| \geq A, \quad \int_0^T \mathbf{1}_{\omega(I)_R \times \mathbf{R}^d}(\phi^t(\rho)) dt \geq \epsilon.$$

Let $x_0 \in L_0$ be such that $|x_0| \geq A$. We consider the Hamiltonian trajectory issued from the point $(x_0, \sqrt{c(x_0)} M^{-1} S_{\pi/2} M x_0)$ constructed in (3.5.4). Then $|x^t|$ is constant over time, which implies that

$$\epsilon \leq \int_0^T \mathbf{1}_{\omega(I)_R \times \mathbf{R}^d}(\phi^t(\rho)) dt = \int_0^T \mathbf{1}_{\omega(I)_R}(x^t) dt = T \mathbf{1}_{I_R}(|x_0|),$$

whence $|x_0| \in I_R$. We deduce that

$$\forall s \in \mathbf{R}_+, \quad I_R \cap [s, s+A] \neq \emptyset,$$

which implies the desired result (3.1.23) with $r = A + 2R$. \square

3.5.2. Proof of Lemma 3.1.11

Firstly we assume that $\frac{\nu_2}{\nu_1}$ is rational: we write it as an irreducible fraction $\frac{p}{q}$. The number $T = \frac{2\pi}{\nu_2}p = \frac{2\pi}{\nu_1}q$ is the period of the Hamiltonian flow associated with $\frac{1}{2}(x \cdot Ax + |\xi|^2)$. Without loss of generality, we can assume that A is diagonal, and that the eigenvectors associated with ν_1^2 and ν_2^2 are the vectors $(1, 0)$ and $(0, 1)$ of the canonical basis of \mathbf{R}^2 . As mentioned in (3.1.29), we seek to compute a sharp uniform upper bound of the ratio between the minimal and the maximal value of the norm of projected trajectories $|x^t|$ on the time interval $[0, T]$.

We want to prove that $\Lambda(\frac{\nu_2}{\nu_1})$ defined in (3.1.25) is equal to the quantity

$$\Lambda_0 = \sup_{\rho_0 \in \mathbf{R}^4 \setminus \{0\}} \frac{\min_{t \in [0, T]} |(\pi \circ \phi^t)(\rho_0)|}{\max_{t \in [0, T]} |(\pi \circ \phi^t)(\rho_0)|}, \quad (3.5.5)$$

where we recall that $\pi : (x, \xi) \mapsto x$.

We start with two remarks, related to explicit expressions of the Hamiltonian flow. First we can replace the supremum on \mathbf{R}^4 by a maximum on a compact set parametrizing trajectories, e.g. the unit sphere \mathbf{S}^3 , because the Hamiltonian flow is homogeneous of degree 1, that is $\phi^t(\lambda\rho_0) = \lambda\phi^t(\rho_0)$ for any scalar $\lambda \in \mathbf{R}$ (it fact ϕ^t is a linear map for all t). Second, since $|x^t|^2 = |x_1^t|^2 + |x_2^t|^2$, it will be easier to compute Λ_0^2 . In view of these remarks, and writing the Hamiltonian trajectories in action-angle coordinates:

$$x_1^t = A_1 \sin(\nu_1 t + \theta_1) \quad \text{and} \quad x_2^t = A_2 \sin(\nu_2 t + \theta_2), \quad (3.5.6)$$

we want to study

$$\begin{aligned} \Lambda_0^2 &= \sup_{\substack{A_1^2 + A_2^2 = 1 \\ \theta_1, \theta_2 \in \mathbf{R}}} \frac{\min_{t \in [0, T]} (A_1^2 \sin^2(\nu_1 t + \theta_1) + A_2^2 \sin^2(\nu_2 t + \theta_2))}{\max_{t \in [0, T]} (A_1^2 \sin^2(\nu_1 t + \theta_1) + A_2^2 \sin^2(\nu_2 t + \theta_2))} \\ &= \sup_{\substack{\lambda \in [0, 1] \\ \theta_1, \theta_2 \in \mathbf{R}}} \frac{\min_{t_1 \in [0, T]} ((1 - \lambda) \sin^2(\nu_1 t_1 + \theta_1) + \lambda \sin^2(\nu_2 t_1 + \theta_2))}{\max_{t_2 \in [0, T]} ((1 - \lambda) \sin^2(\nu_1 t_2 + \theta_1) + \lambda \sin^2(\nu_2 t_2 + \theta_2))} \\ &= \sup_{\substack{\lambda \in [0, 1] \\ \theta_1, \theta_2 \in \mathbf{R}}} \frac{\min_{t_1 \in [0, T]} ((1 - \lambda) \sin^2(\nu_1 t_1 + \theta_1) + \lambda \sin^2(\nu_2 t_1 + \theta_2))}{1 - \min_{t_2 \in [0, T]} ((1 - \lambda) \cos^2(\nu_1 t_2 + \theta_1) + \lambda \cos^2(\nu_2 t_2 + \theta_2))}. \end{aligned}$$

In view of the periodicity in the variables θ_1 and θ_2 , the supremum in the variables $\lambda, \theta_1, \theta_2$ is in fact a supremum over $(\lambda, \theta_1, \theta_2) \in [0, 1] \times [0, 2\pi] \times [0, 2\pi]$. A compactness and continuity argument shows that this supremum is attained for some triple $(\lambda, \theta_1, \theta_2)$. Furthermore, one can check that $\max_{\lambda, \theta_1, \theta_2} = \max_{\theta_1, \theta_2} \max_{\lambda}$. Thus we should simplify the problem first by considering fixed values for θ_1 and θ_2 , and maximizing with respect to these variables ultimately. Therefore our objective is to compute

$$\Lambda_{\theta_1, \theta_2}^2 = \max_{\lambda \in [0, 1]} \frac{\min_{t_1 \in [0, T]} ((1 - \lambda) \sin^2(\nu_1 t_1 + \theta_1) + \lambda \sin^2(\nu_2 t_1 + \theta_2))}{1 - \min_{t_2 \in [0, T]} ((1 - \lambda) \cos^2(\nu_1 t_2 + \theta_1) + \lambda \cos^2(\nu_2 t_2 + \theta_2))}. \quad (3.5.7)$$

We can further simplify this by rewriting in more pleasant terms the minima in the numerator and the denominator. It relies on the following fact.

Step I – Simplification of the optimization problem.

The minimum we want to estimate involves a sum of two squared sine functions that oscillate at different frequencies. Intuitively, it looks reasonable that the minimum of such a sum is attained between two zeroes that achieve the minimal distance between a zero of the first sine function, and a zero of the second. This is a motivation to introduce

$$d_0 = d_0(\theta_1, \theta_2) = \frac{4pq}{T} \min_{\substack{j=1,2 \\ \sin(\nu_j t_j + \theta_j)=0}} |t_1 - t_2|. \quad (3.5.8)$$

It is indeed a minimum, and not only an infimum, thanks to the rational ratio between ν_1 and ν_2 , or equivalently, thanks to the periodicity of the Hamiltonian flow. We can give an explicit expression

of this quantity reasoning as follows: the numbers t_1 and t_2 are such that $\sin(\nu_j t_j + \theta_j) = 0$, $j = 1, 2$, if and only if there exist two integers k_1 and k_2 such that

$$\nu_j t_j + \theta_j = k_j \pi.$$

Therefore it holds

$$|t_1 - t_2| = \left| \pi \left(\frac{k_1}{\nu_1} - \frac{k_2}{\nu_2} \right) - \left(\frac{\theta_1}{\nu_1} - \frac{\theta_2}{\nu_2} \right) \right| = \frac{T}{2pq} \left| (k_1 p - k_2 q) - \left(p \frac{\theta_1}{\pi} - q \frac{\theta_2}{\pi} \right) \right|.$$

Yet since p and q are coprime integers, it follows from Bézout's identity that $k_1 p - k_2 q$ can take any value in \mathbf{Z} when we vary k_1 and k_2 . We deduce that

$$d_0 = 2 \operatorname{dist} \left(p \frac{\theta_1}{\pi} - q \frac{\theta_2}{\pi}, \mathbf{Z} \right) = \operatorname{dist} \left(p \frac{\theta_1}{\pi/2} - q \frac{\theta_2}{\pi/2}, 2\mathbf{Z} \right).$$

Incidentally, this expression implies that $d_0 \in [0, 1]$. Now we claim that

$$\begin{aligned} & \min_{t \in [0, T]} \left((1 - \lambda) \sin^2(\nu_1 t + \theta_1) + \lambda \sin^2(\nu_2 t + \theta_2) \right) \\ &= \min_{s \in [0, 1]} \left((1 - \lambda) \sin^2 \left(\frac{\pi/2}{p} s d_0 \right) + \lambda \sin^2 \left(\frac{\pi/2}{q} (1 - s) d_0 \right) \right). \end{aligned} \quad (3.5.9)$$

It amounts to prove that the minimum in t in the left-hand side of (3.5.9) is attained between two zeros t_1, t_2 of $\sin(\nu_1 t + \theta_1)$ and $\sin(\nu_2 t + \theta_2)$ such that $|t_2 - t_1| = \frac{T}{4pq} d_0$. We first show that the minimum in s (in the right-hand side) is less than the minimum in t (in the left-hand side). To do so, we pick $t_0 \in [0, T]$ that attains the minimum in t . We choose t_j two zeroes of $\sin(\nu_j t + \theta_j)$ respectively, $j = 1, 2$, that are the closest possible to t_0 . Due to periodicity, they verify $|t_j - t_0| \leq \frac{\pi}{2\nu_j}$.

That t_0 attains the minimum means that it is a critical point of the function

$$\begin{aligned} F : t &\mapsto (1 - \lambda) \sin^2(\nu_1 t + \theta_1) + \lambda \sin^2(\nu_2 t + \theta_2) \\ &= (1 - \lambda) \sin^2(\nu_1(t - t_1)) + \lambda \sin^2(\nu_2(t - t_2)). \end{aligned} \quad (3.5.10)$$

Classical trigonometry formulae then yield

$$(1 - \lambda) \nu_1 \sin(2\nu_1(t_0 - t_1)) + \lambda \nu_2 \sin(2\nu_2(t_0 - t_2)) = F'(t_0) = 0. \quad (3.5.11)$$

Recalling that $|2\nu_j(t_0 - t_j)| \leq \pi$, we see that $\sin(2\nu_j(t_0 - t_j))$ is of the same sign as $t_0 - t_j$, thus leading to the condition that

$$(t_0 - t_1)(t_0 - t_2) \leq 0,$$

or in other words, t_0 lies between t_1 and t_2 . Let $s_0 \in [0, 1]$ be such that $t_0 = (1 - s_0)t_1 + s_0 t_2$. We obtain

$$\begin{aligned} F(t_0) &= (1 - \lambda) \sin^2(\nu_1(t_0 - t_1)) + \lambda \sin^2(\nu_2(t_0 - t_2)) \\ &= (1 - \lambda) \sin^2(\nu_1 s_0(t_2 - t_1)) + \lambda \sin^2(\nu_2(1 - s_0)(t_1 - t_2)). \end{aligned}$$

We finally use that $|t_1 - t_2| \geq \frac{T}{4pq} d_0$ and the monotonicity of the sine function on $[0, \frac{\pi}{2}]$ to deduce one inequality in (3.5.9), namely:

$$\min_{t \in [0, T]} F(t) \geq \min_{s \in [0, 1]} \left((1 - \lambda) \sin^2 \left(\frac{\pi/2}{p} s d_0 \right) + \lambda \sin^2 \left(\frac{\pi/2}{q} (1 - s) d_0 \right) \right). \quad (3.5.12)$$

To check the converse inequality, we proceed as follows: we pick t_1 and t_2 , zeroes of $\sin(\nu_j t + \theta_j)$ respectively, that satisfy $|t_1 - t_2| = \frac{T}{4pq} d_0$. Denote by J the closed interval with endpoints t_1, t_2 . Let $t_0 \in J$ be a point where F restricted to J attains its minimum. Then introducing a parameter $s \in [0, 1]$ such that $t = (1 - s)t_1 + s t_2$, we obtain

$$F(t_0) \leq F(t) = (1 - \lambda) \sin^2 \left(\frac{\pi/2}{p} s d_0 \right) + \lambda \sin^2 \left(\frac{\pi/2}{q} (1 - s) d_0 \right),$$

for all $s \in [0, 1]$. This results in

$$\min_{t \in [0, T]} F(t) \leq \min_{s \in [0, 1]} \left((1 - \lambda) \sin^2 \left(\frac{\pi/2}{p} s d_0 \right) + \lambda \sin^2 \left(\frac{\pi/2}{q} (1 - s) d_0 \right) \right),$$

which shows together with (3.5.12) that (3.5.9) is true. We observe in the definition of $\Lambda_{\theta_1, \theta_2}$ (see (3.5.7)) that a similar minimum is involved with cosine functions instead of sine functions. To reduce to the case of sine functions and use (3.5.9), we simply recall that $\cos(x) = \sin(x + \frac{\pi}{2})$. We obtain

$$\begin{aligned} \min_{t \in [0, T]} ((1 - \lambda) \cos^2(\nu_1 t + \theta_1) + \lambda \cos^2(\nu_2 t + \theta_2)) \\ = \min_{t \in [0, T]} \left((1 - \lambda) \sin^2 \left(\nu_1 t + \theta_1 + \frac{\pi}{2} \right) + \lambda \sin^2 \left(\nu_2 t + \theta_2 + \frac{\pi}{2} \right) \right) \\ = \min_{s \in [0, 1]} \left((1 - \lambda) \sin^2 \left(\frac{\pi/2}{p} s d_{\pi/2} \right) + \lambda \sin^2 \left(\frac{\pi/2}{q} (1 - s) d_{\pi/2} \right) \right), \end{aligned}$$

where we set (recall the definition of d_0 in (3.5.8))

$$d_{\pi/2} = d_{\pi/2}(\theta_1, \theta_2) = d_0 \left(\theta_1 + \frac{\pi}{2}, \theta_2 + \frac{\pi}{2} \right) = \text{dist} \left(p \frac{\theta_1}{\pi/2} - q \frac{\theta_2}{\pi/2} + p - q, 2\mathbf{Z} \right).$$

Depending on whether p and q have the same parity, we can state that

$$d_{\pi/2} = \begin{cases} d_0 & \text{if } p - q \equiv 0 \pmod{2} \\ 1 - d_0 & \text{if } p - q \equiv 1 \pmod{2} \end{cases}.$$

With this at hand, we can rewrite $\Lambda_{\theta_1, \theta_2}^2$ defined in (3.5.7) as

$$\Lambda_{\theta_1, \theta_2}^2 = \max_{\lambda \in [0, 1]} \frac{\min_{s_1 \in [0, 1]} \left((1 - \lambda) \sin^2 \left(\frac{\pi/2}{p} s_1 d_0 \right) + \lambda \sin^2 \left(\frac{\pi/2}{q} (1 - s_1) d_0 \right) \right)}{1 - \min_{s_2 \in [0, 1]} \left((1 - \lambda) \sin^2 \left(\frac{\pi/2}{p} s_2 d_{\pi/2} \right) + \lambda \sin^2 \left(\frac{\pi/2}{q} (1 - s_2) d_{\pi/2} \right) \right)}.$$

Step II – Computation of $\Lambda_{\theta_1, \theta_2}^2$.

We set for any $\lambda \in [0, 1]$ and $s \in [0, 1]$:

$$g_\lambda(s) = g_{\lambda, d_0}(s) = (1 - \lambda) \sin^2 \left(\frac{\pi/2}{p} s d_0 \right) + \lambda \sin^2 \left(\frac{\pi/2}{q} (1 - s) d_0 \right).$$

In the perspective of computing $\Lambda_{\theta_1, \theta_2}^2$, we first show the following result.

Lemma 3.5.2. *It holds*

$$\max_{\lambda \in [0, 1]} \min_{s \in [0, 1]} g_\lambda(s) = g_{\lambda_0}(s_0) = \sin^2 \left(\frac{\pi/2}{p + q} d_0 \right),$$

where $s_0 = \frac{p}{p+q}$ and $\lambda_0 = \frac{q}{p+q}$.

Proof. Firstly, we observe that $g_\lambda(s_0)$ is independent of λ , since it solves

$$\sin^2 \left(\frac{\pi/2}{p} s_0 d_0 \right) = \sin^2 \left(\frac{\pi/2}{q} (1 - s_0) d_0 \right).$$

This remarkable property implies that for any $\lambda \in [0, 1]$, it holds

$$\forall \lambda' \in [0, 1], \quad \min_{s \in [0, 1]} g_{\lambda'}(s) \leq g_{\lambda'}(s_0) = g_\lambda(s_0),$$

which results in

$$\max_{\lambda' \in [0, 1]} \min_{s \in [0, 1]} g_{\lambda'}(s) \leq g_\lambda(s_0), \quad \forall \lambda \in [0, 1].$$

Now we to show that the equality is reached when $\lambda = \lambda_0$ introduced in the statement. Noticing that $(1 - \lambda_0)\frac{1}{p} = \lambda_0\frac{1}{q} = \frac{1}{p+q}$, we obtain using classical trigonometry formulae:

$$\begin{aligned} g'_{\lambda_0}(s) &= \frac{\pi}{2}d_0 \left(2\frac{1}{p}(1 - \lambda_0) \cos\left(\frac{\pi/2}{p}sd_0\right) \sin\left(\frac{\pi/2}{p}sd_0\right) \right. \\ &\quad \left. - 2\frac{1}{q}\lambda_0 \cos\left(\frac{\pi/2}{q}(1-s)d_0\right) \sin\left(\frac{\pi/2}{q}(1-s)d_0\right) \right) \\ &= \frac{\pi/2}{p+q}d_0 \left(\sin\left(\frac{\pi}{p}sd_0\right) - \sin\left(\frac{\pi}{q}(1-s)d_0\right) \right) \\ &= \frac{\pi}{p+q}d_0 \cos\left(\frac{\pi}{2}d_0\left(\frac{s}{p} + \frac{1-s}{q}\right)\right) \sin\left(\frac{\pi}{2}d_0\left(\frac{s}{p} - \frac{1-s}{q}\right)\right) \\ &= \frac{\pi}{p+q}d_0 \cos\left(\frac{\pi}{2}d_0\left(\frac{s}{p} + \frac{1-s}{q}\right)\right) \sin\left(\frac{\pi}{2}d_0\left(\frac{1}{p} + \frac{1}{q}\right)(s - s_0)\right). \end{aligned}$$

We observe that the cosine is always non-negative for any $s \in [0, 1]$, because $d_0 \leq 1$. As for the sine, it is non-positive for $s \leq s_0$ and non-negative for $s \geq s_0$. We deduce that $g'_{\lambda_0}(s) \leq 0$ on $[0, s_0]$ and $g'_{\lambda_0}(s) \geq 0$ on $[s_0, 1]$. Therefore, the minimum of g_{λ_0} is attained at s_0 , which concludes the proof of the lemma. \square

Regarding the denominator in the definition of $\Lambda_{\theta_1, \theta_2}^2$, observing that λ_0 and s_0 in the above lemma do not dependent on d_0 or $d_{\pi/2}$, we find

$$\begin{aligned} \min_{\lambda \in [0, 1]} \left(1 - \min_{s \in [0, 1]} \left((1 - \lambda) \sin^2\left(\frac{\pi/2}{q}sd_{\pi/2}\right) + \lambda \sin^2\left(\frac{\pi/2}{p}(1-s)d_{\pi/2}\right) \right) \right) \\ = 1 - \max_{\lambda \in [0, 1]} \min_{s \in [0, 1]} g_{\lambda, d_{\pi/2}}(s) = 1 - g_{\lambda_0, d_{\pi/2}}(s_0) = \cos^2\left(\frac{\pi/2}{p+q}d_{\pi/2}\right). \end{aligned}$$

This implies that λ_0 maximizes the minimum of the numerator and minimizes the maximum of the denominator at once. Moreover, when $\lambda = \lambda_0$, the minimum of the denominator and the maximum of the numerator are reached at a common value s_0 . Therefore

$$\Lambda_{\theta_1, \theta_2}^2 = \frac{\sin^2\left(\frac{\pi/2}{p+q}d_0\right)}{\cos^2\left(\frac{\pi/2}{p+q}d_{\pi/2}\right)}.$$

When p and q have the same parity, it holds $d_{\pi/2} = d_0$, so that

$$\Lambda_{\theta_1, \theta_2} = \tan\left(\frac{\pi/2}{p+q}d_0\right). \quad (3.5.13)$$

When they do not have the same parity, then $d_{\pi/2} = 1 - d_0$ and we obtain

$$\begin{aligned} \Lambda_{\theta_1, \theta_2} &= \frac{\sin\left(\frac{\pi/2}{p+q}d_0\right)}{\cos\left(\frac{\pi/2}{p+q}(1-d_0)\right)} = \sin\left(\frac{\pi/2}{p+q}\right) - \cos\left(\frac{\pi/2}{p+q}\right) \frac{\sin\left(\frac{\pi/2}{p+q}(1-d_0)\right)}{\cos\left(\frac{\pi/2}{p+q}(1-d_0)\right)} \\ &= \sin\left(\frac{\pi/2}{p+q}\right) - \cos\left(\frac{\pi/2}{p+q}\right) \tan\left(\frac{\pi/2}{p+q}(1-d_0)\right). \end{aligned} \quad (3.5.14)$$

Recall that in the above formulae, the dependence on the phase shifts θ_1 and θ_2 is hidden in d_0 . Thus it remains to optimize over these parameters θ_1, θ_2 to compute the quantity Λ_0 defined in (3.5.5). In the first case (3.5.13), we notice that $d_0 \leq 1$, and that the equality is achieved for $\theta_1 = \frac{\pi}{2p}$ and $\theta_2 = 0$ for instance, so that

$$\Lambda_0 = \tan\left(\frac{\pi/2}{p+q}\right).$$

In the second case (3.5.14), the maximum is reached for $d_0 = 1$ as well, so that

$$\Lambda_0 = \sin\left(\frac{\pi/2}{p+q}\right).$$

The conclusion is that $\Lambda_0 = \Lambda(\frac{p}{q})$, where the function Λ is the one defined in (3.1.25).

It remains to deal with the irrational case $\frac{\nu_2}{\nu_1} \notin \mathbf{Q}$. To obtain the sought result, it suffices to show that for any initial data $(A_1, A_2, \theta_1, \theta_2)$ of the flow (in action-angle coordinates), the projected trajectory

$$x_1^t = A_1 \sin(\nu_1 t + \theta_1), \quad x_2^t = A_2 \sin(\nu_2 t + \theta_2),$$

satisfies $\inf_{t \in \mathbf{R}} |x^t| = 0$. Let us consider the convergents $(\frac{p_j}{q_j})_{j \in \mathbf{N}}$ of $\frac{\nu_2}{\nu_1}$, in irreducible form (see Remark 3.1.13). In view of (3.1.30), we introduce $\epsilon_j \in [-1, 1]$ such that

$$\frac{\nu_2}{\nu_1} = \frac{p_j}{q_j} + \frac{\epsilon_j}{q_j^2}. \quad (3.5.15)$$

We exhibit a sequence of times $(t_j)_{j \in \mathbf{N}}$ such that $x_1^{t_j} = 0$ and $x_2^{t_j} \rightarrow 0$ as $j \rightarrow \infty$. Since p_j and q_j are coprime integers, we can fix for each $j \in \mathbf{N}$ a pair of Bézout coefficients $(k_j, l_j) \in \mathbf{Z}^2$, such that

$$k_j p_j - l_j q_j = 1, \quad \text{with} \quad |k_j| \leq q_j. \quad (3.5.16)$$

Set

$$a_j = \left[\frac{\frac{\theta_1}{\pi} p_j - \frac{\theta_2}{\pi} q_j}{1 + \epsilon_j \frac{k_j}{q_j}} \right] \quad \text{and} \quad t_j = \frac{a_j k_j \pi - \theta_1}{\nu_1}. \quad (3.5.17)$$

By definition, of t_j , it holds $x_1^{t_j} = 0$. Thus it remains to check that $x_2^{t_j} \rightarrow 0$ as $j \rightarrow \infty$. We have

$$\begin{aligned} \nu_2 t_j + \theta_2 - a_j l_j \pi &= \left(\frac{p_j}{q_j} + \frac{\epsilon_j}{q_j^2} \right) \times \pi \left(a_j k_j - \frac{\theta_1}{\pi} \right) + \theta_2 - a_j l_j \pi \\ &= \frac{p_j}{q_j} a_j k_j \pi - a_j l_j \pi + \frac{\epsilon_j}{q_j^2} \times \pi \left(a_j k_j - \frac{\theta_1}{\pi} \right) + \frac{\pi}{q_j} \left(\frac{\theta_2}{\pi} q_j - \frac{\theta_1}{\pi} p_j \right) \\ &= a_j \frac{\pi}{q_j} + a_j \epsilon_j \frac{k_j}{q_j^2} \pi - \frac{\theta_1 \epsilon_j}{q_j^2} - \frac{\pi}{q_j} \left(\frac{\theta_1}{\pi} p_j - \frac{\theta_2}{\pi} q_j \right) \\ &= \frac{\pi}{q_j} \left(1 + \epsilon_j \frac{k_j}{q_j} \right) \left(a_j - \frac{\frac{\theta_1}{\pi} p_j - \frac{\theta_2}{\pi} q_j}{1 + \epsilon_j \frac{k_j}{q_j}} \right) - \frac{\theta_1 \epsilon_j}{q_j^2}. \end{aligned}$$

We used (3.5.15) to have the first equality and (3.5.16) for the third one. In the last line, the two factors between parentheses are bounded. Indeed, the first factor is bounded by 2 since we chose k_j such that $|k_j| \leq q_j$ in (3.5.16) and because $|\epsilon_j| \leq 1$ from (3.5.15). The second factor is bounded by 1 due to the definition of a_j (3.5.17). Recalling that $q_j \rightarrow \infty$ since $\frac{\nu_2}{\nu_1}$ is irrational, we obtain $\nu_2 t_j + \theta_2 = a_j l_j \pi + o(1)$ as $j \rightarrow \infty$, hence $x_2^{t_j} \rightarrow 0$, and the proof of Lemma 3.1.11 is complete. \square

3.5.3. Proof of Proposition 3.1.10

As we did in Subsection 3.5.2, we assume without loss of generality that A is diagonal, with eigenvalues ν_1^2 and ν_2^2 associated with the eigenvectors $(1, 0)$ and $(0, 1)$ in \mathbf{R}^2 .

Step 1 – Construction of an equivalent shrunk observation set.

Recall that the sufficient condition of Theorem 3.1.3 implies observability from an “enlarged” observation set. This leads us to construct a shrunk set $\tilde{I} \subset I$, such that $\tilde{I}_R = \tilde{I} + (-R, R)$ is contained in I up to a bounded set, so that the same is true for the sets $\omega(\tilde{I})$ and $\omega(I)$. In the lemma below, when $I \subset \mathbf{R}_+$, we use the notation $I_R := \bigcup_{s \in I} (s - R, s + R)$.

Lemma 3.5.3 (Shrunk observation set). *Let $I = \bigcup_n I_n$ where $I_n \subset \mathbf{R}_+$ are open intervals, with $|I_n| \rightarrow +\infty$ if the union is infinite. Then there exists a family of disjoint open intervals $(\tilde{J}_n)_n$ in \mathbf{R}_+ (with $|\tilde{J}_n| \rightarrow +\infty$ if there are infinitely many of them) such that the set $\tilde{I} = \bigcup_n \tilde{J}_n$ satisfies the following:*

- (i) $\tilde{I} \subset I$;
- (ii) for any $R > 0$, the set $\tilde{I}_R \setminus I$ is bounded;

(iii) for any $R > 0$, it holds $\kappa_*(\tilde{I}) = \kappa_*(\tilde{I}_R) = \kappa_*(I) = \kappa_*(I_R)$.

Proof. Recall the definition of κ_* in (3.1.24). We write the open set I as a union of disjoint open intervals $I = \bigcup_n J_n$. Let us fix $R > 0$. We first deal with the case where there are only finitely many J_n 's. If I is bounded, one has $\kappa_*(I) = \kappa_*(I_R) = 0$ and $\tilde{I} = \emptyset$ satisfies the conclusions of the lemma. If I is not bounded, then there is an index n_0 for which J_{n_0} is of the form $J_{n_0} = (a, +\infty)$. Then one has for any $R > 0$ the equality $\kappa_*(I) = \kappa_*(I_R) = 1$ and $\tilde{I} = J_{n_0}$ satisfies the conclusions of the lemma as well.

We now consider the case where there are infinitely many J_n 's. By assumption, one has $|J_n| \rightarrow +\infty$ as $n \rightarrow \infty$. Writing $J_n = (a_n, b_n)$, with $a_n < b_n < \infty$, we define for any index n the interval

$$\tilde{J}_n = \left(a_n + \frac{\sqrt{4 + \delta_n}}{2}, b_n - \frac{\sqrt{4 + \delta_n}}{2} \right), \quad \text{where } \delta_n = \min(a_n, b_n - a_n).$$

Since the J_n 's are disjoint and $|J_n| = b_n - a_n \rightarrow +\infty$, we also have $a_n \rightarrow +\infty$, so that $\delta_n \rightarrow +\infty$ too. Incidentally, one readily checks that $|\tilde{J}_n| \rightarrow +\infty$ as well. Thus, defining

$$\tilde{I} = \bigcup_n \tilde{J}_n,$$

we have $\tilde{I} \subset I$, namely the property (i), and given any $R > 0$, there are finitely many n 's such that $R \geq \frac{\sqrt{\delta_n}}{2}$. It implies that the thickened set \tilde{I}_R is contained in I modulo a bounded set, hence (ii). The crucial point of this construction is the claim (iii). As a consequence of the inclusions $\tilde{I} \subset \tilde{I}_R$ and $I \subset I_R$, it holds $\kappa_*(\tilde{I}) \leq \kappa_*(\tilde{I}_R)$ and $\kappa_*(I) \leq \kappa_*(I_R)$. Moreover, in virtue of (ii), we can write $\tilde{I}_R = (\tilde{I}_R \cap I) \cup A$, where $A = \tilde{I}_R \setminus I$ is bounded. Since $\frac{1}{r}|A \cap [0, r]| \leq \frac{1}{r}|A| \rightarrow 0$ as $r \rightarrow +\infty$, one can check that $\kappa_*(\tilde{I}_R) \leq \kappa_*(\tilde{I}_R \cap I) \leq \kappa_*(I)$. To sum up, we have proved so far that $\kappa_*(\tilde{I}) \leq \kappa_*(\tilde{I}_R) \leq \kappa_*(I) \leq \kappa_*(I_R)$.

Thus, in order to prove (iii), it remains to check that $\kappa_*(I_R) \leq \kappa_*(\tilde{I})$. Unless we are in the straightforward case $\kappa_*(I_R) = 0$, we pick $\kappa \in (0, \kappa_*(I_R))$, so that by definition of κ_* , it holds

$$\exists c > 0, \exists r_0 > 0 : \forall r \geq r_0, \quad \frac{1}{r}|I_R \cap [\kappa r, r]| \geq c. \quad (3.5.18)$$

In the sequel, to simplify notation, we write $J_n^R = (J_n)_R$. Up to enlarging r_0 , we can assume that for any index n such that $J_n^R \cap [\kappa r_0, +\infty) \neq \emptyset$, it holds $\delta_n \geq 5 + 8R$ (recall that $\delta_n \rightarrow +\infty$). Fix an $r \geq r_0$. Then there is a finite (possibly empty) set of indices $\{n_k\}_k$ such that $J_{n_k}^R \subset [\kappa r, r]$. Assume first that

$$\frac{1}{r} \left| \bigcup_k J_{n_k}^R \cap [\kappa r, r] \right| = \frac{1}{r} \sum_k |J_{n_k}^R| \geq \frac{c}{2}. \quad (3.5.19)$$

Then it holds

$$\begin{aligned} \frac{1}{r} |\tilde{I} \cap [\kappa r, r]| &\geq \frac{1}{r} \sum_k |\tilde{J}_{n_k}| = \frac{1}{r} \sum_k \left(|J_{n_k}^R| - \left(\sqrt{4 + \delta_{n_k}} + 2R \right) \right) \\ &\geq \frac{1}{r} \sum_k \left(1 - \frac{\sqrt{4 + \delta_{n_k}} + 2R}{\delta_{n_k} + 2R} \right) |J_{n_k}^R| \geq \frac{1}{r} \sum_k \left(1 - \sqrt{\frac{4}{\delta_n^2} + \frac{1}{\delta_{n_k}}} - \frac{2R}{\delta_n + 2R} \right) |J_{n_k}^R|. \end{aligned}$$

To obtain the second to last inequality, we used the fact that by definition of δ_n , it holds $|J_n| \geq \delta_n$, which implies in particular that $|J_n^R| \geq \delta_n + 2R$. Using in the last line that $\delta_{n_k} \geq 5 + 8R$, together with (3.5.19), we obtain

$$\frac{1}{r} |\tilde{I} \cap [\kappa r, r]| \geq \left(1 - \sqrt{\frac{9}{25}} - \frac{1}{5} \right) \frac{1}{r} \sum_k |J_{n_k}^R| \geq \frac{1}{5} \times \frac{c}{2}. \quad (3.5.20)$$

Otherwise, if now (3.5.19) is not satisfied, then recalling (3.5.18), it holds

$$\frac{1}{r} \left| \left(I_R \setminus \bigcup_k J_{n_k}^R \right) \cap [\kappa r, r] \right| \geq \frac{c}{2}.$$

Any interval $J_n^R \subset I_R \setminus \bigcup_k J_{n_k}^R$ intersecting $[\kappa r, r]$ must contain κr or r , otherwise it would satisfy $J_n^R \cap [\kappa r, r] = \emptyset$, or $J_n^R \subset (\kappa r, r)$ (the latter would imply that $n \in \{n_k\}_k$). Therefore, there are at most two such intervals. We deduce that there is an index n_* such that $J_{n_*}^R \not\subset [\kappa r, r]$ but $J_{n_*}^R \cap [\kappa r, r] \neq \emptyset$, with

$$\frac{1}{r} |J_{n_*}^R \cap [\kappa r, r]| \geq \frac{c}{4}.$$

Writing $J_{n_*}^R = (a_{n_*} - R, b_{n_*} + R)$, the fact that $J_{n_*}^R \cap [\kappa r, r] \neq \emptyset$ imposes that $a_{n_*} - R \leq r$, hence $a_{n_*} \leq r + R$. Thus we obtain

$$\begin{aligned} \frac{1}{r} |\tilde{I} \cap [\kappa r, r]| &\geq \frac{1}{r} |\tilde{J}_{n_*} \cap [\kappa r, r]| \geq \frac{1}{r} \left(|J_{n_*}^R \cap [\kappa r, r]| - \sqrt{4 + \delta_{n_*}} - 2R \right) \\ &\geq \frac{c}{4} - \frac{\sqrt{4 + r + R} + 2R}{r}. \end{aligned} \quad (3.5.21)$$

We used the fact that $\delta_{n_*} \leq a_{n_*} \leq r + R$ to obtain the last inequality. In view of the estimates (3.5.20) and (3.5.21), in any case we have

$$\frac{1}{r} |\tilde{I} \cap [\kappa r, r]| \geq \min \left(\frac{c}{10}, \frac{c}{4} - \frac{\sqrt{4 + r + R} + 2R}{r} \right).$$

We conclude that

$$\liminf_{r \rightarrow +\infty} \frac{1}{r} |\tilde{I} \cap [\kappa r, r]| > 0.$$

Recalling that κ is any arbitrary number $< \kappa_*(I_R)$, we finally get the desired converse inequality $\kappa_*(\tilde{I}) \geq \kappa_*(I_R)$. Thus (iii) is proved, which concludes the proof of the lemma. \square

In the sequel, we will proceed as follows: to prove that $\kappa_*(I) > \Lambda(\frac{\nu_2}{\nu_1})$ is a sufficient condition to have observability from $\omega(I)$, we will check that the dynamical condition (3.1.7) of Theorem 3.1.3 is true in the smaller set $\omega(\tilde{I})$, where \tilde{I} is given by Lemma 3.5.3. To show that it is also necessary, we will check that the condition (3.1.7) is violated in the larger set $\omega(I)_R = \omega(I_R)$ for any $R > 0$.

Step 2 – Geometric condition of observability for rationally dependent characteristic frequencies.

We investigate the validity of the dynamical condition (3.1.7) of Theorem 3.1.3. In the case where $\frac{\nu_2}{\nu_1} \in \mathbf{Q}$, writing $\frac{\nu_2}{\nu_1} = \frac{p}{q}$ as an irreducible fraction, the period of the Hamiltonian flow is given by $T_0 = \frac{2\pi}{\nu_2} p = \frac{2\pi}{\nu_1} q$. We write for short $\Lambda = \Lambda(\frac{\nu_2}{\nu_1})$ and $\kappa_* = \kappa_*(I)$. Our goal now is to reformulate the dynamical condition (3.1.7) using the Area formula.

Proposition 3.5.4 (Area formula [EG15, Theorem 3.9]). *Let $J \subset \mathbf{R}$ be a bounded interval and let $\gamma : J \rightarrow \mathbf{R}^n$ be a Lipschitz curve. Then γ is differentiable at Lebesgue-almost every point in J and for any Borel set $E \subset \mathbf{R}^n$, it holds*

$$\int_J \mathbf{1}_E(\gamma(t)) |\gamma'(t)| dt = \int_{\text{Im } \gamma \cap E} \#\gamma^{-1}(\{x\}) d\mathcal{H}^1(x).$$

Here, $\text{Im } \gamma = \{\gamma(t) : t \in J\} \subset \mathbf{R}^n$, $\#\gamma^{-1}(\{x\})$ stands for the cardinality of the set $\{t \in J : \gamma(t) = x\}$, and \mathcal{H}^1 is the one-dimensional Hausdorff measure.

We will apply this formula to a curve of the form $\gamma : t \mapsto |x^t| \in \mathbf{R}$ defined on $J = (0, T)$, where $t \mapsto (x^t, \xi^t)$ is a trajectory of the Hamiltonian flow. Calculations will involve the inverse Jacobian $|\gamma'(t)|^{-1}$. Using anisotropy¹¹ of the harmonic oscillator ($p \neq q$), we can check that the Jacobian vanishes only at a finite number of points.

Lemma 3.5.5. *Let $t \mapsto (x^t, \xi^t)$ be a trajectory of the Hamiltonian flow of an anisotropic harmonic oscillator, with initial datum $\rho_0 = (x_0, \xi_0)$. Then the curve $\gamma : \mathbf{R} \ni t \mapsto |x^t| \in \mathbf{R}_+$ is Lipschitz with constant $\sqrt{2p(\rho_0)}$. If $\rho_0 \neq 0$, then γ is of class C^∞ in $\mathbf{R} \setminus \{\gamma = 0\}$. Moreover, the set*

$$S_\gamma := \{t \in \mathbf{R} : \gamma(t) = 0 \quad \text{or} \quad \gamma'(t) = 0\}$$

11. In the excluded isotropic case ($p = q = 1$), one can choose (x^0, ξ^0) so that $|x^t|$ is constant, as we did in the proof of Proposition 3.1.8 (see Subsection 3.5.1). In such a situation, the set $\text{Im } \gamma \subset \mathbf{R}_+$ is reduced to a point. This is a very singular situation, since the Jacobian $|\gamma'(t)|$ is identically zero.

is locally finite, namely for any bounded interval $I \subset \mathbf{R}$, the set $S_\gamma \cap I$ is finite. In addition, for any bounded interval $I \subset \mathbf{R}$, one has

$$\exists k = k(I) \in \mathbf{N} : \forall s \in \mathbf{R}_+, \quad \#\gamma^{-1}(\{s\}) \cap I \leq k. \quad (3.5.22)$$

Proof. That γ is Lipschitz follows from the inverse triangle inequality, the Hamilton equations (3.1.6) and the fact that $p(x, \xi) = V(x) + \frac{1}{2}|\xi|^2$ is preserved by the flow:

$$|\gamma(t_2) - \gamma(t_1)| \leq |x^{t_2} - x^{t_1}| \leq |t_2 - t_1| \sup_{t \in \mathbf{R}} |\xi^t| \leq |t_2 - t_1| \sqrt{2p(\rho_0)}.$$

From now on, we assume that $\rho_0 \neq 0$. First notice that the set $\{\gamma = 0\}$ is closed since γ is continuous. Given that $t \mapsto x^t$ is smooth, the curve γ is smooth in a neighborhood of any point $t \in \mathbf{R} \setminus \{\gamma = 0\}$, so that $\gamma \in C^\infty(\mathbf{R} \setminus \{\gamma = 0\})$. To show that S_γ is locally finite, it is sufficient to prove that it is closed and also discrete, namely that it is made of isolated points.¹²

We first check that it is closed by observing that the map $f : t \mapsto \gamma^2(t) = |x^t|^2$ belongs to $C^\infty(\mathbf{R})$ and that

$$S_\gamma = \{t \in \mathbf{R} : f'(t) = 0\}. \quad (3.5.23)$$

To check this equality, we use the fact that $f'(t) = 2\gamma(t)\gamma'(t)$ for all $t \in \mathbf{R} \setminus S_\gamma$. If $t \notin S_\gamma$, then it follows that $\gamma(t)\gamma'(t) \neq 0$. Conversely, if $t \in S_\gamma$, either $\gamma(t) \neq 0$, so that $\gamma'(t) = 0$, in which case it holds $f'(t) = 2\gamma(t)\gamma'(t) = 0$; or $\gamma(t) = 0$, which implies that $x^t = 0$, hence $f'(t) = 2x^t \cdot \xi^t = 0$. This justifies (3.5.23).

Thus it remains to show that S_γ is discrete. Let us compute the derivatives of f up to order 4:

$$f'(t) = 2x^t \cdot \xi^t, \quad (3.5.24)$$

$$f^{(2)}(t) = 2|\xi^t|^2 - 2x^t \cdot Ax^t, \quad (3.5.25)$$

$$f^{(3)}(t) = -4\xi^t \cdot Ax^t - 2\xi^t \cdot Ax^t - 2x^t \cdot A\xi^t = -8\xi^t \cdot Ax^t, \quad (3.5.26)$$

$$f^{(4)}(t) = 8\left(|Ax^t|^2 - \xi^t \cdot A\xi^t\right). \quad (3.5.27)$$

Let us write the Taylor expansion of f' at order 3 near $t_0 \in \mathbf{R}$:

$$f'(t) = f'(t_0) + (t - t_0)f^{(2)}(t_0) + \frac{(t - t_0)^2}{2}f^{(3)}(t_0) + \frac{(t - t_0)^3}{6}f^{(4)}(t_0) + o((t - t_0)^3). \quad (3.5.28)$$

Suppose that $t_0 \in S_\gamma$. Then $f'(t_0) = 0$ in virtue of (3.5.23). If $f^{(2)}(t_0) \neq 0$, then (3.5.28) yields

$$|f'(t)| \geq \frac{|f^{(2)}(t_0)|}{2}|t - t_0|$$

for all t in a neighborhood U of t_0 . In particular, $S_\gamma \cap U = \{t_0\}$, meaning that t_0 is isolated. Likewise, if $f^{(2)}(t_0) = 0$ but $f^{(3)}(t_0) \neq 0$, then (3.5.28) leads to

$$|f'(t)| \geq \frac{|f^{(3)}(t_0)|}{4}|t - t_0|^2$$

in a neighborhood of t_0 , so that t_0 is isolated again.

Now, if $f^{(2)}(t_0) = f^{(3)}(t_0) = 0$, we show that necessarily $f^{(4)}(t_0) \neq 0$. In view of (3.5.24), (3.5.25), and (3.5.26), it holds

$$x^{t_0} \cdot \xi^{t_0} = 0 \quad |\xi^{t_0}|^2 = x^{t_0} \cdot Ax^{t_0}, \quad \text{and} \quad \xi^{t_0} \cdot Ax^{t_0} = 0. \quad (3.5.29)$$

The first and third equalities mean that $\xi^{t_0} \perp x^{t_0}$ and $\xi^{t_0} \perp Ax^{t_0}$. Moreover, the second equality ensures that $x^{t_0} \neq 0$ and $\xi^{t_0} \neq 0$, otherwise $(x^{t_0}, \xi^{t_0}) = (0, 0)$, hence $\rho_0 = 0$. Since we are in two dimensions, we deduce that Ax^{t_0} and x^{t_0} are parallel, and therefore x^{t_0} is an eigenvector of A . Since $\xi^{t_0} \perp x^{t_0}$ and $\xi^{t_0} \neq 0$, we deduce that ξ^{t_0} is also an eigenvector, associated with a different eigenvalue

¹² If $S \subset \mathbf{R}$ is closed and discrete, then for any compact interval $I \subset \mathbf{R}$, the set $S \cap I$ is compact. Since S is discrete, the set $S \cap I$ can be covered by open sets containing at most one element of S . Then, extracting a finite subcovering shows that $S \cap I$ is finite.

since A has two distinct eigenvalues by assumption. We relabel ν_1 and ν_2 so that $Ax^{t_0} = \nu_x^2 x^{t_0}$ and $A\xi^{t_0} = \nu_\xi^2 \xi^{t_0}$. Plugging this into the second equality in (3.5.29) yields $|\xi^{t_0}|^2 = \nu_x^2 |x^{t_0}|^2$, from which we deduce that the fourth derivative (3.5.27) cannot vanish at t_0 , given that the oscillator is anisotropic ($\nu_x \neq \nu_\xi$):

$$|Ax^{t_0}|^2 - \xi^{t_0} \cdot A\xi^{t_0} = \nu_x^4 |x^{t_0}|^2 - \nu_\xi^2 |\xi^{t_0}|^2 = \nu_x^2 (\nu_x^2 - \nu_\xi^2) |x^{t_0}|^2 \neq 0.$$

Therefore (3.5.28) implies that

$$|f'(t)| \geq \frac{|f^{(4)}(t_0)|}{12} |t - t_0|^3$$

in a neighborhood of t_0 , that is to say the critical point t_0 is again isolated. To sum up, the above argument shows that there exists a neighborhood U of t_0 such that $U \cap S_\gamma = \{t_0\}$, so S_γ is indeed a discrete set.

Now fix $I \subset \mathbf{R}$ a bounded interval. We have just shown that $n = \#(S_\gamma \cap I)$ is finite. To prove (3.5.22), we observe that the complement of S_γ in I is a union of at most $n + 1$ open intervals in I , on which γ' does not vanish and has constant sign (use the intermediate value theorem). Therefore γ is one-to-one in each of these intervals. We infer that

$$\forall s \in \mathbf{R}, \quad \#\{t \in I : \gamma(t) = s\} \leq n + 1 + \#(S_\gamma \cap I) = 2n + 1.$$

This completes the proof of the lemma. \square

Let us assume that $\kappa_* \leq \Lambda$ and fix $R > 0$. Recalling that $\kappa_* = \kappa_*(I) = \kappa_*(I_R)$ from (iii) in Lemma 3.5.3, we know that there exists a sequence $(r_n)_{n \in \mathbf{N}}$ tending to $+\infty$ along which

$$\frac{1}{r_n} |I_R \cap [\kappa_* r_n, r_n]| \xrightarrow{n \rightarrow \infty} 0. \quad (3.5.30)$$

According to Step II of Subsection 3.5.2, considering actions $(A_1, A_2) = (\sqrt{1 - \lambda_0}, \sqrt{\lambda_0}) = (\sqrt{\frac{p}{p+q}}, \sqrt{\frac{q}{p+q}})$ and initial angles $(\theta_1, \theta_2) = (\frac{\pi}{2p}, 0)$, one obtains a trajectory of the Hamiltonian flow $t \mapsto (x^t, \xi^t)$ such that

$$\min_{t \in [0, T]} |x^t| = \Lambda \max_{t \in [0, T]} |x^t|, \quad (3.5.31)$$

that is to say a trajectory that attains the supremum (3.5.5). Here T is any real number larger than the period of the flow T_0 . In view of the homogeneity of degree 1 of the Hamiltonian flow, we know that $t \mapsto (cx^t, c\xi^t)$ is still a trajectory of the Hamiltonian flow, for any scalar $c \in \mathbf{R}$. Note that (3.5.31) above ensures that $|x^t|$ is bounded from below by a positive constant for all times. Therefore, Lemma 3.5.5 implies that the curve $\gamma : (0, T) \ni t \mapsto |x^t|$ is smooth. The corresponding set S_γ of Lemma 3.5.5 is nothing but $S_\gamma = \{\gamma' \neq 0\}$. A consequence of this lemma is that S_γ has vanishing measure. Thus we write

$$(0, T) \setminus S_\gamma = \bigcup_{N \in \mathbf{N}} B_N \quad \text{where} \quad B_N = \{t \in (0, T) : |\gamma'(t)| \geq 2^{-N}\}. \quad (3.5.32)$$

Fix an arbitrary $N \in \mathbf{N}$ and a scalar $c > 0$. Then we obtain

$$\begin{aligned} \int_{B_N} \mathbf{1}_{I_R}(c|x^t|) dt &\leq \frac{2^N}{c} \int_{B_N} \mathbf{1}_{I_R}(c\gamma(t)) |c\gamma'(t)| dt = \frac{2^N}{c} \int_{c\gamma(B_N)} \mathbf{1}_{I_R}(s) \#\left\{t \in (0, T) : \gamma(t) = \frac{s}{c}\right\} ds \\ &\leq \frac{2^N k}{c} \int_{c\gamma(B_N)} \mathbf{1}_{I_R}(s) ds \leq \frac{2^N k}{c} \int_{c\Lambda \max \gamma}^{c \max \gamma} \mathbf{1}_{I_R}(s) ds, \end{aligned} \quad (3.5.33)$$

where the equality results from the Area formula (Proposition 3.5.4) applied to $E = I_R$. The integer k is the one from Lemma 3.5.5 (3.5.22). The last inequality follows from the fact that $|x^t|$ spans the interval $[\Lambda \max \gamma, \max \gamma]$ by construction (recall (3.5.31)). Thus taking $c = c_n = r_n / \max \gamma$, with $(r_n)_{n \in \mathbf{N}}$ the sequence from (3.5.30), we obtain

$$\int_{B_N} \mathbf{1}_{I_R}(c_n \gamma(t)) dt \leq 2^N k (\max \gamma) \times \frac{1}{r_n} |I_R \cap [\Lambda r_n, r_n]| \xrightarrow{n \rightarrow \infty} 0,$$

by (3.5.30), since $\Lambda \geq \kappa_*$. Now going back to (3.5.32), since the set S_γ is negligible, monotone convergence ensures that $|B_N| \rightarrow T$ as $N \rightarrow \infty$. We finally obtain that

$$\int_0^T \mathbb{1}_{\omega(I_R)}(c_n x^t) dt \leq |(0, T) \setminus B_N| + \int_{B_N} \mathbb{1}_{I_R}(c_n |x^t|) dt = T - |B_N| + o(1)$$

as $n \rightarrow \infty$. We let $N \rightarrow \infty$ to conclude that the dynamical condition (3.1.7) is not fulfilled, namely

$$\liminf_{\rho \rightarrow \infty} \int_0^T \mathbb{1}_{\omega(I) \times \mathbf{R}^d}(\phi^t(\rho)) dt = 0.$$

The parameter $R > 0$ is arbitrary. Therefore the necessary condition of Theorem 3.1.3 tells us that observability from $\omega(I)$ in time T does not hold, and $T \geq T_0$ itself is arbitrary.

We turn to the case where $\kappa_* > \Lambda$. This time, we take $T = T_0$ to be the period of the Hamiltonian flow and check that the observability condition (3.1.7) holds in $\omega(\tilde{I})$. We pick $\kappa \in (\Lambda, \kappa_*)$. In virtue of Lemma 3.5.3 (iii), we have $\kappa_* = \kappa_*(I) = \kappa_*(\tilde{I})$ so that

$$\exists c > 0, \exists r_0 > 0 : \forall r \geq r_0, \quad \frac{1}{r} |\tilde{I} \cap [\kappa r, r]| \geq c. \quad (3.5.34)$$

Let (x^t, ξ^t) be a trajectory of the Hamiltonian flow with initial datum ρ_0 . One can estimate $\tilde{r} = \max |x^t|$ from below as follows: since the time t_0 at which the maximum is reached is also a (local) maximum of $|x^t|^2$, the second derivative satisfies:

$$\frac{d^2}{dt^2} |x^t|^2 |_{t=t_0} = 2|\xi^{t_0}|^2 - 2x^{t_0} \cdot Ax^{t_0} \leq 0.$$

Thus it holds

$$\tilde{r}^2 := |x^{t_0}|^2 \geq x^{t_0} \cdot \frac{A}{\|A\|} x^{t_0} \geq \frac{1}{\|A\|} \left(\frac{1}{2} x^{t_0} \cdot Ax^{t_0} + \frac{1}{2} |\xi^{t_0}|^2 \right) = \frac{1}{\|A\|} p(\rho_0). \quad (3.5.35)$$

Provided $|\rho_0|$ is large enough so that $p(\rho_0) \geq \|A\| r_0^2$, we see in particular that $\tilde{r} \geq r_0$. Introduce $\gamma : (0, T) \ni t \mapsto |x^t|$. We know from Lemma 3.5.5 that γ is Lipschitz with constant $\sqrt{2p(\rho_0)} \leq \sqrt{2\|A\|} \tilde{r}$ (this inequality is a consequence of (3.5.35) above). In particular, we have $|\gamma'(t)| \leq \sqrt{2\|A\|} \tilde{r}$ outside the set S_γ from Lemma 3.5.5. Thus we can apply again the Area formula (Proposition 3.5.4):

$$\begin{aligned} \int_0^T \mathbb{1}_{\omega(\tilde{I})}(x^t) dt &= \int_0^T \mathbb{1}_{\tilde{I}}(|x^t|) dt \geq (2\|A\|)^{-1/2} \frac{1}{\tilde{r}} \int_0^T \mathbb{1}_{\tilde{I}}(\gamma(t)) |\gamma'(t)| dt \\ &= (2\|A\|)^{-1/2} \frac{1}{\tilde{r}} \int_{\gamma((0, T))} \mathbb{1}_{\tilde{I}}(s) \# \{t \in (0, T) : \gamma(t) = s\} ds \\ &\geq (2\|A\|)^{-1/2} \frac{1}{\tilde{r}} \int_{\gamma((0, T))} \mathbb{1}_{\tilde{I}}(s) ds. \end{aligned} \quad (3.5.36)$$

This time, one has $\gamma((0, T)) \supset [\Lambda \tilde{r}, \tilde{r}] \supset [\kappa \tilde{r}, \tilde{r}]$ (by definition of Λ , see (3.5.5)). This means that

$$\int_0^T \mathbb{1}_{\omega(\tilde{I})}(x^t) dt \geq (2\|A\|)^{-1/2} \frac{1}{\tilde{r}} \int_{\kappa \tilde{r}}^{\tilde{r}} \mathbb{1}_{\tilde{I}}(s) ds \geq (2\|A\|)^{-1/2} c, \quad (3.5.37)$$

where the last inequality is due to (3.5.34) (recall that $\tilde{r} \geq r_0$). Therefore the dynamical condition (3.1.7) of Theorem 3.1.3 is satisfied. In fact, the explicit expression of the Hamiltonian flow in action-angle coordinates (3.5.6) shows that $|x^t|^2$ is $\frac{T_0}{2}$ -periodic.¹³ Therefore, setting $\tilde{c} := (2\|A\|)^{-1/2} c$, the dynamical condition (3.1.7) is equivalently satisfied in time $\frac{T_0}{2} - \frac{\tilde{c}}{4}$:

$$\int_0^{\frac{T_0}{2} - \frac{\tilde{c}}{4}} \mathbb{1}_{\omega(\tilde{I})}(x^t) dt \geq \frac{1}{2} \int_0^{T_0} \mathbb{1}_{\omega(\tilde{I})}(x^t) dt - \frac{\tilde{c}}{4} \geq (2\|A\|)^{-1/2} \frac{c}{4}.$$

By Theorem 3.1.3, this implies that observability holds from $\omega(\tilde{I})_R \setminus K$ for some $R > 0$ and any compact set $K \subset \mathbf{R}^d$ in any time $> \frac{T_0}{2} - \frac{\tilde{c}}{4}$, which in turn implies observability from $\omega(I)$ in virtue of Lemma 3.5.3 (ii). Incidentally, the optimal observation time is strictly smaller than $T_0/2$.

¹³ One can check that the projected trajectories of rational harmonic oscillators are invariant by point reflection with respect to the origin or axial symmetry with respect to some coordinate axis, depending on whether p and q have the same parity or not.

Step 3 – Diophantine approximation in the irrational case.

We assume that $\frac{\nu_2}{\nu_1} \in \mathbf{R} \setminus \mathbf{Q}$ and denote by $\frac{p_j}{q_j}$ the reduced fraction expression of its convergents (see Remark 3.1.13). We investigate the validity of the dynamical condition (3.1.7) by approximating the trajectories of the “irrational” Hamiltonian flow by the trajectories of the “rational” Hamiltonian flow obtained by replacing $\frac{\nu_2}{\nu_1}$ with its convergent $\frac{p_j}{q_j}$. For instance, a projected trajectory of the irrational harmonic oscillator of the form

$$x_1^t = A_1 \sin(\nu_1 t + \theta_1), \quad x_2^t = A_2 \sin(\nu_2 t + \theta_2), \quad (3.5.38)$$

should be compared to

$$x_{j,1}^t = A_1 \sin(\nu_1 t + \theta_1), \quad x_{j,2}^t = A_2 \sin\left(\frac{p_j}{q_j} \nu_1 t + \theta_2\right), \quad (3.5.39)$$

which is a trajectory of the Hamiltonian flow of the (rational) harmonic oscillator with characteristic frequencies ν_1 and $\frac{p_j}{q_j} \nu_1$, whose classical Hamiltonian is:

$$p_j(x, \xi) = \frac{1}{2} \left(\nu_1^2 x_1^2 + \frac{p_j^2}{q_j^2} \nu_1^2 x_2^2 \right) + \frac{1}{2} (\xi_1^2 + \xi_2^2).$$

The distance between these two trajectories is

$$|x^t - x_j^t| = |x_2^t - x_{j,2}^t| \leq A_2 \left| \nu_2 - \frac{p_j}{q_j} \nu_1 \right| |t| \leq A_2 \frac{\nu_1 |t|}{q_j^2}, \quad (3.5.40)$$

owing to the fact that the sine function is 1-Lipschitz and to the Diophantine approximation result (3.1.30). We already know from Lemma 3.1.11 that

$$\min_{t \in [0, T_j]} |x_j^t| \leq \Lambda_j \max_{t \in [0, T_j]} |x_j^t|, \quad \text{where } T_j = \frac{2\pi}{\nu_1} q_j, \quad \Lambda_j = \Lambda\left(\frac{p_j}{q_j}\right).$$

The time T_j is the period of the flow of the rational harmonic oscillator with characteristic frequencies ν_1 and $\frac{p_j}{q_j} \nu_1$. Let us set

$$m_j = \min_{t \in \mathbf{R}} |x_j^t| \quad \text{and} \quad M_j = \max_{t \in \mathbf{R}} |x_j^t|. \quad (3.5.41)$$

Although the trajectory $t \mapsto x_j^t$ is T_j -periodic, it will be convenient to compare x_j^t and x^t on smaller times. Then in view of (3.5.40), on the time interval $[0, \eta T_j]$, where $\eta \in (0, 1]$, the norm $|x^t|$ spans an interval J_j^η such that

$$J_j^\eta \subset \left[m_j - A_2 \eta \frac{2\pi}{q_j}, M_j + A_2 \eta \frac{2\pi}{q_j} \right], \quad (3.5.42)$$

and if $\eta = 1$, since $|x_j^t|$ attains m_j and M_j on the time interval $[0, T_j]$, it holds

$$\left[m_j + A_2 \frac{2\pi}{q_j}, M_j - A_2 \frac{2\pi}{q_j} \right] \subset J_j^1. \quad (3.5.43)$$

So now, according to the value of κ_* , we check whether the dynamical condition (3.1.7) of Theorem 3.1.3 is satisfied, using the Area formula.

Step 4 – Geometric condition of observability for rationally independent characteristic frequencies.

Take $\eta = 1$, that is we consider a whole period of the rational Hamiltonian flow. We first establish a lower bound on the time spent by $t \mapsto x^t$ in $\omega(\tilde{I})$. We consider $\kappa_* > 0$ here. From Lemma 3.5.5, we know that $\gamma : (0, T_j) \ni t \mapsto |x^t|$ is Lipschitz with constant $\sqrt{2p(\rho_0)}$. Yet, similarly to (3.5.35), it holds

$$p(\rho_0) \leq \|A\| \tilde{M}_j^2, \quad \text{where } \tilde{M}_j = \max_{t \in [0, T_j]} |x^t|,$$

so that γ is Lipschitz with constant $\sqrt{2\|A\|}\tilde{M}_j$. Applying the Area formula (Proposition 3.5.4), we obtain as in (3.5.36) the lower bound:

$$\int_0^{T_j} \mathbb{1}_{\omega(\tilde{I})}(x^t) dt \geq (2\|A\|)^{-1/2} \frac{1}{\tilde{M}_j} \int_{J_j^1} \mathbb{1}_{\tilde{I}}(s) ds,$$

and in view of (3.5.43) and (3.5.42) with $\eta = 1$, we deduce that

$$\int_0^{T_j} \mathbb{1}_{\omega(\tilde{I})}(x^t) dt \geq \frac{(2\|A\|)^{-1/2}}{M_j + A_2 \frac{2\pi}{q_j}} \int_{m_j + A_2 \frac{2\pi}{q_j}}^{M_j - A_2 \frac{2\pi}{q_j}} \mathbb{1}_{\tilde{I}}(s) ds.$$

Observing that $A_2 \leq M_j$ and that $m_j \leq \Lambda_j M_j$, we obtain

$$\int_0^{T_j} \mathbb{1}_{\omega(\tilde{I})}(x^t) dt \geq \frac{(2\|A\|)^{-1/2}}{M_j(1 + \frac{2\pi}{q_j})} \int_{M_j(\Lambda_j + \frac{2\pi}{q_j})}^{M_j(1 - \frac{2\pi}{q_j})} \mathbb{1}_{\tilde{I}}(s) ds. \quad (3.5.44)$$

Setting

$$r = M_j \left(1 - \frac{2\pi}{q_j}\right) \quad \text{and} \quad \tilde{\Lambda}_j = \frac{\Lambda_j + \frac{2\pi}{q_j}}{1 - \frac{2\pi}{q_j}}, \quad (3.5.45)$$

we can write the lower bound in (3.5.44) under the form

$$\int_0^{T_j} \mathbb{1}_{\omega(\tilde{I})}(x^t) dt \geq (2\|A\|)^{-1/2} \frac{1 - \frac{2\pi}{q_j}}{1 + \frac{2\pi}{q_j}} \times \frac{1}{r} \int_{\tilde{\Lambda}_j r}^r \mathbb{1}_{\tilde{I}}(s) ds. \quad (3.5.46)$$

We assume that $q_j > 2\pi$ so that $r > 0$, which is the case for j large enough since $q_j \rightarrow \infty$. The above estimate (3.5.46) is valid for any trajectory of the (irrational) Hamiltonian flow with initial datum $\rho_0 \neq 0$. In addition, we remark that M_j defined in (3.5.41) tends to infinity as $\rho_0 \rightarrow \infty$, so that r defined in (3.5.45) tends to $+\infty$ as $\rho_0 \rightarrow \infty$ too. Thus (3.5.46) leads to

$$\liminf_{\rho \rightarrow \infty} \int_0^{T_j} \mathbb{1}_{\omega(\tilde{I}) \times \mathbf{R}^d}(\phi^t(\rho)) dt \geq (2\|A\|)^{-1/2} \frac{1 - \frac{2\pi}{q_j}}{1 + \frac{2\pi}{q_j}} \times \liminf_{r \rightarrow +\infty} \frac{1}{r} |\tilde{I} \cap [\tilde{\Lambda}_j r, r]|. \quad (3.5.47)$$

In order to deduce a positive lower bound, it suffices that $\tilde{\Lambda}_j < \kappa_* = \kappa_*(\tilde{I}) = \kappa_*(I)$. This is achieved provided $q_j \geq 6\pi/\kappa_* \geq 6\pi$. Indeed, under this condition, we have on the one hand

$$\frac{1 - \frac{2\pi}{q_j}}{1 + \frac{2\pi}{q_j}} \geq \frac{1 - \frac{2\pi}{6\pi}}{1 + \frac{2\pi}{6\pi}} = \frac{1}{2}, \quad (3.5.48)$$

and on the other hand, recalling the definition of $\tilde{\Lambda}_j$ in (3.5.45), the formula (3.1.25) for Λ_j given by Lemma 3.1.11, and using that $\sin x \leq x$ and $\tan x \leq \frac{4}{\pi}x$ for $x \in [0, \frac{\pi}{4}]$, we obtain

$$\tilde{\Lambda}_j \leq \frac{\frac{4}{\pi} \times \frac{\pi/2}{p_j + q_j} + \frac{2\pi}{q_j}}{1 - \frac{2\pi}{6\pi}} \leq 3 \frac{1 + \pi}{q_j} \leq \frac{1}{2} \left(\frac{1}{\pi} + 1 \right) \kappa_* < \kappa_*. \quad (3.5.49)$$

Now we turn to the upper bound on the time spent by projected trajectories of the (irrational) Hamiltonian flow in $\omega(I)_R$, for a fixed $R > 0$. We consider $\kappa_* \in [0, 1]$ arbitrary now, with the convention $1/\kappa_* = +\infty$ if $\kappa_* = 0$. We go back to $\eta \in (0, 1]$. We select a curve $t \mapsto (x_j^t, \xi_j^t)$ of the rational flow that maximizes the ratio $\min_t |x_j^t| / \max_t |x_j^t|$, namely that satisfies

$$m_j = \min_{t \in [0, T_j]} |x_j^t| = \Lambda_j \max_{t \in [0, T_j]} |x_j^t| = \Lambda_j M_j.$$

This curve is of the form (3.5.39) for well-chosen action and angle variables. We consider $t \mapsto (x^t, \xi^t)$ the corresponding trajectory of the irrational flow given by (3.5.38), that is the integral curve obtained by substituting ν_2 for $\frac{p_j}{q_j} \nu_1$ in (3.5.39). Notice that this trajectory depends on j . We still

write $\gamma(t) = |x^t|$. By Lemma 3.5.5, we know that it is a Lipschitz map and that there exists an integer k_0 such that $\#\gamma^{-1}(s) \cap [0, T_j] \leq k_0$ for all $s \in \mathbf{R}_+$. Reproducing the computation (3.5.33), we find:

$$\int_{B_N} \mathbb{1}_{I_R}(c|x^t|) dt \leq \frac{2^N k_0}{c} \int_{c\Lambda_j \max \gamma}^{c \max \gamma} \mathbb{1}_{I_R}(s) ds \leq \frac{2^N k_0}{c} \int_{cJ_j^\eta} \mathbb{1}_{I_R}(s) ds,$$

where we recall that the parameter $c > 0$ is an arbitrary scaling factor, and B_N is defined similarly to (3.5.32) by

$$B_N = \{t \in [0, \eta T_j] : |\gamma'(t)| \geq 2^{-N}\}.$$

In view of (3.5.42), this leads to

$$\int_{B_N} \mathbb{1}_{I_R}(c|x^t|) dt \leq \frac{2^N k_0}{c} \int_{c(m_j - A_2 \eta \frac{2\pi}{q_j})}^{c(M_j + A_2 \eta \frac{2\pi}{q_j})} \mathbb{1}_{I_R}(s) ds.$$

As we did before in (3.5.44), we use the fact that $A_2 \leq M_j$, together with $m_j = \Lambda_j M_j$ (the equality is important here) to obtain

$$\int_{B_N} \mathbb{1}_{I_R}(c|x^t|) dt \leq \frac{2^N k_0}{c} \int_{cM_j(\Lambda_j - \eta \frac{2\pi}{q_j})}^{cM_j(1 + \eta \frac{2\pi}{q_j})} \mathbb{1}_{I_R}(s) ds.$$

Defining now

$$r = M_j \left(1 + \eta \frac{2\pi}{q_j}\right) \quad \text{and} \quad \tilde{\Lambda}_j = \frac{\Lambda_j - \eta \frac{2\pi}{q_j}}{1 + \eta \frac{2\pi}{q_j}},$$

we end up with

$$\int_{B_N} \mathbb{1}_{I_R}(c|x^t|) dt \leq 2^N k_0 M_j \left(1 + \eta \frac{2\pi}{q_j}\right) \frac{1}{cr} \int_{\tilde{\Lambda}_j cr}^{cr} \mathbb{1}_{I_R}(s) ds.$$

We finally prove that this upper bound tends to zero along a well-chosen sequence of parameters c provided $\tilde{\Lambda}_j \geq \kappa_*$. This is fulfilled whenever $q_j \leq \delta/\kappa_*$, for a small enough constant δ . To see this, we can use that $\tan x \geq x$ and $\sin x \geq \frac{2}{\pi}x$ on $[0, \frac{\pi}{2}]$ to control Λ_j from below by $\frac{1}{p_j + q_j}$. Then (3.1.30) leads to $\frac{p_j}{q_j} \leq \frac{\nu_2}{\nu_1} + 1$, which yields

$$\Lambda_j \geq \frac{1}{p_j + q_j} \geq \frac{1}{q_j(2 + \frac{\nu_2}{\nu_1})} =: \frac{C}{q_j}.$$

Assuming that $\eta < \frac{C}{2\pi} \leq 1$, we obtain

$$\tilde{\Lambda}_j \geq \frac{C - 2\pi\eta}{q_j} \geq \frac{1}{q_j} \times \frac{C - 2\pi\eta}{1 + 2\pi\eta} \geq \frac{C - 2\pi\eta}{\delta(1 + 2\pi\eta)} \kappa_*.$$

This yields $\tilde{\Lambda}_j \geq \kappa_*$ if δ is small enough, so that by definition of κ_* , letting $c \rightarrow +\infty$, we obtain

$$\begin{aligned} \liminf_{c \rightarrow +\infty} \int_0^{\eta T_j} \mathbb{1}_{\omega(I_R)}(cx^t) dt &\leq |[0, \eta T_j] \setminus B_N| + 2^N k_0 M_j \left(1 + \eta \frac{2\pi}{q_j}\right) \liminf_{c \rightarrow +\infty} \frac{1}{cr} \int_{\tilde{\Lambda}_j cr}^{cr} \mathbb{1}_{I_R}(s) ds \\ &= \eta T_j - |B_N|, \end{aligned} \quad (3.5.50)$$

which tends to zero as $N \rightarrow \infty$.

The general conclusion is the following: if $\kappa_* > 0$ and $j \in \mathbf{N}$ is such that $q_j \geq \frac{6\pi}{\kappa_*}$, we know by (3.5.49) that $\tilde{\Lambda}_j < \kappa_*$, so that by definition of κ_* , the estimate (3.5.47), together with (3.5.48), proves that the dynamical condition (3.1.7) of Theorem 3.1.3 holds for $\omega(\tilde{I})$ in time $T_j = \frac{2\pi}{\nu_1} q_j$. If on the contrary $\kappa_* \in [0, 1]$ and it holds $q_j \leq \frac{\delta}{\kappa_*}$ for some $\delta > 0$ depending only on $\frac{\nu_2}{\nu_1}$, then from (3.5.50), the dynamical condition (3.1.7) is violated in $\omega(I)_R$ for any $R > 0$ on the time interval $[0, \eta T_j]$, where $\eta > 0$ depends only on $\frac{\nu_2}{\nu_1}$ again. Theorem 3.1.3 then implies that the Schrödinger equation is observable from $\omega(I)$ if and only if $\kappa_* > 0$. If indeed $\kappa_* > 0$, then the

optimal observation time $T_\star = T_\star(\omega(I))$ is controlled as follows: there exist constants $C, c > 0$ such that

$$cq_{j_1} \leq T_\star \leq Cq_{j_2}, \tag{3.5.51}$$

where j_1 is the largest index such that $q_j \leq \frac{\delta}{\kappa_\star}$ and j_2 is the smallest index such that $q_j \geq \frac{6\pi}{\kappa_\star}$.

To go from (3.5.51) to the desired estimate (3.1.28) in the case where $\frac{\nu_2}{\nu_1}$ is Diophantine, we use the fact that the irrationality exponent τ , defined in (3.1.26), is related to the growth of the q_j 's. This comes from the formula

$$\tau(\mu) = 1 + \limsup_{j \rightarrow \infty} \frac{\log q_{j+1}}{\log q_j}$$

(see [Dur, Proposition 1.8] or [Son04, Theorem 1]). When τ is finite, we deduce in particular that for any $\varepsilon > 0$, we have for any j large enough

$$\frac{\log q_{j+1}}{\log q_j} \leq \tau - 1 + \varepsilon,$$

which leads to the existence of a constant $C_\varepsilon > 0$ such that

$$q_{j+1} \leq C_\varepsilon q_j^{\tau-1+\varepsilon}, \quad \forall j \in \mathbf{N}.$$

We obtain by definition of the indices j_1 and j_2 :

$$\frac{\delta}{\kappa_\star} \leq q_{j_1+1} \leq C_\varepsilon q_{j_1}^{\tau-1+\varepsilon} \quad \text{and} \quad q_{j_2} \leq C_\varepsilon q_{j_2-1}^{\tau-1+\varepsilon} \leq C_\varepsilon \left(\frac{6\pi}{\kappa_\star}\right)^{\tau-1+\varepsilon}.$$

Plugging this into (3.5.51), we finally deduce (3.1.28). This concludes the proof of Proposition 3.1.10. \square

3.A. Reduction to a weaker observability inequality

The following proposition shows that $\text{Obs}(\omega, T)$ is equivalent to a similar inequality with a remainder involving a compact operator. The argument goes back to Bardos, Lebeau and Rauch [BLR92]. This reformulation of the problem paves the way for the use of microlocal analysis: we are interested in the propagation of high-energy modes through the Schrödinger evolution, discarding anything that is microlocalized near a fixed energy sub-level $\{p \leq \text{cst}\}$. An alternative route could be to slice the phase space according to energy layers of the Hamiltonian $p(x, \xi) = V(x) + \frac{1}{2}|\xi|^2$; see [Leb92b, BZ12, AM14].

Proposition 3.A.1. *Suppose P is a self-adjoint operator with compact resolvent, and let B be a bounded operator on $L^2(\mathbf{R}^d)$ satisfying the unique continuation property:*

$$\text{for any eigenfunction } u \text{ of } P, \quad Bu = 0 \implies u = 0. \tag{3.A.1}$$

Let $T_0 > 0$ and assume there exists a compact self-adjoint operator K such that

$$\exists C_0 > 0 : \forall u \in L^2(\mathbf{R}^d), \quad \|u\|_{L^2}^2 \leq C_0 \int_0^{T_0} \|Be^{-itP}u\|_{L^2}^2 dt + (u, Ku)_{L^2}. \tag{3.A.2}$$

Then for every $T > T_0$, there exists $C > 0$ such that

$$\forall u \in L^2(\mathbf{R}^d), \quad \|u\|_{L^2}^2 \leq C \int_0^T \|Be^{-itP}u\|_{L^2}^2 dt.$$

Remark 3.A.2. The operators of the form $P = V(x) - \frac{1}{2}\Delta$ that we consider, with V subject to Assumption 3.1.1, satisfy the unique continuation property of the statement when B is the multiplication by the indicator function of a non-empty open set. See [LRLR22a, Theorem 5.2].

Proof. Let us introduce for any $S \in \mathbf{R}$:

$$A_S = \int_0^S e^{itP} B^* B e^{-itP} dt,$$

and denote by \mathcal{I}_S its kernel (the space of so-called invisible solutions). One can check that

$$\mathcal{I}_S = \bigcap_{t \in [0, S]} \ker B e^{-itP} = \{u \in L^2(\mathbf{R}^d) : \forall t \in [0, S], B e^{-itP} u = 0\},$$

using the fact that $e^{itP} B^* B e^{-itP} \geq 0$ for all $t \in \mathbf{R}$ as operators, and that the map $t \mapsto B e^{-itP}$ is strongly continuous. The space \mathcal{I}_S is a closed linear subspace of $L^2(\mathbf{R}^d)$, both for the strong and the weak topology (use for instance that A_S is a bounded operator). Moreover, one has the property that $S_1 \leq S_2$ yields $\mathcal{I}_{S_1} \supset \mathcal{I}_{S_2}$. It implies that for any S , the set

$$\mathcal{I}_S^- = \bigcup_{S' > S} \mathcal{I}_{S'}$$

is also a linear subspace, contained in \mathcal{I}_S .

Step 1 – \mathcal{I}_{T_0} is finite-dimensional. This assertion is a consequence of the fact that K is coercive on \mathcal{I}_{T_0} , namely

$$\forall u \in \mathcal{I}_{T_0}, \quad \|u\|_{L^2} \leq \|Ku\|_{L^2},$$

It follows directly from the assumption (3.A.2) and the Cauchy-Schwarz inequality. Setting $W = \text{Ran } K|_{\mathcal{I}_{T_0}}$, we deduce that $K : \mathcal{I}_{T_0} \rightarrow W$ is one-to-one and its inverse K^{-1} is bounded as an operator in $\mathcal{L}(W, \mathcal{I}_{T_0})$. Now denote by $\bar{B}_{\mathcal{I}_{T_0}}$ the closed unit ball of \mathcal{I}_{T_0} . Since \mathcal{I}_{T_0} is strongly and weakly closed, the same holds for its closed unit ball as a subset of $L^2(\mathbf{R}^d)$. We deduce that $\bar{B}_{\mathcal{I}_{T_0}}$ is weakly compact. The compactness of K implies that $K(\bar{B}_{\mathcal{I}_{T_0}})$ is (strongly) compact in $L^2(\mathbf{R}^d)$. Since it is contained in W , it is compact in W . Therefore the fact that $K^{-1} : W \rightarrow \mathcal{I}_{T_0}$ is bounded implies that $\bar{B}_{\mathcal{I}_{T_0}} = K^{-1}(K(\bar{B}_{\mathcal{I}_{T_0}}))$ is compact. We deduce by the Riesz's Theorem that \mathcal{I}_{T_0} is finite-dimensional.

Step 2 – $\mathcal{I}_{T_0}^-$ is stable by P . Let us check that $\mathcal{I}_{T_0}^- \subset \text{dom } P$. Let $u \in \mathcal{I}_{T_0}^-$ and set

$$u_\epsilon = \frac{e^{-i\epsilon P} u - u}{\epsilon}, \quad \forall \epsilon \neq 0.$$

By definition of $\mathcal{I}_{T_0}^-$, the function u belongs to $\mathcal{I}_{T_0 + \epsilon_0}$ for some $\epsilon_0 > 0$, so that $u_\epsilon \in \mathcal{I}_{T_0}^-$ for any $\epsilon \in (0, \epsilon_0)$. Recall from the previous step that $\mathcal{I}_{T_0} \supset \mathcal{I}_{T_0}^-$ is finite dimensional. We observe that $v \mapsto \|(P - i)^{-1} v\|_{L^2}$ is a norm on \mathcal{I}_{T_0} , so it is equivalent to the L^2 norm. Yet we see that

$$(P - i)^{-1} u_\epsilon = \frac{e^{-i\epsilon P} (P - i)^{-1} u - (P - i)^{-1} u}{\epsilon},$$

with $(P - i)^{-1} u \in \text{dom } P$, so that $(P - i)^{-1} u_\epsilon$ converges as $\epsilon \rightarrow 0$ to some $v \in \text{dom } P$. Therefore we conclude that

$$\|u_\epsilon - (P - i)v\|_{L^2} \leq C \|(P - i)^{-1} u_\epsilon - v\|_{L^2} \xrightarrow{\epsilon \rightarrow 0} 0.$$

The fact that u_ϵ converges shows that $u \in \text{dom } P$, hence $\mathcal{I}_{T_0}^- \subset \text{dom } P$. It remains to see that $\lim_{\epsilon \rightarrow 0} u_\epsilon = -iPu$ belongs to $\mathcal{I}_{T_0}^-$, which is a consequence of the fact that $\mathcal{I}_{T_0}^-$ is finite-dimensional, hence closed.

Step 3 – $\mathcal{I}_{T_0}^- = \{0\}$. This results from the unique continuation property (3.A.1). Indeed, we can argue as follows: from the previous steps, $\mathcal{I}_{T_0}^-$ is a finite-dimensional linear subspace of $L^2(\mathbf{R}^d)$ which is stable by the self-adjoint operator P . Therefore there exists a basis (u_1, u_2, \dots, u_n) of $\mathcal{I}_{T_0}^-$ made of eigenvectors of P . By definition of \mathcal{I}_S , these eigenvectors satisfy in particular $Bu_j = 0$. So by the unique continuation result (3.A.1), we find that $\mathcal{I}_{T_0}^-$ must be trivial.

Step 4 – Conclusion. Let $T > T_0$. We want to show that $A_T \geq c$ for some $c > 0$. To do this, it suffices to prove that A_T is invertible, because A_T is self-adjoint and $A_T \geq 0$. The

assumption (3.A.2) implies that the self-adjoint operator $A_T + K$ is invertible, meaning that zero does not belong to its spectrum. Since K is compact and self-adjoint, we classically know that A_T has the same essential spectrum as $A_T + K$, so in particular zero is not in the essential spectrum of A_T . It is not an eigenvalue neither since $\ker A_T \subset \mathcal{F}_{T_0}^- = \{0\}$. Therefore A_T is invertible, and the conclusion follows. \square

The following lemma is not related to the previous proposition. Still, it is worth stating it properly since we use it on several occasions throughout the article.

Lemma 3.A.3. *Let $\omega \subset \mathbf{R}^d$ be measurable. Assume $\text{Obs}(\omega, T)$ holds in some time $T > 0$ with a cost $C > 0$, namely*

$$\forall u \in L^2(\mathbf{R}^d), \quad \|u\|_{L^2(\mathbf{R}^d)}^2 \leq C \int_0^T \|e^{-itP} u\|_{L^2(\omega)}^2 dt.$$

Then $\text{Obs}(\omega, T - \varepsilon)$ holds for any $\varepsilon < 1/C$.

Proof. We use the fact that the propagator e^{-itP} is an isometry on $L^2(\mathbf{R}^d)$ to get

$$C \int_{T-\varepsilon}^T \|e^{-itP} u\|_{L^2(\omega)}^2 dt \leq C \int_{T-\varepsilon}^T \|e^{-itP} u\|_{L^2(\mathbf{R}^d)}^2 dt = C\varepsilon \|u\|_{L^2(\mathbf{R}^d)}^2.$$

Thus we can absorb this term in the left-hand side of the observability inequality provided $C\varepsilon < 1$:

$$(1 - C\varepsilon) \|u\|_{L^2(\mathbf{R}^d)}^2 \leq C \int_0^{T-\varepsilon} \|e^{-itP} u\|_{L^2(\omega)}^2 dt,$$

namely $\text{Obs}(\omega, T - \varepsilon)$ holds with cost $C(1 - C\varepsilon)^{-1}$. \square

3.B. Pseudo-differential operators

We recall below basics of the theory of pseudo-differential operators (see the textbooks [Hör85, Ler10, Mar02, Zwo12] for further details). We will also need a precise bound on the remainder of the pseudo-differential calculus and of the sharp Gårding inequality. This is why we reproduce the proofs of these results below.

3.B.1. Weyl quantization

Let $a \in \mathcal{S}(\mathbf{R}^{2d})$. We define the operator $\text{Op}(a)$ acting on the Schwartz class $\mathcal{S}(\mathbf{R}^d)$ by

$$[\text{Op}(a)u](x) = (2\pi)^{-d} \int_{\mathbf{R}^{2d}} e^{i(x-y)\cdot\xi} a\left(\frac{x+y}{2}, \xi\right) u(y) dy d\xi, \quad u \in \mathcal{S}(\mathbf{R}^d), x \in \mathbf{R}^d.$$

It is known that $\text{Op}(a) : \mathcal{S}(\mathbf{R}^d) \rightarrow \mathcal{S}(\mathbf{R}^d)$ is continuous. The quantization Op extends to tempered distributions: for any $a \in \mathcal{S}'(\mathbf{R}^{2d})$, the operator $\text{Op}(a) : \mathcal{S}(\mathbf{R}^d) \rightarrow \mathcal{S}'(\mathbf{R}^d)$ is continuous.

3.B.2. Symbol classes

Definition 3.B.1 (Symbol classes). Let f be an order function.¹⁴ Then the symbol class $S(f)$ is the set of functions $a \in C^\infty(\mathbf{R}^{2d})$ satisfying

$$\forall \alpha \in \mathbf{N}^{2d}, \exists C_\alpha > 0 : \forall \rho \in \mathbf{R}^{2d}, \quad |\partial^\alpha a(\rho)| \leq C_\alpha f(\rho).$$

Collecting the best constants C_α for each α , the quantities

$$|a|_{S(f)}^\ell = \max_{|\alpha| \leq \ell} C_\alpha, \quad \ell \in \mathbf{N},$$

are seminorms that turn the vector space $S(f)$ into a Fréchet space.

Any $a \in S(f)$ is a tempered distribution and yields a continuous linear operator $\text{Op}(a) : \mathcal{S}(\mathbf{R}^d) \rightarrow \mathcal{S}'(\mathbf{R}^d)$.

¹⁴ A positive function f on the phase space is said to be an order function if

$$\exists C > 0, \exists N > 0 : \forall \rho, \rho_0 \in \mathbf{R}^{2d}, \quad f(\rho) \leq C(\rho - \rho_0)^N f(\rho_0).$$

3.B.3. L^2 -boundedness of pseudo-differential operators

Theorem 3.B.2 (Calderón-Vaillancourt). *There exist constants $C_d, k_d > 0$ depending only on the dimension d such that the following holds: for any $a \in S(1)$, the operator $\text{Op}(a)$ can be extended to a bounded operator on $L^2(\mathbf{R}^d)$ with the bound*

$$\|\text{Op}(a)\|_{L^2 \rightarrow L^2} \leq C_d |a|_{S(1)}^{k_d}.$$

3.B.4. Refined estimate in the pseudo-differential calculus

Let a_1, a_2 be two symbols. We have seen previously that the composition $\text{Op}(a_1)\text{Op}(a_2)$ makes sense as an operator on the Schwartz space. This operator is also a pseudo-differential operator, whose symbol is denoted by $a_1 \# a_2$, called the Moyal product of a_1 and a_2 , and satisfies

$$\text{Op}(a_1)\text{Op}(a_2) = \text{Op}(a_1 \# a_2). \quad (3.B.1)$$

More generally, one can define the h -Moyal product, depending on a parameter $h \in (0, 1]$, as

$$(a_1 \#_h a_2)(\rho) = e^{-\frac{ih}{2}\sigma(\partial_{\rho_1}, \partial_{\rho_2})} a_1(\rho_1) a_2(\rho_2)|_{\rho_1=\rho_2=\rho},$$

where σ is the canonical symplectic form on \mathbf{R}^{2d} . Taking $h = 1$, one gets a formula for the Moyal product in (3.B.1) above. The h -Moyal product is known to be a bilinear continuous map between symbol classes; see [Zwo12, Theorem 4.17] or [Ler10, Theorem 2.3.7] for instance.

Proposition 3.B.3 (Continuity of Moyal product). *Let f_1, f_2 be two order functions. Then the map*

$$\begin{aligned} S(f_1) \times S(f_2) &\rightarrow S(f_1 f_2) \\ (a_1, a_2) &\mapsto a_1 \#_h a_2 \end{aligned}$$

is bilinear continuous, with constants independent of $h \in (0, 1]$. More precisely, for any $\ell \in \mathbf{N}$, there exist $k \in \mathbf{N}$ and $C_\ell > 0$ such that

$$|a_1 \#_h a_2|_{S(f_1 f_2)}^\ell \leq C_\ell |a_1|_{S(f_1)}^k |a_2|_{S(f_2)}^k, \quad \forall h \in (0, 1], \forall (a_1, a_2) \in S(f_1) \times S(f_2).$$

A stationary phase argument leads to an asymptotic expansion of the Moyal product

$$a_1 \# a_2 \sim \sum_j \frac{(-i/2)^j}{j!} \sigma(\partial_{\rho_1}, \partial_{\rho_2})^j a_1(\rho_1) a_2(\rho_2)|_{\rho_1=\rho_2=\rho}.$$

In the sequel, we denote by $\mathcal{R}_{j_0}(a_1, a_2)$ the remainder of order j_0 in this asymptotic expansion, namely

$$\mathcal{R}_{j_0}(a_1, a_2)(\rho) = a_1 \# a_2 - \sum_{j=0}^{j_0-1} \frac{(-i/2)^j}{j!} \sigma(\partial_{\rho_1}, \partial_{\rho_2})^j a_1(\rho_1) a_2(\rho_2)|_{\rho_1=\rho_2=\rho}.$$

Estimates on this remainder term are usually stated as follows.

Proposition 3.B.4 (Pseudo-differential calculus). *Let f_1, f_2 be two order functions. Then for any integer $j_0 \geq 1$, the map*

$$\begin{aligned} S(f_1) \times S(f_2) &\rightarrow S(f_1 f_2) \\ (a_1, a_2) &\mapsto \mathcal{R}_{j_0}(a_1, a_2) \end{aligned}$$

is bilinear continuous.

In our study, it will be convenient to have a slightly more precise statement. Actually, the explicit formula for the remainder allows to prove that its seminorms are controlled not only by the seminorms of a_1 and a_2 but more precisely by the seminorms of the derivatives $d^{j_0} a_1$ and $d^{j_0} a_2$.

Proposition 3.B.5 (Refined estimate). *Let f_1, f_2 be two order functions. Then for any $j_0 \geq 1$, it holds*

$$\forall \ell \in \mathbf{N}, \exists k \in \mathbf{N}, \exists C_\ell > 0 : \quad |\mathcal{R}_{j_0}(a_1, a_2)|_{S(f_1 f_2)}^\ell \leq C_\ell |d^{j_0} a_1|_{S(f_1)}^k |d^{j_0} a_2|_{S(f_2)}^k,$$

for all $(a_1, a_2) \in S(f_1) \times S(f_2)$.

Proof. We outline the arguments of the proof, which are classical, trying to keep track of constants carefully. The starting point of this result is the explicit expression of the remainder (see [Zwo12, Theorem 4.11] for instance):

$$\mathcal{R}_{j_0}(a_1, a_2)(\rho) = \left(\frac{-i}{2}\right)^{j_0} \int_0^1 \frac{(1-t)^{j_0-1}}{(j_0-1)!} e^{-i\frac{t}{2}\sigma(\partial_{\rho_1}, \partial_{\rho_2})} \sigma(\partial_{\rho_1}, \partial_{\rho_2})^{j_0} a_1(\rho_1) a_2(\rho_2)|_{\rho_1=\rho_2=\rho} dt.$$

The binomial expansion of $\sigma(\partial_{\rho_1}, \partial_{\rho_2})^{j_0}$ exhibits a particular structure: we observe that the integrand of the integral over t can be written as a sum of terms of the form

$$e^{-i\frac{t}{2}\sigma(\partial_{\rho_1}, \partial_{\rho_2})} (\partial^{\alpha_1} a_1)(\rho_1) (\partial^{\alpha_2} a_2)(\rho_2)|_{\rho_1=\rho_2=\rho}$$

with $|\alpha_1| = |\alpha_2| = j_0$, which corresponds exactly to $\partial^{\alpha_1} a_1 \#_t \partial^{\alpha_2} a_2$. By Proposition 3.B.3, we know that the Moyal product is a bilinear continuous map $S(f_1) \times S(f_2) \rightarrow S(f_1 f_2)$ with respect to the Fréchet space topology, with seminorm estimates independent of $t \in (0, 1]$. This yields

$$|\mathcal{R}_{j_0}(a_1, a_2)|_{S(f_1 f_2)}^0 \leq C_0 |d^{j_0} a_1|_{S(f_1)}^k |d^{j_0} a_2|_{S(f_2)}^k. \quad (3.B.2)$$

In order to handle seminorms of order $\ell \geq 0$, we use the Leibniz formula:

$$\partial \mathcal{R}_{j_0}(a_1, a_2) = \mathcal{R}_{j_0}(\partial a_1, a_2) + \mathcal{R}_{j_0}(a_1, \partial a_2),$$

and we apply (3.B.2). The result follows. \square

3.B.5. Positivity

Heuristically, the quantization of a non-negative symbol is an almost-non-negative operator. The formal statement, known as the Gårding inequality, says that the negative part of the operator is controlled in terms of the Planck parameter in semiclassical analysis, or exhibits some decay at infinity in the phase space in microlocal analysis. In the main part of the article, we need to apply the Gårding inequality to a symbol in $S(1)$ whose derivatives, of any order, behave like $1/R$, where R is a large parameter. Unfortunately, such a symbol does not fit in the semiclassical framework, in which derivatives of order j behave like $1/R^j$. Thus we provide in this paragraph a refined statement of the sharp Gårding inequality that keeps track of the dependence of the remainder term on the seminorms of the derivatives of the symbol.

Proposition 3.B.6 (Sharp Gårding inequality). *There exists a constant $c_d > 0$ and an integer $k_d \geq 0$ depending only on the dimension d such that the following holds. For any real-valued symbol $a \in S(1)$ satisfying $a \geq 0$, one has*

$$\text{Op}(a) \geq -c_d |\text{Hess } a|_{S(1)}^{k_d} \text{Id}.$$

Proof. We redo the usual proof (see for instance [Zwo12]) using the refined estimate on the remainder in the pseudo-differential calculus (Proposition 3.B.5). Let us prove that for z sufficiently negative, the operator $\text{Op}(a - z)$ is invertible, which in turn shows that it is non-negative by classical arguments.

Step 1 – Estimate of the derivatives of $(a - z)^{-1}$. Using the assumption that $a \geq 0$, we classically have

$$|\nabla a(\rho)| \leq \sqrt{2|\text{Hess } a|_{\infty} a(\rho)}, \quad \forall \rho \in \mathbf{R}^{2d} \quad (3.B.3)$$

(see [Zwo12, Lemma 4.31] for instance). Besides the Faà di Bruno Formula tells us that for any nonzero $\alpha \in \mathbf{N}^{2d}$, the partial derivative $\partial^\alpha (a - z)^{-1}$ can be computed as a sum of terms of the form

$$\frac{1}{(a - z)^{1+\ell}} \prod_{j=1}^{\ell} \partial^{\alpha_j} a,$$

with $1 \leq \ell \leq |\alpha|$, $\sum_{j=1}^{\ell} \alpha_j = \alpha$, $|\alpha_j| \neq 0, \forall j$. Denote by ℓ' the number indices j such that $|\alpha_j| = 1$. We apply (3.B.3) to the ℓ' factors of the form $\partial^{\alpha_j} a$ corresponding to these indices, and we bound

the $\ell - \ell'$ other ones by seminorms of the Hessian of a (recall that $|\alpha_j| \geq 2$ for those remaining indices). We obtain

$$\left| \frac{1}{(a-z)^{1+\ell}} \prod_{j=1}^{\ell} \partial^{\alpha_j} a \right| \leq \frac{1}{|a-z|^{1+\ell}} (2|\text{Hess } a|_{\infty} a(\rho))^{\ell'/2} \left(|\text{Hess } a|_{S(1)}^{|\alpha|} \right)^{\ell-\ell'}.$$

We deduce that

$$\begin{aligned} \left| \frac{1}{(a-z)^{1+\ell}} \prod_{j=1}^{\ell} \partial^{\alpha_j} a \right| &\leq \frac{1}{|a-z|^{1+\ell}} 2^{\frac{\ell'}{2}} |a(\rho)|^{\frac{\ell'}{2}} \left(|\text{Hess } a|_{S(1)}^{|\alpha|} \right)^{\ell-\frac{\ell'}{2}} \\ &\leq \frac{1}{|a-z|^{1+\ell}} 2^{\ell'} \left(|a-z|^{\frac{\ell'}{2}} + |z|^{\frac{\ell'}{2}} \right) \left(|\text{Hess } a|_{S(1)}^{|\alpha|} \right)^{\ell-\frac{\ell'}{2}}. \end{aligned}$$

Putting together all the terms in the Faà di Bruno Formula, and using that $a-z \geq |z|$ (since $z \leq 0$), we finally get that there exists a constant $C > 0$ (depending on $|\alpha|$) such that

$$\left| \partial^{\alpha} \frac{1}{a-z} \right| \leq \frac{C}{|z|} \max_{\substack{1 \leq \ell \leq |\alpha| \\ 0 \leq \ell' \leq \ell}} \left(\frac{|\text{Hess } a|_{S(1)}^{|\alpha|}}{|z|} \right)^{\ell-\frac{\ell'}{2}}.$$

Assuming that $|z| \geq |\text{Hess } a|_{S(1)}^{|\alpha|}$, we arrive at

$$\left| \partial^{\alpha} \frac{1}{a-z} \right| \leq \frac{C}{|z|} \sqrt{\frac{|\text{Hess } a|_{S(1)}^{|\alpha|}}{|z|}}. \quad (3.B.4)$$

Step 2 – Invertibility of $\text{Op}(a-z)$. From the previous step, we know that $a-z$ and $(a-z)^{-1}$ are in $S(1)$ with explicit seminorm estimates, provided $|z|$ is large enough. We perform the pseudo-differential calculus:

$$\text{Op}(a-z)\text{Op}\left(\frac{1}{a-z}\right) = \text{Id} + 0 + \text{Op}(\mathcal{R}_2),$$

keeping in mind that the second term in the asymptotic expansion vanishes because both symbols are functions of the same symbol. According to the Calderón-Vaillancourt Theorem (Theorem 3.B.2), our refined estimate on the remainder (Proposition 3.B.5), and finally to (3.B.4), we obtain

$$\|\text{Op}(\mathcal{R}_2)\|_{L^2 \rightarrow L^2} \leq C_d |\mathcal{R}_2|_{S(1)}^{k_d} \leq C_d |\text{Hess } a|_{S(1)}^{k'_1} |\text{Hess}(a-z)^{-1}|_{S(1)}^{k'_2} \leq C \left(\frac{|\text{Hess } a|_{S(1)}^k}{|z|} \right)^{3/2},$$

for some constant C and some integer k independent of a and z , and provided z is negative enough. Actually when $z \leq -(2C)^{2/3} |\text{Hess } a|_{S(1)}^k$, we obtain that $\|\text{Op}(\mathcal{R}_2)\| \leq 1/2$, so that $\text{Id} + \text{Op}(\mathcal{R}_2)$ is invertible by Neumann series. This leads classically to the invertibility of $\text{Op}(a-z)$, which concludes the proof. \square

4 - Egorov's theorem in the Weyl–Hörmander calculus

We prove a general version of Egorov's theorem for evolution propagators in the framework of the Weyl–Hörmander calculus in the Euclidean space. Mild assumptions on the Hamiltonian allow for a wide range of applications that we describe in the paper. We also take care of quantifying the Ehrenfest time and describing the full symbol of the conjugated operator. Our main result is a consequence of a stronger theorem, related to the notion of second-microlocalization, on the propagation of quantum partitions of unity.

4.1. Introduction and results

One of the simplest instances of the correspondence principle is the description of the evolution of coherent states of the quantum harmonic oscillator by Schrödinger in 1926 [Sch26a]. One can check by an explicit computation that in \mathbf{R}^d , the wave function

$$\varphi(t, x) = \frac{e^{-\frac{i}{2}td}}{\pi^{d/4}} \exp\left(-\frac{|x - x_t|^2}{2}\right) e^{-\frac{i}{2}\xi_t \cdot x_t + i\xi_t \cdot x}, \quad (t, x) \in \mathbf{R} \times \mathbf{R}^d,$$

is a solution to the Schrödinger equation

$$D_t \psi + \frac{1}{2}(-\Delta + |x|^2)\psi = 0, \quad D_t = \frac{1}{i}\partial_t,$$

where $t \mapsto (x_t, \xi_t)$ satisfy Newton's second law of classical mechanics with a force field $\vec{F}(x) = -x = -\nabla(\frac{1}{2}|x|^2)$, i.e.

$$\begin{cases} \dot{x}_t = \xi_t \\ \dot{\xi}_t = -x_t \end{cases}.$$

We can formulate this observation as saying that the wave packet centered at x_0 with momentum ξ_0 propagates under the quantum evolution along the classical trajectory of a point mass initially at position and momentum (x_0, ξ_0) . This case is quite exceptional since the correspondence between classical and quantum mechanics appears regardless of any asymptotic regime. Actually this is a very particular instance of *exact* Egorov's theorem due to the fact that the Hamiltonian is quadratic.

The modern treatment of the quantum-classical correspondence principle is carried out in the framework of microlocal analysis—see the books for a comprehensive account of this theory [Tay91, Hör85, Ler10, Mar02, DS99, Zwo12]. A landmark paper is the work of Egorov [Ego69], who shows that local canonical transformation χ (also called symplectomorphism) can be quantized, namely there exists a (microlocally unitary Fourier integral) operator U_χ such that

$$U_\chi \text{Op}(a) U_\chi^* \approx \text{Op}(a \circ \chi).$$

In this expression, $\text{Op}(a)$ is a quantization procedure, that associates with a symbol a (a smooth function on phase space $\mathbf{R}^d \times \mathbf{R}^d$) an operator $\text{Op}(a)$ acting on $L^2(\mathbf{R}^d)$ (see the next subsection for more details). This equality, which is usually valid only up to a remainder term (except in very particular situations), tells us that a transformation at the symbolic level, i.e. on the classical-mechanical side, has a counterpart on the quantum-mechanical side. In this paper, we are interested in going the other way around (also called Egorov's theorem in the literature): starting from a self-adjoint operator $P = \text{Op}(p)$ and the associated unitary propagator e^{-itP} , we want to prove a statement of the form

$$e^{itP} \text{Op}(a) e^{-itP} \approx \text{Op}(a \circ \phi^t), \quad (4.1.1)$$

where $(\phi^t)_{t \in \mathbf{R}}$ is the so-called Hamiltonian flow associated with the symbol p , for a very general class of Hamiltonians p and symbols a . What we want it to study the action of the propagator from the knowledge of the classical flow $(\phi^t)_{t \in \mathbf{R}}$ on phase space. See shall discuss our motivation in greater detail below.

Since Egorov's paper [Ego69], many generalizations have been studied. We refer to Taylor's book [Tay91, Chapter 6] for a microlocal version. See also Zworski's book [Zwo12, Chapter 11] for a comprehensive presentation in the semiclassical setting. An important question, originating in physics [Chi79, Zas81], is to figure out the time range on which the approximation (4.1.1) is true, the so-called Ehrenfest time. In a semiclassical setting, it was proved by Bambusi, Graffi and Paul [BGP99], and Bouzouina–Robert [BR02] that this time behaves logarithmically with respect to the semiclassical parameter. The (inverse) Lyapunov exponent of the classical dynamics appears as a constant factor in the Ehrenfest time, which means that the semiclassical approximation is valid all the longer as the underlying classical dynamics is stable. We shall recover this in Theorem 4.1.15 below in a more general setting.

Egorov-type theorems have been applied in a wide range of mathematical situations. Let us mention a few of them (the list is not exhaustive).

- It has multiple consequences in spectral geometry. It allows for instance to relate singularities of the trace of the half-wave propagator with the length spectrum of compact Riemannian manifolds; the first papers in this direction go back to Duistermaat–Guillemin [DG75] and Chazarain [Cha74]. We refer to the recent paper by Canzani and Galkowski [CG23] for an application to improved remainders in the Weyl law.
- Quantum chaos is perhaps the field where Egorov's theorem has been mostly used. It has proved very powerful to describe the concentration or delocalization properties of Laplace eigenfunctions on compact Riemannian manifolds with a chaotic underlying classical dynamics, through semiclassical defect measures. See for example the paper of Colin de Verdière [CdV85] on quantum ergodicity. We also refer for instance to the work of Anantharaman [Ana08], Anantharaman–Nonnenmacher [AN07], Rivière [Riv10b, Riv10a, Riv14], Anantharaman–Rivière [AR12] and Dyatlov–Jin–Nonnenmacher [DJN22]. See also Dyatlov–Guillarmou in non-compact manifolds [DG14].
- In control theory, the idea of using Egorov's theorem to prove observability inequalities was introduced for the wave equation by Laurent and Léautaud [LL16], based on earlier works by Dehman and Lebeau [DL09]. We recently applied the same method to study the observability of the Schrödinger equation in the Euclidean space [Pro23].
- In the theory of scattering resonances, examples of application of Egorov's theorem can be found in papers by Nonnenmacher and Zworski [NZ09, NZ15], Dyatlov [Dya15] and Dyatlov–Galkowski [DG17]. See also [DZ19, Section 7.1] for an interesting application to lower bound resolvent estimates in the context of geometric scattering.
- In the wider context of resolvent estimates, let us mention Bony–Burq–Ramond [BBR10], Arnaiz and Rivière [AR20] who discuss Egorov's theorem in the Gevrey category. For non-self-adjoint versions of Egorov's theorem, we refer to the works of Royer [Roy10], Rivière [Riv12] and Léautaud [Lé23] who gives a non-self-adjoint version.
- Ideas related to Egorov's theorem were also used recently to study fractal Weyl laws for Anosov flows by Faure and Tsujii [FT23a, FT23b]. We shall mention this again in Subsection 4.1.7.3.

Our goal is to prove a version of Egorov's theorem in the Weyl–Hörmander calculus, to provide a unifying viewpoint of the aforementioned approaches. In a forthcoming work, we plan to give applications to control theory (stabilization, observability), where the Weyl–Hörmander calculus arises as a natural tool to study various wave or Schrödinger-type equations in the Euclidean space. Let us mention that a study of the quantization of canonical transformation in the continuation of Egorov's work [Ego69] was proposed by Beals [Bea74, Section 5] and later by Hörmander [Hör79, Section 9]. We also discuss in more detail in Subsection 4.1.10 the contributions of Bony.

The rest of the introduction is structured as follows. In Subsection 4.1.1, we set the geometric framework of this paper, we introduce the Weyl quantization and we define precisely the classical and quantum dynamics that we will study. We give some additional notation and conventions in Subsection 4.1.2. Next we give our main result in Subsection 4.1.4, and comment it in the subsequent Subsection 4.1.5. Subsection 4.1.6 is a discussion on the Egorov asymptotic expansion in terms of a Dyson series. The reader can find three concrete examples of applications of our main theorem in Subsection 4.1.7. Then we introduce the basics of the theory of metrics on the phase space in Subsection 4.1.8, which is not necessary to understand the main result but is needed as a tool box for the proofs. Then we introduce a result on the propagation of quantum partitions of unity adapted

to a metric g in Subsection 4.1.9. This is in fact the core result of this article (our main result is a consequence of the latter). We finish in Subsections 4.1.10 and 4.1.11 with a review of related works by Bony and give the strategy of the proof.

4.1.1. The classical and quantum dynamics

4.1.1.1. Geometric framework

We work in the manifold $M = \mathbf{R}^d$, viewed as a finite dimensional real affine space. The reason we stick to the notation M instead of \mathbf{R}^d is that we will strive to avoid any use of the vector space or Euclidean structure of \mathbf{R}^d . Indeed, classical mechanics on the configuration space M takes place naturally on the cotangent bundle T^*M . Typical points of T^*M will be denoted by $\rho = (x, \xi)$. The manifold T^*M is called the *phase space* of classical mechanics. It is equipped canonically with a symplectic form σ , defined intrinsically as the exterior derivative of the Liouville 1-form [DS99, Chapter 1]. In coordinates, it reads $\sigma = d\xi \wedge dx$.

The Hilbert space that we consider is the usual space $L^2(M)$ of square-integrable functions with respect to the Lebesgue measure on M .¹

Remark 4.1.1. The analysis of a quantum mechanical system on M , from the Weyl–Hörmander framework perspective, essentially consists in considering a good Riemannian metric g on T^*M which is relevant to the typical scales of the problem. For this reason, it would be quite confusing to rely on a Euclidean structure on M , in addition to a Weyl–Hörmander metric. This is the motivation for writing M instead of \mathbf{R}^d .

4.1.1.2. Quantization

The affine structure of M allows to make sense of the Weyl quantization (thus we have an unequivocal notion of *full symbol* of an operator). The affine structure is given by the transitive and free action by translation of a finite dimensional real vector space $V \simeq \mathbf{R}^d$:

$$\begin{aligned} V \times M &\longrightarrow M \\ (v, x) &\longmapsto x + v. \end{aligned}$$

This induces a natural action on the phase space by

$$\begin{aligned} W \times T^*M &\longrightarrow T^*M \\ (\zeta, \rho) &\longmapsto \rho + \zeta, \end{aligned}$$

where $W = V \oplus V^*$. Notice that all the tangent planes $T_\rho T^*M$ are naturally identified with W through this action.

In this article, we work with the Weyl quantization. Given $a \in \mathcal{S}(T^*M)$, the Weyl quantization of a is the operator $\text{Op}^{\text{W}}(a)$ defined by

$$[\text{Op}^{\text{W}}(a)u](x) = \int_{T^*M} e^{i\xi \cdot (x-y)} a\left(\frac{x+y}{2}, \xi\right) u(y) dy d\xi, \quad x \in M,$$

where the measure $dy d\xi$ on T^*M is a suitable normalization of the Lebesgue measure, or equivalently the symplectic volume,² so that $\text{Op}^{\text{W}}(1) = \text{Id}$. This quantization procedure can be extended to tempered distributions $a \in \mathcal{S}'(T^*M)$. The operator $\text{Op}^{\text{W}}(a) : \mathcal{S}(M) \rightarrow \mathcal{S}'(M)$ is defined by

$$\langle \text{Op}^{\text{W}}(a)u, v \rangle_{\mathcal{S}', \mathcal{S}(M)} := \langle a, u \otimes \bar{v} \rangle_{\mathcal{S}', \mathcal{S}(T^*M)}, \quad \forall u, v \in \mathcal{S}(M), \quad (4.1.2)$$

where $u_1 \otimes u_2$ is the Wigner transform of $u_1, u_2 \in \mathcal{S}(M)$:

$$(u_1 \otimes u_2)(x, \xi) = \int_V \bar{u}_2\left(x + \frac{v}{2}\right) u_1\left(x - \frac{v}{2}\right) e^{i\xi \cdot v} dv, \quad \forall (x, \xi) \in T^*M. \quad (4.1.3)$$

1. Rigorously, we would rather work with the intrinsic L^2 space, that is the completion of the space of half-densities with respect to the L^2 norm [Zwo12, Section 9.1]. In our case, this space identifies with the space of square-integrable functions through the (non-canonical) choice of a normalization of the Lebesgue measure.

2. Recall that the symplectic volume is the d -fold exterior product $\sigma^d = \sigma \wedge \sigma \wedge \cdots \wedge \sigma$, where $d = \dim M$.

Here we follow the presentation of [Ler10, Section 2.1]. Classical properties of the Weyl quantization are recalled in Appendix 4.A. When it makes sense, the symbol of the composition of $\text{Op}^{\text{w}}(a_1)$ and $\text{Op}^{\text{w}}(a_2)$ is the Moyal product $a_1 \# a_2$, given by

$$(a_1 \# a_2)(\rho) = \int_{W \times W} a_1 \left(\rho + \frac{\zeta_1}{\sqrt{2}} \right) a_2 \left(\rho + \frac{\zeta_2}{\sqrt{2}} \right) e^{-i\sigma(\zeta_1, \zeta_2)} d\zeta_1 d\zeta_2 \quad (4.1.4)$$

(this has to be understood as an oscillatory integral in general). It satisfies

$$\text{Op}^{\text{w}}(a_1 \# a_2) = \text{Op}^{\text{w}}(a_1)\text{Op}^{\text{w}}(a_2).$$

We discuss composition of such operators in Subsection 4.2.2.

4.1.1.3. The classical dynamics

Consider a smooth real-valued function p on T^*M with temperate growth. The Hamiltonian vector field H_p associated with p is the unique vector field satisfying

$$\sigma(H_p, X) = -dp \cdot X, \quad (4.1.5)$$

for all smooth vector field X on T^*M . The so-called Hamiltonian flow is generated by H_p , and will be written $(\phi^t)_{t \in \mathbf{R}}$, and solves the o.d.e.

$$\frac{d}{dt} \phi^t = H_p \circ \phi^t \quad (4.1.6)$$

which is a general form of Newton's second law of classical mechanics. Under mild assumptions on p , it is well-defined for all times. It is known that the Hamiltonian flow is a group of symplectomorphisms, that is to say $(\phi^t)^* \sigma = \sigma$ for all times. As a consequence, it also preserves the symplectic volume (here the Lebesgue measure).

The Hamiltonian flow acts on Schwartz functions $a \in \mathcal{S}(T^*M)$ through $t \mapsto a \circ \phi^t$, which solves the p.d.e.

$$\boxed{\partial_t a = H_p a} \quad (4.1.7)$$

where H_p is viewed as a differential operator of order 1. For any function a on phase space, we define

$$e^{tH_p} a := a \circ \phi^t, \quad t \in \mathbf{R}. \quad (4.1.8)$$

The notation is justified by (4.1.7). Actually, we can give a stronger meaning to e^{tH_p} for L^2 functions on phase space. Modulo some natural assumptions, we can see H_p as a skew-symmetric operator on $L^2(T^*M)$ with domain $\mathcal{S}(T^*M)$ (here again, the space $L^2(T^*M)$ involves the Lebesgue measure, or symplectic volume, on T^*M). As a consequence of Stone's theorem [RS80, VIII.4], we show in Proposition 4.3.2 that the family of operators $(e^{tH_p})_{t \in \mathbf{R}}$, viewed as operators acting on $L^2(T^*M)$, is a strongly continuous one-parameter unitary group, generated by a skew-adjoint extension of H_p , that we call the *classical dynamics*. We will use this unitary group to describe the quantum dynamics defined below.

4.1.1.4. The quantum dynamics

We consider a self-adjoint operator P with domain $\text{dom } P$, acting on $L^2(M)$. We denote by p the Weyl symbol of P , so that $P = \text{Op}^{\text{w}}(p)$, and assume it is a well-behaved symbol (smooth and with temperate growth). Stone's theorem states that the family of operators $(e^{-itP})_{t \in \mathbf{R}}$ constructed by functional calculus is a strongly-continuous one-parameter unitary group. For any $u \in L^2(M)$, the map $t \mapsto e^{-itP} u$, belonging to $C^0(\mathbf{R}; L^2(M))$, solves in a weak sense the initial value problem

$$D_t \psi = -P\psi, \quad \psi(0) = u, \quad (4.1.9)$$

with $D_t = \frac{1}{i} \partial_t$. For this reason, we will refer to e^{-itP} as the Schrödinger propagator associated with P . The Schrödinger equation can be studied in the so-called Heisenberg picture of quantum mechanics: letting A be a bounded operator on $L^2(M)$ (a “quantum observable”), we have

$$(e^{-itP} u, A e^{-itP} u)_{L^2} = (u, A(t)u)_{L^2}, \quad \forall t \in \mathbf{R},$$

where the map $t \mapsto A(t) := e^{itP} A e^{-itP}$ solves the equation

$$D_t \Psi = [P, \Psi], \quad \Psi(0) = A. \quad (4.1.10)$$

Expressing (4.1.10) at the level of symbols, namely writing $\Psi(t) = \text{Op}^w(a(t))$, we have formally

$$D_t \text{Op}^w(a) = \text{Op}^w(p \# a - a \# p),$$

where $P = \text{Op}^w(p)$. Therefore, $t \mapsto a(t)$ is a solution to the equation

$$\boxed{\partial_t a = \mathcal{H}_p a} \quad (4.1.11)$$

where \mathcal{H}_p is the operator

$$\mathcal{H}_p a := i(p \# a - a \# p), \quad a \in \mathcal{S}(T^*M). \quad (4.1.12)$$

We introduce the main object that we study in this article.

Definition 4.1.2. Let $a \in \mathcal{S}'(T^*M)$ and $t \in \mathbf{R}$, and suppose $e^{itP} \text{Op}^w(a) e^{-itP}$ makes sense as a continuous operator $\mathcal{S}(M) \rightarrow \mathcal{S}'(M)$. Then we denote by $e^{t\mathcal{H}_p} a$ its Weyl symbols, namely the unique tempered distribution on T^*M such that

$$\text{Op}^w\left(e^{t\mathcal{H}_p} a\right) = e^{itP} \text{Op}^w(a) e^{-itP}.$$

Observe that this definition applies in particular to any tempered distribution a such that $\text{Op}^w(a)$ extends to a bounded operator on $L^2(M)$. Moreover this definition makes sense in virtue of Proposition 4.B.1 (a consequence of the Schwartz kernel theorem), and the notation is justified by (4.1.11).

Actually, we can give a stronger meaning to $e^{t\mathcal{H}_p}$ for L^2 symbols. The operator \mathcal{H}_p introduced in (4.1.12) can be seen as a skew-symmetric operator on $L^2(T^*M)$ with domain $\mathcal{S}(T^*M)$. We show in Proposition 4.3.2 that the family of operators $(e^{t\mathcal{H}_p})_{t \in \mathbf{R}}$, viewed as operators acting on $L^2(T^*M)$, is in fact a strongly continuous one-parameter unitary group, generated by a skew-adjoint extension of \mathcal{H}_p , that we call the *quantum dynamics*. Our goal in this paper is to study this unitary group.

4.1.1.5. The quantum-classical correspondence principle

The generator H_p of the classical dynamics is a fairly simple object, namely a vector field. In contrast, the operator \mathcal{H}_p looks much more difficult to describe. The idea of a correspondence between the classical and the quantum dynamics follows from pseudo-differential calculus, as we explain now. We introduce the operator $\mathcal{H}_p^{(3)}$ in such a way that

$$\mathcal{H}_p = H_p + \mathcal{H}_p^{(3)}. \quad (4.1.13)$$

This equality makes sense in the sense of continuous³ operators $\mathcal{S}(M) \rightarrow \mathcal{S}(M)$. Applying pseudo-differential calculus at order 3 (see Proposition 4.2.2), we have in fact

$$i(p \# a - a \# p) = i(pa - ap) + \{p, a\} + \mathcal{H}_p^{(3)} a, \quad a \in \mathcal{S}(T^*M), \quad (4.1.14)$$

where $\{p, a\} = H_p a$ is the Poisson bracket.⁴ This is nothing but (4.1.13). The remainder operator $\mathcal{H}_p^{(3)}$ contains all the “non-locality” of quantum mechanics, and quantifies the deviation of the latter from classical mechanics. It involves derivatives of order ≥ 3 of p (actually it can be thought as a non-local version of the differential operator $\partial^3 p \cdot \partial^3$). Thus we shall make assumptions on $\nabla^3 p$ ensuring that it can indeed be considered as a lower order term (in the usual semiclassical setting, it would be of order \hbar^3). The connection between the quantum and the classical dynamics will

3. Continuity holds in view of the pseudo-differential calculus (Proposition 4.2.3) as soon as p has temperate growth).

4. With the notation of Proposition 4.2.2, we have

$$\mathcal{H}_p^{(3)} = \widehat{\mathcal{P}}_3(p, \bullet) - \widehat{\mathcal{P}}_3(\bullet, p). \quad (4.1.15)$$

The notation $\mathcal{H}_p^{(3)}$ is justified by the fact that the order-2 terms in the pseudo-differential calculus (4.1.14) cancel for symmetry reasons.

be studied via the Dyson series expansion associated with the decomposition (4.1.13) of \mathcal{H}_p . See Subsection 4.1.6. We are aiming for a statement of the form

$$e^{t\mathcal{H}_p}a = e^{tH_p}a + \text{remainder terms.}$$

At the operator level, that corresponds to (4.1.1), which is the usual way Egorov's theorem is presented. This is exactly what we achieve in Theorem 4.1.15. In fact, we prove that the conjugated operator in the left-hand side of (4.1.1) is pseudo-differential, and quantify this property in terms of continuity estimates of the quantum dynamics $(e^{t\mathcal{H}_p})_{t \in \mathbf{R}}$ on symbol classes.

4.1.2. Notation and conventions

4.1.2.1. Symplectic and Riemannian structures on phase space

We follow the conventions of Lerner [Ler10, Subsection 4.4.1] here. See also Hörmander [Hör85, Chapter XVIII] for a similar treatment. Recall that the symplectic form σ on T^*M is a non-degenerate 2-form. Therefore it induces a bundle isomorphism

$$\sigma : TT^*M \longrightarrow T^*T^*M, \quad (4.1.16)$$

still denoted by σ , through the formula

$$\langle \sigma X, Y \rangle_{T^*TM, TTM} := \sigma(X, Y),$$

for all pair of vector fields X, Y on T^*M . The adjoint map

$$\sigma^* : TT^*M \longrightarrow T^*T^*M$$

satisfies $\sigma^* = -\sigma$ given that σ is alternating.

Let g be a Riemannian metric on T^*M , that is to say a smooth symmetric 2-tensor field that is positive definite. Denote by $|\zeta|_g(\rho) = |\zeta|_{g_\rho} = \sqrt{g_\rho(\zeta, \zeta)}$ the norm induced by g on the tangent space $T_\rho T^*M \simeq W \ni \zeta$. We also introduce the notation $\langle \bullet \rangle_g$ for the Japanese bracket associated with this norm. The metric g can be regarded as a bilinear bundle map

$$g_\rho : T_\rho T^*M \times T_\rho T^*M \longrightarrow \mathbf{R},$$

assigning to each phase space point $\rho \in T^*M$ an inner product on $T_\rho T^*M$; or we can see g as a bundle isomorphism

$$g : TT^*M \longrightarrow T^*T^*M,$$

still denoted by g , through the formula

$$\langle gX, Y \rangle_{T^*TM, TTM} := g(X, Y), \quad \forall X, Y \in \Gamma(T^*M),$$

where $\Gamma(T^*M)$ refer to the space of smooth vector fields on T^*M . We will also use the inverse map

$$g^{-1} : T^*T^*M \longrightarrow TT^*M,$$

which can be seen as a smooth positive definite symmetric 2-tensor field acting on 1-forms instead of vector fields, and reads

$$g^{-1}(\omega, \eta) = \langle \omega, g^{-1}\eta \rangle_{T^*T^*M, TT^*M} = g(g^{-1}\omega, g^{-1}\eta), \quad \forall \omega, \eta \in \Lambda^1(T^*M),$$

where $\Lambda^1(T^*M)$ refers to the space of 1-forms on T^*M . The maps g and g^{-1} are usually called the musical isomorphisms [Lee09, Section 7.6] (respectively the flattening and sharpening operators).

We now give an important definition in the Weyl–Hörmander theory.

Definition 4.1.3 (σ -dual metric – [Ler10, Definition 4.4.22]). Let g be a Riemannian metric on T^*M . We define the bundle map

$$g^\sigma := \sigma^* g^{-1} \sigma : TT^*M \longrightarrow T^*T^*M. \quad (4.1.17)$$

It induces a Riemannian metric⁵ on T^*M called the σ -dual metric associated with g .

5. The verification that g^σ gives a genuine Riemannian metric goes as follows: for all pair of vector fields X, Y on T^*M , one has

$$\langle g^\sigma X, Y \rangle_{T^*T^*M, TTM} = g^{-1}(\sigma X, \sigma Y) = g(g^{-1}\sigma X, g^{-1}\sigma Y).$$

This definition gives a representation of the metric g^{-1} using the isomorphism (4.1.16) given by the symplectic form. The σ -duality $g \mapsto g^\sigma$ is an involution. Any metric satisfying $g = g^\sigma$ will be called a *symplectic metric*. An alternative definition consists in introducing the (unique) bundle map $J_g : TT^*M \rightarrow TT^*M$ such that

$$g(X, Y) = \sigma(X, J_g Y), \quad (4.1.18)$$

for all vector fields X, Y on T^*M . Then one can check that

$$g^\sigma(X, Y) = \sigma(J_g^{-1} X, Y). \quad (4.1.19)$$

Just as the inverse $g \mapsto g^{-1}$, σ -duality reverses the order,⁶ in the sense that

$$g_1 \leq g_2 \iff g_1^\sigma \geq g_2^\sigma. \quad (4.1.20)$$

Given a diffeomorphism $\varphi : T^* \rightarrow T^*M$, we denote by φ^*g the pullback of g by φ , that is

$$\forall X, Y \in \Gamma(T^*M), \quad (\varphi^*g)_\rho(X, Y) = g_{\varphi(\rho)}(d\varphi(\rho).X, d\varphi(\rho).Y),$$

which is still a Riemannian metric. In addition, given a Riemannian metric g and a vector field X , we recall that the Lie derivative of g with respect to X is given by

$$\mathcal{L}_X g = \frac{d}{dt} \Big|_{t=0} (\varphi_X^t)^* g, \quad (4.1.21)$$

where φ_X^t is the (locally well-defined) flow generated by the vector field X .

4.1.2.2. Tensors and norms

The affine structure on M provides a connection ∇ on M which is torsion free and has vanishing curvature, which extends naturally to T^*M . It allows to make sense of the k -th differential of a smooth function $a : T^*M \rightarrow \mathbf{C}$, that we denote by $\nabla^k a$, regardless of a Euclidean structure on T^*M [Lee09, Section 12.8]. The differentials $\nabla^k a$ are instance of covariant tensors, namely they are naturally paired with vector fields $X \in \Gamma(T^*M)$:

$$\begin{aligned} \nabla^k a : \Gamma(T^*M)^k &\longrightarrow C^\infty(T^*M) \\ (X_1, X_2, \dots, X_k) &\longmapsto \nabla^k a(X_1, X_2, \dots, X_k) = \nabla_{X_1, X_2, \dots, X_k} a, \end{aligned}$$

as opposed to vector fields (contravariant tensors) which are naturally paired with differential 1-forms $\omega \in \Lambda^1(T^*M)$. For a general k -covariant, l -contravariant tensor B , namely a $C^\infty(T^*M)$ -multilinear map

$$\begin{aligned} T : \Gamma(T^*M)^k \times \Lambda^1(T^*M)^l &\longrightarrow C^\infty(T^*M) \\ (X_1, X_2, \dots, X_k, \omega_1, \omega_2, \dots, \omega_l) &\longmapsto B(X_1, X_2, \dots, X_k, \omega_1, \omega_2, \dots, \omega_l), \end{aligned} \quad (4.1.22)$$

its norm with respect to a Riemannian metric g on T^*M is the map

$$|B|_g = |B|_g(\rho) = \sup_{\substack{|X_j|_g(\rho) \leq 1 \\ |\omega_n|_{g^{-1}}(\rho) \leq 1}} |B(X_1, X_2, \dots, X_k, \omega_1, \omega_2, \dots, \omega_l)|, \quad \rho \in T^*M.$$

Analogously to tensors, if $\kappa : T^*M \rightarrow T^*M$ is a smooth map, we can also define for all $k \in \mathbf{N}^*$ and all $\rho \in T^*M$ a norm $|\nabla^k \kappa|_g(\rho)$ (beware that $\nabla^k \kappa$ is not really a tensor since it maps a collection of tangent vectors at ρ to a tangent vector at $\kappa(\rho)$). See Subsection 4.4.1 for more details.

Throughout the paper, we shall write $|B|_{g, \infty} = \sup_{T^*M} |B|_g$ and $|\nabla^k \kappa|_{g, \infty} = \sup_{T^*M} |\nabla^k \kappa|_g \in [0, +\infty]$.

Remark 4.1.4. Since the connection ∇ has vanishing torsion and curvature, derivatives of a symmetric tensor is still a symmetric tensor. Moreover, for any ℓ -linear symmetric form B , one can show that

$$\sup_{|X|=1} |B(X^\ell)| = \sup_{|X|=1} |B(X, X, \dots, X)| = \sup_{|X_j|=1} |B(X_1, X_2, \dots, X_\ell)|,$$

provided the norm $|\bullet|$ comes from an inner product (see for instance [Har96]). Therefore, to estimate the norm of a tensor T with respect to a metric g , it will be sufficient to give bounds for the diagonal elements of the tensor only. See Remark 4.D.2 for more details.

6. This is a consequence of $|\zeta|_{g^\sigma} = |\sigma \zeta|_{g^{-1}} = \sup_{\zeta' \in W \setminus \{0\}} \frac{|\sigma(\zeta, \zeta')|}{|\zeta'|_g}$.

4.1.3. Metrics on the phase space

We are now ready to introduce the Weyl–Hörmander framework of metrics on the phase space. Here again we follow [Ler10, Hör85]. Let us give a short account of the roots of this theory. General algebras of pseudo-differential operators were introduced by Kohn and Nirenberg [KN65] in the 1960's. Later, Hörmander gave a generalization of the Kohn–Nirenberg symbol classes motivated by the study of hypoelliptic operators [Hör67]. In [BF73, BF74, Bea75], Beals and Fefferman introduced even more general classes of symbols for the study of local solvability of linear partial differential equations. Finally, a unifying framework using Riemannian metrics on the phase space was designed by Hörmander [Hör79] (see also [Den86]).

Given a Riemannian metric g , a point $\rho_0 \in T^*M$ and $r \geq 0$, we introduce the open “tangential” ball

$$B_r^g(\rho_0) = \left\{ \rho \in T^*M : |\rho - \rho_0|_{g_{\rho_0}} < r \right\}. \quad (4.1.23)$$

In our analysis, the most important quantity associated with a phase space metric g is its *gain function*. We recall that $W \simeq T_\rho T^*M$ is the real vector space given by the affine structure (4.1.1.2) on T^*M .

Definition 4.1.5 (Gain function). Let g be a Riemannian metric on T^*M . Then we define the gain function of g as ⁷

$$h_g(\rho) := \sup_{\zeta \in W \setminus \{0\}} \frac{|\zeta|_{g_\rho}}{|\zeta|_{g_\rho^\sigma}}, \quad \rho \in T^*M,$$

where g^σ is the σ -dual metric defined in (4.1.17). We also define the maximal gain to be

$$\underline{h}_g := \sup_{T^*M} h_g.$$

In order to study pseudo-differential operators, e.g. their L^2 boundedness, it is important that the metrics g satisfies several requirements.

Definition 4.1.6 (Admissible metric). A Riemannian metric g on T^*M is said to be admissible if it satisfies the following three properties:

1. (Slow variation:) there exist $C, r > 0$ such that for all $\rho_0, \rho \in T^*M$,

$$\rho \in B_r^g(\rho_0) \quad \implies \quad C^{-2}g_{\rho_0} \leq g_\rho \leq C^2g_{\rho_0};$$

2. (Temperance:) there exist $C, N > 0$ such that for all $\rho_0, \rho \in T^*M$,

$$g_\rho \leq C^2g_{\rho_0} \langle \rho - \rho_0 \rangle_{g_{\rho_0}^\sigma}^{2N},$$

3. (Uncertainty principle:) the gain function associated with g introduced in Definition 4.1.5 satisfies $h_g(\rho) \leq 1$ for any $\rho \in T^*M$.

The constants r, C, N arising in this definition are called the structure constants of the metric g .

Now we turn to the definition of admissible weight functions on phase space.

Definition 4.1.7 (g -admissible weight). Let g be an admissible metric on T^*M . A smooth function $m : T^*M \rightarrow \mathbf{R}_+^*$ is said to be a g -admissible weight if it satisfies the following two properties:

1. (g -slow variation) there exist $C, r > 0$ such that for all $\rho_0 \in T^*M$,

$$\forall \rho \in B_r^g(\rho_0), \quad C^{-1}m(\rho_0) \leq m(\rho) \leq Cm(\rho_0);$$

2. (g -temperance) there exist $C, N > 0$ such that for all $\rho_0, \rho \in T^*M$,

$$m(\rho) \leq Cm(\rho_0) \langle \rho - \rho_0 \rangle_{g_{\rho_0}^\sigma}^N.$$

7. One way to compute this function is to recall the section J_g introduced in (4.1.18). One can check that

$$h_g = \sup_{\zeta \in W \setminus \{0\}} \sqrt{\frac{g(J_g \zeta)}{g^\sigma(J_g \zeta)}} = \sup_{\zeta \in W \setminus \{0\}} \frac{|J_g \zeta|_g}{|\zeta|_g} = |J_g|_g.$$

The constants r , C , N arising in this definition are called the structure constants of the weight m .

Remark 4.1.8. It is known that all real powers h_g^s of the gain function of g are g -admissible weights. See [Ler10, Remark 2.2.17 and Lemma 2.2.22].

We are now able to introduce the Weyl–Hörmander symbol classes.

Definition 4.1.9 (Symbol classes). Let g be a Riemannian metric on T^*M and $m : T^*M \rightarrow \mathbf{R}_+$ be a positive function. Then the symbol class $S(m, g)$ is the vector space of C^∞ functions $a : T^*M \rightarrow \mathbf{C}$ such that

$$\forall j \in \mathbf{N}, \exists C_j > 0 : \quad |\nabla^j a|_g \leq C_j m \quad \text{on } T^*M.$$

The space $S(m, g)$ becomes a Fréchet space once it is equipped with the countable family of seminorms given by

$$|a|_{S(m, g)}^{(\ell)} := \max_{0 \leq j \leq \ell} \sup_{\rho \in T^*M} \frac{|\nabla^j a|_g(\rho)}{m(\rho)}, \quad \ell \in \mathbf{N}.$$

From the definition of $S(m, g)$, given m and m' are such that m/m' is bounded on T^*M and $g \leq Cg'$, we have

$$S(m, g) \subset S(m', g'),$$

where the embedding is continuous. Actually the definition of $S(m, g)$ makes sense for general positive weights m and metrics g . But if g and m are admissible in the sense of Definitions 4.1.6 and (4.1.7), then one can check that these symbol classes satisfy

$$\mathcal{S}(M) \subset S(m, g) \subset \mathcal{S}'(M),$$

where the inclusions are continuous. (One may topologize $\mathcal{S}(M)$ with the usual Schwartz seminorms by choosing an arbitrary euclidean structure on M .)

Remark 4.1.10 (Extension of symbol classes to tensors). Given a tensor T as in (4.1.22), we will say that $T \in S(m, g)$ if

$$\forall j \in \mathbf{N}, \exists C_j > 0 : \quad |\nabla^j T|_g \leq C_j m \quad \text{on } T^*M.$$

We will also need to consider a quantity that is not standard in the classical theory of the Weyl–Hörmander calculus. It quantifies the temperance property of the metric (see Definition 4.1.6).

Definition 4.1.11 (Temperance weight). Let g be an admissible metric in the sense of Definition 4.1.6. Then we define the temperance weight of g by

$$\theta_g(\rho) := \sup_{\zeta \in W \setminus \{0\}} \frac{|\zeta|_{g_\rho^\sigma}}{|\zeta|_{\mathbf{g}}} = \sup_{\zeta \in W \setminus \{0\}} \frac{|\zeta|_{\mathbf{g}^\sigma}}{|\zeta|_{g_\rho}}, \quad (4.1.24)$$

where \mathbf{g} is a fixed Euclidean metric such that $\mathbf{g} = \mathbf{g}^\sigma$.

Remark 4.1.12. General properties of the temperance weight are listed in Proposition 4.1.31. Bear in mind that it satisfies $\theta_g \geq 1$ (Proposition 4.1.32). The justification for the equalities in (4.1.24) is recalled in Appendix 4.C.2 (see (4.C.1)).

4.1.4. Assumptions and main result

Theorem 4.1.15 below establishes a correspondence principle between quantum and classical dynamics. Let us discuss our assumptions on p and g . Our first set of assumptions is mandatory to make sense of the problem.

Assumption 4.1.13 (Classical and quantum well-posedness). *The classical Hamiltonian $p \in \mathcal{S}'(T^*M)$ is a real-valued function of class C^∞ and the following holds.*

- (Completeness of the Hamiltonian flow:) *The Hamiltonian flow $(\phi^t)_{t \in \mathbf{R}}$ is complete.*
- (Essential self-adjointness:) *The operator $\text{Op}^w(p)$ with domain $\mathcal{S}(M)$ is essentially self-adjoint on $L^2(M)$. We denote by P the unique self-adjoint extension.*

The second set of assumptions concerns Egorov’s theorem specifically.

Assumption 4.1.14 (Compatibility of the Hamiltonian and the metric). *The metric g on T^*M and the Hamiltonian p satisfy the following conditions.*

(i) (Flow expansion:) *The following Lyapunov exponent is finite:*

$$\Lambda := \frac{1}{2} \sup_{T^*M} |\mathcal{L}_{H_p} g|_g < \infty. \quad (4.1.25)$$

(ii) (Strong sub-quadraticity:) *There exists $\epsilon \in (0, 1/2]$ such that*

$$\nabla^3 p \in S\left((\theta_g \underline{h}_g^{1/2})^{-\epsilon} (h_g / \underline{h}_g)^{-3}, g\right) \cap S\left((h_g / \underline{h}_g)^{-1}, g\right). \quad (4.1.26)$$

(iii) (Metric control along the flow:) *There exist $\Upsilon \geq 0$ and $C_\Upsilon > 0$ such that*

$$\forall \rho \in T^*M, \forall t \in \mathbf{R}, \quad g_{\phi(\rho)} \leq C_\Upsilon^2 e^{2\Upsilon|t|} g_\rho. \quad (4.1.27)$$

Here \mathcal{L}_{H_p} is the Lie derivative with respect to the Hamiltonian vector field, whose definition is recalled in (4.1.21).

We introduce

$$g(t) := e^{2(\Lambda+2\Upsilon)|t|} g, \quad g^\sigma(t) = g(t)^\sigma = e^{-2(\Lambda+2\Upsilon)|t|} g^\sigma \quad t \in \mathbf{R}. \quad (4.1.28)$$

Remark that the map $t \mapsto g(t)$ is increasing on \mathbf{R}_+ . We call *Ehrenfest time* the number:

$$T_E = T_E(p, g) := \frac{1/2}{\Lambda + 2\Upsilon} \log\left(\frac{1}{\underline{h}_g}\right), \quad \underline{h}_g = \sup_{T^*M} h_g. \quad (4.1.29)$$

This time is set so that $g(t)$ complies with the uncertainty principle for all $t \in [-T_E, T_E]$, that is to say $h_{g(t)} \leq 1$ (see Remark 4.1.30 for a proof of this statement).

Our main result is the following.

Theorem 4.1.15. *Let $T \in [0, \frac{1}{6}T_E]$. Let m be a g -admissible weight, and assume that $m(t) = e^{tH_p} m$ is $g(t)$ -admissible with uniform structure constants for all $t \in [0, T]$. Then for all $a \in S(m, g)$ and all $t \in [-T, T]$, the operator $e^{itP} \text{Op}^w(a) e^{-itP}$ makes sense as a continuous operator $\mathcal{S}(M) \rightarrow \mathcal{S}'(M)$. Its Weyl symbol $e^{t\mathcal{H}_p} a$ defined in Definition 4.1.2 belongs to $S(m(t), g(t))$.*

We have the following estimate: for all $\ell \in \mathbf{N}$, there exists $k \in \mathbf{N}$ and a constant $C_\ell > 0$ such that

$$\forall a \in S(m, g), \forall t \in [-T, T], \quad \left| e^{t\mathcal{H}_p} a \right|_{S(m(t), g(t))}^{(\ell)} \leq C_\ell |a|_{S(m, g)}^{(k)}. \quad (4.1.30)$$

Moreover, we have an asymptotic expansion

$$e^{t\mathcal{H}_p} a \sim e^{tH_p} a + \sum_{j \geq 1} \mathcal{E}_j(t) a, \quad (4.1.31)$$

which holds in the following sense. For all $\ell \in \mathbf{N}$, there exist integers $(k_{j_0, \ell})_{j_0 \in \mathbf{N}}$ and constants $(C_{j_0, \ell})_{j_0 \in \mathbf{N}}, (C'_{j_0, \ell})_{j_0 \in \mathbf{N}}$ such that for all $a \in S(m, g)$ and all $t \in [-T, T]$, we have

$$\left\{ \begin{array}{l} |e^{tH_p} a|_{S(m(t), g(t))}^{(\ell)} \leq C_{0, \ell} |a|_{S(m, g)}^{(k)}, \end{array} \right. \quad (4.1.32)$$

$$\left\{ \begin{array}{l} |\mathcal{E}_{j_0}(t) a|_{S(h_{g(t)}^{2j_0} m(t), g(t))}^{(\ell)} \leq C_{j_0, \ell} |\nabla a|_{S(m, g)}^{(k)}, \end{array} \right. \quad j_0 \geq 1 \quad (4.1.33)$$

$$\left\{ \begin{array}{l} \left| e^{t\mathcal{H}_p} a - e^{tH_p} a - \sum_{j=1}^{j_0} \mathcal{E}_j(t) a \right|_{S(h_{g(t)}^{2(j_0+1)} m(t), g(t))}^{(\ell)} \leq C'_{j_0+1, \ell} |\nabla a|_{S(m, g)}^{(k)}, \end{array} \right. \quad j_0 \geq 1. \quad (4.1.34)$$

The operators $\mathcal{E}_j(t)$ are described in Subsection 4.1.6. In addition, all the seminorm indices and constants in the above seminorm estimates depend on g , m and p only through structure constants of g and m , seminorms of p in the symbol classes (4.1.26), the constant C_Υ in (4.1.27) and on any constant c such that $\Lambda \geq c \underline{h}_g$.⁸ In particular, constants do not depend on \underline{h}_g .

We shall explain in Subsection 4.1.5.3 how to apply this result in a semiclassical setting.

8. The dependence on c degenerates as $c \rightarrow 0$. See Remark 4.1.21 for more details.

4.1.5. Comments

4.1.5.1. Comments on Assumption 4.1.13

A simple sufficient condition on p ensures that Assumption 4.1.13 is fulfilled.

Proposition 4.1.16 (Quantum and classical well-posedness). *Suppose that p is sub-quadratic with respect to an admissible metric g_0 , in the sense $\nabla^2 p \in S(1, g_0)$, and further assume that*

$$\exists E \in \mathbf{R} : \quad \sup_{\{p=E\}} |\nabla p|_{g_0} < \infty. \quad (4.1.35)$$

Then Assumption 4.1.13 is satisfied.

Proposition 4.1.16 is proved in Subsections 4.3.1 and 4.3.2.

Remark 4.1.17. In practice, we can check the assumptions of the above proposition as follows. In general, we take $g_0 = g^\sharp$ the symplectic intermediate metric associated with g (see Lemma 4.C.3 or [Ler10, Definition 2.2.19]). For any vector field X on T^*M , we have

$$\forall k \geq 2, \quad |\nabla^k p \cdot X^k| \leq h_g^{-1} |X|_g^k |\nabla^2 p|_{S(h_g^{-1}, g)}^{(k-2)} \leq |X|_{g^\sharp}^k |\nabla^2 p|_{S(h_g^{-1}, g)}^{(k-2)}, \quad (4.1.36)$$

because $h_g^{-1}g \leq g^\sharp$ by Lemma 4.C.3. Therefore it suffices to have

$$\nabla^2 p \in S(h_g^{-1}, g)$$

to conclude that $\nabla^2 p \in S(1, g_0)$. The same reasoning as in (4.1.36) for $k = 1$ shows that it suffices to check that

$$\exists E \in \mathbf{R} : \quad \sup_{\{p=E\}} h_g^{1/2} |\nabla p|_g < \infty$$

in order to secure (4.1.35).

Incidentally, observe that (4.1.35) is automatically fulfilled if p is semi-bounded, by choosing E sufficiently small or large so that $\{p = E\} = \emptyset$.

It sounds reasonable that for well-behaved Schrödinger operators, classical-mechanical and quantum-mechanical completeness should be more or less equivalent. We do not know whether this is true under Assumption 4.1.14. This is false for general Schrödinger operators in dimension 1, as evidenced by [RS75, Examples 1 and 2 – Appendix X.1].

The smoothness assumption is very classical in microlocal analysis. Although it rules out some interesting cases where the Hamiltonian contains irregular terms (for instance a rough potential), our assumptions allow for a fairly large class of Hamiltonians as illustrated in Subsection 4.1.7 below.

4.1.5.2. Comments on Assumption 4.1.14

We start with a general observation on the requirements of Assumption 4.1.14.

Remark 4.1.18 (Homogeneity). Observe that if Assumption 4.1.14 is verified for some metric g , then it is also satisfied with the metric $g(t)$ for any $t \in [0, T_E]$. Indeed, by definition, Λ is 0-homogeneous with respect to multiplication of the metric by a constant conformal factor. Likewise, the ratios h_g/\underline{h}_g and $\theta_g \underline{h}_g^{1/2}$ are 0-homogeneous. Finally, seminorms with respect to $g(t)$ decrease as t grows. The last assumption involving the parameter Υ is also invariant under scaling of the metric. As for the Ehrenfest time, one readily checks that it behaves as

$$T_E(g(t)) = T_E - |t|.$$

Next we observe that Assumption 4.1.14 implies temperate growth of p , that is to say

$$\exists n \geq 0, \exists \rho_0 \in T^*M : \forall \ell \in \mathbf{N}, \exists C_\ell > 0 : \forall \rho \in T^*M \quad |\nabla^\ell p|_{\mathbf{g}}(\rho) \leq C_\ell \langle \rho - \rho_0 \rangle_{\mathbf{g}}^n, \quad (4.1.37)$$

for some *Euclidean* metric \mathbf{g} on the phase space. This is the content of Lemma 4.C.1.

Now we discuss each point of Assumption 4.1.14.

Assumption (i)

The condition $\Lambda < \infty$ on the Lyapunov exponent implies that

$$(\phi^t)^* g \leq e^{2\Lambda|t|} g, \quad \forall t \in \mathbf{R}, \quad (4.1.38)$$

by a Grönwall argument, or equivalently

$$|d\phi^t|_g \leq e^{\Lambda|t|}, \quad \forall t \in \mathbf{R}.$$

The exponential expansion rate of the Hamiltonian flow is controlled uniformly on the whole phase space.

Remark 4.1.19 (Sub-quadraticity). We shall see in Proposition 4.4.6, assuming smoothness of p only, that

$$\Lambda \leq \sup_{T^*M} \left(h_g |\nabla^2 p|_g + \frac{1}{2} |\nabla_{H_p} g|_g \right).$$

Therefore in practice, to check that $\Lambda < \infty$, it will be sufficient to prove that

$$\nabla^2 p \in S((h_g/\underline{h}_g)^{-1}, g) \quad \text{and} \quad \sup_{T^*M} |\nabla_{H_p} g|_g < \infty. \quad (4.1.39)$$

The first condition on $\nabla^2 p$ can be regarded as a “sub-quadraticity” property of the Hamiltonian with respect to the metric g . The sub-quadraticity assumption is quite classical in the context of Egorov’s theorem (see Robert [Rob87, Theorem (IV-10)] for instance). Moreover, we make no ellipticity assumption (unlike [Zwo12, Chapter 11] for instance).

In fact for technical reasons we need to take into account both Υ and Λ to measure the instability of the Hamiltonian flow. This is why $\Lambda + 2\Upsilon$ appears in the definition (4.1.28) of $g(t)$ and of the Ehrenfest time T_E in (4.1.29). However, for a good and natural choice of g , we will have $\Upsilon = 0$ in many of cases (see the first two examples in Subsection 4.1.7).

It is not clear whether one can replace this definition of Λ in (4.1.25) with a weaker assumption on the maximal expansion:

$$\Lambda_0 = \limsup_{t \rightarrow \infty} \frac{1}{|t|} \log |d\phi^t|_{g, \infty}$$

(which is used for instance in [AN07, DG14, DJN22]). The problem lies in the fact that we need a control of the form $|d\phi^t|_g \leq C_\Lambda e^{\Lambda|t|}$ with a constant $C_\Lambda = 1$. It seems that having $C_\Lambda > 1$ poses a problem in Proposition 4.5.6 – see Remark 4.5.7.

Assumption (ii)

The stronger version of sub-quadraticity (4.1.26), which concerns all derivatives of p of order larger than 3, is intended control the time evolution both at the classical and quantum levels. It is useful in order to ensure that the non-local effects of quantum mechanics deviating from classical mechanics remain small. Notice that the condition on the third derivative $\nabla^3 p \in S((h_g/\underline{h}_g)^{-1}, g)$ was already more or less present in the work of Bony that we comment further in Subsection 4.1.10; see the section 3 of [Bon07, Bon09].

Assumption (iii)

The control of the metric along the Hamiltonian flow, involving the parameter Υ , is convenient in our analysis, and it is clearly verified in most cases of interest for us where $\nabla_{H_p} g = 0$ (i.e. $\Upsilon = 0$). However we will explain further in Remark 4.1.33 why this assumption is not so natural.

4.1.5.3. Comments on Theorem 4.1.15

Before commenting on Theorem 4.1.15, let us insist that it is a consequence of a more precise result on the propagation of partitions of unity adapted to the metric g . See Theorem 4.1.40 in Subsection 4.1.9.

- The assumption that $m(t)$ is $g(t)$ -admissible uniformly with respect to time can look annoying. In practice, the weight m is often a function of the Hamiltonian p , so that it is invariant by the flow: $m(t) = m$ for all times. Uniform admissibility on the time interval $[-T_E, T_E]$ then follows by Proposition 4.1.29 (see also Remark 4.1.30).

- If one wants to deal with more general weight functions, a good sufficient condition on m to ensure that it is uniformly admissible is to require that

$$\kappa := \sup_{T^*M} \frac{|\nabla_{H_p} m|}{m} < \infty.$$

Then $m(t)$ is uniformly $g(t)$ -admissible up to a fraction δT_E of the Ehrenfest time, with δ of order $\langle \kappa \rangle^{-1}$ —see Proposition 4.8.4 for details.

- Remark that the asymptotic expansion (4.1.31) of the symbol consists in powers of $h_{g(t)}^2$ and not in powers of $h_{g(t)}$; see (4.1.33). Actually this is just a matter of how the terms contained in $\mathcal{E}_j(t)a$ are arranged. Using pseudo-differential calculus, one can see that $\mathcal{H}_p^{(3)}$ contains powers of order ≥ 3 of h_g actually (recall this is a “non-local” operator). Thus, applying pseudo-differential calculus to decompose all the operators $\mathcal{H}_p^{(3)}$ and grouping terms by powers of $h_{g(t)}$ would yield an asymptotic expansion in powers of $h_{g(t)}^2, h_{g(t)}^3, h_{g(t)}^4$, etc. The fact that there is not term of order $h_{g(t)}$ is due to the use of the Weyl quantization. The operators $\mathcal{E}_j(t)$ are discussed in more detail in Subsection 4.1.6.

Remark 4.1.20 (Special case $\underline{h}_g = 1$). Recall that the uncertainty principle write $\underline{h}_g \leq 1$ (Definition 4.1.6). Obviously, a problem occurs when $\underline{h}_g = 1$, namely we end up with $T_E = 0$. A simple argument allows to remedy this problem, and show that Theorem 4.1.15 still holds for $t \in [-T, T]$ for any $T > 0$ fixed. To this aim, we consider the metric $e^{-T}g$ instead of g . Then one can check that $h_{e^{-T}g} = e^{-T}h_g$, so that

$$T_E(e^{-T}g) = T_E(g) + \frac{1/2}{\Lambda + 2\Upsilon}T.$$

Notice that changing g to $e^{-T}g$ leaves Λ and Υ unchanged since both quantities have the right homogeneity with respect to g . Scaling of the metric may increase seminorms of p , but this is not a problem as long as we do not seek to let T go to infinity.

Remark 4.1.21 (Semiclassical setting). In semiclassical analysis, one is concerned with an Hamiltonian $P = P_{\hbar} = -\hbar^2\Delta$ depending on a small Planck parameter $\hbar \in (0, 1]$. The Weyl–Hörmander framework can handle such a situation, although specific care is needed. In this setting, one is lead to study a family of metrics $(g_{\hbar})_{\hbar}$ (for instance $g_{\hbar} = dx^2 + \hbar^2 d\xi^2$). Uniformity of structure constants with respect to $\hbar \in (0, 1]$ is very important to make sure that constants do not depend on \hbar in an uncontrolled way.

Another delicate point is related to the semiclassical time scale. Usually, one considers the propagator $e^{-i\frac{\tau}{\hbar}P_{\hbar}}$ associated with P_{\hbar} with a “semiclassical time” $\tau = \hbar t$. Here we rather use the variable $t = \hbar^{-1}\tau$. If the Lyapunov exponent of the semiclassical scaling is of order $\lambda \asymp 1$, then because of the semiclassical time rescaling, the Lyapunov exponent Λ defined in (4.1.25) is typically of order $\hbar\lambda \asymp \hbar$. Therefore the Ehrenfest time is of order $\hbar^{-1} \log \hbar^{-1}$.

To ensure a uniform control in the Egorov asymptotics when t approaches the Ehrenfest time and $\hbar \rightarrow 0$, we need take care of the dependence of all the quantities involved in Assumption 4.1.14 on \underline{h}_g . Of course all the seminorms of $\nabla^3 p_{\hbar}$ measured with respect to g_{\hbar} should be uniform in \hbar . We also require that Υ and C_{Υ} are bounded independently of \hbar . As for Λ , we shall see in the proofs (for instance in Proposition 4.5.5) that it is natural to assume additionally that

$$\Lambda \geq c\underline{h}_g \tag{4.1.40}$$

for some absolute constant c , in order to have estimates uniform in \hbar . This is reasonable since we do not want the Ehrenfest time to grow faster than $\hbar^{-1} \log \hbar^{-1}$ as $\hbar \rightarrow 0$.

4.1.6. Egorov’s theorem as a Dyson series

The quantum and the classical dynamics introduced in Subsection 4.1.1 can be related through a so-called Dyson series expansion of $e^{t\mathcal{H}_p}$. The relevance of the Dyson series expansion comes from the fact that $\mathcal{H}_p^{(3)}$ introduced in (4.1.13) allows to gain smallness in terms of powers of h_g under Assumption 4.1.14. This formula arises naturally in the context of scattering theory or in the *interaction picture* of quantum mechanics (also known as the “Dirac picture”), where the generator of the dynamics under consideration (here \mathcal{H}_p) is a perturbation of the generator of the free dynamics

(here H_p). The formula relating the two propagators involves the conjugation of the perturbation by the free evolution, that is to say

$$\mathcal{H}_p(t) := e^{-tH_p} \mathcal{H}_p^{(3)} e^{tH_p} = \text{Ad}_{e^{tH_p}} \mathcal{H}_p^{(3)}.$$

Throughout the article, we denote by Δ_k the k -dimensional simplex

$$\Delta_k = \{(s_1, s_2, \dots, s_k) \in \mathbf{R}^k : 0 \leq s_1 \leq s_2 \leq \dots \leq s_k \leq 1\}, \quad (4.1.41)$$

and we set

$$t\Delta_k = \{ts \in \mathbf{R}^k : s \in \Delta_k\}, \quad t \in \mathbf{R}.$$

Typical points of the simplex $t\Delta_k$ will be denoted for simplicity by $\mathbf{s} = (s_1, s_2, \dots, s_k)$, and the Lebesgue measure restricted to $t\Delta_k$ will also be denoted by $ds = ds_1 ds_2 \dots ds_k$.

Proposition 4.1.22. *For any $j_0 \in \mathbf{N}$ and any time $t \in \mathbf{R}$, we have*

$$e^{t\mathcal{H}_p} = \sum_{j=0}^{j_0} \mathcal{E}_j(t) + \widehat{\mathcal{E}}_{j_0+1}(t), \quad (4.1.42)$$

where $\mathcal{E}_0(t) = e^{tH_p}$ and for $j \geq 1$:

$$\begin{aligned} \mathcal{E}_j(t) &= \int_{t\Delta_j} e^{(t-s_j)H_p} \mathcal{H}_p^{(3)} e^{(s_j-s_{j-1})H_p} \mathcal{H}_p^{(3)} \dots \mathcal{H}_p^{(3)} e^{s_1 H_p} ds \\ \widehat{\mathcal{E}}_j(t) &= \int_{t\Delta_j} e^{(t-s_j)\mathcal{H}_p} \mathcal{H}_p^{(3)} e^{(s_j-s_{j-1})H_p} \mathcal{H}_p^{(3)} \dots \mathcal{H}_p^{(3)} e^{s_1 H_p} ds. \end{aligned}$$

The equality holds as operators $\mathcal{S}(T^*M) \rightarrow L^2(T^*M)$, and the integrals converge absolutely with respect to the strong topology on L^2 .

Proposition 4.1.22 is proved in Subsection 4.6.1. A key step to prove Theorem 4.1.15 will be to prove continuity estimates for the operators $\mathcal{E}_j(t)$ in symbol classes; see Proposition 4.5.5. Throughout the paper, we will use the notation

$$\mathcal{E}_{\leq j_0}(t) := \sum_{j=0}^{j_0} \mathcal{E}_j(t).$$

Remark 4.1.23 (Recurrence relation). It follows directly from the definition that for all $j \geq 0$:

$$\mathcal{E}_{j+1}(t) = \int_0^t e^{(t-s)H_p} \mathcal{H}_p^{(3)} \mathcal{E}_j(s) ds \quad \text{and} \quad \widehat{\mathcal{E}}_{j+1}(t) = \int_0^t e^{(t-s)\mathcal{H}_p} \mathcal{H}_p^{(3)} \mathcal{E}_j(s) ds \quad (4.1.43)$$

Remark 4.1.24. To obtain estimates uniform in time on these symbols, it will be important not to forget that the volume of the simplex is $|t\Delta_j| = t^j/j!$.

4.1.7. Examples of application

In this section, we present three different settings in which Theorem 4.1.15 applies, namely a Schrödinger equation in the Euclidean space, a (half-)wave equation in a curved space and a transport equation. In each of these cases, we describe appropriate metrics g on the phase space to which we can apply Theorem 4.1.15.

To ease the understanding of the computations presented in this subsection, let us discuss briefly the structure of the phase space T^*M . We have a natural splitting of the tangent space to T^*M :

$$TT^*M \simeq TM \oplus T^*M. \quad (4.1.44)$$

The first component is parallel to M , while the second one is perpendicular to M in the sense that it is tangent to the fibers of T^*M . See the beginning of Section 4.9 for more details.

4.1.7.1. Semiclassical Schrödinger operator in the (flat) Euclidean space

We equip M with a fixed Euclidean structure γ . Consider a semiclassical Schrödinger operator with flat Laplacian, electric and magnetic potentials V and β , i.e.

$$P = \frac{1}{2} \left| \frac{\hbar}{i} \partial - \beta \right|_{\gamma}^2 + V = -\frac{\hbar^2}{2} \Delta - \frac{1}{i} \partial \cdot \beta - \frac{\hbar}{2i} \operatorname{div} \beta + \frac{1}{2} |\beta|_{\gamma}^2 + V, \quad (4.1.45)$$

acting on Schwartz functions. The Planck parameter is such that $\hbar \in (0, 1]$. Here, ∂ refers to the gradient with respect to the Euclidean metric γ , the divergence is its adjoint with respect to the γ inner product and $\Delta = \Delta_{\gamma}$ is the flat Laplacian associated with γ on M .

Proposition 4.1.25. *As soon as V and β have temperate growth, we have*

$$P = \operatorname{Op}^w(p) \quad \text{with} \quad p(x, \xi) = \frac{\hbar^2}{2} |\xi|_{\gamma^{-1}}^2 - \hbar \xi \cdot \beta + \frac{1}{2} |\beta|_{\gamma}^2 + V(x).$$

Moreover, assume the following on the magnetic and electric potentials.

- The vector potential $\beta : M \rightarrow TM$ is an affine vector field, namely $\nabla^2 \beta = 0$.
- The electric potential $V : M \rightarrow \mathbf{R}$ is sub-quadratic, namely

$$\forall k \geq 0, \quad \sup_{T^*M} |\nabla^{2+k} V|_{\gamma} < \infty. \quad (4.1.46)$$

and bounded from below.

Then Assumption 4.1.13 is satisfied, as well as Assumption 4.1.14 with the metric

$$g = g_{\hbar} = \gamma \oplus \hbar^2 \gamma^{-1}, \quad (4.1.47)$$

uniformly with respect to $\hbar \in (0, 1]$.

Proposition 4.1.25 is proved in Subsection 4.9.1. This result gives a *global* Egorov's theorem, meaning that it describes the quantum evolution of symbols defined globally on phase space, and not only in the vicinity of an energy shell.

Remark 4.1.26. The gain function associated with g_{\hbar} is the semiclassical parameter $h_{g_{\hbar}} = h_{g_{\hbar}} = \hbar$. The Lyapunov exponent defined in (4.1.25) is then of order $\Lambda = \Lambda_{\hbar} \approx \hbar$, so that the Ehrenfest time (4.1.29) behaves like $\hbar^{-1} \log \hbar^{-1}$ (or more classically of order $\log \hbar^{-1}$ in the semiclassical time scale).

In view of this remark, Proposition 4.1.25 yields for example the following result. In the usual semiclassical symbol class $S(1, g_{\hbar})$ (see [Ler10, (1.1.33)] or [Zwo12, (4.4.4)] with a different convention), it reads: for all $a \in S(1, g_{\hbar})$, we have

$$e^{i\frac{\tau}{\hbar} P} \operatorname{Op}^w(a) e^{-i\frac{\tau}{\hbar} P} = \operatorname{Op}^w(a(\tau))$$

where $a(\tau) \in S(1, g_{\hbar}(\tau \hbar^{-1}))$ with seminorm estimates uniform with respect to (τ, \hbar) subject to $|\tau| \leq \epsilon \log \hbar^{-1}$, where ϵ is a small enough constant. In particular, the family of symbols $a(\tau)$ belongs to a bounded subset of $S(1, \bar{g}_{\hbar})$ where

$$\bar{g}_{\hbar} = \hbar^{-2\delta} \gamma \oplus \hbar^{2(1-\delta)} \gamma^{-1},$$

for some parameter $\delta \in [0, 1/2]$.

Let us comment on the “non-semiclassical” case (\hbar fixed or $\hbar = 1$).

- The metric g in (4.1.47) is roughly speaking the only relevant one to consider here. Indeed, the second derivative of p with respect to ξ , namely $(\nabla^2 p)_{\xi\xi} = \gamma^{-1}$, which is constant on the whole phase space, hence does not get small in any phase space region. Therefore, one cannot go down to smaller scales in x , otherwise the uncertainty principle ($h_g \leq 1$) would be violated. See Figure 4.1 for an illustration.
- It is very important here that the metric γ is perfectly flat. This was already evidenced in our earlier work [Pro23] on the observability of the Schrödinger equation. The fact that $\nabla \gamma = 0$ ensures that the position and momentum variables are somewhat “separated”. If it is not the case, the second derivative with respect to x , namely $(\nabla^2 p)_{xx}$, contains a term of the form

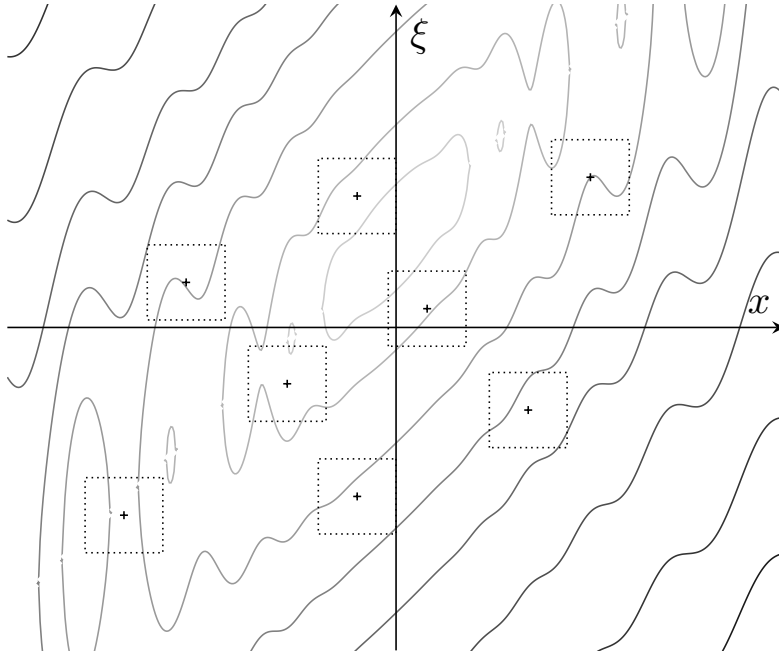

Figure 4.1 – Level sets of the classical Hamiltonian p defined in dimension 1 by (4.1.45), with a confining potential V and $\nabla\beta$ constant. Dotted lines represent the unit boxes of the metric introduced in (4.1.47) $g_1 = \gamma \oplus \gamma^{-1}$ (i.e. the product of unit balls of γ and γ^{-1}). These boxed are squares with sidelength ≈ 1 that saturate the uncertainty principle $h_{g_1} \leq 1$.

$\nabla^2 \gamma^{-1}(\xi, \xi)$, which may blow up like $\langle \xi \rangle_{\gamma^{-1}}^2$ at fiber infinity. To have boundedness of the second derivative of p with respect to g , this would force us to chose g of the form

$$g = \langle \xi \rangle_{\gamma^{-1}}^2 \gamma \oplus \gamma^{-1},$$

which strongly violates the uncertainty principle since then $h_g \approx \langle \xi \rangle_{\gamma^{-1}}$. This is related to the infinite speed of propagation of singularities for the Schrödinger equation: frequencies ξ propagate at speed of the order of $\langle \xi \rangle_{\gamma^{-1}}$, so that they see an effective Lyapunov exponent of order $\langle \xi \rangle_{\gamma^{-1}} \Lambda$ instead of Λ while propagating along bicharacteristics. This is a clear obstruction to having a *global* Egorov's theorem. The only way to make it work would be to truncate the Hamiltonian in the vicinity of a fixed energy shell and reduce our investigation to frequency-localized symbols.

The Egorov's theorem that we obtain in Theorem 4.1.15 is perfectly consistent with the work of Bouzouina and Robert [BR02] (see also Robert [Rob87, Theorem (IV-10)]). Notice that the boundedness of derivatives of order larger than 2 (4.1.46) was already required there; see [BR02, Theorem 1.2 (9)] or [Rob87, Theorem (IV-10) ii)]. Our result generalizes their work by considering symbol classes with general weight functions m , instead of symbols a satisfying $\nabla a \in S(1, g_{\hbar})$ as in [BR02, Theorem 1.2 (11)]. In addition, we not only provide an asymptotic expansion but also prove that the full symbol belongs to the expected symbol class. Lastly, Theorem 4.1.40 on the quantum evolution of partitions of unity is new even in this context to our knowledge.

4.1.7.2. Half-wave operator in a curved space

Proofs of the results presented here can be found in Subsection 4.9.2.

As explained in the previous section, if one wants to consider a curved geometry on M instead of a Euclidean structure, it is hopeless to look for a global Egorov's theorem for the Laplace–Beltrami operator (unless we consider only symbols supported near a fixed energy shell). However, considering the wave operator instead of the Schrödinger operator, i.e. passing from $-\Delta$ (Schrödinger) to $\sqrt{-\Delta}$ (waves), brings us back in a setting where there exists admissible metrics fulfilling our assumptions. The reason for this is that we go from infinite speed of propagation of energy for $e^{it\Delta}$ to finite speed of propagation for $e^{-it\sqrt{-\Delta}}$.

So here we put a smooth Riemannian metric γ on M (not necessarily flat). We assume that it satisfies

$$\exists C_\gamma > 0 : \forall x_1, x_2 \in M, \quad \gamma_{x_1} \leq C_\gamma^2 \gamma_{x_2} \quad \text{and} \quad \forall k \in \mathbf{N}, \quad \sup_M |\nabla^k \gamma|_\gamma < \infty. \quad (4.1.48)$$

This implies in particular a uniform control of the form $c^{-2} \leq \gamma \leq c^2 I$. This includes metrics with no specific asymptotic behavior at space infinity.

The Riemannian manifold (M, γ) carries a natural volume form Vol_γ , and the Laplace–Beltrami operator Δ_γ acting on compactly supported smooth functions (or Schwartz functions). Fixing (global) Euclidean coordinates on M , it reads

$$\Delta_\gamma = |\gamma|^{-1/2} \partial_j \gamma^{ij} |\gamma|^{1/2} \partial_i,$$

where repeated indices are summed according to Einstein convention. In this expression, $|\gamma|$ refers to the determinant of γ with respect to the chosen Euclidean coordinate system, so that $d\text{Vol}_\gamma = |\gamma|^{1/2} dx$, and γ^{ij} are the matrix components of γ^{-1} . The operator Δ_γ is seen naturally as an unbounded operator on the Hilbert space $L^2(M, \text{Vol}_\gamma)$. To fit this in our setting, we need to construct from Δ_γ an operator that acts on $L^2(M)$. This is done by identifying elements $v \in L^2(M, \text{Vol}_\gamma)$ with functions $u \in L^2(M)$ through the correspondence

$$\begin{aligned} L^2(M, \text{Vol}_\gamma) &\longrightarrow L^2(M) \\ v &\longmapsto v|\gamma|^{1/4} = u. \end{aligned}$$

One can check that this is an isometry (provided the chosen volume element on $L^2(M)$ and the coordinate we consider agree). Through this identification, the Laplace–Beltrami operator gets conjugated by $|\gamma|^{1/4}$ and we obtain

$$\tilde{\Delta}_\gamma = |\gamma|^{1/4} \Delta_\gamma |\gamma|^{-1/4} = |\gamma|^{-1/4} \partial_j \gamma^{ij} |\gamma|^{1/2} \partial_i |\gamma|^{-1/4}. \quad (4.1.49)$$

The operator $-\tilde{\Delta}_\gamma$ is indeed symmetric with respect to the scalar product of $L^2(M)$, while Δ_γ is symmetric for the scalar product of $L^2(M, \text{Vol}_\gamma)$.

In Subsection 4.9.2, we prove that $-\tilde{\Delta}_\gamma = \text{Op}^w(p)$ with

$$p(x, \xi) = |\xi|_{\gamma_x^{-1}}^2 + R_\gamma(x),$$

where $R_\gamma \in C_b^\infty(M)$. See Lemma 4.9.3 for the expression of the remainder R_γ .

Recall the fact that

$$\partial_t^2 - \Delta_\gamma = \left(\partial_t - i\sqrt{-\Delta_\gamma} \right) \left(\partial_t + i\sqrt{-\Delta_\gamma} \right),$$

the study of the wave equation in this context reduces⁹ to that of the evolution associated with the operator

$$|\gamma|^{1/4} \sqrt{-\Delta_\gamma} |\gamma|^{-1/4} = \sqrt{-\tilde{\Delta}_\gamma}.$$

We show in Lemma 4.9.7 (Subsection 4.9.2) that the operator $\text{Op}^w(\langle \xi \rangle_{\gamma^{-1}})$ is a good approximation of $\sqrt{-\tilde{\Delta}_\gamma}$. Indeed, putting the Japanese bracket instead of $|\xi|_{\gamma^{-1}}$ ensures smoothness of the symbol. Thus in this subsection we consider the operator

$$P = \text{Op}^w(p) \quad \text{with} \quad p(x, \xi) = \langle \xi \rangle_{\gamma_x^{-1}}. \quad (4.1.50)$$

The main result of this subsection is the following.

Proposition 4.1.27. *Under the assumptions (4.1.48), the symbol p defined in (4.1.50) satisfies Assumptions 4.1.13 and 4.1.14 with the family of metrics*

$$g_{(x,\xi)} = \langle \xi \rangle_{\gamma_x^{-1}}^{1-\alpha} \gamma_x \oplus \langle \xi \rangle_{\gamma_x^{-1}}^{-(1+\alpha)} \gamma_x^{-1} = \frac{1}{p^\alpha} (p\gamma_x \oplus p^{-1}\gamma_x^{-1}), \quad \alpha \in [0, 1]. \quad (4.1.51)$$

9. We refer to [DL09, LL16, L 23] for more details on this factorization.

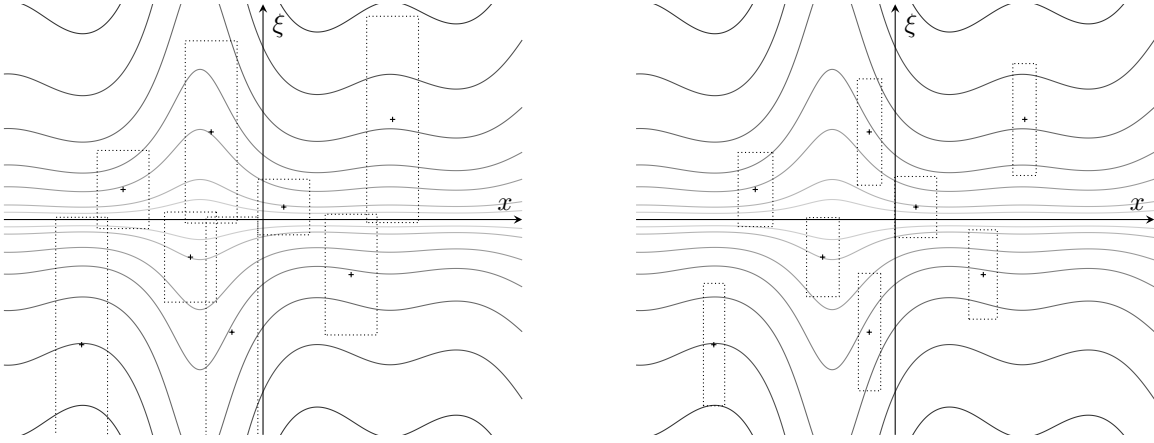

(a) Case $\alpha = 1$. The unit boxes have sidelength ≈ 1 in the space variable and $\approx \langle \xi \rangle_{\gamma-1}$ in the momentum variable. Their area increases as their center goes away from the null section $\{\xi = 0\}$. This is consistent with the expression of the gain function $h_g(x, \xi) \approx \langle \xi \rangle_{\gamma-1}^{-1}$ associated with this metric.

(b) Case $\alpha = 0$. The unit boxes have sidelength $\approx \langle \xi \rangle_{\gamma-1}^{-1/2}$ in the space variable and $\approx \langle \xi \rangle_{\gamma-1}^{1/2}$ in the momentum variable. Their area is of order 1, which illustrates the fact that the metric saturates the uncertainty principle $h_g \leq 1$.

Figure 4.2 – Level sets of the classical Hamiltonian $p(x, \xi) = \langle \xi \rangle_{\gamma-1}$. Dotted lines represent unit boxes of the metric g defined in (1.4.30). They correspond to products of unit balls of γ_1 and γ_2 associated with the decomposition $g = \gamma_1 \oplus \gamma_2$ in (1.4.30).

Theorem 4.1.15 in this context and for a weight $m = \langle \xi \rangle^n$ ($n \in \mathbf{R}$) reads as follows: for any $a \in S(\langle \xi \rangle^n, g)$, the family $a(t)$ such that

$$e^{itP} \text{Op}^w(a) e^{-itP} = \text{Op}^w(a(t))$$

remains in a bounded subset of $S(\langle \xi \rangle^n, g)$ for all $t \in [-T, T]$, for any fixed $T > 0$. We recover a result stated by Taylor [Tay91, Section 6, Proposition 6.3.B] in the symbol classes

$$S_{\rho, \delta}^n = \left\{ a \in C^\infty(\mathbf{R}^{2d}) : \forall \beta_1, \beta_2 \in \mathbf{N}^d, \exists C_{\beta_1, \beta_2} > 0 : \left| \partial_x^{\beta_2} \partial_\xi^{\beta_1} a(x, \xi) \right| \leq C_{\beta_1, \beta_2} \langle \xi \rangle^{n - \rho|\beta_1| + \delta|\beta_2|} \right\}.$$

(See also [Tay96, Chapter 7, Section 8] for a simpler version.) Our result clarifies the range of admissible indices $\rho = 1 - \delta > 1/2$ (here we have $\alpha = \rho - \delta$). In fact we can reach the boundary case $\rho = 1 - \delta = 1/2$ corresponding to $\alpha = 0$ in Proposition 4.1.27). Moreover, Theorem 4.1.15 is valid for more general g -admissible weight functions and is not restricted to $m(x, \xi) = \langle \xi \rangle^n$.

The two boundary cases $\alpha = 1$ and $\alpha = 0$ are of particular interest.

- The metric g for $\alpha = 1$, namely

$$g = \gamma \oplus \frac{1}{\langle \xi \rangle_{\gamma-1}^2} \gamma^{-1}$$

is the most common one in microlocal analysis (it corresponds to $S_{\rho, \delta}$ with $\rho = 1$ and $\delta = 0$). This is the “principal microlocal scale”, namely the most natural way to put a metric on phase space while studying the wave equation. See Figure 4.2a for an illustration.

- The case $\alpha = 0$, i.e.

$$g = \langle \xi \rangle_{\gamma-1} \gamma \oplus \frac{1}{\langle \xi \rangle_{\gamma-1}} \gamma^{-1}$$

corresponds to a *second-microlocal* scale of propagation of waves. It is related to [BZ16, BG20, Rou23] on the (damped) wave equation, mostly in a semiclassical setting. The key fact is that a $o(h)$ -quasimode of typical frequency $\langle \xi \rangle_{\gamma-1} \asymp h^{-1}$ cannot concentrate at scales smaller than \sqrt{h} . See Figure 4.2b for an illustration.

4.1.7.3. Vector field

Our last application concerns differential operators of order 1, namely vector fields. These are quite different from the previous cases for several reasons. The first difference with the examples discussed in Subsections 4.1.7.1 and 4.1.7.2 is that vector fields are not semibounded nor elliptic. The other interesting feature is that the relevant metric on phase space that we introduce is not invariant by the Hamiltonian flow, contrary to the first two examples discussed above.

Although the analysis of such operators seems to fall under classical mechanics at first glance, microlocal techniques have proved very powerful and natural in this context, as evidenced e.g. by the works of Faure–Sjöstrand [FS11], Dyatlov–Zworski [DZ16] and Faure–Tsuji [FT23a, FT23b].

In what follows, we place ourselves in the following setting: a vector field on (the non-compact manifold) M , bounded with respect to a fixed Euclidean metric. We first consider the case of a vector field X on M that is non-vanishing and preserves a smooth density $\mu = |\mu| dx$, in such a way that the derivation operator $\frac{1}{i}X$ acting on compactly supported functions is symmetric as an operator on $L^2(M, \mu)$. To fit in our framework, we identify $L^2(M, \mu)$ and $L^2(M)$ via

$$\begin{aligned} L^2(M, \mu) &\longrightarrow L^2(M) \\ u &\longmapsto u|\mu|^{1/2}. \end{aligned}$$

This is an isometric isomorphism provided $|\mu|$ does not vanish. Then the operator $\frac{1}{i}X$ gets conjugated by $|\mu|^{1/2}$, so that it acts on $L^2(M)$ as

$$\frac{1}{i}|\mu|^{1/2}X|\mu|^{-1/2} = \frac{1}{i}X - \frac{1}{2i}(X \log|\mu|). \quad (4.1.52)$$

In Lemma 4.9.8, we compute the logarithmic derivative of $|\mu|$, which reads $X \log|\mu| = -\operatorname{div} X$. Therefore the operator of interest here is

$$P = \frac{1}{i}X + \frac{1}{2i}\operatorname{div} X, \quad (4.1.53)$$

which is symmetric as an operator on $L^2(M)$. We will consider this operator for an arbitrary vector field X (that can possibly vanish). The only assumption that we make is that

$$\forall k \in \mathbf{N}, \quad \sup_M |\nabla^k X|_\gamma < \infty \quad (4.1.54)$$

for some Euclidean metric γ on M . The main result of this subsection is the following.

Proposition 4.1.28. *With P in (4.1.53), we have*

$$P = \operatorname{Op}^w(p) \quad \text{with} \quad p(x, \xi) = \xi \cdot X(x). \quad (4.1.55)$$

Moreover, assuming (4.1.54) and Assumptions 4.1.13 and 4.1.14 are satisfied with the metric

$$g_{(x, \xi)} = \langle \xi \rangle_{\mathbf{g}^{-1}}^{2\alpha_1} \mathbf{g} \oplus \langle \xi \rangle_{\mathbf{g}^{-1}}^{-2\alpha_2} \mathbf{g}^{-1}, \quad (4.1.56)$$

where the parameters α_1 and α_2 are subject to

$$0 \leq \alpha_1 \leq \alpha_2 \leq 1, \quad \alpha_1 + \alpha_2 \geq 1 \quad \text{and} \quad \alpha_1 < 1. \quad (4.1.57)$$

The proof of this results is presented in Subsection 4.9.3. Notice that the conjugated operator $e^{itP}\operatorname{Op}^w(a)e^{-itP}$ can be described explicitly in the case where $a = a(x)$ depends only on the position variable. Indeed, we have by Duhamel's formula:

$$e^{-itP}u = \exp\left(-\frac{1}{2}\int_0^t e^{-sX}(\operatorname{div} X) ds\right)e^{-tX}u, \quad \forall u \in \mathcal{S}(M),$$

and one can then check that

$$e^{itP}\operatorname{Op}^w(a(x))e^{-itP} = \operatorname{Op}^w(e^{tX}a).$$

This is an instance of exact Egorov's theorem related to the fact that the Hamiltonian (4.1.55) is linear in the momentum variable (derivatives of order larger than 2 with respect to ξ vanish).

Therefore, the main interest of our result concerns the evolution of observables depending on both variables x and ξ . In this context, Theorem 4.1.15 gives the following, say in the symbol class $S(1, g)$: for any $a \in S(1, g)$, we have

$$e^{itP} \text{Op}^w(a) e^{-itP} = \text{Op}^w(a(t)),$$

where the family of symbols $a(t)$ remains in a bounded subset of $S(1, g)$ for all $t \in [-T, T]$ with fixed $T > 0$.

In [FT23a, FT23b], Faure and Tsujii introduce a specific family of metrics on the phase space to study flows of Anosov vector fields on compact manifolds. The principal symbol of the Hamiltonian that the authors consider is the same as ours, namely $\xi \cdot X(x)$. To define the relevant metrics adapted to the dynamics, they introduce flow box coordinates: position and momentum variables split into perpendicular and parallel components

$$x = (x_\perp, x_\parallel) \in \mathbf{R}^{d-1} \times \mathbf{R}, \quad \xi = (\xi_\perp, \xi_\parallel) \in \mathbf{R}^{d-1} \times \mathbf{R},$$

in such a way that the vector field X generating the flow corresponds to $-X = \partial_{x_\parallel}$. Then the family of metrics that they consider is defined as

$$g_{(x, \xi)} = \langle \xi \rangle^{2\alpha^\perp} dx_\perp^2 + \frac{1}{\langle \xi \rangle^{2\alpha^\perp}} d\xi_\perp^2 + \langle \xi \rangle^{2\alpha^\parallel} dx_\parallel^2 + \frac{1}{\langle \xi \rangle^{2\alpha^\parallel}} d\xi_\parallel^2, \quad (4.1.58)$$

in those coordinates. The parameters $\alpha_\perp, \alpha_\parallel$ satisfy

$$0 \leq \alpha^\parallel \leq \alpha^\perp < 1 \quad \text{and} \quad \frac{1}{2} \leq \alpha_\perp < 1.$$

These conditions ensure that changing charts does not affect the metric, up to a global conformal factor (actually they define an equivalence class of metrics invariant under flow box coordinates changes). A relevant choice of these parameters then allows Faure and Tsujii to describe the Ruelle spectrum of the flow and analyze the corresponding resonant states.

Conditions (4.1.57) implies in particular that $\alpha_2 \geq 1/2$. The metric of Faure and Tsujii (4.1.58) is symplectic, which means that $g = g^\sigma$. In our case, the metric g defined in (4.1.56) is symplectic when $\alpha_1 = \alpha_2$, and then it coincides with Faure and Tsujii's one if we take $\alpha_\parallel = \alpha_\perp$ there. An interesting feature of Faure and Tsujii's metric (4.1.58) is the fact that it is adapted to X in the sense that it allows measurements at different scales in the direction of the flow and in the transverse direction. It is not clear how to reproduce such an anisotropy in our framework. This is certainly due to the subtle construction of Faure and Tsujii using flow box coordinates, while we work in a global Euclidean coordinate system.

4.1.8. More on admissibility of phase space metrics

In this article, we work with a metric g on the phase space, but we will see that the metric $g(t)$ introduced in (4.1.28) will arise naturally while considering the action of the Hamiltonian flow e^{tH_p} on symbol classes. Indeed, $g(t)$ is a metric conformal to g , for which (4.1.38) holds. In the Weyl–Hörmander framework, the Ehrenfest time (4.1.29) arises as the time from which admissibility of $g(t)$ breaks down, due to the failure of the uncertainty principle $h_{g(t)} \leq 1$. The purpose of the proposition below is to ensure that the family of metrics $g(t)$ is uniformly admissible, namely its structure constants are uniform with respect to $t \in [-T_E, T_E]$. It involves the so-called *symplectic intermediate metric* g^\natural , which is defined as the geometric mean of g and g^σ (we refer to [Ler10, Definition 2.2.19] for a precise definition since the notion of geometric mean for quadratic forms is quite involved). The main properties of g^\natural is that it is symplectic, namely $g^\natural = (g^\natural)^\sigma$, and

$$g \leq h_g g^\natural \leq g^\natural = (g^\natural)^\sigma \leq \frac{1}{h_g} g^\natural \leq g^\sigma. \quad (4.1.59)$$

Proposition 4.1.29 (Improved admissibility – [Ler10, Proposition 2.2.20]). *Let g be an admissible metric. Then there exist $r_g \in (0, 1]$, $C_g > 0$, $N_g \geq 0$ such that*

$$\forall t \in \mathbf{R}, \forall \rho_0, \rho \in T^*M, \quad g_\rho(t) \leq C_g^2 \left\langle \text{dist}_{(g_{\rho_0}^\natural + g_\rho^\natural)^\sigma} \left(B_{r_g}^g(\rho_0), B_{r_g}^g(\rho) \right) \right\rangle^{2N_g} g_{\rho_0}(t). \quad (4.1.60)$$

Similarly, for any g -admissible weight m , there exist $r \in (0, 1]$, $C > 0$, $N \geq 0$ such that

$$\forall \rho_0, \rho \in T^*M, \quad m(\rho) \leq C^2 \left\langle \text{dist}_{(g_{\rho_0}^{\natural} + g_{\rho}^{\natural})^\sigma} (B_r^g(\rho_0), B_r^g(\rho)) \right\rangle^{2N} m(\rho_0), \quad (4.1.61)$$

with constants C, r, N depending only on structure constants of g and m .

This improved admissibility property is a consequence of a stronger form of temperance involving the metric g^{\natural} (see Lemma 4.C.3 in Appendix 4.C.4).

Remark 4.1.30 (Uniform admissibility of the metrics $g(t)$). By σ -duality (4.1.20), the estimate (4.1.60) holds replacing $g_\rho(t)$ and $g_{\rho_0}(t)$ with $g_\rho^\sigma(t)$ and $g_{\rho_0}^\sigma(t)$ respectively. We also provide less precise upper bounds for the right-hand side of (4.1.60) and (4.1.61) that will be useful throughout the paper. From (4.1.59), we have $g^{\natural} \geq \frac{h_g}{h_g} g^{\natural} \geq h_g^{-1} g \geq g(t) \geq g$ for all $|t| \leq T_E$, so that

$$\begin{aligned} \text{dist}_{(g_{\rho_1}^{\natural} + g_{\rho_2}^{\natural})^\sigma} (B_r^g(\rho_1), B_r^g(\rho_2)) &\leq \text{dist}_{(g_{\rho_1} + g_{\rho_2})^\sigma} (B_r^g(\rho_1), B_r^g(\rho_2)) \leq \min_{j \in \{1, 2\}} \text{dist}_{g_{\rho_j}^\sigma} (B_r^g(\rho_1), B_r^g(\rho_2)) \\ &\leq \min_{j \in \{1, 2\}} |\rho_2 - \rho_1|_{g_{\rho_j}^\sigma}. \end{aligned}$$

In particular, (4.1.60) and (4.1.61) can be seen as a compact way of writing both slow variation and temperance properties (Definitions 4.1.6 and 4.1.7) with a single inequality. Lastly, $g(t)$ satisfies the uncertainty principle for all $t \in [0, T_E]$, since by definition of the gain function (Definition 4.1.5) and of the Ehrenfest time (4.1.29):

$$h_{g(t)} = \sup_{\zeta \in W \setminus \{0\}} \frac{e^{(\Lambda+2\Upsilon)|t|} |\zeta|_{g_\rho}}{e^{-(\Lambda+2\Upsilon)|t|} |\zeta|_{g_\rho^\sigma}} = e^{2(\Lambda+2\Upsilon)|t|} h_g \leq e^{2(\Lambda+2\Upsilon)T_E} h_g = 1.$$

From now on, we fix $r_g \in (0, 1]$, $C_g > 0$ and $N_g \geq 0$ common structure constants of the family of metrics $g(t)$, $t \in [-T_E, T_E]$, i.e. Definition 4.1.6 is satisfied by $g(t)$ with these constants r_g, C_g, N_g . We will often call r_g a slow variation radius and C_g the slow variation constant of g . See Appendix 4.C.3 for more information on slow variation radii.

We proceed with a sanity check on temperance weights.

Proposition 4.1.31. *The temperance weight θ_g defined in Definition 4.1.11 is a g -admissible weight. Moreover r_g (introduced above) is a slow variation radius of θ_g . If θ'_g is the temperance weight defined with a flat metric \mathbf{g}' instead of \mathbf{g} , one has*

$$\exists C = C(\mathbf{g}, \mathbf{g}') > 0: \quad C^{-1} \theta_g \leq \theta'_g \leq C \theta_g \quad \text{on } T^*M. \quad (4.1.62)$$

Proposition 4.1.31 says that the temperance weight θ_g is essentially independent of the chosen background euclidean metric in its definition. The temperance weight and the gain function are somewhat related through the following observation.

Proposition 4.1.32. *The following holds:*

$$\forall \rho_0, \rho \in T^*M, \quad g_\rho^\sigma \leq \theta_g(\rho_0) \theta_g(\rho) g_{\rho_0}.$$

Moreover, one has

$$h_g \times \theta_g^2 \geq 1.$$

In particular, $\theta_g \geq 1$ provided g satisfies the uncertainty principle $h_g \leq 1$.

These results are proved in Appendix 4.C.

We end this subsection with a discussion on possible improvements regarding Assumption 4.1.14.

Remark 4.1.33. The following two assumptions could perhaps be relaxed.

- First, the introduction of the temperance weight θ_g relies on the choice of a background Euclidean metric \mathbf{g} . Hence it is not an intrinsic feature of the metric g . However it is crucial in our argument in order to apply Beals theorem. Roughly speaking, it allows to handle derivatives of the propagator $\text{ad}_F e^{-itP}$ with $F = \text{Op}^W(f)$ being the quantization of an affine function f (see the symbols of the form c_π in Corollary 4.6.7). It ensures that the long-range effects of the possible blow up of the metric at phase space infinity (i.e. θ_g unbounded), in connection with the non-local nature of quantum mechanics, are balanced by the gain $\theta_g^{-\epsilon}$ appearing at each step of the Egorov expansion (4.1.31).

- Second, the use of θ_g seems to require an estimate of the growth of the metric along the flow, hence the importance of the parameter Υ introduced in Assumption 4.1.14 (iii). Proposition 4.5.1 is quite illuminating in this respect: the gain function h_g is defined intrinsically, and understanding $e^{tH_p}h_g$ only requires the very natural control (4.1.38), whereas θ_g requires the choice of a background Euclidean metric, and understanding $e^{tH_p}\theta_g$ involves the extra assumption on the growth of g_{ϕ^t} .

4.1.9. Propagation of quantum partitions of unity

Theorem 4.1.15 is in fact a consequence of the more general Theorem 4.1.40 below, namely an Egorov's theorem for confined family of symbols. We introduce first partitions of unity adapted to an admissible metric g .

Throughout this paper, given a quadratic form q , we denote by

$$\text{dist}_q(\rho_1, \rho_2) = |\rho_2 - \rho_1|_q$$

the distance between ρ_1 and ρ_2 for the constant metric equal to q . This definition naturally extends to distances between points and sets or between two sets.

Proposition 4.1.34 (Existence of partitions of unity – [Ler10, Theorem 2.2.7]). *Let g be an admissible metric. Let $r_g > 0$ be the slow variation radius given in Proposition 4.1.29. There exists $r_g > 0$ such that for any $r \in (0, r_g)$, there exists a family of functions $(\varphi_{\rho_0})_{\rho_0 \in T^*M}$ uniformly in $S(1, g)$, namely*

$$\sup_{\rho_0 \in T^*M} |\varphi_{\rho_0}|_{S(1, g)}^{(\ell)} < \infty, \quad \forall \ell \in \mathbf{N}, \quad (4.1.63)$$

such that for all $\rho_0 \in T^*M$, $\text{supp } \varphi_{\rho_0} \subset B_r^g(\rho_0)$ and

$$\forall \rho \in T^*M, \quad \int_{T^*M} \varphi_{\rho_0}(\rho) d\text{Vol}_g(\rho) = 1. \quad (4.1.64)$$

More precisely, there exists a constant c depending only on structure constants of g such that

$$\forall \ell \in \mathbf{N}, \forall \rho_0 \in T^*M, \forall r \in (0, r_g), \quad |\nabla^\ell \varphi_{\rho_0}|_{g, \infty} \leq cr^{-\ell-2 \dim M}. \quad (4.1.65)$$

Remark 4.1.35. The r -dependent estimate (4.1.65) is not given in Lerner's book, but it follows from the proof. To convince oneself that this is the good scaling with respect to r , one can argue as follows: if we take a smooth function χ supported in $B_{r_g}^g(\rho_0)$, then the function $\chi_r = \chi(\rho_0 + r^{-1}(\bullet - \rho_0))$ is compactly supported in $B_r^g(\rho_0)$ and its order- ℓ derivatives behave indeed as $r^{-\ell}$. The extra factor $r^{-2 \dim M}$ is due to the fact that we want (4.1.64) to be true, so we need it in order to compensate for the fact that the integral of χ_r is of the same order as the volume of $B_r^g(\rho_0)$, namely $r^{2 \dim M}$.

We introduce the space of *confined symbols*.

Definition 4.1.36 (Spaces of confined symbols). Let g be an admissible metric on T^*M , let $r > 0$ and $\rho_0 \in T^*M$. We say a smooth function ψ belongs to the class $\text{Conf}_r^g(\rho_0)$ if it satisfies

$$\forall \ell \in \mathbf{N}, \exists C_\ell > 0 : \forall k \in \mathbf{N}, \forall \rho \in T^*M, \quad |\nabla^k \psi(\rho)|_g \leq \frac{C_\ell}{(\text{dist}_{g_{\rho_0}}(\rho, B_r^{g_{\rho_0}}(\rho_0)))^\ell}.$$

For $\ell \in \mathbf{N}$ fixed and k ranging in $\{0, 1, \dots, \ell\}$, the best constant C_ℓ is written $|\psi|_{\text{Conf}_r^g(\rho_0)}^{(\ell)}$. These are seminorms which endow the space $\text{Conf}_r^g(\rho_0)$ with a structure of a Fréchet space.

Remark 4.1.37. It turns out that the spaces $\text{Conf}_r^g(\rho_0)$ coincide with the Schwartz class $\mathcal{S}(T^*M)$ as Fréchet spaces. However, the seminorms are designed in a way that quantifies the confinement of symbols around the ball $B_r^g(\rho_0)$ introduced in (4.1.23) with respect to the metric g .

Definition 4.1.38 (Uniformly confined family of symbols – [Ler10, Definition 2.3.14]). Let g be an admissible metric on T^*M , and let $r_g > 0$ be the slow variation radius of g , introduced in Proposition 4.1.29. We say a family of functions $(\psi_{\rho_0})_{\rho_0 \in T^*M}$ on T^*M is a g -uniformly confined family of symbols if there exists $r \in (0, r_g/2)$ such that

$$\forall \ell \in \mathbf{N}, \quad \sup_{\rho_0 \in T^*M} |\psi_{\rho_0}|_{\text{Conf}_r^g(\rho_0)}^{(\ell)} < \infty.$$

The parameter r is called a confinement radius of the family of symbols $(\psi_{\rho_0})_{\rho_0 \in T^*M}$.

Example 4.1.39. Partitions of unity given by Proposition 4.1.34 are instances of g -uniformly confined families of symbols (confinement is clear since each function has compact support in $B_r^g(\rho_0)$, and the uniform seminorm estimates come from (4.1.63)).

At the level of the classical dynamics, the confinement radius of a confined symbol is expected to grow exponentially in time under propagation by the Hamiltonian flow. The same holds at the level of the quantum dynamics. This is the reason why, given a radius r , we introduce

$$r(t) := r e^{(2(\Lambda+\Upsilon)+C_g^3 \frac{C_p}{4} \underline{h}_g)|t|}, \quad t \in \mathbf{R}, \quad (4.1.66)$$

where C_g is the slow variation constant from Proposition 4.1.29 and $C_p = |\nabla^3 p|_{S((h_g/\underline{h}_g)^{-1}, g)}^{(0)}$. This particular definition is motivated by Proposition 4.4.9. To make the analysis works, we need to ensure that the condition

$$r(t) \leq r_g \quad \iff \quad |t| \leq \frac{\log(r_g/r)}{2(\Lambda+\Upsilon) + C_g^3 \frac{C_p}{4} \underline{h}_g} \quad (4.1.67)$$

is satisfied. We shall always assume that r is chosen in such a way that (4.1.67) is fulfilled on the time range under consideration. Bear in mind that with this definition, the inclusion

$$\text{Conf}_r^g(\rho_0) \longrightarrow \text{Conf}_{r(t)}^{g(t)}(\rho_0) \quad (4.1.68)$$

is “1-Lipschitz” for any $t \in \mathbf{R}$ and $\rho_0 \in T^*M$, in the sense that

$$\forall \ell \in \mathbf{N}, \forall \psi \in \text{Conf}_r^g(\rho_0), \quad |\psi|_{\text{Conf}_{r(t)}^{g(t)}(\rho_0)}^{(\ell)} \leq |\psi|_{\text{Conf}_r^g(\rho_0)}^{(\ell)}.$$

The following result says that the quantum evolution of a g -uniformly confined family of symbols remains g -uniformly confined for times not exceeding a fraction of the Ehrenfest time (4.1.29).

Theorem 4.1.40 (Quantum evolution of g -uniformly confined families of symbols). *Let $T \in (0, \frac{1}{6}T_E]$ and $r > 0$ such that $r(T) \leq r_g$. Then for any $\ell \in \mathbf{N}$, there exists $k \in \mathbf{N}$ and a constant $C_\ell > 0$ such that*

$$\forall t \in [-T, T], \forall \rho_0 \in T^*M, \forall \psi \in \text{Conf}_r^g(\rho_0), \quad \left| e^{t\mathcal{H}_p} \psi \right|_{\text{Conf}_{r(t)}^{g(t)}(\phi^{-t}(\rho_0))}^{(\ell)} \leq C_\ell |\psi|_{\text{Conf}_r^g(\rho_0)}^{(k)}. \quad (4.1.69)$$

Let $(\psi_{\rho_0})_{\rho_0 \in T^*M}$ be a g -uniformly confined family of symbols with radius r and define

$$\psi_{\rho_0}^t := e^{t\mathcal{H}_p} \psi_{\phi^t(\rho_0)}, \quad (4.1.70)$$

in order that

$$e^{itP} \text{Op}^w(\psi_{\rho_0}) e^{-itP} = \text{Op}^w\left(e^{t\mathcal{H}_p} \psi_{\rho_0}\right) = \text{Op}^w\left(\psi_{\phi^{-t}(\rho_0)}^t\right), \quad \forall \rho_0 \in T^*M, \forall t \in \mathbf{R}.$$

Then for any $t \in [-T, T]$, the family of symbols $(\psi_{\rho_0}^t)_{\rho_0}$ is $g(t)$ -uniformly confined with radius $r(t)$, and we have

$$\forall \ell \in \mathbf{N}, \exists k \in \mathbf{N}, \exists C_\ell > 0 : \forall t \in [-T, T], \quad \sup_{\rho_0 \in T^*M} |\psi_{\rho_0}^t|_{\text{Conf}_{r(t)}^{g(t)}(\rho_0)}^{(\ell)} \leq C_\ell \sup_{\rho_0 \in T^*M} |\psi_{\rho_0}|_{\text{Conf}_r^g(\rho_0)}^{(k)}.$$

All the seminorm indices and constants in the seminorm estimates (4.1.69) depend on g , m and p only through structure constants of g and m , seminorms of p in the symbol classes (4.1.26), the constant C_Υ in (4.1.27) and on any constant c such that $\Lambda \geq c\underline{h}_g$.¹⁰ In particular, constants do not depend on \underline{h}_g .

Remark 4.1.41. As for Theorem 4.1.15, given a fixed metric g , one can artificially extend the Ehrenfest time (4.1.29) by considering the metric $e^{-T}g$ instead (see Remark 4.1.20).

¹⁰ The dependence on c degenerates as $c \rightarrow 0$. See Remark 4.1.21 for more details.

Remark 4.1.42. The asymptotic expansion (4.1.31) is also valid in spaces of confined symbols. In particular, we have

$$e^{t\mathcal{H}_p}\psi_{\rho_0} = e^{tH_p}\psi_{\rho_0} + \tilde{\psi}_{\rho_0,t}$$

where $\tilde{\psi}_{\rho_0,t}$ belongs to $h_{g(t)}^2 \text{Conf}_{r(t)}^{g(t)}(\phi^{-t}(\rho_0))$. In other words, $\psi_{\phi^{-t}(\rho_0)}^t$ is approximated at leading order by $\psi_{\rho_0} \circ \phi^t$.

Several consequences can be drawn from Theorem 4.1.40. One is the fact that the quantum (and also the classical) dynamics act continuously on $\mathcal{S}(T^*M)$, to that it extends to $\mathcal{S}'(T^*M)$.

Corollary 4.1.43. *Let p satisfy Assumption 4.1.13 and suppose there exists a metric g such that (p, g) satisfies Assumption 4.1.14. Then the unitary groups $(e^{t\mathcal{H}_p})_{t \in \mathbf{R}}$ and $(e^{tH_p})_{t \in \mathbf{R}}$ act continuously on $\mathcal{S}(T^*M)$ and extend continuously to $\mathcal{S}'(T^*M)$.*

A less evident consequence is the fact that the Schrödinger propagator itself acts continuously on the Schwartz class, and can thus be extended to a continuous operator on $\mathcal{S}'(M)$.

Corollary 4.1.44. *Let p satisfy Assumption 4.1.13 and suppose there exists a metric g such that (p, g) satisfies Assumption 4.1.14. Then for any $t \in \mathbf{R}$, the propagator e^{-itP} maps $\mathcal{S}(M)$ to itself continuously.*

The latter corollary is proved in Section 4.8. Notice that the conclusion relies only on the existence of an admissible metric g which is compatible with p in the sense of Assumption 4.1.14, and is not related to specific properties of this metric.

Another consequence is Egorov's theorem in general symbols classes $S(m, g)$ stated in Theorem 4.1.15. The connection between Theorem 4.1.40 and Theorem 4.1.15 is the fact that any symbol in $S(m, g)$ can be decomposed as a collection of g -confined symbols thanks to a partition of unity adapted to g , and conversely, a weighted superposition of a g -uniformly confined family of symbols gives a symbol in $S(m, g)$. See Proposition 4.8.1. Proofs can be found in Section 4.8.

We finish with an important remark concerning the semiclassical regime ($\hbar_g \rightarrow 0$).

Remark 4.1.45 (Semiclassical regime $\hbar_g \rightarrow 0$). We draw the reader's attention to the fact that Theorem 4.1.40 is mostly relevant for fixed bounded times $T > 0$, independent of \hbar_g , if one wants to consider a semiclassical regime. Indeed, pushing T up to a fraction of T_E would force us to consider r very small, of order \hbar_g^β for some $\beta > 0$, so that the requirement $r(T) \leq r_g$ is fulfilled.

Yet if we take ψ_\hbar confined in a g -ball of radius \hbar^β and oscillating at scale 1, namely $|\nabla\psi_\hbar|_g = O(1)$, then the sup-norm of ψ_\hbar should be of order \hbar^β as well. In the other way around, if we look for a symbol ψ_\hbar with $\psi_\hbar(\rho_0) = 1$ that is confined (or say compactly supported) in $B_{\hbar^\beta}^g(\rho_0)$, then we must allow for the derivatives of ψ_\hbar to satisfy $|\nabla^\ell\psi_\hbar|_g = O(\hbar^{-\beta\ell})$. That means that seminorms in $\text{Conf}_r^g(\rho_0)$ would blow up as negative powers of \hbar .

Although this could seem to be troublesome, we will be able to deduce Theorem 4.1.15 from the above Theorem 4.1.40 up to a fraction of the Ehrenfest time by considering the expansion (4.1.31) at a sufficiently high order to cancel the negative powers of \hbar_g that will arise from (4.1.65) while introducing a suitable g -partition of unity.

4.1.10. Related works: the contributions of Jean-Michel Bony

Our results are in line with previous investigations conducted by Bony in the late 1990s and the 2000s. His contributions essentially consist in generalizing the Fourier integral operator theory to the framework of the Weyl–Hörmander calculus. In a series of works that we review below, he introduces a very efficient algebraic approach to Fourier integral operators.

Let κ be a canonical transformation and g_0, g_1 be two Weyl–Hörmander symplectic metrics subject to $g_0 = \kappa_*g_1$. In [Bon94, Bon96], Bony introduces classes of Fourier integral operators $\text{FIO}(\kappa, g_0, g_1)$ as superpositions of metaplectic operators (quantizations of the tangent map of κ at each phase space point), weighted by g_0 -confined symbols. Later [Bon97], he gives an alternative definition of these classes for more general metrics. He introduces a beautiful definition of $\text{FIO}(\kappa, g_0, g_1)$ involving “twisted commutators”. This is based on delicate characterizations of pseudo-differential operators in Weyl–Hörmander classes [Bon13], that generalize Beals' criterion [Bea77, Bea79] to non-Euclidean metrics. With this definition, the fact that Fourier integral operators conjugate operators with symbol in $S(1, g_0)$ to operators with symbol in $S(1, g_1)$ becomes practically tautological. This axiomatic approach allows him to check that these classes of Fourier integral operators

obey a natural calculus. However, these characterizations of pseudo-differential operators do not go along with precise estimates and require some additional assumptions on the metrics under consideration (geodesic temperance and above all absence of symplectic eccentricity). In later papers [Bon03, Bon07, Bon09], Bony shows the equivalence between the previous definitions of the class $\text{FIO}(\kappa, g_0, g_1)$, introduces an abstract notion of principal symbol and discusses boundedness properties of these operators in Sobolev spaces attached to a Weyl–Hörmander metric. He also points out that the case of propagators of the form e^{-itP} should fit in this framework, taking $\kappa = \kappa_t$ the Hamiltonian flow associated with the generator P and $g_t = (\phi^t)^*g_0$. Nevertheless, a lot of work is still to be done to check that a concrete unitary group e^{-itP} with simple assumptions on P have indeed this Fourier integral operator property. This is what we address in the present paper.

All the articles mentioned above mostly consist in proceeding papers and seminar notes. Proofs are very succinct and the algebraic framework makes the results very difficult to apply in practice for p.d.e.-related applications. In particular, it is in general intricate to draw precise estimates from the theorems presented in the aforementioned references, which is an issue for applications in mathematical analysis. Lastly, the very abstract assumptions in the applications to evolution equations turn out to be quite difficult to check on concrete cases. That being said, these papers are a great source of inspiration and we plan to investigate this matter from an analytical viewpoint in future works.

4.1.11. Strategy of the proof and plan of the article

Studying the quantum dynamics $(e^{t\mathcal{H}_p})_{t \in \mathbf{R}}$ amounts to solving the equation (4.1.11). The latter can be solved in $L^2(T^*M)$ by classical semi-group arguments as we shall see in Subsection 4.3.2. However Theorems 4.1.15 and 4.1.40 boil down to solve it in symbol classes and spaces of confined symbols, which turns out to be much more difficult. Indeed, the only a priori information that we have on the quantum dynamics is that it is a unitary group on $L^2(T^*M)$ (or equivalently e^{-itP} is a unitary group acting on $L^2(M)$).

The strategy of our proof consists in showing that $e^{itP}\text{Op}^w(a)e^{-itP} = \text{Op}^w(e^{t\mathcal{H}_p})$ is a pseudo-differential operator through the characterization known as Beals theorem (see Proposition 4.B.5). Applying this criterion requires quite intricate computations involving iterated commutators with operators of the form $\text{Op}^w(f)$ with $f \in \text{Aff}(T^*M)$ an affine function.

A very delicate point, especially in the proof of Theorem 4.1.40, is to care about the dependence on ρ_0 in all the computations. The dependence on t is also to be taken into account carefully. In particular, when applying the pseudo-differential calculus, we will always make sure that the metrics $g(t)$ and weight $m(t)$ involved have structure constants bounded independently of t . Fortunately, the Weyl–Hörmander theory is well-suited to handle this uniformity question.

We proceed in several steps:

- Section 4.2 introduces basic notations and the so-called pseudo-differential Weyl–Hörmander calculus. Our main reference for this is the treatise of Lerner [Ler10, Chapter 2], but our presentation is also inspired from Hörmander [Hör94, Chapter XVIII]. Proofs of this section are collected in Appendix 4.A. We chose to redo the proofs to justify the precise seminorm estimates that we need.
- Then in Section 4.3 we discuss the well-posedness of the classical and quantum dynamics on $L^2(T^*M)$. We show that Assumption 4.1.14 is sufficient to make sense of the classical and quantum dynamics globally in time. This part is not related to microlocal analysis but follows from classical evolution equations and spectral theory arguments.
- Next we study the classical dynamics in 4.4. We essentially prove global estimates on the Hamiltonian flow and its derivatives on the whole phase space. The content of this section is quite classical but we chose to include the proofs in the paper to be self-contained and be consistent with our notation.
- In Section 4.5, we discuss the mapping properties in symbol classes and spaces of confined symbols of the operators $\mathcal{E}_j(t)$ appearing in the Dyson expansion (4.1.42). More precisely, we prove continuity estimates for these operators, taking care of the dependence on time and on the parameter $\rho_0 \in T^*M$ for confined families of symbols.
- In Section 4.6 we deal with the delicate computations involving commutators in preparation for the application of Beals theorem. We discuss the boundedness of operators given by

iterated commutators with affine symbols. This section contains the key arguments to prove smoothness and decay of the conjugated operator $e^{itP}\text{Op}^w(\psi)e^{-itP}$ in Theorem 4.1.40.

- The proof of Theorem 4.1.40 on the propagation of partitions of unity is presented in Section 4.7. Roughly speaking, it consists in putting together the estimates given in Section 4.6 related to iterated commutators, taking care of the dependence on the parameters t and ρ_0 . Then the sought seminorm estimates (4.1.69) follow from Beals theorem (Proposition 4.B.5).
- Then Section 4.8 is devoted to the proof of Theorem 4.1.15 and several other consequences of Theorem 4.1.40.
- Proofs of the results of Section 4.1.7 concerning applications to Schrödinger, wave and transport equations are collected in the final Section 4.9.
- The paper ends with four appendices. Appendix 4.A is devoted to the proofs of the precise estimates for the pseudo-differential calculus in the Weyl–Hörmander framework given in Section 4.2. Then basic results on pseudo-differential operators are recalled in Appendix 4.B, and some technical lemmata on phase space metrics are gathered in Appendix 4.C. We finally recall the Faà di Bruno formula for “vector-valued” functions in Appendix 4.D.

Acknowledgments

I am grateful to Matthieu Léautaud for his encouragements and his helpful comments on a preliminary version of this paper.

4.2. The Weyl–Hörmander calculus

In this section, we introduce the Weyl–Hörmander calculus of pseudo-differential operators, that is to say we describe how the composition of these operators works in the Weyl–Hörmander symbol classes.

4.2.1. Functional framework

Recall that the symbol classes $S(m, g)$ defined in 4.1.9 are Fréchet spaces contained in $\mathcal{S}'(T^*M)$. Also recall that we extended the definition of $S(m, g)$ to tensors in Remark 4.1.10. For any $k \in \mathbf{N}$, we define

$$\nabla^{-k}S(m, g) = \{a \in \mathcal{S}'(T^*M) : \nabla^k a \in S(m, g)\}.$$

Notice that similar spaces were already considered by other authors, such as Bony [Bon13, Definition 2.5]. This is a linear subspace of $\mathcal{S}'(T^*M)$. We endow it with the following family of seminorms:

$$a \longmapsto |\nabla^k a|_{S(m, g)}^{(\ell)}, \quad \ell \in \mathbf{N}, a \in \nabla^{-k}S(m, g).$$

The topology induced by these seminorms coincides with the topology induced by $S(m, g)$ through the linear map

$$\nabla^k : \nabla^{-k}S(m, g) \longrightarrow S(m, g), \quad (4.2.1)$$

which is then continuous. Notice that $\nabla^{-k}S(m, g)$ is not a topological vector space (singletons are not closed), so in particular it is not a Fréchet space. Open sets of $\nabla^{-k}S(m, g)$ are of the form $(\nabla^k)^{-1}U$ where U is an open set of $S(m, g)$. Also notice that the “fiber” of the map ∇^k in (4.2.1) seen as a projection is given by $\ker \nabla^k$, that is the set of degree $k - 1$ polynomial functions. A consequence is that continuous maps on $\nabla^{-k}S(m, g)$ are constant on the fibers of the map (4.2.1).

One can readily check that

$$\nabla : \nabla^{-(k+1)}S(m, g) \longrightarrow \nabla^{-k}S(m, g)$$

is continuous. Given a linear map $L : \nabla^{-k_1}S(m_1, g_1) \rightarrow \nabla^{-k_2}S(m_2, g_2)$, if we have an estimate of the form

$$\forall \ell \in \mathbf{N}, \exists k \in \mathbf{N}, \exists C_\ell > 0 : \forall a \in S(m_1, g_1), \quad |\nabla^{k_2} L a|_{S(m_2, g_2)}^{(\ell)} \leq C_\ell |\nabla^{k_1} a|_{S(m_1, g_1)}^{(k)},$$

then we shall write

$$\nabla^{-k_1}S(m_1, g_1) \xrightarrow{L} \nabla^{-k_2}S(m_2, g_2).$$

For $k_1 \leq k_2$, the inclusion is continuous:

$$\nabla^{-k_1} S(m, g) \xrightarrow{L} \nabla^{-k_2} S(m, g),$$

while for the covariant derivative, we have

$$\forall k_0 \in \{0, 1, 2, \dots, k\}, \quad \nabla^{-k} S(m, g) \xrightarrow{\nabla^{k_0}} \nabla^{-(k-k_0)} S(m, g).$$

From the last two properties, we deduce that for any $k_0, k_1, k_2 \in \mathbf{N}$ such that $k_1 \leq k_0 + k_2$,

$$\nabla^{-k_1} S(m, g) \xrightarrow{\nabla^{k_0}} \nabla^{-k_2} S(m, g).$$

When considering a family of operators $L(t)$ depending on some parameter $t \in \mathbf{R}$ (usually time), it is interesting to keep track of the dependence of the continuity constants C_ℓ on t . Give $C \in C^0(\mathbf{R}; \mathbf{R}_+)$, we will write

$$\nabla^{-k_1} S(m_1, g) \xrightarrow{L(t)} C(t) \nabla^{-k_2} S(m_2, g)$$

to mean

$$\forall \ell \in \mathbf{N}, \exists k \in \mathbf{N}, \exists C_\ell > 0 : \forall t \in \mathbf{R}, \forall a \in S(m_1, g), \quad |\nabla^{k_2} L a|_{S(m_2, g)}^{(\ell)} \leq C_\ell C(t) |\nabla^{k_1} a|_{S(m_1, g)}.$$

In particular, we shall write

$$\nabla^{-k_1} S(m_1, g) \xrightarrow{L(t)} \nabla^{-k_2} S(m_2, g)$$

when seminorm estimates are uniform with respect to t .

4.2.2. Pseudodifferential calculus

Quantization of quantum observables follows well-known rules. Let a_1 and a_2 be tempered distributions. The composition $\text{Op}^w(a_1)\text{Op}^w(a_2)$ makes sense as a continuous operator $\mathcal{S}(\mathbf{R}^d) \rightarrow \mathcal{S}'(\mathbf{R}^d)$ as soon as one of the two operators maps $\mathcal{S}(\mathbf{R}^d)$ to itself continuously. In such a case, the Weyl symbol of the corresponding operator, given by the Schwartz kernel theorem (Proposition 4.B.1) is called the Moyal product of a_1 and a_2 and is denoted by $a_1 \# a_2$, so that

$$\text{Op}^w(a_1)\text{Op}^w(a_2) = \text{Op}^w(a_1 \# a_2).$$

The moyal product is a bilinear map. Assume now that a_1 and a_2 are Schwartz functions, so that $a_1 \# a_2$ is well-defined. One can show that the Moyal product of the two symbols is again a Schwartz function that can be computed according to the formula (4.1.4). For more general symbols, the latter expression can be understood as an oscillatory integral.

The proposition below ensures that the composition of two operators of the form $\text{Op}^w(a)$ with a in some symbol class $S(m, g)$ makes sense.

Proposition 4.2.1 ([Hör85, Theorem 18.6.2]). *Let g be an admissible metric and m be a g -admissible weight. Then for any $a \in S(m, g)$, the operator $\text{Op}^w(a)$ maps $\mathcal{S}(M) \rightarrow \mathcal{S}(M)$ and $\mathcal{S}'(M) \rightarrow \mathcal{S}'(M)$ continuously.*

The formula (4.1.4) for the Moyal product can be rewritten

$$a_1 \# a_2 = e^{-\frac{i}{2}\mathfrak{P}}(a_1 \otimes a_2)|_{\text{diag}}. \quad (4.2.2)$$

In this expression, $a_1 \otimes a_2$ is the map $(\rho_1, \rho_2) \mapsto a_1(\rho_1)a_2(\rho_2)$ defined on $T^*M \oplus T^*M$, diag refers to the restriction to the diagonal $\{\rho_1 = \rho_2\}$ and the operator $e^{-\frac{i}{2}\mathfrak{P}}$ is a Fourier multiplier that one can see as the exponential of $\mathfrak{P} = \{\nabla^{\rho_1}, \nabla^{\rho_2}\}$, which is a symbolic notation for

$$\mathfrak{P}(a_1 \otimes a_2)(\rho_1, \rho_2) = \sigma(H_{a_1}(\rho_1), H_{a_2}(\rho_2)), \quad \forall \rho_1, \rho_2 \in T^*M.$$

(See Subsections 4.A.2 and 4.A.3 of Appendix 4.A for further details on these definition.) A formal Taylor expansion of the exponential in (4.2.2), which can be made rigorous, gives

$$a_1 \# a_2 = \sum_{j=0}^{j_0} \mathcal{P}_j(a_1, a_2) + \widehat{\mathcal{P}}_{j_0+1}(a_1, a_2),$$

where for all $j \geq 0$,

$$\begin{cases} \mathcal{P}_j(a_1, a_2) = \frac{(2i)^{-j}}{j!} \mathfrak{P}^j(a_1 \otimes a_2)|_{\text{diag}} \\ \widehat{\mathcal{P}}_{j+1}(a_1, a_2) = \int_0^1 \frac{(1-s)^j}{j!} e^{-i\frac{s}{2}\mathfrak{P}} \frac{1}{(2i)^{j+1}} \mathfrak{P}^{j+1}(a_1 \otimes a_2)|_{\text{diag}} ds \end{cases},$$

and $\widehat{\mathcal{P}}_0(a_1, a_2) = a_1 \# a_2$ by convention.

The operators $(\mathcal{P}_j)_{j \in \mathbf{N}}$ and $(\widehat{\mathcal{P}}_j)_{j \in \mathbf{N}}$ are bilinear maps acting on the space of Schwartz symbols. The most important ones are the 0th order and the 1st order terms in the expansion, namely

$$\mathcal{P}_0(a_1, a_2) = a_1 a_2, \quad \mathcal{P}_1(a_1, a_2) = \frac{1}{2i} \{a_1, a_2\}.$$

The term \mathcal{P}_j depends on derivatives of order j of a_1 and a_2 , while $\widehat{\mathcal{P}}_j$ depends on derivatives of order larger than j . When a_1 and a_2 belong to symbol classes $S(m, g)$, we can make sense of the asymptotic expansion

$$a_1 \# a_2 \sim \sum_{j \geq 0} \mathcal{P}_j(a_1, a_2), \quad a_1, a_2 \in \mathcal{S}(T^*M), \quad (4.2.3)$$

by explaining how the bilinear operators \mathcal{P}_j and $\widehat{\mathcal{P}}_j$ extend to symbol classes or spaces of confined symbols, and give bounds for the remainder. In Proposition 4.2.2 below, we describe the mapping properties of these bilinear operators on symbol classes $S(m_1, g_1)$ and $S(m_2, g_2)$, with precise seminorm estimates. Derivatives of a_1 and a_2 are measured with respect to two possibly different metrics g_1 and g_2 . Beyond admissibility, some compatibility condition is required on these metrics. We introduce this notion of compatibility in Definition 4.A.5, based on [Hör85, Proposition 18.5.3].

An important object appearing in the statements below is the joint gain function of g_1 and g_2 , defined by¹¹

$$\forall \rho \in T^*M, \quad h_{g_1, g_2}(\rho) := \sup_{\zeta \in W \setminus \{0\}} \frac{|\zeta|_{g_{1, \rho}}}{|\zeta|_{g_{2, \rho}}} = \sup_{\zeta \in W \setminus \{0\}} \frac{|\zeta|_{g_{2, \rho}}}{|\zeta|_{g_{1, \rho}}}. \quad (4.2.4)$$

Notice that when $g_1 = g_2 = g$, one recovers the usual gain function of g of Definition 4.1.5.¹²

Proposition 4.2.2 (Pseudo-differential calculus in symbol classes). *Let g_1 and g_2 be admissible metrics that are compatible in the sense of Definition 4.A.5. Let m_1 and m_2 be $(g_1 + g_2)$ -admissible weights. Then we have for all $j \in \mathbf{N}$:*

$$\begin{aligned} \nabla^{-j} S(m_1, g_1) \times \nabla^{-j} S(m_2, g_2) &\xrightarrow{\mathcal{P}_j} S(h_{g_1, g_2}^j m_1 m_2, g_1 + g_2), \\ \nabla^{-j} S(m_1, g_1) \times \nabla^{-j} S(m_2, g_2) &\xrightarrow{\widehat{\mathcal{P}}_j} S(h_{g_1, g_2}^j m_1 m_2, g_1 + g_2), \end{aligned}$$

namely, for all $j \in \mathbf{N}$ and all $\ell \in \mathbf{N}$, there exist $k = k_\ell \in \mathbf{N}$ and positive constants (C_ℓ, C'_ℓ) such that

$$\begin{aligned} |\mathcal{P}_j(a_1, a_2)|_{S(h_{g_1, g_2}^j m_1 m_2, g_1 + g_2)}^{(\ell)} &\leq C_\ell |\nabla^j a_1|_{S(m_1, g_1)}^{(0)} |\nabla^j a_2|_{S(m_2, g_2)}^{(0)}, \\ |\widehat{\mathcal{P}}_j(a_1, a_2)|_{S(h_{g_1, g_2}^j m_1 m_2, g_1 + g_2)}^{(\ell)} &\leq C'_\ell |\nabla^j a_1|_{S(m_1, g_1)}^{(k)} |\nabla^j a_2|_{S(m_2, g_2)}^{(k)}. \end{aligned}$$

The estimates depend on g_1, g_2 and m_1, m_2 only through structure constants.

Another version of pseudo-differential calculus consists in pairing a symbol in a genuine Weyl–Hörmander symbol class with a confined symbol.

11. The justification for the equality in (4.2.4) can be found in (4.C.1).

12. Observe that the definition of the temperance weight θ_g in (4.1.24) goes somewhat in the other way around compared with the joint gain function $h_{g, g}$ of g and g defined in (4.2.4).

Proposition 4.2.3 (Pseudo-differential calculus with confined symbols). *Let g_0 and g be two compatible admissible metrics. Suppose there exists $\kappa \geq 1$ such that $g \leq \kappa^2 g_0$. Let m be a $g+g_0$ -admissible weight such that r_{g+g_0} is a slow variation radius for m , namely (1) holds with $r = r_{g+g_0}$. Let $r > 0$ be such that $r < \frac{\kappa-1}{2} \min\{r_g, r_{g_0}\}$. Then for all $j \in \mathbf{N}$, the following maps are continuous:*

$$\nabla^{-j} S(m, g) \times \text{Conf}_r^{g_0}(\rho_0) \xrightarrow{\mathcal{P}_j} h_{g, g_0}^{j_0}(\rho_0) m(\rho_0) \text{Conf}_{\kappa r}^{(g+g_0)/2}(\rho_0), \quad (4.2.5)$$

$$\nabla^{-j} S(m, g) \times \text{Conf}_r^{g_0}(\rho_0) \xrightarrow{\widehat{\mathcal{P}}_j} h_{g, g_0}^{j_0}(\rho_0) m(\rho_0) \text{Conf}_{\kappa r}^{(g+g_0)/2}(\rho_0), \quad (4.2.6)$$

namely, for all $j \in \mathbf{N}$ and all $\ell \in \mathbf{N}$, there exist $k = k_\ell \in \mathbf{N}$ and positive constants (C_ℓ, C'_ℓ) such that

$$\begin{aligned} |\mathcal{P}_j(a, a_0)|_{\text{Conf}_{\kappa r}^{(g+g_0)/2}(\rho_0)}^{(\ell)} &\leq C_\ell h_{g, g_0}^{j_0}(\rho_0) m(\rho_0) |\nabla^j a|_{S(m, g)}^{(0)} |\nabla^j a_0|_{\text{Conf}_r^{g_0}(\rho_0)}^{(k)}, \\ |\widehat{\mathcal{P}}_j(a, a_0)|_{\text{Conf}_{\kappa r}^{(g+g_0)/2}(\rho_0)}^{(\ell)} &\leq C'_\ell h_{g, g_0}^{j_0}(\rho_0) m(\rho_0) |\nabla^j a|_{S(m, g)}^{(0)} |\nabla^j a_0|_{\text{Conf}_r^{g_0}(\rho_0)}^{(k)}. \end{aligned}$$

The estimates are uniform with respect to $\rho_0 \in T^*M$ and r , and depend on g_0, g and m only through structure constants.

Several subtleties in these statements are not covered by [Hör79, Hör85, Ler10]. For this reason we prove Propositions 4.2.2 and 4.2.3 in Appendix 4.A, following the strategy of [Ler10, Section 2.3].

In practice, g_1 and g_2 (or g and g_0) will always be conformal, so that in particular $g_1^\natural = g_2^\natural$. Yet compatibility in the sense of Definition 4.A.5 is always true for such metrics as stated in Proposition 4.A.6 and Remark 4.A.7. So we will just ignore this assumption in the sequel. Similarly for weight functions, in that case it will be sufficient to check that m is g_1 -admissible or g_2 -admissible in order to ensure that it is $(g_1 + g_2)$ -admissible (see Proposition 4.1.29).

Remark 4.2.4. We will often apply these results to $g_1 = g(t)$ and $g_2 = g(s)$ for different times t and s smaller than the Ehrenfest time. Since the structure constants of these metrics are uniform with respect to t (Proposition 4.1.29 and the subsequent Remark 4.1.30), the implicit constants appearing in the continuity estimates below will not depend on time.

4.3. Classical and quantum well-posedness

In this section, we prove Proposition 4.1.16 which provides with a sufficient condition for the global existence of the Hamiltonian flow and the essential self-adjointness of P . A first step is the following lemma.

Lemma 4.3.1 (Estimate on the first derivative of p). *Under the assumptions of Proposition 4.1.16, we have*

$$\exists c > 0 : \forall \rho \in T^*M, \quad |\nabla p|_{g_0}(\rho) \leq c \langle p(\rho) \rangle. \quad (4.3.1)$$

Proof. Denote by r_{g_0} and C_{g_0} slow variation radius and slow variation constant of g_0 (Proposition 4.1.29). Recall the real number E from (4.1.35). Let $\tilde{\rho}, \tilde{\rho}' \in T^*M$. By Taylor's theorem, we know that

$$p(\tilde{\rho}') = p(\tilde{\rho}) + \nabla p(\tilde{\rho}) \cdot (\tilde{\rho}' - \tilde{\rho}) + \int_0^1 (1-t) \nabla^2 p((1-t)\tilde{\rho} + t\tilde{\rho}') \cdot (\tilde{\rho}' - \tilde{\rho})^2 dt. \quad (4.3.2)$$

Suppose $\tilde{\rho}$ is such that $p(\tilde{\rho}) = E$ and $|\tilde{\rho}' - \tilde{\rho}|_{g_0, \tilde{\rho}} \leq r$ with $r \in (0, r_{g_0})$. Then we have

$$\begin{aligned} |p(\tilde{\rho}') - E| &\leq |\nabla p|_{g_0}(\rho_0) |\tilde{\rho}' - \tilde{\rho}|_{g_0, \tilde{\rho}} + \frac{1}{2} |\nabla^2 p|_{g_0, \infty} \sup_{t \in [0, 1]} |\rho'_0 - \rho_0|_{g_0, (1-t)\tilde{\rho} + t\tilde{\rho}'}^2 \\ &\leq r \sup_{\{p=E\}} |\nabla p|_{g_0} + \frac{1}{2} C_{g_0}^2 r^2 |\nabla^2 p|_{g_0, \infty}, \end{aligned} \quad (4.3.3)$$

We used slow variation of g_0 to deal with the right-most term. Now we let $\rho \in T^*M$ and we show (4.3.1). We distinguish two cases.

First case: $p(\rho) \geq E$. In (4.3.2), we take $\tilde{\rho} = \rho$ such that $p(\rho) \geq E$ and we consider $\tilde{\rho}'$ of the form $\rho'_s = \rho + s\zeta$, $s \in (-r, r)$, where $\zeta \in W$ is chosen in such a way that

$$|\zeta|_{g_0, \rho} = 1 \quad \text{and} \quad \nabla p(\rho) \cdot \zeta = |\nabla p|_{g_0}(\rho).$$

Assume $p(\rho'_s) \leq E$ for some $s \in (-r, r)$. By the intermediate value theorem, there is an $s_0 \in (-r, r)$ such that $p(\rho'_{s_0}) = E$. Given that $|\rho'_{s_0} - \rho|_{g_0, \rho} = |s_0| \leq r$, we can apply (4.3.3) to have for some constant $C > 0$:

$$E - C \leq p(\rho'_{s_0}).$$

This is obviously true if $p(\rho'_s) \geq E$. Going back to (4.3.2), we deduce that

$$E - C \leq p(\rho) + s|\nabla p|_{g_0}(\rho) + \frac{s^2}{2} \left\langle |\nabla^2 p|_{g_0, \infty} \right\rangle C_{g_0}(r)^2, \quad \forall s \in (-r, r),$$

where we used slow variation of g_0 again. Seeing the above function of s as a degree-two polynomial, either the discriminant δ is non-positive, namely

$$|\nabla p|_{g_0}^2(\rho) \leq 2 \left\langle |\nabla^2 p|_{g_0, \infty} \right\rangle C_{g_0}(r)^2 (p(\rho) - E + C),$$

which implies in particular the desired result $|\nabla p|_{g_0}(\rho) \leq c\langle p(\rho) \rangle^{1/2} \leq c\langle p(\rho) \rangle$, or it is positive and we have two real distinct roots $s_- < s_+$. Notice that since $p(\rho) \geq E \geq E - C$, we know that $s_+ \leq 0$. Given that the polynomial is non-negative on $(-r, r)$, and that it has to change sign around s_+ , we deduce that $s_+ \leq -r$, namely

$$\begin{aligned} \frac{-|\nabla p|_{g_0}(\rho) + \sqrt{\delta}}{\left\langle |\nabla^2 p|_{g_0, \infty} \right\rangle C_{g_0}(r)^2} &\leq -r \\ \Leftrightarrow & \\ \delta &\leq \left(|\nabla p|_{g_0}(\rho) - r \left\langle |\nabla^2 p|_{g_0, \infty} \right\rangle C_{g_0}(r)^2 \right)^2 \\ \Leftrightarrow & \\ -2 \left\langle |\nabla^2 p|_{g_0, \infty} \right\rangle C_{g_0}(r)^2 (p(\rho) - E + C) &\leq -2r \left\langle |\nabla^2 p|_{g_0, \infty} \right\rangle C_{g_0}(r)^2 |\nabla p|_{g_0}(\rho) \\ &\quad + \left(r \left\langle |\nabla^2 p|_{g_0, \infty} \right\rangle C_{g_0}(r)^2 \right)^2 \\ \Leftrightarrow & \\ |\nabla p|_{g_0}(\rho) &\leq \frac{p(\rho) - E + C}{r} + \frac{r^2}{2} \left\langle |\nabla^2 p|_{g_0, \infty} \right\rangle C_{g_0}(r)^2, \end{aligned}$$

which yields the desired result $|\nabla p|_{g_0}(\rho) \leq c\langle p(\rho) \rangle$.

Second case: $p(\rho) \leq E$. If we take ρ such that $p(\rho) \leq E$, we can reduce to the previous case by considering $-p$ and $-E$ instead of p and E . The previous step yields the final result. \square

4.3.1. Proof of Proposition 4.1.16: global-in-time existence of the Hamiltonian flow

Here we prove the ‘‘classical part’’ of Proposition 4.1.16, namely that the Hamiltonian flow is well-defined globally. Let $\rho \in T^*M$ and consider $t \mapsto \rho(t)$ solution to the Cauchy problem

$$\frac{d}{dt}\rho(t) = H_p(\rho(t)), \quad \rho(0) = \rho.$$

Let $I \subset \mathbf{R}$ be a relatively compact interval on which the solution exists. We show that the range of $I \ni \tau \rightarrow \rho(\tau)$ is relatively compact. From Lemma 4.3.1 (and Lemma 4.4.2), we know that $|H_p|_{g_0} \leq |\nabla p|_{g_0} \leq c\langle p(\rho) \rangle$ on the entire energy shell $\{p = p(\rho)\}$, which contains $\tau \mapsto \rho(\tau)$. Fix $t \in I$ and let

$$s = s(t) = \sup \left\{ s' \geq 0 : \forall \tau \in (t - s', t + s') \cap I, \rho(\tau) \in B_{r_{g_0}/2}^{g_0}(\rho(\tau)) \right\}.$$

Then by the mean value inequality, we have for all $\tau \in (t - s, t + s) \cap I$:

$$\begin{aligned} |\rho(\tau) - \rho(t)|_{g_{\rho(t)}} &\leq |s| \sup_{\tau \in (t-s, t+s)} |H_p(\rho(\tau))|_{g_{0, \rho(t)}} \leq C_{g_0} |s| \sup_{\tau \in (t-s, t+s)} |H_p(\rho(\tau))|_{g_{0, \rho(\tau)}} \\ &\leq cC_{g_0} |s| \langle p(\rho) \rangle. \end{aligned}$$

Since $\tau \mapsto \rho(\tau)$ is continuous, we deduce that $s(t) \geq r_{g_0}/(2cC_{g_0} \langle p(\rho) \rangle)$. Therefore, we can cover I with a finite number of compact intervals of size $r_{g_0}/(cC_{g_0} \langle p(\rho) \rangle)$, on which $\tau \mapsto \rho(\tau)$ takes values in a g_0 -ball of radius $r_{g_0}/2$. We deduce that the range of $I \ni \tau \mapsto \rho(\tau)$ is relatively compact. Therefore the solution can be extended to the whole real line.

4.3.2. Proof of Proposition 4.1.16: essential self-adjointness

We finish the proof of Proposition 4.1.16, showing essential self-adjointness of P . In this proof $P = \text{Op}^w(p)$ acts on $\mathcal{S}(M)$. Since $P - E$ is essentially self-adjoint if and only if P is essentially self-adjoint, we can assume without loss of generality that $E = 0$. The result will follow from the classical characterization of essential self-adjointness [RS75, Theorem X.2]:

$$\exists \lambda > 0 : \quad \ker(P^* + i\lambda) = \{0\} \quad \text{and} \quad \ker(P^* - i\lambda) = \{0\}. \quad (4.3.4)$$

Let $\lambda \geq 1$ to be chosen properly later. We first give an estimate on derivatives of $q = q_\lambda = (p \pm \lambda i)^{-1}$ using the Faà di Bruno formula (see Appendix 4.D): for any $\ell \in \mathbf{N}$:

$$\left| q^{(\ell)} \right|_{g_0} \leq \sum_{j=1}^{\ell} |q|^{j+1} \sum_{\substack{\mathbf{n} \in (\mathbf{N}^*)^j \\ |\mathbf{n}| = \ell}} \left| \frac{1}{\mathbf{n}!} \nabla^{\mathbf{n}} p \right|_{g_0},$$

where the constant $C_\ell(p)$ depends on ℓ , on seminorms of $\nabla^2 p$ in $S(1, g_0)$ and on the constant from Lemma 4.3.1 (which depends also on p). We can bound the right-hand side from above by using Lemma 4.3.1 for the indices $\mathbf{n}_l = 1$ and using the sub-quadraticity assumption $\nabla^2 p \in S(1, g_0)$ for the indices $\mathbf{n}_l \geq 2$:

$$\left| q^{(\ell)} \right|_{g_0} \leq C_\ell(p) \max_{1 \leq j \leq \ell} |q|^{j+1} \langle p \rangle^j.$$

Yet we have $|q| \leq \max\{\frac{1}{\langle p \rangle}, \frac{1}{\lambda}\}$, so that

$$\left| q^{(\ell)} \right|_{g_0} \leq \frac{C_\ell(p)}{c_0} \iff q \in S(\lambda^{-1}, g_0).$$

Now from pseudo-differential calculus (Proposition 4.2.2), we obtain

$$\text{Op}^w(p \pm \lambda i) \text{Op}^w\left(\frac{1}{p \pm \lambda i}\right) = \text{Id} + \text{Op}^w\left(\widehat{\mathcal{P}}_2(p \pm \lambda i, q)\right)$$

with

$$\nabla^{-2} S(1, g_0) \times S(\lambda^{-1}, g_0) \xrightarrow{\widehat{\mathcal{P}}_2} S(\lambda^{-1}, g_0).$$

The Calderón-Vaillancourt theorem (Proposition 4.B.4) applies in $S(1, g_0)$, so we arrive at

$$\left\| \text{Op}^w\left(\widehat{\mathcal{P}}_2(p \pm \lambda i, q)\right) \right\|_{\mathcal{L}(L^2)} \leq \left| \widehat{\mathcal{P}}_2(p \pm \lambda i, q) \right|_{S(1, g_0)}^{k_0} = O\left(\frac{1}{\lambda}\right).$$

Taking λ large enough ensures that $R = \text{Op}^w\left(\widehat{\mathcal{P}}_2(p \pm \lambda i, q)\right)$ satisfies $\|R\|_{\mathcal{L}(L^2)} \leq 1/2$. Now writing $A_n = \text{Id} - R + R^2 - \dots + (-1)^n R^n$ for any $n \in \mathbf{N}$, we have

$$\text{Op}^w(p \pm \lambda i) \text{Op}^w\left(\frac{1}{p \pm \lambda i}\right) A_n = \text{Id} + (-1)^{n+1} R^{n+1},$$

where $\text{Op}^w(q)A_n$ and R^{n+1} map $\mathcal{S}(M)$ to itself continuously (Proposition 4.B.2) and $\|R^{n+1}\| \leq 2^{-(n+1)}$. We deduce that for any $u_0 \in \text{dom } P^*$ and $u \in \mathcal{S}(M)$,

$$\begin{aligned} ((P \pm \lambda i)^* u_0, \text{Op}^w(q)A_n u)_{L^2} &= (u_0, (P \pm \lambda i) \text{Op}^w(q)A_n u)_{L^2} \\ &= (u_0, u)_{L^2} + (-1)^{n+1} (u_0, R^{n+1} u)_{L^2} = (u_0, u)_{L^2} + O\left(2^{-(n+1)}\right). \end{aligned}$$

The first equality is justified by the fact that $\text{Op}^w(q)A_n u \in \mathcal{S}(M)$ (this is the reason why we did not take $n = \infty$ directly). We let $n \rightarrow \infty$, observing that $A_n \rightarrow (\text{Id} + R)^{-1}$ in operator norm by Neumann series, to obtain

$$((P \pm \lambda i)^* u_0, \text{Op}^w(q)(\text{Id} + R)^{-1} u)_{L^2} = (u_0, u)_{L^2}.$$

Therefore, $u_0 \in \ker(P^* \mp \lambda i)$ implies that $u_0 \perp \mathcal{S}(M)$ in $L^2(M)$, that is to say $u_0 = 0$. This concludes the proof of (4.3.4) and thus of Proposition 4.1.16. \square

4.3.3. The quantum and classical dynamics as an evolution group on L^2 symbols

In the proof of the proposition below, we use an important aspect of the Weyl quantization: it is an isometry between $L^2(T^*M)$ and the space of Hilbert–Schmidt operators (Proposition 4.B.7):

$$\text{Op}^w : L^2(T^*M) \longrightarrow \mathcal{L}^2(L^2(M)).$$

That is to say for all $a_1, a_2 \in L^2(T^*M)$, the operators $\text{Op}^w(a_1)$ and $\text{Op}^w(a_2)$ are Hilbert–Schmidt and

$$(a_2, a_1)_{L^2(T^*M)} = \text{tr}(\text{Op}^w(a_2)^* \text{Op}^w(a_1)). \quad (4.3.5)$$

Proposition 4.3.2. *For all $t \in \mathbf{R}$ let $\mathcal{U}(t) := e^{t\mathcal{H}_p}$ and $U(t) := e^{tH_p}$ defined in Definition 4.1.2 and (4.1.8) respectively, viewed as operators acting on $L^2(T^*M)$, in such a way that*

$$\text{Op}^w(\mathcal{U}(t)a) = \text{Ad}_{e^{itP}} \text{Op}^w(a) = e^{itP} \text{Op}^w(a) e^{-itP} \quad \text{and} \quad U(t)a = a \circ \phi^t, \quad \forall a \in L^2(T^*M)$$

*Then under Assumption 4.1.13 and if additionally p has temperate growth in the sense of (4.1.37), then $(\mathcal{U}(t))_{t \in \mathbf{R}}$ and $(U(t))_{t \in \mathbf{R}}$ are strongly continuous unitary groups on $L^2(T^*M)$. Their respective generators are self-adjoint extensions of $i\mathcal{H}_p$ and iH_p defined in (4.1.12) and (4.1.5) respectively.*

Proof. We first mention that $\mathcal{U}(t)$ clearly satisfies the group property $\mathcal{U}(t)\mathcal{U}(s) = \mathcal{U}(t+s)$, for all $t, s \in \mathbf{R}$, since $(e^{-itP})_{t \in \mathbf{R}}$ itself is a group of isometries. That $\mathcal{U}(t)$ is an isometry follows from the cyclicity of the trace and (4.3.5): for all $a \in L^2(T^*M)$, we have

$$\|\mathcal{U}(t)a\|_{L^2(T^*M)}^2 = \text{tr}(e^{itP} \text{Op}^w(a)^* \text{Op}^w(a) e^{-itP}) = \text{tr}(\text{Op}^w(a)^* \text{Op}^w(a)) = \|a\|_{L^2(T^*M)}^2.$$

The group property of $U(t)$ and the unitarity of $U(t)$ follow from the fact that $(\phi^t)_{t \in \mathbf{R}}$ is a group of symplectomorphisms (Liouville theorem tells us that it is measure preserving [Arn89, Section 16]).

It remains to show that the maps $t \mapsto \mathcal{U}(t)$ and $t \mapsto U(t)$ are weakly continuous. In view of the density of $\mathcal{S}(T^*M)$ in $L^2(T^*M)$, it is sufficient to verify that the maps $t \mapsto \mathcal{U}(t)w$ and $t \mapsto U(t)w$ are strongly continuous for $w \in \mathcal{S}(T^*M)$. Yet for any $u \in \mathcal{S}(M) \subset \text{dom } P$ we have

$$\text{Op}^w(\mathcal{U}(t)w) - \text{Op}^w(w) = i \int_0^t \text{Ad}_{e^{isP}} [P, \text{Op}^w(w)] u \, ds. \quad (4.3.6)$$

The operator $[P, \text{Op}^w(w)]$ can be extended to a bounded operator on $L^2(M)$ since $w \in \mathcal{S}(T^*M)$ and p has temperate growth by assumption (use the pseudo-differential calculus in Proposition 4.2.2 and the Calderón–Vailancourt theorem in Proposition 4.B.4). Its symbol is even in the Schwartz class, so that $[P, \text{Op}^w(w)]$ is in fact a Hilbert–Schmidt operator. Hence the expression (4.3.6) still makes sense for any $u \in L^2(M)$.

We fix $(e_j)_j$ a Hilbert basis of $L^2(M)$. By definition of the Hilbert–Schmidt norm and of the trace, we have

$$\begin{aligned} \|\text{Op}^w(\mathcal{U}(t)w)u - \text{Op}^w(w)u\|_{\mathcal{L}^2(L^2(M))}^2 &= \text{tr} \left| \int_0^t \text{Ad}_{e^{isP}} [P, \text{Op}^w(w)] \, ds \right|^2 \\ &= \sum_j \left\| \int_0^t \text{Ad}_{e^{isP}} [P, \text{Op}^w(w)] \, ds e_j \right\|_{L^2(M)}^2. \end{aligned}$$

Then by Jensen's inequality, and again the definition of the trace, we obtain

$$\begin{aligned} \|\mathrm{Op}^w(\mathcal{U}(t)w) - \mathrm{Op}^w(w)\|_{\mathcal{L}^2(L^2(M))}^2 &\leq \sum_j |t| \int_0^{|t|} \|[P, \mathrm{Op}^w(w)]e^{isP}e_j\|_{L^2(M)}^2 ds \\ &= |t| \int_0^{|t|} \mathrm{tr} \left(|[P, \mathrm{Op}^w(w)]|^2 \right) ds. \end{aligned}$$

This works because $(e^{isP}e_j)_j$ is a Hilbert basis for all $s \in \mathbf{R}$ if and only if $(e_j)_j$ is a Hilbert basis of $L^2(M)$. Finally, we change the order of the sum and the integral since the integrand is non-negative. We finish with the definition of the Hilbert–Schmidt norm in the right-hand side again, and we use (4.3.5) in the left-hand side to deduce that

$$\|\mathcal{U}(t)w - w\|_{L^2(T^*M)}^2 \leq |t|^2 \|[P, \mathrm{Op}^w(w)]\|_{\mathcal{L}^2(L^2(M))}^2.$$

This means that strong continuity holds at $t = 0$, and the group property of $\mathcal{U}(t)$ allows to extend continuity to the whole real line. Thus we can apply Stone's theorem [RS80, VIII.4] to prove that $\mathcal{U}(t)$ is indeed a unitary group. To see that the generator of $\mathcal{U}(t)$ is a self-adjoint extension of $i\mathcal{H}_p$, we simply remark that the generator and $i\mathcal{H}_p$ both agree on $\mathcal{S}(T^*M)$ since we have

$$\forall w \in \mathcal{S}(T^*M), \quad \frac{d}{dt} \mathrm{Op}^w(\mathcal{U}(t)w)|_{t=0} = i[P, \mathrm{Op}^w(w)] = \mathrm{Op}^w(i\mathcal{H}_p w)$$

where the last equality follows directly from the definition of \mathcal{H}_p in (4.1.12).

The situation is simpler for $U(t)$. We prove that for any $w \in \mathcal{S}(T^*M)$, the map $t \mapsto U(t)w$ is strongly continuous by observing that

$$\|U(t)w - w\|_{L^2} \leq \int_{[0,t]} \|U(s)H_p w\|_{L^2} ds = |t| \|H_p w\|_{L^2}.$$

The first inequality comes from the mean-value inequality and the equality is due to the fact that $U(s)$ is an isometry. The norm in the right-hand side is finite since p has temperate growth (4.1.37) by assumption. The conclusion follows from Stone's theorem once again. \square

4.4. The classical dynamics

The goal of this section is to provide general estimates on derivatives of the Hamiltonian flow $(\phi^t)_{t \in \mathbf{R}}$ associated with a Hamiltonian p . The derivatives we consider are in the sense of the covariant derivative, using the natural connection ∇ on T^*M , $M = \mathbf{R}^d$. We will set by convention $\nabla^0 \phi^t = \phi^t$ and $\nabla \phi^t = d\phi^t$. Similarly to the definition of covariant derivatives of tensors, higher-order derivatives are defined by induction so that the Leibniz formula holds:

$$\nabla_{X_1, X_2, \dots, X_{k+1}}^{k+1} \phi^t = \nabla_{X_{k+1}} (\nabla_{X_1, X_2, \dots, X_k}^k \phi^t) - \sum_{j=1}^k \nabla_{X_1, X_2, \dots, \nabla_{X_{k+1}} X_j, \dots, X_k}^k \phi^t,$$

for any family of vector fields X_1, X_2, \dots, X_{k+1} on T^*M . For all $k \geq 1$, the input of $\nabla^k \phi^t$ is a k -tuple of vector fields. The result is a vector field on T^*M . Beware that $(\nabla_{X_1, X_2, \dots, X_k}^k \phi^t)(\rho)$ is a tangent vector at the point $\phi^t(\rho)$, and not at ρ . In other words, $\nabla^k \phi^t(\rho)$ sends k tangent vectors at ρ to a tangent vector at $\phi^t(\rho)$. Thus we can think of these covariant derivatives as tensors of type $(1, k)$. One can check that $\nabla^k \phi^t$ is symmetric with respect to the input vector fields, for any $k \geq 0$, owing to the fact that the connection is torsion free and has vanishing curvature [Lee09, Section 12.8].

4.4.1. Norms with respect to a metric

The size of these derivatives will be measured using a Riemannian metric g on T^*M . We denote by $|\nabla^k \phi^t|_g$ the function on T^*M that corresponds to the smallest constant $C = C(\rho)$ such that

$$|\nabla_{X_1, X_2, \dots, X_k}^k \phi^t|_{g_{\phi^t(\rho)}} \leq C \prod_{j=0}^k |X_j|_{g_\rho},$$

for all vector fields X_1, X_2, \dots, X_k .

Remark 4.4.1 (Norm of a volume-preserving diffeomorphism). For any Riemannian metric g , we always have $|d\phi^t|_g \geq 1$. This is a consequence of the fact that ϕ^t is a symplectomorphism. Indeed, given a finite dimensional real normed vector space $(F, \|\bullet\|)$, denoting by μ any multiple of the Lebesgue measure, then for any isomorphism A , we have

$$|\det A| \mu(B_1(0)) = \mu(AB_1(0)) \leq \mu(B_{\|A\|}(0)) = \|A\|^{\dim F} \mu(B_1(0)),$$

where $B_r(0)$ is the ball of radius r centered at the origin. Therefore

$$|\det A| \leq \|A\|^{\dim F}.$$

Applying this with $(F, \|\bullet\|) = (T_\rho T^*M, |\bullet|_g)$ and $A = d\phi^t(\rho)$, and recalling that $|\det d\phi^t(\rho)| = 1$, we obtain $|d\phi^t(\rho)|_g \geq 1$.

We start with a lemma that relates derivatives of H_p to seminorms of p .

Lemma 4.4.2 (Seminorms of the Hamiltonian vector field). *Let $a \in C^\infty(T^*M)$. One has for any $k \in \mathbf{N}$:*

$$|\nabla^k H_a|_{g^\sigma} \leq h_g^k |\nabla^{k+1} a|_g \quad \text{and} \quad |\nabla^k H_a|_g \leq h_g |\nabla^{k+1} a|_g, \quad \forall k \geq 0.$$

One also has

$$|H_a|_g \leq |\nabla a|_{g^\sigma}.$$

Proof. Let us check by induction that for any $k \geq 0$, the following is true: for all vector fields X_0, X_1, \dots, X_k ,

$$-\nabla^{k+1} a(X_0, X_1, X_2, \dots, X_k) = \sigma(\nabla^k H_a(X_1, X_2, \dots, X_k), X_0). \quad (4.4.1)$$

The case $k = 0$ is merely the definition of the Hamiltonian vector field. Now assume (4.4.1) holds for some $k \geq 0$. We pick $k + 2$ vector fields X_0, X_1, \dots, X_{k+1} and we differentiate (4.4.1) with respect to X_{k+1} :

$$-d(\nabla^{k+1} a(X_0, X_1, \dots, X_k)) X_{k+1} = d(\sigma(\nabla^k H_a(X_1, X_2, \dots, X_k), X_0)) X_{k+1}.$$

Using the Leibniz formula on both sides and using that $\nabla \sigma = 0$, we obtain

$$\begin{aligned} & -\nabla^{k+2} a(X_0, X_1, \dots, X_{k+1}) - \sum_{j=0}^k \nabla^{k+1} a(X_0, X_1, \dots, \nabla_{X_{k+1}} X_j, \dots, X_k) \\ &= \sigma(\nabla^k H_a(X_1, X_2, \dots, X_k), \nabla_{X_{k+1}} X_0) + \sigma(\nabla^{k+1} H_a(X_1, X_2, \dots, X_{k+1}), X_0) \\ & \quad + \sum_{j=1}^k \sigma(\nabla^k H_a(X_1, X_2, \dots, \nabla_{X_{k+1}} X_j, \dots, X_k), X_0). \end{aligned}$$

The induction hypothesis (4.4.1) implies that the j -th term in the left-hand side sum, for $j \geq 1$, coincides with the j -th in the right-hand side sum, while the term corresponding to $j = 0$ in the left-hand side equals the first term in the right-hand side. We obtain (4.4.1) at step $k + 1$, hence the induction is complete.

Now recall the section J_g of the fiber bundle $\text{End}(TT^*M)$ such that

$$g(X, Y) = \sigma(X, J_g Y),$$

for all vector fields X, Y on T^*M . Also recall that by definition, $g = J_g^* g^\sigma$, so that in particular $|\bullet|_g = |J_g \bullet|_{g^\sigma}$, or equivalently $|J_g^{-1} \bullet|_g = |\bullet|_{g^\sigma}$.

We use (4.4.1) with $X_0 = J_g X$ for some vector field X to get

$$g(\nabla^k H_a(X_1, X_2, \dots, X_k), X) = \sigma(\nabla^k H_a(X_1, X_2, \dots, X_k), X_0) = -\nabla^{k+1} a(X_0, X_1, X_2, \dots, X_k)$$

for any $k \geq 0$, from which it follows that

$$|g(\nabla^k H_a(X_1, X_2, \dots, X_k), X)| \leq |\nabla^{k+1} a|_g |J_g|_g |X|_g \times \prod_{j=1}^k |X_j|_g.$$

We deduce that

$$|\nabla^k H_a(X_1, X_2, \dots, X_k)|_g \leq h_g |\nabla^{k+1} a|_g \prod_{j=1}^k |X_j|_g,$$

hence the second claim.

The third claim can be handled similarly: for any vector field X , one has

$$|g(H_a, X)| = |\sigma(H_a, J_g X)| = |\nabla a \cdot J_g X| \leq |\nabla a|_{g^\sigma} |J_g X|_{g^\sigma} = |\nabla a|_{g^\sigma} |X|_g.$$

We proceed similarly to obtain the first estimate: we use (4.4.1) again to obtain

$$\begin{aligned} g^\sigma(X, \nabla^k H_a(X_1, X_2, \dots, X_k)) &= \sigma(J_g^{-1} X, \nabla^k H_a(X_1, X_2, \dots, X_k)) \\ &= \nabla^{k+1} a(J_g^{-1} X, X_1, X_2, \dots, X_k). \end{aligned}$$

This implies that

$$|g^\sigma(X, \nabla^k H_a(X_1, X_2, \dots, X_k))| \leq |\nabla^{k+1} a(\bullet, X_1, X_2, \dots, X_k)|_g |X|_{g^\sigma},$$

hence

$$\begin{aligned} |\nabla^k H_a(X_1, X_2, \dots, X_k)|_{g^\sigma} &\leq |\nabla^{k+1} a(\bullet, X_1, X_2, \dots, X_k)|_g \leq |\nabla^{k+1} a|_g \prod_{j=1}^k |X_j|_g \\ &\leq |\nabla^{k+1} a|_g h_g^k \prod_{j=1}^k |X_j|_{g^\sigma}, \end{aligned}$$

which is the desired estimate. \square

Remark 4.4.3. For a general linear map κ , there is no general estimate relating $|\kappa|_g$ and $|\kappa|_{g^\sigma}$ since we change the norm both in the domain and codomain. However, we check below that if κ is symplectic, then

$$|\kappa|_{g^\sigma} = |\kappa^{-1}|_g. \quad (4.4.2)$$

Applying this to $\kappa = d\phi^t$, it means that measuring the expansion of the flow in the future with respect to g^σ is the same as measuring the expansion of the flow in the past with respect to g . To check (4.4.2), we merely deduce from the fact that κ is symplectic the following:

$$g^\sigma(\kappa X, J_g Y) = \sigma(\kappa X, Y) = \sigma(X, \kappa^{-1} Y) = g(J_g^{-1} X, \kappa^{-1} Y).$$

We divide these equality by the quantity $|X|_{g^\sigma} |J_g Y|_{g^\sigma} = |J_g^{-1} X|_g |Y|_g$ (in which equality follows from (4.1.18) and (4.1.19)), so as to obtain

$$\frac{g^\sigma(\kappa X, J_g Y)}{|X|_{g^\sigma} |J_g Y|_{g^\sigma}} = \frac{g(J_g^{-1} X, \kappa^{-1} Y)}{|J_g^{-1} X|_g |Y|_g}.$$

Writing $\tilde{X} = J_g^{-1} X$ and $\tilde{Y} = J_g Y$, that yields

$$\frac{g^\sigma(\kappa X, \tilde{Y})}{|X|_{g^\sigma} |\tilde{Y}|_{g^\sigma}} = \frac{g(\tilde{X}, \kappa^{-1} Y)}{|\tilde{X}|_g |Y|_g}.$$

Maximizing separately over (X, \tilde{Y}) and (\tilde{X}, Y) yields (4.4.2).

4.4.2. A general estimate

In this subsection, we provide a general estimate on the derivatives of the Hamiltonian flow. Here g is an arbitrary Riemannian metric on T^*M . The rough idea is to differentiate successively the equation on the differential:

$$\frac{d}{dt} d\phi^t(\rho) = \nabla H_p(\phi^t(\rho)) \cdot d\phi^t(\rho),$$

and use Duhamel's formula to express $\nabla^{k+1}\phi^t$ as a function of lower order derivatives of ϕ^t .

We define several functions of time quantifying the growth of the differential of the Hamiltonian flow: on the one hand, we consider the successive primitives of $|d\phi^t(\rho)|_g$ with respect to time:

$$\forall k \in \mathbf{N}^*, \quad \mathcal{I}_{k+1}(t, \rho) := \int_{[0,t]} \mathcal{I}_k(s, \rho) ds, \quad \text{with } \mathcal{I}_0(t, \rho) := |d\phi^t(\rho)|_g.$$

On the other hand, we handle products arising from iterating Duhamel's formula by introducing for any $t \in \mathbf{R}$ and $\rho \in T^*M$:

$$\mathcal{N}_k(t, \rho) := \sup_{s \in [0,t]} |d\phi^s(\rho)|_g \quad \text{and} \quad \forall k \in \mathbf{N}^*, \quad \mathcal{N}_k(t, \rho) := \sup_{s \in [0,t]} \sup_{\mathbf{s} \in s\Delta_k} \prod_{j=0}^k |d\phi^{s_{j+1}-s_j}(\phi^{s_j}(\rho))|_g.$$

In the latter definition, $\mathbf{s} = (s_1, s_2, \dots, s_k) \in s\Delta_k$ refers to a point in the k -dimensional simplex defined in (4.1.41), with the boundary conventions $s_0 = 0$ and $s_{k+1} = s$. We also set for any energy level $E \in \mathbf{R}$:

$$\mathcal{I}_k(t, E) := \sup_{\rho \in \{p=E\}} \mathcal{I}_k(t, \rho) \quad \text{and} \quad \mathcal{N}_k(t, E) := \sup_{\rho \in \{p=E\}} \mathcal{N}_k(t, \rho)$$

Note that \mathcal{I}_k and \mathcal{N}_k are non-decreasing as functions of t by definition.

We set for any smooth function f on T^*M (or more generally for any tensor over T^*M):

$$\|f\|_n^k = \|f\|_n^k(\rho) := \max_{\substack{\mathbf{n} \in \mathbf{N}^n \\ |\mathbf{n}|=k}} \prod_{j=1}^n \frac{|\nabla^{n_j} f(\rho)|_g}{n_j!}, \quad \rho \in T^*M, \quad k \in \mathbf{N}, \quad n \in \mathbf{N}^*. \quad (4.4.3)$$

We also set $\|f\|_{n,E}^k := \sup_{\{p=E\}} \|f\|_n^k$. Note that in case f is an analytic function, the quantity $\|f\|_n^k$ behaves roughly as r^{-k} , where r is the radius of analyticity of f around ρ . Such quantities will appear naturally while applying the Faà di Bruno formula (Appendix 4.D). This interpretation of this quantity justifies why we chose to emphasize the dependence on k by putting it as an exponent. However, notice that when $k = 0$, $\|f\|_n^k$ behaves as $|f|^n$.

To simplify notation, the dependence of the quantities $\mathcal{I}_k, \mathcal{N}_k$ and $\|\bullet\|_n^k$ on the metric g will not be made explicit.

Proposition 4.4.4 (Derivative estimates of the flow). *Let g be a Riemannian metric on T^*M . Then for all $k \geq 2$, we have for all $t \in \mathbf{R}$ and $\rho \in T^*M$:*

$$\begin{aligned} & \frac{1}{k!} |\nabla^k \phi^t|_g(\rho) \\ & \leq k^{k-1} \max_{1 \leq n \leq k-1} \left(\frac{|\nabla^2 H_p|_{n,E}^{k-1-n}}{2^n} \max_{1 \leq j \leq k/2} \max_{\substack{\mathbf{n} \in \mathbf{N}^j \\ |\mathbf{n}|=n}} \mathcal{N}_0^{k-2j}(t, \rho) \prod_{\ell=1}^j \mathcal{N}_{n_\ell}(t, \rho) \mathcal{I}_{n_\ell}(t, \rho) \right). \end{aligned} \quad (4.4.4)$$

Proposition 4.4.4 states that the derivative of ϕ^t of order k will be bounded by a sum of terms behaving differently on short time intervals, namely as t^n for $1 \leq n \leq k-1$. This is due to the fact that these derivatives can be computed iterating Duhamel's formula. In fact, the index n indicates the number of iterated Duhamel integrals. These integrals are controlled by

$$\max_{1 \leq j \leq k/2} \max_{\substack{n_1+n_2+\dots+n_j=n \\ n_k \geq 1}} \mathcal{N}_0^{k-2j}(t, \rho) \prod_{\ell=1}^j \mathcal{N}_{n_\ell}(t, \rho) \mathcal{I}_{n_\ell}(t, \rho).$$

This is of order 1 as $t \rightarrow 0$. However, the larger the exponent n is, the worse is the constant in front of this term: this constant behaves as $|\nabla^2 p|_{g,E}^{k-1}$, that is to say a product of seminorms of p .

Proof. We will proceed by induction. The starting point is the equation defining the Hamiltonian flow:

$$\frac{d}{dt} \phi^t(\rho) = H_p(\phi^t(\rho)).$$

We differentiate it k times with respect to the variable ρ using the Faà di Bruno formula (Appendix 4.D): isolating the term of order $j = 1$, one has

$$\frac{d}{dt} \left(\frac{1}{k!} \nabla^k \phi^t \right)_\rho = (\nabla H_p)_{\phi^t(\rho)} \cdot \left(\frac{1}{k!} \nabla^k \phi^t \right)_\rho + \sum_{j=2}^k \sum_{\substack{\mathbf{n} \in (\mathbf{N}^*)^j \\ |\mathbf{n}|=k}} \frac{1}{j!} (\nabla^j H_p)_{\phi^t(\rho)} \cdot \left(\frac{1}{\mathbf{n}!} \nabla^{\mathbf{n}} \phi^t \right). \quad (4.4.5)$$

The notation $\frac{1}{\mathbf{n}!} \nabla^{\mathbf{n}}$ is defined in (4.D.1).

To obtain the estimate (4.4.4), we observe from (4.4.5) that the equation satisfied by $A(t) := \frac{1}{k!} \nabla^k \phi^t$ for $k \geq 2$ is of the form

$$\frac{d}{dt} A_\rho(t) = (\nabla H_p)_{\phi^t(\rho)} \cdot A_\rho(t) + B_\rho(t), \quad (4.4.6)$$

where the source term $B(t)$ depends on derivatives of order less than $k - 1$ of ϕ^t . We observe that the solution to the homogeneous equation

$$\frac{d}{dt} a_\rho(t) = (\nabla H_p)_{\phi^t(\rho)} \cdot a_\rho(t),$$

is given by the formula

$$a_\rho(t) = d\phi^t(\rho) a_\rho(0),$$

so that Duhamel's formula in (4.4.6) (with initial datum $\nabla^k \phi^0 = \nabla^k \text{Id} = 0$ since $k \geq 2$) yields

$$A(t) = \int_0^t d\phi^{t-s}(\phi^s(\rho)) B(s) ds. \quad (4.4.7)$$

With this at hand, we can start the induction. We check the basis step $k = 2$ of (4.4.4):

$$\frac{1}{2!} \nabla^2 \phi^t = \int_0^t d\phi^{t-s}(\phi^s(\rho)) \frac{1}{2!} \nabla^2 H_p(\phi^s(\rho)) \cdot (\nabla \phi^s(\rho))^2 ds,$$

so that

$$\frac{1}{2!} |\nabla^2 \phi^t(\rho)|_g \leq \frac{1}{2!} |\nabla^2 H_p|_{g,E} \int_0^t |\nabla \phi^{t-s}(\phi^s(\rho))|_g |\nabla \phi^s(\rho)|_g^2 ds \leq \frac{1}{2} \|\nabla^2 H_p\|_{1,E}^0 \mathcal{N}_1(t, \rho) \mathcal{I}_1(t, \rho),$$

which was the expected bound. Now assume (4.4.4) is true for some $k \geq 2$. From the Faà di Bruno formula written in (4.4.5), we know that the source term in (4.4.6) with $A(t) = \frac{1}{(k+1)!} \nabla^{k+1} \phi^t$ is bounded by derivatives of order less than k ,

$$|B_\rho(s)|_g \leq \sum_{j=2}^{k+1} \sum_{\substack{n_1+n_2+\dots+n_j=k+1 \\ n_\ell \geq 1}} \frac{1}{j!} |\nabla^j H_p|_{g,E} \prod_{\ell=1}^j \frac{1}{n_\ell!} |\nabla^{n_\ell} \phi^s(\rho)|_g. \quad (4.4.8)$$

To get $A(t)$, we apply Duhamel's formula. We deal with the term $j = k + 1$ in the above sum separately. We bound all but one factors $|\nabla \phi^s|$ by the infinity norm in time, keeping only one of them in the integral. It yields

$$\int_0^t |d\phi^{t-s}(\phi^s(\rho))|_g \frac{|\nabla^{k+1} H_p|_{g,E}}{(k+1)!} |\nabla \phi^s(\rho)|_g^{k+1} ds \leq \frac{\|\nabla^2 H_p\|_{1,E}^{k-1}}{2} \mathcal{N}_0^{k-2}(t, \rho) \mathcal{N}_1(t, \rho) \mathcal{I}_1(t, \rho),$$

which matches (4.4.4) with $n = 1$ and $j = 1$. Now we use the induction hypothesis to handle the terms of order $j \in \{2, 3, \dots, k\}$. Fix such a j and a multi-index (n_1, n_2, \dots, n_j) , with $n_1 + n_2 + \dots + n_j = k + 1$. Denote by j_0 the number of indices ℓ such that $n_\ell = 1$. Up to relabeling, we assume that those indices are n_1, n_2, \dots, n_{j_0} . Note that we know that $j_0 < j$ since the case $j = k + 1$ is excluded. The product of $\frac{1}{n_\ell!} |\nabla^{n_\ell} \phi^s|$ for $\ell > j_0$ leads to the multiplication of the bounds (4.4.4), with n_ℓ in place of k . For any $\ell > j_0$, we fix m_ℓ between 1 and $n_\ell - 1$ for which the maximum over

$1 \leq n \leq k-1$ is attained in (4.4.4). Here, m_ℓ and n_ℓ will play the role of n and k respectively for the ℓ -th term. The combinatorial factor k^{k-1} in this bound can be controlled as follows:

$$\prod_{\ell=j_0+1}^j n_\ell^{n_\ell-1} \leq \prod_{\ell=1}^j k^{n_\ell-1} = k^{k+1-j}.$$

We used $n_\ell \leq k$, as a consequence of the fact that $j \geq 2$ (there are at least two positive numbers whose sum is equal to $k+1$). Next we look at the quantities involving ∇H_p : if for any $\ell > j_0$ we pick an m_ℓ such that $1 \leq m_\ell \leq n_\ell - 1$, we have

$$\begin{aligned} \frac{1}{j!} |\nabla^j H_p|_{g,E} \prod_{\ell=j_0+1}^j \frac{1}{2^{m_\ell}} |\nabla^2 H_p|_{m_\ell,E}^{n_\ell-1-m_\ell} &\leq \frac{1}{2} |\nabla^2 H_p|_{1,E}^{j-2} \times \frac{1}{2^m} |\nabla^2 H_p|_{m,E}^{k+1-j-m} \\ &\leq \frac{1}{2^{m+1}} |\nabla^2 H_p|_{m+1,E}^{k-(m+1)}, \end{aligned}$$

where $1 \leq m = m_{j_0+1} + \dots + m_j \leq n_1 + n_2 + \dots + n_j - j = k+1-j \leq k-1$. This yields the expected factor in (4.4.4), with $n = m+1$ between 2 and k . Lastly we deal with the factors involving $\mathcal{N}(t, \rho)$ and $\mathcal{I}(t, \rho)$. For any $\ell > j_0$, we pick $\mathbf{n}_\ell = (n_{\ell,1}, n_{\ell,2}, \dots, n_{\ell,m_\ell})$ in \mathbf{N}^{m_ℓ} with $|\mathbf{n}_\ell| \leq n_\ell - 1$. Take them such that they achieve the corresponding maximum in (4.4.4). Here m_ℓ plays the role of j subject to $1 \leq j \leq (k+1)/2$ in (4.4.4). It has to satisfy $1 \leq m_\ell \leq n_\ell/2$. Applying Duhamel's formula, we are lead to consider terms of the form

$$\int_0^t |\nabla \phi^{t-s}(\phi^s(\rho))|_g |\nabla \phi^s(\rho)|_g^{j_0} \prod_{\ell=j_0+1}^j \mathcal{N}_0^{n_\ell-2m_\ell}(s, \rho) \prod_{i=1}^{m_\ell} \mathcal{N}_{n_{\ell,i}}(s, \rho) \mathcal{I}_{n_{\ell,i}}(s, \rho) ds. \quad (4.4.9)$$

We concatenate the \mathbf{n}_ℓ to get a multi-index $\mathbf{n} = (\mathbf{n}_{j_0+1}, \dots, \mathbf{n}_j)$ such that

$$|\mathbf{n}| = \sum_{\ell=j_0+1}^j |\mathbf{n}_\ell| \leq \sum_{\ell=1}^j (n_\ell - 1) = k+1-j.$$

This multi-index belongs to $(\mathbf{N}^*)^m$ with $1 \leq m = m_{j_0+1} + \dots + m_j \leq \frac{1}{2}(n_1 + n_2 + \dots + n_j) = \frac{1}{2}(k+1)$. The product of the $\mathcal{N}_0^{n_\ell-2m_\ell}(s, \rho)$, for $\ell = j_0+1, \dots, j$, can be bounded by the same product at time t , which yields $\mathcal{N}_0^{k+1-j_0-2m}(t, \rho)$. As for $|\nabla \phi^s(\rho)|_g^{j_0}$, we can bound it by $\mathcal{N}_0^{j_0}(t)$. Now in (4.4.9), we gather $|\nabla \phi^{t-s}(\phi^s(\rho))|$ with $\mathcal{N}_{n_j, m_j}(s, \rho)$, and we use that

$$|\nabla \phi^{t-s}(\phi^s(\rho))| \mathcal{N}_{n_j, m_j}(s, \rho) \leq \mathcal{N}_{n_j, m_j+1}(t, \rho),$$

for any t and ρ . Finally, using monotonicity in time, we bound from above all the factors $\mathcal{N}_{n_{\ell,i}}(s, \rho)$ and $\mathcal{I}_{n_{\ell,i}}(s, \rho)$, for $j_0 < \ell < j$ or $\ell = j$ and $i < m_j$, by the same factor at time t . As for the remaining factor \mathcal{I}_{n_j, m_j} , we keep it in the integral, and use that by definition:

$$\int_0^t \mathcal{I}_{n_j, m_j}(s) ds = \mathcal{I}_{n_j, m_j+1}(t).$$

In the end, the term (4.4.9) admits a bound of the form

$$\mathcal{N}_0^{j_0}(t) \mathcal{N}_0^{k+1-j_0-2m}(t) \prod_i \mathcal{N}_{\tilde{n}_i}(t) \mathcal{I}_{\tilde{n}_i}(t),$$

where the multi-index $\tilde{\mathbf{n}} = (\tilde{n}_i)_i$ is built from \mathbf{n} by modifying solely its last component, changing n_{n_j, m_j} into $n_{n_j, m_j} + 1$. We get indeed a bound of the form of the right-hand side of (4.4.4), since $m \leq (k+1)/2$ and $|\tilde{\mathbf{n}}| = |\mathbf{n}| + 1 = m+1 \leq k+1-j+1 \leq k$, in view of $j \geq 2$. It remains to handle the sum over j . We observe that only the combinatorial factors depends on j (the seminorms of p and the quantities $\mathcal{I}_k, \mathcal{N}_k$ can be factored outside the sum). Summing these combinatorial factors, we can use Remark 4.D.3 to arrive at

$$\sum_{j=2}^{k+1} \sum_{\substack{\mathbf{n} \in (\mathbf{N}^*)^j \\ |\mathbf{n}|=k+1}} (k+1)^{k+1-j} = \sum_{j=2}^{k+1} \binom{k}{j-1} k^{k+1-j} \leq (k+1)^k.$$

This completes the induction. \square

4.4.3. Exponentially expanding flows

Proposition 4.4.4 in Subsection 4.4.2 gives a general bound, which can be used to study the growth of derivatives of polynomially expanding flows. This case will not be discussed further in this work since it corresponds to very particular situation (see for instance [BR02]). So from now on we will focus on the generic situation in which the differential of the flow increases like an exponential.

Proposition 4.4.5 (Exponential growth of flow derivatives). *Fix an energy level E . Assume there exist $\Lambda \geq 0$ and $C_\Lambda \geq 1$ such that*

$$|d\phi^t|_{g,E} \leq C_\Lambda e^{\Lambda t}, \quad \forall t \geq 0.$$

Then one has

$$|\nabla^k \phi^t|_{g,E} \leq k^{k-1} (C_\Lambda e^{\Lambda t})^k \max_{1 \leq n \leq k-1} \left(\left(\frac{C_\Lambda}{2\Lambda} \right)^n |\nabla^2 H_p|_{n,E}^{k-1-n} \right), \quad \forall t \geq 0, \forall k \geq 2.$$

Proof. This is a consequence of Proposition 4.4.4. We estimate each term in the right-hand side of (4.4.4). The product in its definition of $\mathcal{N}_k(t, \rho)$ is telescopic:

$$\mathcal{N}_k(t, E) \leq \sup_{s \in [0, t]} \sup_{s \in s\Delta_k} C_\Lambda^{k+1} \prod_{j=0}^k e^{\Lambda(s_{j+1} - s_j)} = C_\Lambda^{k+1} \sup_{s \in [0, t]} e^{\Lambda(s_{k+1} - s_0)} = C_\Lambda^{k+1} \sup_{s \in [0, t]} e^{\Lambda s} = C_\Lambda^{k+1} e^{\Lambda t}.$$

As for $\mathcal{J}_k(t, E)$, we can proceed by induction and check that each integration yields a factor Λ^{-1} , so that:

$$\mathcal{J}_k(t, E) \leq \frac{C_\Lambda}{\Lambda^k} e^{\Lambda t}.$$

For any n between 1 and $k-1$, it leads to

$$\begin{aligned} \max_{1 \leq j \leq k/2} \max_{\substack{\mathbf{n} \in \mathbf{N}^j \\ |\mathbf{n}|=n}} \mathcal{N}_0^{k-2j}(t, E) \prod_{\ell=1}^j \mathcal{N}_{n_\ell}(t, E) \mathcal{J}_{n_\ell}(t, E) \\ \leq \max_{1 \leq j \leq k/2} \max_{\substack{\mathbf{n} \in \mathbf{N}^j \\ |\mathbf{n}|=n}} C_\Lambda^{k-2j} e^{(k-2j)\Lambda t} \prod_{\ell=1}^j C_\Lambda^{n_\ell+1} e^{\Lambda t} \frac{C}{\Lambda^{n_\ell}} e^{\Lambda t} = \frac{C_\Lambda^{k+n}}{\Lambda^n} e^{k\Lambda t}. \end{aligned}$$

Proposition 4.4.4 give the sought result. \square

Under Assumption 4.1.14, it will be sufficient to pick Λ defined in (4.1.25) and $C_\Lambda = 1$ according to the following a priori estimate.

Proposition 4.4.6 (A priori exponential growth estimate). *Under Assumption 4.1.14,*

$$|d\phi^t(\rho)|_g \leq \exp \left(\int_{[0, t]} |\mathcal{L}_{H_p} g|_g(\phi^s(\rho)) ds \right), \quad \forall \rho \in T^*M, \forall t \in \mathbf{R}, \quad (4.4.10)$$

so in particular

$$|d\phi^t|_{g, \infty} \leq e^{\Lambda|t|}, \quad \forall t \in \mathbf{R}, \quad (4.4.11)$$

where Λ is the Lyapunov exponent introduced in (4.1.25). Moreover we have

$$\Lambda \leq \sup_{T^*M} \left(h_g |\nabla^2 p|_g + \frac{1}{2} |\nabla_{H_p} g|_g \right). \quad (4.4.12)$$

Proof. We have for any $\rho \in T^*M$ and any $t \in \mathbf{R}$:

$$\frac{d}{dt} (\phi^t)^* g = (\phi^t)^* \mathcal{L}_{H_p} g \leq |\mathcal{L}_{H_p} g|_g(\phi^t(\rho)) (\phi^t)^* g, \quad (4.4.13)$$

so Grönwall's inequality yields (4.4.10) and (4.4.11) follows from the definition of Λ in (4.1.25). It remains to prove (4.4.12). For any couple of vector fields X, Y on T^*M , we have

$$\begin{aligned} (\mathcal{L}_{H_p}g)_\rho(X, Y) &= \frac{d}{dt}\Big|_{t=0} g_{\phi^t(\rho)}(d\phi^t(\rho).X, d\phi^t(\rho).Y) \\ &= g_\rho(\nabla H_p.X, Y) + g_\rho(X, \nabla H_p.Y) + (\nabla_{H_p}g)_\rho(X, Y), \end{aligned}$$

and combining this with $|\nabla H_p|_g \leq h_g|\nabla^2 p|_g$ (see Lemma 4.4.2), we obtain inequality (4.4.12). \square

Now we provide estimates for the composition of a symbol with the flow. We shall study this composition as an operator, acting on various spaces. We recall the notation

$$e^{tH_p}a = a \circ \phi^t, \quad \forall t \in \mathbf{R}, \forall a \in C^\infty(T^*M).$$

Lemma 4.4.7 (Composition by the flow). *Let us assume that $p \in C^\infty(T^*M)$ is such that the associated Hamiltonian flow $(\phi^t)_{t \in \mathbf{R}}$ is complete and let g be a Riemannian metric on T^*M . Let $E \in \mathbf{R}$ and assume that the flow has an exponential growth on the energy layer $\{p = E\}$, i.e.*

$$\exists C = C(E) \geq 1, \exists \Lambda = \Lambda(E) > 0 : \quad |d\phi^t|_{g,E} \leq Ce^{\Lambda t}, \quad \forall t \geq 0.$$

Then for all $a \in C^\infty(T^*M)$ and all $k \in \mathbf{N}^*$, we have

$$\frac{1}{k!} |\nabla^k e^{tH_p}a|_g(\rho) \leq (Cke^{\Lambda t})^k \max_{1 \leq j \leq k} \left(\frac{1}{j!} |(\nabla^j a)_{\phi^t(\rho)}|_g \max_{1 \leq n \leq k-j} \left(\left(\frac{C}{2\Lambda} \right)^n |\nabla^2 H_p|_{n,E}^{k-j-n} \right) \right). \quad (4.4.14)$$

When $j = k$, we adopt the convention that the maximum over n in the empty set is equal to 1.

Remark 4.4.8. This estimate implies the simpler estimate

$$\forall k \geq 1, \quad \frac{1}{k!} |\nabla^k e^{tH_p}a|_g(\rho) \leq (Cke^{\Lambda t})^k |\nabla a|_g^{(k-1)}(\phi^t(\rho)) \left\langle \frac{C}{2\Lambda} |\nabla^2 H_p|_E^{(k-2)} \right\rangle^{k-1},$$

where $|\nabla a|_g^{(k-1)} = \max_{0 \leq j \leq k-1} |\nabla^{1+j} a|_g$ and $|\nabla^2 H_p|_E^{(k-2)} = \max_{0 \leq j \leq k-2} |\nabla^{2+j} H_p|_{g,E}$. This follows directly from the definition of $|\nabla^2 H_p|_n^k$ in (4.4.3).

Proof. The statement for $k = 1$ follows from the chain rule. Thus we suppose $k \geq 2$ in the sequel. The result follows from the Faà di Bruno formula (Lemma 4.D.1) and Proposition 4.4.4. Lemma 4.D.1 gives

$$\frac{1}{k!} |\nabla^k (a \circ \phi^t)|_g(\rho) \leq \sum_{j=1}^k \frac{1}{j!} |(\nabla^j a)_{\phi^t(\rho)}|_g \sum_{\substack{n_1+n_2+\dots+n_j=k \\ n_\ell \geq 1}} \prod_{\ell=1}^j \frac{1}{n_\ell!} |\nabla^{n_\ell} \phi^t|_g.$$

We observe that there is a single term corresponding to $j = k$, given by the multi-index $(n_1, n_2, \dots, n_j) = (1, 1, \dots, 1)$. It is bounded by $|(\nabla^k a)_{\phi^t(\rho)}|_g (Ce^{\Lambda t})^k$. Now we focus on terms associated with $j < k$.

To estimate the products appearing in the sum, we multiply the bounds given by Proposition 4.4.4 for all the factors with index $n_\ell \geq 2$. Up to relabeling, we assume that there is a $j_0 \in \{1, 2, \dots, j\}$ such that $n_\ell = 1$ for all $\ell < j_0$ and $n_\ell > 1$ for $\ell \geq j_0$. So we bound from above the product of the $j_0 - 1$ first factors by $(Ce^{\Lambda t})^{j_0-1}$. For the remaining factors, Proposition 4.4.4 gives a bound of the form

$$\left(\prod_{\ell=j_0}^j n_\ell^{n_\ell-1} \right) (Ce^{\Lambda t})^{k-j_0} \max_{1 \leq n \leq k-j} \left(\left(\frac{C}{2\Lambda} \right)^n |\nabla^2 H_p|_{n,E}^{k-j-n} \right).$$

The combinatorial factor can be estimated as follows:

$$\prod_{\ell=j_0}^j n_\ell^{n_\ell-1} \leq \prod_{\ell=j_0}^j (k-1)^{n_\ell-1} = (k-1)^{k-(j_0-1)-(j-j_0+1)} = (k-1)^{k-j}.$$

On the whole, we have

$$\prod_{\ell=1}^j \frac{1}{n_\ell!} |\nabla^{n_\ell} \phi^t|_g \leq (k-1)^{k-j} (Ce^{\Lambda t})^k \max_{1 \leq n \leq k-j} \left(\left(\frac{C}{2\Lambda} \right)^n |\nabla^2 H_p|_{n,E}^{k-j-n} \right).$$

We used that $n_\ell \leq k-1$, owing to the fact that $j < k$, as well as $\sum_\ell n_\ell = k$ and $n_\ell = 1$ for all $\ell < j_0$. Taking into account the factor depending on the j -th derivative of a , we obtain that each term is bounded by

$$(k-1)^{k-j} (Ce^{\Lambda t})^k \max_{1 \leq j \leq k} \left(\frac{1}{j!} |(\nabla^j a)_{\phi^t(\rho)}|_g \max_{1 \leq n \leq k-j} \left(\left(\frac{C}{2\Lambda} \right)^n |\nabla^2 H_p|_{n,E}^{k-j-n} \right) \right),$$

with the right convention. It remains to sum over j the combinatorial factors $\sum_{j=1}^k (k-1)^{k-j} = k^{k-1}$. It yields the desired estimate (4.4.14). \square

4.4.4. Lipschitz-type properties of the flow

We wish to prove a Lipschitz-type property of the flow. Here the slow variation of the metric g matters. Recall the slow variation radius r_g and the slow variation constant C_g from Proposition 4.1.29, as well as the Lyapunov exponent Λ and the number Υ introduced in Assumption 4.1.14.

Proposition 4.4.9. *Write $C_p = |\nabla^3 p|_{S((h_g/h_g)^{-1},g)}^{(0)}$. For all $r \in (0, r_g)$ and all $t \in \mathbf{R}$ such that*

$$r \leq r_g e^{-(\Lambda + C_g^3 \frac{C_p}{4} h_g)|t|},$$

we have

$$\forall \rho_0 \in T^*M, \forall \rho \in B_r^g(\rho_0), \quad |\phi^t(\rho) - \phi^t(\rho_0)|_{g_{\phi^t(\rho_0)}} \leq |\rho - \rho_0|_{g_{\rho_0}} e^{(\Lambda + C_g^3 \frac{C_p}{4} h_g)|t|}.$$

Proof. Given $\rho_0, \rho \in T^*M$, we differentiate with respect to t the quantity

$$\mathcal{N}(t) := |\phi^t(\rho) - \phi^t(\rho_0)|_{g_{\phi^t(\rho_0)}}^2.$$

Writing for short $\rho_t = \phi^t(\rho_0)$, $\rho_{t,s} = (1-s)\phi^t(\rho_0) + s\phi^t(\rho)$ and $\zeta_t = \phi^t(\rho) - \phi^t(\rho_0)$, we obtain

$$\begin{aligned} \frac{d}{dt} \mathcal{N}(t) &= 2g_{\rho_t} (H_p(\phi^t(\rho)) - H_p(\phi^t(\rho_0)), \zeta_t) + \nabla_{H_p} g_{\rho_t}(\zeta_t, \zeta_t) \\ &= \int_0^1 2g_{\rho_t}(\nabla H_p(\rho_{t,s}), (\zeta_t), \zeta_t) ds + \nabla_{H_p} g_{\rho_t}(\zeta_t, \zeta_t) \\ &= (\mathcal{L}_{H_p} g)_{\rho_t}(\zeta_t, \zeta_t) + \int_0^1 g_{\rho_t}((\nabla H_p(\rho_{t,s}) - \nabla H_p(\rho_t)), \zeta_t, \zeta_t) ds \\ &= (\mathcal{L}_{H_p} g)_{\rho_t}(\zeta_t, \zeta_t) + \int_0^1 \int_0^1 g_{\rho_t}((\nabla^2 H_p((1-\tau)\rho_t + \tau\rho_{t,s})), (\zeta_t, s\zeta_t), \zeta_t) d\tau ds \\ &\leq 2\Lambda \mathcal{N}(t) + \frac{1}{2} \sup_{s, \tau \in [0,1]} |\nabla^2 H_p((1-\tau)\rho_t + \tau\rho_{t,s})|_{g_{\rho_t}} \mathcal{N}(t)^3. \end{aligned} \quad (4.4.15)$$

The second equality comes from Taylor's theorem, then we make the Lie derivative appear by adding and subtracting $\nabla H_p(\rho_t)$, we use Taylor's theorem again in the fourth equality, and finally we use the definition of Λ . We now set

$$t_\star = \sup A \quad \text{where} \quad A = \left\{ T \geq 0 : \forall t \in [-T, T], \forall \rho \in B_r^g(\rho_0), |\phi^t(\rho) - \phi^t(\rho_0)|_{g_{\rho_t}} \leq r_g \right\}.$$

Notice that $0 \in A$ and $t_\star > 0$ by a continuity argument. If $\rho \in B_r^g(\rho_0)$ and $t \in (-t_\star, t_\star)$, we have $\rho_{t,s,\tau} := (1-\tau)\rho_t + \tau\rho_{t,s} \in B_r^g(\phi^t(\rho_0))$, so that slow variation of the metric g combined with Lemma 4.4.2 gives

$$\begin{aligned} |\nabla^2 H_p((1-\tau)\rho_t + \tau\rho_{t,s})|_{g_{\rho_t}} &\leq C_g^3 |\nabla^2 H_p((1-\tau)\rho_t + \tau\rho_{t,s})|_{g_{\rho_{t,s,\tau}}} \\ &\leq C_g^3 \sup_{T^*M} h_g |\nabla^3 p|_g \leq C_g^3 C_p h_g. \end{aligned}$$

In addition, we have $\nabla N(t) \leq r_g^2 \leq 1$, hence from (4.4.15):

$$\frac{d}{dt} \mathcal{N}(t) \leq \left(2\Lambda + C_g^3 \frac{C_p}{2} h_g \right) \mathcal{N}(t).$$

Therefore Grönwall's inequality yields

$$\mathcal{N}(t) \leq \mathcal{N}(0) e^{(2\Lambda + C_g^3 \frac{C_p}{2} h_g)|t|},$$

that is to say

$$|\phi^t(\rho) - \phi^t(\rho_0)|_{g_{\phi^t(\rho_0)}} \leq |\rho - \rho_0|_{g_{\rho_0}} e^{(\Lambda + C_g^3 \frac{C_p}{4} h_g)|t|}.$$

By a continuity argument, we conclude that t_* is such that $r e^{(\Lambda + C_g^3 \frac{C_p}{4} h_g)t_*} \geq r_g$. Given a time $t \in \mathbf{R}$, in order to ensure that $t_* \geq |t|$, it suffices to require that

$$\frac{r_g}{r} \geq e^{(\Lambda + C_g^3 \frac{C_p}{4} h_g)|t|},$$

hence the result. \square

Proposition 4.4.10. *There exist constants $C > 0$ and $N \geq 0$, depending only on structure constants of g , such that the following holds: for all $\rho_0 \in T^*M$ and all $\tilde{\rho} \in B_{r_g}^g(\rho_0)$, we have*

$$\begin{aligned} \forall \rho \in T^*M, \forall t \in [-T_E, T_E], \quad & |\phi^t(\rho) - \phi^t(\tilde{\rho})|_{g_{\phi^t(\rho_0)}^\sigma} \leq C |\rho - \tilde{\rho}|_{g_{\rho_0}^\sigma} \langle \rho - \tilde{\rho} \rangle_{g_{\rho_0}^\sigma}^N \\ & \leq C |\rho - \tilde{\rho}|_{g_{\rho_0}^\sigma} \langle \rho - \tilde{\rho} \rangle_{g_{\rho_0}^\sigma}^N, \end{aligned}$$

where T_E is the Ehrenfest time introduced in (4.1.29).

Proof. Introduce for any $s \in [0, 1]$ the point $\rho_s = (1-s)\tilde{\rho} + s\rho$. Then we have

$$|\phi^t(\rho) - \phi^t(\tilde{\rho})|_{g_{\phi^t(\rho_0)}^\sigma} \leq C_g C_\Upsilon e^{h_g \Upsilon |t|} \int_0^1 |d\phi^t(\rho_s) \cdot (\rho - \tilde{\rho})|_{g_s^\sigma} ds.$$

This first inequality consists in applying the fundamental theorem of analysis, the triangle inequality, the fact that $g_{\phi^t(\rho_0)} \leq e^{2h_g \Upsilon |t|} g_{\rho_0}$ and slow variation of g , which applies since $\tilde{\rho} \in B_{r_g}^g(\rho_0)$. Then we use the temperance property of g^σ (strong version of Proposition 4.1.29) between the points $\tilde{\rho}$ and ρ_s to have

$$|\phi^t(\rho) - \phi^t(\tilde{\rho})|_{g_{\phi^t(\rho_0)}^\sigma} \leq C_g^2 e^{h_g \Upsilon |t|} \int_0^1 |d\phi^t(\rho_s) \cdot (\rho - \tilde{\rho})|_{g_s^\sigma} \langle \rho_s - \tilde{\rho} \rangle_{g_s^\sigma}^{N_g} ds.$$

Next we use the fact that $g_{\rho_s} \leq e^{2h_g \Upsilon |t|} g_{\phi^t(\rho_0)}$ with slow variation of g^\natural between $\tilde{\rho}_s$ and ρ_0 once again:

$$|\phi^t(\rho) - \phi^t(\tilde{\rho})|_{g_{\phi^t(\rho_0)}^\sigma} \leq C_g^{2+N_g} C_\Upsilon^2 e^{2\Upsilon |t|} \int_0^1 |d\phi^t(\rho_s) \cdot (\rho - \tilde{\rho})|_{g_{\phi^t(\rho_s)}^\sigma} \langle s(\rho - \tilde{\rho}) \rangle_{g_{\rho_0}^\sigma}^{N_g} ds.$$

Then we apply the strong version of temperance again (Proposition 4.1.29) for g^σ between the points ρ_s and $\tilde{\rho}$.

$$\begin{aligned} |\phi^t(\rho) - \phi^t(\tilde{\rho})|_{g_{\phi^t(\rho_0)}^\sigma} & \leq C_g^{3+N_g} C_\Upsilon^2 e^{2\Upsilon |t|} \int_0^1 |d\phi^t(\rho_s)|_{g_{\rho_s}^\sigma} |\rho - \tilde{\rho}|_{g_{\tilde{\rho}}^\sigma} \langle \rho_s - \tilde{\rho} \rangle_{g_{\tilde{\rho}}^\sigma}^{N_g} \langle \rho - \tilde{\rho} \rangle_{g_{\rho_0}^\sigma}^{N_g} ds \\ & \leq C_g^{4+2N_g} C_\Upsilon^2 e^{(2\Upsilon + \Lambda)|t|} |\rho - \tilde{\rho}|_{g_{\rho_0}^\sigma} \langle \rho - \tilde{\rho} \rangle_{g_{\rho_0}^\sigma}^{2N_g}. \end{aligned}$$

For the last inequality, we used Remark 4.4.1 to handle the norm of the differential of the flow with respect to g^σ , and we used the slow variation for g^σ between the points $\tilde{\rho}$ and ρ_0 .

To finish the proof, we recall that $g^\natural \leq g^\sigma$ from (4.1.59) and that $g^\sigma(t) = e^{-2(2\Upsilon + \Lambda)|t|} g^\sigma$ by definition (4.1.28). \square

Remark 4.4.11. In the proof of Proposition 4.4.10, we used the assumption that $g_{\phi^t(\rho)} \leq C_{\Upsilon}^2 e^{2\Upsilon|t|} g_\rho$ (see Assumption 4.1.14). In fact we could bypass the use of this assumption here by strengthening the assumption on g . Instead of assuming that g is temperate, we could assume g to be geodesically temperate, namely to verify

$$\exists C > 0, N \geq 0 : \forall \rho_0, \rho \in T^*M, \quad g_\rho \leq C^2 \langle d_g(\rho_0, \rho) \rangle^{2N} g_{\rho_0},$$

where d_g is the geodesic distance. This implies temperance in the sense of Definition 4.1.6, although we are not aware of examples of temperate metrics that are not geodesically temperate. This assumption is much more difficult to check in practice, although it is fulfilled for all the examples discussed in 4.1.7 (see [Ler10, Subsection 2.6.5]).

4.5. Mapping properties of the Egorov expansion operators

We provide estimates on the operators $\mathcal{E}_j(t)$ that appear in the Dyson series (4.1.42). In all this section, we work with a classical Hamiltonian p and a Riemannian metric g on T^*M that satisfy Assumptions 4.1.13 and 4.1.14.

Let us first state a technical result explaining how the gain function and the temperance weight (defined in Definitions 4.1.5 and 4.1.11) behave when composed by the Hamiltonian flow.

Lemma 4.5.1. *The following holds:*

$$e^{tH_p} h_g \leq h_{g(t)} \quad \text{and} \quad e^{tH_p} \theta_g \geq \theta_{g(t)}, \quad \forall t \in \mathbf{R}.$$

Proof. Given $\rho \in T^*M$, since $d\phi^t$ is an isomorphism:

$$e^{tH_p} h_g(\rho) = \sup_{\zeta \in W \setminus \{0\}} \frac{|\zeta|_{g_{\phi^t(\rho)}}}{|\zeta|_{g_{\phi^t(\rho)}^\sigma}} = \sup_{\zeta \in W \setminus \{0\}} \frac{|d\phi^t(\rho)\zeta|_{g_{\phi^t(\rho)}}}{|d\phi^t(\rho)\zeta|_{g_{\phi^t(\rho)}^\sigma}} = h_{(\phi^t)^*g}(\rho).$$

Yet by Proposition 4.4.6 and (4.4.2), we have

$$\begin{cases} |d\phi^t(\rho)\zeta|_{g_{\phi^t(\rho)}} \leq e^{\Lambda|t|} |\zeta|_{g_\rho} = |\zeta|_{g_\rho(t)} \\ |\zeta|_{g_\rho^\sigma(t)} = e^{-(\Lambda+2\Upsilon)|t|} |\zeta|_{g_\rho^\sigma} \leq e^{-(\Lambda+2\Upsilon)|t|} |d\phi^{-t}(\phi^t(\rho))|_{g_\rho} |d\phi^t(\rho)\zeta|_{g_{\phi^t(\rho)}^\sigma} \leq |d\phi^t(\rho)\zeta|_{g_{\phi^t(\rho)}^\sigma} \end{cases}.$$

Therefore, we deduce that

$$e^{tH_p} h_g(\rho) \leq \sup_{\zeta \in W \setminus \{0\}} \frac{|\zeta|_{g_\rho(t)}}{|\zeta|_{g_\rho^\sigma(t)}} \leq h_{g(t)}.$$

As for the temperance weight, we have

$$\forall \zeta \in W \setminus \{0\}, \quad \frac{|\zeta|_{g_{\phi^t(\rho)}^\sigma}}{|\zeta|_{\mathbf{g}}} \geq \frac{e^{-\Upsilon|t|} |\zeta|_{g_\rho^\sigma}}{|\zeta|_{\mathbf{g}}} \geq \frac{|\zeta|_{g_\rho(t)^\sigma}}{|\zeta|_{\mathbf{g}}},$$

so that taking the supremum over ζ yields the sought result. \square

4.5.1. Mapping properties in symbol classes

We investigate the mapping properties of e^{tH_p} on symbol classes.

Corollary 4.5.2 (Continuity of the Hamiltonian flow on symbol classes). *Let p and g satisfy Assumptions 4.1.13 and 4.1.14. Setting $g(t) = e^{2(\Lambda+2\Upsilon)|t|} g$ and $m(t) = e^{tH_p} m$, one has*

$$S(m, g) \xrightarrow{e^{tH_p}} S(m(t), g(t)) \quad \text{and} \quad \nabla^{-1} S(m, g) \xrightarrow{e^{tH_p}} \nabla^{-1} S(m(t), g(t))$$

uniformly with respect to $t \in \mathbf{R}$.

Remark 4.5.3. We do not discuss admissibility of $g(t)$ or $m(t)$ in Corollary 4.5.2, since symbol classes make sense for metrics and weights that are not necessarily admissible. However, we shall take care of this issue while using pseudodifferential calculus.

Proof. This is a direct consequence of Lemma 4.4.7 (or rather the simplified estimate of Remark 4.4.8). Indeed, if $a \in S(m, g)$, we have for all $k \geq 1$ and all $\rho \in \{p = E\}$:

$$\begin{aligned} |\nabla^k e^{tH_p} a|_g(\rho) &\leq C_k e^{k\Lambda t} |\nabla a|_g^{(k-1)}(\phi^t(\rho)) \left\langle \frac{C}{2\Lambda} |\nabla^2 H_p|_E^{(k-2)} \right\rangle^{k-1} \\ &\leq C_k e^{k(\Lambda+2\Upsilon)t} |\nabla a|_{S(m, g)}^{(k-1)} m(\phi^t(\rho)) \left\langle \frac{C}{2\Lambda} |\nabla^2 H_p|_E^{(k-2)} \right\rangle^{k-1}. \end{aligned} \quad (4.5.1)$$

Yet by Lemma 4.4.2 and the fact that $\nabla^3 p \in S((h_g/\underline{h}_g)^{-1}, g)$ (Assumption 4.1.14 (ii)), we have

$$\forall j \in \mathbf{N}, \quad |\nabla^{2+j} H_p|_E^{(k-2)} \leq \sup_{\{p=E\}} h_g |\nabla^{3+j} p|_g \leq \underline{h}_g |\nabla^3 p|_{S((h_g/\underline{h}_g)^{-1}, g)}^{(j)}.$$

Plugging this into (4.5.1), and using (4.1.40), we deduce that

$$|\nabla^k e^{tH_p} a|_{g(t)}(\rho) \leq C_k |\nabla a|_{S(m, g)}^{(k-1)} m(\phi^t(\rho)) \left\langle \frac{C}{2c} |\nabla^3 p|_{S((h_g/\underline{h}_g)^{-1}, g)}^{(k-2)} \right\rangle^{k-1}.$$

This proves that $e^{tH_p} : \nabla^{-1} S(m, g) \rightarrow \nabla^{-1} S(m(t), g(t))$, with continuity constants depending only on seminorms of p (and not on t). For $k = 0$, we also have

$$|a \circ \phi^t|(\rho) \leq |a|(\phi^t(\rho)) \leq m(\phi^t(\rho)),$$

so that $e^{tH_p} : S(m, g) \rightarrow S(m(t), g(t))$ too. This finishes the proof of the proposition. \square

Recall that from Assumption 4.1.14, we have

$$\nabla^3 p \in S((h_g/\underline{h}_g)^{-1}, g) \cap S((\theta_g \underline{h}_g^{1/2})^{-\epsilon} (h_g/\underline{h}_g)^{-3}, g),$$

with $\epsilon \leq 1/2$. The key ingredient in the proof of the result below is pseudo-differential calculus.

Lemma 4.5.4 (Continuity of $\mathcal{H}_p^{(3)}$ on symbol classes). *Let p and g satisfy Assumptions 4.1.13 and 4.1.14. For any g -admissible weight m , we have*

$$\nabla^{-3} S(m, g(t)) \xrightarrow{\mathcal{H}_p^{(3)}} S(\theta_{g(t)}^{-\epsilon} \underline{h}_g^{3/2} m, g(t)) \cap S(h_{g(t)}^2 \underline{h}_g e^{-(\Lambda+2\Upsilon)|t|} m, g(t)), \quad \forall |t| \leq T_E.$$

Proof. In view of the definition of the operator $\mathcal{H}_p^{(3)}$ in (4.1.15), this is a direct application of pseudodifferential calculus (Proposition 4.2.2), namely

$$\nabla^{-3} S((\theta_g \underline{h}_g^{1/2})^{-\epsilon} (h_g/\underline{h}_g)^{-3}, g) \times \nabla^{-3} S(m, g(t)) \xrightarrow{\widehat{\mathcal{P}}_3} S(h_{g(t), g}^3 m(\theta_g \underline{h}_g^{1/2})^{-\epsilon} (h_g/\underline{h}_g)^{-3}, g(t)).$$

Yet we have

$$h_{g(t), g} = e^{(\Lambda+2\Upsilon)|t|} h_g,$$

so that

$$h_{g(t), g}^3 \theta_g^{-\epsilon} \underline{h}_g^{-\epsilon/2} (h_g/\underline{h}_g)^{-3} = \theta_{g(t)}^{-\epsilon} e^{(3-\epsilon)(\Lambda+2\Upsilon)|t|} \underline{h}_g^{3-\epsilon/2} \leq \theta_{g(t)}^{-\epsilon} \underline{h}_g^{3/2}, \quad \forall |t| \leq T_E.$$

Similarly, we have

$$\nabla^{-3} S((h_g/\underline{h}_g)^{-1}, g) \times \nabla^{-3} S(m, g(t)) \xrightarrow{\widehat{\mathcal{P}}_3} S(h_{g(t), g}^3 m (h_g/\underline{h}_g)^{-1}, g(t)).$$

Yet we have

$$h_{g(t), g}^3 (h_g/\underline{h}_g)^{-1} = h_{g(t)}^2 e^{-(\Lambda+2\Upsilon)|t|} \underline{h}_g,$$

hence the result. \square

We immediately deduce the following result on the mapping properties of the operators $\mathcal{E}_j(t)$ introduced in Proposition 4.1.22. These operators are defined as multiple compositions of e^{tH_p} and of $\mathcal{H}_p^{(3)}$, which we studied in Corollary 4.5.2 and Lemma 4.5.4 above. Let us highlight the fact that the following holds for $j \geq 1$ only. The case $j = 0$ is covered by Corollary 4.5.2 since $\mathcal{E}_0(t) = e^{tH_p}$.

Proposition 4.5.5 (Continuity estimates for $\mathcal{E}_j(t)$ on symbol classes, $j \geq 1$). *Let p and g satisfy Assumptions 4.1.13 and 4.1.14. Let m be a g -admissible weight and suppose that $m(t) := e^{tH_p}m$ is $g(t)$ -admissible, with structure constants uniform in $t \in [-T_E, T_E]$. Then for any $j \in \mathbf{N}^*$, we have*

$$\nabla^{-1}S(m, g) \xrightarrow{\mathcal{E}_j(t)} S\left(m(t)\theta_{g(t)}^{-j\epsilon}, g(t)\right) \cap S\left(m(t)h_{g(t)}^{2j}, g(t)\right), \quad \forall |t| \leq T_E. \quad (4.5.2)$$

If in addition m satisfies

$$\kappa := \sup_{T^*M} \frac{|\nabla_{H_p} m|}{m} < \infty, \quad (4.5.3)$$

then¹³

$$\nabla^{-1}S(m, g) \xrightarrow{\mathcal{E}_j(t)} S\left(e^{\kappa|t|}m\theta_{g(t)}^{-j\epsilon}, g(t)\right) \cap S\left(e^{\kappa|t|}mh_{g(t)}^{2j}, g(t)\right), \quad \forall |t| \leq T_E, \quad (4.5.4)$$

with implicit constants depending on structure constants of m and g only.

Proof. We prove (4.5.2) by induction on $j \in \mathbf{N}^*$. The basis step $j = 1$ is as follows: by Corollary 4.5.2, we have

$$\nabla^{-1}S(m, g) \xrightarrow{e^{s_1 H_p}} \nabla^{-1}S(m(s_1), g(s_1)). \quad (4.5.5)$$

We apply Lemma 4.5.4 (dependence on structure constants of m does not degenerate since those constants are uniform in $t \in [-T_E, T_E]$ by assumption):

$$\nabla^{-1}S(m(s_1), g(s_1)) \xrightarrow{\mathcal{H}_p^{(3)}} S\left(m(s_1)\theta_{g(s_1)}^{-\epsilon}h_{g(s_1)}^{3/2}, g(s_1)\right) \cap S\left(h_{g(s_1)}^2h_g e^{-(\Lambda+2\Upsilon)|s_1|}m(s_1), g(s_1)\right). \quad (4.5.6)$$

Next we apply Corollary 4.5.2 again to obtain

$$S\left(m(s_1)\theta_{g(s_1)}^{-\epsilon}h_{g(s_1)}^{3/2}, g(s_1)\right) \xrightarrow{e^{(t-s_1)H_p}} S\left(e^{(t-s_1)H_p}(m(s_1)\theta_{g(s_1)}^{-\epsilon})h_{g(s_1)}^{3/2}, g(t)\right). \quad (4.5.7)$$

From the assumption (4.5.3) and Lemma 4.5.1, we also have

$$e^{(t-s_1)H_p}(m(s_1)\theta_{g(s_1)}^{-\epsilon}) \leq m(t)\theta_{g(t)}^{-\epsilon}. \quad (4.5.8)$$

Similarly, we deduce from Corollary 4.5.2, from the assumption on m (4.5.3) and from Lemma 4.5.4 that

$$S\left(h_{g(s_1)}^2h_g e^{-(\Lambda+2\Upsilon)|s_1|}m(s_1), g(s_1)\right) \xrightarrow{e^{(t-s_1)H_p}} S\left(h_{g(t)}^2h_g e^{-(\Lambda+2\Upsilon)|s_1|}m(t), g(t)\right). \quad (4.5.9)$$

Combining all the estimates (4.5.5), (4.5.6), (4.5.7), (4.5.8) and (4.5.9), we obtain

$$\nabla^{-1}S(m, g) \xrightarrow{e^{(t-s_1)H_p} \mathcal{H}_p^{(3)} e^{s_1 H_p}} S\left(\theta_{g(t)}^{-\epsilon}h_{g(t)}^{3/2}m(t), g(t)\right) \cap S\left(h_{g(t)}^2h_g e^{-(\Lambda+2\Upsilon)|s_1|}m(t), g(t)\right). \quad (4.5.10)$$

Then it remains to integrate over s_1 . Yet in view of Assumption (4.1.40):

$$|t|h_g^{3/2} \leq \frac{h_g^{3/2}}{2(\Lambda+2\Upsilon)} \log\left(\frac{1}{h_g}\right) \leq \frac{C_{1/2}}{2c}, \quad (4.5.11)$$

where $C_\delta = \sup_{\tau \in [0,1]} \tau^\delta \log|\tau|^{-1}$. Likewise, we find

$$\int_{t\Delta_1} h_g e^{-(\Lambda+2\Upsilon)|s_{j+1}|} ds_{j+1} \leq \frac{h_g}{\Lambda+2\Upsilon} \leq \frac{1}{c}. \quad (4.5.12)$$

13. In fact we only need the slightly weaker property that $e^{tH_p}m \leq C_\kappa e^{\kappa|t|}m$ for some $\kappa \geq 0$ and $C_\kappa > 0$.

Combining (4.5.10), (4.5.11) and (4.5.12), we obtain (4.5.2) for $j = 1$.

Now we assume that the assertion (4.5.2) is true at step j , and prove it at step $j + 1$. Given that

$$\mathcal{E}_{j+1}(t) = \int_0^t e^{(t-s_{j+1})H_p} \mathcal{H}_p^{(3)} \mathcal{E}_j(s_{j+1}) ds_{j+1}, \quad (4.5.13)$$

it suffices to check that

$$\begin{aligned} S\left(m(s_{j+1})\theta_{g(s_{j+1})}^{-j\epsilon}, g(s_{j+1})\right) &\xrightarrow{e^{(t-s_{j+1})H_p} \mathcal{H}_p^{(3)}} S\left(m(t)\theta_{g(t)}^{-(j+1)\epsilon} \underline{h}_g^{5/4}, g(t)\right) \\ S\left(m(s_{j+1})h_{g(s_{j+1})}^{2j}, g(s_{j+1})\right) &\xrightarrow{e^{(t-s_{j+1})H_p} \mathcal{H}_p^{(3)}} S\left(m(t)h_{g(t)}^{2(j+1)} \underline{h}_g e^{-(\Lambda+2\Upsilon)|s_{j+1}|}, g(t)\right) \end{aligned} \quad (4.5.14)$$

(s_{j+1} now plays the role of t in the j -th step). This follows first from an application of Lemma 4.5.4 for $\mathcal{H}_p^{(3)}$:

$$\begin{aligned} S\left(m(s_{j+1})\theta_{g(s_{j+1})}^{-j\epsilon}, g(s_{j+1})\right) &\xrightarrow{\mathcal{H}_p^{(3)}} S\left(m(s_{j+1})\theta_{g(s_{j+1})}^{-(j+1)\epsilon} \underline{h}_g^{3/2}, g(s_{j+1})\right) \\ S\left(m(s_{j+1})h_{g(s_{j+1})}^{2j}, g(s_{j+1})\right) &\xrightarrow{\mathcal{H}_p^{(3)}} S\left(m(s_{j+1})h_{g(s_{j+1})}^{2(j+1)} \underline{h}_g e^{-(\Lambda+2\Upsilon)|s_{j+1}|}, g(s_{j+1})\right) \end{aligned}$$

together with Corollary 4.5.2 to handle the composition with $e^{(t-s_{j+1})H_p}$, and the fact that

$$e^{(t-s_{j+1})H_p} \left(m(s_{j+1})\theta_{g(s_{j+1})}^{-(j+1)\epsilon} \underline{h}_g^{3/2}\right) \leq m(t)\theta_{g(t)}^{-(j+1)\epsilon} \underline{h}_g^{3/2}, \quad (4.5.15)$$

as well as

$$e^{(t-s_{j+1})H_p} \left(m(s_{j+1})h_{g(s_{j+1})}^{2(j+1)}\right) \leq m(t)h_{g(t)}^{2(j+1)} \quad (4.5.16)$$

(recall Lemma 4.5.1). The factor $\underline{h}_g^{3/2}$ in (4.5.15) allows to absorb the factor t that appears while considering the integral over s_{j+1} in (4.5.13), exactly as in (4.5.11). Similarly, the factor $\underline{h}_g e^{-(\Lambda+2\Upsilon)|s_{j+1}|}$ appearing with (4.5.16) in (4.5.14) while applying Lemma 4.5.4 allows to get rid of the extra integral over s_{j+1} as in (4.5.12). This finishes the induction.

For the case where m satisfies in addition (4.5.3), the same proof works, except that after each application of the Hamiltonian flow, one may use that $e^{\tau H_p} m \leq e^{\kappa|\tau|} m$, so that Lemma 4.5.4 on the continuity of $\mathcal{H}_p^{(3)}$ produces only constants depending on structure constants of m (and not of $m(\tau)$). \square

4.5.2. Mapping properties in spaces of confined symbols

We conduct exactly the same investigation as in Subsection 4.5.1 but on spaces of confined symbols instead of symbol classes.

Proposition 4.5.6 (Continuity of the flow). *Let p and g satisfy Assumptions 4.1.13 and 4.1.14. Let $r \in (0, r_g]$ and $T \in [0, T_E]$, and suppose they satisfy*

$$r(T) \leq r_g \quad \text{with } r(\tau) := r e^{(2(\Lambda+\Upsilon) + C_g^3 \frac{C_p}{4} \underline{h}_g)|\tau|}. \quad (4.5.17)$$

Then for any t_1, t_2 such that $t := |t_1| + |t_2| \leq T$, we have

$$e^{t_2 H_p} : \text{Conf}_{r(t_1)}^{g(t_1)}(\rho_0) \longrightarrow \text{Conf}_{r(t)}^{g(t)}(\phi^{-t_2}(\rho_0)),$$

uniformly in $\rho_0 \in T^*M$.

Remark 4.5.7. Here it seems that it is important to have a control of the flow of the form $|d\phi^t|_g \leq C_\Lambda e^{\Lambda|t|}$ with $C_\Lambda = 1$ (this is the case under Assumption 4.1.14; see Proposition 4.4.6). Indeed, if $C_\Lambda > 1$, the confinement radius r could be instantaneously increased by a factor C_Λ under the action of e^{tH_p} , $t > 0$. This could prevent us from keeping $r(t)$ under control after several applications of the Hamiltonian flow in the higher order terms of the Dyson expansion (4.1.42).

Proof. In the proof, we write $\tilde{r}(\bullet) := re^{(\Lambda + C_g^3 \frac{C_p}{4} \underline{h}_g)|\bullet|}$.

Firstly, we have

$$B_{r(t_1)}^{g(t_1)}(\rho_0) = B_{\tilde{r}(t_1)}^g(\rho_0). \quad (4.5.18)$$

Therefore Proposition 4.4.9 gives

$$\phi^{-t_2} \left(B_{r(t_1)}^{g(t_1)}(\rho_0) \right) \subset B_{\tilde{r}(t)}^g(\phi^{-t_2}(\rho_0)) = B_{r(t)}^{g(t)}(\phi^{-t_2}(\rho_0)). \quad (4.5.19)$$

Secondly, given ρ outside $B_1 := B_{r(t_1)}^{g(t_1)}(\rho_0) = B_{\tilde{r}(t_1)}^g(\rho_0)$, we estimate the $g_{\rho_0}^\sigma(t_1)$ -distance from $\phi^{-t_2}(\rho)$ to $\phi^{-t_2}(B_1)$. We pick $\tilde{\rho} \in \bar{B}_1$ such that

$$|\rho - \tilde{\rho}|_{g_{\rho_0}^\sigma(t_1)} = \text{dist}_{g_{\rho_0}^\sigma(t_1)}(\rho, B_1). \quad (4.5.20)$$

Notice that by definition of $\tilde{\rho}$, we have $|\tilde{\rho} - \rho_0|_{g_{\rho_0}(t_1)} \leq r(t_1)$, so

$$|\tilde{\rho} - \rho_0|_{g_{\rho_0}} \leq \tilde{r}(t_1) \leq r_g \quad (4.5.21)$$

due to the assumption (4.5.17) on r . Applying Proposition 4.4.10, we have

$$|\phi^{-t_2}(\rho) - \phi^{-t_2}(\tilde{\rho})|_{g_{\phi^{-t_2}(\rho_0)}^\sigma(t_2)} \leq C|\rho - \tilde{\rho}|_{g_{\rho_0}^\sigma} \langle \rho - \tilde{\rho} \rangle_{g_{\rho_0}^\sigma}^N.$$

Now recall that by (4.1.59), we have

$$g^\natural \leq h_g g^\sigma \leq \underline{h}_g g^\sigma = (\underline{h}_g^{-1} g)^\sigma = g^\sigma(T_E) \leq g^\sigma(t), \quad \forall t \in [-T_E, T_E]$$

(we used (4.1.20) in the last inequality). Combining this with the definition of $\tilde{\rho}$ in (4.5.20), we obtain

$$|\rho - \tilde{\rho}|_{g_{\rho_0}^\natural} \leq |\rho - \tilde{\rho}|_{g_{\rho_0}^\sigma(t_1)} \leq \text{dist}_{g_{\rho_0}^\sigma(t_1)}(\rho, B_1).$$

We deduce that

$$\text{dist}_{g_{\phi^{-t_2}(\rho_0)}^\sigma}(\phi^{-t_2}(\rho), \phi^{-t_2}(B_1)) \leq C(g)e^{(2\Upsilon + \Lambda)|t_2|} \text{dist}_{g_{\rho_0}^\sigma}(\rho, B_1) \left\langle \text{dist}_{g_{\rho_0}^\sigma(t_1)}(\rho, B_1) \right\rangle^{N(g)},$$

so that multiplying by $e^{-(2\Upsilon + \Lambda)t}$ we arrive at

$$\text{dist}_{g_{\phi^{-t_2}(\rho_0)}^\sigma(t)}(\phi^{-t_2}(\rho), \phi^{-t_2}(B_1)) \leq C(g) \text{dist}_{g_{\rho_0}^\sigma(t_1)}(\rho, B_1) \left\langle \text{dist}_{g_{\rho_0}^\sigma(t_1)}(\rho, B_1) \right\rangle^{N(g)}. \quad (4.5.22)$$

Now that we have (4.5.19) and (4.5.22), we can write for any $\rho \in T^*M$:

$$\begin{aligned} \text{dist}_{g_{\phi^{-t_2}(\rho_0)}^\sigma(t)}(\phi^{-t_2}(\rho), B_{r(t)}^{g(t)}(\phi^{-t_2}(\rho_0))) &\leq \text{dist}_{g_{\phi^{-t_2}(\rho_0)}^\sigma(t)}(\phi^{-t_2}(\rho), \phi^{-t_2}(B_1)) \\ &\leq C(g) \left\langle \text{dist}_{g_{\rho_0}^\sigma(t_1)}(\rho, B_{r(t_1)}^{g(t_1)}(\rho_0)) \right\rangle^{N(g)+1}. \end{aligned} \quad (4.5.23)$$

To conclude the proof of the proposition, it suffices to have bounds on $\nabla^\ell e^{t_2 H_p} \psi_{\rho_0}$ with $\psi_{\rho_0} \in \text{Conf}_{g(t_1)}(\rho_0, r(t_1))$ for any $\ell \in \mathbf{N}$, with respect to the metric $g(t)$. We have from Lemma 4.4.7:

$$\begin{aligned} |\nabla^\ell e^{t_2 H_p} \psi_{\rho_0}(\rho)|_{g(t)} &\leq C_\ell(p) \max_{0 \leq j \leq \ell} |\nabla^j \psi_{\rho_0}|_g(\phi^{t_2}(\rho)) \\ &\leq C_\ell(p) |\psi_{\rho_0}|_{\text{Conf}_{r(t_1)}^{g(t_1)}(\rho_0)}^{(\ell k)} \left\langle \text{dist}_{g_{\rho_0}^\sigma(t_1)}(\phi^{t_2}(\rho), B_{r(t_1)}^{g(t_1)}(\rho_0)) \right\rangle^{-\ell k} \\ &\leq C_\ell(p) C(g) |\psi_{\rho_0}|_{\text{Conf}_{r(t_1)}^{g(t_1)}(\rho_0)}^{(\ell k)} \left\langle \text{dist}_{g_{\rho_0}^\sigma(t)}(\rho, B_{r(t)}^{g(t)}(\phi^{-t_2}(\rho_0))) \right\rangle^{-\frac{\ell k}{N(g)+1}}. \end{aligned}$$

Notice that it was important to consider the seminorms in $\text{Conf}_{r(t)}^{g(t)}(\phi^{-t_2}(\rho_0))$ with respect to $g(t)$ and not $g_{\rho_0}(t)$ in order to ensure that the Lyapunov exponent Λ is independent of ρ_0 (see the discussion in Appendix 4.C.5). Choosing $k = \lceil N(g) + 1 \rceil$, we conclude that

$$|e^{t_2 H_p} \psi_{\rho_0}|_{\text{Conf}_{g(t)}(\phi^{-t_2}(\rho_0), r(t))}^{(\ell)} \leq C |\psi_{\rho_0}|_{\text{Conf}_{g(t_1)}(\rho_0, r(t_1))}^{(\ell k)}.$$

The constant C depends on r but not on t or ρ_0 . \square

We now turn to mapping properties of $\mathcal{H}_p^{(3)}$. Proposition 4.5.8 is an instance of a strong version of pseudo-differential calculus in spaces of confined symbols, and follows from Proposition 4.2.3. Recall that Proposition 4.2.3 is proved in Appendix 4.A.5.

Proposition 4.5.8. *Let p and g satisfy Assumptions 4.1.13 and 4.1.14. Let $r \in (0, r_g]$. Then*

$$\text{Conf}_{r(t)}^{g(t)}(\rho_0) \xrightarrow{\mathcal{H}_p^{(3)}} \theta_{g(t)}^{-\epsilon}(\rho_0) \underline{h}_g^{3/2} \text{Conf}_{r(t)}^{g(t)}(\rho_0)$$

uniformly with respect to $\rho_0 \in T^*M$ and $|t| \leq T_E$.

Proof of Proposition 4.5.8 from Proposition 4.2.3. Given that $\mathcal{H}_p^{(3)} = \widehat{\mathcal{P}}_3(p, \bullet) - \widehat{\mathcal{P}}_3(\bullet, p)$ (recall (4.1.15)) with $p \in \nabla^{-3}S((\theta_g \underline{h}_g^{1/2})^{-\epsilon} (h_g/\underline{h}_g)^{-3}, g)$, we apply Proposition 4.2.3 with $j = 3$, noticing that the weight θ_g has indeed slow variation radius larger than r_g (Proposition 4.1.31). From (4.2.6),

$$\text{Conf}_{r(t)}^{g(t)}(\rho_0) \times \nabla^{-3}S\left((\theta_g \underline{h}_g^{1/2})^{-\epsilon} (h_g/\underline{h}_g)^{-3}, g\right) \xrightarrow{\widehat{\mathcal{P}}_3} \left(\frac{h_{g(t),g}(\rho_0)}{h_g(\rho_0)} \underline{h}_g\right)^3 \theta_g^{-\epsilon}(\rho_0) \underline{h}_g^{-\epsilon/2} \text{Conf}_{r(t)}^{g(t)}(\rho_0).$$

(Since $\widehat{\mathcal{P}}_3$ is skew-symmetric, we can also invert the order of the two factors in the left-hand side.) But for any $|t| \leq T_E$, the definitions of $h_{g(t),g}$ in (4.2.4) and of θ_g (Definition 4.1.11) yield

$$\left(\frac{h_{g(t),g}(\rho_0)}{h_g(\rho_0)} \underline{h}_g\right)^3 \theta_g^{-\epsilon}(\rho_0) \underline{h}_g^{-\epsilon/2} = e^{(3-\epsilon)(\Lambda+2\Upsilon)|t|} \underline{h}_g^{3-\epsilon/2} \theta_{g(t)}^{-\epsilon}(\rho_0) \leq \theta_{g(t)}^{-\epsilon}(\rho_0) \underline{h}_g^{3/2},$$

and the result follows. \square

Putting together Proposition 4.5.6 and Proposition 4.5.8, we obtain the following.

Proposition 4.5.9 (Continuity estimates for $\mathcal{E}_j(t)$ on spaces of confined symbols). *Let $r \in (0, r_g]$ and $T \in (0, \frac{1}{3}T_E]$, and suppose they satisfy $r(T) \leq r_g$ where $r(\bullet)$ is defined in (4.1.66). Then for any $j \in \mathbf{N}$, we have*

$$\text{Conf}_r^{g(t)}(\rho_0) \xrightarrow{\mathcal{E}_j(t)} \theta_{g(t)}^{-j\epsilon}(\phi^{-t}(\rho_0)) \text{Conf}_{r(t)}^{g(t)}(\phi^{-t}(\rho_0)), \quad \forall t \in [-T, T].$$

Proof. We prove the statement by induction. For $j = 0$, we have $\mathcal{E}_0(t) = e^{tH_p}$, so the result follows from Proposition 4.5.6. Assume that the statement is true at step $j \geq 0$. We prove that for all $t \in [-T_E, T_E]$ and all $s \in t\Delta_1$, we have

$$\text{Conf}_{r(s)}^{g(s)}(\phi^{-s}(\rho_0)) \xrightarrow{e^{(t-s)H_p} \mathcal{H}_p^{(3)}} \theta_{g(t)}^{-\epsilon}(\phi^{-t}(\rho_0)) \underline{h}_g^{3/2} \text{Conf}_{r(t)}^{g(t)}(\phi^{-t}(\rho_0)).$$

Applying Proposition 4.5.8 and Proposition 4.5.6, it follows that

$$\begin{aligned} \text{Conf}_{r(s)}^{g(s)}(\phi^{-s}(\rho_0)) &\xrightarrow{\mathcal{H}_p^{(3)}} \theta_{g(s)}^{-\epsilon}(\phi^{-s}(\rho_0)) \underline{h}_g^{3/2} \text{Conf}_{r(s)}^{g(s)}(\phi^{-s}(\rho_0)) \\ &\xrightarrow{e^{(t-s)H_p}} \theta_{g(s)}^{-\epsilon}(\phi^{-s}(\rho_0)) \underline{h}_g^{3/2} \text{Conf}_{r(t)}^{g(t)}(\phi^{-t}(\rho_0)). \end{aligned}$$

By Lemma 4.5.1 we have

$$\theta_{g(s)}^{-\epsilon}(\phi^{-s}(\rho_0)) = \theta_{g(s)}^{-\epsilon}(\phi^{t-s}(\phi^{-t}(\rho_0))) \leq \theta_{g(t)}^{-\epsilon}(\phi^{-t}(\rho_0))$$

($s \in t\Delta_1$ is important here). Combining this with the induction hypothesis, in view of (4.5.13), we deduce that

$$\text{Conf}_r^{g(t)}(\rho_0) \xrightarrow{\mathcal{E}_{j+1}(t)} I(t) \text{Conf}_{r(t)}^{g(t)}(\phi^{-t}(\rho_0)),$$

with

$$I(t) = |t| \theta_{g(t)}^{-(j+1)\epsilon}(\phi^{-t}(\rho_0)) \underline{h}_g^{3/2} \leq \frac{C_{1/2}}{2c} \theta_{g(t)}^{-(j+1)\epsilon}(\phi^{-t}(\rho_0))$$

as we did in (4.5.11), where the constants $C_{1/2}, c$ are independent of \underline{h}_g . We obtain the sought statement, and the induction is finished. \square

4.6. The quantum dynamics

In this section, we establish Egorov's theorem for a specific class of symbols, whose gradient is controlled by (a power of) the temperance weight θ_g (Corollary 4.6.1). This covers in particular affine symbols. Another important result of this section is Lemma 4.6.5 in which we investigate quantitatively the action of commutators of symbols of the form $e^{t\mathcal{H}_p}$ with affine symbols, in preparation for the application of Beals theorem (Proposition 4.B.5). In the same vein, Lemma 4.6.8 deals with one-sided compositions with affine symbols, so as to investigate the decay of $e^{t\mathcal{H}_p}a$ when a is a confined symbol.

4.6.1. Egorov expansion for a specific class of symbols

Proof of Proposition 4.1.22. Fix $w \in \mathcal{S}(T^*M)$. Recall that $\mathcal{S}(T^*M) \subset \text{dom } \mathcal{H}_p$ and that \mathcal{H}_p preserves the Schwartz class (a consequence of Proposition 4.2.3), so that $\mathcal{S}(T^*M) \subset \text{dom } \mathcal{H}_p^k$ for all $k \in \mathbf{N}$. Let $w \in \mathcal{S}(T^*M)$. For any $t \in \mathbf{R}$, the map

$$s \longmapsto e^{(t-s)\mathcal{H}_p} e^{sH_p} w$$

is of class C^1 , and we can differentiate it with the chain rule. Indeed, the map $s \mapsto e^{sH_p} w$ is C^1 in view of Proposition 4.1.16 and e^{sH_p} preserves the Schwartz class (by Proposition 4.5.6 for instance). Thus we compute that

$$\frac{d}{ds} e^{(t-s)\mathcal{H}_p} e^{sH_p} w = -e^{(t-s)\mathcal{H}_p} \mathcal{H}_p e^{sH_p} w + e^{(t-s)\mathcal{H}_p} H_p e^{sH_p} w = -e^{(t-s)\mathcal{H}_p} \mathcal{H}_p^{(3)} e^{sH_p} w.$$

Integrating over $s \in [0, t]$ yields

$$\int_0^t e^{(t-s)\mathcal{H}_p} \mathcal{H}_p^{(3)} e^{sH_p} w ds = e^{t\mathcal{H}_p} w - e^{tH_p} w.$$

This is exactly the Dyson expansion (4.1.42) at order $j_0 = 0$. We proceed by induction to prove the higher order Dyson expansion: if (4.1.42) is valid for $j_0 \geq 0$, then we observe that given a $w \in \mathcal{S}(T^*M)$, we have

$$\tilde{w} := \mathcal{H}_p^{(3)} e^{(s_{j_0+1}-s_{j_0})H_p} \mathcal{H}_p^{(3)} e^{(s_{j_0}-s_{j_0-1})H_p} \dots e^{(s_2-s_1)H_p} \mathcal{H}_p^{(3)} e^{s_1 H_p} w \in \mathcal{S}(T^*M)$$

for any $(s_1, s_2, \dots, s_{j_0+1}) \in t\Delta_{j_0+1}$. Therefore the Dyson expansion at order 0 allows to write

$$e^{(t-s_{j_0+1})\mathcal{H}_p} \tilde{w} = e^{(t-s_{j_0+1})H_p} \tilde{w} + \int_0^{t-s_{j_0+1}} e^{(t-s_{j_0+1}-s)\mathcal{H}_p} \tilde{w} ds \quad (4.6.1)$$

We change variables in the integral of the right-hand side by setting $s_{j_0+2} = s + s_{j_0+1}$, which ranges between s_{j_0+1} and t . This term becomes

$$\int_{s_{j_0+1}}^t e^{(t-s_{j_0+2})\mathcal{H}_p} \mathcal{H}_p^{(3)} e^{(s_{j_0+1}-s_{j_0})H_p} \mathcal{H}_p^{(3)} e^{(s_{j_0}-s_{j_0-1})H_p} \dots e^{(s_2-s_1)H_p} \mathcal{H}_p^{(3)} e^{s_1 H_p} w ds_{j_0+2}.$$

Plugging this into (4.6.1) and integrating over $(s_1, s_2, \dots, s_{j_0+1}) \in t\Delta_{j_0+1}$, we obtain

$$\widehat{\mathcal{E}}_{j_0+1}(t) = \mathcal{E}_{j_0+1}(t) + \widehat{\mathcal{E}}_{j_0+2}(t),$$

which gives the conclusion. \square

By a density argument, one can extend the validity of the Dyson expansion to symbols on phase space with bounded derivatives. The difficulty is that we do not know yet that $e^{t\mathcal{H}_p}$ preserves the Schwartz class (it only preserves $\text{dom } \mathcal{H}_p$ a priori), although its generator \mathcal{H}_p preserves $\mathcal{S}(T^*M)$.

We already know that the operator $e^{t\mathcal{H}_p}$ is well defined as a map

$$e^{t\mathcal{H}_p} : S(1, g) \longrightarrow \mathcal{S}'(T^*M).$$

In the following Corollary, we show that it can be extended to classes of the form $S(\theta_g^N, g)$ for any $N \in \mathbf{R}$.

Corollary 4.6.1. *Let $f \in C^\infty(T^*M)$ be such that*

$$\exists N \in \mathbf{N} : \quad \nabla f \in S(\theta_g^N, g). \quad (4.6.2)$$

Then the operator

$$\text{Op}^w(f)e^{-itP} : \mathcal{S}(M) \rightarrow L^2(M)$$

is continuous, so that it can be composed with the Schrödinger propagator e^{itP} on the left. Thus $e^{t\mathcal{H}_p}f$ is well-defined and for any $j_0 \in \mathbf{N}$, we have

$$e^{t\mathcal{H}_p}f = \sum_{j=0}^{j_0} \mathcal{E}_j(t)f + \widehat{\mathcal{E}}_{j_0+1}(t)f, \quad \forall t \in \mathbf{R}.$$

Proof. Observe first that throughout the proof, we do not care about the dependence of seminorms with respect to time. Only mapping properties for fixed times t matter.

Fix in this proof a g -partition of unity $(\varphi_{\rho_0})_{\rho_0 \in T^*M}$ (Proposition 4.1.34). We can assume here that the φ_{ρ_0} 's are compactly supported. Let $(B_n)_{n \in \mathbf{N}}$ be an exhaustive sequence of compact sets that cover the phase space: $\bigcup_n B_n = T^*M$. We define

$$\chi_n(\rho) = \int_{B_n} \varphi_{\rho_0}(\rho) d\text{Vol}_g(\rho_0), \quad n \in \mathbf{N}.$$

This symbol is clearly compactly supported. Applying Proposition 4.8.1 to the uniformly confined family of symbols $(\mathbb{1}_{B_n}(\rho_0)\varphi_{\rho_0})_{\rho_0 \in T^*M}$, we know that $\chi_n \in S(1, g)$. In addition, the sequence $(\chi_n)_{n \in \mathbf{N}}$ is bounded in $S(1, g)$ since the seminorms of $\mathbb{1}_{B_n}(\rho_0)\varphi_{\rho_0}$ are bounded uniformly in n .

Now by dominated convergence, one checks that $\chi_n \rightarrow 1$ in $\mathcal{S}'(T^*M)$ as $n \rightarrow \infty$, so that $f_n := \chi_n f \rightarrow f$ in $\mathcal{S}'(T^*M)$ as well.

Then the Dyson expansion works on any f_n and at any order by Proposition 4.1.22:

$$\text{Op}^w(f_n)e^{-itP} = \sum_{j=0}^{j_0} e^{-itP} \text{Op}^w(\mathcal{E}_j(t)f_n) + e^{-itP} \text{Op}^w(\widehat{\mathcal{E}}_{j_0+1}(t)f_n), \quad \forall t \in \mathbf{R}. \quad (4.6.3)$$

We wish to pass to the limit as $n \rightarrow \infty$ in both sides of (4.6.3).

- To pass to the limit in the terms $\mathcal{E}_j(t)$, we simply argue that the operators $\mathcal{H}_p^{(3)}$ and e^{sH_p} are continuous on $\mathcal{S}(T^*M)$, so that they extend to continuous operators on $\mathcal{S}'(T^*M)$. We immediately deduce that

$$\mathcal{E}_j(t)f_n \xrightarrow[n \rightarrow \infty]{\mathcal{S}'(T^*M)} \mathcal{E}_j(t)f.$$

We deduce that

$$\text{Op}^w(\mathcal{E}_j(t)f_n) \xrightarrow[n \rightarrow \infty]{\mathcal{L}(\mathcal{S}, \mathcal{S}'(M))} \text{Op}^w(\mathcal{E}_j(t)f).$$

For $j = 0$, in view of the assumption (4.6.2) on ∇f , Corollary (4.5.2) tells us that $\nabla \mathcal{E}_0(t)f \in S(e^{tH_p}\theta_g, g(t)) \subset S(C_\Upsilon e^{\Upsilon|t|\theta_g}, g(t))$. Using the admissibility of $g(t)$ and θ_g , we deduce that $\mathcal{E}_0(t)f$ itself belongs to a genuine symbol class,¹⁴ so that

$$\text{Op}^w(\mathcal{E}_0(t)f) : \mathcal{S}(M) \longrightarrow \mathcal{S}(M)$$

continuously by Proposition 4.B.2. Similarly for $j \in \mathbf{N}^*$, Proposition 4.5.5 tells us that $\mathcal{E}_j(t)f$ belongs to a symbol class (recall that $e^{tH_p}\theta_g \leq C_\Upsilon e^{\Upsilon|t|\theta_g}$) so that Proposition 4.B.2 again yields

$$\text{Op}^w(\mathcal{E}_j(t)f) : \mathcal{S}(M) \longrightarrow \mathcal{S}(M).$$

In particular, the operators $\text{Op}^w(\mathcal{E}_j f)$ for all $j \in \mathbf{N}$ map $\mathcal{S}(M)$ to $L^2(M)$ continuously and can be composed on the left by e^{-itP} .

14. For instance $S(f(\rho_0) + \theta_g(\rho_0)\langle \rho - \rho_0 \rangle_{g_{\rho_0}}^n, g_{\rho_0})$ for some $\rho_0 \in T^*M$ and some large $n \geq 0$, using the improved temperance property 4.1.29. Dependence of seminorms on t do not matter here.

- To pass to the limit in $\widehat{\mathcal{E}}_{j_0+1}(t)f_n$, we use the fact that this term involves only derivatives of f_n and not f_n itself. We assume first that j_0 is large enough so that $\epsilon_{j_0} \geq N$, but this is not restrictive for our purpose. By the recurrence relation (4.1.43), we reduce the problem to studying the action of $\mathcal{E}_{j_0}(t)$ and $\mathcal{H}_p^{(3)}$. Yet from Proposition 4.5.5 (applied with $\kappa = \Upsilon$) and Proposition 4.5.4, we have

$$\begin{aligned} \nabla^{-1}S(\theta_g, g) &\xrightarrow{\mathcal{E}_{j_0}(t-s)} S\left(e^{N\Upsilon|t-s|}\theta_g^N\theta_{g(t-s)}^{-j_0\epsilon}, g(t-s)\right) \\ &\xrightarrow{\mathcal{H}_p^{(3)}} S\left(e^{N\Upsilon|t-s|}\theta_g^N\theta_{g(t-s)}^{-j_0\epsilon}h_{g(t)}^2\hbar_g e^{-(\Lambda+2\Upsilon)|t-s|}, g(t-s)\right). \end{aligned}$$

Yet using that $\theta_{g(t)} = \theta_g e^{-(\Lambda+2\Upsilon)|t|}$, we can crudely bound the weight in the right-hand side symbol class by

$$e^{N\Upsilon|t-s|}\theta_g^N\theta_{g(t-s)}^{-j_0\epsilon}h_{g(t)}^2\hbar_g e^{-(\Lambda+2\Upsilon)|t-s|} \leq e^{N(\Lambda+3\Upsilon)|t|}\theta_{g(t)}^{N-j_0\epsilon}.$$

Recalling that $\epsilon_{j_0} \geq N$, we deduce that the symbol $\mathcal{H}_p^{(3)}\mathcal{E}_{j_0}(t-s)f_n$ belongs to $S(1, g(t))$ with uniform seminorms with respect to n and s, t in a bounded interval, since $f_n = \chi_n f$ belongs to a bounded subset of $\nabla^{-1}S(\theta_g^N, g)$.

Therefore, the Calderón-Vaillancourt theorem ensures that these symbols yield bounded operators on $L^2(M)$ which are uniformly bounded. In addition, since all the operators involved are continuous on $\mathcal{S}'(T^*M)$, we also have

$$\mathcal{H}_p^{(3)}\mathcal{E}_{j_0}(t-s)f_n \xrightarrow[n \rightarrow \infty]{\mathcal{S}'(T^*M)} \mathcal{H}_p^{(3)}\mathcal{E}_{j_0}(t-s)f.$$

Therefore Lemma 4.6.2 applies and we obtain

$$\text{Op}^w\left(e^{(t-s_{j_0+1})\mathcal{H}_p}\mathcal{H}_p^{(3)}\mathcal{E}_{j_0}(t-s)f_n\right) \xrightarrow[n \rightarrow \infty]{} \text{Op}^w\left(e^{(t-s_{j_0+1})\mathcal{H}_p}\mathcal{H}_p^{(3)}\mathcal{E}_{j_0}(t-s)f\right) \quad (4.6.4)$$

for the weak operator topology on L^2 , which finally results in

$$\text{Op}^w\left(\widehat{\mathcal{E}}_p^{j_0+1}(t)f_n\right) \xrightarrow[n \rightarrow \infty]{} \text{Op}^w\left(\widehat{\mathcal{E}}_p^{j_0+1}(t)f\right),$$

after integrating (4.6.4) over $s \in t\Delta_1$. Notice that in particular the right-hand side is a bounded operator.

- Lastly, we try to make sense of the left-hand side of (4.1.42) as $n \rightarrow \infty$. We claim that it suffices to prove that for all $v \in \mathcal{S}(M)$, the sequence $(\text{Op}^w(\bar{f}_n)v)_{n \in \mathbf{N}}$ is bounded in $L^2(M)$. Indeed, if this is true, since $f_n \rightharpoonup f$ in $\mathcal{S}'(T^*M)$ we deduce that $\text{Op}^w(\bar{f}_n)v \rightharpoonup \text{Op}^w(\bar{f})v$ weakly in $L^2(M)$, so that

$$(e^{-itP}u, \text{Op}^w(\bar{f}_n)v)_{L^2} \xrightarrow[n \rightarrow \infty]{L^2(M)} (e^{-itP}u, \text{Op}^w(\bar{f})v)_{L^2}, \quad \forall u \in L^2(M),$$

which means in particular that

$$\text{Op}^w(f_n)e^{-itP}u \xrightarrow[n \rightarrow \infty]{\mathcal{S}'(M)} \text{Op}^w(f)e^{-itP}u$$

for any $u \in L^2(M)$, which is the desired result. In view of the definition of $f_n = \chi_n f$, we use the pseudo-differential calculus

$$S(1, g) \# S(\theta_g^N, g) \subset S(\theta_g^N, g)$$

(Proposition 4.2.2) with $\chi_n \in S(1, g)$ and $f \in \nabla^{-1}S(\theta_g^N, g)$ to have

$$f_n = \chi_n f = \chi_n \# f - \widehat{\mathcal{P}}_1(\chi_n, f),$$

where $\widehat{\mathcal{P}}_1(\chi_n, f)$ lies in a bounded subset of $S(\theta_g^N, g)$, given that $(\chi_n)_{n \in \mathbf{N}}$ is a bounded sequence in $S(1, g)$. Now by [Ler10, Corollary 2.6.16], there exist $a \in S(\theta_g^{-N}, g)$ and $b \in S(\theta_g^N, g)$ such that $a \# b = 1$. Thus we can write

$$f_n = \chi_n \# f - \widehat{\mathcal{P}}_1(\chi_n, f) \# a \# b,$$

where $\widehat{\mathcal{P}}_1(\chi_n, f) \# a$ lies in a bounded subset of $S(1, g)$ by pseudo-differential calculus. In particular, its quantization gives rise to a bounded operator on $L^2(M)$, with norm bounded independently of n . Quantizing and applying to a function $v \in \mathcal{S}(M)$, we arrive at

$$\text{Op}^w(f_n)v = \text{Op}^w(\chi_n)\text{Op}^w(f)v - \text{Op}^w\left(\widehat{\mathcal{P}}_1(\chi_n, f) \# a\right)\text{Op}^w(b)v.$$

As we saw, $\text{Op}^w(\chi_n)$ and $\text{Op}^w\left(\widehat{\mathcal{P}}_1(\chi_n, f) \# a\right)$ are bounded uniformly with respect to n , so that

$$\|\text{Op}^w(f_n)v\|_{L^2} \leq c(\|\text{Op}^w(f)v\|_{L^2} + \|\text{Op}^w(b)v\|_{L^2}).$$

for some constant $c > 0$ independent of n . Notice that $\text{Op}^w(f)v$ and $\text{Op}^w(b)v$ lie in $\mathcal{S}(M)$, so in particular in $L^2(M)$, by Proposition 4.B.2.

The conclusion is as follows: one can pass to the limit $n \rightarrow \infty$ in (4.6.3) to obtain the same equality with f instead of f_n . Applying it to a function $v \in \mathcal{S}(M)$, one observes that the right-hand side makes sense as an operator $\mathcal{S}(M) \rightarrow L^2(M)$, so that the operator $\text{Op}^w(f)e^{-itP} : \mathcal{S}(M) \rightarrow L^2(M)$ continuously. Therefore it can be composed on the left by the Schrödinger propagator, and we obtain the sought result. \square

Lemma 4.6.2. *Let $(a_n)_{n \in \mathbf{N}}$ be a sequence in $\mathcal{S}'(T^*M)$ converging to some $a \in \mathcal{S}'(T^*M)$ as $n \rightarrow \infty$. Assume that the operators $\text{Op}^w(a_n)$ extend to bounded operators on $L^2(M)$, and that*

$$\sup_{n \in \mathbf{N}} \|\text{Op}^w(a_n)\|_{\mathcal{L}(L^2)} < \infty. \quad (4.6.5)$$

Then

$$\text{Op}^w\left(e^{t\mathcal{H}_p} a_n\right) \xrightarrow[n \rightarrow \infty]{} \text{Op}^w\left(e^{t\mathcal{H}_p} a\right), \quad \forall t \in \mathbf{R},$$

for the weak operator topology. In particular, convergence holds as continuous operators $\mathcal{S}(M) \rightarrow \mathcal{S}'(M)$.

Proof. Since $a_n \rightharpoonup a$ in $\mathcal{S}'(T^*M)$, we know by definition of the Weyl quantization that

$$\text{Op}^w(a_n)u \xrightarrow[n \rightarrow \infty]{\mathcal{S}'(T^*M)} \text{Op}^w(a)u, \quad \forall u \in \mathcal{S}(M).$$

Taking adjoints, we deduce now that when $u \in L^2(M)$, we have $\text{Op}^w(a_n)u \rightharpoonup \text{Op}^w(a)u$ in $\mathcal{S}'(T^*M)$. Once again, using the uniform boundedness assumption (4.6.5), weak compactness results in

$$\text{Op}^w(a_n)u \xrightarrow[n \rightarrow \infty]{L^2(M)} \text{Op}^w(a)u, \quad \forall u \in L^2(M),$$

or in other words, $\text{Op}^w(a_n) \rightarrow \text{Op}^w(a)$ weakly as operators on $L^2(M)$. This property is preserved by conjugation with the propagator e^{-itP} , hence the result. Testing against Schwartz functions instead of L^2 functions, we obtain the convergence in the sense of continuous operators $\mathcal{S}(M) \rightarrow \mathcal{S}'(M)$. \square

4.6.2. Preliminary lemmata

In the sequel, given a smooth function f lying in some symbol class, we denote by H_f the Hamiltonian vector field associated with f , defined as in (4.1.5), and we introduce the operator \mathcal{H}_f acting on symbol, defined according to (4.1.12). Notice that H_f satisfies the Leibniz formula with respect to the pointwise product, while \mathcal{H}_f satisfies the Leibniz formula with respect to the Moyal product, that is to say:

$$H_f(a_1 a_2) = (H_f a_1) a_2 + a_1 (H_f a_2) \quad \text{and} \quad \mathcal{H}_f(a_1 \# a_2) = (\mathcal{H}_f a_1) \# a_2 + a_1 \# (\mathcal{H}_f a_2).$$

Lemma 4.6.3. *Let $f \in \text{Aff}(T^*M; \mathbf{R})$. Then we have $\nabla f \in S(\theta_g, g)$ and*

$$\forall \ell \in \mathbf{N}, \forall \rho_0 \in T^*M, \forall t \in \mathbf{R}, \quad |\nabla f|_{S(\theta_g, g)}^{(\ell)} = |\nabla f|_{S(\theta_g, g)}^{(0)} \leq |H_f|_{g_{\rho_0}(t)} \theta_{g(t)}(\rho_0).$$

Proof. This is a direct consequence of the definition of the temperance weight:

$$\forall \rho \in T^*M, \quad |\nabla f|_{g_\rho} = |H_f|_{g_\rho^\sigma} \leq |H_f|_{\mathbf{g}} \theta_g(\rho) \leq |H_f|_{\mathbf{g}^\sigma} \theta_g(\rho) \leq |H_f|_{g_{\rho_0}(t)} \theta_g(\rho) \theta_{g(t)}(\rho_0).$$

Then we recall that $\nabla^2 f = 0$ because f is affine and the result follows. \square

Lemma 4.6.4. *Fix $N_0 \leq 1$ and $N \in \mathbf{R}$, and let $f_0 \in \nabla^{-1}S(\theta_g^{N_0}, g)$. For all $s \in \mathbf{R}$, write $f_0(s) = \mathcal{E}_{\leq j_0}(s) f_0$. Then for any $s, t \in \mathbf{R}$ such that $|s| \leq |t| \leq \frac{2}{3}T_E$, we have*

$$\nabla^{-1}S\left(\theta_{g(t)}^N, g(t)\right) \xrightarrow{\mathcal{H}_{f_0(s)}} S\left(\theta_{g(t)}^{N+N_0}, g(t)\right)$$

uniformly with respect to s, t , and we have the estimate

$$\begin{aligned} \forall \ell \in \mathbf{N}, \exists k \in \mathbf{N}, \exists C > 0 : \forall a \in \nabla^{-1}S\left(\theta_{g(t)}^N, g(t)\right), \\ |\mathcal{H}_{f_0(s)} a|_{S(\theta_{g(t)}^{N-N_0}, g(t))}^{(\ell)} \leq C |\nabla f_0|_{S(\theta_g^{N_0}, g)}^{(k)} \times |\nabla a|_{S(\theta_{g(t)}^N, g(t))}^{(k)}. \end{aligned}$$

Proof. First of all, from Proposition 4.5.5, we know that

$$f_0(s) \in \nabla^{-1}S\left(e^{N_0\Upsilon|s|} \theta_g^{N_0}, g(s)\right), \quad \forall |s| \leq T_E.$$

Thus we apply pseudo-differential calculus (Proposition 4.2.2):

$$\nabla^{-1}S\left(e^{N_0\Upsilon|s|} \theta_g^{N_0}, g(s)\right) \times S\left(\theta_{g(t)}^N, g(t)\right) \xrightarrow{\widehat{\mathcal{P}}_1} S\left(e^{N_0\Upsilon|s|} h_{g(t)} \theta_g^{N_0} \theta_{g(t)}^N, g(t)\right).$$

Yet we have

$$e^{N_0\Upsilon|s|} h_{g(t)} \theta_g^{N_0} \theta_{g(t)}^N \leq e^{N_0\Upsilon|t|+2(\Lambda+2\Upsilon)|t|} \underline{h}_g \theta_{g(t)}^{N+N_0} \leq e^{3(\Lambda+2\Upsilon)|t|} \underline{h}_g \theta_{g(t)}^{N+N_0} \leq \theta_{g(t)}^{N+N_0},$$

where we used that $\theta_g = e^{(\Lambda+2\Upsilon)|t|} \theta_{g(t)}$ in the first inequality, $N_0 \leq 1$ in the second one and $|t| \leq \frac{2}{3}T_E$ in the last one. Therefore, the estimate reads

$$\begin{aligned} \forall \ell \in \mathbf{N}, \exists k \in \mathbf{N} : \quad |\mathcal{H}_{f_0(s)} a|_{S(\theta_{g(t)}^{N+N_0}, g(t))}^{(\ell)} &\leq |\nabla f_0(s)|_{S(e^{2N_0\Upsilon|s|} \theta_g^{N_0}, g(s))}^{(k)} |\nabla a|_{S(\theta_{g(t)}^N, g(t))}^{(k)} \\ &\leq |\nabla f_0|_{S(\theta_g^{N_0}, g)}^{(k)} |\nabla a|_{S(\theta_{g(t)}^N, g(t))}^{(k)} \end{aligned}$$

which is exactly the expected result. \square

4.6.3. Two commutator lemmata

Below we compute how an operator derivative ad_F acts on the quantum evolution of an observable.

Recall the definition of the k -dimensional simplex $t\Delta_k$ in (4.1.41).

We also use the following notation: given a finite set of symbols $\{a_j\}_j$, we denote by $\#_j a_j$ any symbol of the form

$$\#_j a_j = a_{j_1} \# a_{j_2} \# \cdots \# a_{j_*}, \quad (4.6.6)$$

where (j_1, j_2, \dots, j_*) is an enumeration of the indices j . This notation makes sense as long as we don't care about the ordering of factors in (4.6.6). In case the order matter, we shall be more specific and spell out the precise enumeration that we use. We work with the convention

$$\#_{\emptyset} a_j = 1.$$

(the empty product is equal to 1). We also write $\mathcal{H}_{a_j}^j$ any operator of the form

$$\mathcal{H}_{a_j}^j = \mathcal{H}_{a_{j_*}} \cdots \mathcal{H}_{a_{j_2}} \mathcal{H}_{a_{j_1}},$$

provided the ordering of composition does not matter.

Lastly, we work with the convention

$$\int_{t\Delta_0} a(s) ds = a(t).$$

Lemma 4.6.5. *Let $\ell \in \mathbf{N}$ and fix $N \in \mathbf{R}$. Let $a \in S(\theta_g^{-\ell N}, g)$ and introduce*

$$a(t) = e^{t\mathcal{H}_p} a, \quad \forall t \in \mathbf{R}.$$

Then for any integer $j_0 \geq \ell N/\epsilon$, and for any $t \in [-T_E, T_E]$ the following holds: for any family of symbols $f_j \in \nabla^{-1}S(\theta_g^N, g)$, $j \in \{1, 2, \dots, \ell\}$, the distribution

$$\mathcal{H}_{f_j}^j a(t)$$

can be written as a sum of symbols of the form

$$\int_{t\Delta_k} \left(\#_{k_1} e^{s_{k_1}\mathcal{H}_p} c_{\pi(k_1)}(s_{k_1}) \right) \# e^{t\mathcal{H}_p} a_{\tilde{\pi}}(t) \# \left(\#_{k_2} e^{s_{k_2}\mathcal{H}_p} c_{\pi(k_2)}(s_{k_2}) \right) ds, \quad k \in \{0, \dots, \ell\}. \quad (4.6.7)$$

The number of terms in the sum depends only on ℓ , N and j_0 . The indices split into disjoint families of indices as follows:

$$\{1, 2, \dots, k\} = \{k_1\} \cup \{k_2\} \quad \text{and} \quad \{1, 2, \dots, \ell\} = \tilde{\pi} \cup \bigcup_{k_1} \pi(k_1) \cup \bigcup_{k_2} \pi(k_2) \quad (4.6.8)$$

and the $\pi(k_j)$, $j = 1, 2$ are non-empty. Writing for short

$$f_j(s) = \mathcal{E}_{\leq j_0}(-s)f_j \quad \text{and} \quad \hat{f}_j(s) = \mathcal{H}_p^{(3)} \mathcal{E}_{j_0}(s)f_j,$$

the symbols c_π and a_π are of the form

$$c_\pi(s) = \mathcal{H}_{f_{\pi_j}(s)}^j \hat{f}_{\pi_0}(s) \quad \text{and} \quad a_{\tilde{\pi}}(s) = \mathcal{H}_{f_{\tilde{\pi}_j}(s)}^j a, \quad s \in \mathbf{R}, \quad (4.6.9)$$

where $(\pi_0, (\pi_j)_j)$ is an enumeration of π (ranging in the $\pi(k_j)$'s) and $(\tilde{\pi}_j)_j$ is an enumeration of $\tilde{\pi}$.

Remark 4.6.6. All the symbols involved in (4.6.7) belong to $S(1, g)$. This is a consequence of Lemma 4.6.4 for symbols of the form $a_{\tilde{\pi}}(s)$ and of Proposition 4.5.5 together with Lemma 4.6.4 for those of the form $c_\pi(s)$. We need this fact to make sure that the Moyal products in (4.6.7) make sense. More precise bounds is given in the special case where the f_j 's are affine functions.

Corollary 4.6.7. *Let $L \in \mathbf{N}$. There exist $k \in \mathbf{N}$ and $C > 0$, depending only on p and L , such that for any $t, s \in \mathbf{R}$ with $|t| + |s| \leq \frac{1}{6}T_E$, the following holds: for any $f_1, f_2, \dots, f_L \in \text{Aff}(T^*M; \mathbf{R})$, we have for all $a \in S(\theta_{g(s)}^{-L}, g(s))$:*

$$\forall \rho_0 \in T^*M, \quad \left\| \text{Op}^w \left(\mathcal{H}_{f_L} \cdots \mathcal{H}_{f_2} \mathcal{H}_{f_1} e^{t\mathcal{H}_p} a \right) \right\|_{L^2 \rightarrow L^2} \leq C |a|_{S(\theta_{g(s)}^{-L}, g(s))}^{(k)} \theta_{g(t)}^L(\rho_0) \prod_{j=1}^L |H_{f_j}|_{g_{\rho_0}(t)}.$$

Proof of Corollary 4.6.7. We fix $j_0 \geq \frac{L+1}{\epsilon}$. By Lemma 4.6.3, we know that $f_j \in \nabla^{-1}S(\theta_g, g)$, so that Lemma 4.6.5 applies with $N = 1$. Equipped with the Calderón-Vaillancourt theorem (Proposition 4.B.4), and given that

$$\left\| \text{Op}^w \left(e^{s\mathcal{H}_p} b \right) \right\|_{L^2 \rightarrow L^2} = \|e^{isP} \text{Op}^w(b) e^{-isP}\|_{L^2 \rightarrow L^2} = \|\text{Op}^w(b)\|_{L^2 \rightarrow L^2},$$

it suffices to estimate the $S(1, g(t_0))$ seminorms of the symbols $c_\pi(\tau)$ and $a_{\tilde{\pi}}(\tau)$ arising in (4.6.7), $t_0 = \max(|s|, |\tau|)$. In this proof, write $|\pi|$ for the cardinality of π . On the one hand, successive applications of Lemma 4.6.4 with $N_0 = 1$ give

$$\forall \ell \in \mathbf{N}, \exists k \in \mathbf{N} : \quad |a_{\tilde{\pi}}(\tau)|_{S(1, g(t_0))}^{(\ell)} \leq C |a|_{S(\theta_{g(t_0)}^{-|\tilde{\pi}|}, g(t_0))}^{(k)} \prod_{j \in \tilde{\pi}} |\nabla f_j|_{S(\theta_{g, g})}^{(k)}.$$

Now we remark that the seminorm of a in $S(\theta_{g(t_0)}^{-|\tilde{\pi}|}, g(t_0))$ is smaller than the seminorm in $S(\theta_{g(s)}^{-L}, g(\tau))$, and we use Lemma 4.6.3 to handle the seminorms of ∇f_j :

$$|a_{\tilde{\pi}}(\tau)|_{S(1, g(t_0))}^{(\ell)} \leq C |a|_{S(\theta_{g(s)}^{-L}, g(s))}^{(k)} \theta_{g(\tau)}^{|\tilde{\pi}|}(\rho_0) \prod_{j \in \tilde{\pi}} |H_{f_j}|_{g_{\rho_0}(\tau)}. \quad (4.6.10)$$

Notice that the constant C is independent of ρ_0 and s .

We proceed similarly for the symbols of the form $c_\pi(\tau)$ in (4.6.7), taking $s = \tau$. For all $\ell \in \mathbf{N}$, there exist $k \in \mathbf{N}$ and $C > 0$ such that

$$\forall \rho_0 \in T^*M, \quad |c_\pi(\tau)|_{S(1, g(\tau))}^{(\ell)} \leq C |\hat{f}_{\pi_0}(\tau)|_{S(\theta_{g(\tau)}^{-L}, g(\tau))}^{(k)} \theta_{g(\tau)}^{|\pi|-1}(\rho_0) \prod_j |H_{f_{\pi_j}}|_{g_{\rho_0}(\tau)}, \quad (4.6.11)$$

where $\pi = (\pi_0, (\pi_j)_j)$ is an enumeration of π . Now from Lemma 4.5.4 and Proposition 4.5.5 (with $m = \theta_g$ and $\kappa = \Upsilon$), we have

$$\begin{aligned} f_{\pi_0} &\in \nabla^{-1} S(\theta_g, g) \xrightarrow{\mathcal{E}_{j_0}(\tau)} S\left(e^{\Upsilon|\tau|} \theta_g \theta_{g(\tau)}^{-j_0 \epsilon}, g(\tau)\right) \\ &\xrightarrow{\mathcal{H}_p^{(3)}} S\left(\hbar_g^{3/2} e^{\Upsilon|\tau|} \theta_g \theta_{g(\tau)}^{-(j_0+1)\epsilon}, g(\tau)\right) \subset S\left(\hbar_g^{3/2} e^{3(\Lambda+2\Upsilon)|\tau|} \theta_{g(\tau)}^{-(j_0+1)\epsilon+1}, g(\tau)\right). \end{aligned} \quad (4.6.12)$$

The last inclusion follows from the fact that $\theta_g = e^{(\Lambda+2\Upsilon)|\tau|} \theta_{g(\tau)}$. Under our assumption on j_0 , we have $(j_0+1)\epsilon - 1 \geq L$ and moreover, in the time interval $|\tau| \leq \frac{1}{6} T_E$, we have

$$\hbar_g^{1/4} e^{3(\Lambda+2\Upsilon)|\tau|} = \hbar_g \left(\hbar_g e^{12(\Lambda+2\Upsilon)|\tau|} \right)^{1/4} \leq 1.$$

Therefore we obtain the estimate

$$|\hat{f}_{\pi_0}(\tau)|_{S(\theta_{g(\tau)}^L, g(\tau))}^{(k)} \leq C \hbar_g^{5/4} |\nabla f_{\pi_0}|_{S(\theta_{g, g})}^{(k')} \leq C' \hbar_g^{5/4} \theta_{g(\tau)}(\rho_0) |H_{f_{\pi_0}}|_{g_{\rho_0}(\tau)},$$

in virtue of Lemma 4.6.3. Plugging this into (4.6.11), we arrive at

$$|c_\pi(\tau)|_{S(1, g(\tau))}^{(\ell)} \leq C \hbar_g^{5/4} \theta_{g(\tau)}^{|\pi|}(\rho_0) \prod_{j \in \pi} |H_{f_j}|_{g_{\rho_0}(\tau)}. \quad (4.6.13)$$

These estimates (4.6.10) and (4.6.13) apply to each factor in (4.6.7), with $s = t$ or $s = s_{k_j}$, that verify in any case $|s| \leq |t|$. We can conclude by the Calderón-Vaillancourt theorem that the operator norm of the quantization of (4.6.7) is bounded by

$$C \hbar_g^{5k/4} |t \Delta_k| |a|_{S(\theta_{g(s)}^{-L}, g(s))}^{(k)} \theta_{g(t)}^L(\rho_0) \prod_{j=1}^L |H_{f_j}|_{g_{\rho_0}(t)}$$

(recall also (4.6.8) so that each f_j appears exactly once). Recalling that $k \in \{0, 1, \dots, \ell\}$, we obtain using the fact that $|t| \leq T_E$:

$$\hbar_g^{5k/4} |t \Delta_k| \leq \frac{1}{k!} \left(\frac{\hbar_g^{1+1/4}}{\Lambda} \log \left(\frac{1}{\hbar_g} \right) \right)^k \leq \frac{1}{k!} \left(\frac{C_{1/4}}{c} \right)^k,$$

where c is the constant in (4.1.40) and $C_{1/4} = \sup_{\tau \in [0, 1]} \tau^{1/4} |\log \tau|$. This gives the desired estimate. \square

Proof of Lemma 4.6.5. In this proof, we do not care about the time dependence of seminorms. All what we need is to check that the different symbols arising in the computations give rise to bounded operators, for any fixed time t .

We prove the lemma by induction on ℓ (at each step of the induction, N and the symbol a are arbitrary). The case $\ell = 0$ is a matter of convention. Let us check the basis step $\ell = 1$. We write $f = f_1$. In view of Corollary 4.6.1, we have

$$\begin{aligned} [F, \text{Ad}_{e^{itP}} \text{Op}^w(a)] &= \text{Ad}_{e^{itP}} [\text{Ad}_{e^{-itP}} F, \text{Op}^w(a)] \\ &= \text{Ad}_{e^{itP}} \left[\text{Op}^w \left(\mathcal{E}_{\leq j_0}(-t)f - \int_0^t \text{Ad}_{e^{-i(t-s)j_0+1}P} \text{Op}^w(\hat{f}(s_{j_0+1})) ds_{j_0+1} \right), \text{Op}^w(a) \right] \\ &= \text{Ad}_{e^{itP}} \text{Op}^w(\mathcal{H}_{f(t)}a) + \int_0^t \left[\text{Ad}_{e^{isP}} \text{Op}^w(\hat{f}(s)), \text{Ad}_{e^{itP}} \text{Op}^w(a) \right] ds. \end{aligned} \quad (4.6.14)$$

Expanding the commutator, we obtain that $\mathcal{H}_f a(t)$ is equal to the sum of three terms: the first one of the form

$$e^{t\mathcal{H}_P} \mathcal{H}_{f(t)} a, \quad (4.6.15)$$

the second of the form

$$\int_0^t \left(e^{s\mathcal{H}_P} \hat{f}(s) \right) \# \left(e^{t\mathcal{H}_P} a \right) ds \quad (4.6.16)$$

and the third one with the Moyal product in the other way around. Those three terms are of the expected form. Notice that the expression we found makes sense as a bounded operator on $L^2(M)$. Indeed, $\mathcal{H}_{f(s)}a \in S(1, g(s))$ by Lemma 4.6.4 since $a \in S(\theta_g^{-\ell N}, g) \subset S(\theta_{g(t)}^{-\ell N}, g(t))$ by assumption.

In addition, given that $\hat{f}(s) = \mathcal{H}_P^{(3)} \mathcal{E}_{j_0}(s)f$, one sees from Proposition 4.5.5 and Lemma 4.5.4 that it belongs to $\hat{f}(s) \in S(\theta_{g(t)}^{N-j_0\epsilon}, g(t))$, up to an exponential-in-time factor (which we do not care about here¹⁵). The latter symbol class is contained in $S(1, g(t))$ as soon as $j_0 \geq N/\epsilon$, and then gives rise to a bounded operator by the Calderón-Vaillancourt Theorem. That ends the basis step of the induction.

Now assume that the claim holds at step $\ell \in \mathbf{N}^*$. We fix $N \in \mathbf{R}$ and a family of $\ell + 1$ symbols $f_j \in \nabla^{-1}S(\theta_g^N, g)$, $j \in \{1, \dots, \ell, \ell + 1\}$. We consider $a \in S(\theta_g^{-(\ell+1)N}, g)$. We apply the induction hypothesis to handle the ℓ first derivations \mathcal{H}_{f_j} , with $j_0 \geq N(\ell + 1)/2$, and we obtain a sum of terms of the form (4.6.7). Then the last derivation $\mathcal{H}_{f_{\ell+1}}$ can land on any of the factors in (4.6.7) in virtue of the Leibniz formula.

The derivative lands on the factor of the form $e^{s\mathcal{H}_P} b(s)$, with $b(s) = a_{\tilde{\pi}}(s)$ or $b(s) = c_{\pi}(s)$. Then from the calculations of step $\ell = 1$, the resulting symbol can be written as a sum of terms of the form $e^{s\mathcal{H}_P} \mathcal{H}_{f_{\ell+1}(s)} b(s)$ as in (4.6.15), or

$$\int_0^s \left(e^{\tau\mathcal{H}_P} \hat{f}_{\ell+1}(\tau) \right) \# \left(e^{s\mathcal{H}_P} b(s) \right) d\tau \quad (4.6.17)$$

as in (4.6.16), or the same kind of term with the Moyal product in the other way around. Recall that $f_{\ell+1}(s)$ and $\hat{f}_{\ell+1}(\tau)$ are defined using Corollary 4.6.1 at an order $j_0 \geq N(\ell + 1)/\epsilon$.

- Considering first the resulting terms involving $e^{s\mathcal{H}_P} \mathcal{H}_{f_{\ell+1}(s)} b(s)$, in view of (4.6.9), the symbol $\mathcal{H}_{f_{\ell+1}(s)} b(s)$ is still of the form $a_{\tilde{\pi}'}(s)$ with $\tilde{\pi}' = (\ell + 1, \tilde{\pi})$ if $b(s) = a_{\tilde{\pi}}(s)$, or of the form $c_{\pi'}(s)$ with $\pi' = (\ell + 1, \pi_0, (\pi_j)_j)$ if $b(s) = c_{\pi}(s)$. Therefore the resulting term is of the form (4.6.7) and we are done.
- Now considering the second type of terms, namely those of the form (4.6.17), we see that we can write it

$$\int_0^s \left(e^{\tau\mathcal{H}_P} c_{\{\ell+1\}}(\tau) \right) \# \left(e^{s\mathcal{H}_P} b(s) \right) ds.$$

Depending on which factor of (4.6.7) was hit by $\mathcal{H}_{f_{\ell+1}}$, we should take $s = s_{k_0}$ to be one of the \mathbf{s} variables (meaning $s = t$ if $k_0 = k + 1$). Plugging this into (4.6.7) yields

$$\int_{t\Delta_k} \int_0^{s_{k_0}} \left(\#_{k'_1} e^{s_{k'_1}\mathcal{H}_P} c_{\pi(k'_1)}(s_{k'_1}) \right) \# e^{t\mathcal{H}_P} a_{\tilde{\pi}}(t) \# \left(\#_{k_2} e^{s_{k_2}\mathcal{H}_P} c_{\pi(k_2)}(s_{k_2}) \right) d\tau ds,$$

15. The reasoning is the same as in Corollary 4.6.1.

where $\{k'_1\} = \{k_1\} \cup \{\tau\}$. It remains to see that it is indeed a symbol of the form (4.6.7). This follows from the fact that the integration domain can be split into a union of simplices:

$$\begin{aligned} & \{(s, \mathbf{s}) \in \mathbf{R}^{k+1} : s \in t\Delta_k, s \in s_k\Delta_1\} \\ &= \bigcup_{k'=0}^{k_0-1} \{(s, \mathbf{s}) \in \mathbf{R}^{k+1} : 0 = s_0 \leq s_1 \leq s_2 \leq \dots \leq s_{k'} \leq s \leq s_{k'+1} \leq \dots \leq s_{k_0} \leq \dots \leq s_k \leq t\} \end{aligned}$$

if $t \geq 0$, and similarly if $t \leq 0$.

That gives the desired result. \square

Lemma 4.6.8. *Let $a \in \mathcal{S}(T^*M)$ and fix $N \in \mathbf{R}$ and $\ell \in \mathbf{N}$. Then for any $j_0 \geq 2\ell N/\epsilon$, the following holds. For any $f_j \in \nabla^{-1}S(\theta_g^N, g)$, $j \in \{1, 2, \dots, \ell\}$ and any $t \in [-T_E, T_E]$, the distribution*

$$\left(e^{t\mathcal{H}_p} a \right) \# f_\ell \# \dots \# f_2 \# f_1 \quad (4.6.18)$$

can be written as a sum of terms of symbols of the form

$$e^{t\mathcal{H}_p} \left(a \# \left(\#_{k_1} f_{k_1}(t) \right) \right) \# \left(\#_{\pi \in \Pi} c_\pi(t) \right).$$

The number of terms in the sum depends only on ℓ and N . The indices split into disjoint families

$$\{1, 2, \dots, \ell\} = \{k_1\} \cup \{k_2\}$$

and Π is a partition of $\{k_2\}$ ($\pi \in \Pi$ referring to the non-empty blocks of the partition). Writing for short

$$f_j(s) = \mathcal{E}_{\leq j_0}(-s)f_j \quad \text{and} \quad \hat{f}_j(s) = \int_{s\Delta_{j_0}} \mathcal{H}_p^{(3)} \mathcal{E}_{j_0}(s) ds,$$

the symbols c_π are of the form

$$c_\pi(s) = \mathcal{H}_{f_{\pi_j}}^j \int_0^s e^{s\mathcal{H}_p} \hat{f}_{\pi_0}(s) ds, \quad s \in \mathbf{R},$$

where $(\pi_0, (\pi_j)_j)$ is an enumeration of π .

Remark 4.6.9. We first notice that the operator whose symbol is (4.6.18) is well defined as a continuous linear operator $\mathcal{S}(M) \rightarrow \mathcal{S}'(M)$ and even as a bounded operator on $L^2(M)$ since the operators of the form $\text{Op}^w(f_j)$ are continuous on $\mathcal{S}(M)$. Actually, under the assumption $j_0 \geq 2\ell N/\epsilon$, it holds $\hat{f}_j(s) \in S(\theta_g^{-\ell N}, g)$ from Proposition 4.5.5 and Lemma 4.5.4, so that Lemma 4.6.5 applies and ensures that c_π gives rise to a bounded operator. Again, more precise bounds will be established in Subsection 4.7.3.

Proof. We prove the claim by induction on $\ell \in \mathbf{N}$. The basis step $\ell = 0$ is a matter of convention. The step $\ell = 1$ is a consequence Corollary 4.6.1:

$$\begin{aligned} \left(e^{t\mathcal{H}_p} a \right) \# f_1 &= e^{t\mathcal{H}_p} \left(a \# e^{-t\mathcal{H}_p} f_1 \right) = e^{t\mathcal{H}_p} \left(a \# \mathcal{E}_{\leq j_0}(t)f_1 + a \# \int_0^t e^{-(t-s)\mathcal{H}_p} \hat{f}_1(s) ds \right) \\ &= e^{t\mathcal{H}_p} \left(a \# \mathcal{E}_{\leq j_0}(t)f_1 \right) + \left(e^{t\mathcal{H}_p} a \right) \# \int_0^t e^{s\mathcal{H}_p} \hat{f}_1(s) ds. \end{aligned}$$

These terms are exactly of the expected form.

Now suppose the claim is true at step $\ell \geq 1$. Let $f_0, f_1, \dots, f_\ell \in \nabla^{-1}S(\theta_g^N, g)$. We apply the induction hypothesis with f_1, f_2, \dots, f_ℓ : we obtain that the symbol

$$\left(e^{t\mathcal{H}_p} a \right) \# f_\ell \# \dots \# f_1 \# f_0$$

can be written as a sum of terms of the form

$$\begin{aligned} e^{t\mathcal{H}_p} \left(a \# \left(\#_{k_1} f_{k_1}(t) \right) \right) \# \left(\#_{\pi \in \Pi} c_\pi(t) \right) \# f_0 &= e^{t\mathcal{H}_p} \left(a \# \left(\#_{k_1} f_{k_1}(t) \right) \right) \# f_0 \# \left(\#_{\pi \in \Pi} c_\pi(t) \right) \\ &\quad - e^{t\mathcal{H}_p} \left(a \# \left(\#_{k_1} f_{k_1}(t) \right) \right) \# \mathcal{H}_{f_0} \left(\#_{\pi \in \Pi} c_\pi(t) \right). \end{aligned} \quad (4.6.19)$$

We deal with the first term that we call A_1 : from Corollary 4.6.1 we can write

$$e^{-t\mathcal{H}_p} f_0 = \mathcal{E}_{\leq j_0}(-t) f_0 - e^{-t\mathcal{H}_p} \int_0^t e^{s\mathcal{H}_p} \hat{f}_0(s) ds,$$

so that

$$\begin{aligned} A_1 &= e^{t\mathcal{H}_p} \left(a \# \left(\#_{k_1} f_{k_1}(t) \right) \# f_0(t) \right) \# \left(\#_{\pi \in \Pi} c_\pi(t) \right) \\ &\quad - e^{t\mathcal{H}_p} \left(a \# \left(\#_{k_1} f_{k_1}(t) \right) \# f_0(t) \right) \# \left(\int_0^t e^{s\mathcal{H}_p} \hat{f}_0(s) ds \right) \# \left(\#_{\pi \in \Pi} c_\pi(t) \right). \end{aligned}$$

This yields two terms of the expected form.

We now deal with the second term in (4.6.19) that we call A_2 : we use the Leibniz formula to compute the action of \mathcal{H}_{f_0} on the Moyal product of the $c_\pi(t)$ symbols. We obtain a product of the form

$$c_{\Pi_1}(t) \# \cdots \# c_{\Pi_{l-1}}(t) \# \mathcal{H}_{f_0} c_{\Pi_l}(t) \# c_{\Pi_{l+1}}(t) \# \cdots \# c_{\Pi_*}(t),$$

where $(\Pi_1, \Pi_2, \dots, \Pi_*)$ is an enumeration of Π . This can be written as

$$\#_{\pi' \in \Pi'} c_{\pi'}(t),$$

where Π' is a partition of $\{0, 1, \dots, \ell\}$ with $\Pi'_j = \Pi_j$ except for $j = l$ where $\Pi'_l = \Pi_l \cup \{0\}$. Therefore we obtain symbols of the desired form. This finishes the induction. \square

4.7. Quantum evolution of confined symbols: proof of Theorem 4.1.40

4.7.1. Control of the terms of the Dyson expansion

We start with a lemma on confined symbols.

Lemma 4.7.1. *Let g be an admissible metric and m a g -admissible weight. Then any uniformly g -confined family of symbols $(\psi_{\rho_0})_{\rho_0 \in T^*M}$ with radius $r \leq \min\{r_g, r_m\}$ satisfies:*

$$\psi_{\rho_0} \in \frac{1}{m(\rho_0)} S(m, g),$$

uniformly in $\rho_0 \in T^*M$, that is to say

$$\forall \ell \in \mathbf{N}, \exists C_\ell > 0 : \forall \rho_0 \in T^*M, \quad |\psi_{\rho_0}|_{S(m, g)}^{(\ell)} \leq \frac{C_\ell}{m(\rho_0)}.$$

Proof. Let $r_0 = \min(r_g, r_m)$ be the minimum of slow variation radii of g and m . We assume that $(\psi_{\rho_0})_{\rho_0}$ is uniformly g -confined with radius $r \in (0, r_0]$. For any fixed $\rho \in T^*M$, Proposition 4.1.29 tells us that

$$m(\rho_0) \leq C_m m(\rho) \left\langle \text{dist}_{g_{\rho_0}}(\rho, B_r^{g_{\rho_0}}(\rho_0)) \right\rangle^{N_m}, \quad \forall \rho \in T^*M.$$

Notice that it is important that $r \leq \min(r_g, r_m)$ to use the slow variation properties of both g and m .

Now we are able to prove the estimate of the statement. That ψ_{ρ_0} is g -confined near $B_r^g(\rho_0)$ yields (recall Lemma 4.C.4 which applies since $r < r_g$):

$$\begin{aligned} \frac{1}{\ell!} |\nabla^\ell \psi_{\rho_0}(X_1, X_2, \dots, X_\ell)| &\leq |\psi_{\rho_0}|_{\text{Conf}_g(\rho_0, r)}^{(\ell+k)} \left\langle \text{dist}_{g^{\sigma_{\rho_0}}}(\rho, B_r^{g^{\rho_0}}(\rho_0)) \right\rangle^{-k} \prod_{j=1}^{\ell} |X_j|_g \\ &\leq |\psi_{\rho_0}|_{\text{Conf}_g(\rho_0, r)}^{(\ell+j)} C_m \frac{m(\rho)}{m(\rho_0)} \left\langle \text{dist}_{g^{\sigma_{\rho_0}}}(\rho, B_r^{g^{\rho_0}}(\rho_0)) \right\rangle^{N_m-k} \prod_{j=1}^{\ell} |X_j|_g. \end{aligned}$$

Taking $k \geq N_m$ suffices to show that $\psi_{\rho_0} \in m^{-1}(\rho_0)S(m, g)$. Seminorms in the latter symbol class are uniform in ρ_0 for uniformly confined families of symbols. \square

4.7.2. Confinement estimate of the remainder

Before getting into the proof, let us explain our strategy. If a is g -confined near $\rho_0 \in T^*M$, we expect $a_t = e^{t\mathcal{H}_P} a$ to be $g(t)$ -confined near $\phi^{-t}(\rho_0)$. Therefore, our purpose will be to show that

$$\rho \mapsto \left\langle \text{dist}_{g^{\sigma(t)}}(\rho, B_{r(t)}^{g(t)}(\phi^{-t}(\rho_0))) \right\rangle^n a_t(\rho)$$

is smooth and bounded, applying Beals theorem (Proposition 4.B.5). Multiplication of the symbol a_t by powers of the distance function could possibly be achieved at the operator level by composing $\text{Op}^w(a_t) = e^{itP} \text{Op}^w(a) e^{-itP}$ with operators of the form $\text{Op}^w(w_{g(t), \phi^{-t}(\rho_0)})$, where w_{g, ρ_0} would a smooth version of

$$\rho \mapsto \langle \text{dist}_{g^\sigma}(\rho, B_r^g(\rho_0)) \rangle.$$

However, pseudodifferential calculus would lead lower order terms

$$\text{Op}^w(a_t) \text{Op}^w(w_{g, \rho_0}) = \text{Op}^w(a_t w_{g, \rho_0} + \mathcal{P}_1(a_t, w_{g, \rho_0}))$$

making the analysis more complicated. Instead, we will compose $\text{Op}^w(a_t)$ with operators of the form $\text{Op}^w(f_j)$ where

$$f_j(\rho) = g^\sigma(\rho - \phi^{-t}(\rho_0), e_j),$$

where $(e_j)_j$ is an orthonormal basis of W for the metric g^σ . These affine functions satisfy

$$\sum_j f_j^2 = |\bullet - \phi^{-t}(\rho_0)|_{g^\sigma}^2.$$

To multiply a_t by this weight, one can do the following operation at the operator level:

$$f_j \# a_t + a_t \# f_j = \text{Op}^w(2f_j a_t).$$

This holds without remainder term because $\nabla f_j = 0$, and the terms of order 1 in pseudodifferential calculus cancel because \mathcal{P}_1 is skew-symmetric. By taking sufficiently many such anti-commutators, one is able to obtain the operator

$$\text{Op}^w\left(\langle \rho - \phi^{-t}(\rho_0) \rangle_{g^\sigma}^{2k} a_t\right)$$

for any k , and Lemma 4.6.8 gives another way of writing this operator that allows to estimate its L^2 -norm, using that a was g -confined near ρ_0 . Then Lemma 4.6.5 allows to handle derivatives of this symbol, and Beals theorem should then give that

$$\rho \mapsto \langle \rho - \phi^{-t}(\rho_0) \rangle_{g^\sigma}^{2k} a_t$$

belongs to $S(1, g_{\phi^{-t}(\rho_0)})$.

However there is a price to pay: indeed, we cannot expect for such bounds in $S(1, g_{\phi^{-t}(\rho_0)})$ to be uniform in ρ_0 . The reason for this is that

$$\rho \mapsto \langle \rho - \rho_0 \rangle_{g_{\rho_0}^\sigma}$$

is potentially much larger than

$$\rho \mapsto \left\langle \text{dist}_{g_{\rho_0}^\sigma}(\rho, B_r^g(\rho_0)) \right\rangle$$

in $B_r^g(\rho_0)$, since $g^\sigma \geq g$. In fact the loss that we have at this stage is of order

$$\sup_{\rho \in t^*M} \frac{\langle \rho - \rho_0 \rangle_{g_{\rho_0}^\sigma}}{\left\langle \text{dist}_{g_{\rho_0}^\sigma}(\rho, B_r^g(\rho_0)) \right\rangle} \approx \sup_{\zeta \in W \setminus \{0\}} \frac{|\zeta|_{g_{\rho_0}^\sigma}}{|\zeta|_{g_{\rho_0}}}$$

This quantity turns out to be controlled by m_g^{-1} . Thus, applying this strategy to $\widehat{\mathcal{E}}_j(t)a$ instead of $e^{t\mathcal{H}_p}a$ should allow to compensate this loss.

Lemma 4.7.2. *Let $T \in [0, T_E/2]$ and $r \in (0, r_g)$ satisfy (4.5.17). Let $(\psi_{\rho_0})_{\rho_0 \in T^*M}$ be a uniformly $g(t)$ -confined family of symbols with radius $r(t)$. Let $f \in \text{Aff}(T^*M; \mathbf{R})$. Then for any $j_0 \geq 0$, we have*

$$\psi_{\rho_0} \# \mathcal{E}_{\leq j_0}(s)f \in \left(|f(\phi^s(\rho_0))| + |H_f|_{g_{\phi^s(\rho_0)}(t)} \theta_{g(t)}^4(\phi^s(\rho_0)) \right) \text{Conf}_{g(t)}^{r(t)}(\rho_0)$$

uniformly in $\rho_0 \in T^*M$, $|s| \leq |t|$ and $t \in [-T, T]$.

Proof. In all the proof, we write $\rho_s = \phi^s(\rho_0)$ for simplicity. We first isolate¹⁶ the term $\mathcal{E}_0(s)f$ by writing

$$\mathcal{E}_{\leq j_0}(s)f = e^{sH_p}f + \tilde{f}(s).$$

Applying pseudo-differential calculus at order 1, we have

$$\psi_{\rho_0} \# \mathcal{E}_{\leq j_0}(s)f = \psi_{\rho_0} e^{sH_p}f + \psi_{\rho_0} \tilde{f}(s) + \widehat{\mathcal{P}}_1(\psi_{\rho_0}, \mathcal{E}_{\leq j_0}(s)f). \quad (4.7.1)$$

We handle the three terms in (4.7.1) separately.

- We first deal with the third term. Since $f \in \nabla^{-1}S(\theta_g, g)$ by Lemma 4.6.3, we have by Proposition 4.5.5 (applied with $m = \theta_g$, $\kappa = \Upsilon$):

$$\mathcal{E}_{\leq j_0}(s)f \in \nabla^{-1}S\left(e^{\Upsilon|s|}\theta_g, g(s)\right) \subset \nabla^{-1}S\left(e^{\frac{3}{2}(\Lambda+2\Upsilon)|t|}\theta_{g(t)}, g(t)\right).$$

By the pseudo-differential calculus for confined symbols (Proposition 4.2.3), we have

$$\text{Conf}_{g(t)}^{r(t)}(\rho_0) \times \nabla^{-1}S\left(e^{\frac{3}{2}(\Lambda+2\Upsilon)|t|}\theta_{g(t)}, g(t)\right) \xrightarrow{\widehat{\mathcal{P}}_1} h_{g(t)}(\rho_0) e^{\frac{3}{2}(\Lambda+2\Upsilon)|t|} \theta_{g(t)}(\rho_0) \text{Conf}_{g(t)}^{r(t)}(\rho_0).$$

Yet recalling that $\theta_{g(t)} \circ \phi^s \leq e^{\Upsilon|s|}\theta_{g(t)}$, as soon as $|t| \leq \frac{1}{2}T_E$, we have

$$h_{g(t)}(\rho_t) e^{\frac{3}{2}(\Lambda+2\Upsilon)|t|} \theta_{g(t)}(\rho_0) \leq \underline{h}_g e^{4(\Lambda+2\Upsilon)|t|} \theta_{g(t)}(\rho_s) \leq \theta_{g(t)}(\rho_s).$$

Recalling that from Lemma 4.6.3, one has

$$|\nabla f|_{S(\theta_g, g)}^{(0)} \leq \theta_{g(t)}(\rho_s) |H_f|_{g_{\rho_s}(t)},$$

we obtain

$$\widehat{\mathcal{P}}_1(\psi_{\rho_0}, \mathcal{E}_{\leq j_0}(s)f) \in |H_f|_{g_{\rho_s}(t)} \theta_{g(t)}^2(\rho_s) \text{Conf}_{g(t)}^{r(t)}(\rho_0), \quad (4.7.2)$$

which handles the third term in (4.7.1).

- Similarly for the second term, we have by Proposition 4.5.5:

$$\tilde{f}(s) \in S\left(\theta_{g(t)}(\rho_s) |H_f|_{g_{\rho_s}(t)} e^{\Upsilon|s|} \theta_g, g(s)\right) \subset S\left(\theta_{g(t)}(\rho_s) |H_f|_{g_{\rho_s}(t)} e^{2(\Lambda+2\Upsilon)|t|} \theta_{g(t)}, g(t)\right),$$

16. In principle we could simplify this proof by observing that $f - f(\rho_s) \in S(\theta_g \langle \rho - \rho_s \rangle_{g_{\rho_s}^\sigma}, g)$. However, the weight does not have uniform structure constants with respect to ρ_0 : slow variation of $\langle \bullet - \rho_s \rangle_{g_{\rho_s}^\sigma}$ with respect to g degenerates away from ρ_s . This is a problem to keep track of the dependence of constants on ρ_0 while applying pseudo-differential calculus.

and the pseudo-differential calculus for confined symbols (Proposition 4.2.3) yields

$$\begin{aligned} \text{Conf}_{g(t)}^{r(t)}(\rho_0) \times S\left(\theta_{g(t)}(\rho_s)|H_f|_{g_{\rho_s}(t)}e^{2(\Lambda+2\Upsilon)|t}|\theta_{g(t)}, g(t)\right) \\ \xrightarrow{\mathcal{P}_0} \theta_{g(t)}^2(\rho_s)|H_f|_{g_{\rho_s}(t)}e^{2(\Lambda+2\Upsilon)|t}|\text{Conf}_{g(t)}^{r(t)}(\rho_0). \end{aligned} \quad (4.7.3)$$

Now from Proposition 4.1.32, we have

$$e^{2(\Lambda+2\Upsilon)|t} \leq e^{2(\Lambda+2\Upsilon)|t} h_{g(t)}(\rho_s) \theta_{g(t)}^2(\rho_s) \leq e^{4(\Lambda+2\Upsilon)|t} \underline{h}_g \theta_{g(t)}^2(\rho_s) \leq \theta_{g(t)}^2(\rho_s), \quad \forall |t| \leq \frac{T_E}{2}. \quad (4.7.4)$$

Therefore

$$\psi_{\rho_0} \tilde{f}(s) \in \theta_{g(t)}^4(\rho_s) |H_f|_{g_{\rho_s}(t)} \text{Conf}_{g(t)}^{r(t)}(\rho_0). \quad (4.7.5)$$

- Lastly, the first term in (4.7.1) is treated separately as follows: by the triangle inequality, choosing $\tilde{\rho}$ such that

$$|\tilde{\rho} - \rho_0|_{g_{\rho_0}^\sigma(t)} = \text{dist}_{g_{\rho_0}^\sigma(t)}\left(\rho, B_{r(t)}^{g(t)}(\rho_0)\right),$$

we have, because f is affine:

$$|e^{sH_p} f(\rho)| \leq |f(\phi^s(\rho_0))| + |\sigma(H_f, \phi^s(\tilde{\rho}) - \phi^s(\rho_0))| + |\sigma(H_f, \phi^s(\rho) - \phi^s(\tilde{\rho}))|.$$

We handle the third term thanks to Proposition 4.4.10:

$$\begin{aligned} |\sigma(H_f, \phi^s(\rho) - \phi^s(\tilde{\rho}))| &\leq |H_f|_{g_{\rho_s}(t)} |\phi^s(\rho) - \phi^s(\tilde{\rho})|_{g_{\rho_s}^\sigma(t)} \\ &\leq C |H_f|_{g_{\rho_s}(t)} e^{(\Lambda+2\Upsilon)|t|} |\rho - \tilde{\rho}|_{g_{\rho_0}^\sigma(t)} \langle \rho - \tilde{\rho} \rangle_{g_{\rho_0}^\sigma}^N \\ &\leq C |H_f|_{g_{\rho_s}(t)} \theta_{g(t)}^2(\rho_s) \left\langle \text{dist}_{g_{\rho_0}^\sigma(t)}\left(\rho, B_{r(t)}^{g(t)}(\rho_0)\right) \right\rangle^{N+1}. \end{aligned}$$

We used (4.7.4) in the last inequality. As for the second term, we have by Proposition 4.4.9 and by definition of the temperance weight θ_g :

$$\begin{aligned} |\sigma(H_f, \phi^s(\tilde{\rho}) - \phi^s(\rho_0))| &\leq |H_f|_{g_{\rho_s}^\sigma(t)} |\phi^s(\tilde{\rho}) - \phi^s(\rho_0)|_{g_{\rho_s}(t)} \\ &\leq \theta_{g(t)}^2(\rho_s) |H_f|_{g_{\rho_s}(t)} \times |\tilde{\rho} - \rho_0|_{g_{\rho_0}(t)} e^{(\Lambda+C_g^3 \frac{C_p}{4} \underline{h}_g)|t|} \\ &\leq \theta_{g(t)}^2(\rho_s) |H_f|_{g_{\rho_s}(t)}. \end{aligned}$$

We used the condition (4.1.67) on $r(t)$ to obtain the last inequality. This shows that $\psi_{\rho_0} e^{sH_p} f$ decays like a confined symbol in

$$\left(|f(\rho_s)| + \theta_{g(t)}^4(\rho_s) |H_f|_{g_{\rho_s}(t)}\right) \text{Conf}_{g(t)}^{r(t)}(\rho_0). \quad (4.7.6)$$

To handle derivatives, we differentiate the product $\psi_{\rho_0} e^{sH_p} f$ using the Leibniz formula. When derivatives hit ψ_{ρ_0} , the previous argument shows that $(\nabla^\ell \psi_{\rho_0}) e^{sH_p} f$ still decays like a confined symbol in (4.7.6). When derivatives hit $e^{sH_p} f$, since

$$\nabla e^{sH_p} f \in S\left(|H_f|_{g_{\rho_s}(t)} \theta_{g(t)}(\rho_s) \theta_{g(t)}, g(t)\right),$$

and we apply (4.7.3) to obtain

$$\psi_{\rho_0} \nabla e^{sH_p} f \in |H_f|_{g_{\rho_s}(t)} \theta_{g(t)}^4(\rho_s) \text{Conf}_{g(t)}^{r(t)}(\rho_0).$$

So finally we obtain that $\psi_{\rho_0} e^{sH_p} f$ belongs to (4.7.6).

Putting together the estimates (4.7.2), (4.7.5) and (4.7.6) in (4.7.1), we finally obtain the sought result. \square

4.7.3. End of the proof of Theorem 4.1.40

Let $T \in (0, T_E)$ and let $(\psi_{\rho_0})_{\rho_0 \in T^*M}$ be a g -uniformly confined family of symbols with radius $r > 0$ satisfying

$$r = r_g e^{-(2(\Lambda+\Upsilon)+C_g^3 \frac{C_p}{4} h_g)T}.$$

Fix $\rho_0 \in T^*M$ and set $\rho_t = \phi^{-t}(\rho_0)$ for all $t \in [-T, T]$. Let $L, N \in \mathbf{N}^*$ be integers.

Multiplication step.

Let $(e_j)_j$ be an orthonormal basis of W for the metric $g_{\rho_t}^\sigma(t)$ and introduce

$$w_j(\rho) = g_{\rho_t}^\sigma(t) (\rho - \rho_t, e_j),$$

in such a way that

$$|\rho - \rho_t|_{g_{\rho_t}^\sigma(t)}^2 = \sum_j w_j^2(\rho), \quad \forall \rho \in T^*M.$$

Then one has

$$\forall j, \quad w_j(\rho_t) = 0 \quad \text{and} \quad |H_{w_j}|_{g_{\rho_t}^\sigma(t)} = 1, \quad (4.7.7)$$

because $|e_j|_{g_{\rho_t}^\sigma(t)} = 1$.

Fix K and even integer. Expanding the power K below, the symbol

$$a : \rho \mapsto \langle \rho - \rho_t \rangle_{g_{\rho_t}^\sigma(t)}^{2K} \widehat{\mathcal{E}}_{j_0+1}(t) \psi_{\rho_0} \quad (4.7.8)$$

can be written as a sum of symbols of the form

$$\prod_n w_n \times \widehat{\mathcal{E}}_{j_0+1}(t) \psi_{\rho_0},$$

where the number of factors in the product is less than K . The factors $(w_n)_n$ are relabeled to form a family of N affine functions (w_1, w_2, \dots, w_N) , with $N \leq 2K$. This symbol can be rewritten itself as a sum of anti-commutators with operators of the form $\text{Op}^W(w_n)$. Therefore, we are left with studying

$$\left(\#_{n_1} w_{n_1} \right) \# \widehat{\mathcal{E}}_{j_0+1}(t) \psi_{\rho_0} \# \left(\#_{n_2} w_{n_2} \right) = \int_0^t \left(\#_{n_1} w_{n_1} \right) \# e^{s\mathcal{H}_p} \mathcal{H}_p^{(3)} \mathcal{E}_{j_0}(t-s) \psi_{\rho_0} \# \left(\#_{n_2} w_{n_2} \right) ds,$$

where the right-hand side comes from the recurrence relation (4.1.43), and the sets of indices $\{n_1\}$ and $\{n_2\}$ partition $\{n\}$. Applying Lemma 4.6.8, we can write this symbol as a sum of symbols of the form

$$\tilde{a} := \int_0^t \left(\#_{\pi_1 \in \Pi_1} c_{\pi_1}(s) \right) \# e^{s\mathcal{H}_p} \tilde{\psi}(t, s) \# \left(\#_{\pi_2 \in \Pi_2} c_{\pi_2}(s) \right) ds. \quad (4.7.9)$$

where

$$\tilde{\psi}(t, s) := \left(\#_{l_1} w_{l_1}(s) \right) \# \mathcal{H}_p^{(3)} \mathcal{E}_{j_0}(t-s) \psi_{\rho_0} \# \left(\#_{l_2} w_{l_2}(s) \right). \quad (4.7.10)$$

Here we have the partitions of indices

$$\{k_j\} \cup \{l_j\} = \{n_j\}, \quad j \in \{1, 2\}, \quad (4.7.11)$$

the set Π_j is a partition of $\{k_j\}$ and

$$w_l(s) = \mathcal{E}_{\leq j_0}(-s) w_l(s), \quad \hat{w}_{\pi_0}(s) = \mathcal{H}_p^{(3)} \mathcal{E}_{j_0}(s) w_{\pi_0};$$

and given $\pi = (\pi_0, \pi_1, \dots, \pi_*)$, we have

$$c_\pi(s) = \mathcal{H}_{w_{\pi_*}} \cdots \mathcal{H}_{w_{\pi_2}} \mathcal{H}_{w_{\pi_1}} \int_0^s e^{\tau \mathcal{H}_p} \hat{w}_{\pi_0}(\tau) d\tau. \quad (4.7.12)$$

We claim that

$$\tilde{\psi}(t, s) \in \underline{h}_g^{3/2} \theta_{g(t)}^{4(L_1+L_2)-(j_0+1)\epsilon/2} (\rho_t) \text{Conf}_{\tau(t)}^{g(t)} (\rho_{t-s}), \quad (4.7.13)$$

where L_j is the cardinality of the family of indices $\{l_j\}$ in (4.7.10). Indeed, we have

$$\mathcal{H}_p^{(3)} \mathcal{E}_{j_0}(t-s) \psi_{\rho_0} \in \underline{h}_g^{3/2} \theta_{g(t-s)}^{-(j_0+1)\epsilon} (\rho_{t-s}) \text{Conf}_{r(t-s)}^g (\rho_{t-s}),$$

since by Proposition 4.5.9 and Proposition 4.5.8,

$$\text{Conf}_r^g(\rho_0) \xrightarrow{\mathcal{E}_{j_0}(t-s)} \theta_{g(t-s)}^{-j_0\epsilon} (\rho_{t-s}) \text{Conf}_{r(t-s)}^g (\rho_{t-s}) \xrightarrow{\mathcal{H}_p^{(3)}} \underline{h}_g^{3/2} \theta_{g(t-s)}^{-(j_0+1)\epsilon} (\rho_{t-s}) \text{Conf}_{r(t-s)}^g (\rho_{t-s}).$$

Yet recalling (4.1.68), we have

$$\text{Conf}_{g(t-s)}^{r(t-s)}(\rho_{t-s}) \subset \text{Conf}_{g(t)}^{r(t)}(\rho_{t-s}),$$

and from Proposition 4.1.32,

$$\begin{aligned} \theta_{g(t-s)}(\rho_{t-s}) &\geq \theta_{g(t)}(\rho_{t-s}) \geq \theta_{g(t)}(\rho_t) e^{-|s|\Upsilon} \\ &\geq \theta_{g(t)}(\rho_t) \left(e^{2(\Lambda+2\Upsilon)|t|} h_{g(t)}(\rho_t) \theta_{g(t)}^2(\rho_t) \right)^{-1/4} \geq \theta_{g(t)}^{1/2}(\rho_t), \end{aligned}$$

whenever $|t| \leq T_E/2$. Therefore we have

$$\mathcal{H}_p^{(3)} \mathcal{E}_{j_0}(t-s) \psi_{\rho_0} \in \underline{h}_g^{3/2} \theta_{g(t)}^{-(j_0+1)\epsilon/2} (\rho_t) \text{Conf}_{r(t)}^g (\rho_{t-s}), \quad (4.7.14)$$

uniformly with respect to ρ_0 , t and s in $[-T_E/2, T_E/2]$.

Then we apply Lemma 4.7.2 to $\mathcal{H}_p^{(3)} \mathcal{E}_{j_0}(t-s) \psi_{\rho_0}$ satisfying (4.7.14) and $w_l(s)$ satisfying (4.7.7). Given that $\phi^{-s}(\rho_{t-s}) = \phi^{-t}(\rho_0) = \rho_t$, we have

$$|w_n(\rho_t)| + |H_{w_n}|_{g_{\rho_t}(t)} \theta_{g(t)}^4(\rho_t) = \theta_{g(t)}^4(\rho_t),$$

so that (4.7.13) holds.

Differentiation step.

We fix a family $f_1, f_2, \dots, f_L \in \text{Aff}(T^*M; \mathbf{R})$. From the previous computations, we know that the symbol $\mathcal{H}_{f_L} \dots \mathcal{H}_{f_2} \mathcal{H}_{f_1} a$ (where a is defined in (4.7.8)) can be written as a sum of terms of the form $\mathcal{H}_{f_\ell} \dots \mathcal{H}_{f_2} \mathcal{H}_{f_1} \tilde{a}$ (defined in (4.7.9)), where $\{f_1, f_2, \dots, f_\ell\}$ is in fact a relabeled sub-family of $\{f_1, f_2, \dots, f_L\}$. Applying the Leibniz formula, derivatives distribute on the various Moyal factors in (4.7.9). Therefore we have two cases to study: either derivatives hit $e^{s\mathcal{H}_p} \tilde{\psi}(t, s)$, or they land on a symbol of the form $c_\pi(s)$.

- In the first case, from (4.7.13), we have thanks to Lemma 4.7.1

$$\tilde{\psi}(t, s) \in \underline{h}_g^{3/2} \theta_{g(t)}^{4(L_1+L_2)+\ell-(j_0+1)\epsilon/2} (\rho_t) S \left(\theta_{g(t)}^{-\ell}, g(t) \right).$$

Therefore Corollary 4.6.7 gives

$$\left\| \text{Op}^w \left(\mathcal{H}_{f_\ell} \dots \mathcal{H}_{f_2} \mathcal{H}_{f_1} e^{s\mathcal{H}_p} \tilde{\psi}(t, s) \right) \right\|_{L^2 \rightarrow L^2} \leq C \underline{h}_g^{3/2} \theta_{g(t)}^{4(L_1+L_2)+2\ell-(j_0+1)\epsilon/2} (\rho_t) \prod_{j=1}^{\ell} |H_{f_j}|_{g_{\rho_t}(t)}, \quad (4.7.15)$$

with a constant C independent of ρ_0 , t , $s \in [-T_E/2, T_E/2]$.

- In the second case, recalling (4.7.12), we have to consider a symbol of the form

$$\mathcal{H}_{f_\ell} \dots \mathcal{H}_{f_2} \mathcal{H}_{f_1} c_\pi(s) = \mathcal{H}_{f_\ell} \dots \mathcal{H}_{f_2} \mathcal{H}_{f_1} \mathcal{H}_{w_{\pi_*}} \dots \mathcal{H}_{w_{\pi_2}} \mathcal{H}_{w_{\pi_1}} \int_0^s e^{\tau \mathcal{H}_p} \hat{w}_{\pi_0}(\tau) d\tau.$$

Yet from Proposition 4.5.5 and Lemma 4.5.4, as we did in (4.6.12):

$$\begin{aligned} \nabla^{-1} S(\theta_g, g) \xrightarrow{\mathcal{E}_{j_0}(\tau)} S \left(e^{\Upsilon|\tau|} \theta_g \theta_{g(\tau)}^{-j_0\epsilon}, g(\tau) \right) \xrightarrow{\mathcal{H}_p^{(3)}} S \left(\underline{h}_g^{3/2} e^{3(\Lambda+2\Upsilon)|\tau|} \theta_{g(\tau)}^{-(j_0+1)\epsilon+1}, g(\tau) \right) \\ \subset S \left(\underline{h}_g^{5/4} \theta_{g(\tau)}^{-(j_0+1)\epsilon+1}, g(\tau) \right), \end{aligned}$$

where the last inclusion is valid in the time range $|\tau| \leq T_E/6$. Since we have

$$w_{\pi_0} \in \theta_{g(t)}(\rho_t) |H_{w_{\pi_0}}|_{g_{\rho_t}(t)} \nabla^{-1} S(\theta_g, g)$$

by Lemma 4.6.3 and (4.7.7), we deduce that

$$\hat{w}_{\pi_0}(\tau) = \mathcal{H}_p^{(3)} \mathcal{E}_{j_0}(s) w_{\pi_0} \in \theta_{g(t)}(\rho_t) |H_{w_{\pi_0}}|_{g_{\rho_t}(t)} S \left(\hbar_g^{5/4} \theta_{g(\tau)}^{-L}, g(\tau) \right),$$

because $j_0 \geq (L+1)/\epsilon$. Then we can apply Corollary 4.6.7 to obtain

$$\|\text{Op}^w(\mathcal{H}_{f_\ell} \cdots \mathcal{H}_{f_2} \mathcal{H}_{f_1} c_\pi(s))\|_{L^2 \rightarrow L^2} \leq C |s| \hbar_g^{5/4} \theta_{g(t)}^{|\pi|+\ell}(\rho_t) \prod_j |H_{w_{\pi_j}}|_{g_{\rho_t}(t)} \times \prod_{j=1}^{\ell} |H_{f_j}|_{g_{\rho_t}(t)}.$$

In the right-hand side, the norm of the vectors $H_{w_{\pi_j}}$ is one due to (4.7.7), and the factor $\hbar_g^{5/4} |s|$ is bounded by a constant since $|s| \leq T_E$. Therefore

$$\|\text{Op}^w(\mathcal{H}_{f_\ell} \cdots \mathcal{H}_{f_2} \mathcal{H}_{f_1} c_\pi(s))\|_{L^2 \rightarrow L^2} \leq C' \theta_{g(t)}^{|\pi|+\ell}(\rho_t) \prod_{j=1}^{\ell} |H_{f_j}|_{g_{\rho_t}(t)}. \quad (4.7.16)$$

On the whole, plugging the estimates (4.7.15) and (4.7.16) into (4.7.9), we deduce that

$$\|\text{Op}^w(\mathcal{H}_{f_\ell} \cdots \mathcal{H}_{f_2} \mathcal{H}_{f_1} \tilde{a})\|_{L^2 \rightarrow L^2} \leq C |t| \hbar_g^{3/2} \theta_{g(t)}^{4N+2L-(j_0+1)\epsilon/2}(\rho_t) \prod_j |H_{f_j}|_{g_{\rho_t}(t)}. \quad (4.7.17)$$

The exact power of $\theta_{g(t)}$ is due to (4.7.11). Indeed, concerning the multiplications by w_n , the indices $\{l_1\}$ and $\{l_2\}$ are counted in the estimate (4.7.15), while the remaining indices $\{k_1\}$ and $\{k_2\}$ are partitioned by Π_1 and Π_2 respectively, and the blocks of these partitions appear in (4.7.16). Regarding the differentiation with respect to f_j , we simply observe that all the f_j 's appear exactly once in one of the Moyal factors of \tilde{a} in (4.7.9) while applying the Leibniz formula. Now in (4.7.17), we recall that $|t| \hbar_g^{3/2}$ is bounded by a constant for $|t| \leq T_E$, hence

$$\|\text{Op}^w(\mathcal{H}_{f_\ell} \cdots \mathcal{H}_{f_2} \mathcal{H}_{f_1} a)\|_{L^2 \rightarrow L^2} \leq C' \theta_{g(t)}^{4N+2L-(j_0+1)\epsilon/2}(\rho_t) \prod_j |H_{f_j}|_{g_{\rho_t}(t)}. \quad (4.7.18)$$

This holds for any j_0 large enough, with a constant C' possibly depending on j_0 , but not on t nor on ρ_0 .

Beals theorem.

We finish by applying Beals theorem (Proposition 4.B.5). We take $\ell \in \mathbf{N}$ and we consider the integer k_0 of Proposition 4.B.5. Then

$$|a|_{S(1, g_{\rho_t}(t))}^{(\ell)} \leq C \ell \theta_{g(t)}^{4N+2(\ell+k_0)-(j_0+1)\epsilon/2}.$$

Going back to (4.7.8), that means that if $j_0 \geq 16(K + \ell + k_0)/\epsilon$, then

$$\left| \nabla^\ell \langle \rho - \rho_t \rangle_{g_{\rho_t}(t)}^{2K} \widehat{\mathcal{E}}_{j_0+1}(t) \psi_{\rho_0}(\rho) \right|_{g_{\rho_t}(t)} \leq C \theta_{g(t)}^{4N+2(\ell+k_0)-(j_0+1)\epsilon/2}, \quad (4.7.19)$$

for some constant C independent of ρ_0 and $|t| \leq \frac{1}{6} T_E$. We deduce that

$$\left| \langle \rho - \rho_t \rangle_{g_{\rho_t}(t)}^{2K} \nabla^\ell \widehat{\mathcal{E}}_{j_0+1}(t) \psi_{\rho_0}(\rho) \right|_{g_{\rho_t}(t)} \leq C, \quad (4.7.20)$$

with a possibly different constant. For $\ell = 0$, this is exactly (4.7.19). Then by induction, if this is true for some $0 \leq \ell' \leq \ell - 1$, then we can show (4.7.20) for $\ell' + 1$ by applying the Leibniz formula:

$$\frac{1}{(\ell' + 1)!} \left(\nabla^{\ell'+1} \langle \rho - \rho_t \rangle_{g_{\rho_t}(t)}^{2K} \widehat{\mathcal{E}}_{j_0+1}(t) \psi_{\rho_0}(\rho) \right) = \sum_{j=0}^{\ell'+1} \nabla^j \langle \rho - \rho_t \rangle_{g_{\rho_t}(t)}^{2K} \nabla^{\ell'+1-j} \widehat{\mathcal{E}}_{j_0+1}(t) \psi_{\rho_0}(\rho).$$

Indeed, the left-hand side is bounded by (4.7.19), and all the terms in the sum for $j \neq 0$ are bounded using the induction hypothesis (4.7.20) and because for any vector field X ,

$$\left| \nabla_{X^j}^j \langle \rho - \rho_t \rangle_{g_{\rho_t}^\sigma}^{2K} \right| \lesssim \langle \rho - \rho_t \rangle_{g_{\rho_t}^\sigma}^{2K-j} |X|_{g_{\rho_t}^\sigma}^j \leq \langle \rho - \rho_t \rangle_{g_{\rho_t}^\sigma}^{2K} |X|_{g_{\rho_t}^\sigma}^j \theta_{g(t)}^{2j}(\rho_t).$$

We deduce that

$$\left| \nabla^j \langle \rho - \rho_t \rangle_{g_{\rho_t}^\sigma}^{2K} \nabla^{\ell'+1-j} \widehat{\mathcal{E}}_{j_0+1}(t) \psi_{\rho_0}(\rho) \right|_{g_{\rho_t}^\sigma} \leq C \theta_{g(t)}^{4N+4(\ell'+k_0)-(j_0+1)\epsilon/2} \leq C',$$

hence isolating the $j = 0$ term in the sum, we obtain (4.7.20) for $\ell' + 1$.

Final conclusion.

We conclude that for any ℓ , there exists j_0 sufficiently large and $C > 0$ (uniform with respect to t and ρ_0) such that

$$\left| \nabla^\ell \widehat{E}_{j_0+1}(t) \psi_{\rho_0}(\rho) \right|_{g_{\rho_t}^\sigma} \leq C \langle \rho - \rho_t \rangle_{g_{\rho_t}^\sigma}^{-2\ell} \leq C \left\langle \text{dist}_{g_{\rho_t}^\sigma}(\rho, B_{r(t)}^g(\rho_t)) \right\rangle^{-2\ell}.$$

Yet by Proposition 4.5.9, this estimate is equally true for $\mathcal{E}_j(t) \psi_{\rho_0}$ for any $j_0 \in \mathbf{N}$. We deduce that

$$\exists C > 0 : \forall \rho_0 \in T^*M, \forall t \in [-\frac{1}{6}T_E, \frac{1}{6}T_E], \forall \ell \in \mathbf{N}, \exists k \in \mathbf{N} : \left| e^{t\mathcal{H}_p} \psi_{\rho_0} \right|_{\text{Conf}_{r(t)}^g(\rho_0)}^{(\ell)} \leq C |\psi_{\rho_0}|_{\text{Conf}_r^g(\rho_0)}^{(k)},$$

which is exactly the sought result. \square

4.8. Quantum evolution in symbol classes: proof of the main theorem and applications

4.8.1. Continuity on the Schwartz class: proof of Corollary 4.1.44

Recalling that spaces of confined symbols can be endowed with seminorms built from flat metrics (see Lemma 4.C.4 in the appendix), we know that seminorms of $\mathcal{S}(M)$ and seminorms of $\text{Conf}_r^g(\rho_0)$ are equivalent, for any admissible metric g , any $r > 0$ and any $\rho_0 \in T^*M$. Let $u \in \mathcal{S}(M)$. Then by definition of the Weyl quantization (4.1.2) and Proposition 4.B.7, writing $u(t) = e^{-itP}u$, we have for all $a \in \mathcal{S}(T^*M)$ and $t \in \mathbf{R}$:

$$\begin{aligned} (a, u(t) \otimes u(t))_{L^2(T^*M)} &= (u(t), \text{Op}^w(a)u(t))_{L^2} = (u, e^{itP} \text{Op}^w(a) e^{-itP} u)_{L^2(M)} \\ &= \left(e^{t\mathcal{H}_p} a, u \otimes u \right)_{L^2(T^*M)} = \left(a, e^{-t\mathcal{H}_p} (u \otimes u) \right)_{L^2(T^*M)}, \end{aligned}$$

where we used the fact that $e^{t\mathcal{H}_p}$ is a group of isometries in the last equality (Proposition 4.3.2). It is classical that $u \otimes u \in \mathcal{S}(T^*M)$ when u is a Schwartz function (see [Fol89, Proposition (1.92)]). Therefore, applying Theorem 4.1.40, we infer that

$$u(t) \otimes u(t) = e^{-t\mathcal{H}_p} (u \otimes u) \in \mathcal{S}(T^*M)$$

with relevant continuity estimates for the seminorms, provided $t > 0$ is not too large. Then partial integration with respect to the position or momentum variables yield

$$\int_{T_x^*M} (u(t) \otimes u(t))(x, \xi) d\xi = |u(t)(x)|^2 \quad \text{and} \quad \int_M (u(t) \otimes u(t))(x, \xi) dx = |(\mathcal{F} u(t))(\xi)|^2$$

for suitably normalized Lebesgue measures dx and $d\xi$ (see [Fol89, Proposition (1.96)]). We deduce that both $|u(t)|^2$ and $|(\mathcal{F} u(t))|^2$ are Schwartz functions. Indeed, fixing an origin $\rho_0 = (x_0, \xi_0) \in T^*M$, we can write by dominated convergence

$$\begin{aligned} \left| \langle x - x_0 \rangle^n \nabla^k |u(t)(x)|^2 \right| &\leq \int_{T_x^*M} \left| \langle x - x_0 \rangle^n \langle \xi - \xi_0 \rangle^{\dim M + 1} \nabla^k (u(t) \otimes u(t))(x, \xi) \right| \frac{d\xi}{\langle \xi - \xi_0 \rangle^{\dim M + 1}} \\ &\leq C \sup_{\rho \in T^*M} \left| \langle \rho - \rho_0 \rangle^{n + \dim M + 1} \nabla^k u(t) \otimes u(t) \right|, \end{aligned}$$

hence

$$\forall \ell \in \mathbf{N}, \exists C_\ell > 0 : \quad | |u(t)(x)|^2 |_{\mathcal{S}(M)}^{(\ell)} \leq C_\ell |u(t) \circledast u(t)|_{\mathcal{S}(T^*M)}^{(n+\dim M+1)}. \quad (4.8.1)$$

The same holds for $|\mathcal{F} u(t)|^2$, which implies in turn that $u(t)$ itself is a Schwartz function. To establish the continuity estimate, we observe that

$$\forall v \in \mathcal{S}(M), \quad \left(\sup_{x \in M} |\langle x - x_0 \rangle^n \nabla^k v(x)| \right)^2 = \sup_{x \in M} |\langle x - x_0 \rangle^n \nabla^k v(x)|^2 \leq \sup_{x \in M} |\langle x - x_0 \rangle^{2n} \nabla^{2k} v^2(x)| \quad (4.8.2)$$

by the Leibniz formula. Putting together all the arguments, we obtain

$$\left(|u(t)|_{\mathcal{S}(M)}^{(\ell)} \right)^2 \leq | |u(t)|^2 |_{\mathcal{S}(M)}^{(2\ell)} \leq C_\ell |u(t) \circledast u(t)|_{\mathcal{S}(T^*M)}^{(2\ell+\dim M+1)} \leq C |u \circledast u|_{\mathcal{S}(T^*M)}^{(k)} \leq C' \left(|u|_{\mathcal{S}(M)}^{(k')} \right)^2.$$

The first inequality comes from (4.8.2), the second one from (4.8.1), the third one is due to Theorem 4.1.40 together with the equivalence between the seminorms of $\mathcal{S}(T^*M)$ and that of spaces of confined symbols, and the last one follows from the continuity of the Wigner transform on Schwartz classes ([Fol89, Proposition (1.92)]). That yields the desired estimate. This holds on a non trivial time interval $t \in [-T, T]$. Using the equivalence of seminorms (here we do not care about the uniformity with respect to any parameter), we can bootstrap the argument to reach the conclusion for all times $t \in \mathbf{R}$. This finishes proof. \square

4.8.2. Proof of Theorem 4.1.15

As explained in the introduction, in order to pass from Theorem 4.1.40 to Theorem 4.1.15, we will use the following characterization of symbols in $S(m, g)$.

Proposition 4.8.1 ([Ler10, Proposition 2.3.16]). *Let g be an admissible metric, m be a g -admissible weight with a g -slow variation radius r_m , and $(\psi_{\rho_0})_{\rho_0 \in T^*M}$ be a g -uniformly confined family of symbols with radius $r \leq \min\{r_g, r_m\}$. Then the symbol a defined by*

$$a(\rho) = \int_{T^*M} m(\rho_0) \psi_{\rho_0}(\rho) d\text{Vol}_g(\rho_0), \quad \forall \rho \in T^*M, \quad (4.8.3)$$

belongs to $S(m, g)$, with the estimate:

$$\forall \ell \in \mathbf{N}, \exists k \in \mathbf{N}, \exists C_\ell > 0 : \quad |a|_{S(m, g)}^{(\ell)} \leq C_\ell \sup_{\rho_0 \in T^*M} |\psi_{\rho_0}|_{\text{Conf}_r^g(\rho_0)}^{(k)}.$$

Conversely, if $a \in S(m, g)$, then the family of symbols

$$\varphi_{\rho_0} := \frac{1}{m(\rho_0)} \psi_{\rho_0} a, \quad \rho_0 \in T^*M,$$

is g -uniformly confined with the estimates:

$$\forall \ell \in \mathbf{N}, \exists k \in \mathbf{N}, \exists C_\ell > 0 : \quad \sup_{\rho_0 \in T^*M} |\varphi_{\rho_0}|_{\text{Conf}_r^g(\rho_0)}^{(\ell)} \leq C_\ell |a|_{S(m, g)}^{(k)} \sup_{\rho_0 \in T^*M} |\psi_{\rho_0}|_{\text{Conf}_r^g(\rho_0)}^{(k)}.$$

The constants C_ℓ and integers k depend only on structure constants of g and m .

Remark 4.8.2. The precise estimates are not stated explicitly in Lerner's book [Ler10], though they follow directly from the proof.

We start with a technical lemma.

Lemma 4.8.3. *Let a be defined as in (4.8.3). Then for any $u, v \in \mathcal{S}(M)$, we have*

$$\begin{aligned} (v, e^{itP} \text{Op}^w(a) e^{-itP} u)_{L^2} &= (v, \text{Op}^w(e^{t\mathcal{H}_v} a) u)_{L^2} \\ &= \int_{T^*M} m(\rho_0) (v, \text{Op}^w(e^{t\mathcal{H}_v} \varphi_{\rho_0}) u)_{L^2} d\text{Vol}_g(\rho_0), \end{aligned}$$

where the right-hand side is absolutely convergent.

Proof. Recalling Proposition 4.B.7, we have

$$\left(v, \text{Op}^w \left(e^{t\mathcal{H}_p} \varphi_{\rho_0} \right) u \right)_{L^2(M)} = \left(e^{t\mathcal{H}_p} \varphi_{\rho_0}, u \otimes v \right)_{L^2(T^*M)},$$

to the result is just a matter of justifying the absolute convergence of the double integral

$$\int_{T^*M} \int_{T^*M} \overline{m(\rho_0) e^{t\mathcal{H}_p} \varphi_{\rho_0}(\rho)} (u \otimes v)(\rho) d\rho d\text{Vol}_g(\rho_0)$$

and applying Fubini's theorem. To justify the fact that $e^{t\mathcal{H}_p}$ and the integral over ρ_0 commute, one can argue as follows: by Corollary 4.1.44, the Schrödinger propagator e^{-itP} preserves the Schwartz class. If we fix an exhaustive sequence of compact sets $(K_n)_{n \in \mathbf{N}}$ that covers T^*M , the sequence of symbols

$$a_n := \int_{K_n} m(\rho_0) \varphi_{\rho_0} d\text{Vol}_g(\rho_0)$$

is bounded in $S(m, g)$ by Proposition 4.8.1, and

$$\begin{aligned} \forall u, v \in \mathcal{S}(M), \quad \left(v, e^{itP} \text{Op}^w(a_n) e^{-itP} u \right)_{L^2} &= \left(v, \text{Op}^w \left(e^{t\mathcal{H}_p} a_n \right) u \right)_{L^2} \\ &= \int_{K_n} m(\rho_0) \left(v, \text{Op}^w \left(e^{t\mathcal{H}_p} \varphi_{\rho_0} \right) u \right)_{L^2} d\text{Vol}_g(\rho_0) \end{aligned}$$

by dominated convergence. Now the left-hand side converges to $(v, \text{Op}^w(e^{t\mathcal{H}_p} a) u)_{L^2}$ because $a_n \rightarrow a$ as tempered distributions (keep in mind that e^{-itP} is continuous on $\mathcal{S}(M)$). As for the right-hand side, the inner product can be rewritten $(e^{t\mathcal{H}_p} \varphi_{\rho_0}, u \otimes v)_{L^2(T^*M)}$, and from there, one can check from the admissibility of m and the bi-confinement estimate (Proposition 4.A.3) that the integral is absolutely convergent. \square

Proof of Theorem 4.1.15. We proceed in two steps.

Step 1 – Crude estimate for $e^{t\mathcal{H}_p}$. Let $s, \tau \in \mathbf{R}$ be such that $|s| + |\tau| \leq T \leq \frac{1}{6}T_E$. Notice that we can apply Theorem 4.1.40 to $g(s)$ in place of g and τ in place of t , since the metrics $g(t)$ are uniformly admissible for $|t| \leq T_E$ by Proposition 4.1.29, and our assumptions on p are verified for $g(t)$ as well (see Remark 4.1.18). Let M be a g -admissible weight, such that $M(\tau) = e^{\tau H_p} M$ has uniform structure constants in $|\tau| \leq T - |s|$ (for instance $M = m(s)$). Let $b \in S(m, g(s))$ and let us first prove that $e^{\tau\mathcal{H}_p} b \in S(m(\tau), g(t))$, with $t = |s| + |\tau|$, with a loss of powers of \hbar_g . We consider $r > 0$ such that $r(\bullet)$ defined in (4.1.66) satisfies $r(T) = \min\{r_g, r_m\}$, where r_m is the g -slow variation radius of m . We fix a partition of unity $(\psi_{\rho_0})_{\rho_0 \in T^*M}$ adapted to $g(s)$ with radius r , given by Proposition 4.1.34. Recall that

$$\sup_{\rho_0 \in T^*M} |\psi_{\rho_0}|_{\text{Conf}_r^{g(s)}(\rho_0)}^{(\ell)} = O(r^{-(\ell+1)(1+2 \dim M)}) = O(\hbar_g^{-\ell\beta}) \quad (4.8.4)$$

for some $\beta > 0$ by definition of r and T_E .

Since $(\psi_{\rho_0})_{\rho_0 \in T^*M}$ is a partition of unity, we can write

$$b = \int_{\rho_0 \in T^*M} m(\rho_0) \varphi_{\rho_0} d\text{Vol}_{g(s)}(\rho_0),$$

where $\varphi_{\rho_0} = m^{-1}(\rho_0) \psi_{\rho_0} \# b$ is a $g(s)$ -uniformly confined family of symbols with radius r by Proposition 4.8.1, with estimates:

$$\forall \ell \in \mathbf{N}, \exists C_\ell > 0, \exists k \in \mathbf{N} : \quad \sup_{\rho_0 \in T^*M} |\varphi_{\rho_0}|_{\text{Conf}_r^{g(s)}(\rho_0)}^{(\ell)} \leq C_\ell |a|_{S(m, g)}^{(k)} \hbar_g^{-\beta k} \quad (4.8.5)$$

in view of (4.8.4). We apply the quantum evolution of the symbol:

$$e^{\tau\mathcal{H}_p} b = \int_{T^*M} m(\rho_0) e^{\tau\mathcal{H}_p} \varphi_{\rho_0} d\text{Vol}_{g(s)}(\rho_0) = \int_{T^*M} m(\rho_0) \varphi_{\phi^{-\tau}(\rho_0)}^\tau d\text{Vol}_{g(s)}(\rho_0), \quad (4.8.6)$$

where $\varphi_{\phi^{-\tau}(\rho_0)}^\tau$ is defined similarly to (4.1.70). The fact that $e^{\tau\mathcal{H}_p}$ and the integral over ρ_0 commute follow from the fact that, give two Schwartz functions u and v , the double integral

$$\int_{T^*M} \int_{T^*M} m(\rho_0) \overline{e^{\tau\mathcal{H}_p} \varphi_{\rho_0}(\rho)} (u \otimes v)(\rho) d\rho d\text{Vol}_{g(s)}(\rho_0)$$

is absolutely convergent by Lemma 4.8.3 (recall the definition of the Wigner transform $u \otimes v$ in (4.1.3)), so that Fubini's theorem gives indeed

$$\left(b, e^{-\tau\mathcal{H}_p} u \otimes v \right)_{L^2(T^*M)} = \int_{T^*M} m(\rho_0) \left(\varphi_{\rho_0}, e^{-\tau\mathcal{H}_p} (u \otimes v) \right)_{L^2(T^*M)} d\text{Vol}_{g(s)}(\rho_0),$$

which is exactly (4.8.6) by Proposition 4.3.2 and Proposition 4.B.7. Now we perform a change of variables in (4.8.6) to have

$$e^{\tau\mathcal{H}_p} b = \int_{T^*M} (e^{\tau H_p} m)(\rho_0) \varphi_{\rho_0}^\tau d\text{Vol}_{(\phi^\tau)^*g(s)}(\rho_0),$$

since $(\phi^{-\tau})_* \text{Vol}_{g(s)} = \text{Vol}_{(\phi^\tau)^*g(s)}$ (see for instance [Lee18, Exercise 2.42]). Now by definition, $(\phi^\tau)^*g(s) \leq g(t)$ (recall $t = |s| + |\tau|$) so that the Radon-Nikodym theorem gives a measurable function $f_\tau : T^*M \rightarrow [0, 1]$ such that $\text{Vol}_{(\phi^\tau)^*g(s)} = f_\tau \text{Vol}_{g(t)}$. By Theorem 4.1.40, the family of symbols $(f_\tau(\rho_0) \varphi_{\rho_0}^\tau)_{\rho_0 \in T^*M}$ is a $g(t)$ -uniformly confined family of symbols with radius $r(\tau) \leq r(t)$, with

$$\forall \ell \in \mathbf{N}, \exists C_\ell > 0, \exists k \in \mathbf{N} : \sup_{\rho_0 \in T^*M} \left| \nabla^\ell (f_\tau(\rho_0) \varphi_{\rho_0}^\tau) \right|_{\text{Conf}_{r(t)}^{g(t)}(\rho_0)}^{(\ell)} \leq C_\ell \sup_{\rho_0 \in T^*M} |\varphi_{\rho_0}|_{\text{Conf}_r^{g(s)}(\rho_0)}^{(k)}.$$

Combining this with (4.8.5), Proposition 4.8.1 yields

$$\forall \ell \in \mathbf{N}, \exists C_\ell > 0, \exists k \in \mathbf{N} : \left| e^{t\mathcal{H}_p} a \right|_{S(m(\tau), g(t))}^{(\ell)} \leq C_\ell \underline{h}_g^{-\beta k} |b|_{S(m, g(s))}^{(k)}. \quad (4.8.7)$$

The property of uniform admissibility of m is important here; otherwise the constants in the estimates given by Proposition 4.8.1 could blow up as t grows.

Step 2 – Asymptotic expansion. Now we prove the continuity estimates on symbol classes for $\mathcal{E}_{j_0}(t)$ and for the remainder in the asymptotic expansion (4.1.31). We will beat the loss of powers of \underline{h}_g in (4.8.7) by considering the Dyson expansion at a sufficiently high order j_0 . Notice that for $\mathcal{E}_0(t)$, the estimate is provided by Corollary 4.5.2. For $\mathcal{E}_{j_0}(t)$ with $j_0 \geq 1$, Proposition 4.5.5 gives

$$\nabla^{-1} S(m, g) \xrightarrow{\mathcal{E}_{j_0}(t)} S\left(h_{g(t)}^{2j_0} m(t), g(t)\right),$$

which is the desired estimate. For the remainder (4.1.34) in the asymptotic expansion (4.1.31), we use the above estimate for $\mathcal{E}_{j_0}(t)$ and recall the recurrence relation (4.1.43): Lemma 4.5.4 yields

$$\nabla^{-1} S(m, g) \xrightarrow{\mathcal{E}_{j_0}(s)} S\left(h_{g(s)}^{2j_0} m(s), g(s)\right) \xrightarrow{\mathcal{H}_p^{(3)}} S\left(h_{g(s)}^{2(j_0+1)} m(s) e^{-(\Lambda+2\Upsilon)|s|} \underline{h}_g, g(s)\right).$$

Now we apply (4.8.7) with $b = \mathcal{H}_p^{(3)} \mathcal{E}_{j_0}(s) a$ for some $a \in S(m, g)$, $M = h_{g(s)}^{2(j_0+1)} m(s)$ and $\tau = t - s$. We obtain

$$\forall \ell \in \mathbf{N}, \exists C_\ell > 0, \exists k \in \mathbf{N} :$$

$$\left| e^{(t-s)\mathcal{H}_p} \mathcal{H}_p^{(3)} \mathcal{E}_{j_0}(s) a \right|_{S(h_{g(t)}^{2(j_0+1)} m(t), g(t))}^{(\ell)} \leq C_\ell \underline{h}_g^{-\beta k} \underline{h}_g e^{-(\Lambda+2\Upsilon)|s|} |a|_{S(m, g)}^{(k)}$$

(we also used Lemma 4.5.1 here by the way). Now we sacrifice half of the gain $h_{g(t)}^{2(j_0+1)}$, using that for $|t| \leq \frac{1}{6} T_E$, we have $h_{g(t)} \leq \underline{h}_g^{5/6}$. That gives:

$$\left| e^{(t-s)\mathcal{H}_p} \mathcal{H}_p^{(3)} \mathcal{E}_{j_0}(s) a \right|_{S(h_{g(t)}^{j_0+1} m(t), g(t))}^{(\ell)} \leq C_\ell \underline{h}_g^{-\beta k + \frac{5}{6}(j_0+1)} \underline{h}_g e^{-(\Lambda+2\Upsilon)|s|} |a|_{S(m, g)}^{(k)}.$$

So for fixed ℓ , choosing j_0 large enough gives

$$\left| \int_{t\Delta_1} e^{(t-s)\mathcal{H}_p} \mathcal{H}_p^{(3)} \mathcal{E}_{j_0}(s) a \, ds \right|_{S(h_g^{j_0+1} m(t), g(t))}^{(\ell)} \leq C'_\ell \int_{t\Delta_1} h_g e^{-(\Lambda+2\Upsilon)|s|} |a|_{S(m,g)}^{(k)} \, ds \leq \frac{C'_\ell}{c} |a|_{S(m,g)}^{(k)}$$

(recall (4.1.40) in the last step). This finishes the proof of the asymptotic expansion. Combining this with the estimates for $\mathcal{E}_j(t)$ gives

$$\forall \ell \in \mathbf{N}, C_\ell > 0, \exists k \in \mathbf{N} : \quad \left| e^{t\mathcal{H}_p} a \right|_{S(m(t), g(t))}^{(\ell)} \leq C_\ell |a|_{S(m,g)}^{(k)}.$$

The proof is finished. \square

We end this section with a proposition addressing the assumption of uniform admissibility of m discussed in the remarks right after Theorem 4.1.15.

Proposition 4.8.4 (Sufficient condition of uniform admissibility). *Let m be a g -admissible weight. Further assume that*

$$\exists \kappa > 0, \exists C_\kappa > 0 : \forall t \in \mathbf{R}, \quad e^{tH_p} m \leq C_\kappa e^{\kappa|t|} m, \quad (4.8.8)$$

which is the case in particular with $C_\kappa = 1$ if

$$\kappa := \sup_{T^*M} \frac{|\nabla_{H_p} m|}{m} < \infty.$$

Then $m(t) = e^{tH_p} m$ is a $g(t)$ -admissible weight with uniform structure constants in $t \in [-\delta T_E, \delta T_E]$ with

$$\delta = \frac{\Lambda + 2\Upsilon}{\kappa + \Lambda + 2\Upsilon}.$$

Proof. Slow variation. Let $r_0 = \min\{r_g, r_m\}$ be the minimum of the slow variation radii of g and m , and set $\tilde{r}_0 = r_0/(1 + C_g^2)$, let $\rho_0 \in T^*M$ and introduce

$$t_* = \sup \left\{ \tau \geq 0 : \forall |t| \leq \tau, \phi^t \left(B_{\tilde{r}_0}^{g(t)}(\rho_0) \right) \subset B_{r_0}^g(\phi^t(\rho_0)) \right\}.$$

By a continuity argument, we have $t_* > 0$. So let $t \in (-t_*, t_*)$. Using the fundamental theorem of calculus and the slow variation of g in $B_{\tilde{r}_0}^g(\rho_0)$, we have for all $\rho \in B_{\tilde{r}_0}^g(\rho_0)$:

$$\begin{aligned} |\phi^t(\rho) - \phi^t(\rho_0)|_{g_{\phi^t(\rho_0)}} &\leq \int_0^1 |d\phi^t((1-s)\rho_0 + s\rho) \cdot (\rho - \rho_0)|_{g_{\phi^t(\rho_0)}} \, ds \\ &\leq C_g \int_0^1 |d\phi^t((1-s)\rho_0 + s\rho) \cdot (\rho - \rho_0)|_{g_{\phi^t((1-s)\rho_0 + s\rho)}} \, ds \\ &\leq C_g e^{\Lambda|t|} \int_0^1 |\rho - \rho_0|_{g_{\phi^t((1-s)\rho_0 + s\rho)}} \, ds \\ &\leq C_g^2 e^{\Lambda|t|} |\rho - \rho_0|_{g_{\rho_0}} = C_g^2 |\rho - \rho_0|_{g_{\rho_0}(t)} \leq r_0 \frac{C_g^2}{1 + C_g^2}. \end{aligned}$$

We deduce that

$$\forall t \in (-t_*, t_*), \quad \phi^t \left(B_{\tilde{r}_0}^{g(t)}(\rho_0) \right) \subset B_{\frac{r_0 C_g^2}{1 + C_g^2}}^g(\phi^t(\rho_0)),$$

therefore by a continuity argument, one concludes that $t_* = +\infty$. We infer that for all $t \in \mathbf{R}$, we have by slow variation of m :

$$\forall \rho_0 \in T^*M, \forall \rho \in B_{\tilde{r}_0}^{g(t)}(\rho_0), \quad m(\phi^t(\rho)) \leq C m(\phi^t(\rho_0)), \quad \forall t \in \mathbf{R},$$

hence uniform $g(t)$ -slow variation.

Temperance. Recall from Proposition 4.1.29 that m is in fact g^h -admissible. That means that

$$\forall \rho_0, \rho \in T^*M, \quad m(\rho) \leq C m(\rho_0) \langle \rho - \rho_0 \rangle_{g_{\rho_0}^h}^N$$

for some constants $C > 0$ and $N \geq 0$. We combine this with the growth assumption along the flow (4.8.8):

$$m(\phi^t(\rho)) \leq C_\kappa e^{\kappa|t|} m(\rho) \leq CC_\kappa e^{\kappa|t|} m(\rho_0) \langle \rho - \rho_0 \rangle_{g_{\rho_0}^\natural}^N \leq CC_\kappa^2 e^{2\kappa|t|} m(\phi^t(\rho_0)) \langle \rho - \rho_0 \rangle_{g_{\rho_0}^\natural}^N.$$

Then to obtain the uniform temperance with respect to t , it remains to absorb the exponential factor by checking that

$$\forall t \in [-\delta T_E, \delta T_E], \quad e^{2\frac{\kappa}{N}|t|} g^\natural \leq g^\sigma(t). \quad (4.8.9)$$

This is indeed the case since by definition of δ ,

$$e^{-2(\Lambda+2\Upsilon)T_E} \leq e^{-2(\Lambda+2\Upsilon+\frac{\kappa}{N})\delta T_E},$$

so that

$$g^\natural \leq g^\sigma(T_E) \leq e^{-2\frac{\kappa}{N}\delta T_E} g^\sigma(\delta T_E),$$

which in turn implies (4.8.9). This finishes the proof. \square

4.9. Examples of application: proofs of statements in Section 4.1.7

The splitting (4.1.44) can be understood as follows: introducing

$$\pi : T^*M \longrightarrow M \quad \text{and} \quad \iota : M \longrightarrow T^*M$$

the cotangent bundle projection and the null section, we know that $\pi \circ \iota = \text{Id}_M$ and

$$\pi_0 = \iota \circ \pi : T^*M \longrightarrow T^*M$$

is the projection onto the null section of T^*M . The kernel and range of the projection have same dimension and we naturally have

$$TT^*M = \text{Ran } d\pi_0 \oplus \ker d\pi_0.$$

The first component can be naturally identified with TM through the map $d\iota$. As for the second component, we identify the fibers T_x^*M with their tangent space, which turns out to project onto the zero vector under $d\pi_0$.

4.9.1. Schrödinger operator: proofs of statements in Subsection 4.1.7.1

Proof of Proposition 4.1.25. Let us compute the Weyl symbol of this operator. The symbol of $-\frac{\hbar^2}{2}\Delta + V$ is classically $\frac{\hbar^2}{2}|\xi|_{\gamma^{-1}} + V(x)$. As for the rest of the operator, we can take Euclidean coordinates in which $\beta = \sum_j \beta^j(x)\partial_j$, and find

$$\begin{aligned} \frac{1}{i}\beta &= \sum_j \text{Op}^w(\beta^j)\text{Op}^w(\xi_j) = \sum_j \text{Op}^w(\beta^j\xi_j + \frac{1}{2i}\{\beta_j, \xi_j\}) = \text{Op}^w\left(\xi \cdot \beta - \frac{1}{2i}\sum_j \partial_j \beta^j\right) \\ &= \text{Op}^w(\xi \cdot \beta - \frac{1}{2i}\text{div } \beta). \end{aligned}$$

This results from the pseudo-differential calculus (Proposition 4.2.2), which is exact at order 1. We deduce that

$$P = \text{Op}^w(p) \quad \text{with} \quad p(x, \xi) = \frac{\hbar^2}{2}|\xi|_{\gamma^{-1}}^2 - \hbar\xi \cdot \beta + \frac{1}{2}|\beta|_\gamma^2 + V(x).$$

This symbol is semi-bounded, so that Proposition 4.1.16 applies and ensures that Assumption 4.1.13 is satisfied.

Next we compute the Hessian of p :

$$\nabla^2 p = \begin{pmatrix} \gamma(\nabla\beta, \nabla\beta) + \nabla^2 V & -\hbar(\nabla\beta)^\star \\ -\hbar\nabla\beta & \hbar^2\gamma^{-1} \end{pmatrix}. \quad (4.9.1)$$

In this expression, $\nabla\beta$ is seen as a map $\nabla\beta : M \rightarrow \text{Hom}(TT^*M)$ which sends vector fields to vector fields. The map $(\nabla\beta)^*$ refers to the dual map acting on covectors, or differential 1-forms. We crucially used the fact that $\nabla^2\beta = 0$ here. In addition, ∇^2V has to be interpreted as a map $M \rightarrow \text{Hom}(TM, T^*M)$. We observe that under the assumption (4.1.46) and the fact that β is affine (in particular $|\nabla\beta|$ is bounded), we deduce that

$$\sup_{\hbar \in (0,1]} \sup_{T^*M} |\nabla^2 p|_{g_\hbar} < \infty.$$

Since the metric γ is flat, we clearly have $\nabla_{H_p} g = 0$. It also follows that g is slowly varying and temperate, and its gain function is classically $h_{g_\hbar} = \hbar \leq 1$, hence admissibility of g_\hbar , uniformly with respect to \hbar . Regarding the temperance weight θ_g , we should compute it using a fixed background Euclidean metric γ (for instance the symplectic metric $g_1 = \hbar^{-1} dx^2 + \hbar d\xi^2$) in order to find $\theta_{g_\hbar} = \underline{h}_g^{-1/2}$.

Then we estimate higher order derivatives of p . We observe that all mixed derivatives in x and ξ vanish due to the particular structure of (4.1.45). We deduce that for any $\ell \geq 3$, we have

$$|\nabla^\ell p|_g = |\nabla^\ell V|_g = |\nabla^\ell V|_\gamma, \quad \forall \ell \geq 3,$$

that is to say

$$\nabla^3 V \in S(1, g).$$

That means that both sub-quadraticity and strong sub-quadraticity assumptions (see Assumptions 4.1.14) are verified. \square

4.9.2. Half-wave operator: proofs of statements in Subsection 4.1.7.2

Remark 4.9.1. The first assumption in (4.1.48) is equivalent to saying that there is a Euclidean metric \mathbf{g} and a constant $c > 0$ such that

$$c^{-2}\mathbf{g} \leq \gamma \leq c^2\mathbf{g}.$$

Therefore this is a boundedness/ellipticity assumption on the metric γ . This can also be seen as a slow variation property with infinite radius. The second requirement can then be understood as saying that the metric is C_b^∞ .

The assumptions (4.1.48) are equally true for γ^{-1} .

Lemma 4.9.2. *Under assumption (4.1.48), we have*

$$\forall x_1, x_2 \in M, \quad \gamma_{x_1}^{-1} \leq C_\gamma^2 \gamma_{x_2}^{-1} \quad \text{and} \quad \forall k \in \mathbf{N}, \quad \sup_M \left(|\nabla^k \gamma|_{\mathbf{g}} + |\nabla^k \gamma^{-1}|_{\mathbf{g}} \right) < \infty. \quad (4.9.2)$$

Proof. The first assertion in (4.9.2) follows directly from the corresponding property in (4.1.48) on γ and the fact that

$$|\xi|_{\gamma^{-1}} = \sup_{x \in V \setminus \{0\}} \frac{|\langle \xi, v \rangle|}{|v|_\gamma}.$$

Boundedness of derivatives of γ with respect to \mathbf{g} follows from Remark 4.9.1.

We prove the boundedness of derivatives of γ^{-1} by induction on k . For $k = 0$, we know that $|\gamma^{-1}|_{\mathbf{g}}$ is bounded on the whole M thanks to the first assertion in (4.9.2). Now assume we have $|\nabla^\ell \gamma^{-1}|_{\mathbf{g}}$ is uniformly bounded on M for all $\ell \leq k$, for some $k \geq 0$. By the Leibniz formula, we have

$$0 = \frac{1}{(k+1)!} \nabla^{k+1} \gamma \gamma^{-1} = \sum_{\ell=0}^{k+1} \frac{1}{(k+1-\ell)!} \nabla^{k+1-\ell} \gamma \frac{1}{\ell!} \nabla^\ell \gamma^{-1}.$$

All the terms in the sum are bounded by the induction hypothesis, except the one corresponding to $\ell = k+1$. Then we obtain

$$\frac{1}{(k+1)!} \nabla^{k+1} \gamma^{-1} = -\gamma^{-1} \sum_{\ell=0}^k \frac{1}{(k+1-\ell)!} \nabla^{k+1-\ell} \gamma \frac{1}{\ell!} \nabla^\ell \gamma^{-1}.$$

Each term in the right-hand side is bounded uniformly on M since

$$|\gamma^{-1} \nabla^{k+1-\ell} \gamma \nabla^\ell \gamma^{-1}|_{\mathbf{g}} \leq |\gamma^{-1}|_{\mathbf{g}} |\nabla^{k+1-\ell} \gamma|_{\mathbf{g}} |\nabla^\ell \gamma^{-1}|_{\mathbf{g}}$$

and we deduce that $|\nabla^{k+1} \gamma^{-1}|_{\mathbf{g}}$ is bounded, which concludes the induction. \square

We compute the full Weyl symbol of the operator $-\tilde{\Delta}_\gamma$ defined in (4.1.49).

Lemma 4.9.3. *We have*

$$-\tilde{\Delta}_\gamma = \text{Op}^w \left(|\xi|_{\gamma^{-1}}^2 + \frac{1}{4} \partial_{ij}^2 \gamma^{ij} + \frac{1}{4} \gamma^{ij} w_i w_j + \frac{1}{2} \partial_i (w_j \gamma^{ij}) \right), \quad (4.9.3)$$

where $w_j = \partial_j \log \sqrt{|\gamma|}$.

Remark 4.9.4. All the sub-principal terms involved in the expression of the symbol of $-\tilde{\Delta}_\gamma$ can be written on terms of Christoffel symbols. It seems that those terms are somehow related to the scalar curvature of γ , although other terms still remain.

One can compute w_j as derivatives of the metric, since we classically have

$$w_j = \frac{1}{2} \text{tr} (\gamma^{-1} \partial_j \gamma)$$

(this is known as Jacobi's formula). Using Lemma 4.9.2, we deduce that the sub-principal terms in (4.9.3) are controlled by first and second order derivatives of g . Therefore under our assumptions (4.1.48), the symbol of $-\tilde{\Delta}_\gamma$ is $|\xi|_{\gamma^{-1}}^2$ modulo a C_b^∞ symbol.

Proof of Lemma 4.9.3. We factor $-\tilde{\Delta}_\gamma$ into

$$-\tilde{\Delta}_\gamma = A_j^* \gamma^{ij} A_i, \quad (4.9.4)$$

where

$$A_j = |\gamma|^{1/4} \frac{1}{i} \partial_j |\gamma|^{-1/4} = \frac{1}{i} \partial_j + \frac{1}{i} |\gamma|^{1/4} \left(\partial_j |\gamma|^{-1/4} \right) = \frac{1}{i} \partial_j + \frac{1}{i} \left(\partial_j \log |\gamma|^{-1/4} \right).$$

With the notation w_j of the statement, we have

$$A_j = \frac{1}{i} \partial_j - \frac{1}{2i} w_j = \text{Op}^w \left(\xi_j - \frac{1}{2i} w_j \right).$$

Plugging this into (4.9.4) and using pseudodifferential calculus leads to

$$\begin{aligned} -\tilde{\Delta}_\gamma &= \text{Op}^w \left(\xi_i + \frac{1}{2i} w_i \right) \text{Op}^w (\gamma^{ij}) \text{Op}^w \left(\xi_j - \frac{1}{2i} w_j \right) \\ &= \text{Op}^w \left(\xi_i + \frac{1}{2i} w_i \right) \text{Op}^w (\gamma^{ij} (\xi_j - \frac{1}{2i} w_j) + \frac{1}{2i} \{ \gamma^{ij}, \xi_j \}) \\ &= \text{Op}^w \left((\xi_i + \frac{1}{2i} w_i) (\gamma^{ij} \xi_j - \frac{1}{2i} \gamma^{ij} w_j - \frac{1}{2i} \partial_j \gamma^{ij}) + \frac{1}{2i} \{ \xi_i + \frac{1}{2i} w_i, \gamma^{ij} \xi_j - \frac{1}{2i} \gamma^{ij} w_j - \frac{1}{2i} \partial_j \gamma^{ij} \} \right) \\ &= \text{Op}^w \left(\gamma^{ij} \xi_i \xi_j + \frac{1}{4} \gamma^{ij} w_i w_j + \frac{1}{4} w_i \partial_j \gamma^{ij} + \frac{1}{4} \partial_i (w_j \gamma^{ij}) + \frac{1}{4} \partial_{ij}^2 \gamma^{ij} + \frac{1}{4} \gamma^{ij} \partial_j w_i \right), \end{aligned}$$

hence the sought result by grouping terms according to the Leibniz formula and suitably permuting indices. \square

We now discuss admissibility of g .

Lemma 4.9.5. *The metric g is admissible for $\alpha \in [0, 1]$. Its gain function is*

$$h_g(x, \xi) = \frac{1}{\langle \xi \rangle_{\gamma_x^{-1}}^\alpha} = \frac{1}{p^\alpha}, \quad (x, \xi) \in T^*M.$$

Its temperance weight is given by

$$\theta_g(x, \xi) \asymp \langle \xi \rangle_{\gamma_x^{-1}}^{\frac{1+\alpha}{2}}.$$

Proof. We introduce the metric

$$\tilde{g}_{(x, \xi)} = \langle \xi \rangle_{\mathbf{g}_x^{-1}}^{1-\alpha} \mathbf{g}_x \oplus \langle \xi \rangle_{\mathbf{g}_x^{-1}}^{-(1+\alpha)} \mathbf{g}_x^{-1},$$

where \mathbf{g} is a fixed Euclidean metric on T^*M . From (4.1.48) and (4.9.2), we have for some sufficiently large constant $c > 0$:

$$c^{-2} \tilde{g} \leq g \leq c^2 \tilde{g}. \quad (4.9.5)$$

Therefore we also have $c^{-2}\tilde{g}^\sigma \leq g^\sigma \leq c^2\tilde{g}^\sigma$. Yet from [Ler10, Lemma 2.2.18], the metric \tilde{g} is admissible, since it can be written as

$$\tilde{g} = \langle \xi \rangle^{2a} dx^2 + \langle \xi \rangle^{-2b} d\xi^2,$$

where $a = \frac{1-\alpha}{2}$ and $b = \frac{1+\alpha}{2}$ satisfy

$$0 \leq a \leq b \leq 1 \quad \text{and} \quad a < 1.$$

Admissibility of g follows. Finally, passing to matrix representation in an orthonormal frame for $\gamma \oplus \gamma^{-1}$, we have

$$\begin{aligned} g^\sigma &= \sigma^{-1} \left(\langle \xi \rangle_{\gamma^{-1}}^{-2a} \gamma^{-1} \oplus \langle \xi \rangle_{\gamma^{-1}}^{2b} \gamma \right) \sigma = \begin{pmatrix} 0 & -1 \\ 1 & 0 \end{pmatrix} \begin{pmatrix} \langle \xi \rangle_{\gamma^{-1}}^{-2a} \gamma^{-1} & 0 \\ 0 & \langle \xi \rangle_{\gamma^{-1}}^{2b} \gamma \end{pmatrix} \begin{pmatrix} 0 & 1 \\ -1 & 0 \end{pmatrix} \\ &= \begin{pmatrix} \langle \xi \rangle_{\gamma^{-1}}^{2b} \gamma & 0 \\ 0 & \langle \xi \rangle_{\gamma^{-1}}^{-2a} \gamma^{-1} \end{pmatrix}, \end{aligned}$$

from which we obtain $h_g(x, \xi) = \langle \xi \rangle_{\gamma^{-1}}^{2a-2b} = \langle \xi \rangle_{\gamma^{-1}}^{-\alpha}$.

Now for the temperance weight, we can see that $c^{-1}\theta_{\tilde{g}} \leq \theta_g \leq c\theta_{\tilde{g}}$ as a consequence of (4.9.5), and we can compute $\theta_{\tilde{g}}$ with respect to the background metric $\mathbf{g} \oplus \mathbf{g}^{-1}$ (assuming that \mathbf{g} satisfies $\mathbf{g} \leq \mathbf{g}^\sigma$), and we directly find the desired estimate. \square

We estimate successive derivatives of p thanks to the Faà di Bruno formula.

Lemma 4.9.6. *The following holds*

$$|\nabla^k p(x, \xi)|_g \leq C_{k, \gamma} p^{1 - \frac{1-\alpha}{2}k}$$

Proof. According to Remark 4.1.4, it suffices to pick a vector field X on T^*M and establish the bound

$$|\nabla^k p \cdot X^k| \leq C_{\gamma, k} p^{1 - (\frac{1-\alpha}{2})k} |X|_g^k.$$

We view p as the composition of $f : s \mapsto \sqrt{1+s}$ with $q : (x, \xi) \mapsto \gamma^{-1}(\xi, \xi)$. The the Faà di Bruno formula yields

$$\frac{1}{k!} \nabla^k p \cdot X^k = \sum_{j=1}^k \sum_{\substack{\mathbf{n} \in (\mathbf{N}^*)^j \\ |\mathbf{n}|=k}} \frac{1}{j!} (f^{(j)} \circ q) \cdot \left(\frac{1}{\mathbf{n}!} \nabla^{\mathbf{n}} q \cdot X^{\mathbf{n}} \right). \quad (4.9.6)$$

On the one hand, we notice that $|f^{(j)}(s)| \leq C_j (1+s)^{1/2-j}$, so that

$$|f^{(j)} \circ q| \leq C_j (p^2)^{1/2-j} = C_j \frac{1}{p} \times p^{-2(j-1)}. \quad (4.9.7)$$

On the other hand, we shall write the components of X according to the splitting (4.1.44):

$$X = X_{\parallel} + X_{\perp}.$$

Expanding $\nabla_{X^k}^k$ according to this decomposition, we are lead to estimate

$$\nabla^k q \cdot \left(X_{\parallel}^{k_1}, X_{\perp}^{k_2} \right) = \nabla_{X_{\perp}^{k_2}}^{k_2} \left(\nabla_{X_{\parallel}^{k_1}}^{k_1} \gamma^{-1} \right) (\xi, \xi), \quad \text{with } k_1 + k_2 = k.$$

Indeed, derivatives with X_{\parallel} or X_{\perp} affect only the x variable or the ξ variable respectively (that is they correspond to ∂_x and ∂_{ξ}). Since this quantity is polynomial of order 2 in ξ , the derivative vanishes as soon as $k_2 \geq 3$, while for $k_2 = 1$ and $k_2 = 2$, we have

$$\nabla^k q \cdot \left(X_{\parallel}^{k_1}, X_{\perp} \right) = 2 \left(\nabla_{X_{\parallel}^{k_1}}^{k_1} \gamma^{-1} \right) (X_{\perp}, \xi), \quad \nabla^k q \cdot \left(X_{\parallel}^{k_1}, X_{\perp}, X_{\perp} \right) = 2 \nabla_{X_{\perp}^{k_2}}^{k_2} \left(\nabla_{X_{\parallel}^{k_1}}^{k_1} \gamma^{-1} \right) (X_{\perp}, X_{\perp}).$$

In particular, we have the estimate

$$\left| \nabla^k q. \left(X_{\parallel}^{k_1}, X_{\perp}^{k_2} \right) \right| \leq C_{\gamma} p^{2-k_2} |X_{\parallel}|_{\mathbf{g}}^{k_1} |X_{\perp}|_{\mathbf{g}^{-1}}^{k_2}, \quad (4.9.8)$$

still valid for $k_2 = 0$. This is an estimate with respect to the metric $\mathbf{g} \oplus \mathbf{g}^{-1}$. In terms of the metric g , we have

$$\left| \nabla^k q. \left(X_{\parallel}^{k_1}, X_{\perp}^{k_2} \right) \right| \leq C_{\gamma} p^{2-k_2-\frac{1-\alpha}{2}k_1+\frac{1+\alpha}{2}k_2} |X_{\parallel}|_g^{k_1} |X_{\perp}|_g^{k_2} \leq C_{\gamma} p^{2-\frac{1-\alpha}{2}k} |X|_g^k.$$

Combining this with (4.9.7) tells us that all the terms arising in the Faà di Bruno formula (4.9.6) are of order

$$\frac{1}{p} \times p^{2-(\frac{1-\alpha}{2}k+2(j-1))} \leq p^{1-\frac{1-\alpha}{2}k}$$

hence the sought result. \square

We are now in a position to prove the main result of Subsection 4.1.7.2.

Proof of Proposition 4.1.27. The metric g is admissible by Lemma 4.9.5. Moreover, in view of the assumption (4.1.48) on γ , we clearly have $\gamma_{\phi^t(\rho)} \leq C_{\Upsilon}^2 e^{2\Upsilon|t|} \gamma_{\rho}$ for any $\rho \in T^*M$ with $\Upsilon = 0$ and $C_{\Upsilon} = C_{\gamma}$. Since p is invariant by the Hamiltonian flow, the same holds for g .

Let us check the boundedness of the Lie derivative $\mathcal{L}_{H_p} g$ in (4.1.25) (Assumption 4.1.14). To do that we use Remark 4.1.19. On the one hand, we can estimate $|\nabla_{H_p} g|_g$ by remarking that by definition of g , the coefficients of the metric depend only on p which is invariant by the flow, so that the derivative ∇_{H_p} affects only γ_x and γ_x^{-1} . The latter depend only on x . Yet the x component of H_p is

$$\frac{\gamma^{-1}\xi}{\langle \xi \rangle_{\gamma^{-1}}},$$

whose γ norm remains bounded on the whole phase space, so indeed $|\nabla_{H_p} g|_g$ is uniformly bounded.

Now we estimate the Hessian and the higher-order derivatives of p . Lemma 4.9.6 gives $\nabla^2 p \in S(m, g)$ where

$$m = p^{1-2\frac{1-\alpha}{2}} = p^{\alpha} = h_g^{-1},$$

so sub-quadraticity holds. Now for derivatives of order $k \geq 3$, Lemma 4.9.6 gives $\nabla^3 p \in S(m, g)$ with

$$m = p^{1-3\frac{1-\alpha}{2}} = p^{3\alpha} p^{-\frac{1}{2}-\alpha(3-\frac{3}{2})} \leq h_g^{-3} p^{-1/2},$$

hence strong sub-quadraticity holds too (recall that the temperance weight is a power of p by Lemma 4.9.5). This proves that Assumption 4.1.14 is fulfilled. Lastly the symbol p is semi-bounded, which ensures that Assumption 4.1.13 is fulfilled too by Proposition 4.1.16, and finishes the proof. \square

We end this subsection giving a brief explanation of why the operator P defined in (4.1.50) is close to $\sqrt{\widetilde{\Delta}_{\gamma}}$.

Lemma 4.9.7. *The operator $-\widetilde{\Delta}_{\gamma} - P^2$ extends to a bounded operator on $L^2(M)$.*

Proof. We use pseudodifferential calculus with p and itself, bearing in mind that the Poisson bracket vanishes:

$$P^2 = \text{Op}^w \left(p^2 + \widehat{\mathcal{P}}_2(p, p) \right).$$

Lemma 4.9.6 tells us that $p \in \nabla^{-2} S(h_g^{-1}, g)$, so that

$$\widehat{\mathcal{P}}_2(p, p) \in S(1, g).$$

Setting

$$a = -1 + \frac{1}{2} \widehat{\mathcal{P}}_2(p, p) + \frac{1}{4} \partial_{ij}^2 \gamma^{ij} + \frac{1}{4} \gamma^{ij} w_i w_j + \frac{1}{2} \partial_i (w_j \gamma^{ij}),$$

we have $-\widetilde{\Delta}_{\gamma} = P^2 + \text{Op}^w(a)$ in view of Lemma 4.9.3, and under the assumptions (4.1.48), we have indeed

$$a \in S(1, g).$$

(Sub-principal terms involving derivatives of γ belong to $S(1, g)$ since they depend only on the x variable.) The result follows from the Calderón-Vaillancourt theorem. \square

4.9.3. Vector fields: proofs of statements in Subsection 4.1.7.3

We start with the computation of the logarithmic derivative in (4.1.52).

Lemma 4.9.8. *Let X be a non-vanishing vector field preserving a smooth density $\mu = |\mu| dx$, where dx is (a fixed normalization of) the Lebesgue measure on M . Then $X \log|\mu| = -\operatorname{div} X$, where¹⁷ $\operatorname{div} = \operatorname{tr} \nabla$.*

Proof. For any test function $C_c^\infty(M)$, we have by integration by parts

$$\int_M \varphi \operatorname{div} X dx = - \int_M \nabla_X \varphi dx = - \int_M (X\varphi)|\mu|^{-1} d\mu = \int_M \varphi (X|\mu|^{-1}) d\mu = - \int_M \varphi (X \log|\mu|) dx.$$

The two crucial steps consist in an integration by parts with respect to the measure dx in the first equality, and using the symmetry of X with respect to the measure $d\mu$ in the third equality. \square

Now we proceed with the computation of the Weyl symbol of P defined in (4.1.53). Writing $X = \sum_j X^j \partial_j$ in a global Euclidean coordinate system, we have

$$\begin{aligned} \operatorname{Op}^w(\tfrac{1}{i}X) &= \sum_j \operatorname{Op}^w(X^j) \operatorname{Op}^w(\xi_j) = \sum_j \operatorname{Op}^w\left(X_j \xi_j - \frac{1}{2i} \partial_j X^j\right) \\ &= \operatorname{Op}^w\left(\xi \cdot X - \frac{1}{2i} \operatorname{div} X\right) \end{aligned}$$

according to pseudodifferential calculus, hence the Weyl symbol of p is $\xi \cdot X$. As a preparation for the proofs below, let us compute the Hamiltonian vector field and the Hessian of p :

$$H_p = \begin{pmatrix} X \\ -(\nabla X)^* \xi \end{pmatrix}, \quad \nabla^2 p = \begin{pmatrix} \xi \cdot \nabla^2 X & \nabla X \\ \nabla X & 0 \end{pmatrix}. \tag{4.9.9}$$

Here $(\nabla X)^* \in \operatorname{hom}(T^*M)$ refers to the map dual to ∇X , viewed as a linear map acting on TM (recall the canonical splitting (4.1.44)). We observe that derivatives of any order with respect to the x variable can possibly blow up at fiber infinity, in a situation similar to the previous case of waves with a non-flat metric, while derivatives of order larger than 2 with respect to ξ vanish.

We discuss admissibility of the metric (4.1.56).

Lemma 4.9.9. *The metric g is admissible. Its gain function and temperance rate are given by*

$$h_g(x, \xi) = \frac{1}{\langle \xi \rangle_{\gamma^{-1}}^{\alpha_2 - \alpha_1}} \quad \text{and} \quad \theta_g(x, \xi) \asymp \langle \xi \rangle_{\gamma^{-1}}^{\alpha_2}.$$

Proof. Admissibility of g comes from [Ler10, Lemma 2.2.18] under conditions (4.1.57). The expressions of the gain function and of the temperance weight follow immediately from the definitions. \square

Essential self-adjointness of P has to be verified separately, since it seems that our condition (4.1.35) is not true here in general, so that Proposition 4.1.16 does not apply.

Lemma 4.9.10. *The operator P acting on compactly supported functions is essentially self-adjoint. The Hamiltonian flow is globally well-defined.*

Proof. We first show that the Hamiltonian flow is well-defined for all times. In view of the expression (4.9.9) of the Hamiltonian vector field and (4.1.54), we see that H_p is a locally Lipschitz vector field. Then the Picard-Lindelöf theorem ensures that the Cauchy problem

$$\frac{d}{dt} \rho(t) = H_p(\rho(t)), \quad \rho(0) = \rho_0 \in T^*M$$

admits a solution on some time interval $(-t_0, t_0)$, $t_0 > 0$. Then for any t in this interval, the expression (4.9.9) of H_p and the Cauchy-Schwarz inequality yield

$$\begin{aligned} \frac{d}{dt} |\rho(t) - \rho_0|_{\gamma}^2 &\leq 2 |H_p(\rho(t))|_{\gamma} |\rho(t) - \rho_0|_{\gamma} \leq 2 \left(|X|_{\gamma, \infty} + |\nabla X|_{\gamma, \infty} |\rho(t)|_{\gamma} \right) |\rho(t) - \rho_0|_{\gamma} \\ &\leq 4 \left(|X|_{\gamma, \infty} + |\nabla X|_{\gamma, \infty} \right) \langle \rho_0 \rangle_{\gamma} |\rho(t) - \rho_0|_{\gamma}^2. \end{aligned}$$

¹⁷ The div operator coincides with the divergence div_{dx} with respect to the Lebesgue measure. One can check that it does not depend on the normalization of the latter.

Therefore, Grönwall's lemma tells us that $\langle \rho(t) \rangle \leq C e^{C|t|}$ for some constant C , which classically implies that $t_0 = +\infty$.

Denote by $(\phi_X^t)_{t \in \mathbf{R}}$ the flow generated by X , that is to say the restriction of H_p to the null section of T^*M . Now it remains to show that P is essentially self-adjoint. To check this, we let $u \in \ker(P^* \pm i)$. Then for any $v \in C_c^\infty(M)$, the function

$$v(t, x) = \exp\left(\int_0^t \frac{1}{2}(\operatorname{div} X)(\phi_X^s(x)) ds\right) v(\phi_X^t(x)), \quad x \in M, t \in \mathbf{R}.$$

One checks that $v(t, \bullet) \in C_c^\infty(M)$ for all times and that it solves

$$\partial_t v(t, x) = iPv(t, x).$$

Then we proceed as follows: by dominated convergence,

$$\frac{d}{dt}(u, v(t))_{L^2} = i(u, Pv(t))_{L^2} = i(P^*u, v(t))_{L^2} = \mp(P^*u, v(t))_{L^2}.$$

The second equality relies on the fact that $v(t)$ remains in $C_c^\infty(M)$ while the last one comes from the choice of u . We deduce that

$$(u, v(t))_{L^2} = e^{\mp t}(u, v(0))_{L^2},$$

which leads to $(u, v_0)_{L^2} = 0$, hence $u = 0$. \square

Next we estimate the derivatives of p .

Lemma 4.9.11. *We have*

$$\forall k \in \mathbf{N}, \quad |\nabla^k p|_g \leq C_k \langle \xi \rangle_{\gamma^{-1}}^{1-k(1-\alpha_2)}.$$

Proof. We reproduce mutatis mutandis the proof of Lemma 4.9.6. The only difference is that now (4.9.8) yields

$$\left| \nabla^k q \left(X_{\parallel}^{k_1}, X_{\perp}^{k_2} \right) \right| \leq C_{\gamma} p^{2-k_2-\alpha_1 k_1+\alpha_2 k_2} |X_{\parallel}|_g^{k_1} |X_{\perp}|_g^{k_2} \leq C_{\gamma} p^{2-(1-\alpha_2)k} |X|_g^k,$$

where the last inequality is due to $1 - \alpha_2 \leq \alpha_1$ (see (4.1.57)). Combining this with (4.9.7) and putting this into the Faà di Bruno formula (4.9.6) gives the expected conclusion. \square

We finally prove the main result of Subsection 4.1.7.3.

Proof of Proposition 4.1.28. Assumption 4.1.13 is satisfied by Lemma 4.9.10, and the metric g is admissible by Lemma 4.9.9. We check sub-quadraticity: from Lemma 4.9.11, we have $\nabla^2 p \in S(m, g)$ with

$$m = \langle \xi \rangle_{\gamma^{-1}}^{1-2(1-\alpha_2)} = \langle \xi \rangle_{\gamma^{-1}}^{\alpha_2-\alpha_1} \langle \xi \rangle_{\gamma^{-1}}^{\alpha_1+\alpha_2-1} \leq h_g^{-1}$$

according to Lemma 4.9.9. As for strong sub-quadraticity, we have $\nabla^3 p \in S(m, g)$ with

$$m = \langle \xi \rangle_{\gamma^{-1}}^{1-3(1-\alpha_2)} = h_g^{-3} \langle \xi \rangle_{\gamma^{-1}}^{3\alpha_1-2},$$

and the temperance weight is indeed a power of $\langle \xi \rangle_{\gamma^{-1}}$ by Lemma 4.9.9. Finally, recalling (4.9.9), we have

$$H_p \langle \xi \rangle_{\gamma^{-1}} = O\left(\langle \xi \rangle_{\gamma^{-1}}\right).$$

Indeed, the action of H_p with respect to the position variable is the differential operator X , which does not affect $\langle \xi \rangle_{\gamma^{-1}}$, since the latter quantity does not depend on x . As for the momentum variable, we have

$$\left| [(\nabla X)^* \xi] \langle \xi \rangle_{\gamma^{-1}} \right| \lesssim \langle \xi \rangle_{\gamma^{-1}}^{-1} \langle \gamma^{-1}(\xi, (\nabla X)^* \xi) \rangle \lesssim \langle \xi \rangle_{\gamma^{-1}}.$$

Then one deduces that $\nabla_{H_p} g \leq Cg$ for some constant C depending on the derivatives of X (4.1.54), and this concludes the proof that Assumption 4.1.14 is verified. \square

4.A. Refined estimates for the Weyl–Hörmander calculus

Here we collect proofs of the statements of Section 4.2. We start with some definitions.

4.A.1. Symplectic Fourier transform

We introduce \mathcal{F}_σ to be the symplectic Fourier transform acting on functions on the symplectic vector space $W = V \oplus V^*$:

$$\mathcal{F}_\sigma f(\zeta) = \int_W f(\zeta') e^{-i\sigma(\zeta, \zeta')} d\zeta',$$

where $d\zeta$ is normalized in such a way that $\mathcal{F}_\sigma^2 = \text{Id}$, that is to say $\mathcal{F}_\sigma^{-1} = \mathcal{F}_\sigma$. The symplectic Fourier transform is continuous on $\mathcal{S}(W)$ and can be extended as a continuous operator on $\mathcal{S}'(W)$.

When working on the product of two copies of W , we shall use the symplectic Fourier transform $\mathcal{F}_{\sigma \oplus \sigma} = \mathcal{F}_\sigma \otimes \mathcal{F}_\sigma$, acting on Schwartz functions (or tempered distributions) on $W \oplus W$.

Once equipped with these Fourier transforms, we can build Fourier multipliers: given a tempered distribution $a \in T^*M$, we define the operator $a(D)\mathcal{S}(T^*M) \rightarrow \mathcal{S}'(T^*M)$ as

$$a(D)f(\rho) := \int_W a(\zeta) \left(\int_W f(\rho_0 + \zeta') e^{-i\sigma(\zeta, \zeta')} d\zeta' \right) e^{-i\sigma(\rho - \rho_0, \zeta)} d\zeta,$$

where $\rho_0 \in T^*M$ is a fixed origin. The operator $a(D)$ does not depend on the choice of ρ_0 , essentially because the symplectic form is invariant by translation. Therefore we shall write

$$a(D) = \mathcal{F}_\sigma^{-1} a \mathcal{F}_\sigma$$

Moreover $a(D)$ commutes with ∇ since $\nabla\sigma = 0$. The same applies for Fourier multipliers on $T^*M \oplus T^*M = T^*M^{\oplus 2}$ using $\mathcal{F}_{\sigma \oplus \sigma}$.

4.A.2. Poisson operator

Let us define the following Fourier multiplier

$$\mathfrak{P} = -\mathcal{F}_{\sigma \oplus \sigma}^{-1} \sigma \mathcal{F}_{\sigma \oplus \sigma},$$

acting on $\mathcal{S}(T^*M^{\oplus 2})$. More explicitly, this operator acts on functions $f \in \mathcal{S}(W \oplus W)$ as

$$(\mathfrak{P}f)(\zeta_1, \zeta_2) = - \int_{W \oplus W} \sigma(\zeta_1, \zeta_2) (\mathcal{F}_{\sigma \oplus \sigma} f)(\zeta_1, \zeta_2) e^{-i\sigma(\zeta_1, \zeta_1') - i\sigma(\zeta_2, \zeta_2')} d\zeta_1' d\zeta_2'.$$

One can check that it is continuous on $\mathcal{S}(T^*M^{\oplus 2})$, so that it extends to tempered distributions. To sum up, we have that

$$\mathfrak{P} : \mathcal{S}(T^*M^{\oplus 2}) \longrightarrow \mathcal{S}(T^*M^{\oplus 2}) \quad \text{and} \quad \mathfrak{P} : \mathcal{S}'(T^*M^{\oplus 2}) \longrightarrow \mathcal{S}'(T^*M^{\oplus 2})$$

are continuous. Notice that the map $s : (\rho_1, \rho_2) \mapsto (\rho_2, \rho_1)$ on $T^*M^{\oplus 2}$ (or rather the composition by this map) acts as follows on \mathfrak{P} :

$$\mathfrak{P}s = -s\mathfrak{P}. \tag{4.A.1}$$

In addition, one can check that the complex conjugation commutes with \mathfrak{P} . Formally, one can think of this operator as

$$\mathfrak{P} = \{\nabla^{\rho_1}, \nabla^{\rho_2}\} = \sigma(H_{\bullet}^{\rho_1}, H_{\bullet}^{\rho_2}),$$

where H_{\bullet} is the Hamiltonian vector field. These expressions are quite formal. The action of this operator can be made explicit for functions of the form $f = a_1 \oplus a_2$, but a formula is also available for general functions f of ρ_1, ρ_2 .

Lemma 4.A.1. *For any $f \in \mathcal{S}(T^*M^{\oplus 2})$, we have*

$$\mathfrak{P}f(\rho_1, \rho_2) = \text{div}_{\rho_2} \left(H_{a(\rho_1, \rho_2)}^{\rho_1} \right) = -\text{div}_{\rho_1} \left(H_{a(\rho_1, \rho_2)}^{\rho_2} \right).$$

Proof. We deal with functions $f \in \mathcal{S}(W^{\oplus 2})$. Going to functions of $T^*M^{\oplus 2}$ follows by choosing an arbitrary origin ρ_0 . By integration by parts, we classically have

$$\mathcal{F}_\sigma \frac{1}{i} \nabla_{\zeta_0} a(\zeta) = \sigma(\zeta, \zeta_0) \mathcal{F}_\sigma a(\zeta), \quad \forall a \in \mathcal{S}(W), \forall \zeta, \zeta_0 \in W,$$

as well as for any compactly supported vector field X on W :

$$\mathcal{F}_\sigma (\operatorname{div} X)(\zeta) = \int_W i\sigma(\zeta, X(\zeta')) e^{-i\sigma(\zeta, \zeta')} d\zeta' = i \mathcal{F}_\sigma (\sigma(\zeta, X(\bullet)))(\zeta)$$

From these two facts, together with the definition of the Hamiltonian vector field, we deduce the following:

$$\begin{aligned} \mathfrak{P}f(\zeta_1, \zeta_2) &= - \left(\mathcal{F}_{\sigma \oplus \sigma}^{-1} \right)_{(\zeta'_1, \zeta'_2) \rightarrow (\zeta_1, \zeta_2)} (\mathcal{F}_\sigma)_{\zeta''_2 \rightarrow \zeta'_2} (\sigma(\zeta'_1, \zeta'_2) (\mathcal{F}_\sigma)_{\zeta''_1 \rightarrow \zeta'_1} a(\zeta''_1, \zeta''_2)) \\ &= - \left(\mathcal{F}_{\sigma \oplus \sigma}^{-1} \right)_{(\zeta'_1, \zeta'_2) \rightarrow (\zeta_1, \zeta_2)} (\mathcal{F}_\sigma)_{\zeta''_2 \rightarrow \zeta'_2} \left((\mathcal{F}_\sigma)_{\zeta''_1 \rightarrow \zeta'_1} \frac{1}{i} \nabla_{\zeta'_2}^{\rho'_1} a(\zeta''_1, \zeta''_2) \right) \\ &= - \left(\mathcal{F}_{\sigma \oplus \sigma}^{-1} \right)_{(\zeta'_1, \zeta'_2) \rightarrow (\zeta_1, \zeta_2)} (\mathcal{F}_\sigma)_{\zeta''_1 \rightarrow \zeta'_1} (\mathcal{F}_\sigma)_{\zeta''_2 \rightarrow \zeta'_2} \frac{1}{i} \sigma \left(\zeta'_2, H_{a(\zeta''_1, \zeta''_2)}^{\zeta'_1} \right) \\ &= \left(\mathcal{F}_{\sigma \oplus \sigma}^{-1} \right)_{(\zeta'_1, \zeta'_2) \rightarrow (\zeta_1, \zeta_2)} (\mathcal{F}_\sigma)_{\zeta''_1 \rightarrow \zeta'_1} (\mathcal{F}_\sigma)_{\zeta''_2 \rightarrow \zeta'_2} \operatorname{div}_{\zeta''_2} H_{a(\zeta''_1, \zeta''_2)}^{\zeta'_1}, \end{aligned}$$

which gives the desired result by the Fourier inversion formula. To have the expression in the other way around, we simply use (4.A.1). This finishes the proof of the lemma. \square

Next we give bounds on the operator \mathfrak{P} when derivatives are measures with respect to a certain metric on $T^*M^{\oplus 2}$.

Lemma 4.A.2. *Let g_1 and g_2 be two Riemmanian metrics on T^*M . Then*

$$\forall j \in \mathbf{N}, \forall \ell \in \mathbf{N}, \quad |\nabla^\ell \mathfrak{P}^j f|_{g_1 \oplus g_2} \leq (2 \dim M)^j h_{g_1 \oplus g_2}^j |\nabla^{j+\ell} f|_{g_1 \oplus g_2},$$

where $h_g(\rho_1, \rho_2)$ is the “joint gain function” of g_1 and g_2 defined by

$$h_{g_1 \oplus g_2}(\rho_1, \rho_2) = \sup_{\zeta \in W \setminus \{0\}} \frac{|\zeta|_{(g_1)_{\rho_1}}}{|\zeta|_{(g_2)_{\rho_2}}} = \sup_{\zeta \in W \setminus \{0\}} \frac{|\zeta|_{(g_2)_{\rho_2}}}{|\zeta|_{(g_1)_{\rho_1}}}, \quad \rho_1, \rho_2 \in T^*M.$$

Proof. We recall that $\operatorname{div} X = \operatorname{tr} \nabla X$ for any vector field X , and that for any norm on $T_\rho T^*M$, we have $|\operatorname{tr} \nabla X| \leq \dim(T^*M) \|\nabla X\|$. We fix two points $\rho_1, \rho_2 \in T^*M$ and write $g_j = (g_j)_{\rho_j}$, $j = 1, 2$, for simplicity. Thus we deduce that

$$\begin{aligned} |\mathfrak{P}f(\rho_1, \rho_2)| &\leq \dim(T^*M) \left| \nabla^{\rho_2} H_f^{\rho_1} \right|_{g_1^\sigma} = \dim(T^*M) \sup_{\zeta_2 \in W \setminus \{0\}} \frac{|\nabla_{\zeta_2}^{\rho_2} H_f^{\rho_1}|_{g_1^\sigma}}{|\zeta_2|_{g_1^\sigma}} \\ &= \dim(T^*M) \sup_{\zeta_2 \in W \setminus \{0\}} \frac{|\zeta_2|_{g_2}}{|\zeta_2|_{g_1^\sigma}} \frac{\left| H_{\nabla_{\zeta_2}^{\rho_2} f}^{\rho_1} \right|_{g_1^\sigma}}{|\zeta_2|_{g_2}} \\ &= \dim(T^*M) \sup_{\zeta_2 \in W \setminus \{0\}} \sup_{\zeta_1 \in W \setminus \{0\}} \frac{|\zeta_2|_{g_2}}{|\zeta_2|_{g_1^\sigma}} \frac{|\nabla_{\zeta_1}^{\rho_1} \nabla_{\zeta_2}^{\rho_2} f|}{|\zeta_1|_{g_1} |\zeta_2|_{g_2}} \\ &\leq \dim(T^*M) h_g(\rho_1, \rho_2) |\nabla f(\rho_1, \rho_2)|_{g_1 \oplus g_2}. \end{aligned}$$

The third equality comes from the fact that

$$|H_a|_{g^\sigma} = \sup_{\zeta \in W \setminus \{0\}} \frac{|\sigma(H_a, \zeta)|}{|\zeta|_g} = \sup_{\zeta \in W \setminus \{0\}} \frac{|\nabla_\zeta a|}{|\zeta|_g} = |\nabla a|_g.$$

To handle derivatives, we remark that ∇ commutes with \mathfrak{P} since the latter is a Fourier multiplier, hence the result for $j = 1$. Iterating this result, we obtain the statement for any $j \geq 1$ (the result for $j = 0$ is direct). \square

4.A.3. Moyal operator

Let us also introduce for any $s \in \mathbf{R}$ the operator defined by

$$e^{-\frac{i}{2}s\mathfrak{P}} = \mathcal{F}_{\sigma \oplus \sigma}^{-1} e^{-i\frac{s}{2}\sigma} \mathcal{F}_{\sigma \oplus \sigma}.$$

Similarly to \mathfrak{P} , one can show that the operators

$$e^{-\frac{i}{2}s\mathfrak{P}} : \mathcal{S}(T^*M^{\oplus 2}) \longrightarrow \mathcal{S}(T^*M^{\oplus 2}) \quad \text{and} \quad e^{-\frac{i}{2}s\mathfrak{P}} : \mathcal{S}'(T^*M^{\oplus 2}) \longrightarrow \mathcal{S}'(T^*M^{\oplus 2})$$

are continuous. One can see from the definition that

$$e^{-i\frac{s}{2}\mathfrak{P}} f = \overline{e^{-i\frac{s}{2}\mathfrak{P}}(f \circ \mathfrak{s})} \circ \mathfrak{s}, \quad (4.A.2)$$

where \mathfrak{s} is the map $(\rho_1, \rho_2) \mapsto (\rho_2, \rho_1)$. Notice that this is consistent with (4.A.1).

4.A.4. Bi-confinement estimate

The operator $e^{-\frac{i}{2}s\mathfrak{P}}$ is related to the Moyal product by just taking the restriction to the diagonal. We quickly reproduce the so-called bi-confinement estimate. The proposition below is the cornerstone of the pseudo-differential calculus. A classical computation involving Fourier transforms of imaginary Gaussian functions gives for all $f \in \mathcal{S}(T^*M^{\oplus 2})$:

$$\forall s \in \mathbf{R}, \forall \rho_1, \rho_2 \in T^*M, \quad e^{-i\frac{s}{2}\mathfrak{P}} f(\rho_1, \rho_2) = \int_{W \oplus W} f\left(\rho_1 + \sqrt{\frac{s}{2}}\zeta_1, \rho_2 + \sqrt{\frac{s}{2}}\zeta_2\right) e^{-i\sigma(\zeta_1, \zeta_2)} d\zeta_1 d\zeta_2.$$

Proposition 4.A.3 (Bi-confinement estimate). *Let g_1 and g_2 be two admissible metrics on T^*M . There exists an integer k_0 depending only on the dimension of M and the structure constants of g_1, g_2 such that the following holds. For any pair of points $\rho_1, \rho_2 \in T^*M$, introducing for $j = 1, 2$ the balls $B_j = B_{r_j}^{g_j}(\rho_j)$, for any $r_j \in (0, r_{g_j})$, we have for all $f \in \mathcal{S}(T^*M^{\oplus 2})$:*

$$\forall k \in \mathbf{N}, \exists C_k > 0 : \quad \left| e^{-i\frac{s}{2}\mathfrak{P}} f(\rho, \rho) \right| \leq C_k \frac{\mathcal{N}_k(f; \rho_1, \rho_2)}{\left\langle \text{dist}_{(g_1, \rho_1 + g_2, \rho_2)^\sigma}(\rho, B_1) + \text{dist}_{(g_1, \rho_1 + g_2, \rho_2)^\sigma}(\rho, B_2) \right\rangle^k},$$

where

$$\begin{aligned} \mathcal{N}_k(f; \rho_1, \rho_2) &= \max_{0 \leq \ell \leq (1+k)k_0} \sup_{\rho'_1, \rho'_2 \in T^*M} \left\langle \text{dist}_{g_{1, \rho_1}^\sigma}(\rho'_1, B_1) \right\rangle^{(1+k)k_0} \\ &\quad \times \left\langle \text{dist}_{g_{2, \rho_2}^\sigma}(\rho'_2, B_2) \right\rangle^{(1+k)k_0} \left| \nabla^\ell f(\rho'_1, \rho'_2) \right|_{g_1 \oplus g_2}. \end{aligned}$$

The constant C_k depends only on k and the structure constants of g_1, g_2 .

Remark 4.A.4. Notice that when $f = a_1 \otimes a_2$, we have

$$\mathcal{N}_k(f; \rho_1, \rho_2) \leq |a_1|_{\text{Conf}_{r_1}^{g_1}(\rho_1)}^{((1+k)k_0)} |a_2|_{\text{Conf}_{r_2}^{g_2}(\rho_2)}^{((1+k)k_0)}.$$

Proof. For simplicity, write $\mathfrak{g}_j = g_{j, \rho_j}$, $j = 1, 2$. Given $\zeta_1 \in W$, we set

$$Z = Z(\zeta_1) = \frac{\sigma^{-1} \mathfrak{g}_2^\sigma \zeta_1}{|\zeta_1|_{\mathfrak{g}_2^\sigma}} = \frac{\mathfrak{g}_2^{-1} \sigma \zeta_1}{|\zeta_1|_{\mathfrak{g}_2^\sigma}},$$

and we perform integration by parts in the integral over ζ_2 using the fact that

$$\left(1 + \frac{1}{i} \sqrt{\frac{2}{s}} \nabla_Z^{\zeta_2}\right) e^{-i\sigma(\zeta_1, \zeta_2)} = \left(1 - \sqrt{\frac{2}{s}} \sigma(\zeta_1, Z)\right) e^{-i\sigma(\zeta_1, \zeta_2)} = \left(1 + \sqrt{\frac{2}{s}} |\zeta_1|_{\mathfrak{g}_2^\sigma}\right) e^{-i\sigma(\zeta_1, \zeta_2)}.$$

We obtain

$$e^{-i\frac{s}{2}\mathfrak{P}} f(\rho, \rho) = \int_{W \oplus W} \left(1 - \frac{1}{i} \sqrt{\frac{2}{s}} \nabla_Z^{\zeta_2}\right)^k f\left(\rho + \sqrt{\frac{s}{2}}\zeta_1, \rho + \sqrt{\frac{s}{2}}\zeta_2\right) \times \frac{e^{-i\sigma(\zeta_1, \zeta_2)}}{\left(1 + \sqrt{\frac{2}{s}} |\zeta_1|_{\mathfrak{g}_2^\sigma}\right)^k} d\zeta_1 d\zeta_2. \quad (4.A.3)$$

Writing for $k, n_1, n_2 \in \mathbf{N}$:

$$N_{k, n_1, n_2}(f) = \max_{0 \leq \ell \leq k} \sup_{\rho'_1, \rho'_2 \in T^*M} \langle \text{dist}_{\mathfrak{g}_1^\sigma}(\rho'_1, B_1) \rangle^{n_1} \langle \text{dist}_{\mathfrak{g}_2^\sigma}(\rho'_2, B_2) \rangle^{n_2} |\nabla^\ell f(\rho'_1, \rho'_2)|_{g_1 \oplus g_2},$$

we obtain

$$\begin{aligned} |e^{-i\frac{s}{2}\mathfrak{P}} f(\rho, \rho)| &\leq C(g_2) 2^k N_{k, n_1, n_2}(f) \int_{W \oplus W} \langle \text{dist}_{\mathfrak{g}_1^\sigma}(\rho + \sqrt{\frac{s}{2}}\zeta_1, B_1) \rangle^{-n_1} \\ &\quad \times \langle \text{dist}_{\mathfrak{g}_2^\sigma}(\rho + \sqrt{\frac{s}{2}}\zeta_2, B_2) \rangle^{kN(g_2) - n_2} \frac{d\zeta_1 d\zeta_2}{(1 + \sqrt{\frac{2}{s}}|\zeta_1|_{\mathfrak{g}_2^\sigma})^k}, \end{aligned}$$

where $C(g_2)$ and $N(g_2)$ depend only on structure constants of g_2 . This is because $|Z|_{g_2} = 1$ and since g_2 is admissible (and $r_2 \leq r_{g_2}/2$):

$$|Z|_{g_2}(\rho'_2) \leq |Z|_{g_2}(\rho_2) C(g_2) \langle \text{dist}_{\mathfrak{g}_2^\sigma}(\rho'_2, B_2) \rangle^{N(g_2)}.$$

Now we make two observations: on the one hand, we have by the triangle inequality

$$\begin{aligned} 2 \left(1 + \sqrt{\frac{2}{s}}|\zeta_1|_{\mathfrak{g}_2^\sigma} \right) \langle \text{dist}_{\mathfrak{g}_1^\sigma}(\rho + \sqrt{\frac{s}{2}}\zeta_1, B_1) \rangle &\geq 1 + \left| \sqrt{\frac{s}{2}}\zeta_1 \right|_{\mathfrak{g}_2^\sigma} + \text{dist}_{\mathfrak{g}_1^\sigma}(\rho + \sqrt{\frac{s}{2}}\zeta_1, B_1) \\ &\geq \langle \text{dist}_{(\mathfrak{g}_1 + \mathfrak{g}_2)^\sigma}(\rho, B_1) \rangle; \end{aligned}$$

on the other hand, we have

$$1 + \left| \sqrt{\frac{s}{2}}\zeta_2 + \rho - \rho_2 \right|_{\mathfrak{g}_2} \leq 1 + r_2 + \text{dist}_{\mathfrak{g}_2}(\rho + \sqrt{\frac{s}{2}}\zeta_2, B_2) \leq 4 \langle \text{dist}_{\mathfrak{g}_2^\sigma}(\rho + \sqrt{\frac{s}{2}}\zeta_2, B_2) \rangle.$$

We deduce that

$$\begin{aligned} |e^{-i\frac{s}{2}\mathfrak{P}} f(\rho, \rho)| &\leq N_{k, n_1, n_2}(f) \frac{C(g_2) 2^{k+2n_1+2n_2}}{\langle \text{dist}_{(\mathfrak{g}_1 + \mathfrak{g}_2)^\sigma}(\rho, B_1) \rangle^{n_1}} \\ &\quad \times \int_{W \oplus W} \left(1 + \left| \sqrt{\frac{s}{2}}\zeta_2 + \rho - \rho_2 \right|_{\mathfrak{g}_2} \right)^{kN(g_2) - n_2} \frac{d\zeta_1 d\zeta_2}{(1 + \sqrt{\frac{2}{s}}|\zeta_1|_{\mathfrak{g}_2^\sigma})^{k-n_1}}. \end{aligned}$$

Now taking n_1 arbitrary, $k = n_1 + 2 \dim M + 1$ and $n_2 = k[N(g_2)] + 2 \dim M + 1$, we observe that the integral in the right-hand side is bounded by

$$\int_{W \oplus W} \frac{d\zeta_1 d\zeta_2}{((1 + |\zeta_1|_{\mathfrak{g}_2})(1 + |\zeta_1|_{\mathfrak{g}_2^\sigma}))^{2 \dim M + 1}},$$

which is finite and independent of \mathfrak{g}_2 . Indeed, denoting by G_2 and G_2^σ the matrices of \mathfrak{g}_2 and \mathfrak{g}_2^σ in a symplectic basis, we have $G_2^\sigma = -JG_2^{-1}J$ where J is the symplectic matrix, hence $|\det G_2^\sigma| |\det G_2| = 1$. Therefore we have

$$|e^{-i\frac{s}{2}\mathfrak{P}} f(\rho, \rho)| \leq CN_{k, n_1, n_2}(f) \frac{2^{k+2n_1+2n_2}}{\langle \text{dist}_{(\mathfrak{g}_1 + \mathfrak{g}_2)^\sigma}(\rho, B_1) \rangle^{n_1}}, \quad (4.A.4)$$

where the constant C depends only on the dimension of M and the structure constants of g_2 .

Recalling (4.A.2), we apply the previous estimate, exchanging the roles of B_1, B_2 and g_1, g_2 , we obtain

$$|e^{-i\frac{s}{2}\mathfrak{P}} f(\rho, \rho)| \leq CN_{k, n_1, n_2}(f \circ \mathfrak{s}) \frac{2^{k+2n_1+2n_2}}{\langle \text{dist}_{(\mathfrak{g}_1 + \mathfrak{g}_2)^\sigma}(\rho, B_2) \rangle^{n_1}}, \quad (4.A.5)$$

with a similar choice of k, n_1 and n_2 . Yet in view of the triangle inequality, we have

$$\max \{ \text{dist}_{(\mathfrak{g}_1 + \mathfrak{g}_2)^\sigma}(\rho, B_1), \text{dist}_{(\mathfrak{g}_1 + \mathfrak{g}_2)^\sigma}(\rho, B_2) \} \geq \frac{1}{2} \text{dist}_{(\mathfrak{g}_1 + \mathfrak{g}_2)^\sigma}(\rho, B_1) + \frac{1}{2} \text{dist}_{(\mathfrak{g}_1 + \mathfrak{g}_2)^\sigma}(\rho, B_2)$$

Therefore we infer from (4.A.4) and (4.A.5) that

$$|e^{-i\frac{s}{2}\mathfrak{P}} f(\rho, \rho)| \leq CN_{k', n'_1, n'_2}(f) \frac{2^{k'+2n'_1+2n'_2}}{\langle \text{dist}_{(\mathfrak{g}_1 + \mathfrak{g}_2)^\sigma}(\rho, B_1) + \text{dist}_{(\mathfrak{g}_1 + \mathfrak{g}_2)^\sigma}(\rho, B_2) \rangle^{n'_1}}.$$

This is the sought result. \square

4.A.5. Pseudodifferential calculus

4.A.5.1. Compatible metrics

To perform pseudo-differential calculus with two different metrics, we need a some conditions on these metrics.

Definition 4.A.5. Two admissible metrics g_1 and g_2 are compatible if there exist $C > 0$ and $N \geq 0$ such that

$$\forall \rho, \rho_1, \rho_2 \in T^*M, \quad \begin{cases} g_{1,\rho} \leq C^2 g_{1,\rho_1} \langle \rho - \rho_1 \rangle_{g_{2,\rho_1}^\sigma}^{2N} \\ g_{2,\rho} \leq C^2 g_{2,\rho_2} \langle \rho - \rho_2 \rangle_{g_{1,\rho_2}^\sigma}^{2N} \end{cases} \quad (4.A.6)$$

and the joint weight function is less than one:

$$\forall \rho \in T^*M, \quad h_{g_1,g_2}(\rho) = \sup_{\zeta \in W \setminus \{0\}} \frac{|\zeta|_{g_1,\rho}}{|\zeta|_{g_{2,\rho}^\sigma}} = \sup_{\zeta \in W \setminus \{0\}} \frac{|\zeta|_{g_{2,\rho}}}{|\zeta|_{g_{1,\rho}^\sigma}} \leq 1.$$

We give a sufficient condition for two admissible metrics to be compatible.

Proposition 4.A.6. Let g_1 and g_2 be admissible metrics. If $g_1^{\natural} = g_2^{\natural}$, and $h_{g_1,g_2} \leq 1$, then they are compatible, and the constants in (4.A.6) depend only on the structure constants of g_1 and g_2 .

Remark 4.A.7. The condition $g_1^{\natural} = g_2^{\natural}$ is true in particular when g_1 and g_2 are conformal.

Proof. This is a mere consequence of the improved admissibility property of Proposition 4.1.29 since $g_1^{\natural} = g_2^{\natural} \leq g_2^{\sigma}$ and vice versa exchanging the roles of g_1 and g_2 . \square

Proposition 4.A.8. Let g_1, g_2 be compatible admissible metrics. Then the metric $\hat{g} := g_1 + g_2$ is admissible with slow variation radius $r \geq \min\{r_{g_1}, r_{g_2}\}$ and with structure constants depending only on those of g_1, g_2 and the constants in (4.A.6). Moreover, the weight h_{g_1,g_2} is \hat{g} -admissible and we have for all $\rho_1, \rho_2, \rho'_1, \rho'_2 \in T^*M$:

$$h_{g_1 \oplus g_2}(\rho'_1, \rho'_2) \leq C h_{g_1 \oplus g_2}(\rho_1, \rho_2) \left\langle \text{dist}_{(\hat{g}_{\rho_1} + \hat{g}_{\rho'_1})^\sigma}(B_1, B'_1) \right\rangle^N \left\langle \text{dist}_{(\hat{g}_{\rho_2} + \hat{g}_{\rho'_2})^\sigma}(B_2, B'_2) \right\rangle^N \quad (4.A.7)$$

where $B_j = B_r^{\hat{g}}(\rho_j)$, $B'_j = B_r^{\hat{g}}(\rho'_j)$, $j = 1, 2$, for some $r \leq r_{\hat{g}}/2$, and C depends only on the structure constants of g_1, g_2 and \hat{g} .

Proof. The fact that \hat{g} is admissible follows directly from (4.A.6) together with the temperance of g_1 and g_2 yield

$$\forall \rho, \rho_1, \rho_2 \in T^*M, \quad \begin{cases} g_{1,\rho} \leq C^2 g_{1,\rho_1} \langle \rho - \rho_1 \rangle_{\hat{g}_{\rho_1}^\sigma}^{2N} \\ g_{2,\rho} \leq C^2 g_{2,\rho_2} \langle \rho - \rho_2 \rangle_{\hat{g}_{\rho_2}^\sigma}^{2N} \end{cases}. \quad (4.A.8)$$

The claim on slow variation follows similarly from slow variation of g_1 and g_2 . See [Hör85, Proposition 18.5.3] for details. Finally for the joint gain function, we do the following: fix $\rho_0 \in T^*M$ and write $B_0 = B_r^{\hat{g}}(\rho_0)$ for some $r \leq r_{\hat{g}}/2$. Then for all $\rho_1, \rho_2 \in T^*M$ it holds for any non-zero $\zeta \in W$:

$$\frac{|\zeta|_{g_1}(\rho'_1)}{|\zeta|_{g_2^\sigma}(\rho'_2)} \leq C \frac{|\zeta|_{g_1}(\rho_1)}{|\zeta|_{g_2^\sigma}(\rho_1)} \left\langle \text{dist}_{(\hat{g}_{\rho_1} + \hat{g}_{\rho'_1})^\sigma}(B_1, B'_1) \right\rangle^N \left\langle \text{dist}_{(\hat{g}_{\rho_2} + \hat{g}_{\rho'_2})^\sigma}(B_2, B'_2) \right\rangle^N,$$

where we used (4.A.8), and taking the supremum with respect to ζ yields the result. Admissibility of h_{g_1,g_2} with respect to \hat{g} follows from this estimate with $\rho_1 = \rho_2$ and $\rho'_1 = \rho'_2$. \square

4.A.5.2. Proof of pseudo-differential calculus with confined symbols

From the bi-confinement estimate, we can deduce several variations of the pseudo-differential calculus.

Proof of Proposition 4.2.3. Write for simplicity $\hat{g} = \frac{1}{2}(g + g_0)$. Let $\psi \in \text{Conf}_r^{g_0}(\rho_0)$ and $a \in \nabla^{-j}S(m, g)$. We introduce a partition of unity $(\varphi_{\rho_1})_{\rho_1 \in T^*M}$ adapted to the metric $g + g_0$, with radius $\kappa r \leq \frac{1}{2} \min\{r_g, r_{g_0}\}$, whose existence is given by Proposition 4.1.34.

We claim that for any k , the quantity

$$\mathcal{N}_k = \mathcal{N}_k(\rho_1, \rho_0) = \max_{0 \leq \ell \leq k} \sup_{\rho'_1, \rho'_2 \in T^*M} \left\langle \text{dist}_{\hat{g}_{\rho_1}}(\rho'_1, B_1) \right\rangle^k \left\langle \text{dist}_{\hat{g}_{\rho_2}}(\rho'_2, B_2) \right\rangle^k |\nabla^\ell f(\rho'_1, \rho'_2)|_{\hat{g} \oplus \hat{g}}$$

is bounded, where

$$f = f_{\rho_1} = (\varphi_{\rho_1} \otimes 1) \times \mathfrak{P}^{j_0}(a \otimes \psi), \quad (4.A.9)$$

and $B_1 = B_{\kappa r}^{\hat{g}}(\rho_1)$, $B_2 = B_{\kappa r}^{\hat{g}}(\rho_0)$. We distribute derivatives in $\nabla^\ell f$ on both factors in (4.A.9) thanks to the Leibniz formula. Hence it suffices to estimate the following terms: on the one hand,

$$\forall k_1 \in \mathbf{N}, \quad |\nabla^\ell(\varphi_{\rho_1} \otimes 1)(\rho'_1, \rho'_2)| \leq \left\langle \text{dist}_{\hat{g}_{\rho_1}}(\rho'_1, B_1) \right\rangle^{-k_1} |\varphi_{\rho_1}|_{\text{Conf}_{\kappa r}^{\hat{g}}(\rho_1)}^{(k_1)}, \quad (4.A.10)$$

on the other hand, we have thanks to Lemma 4.A.2:

$$|\nabla^\ell \mathfrak{P}^{j_0}(a \otimes \psi)|_{g \oplus g_0}(\rho'_1, \rho'_2) \leq (2 \dim M)^{j_0} h_{g \oplus g_0}^{j_0} |\nabla^{j_0 + \ell}(a \otimes \psi)|_{g \oplus g_0} \quad (4.A.11)$$

$$\begin{aligned} &\leq (2 \dim M)^{j_0} h_{g \oplus g_0}^{j_0} |\nabla^{j_0 + \ell} a|_g \otimes |\nabla^{j_0 + \ell} \psi|_{g_0} \\ &\leq (2 \dim M)^{j_0} h_{g \oplus g_0}^{j_0} m(\rho'_1) \frac{|\nabla^{j_0} a|_{S(m, g)}^{(\ell)} |\psi|_{\text{Conf}_r^{g_0}(\rho_0)}^{(j_0 + \ell + k_2)}}{\left\langle \text{dist}_{g_{0, \rho_0}^\sigma}(\rho'_2, B_r^{g_0}(\rho_0)) \right\rangle^{k_2}} \end{aligned} \quad (4.A.12)$$

$$\leq (2 \dim M)^{j_0} h_{g \oplus g_0}^{j_0} m(\rho'_1) \frac{|\nabla^{j_0} a|_{S(m, g)}^{(\ell)} |\psi|_{\text{Conf}_r^{g_0}(\rho_0)}^{(j_0 + \ell + k_2)}}{\left\langle \text{dist}_{\hat{g}_{\rho_0}}(\rho'_2, B_2) \right\rangle^{k_2}}, \quad (4.A.13)$$

for any $k_2 \in \mathbf{N}$. We used that $\nabla^j a \in S(m, g)$ and the confinement of ψ , and the last step follows from the fact that $\hat{g}^\sigma \leq 2g_0^\sigma$ by σ -duality and the fact that

$$\forall \zeta \in W \setminus \{0\}, \quad |\zeta|_{g_0} \leq r \implies |\zeta|_{\hat{g}}^2 \leq \frac{1 + \kappa^2}{2} |\zeta|_{g_0}^2 \leq (\kappa r)^2,$$

that is to say $B_r^{g_0}(\rho_0) \subset B_2$, because $g \leq \kappa^2 g_0$ with $\kappa \geq 1$. Yet m \hat{g} -admissible, so we infer that

$$m(\rho'_1) \leq C m(\rho_1) \left\langle \text{dist}_{\hat{g}_{\rho_1}}(\rho'_1, B_1) \right\rangle^N \leq C' m(\rho_0) \left\langle \text{dist}_{\hat{g}_{\rho_1}}(\rho'_1, B_1) \right\rangle^N \left\langle \text{dist}_{(\hat{g}_{\rho_1} + \hat{g}_{\rho_0})^\sigma}(B_1, B_2) \right\rangle^{N'}. \quad (4.A.14)$$

Similarly, applying (4.A.7) in Proposition 4.A.8 twice, we have

$$\begin{aligned} h_{g \oplus g_0}(\rho'_1, \rho'_2) &\leq C h_{g \oplus g_0}(\rho_1, \rho_2) \left\langle \text{dist}_{\hat{g}_{\rho_1}}(\rho'_1, B_1) \right\rangle^N \left\langle \text{dist}_{\hat{g}_{\rho_0}}(\rho'_2, B_2) \right\rangle^N \\ &\leq C' h_{g, g_0}(\rho_0) \left\langle \text{dist}_{(\hat{g}_{\rho_1} + \hat{g}_{\rho_0})^\sigma}(B_1, B_2) \right\rangle^{N'} \left\langle \text{dist}_{\hat{g}_{\rho_1}}(\rho'_1, B_1) \right\rangle^N \left\langle \text{dist}_{\hat{g}_{\rho_0}}(\rho'_2, B_2) \right\rangle^N. \end{aligned}$$

The constants depend only on structure constants of the metrics involved. Combining this with the estimate on m (4.A.14), inequality (4.A.11) becomes

$$\begin{aligned} |\nabla^\ell \mathfrak{P}^{j_0}(a \otimes \psi)|_{g \oplus g_0}(\rho'_1, \rho'_2) &\leq C_{j_0, g, g_0, \hat{g}} h_{g, g_0}^{j_0}(\rho_0) m(\rho_0) \left\langle \text{dist}_{(\hat{g}_{\rho_1} + \hat{g}_{\rho_0})^\sigma}(B_1, B_2) \right\rangle^{N'} \\ &\times \left\langle \text{dist}_{\hat{g}_{\rho_1}}(\rho'_1, B_1) \right\rangle^N \left\langle \text{dist}_{\hat{g}_{\rho_2}}(\rho'_2, B_2) \right\rangle^{N - k_2} |\nabla^{j_0} a|_{S(m, g)}^{(\ell)} |\psi|_{\text{Conf}_r^{g_0}(\rho_0)}^{(j_0 + \ell + k_2)} |\varphi_{\rho_1}|_{\text{Conf}_r^g(\rho_1)}^{(k_1)}, \end{aligned} \quad (4.A.15)$$

and together with (4.A.10), we arrive at

$$\begin{aligned} |\nabla^\ell f|_{g \oplus g_0}(\rho'_1, \rho'_2) &\leq C_{j_0, g, g_0, \hat{g}} h_{g, g_0}^{j_0}(\rho_0) m(\rho_0) \left\langle \text{dist}_{(\hat{g}_{\rho_1} + \hat{g}_{\rho_0})^\sigma}(B_1, B_2) \right\rangle^{N'} \\ &\times \left\langle \text{dist}_{\hat{g}_{\rho_1}}(\rho'_1, B_1) \right\rangle^{N - k_1} \left\langle \text{dist}_{\hat{g}_{\rho_2}}(\rho'_2, B_2) \right\rangle^{N - k_2} |\nabla^{j_0} a|_{S(m, g)}^{(\ell)} |\psi|_{\text{Conf}_r^{g_0}(\rho_0)}^{(j_0 + \ell + k_2)} |\varphi_{\rho_1}|_{\text{Conf}_r^g(\rho_1)}^{(k_1)}. \end{aligned} \quad (4.A.16)$$

At this stage, we remark that (4.A.15) with $\rho_1 = \rho_2$ and ρ in place of ρ'_1 and ρ'_2 yields

$$\begin{aligned} |\nabla^\ell \mathfrak{P}^{j_0}(a \otimes \psi)|_{g \oplus g_0}(\rho, \rho) &\leq C_{j_0, g, g_0, \hat{g}} h_{g, g_0}^{j_0}(\rho_0) m(\rho_0) \\ &\times \left\langle \text{dist}_{\hat{g}_{\rho_1}}(\rho'_1, B_1) \right\rangle^N \left\langle \text{dist}_{\hat{g}_{\rho_2}}(\rho'_2, B_2) \right\rangle^{N - k_2} |\nabla^{j_0} a|_{S(m, g)}^{(\ell)} |\psi|_{\text{Conf}_r^{g_0}(\rho_0)}^{(j_0 + \ell + k_2)}, \end{aligned}$$

which is the expected estimate for the continuity of \mathcal{P}_j in (4.2.5). From (4.A.16), we deduce that for some k' sufficiently large,

$$\mathcal{N}_k \leq C_{j_0, g, g_0} h_{g, g_0}^j(\rho_0) m(\rho_0) \left\langle \text{dist}_{(\hat{g}_{\rho_1} + \hat{g}_{\rho_0})^\sigma}(B_1, B_2) \right\rangle^{N'} |\nabla^{j_0} a|_{S(m, g)}^{(\ell)} |\psi|_{\text{Conf}_{r^0}^{g_0}(\rho_0)}^{(j_0 + \ell + k')} |\varphi_{\rho_1}|_{\text{Conf}_{kr}^{\hat{g}}(\rho_1)}^{(k')}. \quad (4.A.17)$$

Therefore the bi-confinement estimate (Proposition 4.A.3) gives for all $\rho \in T^*M$:

$$|e^{-i\frac{s}{2}\mathfrak{P}} f(\rho, \rho)| \leq C_k C_{j_0, g, g_0} h_{g, g_0}^{j_0}(\rho_0) m(\rho_0) \frac{|\nabla^{j_0} a|_{S(m, g)}^{(\ell)} |\psi|_{\text{Conf}_{r^0}^{g_0}(\rho_0)}^{(j_0 + \ell + k')} |\varphi_{\rho_1}|_{\text{Conf}_{kr}^{\hat{g}}(\rho_1)}^{(k')}}{\left\langle \text{dist}_{(\hat{g}_{\rho_1} + \hat{g}_{\rho_0})^\sigma}(\rho, B_1) + \text{dist}_{(\hat{g}_{\rho_1} + \hat{g}_{\rho_0})^\sigma}(\rho, B_2) \right\rangle^{k - N'}}.$$

We got rid of the factor to the power N' in (4.A.17) thanks to the triangle inequality. Taking k large enough, we observe that for fixed ρ , we obtain a quantity that is integrable with respect to ρ_1 . That means that performing sufficiently many integration by parts as in (4.A.3), one has an absolutely convergent integral, and by Fubini's theorem, we obtain

$$\int_{T^*M} e^{-i\frac{s}{2}\mathfrak{P}} f d\text{Vol}_{\hat{g}}(\rho_1) = e^{-i\frac{s}{2}\mathfrak{P}} \int_{T^*M} (\varphi_{\rho_1} \otimes 1) \mathfrak{P}^{j_0}(a \otimes \psi) d\text{Vol}_{\hat{g}}(\rho_1) = e^{-i\frac{s}{2}\mathfrak{P}} \mathfrak{P}^{j_0}(a \otimes \psi),$$

with the estimate

$$\begin{aligned} |e^{-i\frac{s}{2}\mathfrak{P}} \mathfrak{P}^{j_0}(a \otimes \psi)(\rho, \rho)| &\leq C_k C_{j_0, g, g_0} h_{g, g_0}^{j_0}(\rho_0) m(\rho_0) \\ &\times \int_{T^*M} \frac{|\nabla^{j_0} a|_{S(m, g)}^{(\ell)} |\psi|_{\text{Conf}_{r^0}^{g_0}(\rho_0)}^{(j_0 + \ell + k')} |\varphi_{\rho_1}|_{\text{Conf}_{kr}^{\hat{g}}(\rho_1)}^{(k')}}{\left\langle \text{dist}_{(\hat{g}_{\rho_1} + \hat{g}_{\rho_0})^\sigma}(\rho, B_1) + \text{dist}_{(\hat{g}_{\rho_1} + \hat{g}_{\rho_0})^\sigma}(\rho, B_2) \right\rangle^{k - N'}} d\text{Vol}_{\hat{g}}(\rho_1). \end{aligned}$$

Now we check the decay as $\rho \rightarrow \infty$ as follows: from Proposition 4.A.8, the metric \hat{g} is admissible, so that

$$\hat{g}_{\rho_0}^\sigma \leq \tilde{C} (\hat{g}_{\rho_1} + \hat{g}_{\rho_0})^\sigma \left\langle \text{dist}_{(\hat{g}_{\rho_1} + \hat{g}_{\rho_0})^\sigma}(B_1, B_2) \right\rangle^{2\tilde{N}},$$

which implies that

$$\text{dist}_{(\hat{g}_{\rho_1} + \hat{g}_{\rho_0})^\sigma}(\rho, B_2) \geq \tilde{C}^{-1} \text{dist}_{\hat{g}_{\rho_0}^\sigma}(\rho, B_2) \left\langle \text{dist}_{(\hat{g}_{\rho_1} + \hat{g}_{\rho_0})^\sigma}(B_1, B_2) \right\rangle^{-\tilde{N}},$$

and by the triangle inequality

$$\text{dist}_{(\hat{g}_{\rho_1} + \hat{g}_{\rho_0})^\sigma}(\rho, B_1) + \text{dist}_{(\hat{g}_{\rho_1} + \hat{g}_{\rho_0})^\sigma}(\rho, B_2) \geq \text{dist}_{(\hat{g}_{\rho_1} + \hat{g}_{\rho_0})^\sigma}(B_1, B_2).$$

Therefore, if k was chosen large enough, we can secure

$$\begin{aligned} \int_{T^*M} \left\langle \text{dist}_{(\hat{g}_{\rho_1} + \hat{g}_{\rho_0})^\sigma}(\rho, B_1) + \text{dist}_{(\hat{g}_{\rho_1} + \hat{g}_{\rho_0})^\sigma}(\rho, B_2) \right\rangle^{-(k - N')} d\text{Vol}_{\hat{g}}(\rho_1) \\ \leq \left\langle \text{dist}_{\hat{g}_{\rho_0}^\sigma}(\rho, B_2) \right\rangle^{-n} \int_{T^*M} \left\langle \text{dist}_{(\hat{g}_{\rho_1} + \hat{g}_{\rho_0})^\sigma}(B_1, B_2) \right\rangle^{-n_0} d\text{Vol}_{\hat{g}}(\rho_1). \end{aligned}$$

Then [Ler10, Lemma 2.2.24] ensures that the integral in the right-hand side is bounded uniformly with respect to ρ_0 .

It remains to integrate the estimate with respect to $s \in [0, 1]$ to obtain

$$\left| \widehat{\mathcal{P}}_j(a, \psi)(\rho, \rho) \right| \leq C_k C_{j_0, g, g_0} h_{g, g_0}^{j_0}(\rho_0) m(\rho_0) |\nabla^{j_0} a|_{S(m, g)}^{(\ell)} |\psi|_{\text{Conf}_{r^0}^{g_0}(\rho_0)}^{(j_0 + \ell + k')} \left\langle \text{dist}_{\hat{g}_{\rho_0}^\sigma}(\rho, B_2) \right\rangle^{-n},$$

which is the desired estimate to establish (4.2.6). \square

4.A.5.3. Proof of pseudo-differential calculus in symbol classes

Proof of Proposition 4.2.2. We indicate how to modify the previous proof in order to obtain the desired result. Let $a_1 \in \nabla^{-j_0} S(m_1, g_1)$, $a_2 \in \nabla^{-j_0} S(m_2, g_2)$. As a first step, we have

$$\begin{aligned} |\nabla^\ell \mathfrak{P}^{j_0}(a_1 \otimes a_2)|_{(g_1+g_2) \oplus (g_1+g_2)} &\leq C_{j_0} h_{g_1 \oplus g_2}^{j_0} |\nabla^{j_0+\ell}(a_1 \otimes a_2)|_{g_1 \oplus g_2} \\ &\leq C_{j_0} h_{g_1 \oplus g_2}^{j_0} m_1 \otimes m_2 |\nabla^{j_0} a_1|_{S(m_1, g_1)}^{(\ell)} |\nabla^{j_0} a_2|_{S(m_2, g_2)}^{(\ell)}. \end{aligned} \quad (4.A.18)$$

We used the fact that $(g_1 + g_2)^{\oplus 2} \geq g_1 \oplus g_2$, next we applied Lemma 4.A.2 and we used that $a_j \in \nabla^{-j_0} S(m_j, g_j)$, $j = 1, 2$.

Then we observe that the continuity estimate for \mathcal{P}_{j_0} follows from restricting this estimate to the diagonal through the chain rule:

$$\begin{aligned} |\nabla^\ell (\mathfrak{P}^{j_0}(a_1 \otimes a_2)(\rho, \rho))|_{g_1+g_2} &\leq C_\ell \max_{0 \leq \ell_1, \ell_2 \leq \ell} |\nabla^{\ell_1} \otimes \nabla^{\ell_2} (\mathfrak{P}^{j_0} a_1 \otimes a_2)|_{(g_1+g_2) \oplus (g_1+g_2)}(\rho, \rho) \\ &\leq C_{j_0, \ell} h_{g_1, g_2}^{j_0}(\rho) (m_1 m_2)(\rho) |\nabla^{j_0} a_1|_{S(m_1, g_1)}^{(\ell)} |\nabla^{j_0} a_2|_{S(m_2, g_2)}^{(\ell)}. \end{aligned}$$

We now turn to the proof of the continuity estimate for $\widehat{\mathcal{P}}_{j_0}$. Write for simplicity $\hat{g} = g_1 + g_2$ and fix a partition of unity $(\varphi_{\rho_1})_{\rho_1 \in T^*M}$ adapted to the metric \hat{g} and with radius $r = r_{\hat{g}}/2$, given by Proposition 4.1.34. Similarly to (4.A.9), we define

$$f = f_{\rho_1, \rho_2} = (\varphi_{\rho_1} \otimes \varphi_{\rho_2}) \times \mathfrak{P}^{j_0}(a_1 \otimes a_2), \quad (4.A.19)$$

and we show that for any $k \in \mathbf{N}$, the quantity

$$\mathcal{N}_k = \mathcal{N}_k(\rho_1, \rho_2) = \max_{0 \leq \ell \leq k} \sup_{\rho'_1, \rho'_2 \in T^*M} \left\langle \text{dist}_{\hat{g}_{\rho'_1}}(\rho'_1, B_1) \right\rangle^k \left\langle \text{dist}_{\hat{g}_{\rho'_2}}(\rho'_2, B_2) \right\rangle^k |\nabla^\ell f(\rho'_1, \rho'_2)|_{\hat{g} \oplus \hat{g}}$$

is bounded, where $B_j = B_r^{\hat{g}}(\rho_j)$, $j = 1, 2$. Now in (4.A.18), the admissibility properties of m_1 and m_2 together with (4.A.7) in Proposition 4.A.8 give

$$\begin{aligned} h_{g_1 \oplus g_2}^{j_0}(\rho'_1, \rho'_2) m_1(\rho'_1) m_2(\rho'_2) &\leq C h_{g_1 \oplus g_2}^{j_0}(\rho_1, \rho_2) m_1(\rho_1) m_2(\rho_2) \\ &\quad \times \left\langle \text{dist}_{(\hat{g}_{\rho_1} + \hat{g}_{\rho'_1})^\sigma}(\rho'_1, B_1) \right\rangle^{N'} \left\langle \text{dist}_{(\hat{g}_{\rho_2} + \hat{g}_{\rho'_2})^\sigma}(\rho'_2, B_2) \right\rangle^{N'} \\ &\leq C' h_{g_1, g_2}^{j_0}(\rho) (m_1 m_2)(\rho) \left\langle \text{dist}_{\hat{g}_{\rho_1}}(\rho'_1, B_1) \right\rangle^{N'} \left\langle \text{dist}_{\hat{g}_{\rho_2}}(\rho'_2, B_2) \right\rangle^{N'} \\ &\quad \times \left\langle \text{dist}_{(\hat{g}_{\rho_1} + \hat{g}_\rho)^\sigma}(\rho, B_1) \right\rangle^{N'} \left\langle \text{dist}_{(\hat{g}_{\rho_2} + \hat{g}_\rho)^\sigma}(\rho, B_2) \right\rangle^{N'}, \end{aligned}$$

where $B_j = B_r^{\hat{g}}(\rho_j)$, $B'_j = B_r^{\hat{g}}(\rho'_j)$, $j = 1, 2$. Plugging this into (4.A.18), then in view of (4.A.19), we know that for any k , taking advantage of the confinement of φ_{ρ_j} , $j = 1, 2$, one has

$$\mathcal{N}_k \leq C'_{j_0, k} (h_{g_1, g_2}^{j_0} m_1 m_2)(\rho) \left\langle \text{dist}_{\hat{g}_{\rho_1}}(\rho, B_1) \right\rangle^{N'} \left\langle \text{dist}_{\hat{g}_{\rho_2}}(\rho, B_2) \right\rangle^{N'} |\nabla^{j_0} a_1|_{S(m_1, g_1)}^{(\ell)} |\nabla^{j_0} a_2|_{S(m_2, g_2)}^{(\ell)}.$$

Therefore the bi-confinement estimate (Proposition 4.A.3) yields for all $\rho \in T^*M$:

$$\begin{aligned} |e^{-i\frac{\sigma}{2}} \mathfrak{P} f(\rho, \rho)| &\leq C'_{j_0, k} (h_{g_1, g_2}^{j_0} m_1 m_2)(\rho) \frac{|\nabla^{j_0} a_1|_{S(m_1, g_1)}^{(\ell+k')} |\nabla^{j_0} a_2|_{S(m_2, g_2)}^{(\ell+k')} |\varphi_{\rho_1}|_{\text{Conf}_r^{\hat{g}}(\rho_1)}^{(k')} |\varphi_{\rho_2}|_{\text{Conf}_r^{\hat{g}}(\rho_2)}^{(k')}}{\left\langle \text{dist}_{(\hat{g}_{\rho_1} + \hat{g}_{\rho_2})^\sigma}(\rho, B_1) + \text{dist}_{(\hat{g}_{\rho_1} + \hat{g}_{\rho_2})^\sigma}(\rho, B_2) \right\rangle^k} \\ &\quad \times \left\langle \text{dist}_{\hat{g}_{\rho_1}}(\rho, B_1) \right\rangle^{N'} \left\langle \text{dist}_{\hat{g}_{\rho_2}}(\rho, B_2) \right\rangle^{N'}. \end{aligned}$$

Yet the admissibility of \hat{g} yields

$$\hat{g}_{\rho_j}^\sigma \leq \tilde{C}^2 (\hat{g}_{\rho_1} + \hat{g}_{\rho_2})^\sigma \left\langle \text{dist}_{(\hat{g}_{\rho_1} + \hat{g}_{\rho_2})^\sigma}(B_1, B_2) \right\rangle^{2\tilde{N}}, \quad j = 1, 2,$$

hence

$$|e^{-i\frac{s}{2}\mathfrak{P}} f(\rho, \rho)| \leq C'_{j_0, k}(h_{g_1, g_2}^{j_0} m_1 m_2)(\rho) \frac{|\nabla^{j_0} a_1|_{S(m_1, g_1)}^{(\ell+k')} |\nabla^{j_0} a_2|_{S(m_2, g_2)}^{(\ell+k')} |\varphi_{\rho_1}|_{\text{Conf}_r^{\hat{g}}(\rho_1)}^{(k')} |\varphi_{\rho_2}|_{\text{Conf}_r^{\hat{g}}(\rho_2)}^{(k')}}{\left\langle \text{dist}_{(\hat{g}_{\rho_1} + \hat{g}_{\rho_2})^\sigma}(\rho, B_1) + \text{dist}_{(\hat{g}_{\rho_1} + \hat{g}_{\rho_2})^\sigma}(\rho, B_2) \right\rangle^{k-2N'(1+\tilde{N})}}.$$

Admissibility of \hat{g} again gives

$$(\hat{g}_{\rho_j} + \hat{g}_\rho)^\sigma \leq \tilde{C}^2 (\hat{g}_{\rho_1} + \hat{g}_{\rho_2})^\sigma \left\langle \text{dist}_{(\hat{g}_{\rho_1} + \hat{g}_{\rho_2})^\sigma}(\rho, B_j) \right\rangle^{2\tilde{N}}, \quad j = 1, 2,$$

hence

$$\text{dist}_{(\hat{g}_{\rho_1} + \hat{g}_{\rho_2})^\sigma}(\rho, B_j) \geq \tilde{C} \text{dist}_{(\hat{g}_{\rho_j} + \hat{g}_\rho)^\sigma}(\rho, B_j) \left\langle \text{dist}_{(\hat{g}_{\rho_1} + \hat{g}_{\rho_2})^\sigma}(\rho, B_{j+1}) \right\rangle^{\tilde{N}}$$

where $(j, j + 1) = (1, 2)$ or $(2, 1)$. To conclude, taking k large enough results in

$$|e^{-i\frac{s}{2}\mathfrak{P}} f(\rho, \rho)| \leq \tilde{C}'_{j_0, k}(h_{g_1, g_2}^{j_0} m_1 m_2)(\rho) \frac{|\nabla^{j_0} a_1|_{S(m_1, g_1)}^{(\ell+\tilde{k})} |\nabla^{j_0} a_2|_{S(m_2, g_2)}^{(\ell+\tilde{k})} |\varphi_{\rho_1}|_{\text{Conf}_r^{\hat{g}}(\rho_1)}^{(\tilde{k})} |\varphi_{\rho_2}|_{\text{Conf}_r^{\hat{g}}(\rho_2)}^{(\tilde{k})}}{\left\langle \text{dist}_{(\hat{g}_{\rho_1} + \hat{g}_\rho)^\sigma}(\rho, B_1) \right\rangle^{n_0} \left\langle \text{dist}_{(\hat{g}_{\rho_2} + \hat{g}_\rho)^\sigma}(\rho, B_2) \right\rangle^{n_0}},$$

for some \tilde{k} depending on n_0 , which depends itself on structure constants of g_1, g_2, \hat{g} . Taking n_0 sufficiently large, [Ler10, Lemma 2.2.24] ensures that this estimate is integrable with respect to ρ_1, ρ_2 , independently of ρ . Further integrating in $s \in [0, 1]$ provides the sought estimate. \square

4.B. Continuity properties of pseudodifferential operators

4.B.1. Distributional continuity

We first recall a reformulation of the Schwartz kernel theorem in the context of the Weyl quantization.

Proposition 4.B.1. *Let $A : \mathcal{S}(M) \rightarrow \mathcal{S}'(M)$ be a continuous linear operator. Then there exists a tempered distribution $a \in \mathcal{S}'(T^*M)$ such that $A = \text{Op}^W(a)$.*

Proof. Suppose $A = \text{Op}^W(a)$ with $a \in \mathcal{S}(T^*M)$. From [Fol89, (2.4) p. 80], the Schwartz kernel K_A and the Weyl symbol a of A are related through the formula

$$a(x, \xi) = \int_V K_A \left(x - \frac{v}{2}, x + \frac{v}{2} \right) e^{i\xi \cdot v} dv. \tag{4.B.1}$$

In other words, a is the (extended) Wigner transform of K_A . Since the Wigner transform essentially consists in an affine change of variables and a partial Fourier transform, we deduce that it maps $\mathcal{S}(T^*M)$ and $\mathcal{S}'(T^*M)$ to themselves continuously ([Fol89, Proposition (1.92)]) and therefore the above formula (4.B.1) still makes sense for general tempered distributions K_A . Given a general continuous linear operator $A : \mathcal{S}(M) \rightarrow \mathcal{S}'(M)$, the existence and uniqueness of $K_A \in \mathcal{S}'(T^*M)$ is given by the Schwartz kernel theorem (see for instance [Trè67, Corollary of Theorem 51.7]). That yields the result. \square

Proposition 4.B.2 (Continuity of pseudo-differential operators – [Hör85, Theorem 18.6.2]). *Let g be an admissible metric and m be a g -admissible weight. Then for any $a \in S(m, g)$, the operator $\text{Op}^W(a)$ maps $\mathcal{S}(M)$ to itself continuously, and can be extended as a continuous operator on $\mathcal{S}'(M)$.*

Proposition 4.B.3 (Continuity of operator with Schwartz kernel – [Zwo12, Theorem 4.1]). *Let $k \in \mathcal{S}(T^*M)$. Then*

$$\text{Op}^W(k) : \mathcal{S}'(T^*M) \longrightarrow \mathcal{S}(T^*M)$$

is continuous.

4.B.2. L^2 boundedness

We also have the L^2 boundedness of operators whose symbol lies in $S(1, g)$.

Proposition 4.B.4 (Calderón-Vaillancourt). *Let g be an admissible metric. Then there exists a constant C_0 and an integer ℓ_0 , depending only on $\dim M$ and structure constants of g , such that for all $a \in S(1, g)$, the operator $\text{Op}^w(a)$ extends to a bounded operator on $L^2(M)$ and*

$$\|\text{Op}^w(a)\|_{\mathcal{L}(L^2)} \leq C_0 |a|_{S(1,g)}^{(\ell_0)}.$$

We will need a characterization of pseudo-differential operators, namely, we want to know when a continuous linear operator $A : \mathcal{S}(M) \rightarrow \mathcal{S}'(M)$ can be written $A = \text{Op}^w(a)$ with a symbol $a \in S(m, g)$. We refer to Lerner's book for proofs of the results below.

In the sequel, we denote affine maps $T^*M \rightarrow \mathbf{R}$ by the letter f , and the corresponding operator by $F = \text{Op}^w(f)$.

Proposition 4.B.5 (Beals theorem – [Ler10, Theorem 2.2.6]). *There exists $k_0 \in \mathbf{N}$ such that the following holds. Let $A : \mathcal{S}(M) \rightarrow \mathcal{S}'(M)$ be a linear continuous operator and denote by a its Weyl symbol, so that $A = \text{Op}^w(a)$. Then for all $\ell \in \mathbf{N}$, there exists $C_\ell > 0$ such that*

$$|a|_{S(1,g)}^{(\ell)} \leq C_\ell \max_{0 \leq j \leq k_0 + \ell} \sup_{f_1, f_2, \dots, f_j \in \text{Aff}(T^*M, \mathbf{R}) \setminus \{0\}} \frac{\left\| \text{ad}_{\text{Op}^w(f_1)} \text{ad}_{\text{Op}^w(f_2)} \cdots \text{ad}_{\text{Op}^w(f_j)} A \right\|_{\mathcal{L}(L^2)}}{|H_{f_1}|_{\mathbf{g}} |H_{f_2}|_{\mathbf{g}} \cdots |H_{f_j}|_{\mathbf{g}}},$$

where \mathbf{g} is any flat admissible metric on T^*M .

Remark 4.B.6. The independence of k_0 and above all C_ℓ on \mathbf{g} is possible thanks to the requirement that \mathbf{g} is admissible. See the proof of [Ler10, Theorem 2.6.6], with a suitable choice of symplectic Euclidean coordinates.

4.B.3. Trace class and Hilbert–Schmidt operators

Proposition 4.B.7 (Weyl quantization as an isometry – [Poo66] and [Ber67, Theorem V]). *The Weyl quantization is an isometry between Hilbert spaces:*

$$\text{Op}^w : L^2(T^*M) \longrightarrow \mathcal{L}^2(L^2(M)).$$

Proposition 4.B.8 (Trace class and duality – [RS80, Theorem VI.26]). *The map*

$$\begin{aligned} \mathcal{L}^1(L^2(M)) &\longrightarrow \mathcal{K}(L^2(M))^* \\ A &\mapsto \text{tr}(A \bullet) \end{aligned}$$

is an isometry.

4.C. Technical lemmata on phase space metrics

This section collects miscellaneous technical results related to Weyl–Hörmander metrics.

4.C.1. Temperate growth of the Hamiltonian

Lemma 4.C.1 (Temperate growth). *Under Assumption 4.1.14, the classical Hamiltonian p satisfies (4.1.37).*

Proof. We let $\rho_0 \in T^*M$ and we do a Taylor expansion of p at ρ_0 :

$$\begin{aligned} \forall \rho \in T^*M, \quad \nabla^\ell p(\rho) &= \nabla^\ell p(\rho_0) + \nabla^{\ell+1} p(\rho_0) \cdot (\rho - \rho_0) + \frac{1}{2} \nabla^{\ell+2} p(\rho_0) \cdot (\rho - \rho_0)^2 \\ &\quad + \int_0^1 \frac{(1-s)^2}{2} \nabla^{\ell+3} p((1-s)\rho_0 + s\rho) \cdot (\rho - \rho_0)^3 ds. \end{aligned}$$

Now using the temperance of the metric g the fact that $\nabla^3 p \in S(h_g^{-1}, g)$ and the admissibility of the weight h_g^{-1} , we obtain

$$\begin{aligned} |\nabla^{\ell+3} p((1-s)\rho_0 + s\rho) \cdot (\rho - \rho_0)^3|_{g_{\rho_0}} &\leq |\rho - \rho_0|_{g_{\rho_0}}^2 |\nabla^{\ell+3} p((1-s)\rho_0 + s\rho)|_{g_{(1-s)\rho_0 + s\rho}} C_g \langle s(\rho - \rho_0) \rangle_{g_{\rho_0}}^{N_g} \\ &\leq C_g \langle \rho - \rho_0 \rangle_{g_{\rho_0}}^{N_g+2} |\nabla^{\ell+3} p|_{S(h_g^{-1}, g)}^{(0)} h_g^{-1}((1-s)\rho_0 + s\rho) \\ &\leq C_g \langle \rho - \rho_0 \rangle_{g_{\rho_0}}^{N_g+2+N} |\nabla^{\ell+3} p|_{S(h_g^{-1}, g)}^{(0)} C h_g^{-1}(\rho_0). \end{aligned}$$

The terms of order 0, 1 and 2 of the Taylor expansion satisfy the same type of estimate. So in the end we obtain

$$|\nabla^\ell p(\rho)|_{g_{\rho_0}^\sigma} \leq |\nabla^\ell p(\rho)|_{g_{\rho_0}} \leq C' \langle \rho - \rho_0 \rangle_{g_{\rho_0}}^{N'}.$$

The constant C' depends on ℓ and ρ_0 , but N' is independent of ℓ . This gives the sought result with $\mathfrak{g} = g_{\rho_0}^\sigma$. \square

4.C.2. Properties of the temperance weight

We start with a justification of the equalities in (4.1.24). We reproduce the argument of If g_1 and g_2 are two definite positive quadratic forms on W , we have for all $\zeta \in W$:

$$\frac{|\zeta|_{g_1^\sigma}}{|\zeta|_{g_2}} = \frac{\sigma(\zeta, g_1^{-1}\sigma\zeta)^2}{|g_1^{-1}\sigma\zeta|_{g_1} |\zeta|_{g_2}} \leq \frac{|\zeta|_{g_2} |g_1^{-1}\sigma\zeta|_{g_2^\sigma}}{|g_1^{-1}\sigma\zeta|_{g_1} |\zeta|_{g_2}} = \frac{|g_1^{-1}\sigma\zeta|_{g_2^\sigma}}{|g_1^{-1}\sigma\zeta|_{g_1}}. \quad (4.C.1)$$

We used the Cauchy-Schwarz inequality

$$|\sigma(\zeta_1, \zeta_2)| = |g(g^{-1}\sigma\zeta_1, \zeta_2)| \leq |g^{-1}\sigma\zeta_1|_g |\zeta_2|_g = |\zeta_1|_{g^\sigma} |\zeta_2|_g, \quad \forall \zeta_1, \zeta_2 \in W.$$

Yet the map $\zeta \mapsto g_1^{-1}\sigma\zeta$ is an isomorphism, and g_1, g_2 play a symmetric role, so taking the infimum and the supremum over $\zeta \neq 0$, we obtain

$$\inf_{\zeta \in W \setminus \{0\}} \frac{|\zeta|_{g_1^\sigma}}{|\zeta|_{g_2}} = \inf_{\zeta \in W \setminus \{0\}} \frac{|\zeta|_{g_2^\sigma}}{|\zeta|_{g_1}} \quad \text{and} \quad \sup_{\zeta \in W \setminus \{0\}} \frac{|\zeta|_{g_1^\sigma}}{|\zeta|_{g_2}} = \sup_{\zeta \in W \setminus \{0\}} \frac{|\zeta|_{g_2^\sigma}}{|\zeta|_{g_1}}.$$

Proof of Proposition 4.1.31. Slow variation of θ_g follows directly from admissibility of g (via 4.1.29 for instance), with the same slow variation radius. The fact that θ_g is comparable to θ'_g (4.1.62) simply follows from norm equivalence in finite dimension. \square

Proposition 4.1.32. We simply write for any $\zeta \in W$:

$$|\zeta|_{g_\rho^\sigma} \leq \theta_g(\rho) |\zeta|_{\mathfrak{g}} \leq \theta_g(\rho) |\zeta|_{g^\sigma} \leq \theta_g(\rho) \theta_g(\rho_0) |\zeta|_{g_{\rho_0}}.$$

The second assertion is proved as follows. For any non-zero $\zeta \in W$:

$$1 = \frac{|\zeta|_{\mathfrak{g}}}{|\zeta|_{g^\sigma}} \times \frac{|\zeta|_{g^\sigma}}{|\zeta|_{\mathfrak{g}}} \leq h_g \theta_g^2,$$

where we took advantage of the fact that $\mathfrak{g} = g^\sigma$. \square

4.C.3. Slow variation radius

To any slowly varying metric, we can associate a number:

$$R_g := \sup \{ r \in \mathbf{R}_+ : \exists C > 0 : \forall \rho_0 \in T^*M, \forall \rho \in B_r^g(\rho_0), C^{-2}g_{\rho_0} \leq g_\rho \leq C^2g_{\rho_0} \} \in [0, +\infty]. \quad (4.C.2)$$

Lemma 4.C.2. *If for any $r < R_g$ we set*

$$C_g(r) := \inf \{ C \in \mathbf{R}_+ : \forall \rho_0, \rho \in T^*M, (|\rho - \rho_0|_{g_{\rho_0}} \leq r \implies C^{-2}g_{\rho_0} \leq g_\rho \leq C^2g_{\rho_0}) \} \in [1, +\infty),$$

we have

$$R_g = +\infty \quad \text{or} \quad C_g(r) \xrightarrow[r \rightarrow r_g^-]{} +\infty.$$

Proof. Indeed, if $R_g < \infty$, we can do the following for any $r \in (0, R_g)$ and $C > C_g(r)$: pick $\rho_0, \rho \in T^*M$ such that $|\rho - \rho_0|_{g_{\rho_0}} \leq r(1 + C^{-1})$. Introducing

$$\rho_1 = \rho_0 + r \frac{\rho - \rho_0}{|\rho - \rho_0|_{g_{\rho_0}}},$$

we have $|\rho_1 - \rho_0|_{g_{\rho_0}} = r$ so that

$$C^{-2}g_{\rho_0} \leq g_{\rho_1} \leq C^2g_{\rho_0}, \quad (4.C.3)$$

which yields in particular

$$|\rho - \rho_1|_{g_{\rho_1}} \leq C|\rho - \rho_1|_{g_{\rho_0}} = C|\rho - \rho_0|_{g_{\rho_0}} \left(1 - \frac{r}{|\rho - \rho_0|_{g_{\rho_0}}}\right) = C(r(1 + C^{-1}) - r) = r.$$

Slow variation again implies

$$C^{-2}g_{\rho_1} \leq g_\rho \leq C^2g_{\rho_1},$$

and therefore, combined with (4.C.3), we obtain

$$C^{-4}g_{\rho_0} \leq g_\rho \leq C^4g_{\rho_0}.$$

That means that $r(1 + C^{-1}) \leq R_g$, which can be rewritten as $C \geq (\frac{R_g}{r} - 1)^{-1}$. Taking the infimum in C , that leads to

$$C_g(r) \geq \frac{r}{R_g - r},$$

which goes to infinity as $r \rightarrow R_g^-$. \square

4.C.4. Improved admissibility

The temperance property introduced in Definition 4.1.6 is not homogeneous under multiplication by a conformal factor. This indicates that temperance as introduced in 4.1.6 is not sharp. Indeed, it turns out that admissible metrics satisfy a stronger temperance property than the one we stated in Definition 4.1.6. It involves the so-called symplectic intermediate metric.

Lemma 4.C.3 (Symplectic intermediate metric – [Ler10, Proposition 2.2.20]). *Let g be an admissible metric. Then the symplectic intermediate metric g^{\natural} defined as the harmonic mean of g and g^σ (see [Ler10, Definition 2.2.19]) is admissible and satisfies*

$$g \leq h_g g^{\natural} \leq g^{\natural} = (g^{\natural})^\sigma \leq h_g^{-1} g^{\natural} \leq g^\sigma.$$

Moreover, any g -admissible weight is also g^{\natural} -admissible.

Proof of Proposition 4.1.29. By [Ler10, Proposition 2.2.20], there exist $C > 0$ and $N \geq 0$ such that

$$\forall \rho_1, \rho_2 \in T^*M, \quad g_{\rho_2} \leq C^2 g_{\rho_1} \langle \rho_2 - \rho_1 \rangle_{(g_{\rho_1}^{\natural} + g_{\rho_2}^{\natural})^\sigma}^{2N}.$$

Given $\rho_0, \rho \in T^*M$, we apply the above inequality to $\rho'_0 \in \bar{B}_r^g(\rho_0)$ and $\rho' \in \bar{B}_r^g(\rho)$ that achieve the minimal distance between the two balls, where $r = \frac{1}{2} \min(R_g, R_{g^{\natural}})$ (see (4.C.2)). Combining this with slow variation of g in each ball yields

$$g_\rho \leq C_g^2(r_g) g_{\rho'} \leq C_g^2(r_g) C^2 \langle \rho'_0 - \rho' \rangle_{(g_{\rho'_0}^{\natural} + g_{\rho'}^{\natural})^\sigma}^{2N} g_{\rho'_0} \leq C_g^4(r_g) C^2 \langle \rho'_0 - \rho' \rangle_{(g_{\rho'_0}^{\natural} + g_{\rho'}^{\natural})^\sigma}^{2N} g_{\rho'}.$$

We finally use slow variation of g^{\natural} on each of the balls to obtain

$$g_\rho \leq C_g^4(R_g/2) C_{g^{\natural}}^2(R_{g^{\natural}}/2) C^2 \langle \rho'_0 - \rho' \rangle_{(g_{\rho'_0}^{\natural} + g_{\rho'}^{\natural})^\sigma}^{2N} g_{\rho'}.$$

Therefore we set $r_g = r$, $C_g = C_g^2(R_g/2) C_{g^{\natural}}^2(R_{g^{\natural}}/2) C$ and $N_g = N$, and the conclusion follows by multiplying on both sides by $e^{2(\Lambda + 2\Upsilon)|t|}$.

We proceed similarly for the weight function; see [Ler10, Proposition 2.2.20 and Lemma 2.2.25]. \square

4.C.5. Equivalent seminorms on spaces of confined symbols

The space $\text{Conf}_g^r(\rho_0)$ can be topologized in two distinct but equivalent ways, measuring the size of derivatives with respect to g or to the constant metric g_{ρ_0} . For a Riemannian metric \tilde{g} , we set

$$|\psi|_{\text{Conf}_g^r(\rho_0), \tilde{g}}^{(\ell)} = \max_{j \leq \ell} \sup_{\rho \in T^*M} \sup_{X_1, X_2, \dots, X_j \in \Gamma(T^*M)} \frac{|\nabla^j \psi(X_1, X_2, \dots, X_j)|(\rho)}{|X_1|_{\tilde{g}} |X_2|_{\tilde{g}} \cdots |X_j|_{\tilde{g}}} \left\langle \text{dist}_{g_{\rho_0}}(\rho, B_r^g(\rho_0)) \right\rangle^\ell. \tag{4.C.4}$$

Lemma 4.C.4 (Equivalent seminorms on $\text{Conf}_g^r(\rho_0)$). *Then there exists an integer k and a constant $C > 0$ such that for any $r < r_g$, we have*

$$\forall \ell \in \mathbf{N}, \forall \psi \in \text{Conf}_g^r(\rho_0), \quad C^{-\ell} |\psi|_{\text{Conf}_g^r(\rho_0), g}^{(\ell)} \leq |\psi|_{\text{Conf}_g^r(\rho_0), g_{\rho_0}}^{(\ell+k)} \leq C^\ell |\psi|_{\text{Conf}_g^r(\rho_0), g}^{(\ell+2k)}.$$

Proof. The proof relies on the improved admissibility property of Proposition 4.1.29:

$$g_\rho \leq C_g^2 \left\langle \text{dist}_{g_{\rho_0}}(\rho, B_r^g(\rho_0)) \right\rangle^{2N} g_{\rho_0},$$

and the same exchanging g_ρ and g_{ρ_0} . Plugging this in the denominator of (4.C.4) gives the desired estimate with $C = C_g$ and $k = \lceil N \rceil$. \square

4.D. Faà di Bruno formula

Before stating the main result on the derivatives of the Hamiltonian flow, we recall and comment the classical Faà di Bruno formula, that allows to compute derivatives of a composition of two functions. We follow the presentation from the appendix of [Ler10]. We redo the proofs as we consider vector valued functions, and not only scalar function. To simplify the writing, we will denote by bold letters multi-indices. For instance, we will write $\mathbf{n} = (n_1, n_2, \dots, n_j) \in \mathbf{N}^j$. The length of such a multi-index is

$$|\mathbf{n}| = n_1 + n_2 + \cdots + n_j.$$

For any smooth function f , we also use the shorthand

$$\nabla^{\mathbf{n}} f.(X^{\mathbf{n}}) = (\nabla^{n_1} f.(X^{n_1}), \nabla^{n_2} f.(X^{n_2}), \dots, \nabla^{n_j} f.(X^{n_j})), \tag{4.D.1}$$

as well as

$$\mathbf{n}! = n_1! n_2! \cdots n_j!$$

Lemma 4.D.1 (Faà di Bruno formula). *Let $H : T^*M \rightarrow TT^*M$ be a vector field and $\phi : T^*M \rightarrow T^*M$ a smooth function. Then for any vector field X on T^*M and any integer $\ell \geq 1$, we have for all $\rho \in T^*M$:*

$$\frac{1}{\ell!} \nabla^\ell (H \circ \phi)_\rho.(X^\ell) = \sum_{j=1}^{\ell} \sum_{\substack{\mathbf{n} \in (\mathbf{N}^*)^j \\ |\mathbf{n}|=\ell}} \frac{1}{j!} (\nabla^j H)_{\phi(\rho)} \cdot \left(\frac{1}{\mathbf{n}!} \nabla^{\mathbf{n}} \phi.(X^{\mathbf{n}}) \right).$$

Proof. We establish the equality by induction. For $\ell = 1$, this is nothing but the chain rule. Suppose the formula is true for some $\ell \geq 1$. We differentiate once again, using the Leibniz formula:

$$\begin{aligned} & \frac{1}{\ell!} \nabla^{\ell+1} (H \circ \phi)_\rho.(X^{\ell+1}) \\ &= \sum_{j=1}^{\ell} \sum_{n_1+n_2+\dots+n_j=\ell} \frac{1}{j!} (\nabla^{j+1} H)_{\phi(\rho)} \cdot \frac{1}{\mathbf{n}!} (\nabla^{n_1} \phi.(X^{n_1}), \nabla^{n_2} \phi.(X^{n_2}), \dots, \nabla^{n_j} \phi.(X^{n_j}), \nabla \phi.X) \\ & \quad + \frac{1}{j!} (\nabla^j H)_{\phi(\rho)} \cdot \left(\frac{1}{n_1!} \nabla^{n_1+1} \phi.(X^{n_1+1}), \frac{1}{n_2!} \nabla^{n_2} \phi.(X^{n_2}), \dots, \frac{1}{n_j!} \nabla^{n_j} \phi.(X^{n_j}) \right) \\ & \quad + \frac{1}{j!} (\nabla^j H)_{\phi(\rho)} \cdot \left(\frac{1}{n_1!} \nabla^{n_1} \phi.(X^{n_1}), \frac{1}{n_2!} \nabla^{n_2+1} \phi.(X^{n_2+1}), \dots, \frac{1}{n_j!} \nabla^{n_j} \phi.(X^{n_j}) \right) \\ & \quad + \cdots \frac{1}{j!} (\nabla^j H)_{\phi(\rho)} \cdot \left(\frac{1}{n_1!} \nabla^{n_1} \phi.(X^{n_1}), \frac{1}{n_2!} \nabla^{n_2} \phi.(X^{n_2}), \dots, \frac{1}{n_j!} \nabla^{n_j+1} \phi.(X^{n_j+1}) \right). \end{aligned}$$

The first term appears when the derivative hits $\nabla^j H$, thus leading to an extra $\nabla\phi.X$ as input vector of the derivative of H , while the other terms correspond to the derivative landing on each derivative of ϕ , according to the Leibniz rule. We symmetrize the term coming from the chain rule:

$$\begin{aligned} & \frac{1}{j!} (\nabla^{j+1} H)_{\phi(\rho)} \cdot \frac{1}{\mathbf{n}!} (\nabla^{n_1} \phi.(X^{n_1}), \nabla^{n_2} \phi.(X^{n_2}), \dots, \nabla^{n_j} \phi.(X^{n_j}), \nabla\phi.X) \\ &= \sum_{k=1}^{j+1} \frac{1}{(j+1)!} (\nabla^{j+1} H)_{\phi(\rho)} \cdot \frac{1}{\mathbf{n}!} (\nabla^{n_1} \phi.(X^{n_1}), \nabla^{n_2} \phi.(X^{n_2}), \dots, \nabla\phi.X, \dots, \nabla^{n_j} \phi.(X^{n_j})), \end{aligned}$$

where $\nabla\phi.X$ is inserted in the k -th slot. Here we used crucially that successive derivatives are symmetric tensors, due to the fact that our connection has vanishing torsion and curvature. So at this stage, it remains to sort out the factorials. As we saw, we have to deal with two types of terms of degree j (that is, containing the j -th derivative of H): those resulting from the chain rule and those resulting from the Leibniz rule. The first and second type of terms correspond respectively to partitions of the form

$$n'_1 + n'_2 + \dots + (n'_k + 1) + \dots + n'_j = \ell + 1, \quad n'_1 + n'_2 + \dots + 1 + \dots + n'_{j-1} = \ell + 1.$$

So we must count how many partitions of the form $n'_1 + n'_2 + \dots + n'_j = \ell$ and $n'_1 + n'_2 + \dots + n'_{j-1} = \ell$ leading to a fixed partition $n_1 + n_2 + \dots + n_j = \ell + 1$ through this process. For any $k \in \{1, 2, \dots, j\}$, we look at how one can produce a new partition at step $\ell + 1$ from a partition at step ℓ , changing only the k -th slot. Either $n_k = 1$ and we can build our partition at step $\ell + 1$ from the same partition with $j - 1$ blocks, without n_k ; or $n_k \geq 2$ and we can build our new partition from the same partition with j blocks, with $n_k - 1 \geq 1$ in place of n_k . In this latter case, we have to take into account an extra factor n_k in order to have the good factorial in front of $\nabla^{n_k} \phi$. Denoting by m the number of indices k such that $n_k = 1$, we get a factor

$$\frac{1}{j!} \left(m + \sum_{n_k \geq 2} n_k \right) = \frac{1}{j!} (n_1 + n_2 + \dots + n_j) = \frac{\ell + 1}{j!}.$$

We obtain the desired result after dividing by $\ell + 1$. □

Remark 4.D.2 (Polarization). Notice that this lemma allows to compute only diagonal elements of the symmetric tensor $\nabla^\ell(H \circ \phi)$. This is not a problem since any tuple $(X_1, X_2, \dots, X_\ell)$ can be written as a sum of tuples having all the same components (this is nothing but polarization of multilinear forms).

Remark 4.D.3 (Combinatorics of the Faà di Bruno formula). The number of terms in the right-hand side of the formula is $2^{\ell-1}$. This can be seen in two ways. For instance in the one-dimensional scalar case, one can apply the formula to the function $f(x) = \frac{x}{1-x}$ at $x = 0$. For any $\ell \in \mathbf{N}^*$, we have $\frac{1}{\ell!} f^{(\ell)}(0) = 1$ from the series expansion, and on the left-hand side of the formula, expanding $(f \circ f)(x) = \frac{x}{1-2x}$ around $x = 0$ tells us that $\frac{1}{\ell!} (f \circ f)^{(\ell)}(0) = 2^{\ell-1}$, hence the result. Otherwise, one can count how many tuples (n_1, n_2, \dots, n_j) of positive integers sum to ℓ . Considering such a tuple is equivalent to the data of the $j - 1$ partial sums $n_1 + n_2 + \dots + n_k$, $k = 1, 2, \dots, j - 1$, that range from 1 to $\ell - 1$. Thus there are $\binom{\ell-1}{j-1}$ such partitions. Summing over $j = 1, 2, \dots, \ell$, one recovers that there are indeed $2^{\ell-1}$ terms in the formula.

Bibliography

- [AFKM15] Nalini Anantharaman, Clotilde Fermanian Kammerer, and Fabricio Macià. Semiclassical completely integrable systems: long-time dynamics and observability via two-microlocal Wigner measures. *Amer. J. Math.*, 137(3):577–638, 2015.
- [AL14] Nalini Anantharaman and Matthieu Léautaud. Sharp polynomial decay rates for the damped wave equation on the torus. *Anal. PDE*, 7(1):159–214, 2014. With an appendix by Stéphane Nonnenmacher.
- [ALM16a] Nalini Anantharaman, Matthieu Léautaud, and Fabricio Macià. Delocalization of quasimodes on the disk. *C. R. Math. Acad. Sci. Paris*, 354(3):257–263, 2016.
- [ALM16b] Nalini Anantharaman, Matthieu Léautaud, and Fabricio Macià. Wigner measures and observability for the Schrödinger equation on the disk. *Invent. Math.*, 206(2):485–599, 2016.
- [AM10] Daniel Azagra and Fabricio Macià. Concentration of symmetric eigenfunctions. *Nonlinear Anal.*, 73(3):683–688, 2010.
- [AM12] Nalini Anantharaman and Fabricio Macià. The dynamics of the Schrödinger flow from the point of view of semiclassical measures. In *Spectral geometry*, volume 84 of *Proc. Sympos. Pure Math.*, pages 93–116. Amer. Math. Soc., Providence, RI, 2012.
- [AM14] Nalini Anantharaman and Fabricio Macià. Semiclassical measures for the Schrödinger equation on the torus. *J. Eur. Math. Soc. (JEMS)*, 16(6):1253–1288, 2014.
- [AM22a] Víctor Arnaiz and Fabricio Macià. Localization and delocalization of eigenmodes of harmonic oscillators. *Proc. Amer. Math. Soc.*, 150(5):2195–2208, 2022.
- [AM22b] Víctor Arnaiz and Fabricio Macià. Concentration of quasimodes for perturbed harmonic oscillators. [arXiv:2206.10307](https://arxiv.org/abs/2206.10307) [math.AP], 2022.
- [AN07] Nalini Anantharaman and Stéphane Nonnenmacher. Half-delocalization of eigenfunctions for the Laplacian on an Anosov manifold. *Ann. Inst. Fourier (Grenoble)*, 57(7):2465–2523, 2007. Festival Yves Colin de Verdière.
- [AN09a] Nalini Anantharaman and Stéphane Nonnenmacher. Chaotic vibrations and strong scars. *Eur. Math. Soc. Newsl.*, (74):19–24, 2009.
- [AN09b] Nalini Anantharaman and Stéphane Nonnenmacher. Vibrations chaotiques et grosses balafres. *Gaz. Math.*, (119):16–32, 2009.
- [Ana08] Nalini Anantharaman. Entropy and the localization of eigenfunctions. *Ann. of Math. (2)*, 168(2):435–475, 2008.
- [Ana10] Nalini Anantharaman. Spectral deviations for the damped wave equation. *Geom. Funct. Anal.*, 20(3):593–626, 2010.
- [AR12] Nalini Anantharaman and Gabriel Rivière. Dispersion and controllability for the Schrödinger equation on negatively curved manifolds. *Anal. PDE*, 5(2):313–338, 2012.
- [AR20] Víctor Arnaiz and Gabriel Rivière. Semiclassical asymptotics for nonselfadjoint harmonic oscillators. *Pure and Applied Analysis, to appear*, 2020.
- [Arn89] Vladimir Igorevich Arnol’d. *Mathematical methods of classical mechanics*, volume 60 of *Graduate Texts in Mathematics*. Springer-Verlag, New York, 1989. Translated from the 1974 Russian original by K. Vogtmann and A. Weinstein, Corrected reprint of the second (1989) edition.
- [BBR10] Jean-François Bony, Nicolas Burq, and Thierry Ramond. Minoration de la résolvante dans le cas captif. *C. R. Math. Acad. Sci. Paris*, 348(23-24):1279–1282, 2010.
- [BBZ13] Jean Bourgain, Nicolas Burq, and Maciej Zworski. Control for Schrödinger operators on 2-tori: rough potentials. *J. Eur. Math. Soc. (JEMS)*, 15(5):1597–1628, 2013.
- [BC15] Nicolas Burq and Hans Christianson. Imperfect geometric control and overdamping for the damped wave equation. *Comm. Math. Phys.*, 336(1):101–130, 2015.
- [Bea74] Richard Beals. Spatially inhomogeneous pseudodifferential operators. II. *Comm. Pure Appl. Math.*, 27:161–205, 1974.
- [Bea75] Richard Beals. A general calculus of pseudodifferential operators. *Duke Math. J.*, 42:1–42, 1975.
- [Bea77] Richard Beals. Characterization of pseudodifferential operators and applications. *Duke Math. J.*, 44(1):45–57, 1977.
- [Bea79] Richard Beals. Correction to: “Characterization of pseudodifferential operators and applications” (*Duke Math. J.* 44 (1977), no. 1, 45–57). *Duke Math. J.*, 46(1):215, 1979.

- [Ber67] Feliks Aleksandrovich Berezin. A certain representation of operators by means of functionals. *Trudy Moskov. Mat. Obšč.*, 17:117–196, 1967.
- [BF73] Richard Beals and Charles Fefferman. Classes of spatially inhomogeneous pseudodifferential operators. *Proc. Nat. Acad. Sci. U.S.A.*, 70:1500–1501, 1973.
- [BF74] Richard Beals and Charles Fefferman. Spatially inhomogeneous pseudodifferential operators. I. *Comm. Pure Appl. Math.*, 27:1–24, 1974.
- [BG20] Nicolas Burq and Patrick Gérard. Stabilization of wave equations on the torus with rough dampings. *Pure Appl. Anal.*, 2(3):627–658, 2020.
- [BGP99] Dario Bambusi, Sandro Graffi, and Thierry Paul. Long time semiclassical approximation of quantum flows: a proof of the Ehrenfest time. *Asymptot. Anal.*, 21(2):149–160, 1999.
- [BH07] Nicolas Burq and Michael Hitrik. Energy decay for damped wave equations on partially rectangular domains. *Math. Res. Lett.*, 14(1):35–47, 2007.
- [BJ16] Nicolas Burq and Romain Joly. Exponential decay for the damped wave equation in unbounded domains. *Commun. Contemp. Math.*, 18(6):1650012, 27, 2016.
- [BLR88] Claude Bardos, Gilles Lebeau, and Jeffrey Rauch. Un exemple d’utilisation des notions de propagation pour le contrôle et la stabilisation de problèmes hyperboliques. *Rend. Sem. Mat. Univ. Politec. Torino*, (Special Issue):11–31 (1989), 1988. Nonlinear hyperbolic equations in applied sciences.
- [BLR92] Claude Bardos, Gilles Lebeau, and Jeffrey Rauch. Sharp sufficient conditions for the observation, control, and stabilization of waves from the boundary. *SIAM J. Control Optim.*, 30:1024–1065, 1992.
- [BLR22] Dario Bambusi, Beatrice Langella, and Marc Rouveyrol. On the stable eigenvalues of perturbed anharmonic oscillators in dimension two. *Comm. Math. Phys.*, 390(1):309–348, 2022.
- [Bon94] Jean-Michel Bony. Opérateurs intégraux de Fourier et calcul de Weyl-Hörmander (cas d’une métrique symplectique). In *Journées “Équations aux Dérivées Partielles” (Saint-Jean-de-Monts, 1994)*, pages Exp. No. IX, 14. École Polytech., Palaiseau, 1994.
- [Bon96] Jean-Michel Bony. Weyl quantization and Fourier integral operators. In *Partial differential equations and mathematical physics (Copenhagen, 1995; Lund, 1995)*, volume 21 of *Progr. Nonlinear Differential Equations Appl.*, pages 45–57. Birkhäuser Boston, Boston, MA, 1996.
- [Bon97] Jean-Michel Bony. Fourier integral operators and Weyl-Hörmander calculus. In *New trends in microlocal analysis (Tokyo, 1995)*, pages 3–21. Springer, Tokyo, 1997.
- [Bon03] Jean-Michel Bony. Evolution equations and microlocal analysis. In *Hyperbolic problems and related topics*, Grad. Ser. Anal., pages 17–40. Int. Press, Somerville, MA, 2003.
- [Bon07] Jean-Michel Bony. Analyse microlocale et équations d’évolution. In *Séminaire: Équations aux Dérivées Partielles. 2006–2007*, Sémin. Équ. Dériv. Partielles, pages Exp. No. XX, 16. École Polytech., Palaiseau, 2007.
- [Bon09] Jean-Michel Bony. Evolution equations and generalized Fourier integral operators. In *Advances in phase space analysis of partial differential equations*, volume 78 of *Progr. Nonlinear Differential Equations Appl.*, pages 59–72. Birkhäuser Boston, Boston, MA, 2009.
- [Bon13] Jean-Michel Bony. On the characterization of pseudodifferential operators (old and new). In *Studies in phase space analysis with applications to PDEs*, volume 84 of *Progr. Nonlinear Differential Equations Appl.*, pages 21–34. Birkhäuser/Springer, New York, 2013.
- [BR02] Abdelkader Bouzouina and Didier Robert. Uniform semiclassical estimates for the propagation of quantum observables. *Duke Math. J.*, 111(2):223–252, 2002.
- [Bur04] Nicolas Burq. Smoothing effect for Schrödinger boundary value problems. *Duke Math. J.*, 123(2):403–427, 2004.
- [BZ04] Nicolas Burq and Maciej Zworski. Geometric control in the presence of a black box. *J. Amer. Math. Soc.*, 17(2):443–471, 2004.
- [BZ12] Nicolas Burq and Maciej Zworski. Control for Schrödinger operators on tori. *Math. Res. Lett.*, 19(2):309–324, 2012.
- [BZ16] Nicolas Burq and Claude Zuily. Concentration of Laplace eigenfunctions and stabilization of weakly damped wave equation. *Comm. Math. Phys.*, 345(3):1055–1076, 2016.
- [BZ19] Nicolas Burq and Maciej Zworski. Rough controls for Schrödinger operators on 2-tori. *Ann. H. Lebesgue*, 2:331–347, 2019.
- [CdV85] Yves Colin de Verdière. Ergodicité et fonctions propres du laplacien. *Comm. Math. Phys.*, 102(3):497–502, 1985.

- [CG23] Yaiza Canzani and Jeffrey Galkowski. Weyl remainders: an application of geodesic beams. *Invent. Math.*, 232(3):1195–1272, 2023.
- [Cha74] Jacques Chazarain. Formule de Poisson pour les variétés riemanniennes. *Invent. Math.*, 24:65–82, 1974.
- [Chi79] Boris V Chirikov. A universal instability of many-dimensional oscillator systems. *Physics Reports*, 52(5):263–379, 1979.
- [Chr07] Hans Christianson. Semiclassical non-concentration near hyperbolic orbits. *J. Funct. Anal.*, 246(2):145–195, 2007.
- [Chr10] Hans Christianson. Corrigendum to “Semiclassical non-concentration near hyperbolic orbits” [J. Funct. Anal. 246 (2) (2007) 145–195]. *J. Funct. Anal.*, 258(3):1060–1065, 2010.
- [Chr11] Hans Christianson. Quantum monodromy and nonconcentration near a closed semi-hyperbolic orbit. *Trans. Amer. Math. Soc.*, 363(7):3373–3438, 2011.
- [CR97] Monique Combescure and Didier Robert. Semiclassical spreading of quantum wave packets and applications near unstable fixed points of the classical flow. *Asymptot. Anal.*, 14(4):377–404, 1997.
- [CSVW14] Hans Christianson, Emmanuel Schenck, András Vasy, and Jared Wunsch. From resolvent estimates to damped waves. *J. Anal. Math.*, 122:143–162, 2014.
- [dB24] Louis Albert de Broglie. *Recherches sur la théorie des quanta*. PhD thesis, Thèse de Doctorat, 1924.
- [Den86] Nils Dencker. The Weyl calculus with locally temperate metrics and weights. *Ark. Mat.*, 24(1):59–79, 1986.
- [DG75] Johannes J. Duistermaat and Victor W. Guillemin. The spectrum of positive elliptic operators and periodic bicharacteristics. *Invent. Math.*, 29(1):39–79, 1975.
- [DG14] Semyon Dyatlov and Colin Guillarmou. Microlocal limits of plane waves and Eisenstein functions. *Ann. Sci. Éc. Norm. Supér. (4)*, 47(2):371–448, 2014.
- [DG17] Semyon Dyatlov and Jeffrey Galkowski. Fractal Weyl laws and wave decay for general trapping. *Nonlinearity*, 30(12):4301–4343, 2017.
- [DH72] Johannes J. Duistermaat and Lars Hörmander. Fourier integral operators. II. *Acta Mathematica*, 128(none):183 – 269, 1972.
- [DJ18] Semyon Dyatlov and Long Jin. Semiclassical measures on hyperbolic surfaces have full support. *Acta Math.*, 220(2):297–339, 2018.
- [DJN22] Semyon Dyatlov, Long Jin, and Stéphane Nonnenmacher. Control of eigenfunctions on surfaces of variable curvature. *J. Amer. Math. Soc.*, 35(2):361–465, 2022.
- [DL09] Belhassen Dehman and Gilles Lebeau. Analysis of the HUM control operator and exact controllability for semilinear waves in uniform time. *SIAM J. Control Optim.*, 48(2):521–550, 2009.
- [DLRL14] Belhassen Dehman, Jérôme Le Rousseau, and Matthieu Léautaud. Controllability of two coupled wave equations on a compact manifold. *Arch. Ration. Mech. Anal.*, 211(1):113–187, 2014.
- [Doi05] Shin-ichi Doi. Smoothness of solutions for Schrödinger equations with unbounded potentials. *Publ. Res. Inst. Math. Sci.*, 41(1):175–221, 2005.
- [DR77] Szymon Dolecki and David L. Russell. A general theory of observation and control. *SIAM J. Control Optim.*, 15(2):185–220, 1977.
- [DS99] Mouez Dimassi and Johannes Sjöstrand. *Spectral asymptotics in the semi-classical limit*, volume 268 of *London Mathematical Society Lecture Note Series*. Cambridge University Press, Cambridge, 1999.
- [DSV23] Alexander Dicke, Albrecht Seelmann, and Ivan Veselić. Correction: Uncertainty Principle for Hermite Functions and Null-Controllability with Sensor Sets of Decaying Density. *J. Fourier Anal. Appl.*, 29(2):Paper No. 18, 2023.
- [Dur] Arnaud Durand. Topics in metric number theory. Lecture notes, https://www.imo.universite-paris-saclay.fr/~arnaud.durand/files/topics_mnt.pdf.
- [Dya15] Semyon Dyatlov. Resonance projectors and asymptotics for r -normally hyperbolic trapped sets. *J. Amer. Math. Soc.*, 28(2):311–381, 2015.
- [Dya19] Semyon Dyatlov. An introduction to fractal uncertainty principle. *J. Math. Phys.*, 60(8):081505, 31, 2019.
- [DZ16] Semyon Dyatlov and Maciej Zworski. Dynamical zeta functions for Anosov flows via microlocal analysis. *Ann. Sci. Éc. Norm. Supér. (4)*, 49(3):543–577, 2016.

- [DZ19] Semyon Dyatlov and Maciej Zworski. *Mathematical theory of scattering resonances*, volume 200 of *Graduate Studies in Mathematics*. American Mathematical Society, Providence, RI, 2019.
- [EG15] Lawrence C. Evans and Ronald F. Gariepy. *Measure theory and fine properties of functions*. Textbooks in Mathematics. CRC Press, Boca Raton, FL, revised edition, 2015.
- [Ego69] Yuriĭ Vladimirovich Egorov. The canonical transformations of pseudodifferential operators. *Uspehi Mat. Nauk*, 24(5(149)):235–236, 1969.
- [EN00] Klaus-Jochen Engel and Rainer Nagel. *One-parameter semigroups for linear evolution equations*, volume 194 of *Graduate Texts in Mathematics*. Springer-Verlag, New York, 2000.
- [ER17] Suresh Eswarathan and Gabriel Rivière. Perturbation of the semiclassical Schrödinger equation on negatively curved surfaces. *J. Inst. Math. Jussieu*, 16(4):787–835, 2017.
- [EW11] Manfred Einsiedler and Thomas Ward. *Ergodic theory with a view towards number theory*, volume 259 of *Graduate Texts in Mathematics*. Springer-Verlag London, Ltd., London, 2011.
- [FK00] Clotilde Fermanian Kammerer. Mesures semi-classiques 2-microlocales. *C. R. Acad. Sci. Paris Sér. I Math.*, 331(7):515–518, 2000.
- [FK05] Clotilde Fermanian Kammerer. Analyse à deux échelles d’une suite bornée de L^2 sur une sous-variété du cotangent. *C. R. Math. Acad. Sci. Paris*, 340(4):269–274, 2005.
- [FKG02] Clotilde Fermanian Kammerer and Patrick Gérard. Mesures semi-classiques et croisement de modes. *Bull. Soc. Math. France*, 130(1):123–168, 2002.
- [FN04] Frédéric Faure and Stéphane Nonnenmacher. On the maximal scarring for quantum cat map eigenstates. *Comm. Math. Phys.*, 245(1):201–214, 2004.
- [FNDB03] Frédéric Faure, Stéphane Nonnenmacher, and Stephan De Bièvre. Scarred eigenstates for quantum cat maps of minimal periods. *Comm. Math. Phys.*, 239(3):449–492, 2003.
- [Fol89] Gerald B. Folland. *Harmonic analysis in phase space*, volume 122 of *Annals of Mathematics Studies*. Princeton University Press, Princeton, NJ, 1989.
- [FS11] Frédéric Faure and Johannes Sjöstrand. Upper bound on the density of Ruelle resonances for Anosov flows. *Comm. Math. Phys.*, 308(2):325–364, 2011.
- [FT23a] Frédéric Faure and Masato Tsujii. Fractal Weyl law for the Ruelle spectrum of Anosov flows. *Ann. H. Lebesgue*, 6:331–426, 2023.
- [FT23b] Frédéric Faure and Masato Tsujii. Micro-local analysis of contact Anosov flows and band structure of the Ruelle spectrum. [arXiv:2102.11196](https://arxiv.org/abs/2102.11196) [math.DS], 2023.
- [Gea78] Larry Gearhart. Spectral theory for contraction semigroups on Hilbert space. *Trans. Amer. Math. Soc.*, 236:385–394, 1978.
- [Gér91a] Patrick Gérard. Mesures semi-classiques et ondes de Bloch. In *Séminaire sur les Équations aux Dérivées Partielles, 1990–1991*, pages Exp. No. XVI, 19. École Polytech., Palaiseau, 1991.
- [Gér91b] Patrick Gérard. Microlocal defect measures. *Comm. Partial Differential Equations*, 16(11):1761–1794, 1991.
- [GL93] Patrick Gérard and Éric Leichtnam. Ergodic properties of eigenfunctions for the Dirichlet problem. *Duke Math. J.*, 71(2):559–607, 1993.
- [Ham28] William Rowan Hamilton. *Theory of Systems of Rays*. Number vol. 4 in *Theory of Systems of Rays*. 1828.
- [Har89] Alain Haraux. Séries lacunaires et contrôle semi-interne des vibrations d’une plaque rectangulaire. *J. Math. Pures Appl. (9)*, 68(4):457–465 (1990), 1989.
- [Har96] Lawrence A. Harris. Bernstein’s polynomial inequalities and functional analysis. *Irish Math. Soc. Bull.*, (36):19–33, 1996.
- [Has10] Andrew Hassell. Ergodic billiards that are not quantum unique ergodic. *Ann. of Math. (2)*, 171(1):605–619, 2010. With an appendix by the author and Luc Hillairet.
- [HHM09] Andrew Hassell, Luc Hillairet, and Jeremy Marzuola. Eigenfunction concentration for polygonal billiards. *Comm. Partial Differential Equations*, 34(4-6):475–485, 2009.
- [Hit03] Michael Hitrik. Eigenfrequencies and expansions for damped wave equations. *Methods Appl. Anal.*, 10(4):543–564, 2003.
- [Hör67] Lars Hörmander. Pseudo-differential operators and hypoelliptic equations. In *Singular Integrals (Proc. Sympos. Pure Math., Chicago, Ill., 1966)*, pages 138–183. Amer. Math. Soc., Providence, RI, 1967.
- [Hör71a] Lars Hörmander. Fourier integral operators. I. *Acta Mathematica*, 127(none):79 – 183, 1971.
- [Hör71b] Lars Hörmander. On the existence and the regularity of solutions of linear pseudo-differential equations. *Enseign. Math. (2)*, 17:99–163, 1971.

- [Hör79] Lars Hörmander. The Weyl calculus of pseudodifferential operators. *Comm. Pure Appl. Math.*, 32(3):360–444, 1979.
- [Hör85] Lars Hörmander. *The Analysis of Linear Partial Differential Operators*, volume III. Springer-Verlag, 1985. Second printing 1994.
- [Hör94] Lars Hörmander. *The analysis of linear partial differential operators. IV*, volume 275 of *Grundlehren der Mathematischen Wissenschaften*. Springer-Verlag, Berlin, 1994. Fourier integral operators, Corrected reprint of the 1985 original.
- [HS04] Michael Hitrik and Johannes Sjöstrand. Non-selfadjoint perturbations of selfadjoint operators in 2 dimensions. I. *Ann. Henri Poincaré*, 5(1):1–73, 2004.
- [HS05] Michael Hitrik and Johannes Sjöstrand. Nonselfadjoint perturbations of selfadjoint operators in two dimensions. II. Vanishing averages. *Comm. Partial Differential Equations*, 30(7-9):1065–1106, 2005.
- [HS08a] Michael Hitrik and Johannes Sjöstrand. Non-selfadjoint perturbations of selfadjoint operators in two dimensions. IIIa. One branching point. *Canad. J. Math.*, 60(3):572–657, 2008.
- [HS08b] Michael Hitrik and Johannes Sjöstrand. Rational invariant tori, phase space tunneling, and spectra for non-selfadjoint operators in dimension 2. *Ann. Sci. Éc. Norm. Supér. (4)*, 41(4):511–571, 2008.
- [Hua85] Fa Lun Huang. Characteristic conditions for exponential stability of linear dynamical systems in Hilbert spaces. *Ann. Differential Equations*, 1(1):43–56, 1985.
- [HWW22] Shanlin Huang, Gengsheng Wang, and Ming Wang. Observable sets, potentials and Schrödinger equations. *Comm. Math. Phys.*, 395(3):1297–1343, 2022.
- [Jaf90] Stéphane Jaffard. Contrôle interne exact des vibrations d’une plaque rectangulaire. *Portugal. Math.*, 47(4):423–429, 1990.
- [Jak97] Dmitry Jakobson. Quantum limits on flat tori. *Ann. of Math. (2)*, 145(2):235–266, 1997.
- [Jin18] Long Jin. Control for Schrödinger equation on hyperbolic surfaces. *Math. Res. Lett.*, 25(6):1865–1877, 2018.
- [Jin20] Long Jin. Damped wave equations on compact hyperbolic surfaces. *Comm. Math. Phys.*, 373(3):771–794, 2020.
- [JZ99] Dmitry Jakobson and Steve Zelditch. Classical limits of eigenfunctions for some completely integrable systems. In *Emerging applications of number theory (Minneapolis, MN, 1996)*, volume 109 of *IMA Vol. Math. Appl.*, pages 329–354. Springer, New York, 1999.
- [KN65] Joseph J. Kohn and Louis Nirenberg. An algebra of pseudo-differential operators. *Comm. Pure Appl. Math.*, 18:269–305, 1965.
- [Kom92] Vilmos Komornik. On the exact internal controllability of a Petrowsky system. *J. Math. Pures Appl. (9)*, 71(4):331–342, 1992.
- [Lau14] Camille Laurent. Internal control of the Schrödinger equation. *Math. Control Rel. Fields*, 4(2):161–186, 2014.
- [LBM23] Kévin Le Balc’h and Jérémy Martin. Observability estimates for the Schrödinger equation in the plane with periodic bounded potentials from measurable sets. [arXiv:2304.08050](https://arxiv.org/abs/2304.08050) [math.AP], 2023.
- [Leb92a] Gilles Lebeau. Control for hyperbolic equations. In *Journées “Équations aux Dérivées Partielles” (Saint-Jean-de-Monts, 1992)*, page 24. École Polytech., Palaiseau, 1992.
- [Leb92b] Gilles Lebeau. Contrôle de l’équation de Schrödinger. *J. Math. Pures Appl. (9)*, 71(3):267–291, 1992.
- [Leb96] Gilles Lebeau. Équation des ondes amorties. In *Algebraic and geometric methods in mathematical physics (Kaciveli, 1993)*, volume 19 of *Math. Phys. Stud.*, pages 73–109. Kluwer Acad. Publ., Dordrecht, 1996.
- [Lee09] Jeffrey M. Lee. *Manifolds and differential geometry*, volume 107 of *Graduate Studies in Mathematics*. American Mathematical Society, Providence, RI, 2009.
- [Lee18] John M. Lee. *Introduction to Riemannian manifolds*, volume 176 of *Graduate Texts in Mathematics*. Springer, Cham, second edition, 2018.
- [Ler10] Nicolas Lerner. *Metrics on the phase space and non-selfadjoint pseudo-differential operators*. Birkhäuser Verlag, Basel, 2010.
- [Ler14] Nicolas Lerner. *A course on integration theory*. Birkhäuser/Springer, Basel, 2014. Including more than 150 exercises with detailed answers.

- [Lin06] Elon Lindenstrauss. Invariant measures and arithmetic quantum unique ergodicity. *Ann. of Math. (2)*, 163(1):165–219, 2006.
- [Lio88] Jacques-Louis Lions. *Contrôlabilité exacte, perturbations et stabilisation de systèmes distribués. Tome 1*, volume 8 of *Recherches en Mathématiques Appliquées*. Masson, Paris, 1988.
- [Lis57] Jules Lissajous. Mémoire sur l'étude optique des mouvements vibratoires. *Annal. Chim. Phys.*, 51:147–231, 1857.
- [LL16] Camille Laurent and Matthieu Léautaud. Uniform observability estimates for linear waves. *ESAIM Control Optim. Calc. Var.*, 22(4):1097–1136, 2016.
- [LL17] Matthieu Léautaud and Nicolas Lerner. Energy decay for a locally undamped wave equation. *Ann. Fac. Sci. Toulouse Math. (6)*, 26(1):157–205, 2017.
- [LP93] Pierre-Louis Lions and Thierry Paul. Sur les mesures de Wigner. *Rev. Mat. Iberoamericana*, 9(3):553–618, 1993.
- [LR05] Zhuangyi Liu and Bopeng Rao. Characterization of polynomial decay rate for the solution of linear evolution equation. *Z. Angew. Math. Phys.*, 56(4):630–644, 2005.
- [LRLR22a] Jérôme Le Rousseau, Gilles Lebeau, and Luc Robbiano. *Elliptic Carleman estimates and applications to stabilization and controllability. Vol. I. Dirichlet boundary conditions on Euclidean space*, volume 97 of *Progress in Nonlinear Differential Equations and their Applications*. Birkhäuser/Springer, Cham, ©2022. PNLDE Subseries in Control.
- [LRLR22b] Jérôme Le Rousseau, Gilles Lebeau, and Luc Robbiano. *Elliptic Carleman estimates and applications to stabilization and controllability. Vol. II. General boundary conditions on Riemannian manifolds*, volume 98 of *Progress in Nonlinear Differential Equations and their Applications*. Birkhäuser/Springer, Cham, ©2022. PNLDE Subseries in Control.
- [Lé23] Matthieu Léautaud. Long time energy averages and a lower resolvent estimate for damped waves. [arXiv:2309.12709](https://arxiv.org/abs/2309.12709) [math.AP], 2023.
- [Mac08] Fabricio Macià. Some remarks on quantum limits on Zoll manifolds. *Comm. Partial Differential Equations*, 33(4-6):1137–1146, 2008.
- [Mac10] Fabricio Macià. High-frequency propagation for the Schrödinger equation on the torus. *J. Funct. Anal.*, 258(3):933–955, 2010.
- [Mac15] Fabricio Macià. High-frequency dynamics for the Schrödinger equation, with applications to dispersion and observability. In *Nonlinear optical and atomic systems*, volume 2146 of *Lecture Notes in Math.*, pages 275–335. Springer, Cham, 2015.
- [Mar02] André Martinez. *An introduction to semiclassical and microlocal analysis*. Universitext. Springer-Verlag, New York, 2002.
- [Mar22] Jérémy Martin. Spectral inequalities for anisotropic shubin operators. [arXiv:2205.11868](https://arxiv.org/abs/2205.11868) [math.AP], 2022.
- [Mil96] Luc Miller. *Propagation d'ondes semi-classiques à travers une interface et mesures 2-microlocales*. PhD thesis, École Polytechnique, Palaiseau, 1996.
- [Mil97] Luc Miller. Short waves through thin interfaces and 2-microlocal measures. In *Journées “Équations aux Dérivées Partielles” (Saint-Jean-de-Monts, 1997)*, pages Exp. No. XII, 12. École Polytech., Palaiseau, 1997.
- [Mil05] Luc Miller. Controllability cost of conservative systems: resolvent condition and transmutation. *J. Funct. Anal.*, 218(2):425–444, 2005.
- [Mil12] Luc Miller. Resolvent conditions for the control of unitary groups and their approximations. *J. Spectr. Theory*, 2(1):1–55, 2012.
- [MN] Fabricio Macià and Shu Nakamura. Observability for Schrödinger flows in unbounded geometries. unpublished.
- [MN09] Shikuan Mao and Shu Nakamura. Wave front set for solutions to perturbed harmonic oscillators. *Comm. Partial Differential Equations*, 34(4-6):506–519, 2009.
- [MPS21] Jérémy Martin and Karel Pravda-Starov. Geometric conditions for the exact controllability of fractional free and harmonic Schrödinger equations. *J. Evol. Equ.*, 21(1):1059–1087, 2021.
- [MR16] Fabricio Macià and Gabriel Rivière. Concentration and non-concentration for the Schrödinger evolution on Zoll manifolds. *Comm. Math. Phys.*, 345(3):1019–1054, 2016.
- [MR18] Fabricio Macià and Gabriel Rivière. Two-microlocal regularity of quasimodes on the torus. *Anal. PDE*, 11(8):2111–2136, 2018.
- [MR19] Fabricio Macià and Gabriel Rivière. Observability and quantum limits for the Schrödinger equation on \mathbb{S}^d . In *Probabilistic methods in geometry, topology and spectral theory*, volume 739 of *Contemp. Math.*, pages 139–153. Amer. Math. Soc., Providence, RI, ©2019.

- [Nie96] Francis Nier. A semi-classical picture of quantum scattering. *Ann. Sci. École Norm. Sup. (4)*, 29(2):149–183, 1996.
- [Non13] Stéphane Nonnenmacher. Anatomy of quantum chaotic eigenstates. In *Chaos*, volume 66 of *Prog. Math. Phys.*, pages 193–238. Birkhäuser/Springer, Basel, 2013.
- [NZ09] Stéphane Nonnenmacher and Maciej Zworski. Quantum decay rates in chaotic scattering. *Acta Math.*, 203(2):149–233, 2009.
- [NZ15] Stéphane Nonnenmacher and Maciej Zworski. Decay of correlations for normally hyperbolic trapping. *Invent. Math.*, 200(2):345–438, 2015.
- [Paz83] Amnon Pazy. *Semigroups of Linear Operators and Applications to Partial Differential Equations*. Springer-Verlag, New York, 1983.
- [Phu01] Kim Dang Phung. Observability and control of Schrödinger equations. *SIAM J. Control Optim.*, 40(1):211–230, 2001.
- [Phu07] Kim Dang Phung. Mémoire d’Habilitation à diriger des Recherches. 2007.
- [Phu08] Kim Dang Phung. Boundary stabilization for the wave equation in a bounded cylindrical domain. *Discrete Contin. Dyn. Syst.*, 20(4):1057–1093, 2008.
- [Poo66] James C. T. Pool. Mathematical aspects of the Weyl correspondence. *J. Mathematical Phys.*, 7:66–76, 1966.
- [Pro23] Antoine Prouff. Observability of the Schrödinger equation with subquadratic confining potential in the Euclidean space. [arXiv:2307.00839](https://arxiv.org/abs/2307.00839) [math.AP], 2023. Accepted in *Analysis & PDE*.
- [Prü84] Jan Prüss. On the spectrum of C_0 -semigroups. *Trans. Amer. Math. Soc.*, 284(2):847–857, 1984.
- [PTZ16] Yannick Privat, Emmanuel Trélat, and Enrique Zuazua. Optimal observability of the multi-dimensional wave and Schrödinger equations in quantum ergodic domains. *J. Eur. Math. Soc. (JEMS)*, 18(5):1043–1111, 2016.
- [Ral69] James V. Ralston. Solutions of the wave equation with localized energy. *Comm. Pure Appl. Math.*, 22:807–823, 1969.
- [RC21] Didier Robert and Monique Combescure. *Coherent states and applications in mathematical physics*. Theoretical and Mathematical Physics. Springer, Cham, ©2021. Second edition.
- [Riv10a] Gabriel Rivière. Entropy of semiclassical measures for nonpositively curved surfaces. *Ann. Henri Poincaré*, 11(6):1085–1116, 2010.
- [Riv10b] Gabriel Rivière. Entropy of semiclassical measures in dimension 2. *Duke Math. J.*, 155(2):271–336, 2010.
- [Riv12] Gabriel Rivière. Delocalization of slowly damped eigenmodes on Anosov manifolds. *Comm. Math. Phys.*, 316(2):555–593, 2012.
- [Riv14] Gabriel Rivière. Eigenmodes of the damped wave equation and small hyperbolic subsets. *Ann. Inst. Fourier (Grenoble)*, 64(3):1229–1267, 2014. With an appendix by Stéphane Nonnenmacher and Rivière.
- [Rob87] Didier Robert. *Autour de l’approximation semi-classique*, volume 68 of *Progress in Mathematics*. Birkhäuser Boston, Inc., Boston, MA, 1987.
- [Rob13] Luc Robbiano. Kato smoothing effect for Schrödinger operator. In *Studies in phase space analysis with applications to PDEs*, volume 84 of *Progr. Nonlinear Differential Equations Appl.*, pages 355–369. Birkhäuser/Springer, New York, 2013.
- [Rou23] Marc Roveyrol. Stabilization of the wave equation on larger-dimension tori with rough dampings. [arXiv:2303.03733](https://arxiv.org/abs/2303.03733) [math.AP], 2023.
- [Roy10] Julien Royer. *Analyse haute fréquence de l’équation de Helmholtz dissipative*. Thèse de Doctorat. Université de Nantes, 2010. <http://www.math.sciences.univ-nantes.fr/~jroyer/these.pdf>.
- [Roy18] Julien Royer. Energy decay for the Klein-Gordon equation with highly oscillating damping. *Ann. H. Lebesgue*, 1:297–312, 2018.
- [RS75] Michael Reed and Barry Simon. *Methods of modern mathematical physics. II. Fourier analysis, self-adjointness*. Academic Press [Harcourt Brace Jovanovich, Publishers], New York-London, 1975.
- [RS80] Michael Reed and Barry Simon. *Methods of modern mathematical physics. I*. Academic Press, Inc. [Harcourt Brace Jovanovich, Publishers], New York, second edition, 1980. Functional analysis.
- [RS94] Zeév Rudnick and Peter Sarnak. The behaviour of eigenstates of arithmetic hyperbolic manifolds. *Comm. Math. Phys.*, 161(1):195–213, 1994.

- [RT74] Jeffrey Rauch and Michael Taylor. Exponential decay of solutions to hyperbolic equations in bounded domains. *Indiana Univ. Math. J.*, 24:79–86, 1974.
- [RTTT05] Karim Ramdani, Takéo Takahashi, Gérald Tenenbaum, and Marius Tucsnak. A spectral approach for the exact observability of infinite-dimensional systems with skew-adjoint generator. *J. Funct. Anal.*, 226(1):193–229, 2005.
- [RZ08] Luc Robbiano and Claude Zuily. Remark on the Kato smoothing effect for Schrödinger equation with superquadratic potentials. *Comm. Partial Differential Equations*, 33(4-6):718–727, 2008.
- [RZ09] Luc Robbiano and Claude Zuily. The Kato smoothing effect for Schrödinger equations with unbounded potentials in exterior domains. *Int. Math. Res. Not. IMRN*, (9):1636–1698, 2009.
- [Sch26a] Erwin Schrödinger. Der stetige übergang von der mikro- zur makromechanik. *Naturwissenschaften*, 14:664–666, 1926.
- [Sch26b] Erwin Schrödinger. An undulatory theory of the mechanics of atoms and molecules. *Phys. Rev.*, 28:1049–1070, Dec 1926.
- [Sch91] Wolfgang M. Schmidt. *Diophantine approximations and Diophantine equations*, volume 1467 of *Lecture Notes in Mathematics*. Springer-Verlag, Berlin, 1991.
- [Sch10] Emmanuel Schenck. Energy decay for the damped wave equation under a pressure condition. *Comm. Math. Phys.*, 300(2):375–410, 2010.
- [Sch11] Emmanuel Schenck. Exponential stabilization without geometric control. *Math. Res. Lett.*, 18(2):379–388, 2011.
- [Sjö00] Johannes Sjöstrand. Asymptotic distribution of eigenfrequencies for damped wave equations. *Publ. Res. Inst. Math. Sci.*, 36(5):573–611, 2000.
- [Šni74] Alexander I. Šnirel'man. Ergodic properties of eigenfunctions. *Uspehi Mat. Nauk*, 29(6(180)):181–182, 1974.
- [Son04] Jonathan Sondow. Irrationality measures, irrationality bases, and a theorem of Jarnik. [arXiv:math/0406300](https://arxiv.org/abs/math/0406300) [math.NT], 2004.
- [SR11] Arnold Sommerfeld and Iris Runge. Anwendung der Vektorrechnung auf die Grundlagen der geometrischen Optik. *Annalen der Physik*, 340(7):277–298, 1911.
- [SSY23] Pei Su, Chenmin Sun, and Xu Yuan. Quantitative observability for one-dimensional Schrödinger equations with potentials. [arXiv:2309.00963](https://arxiv.org/abs/2309.00963) [math.AP], 2023.
- [Str81] Karl R. Stromberg. *An introduction to classical real analysis*. AMS Chelsea Publishing, Providence, RI, 1981. 2015, corrected reprint of the 1981 original.
- [Sun23] Chenmin Sun. Sharp decay rate for the damped wave equation with convex-shaped damping. *Int. Math. Res. Not. IMRN*, (7):5905–5973, 2023.
- [Tar90] Luc Tartar. H -measures, a new approach for studying homogenisation, oscillations and concentration effects in partial differential equations. *Proc. Roy. Soc. Edinburgh Sect. A*, 115(3-4):193–230, 1990.
- [Tay91] Michael E. Taylor. *Pseudodifferential operators and nonlinear PDE*, volume 100 of *Progress in Mathematics*. Birkhäuser Boston, Inc., Boston, MA, 1991.
- [Tay96] Michael E. Taylor. *Partial Differential Equations 2: Qualitative Studies of Linear Equations*, volume 116 of *Applied Mathematical Sciences*. Springer-Verlag, New-York, 1996.
- [TEM⁺89] A. Tonomura, J. Endo, T. Matsuda, T. Kawasaki, and H. Ezawa. Demonstration of single-electron buildup of an interference pattern. *Am. J. Phys*, 57(2):117–120, 1989.
- [Trè67] François Trèves. *Topological vector spaces, distributions and kernels*. Academic Press, New York-London, 1967.
- [TW09] Marius Tucsnak and George Weiss. *Observation and control for operator semigroups*. Birkhäuser Advanced Texts: Basel Textbooks. Birkhäuser Verlag, Basel, 2009.
- [Tä22] Matthias Täufer. Controllability of the Schrödinger equation on unbounded domains without geometric control condition. [arXiv:2206.10204](https://arxiv.org/abs/2206.10204) [math.AP], 2022.
- [Van97] Jeffrey M. VanderKam. L^∞ norms and quantum ergodicity on the sphere. *Internat. Math. Res. Notices*, (7):329–347, 1997.
- [Van98] Jeffrey M. VanderKam. Correction to: “ L^∞ norms and quantum ergodicity on the sphere” [Internat. Math. Res. Notices **1997**, no. 7, 329–347; MR 99d::58175]. *Internat. Math. Res. Notices*, (1):65, 1998.
- [Wan24] Ruoyu P. T. Wang. Exponential decay for damped Klein–Gordon equations on asymptotically cylindrical and conic manifolds. *Annales de l'Institut Fourier*, 2024. Online first.

- [Wat23] Alden Waters. Observability for Schrödinger equations with quadratic Hamiltonians. *Partial Differ. Equ. Appl.*, 4(2):Paper No. 12, 33, 2023.
- [WDX23] Longben Wei, Zhiwen Duan, and Hui Xu. Geometric conditions for the exact observability of Schrödinger equations with point interaction and inverse-square potentials on half-line. [arXiv:2307.09592](https://arxiv.org/abs/2307.09592) [math.AP], 2023.
- [Wig32] Eugene P. Wigner. On the quantum correction for thermodynamic equilibrium. *Phys. Rev.*, 40:749–759, 1932.
- [Wun17] Jared Wunsch. Periodic damping gives polynomial energy decay. *Math. Res. Lett.*, 24(2):571–580, 2017.
- [You04] Thomas Young. Experimental demonstration of the general law of the interference of light. *Philosophical Transactions of the Royal society of London*, 94(1804):1, 1804.
- [Zas81] George M. Zaslavsky. Stochasticity in quantum systems. *Physics Reports*, 80(3):157–250, 1981.
- [Zel87] Steven Zelditch. Uniform distribution of eigenfunctions on compact hyperbolic surfaces. *Duke Math. J.*, 55(4):919–941, 1987.
- [Zel92] Steven Zelditch. Quantum ergodicity on the sphere. *Comm. Math. Phys.*, 146(1):61–71, 1992.
- [Zhu18] Hui Zhu. Stabilization of damped waves on spheres and Zoll surfaces of revolution. *ESAIM Control Optim. Calc. Var.*, 24(4):1759–1788, 2018.
- [Zua91] Enrique Zuazua. Exponential decay for the semilinear wave equation with localized damping in unbounded domains. *J. Math. Pures Appl. (9)*, 70(4):513–529, 1991.
- [Zwo12] Maciej Zworski. *Semiclassical analysis*, volume 138 of *Graduate Studies in Mathematics*. American Mathematical Society, Providence, RI, 2012.
- [ZZ96] Steven Zelditch and Maciej Zworski. Ergodicity of eigenfunctions for ergodic billiards. *Comm. Math. Phys.*, 175(3):673–682, 1996.