



HAL
open science

Subshifts of Finite Type on Groups : Emptiness and Aperiodicity

Nicolás Bitar

► **To cite this version:**

Nicolás Bitar. Subshifts of Finite Type on Groups : Emptiness and Aperiodicity. Dynamical Systems [math.DS]. Université Paris-Saclay, 2024. English. NNT : 2024UPASG034 . tel-04635844

HAL Id: tel-04635844

<https://theses.hal.science/tel-04635844>

Submitted on 4 Jul 2024

HAL is a multi-disciplinary open access archive for the deposit and dissemination of scientific research documents, whether they are published or not. The documents may come from teaching and research institutions in France or abroad, or from public or private research centers.

L'archive ouverte pluridisciplinaire **HAL**, est destinée au dépôt et à la diffusion de documents scientifiques de niveau recherche, publiés ou non, émanant des établissements d'enseignement et de recherche français ou étrangers, des laboratoires publics ou privés.

Subshifts of Finite Type on Groups: Emptiness and Aperiodicity

*Sous-décalages de type fini sur des groupes :
problèmes du vide et d'apériodicité*

Thèse de doctorat de l'université Paris-Saclay

École doctorale n°580 :
Sciences et technologies de l'information et de la communication (STIC)
Spécialité de doctorat : Informatique mathématique
Graduate School : Informatique et sciences du numérique
Réfèrent : Faculté des sciences d'Orsay

Thèse préparée dans l'unité de recherche **Laboratoire interdisciplinaire des sciences du numérique**
(**CNRS, Université Paris-Saclay**), sous la direction de
Nathalie AUBRUN, Chargée de Recherche CNRS

Thèse soutenue à Paris-Saclay, le 28 juin 2024, par

Nicolás BITAR

Composition du jury

Membres du jury avec voix délibérative

Emmanuel JEANDEL Professeur, Université de Lorraine (LORIA)	Président
Laurent BARTHOLDI Professeur, Universität des Saarlandes (Allemagne)	Rapporteur & Examineur
Jarkko KARI Professeur, Turun Yliopisto (Finlande)	Rapporteur & Examineur
Irène MARCOVICI Professeure, Université de Rouen Normandie (LMRS)	Examinatrice
Samuel PETITE Professeur, Université de Picardie Jules Verne (LAMFA)	Examineur
Matthieu PICANTIN Maître de Conférences, Université Paris-Cité (IRIF)	Examineur
Guillaume THEYSSIER Chargé de Recherche, CNRS, Université d'Aix-Marseille (I2M)	Examineur

Titre: Sous-décalage de type fini sur des groupes : problèmes du vide et d'apériodicité

Mots clés: pavages, sous-décalages de type fini, groupes de type fini, apériodicité, substitutions, calculabilité.

Résumé: Un sous-décalage de type fini est un ensemble de pavages d'un groupe sujet à un nombre fini de contraintes locales, où le groupe agit par translation. Ces dernières années, de nombreux progrès ont été réalisés dans la compréhension de leurs propriétés dynamiques et calculatoires. Le but de cette thèse est de poursuivre cette étude sur la manière dont les propriétés algébriques et géométriques du groupe sous-jacent influencent les propriétés des sous-décalages de type fini définis sur le groupe. Les résultats sont regroupés en trois grandes catégories : décidabilité, apériodicité et substitutions.

Dans la première partie, nous étudions le problème du domino, ses variantes, et les conséquences de son indécidabilité sur de nombreux groupes de type fini. Nous classifions la calculabilité du Problème du Domino à Première Tuile Fixée, du Problème du Domino Récurrent, du Problème k -SAT, et des Problèmes du Domino Serpent pour de nombreuses classes de groupes bien connues. En particulier, ils sont tous décidables pour des groupes virtuellement libres. Cette classification est obtenue par des réductions utilisant des constructions SFT, la théorie des automates, et la logique monadique du second ordre. A la fin de la première partie, nous prenons une tangente pour étudier l'ensemble des marches auto-évitantes bi-infinies sur les graphes de Cayley. Cet ensemble apparaît naturellement dans l'étude du problème du serpent infini et est un sous-décalage de \mathbb{Z} . Nous classifions les groupes pour lesquels ce sous-décalage est apériodique, de type fini, et sofique. Nous étudions également son entropie et sa relation avec la constante connective du graphe de Cayley.

La deuxième partie traite de l'existence de sous-décalages de type fini fortement et faiblement apériodiques. Nous commençons par une étude de l'état de l'art de ces problèmes et explorons les parallèles avec des problèmes de probabilité et de combina-

toire. Nous examinons ensuite quels sous-groupes d'un groupe peuvent être réalisés en tant que stabilisateurs de sous-décalages de type fini, en établissant des conditions algébriques et calculatoires pour que cela se produise. Dans ce même cadre, nous introduisons la classe des groupes périodiquement rigides, c'est-à-dire des groupes où chaque sous-décalage de type fini faiblement apériodique est fortement apériodique. Nous terminons cette partie en construisant, à partir des travaux d'Aubrun et de Kari, les premiers exemples de sous-décalages de type fini fortement apériodiques sur des groupes de Baumslag-Solitar non résolubles et sur $\mathbb{F}_n \times \mathbb{Z}$. Par des théorèmes de Whyte et Cohen, nous obtenons l'existence de tels sous-décalages pour les groupes de Baumslag-Solitar généralisés non cycliques.

La dernière partie de cette thèse introduit de nouvelles notions de substitutions, de systèmes S -adiques, et leurs sous-décalages correspondants pour les groupes dénombrables. Nous identifions trois classes de groupes. Premièrement, nous définissons les groupes S -décomposables. Ces groupes ont la structure hiérarchique appropriée pour définir des systèmes S -adiques généraux. Deuxièmement, nous étudions les groupes ccc introduits par Gao, Jackson et Seward, car ils permettent de définir des systèmes S -adiques à forme constante. Troisièmement, nous introduisons les groupes monoformes. Ces groupes permettent de définir des substitutions à forme constante. Nous fournissons des exemples pour les trois classes et des exemples pour leurs systèmes S -adiques correspondants. Nous terminons par l'étude des propriétés dynamiques des sous-décalages définis par ces systèmes. Nous montrons qu'en général, ils sont minimaux sous des conditions de primitivité, et que pour certains groupes ccc moyennables, ils ont une entropie nulle et sont uniquement ergodiques.

Title: Subshifts of Finite Type on Groups: Emptiness and Aperiodicity

Keywords: tilings, subshift of finite type, finitely generated groups, aperiodicity, substitutions, computability.

Abstract: A subshift of finite type is a set of tilings of a group subject to a finite number of local constraints, where the group acts by translation. In recent years, much progress has been made in understanding their dynamical and computational properties. The goal of this thesis is to continue the study of how the algebraic and geometric properties of the underlying group influence the properties of subshifts of finite type defined on the group. The results are divided into three broad categories: decidability, aperiodicity, and substitutions.

For the first part, we study the Domino Problem, its variants, and the consequences of its undecidability on many finitely generated groups. We classify the computability of the Seeded Domino Problem, the Recurring Domino Problem, the k -SAT Problem, and Domino Snake Problems for many well-known classes of groups. In particular, they are all decidable for virtually free groups. This classification is obtained through reductions involving SFT constructions, automata theory, and Monadic Second Order Logic. At the end of the first part, we go on a tangent to study the set of bi-infinite self-avoiding walks on Cayley graphs. This set appears naturally in the study of the Infinite Snake Problem and is a \mathbb{Z} -subshift. We classify for which groups this subshift is aperiodic, of finite type, and sofic. We also study its entropy and its relation to the connective constant of the Cayley graph.

The second part tackles the existence of strongly and weakly aperiodic subshifts of finite type. We begin with a survey on the state of the art of these problems and explore parallels with problems from probability and com-

binatorics. We then look at which subgroups of a group can be realized as the stabilizers of subshifts of finite type, establishing both algebraic and computational conditions for this to happen. Within this same framework, we introduce the class of periodically rigid groups, i.e. groups where every weakly aperiodic subshift of finite type is strongly aperiodic. We end this part by building upon the work of Aubrun and Kari to construct the first examples of strongly aperiodic subshifts of finite type on non-solvable Baumslag-Solitar groups and on $\mathbb{F}_n \times \mathbb{Z}$. By theorems of Whyte and Cohen, we obtain the existence of such subshifts for non-cyclic generalized Baumslag-Solitar groups.

The final part of the thesis introduces new notions of substitutions, S -adic systems, and their corresponding subshifts for countable groups. We identify three classes of groups. First, we define S -decomposable groups. These groups have the appropriate hierarchical structure for defining general S -adic systems. Second, we study ccc groups introduced by Gao, Jackson, and Seward, as they allow the definition of constant-shape S -adic systems. Third, we introduce monoform groups. These groups allow for the definition of constant-shape substitutions. We provide examples for all three classes and examples for their corresponding S -adic systems. We finish studying the dynamical properties of the subshifts defined by these systems. We show that, in general, they are minimal under primitivity conditions, and that for some amenable ccc groups, they have zero entropy and are uniquely ergodic.

Acknowledgements

Even though this thesis bears my name, its existence would not have been possible without the help of many. I have been fortunate enough to have had the support of many wonderful people through these three years of thesis, and I want to take the time to thank you all. Everyone who is mentioned in these paragraphs is contained within the words and results of the manuscript; your friendship, kindness and love permeates my work. I wanted to convey my thankfulness as effectively as possible, so the next paragraphs will contain a patchwork of different languages.

Fist off, I am incredibly thankful to my supervisor Nathalie Aubrun for believing in me and giving me her unconditional support. I want to thank her for her guidance and inspiration not only on research, academia and administrative things, but on running and many things beyond work. Merci beaucoup Nathalie pour tes encouragements et ta patience face à mes questions, mes inquiétudes et mon intensité.

I want to thank Laurent Bartholdi and Jarkko Kari for accepting the daunting task of being the reviewers of my thesis and for taking the time to read it. I would also like to extend this thanks to Emmanuel Jeandel, Irène Marcovici, Samuel Petite, Matthieu Picantin and Guillaume Theyssier for being part of the jury. Many thanks to Benjamin Hellouin de Menibus and Etienne Moutot for proof-reading some of the chapters in the thesis.

Quiero agradecer a mi familia por su apoyo y amor incondicional. Quiero agradecer especialmente a mi papá Javier Bitar, a mi mamá Claudia Varleta y a mis hermanos Sebastián, Francisca y Catalina. Nada de esto hubiese sido posible sin ustedes. Quiero agradecer también a mis abuelos y abuelas Sergio, Kenny, Lucho y Teté por todo su apoyo y cariño, además de todo lo que me enseñaron para poder llegar hasta acá. Además quiero agradecer a todos mis tíos, tías, primos y primas por su preocupacion, cariño y ocasionales visitas al otro lado del mundo.

Many of the results of this thesis come from discussions and work with many researchers and colleagues. I want to thank them for the positive influence they had on me both in the professional and personal level. Je veux remercier Benjamin Hellouin de Menibus pour son amitié et les nombreux jeux de mots, les discussions sur la recherche et les sessions de jeux de société. Merci de m'avoir aidé à savoir comment procéder dans les moments critiques. Je veux remercier Pierre Guillon et Etienne Moutot pour leur supervision du master et leur amitié tout au long de ces quatre années. Je suis désolée que vous ayez dû subir le début de mon apprentissage du français. Quiero agradecer también a Christopher Cabezas y Sebastián Barbieri, no solo por el trabajo que hemos hecho juntos, si no también por su amistad y apoyo. Je veux remercier Pierre Béaur d'avoir été le meilleur collègue de bureau. Merci pour tout le soutien, les rires, les commérages et bien d'autres choses encore qui ont rendu le quotidien au bureau inoubliable.

Je veux aussi remercier François Pirot, Johanne Cohen, Hoang La, Chiara Marmo, Nicolas Thiéry, Florent Hivert et le reste de l'équipe GALaC pour avoir toujours été accueillants et avoir fait en sorte que le laboratoire se sente comme à la maison. Je n'oublierai jamais nos déjeuners au CESFO et surtout nos parties de billard. Et bien sûr, ces matchs n'auraient pas été aussi passionnants sans les doctorants de l'équipe. Merci à Loïc Le Mogne, Léo Kulinski, Valentin Dardilhac, Quentin Chuet, Manon Blanc, Balthazar Charles, Marc Velay, Hugo Thimonier et Philippe Rambaud pour tous ces bons moments au laboratoire, les raclettes, les tartiflettes et les nombreux autres plats à base de fromage que j'ai réussi à vous convaincre que je n'avais jamais essayés. También quiero agradecer a Daniel Tamayo por su amistad, y como lo dijo él tan elocuentemente "por traer más vida latina al laboratorio!".

Vivir lejos del país donde uno creció no es fácil. Por esto, quiero agradecer a Eduardo Silva, Pablo López, Bruno Galvez, Pablo Uribe, Mercedes Sellares, Ari Wortsmann y Charly Rodriguez por hacer increíble esta estadía en Francia. Gracias por todas las risas, salidas y buenos momentos que nunca voy a olvidar.

A pesar de la distancia física entre nosotros estos últimos 4 años, quiero agradecer a mis amigos Andrés Riveros,

Acknowledgements

Felipe Garrido, Juan Pablo Suazo, Eric Patrick y mis amigas Camilla Cordano, Antonia Arroyo, Macarena Moreno, Trinidad Campusano, Natalia Bruna, Catalina Undurraga y Ceniza. Gracias por su cariño y por siempre estar ahí para apoyarme. También quiero agradecer a mis amigos del DIM y la universidad que me han apoyado a lo largo de este camino: Bastián Espinoza, Juan d'Etigny, Diego Ramírez, Tomás (Maika) Martínez, Manuel Morales, Nicolás Cardenas, Giovanni Pais, Matías Altamirano, Alonso Letelier, Juan Pedro Ross y Julio Maldonado.

Je tiens également à remercier toutes les personnes que j'ai eu le plaisir de rencontrer lors de conférences et avec qui j'ai partagé de bons moments : Antonin Callard, Léo Paviet-Salomon, France Gheeraert, Solène Esnay, Victor Lutfalla, Firas Ben Ramdhane, Nikolai Prochorov, Matthieu Rosenfeld, Pierre Stas, Pascal Vanier, Olivier Bournez, Raphaël Henry, Bastien Laboureix, Pacôme Perrotin et Amelia Durbec.

Lastly and most importantly, I want to thank my wife Moira Mac Auliffe. Creo que no es una exageración decir nada de esto hubiese sido posible sin ti. Gracias por todo tu amor y apoyo incondicional, especialmente en los momentos más difíciles.

Thank you all for making these three years of PhD, and four years in France, an incredible experience.

Contents

Introduction (English)	i
Introduction (Français)	xi
I Background and Definitions	1
1 Subshifts, Computability, and Groups	3
1.1 Symbolic dynamics	3
1.1.1 Definitions	3
1.1.2 Morphisms	5
1.1.3 Dynamics	7
1.1.4 Subshifts of finite type	8
1.1.5 Sofic subshifts	11
1.2 Computability	12
1.2.1 Decision problems	14
1.2.2 The arithmetical hierarchy and beyond	14
1.2.3 Reductions and oracles	15
1.3 Some notions from group theory	16
1.3.1 The word problem	17
1.3.2 Nilpotent and polycyclic groups	18
1.3.3 Amenable groups	20
1.3.4 Combining groups	21
1.3.5 Cayley graphs and ends	22
1.3.6 Quasi-isometries	24
1.3.7 Translation-like actions	25
1.4 Computability and entropy of subshifts	26
1.4.1 Pattern codings and effectively closed subshifts	26
1.4.2 Entropy for amenable groups	28
1.5 Canonical constructions	30
1.5.1 Free extension	30
1.5.2 Higher power and higher block	32
1.5.3 Pull-back	34
1.5.4 Push-forward	34
1.6 Analogies between groups and subshifts	36
1.6.1 An analog for residual finiteness	37

II	Emptiness	39
2	The Domino Problem	41
2.0.1	Definitions and properties	42
2.0.2	Deciding decidability	44
2.1	Variants of the Domino Problem	45
2.1.1	Seeded Domino Problem	45
2.1.2	Recurring Domino Problem	45
2.2	Properties for seeded and recurring variants	46
2.2.1	General inheritance properties	46
2.2.2	Recurring Domino Problem on free groups	48
2.2.3	Consequences and conjectures	50
2.3	(A)periodic Domino Problem	51
2.3.1	Periodic dominos	52
2.3.2	Aperiodic dominos	53
2.4	Consequences of undecidability	54
2.4.1	The k -SAT problem on groups	54
3	Domino Snake Problems	59
3.1	Snake behaviour	60
3.1.1	General properties	62
3.2	Ossuary	63
3.2.1	Skeletons and decidability	64
3.3	Snake embeddings	66
3.4	Virtually nilpotent groups	68
3.5	Snakes and logic	70
3.6	Discussion and open questions	73
4	Self-Avoiding Walks	75
4.1	Cayley graphs and self-avoiding walks	76
4.1.1	Connective constants	77
4.2	General properties	78
4.2.1	Bi-infinite SAWs through group elements and computability	78
4.2.2	Entropy	79
4.3	Dynamic and computational aspects	81
4.3.1	SFT skeletons	81
4.3.2	Effective skeletons	84
4.3.3	Periodic configurations	86
4.3.4	Minimality	87
4.4	Sofic skeletons	88
4.4.1	Ends and automorphisms	89
4.4.2	Characterizing sofic skeletons	90
4.5	Approximating entropy and connective constants	93
4.5.1	Bridges and periodic points	93
4.5.2	Lower bounds with self-avoiding polygons	95
4.5.3	Free Burnside groups	96
4.6	Geodesic skeletons	98
4.6.1	Entropy and connective constant for geodesics	99

III	Aperiodicity	101
5	Strong Aperiodicity, Weak Aperiodicity and Everything In Between	103
5.1	Strongly aperiodic SFTs	104
5.2	Weakly aperiodic SFTs	107
5.2.1	Connections with decision problems and computability	108
5.2.2	Analogies: percolation, angels and cellular automata	109
5.3	Subgroup Realizability: How I Learned to Stop Worrying and Love Periodicity	114
5.3.1	General properties	114
5.3.2	Quotients and realizability	116
5.3.3	No restrictions	117
5.3.4	Computational restrictions	118
5.4	Periodic rigidity	119
5.4.1	Virtually nilpotent and polycyclic groups	122
5.5	A graphical summary	123
6	Aperiodic SFTs on Generalized Baumslag-Solitar Groups	125
6.1	Graphs of groups and GBS groups	126
6.1.1	Definition	126
6.1.2	Torus knot groups	127
6.1.3	Baumslag-Solitar groups	128
6.2	Weak aperiodicity and the Domino Problem	128
6.3	Lifting strongly aperiodic subshifts	129
6.3.1	Erratum to <i>Strongly Aperiodic SFTs on generalized Baumslag-Solitar groups</i>	130
6.4	Strong aperiodicity for GBS groups	132
6.5	A minimal, strongly aperiodic and horizontally expansive SFT on \mathbb{Z}^2	132
6.6	The path-folding technique on $\mathbb{F}_n \times \mathbb{Z}$	133
6.6.1	The flow SFT	134
6.6.2	The structure of a path-folding SFT	134
6.6.3	Minimality	137
6.7	Adaptation to the Baumslag-Solitar group $BS(2, 3)$	139
6.7.1	The group $BS(2, 3)$	140
6.7.2	The orbit coding construction	140
6.7.3	A flow SFT on $BS(2, 3)$	141
6.7.4	Embedding $BS(2, 3)$ into \mathbb{R}^2 along a flow configuration	143
6.7.5	A strongly aperiodic SFT on $BS(2, 3)$	144
6.8	Consequences	148
IV	Substitutive Tools	149
7	Substitutions and Hierarchical Structures	151
7.1	A general framework for S -adic representations	152
7.1.1	Decomposing infinite countable groups	153
7.1.2	S -adic systems	155
7.2	Constant-shape S -adic representations	159
7.2.1	Group tileability	159
7.2.2	Constant-shape S -adic systems on ccc groups	160
7.3	Constant-shape substitutions for groups	163
7.3.1	Monoform groups	163
7.3.2	Constant-shape substitutions on monoform groups	170
7.4	Dynamical properties	171

Contents

7.4.1	Minimality	171
7.4.2	Entropy	172
7.4.3	Unique ergodicity	172
7.5	Perspectives and questions	177
Bibliography		181
Personal Bibliography		203
Index		205

List of Figures

Introduction (English)	i
1 An example of the discretization of the dynamical system (X, T) . The orbit of a point $p \in X$ is depicted over a partition of the space X , along with the corresponding bi-infinite sequence of symbols it generates. This figure is an essential part of any introduction to a thesis or HDR on symbolic dynamics.	ii
2 Thesis outline and dependencies.	vi
Introduction (Français)	xi
3 Exemple de discrétisation du système dynamique (X, T) . L'orbite d'un point $p \in X$ est représentée sur une partition de l'espace X , ainsi que la suite bi-infinie correspondante de symboles qu'elle génère. Cette figure est une partie essentielle de toute introduction à une thèse ou à une HDR sur la dynamique symbolique.	xii
4 Plan de la thèse et dépendances.	xvii
1.1 A configuration x from the full-shift over the alphabet $A = \{\text{a}, \text{b}, \text{c}, \text{d}\}$ and group $G = \mathbb{Z} \times \mathbb{Z}/2\mathbb{Z}$, as well as its shift by $g = (3, 1)$. The configuration is inspired by the frieze patterns at the Alhambra [Bod07].	4
1.2 An application of the majority rule map to a configuration from the full-shift.	6
1.3 An application of the shift map defined by the element $(-4, -4)$ to a configuration from the full-shift. The support of the map and its image are highlighted in red.	6
1.4 Examples of aperiodic (left) and periodic (right) configurations on \mathbb{Z}^2	7
1.5 A portion of a configuration of the hard-square model on \mathbb{F}_2	9
1.6 A Wang tile.	10
1.7 An example of a tiling by Wang tiles. This particular tiling will reappear in Chapter 5.	10
1.8 An example of the tileset graph obtained from two Wang tiles t_1 and t_2 . Inverses of the generators for \mathbb{Z}^2 are omitted for simplicity	10
1.9 A portion of a configuration of the SFT cover of $X_{\leq 1}$ on the free group (left) and its corresponding image under the factor map (left).	11
1.10 Applying a transition to a configuration from $\{0, 1, \sqcup\}^{\mathbb{Z}}$	13
1.11 A Cayley graph of the affine Coxeter group \tilde{A}_2 . The red edges represent a , blue edges represent b , and green edges c	22
1.12 A Cayley graph of the group $\mathbb{Z} \times \mathbb{Z}/2\mathbb{Z}$. The generator t defines the horizontal right-pointing edges, and the generator s defines the vertical undirected edges.	22
1.13 An example of a configuration from the mirror subshift X_M in \mathbb{Z}^2 containing a vertical line.	27
1.14 An example of a configuration from the free extension of the sunny-side up shift $X_{\leq 1}$ from \mathbb{Z} to \mathbb{Z}^2	31

2.1	A Wang tile again.	41
2.2	On the left, a balloon given by $C = \blacksquare b \blacksquare a \blacksquare b \square a \blacksquare b^{-1} \blacksquare$ based at $a_0 = \blacksquare$, generators $a, b \in S$, and $k = 1$. On the right, a portion of a configuration from $\mathcal{X}_{\mathcal{F}}$ obtained by repeating the pattern defined by the vertices of the balloon.	48
2.3	On the left, the path defined by y in the configuration. This is an example of the first case, where $y(j_1 - 1) \neq y(j_2 - 1)$ and the repeated letter is $a = x(\omega(j_1)) = x(\omega(j_2))$. On the right, the corresponding balloon within the tiling graph $\Gamma_{\mathcal{F}}$	50
2.4	On the left, the path defined by y in the configuration as well as the path leading from the root $x(\omega(i))$ to w . This is an example of the second case, where $y(j_1 - 1) = y(j_2 - 1)$ and the repeated letter is $a = x(\omega(j_1)) = x(\omega(j_2))$. On the right, the corresponding balloon within the tiling graph $\Gamma_{\mathcal{F}}$	50
2.5	To reduce the k -SAT problem to the Domino Problem, we represent each letter of the alphabet by a unique code over the right coset representatives of the chosen subgroup.	58
2.6	An example on how to code a tiling on the right coset representatives of a subgroup using boolean functions.	58
3.1	A tiling graph Γ that does not tile \mathbb{Z}^2 for the generating set $\{(1, 0), (0, 1)\}$ (edges labeled with generator inverses are omitted for more readability) and a Γ -snake with $I = \mathbb{N}$	60
3.2	An example of tiling graph Γ for groups with two generators a, b (inverses are omitted for simplicity). There exists a Γ -snake for the free group $\mathbb{F}_2 = \langle a, b \mid \rangle$ as pictured in the middle, with $\omega(\mathbb{Z}) = (aba^{-1}b^{-1})^{\mathbb{Z}}$, but not for $\mathbb{Z}^2 = \langle a, b \mid ab = ba \rangle$ since one of the finite snakes on the right must appear but cannot be extended into an infinite one.	60
3.3	A tiling graph Γ on the left (inverses are omitted for simplicity). We consider \mathbb{Z}^2 with its standard presentation $\langle a, b \mid ab = ba \rangle$. On the top right a Γ -snake for \mathbb{Z}^2 that is not strong. On the bottom right a strong Γ -snake for \mathbb{Z}^2	61
3.4	Reducing snake problems using a snake-embedding.	67
3.5	The transducer \mathcal{A} that embeds \mathbb{Z}^2 into $(G, S \cup \{g\})$. The notation $s \mid t$ represents $\eta(q, s) = t$ for the corresponding state.	69
3.6	The transducer that defines a snake embedding from $(\mathbb{Z}^2, \{a^{\pm 1}, b^{\pm 1}\})$ into $(H_3, \{x^{\pm 1}, y^{\pm 1}, z^{\pm 1}\})$	70
4.1	A self-avoiding walk, marked in red, on the hexagonal grid.	75
4.2	On \mathbb{Z}^2 with standard generating set: a finite SAW that does not appear in a bi-infinite SAW.	77
4.3	In blue, an example of regular spanning tree of degree 2 – thus a bi-infinite Hamiltonian path – for \mathbb{Z}^2 with its standard presentation. In green a path from $(0, 0)$ to $(2, 2)$ extracted from this regular spanning tree. Note that this path is highly non-geodesic.	78
4.4	A portion of the Cayley graph of the plain group $S_3 * \mathbb{Z}/3\mathbb{Z}$. The two generators for S_3 are pictured in red and blue; the generator for $\mathbb{Z}/3\mathbb{Z}$ is pictured in green.	84
4.5	The configuration used for the Pumping Lemma (with $p = 4$) depicted in the Cayley graph of the subgroup $\langle s, t \rangle$. The blue edges represent s and the red edges t	89
4.6	The periodic subdivision of the 3-ladder with the configuration x highlighted in red and blue. The word $\lambda_3 \lambda_4^3 \lambda_3^{-1} \lambda_1^{-2}$ is marked in blue, whereas the infinite prefix and suffix of x are marked in red.	91
4.7	The periodic subdivision of the 2-ladder with the configuration x highlighted in red and blue. The word $\lambda_2 \lambda_3^3 \lambda_2^{-1} \lambda_1^{-2}$ is marked in blue, whereas the infinite prefix and suffix of x are marked in red.	92
5.1	The Jeandel-Rao tiling set. This tiling set has the smallest possible size for an aperiodic Wang tiling set.	103
5.2	An example of a g -strip of size 2 with defining set A , in red. We can separate translates of the ball $B_S(n)$ provided we take a sufficiently large exponent for g	105

5.3	For SFTs in \mathbb{Z}^2 , having a configuration with non-trivial stabilizer (on the left) implies the existence of a periodic configuration (on the right). This is done by finding a repeating motif on the strip defined by the period vector, and repeating this motif in a way compatible with the forbidden patterns of the nearest neighbor SFT.	120
6.1	Tileset graph Γ defining the SFT X that shows \hat{X} is not shift invariant.	130
6.2	A Wang tile and its rotation by $\frac{\pi}{2}$	133
6.3	Flow tiles for \mathbb{F}_2	134
6.4	If we look at the configuration in $\mathbb{F}_2 = \langle a, b \rangle$ as shown, the prefix of its infinite word is given by bab	135
6.5	The first three steps to go from the word $(ba)^\infty$ to $(b^{-1}a^{-1})^\infty$, with error term $e_n = a^{-1}$ for all n . The original word is marked in red, the new one in blue, and the error term in green.	138
6.6	The Cayley graph of $BS(2, 3) = \langle a, t \mid t^{-1}a^2t = a^3 \rangle$	140
6.7	On the left the Cayley graph of $\mathbb{Z}^2 = \langle a, t \mid at = ta \rangle$ where is pictured how an orbit for f is encoded. In the middle the equivalent picture for $BS(2, 3) = \langle a, t \mid t^{-1}a^2t = a^3 \rangle$. For these two pictures, edges corresponding to generator t in the Cayley graphs are pictured with a double arrow. On the right, edges with double arrows represent the direction given by the flow SFT on $BS(2, 3)$	141
6.8	The allowed patterns $p^{(1)}$ to $p^{(5)}$ for the flow SFT on $BS(2, 3)$. For more readability the outgoing edges are pictured in red.	142
6.9	A configuration in the flow SFT on $BS(2, 3)$, pictured on the Bass-Serre tree only. Starting from the upper-left corner, this configuration is represented by a word with prefix tta^2t^{-1}	142
6.10	A Wang tile for $BS(2, 3)$	144
6.11	The flow configuration drives the choice for computing T or T^{-1} in the different sheets of $BS(2, 3)$	146
6.12	Wang tileset τ that computes T along a flow configuration for $BS(2, 3)$	146
7.1	Applying the concatenation of elements of the directive sequence, namely $\tau_{[0,3]}$, to \square which generates a pattern of support $F_{3,\square} = \{0, \dots, 5\}^2$	157
7.2	An example of a two-dimensional constant-shape substitution with map $L = 2I$, where I is the identity matrix, and fundamental domain is $F = \{(0, 0), (1, 0), (0, 1), (-1, -1)\}$. This substitution is known as the triangular Thue-Morse substitution	158
7.3	A depiction of the application of $\tau_{[0,2]}$ on the Cayley graph of $BS(1, 2)$. It begin by applying τ_1 , which has support C_1 , and then applying $\tau_0 = \sigma$ to each point on C_1 . This implies leaves a support of $F_2 = R_4$	162
7.4	The successive construction of the first 4 steps of the monofrom decomposition of the free group \mathbb{F}_2 , as explained in Theorem 7.3.13, starting from the subtree $T_1 = \{1_{\mathbb{F}_2}, \mathbf{b}\}$. The identity is represented by a double circle, edges corresponding to \mathbf{a} are colored red, and edges representing \mathbf{b} are colored blue.	170

List of Tables

1.1	The Jeandel-Vanier dictionary between groups and subshifts as introduced in [JV19].	36
5.1	A summary of the state of the art concerning the Domino Problem, aperiodicity and periodic rigidity. The blue section represents the absence of recursively presented groups, and the red section the absence of groups with ReFQ (see Definition 2.3.3). The group \mathcal{J} is a finitely generated group with undecidable word problem as given by the Novikov-Boone theorem (see Theorem 1.3.14)	124

Introduction

*"Karpal wore a secretive smile.
Paolo said, 'What?'
'Wang tiles. The carpets are made out of Wang tiles.'"*

– Greg Egan, *Diaspora*.

Imagine you are handed a box with infinite puzzle pieces of finite different types. Is it possible to determine if the pieces allow you to complete a puzzle that fills the infinite plane? This seemingly innocuous question, known as the Domino Problem, hides a deep theory behind it that has developed over the last 63 years and has impacted several branches of computer science and mathematics.

The Domino Problem was introduced by Hao Wang in 1961 to study the decidability of the $\forall\exists\forall$ fraction of first-order logic [Wan61]. Wang used an abstract version of puzzle pieces, now known as Wang tiles. A Wang tile is a unit square with a color on each of each edge. Two tiles can be placed side by side if their touching edge has the same color. The question is, given a finite set of Wang tiles, is it possible to determine if they tile the plane while respecting the adjacency rules? Wang conjectured that if a set of tiles can tile the plane, then they must be able to tile periodically, making the problem decidable. However, in 1966 Wang's PhD student Robert Berger proved the undecidability of the Domino Problem [Ber66] and constructed the first example of an aperiodic tiling made up of over twenty thousand tiles.

Berger's landmark result spawned two research directions. First, the Domino Problem's undecidability has been used to prove the undecidability of many problems, ranging from problems in cellular automata [Kar90; Kar92; Kar94] to the spectral gap of many-body quantum systems [CPW22]. Second, the existence of aperiodic tilings on the plane has launched the study of quasi-crystals [BG13] and the study of aperiodicity on different surfaces and spaces [Moz97].

In this thesis, we continue both these threads by exploring the undecidability of the Domino Problem and the existence of aperiodic tilings for finitely generated groups. As has been done for the last 30 years, we understand both of these problems through the lens of symbolic dynamics. Specifically, we see them as questions on the class of subshifts of finite type. The goal of this thesis is taking steps to understand the following general question.

Question. How do the algebraic and geometric properties of the underlying group affect the dynamical and computational properties of its subshifts on finite type?

Symbolic Dynamics

The general setting for the thesis is the area of symbolic dynamics. Although it was originally conceived for the study of general dynamical systems, it has become a rich area of study in itself, with many applications both in pure and applied mathematics and computer science.

In its early days, the objective of symbolic dynamics was to study discretizations of continuous dynamical systems. The main idea was to partition the space of possible states into finite pieces, each of which is assigned a symbol. Then, the system is coded by infinite strings of symbols representing the trajectories of points in the

space. The idea was to study this new symbolic system to understand the dynamics of the original system. For instance, consider a dynamical system (X, T) , where X is a compact space and T a homeomorphism. We can partition the space into open subsets X_{\square} , X_{\blacksquare} , X_{\blacklozenge} , and define a function $\gamma : X \rightarrow \{\square, \blacksquare, \blacklozenge\}$ sending points in the space to the symbol of its corresponding partition. We then define a function $\varphi : X \rightarrow \{\square, \blacksquare, \blacklozenge\}^{\mathbb{Z}}$ that allows us to code an orbit of a point $p \in X$ by a sequence $\varphi(p) \in \{\square, \blacksquare, \blacklozenge\}^{\mathbb{Z}}$ defined by $\varphi(p)(k) = \gamma(T^k(p))$. An example of this process is shown in Figure 1. The space of all symbolic sequence obtained by this process, $\varphi(X)$,

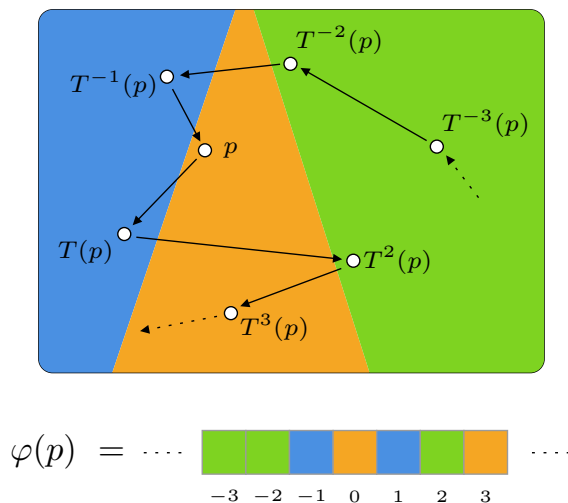

Figure 1: An example of the discretization of the dynamical system (X, T) . The orbit of a point $p \in X$ is depicted over a partition of the space X , along with the corresponding bi-infinite sequence of symbols it generates. This figure is an essential part of any introduction to a thesis or HDR on symbolic dynamics.

is compact in the product topology and is acted upon by the shift action, $\sigma(x)(k) = x(k - 1)$ for all $x \in \varphi(X)$ and $k \in \mathbb{Z}$, making $(\varphi(X), \sigma)$ a dynamical system. Under certain conditions the space of all symbolic sequences completely describe the original system. Early versions of this approach can be traced back to the study of geodesic flows on surfaces of negative curvature by Hadamard [Had98]. The study of these symbolic spaces began in earnest with the works of Morse and Hedlund [MH38; MH40]. They called these spaces **subshifts** and studied their properties of recurrence and minimality. An account on the history of the origins of symbolic dynamics can be found in [CN08].

Nowadays, subshifts are understood as sets of colorings of a group G by a finite alphabet A that are closed for the product topology and invariant under the action of the group by translations. Surprisingly, these systems also have a combinatorial description. A subshift can be equivalently defined as the set of colorings of G that avoid a certain set of forbidden patterns. It is with this alternative definition that the main object of this thesis appears: **subshifts of finite type** (SFT). An SFT is a subshift defined by a finite set of forbidden patterns. Their study began with Parry [Par64], but their name comes from Smale, who used them to understand the dynamics of smooth mappings [Sma67].

Subshifts of finite type on \mathbb{Z} are well understood and have been developed into a robust theory which can be found in Lind and Marcus' classic book [LM21]. It is then natural to wonder what aspects of this theory can be generalized to subshifts on \mathbb{Z}^2 and beyond. It is here where the Domino Problem comes in. The set of tilings generated by a finite set of Wang tiles is a subshift of finite type: the alphabet is the set of tiles and the forbidden patterns are given by violations of the Wang tile rule. It turns out, every SFT on \mathbb{Z}^2 is dynamically equivalent to a subshift defined from Wang tiles.

The Swamp of Undecidability and the Forest of Decidability

As the study of symbolic dynamics began moving into the realm of \mathbb{Z}^2 -actions, it was soon clear that the behavior of two dimensional subshifts of finite type was widely different from its one dimensional counterpart. Specifically, as evidenced by the undecidability of the Domino Problem and the existence of aperiodic SFTs, answering basic questions about these systems is undecidable. This fact prompted Lind to call multidimensional subshifts of finite type the **Swamp of Undecidability** [Lin04]. The existence of this swamp is further evidenced by Hanf and Myer's result on the existence of \mathbb{Z}^2 -SFTs where no tiling is computable [Han74; Mye74], and Hochman and Meyerovitch's result on the existence of \mathbb{Z}^2 -SFTs with uncomputable entropy [HM10]. Although these results limit our computational understanding of these systems – with Lind going as far as to say that the swamp "*is a place you don't want to go*" – some researchers¹ suggest the alternative name **Garden of Undecidability**, as these undecidability results have provided a rich theory on the computational aspects of symbolic systems.

The reach of this Garden is vast. As a consequence of the Domino Problem's undecidability many other problems have been shown to be undecidable in \mathbb{Z}^2 . Among these are the Seeded Domino Problem [KMW62; Büc62], the Recurring Domino Problem [Har85], the Periodic Domino Problem [Jea10], the Aperiodic Domino Problem [GHV18], the k -SAT problem for \mathbb{Z}^2 [Fre99], the Infinite Snake Problem [Adl+09] and the Ouroboros Problem [Ebb82; Kar02], to mention a few.

To better understand which properties of \mathbb{Z}^2 account for the existence of the Garden, researchers have looked at the Domino Problem on other finitely generated groups. A reference for the progress on this project can be found in [ABJ18]. Notably, this study has found the other end of the computational spectrum in the class of **virtually free groups**. For these groups, the Domino Problem and some of its variants have been shown to be decidable [BS18; Pia08]. In fact, these groups are conjectured to be the only ones where this is the case.

Conjecture. A finitely generated group has decidable Domino Problem if and only if it is virtually free.

The crucial characteristic of virtually free groups is that their Cayley graphs have finite tree width [MS85], and thus decidable Monadic Second Order logic [KL05]. Due to this fact, we propose the name **Forest of Decidability** for subshifts of finite type over virtually free groups.

In this thesis, we study the variants and consequences of the Domino Problem on finitely generated groups: the Seeded Domino Problem, the Recurring Domino Problem, the k -SAT problem, the Infinite Snake Problem and the Ouroboros Problem. We show that the Forest of Decidability remains true to its name for all of them.

Aperiodicity

Recall that the second key aspect of Berger's result was the existence of aperiodic subshifts of finite type. Since this construction was published, many more aperiodic tilings of the plane [Rob71; Kar96; JR21], as well as other Riemannian surfaces have been constructed [Pen79; BW92; Moz97; MN14]. The current project is to understand which groups admit aperiodic subshifts of finite type. When working beyond \mathbb{Z}^2 , Mozes observed that there is no longer a unique notion of aperiodicity for tilings [Moz97], but rather two. He coined the names **weakly aperiodic**, for SFTs where the orbit of each tiling is infinite, and **strongly aperiodic**, for SFTs where the stabilizer of every tiling is trivial. A lot of progress has been achieved in establishing the existence of both types of aperiodic SFTs for many classes of groups. For a recent survey see [Rie22].

Through the works of Jeandel [Jea15a] and Cohen [Coh17], we know the existence of strongly aperiodic SFTs is influenced by the number of ends and the co-totality of the word problem of the underlying group. Not many other obstructions are known for their construction. At the time writing, many classes of groups have been shown to verify the following conjecture obtained by combining Jeandel and Cohen's results.

Conjecture. A finitely generated group admits a strongly aperiodic SFT if and only if it is one-ended and has decidable word problem.

¹Guillaume Theyssier, personal communication

In contrast, for weakly aperiodic SFTs we have more tools: they behave well with subgroups, quotients and translation-like actions, to name a few [Jea15c]. When studying the invariance under commensurability of both types of aperiodicity, Carroll and Penland proposed the following conjecture on the existence of weakly aperiodic tilings.

Conjecture. A finitely generated group admits a weakly aperiodic SFT if and only if it is not virtually \mathbb{Z} .

In this thesis, we look at the state of the art of both conjectures and show the conjectures are satisfied for the class of generalized Baumslag-Solitar groups. We also explore a new aspect of aperiodicity, namely, which families of subgroups can be obtained as stabilizers of subshifts of finite type.

The Tools of The Trade

When studying subshifts on \mathbb{Z} a frequently used tool for the construction of examples of subshifts with sought after properties are **S -adic systems**. These systems were introduced in the works of Ferenczi [Fer96], Livschits and Vershik [LV92]. An S -adic system is a sequence of morphisms $(\tau_n)_{n \in \mathbb{N}}$ that generate infinite words by sequentially applying the morphisms on letters. They are a generalization of classical substitutive systems, describe large classes of subshifts [Esp23b], and have been extensively studied for all their dynamical properties [Don+21; Ber+21].

Considering the effectiveness the S -adic formalism has had over the last decades, researchers have begun to study these systems in the multidimensional setting. In \mathbb{Z}^2 , S -adic subshifts, especially substitutive ones, have been a powerful tool to find new proofs of the undecidability of the Domino Problem [DRS12; JV20] and find aperiodic subshifts [Cab23; Lab23; Lab21a]. This is done through simulation theorems, most notably Mozes' theorem [Moz89] and its generalization by Aubrun and Sablik [AS14]. Nevertheless, these systems are also within the reach of the Garden of Undecidability. Jolivet and Kari have shown that given a list of concatenation rules for a \mathbb{Z}^2 -substitution, determining if the image of the substitution is consistent or overlap-free is undecidable [JK12].

In [Cab23], Cabezas formalized the notion of **constant-shape substitutions** of \mathbb{Z}^d , providing a robust theory to study substitutive systems away from the reach of undecidability. His work with Petite and Leroy has also provided many examples of subshifts with interesting dynamical and computational properties [CP23; CL24].

There have also been recent attempts to generalize substitutions to other groups. This has been done for lattices on many non-abelian nilpotent Lie groups [BHP21], the free semigroup on two generators [BL21], and certain locally finite groups [BS24]. In this thesis we generalize S -adic systems to general groups with a different approach. Instead of looking at specific classes of groups, we define classes which contain groups that have the appropriate structure to allow for S -adic sequences of varying degrees of rigidity. The long term objective is to use these systems to establish new undecidability and aperiodicity results.

Contributions

The contributions of this thesis are attempts at answering the question at the beginning of this introduction: how do the properties of the underlying group influence the properties of its subshifts of finite type, and vice versa. The contributions in this thesis are contained, but are not exclusively from, the following articles:

- *Contributions to the Domino Problem: Seeding, Recurrence and Satisfiability.*

In this article we study the Seeded Domino Problem, the Recurring Domino Problem and the k -SAT problem on finitely generated groups. We show invariance properties for the Seeded and Recurring Domino Problems, and that the Recurring Domino Problem is decidable for free groups. We conjecture that the only groups in which the Seeded and Recurring Domino Problems are decidable are virtually free groups. For the k -SAT problem, we show that the subgroup membership problem many-one reduces to the k -SAT problem, that in certain cases the k -SAT problem many one reduces to the Domino Problem, and finally that the Domino Problem reduces to the k -SAT problem for certain groups. This work was presented at

STACS 2024 [[Bit24a](#)].

- *Domino Snake Problems* with Nathalie Aubrun.

In this article we study the computability of Domino Snake Problems on finitely generated groups. We introduce the skeleton subshift that allows us to solve many variations of the Infinite Snake Problem including the Geodesic Snake Problem. We also show that the Infinite Snake and Ouroboros Problems on nilpotent groups are undecidable for any generating set, given that we add a well-chosen element. Finally, we make use of Monadic Second Order logic to prove that Domino Snake Problems are decidable on virtually free groups for all generating sets. This work was presented at FCT 2023 [[AB23](#)], and also has a journal version that has been submitted [[AB24a](#)].

- *Self-Avoiding Walks on Cayley Graphs through the Lens of Symbolic Dynamics* with Nathalie Aubrun.

In this article study dynamical and computational properties of the set of bi-infinite self-avoiding walks on Cayley graphs, as well as ways to compute, approximate and bound their connective constant. This is done through the skeleton, $X_{G,S}$, of a finitely generated group G relative to a generating set S . We provide a characterization of groups which have SFT skeletons and sofic skeletons. We also characterize finitely generated torsion groups as groups whose skeletons are aperiodic. For connective constants, we show that Cayley graphs of finitely generated torsion groups do not admit graph height functions, that for groups that admit transitive graph height functions the connective constant is equal to the growth rate of periodic points of the skeleton, and using a counting argument due to Rosenfeld, we give bounds on the connective constant of infinite free Burnside groups. Finally, we look at the set of bi-infinite geodesics and introduce an analog of the connective constant for the geodesic growth. This work has been submitted to a journal [[AB24b](#)].

- *Realizability of Subgroups by Subshifts of Finite Type*.

In this article we study the problem of realizing families of subgroups as the set of stabilizers of configurations from a subshift of finite type. We show that a normal subgroup is realizable if and only if the quotient by the subgroup admits a strongly aperiodic SFT. We also show that if a subgroup is realizable, its subgroup membership problem must be decidable. The article also contains the introduction of periodically rigid groups, which are groups for which every weakly aperiodic subshift of finite type is strongly aperiodic. We introduce a new conjecture stating that the only periodically rigid groups are virtually \mathbb{Z} groups and torsion-free virtually \mathbb{Z}^2 groups. Finally, we show virtually nilpotent and polycyclic groups satisfy the conjecture. This work is a pre-print [[Bit24b](#)].

- *Strongly Aperiodic SFTs on Generalized Baumslag-Solitar Groups* with Nathalie Aubrun and Sacha Huriot-Tattegrain

In this article we look at constructions of aperiodic SFTs on fundamental groups of graph of groups. In particular, we prove that all non- \mathbb{Z} generalized Baumslag-Solitar groups admit a strongly aperiodic SFT. The constructions rely on a path-folding technique that lifts an SFT on \mathbb{Z}^2 inside an SFT on $\mathbb{F}_n \times \mathbb{Z}$, or an SFT on the hyperbolic plane inside an SFT on $BS(m, n)$. In the case of $\mathbb{F}_n \times \mathbb{Z}$ the path folding technique also preserves minimality. This work was published in *Ergodic Theory and Dynamical Systems* [[ABH24](#)].

- *Substitutions and Hierarchical Structures* with Christopher Cabezas and Pierre Guillon.

In this article we introduce new notions of substitutions, S -adic systems, and their corresponding subshifts for countable groups. We identify three classes groups: S -decomposable groups, ccc groups, and monoform

group. Each of these groups allows for the definition of increasingly rigid S -adic systems. We finish studying the dynamical properties of the subshifts defined by these systems. We show that, in general, they are minimal under primitivity conditions, and that for some amenable ccc groups, they have zero entropy and are uniquely ergodic. This work is in preparation.

Organization of the Manuscript

The thesis is divided into four parts. Part I serves as an introduction to the many concepts from symbolic dynamics, computability theory and group theory that are necessary for the rest of the manuscript. Part II is concerned with the Domino Problem, its variants, and its consequences. Chapter 2 deals with the state of the art on the Domino Problem and its variants, Chapter 3 deals with Domino Snake Problems, and Chapter 4 with bi-infinite self-avoiding walks through the lens of symbolic dynamics. Part III deals with aperiodicity. Within this part, Chapter 5 explores the state of the art of strongly and weakly aperiodic SFTs, as well as new problems and conjectures around aperiodicity. Chapter 6 contains the construction of strongly aperiodic SFTs on the class of generalized Baumslag-Solitar groups. Finally, in Part IV we present a generalization of S -adic systems to general countable groups and explore its dynamical properties. The main dependencies between the chapters are illustrated in Figure 2.

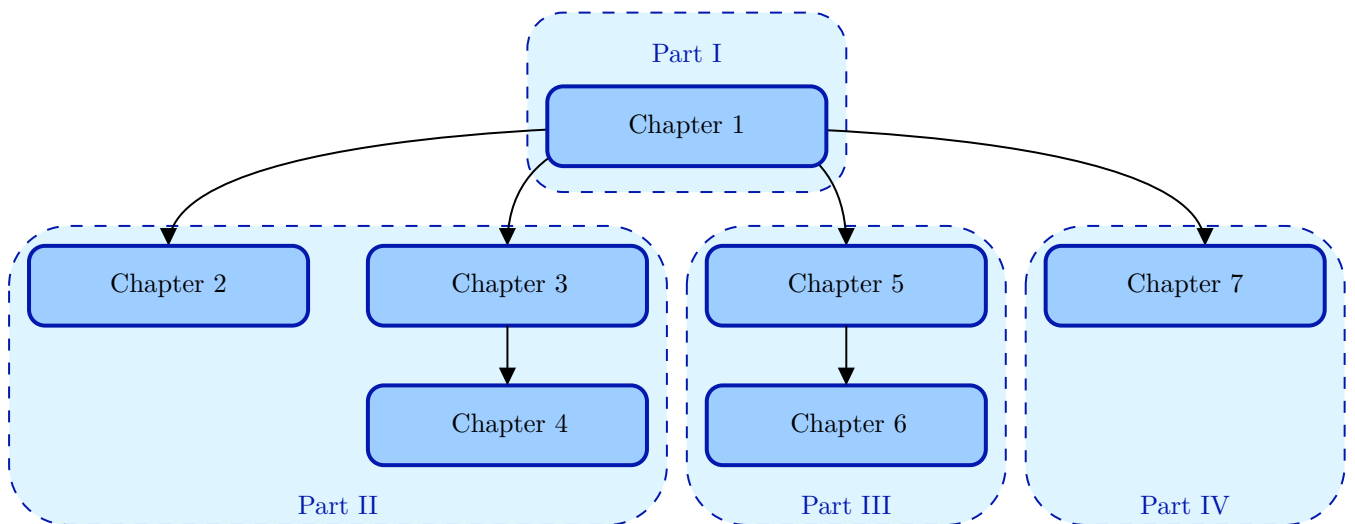

Figure 2: Thesis outline and dependencies.

We have tried to make this thesis as self-contained as possible, and give references to allow the reader to go deeper on their subjects of interest. We have also provided an Index containing key words, and the places where they feature prominently. We have done our best to keep Titivillus² at bay.

Part I: Background and Definitions

Subshifts, Computability and Groups The first part and first chapter of the thesis is devoted to the introduction of the necessary background and context of the rest of the manuscript. We begin in Section 1.1 by introducing subshifts and the notions of morphisms, conjugacy, aperiodicity and minimality. We also define the class of subshifts of finite type, and the class of sofic subshifts. Section 1.2 is devoted to the introduction of the notions of decidability, enumerability, the arithmetical hierarchy and reductions from computability theory.

²Titivillus or Tutivillus is the name given to the "patron demon of scribes". It is said that in the Middle Ages he entered monasteries where scribes worked and added errors and typos into their work when they got distracted [Jen77].

These will be necessary to tackle the different decision problems present in the text. Similarly, Section 1.3 introduces notions from both combinatorial and geometric group theory, including the word problem, quasi-isometries, translation-like actions, and more. With the background provided by these three sections, we are able to define both effectively closed subshifts and entropy in Section 1.4.1 and Section 4.2.2 respectively.

Section 1.5 is devoted to what we call **canonical constructions**. These are constructions that appear often in the literature, and allow to transform a subshift on a given group, to a subshift on an overgroup, a subgroup of finite index, a quotient, or from a quotient. These constructions will appear *recurringly* in the manuscript.

The final section of the chapter, Section 1.6, explores the analogies between finitely generated groups as originally observed by Jeandel and Vanier [JV19]. We finish the section by introducing **residually periodic** subshifts as a proposed analog to residually finite groups.

Part II: Emptiness

The Domino Problem The second part of the manuscript begins with Chapter 2 about the Domino Problem and some of its variants. The chapter starts with a short historical account of the problem, its definition, its properties, and the current state of the art around the **Domino Conjecture**. The chapter continues with Section 2.1 on the current state of the Seeded Domino Problem and the Recurring Domino Problem. This is followed by Section 2.2 where we prove properties for both of these problems as well as Theorem 2.2.5 stating that the Recurring Domino Problem is decidable for free groups. The section ends with Corollary 2.2.11 that shows that the Domino Conjecture implies that the Domino Problem, the Seeded Domino Problem and the Recurring Domino Problem are decidable only on virtually free groups.

Next, Section 2.3 tackles the Periodic Domino Problem and the Aperiodic Domino Problem. For the former, we show that it is co-recursively enumerable for groups with ReFQ, as defined by Rauzy [Rau22] (Proposition 2.3.4). For the latter, we study its connection with an analog of the Adyan-Rabin theorem for subshifts due to Carrasco-Vargas [Car24].

Finally, in Section 2.4 we look at the k -SAT problem for finitely generated groups. We introduce a definition of the problem that differs from the original due to Freedman [Fre99], to make it compatible with finite generated groups. We prove that the subgroup membership problem (SMP) of the underlying group many-one reduces to 2-SAT (Lemma 2.4.3) and that for groups with decidable SMP k -SAT reduces to the Domino Problem (Lemma 2.4.4). This last result implies that virtually free groups have decidable k -SAT problem. In addition, we show that if a group contains a proper finite index subgroup isomorphic to the group, then the Domino Problem reduces to 3-SAT (Theorem 2.4.7). This implies that for many of such groups, 3-SAT is undecidable, as they have undecidable Domino Problem (Corollary 2.4.10).

Domino Snake Problems Chapter 3 studies a remarkable species from the Swamp of Undecidability known as Domino Snake Problems. The objective of the chapter is to study of the generalization of these problems to general finitely generated groups. Section 3.1 introduces and proves properties of the three main problems: the Reachability Problem, the Infinite Snake Problem, and the Ouroboros Problem.

Section 3.2 introduces the **skeleton** associated to a group and a generating set. We prove some preliminary properties of the skeleton and its geodesic version, and show that the dynamical properties of the skeleton impact the decidability of the Infinite Snake Problem (Proposition 3.2.4).

In Section 3.3 we introduce a notion of embedding, which we call **snake embedding**, that allows us to reduce the decidability of snake problems from one group to another. This notion enables us to establish the undecidability of the Infinite Snake and Ouroboros Problems on a large class of groups, which include nilpotent groups, for any generating set provided that we add a torsion-free element from the center of the group (Theorem 3.4.4).

Lastly, Section 3.5 tackles Domino Snake Problems on virtually free groups by expressing them Monadic Second Order logic. We show that the three problems, along with their seeded and strong variants, are decidable on virtually free groups (Theorem 3.5.3 and Corollary 3.5.4).

Self-Avoiding Walks It turns out that the skeleton subshift we define in Chapter 3 is also the set of labels of bi-infinite self-avoiding walks on the Cayley graph. Thus, Chapter 4 is devoted to the study of such walks through the skeleton. Sections 4.1 and 4.2 are devoted to the definition of self-avoiding walks as well as their general properties. In particular, we show Lemma 4.2.4 stating that the entropy of the skeleton is equal to the connective constant of the Cayley graph.

In Section 4.3 we study the different computational and dynamical properties of skeletons. We prove that a group is plain if and only if it admits an SFT skeleton (Theorem 4.3.6), and that a group is a torsion group if and only if every skeleton is aperiodic (Theorem 4.3.17). Similarly, Section 4.4 contains the study of which groups admit sofic skeletons. By using techniques developed by Lindorfer and Woess for thin and thick ends [LW20], we show that a group admits a sofic skeleton if and only if it is plain, $\mathbb{Z} \times \mathbb{Z}/2\mathbb{Z}$ or the direct product of infinite dihedral group with $\mathbb{Z}/2\mathbb{Z}$ (Theorem 4.4.9).

We tackle connective constants in Section 4.5. First, we use graph height functions to show that the skeleton of Cayley graphs with such functions contain periodic points (Lemma 4.5.3). With this, we show Theorem 4.5.4 stating that Cayley graphs of torsion groups do not admit graph height functions, and Theorem 4.5.6 that tells us that the entropy of the skeleton can be approximated by periodic points in Cayley graphs that admit transitive graph height functions. We then proceed to use Rosenfeld's counting method [Ros22] to find lower bounds on the connective constant of free Burnside groups (Corollary 4.5.10).

We finish the chapter by looking at the **geodesic skeleton**. We explore when this skeleton defines an SFT, a sofic subshift, an effectively closed subshift and more. Furthermore, we introduce the **geodesic connective constant** as a geodesic analog of the traditional constant, and find its value for well known lattices (Proposition 4.6.8).

Part III: Aperiodicity

Strong Aperiodicity, Weak Aperiodicity and Everything In Between The fifth chapter of this manuscript is about aperiodicity in all of its forms. We start with Section 5.1, where we give a state of the art of the problem of the existence of strongly aperiodic SFTs. Next, we move to Section 5.2 on weakly aperiodic SFTs. This time, we not only study the state of the art of the problem, but give results on its connection with computability (Section 5.2.1) and its analogies with other problems (Section 5.2.2). Among the analogous problems is the Angel Game, for which we prove some results.

Next, Section 5.3 tackles the realizability of families of subgroups as stabilizers of subshifts of finite type. This problem generalizes the existence of both strongly aperiodic and weakly aperiodic subshifts of finite type. We study how the algebraic, geometric and computational properties of the underlying group determine which families are realizable. For instance, we show that a normal subgroup is realizable if and only if the quotient by the subgroup admits a strongly aperiodic SFT (Theorem 5.3.11), and that if a subgroup of a recursively presented group is realizable, its subgroup membership problem must be decidable (Theorem 5.3.17). In Section 5.4, we study families of subgroup that contain exclusively non-trivial infinite index subgroups. These families are interesting as any SFTs that realizes them is a weakly aperiodic subshift that is not strongly aperiodic. The first explicit search for such a subshift is due to Esnay and Moutot for Baumslag-Solitar groups [EM22a]. We introduce **periodically rigid** groups which are groups where every weakly aperiodic SFT is strongly aperiodic. This generalizes the behavior observed in \mathbb{Z}^2 . We prove many invariance and inheritance properties for periodically rigid groups. We also state Conjecture 5.4.6: a group is periodically rigid if and only if it is virtually \mathbb{Z} or torsion-free virtually \mathbb{Z}^2 (Lemma 5.4.1). In Section 5.4.1, we prove this conjecture holds for virtually nilpotent groups and polycyclic groups (Theorems 5.4.13 and 5.4.15).

We end the chapter with Section 5.5, where we give a summary of the relations between strongly aperiodic SFTs, weakly aperiodic SFTs, periodic rigidity, the Domino Problem, and the word problem (Table 5.1).

Aperiodic SFTs on Generalized Baumslag-Solitar Groups In Chapter 6, we construct strongly aperiodic SFTs for all non- \mathbb{Z} generalized Baumslag-Solitar groups (GBS). To achieve this, we start at Section 6.1 with a definition GBS groups through the notion of a **graph of groups**. Next, in Section 6.2 we take a brief pause from our strongly aperiodic ambitions to study weakly aperiodic SFTs and the Domino Problem for GBS

groups and Artin groups (Propositions 6.2.2 and 6.2.3).

The construction of the strongly aperiodic SFTs is structured as follows. First, Section 6.3 contains an explanation of the method by Carroll and Penland to lift a strongly aperiodic subshift to a group from a finite index subgroup [CP15]. This section also contains an Erratum to a proof from the original presentation of these results in [ABH24] (Section 6.3.1). Second, Section 6.4 shows the roadmap to our goal provided by Whyte’s theorem on the quasi-isometry classification of GBS groups [Why01]. Third, in Section 6.5 we give the description of a minimal, strongly aperiodic, horizontally expansive \mathbb{Z}^2 -SFT that is based on the works of Labbé [Lab21a; Lab21b; Lab21c] and Labbé, Mann, and McLoud-Mann [LMM23] on the minimal subsystem of the Jeandel-Rao Wang tile shift. Fourth, in Section 6.6 we construct a minimal strongly aperiodic SFT on $\mathbb{F}_n \times \mathbb{Z}$ (Theorem 6.6.6) by introducing the **path-folding technique**. Lastly, Section 6.7 tackles the adaptation of the path-folding technique to the non-solvable Baumslag-Solitar group $BS(2, 3)$. By building upon the work of Aubrun and Kari [AK13], we construct a strongly aperiodic SFT on this group (Theorem 6.7.10). The result of the preceding sections are Corollary 6.7.11 that states that all non- \mathbb{Z} GBS groups admit strongly aperiodic SFTs, and Corollary 6.8.2 which is a small generalization for virtually GBS groups.

Part IV: Substitutive Tools

Substitutions and Hierarchical Structures The final part and final chapter of this thesis is about substitutive and S -adic systems on groups, and the structural properties that allow for their definition. Taking an abstract-to-concrete approach, Section 7.1 contains the definition of the most general of the three classes of groups we define: **S -decomposable groups**. These groups allow for the definition of general S -adic sequences and their subshifts. We provide plenty of examples to illustrate the mechanics of the definition. The next section, Section 7.2, studies the class of **ccc groups**, introduced by Gao, Jackson and Seward for the study of hyperfinite relations [GJS16], as they allow for the definition of constant-shape S -adic sequences. We also link ccc groups to congruent monotileable groups from the theory of G -Toeplitz subshifts [CP08; CC19]. In Section 7.3, we introduce the class of **moniform groups** that allow for the definition of constant shape substitutions.

Section 7.4 is devoted to the proof of dynamical properties of S -adic subshifts. First, we prove that weakly primitive S -adic sequences define minimal subshifts (Proposition 7.4.2). Second, for congruent monotileable groups we prove a bound on the entropy of S -adic subshifts (Proposition 7.4.3). In particular, if the alphabets of the S -adic sequence are bounded, the subshift has zero entropy. Finally, we prove that for congruent monotileable groups whose tiling sequence is uniformly bounded, and weakly primitive S -adic sequences with uniformly bounded alphabet, the corresponding subshift is uniquely ergodic (Theorem 7.4.8).

We end the chapter with Section 7.5 where we look at ways in which we can obtain new results of undecidability for the Domino Problem and strongly aperiodic SFTs through recognizability and SFT covers of S -adic subshifts.

Conventions and Notation

The following are conventions and notations we will use throughout the manuscript.

Given an alphabet A , we denote by A^n the set of words on A of length n , $A^{\leq n}$ the set of words of length at most n , and A^* the set of all finite length words including the empty word ε . Furthermore, we denote by $A^+ = A^* \setminus \{\varepsilon\}$ the set of non-empty finite words over A . A factor v of a word w is a contiguous subword of w ; we denote this by $v \sqsubseteq w$. For a word $w \in A^*$, given $i, j \in \mathbb{Z}$, $w_{[i,j]}$ denotes the factor $w_i w_{i+1} \dots w_j$.

The free group defined by the free generating set of size n is denoted by \mathbb{F}_n , and the free group generated by S , \mathbb{F}_S . The commutator of two group elements g, h is denoted by $[g, h] = ghg^{-1}h^{-1}$. We denote the identity element of a group G by 1_G .

A finite subset F of a set E is denoted by $F \subseteq E$. Given a group G , two subsets $F, E \subseteq G$ and a group element $g \in G$, we denote by FE the set obtained by multiplying every element of F with an element of E , by F^{-1} the set of all inverses of elements from F , and by gF the set obtained by multiplying g to every element of F . If F is partitioned by sets $\{A_i\}_{i \in I}$, the disjoint union is denoted as $F = \coprod_{i \in I} A_i$.

Unless otherwise stated the groups considered are infinite and every generating set is finite, symmetric and does not contain the identity.

Introduction

"Karpal wore a secretive smile.

Paolo said, 'What?'

'Wang tiles. The carpets are made out of Wang tiles.'"

– Greg Egan, *Diaspora*.

Imaginez que l'on vous remette une boîte contenant une infinité de pièces de puzzle avec un nombre fini de types de pièces différents. Est-il possible de déterminer si les pièces vous permettent de compléter un puzzle qui remplit le plan infini ? Cette question apparemment anodine, connue sous le nom de « Problème du Domino », cache une théorie profonde qui s'est développée au cours des soixante dernières années et qui a eu un impact sur plusieurs branches de l'informatique théorique et des mathématiques.

Le Problème du Domino a été introduit par Hao Wang en 1961 pour étudier la décidabilité du fragment $\forall\exists\forall$ de la logique du premier ordre [Wan61]. Wang a utilisé une version abstraite de pièces de puzzle, connues aujourd'hui sous le nom de tuiles de Wang. Une tuile de Wang est un carré unitaire dont chaque bord est coloré. Deux tuiles peuvent être placées côte à côte si leur arête commune est de la même couleur. Le problème est le suivant : étant donné un ensemble fini de tuiles de Wang, est-il possible de déterminer si elles pavent le plan tout en respectant les règles d'adjacence ? Wang a conjecturé que si un ensemble de tuiles peut paver le plan, il doit également pouvoir le faire périodiquement, ce qui rend le problème décidable. Cependant, en 1966, Robert Berger, un doctorant de Wang, a prouvé l'indécidabilité du problème du domino [Ber66] et a construit le premier exemple d'un jeu de tuiles apériodique, composé de plus de vingt mille tuiles.

Le célèbre résultat de Berger a fait émerger deux axes de recherche. Premièrement, l'indécidabilité du problème du domino a été utilisée pour prouver l'indécidabilité de nombreux autres problèmes, allant de problèmes sur les automates cellulaires [Kar90; Kar92; Kar94] jusqu'au saut spectral des systèmes quantiques à plusieurs corps [CPW22]. Deuxièmement, l'existence de pavages apériodiques du plan a lancé l'étude des quasi-cristaux [BG13] et l'étude de l'apériodicité sur différentes surfaces et espaces [Moz97].

Dans cette thèse, nous poursuivons ces deux voies en explorant l'indécidabilité du problème du domino et l'existence de tuiles apériodiques pour les groupes finiment engendrés. Comme cela a été fait au cours des trente dernières années, nous appréhendons ces deux problèmes à travers le prisme de la dynamique symbolique. Plus précisément, nous les voyons comme des questions sur la classe des sous-décalages de type fini. Le but de cette thèse est de progresser dans la compréhension de la question générale suivante.

Question. Comment les propriétés algébriques et géométriques du groupe sous-jacent affectent-elles les propriétés dynamiques et de calculabilité de ses sous-décalages de type fini ?

Dynamique symbolique

Le cadre général de la thèse est celui de la dynamique symbolique. Bien qu'elle ait été conçue à l'origine pour l'étude de systèmes dynamiques généraux, elle est devenue un domaine d'étude riche en soi, avec de nombreuses applications à la fois en mathématiques pures et appliquées et en informatique théorique.

À son origine, l'objectif de la dynamique symbolique était d'étudier les discrétisations de systèmes dynamiques continus. L'idée principale était de partitionner l'espace des états possibles en un nombre fini de morceaux, chacun d'entre eux étant associé à un symbole. Ensuite, le système est codé par des suites infinies de symboles représentant les trajectoires des points dans l'espace. L'idée est d'étudier ce nouveau système symbolique pour comprendre la dynamique du système original. Par exemple, considérons un système dynamique (X, T) , où X est un espace compact et T un homéomorphisme. Nous pouvons partitionner l'espace en sous-ensembles ouverts X_{\square} , X_{\blacksquare} , X_{\blacklozenge} , et définir une fonction $\gamma : X \rightarrow \{\square, \blacksquare, \blacklozenge\}$ envoyant des points de l'espace sur le symbole de la partition correspondante. Nous définissons ensuite une fonction $\varphi : X \rightarrow \{\square, \blacksquare, \blacklozenge\}^{\mathbb{Z}}$ qui nous permet de coder une orbite d'un point $p \in X$ par une suite $\varphi(p) \in \{\square, \blacksquare, \blacklozenge\}^{\mathbb{Z}}$ définie par $\varphi(p)(k) = \gamma(T^k(p))$. Un exemple de ce procédé est présenté dans la Figure 3.

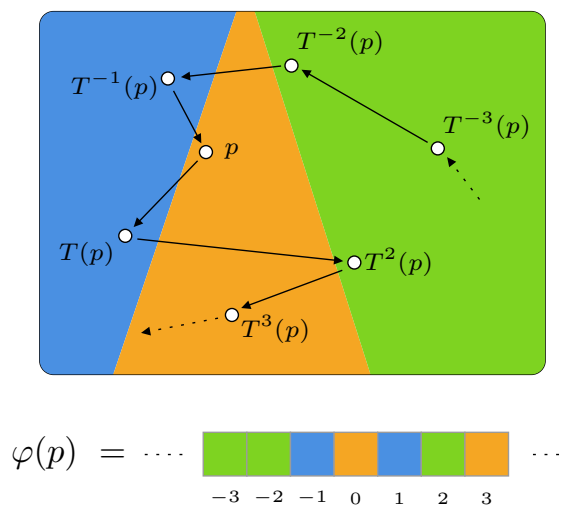

Figure 3: Exemple de discrétisation du système dynamique (X, T) . L'orbite d'un point $p \in X$ est représentée sur une partition de l'espace X , ainsi que la suite bi-infinie correspondante de symboles qu'elle génère. Cette figure est une partie essentielle de toute introduction à une thèse ou à une HDR sur la dynamique symbolique.

L'ensemble de toutes les suites de symboles obtenues par ce procédé, $\varphi(X)$, est compact pour la topologie produit et subit l'action du décalage, $\sigma(x)(k) = x(k - 1)$ pour tout $x \in \varphi(X)$ et $k \in \mathbb{Z}$, ce qui fait de $\varphi(X), \sigma$ un système dynamique. Sous certaines conditions, l'espace de toutes les suites de symboles décrit complètement le système original. Les premières versions de cette approche remontent à l'étude des flux géodésiques sur les surfaces de courbure négative par Hadamard [Had98]. L'étude de ces espaces symboliques a commencé sérieusement avec les travaux de Morse et Hedlund [MH38; MH40]. Ils ont appelé ces espaces **sous-décalages** et ont étudié leurs propriétés de récurrence et de minimalité. Une synthèse de l'histoire des origines de la dynamique symbolique est disponible dans [CN08].

Avec l'approche moderne, les sous-décalages sont vus comme des ensembles de colorations d'un groupe G par un alphabet fini A qui sont fermés pour la topologie produit et invariants sous l'action du groupe par des translations. De manière surprenante, ces systèmes ont également une description combinatoire. Un sous-décalage peut être défini de manière équivalente comme l'ensemble des colorations de G qui évitent un certain ensemble de motifs interdits. C'est avec cette définition alternative que l'objet principal de cette thèse apparaît : les **sous-décalages de type fini** (SFT). Un SFT est un sous-décalage défini par un ensemble fini de motifs interdits. Leur étude a commencé avec Parry [Par64], mais leur nom vient de Smale, qui les a utilisés pour comprendre la dynamique des *mappings* lisses [Sma67].

Les sous-décalages de type fini sur \mathbb{Z} sont bien compris et toute une théorie solide a été développée, notamment dans le livre classique de Lind et Marcus [LM21]. Il est alors naturel de se demander quels aspects de cette théorie peuvent être généralisés aux sous-décalages sur \mathbb{Z}^2 et au-delà. C'est ici qu'intervient le Problème du Domino. L'ensemble des pavages générés par un ensemble fini de tuiles de Wang est un sous-décalage de

type fini : l'alphabet est l'ensemble des tuiles et les motifs interdits sont donnés par des violations de la règle des tuiles de Wang. Il s'avère que chaque SFT sur \mathbb{Z}^2 est dynamiquement équivalent à un sous-décalage défini à partir des tuiles de Wang.

Le marécage de l'indécidabilité et la forêt de la décidabilité

Lorsque la dynamique symbolique a commencé à se interagir avec le domaine des actions de \mathbb{Z}^2 , il est rapidement devenu clair que le comportement des sous-décalages de type fini de deux dimensions était très différent de leurs homologues unidimensionnels. En particulier, comme le montrent l'indécidabilité du Problème du Domino et l'existence de SFT apériodiques, la réponse aux questions fondamentales sur ces systèmes est indécidable. Cette observation a conduit Lind à parler de **Marécage d'indécidabilité** à propos des sous-décalages de type fini multidimensionnels [Lin04]. L'existence de ce marécage est également attestée par le résultat de Hanf et Myer sur l'existence de \mathbb{Z}^2 -SFTs où aucun pavage n'est calculable [Han74; Mye74], et le résultat de Hochman et Meyerovitch sur l'existence de \mathbb{Z}^2 -SFTs avec une entropie non calculable [HM10]. Malgré le fait que ces résultats limitent notre compréhension informatique de ces systèmes - Lind allant jusqu'à dire que le marécage « *[est] un endroit où vous ne voulez pas aller* » - certains chercheurs³ suggèrent le nom alternatif **Jardin de l'indécidabilité**, car ces résultats d'indécidabilité ont fourni une théorie riche sur les aspects informatiques des systèmes symboliques.

Ce jardin est vaste. En conséquence de l'indécidabilité du Problème du Domino, de nombreux autres problèmes ont été montrés comme étant indécidables dans \mathbb{Z}^2 . Parmi eux, on peut citer le Problème du Domino à Origine Fixée [KMW62; Büc62], le Problème du Domino Récurrent [Har85], le Problème du Domino Périodique [Jea10], le Problème du Domino Apériodique [GHV18], le problème k -SAT pour \mathbb{Z}^2 [Fre99], le Problème du Serpent Infini [Adl+09] et le Problème de l'Ouroboros [Ebb82; Kar02], pour en citer quelques-uns.

Pour mieux comprendre quelles propriétés de \mathbb{Z}^2 expliquent l'existence du Jardin, les chercheurs se sont tournés vers le Problème du Domino sur d'autres groupes finiment engendrés. Une référence sur l'avancement de ce projet se trouve dans [ABJ18]. En particulier, cette synthèse met en évidence l'autre extrémité du spectre d'un point de vue calculatoire : la classe des **groupes virtuellement libres**. Pour ces groupes, il a été démontré que le Problème du Domino et certaines de ses variantes sont décidables [BS18; Pia08]. En fait, on conjecture que ces groupes sont les seuls où c'est le cas.

Conjecture. Un groupe finiment engendrés a Problème du Domino décidable si et seulement s'il est virtuellement libre.

La caractéristique cruciale des groupes virtuellement libres est que leurs graphes de Cayley ont une largeur arborescente finie [MS85], et donc une logique monadique du second ordre décidable [KL05]. En fonction de ce fait, nous proposons le nom de **forêt de décidabilité** pour les sous-décalages de type fini sur les groupes virtuellement libres.

Dans cette thèse, nous étudions les variantes et les conséquences du Problème du Domino sur les groupes finiment engendrés : le Problème du Domino à Origine Fixée, le Problème du Domino Récurrent, le problème k -SAT, le Problème du Serpent Infini et le Problème de l'Ouroboros. Nous montrons que la Forêt de la Décidabilité reste fidèle à son nom pour tous ces problèmes.

Aperiodicité

Rappelez-vous que le deuxième aspect clé du résultat de Berger était l'existence de sous-décalages de type fini apériodiques. Depuis la publication de cette construction, de nombreux autres pavages apériodiques du plan [Rob71; Kar96; JR21], ainsi que d'autres surfaces riemanniennes ont été construits [Pen79; BW92; Moz97; MN14]. Le projet actuel est de comprendre quels groupes admettent des sous-décalages de type fini apériodiques.

³Guillaume Theyssier, communication personnelle

En travaillant au-delà de \mathbb{Z}^2 , Mozes a observé qu'il n'y avait plus une seule notion d'apériodicité pour les sous-décalages [Moz97], mais plutôt deux. Il a introduit les noms **faiblement apériodique**, pour les SFT où l'orbite de chaque pavage est infinie, et **fortement apériodique**, pour les SFT où le stabilisateur de chaque pavage est trivial. De nombreux progrès ont été réalisés dans l'établissement de l'existence des deux types de SFT apériodiques pour de nombreuses classes de groupes. Pour une étude récente, voir [Rie22].

Grâce aux travaux de Jeandel [Jea15a] et Cohen [Coh17], nous savons que l'existence de SFTs fortement apériodiques est influencée par le nombre de bouts et la cotalité du problème des mots du groupe sous-jacent. Il n'y a pas beaucoup d'autres obstructions connues pour leur construction. À présent, il a été démontré que de nombreuses classes de groupes vérifient la conjecture suivante, obtenue en combinant les résultats de Jeandel et de Cohen.

Conjecture. Un groupe finiment engendré admet un SFT fortement apériodique si et seulement s'il a un bout et un problème de mot décidable.

En revanche, pour les SFT faiblement apériodiques, nous disposons de plus d'outils : ils se comportent bien avec les sous-groupes, les quotients et les actions de type translation, pour n'en citer que quelques-uns [Jea15c]. En étudiant l'invariance par commensurabilité des deux types d'apériodicité, Carroll et Penland ont proposé la conjecture suivante sur l'existence de pavages faiblement apériodiques.

Conjecture. Un groupe finiment engendré admet un SFT faiblement apériodique si et seulement s'il n'est pas virtuellement \mathbb{Z} .

Dans cette thèse, nous examinons l'état de l'art des deux conjectures et montrons que les conjectures sont satisfaites pour la classe des groupes de Baumslag-Solitar généralisés. Nous explorons également un nouvel aspect de l'apériodicité, à savoir quelles familles de sous-groupes peuvent être obtenues comme stabilisateurs de sous-décalages de type fini.

Les outils du métier

Lors de l'étude des sous-décalages sur \mathbb{Z} , une classe fréquemment utilisée pour la construction d'exemples de sous-décalages ayant les propriétés recherchées est celle des **systèmes S -adiques**. Ces systèmes ont été introduits dans les travaux de Ferenczi [Fer96], Livschits et Vershik [LV92]. Un système S -adique est une suite de morphismes $(\tau_n)_{n \in \mathbb{N}}$ qui engendre des mots infinis en appliquant séquentiellement les morphismes sur les lettres. Ils sont une généralisation des systèmes substitutifs classiques, décrivent de grandes classes de sous-décalages [Esp23b], et ont été largement étudiés pour toutes leurs propriétés dynamiques [Don+21; Ber+21].

Considérant l'efficacité du formalisme S -adique au cours des dernières décennies, les chercheurs ont commencé à étudier ces systèmes dans un cadre multidimensionnel. Dans \mathbb{Z}^2 , les sous-décalages S -adiques, en particulier les substitutifs, ont été un outil puissant pour trouver de nouvelles preuves de l'indécidabilité du Problème du Domino [DRS12; JV20] et trouver des sous-décalages apériodiques [Cab23; Lab23; Lab21a]. Cela est possible grâce à des théorèmes de simulation, notamment le théorème de Mozes [Moz89] et sa généralisation par Aubrun et Sablik [AS14]. Néanmoins, ces systèmes fréquentent également le Jardin d'indécidabilité. Jolivet et Kari ont montré qu'étant donnée une liste de règles de concaténation pour une substitution \mathbb{Z}^2 , déterminer si l'image de la substitution est cohérente ou sans chevauchement est indécidable [JK12].

Dans [Cab23], Cabezas a formalisé la notion de **substitutions de forme constante** de \mathbb{Z}^d , apportant une théorie robuste pour étudier les systèmes substitutifs loin de la portée de l'indécidabilité. Son travail avec Petite et Leroy a également fourni de nombreux exemples de sous-décalages avec des propriétés dynamiques et computationnelles intéressantes [CP23; CL24].

Il y a également eu des tentatives récentes pour généraliser les substitutions à d'autres groupes. Cela a été fait pour les treillis sur de nombreux groupes de Lie nilpotents non abéliens [BHP21], le semigroupe libre sur deux générateurs [BL21], et certains groupes localement finis [BS24]. Dans cette thèse, nous généralisons les systèmes S -adiques aux groupes généraux avec une approche différente. Au lieu de considérer des classes spécifiques de groupes, nous définissons des classes qui contiennent des groupes ayant la structure appropriée

pour permettre des séquences S -adiques de divers degrés de rigidité. L'objectif à long terme est d'utiliser ces systèmes pour établir de nouveaux résultats d'indécidabilité et d'apériodicité.

Contributions

Les contributions de cette thèse sont des tentatives de réponse à la question posée au début de cette introduction : comment les propriétés du groupe sous-jacent influencent-elles les propriétés de ses sous-décalages de type fini, et vice versa. Les contributions de cette thèse sont contenues, mais ne sont pas exclusivement issues des articles suivants :

- *Contributions to the Domino Problem: Seeding, Recurrence and Satisfiability.*

Dans cet article, nous étudions le Problème du Domino à Origine Fixée, le Problème du Domino Récurrent et le problème k -SAT sur les groupes finiment engendrés. Nous montrons des propriétés d'invariance pour les Problèmes du Domino à Origine Fixée et du Domino Récurrent, et que le Problème du Domino Récurrent est décidable pour les groupes libres. Nous conjecturons que les seuls groupes dans lesquels les Problèmes du Domino à Origine Fixée et Récurrent sont décidables sont des groupes virtuellement libres. Pour le problème k -SAT, nous montrons que le problème d'appartenance à un sous-groupe se réduit *many-one* au problème k -SAT, que dans certains cas le problème k -SAT se réduit *many one* au Problème du Domino, et enfin que le Problème du Domino se réduit au problème k -SAT pour certains groupes. Ce travail a été présenté à STACS 2024 [Bit24a].

- *Domino Snake Problems* avec Nathalie Aubrun.

Dans cet article, nous étudions la calculabilité des problèmes de Domino Serpent sur les groupes finiment engendrés. Nous introduisons le sous-décalage squelette qui nous permet de résoudre de nombreuses variantes du Problème du Serpent Infini, y compris le Problème du Serpent Géodésique. Nous montrons également que les problèmes du Serpent Infini et de l'Ouroboros sur les groupes nilpotents sont indécidables pour tout ensemble générateur, à condition d'ajouter un élément bien choisi. Enfin, nous utilisons la logique monadique du second ordre pour prouver que les problèmes du Domino Serpent sont décidables sur les groupes virtuellement libres pour tous les ensembles générateurs. Ce travail a été présenté à FCT 2023 [AB23], et a également une version journal qui a été soumise [AB24a].

- *Self-Avoiding Walks on Cayley Graphs through the Lens of Symbolic Dynamics* avec Nathalie Aubrun.

Dans cet article, nous étudions les propriétés dynamiques et computationnelles de l'ensemble des marches auto-évitantes bi-infinies sur les graphes de Cayley, ainsi que les moyens de calculer, d'approximer et de borner leur constante de connectivité. Pour cela, on utilise le squelette, $\mathbb{X}_{G,S}$, d'un groupe finiment engendré G par rapport à un ensemble générateur S . Nous fournissons une caractérisation des groupes qui ont des squelettes SFT et des squelettes sofiqes. Nous caractérisons aussi les groupes de torsion finiment engendrés comme des groupes dont les squelettes sont apériodiques. Pour les constantes de connectivité, nous montrons que les graphes de Cayley des groupes de torsion finiment générés n'admettent pas de fonctions de hauteur de graphe, que pour les groupes qui admettent des fonctions de hauteur de graphe transitives, la constante de connectivité est égale au taux de croissance des points périodiques du squelette, et en utilisant un argument de comptage dû à Rosenfeld, nous donnons des bornes sur la constante de connectivité des groupes de Burnside libres infinis. Enfin, nous examinons l'ensemble des géodésiques bi-infinies et introduisons un analogue de la constante de connectivité pour la croissance des géodésiques. Ce travail a été soumis à un journal [AB24b].

- *Realizability of Subgroups by Subshifts of Finite Type.*

Dans cet article, nous étudions le problème de la réalisation de familles de sous-groupes en tant qu'ensemble de stabilisateurs de configurations d'un sous-décalage de type fini. Nous montrons qu'un sous-groupe normal est réalisable si et seulement si le quotient par le sous-groupe admet un SFT fortement apériodique. Nous montrons également que si un sous-groupe est réalisable, son problème d'appartenance à un sous-groupe doit être décidable. L'article contient également l'introduction des groupes périodiquement rigides, qui sont des groupes pour lesquels tout sous-décalage faiblement apériodique de type fini est fortement apériodique. Nous introduisons une nouvelle conjecture affirmant que les seuls groupes périodiquement rigides sont les groupes virtuellement \mathbb{Z} et les groupes virtuellement \mathbb{Z}^2 sans torsion. Enfin, nous montrons que les groupes virtuellement nilpotents et polycycliques satisfont la conjecture. Ce travail est une prépublication [Bit24b].

- *Strongly Aperiodic SFTs on Generalized Baumslag-Solitar Groups* avec Nathalie Aubrun et Sacha Huriot-Tattegrain

Dans cet article, nous étudions des constructions de SFT apériodiques sur des groupes fondamentaux de graphes de groupes. En particulier, nous prouvons que tous les groupes de Baumslag-Solitar généralisés non \mathbb{Z} admettent un SFT fortement apériodique. Les constructions s'appuient sur une technique de *path-folding* qui permet de relever un SFT sur \mathbb{Z}^2 en un SFT sur $\mathbb{F}_n \times \mathbb{Z}$, ou encore un SFT sur le plan hyperbolique en un SFT sur $BS(m, n)$. Dans le cas de $\mathbb{F}_n \times \mathbb{Z}$, la technique de *path-folding* préserve également la minimalité. Ce travail a été publié dans *Ergodic Theory and Dynamical Systems* [ABH24].

- *Substitutions and Hierarchical Structures* avec Christopher Cabezas et Pierre Guillon.

Dans cet article, nous introduisons de nouvelles notions de substitutions, de systèmes S -adiques, et leurs sous-décalages correspondants pour les groupes dénombrables. Nous identifions trois classes de groupes : les groupes S -décomposables, les groupes ccc et les groupes monoformes. Chacun de ces groupes permet de définir des systèmes S -adiques de plus en plus rigides. Nous terminons par l'étude des propriétés dynamiques des sous-décalages définis par ces systèmes. Nous montrons que, en général, ils sont minimaux sous des conditions de primitivité, et que pour certains groupes ccc moyennables, ils ont une entropie nulle et sont uniquement ergodiques. Ce travail est en préparation.

Organisation du manuscrit

La thèse est divisée en quatre parties. La partie **I** sert d'introduction aux nombreux concepts de la dynamique symbolique, de la théorie de la calculabilité et de la théorie des groupes qui sont nécessaires pour le reste du manuscrit. La partie **II** est consacrée au Problème du Domino, à ses variantes et à ses conséquences. Le chapitre **2** traite de l'état de l'art sur le Problème du Domino et ses variantes, le chapitre **3** traite du Problème du Domino Serpent, et le chapitre **4** des marches auto-évitantes bi-infinies à travers le prisme de la dynamique symbolique. La partie **III** traite de l'apériodicité. Dans cette partie, le chapitre ?? explore l'état de l'art des SFTs fortement et faiblement apériodiques, ainsi que les nouveaux problèmes et conjectures autour de l'apériodicité. Le chapitre **6** contient la construction de SFTs fortement apériodiques sur la classe des groupes de Baumslag-Solitar généralisés. Enfin, dans la partie **IV**, nous présentons une généralisation des systèmes S -adiques aux groupes généraux dénombrables et explorons ses propriétés dynamiques. Les principales dépendances entre les chapitres sont illustrées dans la Figure 4. Nous avons essayé de rendre cette thèse aussi autonome que possible et de donner des références pour permettre au lecteur d'approfondir les sujets qui l'intéressent. Nous fournissons également un index contenant des mots clés et les endroits où ils figurent de façon importante. Nous avons fait de notre mieux pour tenir le Titivillus⁴ éloigné.

⁴Titivillus ou Tutivillus est le nom donné au « démon patron des scribes ». On raconte qu'au Moyen Âge, il entrait dans les monastères où travaillaient les scribes et ajoutait des erreurs et des coquilles à leur travail lorsqu'ils étaient distraits [Jen77].

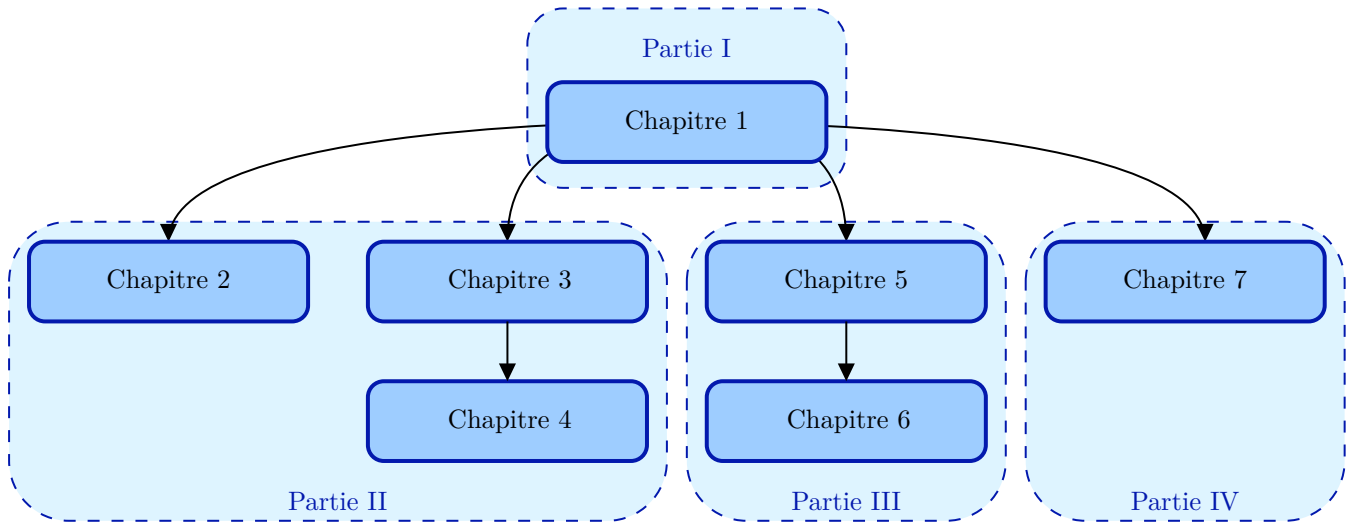

Figure 4: Plan de la thèse et dépendances.

Partie I : Contexte et définitions

Sous-décalages, calculabilité et groupes La première partie et le premier chapitre de la thèse sont consacrés à l'introduction du contexte nécessaire pour le reste du manuscrit. Nous commençons dans la Section 1.1 par introduire les sous-décalages et les notions de morphismes, de conjugaison, d'apériodicité et de minimalité. Nous définissons également la classe des sous-décalages de type fini et la classe des sous-décalages sofiques. La section 1.2 est consacrée à l'introduction des notions de décidabilité, d'énumérabilité, de hiérarchie arithmétique et de réductions issues de la théorie de la calculabilité. Ces notions seront nécessaires pour traiter les différents problèmes de décision présentés dans le texte. De même, la section 1.3 introduit des notions issues de la théorie combinatoire et géométrique des groupes, notamment le problème du mot, les quasi-isométries, les actions de type translation, etc. Grâce au contexte fourni par ces trois sections, nous sommes en mesure de définir à la fois les sous-décalages effectivement fermés et l'entropie dans la Section 1.4.1 et la Section 4.2.2 respectivement.

La section 1.5 est consacrée à ce que nous appelons des **constructions canoniques**. Ce sont des constructions qui apparaissent souvent dans la littérature, et qui permettent de transformer un sous-décalage sur un groupe donné, en un sous-décalage sur un surgroupe, un sous-groupe d'indice fini, un quotient, ou à partir d'un quotient. Ces constructions apparaîtront de façon récurrente dans le manuscrit.

La dernière section du chapitre, Section 1.6, explore les analogies entre les groupes finiment engendrés telles qu'elles ont été observées à l'origine par Jeandel et Vanier [JV19]. Nous terminons la section en introduisant les sous-décalages **résiduellement périodiques** en tant qu'analogues proposés aux groupes résiduellement finis.

Partie II : Le vide

Le Problème du Domino La deuxième partie du manuscrit commence par un chapitre 2 consacré au Problème du Domino et à certaines de ses variantes. Le chapitre commence par un bref historique du problème, sa définition, ses propriétés, et l'état actuel de l'art autour de la **Conjecture du Domino**. Le chapitre se poursuit avec la Section 2.1 sur l'état actuel du Problème du Domino à Origine Fixée et du Problème du Domino Récurrent. Elle est suivie par la Section 2.2 où nous prouvons des propriétés pour ces deux problèmes ainsi que le Théorème 2.2.5 affirmant que le Problème du Domino Récurrent est décidable pour les groupes libres. La section se termine par le Corollaire 2.2.11 qui montre que la Conjecture du Domino implique que le Problème du Domino, le Problème du Domino à Origine Fixée et le Problème du Domino Récurrent ne sont décidables que sur des groupes virtuellement libres.

Ensuite, la section 2.3 aborde le Problème du Domino Périodique et le Problème du Domino Apériodique.

Pour le premier, nous montrons qu'il est co-récursivement énumérable pour les groupes avec ReFQ, tels que définis par Rauzy [Rau22] (Proposition 2.3.4). Pour le deuxième, nous étudions son lien avec un analogue du théorème d'Adyan-Rabin pour les sous-décalages dû à Carrasco-Vargas [Car24].

Enfin, dans la section 2.4, nous examinons le problème k -SAT pour les groupes finiment engendrés. Nous introduisons une définition du problème qui diffère de la définition originale de Freedman [Fre99], afin de la rendre compatible avec les groupes finiment engendrés. Nous prouvons que le problème de l'appartenance à un sous-groupe (SMP) du groupe sous-jacent se réduit many-one à 2-SAT (Lemma 2.4.3) et que pour les groupes avec SMP décidable k -SAT se réduit au Problème du Domino (Lemma 2.4.4). Ce dernier résultat implique que les groupes virtuellement libres ont un problème k -SAT décidable. De plus, nous montrons que si un groupe contient un sous-groupe propre d'indice fini isomorphe au groupe, alors le Problème du Domino se réduit à 3-SAT (Théorème 2.4.7). Cela implique que pour beaucoup de ces groupes, 3-SAT est indécidable, car ils ont un Problème du Domino indécidable (Corollaire 2.4.10).

Problèmes du Domino Serpents Le chapitre 3 étudie une espèce remarquable du marais de l'indécidabilité connue sous le nom de problèmes du Domino Serpent. L'objectif du chapitre est d'étudier la généralisation de ces problèmes aux groupes généraux finiment engendrés. Section 3.1 introduit et prouve les propriétés des trois problèmes principaux : le problème de l'accessibilité, le problème du Serpent Infini, et le problème de l'Ouroboros.

La section 3.2 introduit le **squelette** associé à un groupe et à un ensemble générateur. Nous prouvons quelques propriétés préliminaires du squelette et de sa version géodésique, et montrons que les propriétés dynamiques du squelette ont un impact sur la décidabilité du problème du serpent infini (Proposition 3.2.4).

Dans la section 3.3, nous introduisons une notion de plongement, que nous appelons **plongement serpent**, qui nous permet de réduire la décidabilité des problèmes du serpent d'un groupe à un autre. Cette notion nous permet d'établir l'indécidabilité des problèmes du Serpent Infini et de l'Ouroboros sur une grande classe de groupes, qui incluent les groupes nilpotents, pour tout ensemble générateur à condition d'ajouter un élément sans torsion du centre du groupe (Théorème 3.4.4).

Enfin, la section 3.5 aborde les problèmes de problème du Domino Serpent sur les groupes virtuellement libres en les exprimant dans la logique monadique du second ordre. Nous montrons que les trois problèmes, ainsi que leurs variantes à Origine Fixée et forte, sont décidables sur des groupes virtuellement libres (Théorème 3.5.3 et Corollaire 3.5.4).

Marches auto-évitantes Il s'avère que le sous-décalage squelette que nous définissons dans le chapitre 3 est également l'ensemble des étiquettes des marches auto-évitantes bi-infinies sur le graphe de Cayley. Le chapitre 4 est donc consacré à l'étude de ces marches à travers du squelette. Les sections 4.1 et 4.2 sont consacrées à la définition des marches auto-évitantes ainsi qu'à leurs propriétés générales. En particulier, nous démontrons le Lemme 4.2.4 selon lequel l'entropie du squelette est égale à la constante de connectivité du graphe de Cayley.

Dans la section 4.3, nous étudions les différentes propriétés computationnelles et dynamiques des squelettes. Nous prouvons qu'un groupe est nature si et seulement s'il admet un squelette SFT (Théorème 4.3.6), et qu'un groupe est un groupe de torsion si et seulement si chaque squelette est apériodique (Théorème ??). De même, la section 4.4 contient l'étude des groupes qui admettent des squelettes sofiqes. En utilisant les techniques développées par Lindorfer et Woess pour les bouts fins et épais [LW20], nous montrons qu'un groupe admet un squelette sofic si et seulement s'il est nature, $\mathbb{Z} \times \mathbb{Z}/2\mathbb{Z}$ ou le produit direct d'un groupe diédral infini avec $\mathbb{Z}/2\mathbb{Z}$ (Théorème 4.4.9).

Nous abordons les constantes de connectivité dans la section 4.5. Tout d'abord, nous utilisons les fonctions de hauteur des graphes pour montrer que le squelette des graphes de Cayley ayant ce type de fonctions contient des points périodiques (Lemma 4.5.3). Nous montrons ensuite le Théorème 4.5.4 indiquant que les graphes de Cayley des groupes de torsion n'admettent pas de fonctions de hauteur de graphe, et le Théorème 4.5.6 qui nous indique que l'entropie du squelette peut être approximée par les points périodiques dans les graphes de Cayley qui admettent des fonctions de hauteur de graphe transitives. Nous utilisons ensuite la méthode de comptage de Rosenfeld [Ros22] pour trouver des bornes inférieures sur la constante connective des groupes de Burnside libres (Corollaire 4.5.10).

Nous terminons le chapitre en examinant le **squelette géodésique**. Nous explorons quand ce squelette définit un SFT, un sous-décalage sofique, un sous-décalage effectivement fermé et plus encore. De plus, nous introduisons la **constante de connectivité géodésique** comme analogue géodésique de la constante traditionnelle, et nous trouvons sa valeur pour des treillis bien connus (Proposition 4.6.8).

Partie III : Apériodicité

L'apériodicité forte, l'apériodicité faible et tout ce qui se passe au milieu Le cinquième chapitre de ce manuscrit traite de l'apériodicité sous toutes ses formes. Nous commençons par la Section 5.1, où nous donnons un état de l'art du problème de l'existence de SFTs fortement apériodiques. Ensuite, nous passons à la Section 5.2 sur les SFTs faiblement apériodiques. Cette fois, nous n'étudions pas seulement l'état de l'art du problème, mais nous donnons des résultats sur sa connexion avec la calculabilité (Section 5.2.1) et ses analogies avec d'autres problèmes (Section 5.2.2). Parmi les problèmes analogues se trouve le jeu de l'ange, pour lequel nous prouvons quelques résultats.

Ensuite, la section 5.3 aborde la réalisabilité des familles de sous-groupes en tant que stabilisateurs de sous-décalages de type fini. Ce problème généralise l'existence de sous-décalages fortement apériodiques et faiblement apériodiques de type fini. Nous étudions comment les propriétés algébriques, géométriques et computationnelles du groupe sous-jacent déterminent quelles familles sont réalisables. Par exemple, nous montrons qu'un sous-groupe normal est réalisable si et seulement si le quotient du sous-groupe admet une SFT fortement apériodique (Théorème 5.3.11), et que si un sous-groupe d'un groupe recursivement présenté est réalisable, son problème d'appartenance doit être décidable (Théorème 5.3.17). Dans la section 5.4, nous étudions les familles de sous-groupes qui contiennent exclusivement des sous-groupes non triviaux d'indice infini. Ces familles sont intéressantes car tout SFT qui les réalise est un sous-décalage faiblement apériodique qui n'est pas fortement apériodique. La première recherche explicite d'un tel sous-décalage est due à Esnay et Moutot pour les groupes de Baumslag-Solitar [EM22a]. Nous introduisons les groupes **periodically rigid** qui sont des groupes où chaque SFT faiblement apériodique est fortement apériodique. Ceci généralise le comportement observé dans \mathbb{Z}^2 . Nous prouvons de nombreuses propriétés d'invariance et d'héritage pour les groupes périodiquement rigides. Nous énonçons également la conjecture 5.4.6 : un groupe est périodiquement rigide si et seulement s'il est virtuellement \mathbb{Z} ou virtuellement \mathbb{Z}^2 sans torsion (Lemma 5.4.1). Dans la section 5.4.1, nous prouvons que cette conjecture est valable pour les groupes virtuellement nilpotents et les groupes polycycliques (Théorèmes 5.4.13 et 5.4.15).

Nous terminons le chapitre par la Section 5.5, où nous donnons un résumé des relations entre les SFTs fortement apériodiques, les SFTs faiblement apériodiques, la rigidité périodique, le Problème du Domino, et le problème du mot (Tableau 5.1).

SFTs apériodiques sur les groupes de Baumslag-Solitar généralisés Dans le chapitre 6, nous construisons des SFTs fortement apériodiques pour tous les groupes de Baumslag-Solitar généralisés (GBS) non- \mathbb{Z} . Pour ce faire, nous commençons à la Section 6.1 par une définition des groupes GBS à travers la notion de **graphes de groupes**. Ensuite, dans la Section 6.2 nous faisons une brève pause dans nos ambitions fortement apériodiques pour étudier les SFTs faiblement apériodiques et le Problème du Domino pour les groupes GBS et les groupes d'Artin (Propositions 6.2.2 et 6.2.3).

La construction des SFT fortement apériodiques est détaillée comme suit. Tout d'abord, la section 6.3 contient une explication de la méthode de Carroll et Penland pour relever un sous-décalage fortement apériodique vers un groupe à partir d'un sous-groupe d'indice fini [CP15]. Cette section contient également un Erratum à une preuve de la présentation originale de ces résultats dans [ABH24] (Section 6.3.1). Deuxièmement, la section 6.4 montre le chemin vers notre objectif fourni par le théorème de Whyte sur la classification quasi-isométrique des groupes GBS [Why01]. Troisièmement, dans la Section 6.5 nous donnons la description d'un \mathbb{Z}^2 -SFT minimal, fortement apériodique, horizontalement expansif qui est basé sur les travaux de Labbé [Lab21a; Lab21b; Lab21c] et Labbé, Mann, et McLoud-Mann [LMM23] sur le sous-système minimal du pavage par tuiles de Wang de Jeandel-Rao. Quatrièmement, dans la Section 6.6, nous construisons un SFT minimal fortement apériodique sur $\mathbb{F}_n \times \mathbb{Z}$ (Théorème 6.6.6) en introduisant la **technique du path-folding**. Enfin, la section 6.7 aborde l'adaptation de la technique du path-folding au groupe de Baumslag-Solitar non résoluble $BS(2, 3)$. En

s'appuyant sur les travaux d'Aubrun et Kari [AK13], nous construisons un SFT fortement apériodique sur ce groupe (Théorème 6.7.10). Les résultats des sections précédentes sont le Corollaire 6.7.11 qui établit que tous les groupes GBS non- \mathbb{Z} admettent des SFTs fortement apériodiques, et le Corollaire 6.8.2 qui est une petite généralisation pour les groupes virtuellement GBS.

Partie IV : Outils substitutifs

Substitutions et structures hiérarchiques La dernière partie et le dernier chapitre de cette thèse concernent les systèmes substitutifs et S -adiques sur les groupes, et les propriétés structurales qui permettent de les définir. En adoptant une approche allant de l'abstrait au concret, la section 7.1 contient la définition de la plus générale des trois classes de groupes que nous définissons : **groupes S -décomposables**. Ces groupes permettent de définir des suites S -adiques générales et leurs sous-décalages. Nous fournissons de nombreux exemples pour illustrer la mécanique de la définition. La section suivante, Section 7.2, étudie la classe des **groupes ccc**, introduite par Gao, Jackson et Seward pour l'étude des relations hyperfinies [GJS16], car ils permettent de définir des suites S -adiques de forme constante. Nous établissons également un lien entre les groupes ccc et les groupes monotiléables congruents de la théorie des sous-décalages G -Toeplitz [CP08; CC19]. Dans la section 7.3, nous introduisons la classe des **groupes monofformes** qui permettent de définir des substitutions de formes constantes.

La section 7.4 est consacrée à la preuve des propriétés dynamiques des sous-décalages S -adiques. Tout d'abord, nous prouvons que les séquences S -adiques faiblement primitives définissent des sous-décalages minimaux (Proposition 7.4.2). Deuxièmement, pour les groupes monotiléables congruents, nous prouvons une limite sur l'entropie des sous-décalages S -adiques (Proposition 7.4.3). En particulier, si les alphabets de la séquence S -adique sont bornés, le sous-décalage a une entropie nulle. Enfin, nous prouvons que pour les groupes monotiléables congruents dont la séquence de tuiles est uniformément bornée, et les séquences S -adiques faiblement primitives à alphabet uniformément borné, le sous-décalage correspondant est uniquement ergodique (Théorème 7.4.8).

Nous terminons le chapitre par la Section 7.5 où nous examinons comment nous pouvons obtenir de nouveaux résultats d'indécidabilité pour le Problème du Domino et les SFTs fortement apériodiques à travers la reconnaissabilité et les recouvrements SFT des sous-décalages S -adiques.

Conventions et notations

Etant donné un alphabet A , nous désignons par A^n l'ensemble des mots sur A de longueur n , $A^{\leq n}$ l'ensemble des mots de longueur au plus n , et A^* l'ensemble de tous les mots de longueur finie, y compris le mot vide ε . De plus, on désigne par $A^+ = A^* \setminus \{\varepsilon\}$ l'ensemble des mots finis non vides sur A . Un facteur v d'un mot w est un sous-mot contigu de w ; on le désigne par $v \sqsubseteq w$. Pour un mot w dans A^* , étant donné $i, j \in \mathbb{Z}$, $w_{[i,j]}$ désigne le facteur $w_i w_{i+1} \dots w_j$.

Le groupe libre défini par l'ensemble générateur libre de taille n est noté \mathbb{F}_n , et le groupe libre généré par S , \mathbb{F}_S . Le commutateur de deux éléments de groupe g, h est noté $[g, h] = ghg^{-1}h^{-1}$. On note 1_G l'élément identité d'un groupe G .

Un sous-ensemble fini F d'un ensemble E est noté $F \Subset E$. Etant donné un groupe G , deux sous-ensembles $F, E \subseteq G$ et un élément du groupe $g \in G$, on désigne par FE l'ensemble obtenu en multipliant chaque élément de F par un élément de E , par F^{-1} l'ensemble de tous les inverses d'éléments de F , et par gF l'ensemble obtenu en multipliant g à chaque élément de F . Si F est divisé en ensembles $\{A_i\}_{i \in I}$, l'union disjointe est notée $F = \coprod_{i \in I} A_i$.

Sauf indication contraire, les groupes considérés sont infinis et chaque ensemble générateur est fini, symétrique et ne contient pas l'identité.

Part I

Background and Definitions

Chapter 1

Subshifts, Computability, and Groups

The goal of this chapter is to introduce the definitions and concepts that will be needed for the rest of the manuscript. The structure of the exposition is the following. We begin by introducing subshifts, their notion of morphisms and dynamical properties. Next, we introduce two important classes: subshifts of finite type and sofic subshifts. We then jump to computability, where we define the notions of decidability, enumerability and reductions. We make another jump to introduce the necessary notions from the theories of combinatorial and geometric group theory. We briefly look at group growth, the word problem, nilpotent groups, polycyclic groups, amenable groups, amalgams, extensions, Cayley graphs, ends, quasi-isometries, and translation-like actions. We proceed by combining the three preceding areas to talk about the class of effectively closed subshifts and entropy.

Section 1.5 introduces constructions that allow us to move subshifts between groups, subgroups and quotients. These constructions are the free extension, the higher block and higher power subshifts, the pull-back, and the push-forward. We finish the chapter with an exploration between the analogies between subshifts and groups.

1.1 Symbolic dynamics

1.1.1 Definitions

Let G be a finitely generated group, and A a non-empty finite set which we call the **alphabet**. Elements of A are referred to as **letters**, **symbols** or **tiles** depending of the context. The space of **configurations** or **tilings** with alphabet A over G is the set $A^G = \{x: G \rightarrow A\}$. This space is endowed with a left group action $G \curvearrowright A^G$ given by

$$(g \cdot x)(h) = x(g^{-1}h),$$

for all $x \in A^G$ and $h \in G$. This action is referred to as the **shift**. The dynamical system (A^G, G) is called the **full G -shift** over A . Given a configuration $x \in X$, we define its **orbit** as the set $\text{orb}(x) = \{g \cdot x \mid g \in G\}$.

The space of configurations A^G is endowed with the prodiscrete topology. By Tychonoff's Theorem, this space is compact. Furthermore, with this topology the shift action of G on A^G is by homeomorphisms.

A **pattern** is a map $p \in A^F$, where F is a finite subset of G called the **support** of p . We denote this by $\text{supp}(p) = F$. We denote the set of all patterns by A^{*G} . We say a pattern p **appears in a configuration** $x \in A^G$, denoted $p \sqsubseteq x$, if there exists $g \in G$ such that $p(h) = x(gh)$ for all $h \in \text{supp}(p)$. The **cylinder** defined by a pattern $p \in A^F$ at $g \in G$ is the subset of configurations given by

$$[p]_g = \{x \in A^G \mid \forall h \in F, x(gh) = p(h)\}.$$

When the cylinder is centered at the identity we simply write $[p] = [p]_{1_G}$. The set of all cylinders defines a clopen base for the topology on A^G . Furthermore, when the underlying group is countable this topology is

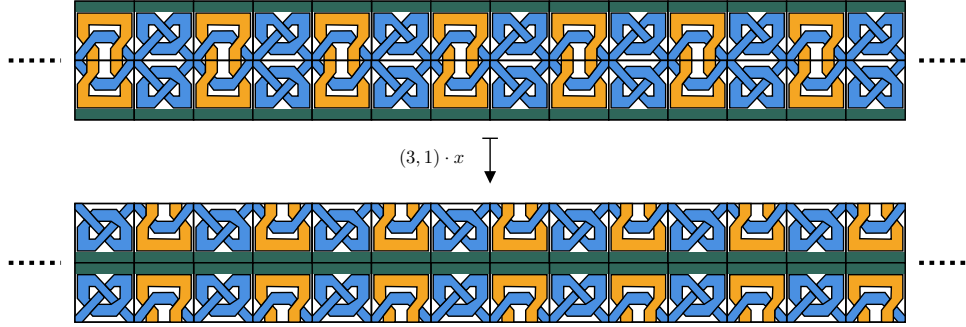

Figure 1.1: A configuration x from the full-shift over the alphabet $A = \{\text{blue square}, \text{orange square}, \text{blue square with cross}, \text{orange square with cross}\}$ and group $G = \mathbb{Z} \times \mathbb{Z}/2\mathbb{Z}$, as well as its shift by $g = (3, 1)$. The configuration is inspired by the frieze patterns at the Alhambra [Bod07].

metrizable. Given an enumeration of G , $\{g_i\}_{i \in \mathbb{N}}$ with $g_0 = 1_G$, the product topology is generated by the metric $d : A^G \times A^G \rightarrow \mathbb{R}$ defined by

$$d(x, y) = 2^{-\inf\{n \in \mathbb{N} \mid x(g_n) \neq y(g_n)\}},$$

for $x, y \in A^G$.

Definition 1.1.1. A G -subshift is a subset $X \subseteq A^G$ that is closed and G -invariant, i.e. $g \cdot X \subseteq X$.

Remark 1.1.2. When the group G is clear for context, we will simply talk about subshifts. Furthermore, to be fully formal we should say the dynamical system (X, G) is a G -subshift. We will not use this naming convention for the sake of clarity.

Subshifts also have a combinatorial description. Given a set of patterns $\mathcal{F} \subseteq A^{*G}$, we define the set of configurations, $\mathcal{X}_{\mathcal{F}}$, generated by the set of **forbidden patterns** \mathcal{F} as

$$\mathcal{X}_{\mathcal{F}} = \{x \in A^G \mid \forall p \in \mathcal{F}, p \text{ does not appear in } x\}.$$

Proposition 1.1.3. A subset $X \subseteq A^G$ is a subshift if and only if there exists a set of patterns $\mathcal{F} \subseteq A^{*G}$ such that $X = \mathcal{X}_{\mathcal{F}}$.

Proof. Consider a set of forbidden patterns $\mathcal{F} \subseteq A^{*G}$. The set $X = \mathcal{X}_{\mathcal{F}}$ can be expressed as

$$X = A^G \setminus \bigcup_{g \in G, p \in \mathcal{F}} [p]_g.$$

Because cylinders are open, X is closed. A simple calculation shows X is shift invariant, making it a subshift.

Conversely suppose X is a subshift. Because X is closed, and cylinders form a base of the topology, there exists a set of patterns $\{p_i\}_{i \in I} \subseteq A^{*G}$ and elements $\{g_i\}_{i \in I} \subseteq G$ such that

$$X = A^G \setminus \bigcup_{i \in I} [p_i]_{g_i}.$$

Furthermore, as X is G -invariant, the expression for X can be re-written as

$$X = A^G \setminus \bigcup_{i \in I, g \in G} [p_i]_g.$$

Taking $\mathcal{F} = \{p_i\}_{i \in I}$ we obtain $X = \mathcal{X}_{\mathcal{F}}$. □

Example 1.1.4. • Consider $G = \mathbb{Z}$, the alphabet $\{\blacksquare, \blacksquare\}$, and the set of forbidden patterns

$$\mathcal{F} = \left\{ \underbrace{\blacksquare \blacksquare \dots \blacksquare \blacksquare}_n \mid \exists m \in \mathbb{Z} : n = 2m + 1 \right\}.$$

The subshift $\mathcal{X}_{\mathcal{F}}$ consists in configurations where the number of \blacksquare tiles between \blacksquare tiles is even, as well as a configuration containing exclusively blue tiles.

• For $G = \mathbb{Z}^2$ consider the alphabet $\{\square, \blacksquare\}$ and the set of forbidden patterns

$$\mathcal{F} = \left\{ \begin{array}{c} \square \\ \square \end{array}, \blacksquare, \begin{array}{cc} \square & \square \end{array}, \begin{array}{cc} \blacksquare & \blacksquare \end{array} \right\}$$

The subshift defined by \mathcal{F} only contains two configurations given by infinite checkerboard patterns, one with \blacksquare at the origin, the other with \square .

Example 1.1.5. A rich family of examples of subshifts in \mathbb{Z} comes from the theory of substitutions. A **substitution** is a word-morphism $\sigma : A \rightarrow A^*$, that is, $\sigma(ab) = \sigma(a)\sigma(b)$ for all $a, b \in A$. For example, take $\sigma_T : \{a, b, c\} \rightarrow \{a, b, c\}^*$ defined¹ as

$$\sigma_T : \begin{cases} a \mapsto ab \\ b \mapsto ac \\ c \mapsto a \end{cases}.$$

We can then iterate σ_T on a letter:

$$\sigma_T^4(a) = \sigma_T^3(ab) = \sigma_T^2(abac) = \sigma_T(abacaba) = abacabaabacab.$$

The subshift associated to a substitution σ is

$$X_\sigma = \{x \in A^{\mathbb{Z}} \mid \forall w \sqsubseteq x, w \sqsubseteq \sigma^n(a) \text{ for some } n \in \mathbb{N}, a \in A\}.$$

This subshift is obtained by the set of forbidden patterns $\mathcal{F} = A^* \setminus \{\sigma^n(a) \mid n \in \mathbb{N}, a \in A\}$. We study substitutions and their subshifts for groups other than \mathbb{Z} in Chapter 7. For a reference on substitutions on \mathbb{Z} see [Fog02].

The **language** of a subshift $X \subseteq A^G$, denoted $\mathcal{L}(X)$, is the set of all patterns that appear within a configuration from X . In other words, $p \in \mathcal{L}(X)$ if there exists $x \in X$ such that $p \sqsubseteq x$. Given a finite support $F \Subset G$ the **language of support** F is given by $\mathcal{L}_F(X) = \mathcal{L}(X) \cap A^F$.

Remark 1.1.6. When working with \mathbb{Z} , we also refer to patterns as words. In addition, the language of a subshift X of patterns of support $[0, n - 1]$ is denoted by $\mathcal{L}_n(X)$. We also use subscript notation, i.e. for a word w we write w_i to mean $w(i)$.

1.1.2 Morphisms

We want to identify when the dynamics of two subshifts are equivalent. This is captured by the notion of isomorphism in the category of subshifts known as **conjugacy**.

Definition 1.1.7. Let $X \subseteq A^G$ and $Y \subseteq B^G$ be two subshifts. A map $\phi : X \rightarrow Y$ is said to be a **morphism** if it is continuous and $\phi(g \cdot x) = g \cdot \phi(x)$ for every $x \in X$ and $g \in G$.

Similarly to subshifts, morphisms have a combinatorial description. Take two alphabets A and B . A map $\phi : A^G \rightarrow B^G$ is called a **sliding-block code** if there exists $F \Subset G$, called the **memory set**, and a **local map** $\Phi : A^F \rightarrow B$ such that

$$\phi(x)(g) = \Phi((g^{-1} \cdot x)|_F).$$

¹ σ_T is known as the **Tribonacci substitution**.

Example 1.1.8. • The majority rule map $\phi : \{\square, \blacksquare\}^{\mathbb{Z}} \rightarrow \{\square, \blacksquare\}^{\mathbb{Z}}$ is the sliding-block code defined by the memory set $F = \{-1, 0, 1\}$ and the local rule $\Phi : \{\square, \blacksquare\}^F \rightarrow \{\square, \blacksquare\}$ that outputs the tile that is most present on the support. See Figure 1.2 for an application of the map on a configuration.

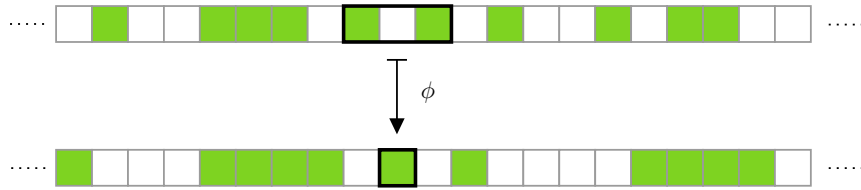

Figure 1.2: An application of the majority rule map to a configuration from the full-shift.

Majority rule maps can be defined on any finitely generated group where the local map outputs the letter with greatest number of occurrences in the support.

- Take any \mathbb{Z}^d -subshift X . Every shift defines a sliding-block code from X to itself. For example, if we take the full- \mathbb{Z}^2 -shift $\{\square, \blacksquare\}^{\mathbb{Z}^2}$, the shift defined by $v = (-4, -4)$ is the sliding-block code given by the memory set $\{(4, 4), (0, 0)\}$ and the local function that outputs the letter at $(4, 4)$. An example of the application of this function is given in Figure 1.3. In general, not every group element's action defines a

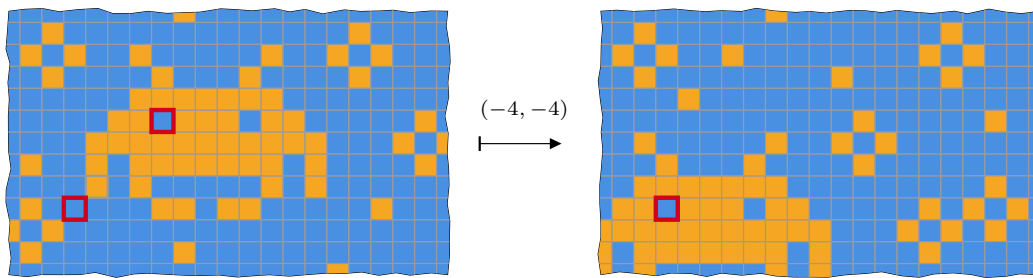

Figure 1.3: An application of the shift map defined by the element $(-4, -4)$ to a configuration from the full-shift. The support of the map and its image are highlighted in red.

sliding-block code. This will be made clear in the next theorem.

The following result is known as the Curtis-Hedlund-Lyndon Theorem for groups.

Theorem 1.1.9. *Let $X \subseteq A^G$ and $Y \subseteq B^G$ be two subshifts along with a map $\phi : X \rightarrow Y$. Then, ϕ is a morphism if and only if ϕ is a sliding-block code.*

The original proof of this result in the case of $G = \mathbb{Z}$ comes from Hedlund [Hed69]. A proof of the group version can be found in [CC10, Theorem 1.8.1].

Remark 1.1.10. A morphism from the full-shift A^G to itself is also known as a G -cellular automaton (G -CA), or simply cellular automaton when the group is clear from context.

Definition 1.1.11. Let A and B be alphabets along with two G -subshifts $X \subseteq A^G$ and $Y \subseteq B^G$. We say a morphism $\phi : X \rightarrow Y$ is,

- a **factor map** if it is surjective. In this case, we say that Y is **factor** of X , and X is an **extension** of Y .
- a **conjugacy** if it is bijective. In this case we say X and Y are **conjugate**.

Example 1.1.12. Let $X \subseteq A^{\mathbb{Z}}$ be a \mathbb{Z} -subshift. The N -**higher block** of X is the \mathbb{Z} -subshift $X^{(N)}$ over the alphabet $B = \mathcal{L}_N(X) \subseteq A^N$ of words of length N in X , where the pattern $(w, w') \in B^2$ is allowed if and only if $w_{[1, N-1]} = w'_{[0, N-2]}$. These subshifts are conjugate by the map $\phi : X^{(N)} \rightarrow X$ defined by the local map $\Phi : B \rightarrow A$ of support $\{0\}$ such that $\Phi(w) = w_1$. We look at a generalization of the higher block subshift to other groups in Section 1.5.2.

Many properties are invariant under conjugation. Such properties are called **dynamical properties**. Examples include, entropy, periodic points, aperiodicity, being a subshift of finite type, being sofic, being minimal or strongly irreducible among many others. In the coming sections we will define and look at these examples.

1.1.3 Dynamics

Let us briefly explore important dynamical properties of subshifts. We begin by looking at periodicity. The **stabilizer** of a configuration $x \in A^G$ is the set

$$\text{stab}(x) = \{g \in G \mid g \cdot x = x\}.$$

In words, the stabilizer of a configuration x is the set of elements whose action on x leave x unchanged. Notice that the stabilizer is a subgroup of G . Elements of the stabilizer are called **periods** of the configuration.

Definition 1.1.13. A configuration $x \in A^G$ is said to be,

- **periodic** if $\text{stab}(x)$ is a finite index subgroup,
- **aperiodic** if $\text{stab}(x) = \{1_G\}$.

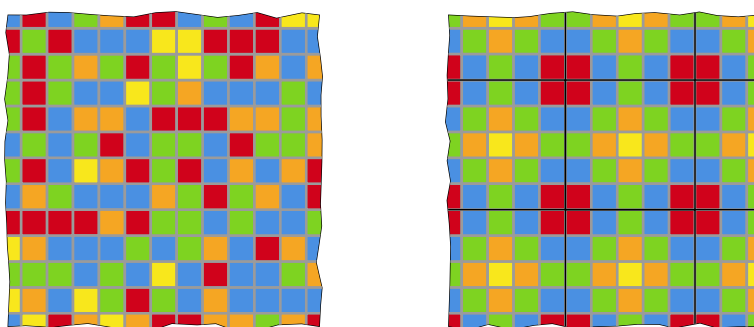

Figure 1.4: Examples of aperiodic (left) and periodic (right) configurations on \mathbb{Z}^2 .

Remark 1.1.14. In the literature periodic configurations are sometimes called strongly periodic, and configurations with non-trivial stabilizers are called weakly periodic. We do not use this terminology.

Definition 1.1.15. We say a subshift $X \subseteq A^G$ is

- **weakly aperiodic** if every configuration has an infinite orbit. Equivalently, if X contains no periodic points.
- **strongly aperiodic** if the stabilizer of every configuration is trivial.

Strongly aperiodic and weakly aperiodic subshifts play a mayor role in this work. We study their properties in detail in Chapter 5.

Remark 1.1.16. Although the empty set is both a strongly and weakly aperiodic subshift, for the purposes of this work we do not consider the empty subshift when talking about aperiodicity, unless explicitly stated.

We now move to another couple of fundamental notions from dynamical systems.

Definition 1.1.17. We say a subshift $X \subseteq A^{\mathcal{F}}$ is

- **minimal** if it does not contain a non-empty closed G -invariant subsets other than itself. Equivalently, for every $x \in X$, $\overline{\text{orb}(x)} = X$.
- **strongly irreducible** if there exists a finite subset $F \Subset G$ such that for every pair of patterns $p, q \in \mathcal{L}(X)$ satisfying $\text{supp}(p) \cap \text{supp}(q)F = \emptyset$ there exists a configuration $x \in X$ such that $x \in [p] \cap [q]$.²

For minimal subshifts we have a characterization involving the rate at which patterns appear on configurations. We say a pattern $p \in \mathcal{L}(X)$ is **uniformly recurrent** if there exists a finite subset $F \Subset G$ such that $p \sqsubseteq x|_{gF}$ for all $g \in G$ and $x \in X$.

Lemma 1.1.18. *Let G be a countable group. A G -subshift X is minimal if and only if every $p \in \mathcal{L}(X)$ is uniformly recurrent.*

Proof. Suppose X is minimal and take a pattern $p \in \mathcal{L}(X)$ with support F . Consider the set

$$K = \bigcup_{g \in G} g \cdot [p].$$

This set is non-empty as p belongs to the language of X . Then, $X \subseteq K$ is a closed G -invariant subset of X . By minimality, $K = X$. Furthermore, because X is compact, there exist $\{g_i\}_{i=1}^n \subseteq G$ such that

$$X = \bigcup_{i=1}^n g_i \cdot [p].$$

Now, define $F' = \bigcup_{i=1}^n g_i^{-1}F$. Then, for any configuration $x \in X$ and $g \in G$ there exists $i \in \{1, \dots, n\}$ such that $g^{-1} \cdot x \in g_i \cdot [p]$. Therefore, $p \sqsubseteq x|_{gF'}$.

Now, suppose every pattern in the language is uniformly recurrent. Take $x \in X$ and an enumeration of $G = \{g_0, g_1, \dots\}$ with $g_0 = 1_G$. Consider another configuration $x' \in X$ and the patterns $p_n = x'|_{B_n} \in \mathcal{L}(X)$ where B_n is the set of the first n elements of the enumeration of G . By uniform recurrence, for each $n \in \mathbb{N}$ there exists a subset $F_n \Subset G$ and $g_n \in G$ such that $p_n \sqsubseteq x|_{g_n F_n}$. By the definition of the metric on X , this implies

$$d(x', g_n^{-1} \cdot x) \leq 2^{-n}.$$

Thus, the orbit of x is dense in X . □

Example 1.1.19. Let $\sigma : A \rightarrow A^*$ be a substitution. We say σ is **primitive** if for every there exists $n \in \mathbb{N}$ such that for all $a, b \in A$ we have $a \sqsubseteq \sigma^n(b)$. A classic result from the theory of substitutions states that if σ is primitive, then X_σ is minimal. For instance, X_{σ_T} as defined in Example 1.1.5 is a minimal \mathbb{Z} -subshift.

1.1.4 Subshifts of finite type

The central object of this thesis is the following class of subshifts.

Definition 1.1.20. A subshift $X \subseteq A^G$ is a **subshift of finite type** (SFT) if there exists a finite set of forbidden patterns $\mathcal{F} \subseteq A^{*G}$ such that $X = \mathcal{X}_{\mathcal{F}}$.

Example 1.1.21. Take $G = \mathbb{Z}^2$, the alphabet $A = \{\square, \blacksquare\}$. Consider the set of forbidden patterns

$$\mathcal{F} = \left\{ \begin{array}{c} \blacksquare \\ \blacksquare \end{array}, \begin{array}{cc} \blacksquare & \blacksquare \end{array} \right\}.$$

The SFT $\mathcal{X}_{\mathcal{F}}$ is known as the **hard-square model** or **golden mean** shift. For more information on this subshift see [Pav12] and its references. Configurations from $\mathcal{X}_{\mathcal{F}}$ consist on isolated \blacksquare tiles surrounded by \square

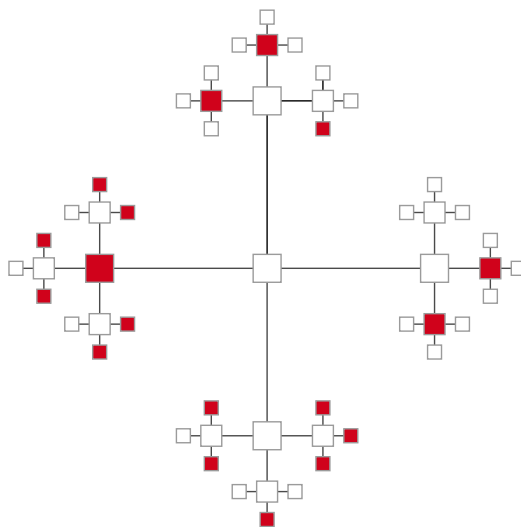

Figure 1.5: A portion of a configuration of the hard-square model on \mathbb{F}_2 .

tiles, except for the all white configuration. We can also define the hard-square model for other groups. A configuration of this subshift on \mathbb{F}_2 is represented in Figure 1.5. This \mathbb{F}_2 -subshift was studied by Piantadosi in [Pia08].

Subshifts of finite type are an important dynamical notion as they are stable under conjugations.

Proposition 1.1.22. *Consider two subshifts $X \subseteq A^G$ and $Y \subseteq B^G$. If X and Y are conjugate and X is an SFT, then Y is an SFT.*

Proof. Let $\phi : X \rightarrow Y$ be a conjugation, and \mathcal{F} a finite set of forbidden patterns for X . Without loss of generality we can assume that all pattern from \mathcal{F} have the same support. By Theorem 1.1.9, there exists a support $F \Subset G$ and local map $\Phi : A^F \rightarrow B$ that locally defining ϕ . We create a new set of forbidden patterns \mathcal{F}' for X by taking all completions of patterns p from \mathcal{F} to the support $\text{supp}(p)F$. Then, the application of ϕ to $p \in \mathcal{F}'$, denoted $\phi(p)$, is defined by $\phi(p)(g) = \Phi(p|_{gF})$ for all $g \in \text{supp}(F)$. The set of forbidden patterns $\mathcal{G} = \{\phi(p) \mid p \in \mathcal{F}'\} \subseteq B^{*G}$ is finite and defines the subshift Y , making it an SFT. \square

Let S be a finite generating set for G . We say a pattern p is **nearest neighbor** if its support is given by $\{1_G, s\}$ for some $s \in S$. We denote nearest neighbor patterns through tuples (a, b, s) representing $p(1_G) = a$ and $p(s) = b$. A subshift defined by a set of nearest neighbor forbidden patterns is known as a **nearest neighbor subshift**. These subshifts are necessarily SFTs, as the maximal number of such patterns is bounded by $|A|^2 \cdot |S|$.

Given a set of nearest neighbor patterns \mathcal{F} , we define its corresponding **tileset graph**, $\Gamma_{\mathcal{F}}$, by the set of vertices A , and edges given by $(a, b, s) \in A^2 \times S$ such that $(a, b, s) \notin \mathcal{F}$, where a is its initial vertex, b its final vertex and s its label.

Example 1.1.23 (Wang Tiles). The quintessential examples of a nearest neighbor SFTs in \mathbb{Z}^2 , with respect to its standard generating set, are those generated by Wang tiles. Let C be a finite set. A **Wang tile** with colors in C is a 4-tuple $c = (c_N, c_E, c_S, c_W) \in C^4$. This 4-tuple is represented as a unit square which is subdivided and colored according to C , as shown in Figure 1.6.

²In the theory of topological dynamical systems strong irreducibility is equivalent to topological mixing.



Figure 1.6: A Wang tile.

Given a set of Wang tiles \mathcal{T} , a tiling $x : \mathbb{Z}^2 \rightarrow \mathcal{T}$ must satisfy the adjacency rules:

$$x(i, j)_E = x(i + 1, j)_W, \quad x(i, j)_N = x(i, j + 1)_S,$$

for all $(i, j) \in \mathbb{Z}^2$. A configuration obtained from Wang tiles is shown in Figure 1.7. The subshift $X_{\mathcal{T}}$ of tilings

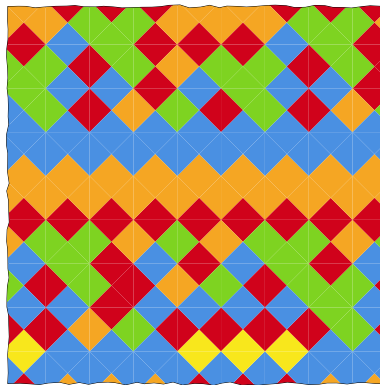

Figure 1.7: An example of a tiling by Wang tiles. This particular tiling will reappear in Chapter 5.

by \mathcal{T} is therefore a nearest neighbor \mathbb{Z}^2 SFT. It is easy to construct the tileset graph corresponding to a set of Wang tiles, as shown in Figure 1.8.

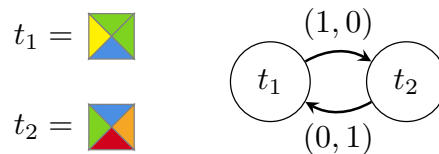

Figure 1.8: An example of the tileset graph obtained from two Wang tiles t_1 and t_2 . Inverses of the generators for \mathbb{Z}^2 are omitted for simplicity

Nearest neighbor SFTs play a crucial role in the theory of SFTs. The following statement tells us that to study dynamical properties of SFTs, it suffices to focus our attention on the case of nearest neighbor SFTs.

Lemma 1.1.24. *For G a finitely generated group with finite generating set S , every SFT is conjugate to a nearest neighbor SFT with respect to S .*

We prove this lemma in Section 1.5.2.

For $G = \mathbb{Z}$, subshifts of finite type have a very rigid structure. Through the tileset graph we see that every \mathbb{Z} -SFT is conjugate to a **vertex shift**. Such a subshift is defined from a finite directed graph $\Gamma = (V, E)$ and is given by

$$X_{\Gamma} = \{x \in V^{\mathbb{Z}} \mid (x(k), x(k + 1)) \in E\}.$$

This rigid structure has allowed for a great understanding of the dynamics of \mathbb{Z} -SFTs. For a complete and comprehensive introduction of this theory see [LM21].

1.1.5 Sofic subshifts

Definition 1.1.25. A subshift $Y \subseteq A^G$ is said to be **sofic** if there exists an SFT $X \subseteq B^G$ and a factor map $\pi : X \rightarrow Y$.

Sofic subshifts were introduced by Weiss in [Wei73] who was studying the smallest class of subshifts that is closed under factor maps and contains subshifts of finite type. A direct consequence of the definition is that the class of sofic subshifts is closed under conjugacies.

Example 1.1.26. Consider a binary alphabet $A = \{\square, \blacksquare\}$. The **sunny-side up** G -subshift, $X_{\leq 1} \subseteq A^G$, is defined as the set of all configurations containing at most one \blacksquare tile. Formally,

$$X_{\leq 1} = \{x \in A^G \mid \forall g, h \in G : x(g) = x(h) = \blacksquare \implies g = h\}.$$

For infinite groups, this subshift is never an SFT [ABJ18, Proposition 9.4.18]. However it is sofic for many groups. For instance, take $G = \mathbb{F}_2$ and the set of tiles

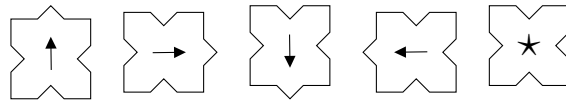

These tiles define a \mathbb{F}_2 -SFT where tiles are placed next to each other if the puzzle pieces fit correctly. Then, the factor map from this SFT to the sunny-side up subshift is defined by mapping arrow tiles to \square , and the star tile to \blacksquare , as seen in Figure 1.9. An analogous construction works for all free groups, and can be adapted to work in \mathbb{Z}^d .

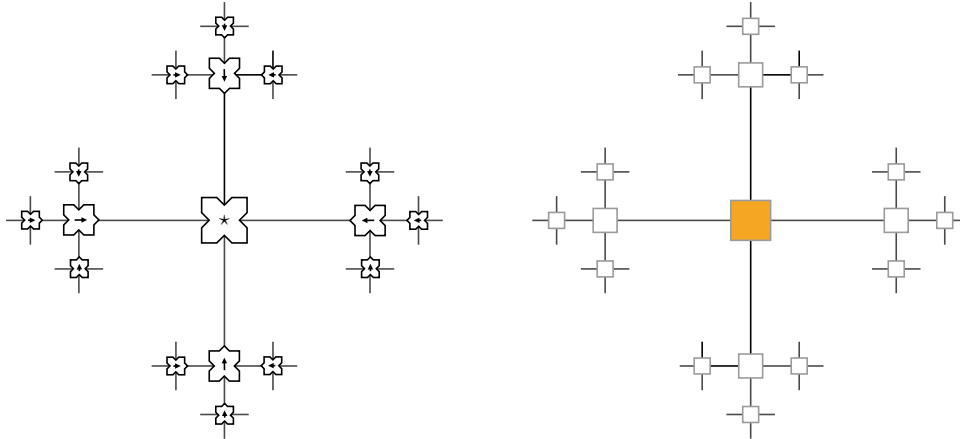

Figure 1.9: A portion of a configuration of the SFT cover of $X_{\leq 1}$ on the free group (left) and its corresponding image under the factor map (left).

By their definition, every SFT is sofic. The natural question that follows is, are these classes distinct? This question has been answered by Raymond who characterized the groups where this happens.

Theorem 1.1.27 (Raymond [Ray23]). *Let G be a countable group. Then, every sofic G -subshift is an SFT if and only if G is locally finite.*

Locally finite groups are groups where the subgroup generated by any finite set of elements is finite. In particular, this theorem tells us that for finitely generated groups there exist sofic subshifts that are not SFTs.

Finally, we would like to mention that the structure of \mathbb{Z} -sofic shifts is very well-understood. For a vertex labeled directed graph $\Gamma = (V, E, \lambda)$ where $\lambda : E \rightarrow A$, we define its **edge-label subshift** by

$$X_\Gamma = \{x \in A^\mathbb{Z} \mid \exists e \in E^\mathbb{Z}, \forall k \in \mathbb{Z} : \mathfrak{t}(e(k)) = \mathfrak{i}(x(k+1)), x(k) = \lambda(e(k))\},$$

where $\mathfrak{i}(e)$ and $\mathfrak{t}(e)$ are the initial and final vertex of e respectively. Every sofic \mathbb{Z} -subshift is an edge-label subshift. A consequence of this fact is the following.

Proposition 1.1.28. *For a subshift $X \subseteq A^\mathbb{Z}$ the following are equivalent:*

- X is sofic,
- $\mathcal{L}(X)$ is a regular language,
- there exists a regular set of forbidden patterns $\mathcal{F} \subseteq A^*$ such that $X = \mathcal{X}_\mathcal{F}$.

For in depth discussion and proofs on sofic \mathbb{Z} -subshifts see [LM21].

1.2 Computability

In this section we introduce notions from the theory of computability that will be needed throughout the manuscript. The notation and the definitions differ slightly from the traditional introduction of these concepts, but ultimately define the same objects. Much of this section is inspired by [Bar17]. For standard references on computability we refer the reader to [Sip96; Soa16].

We begin by defining computability through Turing Machines, as introduced by Alan Turing [Tur36].

Definition 1.2.1. A **Turing machine** is a 6-tuple $(Q, q_0, Q_H, A, \sqcup, \delta)$ where

- Q is a finite set of **states**, where $q_0 \in Q$ is the **initial state**, and $Q_H \subseteq Q$ is the set of **halting states**,
- A is a finite **tape alphabet** containing the **blank space symbol** $\sqcup \in A$,
- $\delta : Q \times A \rightarrow Q \times A \times \{-1, 0, 1\}$ is the **transition function**.

A Turing machine is provided with a bi-infinite tape. This tape is understood as a tuple $(x, p, q) \in A^\mathbb{Z} \times \mathbb{Z} \times Q$ where x is a configuration with the contents of the tape, p denotes the position of the head of the machine, and q its state. The result of Turing machine \mathcal{M} operating on a given tape $(x, p, q) \in A^\mathbb{Z} \times \mathbb{Z} \times Q$, denoted $\mathcal{M}(x, p, q)$, is given by (x', p', q') where $q' = \delta(q, x(p))_1$, $p' = p + \delta(q, x(p))_2$, and

$$x'(k) = \begin{cases} \delta(q, x(p))_3, & \text{if } k = p, \\ x(k), & \text{otherwise.} \end{cases}$$

See Figure 1.10 for a depiction of the application of a machine.

A word on the alphabet $w \in A^*$ that does not contain the blank space symbol is called an **input**. We say a Turing machine \mathcal{M} **halts** on an input w if there exists $n \in \mathbb{N}$ such that $\mathcal{M}^n(x_w, 0, q_0) \in A^\mathbb{Z} \times \mathbb{Z} \times Q_H$, where x_w is the configuration containing w starting at the origin and blank space symbols everywhere else.

Remark 1.2.2. Throughout the manuscript we use the words Turing machine, algorithm or procedure interchangeably.

Definition 1.2.3. We say a language $L \subseteq (A \setminus \sqcup)^*$ is

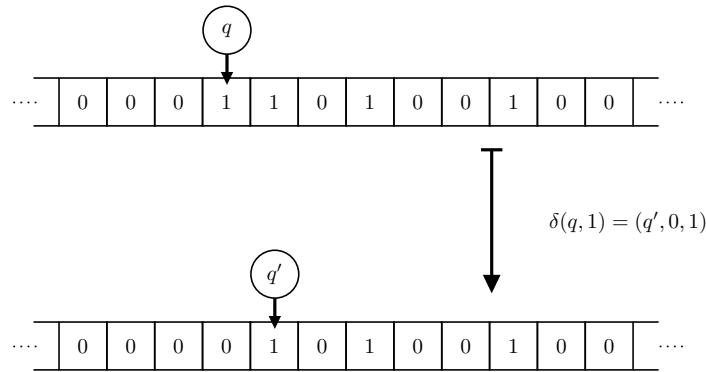

Figure 1.10: Applying a transition to a configuration from $\{0, 1, \sqcup\}^{\mathbb{Z}}$.

- **recursively enumerable** if there exists a Turing machine that halts on an input w if and only if $w \in L$,
- **co-recursively enumerable** if there exists a Turing machine that halts on an input w if and only if $w \notin L$,
- **decidable** if it is both recursively and co-recursively enumerable,
- **undecidable** if it is not decidable.

When a language L is decidable, we can create a single machine \mathcal{M} that runs the machine from the recursive enumerability and the co-recursive enumerability in parallel. This machine halts on all inputs. We can therefore partition the set of halting states into the set of accepting states Q_A and rejecting states Q_R , depending on which machine halts. This way, \mathcal{M} halts on an input w by arriving at a state from Q_A if and only if $w \in L$. When this happens we say \mathcal{M} **accepts** w . Consequently, \mathcal{M} halts on w by arriving at a state from Q_R if and only if $w \notin L$. In this case we say \mathcal{M} **rejects** w .

Remark 1.2.4. Decidable languages are also known as **recursive** or **computable** languages. Similarly, recursively enumerable (resp. co-recursively enumerable) languages are also called **semidecidable** (resp. **co-semidecidable**), and their Turing machines **semi-algorithms** (resp. **co-semi-algorithms**).

Definition 1.2.5. We denote the set of all recursively enumerable languages (resp. co-recursively enumerable) by Σ_1^0 (resp. Π_1^0).

With this definition, a language L is decidable if $L \in \Sigma_1^0 \cap \Pi_1^0$.

Definition 1.2.6. A function $f : A^* \rightarrow B^*$ is **computable** if there exists a Turing machine such that halts on all inputs $w \in A^*$, leaving $f(w)$ in its tape.

To work with functions on objects that are not necessarily languages, we must use **encodings**. For instance, we can encode the natural numbers through their binary representations $[n]_2 \in \{0, 1\}^*$. Thus, a function $f : \mathbb{N} \rightarrow \mathbb{N}$ is interpreted as being a function $f' : [\mathbb{N}]_2 \subseteq \{0, 1\}^* \rightarrow \{0, 1\}^*$. We will talk more about encodings in the next section.

Computable functions give us characterizations of our previously defined classes of languages, as shown in the next two lemmas.

Lemma 1.2.7. A language $L \subseteq A^*$ is decidable if and only if there exists a computable function $f : A^* \rightarrow \{0, 1\}$ such that $f(w) = 1$ if and only if $w \in L$.

Lemma 1.2.8. A set is recursively enumerable if there exists a computable surjective function $f : \mathbb{N} \rightarrow L$.

This last lemma explains the name *recursively enumerable*, as it implies that for a recursively enumerable language L we can define a Turing machine that will successively enumerates elements of L on its tape.

1.2.1 Decision problems

To tackle the computability of problems from different areas, we must first encode them in the formalism of Turing machines.

Example 1.2.9. Suppose we want to study a class of nearest neighbor SFTs \mathfrak{C} . We want to know if a given alphabet A and set of nearest neighbor forbidden patterns $\mathcal{F} \subseteq A^2 \times S$ define an SFT belonging to \mathfrak{C} . This is done by encoding an input (A, \mathcal{F}) as words over the alphabet $\{0, 1, \#\}$. The generators and the alphabet are represented as the sets $\{0, \dots, |A| - 1\}$ and $\{0, \dots, |S| - 1\}$ respectively. Then, every pattern $p = (a, b, s) \in \mathcal{F}$ is encoded as $[p] = [n_a]_2 \#[n_b]_2 \#[n_s]_2$, where n_a , n_b and n_s are the numbers corresponding to a , b and s respectively. Thus, the encoding of the whole input is given by

$$[(A, \mathcal{F})] = [|A|]_2 \#[p_1] \#[p_2] \# \dots \#[p_m] \in \{0, 1, \#\}^*$$

where $\mathcal{F} = \{p_1, \dots, p_m\}$. If we use a unique unambiguous code for the separation symbol $\#$, we can encode the inputs as words on $\{0, 1\}$. Now, the problem of determining if $\mathcal{X}_{\mathcal{F}} \subseteq A^G$ belongs to \mathfrak{C} becomes the problem of determining if the word $[(A, \mathcal{F})]$ belongs to the language $\{[(A, \mathcal{F})] \mid \mathcal{X}_{\mathcal{F}} \in \mathfrak{C}\} \subseteq \{0, 1\}^*$.

Formally, a **decision problem** is a language $D \subseteq \{0, 1\}^*$. In this thesis, D will usually be the language obtained by encoding inputs that satisfy a given property, as in the previous example. Informally, we also understand a decision problem D as the problem of determining whether a given input $w \in \{0, 1\}^*$ belongs to D .

Example 1.2.10. The **Halting Problem** is the decision problem

$$\text{HALT} = \{[(\mathcal{M}, w)] \mid \mathcal{M} \text{ halts on } w\},$$

for an encoding $[\cdot]$ of pairs of Turing Machines and input words. Equivalently, the Halting Problem is the problem of determining if a given Turing machine \mathcal{M} halts on a given input w .

Famously, this problem is the first example of an undecidable language.

Theorem 1.2.11 (Turing [Tur36]). *HALT is undecidable.*

When a decision problem D is defined by a set of encodings of objects satisfying a property, $\text{co}D$ will refer to the language of well-encoded words that are in the complement of D .

1.2.2 The arithmetical hierarchy and beyond

We already saw the classes Σ_1^0 and Π_1^0 of recursively enumerable and co-recursively enumerable problems respectively. Nevertheless, languages and decision problems can be computationally harder. To quantify this we look at the **arithmetical hierarchy**.

Definition 1.2.12. Let $L \subseteq A^*$ be a language, and $m \in \mathbb{N}$. Then,

- L belongs to Σ_m^0 if there exists a computable relation $R : A^* \times \mathbb{N}^m \rightarrow \{0, 1\}$ such that

$$w \in L \iff \exists n_1, \forall n_2, \exists n_3, \dots, Q n_m R(w, n_1, n_2, n_3, \dots, n_m),$$

where Q is \forall if m is even and \exists if not.

- L belongs to Π_m^0 if there exists a computable relation $R : A^* \times \mathbb{N}^m \rightarrow \{0, 1\}$ such that

$$w \in L \iff \forall n_1, \exists n_2, \forall n_3, \dots, Q n_m R(w, n_1, n_2, n_3, \dots, n_m),$$

where Q is \exists if m is even and \forall if not.

- L belongs to Δ_m^0 if it belongs to both Σ_m^0 and Π_m^0 .
- We say a L is **arithmetical** if $L \in \bigcup_{n \in \mathbb{N}} (\Sigma_n^0 \cup \Pi_n^0)$.

We say a function $f : A^* \rightarrow \{0, 1\}$ belongs to one of the previous classes if the language $f^{-1}(1) \subseteq A^*$ does.

Each level of the hierarchy is contained in the next, and the inclusion is strict, i.e. $\Sigma_n^0 \cup \Pi_n^0 \subsetneq \Delta_{n+1}^0$.

Lemma 1.2.13. $L \in \Sigma_n^0$ if and only if $\text{co}L \in \Pi_n^0$.

Although this hierarchy captures decision problems of increasing difficulty, there are problems that are beyond.

Definition 1.2.14. A D language belongs to Σ_1^1 if there exists an arithmetical relation R such that

$$w \in D \iff \exists f \in 2^{\mathbb{N}}, R_f(w),$$

where R_f represents the relation with an oracle on f .

The class Σ_1^1 is at the first level of the **analytical hierarchy**. A problem belonging to this class is the recurrence problem for non-deterministic Turing machines (see [Har85]).

1.2.3 Reductions and oracles

To compare the computational difficulty of different languages and problems, we use reductions.

Definition 1.2.15. Let $L \subseteq A^*$ and $L' \subseteq B^*$ be two languages. We say,

- L **Turing reduces** to L' , denoted $L \leq_T L'$, if L is decidable with an oracle for L' .
- L **enumeration reduces** to L' , denoted $L \leq_e L'$, if for any w and $i \in \mathbb{N}$ one can compute a finite set $F_i(w)$ such that $w \in L$ if and only if there exists $i \in \mathbb{N}$ such that $F_i(w) \subseteq L'$.
- L **positive-reduces** to L' , denoted $L \leq_p L'$ if for any w one can compute finitely many finite sets $F_1(w), \dots, F_n(w)$ such that $w \in L$ if and only if there exists $i \in \{1, \dots, n\}$ such that $F_i(w) \subseteq L'$.
- L **many-one reduces** to L' , denoted $L \leq_m L'$, if there exists a computable function $f : A^* \rightarrow B^*$ such that $w \in L$ if and only if $f(w) \in L'$ for every w .

For the three notions of reducibility, the induced notion of equivalence will be denoted by $L \equiv_* L'$, meaning $L \leq_* L'$ and $L' \leq_* L$. Notice that many-one reducibility implies positive-reducibility, which in turn implies enumeration reducibility and Turing reducibility.

Remark 1.2.16. If A enumeration reduces to B , then there is an algorithm that from an enumeration of B produces an enumeration of A . Therefore, a language A is recursively enumerable if and only if $A \leq_e \emptyset$. We also say a language A is **co-total** if $A \leq_e \text{co}A$.

We implicitly use the following result throughout the text.

Theorem 1.2.17 (Theorem 4.1.4 [Soa16]). *Let L and L' be two languages such that $L' \leq_m L$ and $L \in \Sigma_1^0$. Then, $L' \in \Sigma_1^0$.*

An additional concept we need is completeness. Informally, a problem is complete for a class C if it belongs to the class, and every other problem in C reduces to the problem.

Definition 1.2.18. A language L is Σ_m^0 -**complete** (resp. Π_m^0 -**complete**) if $L \in \Sigma_m^0$ (resp. Π_m^0) and $L' \leq_m L$ for all $L' \in \Sigma_m^0$ (resp. Π_m^0).

The Halting Problem is an example of a Σ_1^0 -complete problem.

1.3 Some notions from group theory

Let G be a finitely generated group and S a finite generating set. In this manuscript we will only consider finite **symmetric** generating sets, that is, generating sets that verify $S = S^{-1}$, that never contain the identity. Elements in the group are represented as words on the alphabet S through the evaluation function $w \mapsto \bar{w}$. Two words w and v represent the same element in G when $\bar{w} = \bar{v}$, and we denote this by $w =_G v$. We say a word is **reduced** if it contains no factor of the form ss^{-1} or $s^{-1}s$ with $s \in S$.

Definition 1.3.1. Let G be a group. We say (S, R) is a **presentation** of G , denoted $G = \langle S \mid R \rangle$, if the group is isomorphic to $\langle S \mid R \rangle = \mathbb{F}_S / \langle\langle R \rangle\rangle$, where $\langle\langle R \rangle\rangle$ is the normal closure of R , i.e. the smallest normal subgroup of \mathbb{F}_S containing R .

We say G is **finitely presented** if it has a presentation (S, R) where S and R are finite, and **recursively presented** if there exists a presentation (S, R) such that S is recursive and R is recursively enumerable.

Example 1.3.2. The Lamplighter group $\mathcal{L} = \mathbb{Z}/2\mathbb{Z} \wr \mathbb{Z}$ is given by the presentation

$$\mathcal{L} = \langle a, t \mid t^2, [t, a^n t a^{-n}], \forall n \in \mathbb{N} \rangle.$$

This group is finitely generated and recursively presented, but not finitely presented.

Example 1.3.3. Recursively presented groups are not necessarily finitely generated. The additive group of rational numbers $(\mathbb{Q}, +)$ admits the recursive presentation

$$\langle \{s_n\}_{n \in \mathbb{N}} \mid (s_n)^n s_{n-1}^{-1}, \forall n \in \mathbb{N} \rangle.$$

The isomorphism from the presentation to \mathbb{Q} is given by $f(s_n) = (n!)^{-1}$.

Lemma 1.3.4. *For any recursively presented group G there exists a decidable set of relations R and generating set S such that (S, R) is a presentation for G .*

Proof. Let (S', R') be a recursive presentation for G and $t \notin S'$. Because R' is recursively enumerable, there exists an algorithm, \mathcal{A} , that halts on $w \in S'^*$ if and only if $w \in R'$. For each $w \in R'$ we can define $n(w)$ as the number of steps it takes \mathcal{A} to accept w . We define the generating set $S = S' \cup \{t\}$, and relations

$$R = \{t^{n(r)} r \mid r \in R'\} \cup \{t\}.$$

It is direct that $G \simeq \langle S \mid R \rangle$. In addition, the new set of relations R is decidable. Indeed, given a word $w \in S^*$ we first check if it is of the form $t^k v$ for some word $v \in S'^*$ and $k \in \mathbb{N}$. If it does not, we reject. Next, if $w = t$, we accept. Finally, for $w = t^k v$, we run algorithm \mathcal{A} on v for k steps. We accept if \mathcal{A} accepts, and reject otherwise. \square

Remark 1.3.5. The proof of the previous lemma is known as **Craig's trick**. In its full generality, Craig's trick states that any recursively axiomatizable theories can be recursively presented [Cra53]. This result has been applied in many contexts (see [Jea17]), one of which we tackle in Section 1.4.1.

The following celebrated theorem by Higman relates recursively presented groups and finitely presented groups.

Theorem 1.3.6 (Higman Embedding [Hig61]). *A finitely generated group is recursively presented if and only if it is a subgroup of a finitely presented group.*

For a group G and a generating set S , we define:

$$\text{WP}(G, S) = \{w \in S^* \mid w =_G \varepsilon\}.$$

We say a word $w \in S^+$ is **G -reduced** if w contains no factor from $\text{WP}(G, S)$. We say a word $w \in S^*$ is a **geodesic** if for all words $v \in S^*$ such that $\bar{w} = \bar{v}$ we have $|w| \leq |v|$. For a given group G and generating set S , we denote its **language of geodesics** by $\text{Geo}(G, S)$. The length of an element $g \in G$ with respect to S is defined as $\|g\|_S = |w|$ where w is any geodesic representing g . This length also defines a left G -invariant metric $d_S : G \times G \rightarrow \mathbb{N}$ given by $d_S(g, h) = \|g^{-1}h\|_S$.

Definition 1.3.7. Let G be a finitely generated group, with generating set S . The **growth function** of G with respect to S , $\gamma_{G,S} : \mathbb{N} \rightarrow \mathbb{N}$, is defined for each $n \in \mathbb{N}$ as the amount of elements of length at most n . In other words, $\gamma_{G,S}(n) = |\{g \in G \mid \|g\|_S \leq n\}|$.

We understand the growth of a group through its growth type. For this, we need the following definition.

Definition 1.3.8. A non-decreasing function $\gamma : \mathbb{N} \rightarrow \mathbb{R}_+$ is called a **growth function**. For two growth functions γ and γ' , we say γ **dominates** γ' , denoted $\gamma' \preceq \gamma$, if there exists a constant $C \geq 1$ such that $\gamma'(n) \leq C\gamma(Cn)$ for all $n \geq 1$. We say γ and γ' are **equivalent**, denoted $\gamma \sim \gamma'$, if γ dominates γ' and γ' dominates γ .

A straightforward computation shows \sim is an equivalence relation. We denote by $[\gamma]$ the equivalence class of γ by \sim .

Proposition 1.3.9 (Corollary 6.4.5 [CC10]). *Let G be a finitely generated group along with S and S' two generating sets. Then, $\gamma_{G,S} \sim \gamma_{G,S'}$.*

We define the **growth type** of G as the equivalence class $[\gamma_{G,S}]$ for any generating set S , and denote it $\text{gr}(G)$.

Definition 1.3.10. We say a finitely generated group G has

- **exponential growth** if $\text{gr}(G) \sim [e^n]$,
- **polynomial growth** if $\text{gr}(G) \sim [n^d]$ for some $d \geq 0$.

We say an element $g \in G$ has **torsion** if there exists $n \geq 1$ such that $g^n = 1_G$. If there is no such n , we say g is **torsion-free**. Analogously, we say G is a **torsion group** if all of its elements have torsion. Otherwise, if the only torsion element is the identity, we say the group is **torsion-free**.

Finally, let \mathcal{P} be a class of groups. We say a group G is **virtually** \mathcal{P} , if there exists a finite index subgroup $H \leq G$ that is in \mathcal{P} .

Example 1.3.11. Consider the class \mathfrak{F} of free groups. A virtually \mathfrak{F} group is known as a **virtually free** group. These groups are of fundamental importance to this manuscript. They enjoy many useful structural and algorithmic properties and play a central role in many areas of group theory. For a comprehensive list of characterizations of virtually free groups, see [Ant11].

1.3.1 The word problem

When working with groups such as \mathbb{Z}^d , each element has a normal form that allows us to ask computational problems about and around them. Nevertheless, from a generating set or presentation we do not have an *a priori* way of understanding the corresponding groups structure. In 1911, Dehn proposed the following problem to understand this regard [Deh11]³.

Definition 1.3.12. The **word problem** of a group G with respect to a set of generators S is the following decision problem: given a word $w \in S^*$, determine whether $w \in \text{WP}(G, S)$.

Remark 1.3.13. A simple computation shows that for two different generating sets of G , S_1 and S_2 , the word problem with respect to S_1 is many-one equivalent to the word problem with respect to S_2 . We can therefore talk about the word problem of the *group*, which we denote by $\text{WP}(G)$.

³Dehn also introduced the **conjugacy problem** and the **isomorphism problem**. Notice that this is 25 years before the introduction of Turing machines!

Since its introduction, many groups have been shown to have decidable word problem. The first examples of groups with undecidable word problem were found independently by Novikov and Boone in the fifties.

Theorem 1.3.14 (Novikov [Nov58], Boone [Boo59]). *There exists a finitely presented group G with undecidable word problem.*

The computational difficulty of the word problem can be made arbitrarily high. For instance, in [Gui+19] Guillon, Jeandel, Kari and Vanier showed that for any Turing degree there exists a subgroup of an automorphism group of a \mathbb{Z}^2 -subshift whose word problem has the degree. There are also examples of finitely presented groups with as little as 10 generators and 30 relations due to Collins [Coh17], and finitely presented solvable groups with undecidable word problem due to Kharlampovic [Kha81]. For exhaustive surveys on the different aspects of the word problem see [AD00; Loh14; Shp24].

Even though the word problem might be undecidable for recursively presented group, there is an upper bound to its difficulty.

Proposition 1.3.15. *Let G be a finitely generated group. G is recursively presented if and only if $\text{WP}(G)$ is in Σ_1^0 .*

Proof. If $\text{WP}(G)$ is recursively enumerable, then $(S, \text{WP}(G))$ is a recursive presentation of G . Conversely, consider a recursive presentation (S, R) of G . By definition, $G \simeq \mathbb{F}_S / \langle\langle R \rangle\rangle$. Therefore, a reduced word w belongs to $\text{WP}(G, S)$ if and only if $w \in \langle\langle R \rangle\rangle$. Let us see that $\langle\langle R \rangle\rangle$ can be enumerated. For every $n \in \mathbb{N}$, run the semi-algorithm for R for n steps on words of S^* of length at most n . If a word is accepted it is added to the set W_n . Next, compute the sets $C_n = \{uwu^{-1} \mid w \in W_n, u \in S^{\leq n}\}$ of conjugates, and the set of their combinations $N_n = \{v \in (C_n)^* \mid |v| \leq n\}$. Notice that the normal closure of R is given by

$$\langle\langle R \rangle\rangle = \{g_1 r_1 g_1^{-1} \cdot \dots \cdot g_m r_m g_m^{-1} \mid m \in \mathbb{N}, r_i \in R, g_i \in \mathbb{F}_S\}.$$

Thus, every word from $\langle\langle R \rangle\rangle$ eventually appears in N_n for some $n \in \mathbb{N}$. □

Is there an algebraic characterization of the decidability of the word problem? Kuznetsov showed in 1958 that finitely presented simple groups have decidable word problem [Kuz58]. Inspired by this result, Boone and Higman proposed the following conjecture.

Conjecture 1.3.16 (Boone-Higman Conjecture). *A finitely generated group G has decidable word problem if and only if it is a subgroup of a finitely presented simple group.*

Although they did not manage to prove this conjecture – which remains open – they did show that a group has solvable word problem if and only if it embeds into a recursively presented simple group [BH74]. This was later improved upon by Thompson [Tho80] to obtain the following.

Theorem 1.3.17 (Boone-Higman-Thompson Theorem). *A finitely generated group G has decidable word problem if and only if it is a subgroup of a finitely generated recursively presented simple group.*

For a recent survey on the history and state of the art of the conjecture see [Bel+23].

1.3.2 Nilpotent and polycyclic groups

A class of groups that will recurrently appear is the class of nilpotent groups. These groups will act as the natural theatre for generalizations of results on \mathbb{Z}^d .

Let G be a group. For each $i \in \mathbb{N}$ inductively define $Z_i(G)$ as

$$Z_{i+1}(G) = \{g \in G \mid [g, h] \in Z_i(G), \forall h \in G\},$$

where $Z_0(G) = \{1_G\}$. The set $Z(G) = Z_1(G)$ is called the **center** of G and, by definition, is the set of elements that commute with every element in G . We say a group is **nilpotent** if there exists $n \geq 0$ such that $Z_n(G) = G$. In this case we also say G has an **upper central series** defined by the sequence of normal subgroups,

$$\{1_G\} \trianglelefteq Z(G) \trianglelefteq Z_2(G) \trianglelefteq \dots \trianglelefteq Z_n(G) = G,$$

where $Z_{i+1}/Z_i = Z(G/Z_i)$.

Example 1.3.18. The following are examples of nilpotent groups.

- Every abelian group is nilpotent, as they satisfy $Z(G) = G$.
- The discrete Heisenberg group, H_3 , of upper triangular 3×3 integer matrices given by the presentation,

$$H_3 = \langle x, y, z \mid [x, z], [y, z], [x, y]z^{-1} \rangle,$$

is nilpotent. This is because $Z(H_3) = \langle z \rangle$, and $Z_2(H_3) = H_3$.

When working with nilpotent groups, we exploit the fact that subgroups and quotients of nilpotent groups are nilpotent, and that every nilpotent group contains a finite index torsion-free nilpotent subgroup.

An important result in the theory of finitely generated (virtually) nilpotent group is their characterization through their growth.

Theorem 1.3.19. *A finitely generated group is virtually nilpotent if and only if it has polynomial growth.*

The *only if* direction is due to Bass [Bas72] and Guivarc'h [Gui70] who provided an explicit formula for the degree of the polynomial growth. The *if* direction is due to Gromov [Gro81]. For this reason, this result is sometimes called Gromov's Theorem.

A similarly defined family of groups is the family of polycyclic groups. A group G is **polycyclic** if it admits a series

$$\{1_G\} = G_0 \trianglelefteq G_1 \trianglelefteq \dots \trianglelefteq G_n = G,$$

for some $n \geq 1$, such that the quotient G_{i+1}/G_i is a cyclic group (finite or infinite).

Example 1.3.20. All nilpotent groups are polycyclic, but the converse is not true. The group $\mathbb{Z}^2 \rtimes_M \mathbb{Z}$ with

$$M = \begin{bmatrix} 2 & 1 \\ 1 & 1 \end{bmatrix}$$

is polycyclic but not nilpotent. Its center is trivial as the matrix has no non-trivial fixed points.

Other examples of polycyclic groups can be obtained from the following.

Theorem 1.3.21 (Auslander-Swan Theorem). *A group G is polycyclic if and only if it is isomorphic to a solvable subgroup of $GL(n, \mathbb{Z})$.*

The necessary condition of this theorem was proven by Mal'cev [Mal56], and the sufficient one by Auslander and Swan [Aus67; Swa67]. A proof can be found in [Seg83].

Polycyclic satisfy properties similar to the one satisfied by nilpotent groups. Subgroups and quotients of polycyclic groups are polycyclic, and every polycyclic group contains a finite index torsion-free polycyclic subgroup. Furthermore, subgroups of polycyclic groups are always finitely generated. This last property is crucial when we want to define SFTs from SFTs on quotients (see Lemma 1.5.16).

The key tool when working with polycyclic groups is their **Hirsch length**. For a polycyclic group G , this length, denoted $h(G)$, is equal to the number of infinite cyclic quotients in its groups series. We make proofs by induction over the Hirsch length by using the following properties.

Proposition 1.3.22. *Let G be a polycyclic group. The following hold,*

- for a subgroup $H \leq G$, $h(H) \leq h(G)$,
- for a normal subgroup $N \trianglelefteq G$, $h(G) = h(N) + h(G/N)$,
- $h(G) = 0$ if and only if G is finite,
- $h(G) = 1$ if and only if G is virtually \mathbb{Z} ,
- $h(G) = 2$ if and only if G is virtually \mathbb{Z}^2 ,
- $h(\mathbb{Z}^d) = d$.

For a proof of this proposition and further properties of polycyclic groups see [Seg83].

1.3.3 Amenable groups

An important class of groups from the point of view of dynamics is the class of amenable groups. They were conceived as a way to generalize finite groups, as they can be approximated by a family of almost left invariant finite sets.

Definition 1.3.23. A countable group G is said to be **amenable** if it satisfies one of the following equivalent conditions,

- G admits a finitely additive left-invariant probability measure $\mu : 2^G \rightarrow [0, 1]$,
- G admits a (right) **Følner sequence**, that is, a sequence of finite sets $(F_n)_{n \in \mathbb{N}}$ such that for all $g \in G$

$$\lim_{n \rightarrow \infty} \frac{|F_n \setminus F_n g|}{|F_n|} = 0.$$

The class of amenable groups includes finite, abelian, nilpotent and solvable groups. It also has several inheritance properties.

Proposition 1.3.24. *Let G be an amenable group. The following properties are satisfied:*

- If $H \leq G$, then H is amenable.
- If $N \trianglelefteq G$, then G/N is amenable. Furthermore if N and G/N are amenable, G is amenable.
- If H is amenable, then $G \times H$ is amenable.

Proofs of these facts can be found in [CC10, Chapter 2]. There are many additional properties and characterizations of amenable groups. For a recent survey on amenability see [Bar18].

Example 1.3.25. The simplest non-amenable group is the free group \mathbb{F}_2 . We can show this fact by contradiction. Suppose \mathbb{F}_2 , with presentation $\langle \mathbf{a}, \mathbf{b} \mid \rangle$, admits a finitely additive left invariant probability measure μ . If we define the set $F_{\mathbf{b}}$ as all elements of \mathbb{F}_2 represented by a reduced word beginning with \mathbf{b} or \mathbf{b}^{-1} , we have that $\mathbb{F}_2 = F_{\mathbf{b}} \cup \mathbf{b}^{-1}F_{\mathbf{b}}$. Then,

$$1 = \mu(\mathbb{F}_2) = \mu(F_{\mathbf{b}} \cup \mathbf{b}^{-1}F_{\mathbf{b}}) \leq 2\mu(F_{\mathbf{b}}).$$

This implies $\mu(F_{\mathbf{b}}) \geq 1/2$. On the other hand, the sets $F_{\mathbf{b}}$, $\mathbf{a}F_{\mathbf{b}}$ and $\mathbf{a}^2F_{\mathbf{b}}$ are disjoint, implying

$$1 \geq \mu(F_{\mathbf{b}} \cup \mathbf{a}F_{\mathbf{b}} \cup \mathbf{a}^2F_{\mathbf{b}}) = 3\mu(F_{\mathbf{b}}).$$

Therefore, $\mu(F_{\mathbf{b}}) \leq 1/3$, which is a contradiction.

It was believed that \mathbb{F}_2 was the source of non-amenability, that is, a group is non-amenable if and only if it contains \mathbb{F}_2 a subgroup. This statement, known as the von Neumann conjecture or von Neumann-Day Problem, was shown to be false by Ol'shanskii in 1980 who proved the existence non-amenable torsion groups [OIS80b; OIS80a].

1.3.4 Combining groups

The **free product** of two groups G and H given by presentations $\langle S_G \mid R_G \rangle$ and $\langle S_H \mid R_H \rangle$ respectively, is the group given by the presentation

$$G * H = \langle S_G \cup S_H \mid R_G \cup R_H \rangle.$$

The fundamental example of free products are free groups. If we denote $\mathbb{F}_1 = \mathbb{Z}$, the free group of rank $n > 2$ can be obtained as the free product $\mathbb{F}_n = \mathbb{F}_{n-1} * \mathbb{Z}$. In Chapter 4 we look at properties of a class of groups obtained from free products of finite groups and free groups. These groups are known as **plain groups**.

Let G and H be two groups given by presentations $\langle S_G \mid R_G \rangle$ and $\langle S_H \mid R_H \rangle$ respectively. Suppose they have subgroups $A \leq G$ and $B \leq H$ that are isomorphic through $\phi : A \rightarrow B$. The **amalgamated free product** of G and H along A is the group given by the presentation

$$G *_A H = \langle S_G \cup S_H \mid R_G \cup R_H \cup \{a\phi(a)^{-1} \mid a \in A\} \rangle.$$

Example 1.3.26. Let $G = SL(2, \mathbb{Z})$ be the special linear group of rank 2 over \mathbb{Z} . This group admits a finite presentation as the amalgamated free product $\mathbb{Z}/4\mathbb{Z} *__{\mathbb{Z}/2\mathbb{Z}} \mathbb{Z}/6\mathbb{Z}$, where the generators for $\mathbb{Z}/4\mathbb{Z}$ and $\mathbb{Z}/6\mathbb{Z}$ are respectively given by the matrices

$$S = \begin{bmatrix} 0 & -1 \\ 1 & 0 \end{bmatrix}, \quad T = \begin{bmatrix} 1 & 1 \\ 0 & 1 \end{bmatrix}.$$

These groups are amalgamated along the subgroup $\mathbb{Z}/2\mathbb{Z} \simeq \langle -I, I \rangle$, where I is the identity matrix.

Let G be a group given by the presentation $\langle S \mid R \rangle$. Suppose G has two subgroups $H, K \leq G$ that are isomorphic through $\psi : H \rightarrow K$. The **HNN-extension** of G with respect to ψ is the group given by the presentation

$$G *_\psi = \langle S \cup \{t\} \mid R \cup \{t^{-1}ht\psi(h)^{-1} \mid h \in H\} \rangle,$$

where $t \notin S$ is known as the **stable generator**. The name comes from Higman, B.H. Neumann, and H. Neumann who introduced these extensions [HNN49].

Example 1.3.27. Examples of HNN-extensions that recurrently appear in this text are **Baumslag-Solitar groups**. The Baumslag-Solitar group $BS(m, n)$ is given by the HNN-extension of \mathbb{Z} where the subgroups $m\mathbb{Z}$ and $n\mathbb{Z}$ are identified.

A useful fact about HNN-extensions is that they have **normal forms**.

Lemma 1.3.28. *Let G be a group with two subgroups $H, K \leq G$ that are isomorphic through $\psi : H \rightarrow K$. Consider the sets of right coset representatives containing 1_G , R_H and R_K , for H and K respectively. Then, every element g in the HNN-extension $G *_\psi$ can be uniquely decomposed as*

$$g = g_0 t^{\varepsilon_1} g_1 \dots t^{\varepsilon_n} g_n,$$

for $n \in \mathbb{N}$, such that $g_i \in G$ and $\varepsilon_i \in \{1, -1\}$. In addition,

- if $\varepsilon_i = 1$, then $g_i \in H$,
- if $\varepsilon_i = -1$ then $g_i \in K$,
- the decomposition contains no factors of the form $t^{\pm 1} 1_G t^{\mp 1}$.

A proof of this lemma can be found in [LS77].

We look at a generalization of these three operations, called the graph of groups, in Chapter 6.

1.3.5 Cayley graphs and ends

Let G be a finitely generated group along with a finite symmetric generating set S . The **Cayley graph** of G with respect to S , denoted $\Gamma(G, S)$, is defined by the set of vertices $V_\Gamma = G$ and the set of labeled edges $E_\Gamma = \{(g, s, gs) \mid g \in G, s \in S\} \subseteq G \times S \times G$. Each edge $e = (g, s, h) \in E_\Gamma$ has an initial vertex $i(e) = g$, a terminal vertex $t(e) = h$ and a label $\lambda(e) = s$. The graph is also endowed with an involution $e \mapsto e^{-1} = (h, s^{-1}, g) \in E_\Gamma$. If a generator has order 2, that is, if $s \in S$ satisfies $s^2 = 1_G$, we take a unique edge between g and gs for every $g \in G$.

Notice that every Cayley graph is $|S|$ -regular, locally finite, transitive and deterministically labeled, that is, for every vertex there is a unique out-going edge for each label S . The group G acts by translation on $\Gamma(G, S)$ by left multiplication. The action of $g \in G$ over a vertex $h \in V_\Gamma$ is given by $g \cdot h = gh$.

We also consider the **undirected Cayley graph** $\hat{\Gamma}(G, S)$, where we collapse each edge e and e^{-1} to a single undirected edge between $i(e)$ to $t(e)$. In other words, $\hat{\Gamma}(G, S)$ is the graph with vertex set G such that $g, h \in G$ are adjacent if $gh^{-1} \in S$.

Example 1.3.29. The hexagonal grid \mathbb{H} is a Cayley graph of the affine Coxeter group \tilde{A}_2 given by the presentation

$$\tilde{A}_2 = \langle a, b, c \mid a^2, b^2, c^2, (ab)^3, (ac)^3, (bc)^3 \rangle.$$

This can be seen in Figure 1.11.

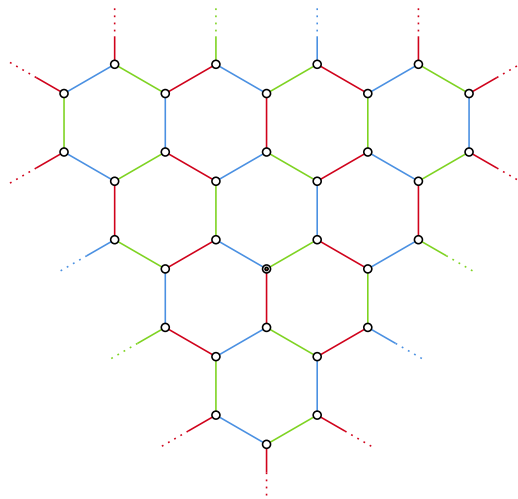

Figure 1.11: A Cayley graph of the affine Coxeter group \tilde{A}_2 . The red edges represent a , blue edges represent b , and green edges c .

Example 1.3.30. The ladder graph \mathbb{L} is the Cayley graph of $\mathbb{Z} \times \mathbb{Z}/2\mathbb{Z}$ for the presentation,

$$\mathbb{Z} \times \mathbb{Z}/2\mathbb{Z} = \langle t, s \mid s^2, tst^{-1}s \rangle.$$

This can be seen in Figure 1.12.



Figure 1.12: A Cayley graph of the group $\mathbb{Z} \times \mathbb{Z}/2\mathbb{Z}$. The generator t defines the horizontal right-pointing edges, and the generator s defines the vertical undirected edges.

This is not the only group that admits the ladder graph as a Cayley graph; this is also the case for the groups \mathcal{D}_∞ and $\mathcal{D}_\infty \times \mathbb{Z}/2\mathbb{Z}$.

A **path** on $\Gamma(G, S)$ is a sequence of edges $\pi = (e_1, \dots, e_n)$ such that for all $i \in \{1, \dots, n-1\}$ we have $i(e_{i+1}) = t(e_i)$. We denote the initial vertex of the path by $i(\pi) = i(e_1)$ and its terminal vertex as $t(\pi) = t(e_n)$. The length of the path is given by $\ell(\pi) = n$, and its label is $\lambda(\pi) = \lambda(e_1) \dots \lambda(e_n) \in S^*$. We also define the sequence of vertices visited by π as the sequence $V(\pi) = (g_0, \dots, g_n)$ with $g_i = i(e_{i+1})$ for all $i \in \{0, \dots, n-1\}$ and $g_n = t(e_n)$. This formalism gives us a one-to-one correspondence between paths starting at 1_G and words in S^* . In particular, a path π satisfies $i(\pi) = t(\pi)$ if and only if $\lambda(\pi) \in \text{WP}(G, S)$.

Cayley graphs define metric spaces when endowed with their **combinatorial distance**, that is, the distance between two vertices $g, h \in G$ is $d_\Gamma(g, h) = \ell(\pi)$ where π is a shortest path between g and h . This metric is the same as the word metric obtained from the generating set S . In fact for different generating set, the metric space defined by the different metrics define equivalent geometries in the following sense.

Definition 1.3.31. Let (X, d_X) and (Y, d_Y) be two metric spaces. We say a function $f: X \rightarrow Y$ is **bilipschitz** if it is bijective and there exists a constant $C \geq 1$ such that

$$\frac{1}{C}d_X(x, y) \leq d_Y(f(x), f(y)) \leq Cd_X(x, y),$$

for all $x, y \in X$. If there exists a bilipschitz function between (X, d_X) and (Y, d_Y) , we say they are **bilipschitz equivalent**.

Lemma 1.3.32. *Let G be a finitely generated group, along with two generating sets S and S' . Then, the metric spaces (G, d_S) and $(G, d_{S'})$ are bilipschitz equivalent through the identity map. In particular, all Cayley graphs of a finitely generated groups are bilipschitz equivalent.*

Proof. Let $w_s \in S^*$ be a geodesic word representing $s \in S'$. If we denote $M = \max_{s \in S'} |w_s|$, we have that

$$\frac{1}{M}d_S(g_1, g_2) \leq d_{S'}(g_1, g_2) \leq Md_S(g_1, g_2).$$

Because the identity map is bijective, we conclude it is bilipschitz. □

We will frequently talk about a particular aspect of the large scale geometry of these spaces called the number of ends of the graph.

Definition 1.3.33. The **number of ends** of a Cayley graph $\Gamma = \Gamma(G, S)$, denoted $e(\Gamma)$, is defined as the quantity

$$e(\Gamma) = \sup_{F \in \mathcal{G}} |\{\text{infinite connected components of } \Gamma[G \setminus F]\}|,$$

where $\Gamma[F']$ is the subgraph induced by the set of vertices F' .

For a finitely generated group, the number of ends of all its Cayley graphs are the same (see [Löh17, Proposition 8.2.8]). We therefore talk about the number of ends of a *group* G , which we denote $e(G)$. We look at ends in greater detail in Section 4.4.1, where we explore properties that are not invariant under changing the generating set.

The number of ends of a group is highly constrained, as the following theorem due to Freudenthal [Fre44] and Hopf [Hop43] shows.

Theorem 1.3.34. *For a finitely generated group G , $e(G) \in \{0, 1, 2, \infty\}$.*

We can classify groups by their number of ends even further. First, a group is finite if and only if it has zero ends. Second, a group has two ends if and only if it is virtually \mathbb{Z} (see [SW79]). Finally, for groups with infinite ends we have the following decomposition due to Stallings.

Theorem 1.3.35 (Stallings' Decomposition Theorem [Sta68; Sta71]). *Let G be a finitely generated group. Then $e(G) > 1$ if and only if one of the following holds,*

- $G = H *_F K$, where F is a finite group different from H and K .
- $G = H *_\psi$ where ψ is an isomorphism between two finite subgroups of H .

*In particular, if $e(G) = \infty$ and G is torsion-free, G can be written as a free product $G = H * K$.*

We will use a corollary of this theorem in Chapter 6 to find weakly aperiodic SFTs on a large class of groups.

1.3.6 Quasi-isometries

To understand which properties of groups do not depend on the Cayley graph, we should use a notion of equivalence that captures the large scale behavior of a group. This idea is formalized through the following definition.

Definition 1.3.36. Let (X, d_X) and (Y, d_Y) be two metric spaces. We say a function $f: X \rightarrow Y$ is a **quasi-isometry** if there exists constants $D, c \geq 0$ and $\lambda \geq 1$ such that

1. f is a **quasi-isometric embedding**: for all $x, y \in X$

$$\frac{1}{\lambda}d_X(x, y) - c \leq d_Y(f(x), f(y)) \leq \lambda d_X(x, y) + c,$$

2. f is **relatively dense**: for all $z \in Y$ there exists $x \in X$ such that $d_Y(z, f(x)) \leq D$.

If there exists a quasi-isometry between (X, d_X) and (Y, d_Y) , we say they are **quasi-isometric**.

Clearly bilipschitz functions are quasi-isometries. The converse is not true in general. Nevertheless, if a quasi-isometry between finitely generated groups is bijective, it is a bilipschitz function.

Example 1.3.37. Take \mathbb{Z}^d with its word metric given by the standard generating set S , and \mathbb{R}^d with the metric induced by norm $\|\cdot\|_1$. The inclusion map from \mathbb{Z}^d to \mathbb{R}^d is a quasi-isometry. Taking $v_1, v_2 \in \mathbb{Z}^d$ we have that

$$d_S(v_1, v_2) = \|v_1 - v_2\|_1,$$

and for every $r = (r_1, \dots, r_d) \in \mathbb{R}^d$ we can take $v = (\lfloor r_1 \rfloor, \dots, \lfloor r_d \rfloor) \in \mathbb{Z}^d$ such that

$$\|r - v\|_1 \leq d.$$

Nevertheless, the inclusion map is not bilipschitz.

Lemma 1.3.38. *Let G be a finite generated group together with $N \trianglelefteq G$ a finite index normal subgroup. Then G is quasi-isometric to N .*

Proof. Let S be a generating set G . Because N has finite index, it is finitely generated. Let T be a generating set for N , and $w_t \in S^*$ a geodesic word representing $t \in T$ within G . If we denote $M = \max_{t \in T} |w_t|$, we have that

$$\frac{1}{M}d_S(h_1, h_2) \leq d_T(h_1, h_2) \leq M d_S(h_1, h_2),$$

for all $h_1, h_2 \in H$. Now, consider R a set of right coset representatives for N . For each $g \in G$ there exists a unique $h \in N$ and $r \in R$ such that $g = hr$. Then,

$$d(g, h) \leq \max_{r \in R} \|r\|_S.$$

Therefore, the inclusion map is a quasi-isometry. □

With this lemma we can relate quasi-isometries with another notion of equivalence for groups.

Definition 1.3.39. We say two groups G_1 and G_2 are **commensurable** if they have finite index subgroups $H_1 \leq G_1$ and $H_2 \leq G_2$ that are isomorphic.

By Lemma 1.3.38 commensurable groups are quasi-isometric. There exist many examples where the converse does not hold. For instance, the Baumslag-Solitar groups $BS(m, n)$ and $BS(p, q)$ are quasi-isometric whenever $1 < n < m$ and $1 < p < q$ [Why01], but are not commensurable if (m, n) are co-prime and (p, q) are co-prime [CKZ21].

Definition 1.3.40. A property \mathcal{P} of finitely generated groups is called a **geometric property** if for every group G that is quasi-isometric to a group that satisfies \mathcal{P} , also satisfies \mathcal{P} .

The following properties are geometric:

- finiteness,
- growth type, and therefore being virtually nilpotent through Gromov's Theorem,
- number of ends [Bri93],
- hyperbolicity [Gro87; GH90],
- amenability [Føl55],
- being virtually free [Woe89],
- finite presentability [BH99, Proposition I.8.24],
- decidability of the word problem for finitely presented groups [Alo90],

among many others. For a more comprehensive list see [DK18]. Proofs of the invariance of many of these properties can be found in [Löh17]. On the other hand, examples of properties that are not geometric are the rank of free groups (as \mathbb{F}_2 and \mathbb{F}_3 are quasi-isometric), being abelian (\mathbb{Z} and \mathcal{D}_∞ are quasi-isometric) and the conjugacy growth of the group [HO13]. Throughout this manuscript we will see that many properties of groups relating to SFTs are quasi-isometry invariants.

1.3.7 Translation-like actions

Definition 1.3.41. Let G be a group and let (X, d) be a metric space. A right action $*$ of G on X is said to be **translation-like** if it satisfies the following two conditions:

- The action is free, i.e. $x * g = x$ implies $g = 1_G$,
- For every $g \in G$, the set $\{d(x, x * g) \mid x \in X\}$ is bounded.

Translation-like actions were introduced by Whyte in order solve the geometric version of the von Neumann conjecture [Why99]. These actions were conceived as a generalization of subgroups: for a finitely generated group G with subgroup H , the right action of H on G given by $g * h = gh$ is a translation-like action.

Example 1.3.42. Let $f : G \rightarrow H$ be a bilipschitz map. Then, H acts translation-like on G through the action $g * h = f^{-1}(f(g)h)$, for $g \in G$ and $h \in H$.

When working with finitely generated groups, we can see each orbit of a translation-like actions of a group G on another group H as an embedding of the Cayley graph of G into the Cayley graph of H . This is made precise by the following result by Seward [Sew14, Corollary 5.2].

Lemma 1.3.43. *Let G and H be finitely generated groups such that H acts translation-like on G . Then, for every generating set S for H , there exists a finite generating set S_G for G and a map $\phi : G \times S \rightarrow S_G$ such that $g * h = g\phi(g, h)$.*

As mentioned before, these actions were used to prove geometric versions of the von Neumann conjecture and the Burnside problem.

Theorem 1.3.44. *(Geometric Burnside problem [Sew14]) Any finitely generated infinite group admits a translation-like action by \mathbb{Z} .*

Theorem 1.3.45. *(Geometric von Neumann conjecture [Why99]) A finitely generated group G is non-amenable if and only if G admits a translation-like action by \mathbb{F}_2 .*

There are also obstructions to the existence of translation-like actions. Whyte's Theorem implies that \mathbb{F}_2 cannot act translation-like on any amenable group. Also, Lemma 1.3.43 implies that if H acts translation-like on G , the growth of H must be smaller than the growth of G . Furthermore, Jiang showed that translation-like actions define regular maps [Jia17], as introduced by Benjamini, Schramm and Timár [BST12]. This implies that if H acts translation-like on G , the asymptotic dimension of H is smaller than the asymptotic dimension of G , and that the separation profile of H is smaller than the separation profile of G . There are also further restrictions on translation-like actions between nilpotent groups coming from their asymptotic cones [CP19].

Translation-like actions have also been shown to have connections with weakly aperiodic SFTs by Jean-del [Jea15c]. We will explore this on Chapter 5.

1.4 Computability and entropy of subshifts

1.4.1 Pattern codings and effectively closed subshifts

An interesting class of \mathbb{Z}^d -subshifts are those defined by a recursively enumerable set of forbidden patterns. Such subshifts are known as effectively closed subshifts. They were originally introduced by Hochman to study projective subdynamics of sofic \mathbb{Z}^2 -subshifts [Hoc09]. Enumerating patterns is clear when the underlying group is \mathbb{Z}^d , but may not be clear in general how to specify finite supports on any finitely generated groups. This problem was solved by Aubrun, Barbieri and Sablik through the concept of pattern codings [ABS17]. The results that follow come originally from their article.

Definition 1.4.1. Let G be a finitely generated group, S a finite set of generators and A a finite alphabet. A **pattern coding** c with respect to S is a set of tuples $c = \{(w_i, a_i)\}_{i \in I}$, where I is a finite set, $w_i \in S^*$ and $a_i \in A$.

Given a set of pattern codings \mathcal{C} , we define its corresponding subshift as:

$$X_{\mathcal{C}} = A^G \setminus \bigcup_{\substack{g \in G \\ c \in \mathcal{C}}} \bigcap_{(w,a) \in c} [a]_{g\bar{w}}.$$

Remark 1.4.2. Notice that a pattern coding c could be **inconsistent**, that is, it could contain pairs (w_1, a) , (w_2, b) where $a \neq b$ and $\bar{w}_1 \neq \bar{w}_2$. In this case, $\bigcap_{(w,a) \in c} [a]_w$ would be empty and would not contribute in the definition of $X_{\mathcal{C}}$. Furthermore, for a finitely generated group G and an alphabet A of size at least 2 the word problem for G is recursively enumerable if and only if the set of inconsistent pattern codings is recursively enumerable. Indeed, if we take a word $w \in S^*$ and take two distinct letters $a, b \in A$ we define the pattern coding $\{(w, a), (1_G, b)\}$. This pattern coding is inconsistent if and only if $w =_G \emptyset$. Conversely, from an enumeration of the word problem we can check in a pattern coding c if $w_1 w_2^{-1} =_G \varepsilon$ and $a \neq b$ for every pair $(w_1, a), (w_2, b) \in c$. If the pattern is inconsistent this procedure will eventually detect it.

Definition 1.4.3. A subshift $X \subseteq A^G$ is **effectively closed** if there exists a recursively enumerable set of pattern codings \mathcal{C} such that $X = X_{\mathcal{C}}$.

Proposition 1.4.4. *Let $X \subseteq A^G$ be an effectively closed subshift. Then, there exists a recursive set of pattern codings \mathcal{C} such that $X = X_{\mathcal{C}}$*

Proof. Because X is effectively closed, there exists a recursively enumerable set of pattern codings \mathcal{C}' such that $X = X_{\mathcal{C}'}$. Take an enumeration $\mathcal{C}' = \{c_0, c_1, \dots\}$. For each $n \in \mathbb{N}$ we define

$$R_n = \max_{k \leq n} \max_{(w,a) \in c_k} |w|.$$

Let \mathcal{C}_n be the set of all pattern codings of support $S^{\leq R_n}$ that are possible completions of pattern codings $c \in \mathcal{C}'$ such that $\max_{(w,a) \in c_k} |w| \leq R_n$. If we define \mathcal{C} as the union of all \mathcal{C}_n we obtain that $X = X_{\mathcal{C}'} = X_{\mathcal{C}}$. Let us see \mathcal{C} is recursive. The procedure is the following: given a pattern coding c we first check if the pattern has support $S^{\leq L_n}$ for some $n \in \mathbb{N}$. If this is not the case we reject. Next, for such $n \in \mathbb{N}$ we compute the set \mathcal{C}_n from the enumeration of \mathcal{C}' . If $c \in \mathcal{C}_n$ we accept, otherwise we reject. \square

This proposition is another instance of Craig's trick as mentioned in Remark 1.3.5 for group presentations. This parallel between forbidden patterns and relations of a group presentation is further explored in Section 1.6.

The class of effectively closed subshifts always contains the class of SFTs, and contains the class of sofic shifts when G is recursively enumerable.

Lemma 1.4.5. *Every SFT is effectively closed.*

Proof. Let $X \subseteq A^G$ be an SFT. Then, there exists a finite set of forbidden patterns $\mathcal{F} \subseteq A^{*G}$ such that $X = \mathcal{X}_{\mathcal{F}}$. Fix a generating set S . For every $p \in \mathcal{F}$, we define the pattern coding $c(p) = \{(w_g, p(g)) \mid g \in \text{supp}(p)\}$ where $w_g \in S^*$ is a word representing g . Clearly, $X = X_{\mathcal{C}}$ and \mathcal{C} is recursively enumerable as \mathcal{F} is finite. \square

Proposition 1.4.6 (Proposition 2.7 [ABS17]). *Let G be a recursively presented group. Then, the class of effectively closed subshifts is closed under factors. In particular, every sofic subshift is effectively closed.*

Although the class of effectively closed contains the class of sofic shifts for recursively presented groups, it can be larger. This is the case in \mathbb{Z}^d

Example 1.4.7. Consider the **mirror subshift** $X_M \subseteq \{\square, \blacksquare, \blacksquare\}^{\mathbb{Z}^2}$. This subshift consists of configurations that contain a vertical line made of \blacksquare tiles such that the rest of the configuration is mirrored along these lines, and configurations made up exclusively of \square and \blacksquare tiles. See Figure 1.13 for an example. This subshift is given

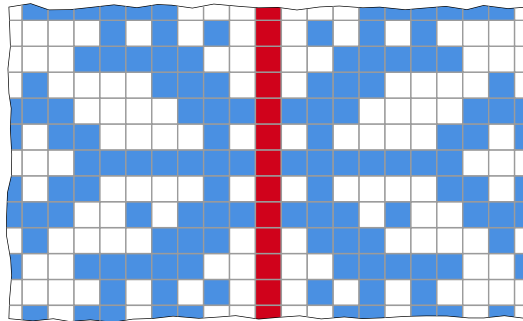

Figure 1.13: An example of a configuration from the mirror subshift X_M in \mathbb{Z}^2 containing a vertical line.

by the forbidden patterns

$$\mathcal{F}_M = \left\{ \begin{array}{|c|c|} \hline \blacksquare & \square \\ \hline \square & \blacksquare \\ \hline \end{array}, \begin{array}{|c|c|} \hline \blacksquare & \blacksquare \\ \hline \blacksquare & \blacksquare \\ \hline \end{array}, \begin{array}{|c|c|} \hline \blacksquare & \blacksquare \\ \hline \blacksquare & \blacksquare \\ \hline \end{array}, \begin{array}{|c|c|} \hline \blacksquare & \blacksquare \\ \hline \blacksquare & \blacksquare \\ \hline \end{array} \right\} \cup \bigcup_{w \in A^*} \{ \blacksquare w \blacksquare, \blacksquare w \blacksquare w^R \square, \square w \blacksquare w^R \blacksquare \},$$

where w^R is the reversal of w . This set of forbidden patterns can be easily converted into a recursive set of pattern codings, making X_M an effectively closed subshift. However, using a counting argument on the number of patterns, it is possible to show that X_M is not sofic (see [ABJ18, Proposition 9.4.5]). Similar arguments to prove \mathbb{Z}^2 -subshifts are not sofic can be found in [DR22]. Analogous mirror subshifts can be defined for \mathbb{Z}^d with $d > 2$ using a fixed hyperplane to mirror configurations.

The ideas from the previous example were generalized to find more groups where the class of effectively closed groups is strictly larger than the class of sofic groups.

Theorem 1.4.8 ([ABS17]). *Let G be a recursively presented group. If G is either amenable or has two or more ends, then there exists an effectively closed G -subshift that is not sofic.*

There are still many cases in which we do not know if the classes can be separated.

Question 1.4.9. Does there exist a recursively presented group where every effectively closed shift is sofic?

There are other notions of effectiveness that prove useful when G is not recursively presented or has undecidable word problem, which we do not tackle here. These notions can be found in [ABS17].

We finish this section by looking at the sunny side-up subshift, defined in Example 1.1.26. In that example, we saw that $X_{\leq 1}$ is never an SFT for infinite groups, and is sofic for \mathbb{Z}^d and \mathbb{F}_2 . Dahmani and Yaman also showed that this is also the case for hyperbolic groups [DY08]. Still, it is possible to give examples where this subshift is not sofic by looking at when it is effectively closed.

Proposition 1.4.10 ([ABS17]). *Let G be a recursively presented group. The sunny-side up subshift $X_{\leq 1}$ on G is effectively closed if and only if G has decidable word problem.*

We finish with the following open question from Aubrun [Aub21].

Question 1.4.11. For which finitely generated groups is $X_{\leq 1}$ sofic?

1.4.2 Entropy for amenable groups

A conjugacy invariant measure of the combinatorial and dynamical properties of a subshift is its **topological entropy**. Although entropy is defined for more general actions of amenable groups, we restrict ourselves to the case of subshifts.

Definition 1.4.12. Let G be an amenable group with a Følner sequence $(F_n)_{n \in \mathbb{N}}$. The **complexity function** of a G -subshift X with respect to $(F_n)_{n \in \mathbb{N}}$ is the function $p_X : \mathbb{N} \rightarrow \mathbb{N}$ defined by $p_X(n) = |\mathcal{L}_{F_n}(X)|$.

The topological entropy of a subshift captures the asymptotic behavior of the complexity function.

Definition 1.4.13. Let G be an amenable group with a Følner sequence $(F_n)_{n \in \mathbb{N}}$. The **topological entropy** of a G -subshift X is defined as

$$h(X) = \lim_{n \rightarrow \infty} \frac{\log(p_X(n))}{|F_n|}.$$

Entropy is well-defined and independent of the chosen Følner sequence by the Orstein-Weiss Lemma [OW80]. For proofs and more information about entropy for general actions of amenable groups see [Kri07; KL16].

Example 1.4.14. Consider the full- G -shift A . For any Følner sequence $\{F_n\}_{n \in \mathbb{N}}$, the complexity of the full-shift is $p_{A^G}(n) = |A|^{|F_n|}$. Therefore, $h(A^G) = \log(|A|)$.

We also understand entropy through admissible patterns.

Definition 1.4.15. Let $\mathcal{F} \subseteq A^{*G}$ be a set of forbidden patterns. A pattern $p \in A^{*G}$ is said to be

- **locally admissible** if p contains no patterns from \mathcal{F} ,
- **globally admissible** if $p \in \mathcal{L}(\mathcal{X}_{\mathcal{F}})$.

Given a subset $F \subseteq G$ we define $q_{\mathcal{F}}(F)$ and $p_{\mathcal{F}}(F)$ as the number of locally and globally admissible patterns with respect to \mathcal{F} , respectively. Notice that $p_{\mathcal{F}}(F) = |\mathcal{L}_F(\mathcal{X}_{\mathcal{F}})|$ and $p_{\mathcal{F}}(F_n) = p_{\mathcal{X}_{\mathcal{F}}}(n)$ for a Følner sequence $\{F_n\}_{n \in \mathbb{N}}$. The **local asymptotic growth rate** and the **global asymptotic growth rate** are defined respectively as

$$\alpha(\mathcal{F}) = \lim_{n \rightarrow \infty} \left(\min_{|F|=n} q_{\mathcal{F}}(F) \right)^{\frac{1}{n}},$$

and

$$\alpha^{\infty}(\mathcal{F}) = \lim_{n \rightarrow \infty} \left(\min_{|F|=n} p_{\mathcal{F}}(F) \right)^{\frac{1}{n}}.$$

Both quantities are well defined through Fekete's Subadditive Lemma [Fek23]. As Downarowicz, Frej and Romagnoli show in [DFR16], through Shearer's inequality we obtain that $h(\mathcal{X}_{\mathcal{F}}) = \log(\alpha^{\infty}(\mathcal{F}))$. In [Ros22], Rosenfeld shows that the same holds for locally admissible patterns.

Theorem 1.4.16 ([Ros22]). *Let G be a finitely generated amenable group. Then, for a set of non-empty forbidden patterns $\mathcal{F} \subseteq A^{*G}$, $\alpha(\mathcal{F}) = \alpha^{\infty}(\mathcal{F})$.*

We will use this expression for entropy with locally admissible patterns in Chapter 4.

An important problem concerning entropy is the problem of determining the set of possible entropies of subshifts for different classes.

Definition 1.4.17. Let \mathfrak{C} be a class of G -subshifts. We define the **set of entropies of \mathfrak{C}** in G as

$$\mathcal{E}(G, \mathfrak{C}) = \{h(X) \mid X \in \mathfrak{C}\}.$$

When \mathfrak{C} is the class of G -SFTs, we simply write $\mathcal{E}(G)$.

We need the following notion of computability for real numbers.

Definition 1.4.18. A number $r \in \mathbb{R}$ is said to be a **Perron number** if it is the maximal eigenvalue of a positive square matrix with integer coefficients.

- A number $r \in \mathbb{R}$ is said to be **right computable** or a Π_1^0 -**number** if there exists a computable sequence of rational numbers $\{q_n\}_{n \in \mathbb{N}}$ such that $r = \inf_{n \in \mathbb{N}} q_n$.

With this definitions we state the following classification of entropies for \mathbb{Z} -subshifts.

Theorem 1.4.19. *The following hold,*

- $\mathcal{E}(\mathbb{Z}) = \mathcal{E}(\mathbb{Z}, \text{SOF}) = \{q \log(r) \mid q \in \mathbb{Q}_+, r \text{ is a Perron number}\}$ [Lin84],
- $\mathcal{E}(\mathbb{Z}, \text{EFF}) = \{r \mid r \geq 0 \text{ is right computable}\}$ [HS08],

where *SOF* and *EFF* are the classes of sofic and effectively closed subshifts respectively.

For \mathbb{Z}^d -subshifts with $d \geq 2$, entropies become more complicated. The celebrated characterization by Hochman and Meyerovitch goes as follows.

Theorem 1.4.20 (Hochman, Meyerovitch [HM10]). $\mathcal{E}(\mathbb{Z}^d) = \{r \mid r \geq 0 \text{ is right computable}\}$, for $d \geq 2$

For general groups it is still an open problem to characterize the entropies of SFTs, sofic subshifts, and effectively closed subshifts. However it has been characterized for SFTs on certain classes of groups:

- If \mathbb{Z}^2 acts translation-like on G , then $\mathcal{E}(G) = \mathcal{E}(\mathbb{Z}^2)$ [Bar21],
- If G is a locally finite group, then

$$\mathcal{E}(G) = \left\{ \frac{\log(n)}{|H|} \mid H \leq_f G, n \in \mathbb{N} \right\},$$

where \leq_f represents being a finite subgroup [Ray23].

- If G is the Lamplighter group \mathcal{L} , or the Baumslag-Solitar group $BS(1, 2)$, then $\mathcal{E}(G) = \mathcal{E}(\mathbb{Z}^2)$ [BS24].

Question 1.4.21. For which finitely generated amenable groups is $\mathcal{E}(G) = \mathcal{E}(\mathbb{Z}^2)$?

1.5 Canonical constructions

This section is focused on introducing constructions that allow us to go from a subshift defined over a group, to one defined on a subgroup or quotient. These constructions appear under varied names throughout the literature, and have been used to prove many results. In particular, they are extensively used throughout this thesis.

To prevent confusion when working with different groups and their subgroups, for a set of forbidden patterns $\mathcal{F} \subseteq A^{*G}$, we denote the G -subshift generated by \mathcal{F} as $\mathcal{X}_{\mathcal{F}}^G$.

1.5.1 Free extension

The first of the constructions we look at is the **free extension**. This construction is perhaps the most direct way to define a subshift on a group starting from a subshift on one of its subgroups. It is because of this that it appears often in the literature, though not always under the same name. Free extensions have been used by Hochman and Meyerovitch [HM10] to characterize the entropies of \mathbb{Z}^d -SFTs, by Ballier and Stein for the Domino Problem [BS18], by Jeandel to prove results about strongly and weakly aperiodic SFTs and the Domino Problem [Jea15b; Jea15c], by Carrol and Penland to prove the commensurability invariance of aperiodicity [CP15], by Barbieri to study the set of possible entropies of certain amenable groups [Bar21], and by Barbieri, Sablik and Salo to obtain simulation theorems on direct products of groups [BSS23]. Recently Raymond has made a careful study of the properties of free extensions in order to study SFTs on locally finite groups [Ray23].

Definition 1.5.1. Let G be a group, $H \leq G$ a subgroup, $X \subseteq A^H$ an H -subshift. The **free extension** of X to G , denoted X^\uparrow , is the G -subshift defined as,

$$X^\uparrow = \{x \in A^G \mid \forall g \in G, x|_{gH} \in X\}.$$

Example 1.5.2. Let us take $X_{\leq 1} \subseteq \{\square, \blacksquare\}^{\mathbb{Z}}$, the sunny-side up subshift on \mathbb{Z} as defined in Example 1.1.26. Then, its free extension to \mathbb{Z}^2 , $X_{\leq 1}^\uparrow$, is the subshift containing configurations that on each row has at most one \blacksquare tile (see Figure 1.14).

Remark 1.5.3. There is an alternative way of lifting a subshift over a subgroup to the whole group, which also appears regularly in the literature. Given an H -subshift $X \subseteq A^H$, and a set of left coset representatives L , the **periodic (or trivial) extension** of X is the set

$$X^\uparrow = \{y \in A^G \mid \exists x \in X, \forall l \in L, y|_{lH} = x\} \subseteq X^\uparrow.$$

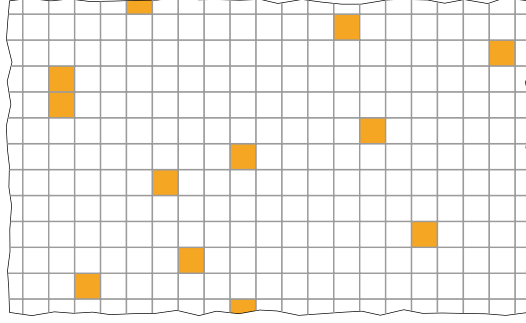

Figure 1.14: An example of a configuration from the free extension of the sunny-side up shift $X_{\leq 1}$ from \mathbb{Z} to \mathbb{Z}^2 .

This set is a subshift for $G = \mathbb{Z}^d$, but may fail to be shift invariant in general (see Section 6.3.1). This extension famously appears on the simulation results independently discovered by Hochman [Hoc09], Aubrun and Sablik [AS13], and Durand, Romaschenko and Shen [DRS12]. It has also been used to prove a Higman Embedding Theorem for subshifts [JV19], characterize extender entropies of \mathbb{Z}^d -subshifts [CSV24], and for simulation theorems on other finitely generated groups [Bar19; BS19; BSS21].

Lemma 1.5.4. *Let $X \subseteq A^H$ be an H -subshift generated by the set of forbidden patterns \mathcal{F} , that is, $X = \mathcal{X}_{\mathcal{F}}^H$. Then, the free extension satisfies the following*

1. $X^\uparrow = \mathcal{X}_{\mathcal{F}}^G$,
2. X^\uparrow is empty if and only if X is empty,
3. for every $x \in X^\uparrow$, $\text{stab}(x) \cap H \subseteq \text{stab}(x|_H)$.

Proof. 1. Take $x \in X^\uparrow$, and suppose there is $g \in G$ and $p \in \mathcal{F}$ such that $x|_{g \cdot \text{supp}(p)} = p$. Then, the configuration $y = x|_{gH}$ contains the forbidden pattern p , which contradicts the fact that $y \in X$. Conversely, take $x \in \mathcal{X}_{\mathcal{F}}^G$ and $g \in G$. Because the supports of patterns from \mathcal{F} are contained in H , $x|_{gH} \in \mathcal{X}_{\mathcal{F}}^H = X$. Thus, $x \in X^\uparrow$.

2. For any $x \in X^\uparrow$, we have $x|_H \in X$. Take L a set of left coset representatives for H . Given a configuration $y \in X$, we define $x \in A^G$ by $x(lh) = y(h)$ for all $l \in L$ and $h \in H$. Then, given $g \in G$ there exists $l \in L$ and $h \in H$ such that $g = lh$. Then, $x(gh') = x(lhh') = y(hh')$, for all $h' \in H$. Thus, $x|_{gH} = h^{-1} \cdot y \in X$.

3. Take $x \in X^\uparrow$, $h \in \text{stab}(x) \cap H$, and $y = x|_H$. Then,

$$h \cdot y(h') = y(h^{-1}h') = x(h^{-1}h') = x(h') = y(h').$$

Therefore, $h \in \text{stab}(y)$. □

A more manageable way to understand free extensions is through the cosets of the subgroup.

Lemma 1.5.5. *Take L a set of left coset representatives for G/H and an H -subshift X . Then, $y \in X^\uparrow$ if and only if there exist a collection of configurations on X , $\{x_l\}_{l \in L}$, such that $y|_{lH} = x_l$.*

Proof. For a configuration $y \in X^\uparrow$, we define our collection of configurations as $x_l = y|_{lH} \in X$. Conversely, let y be defined by the collection $\{x_l\}_{l \in L}$. Take $g \in G$, which is uniquely written as $g = lh$ for some $l \in L, h \in H$. Then, $y(gh') = y(lhh') = x_l(hh')$ for all $h' \in H$, implying that $y|_{gH} = h^{-1} \cdot x_l \in X$. Thus, $y \in X^\uparrow$. □

There are also several other properties that are satisfied by the free extension, relating to entropy and morphisms.

Proposition 1.5.6. *Let G be a group, with $H \leq G$ a subgroup. Take an H -shift X . The following hold:*

- For a morphism $\phi : A^G \rightarrow B^G$, we have that $\phi(X^\uparrow) = \phi_H(X)^\uparrow$, where ϕ_H is ϕ viewed as an H -invariant morphism [Ray23].
- If G is an amenable countable group, $h(X^\uparrow) = h(X)$ [Bar21].

Finally, we note that free extensions and finitely generated groups are some sense universal for SFTs, as the following shows.

Lemma 1.5.7. *Let $X \subseteq A^G$ be a G -SFT. Then, there exists a finitely generated subgroup $H \leq G$ and an SFT $Y \subseteq A^H$ such that $X = Y^\uparrow$.*

Proof. Let \mathcal{F} be a set of forbidden patterns for X and H be the subgroup generated by the union of the supports of the patterns from \mathcal{F} . Thus, all patterns from \mathcal{F} are supported within H , so we can define $Y = \mathcal{X}_{\mathcal{F}}^H$. By Lemma 1.5.4, $X = Y^\uparrow$. \square

Using this lemma we state the following expression for the set of realizable entropies of an amenable group.

Corollary 1.5.8 (Corollary 3.15 [Ray23]). *Let G be a countable amenable group. Then,*

$$\mathcal{E}(G) = \bigcup_{F \in G} \mathcal{E}(\langle F \rangle)$$

1.5.2 Higher power and higher block

Higher block and higher power subshifts are standard and useful constructions for \mathbb{Z} -subshifts (see Example 1.1.12). They allow both to re-scale subshifts – in order to find letter-to-letter sliding-block codes and nearest neighbor subshifts– and to go from a group to a finite index subgroup. This construction has been used by Carroll and Penland to prove aperiodicity is a commensurability invariant [CP15], and by Aubrun, Barbieri and Jeandel to prove every SFT is conjugate to a nearest neighbor SFT [ABJ18].

Definition 1.5.9. Let G be a group, $H \leq G$ a finite index subgroup, and $X \subseteq A^G$. Take R a set of right coset representatives. The **R -higher power** of X , denoted $X^{[R]}$, is the H -subshift over the alphabet A^R defined as,

$$X^{[R]} = \{x \in (A^R)^H \mid \exists y \in X, \forall (h, r) \in H \times R, x(h)(r) = y(hr)\}.$$

Lemma 1.5.10. *Let $X \subseteq A^G$ be a G -subshift, $H \leq G$ a finite index subgroup, and R a set of right coset representatives. Then, X is non-empty if and only if $X^{[R]}$ is non-empty.*

Proof. For a configuration $y \in X$ we define $x \in (A^R)^H$ by $x(h) = y|_{hR}$. By definition, $x \in X^{[R]}$. Conversely, for a configuration $x' \in X^{[R]}$ there exists $y' \in X$ such that $x'(h)(r) = y'(hr)$ for all $h \in H$ and $r \in R$. \square

Given a set of forbidden patterns \mathcal{F} for the base G -subshift X , we create a set of forbidden patterns, \mathcal{F}' , for $X^{[R]}$. Take $q \in \mathcal{F}$ with support $F \in G$, and $r \in R$. For each $f \in F$ there exists $h_f \in H \cap RFR^{-1}$ and $r_f \in R$ such that $h_f r_f = r f$. Define the set $P(q, r) = \{h_f \mid f \in F\}$. Now, for each $q \in \mathcal{F}$ and $r \in R$ the set \mathcal{F}' contains all the patterns p of support $P(q, r)$ such that $p(h_f)(r_f) = q(f)$.

Lemma 1.5.11. *Let $X \subseteq A^G$ be a G -subshift given by the set of forbidden patterns \mathcal{F} . Then $X^{[R]} = \mathcal{X}_{\mathcal{F}'}^H$.*

Proof. Take $x \in X^{[R]}$. By definition there is a configuration $y \in X$ such that $x(h)(r) = y(hr)$ for all $h \in H$ and $r \in R$. Suppose $x \notin \mathcal{X}_{\mathcal{F}'}$. Then, there exists $h \in H$, $q \in \mathcal{F}$, $r \in R$ and $p \in \mathcal{F}'$ of support $P(q, r)$ such that $x|_{hP(q, r)} = p$. For each $f \in \text{supp}(q)$,

$$y(hrf) = y(hh_f r_f) = x(hh_f)(r_f) = q(f).$$

In other words, $y|_{hr \cdot \text{supp}(q)} = q$, which is a contradiction.

Conversely, take $x \in \mathcal{X}_{\mathcal{F}'}$ and define $y \in A^G$ as $y(hr) = x(h)(r)$ for all $h \in H$ and $r \in R$. Suppose $y \notin X$. Then, there exists $h \in H$, $r \in R$ and $q \in \mathcal{F}$ such that $y|_{hr \cdot \text{supp}(q)} = q$. Then, for all $h_f \in P(q, r)$

$$x(hh_f)(r_f) = y(hh_f r_f) = y(hrf) = q(f).$$

This means $x|_{hP(q, r)} \in \mathcal{F}'$, which is a contradiction. Therefore $y \in X$ and $x \in X^{[R]}$. \square

A slight generalization of the R -higher power shift has also been used in the literature ([CP15] for instance). This generalization, called the **R -higher block shift**, consists in taking any finite set $R \subseteq G$ such that $HR = G$ that is not necessarily a set of coset representatives. The definition is the same, but we denote it by $X^{(R)}$. What does change is the set of forbidden patterns that generate $X^{(R)}$. We must now make sure that if hR and $h'R$ intersect, for $h, h' \in H$, every configuration agrees on the intersection. Let X be given by the set of forbidden patterns \mathcal{F} , and denote by \mathcal{F}' the set of forbidden patterns from Lemma 1.5.11. A straightforward computation shows the following.

Lemma 1.5.12. *Let $X \subseteq A^G$ be an G -subshift given by the set of forbidden patterns \mathcal{F} . Then $X^{(R)} = \mathcal{X}_{\mathcal{F}''}^H$, where \mathcal{F}'' is the union of \mathcal{F}' and the set of patterns*

$$\{p : H \cap RR^{-1} \rightarrow A^R \mid p(1_H)(r) \neq p(h)(h^{-1}r) \text{ with } h^{-1}r \in R\}$$

This particular shift is used to prove Lemma 1.1.24, which we re-state.

Lemma 1.5.13 (Lemma 1.1.24). *For G a finitely generated group with finite generating set S , every SFT is conjugate to a nearest neighbor SFT with respect to S .*

Proof. Let X be a G -SFT defined by the set \mathcal{F} . Take $N = \max_{p \in \mathcal{F}} \max_{g \in \text{supp}(p)} |g|_S$, and $R = B_S(1_G, N)$. The R -higher block shift, $X^{(R)}$ is conjugate to X , through the map $\Phi : X \rightarrow X^{(R)}$ defined by $\Phi(x)(g) = (g^{-1} \cdot x)|_R$. Let us show $X^{(R)}$ is a nearest neighbor SFT over the alphabet \hat{A} consisting of the patterns over A^R with no sub-pattern from \mathcal{F} .

Take for each $s \in S$ and $g \in B_S(1_G, N) \cap B_S(s, N)$ we add all the nearest neighbor patterns (p_1, p_2, s) such that $p_1(g) \neq p_2(s^{-1}g)$, to the set \mathcal{G} . Let us show $X^{(R)} = \mathcal{X}_{\mathcal{G}}$. By definition $\mathcal{G} \subseteq \mathcal{F}''$, from Lemma 1.5.12, and therefore $X^{(R)} \subseteq \mathcal{X}_{\mathcal{G}}$. Next, take $x \in \mathcal{X}_{\mathcal{G}}$ and define $y \in A^G$ by $y(hr) = x(h)(r)$ for all $h \in G$ and $r \in B_S(1_G, N)$. This configuration is well defined: suppose there are $h_1, h_2 \in G$ and $r_1, r_2 \in B_S(1_G, N)$ such that $h_1 r_1 = h_2 r_2$. We can express $r_1 =_G s_1 \cdot \dots \cdot s_m$ and $r_2 =_G s'_1 \cdot \dots \cdot s'_n$ for $m, n \leq N$ and $s_i, s'_i \in S$. Because x avoids all patterns from \mathcal{G}

$$\begin{aligned} x(h_1)(r_1) &= x(h_1 s_1)(s_1^{-1} r_1) \\ &= x(h_1 s_1 s_2)(s_2^{-1} s_1^{-1} r_1) \\ &\vdots \\ &= x(h_1 s_1 \cdot \dots \cdot s_{m-1})(s_{m-1}^{-1} \cdot \dots \cdot s_1^{-1} r_1) \\ &= x(h_1 r_1)(1_G) \\ &= x(h_2 r_2)(1_G) \\ &= x(h_2 s'_1 \cdot \dots \cdot s'_{n-1})((s'_{n-1})^{-1} \cdot \dots \cdot (s'_1)^{-1} r_1) \\ &\vdots \\ &= x(h_2)(r_2). \end{aligned}$$

Finally, to see $y \in X = \mathcal{X}_{\mathcal{F}}$ notice that if y contained a pattern from \mathcal{F} , it would appear in some ball $B_S(g, N)$ for some $g \in G$ which would contradict the fact that $y|_{gB_S(1_G, N)} = x(g) \in \hat{A}$. Therefore $x \in X^{(R)}$. \square

1.5.3 Pull-back

Our next construction allows us to go from a quotient to a group. We call it the **pull-back shift**. This construction has been used by Ballier and Stein to show that the undecidability of the Domino Problem and weak aperiodicity can be transported from the quotient to the group [BS18], by Jeandel to construct strongly aperiodic SFTs on polycyclic groups [Jea15b], and by Bartholdi and Salo to obtain simulation theorems for the Lamplighter group [BS24]. Furthermore, the last two authors argue that the simulation results mentioned in Remark 1.5.3 are in fact results about pull-backs. This is restated by Grigorchuk and Salo in [GS24].

Definition 1.5.14. Let G be a group, $N \trianglelefteq G$ a normal subgroup, and $X \subseteq A^{G/N}$ an G/N -subshift. The **pull-back** of X to G , denoted $\pi^*(X)$, is the G -subshift defined as,

$$\pi^*(X) = \{x \circ \pi \in A^G \mid x \in X\},$$

where $\pi : G \rightarrow G/N$ is the quotient map.

Remark 1.5.15. Notice that $\pi^*(X)$ is non-empty if and only if X is non-empty.

Now, let us build a set of forbidden patterns \mathcal{F}' for $\pi^*(X)$ from a set of forbidden patterns \mathcal{F} for X . Let $\rho : G/N \rightarrow G$ be a section and T a set of generators for N . The set \mathcal{F}' contains for each $t \in T$ all patterns $q : \{1_G, t\} \rightarrow A$ such that $q(1_G) \neq q(t)$, and for each $p \in \mathcal{F}$ a pattern $q : \rho(\text{supp}(p)) \rightarrow A$ defined by $q(\rho(g)) = p(g)$.

Lemma 1.5.16. Let $X \subseteq A^{G/N}$ be a G/N -subshift given by the set of forbidden patterns \mathcal{F} . Then, $\pi^*(X) = \mathcal{X}_{\mathcal{F}'}$. In particular, if N is finitely generated and X is an SFT, $\pi^*(X)$ is an SFT.

Proof. Take $y \in \pi^*(X)$ and $x \in X$ such that $y = x \circ \pi$. Suppose $y \notin \mathcal{X}_{\mathcal{F}'}$. If there are distinct $a, b \in A$, $g \in G$ and $t \in T$, such that $y(g) = a$ and $y(gt) = b$, this means $x(\pi(gt)) = x(\pi(g)) = a$ and $x(\pi(g)) = b$ which is a contradiction. On the other hand, if there is $g \in G$ and $p \in \mathcal{F}$ such that $y|_{g \cdot \rho(\text{supp}(p))} = p$, then $x|_{\pi(g) \cdot \text{supp}(p)} = p$ which is a contradiction. Therefore, $y \in \mathcal{X}_{\mathcal{F}'}$.

Conversely, take $y \in \mathcal{X}_{\mathcal{F}'}$ and define $x = y \circ \rho \in A^{G/N}$. Now, for every $g \in G$ there exists $h \in N$ such that $\rho(\pi(g)) = gh$. Then, $(x \circ \pi)(g) = y(gh) = y(g)$, as y is invariant on N . Finally, if $x \notin X$ because it has a pattern $p \in \mathcal{F}$, y would have the pattern $p \circ \rho \in \mathcal{F}'$ which is a contradiction. Thus $x \in X$ and $y \in \pi^*(X)$. \square

1.5.4 Push-forward

Our final construction is the **push-forward shift**. So far this construction has not been present in the literature, although it does fall under the definition of pull-back shifts as defined by Bartholdi and Salo [BS24].

To transport a subshift from a group to its quotient we must ask additional properties on the subshift. To do this we introduce the N -fixed subshift. Let A be a finite alphabet, G a finitely generated group with N a normal subgroup. We define the subshift

$$\text{Fix}_A(N) = \{x \in A^G \mid n \cdot x = x, \forall n \in N\}.$$

Remark 1.5.17. For any subgroup N , $\text{Fix}_A(N)$ is always a closed set of A^G , but it is only shift invariant when N is normal. In the latter case, the subshift is conjugate to $A^{G/N}$.

Notice when N is finitely generated, $\text{Fix}_A(N)$ is an SFT. If we take $S = \{s_1, \dots, s_m\}$ a set of symmetric generators for N , we see that $\text{Fix}_R(N)$ is the SFT by the set of forbidden rules given by

$$\{p : \{1, s_i\} \rightarrow R \mid s_i \in S, p(1) \neq p(s_i)\}.$$

Definition 1.5.18. Let G be a group, $N \trianglelefteq G$ a finitely generated normal subgroup, $X \subseteq \text{Fix}_A(N)$ a G -subshift, and $\rho : G/N \rightarrow G$ a section. The **push-forward** of X to G/N , denoted $\rho^*(X)$, is the G -subshift defined as,

$$\rho^*(X) = \{x \circ \rho \in A^{G/N} \mid x \in X\}.$$

As was the case with the pull-back, we have that $\rho^*(X)$ is non-empty if and only if X is non-empty.

Lemma 1.5.19. Let $X \subseteq \text{Fix}_A(N)$ be a G -subshift. Then, the push-forward is independent of the section, that is, for any two sections $\rho_1, \rho_2 : G/N \rightarrow G$, $\rho_1^*(X) = \rho_2^*(X)$.

Proof. Take $x \in \rho_1^*(X)$. By definition there is a configuration $y \in X$ such that $x = y \circ \rho_1$. Because ρ_1 and ρ_2 are sections, for all $g \in G/N$ there exists some $h \in N$ such that $\rho_1(g) = h\rho_2(g)$. Given that $y \in \text{Fix}_A(N)$, we have that

$$x(g) = y(\rho_1(g)) = y(h\rho_2(g)) = y(\rho_2(g)),$$

for all $g \in G/N$. Thus, $x = y \circ \rho_2$ and therefore belongs in $\rho_2^*(X)$. Because the previous argument is independent of the section, we conclude that $\rho_1^*(X) = \rho_2^*(X)$. \square

Because of this result, we talk about *the* push-forward of a subshift $X \subseteq \text{Fix}_A(N)$.

Lemma 1.5.20. Let G and N be finitely generated, and take S and T finite generating sets for G/N and N respectively. If $X \subseteq A^G$ is a nearest neighbor G -SFT with respect to $\rho(S) \cup T$, then $\rho^*(X)$ is a nearest neighbor G/N -SFT with respect to S .

Proof. Let \mathcal{F} be a set of nearest neighbor forbidden patterns with respect to $\rho(S) \cup T$, for X . Because $X \subseteq \text{Fix}_A(N)$, we suppose that \mathcal{F} contains all patterns (a, b, t) for $a, b \in A$, $a \neq b$ and $t \in T$. Then, define the set of forbidden patterns \mathcal{F}' that contains (a, b, s) with $a, b \in A$ and $s \in S$, for each pattern $(a, b, \rho(s)) \in \mathcal{F}$. Let us show that $\rho^*(X) = \mathcal{X}_{\mathcal{F}'}$. Take $x \in \rho^*(X)$ and suppose $x \notin \mathcal{X}_{\mathcal{F}'}$. Then, there exist $g \in G/N$ and $s \in S$ such that $(x(g), x(gs), s) \in \mathcal{F}'$. Because x belongs to the push-forward, there exists $y \in X$ such that $x = y \circ \rho$. Then, because $y \in \text{Fix}_A(N)$, $x(gs) = y(\rho(g)\rho(s))$. Therefore, $(y(\rho(g)), y(\rho(g)\rho(s)), \rho(s)) \in \mathcal{F}$ appears in y , which is a contradiction.

Conversely, take $x \in \mathcal{X}_{\mathcal{F}'}$ and define $y = x \circ \pi \in A^G$. Notice that for any $g \in G$ and $h \in N$,

$$(h \cdot y)(g) = x(\pi(h^{-1}g)) = x(\pi(g)) = y(g).$$

Next, if $y \notin X$ because there is $g \in G$ and $s \in S$ such that $(y(g), y(g\rho(s)), \rho(s)) \in \mathcal{F}$, then the pattern $(x(\pi(g)), x(\pi(g)s), s) \in \mathcal{F}'$ appears in x , which is a contradiction. Thus, $y \in X$. Finally, for any $g \in G/N$, $y \circ \rho(g) = x(\pi(\rho(g))) = x(g)$. Therefore, $x \in \rho^*(X)$. \square

As the previous proof suggests, the push-forward and pull-back are complementary constructions in the following sense.

Lemma 1.5.21. Let $X \subseteq \text{Fix}_A(N)$ be a G -subshift and Y a G/N -subshift. Then, $X = \pi^*(\rho^*(X))$ and $Y = \rho^*(\pi^*(Y))$.

Proof. We begin with $X \subseteq \text{Fix}_A(N)$. For $x \in \pi^*(\rho^*(X))$, there exists $y \in X$ such that $x = y \circ \rho \circ \pi$. As $\rho(\pi(g)) \in gN$ for all $g \in G$, and $y \in \text{Fix}_A(N)$, we have that $x = y \in X$. Next, take $z \in X$ and define $y = z \circ \rho \circ \pi$. By definition, $y \in \pi^*(\rho^*(X))$. As before, because $\rho(\pi(g)) \in gN$ for all $g \in G$, and $z \in \text{Fix}_A(N)$, both configurations are the same, meaning $z \in \pi^*(\rho^*(X))$.

For the second statement, take $y \in \rho^*(\pi^*(Y))$. There exists $x \in Y$ such that $y = x \circ \rho \circ \pi$. Because $\rho(\pi(g)) = g$ for all $g \in G/N$, x and y are equal. Finally, take $y \in Y$ and define $z = y \circ \rho \circ \pi$, which by definition belongs to $\rho^*(\pi^*(Y))$. We conclude as before that $y = z \in \rho^*(\pi^*(Y))$. \square

This Lemma allows us to show that all subshifts are the pull-forward of some F -subshift, for F a free group.

Proposition 1.5.22. Let X be a G subshift. Then, there exists a free group F and a F -subshift Y such that $\rho^*(Y) = X$.

Proof. Let S be a generating set for G and $F = \mathbb{F}_S$ the free group with S as a free generating set such that we have a quotient map $\pi : F \rightarrow G$. By Lemma 1.5.21, the push-back of X , $Y = \pi^*(X)$ is a F -subshift that verifies $\rho^*(Y) = X$. \square

1.6 Analogies between groups and subshifts

When working with both subshifts and group presentation, many similarities become apparent. The most prominent of these is the role played by forbidden patterns in subshifts and relations in group presentations. If we see the generating set of a group as an alphabet, relations can be interpreted as forbidden patterns which we cannot see on geodesic words. This fact was observed by Jeandel, who also noticed that simple groups and minimal subshifts play similar roles in their respective domains. Explicitly,

Theorem 1.6.1 (Theorem 5 [Jea17]). *The following hold:*

- For a minimal \mathbb{Z}^d -subshift, $\mathcal{L}(X) \leq_e \mathcal{L}(X)^c$,
- For a simple group G , $\text{coWP}(G) \leq_e \text{WP}(G)$.

Versions of this result for SFTs and finitely presented groups were originally proven in [BJ08; Hoc09] and [BH74] respectively.

Later, Jeandel and Vanier took the analogies between multidimensional subshifts and groups even further [JV19]. A summary of the comparisons they made is shown in Table 1.1. In this section we will explore these analogies and propose a new one.

Group	Subshift
Group with n generators	Subshift on n symbols
Free group of rank n	Full-shift on n symbols
Word problem $\text{WP}(G)$	co-language $\mathcal{L}(X)^c$
Finitely presented group	SFT
Recursively presented group	Effectively closed subshift
Simple group	Minimal subshift
Q is a quotient of G	$Y \subseteq X$
H is a subgroup of G	$Y \sqsubseteq X$

Table 1.1: The Jeandel-Vanier dictionary between groups and subshifts as introduced in [JV19].

Their objective was to establish subshift versions of the Higman Embedding Theorem and the Boone-Higman-Thompson Theorem (see Section 1.3.1). The notion that was missing to make this work was an analog of subgroups.

Definition 1.6.2. Take a subshift $X \subseteq A^{\mathbb{Z}^d}$ and a sub-alphabet $B \subseteq A$. A subshift $Y \subseteq B^{\mathbb{Z}^{d'}}$ with $d' \leq d$ is said to be a **full-restriction** of X , denoted $Y \sqsubseteq X$, if $\mathcal{L}(Y) = \mathcal{L}(X) \cap B^{*\mathbb{Z}^{d'}}$.

With this definition, the subshift versions of the previously mentioned theorems are the following.

Theorem 1.6.3. (Higman Embedding for subshifts [JV19]) *A \mathbb{Z}^d -subshift X over the alphabet A is effectively closed if and only if there exists a \mathbb{Z}^{d+1} -SFT Y over an alphabet B such that $A \subseteq B$ and $X \sqsubseteq Y$.*

The proof of this theorem comes from the simulation theorems established by Hochman [Hoc09], Aubrun and Sablik [AS13], and Durand, Romashenko and Shen [DRS12].

Theorem 1.6.4. (Boone-Higman-Thompson for subshifts [JV19]) *A \mathbb{Z}^d -subshift X over the alphabet A . Then, $\mathcal{L}(X)$ is computable if and only if there exists a minimal \mathbb{Z}^{d+2} -SFT Y over an alphabet B such that $A \subseteq B$ and $X \sqsubseteq Y$.*

In fact, this theorem is much stronger than its analog as it proves the Boone-Higman Conjecture for subshifts.

As the aforementioned results suggest, these analogies provide intuition on the sort of theorems it could be possible to prove for subshifts that mimic the behavior of groups. In Section 2.3.2 we will see an analog for the Adyan-Rabin Theorem, and in Chapter 4 we will look at an attempt at establishing these correspondences directly by defining subshifts with the generators as an alphabet and $\text{WP}(G)$ as the forbidden patterns. For the mean time, let us propose an analog for residually finite groups.

1.6.1 An analog for residual finiteness

Definition 1.6.5. A group G is **residually finite** if for every $g \in G \setminus \{1_G\}$ there exists a finite group F and an epimorphism $\phi : G \rightarrow F$ such that $\phi(g) \neq 1_F$.

Examples of finitely generated residually finite groups are finite groups, abelian groups and free groups. In addition, Mal'cev showed that every finitely generated subgroup of $GL_n(\mathbb{K})$, where $n > 1$ and \mathbb{K} is a field, is residually finite [Mal40]. Examples of non-residually finite groups are divisible groups such as \mathbb{Q} . For a complete introduction on residually finite groups see [CC10, Chapter 2].

Proposition 1.6.6. *Let G be a group. The following are equivalent,*

- G is residually finite,
- There exist finite groups $(F_i)_{i \in I}$ such that G is isomorphic to a subgroup of the direct product $\prod_{i \in I} F_i$,
- There exists a sequence of finite index subgroups $\{G_i\}_{i \in \mathbb{N}}$ with $G_{i+1} \leq G_i$ such that $\bigcap_{i \in \mathbb{N}} G_i = \{1_G\}$.

Proofs of these equivalences can be found in [CC10].

We are interested in the following computational property of residually finite groups.

Proposition 1.6.7. *Let G be a finitely presented residually finite group. Then, the word problem for G is decidable.*

Proof. Let G be a finitely presented residually finite group with generating set S . Recall that for recursively presented groups, the word problem is in Π_1^0 , that is, there is an algorithm that stops on $w \in S^*$ if and only if $\bar{w} = 1_G$.

Next, because G is finitely presented we can determine if a finite group F is a quotient of G . It suffices to test if there exists a generating set for F that satisfies the relations from G . Then, given a word $w \in S^*$ we enumerate all finite groups (given by their Cayley table) and determine if a finite group is a quotient of G , and compute the image of w in the quotient. Because G is residually finite, if w does not represent the identity, there exists at least one finite quotient where w represents a non-trivial element. Therefore, this process stops if and only if $\bar{w} \neq 1_G$. By joining both semi-algorithms, we obtain an algorithm that solves the word problem for G . \square

The original proof of this proposition comes from McKinsey [McK43] who proved the result in a larger setting. The proof for groups was first made explicit by Mal'cev [Mal58] and latter by Mostowski [Mos66], and Dyson [Dys74].

To extend the analogies from Table 1.1, we propose the following analog of residual finiteness for multidimensional shifts.

Definition 1.6.8. We say a subshift $X \subseteq A^{\mathbb{Z}^d}$ is **residually periodic** if for every $p \in \mathcal{L}(X)$ there exists a periodic point $x \in X$ such that $p \sqsubseteq x$.

There is an equivalent definition for this notion that is well studied in the literature, as shown by the next lemma.

Lemma 1.6.9. *A subshift $X \subseteq A^{\mathbb{Z}^d}$ is residually periodic if and only if $\text{Per}(X)$ is dense in X .*

Proof. Suppose X is residually periodic and consider $x \in X$. Define the patterns $p_n = x|_{[-n,n]^d}$. By definition, for each $n \in \mathbb{N}$ there exists $x_n \in \text{Per}(X)$ such that $p_n \sqsubseteq x_n$. Without loss of generality we assume that p_n appears in x_n at the origin. Notice that $p_n \sqsubseteq p_{n+1}$. Then, for every $n \in \mathbb{N}$,

$$x|_{[-n,n]^d} = p_n = x_m|_{[-n,n]^d},$$

for all $m \geq n$. Thus, $x_n \rightarrow x$.

Conversely, suppose $\text{Per}(X)$ is dense. Take $p \in \mathcal{L}(X)$ and $x \in X$ such that $p \sqsubseteq x$ at the origin. By density, there exists a periodic configuration $x' \in X$ such that

$$p = x|_{\text{supp}(p)} = x'|_{\text{supp}(p)}.$$

Therefore, $p \sqsubseteq x'$ and X is residually periodic. □

The classic examples of subshifts with dense periodic points are irreducible SFTs and irreducible sofic subshifts on \mathbb{Z} (see [LM21]). For \mathbb{Z}^d , it was shown by Lightwood that if a strongly irreducible \mathbb{Z}^d -SFT contains a periodic point, its set of periodic points is dense [Lig03, Lemma 5.4]. Furthermore, he showed that for $d = 2$ all strongly irreducible \mathbb{Z}^2 -SFTs have dense periodic points [Lig03, Lemma 9.2]. These results can be taken beyond the realm of abelian groups: Ceccherini-Silberstein and Coornaert showed that for a residually finite group G , every strongly irreducible G -SFT with a periodic point has dense periodic points [CC12]. In fact, residually finite groups are closely related to the density of periodic points, as the set of periodic points is dense in the full-shift A^G if and only if G is residually finite (see [Fio09]).

We can now give an analog to Proposition 1.6.7.

Proposition 1.6.10. *Let $X \subseteq A^{\mathbb{Z}^d}$ be a residually periodic SFT. Then, $\mathcal{L}(X)$ is computable.*

Proof. Take a pattern $p \in A^{\mathbb{Z}^d}$, and \mathcal{F} the finite set of forbidden patterns for X . Our algorithm to see if it belongs to $\mathcal{L}(X)$ begins by checking if p contains a pattern from \mathcal{F} . If p is valid, take $N \in \mathbb{N}$ such that $\text{supp}(p) \subseteq [-N, N]^d$. For each successive $n \geq N$, the algorithm tries all possible tilings of the hypercube $[-n, n]^d$ with p at the origin. If there is no possible tiling, it rejects. If on the other hand, it finds a tiling that tiles periodically, it accepts.

Now, if $p \notin \mathcal{L}(X)$ there will exist $n \in \mathbb{N}$ such that there is no valid tiling of $[-n, n]^d$ with p at the origin. If $p \in \mathcal{L}(X)$, by residual periodicity, there exists a periodic configuration x where p appears. Therefore, there will be a $n \in \mathbb{N}$ and a tiling of $[-n, n]^d$ with p at the origin that tiles periodically. □

Question 1.6.11. Is there an analog of the equivalences in Proposition 1.6.6 for residually periodic subshifts?

Part II

Emptiness

Chapter 2

The Domino Problem

In 1961, Hao Wang introduced the **Domino Problem** to study the decidability of the $\forall\exists\forall$ fraction of first order logic [Wan61]. The problem goes as follows: given a finite set of **Wang tiles**, that is, unit squares with colored edges (see Figure 2.1), is it possible to tile the plane in such a way that adjacent squares have the same color along their shared border?



Figure 2.1: A Wang tile again.

As Wang observed, if one manages to tile arbitrarily large squares, by a standard compactness argument, there exists a tiling of the whole plane. This shows that the Domino Problem is co-recursively enumerable, through a simple semi-algorithm. Given a set of tiles, try and tile squares of increasing size. Then, there is no tiling of the plane if and only if this process fails for some size of square. This procedure is known as **Wang's Algorithm**. With the goal of finding a co-semi-algorithm and show the decidability of the Domino Problem, Wang conjectured that if a set of tiles does tile the plane, then there exists a way to use them to tile the plane periodically. If this conjecture holds, by tiling bigger and bigger squares one would either eventually find a square that can be periodically repeated, or eventually fail to tile a square.

Nevertheless, in 1964, Wang's PhD student Robert Berger showed not only that there exist aperiodic sets of Wang tiles, but that the Domino Problem is undecidable [Ber66]. He used the aperiodic tileset to construct a reduction from the Halting Problem. The reduction consists in simulating the space-time diagram of a Turing machine's run within spaces delimited by the aperiodic tiling. Since this proof was found, many alternative proofs have been established. Following Jeandel and Vanier [JV20], these proofs can be divided into four classes: the proof by Berger, later improved by Robinson who uses a much smaller aperiodic tileset [Rob71], the proof by Aanderaa and Lewis using p -adic numbers [AL74; Lew79] (see also [JV20]), the proof by Durand, Romashenko and Shen using self-simulating tilings and Kleene's fixed point theorem [DRS12], and finally the proof by Kari which symbolically encodes the immortality problem for piecewise affine maps [Kar07].

The modern study of the Domino Problem on groups through subshifts of finite type comes from the crossing of two lines of research. On the one hand, in 1988, Kitchens and Schmidt are the first to explicitly give Wang tiles as examples of two-dimensional subshifts of finite type, and the Domino Problem as a particular instance of the emptiness problem of said class of subshifts [KS88]. They also make the crucial step by noting that the equivalent problem for \mathbb{Z} -subshifts of finite type is decidable: because these shifts are conjugate to edge shifts,

they always contain periodic points. In other words, Wang’s algorithm works for \mathbb{Z} . This symbolic dynamics point of view was continued by Piantadosi [Pia08], who studied the Domino Problem on finitely generated free groups and proved it is decidable. This marks the first explicit study of the Domino Problem on groups other than \mathbb{Z}^d . Piantadosi also generalizes Wang tiles to nearest neighbor SFTs. The second line begins in Robinson’s 1971 article, where he conjectured that the Domino Problem for tilings of the hyperbolic plane is undecidable. This was proven independently by Kari [Kar07] and Margenstern [Mar08]. Kari’s proof technique was constructed upon by Aubrun and himself to look at the problem on Baumslag-Solitar groups [AK13]. They showed that it is undecidable. This jump towards finitely generated groups was made independently of Piantadosi.

A particularly important property enjoyed by the Domino Problem is that it can be expressed in the **Monadic Second Order** (MSO) logic of the group’s Cayley graph [BJ08] (see Section 3.5). This prompted Ballier and Stein [BS18] to make the following argument: because virtually free groups can be characterized as having finite tree-width [MS85], and graphs with finite tree-width have decidable MSO logic [KL05], the Domino Problem is decidable for virtually free groups (see Section 3.5 for more details on MSO logic). Furthermore, they observed that if a group is not virtually free, any Cayley graph of the group contains an infinite hexagonal grid as a minor, by Halin’s Grid Theorem [Hal65]. In principle, it could be possible to code this grid symbolically, and exploit the undecidability of the Domino Problem on \mathbb{Z}^2 to show that these groups have undecidable Domino Problem. This reasoning prompted them to state the following conjecture.

Conjecture 2.0.1 (The Domino Conjecture). Let G be a finitely generated group. Then the Domino Problem is decidable if and only if G is virtually free.

Although the conjecture remains unresolved at the time of writing, there has been substantial progress towards its proof. We make a summary of the advances in the next theorem.

Theorem 2.0.2. *The Domino Conjecture holds for the following classes of finitely generated groups:*

- *Virtually free groups,*
- *Polycyclic groups [Jea15b],*
- *Baumslag-Solitar groups [AK13],*
- *Surface groups [ABM19] and more generally hyperbolic groups [Bar23b],*
- *The Lamplighter group [BS24],*
- *K_∞ -minor free groups [EGL23].*

In Chapter 6 we will add Artin groups (Proposition 6.2.3) and generalized Baumslag-Solitar groups (Proposition 6.2.2) to the list.

2.0.1 Definitions and properties

The modern formulation of the Domino Problem for finitely generated groups was introduced in [ABJ18] and is as follows.

Definition 2.0.3. Let G be a finitely generated group and S a finite generating set. The **Domino Problem** on G with respect to S is the following decision problem: given an alphabet A and a finite set of nearest neighbor forbidden patterns \mathcal{F} , determine whether the corresponding subshift $\mathcal{X}_{\mathcal{F}}$ is non-empty. We denote this problem $\text{DP}(G, S)$.

To make the link with general subshifts of finite type, we use pattern codings to encode forbidden patterns of arbitrarily shaped support.

Definition 2.0.4. Let G be a finitely generated group and S a finite generating set. The **Emptiness Problem** on G with respect to S is the following decision problem: given an alphabet A and a set of finite pattern codings \mathcal{C} over S , determine whether the corresponding subshift $X_{\mathcal{C}}$ is non-empty. We denote this problem $\text{EP}(G, S)$.

Notice that the decidability of the Emptiness Problem is independent of the generating set, as pattern codings can be easily re-written in a different generating set. We use this fact often, so we present it as a lemma.

Lemma 2.0.5. *Let G be a finitely generated group with two generating sets S and S' . Then, for every pattern coding c with respect to S there exists a pattern coding c' with respect to S' such that the c and c' define the same pattern and the function $c \mapsto c'$ is computable*

Let us show that the two problems are equivalent. We will make use of the proof ideas from [ABJ18].

Definition 2.0.6. Take G a finitely generated group along with a finite generating set S . For \mathcal{C} , a set of pattern codings over the alphabet A , define $N = \max_{c \in \mathcal{C}} \max_{(w,a) \in c} |w|$ and an alphabet, \hat{A} , consisting of colorings of words of length at most N that contain no pattern from \mathcal{C} :

$$\hat{A} = \{ \phi : S^{\leq N} \rightarrow A \mid \forall c \in \mathcal{C}, \exists (w, a) \in c, \phi(w) \neq a \},$$

and a set, $\mathcal{F}(\mathcal{C})$, of nearest neighbor forbidden patterns over \hat{A} :

$$q \in \mathcal{F}(\mathcal{C}) \iff q \in \hat{A}^{\{1,s\}} : \exists w \in S^{\leq N-1}, q_1(sw) \neq q_s(w).$$

We call $\mathcal{X}_{\mathcal{F}(\mathcal{C})}$ the nearest neighbor SFT associated to \mathcal{C} .

Notice that $\mathcal{F}(\mathcal{C})$ is effectively computable from \mathcal{C} . This subshift also resembles the higher-block construction (Section 1.5.2), the key difference being that in this case we are taking balls in the monoid S^* instead of the actual group.

We now prove that the undecidability of many variants of the Domino Problem is independent of the generating set.

Lemma 2.0.7. *For any finitely generated group G along with a generating set S , $\text{DP}(G, S) \equiv_m \text{EP}(G, S)$. In particular, the decidability of $\text{DP}(G, S)$ is independent of the generating set.*

Due this invariance result, we can talk about *the* Domino Problem on G , denoted $\text{DP}(G)$.

Proof. It is straightforward to re-write nearest neighbor patterns as pattern codings: each pattern (a, b, s) becomes $c = \{(\varepsilon, a), (s, b)\}$. Thus, we have the reduction $\text{DP}(G, S) \leq_m \text{EP}(G, S)$. For the other direction, take a pattern coding \mathcal{C} and $\mathcal{F}(\mathcal{C})$. We claim $X_{\mathcal{C}}$ is empty if and only if $X_{\mathcal{F}(\mathcal{C})}$ is empty. If there exists a configuration $x \in X_{\mathcal{C}}$, we define $y \in X_{\mathcal{F}(\mathcal{C})} \subseteq \hat{A}^G$ by $y(g)(w) = x(g\bar{w})$. This way, y contains no pattern from $\mathcal{F}(\mathcal{C})$, as x does not contain a pattern coding from \mathcal{C} . Conversely, if there is a configuration $y \in X_{\mathcal{F}(\mathcal{C})}$, we construct $x \in X_{\mathcal{C}}$ by $x(g) = y(g)(\varepsilon)$. From the definition of $\mathcal{F}(\mathcal{C})$, if we take $g \in G$ with $|g|_S \leq N$ and a word $w \in S^{\leq N}$ such that $\bar{w} = g$, we have that $y(1_G)(w) = y(g)(\varepsilon)$. Therefore, x is well-defined and contains no pattern codings from \mathcal{C} . \square

The problem also satisfies many inheritance properties, which we summarize in the following proposition.

Proposition 2.0.8. *Let G be a finitely generated group. The following hold:*

1. *For any subgroup $H \leq G$, $\text{DP}(H) \leq_m \text{DP}(G)$.*
2. *For any finitely generated normal subgroup $N \trianglelefteq G$, $\text{DP}(G/N) \leq_m \text{DP}(G)$.*
3. *For any finite index subgroup $H \leq G$, $\text{DP}(H) \equiv_m \text{DP}(G)$.*

4. $WP(G) \leq_m \text{coDP}(G)$.

Item (1) is a consequence of Lemma 1.5.4, and (2) a consequence of Lemma 1.5.16. The proof of (3) is the same as in Lemma 2.2.4. Finally, the proof of (4) can be found in [ABJ18, Theorem 9.3.28].

The problem satisfies additional properties.

- If G and H are commensurable, then $DP(G) \equiv_m DP(H)$. This is due to (3) in the previous proposition.
- The decidability of the Domino Problem is a geometric property for finitely presented groups, that is, if two finitely presented groups, G and H are quasi-isometric, then $DP(G) \equiv_m DP(H)$ [Coh17].
- If H is a finitely presented group that acts translation-like on G , then $DP(H) \leq_m DP(G)$. In particular, the direct product of two infinite groups has undecidable Domino Problem [Jea15c].
- If G admits a Cayley graph $\Gamma(G, S)$ that *simulates* a Cayley graph of H , in the sense of Bartholdi and Salo, then $DP(H) \leq_m DP(G)$ [BS22].

The properties and results mentioned above can be combined to tackle new classes of groups, as in the following proposition.

Proposition 2.0.9. *Free-by-cyclic groups, $\mathbb{F}_n \rtimes_{\theta} \mathbb{Z}$, have undecidable Domino Problem.*

Proof. By Brinkmann's Theorem [Bri00] a free-by-cyclic group contains \mathbb{Z}^2 as a subgroup if and only if it is not hyperbolic. Then, if it actually contains \mathbb{Z}^2 , it has undecidable Domino Problem by Proposition 2.0.8. On the other hand, if the group is hyperbolic it has undecidable Domino Problem by [Bar23b]. \square

The Domino Conjecture has yet to be shown to hold for large classes of groups. The next frontier is the class of solvable groups. This class contains solvable Baumslag-Solitar groups, the Lamplighter group, as well as some groups with undecidable word problem, all for which the undecidability of the Domino Problem is already known.

2.0.2 Deciding decidability

Besides asking if the Domino Problem is decidable on each particular group, we ask if there is an algorithm that, given a presentation of a finitely presented group, determines if the group has decidable Domino Problem. We can answer this question independently of the Domino Conjecture through the Adyan-Rabin Theorem. To do this, we first look at a certain class of group properties.

Definition 2.0.10. A **group property** \mathcal{P} is a class of groups, such that if $G_1 \simeq G_2$ and $G_1 \in \mathcal{P}$, then $G_2 \in \mathcal{P}$. A group property \mathcal{P} is called a **Markov property** if there exists two groups G_+ and G_- such that

- $G_+ \in \mathcal{P}$,
- If G_- embeds into a group G , then $G \notin \mathcal{P}$.

Many natural properties are Markov properties. These include being trivial, finite, abelian, virtually free, simple, torsion-free, among many others. We present a new example through the Domino Problem.

Proposition 2.0.11. *The property of having decidable Domino Problem is a Markov property.*

Proof. From Lemma 2.0.7 we know that having decidable Domino Problem is a group property. Next, we can take $G_+ = \mathbb{Z}$, which has decidable Domino Problem, and $G_- = \mathbb{Z}^2$, as any group that contains it has undecidable Domino Problem by Proposition 2.0.8. \square

Theorem 2.0.12 (Adyan-Rabin Theorem). *Fix a Markov Property \mathcal{P} . Then, the problem of determining if the group defined by a given finite presentation satisfies \mathcal{P} is undecidable.*

This theorem was proven independently by Rabin in [Rab58] and by Adyan in [Ady58]. The proof of this theorem uses the existence of finitely presented groups with undecidable word problem, as given by the Novikov-Boone Theorem (see Theorem 1.3.14). The original formulation of Adyan’s result [Ady57] was stated for what are now known as **pseudo-Markov properties**, which are group properties such that there exist a group G_+ satisfying the property, a group G_- that does not satisfy the property, are inherited by subgroups, and imply the decidability of the word problem for the group (for a detail account on the history of this result see [Nyb22]). By Proposition 2.0.8 we can see that having decidable Domino Problem is in fact a pseudo-Markov property.

Corollary 2.0.13. *There is no algorithm that, given a finite presentation, determines if the corresponding group has decidable Domino Problem.*

2.1 Variants of the Domino Problem

Variations on the Domino Problem have been studied since its conception. This is the case of the Seeded Domino Problem, whose undecidability was established even before the Domino Problem’s [KMW62; Büc62]. In the years since many more variations have been introduced: the Periodic Domino Problem [GK72; Jea10], Domino Snake Problems [Mye79], the Recurring Domino Problem [Har85], and the Aperiodic Domino Problem [CH22; GHV18].

In the following sections we explore some of these variants on finitely generated groups, with the objective of understanding which geometric and algebraic properties of the underlying group account for the undecidability these variants. We hope this will also help us to better understand the Domino Problem.

2.1.1 Seeded Domino Problem

Perhaps the most natural variant of the Domino Problem is its seeded version. In fact, it was introduced simultaneously to the original problem [Wan61] and, as previously mentioned, was shown to be undecidable on \mathbb{Z}^2 before the Domino Problem [Büc62; KMW62].

Definition 2.1.1. Let G be a finitely generated group and S a finite generating set. The **Seeded Domino Problem** on G with respect to S^1 is the following decision problem: given an alphabet A , a finite set of nearest neighbor forbidden patterns \mathcal{F} and a letter $a_0 \in A$, determine whether there exists $x \in \mathcal{X}_{\mathcal{F}}$ such that $x(1_G) = a_0$. We denote it by $\text{SDP}(G, S)$.

As its definition suggests, this problem is computationally harder than the unseeded version: for a set of nearest neighbor forbidden patterns \mathcal{F} over the alphabet A , we create an instance of the Seeded Domino Problem per letter.

Lemma 2.1.2. *Let G be a finitely generated group and S a finite generating set. Then, $\text{DP}(G, S) \leq_p \text{SDP}(G, S)$.*

Just as the Domino Problem, there is a computational jump from the one-dimensional case to the two-dimensional case. Using the fact that nearest neighbor \mathbb{Z} -SFTs correspond to bi-infinite walks on a finite graph, $\text{SDP}(\mathbb{Z}, \{t\})$ is decidable. In fact, this decidability result can be generalized. Just as the Domino Problem, the Seeded Domino Problem can be expressed in monadic second order logic (see [Bar22]), making the problem decidable for virtually free groups.

2.1.2 Recurring Domino Problem

The Recurring Domino Problem was originally introduced by Harel as a natural decision problem that is highly undecidable, in order to find other highly undecidable problems [Har85]. He showed that in \mathbb{Z}^2 the problem is not only undecidable, but it is beyond the arithmetical hierarchy: it is Σ_1^1 -complete [Har86]. We expand the problem’s definition to finitely generated groups.

¹This problem has also been referred to as the Origin Constrained Domino Problem (see [ABJ18]).

Definition 2.1.3. Let G be a finitely generated group and S a finite generating set. The **Recurring Domino Problem** on G with respect to S is the following decision problem: given an alphabet A , a finite set of nearest neighbor forbidden patterns \mathcal{F} and a letter $a_0 \in A$, determine whether there exists $x \in \mathcal{X}_{\mathcal{F}}$ such that the set $\{g \in G \mid x(g) = a_0\}$ is infinite. We denote it by $\text{RDP}(G, S)$.

Lemma 2.1.4. *Let G be a finitely generated group and S a finite generating set. Then, $\text{DP}(G, S) \leq_p \text{RDP}(G, S)$.*

Proof. Let \mathcal{F} be a set of nearest neighbor patterns for $\text{DP}(G, S)$. We create an instance of $\text{RDP}(G, S)$ for \mathcal{F} and each of the letters of the alphabet. Because G is infinite, if the subshift defined by \mathcal{F} is non-empty, then at least one letter is forced to repeat itself infinitely often. \square

Nevertheless, the behavioral jump that occurs between \mathbb{Z} and \mathbb{Z}^2 for the original problem is still present.

Proposition 2.1.5. $\text{RDP}(\mathbb{Z}, \{t\})$ is decidable.

Proof. Let \mathcal{F} be a finite set of nearest neighbor forbidden patterns and $a_0 \in A$. Recall that we can define a graph $\Gamma_{\mathcal{F}}$, that is effectively constructible from \mathcal{F} , such that configurations from $\mathcal{X}_{\mathcal{F}}$ correspond exactly with bi-infinite walks on $\Gamma_{\mathcal{F}}$. Therefore, to decide our problem we search for a simple cycle on $\Gamma_{\mathcal{F}}$ that is based at a_0 . If there is such a cycle, $c = a_0 a_1 a_2 \dots a_n a_0$ with $a_i \in A$, we define the periodic configuration $x = (a_0 a_1 a_2 a_3 \dots a_n)^\infty \in \mathcal{X}_{\mathcal{F}}$. If, on the other hand, there exists a configuration $y \in \mathcal{X}_{\mathcal{F}}$ on which a_0 appears infinitely often; take two consecutive occurrences of a_0 , say $y(k) = y(k') = a_0$ with $k < k'$. Then, because configurations correspond to bi-infinite walks, there is a cycle on $\Gamma_{\mathcal{F}}$ given by $c' = a_0 y(k+1) y(k+2) \dots y(k'-1) a_0$. As searching for simple cycles on a finite graph is computable, our problem is decidable. \square

2.2 Properties for seeded and recurring variants

2.2.1 General inheritance properties

Let us try and recover some inheritance properties enjoyed by the standard Domino Problem for the two variants, starting by the invariance under changing generating sets.

Definition 2.2.1. The seeded (resp. recurring) emptiness problem on G with respect to S asks if, given \mathcal{C} a set of pattern codings and $a_0 \in A$, there exists $x \in X_{\mathcal{C}}$ such that $x(1_G) = a_0$ (resp. a_0 appears infinitely often in x , that is, $|\{g \in G \mid x(g) = a_0\}|$ is infinite).

Let us denote these problems by $\text{SEP}(G, S)$ and $\text{REP}(G, S)$ respectively. We use them to prove the following lemma.

Lemma 2.2.2. *Let G be a f.g. group along with two finite generating sets S_1 and S_2 . Then,*

- $\text{SDP}(G, S_1) \equiv_p \text{SDP}(G, S_2)$,
- $\text{RDP}(G, S_1) \equiv_p \text{RDP}(G, S_2)$.

Notice that for these problems we use positive reductions instead of many-one reductions as in the case of the Domino Problem (Lemma 2.0.7). The proof consists on proving the following reductions,

$$\text{SDP}(G, S_1) \leq_m \text{SEP}(G, S_1) \equiv_m \text{SEP}(G, S_2) \leq_p \text{SDP}(G, S_2),$$

and concluding the positive reduction from the symmetry between the two generating sets.

Proof. By Lemma 2.0.5, $\text{SEP}(G, S)$ does not depend on the generating set, which implies a many-one reduction between the emptiness problems over different generating sets. Furthermore, as we saw in Lemma 2.0.7, nearest neighbor patterns are easily encoded in a pattern coding. This means $\text{SDP}(G, S) \leq_m \text{SEP}(G, S)$. Let us now

focus on proving that $\text{SEP}(G, S)$ positive-reduces to $\text{SDP}(G, S)$. Given a set of pattern codings \mathcal{C} compute its corresponding set of nearest neighbor forbidden patterns $\mathcal{F}(\mathcal{C})$. We also compute the set of all functions $\phi \in \hat{A}$ such that $\phi(\varepsilon) = a_0$, and denote this set by \mathcal{A} . We create $|\mathcal{A}|$ sets of inputs for $\text{SDP}(G, S)$ given by the forbidden patterns $\mathcal{F}(\mathcal{C})$ and a target letter $\phi \in \mathcal{A}$.

If there exists a configuration $x \in X_{\mathcal{C}}$ such that $x(1_G) = a_0$, we define $y \in X_{\mathcal{F}'} \subseteq \hat{A}^G$ by $y(g)(w) = x(g\bar{w})$. This way, y does not contain a pattern from $\mathcal{F}(\mathcal{C})$, as x does not contain a pattern coding from \mathcal{C} , and $y(1_G)(\varepsilon) = x(1_G) = a_0$. Conversely, if there is a function $\phi \in \mathcal{A}$ and a configuration $y \in X_{\mathcal{F}(\mathcal{C})}$ such that $y(1_G) = \phi$, we construct $x \in X_{\mathcal{C}}$ by $x(g) = y(g)(\varepsilon)$. From the definition of $\mathcal{F}(\mathcal{C})$, if we take $g \in G$ with $|g|_S \leq N$ and a word $w \in S^{\leq N}$ such that $\bar{w} = g$, we have that $y(1_G)(w) = y(g)(\varepsilon)$. Therefore, x is well-defined and contains no pattern codings from \mathcal{C} . Furthermore, $x(1_G) = y(1_G)(\varepsilon) = a_0$.

All the previous arguments are analogous for the case of $\text{RDP}(G, S)$ and $\text{REP}(G, S)$. \square

This Lemma allows us to talk about *the Seeded Domino Problem* on G , $\text{SDP}(G)$, and *the Recurring Domino Problem* on G , $\text{RDP}(G)$.

Lemma 2.2.3. *Let G be a f.g. group along with a finitely generated subgroup H . Then, $\text{SDP}(H) \leq_m \text{SDP}(G)$. Furthermore, if H has finite index, then $\text{RDP}(H) \leq_m \text{RDP}(G)$.*

Proof. Let S_H and S_G be finite sets of generators for H and G respectively. We begin with the seeded version. Notice that an instance, (\mathcal{F}, a_0) , of $\text{SDP}(H, S_H)$ is also an instance of $\text{SDP}(G, S_G \cup S_H)$. The former defines an H -subshift $X = \mathcal{X}_{\mathcal{F}}^H$, and the latter $\mathcal{X}_{\mathcal{F}}^G$, which by Lemma 1.5.4 is the free extension X^\uparrow (see Definition 1.5.1).

Now, if there exists $x \in X^\uparrow \subseteq A^G$ with $x(1_G) = a_0$, then the configuration $y = x|_H \in A^H$ contains no patterns from \mathcal{F} and verifies $y(1_H) = a_0$. On the other hand, suppose there exists $y \in X \subseteq A^H$. Let L be a set of left representatives for G/H . We define $x \in A^G$ as $x(lh) = y(h)$ for all $l \in L$ and all $h \in H$. Because the forbidden patterns are supported on S_H , we have that $x \in X^\uparrow \subseteq A^G$.

For the recurring version, we use the same construction, this time with H of finite index. Let L be a finite set of left coset representatives of H . Suppose there exists $x \in X^\uparrow \subseteq A^G$ where a_0 appears infinitely often. By Lemma 1.5.5, there exist a collection of configurations on X , $\{y_l\}_{l \in L}$, such that $x|_{lH} = y_l$. Then, there exists $l_0 \in L$ that contains infinite occurrences of a_0 . On the other hand, suppose there exists $y \in X$ with infinite occurrences of a_0 . As we did before, define $x \in A^G$ as $x(lh) = y(h)$ for all $l \in L$ and all $h \in H$, which will contain a_0 infinitely often. \square

Lemma 2.2.4. *Let G be a f.g. group along with a subgroup H such that $[G : H] < \infty$. Then*

- $\text{SDP}(G) \equiv_p \text{SDP}(H)$,
- $\text{RDP}(G) \equiv_p \text{RDP}(H)$.

Proof. Because finite index subgroups of finitely generated groups are finitely generated, $\text{SDP}(H) \leq_m \text{SDP}(G)$ by Lemma 2.2.3. We now prove that $\text{SDP}(H) \leq_p \text{SDP}(G)$. Without loss of generality, we may assume $H \trianglelefteq G$: every finite index subgroup H contains a normal finite index subgroup N . If we prove $\text{SDP}(G)$ reduces to $\text{SDP}(N)$, we conclude it reduces to $\text{SDP}(H)$ by Lemma 2.2.3.

Let $X \subseteq A^G$ be a subshift, and R a set of right co-set representatives for G/H , containing the identity 1_G . We use the R -higher power shift of X (see Definition 1.5.9). Let S_H be a finite set of generators for H . We define the sets $D = S_H \cup (RRR^{-1} \cap H)$ and $T = RDR^{-1}$. Because $1_G \in R$ and H is a normal subgroup, $H = \langle T \rangle$.

We positive-reduce $\text{SDP}(G, S_H \cup R)$ to $\text{SDP}(H, T)$. Let (\mathcal{F}, a_0) be an instance of $\text{SDP}(G, S_H \cup R)$. By Lemma 1.5.11, there exists a set \mathcal{F}' of forbidden patterns over the alphabet A^R , such that $\mathcal{X}_{\mathcal{F}'} = \mathcal{X}_{\mathcal{F}}^{[R]}$. Furthermore, as \mathcal{F} is a set of nearest neighbor patterns with respect to $S_H \cup R$ s, \mathcal{F}' is a set of nearest neighbor patterns with respect to T . Define the set of R -patterns containing a_0 :

$$\mathcal{A} = \{p \in A^R \mid p(1_G) = a_0\}.$$

We create $|\mathcal{A}|$ inputs for $\text{SDP}(H, T)$ given by \mathcal{F}' and a letter from \mathcal{A} . Suppose there exists $x \in \mathcal{X}_{\mathcal{F}}$ such that $x(1_G) = a_0$. Define $y \in \mathcal{X}_{\mathcal{F}}^{[R]}$ as $y(h)(r) = x(hr)$ for all $h \in H, r \in R$, which implies $y(1_H) = x|_R \in \mathcal{A}$. Conversely, if there exists $y \in \mathcal{X}_{\mathcal{F}}^{[R]}$ such that $y(1_H) \in \mathcal{A}$, define $x \in \mathcal{X}_{\mathcal{F}}$ by $x(hr) = y(h)(r)$ for all $h \in H$ and $r \in R$. Thus, $x(1_G) = y(1_H)(1_G) = a_0$.

Because $|R| < +\infty$, the case for RDP is analogous. □

2.2.2 Recurring Domino Problem on free groups

In this section we prove the following result:

Theorem 2.2.5. *RDP(\mathbb{F}_n) is decidable for every $n \geq 1$.*

Fix S a free generating set for \mathbb{F}_n . Let A be an alphabet, \mathcal{F} a set of nearest neighbor forbidden patterns and $a_0 \in A$ our target tile. The goal is to construct an algorithm that finds a particular structure within the tileset graph $\Gamma_{\mathcal{F}}$ called a **simple balloon**. We then show that the graph contains such a structure if and only if there is a configuration in $\mathcal{X}_{\mathcal{F}}$ where a_0 occurs infinitely often.

Definition 2.2.6. A **balloon** B is an undirected path in $\Gamma_{\mathcal{F}}$, starting and ending at a_0 , which is specified by a sequence of letters and generators $B = a_0 s_1 a_1 \dots s_{n-1} a_{n-1} s_n a_0$, with $a_i \in A, s_i \in S \cup S^{-1}$, such that

- $s_i = s$ if (a_{i-1}, a_i, s) is an edge in $\Gamma_{\mathcal{F}}$, and $s_i = s^{-1}$ if (a_i, a_{i-1}, s) is an edge in $\Gamma_{\mathcal{F}}$,
- its label $s_1 \dots s_n$ is reduced,
- if there exists $k \leq \lfloor \frac{n}{2} \rfloor - 1$ such that

$$s_1 \dots s_k = (s_{n-k+1} \dots s_n)^{-1},$$

then $a_i = a_{n-i}$ for $i \in \{1, \dots, k\}$.

We say the balloon is **simple** if for every $i \in \{1, \dots, n-1\}$ the pair $a_i s_{i+1}$ never repeats.

The last condition in the definition of a balloon asks that if the label is not cyclically reduced, $w = uvu^{-1}$ for instance, then the first $|u|$ must be the same as the last $|u|$ tiles in reverse order (see Figure 2.2).

Given a simple balloon, we want to create a configuration by repeating the letter/generator sequence it defines. Nevertheless, this only covers a portion of the group. To guarantee we are able to complete the configuration we ask for each letter to have the ability to be extended to cover the whole group.

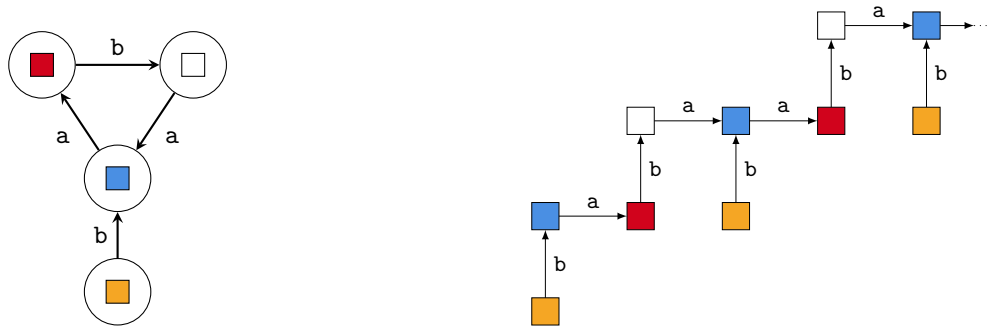

Figure 2.2: On the left, a balloon given by $C = \text{orange } b \text{ blue } a \text{ red } b \text{ white } a \text{ blue } b^{-1} \text{ orange}$ based at $a_0 = \text{orange}$, generators $a, b \in S$, and $k = 1$. On the right, a portion of a configuration from $\mathcal{X}_{\mathcal{F}}$ obtained by repeating the pattern defined by the vertices of the balloon.

Definition 2.2.7. A set of forbidden patterns \mathcal{F} is **complete** if there exists $\mathcal{C}(A) \subseteq A$ maximal under inclusion and a map $f: \mathcal{C}(A) \times (S \cup S^{-1}) \rightarrow \mathcal{C}(A)$ such that for all $a \in \mathcal{C}(A)$ and $s \in S$, both $(a, f(a, s), s)$ and $(f(a, s^{-1}), a, s)$ are edges in $\Gamma_{\mathcal{F}}$.²

Piantadosi showed in [Pia08] that $\mathcal{X}_{\mathcal{F}}$ is non-empty if and only if \mathcal{F} is complete. Furthermore, $\mathcal{C}(A)$ is computable from A and \mathcal{F} , and every letter in a configuration $x \in \mathcal{X}_{\mathcal{F}}$ is contained in $\mathcal{C}(A)$. The algorithm for finding $\mathcal{C}(A)$ consists on iteratively eliminating tiles from $\Gamma_{\mathcal{F}}$ that have no outgoing edge for some generator.

Lemma 2.2.8. *There exists a configuration $x \in \mathcal{X}_{\mathcal{F}}$ containing a_0 infinitely many times if and only if there exists a simple balloon B in $\Gamma_{\mathcal{F}}$ based at a_0 , whose vertices are all in $\mathcal{C}(A)$.*

Proof. Suppose we have a simple balloon $B = a_0 s_1 a_1 \dots s_{n-1} a_{n-1} s_n a_0$ in $\Gamma_{\mathcal{F}}$ based at a_0 with $a_i \in \mathcal{C}(A)$ and label $w = uvu^{-1}$ where $u = s_1 \dots s_k$ with $k \leq \lfloor \frac{n}{2} \rfloor - 1$. The condition over k implies that $v \neq \varepsilon$. We define a configuration $x \in \mathcal{X}_{\mathcal{F}}$ as follows: for every $t \in \mathbb{N}$, $x(\overline{w^t}) = a_0$ and $x(\overline{w^t s_1 \dots s_i}) = a_i$ with $i \in \{1, \dots, n-1\}$ (see Figure 2.2). Because B is a balloon, x is well defined, as the balloon's definition guarantees that

$$x(\overline{w^t u v s_k^{-1} \dots s_i^{-1}}) = a_{n-i} = a_i = x(\overline{w^{t+1} s_1 \dots s_i}).$$

Finally, because every letter belongs to $\mathcal{C}(A)$, the rest of the configuration can be completed without forbidden patterns. Therefore, $x \in \mathcal{X}_{\mathcal{F}}$.

Conversely, suppose there exists $x \in \mathcal{X}_{\mathcal{F}}$ where a_0 occurs infinitely often. Without loss of generality we can assume $x(1_{\mathbb{F}_n}) = a_0$. Recall that $x(\mathbb{F}_n) \subseteq \mathcal{C}(A)$. Let us denote by \mathcal{O} the set of elements $w \in \mathbb{F}_n$ where $x(w) = a_0$. Because \mathcal{O} is infinite, there exists $s_0 \in S \cup S^{-1}$ such that infinitely many words in \mathcal{O} begin with s_0 . Furthermore, there exists $s_1 \in S \cup S^{-1}$ with $s_1 \neq s_0^{-1}$ such that infinitely many words in \mathcal{O} begin with $s_0 s_1$. By iterating this argument, we obtain a one-way infinite sequence $y \in (S \cup S^{-1})^{\mathbb{N}}$ such that $y(i) \neq y(i+1)^{-1}$ for all $i \in \mathbb{N}$. Let $\omega(i) = y(0) \dots y(i-1) \in \mathbb{F}_n$. By definition, for every $i \in \mathbb{N}$ there are infinitely many words in \mathcal{O} that begin with $\omega(i)$. We say $w \in \mathcal{O}$ is **rooted** at $i \in \mathbb{N}$ if $w = \omega(i)v$ for some $v \in (S \cup S^{-1})^*$, and such that $\omega(i)v$ is reduced. Because there are infinitely many words rooted along some prefix of y , and $\mathcal{C}(A)$ is finite, there exist $j_1 < i < j_2$ and $w \in \mathcal{O}$ such that $x(\omega(j_1)) = x(\omega(j_2))$ and w is rooted at i . Using this fact, we will create a balloon depending on two cases.

1. If $y(j_1 - 1) \neq y(j_2 - 1)$, and calling $a_j = x(\omega(j))$, define the balloon that represents going from $x(1_G)$ to $x(\omega(j_2))$ by the path $\omega(j_2)$ and then return via the path $\omega(j_1)$ (see Figure 2.3). Formally,

$$B = a_0 y(0) a_1 \dots y(j_1 - 1) a_{j_1} \dots y(j_2 - 1) a_{j_2} y(j_1 - 1)^{-1} a_{j_1 - 1} \dots y(0)^{-1} a_0,$$

which is labeled by $\omega(j_2)\omega(j_1)^{-1}$, a reduced word.

2. If $y(j_1 - 1) = y(j_2 - 1)$, then $y(j_1) \neq y(j_2 - 1)^{-1}$. Let $v \in (S \cup S^{-1})^k$ such that $w = \omega(i)v$. Once again, calling $a_j = x(\omega(j))$ and $b_j = x(\overline{wv_1 \dots v_j})$, we define the balloon

$$B = a_0 v_k^{-1} b_{k-1} v_{k-1}^{-1} \dots v_1^{-1} a_i y(i) \dots y(j_2 - 1) a_{j_2} y(j_1) \dots y(i - 1) a_i v_1 b_1 \dots v_k a_0,$$

which is labelled by $vy(i) \dots y(j_2 - 1)y(j_1) \dots y(i - 1)v^{-1}$, a reduced word (see Figure 2.4).

Finally, if B contains a repeated letter/generator pair, we cut the portion between them while preserving all other balloon conditions. This guarantees that B will be a simple balloon in $\Gamma_{\mathcal{F}}$ based at a_0 , with all its vertices in $\mathcal{C}(A)$. □

Proof of Theorem 2.2.5. Given a finite set of nearest neighbor forbidden patterns \mathcal{F} and a letter a_0 , by Lemma 2.2.8, it suffices to search for simple balloons in $\Gamma_{\mathcal{F}}$ whose vertices are contained in $\mathcal{C}(A)$. A simple balloon passes through each vertex-label pair at most once; and there are a finite number of such paths starting and ending in a_0 , so we can check whether they satisfy the simple balloon conditions. Therefore, we can effectively decide whether the conditions of Lemma 2.2.8 are met, making the Recurring Domino Problem decidable. □

²This is also known as condition (\star) in [HM20]

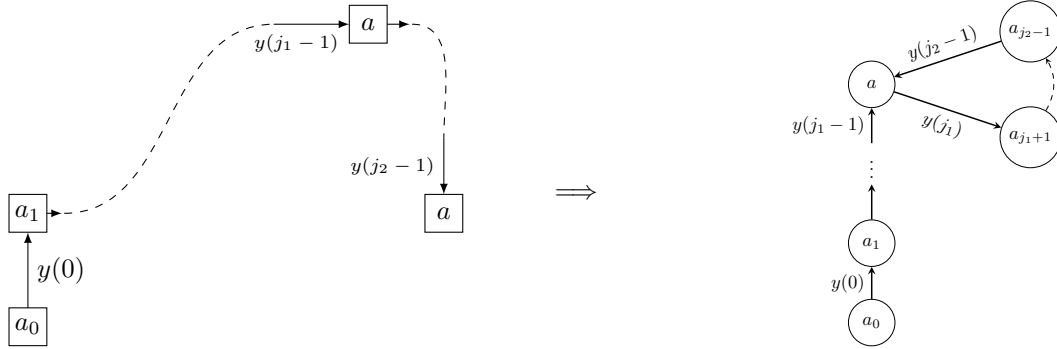

Figure 2.3: On the left, the path defined by y in the configuration. This is an example of the first case, where $y(j_1 - 1) \neq y(j_2 - 1)$ and the repeated letter is $a = x(\omega(j_1)) = x(\omega(j_2))$. On the right, the corresponding balloon within the tileset graph $\Gamma_{\mathcal{F}}$.

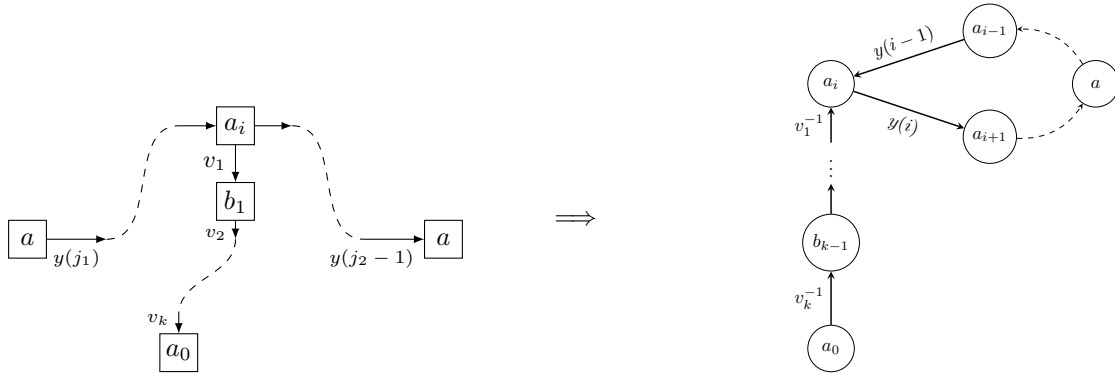

Figure 2.4: On the left, the path defined by y in the configuration as well as the path leading from the root $x(\omega(i))$ to w . This is an example of the second case, where $y(j_1 - 1) = y(j_2 - 1)$ and the repeated letter is $a = x(\omega(j_1)) = x(\omega(j_2))$. On the right, the corresponding balloon within the tileset graph $\Gamma_{\mathcal{F}}$.

We can also use the set $\mathcal{C}(A)$ to state an equivalent result for the Seeded Domino Problem.

Proposition 2.2.9. *SDP(\mathbb{F}_n) is decidable for every $n \geq 1$.*

Proof. As previously mentioned, starting from an alphabet A and a set of nearest neighbor forbidden patterns \mathcal{F} it is possible to compute $\mathcal{C}(A)$ such that $\mathcal{X}_{\mathcal{F}}$ is non-empty if and only if $\mathcal{C}(A)$ is non-empty, and every letter from a configuration from $\mathcal{X}_{\mathcal{F}}$ appears in $\mathcal{C}(A)$. Therefore, to see if there is a configuration where a given $a_0 \in A$ appears, it suffices to see if it is contained in $\mathcal{C}(A)$. \square

2.2.3 Consequences and conjectures

As previously stated, we are interested in understanding the class of groups that have decidable Seeded Domino Problem, and the class of groups that have decidable Recurring Domino Problem.

Theorem 2.2.10. *Let G be a virtually free group. Then, both SDP(G) and RDP(G) are decidable.*

Proof. By Theorem 2.2.5 we know the Recurring Domino Problem is decidable on free groups. Adding Lemma 2.2.4, we have that it is decidable for virtually free groups. Similarly, for the seeded version, mixing Proposition 2.2.9 and Lemma 2.2.4 the problem is also decidable for virtually free groups. \square

Are these the only groups where each individual problem is decidable? The combination of Conjecture 2.0.1 and Lemmas 2.1.2 and 2.1.4 suggest so.

Corollary 2.2.11. *If the Domino Conjecture is true the following are equivalent:*

- G is virtually free,
- $\text{DP}(G)$ is decidable,
- $\text{SDP}(G)$ is decidable,
- $\text{RDP}(G)$ is decidable.

Nevertheless, virtually free groups being the only groups where the Seeded Domino Problem or the Recurring Domino Problem are decidable does not directly imply Conjecture 2.0.1. However, we state a conjecture for the Seeded Domino Problem as it can be expressed in MSO logic.

Conjecture 2.2.12. Let G be a finitely generated group. Then, $\text{SDP}(G)$ is decidable if and only if G is virtually free.

2.3 (A)periodic Domino Problem

The original proof of the undecidability of the Domino Problem is intimately linked to the existence of aperiodic tilesets. One can therefore ask if the problem becomes decidable if we search for a periodic tiling or an aperiodic tiling.

Alongside the Seeded Domino Problem, the periodic variant is one of the oldest variations of the original problem with Wang tiles. Jeandel points out in [Jea10] that the proofs of the undecidability of the Domino Problem on \mathbb{Z}^2 can be slightly modified to obtain the undecidability of the Periodic Domino Problem. Further still, Gurevitch and Koryakov showed that both problems are recursively indistinguishable [GK72].

When working with Wang tiles, the Periodic Domino Problem is naturally in Σ_1^0 as explained at the beginning of the chapter. If the problem is undecidable, by the undecidability of the original Domino Problem and Wang's algorithm, there must exist an aperiodic tileset. In his 2010 article [Jea10], Jeandel showed the converse, namely, if there exists an aperiodic tileset then the Periodic Domino Problem is undecidable. He asked if this also holds for all finitely generated groups.

Question 2.3.1. Is it true that for every finitely generated group the existence of strongly aperiodic SFTs is equivalent to the undecidability of the Periodic Domino Problem?

For non-abelian groups, the only explicitly known result is due to Piantadosi who showed that the Periodic Domino Problem is decidable for free groups [Pia08]. This is consistent with a positive answer to the question as free groups do not admit strongly aperiodic SFTs. In Chapter 5 we explore the links between aperiodicity and the Periodic Domino Problem.

At the other side of periodicity, it took more time for the Aperiodic Domino Problem to appear in the literature. It was first explicitly considered by Grandjean, Hellouin de Menibus and Vanier [GHV18], where they showed the problem is Π_1^0 -complete on \mathbb{Z}^2 . These results were later expanded upon by Callard and Hellouin de Menibus for tilings on \mathbb{Z}^d where $d \geq 3$ [CH22].

Let us give a formal definition of these problems for finitely generated groups.

Definition 2.3.2. Let G be a finitely generated group with generating set S . The **(A)periodic Domino Problem** on G with respect to S is the following decision problem: given an alphabet A , and a set of nearest neighbor forbidden patterns \mathcal{F} , determine whether there exists an (a)periodic configuration $x \in \mathcal{X}_{\mathcal{F}}$.

As we showed for the previous variants, the decidability of these problems is invariant under changes in the generating set. The proof is essentially the same as the ones for Lemma's 2.0.7 and 2.2.2, and consist in showing they are equivalent to their pattern coding versions. As we have done before, we refer to these problems as *the* Periodic and Aperiodic Domino Problems on G , and denote them $\text{ADP}(G)$ and $\text{PDP}(G)$ respectively.

2.3.1 Periodic dominos

Periodic points have a close connection to finite quotients, as each periodic point $x \in A^G$ stabilized by $N \trianglelefteq G$ of finite index defines a configuration over G/N . It stands to reason that to study the computational properties of these points, we must understand the computability of finite quotients.

Looking at different examples in the literature on computability of finite quotients, such as McKinsey's Theorem [McK43] (see Proposition 1.6.7), Rauzy defined the following classes of groups [Rau22].

Definition 2.3.3. Let G be a finitely generated group, along with a finite generating set S . G is said to have **computable finite quotients** (CFQ) if there exists an algorithm that given a finite group F and a function $\phi : S \rightarrow F$, determines whether ϕ extends to a group morphism.

If there exists an algorithm that halts if and only if ϕ extends to a morphism, we say G has **recursively enumerable finite quotients** (ReFQ).

In addition, Rauzy showed that these properties are independent of the generating set, ReFQ is inherited by finite index subgroups, and that both CFQ and ReFQ are preserved under amalgamated free products, HNN-extensions and direct products. Notice that all finitely presented groups have CFQ, as it is possible to check if the generators of the finite group verify the finite relations of the base group.

Proposition 2.3.4. *Let G be a finitely generated group with decidable word problem and ReFQ. Then, the $\text{PDP}(G)$ is in Σ_1^0 .*

Proof. Let S be a finite generating set for G , and a set of nearest neighbor patterns \mathcal{F} over the alphabet A . As G has decidable word problem, given a finite subset $P \subseteq S^*$ we can decide if there exists a coloring $p : P \rightarrow A$ consistent with the group ($p(w) = p(w')$ if $w =_G w'$), such that no forbidden pattern appears in p . Next, as G has ReFQ we can enumerate pairs (F, ϕ) where F is a finite group given by its Cayley table, and $\phi : S \rightarrow F$ a map that extends to a group morphism. Given such a pair, we can always compute a set of coset representatives $R(F, \phi) \subseteq S^*$ that includes ε by computing the images $\phi(S^{\leq n})$ for increasing n . Consider the semi-algorithm presented in Algorithm 1.

Algorithm 1: Semi-Algorithm for PDP

```

Input:  $(A, \mathcal{F})$ 
for  $(F, \phi)$  finite quotient do
    Compute coset representatives  $R = R(F, \phi)$  ;
    if there exists a consistent  $p : R \cdot (S \cup \{\varepsilon\}) \rightarrow A$  such that  $p(w) = p(w')$  if  $\phi(w) = \phi(w')$ , without
        patterns from  $\mathcal{F}$  then
        | Accept
    end
end

```

Now, suppose there exists a periodic point $x \in \mathcal{X}_{\mathcal{F}}$. As $\text{stab}(x)$ has finite index, there exists a finite index normal subgroup N contained in $\text{stab}(x)$. For this normal subgroup, there exists (F, ϕ) such that $F \simeq G/N$ and $\phi : S \rightarrow F$ that extends to a group morphism. Let R be any set of (right) coset representatives. Because x is N -invariant, we have $x(hr) = x(r)$ for all $h \in N$. Therefore, there exists a partial tiling $p : R \cdot (S \cup \{\varepsilon\}) \rightarrow A$ given by $p(w) = x(\bar{w})$, where no pattern from \mathcal{F} appears, and $p(w) = p(w')$ if $\phi(w) = \phi(w')$.

On the other hand, suppose the semi-algorithm stops because it found $p : R \cdot (S \cup \{\varepsilon\}) \rightarrow A$ with the sought after properties, for some pair (F, ϕ) . We define $x \in A^G$ by $x(hr) = p(r)$ for all $h \in \ker(\Phi)$ and $r \in R$, where

Φ is the extension of ϕ . By definition x is a periodic point stabilized by $\ker(\Phi)$. Suppose that there exists a pattern $(a, b, s) \in \mathcal{F}$ that appears in x at $hr \in G$ for some $h \in \ker(\Phi)$ and $r \in R$. Then, $p(r) = x(hr) = a$ and $p(rs) = x(hrs) = b$, which is a contradiction. Thus, $x \in \mathcal{X}_{\mathcal{F}}$. \square

Remark 2.3.5. Any recursively presented group has co-ReFQ (that is, its finite quotients are co-recursively enumerable) [Rau22, Proposition 16]. Thus, every group that satisfies the hypothesis of the previous proposition (decidable word problem and ReFQ) has CFQ. The converse does not always hold: Rauzy showed that there are groups with CFQ that have undecidable word problem [Rau22, Theorem 3].

We re-visit this result in Section 5.2.1, where we see how it connects the undecidability of the Domino Problem to weakly aperiodic SFTs.

2.3.2 Aperiodic dominos

When tackling the Aperiodic Domino Problem, there is a straightforward way to show undecidability for groups that admit strongly aperiodic tilesets. The lemma that follows is a direct generalization of a proof from Callard and Hellouin de Menibus [CH22] adapted to groups.

Lemma 2.3.6. *Let G be a f.g. group that admits a strongly aperiodic SFT. Then, $\text{DP}(G) \leq_m \text{ADP}(G)$.*

Proof. Fix a generating set S , and let \mathcal{G} be the set of nearest neighbor forbidden patterns with respect to S , of a strongly aperiodic SFT Y over the alphabet B . For an input \mathcal{F} of the aperiodic problem over the alphabet A , we define the set of forbidden patterns \mathcal{F}' consisting of patterns $((a, b), (a', b'), s)$ such that $(a, a', s) \in \mathcal{F}$ and all $b, b' \in B$, or $(b, b', s) \in \mathcal{G}$ and all $a, a' \in A$. This way, the subshift generated by \mathcal{F}' over the alphabet $A \times B$ is exactly $\mathcal{X}_{\mathcal{F}} \times Y$. As Y is strongly aperiodic, $\mathcal{X}_{\mathcal{F}} \times Y$ is strongly aperiodic. Finally, $\mathcal{X}_{\mathcal{F}} \times Y$ is empty if and only if $\mathcal{X}_{\mathcal{F}}$ is empty, proving our reduction. \square

This argument was generalized by Carrasco-Vargas for certain properties [Car24]. A property of subshifts is said to be a **dynamical property** if it is invariant under conjugacies. Examples of such properties are having periodic points, being strongly aperiodic, minimal, having zero entropy, among others.

Definition 2.3.7. Let \mathcal{P} be a dynamical property. We say \mathcal{P} is a **Berger property** if there exist G -SFTs X_+ and X_- such that

- X_+ satisfies \mathcal{P} ,
- Every subshift X that admits a factor map to X_- does not satisfy \mathcal{P} ,
- There exists a morphism $X_+ \rightarrow X_-$.

With this definition, when G admits a strongly aperiodic SFT X , having an aperiodic point becomes a co-Berger property, that is, its complementary property (all stabilizers of the subshift are non-trivial) is a Berger property with $X_+ = \emptyset$ and $X_- = X$. Then, the previous lemma is generalized by the following theorem.

Theorem 2.3.8 ([Car24]). *Fix a Berger property \mathcal{P} . If G has undecidable Domino Problem, the problem of determining if a subshift defined by a given finite pattern coding satisfies \mathcal{P} is undecidable.*

Remark 2.3.9. In the context between the analogies between multidimensional shifts and groups as presented in Section 1.6, Carrasco-Vargas' definition of a Berger property is the analog of Markov properties for groups (Definition 2.0.10), and the previous theorem an analog of the Adyan-Rabin Theorem (Theorem 2.0.12).

Nevertheless, the Periodic Domino Problem does not fall under the scope of this theorem: if there is a subshift X_+ that has a periodic point, then through the morphism $X_+ \rightarrow X_-$ the subshift X_- would also have a periodic point, not allowing it to satisfy the second condition of a Berger property. This is also the case for both the Seeded and Recurring Domino Problems. In the next chapter we will study more of these problems known as Domino Snake Problems.

2.4 Consequences of undecidability

The undecidability of the Domino Problem also proved to be useful in proving the undecidability of many decision problems, ranging from problems in tilings such as the infinite snake problem [Adl+09] and the injectivity and surjectivity of two-dimensional cellular automata [Kar90; Kar94], to problems from other areas such as the k -SAT problem on \mathbb{Z}^2 [Fre99], the spectral gap problem of quantum many-body systems [CPW22], the finiteness and order problem of automaton semigroups [Gil14], and translation monotilings [GT23].

In this section we tackle the k -SAT problem on groups. The original version of this problem was introduced by Freedman in [Fre99]. The idea of the generalization was to extend the difference between 2-SAT and 3-SAT, which are in **P** and **NP-complete** respectively, to an infinite context making the former problem decidable and the latter undecidable. This is inserted into the broader program outlined in [Fre98] that searches to separate the complexity classes **P** and **NP** by limit processes, the idea being that limiting behaviors of polynomial time problems should be decidable. We slightly alter the generalization proposed by Freedman to make the decision problem compatible with finitely generated groups. Similar generalizations have been made for other classic decision problems, such as Post's correspondence problem [MNU14; CL21; CLL22], the Knapsack problem, and the Subset Sum problem [MO11; KLZ16; Loh20].

2.4.1 The k -SAT problem on groups

We define a generalized version of the k -SAT problem for finitely generated groups. This version is slightly different from the one introduced by Freedman [Fre99] in order to correctly capture the structure of finitely generated groups.

Let G be a finitely generated group. As variables for our formulas we use elements of G . For $g \in G$, we denote its negation by $\neg g$ and we use the ambiguous notation g' to refer to either g or $\neg g$ depending on the formula. We denote the set of formulas over G that are finite conjunctions of disjunctions of k literals as N_k , that is, $\phi \in N_k$ if it has the form

$$\phi = \bigwedge_{i=1}^m (g'_{i1} \vee \dots \vee g'_{ik}).$$

Next, for $H \leq G$ a finitely generated subgroup, we define HN_k as the set of formulas of the form

$$\bigwedge_{h \in H} \bigwedge_{i=1}^m ((hg_{i1})' \vee \dots \vee (hg_{ik})')$$

We use $\phi(h)$ to denote the formula ϕ with each variable left-multiplied by h . This way,

$$HN_k = \left\{ \bigwedge_{h \in H} \phi(h) \mid \phi \in N_k \right\}.$$

Definition 2.4.1. We say a formula $\phi \in HN_k$ is satisfiable, if there exists an assignment of truth values $\alpha : G \rightarrow \{0, 1\}$ such that:

$$\bigwedge_{h \in H} \bigwedge_{i=1}^m (\alpha(hg_{i1})' \vee \dots \vee \alpha(hg_{ik})') = 1.$$

Let S be a finite generating set for G . To arrive at a valid decision problem, we will code a function by a set of words over S that will evaluate to the literals of the function, and a list of words, also over S , that will specify a generating set for a subgroup. Formally, an **input formula** is a formula of the form

$$\phi = \bigwedge_{i=1}^m (v'_{i1} \vee \dots \vee v'_{ik}),$$

where $v_{ij} \in S^*$ for all $i \in \{1, \dots, m\}$ and $j \in \{1, \dots, k\}$, such that its evaluated version

$$\bar{\phi} = \bigwedge_{i=1}^m (\bar{v}'_{i1} \vee \dots \vee \bar{v}'_{ik})$$

belongs to N_k .

Definition 2.4.2. Let G be a finitely generated group, S a finite generating set and $k > 1$. The k -SAT problem over G is the following decision problem: given an input formula ϕ and $\{w_i\}_{i=1}^n$ determine whether the formula $\bigwedge_{h \in H} \bar{\phi}(h)$ is satisfiable, where $H = \langle \bar{w}_1, \dots, \bar{w}_n \rangle$.

Notice that the decidability of this problem does not depend on the chosen generating set, as we can re-write any input into any other generating set. We therefore denote this problem by k -SAT(G).

The first observation to make is that this problem depends on the computational structure of the group. The **subgroup membership problem** of a f.g. group G is the following decision problem: given words u and $\{w_i\}_{i=1}^n$ over S , determine whether $\bar{u} \in \langle w_1, \dots, w_n \rangle$. This problem is sometimes referred to as the **generalized word problem**.

Lemma 2.4.3. *The subgroup membership problem of G many-one reduces to co2-SAT(G).*

Proof. Let $u, \{w_i\}_{i=1}^n \in S^*$ be an instance of the subgroup membership problem. Fix a generator $s \in S$. We define the formula

$$\psi = (\neg \varepsilon \vee s) \wedge (u \vee s) \wedge (\neg \varepsilon \vee \neg s) \wedge (u \vee \neg s).$$

Notice that ψ is equivalent to the formula $\neg \varepsilon \wedge u$. Let us denote $H = \langle \bar{w}_1, \dots, \bar{w}_n \rangle$ and $\Psi = \bigwedge_{h \in H} \bar{\psi}(h)$.

Suppose $\bar{u} \in H$. Then, we have that $\bar{\psi}(1_G) \wedge \bar{\psi}(\bar{u}) = (\neg 1_G \wedge \bar{u}) \wedge (\neg \bar{u} \wedge \bar{u}^2)$ is never satisfiable, and thus Ψ is not satisfiable. On the other hand, if $\bar{u} \notin H$, we can define the assignment $\alpha: G \rightarrow \{0, 1\}$ by $\alpha(h) = 0$ and $\alpha(hu) = 1$ for all $h \in H$, and $\alpha(g) = 0$ for all other $g \in G \setminus H$. This way $\neg \alpha(h) \wedge \alpha(hu) = 1$ for all h , and therefore Ψ is satisfied. \square

Examples of groups with undecidable subgroup membership problems are $\mathbb{F}_n \times \mathbb{F}_n$ [Mih68], some hyperbolic groups [Rip82], as well as groups with undecidable word problem (see Examples 5.3.18 and 5.3.19 for more details).

Lemma 2.4.4. *Let G be a finitely generated group with decidable subgroup membership problem. Then, for every $k \geq 2$ we have that k -SAT(G) \leq_m DP(G).*

Proof. Let S be a finite generating set for G , ϕ an input formula and $\{w_i\}_i$ words over S that form an instance of k -SAT(G) such that

$$\phi = \bigwedge_{i=1}^m (v'_{i1} \vee \dots \vee v'_{ik}),$$

with $v_{ij} \in S^*$. Let us once again denote $H = \langle \bar{w}_1, \dots, \bar{w}_n \rangle$. Consider the alphabet A of 0-1 matrices of size $m \times k$ that satisfy ϕ , that is, all matrices $M \in \{0, 1\}^{m \times k}$ such that

$$\bigwedge_{i=1}^m ((M_{i1})' \vee \dots \vee (M_{ik})') = 1.$$

To obtain this alphabet we solve the standard k -SAT problem, which is computable. For convenience, let us denote the finite subset of words involved in the formula by $L = \{v_{ij} \mid 1 \leq i \leq m, 1 \leq j \leq k\}$. In addition, we define the set H_L as the set of all $h_{abcd} \in H \cap LL^{-1}$, where

$$h_{abcd} = \begin{cases} v_{ab}v_{cd}^{-1} & \text{if } v_{ab}v_{cd}^{-1} \in H, \\ 1_H & \text{otherwise.} \end{cases}$$

Notice that $|H_L| \leq |L|^2 = m^2k^2$, and that this set is computable from L as G has decidable subgroup membership problem. Let us proceed by specifying a set of nearest neighbor forbidden rules, \mathcal{F} , with respect to the generating set $S \cup H_L$. Given a configuration $x \in \mathcal{X}_{\mathcal{F}}$ the idea is that, for $h \in H$, the matrix $x(h)$ stocks the values assigned to the elements of hL . For each $h_{abcd} \in H_L$, we forbid patterns q of support $\{1_H, h_{abcd}\}$, such that if $q(1_H) = M$ and $q(h_{abcd}) = \hat{M}$, $M_{ab} \neq \hat{M}_{cd}$.

Suppose $\mathcal{X}_{\mathcal{F}}$ contains a configuration x . We define the assignment of truth values $\alpha : G \rightarrow \{0, 1\}$ by

$$\alpha(g) = \begin{cases} 0 & \text{if } g \notin H \cdot L, \\ x(h)_{ab} & \text{if } g = h\bar{v}_{ab} \end{cases}.$$

It follows that α is well defined; if $g = h_1\bar{v}_{ab} = h_2\bar{v}_{cd}$, then $h_2 = h_1h_{abcd}$, and by the forbidden patterns we know $(x_{h_1})_{ab} = (x_{h_2})_{cd}$. In addition, because $x \in A^G$, for all $h \in H$,

$$\bigwedge_{i=1}^m (\alpha(h\bar{v}_{i1})' \vee \dots \vee \alpha(h\bar{v}_{ik})') = \bigwedge_{i=1}^m (x(h)'_{i1} \vee \dots \vee x(h)'_{ik}) = 1.$$

This means that the assignation α satisfies $\bigwedge_{h \in H} \bar{\phi}(h)$.

Finally, suppose we have an assignation of truth values $\beta : G \rightarrow \{0, 1\}$ that satisfies $\bigwedge_{h \in H} \bar{\phi}(h)$. Given a set of right coset representatives R containing 1_G , we define $z \in \{0, 1\}^{m \times k}$ by $z(hr)_{ab} = \beta(hg_{ab})$, for all $h \in H$ and $r \in R$. Because β satisfies $\bigwedge_{h \in H} \bar{\phi}(h)$, for all $h \in H$

$$\bigwedge_{i=1}^m (z(h)'_{i1} \vee \dots \vee z(h)'_{ik}) = \bigwedge_{i=1}^m (\beta(h\bar{v}_{i1})' \vee \dots \vee \beta(h\bar{v}_{ik})') = 1.$$

Therefore, $z \in A^G$. For $h_{abcd} \in H_L$, $h_1 \in H$ and $h_2 = h_1h_{abcd}$ we have that

$$z(h_1)_{ab} = \beta(h_1\bar{v}_{ab}) = \beta(h_1h_{abcd}\bar{v}_{cd}) = \beta(h_2\bar{v}_{cd}) = z(h_2)_{cd}.$$

Therefore z satisfies the local rules and is thus in $\mathcal{X}_{\mathcal{F}}$. This concludes our reduction. \square

Virtually free groups not only have decidable Domino Problem, as previously mentioned, but also have decidable subgroup membership problem (see [Loh23]).

Corollary 2.4.5. *For G a virtually free group, $k\text{-SAT}(G)$ is decidable for all $k > 1$.*

To determine when the converse reduction is true, we look at groups with subgroups satisfying a particular property.

Definition 2.4.6. Let G be a finitely generated group. We say G is **scalable** if there exists a proper finite index subgroup $H \lesssim G$ that is isomorphic to G .

Examples of such groups are finitely generated abelian groups, the Heisenberg group, solvable Baumslag-Solitar groups $BS(1, n)$, Lamplighter groups $F \wr \mathbb{Z}$ with F a finite abelian group, the affine group $\mathbb{Z}^d \rtimes GL(d, \mathbb{Z})$ for $d \geq 2$ [NP11], torus knot groups, Free-by-cyclic groups $\mathbb{F}_n \rtimes_{\theta} \mathbb{Z}$, where θ has finite order in $\text{Out}(\mathbb{F}_n)$ [Bri+10], among others. These groups are also known as finitely generated non finitely co-Hopfian groups [Bri+10]. Examples of non-scalable groups are finitely generated free groups.

Theorem 2.4.7. *For G a scalable group, $\text{DP}(G) \leq_m 3\text{-SAT}(G)$.*

Proof. Let A be a finite alphabet of size n , and \mathcal{F} a finite set of nearest neighbor forbidden patterns for G with generating set S . As G is scalable, there exists H a proper subgroup of finite index as well as an isomorphism $F: G \rightarrow H$. Let $f: S \rightarrow S^*$ the function that is extended to the isomorphism F , that is, $\{f(s)\}_{s \in S}$ represents a generating set for H . Fix $R \subseteq S^*$ a set of words representing a finite set of right coset representatives

for H that includes 1_G . Notice that for every $m \in \mathbb{N}$ the subgroup $H_m = F^m(G)$ is isomorphic to G with $[G : H_m] = [G : H]^m \geq m$. In addition, a simple computation shows that $R_m = F^{m-1}(R) \dots F(R)R$ defines a set of right coset representatives for H_m .

The idea of the reduction is to represent each letter of the alphabet by a unique code on the left coset representatives and then create a formula that assigns a letter to each element of H_m . The index of the subgroup, m , is chosen so there is enough room to code the alphabet and write our formula in the required form.

First off, take as a preliminary estimate $m \geq \lceil \log_2(n) \rceil$, and denote $f_m = f^m$. For each $a \in A$, we can define a unique code $c_a : R_m \rightarrow \{0, 1\}$ (an example of such codes are presented in Example 2.4.8). Let $\{\phi_a\}_{a \in A}$ be the set of formulas that representing the codes c_a for each letter of the alphabet A , using the words in R_m as variables. This way, $\phi_a(h) \equiv 1$ means we place the letter a at $g = (F^m)^{-1}(h)$, and the variables are contained in hR_m . Notice that because the code for each letter is unique, for any $g \in G$ only one $\phi_a(g)$ can be satisfied at the same time. Our complete formula is given by

$$\varphi = \left(\bigvee_{a \in A} \phi_a(1_G) \right) \wedge \left(\bigwedge_{(a,b,s) \in \mathcal{F}} \neg \phi_a(1_G) \vee \neg \phi_b(f_m(s)) \right),$$

which represents the fact that we place one letter at the given point (1_G in this case) and that there are no forbidden patterns in its neighborhood. If modified to be in CNF form, φ is a conjunction of $|\mathcal{F}| + \lceil \log_2(n) \rceil^n$ clauses of $\leq n$ literals (the clauses coding the forbidden patterns contain $2\lceil \log_2(n) \rceil$ literals). By adding $(|\mathcal{F}| + \lceil \log_2(n) \rceil^n)n$ dummy variables we can transform φ into an equivalent formula φ' whose clauses contain exactly 3 literals.

Therefore, take $m \geq (|\mathcal{F}| + \lceil \log_2(n) \rceil^n)n + \lceil \log_2(n) \rceil$, which gives us enough space in the set of left coset representatives to code the elements of the alphabet and the dummy variables. Furthermore, φ' is computable from A and \mathcal{F} , and $\Phi' = \bigwedge_{h \in H} \varphi'(h) \in H_m N_3$.

Let us prove the reduction. If there exists $x \in \mathcal{X}_{\mathcal{F}} \subseteq A^G$, we create an assignment such that for all $g \in G$, the variables in $F^m(g)R_m$ are given values so as to satisfy the code for $\phi_{x(g)}(F^m(g)) \equiv 1$. Because x contains no patterns from \mathcal{F} , $\bigwedge_{h \in H} \varphi(h)$ will be satisfied. We finish by filling out the rest of the variables so that $\Phi' \equiv 1$.

Now, if Φ' is satisfied so is $\bigwedge_{h \in H} \varphi(h)$. Let $y \in A^G$ be the configuration defined by $y(g) = a$ if $\phi_a(F^m(g)) \equiv 1$. Because the codes used make sure that the values in $F^m(g)R_m$ code a unique letter, for each $g \in G$ a unique $\phi_a(F^m(g))$ is satisfied. Thus y is well defined. Finally, $y \in \mathcal{X}_{\mathcal{F}}$ because if there was $g \in G$ such that $y(g) = a$ and $y(gs) = b$ with $(a, b, s) \in \mathcal{F}$ we would have that $\phi_a(F^m(g)) \wedge \phi_b(F^m(g)f_m(s))$ is true. This completes the reduction $\text{DP}(G) \leq_m \text{3-SAT}(G)$. \square

Example 2.4.8. Let us look at an example of the previous reduction in the case of \mathbb{Z}^2 with its standard presentation $\langle \mathbf{a}, \mathbf{b} \mid [\mathbf{a}, \mathbf{b}] \rangle$. Suppose we have the alphabet $A = \{\blacksquare, \blacksquare, \blacksquare, \square\}$, and take the subgroup $\mathbb{Z} \times 2\mathbb{Z}$, which is isomorphic to \mathbb{Z}^2 , and has an index equal to $2 = \lceil \log_2(|A|) \rceil$. As mentioned in the proof, we code our tiles using the elements of a set of right coset representatives, $R = \{1_{\mathbb{Z}^2}, \mathbf{b}\}$, as shown in Figure 2.5. See Figure 2.6 for an example of the coding of a finite pattern. The function for the generators is defined as $f(\mathbf{a}) = \mathbf{a}$ and $f(\mathbf{b}) = \mathbf{b}^2$. This way, if we only forbid the pattern $(\blacksquare, \blacksquare, \mathbf{b})$, the formula coding the problem is given by,

$$\left(\bigvee_{i=1}^4 \phi_i(1_{\mathbb{Z}^2}) \right) \wedge (\neg \phi_3(1_G) \vee \neg \phi_3(\mathbf{b}^2)).$$

This formula is satisfiable if and only if there is a tiling of the plane by A that avoids $(\blacksquare, \blacksquare, \mathbf{b})$.

Remark 2.4.9. The reduction was possible in the previous proof because R_m was computable starting from R . Therefore, if G had a subgroup $H \lesssim G$ isomorphic to G , but of infinite index, we could adapt the previous proof provided that the function that takes $m \in \mathbb{N}$ and outputs a set of m words representing distinct right coset representatives. A similar generalization can be done for virtually scalable groups, where the set of coset is slightly modified. In this case, if H is a scalable finite index subgroup of G , $\text{DP}(H) \leq_m \text{3-SAT}(G)$.

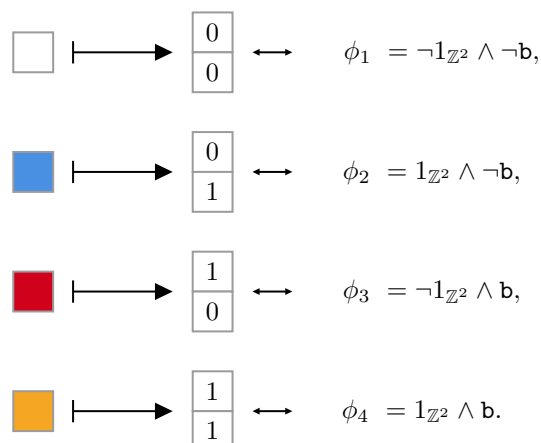

Figure 2.5: To reduce the k -SAT problem to the Domino Problem, we represent each letter of the alphabet by a unique code over the right coset representatives of the chosen subgroup.

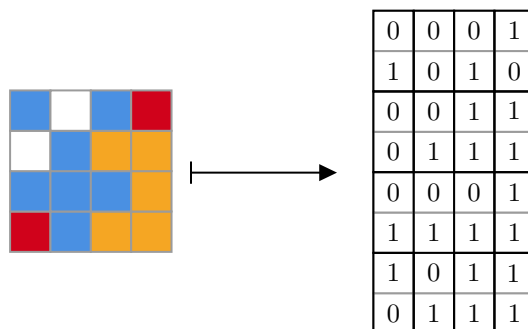

Figure 2.6: An example on how to code a tiling on the right coset representatives of a subgroup using boolean functions.

Finally, we can prove the undecidability of 3-SAT using the undecidability of the Domino Problem on certain classes of groups with the required properties.

Corollary 2.4.10. *3-SAT(G) is undecidable for the following finitely generated groups:*

- *Non virtually \mathbb{Z} virtually abelian groups,*
- *The Heisenberg group,*
- *Solvable Baumslag-Solitar groups,*
- *Torus knot groups,*
- *Free-by-cyclic groups $\mathbb{F}_n \rtimes_{\theta} \mathbb{Z}$, where θ has finite order in $\text{Out}(\mathbb{F}_n)$,*
- *Lamplighter groups,*
- *Affine groups.*

Proof. As we mentioned before, all of these groups are (virtually) scalable and have undecidable Domino Problem (see Theorem 2.0.2, Proposition 2.0.9 and Proposition 6.2.2). \square

Chapter 3

Domino Snake Problems

Eighteen years after the introduction of Wang tiles, Myers proposed a new type of tiling problem: Domino Snake Problems [Mye79]. These problems – also called domino thread problems – ask to determine, given a set of Wang tiles, whether there exists a correctly tiled path in the plane subject to some fixed constraint. The first problem he tackled is known as **Reachability**, and asks whether, given a set of tiles and two points in the plane, there exists a well tiled path connecting the two points. In stark contrast to other domino variants, Myers, Harel and Etzion showed that this problem is decidable on \mathbb{Z}^2 [EHM94]. Stranger still is the result by Ebbinghaus, who showed that the Reachability problem on \mathbb{N}^2 is undecidable [Ebb82]. Next, there is the **Infinite Snake Problem** which asks, given a set of tiles, if there exists a well-tiled bi-infinite injective path. This problem was shown to be undecidable in its seeded version by Ebbinghaus [Ebb87], with an alternative proof by Etzion [Etz91], and later in full generality by Adleman, J. Kari, L. Kari and Reishus [Adl+09]. They showed a reduction from the Domino Problem through the use of tiles that recreate Hilbert’s space-filling curve that were originally used by Kari [Kar90; Kar94] to prove the undecidability of the reversibility of \mathbb{Z}^2 -CA. The third and final problem is the **Ouroboros Problem**¹. Originally called the cycle problem, this problem asks to determine if there exists a non-trivial well-tiled simple cycle from a given set of tiles. It was shown to be undecidable independently by Ebbinghaus [Ebb82] and Kari [Kar02]. The paths in these problems are now known as **snakes**. These three problems have two variants: the normal version where adjacency rules are only required to be respected along the trajectory of the snake, and the strong version where the whole portion of the plane defined by the snake must be correctly tiled. For all of the previously mentioned results, the statements hold for both versions.

In this chapter, we expand the scope of Domino Snake Problems to finitely generated groups, as has been done for other Domino Problems, to understand how the underlying structure affects computability. We present three ways in which to approach these problems. The first is the use of symbolic dynamics to understand the set of all possible snakes. Proposition 3.2.4 states that when this set is defined through a regular language of forbidden patterns, the Infinite Snake Problem becomes decidable. Using this approach we solve many variations of the Infinite Snake Problem including the Geodesic Snake Problem for some classes of groups. Next, we introduce a notion of embedding that allows us to reduce the decidability of snake problems from one group to another. This notion enable us to establish the undecidability of the Infinite Snake and Ouroboros Problems for a large class of groups –that most notably include nilpotent groups– for any generating set, provided that we add a torsion-free element from the group’s center. Finally, we express the three snake problems in the language of Monadic Second Order logic. Because for virtually free groups this fraction of logic is decidable, we show that our three decision problems are decidable on these groups independently of the generating set.

¹Ouroboros, from the greek *οὐροβόρος* meaning ‘tail-devouring’, is the name of the ancient symbol depicting a snake eating its own tail, often representing renewal, cyclic time or eternity [Ree15]. The earliest known appearance of this symbol is in the tomb of ancient egyptian pharaoh Tutankhamun, from the 14th century BCE [Pia49] (see [Ree15, Figure 34]).

3.1 Snake behaviour

To be concise, in this chapter we denote finitely generated groups as pairs (G, S) where G is the group and S a finite generating set. Furthermore, when talking about tileset graphs $\Gamma = (A, B)$ as defined in Section 1.1.4, we make the additional assumption that for every edge $(a, a', s) \in B$, we also have $(a', a, s^{-1}) \in B$. Finally, I denotes \mathbb{Z} , \mathbb{N} , or a discrete interval $[[n, m]]$, depending on the context.

Definition 3.1.1. Let (G, S) be a finitely generated group, and $\Gamma = (A, B)$ a tileset graph for the pair. A **snake** or Γ -**snake** is a pair of functions (ω, ζ) , where $\omega : I \rightarrow G$ is an injective function, referred to as the snake's **skeleton**, and $\zeta : I \rightarrow A$ the snake's **scales**. This pair must satisfy $d\omega_i = \omega(i)^{-1}\omega(i+1) \in S$, and $(\zeta(i), \zeta(i+1), d\omega_i)$ must be an edge in Γ .

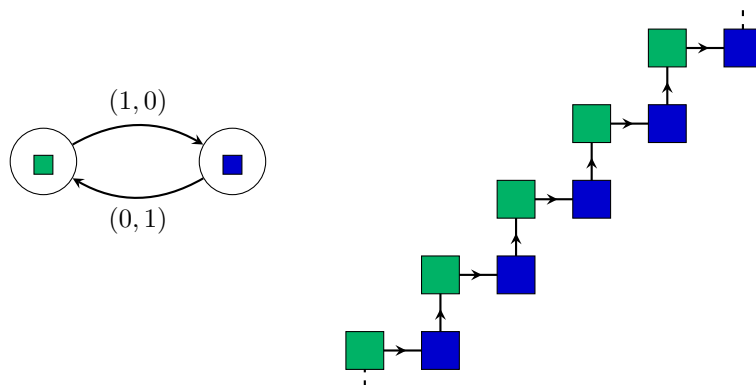

Figure 3.1: A tileset graph Γ that does not tile \mathbb{Z}^2 for the generating set $\{(1, 0), (0, 1)\}$ (edges labeled with generator inverses are omitted for more readability) and a Γ -snake with $I = \mathbb{N}$.

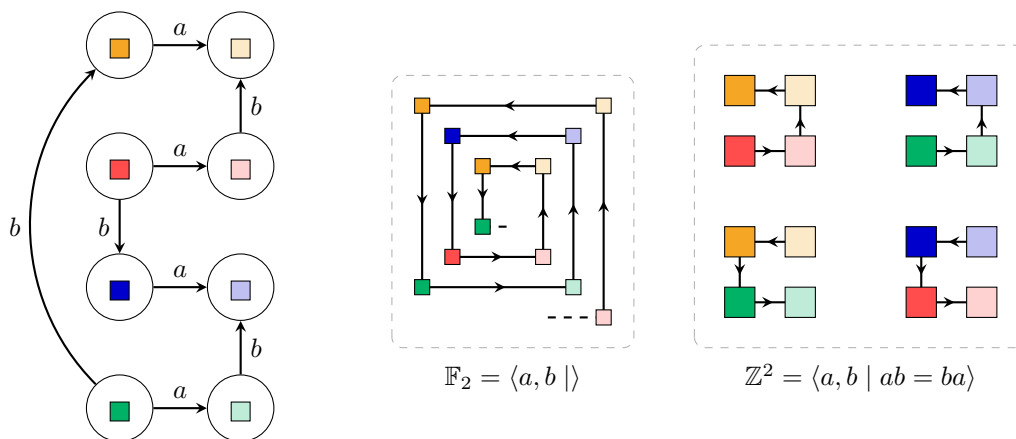

Figure 3.2: An example of tileset graph Γ for groups with two generators a, b (inverses are omitted for simplicity). There exists a Γ -snake for the free group $\mathbb{F}_2 = \langle a, b \mid \rangle$ as pictured in the middle, with $\omega(\mathbb{Z}) = (aba^{-1}b^{-1})^{\mathbb{Z}}$, but not for $\mathbb{Z}^2 = \langle a, b \mid ab = ba \rangle$ since one of the finite snakes on the right must appear but cannot be extended into an infinite one.

It may happen that for a given Γ -snake (ω, ζ) with $\omega : I \rightarrow G$, there exist two indices $i, i' \in I$ such that $\omega(i)^{-1}\omega(i') = s \in S$ but $|i' - i| \neq 1$. In this case, but we do not require $(\zeta(i), \zeta(i'), s)$ to be an edge in Γ (see Figure 3.3). A Γ -snake that fulfills this additional condition for every pair of indices $i, i' \in I$ such that $\omega(i)^{-1}\omega(i') \in S$ is called a **strong Γ -snake**.

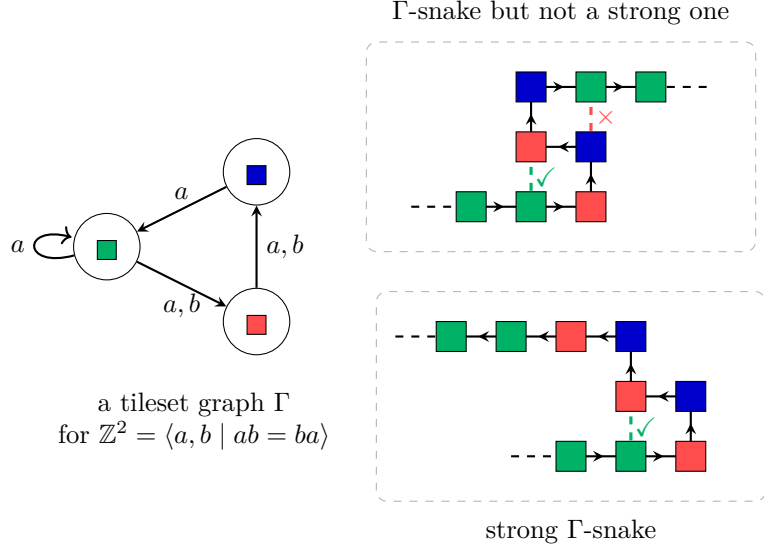

Figure 3.3: A tileset graph Γ on the left (inverses are omitted for simplicity). We consider \mathbb{Z}^2 with its standard presentation $\langle a, b \mid ab = ba \rangle$. On the top right a Γ -snake for \mathbb{Z}^2 that is not strong. On the bottom right a strong Γ -snake for \mathbb{Z}^2 .

We say a snake (ω, ζ) **connects the points** $p, q \in G$ if there exists a $n \in \mathbb{N}$ such that (ω, ζ) is defined over $\llbracket 0, n \rrbracket$, $\omega(0) = p$, and $\omega(n) = q$. We say a snake is **bi-infinite** if its domain is \mathbb{Z} . A Γ -**ouroboros** is a Γ -snake defined over $\llbracket 0, n \rrbracket$, with $n \geq 2$, that is injective except for $\omega(0) = \omega(n)$. In other words, a Γ -ouroboros is a well-tiled non-trivial simple cycle. We study the following three decision problems.

Definition 3.1.2. Let (G, S) be a finitely generated group. Given a tileset graph Γ for (G, S) and two points $p, q \in G$,

- the **Infinite Snake Problem** asks if there exists a bi-infinite Γ -snake,
- the **Ouroboros Problem** asks if there exists a Γ -ouroboros,
- the **Snake Reachability problem** asks if there exists a Γ -snake connecting p and q .

These three problems are also defined for strong snakes. We also define the **seeded** variants of these problems. In the seeded versions, we add a selected tile $a_0 \in A$ to our input and ask for the corresponding snake/ouroboros to satisfy $\zeta(0) = a_0$.

All of these problems have been studied and classified for \mathbb{Z}^2 with its standard generating set $\{(1, 0), (0, 1)\}$.

Theorem 3.1.3. Let S be the standard generating set for \mathbb{Z}^2 . Then,

1. The (strong) Snake Reachability Problem for (\mathbb{Z}^2, S) is PSPACE-complete [EHM94],
2. The (strong) Infinite Snake Problem for (\mathbb{Z}^2, S) is Π_1^0 -complete [Adl+09],
3. The (strong) Ouroboros Problem for (\mathbb{Z}^2, S) is Σ_1^0 -complete [Ebb82; Kar02].

In addition, the seeded variants of these problems are undecidable [Ebb82].

Our aim is to extend these results to larger classes of groups and different generating sets.

3.1.1 General properties

Let (G, S) be a finitely generated group and Γ a tiling graph. If there exists a snake (ω, ζ) , then for every $g \in G$, the pair $(g \cdot \omega, \zeta)$ is a snake. Indeed, if we define $\tilde{\omega}(i) = g \cdot \omega(i)$, then $d\tilde{\omega} = d\omega$, and the adjacency of ζ in Γ remains unchanged. In particular, there exists a snake (ω', ζ) such that $\omega'(0) = 1_G$, i.e. a snake that starts at the identity.

The next result is a straightforward generalization of a result due to Kari [Kar02] for \mathbb{Z}^2 . We provide the proof for completion.

Proposition 3.1.4. *Let Γ be a tiling graph for a finitely generated group (G, S) . Then, the following are equivalent*

1. Γ admits a bi-infinite snake,
2. Γ admits a one-way infinite snake,
3. Γ admits a snake of every length.

Proof. Notice that a bi-infinite snake always contains a one-way infinite snake, and a one-way infinite snake contains snakes of arbitrary length. Therefore, it remains to prove (3) \implies (1). Let $(\omega_n, \zeta_n)_{n \in \mathbb{N}}$ be a sequence of snakes with $\omega_n : \llbracket -n, n \rrbracket \rightarrow G$, which we can take to satisfy $\omega_n(0) = 1_G$ for all $n \in \mathbb{N}$. As we have an infinite amount of snakes, and for every $m \geq 1$ the ball of radius m of the group is finite, we can extract a subsequence $\varphi : \mathbb{N} \rightarrow \mathbb{N}$ such that $\omega_{\varphi(n)}(\llbracket -m, m \rrbracket)$ and $\zeta_{\varphi(n)}(\llbracket -m, m \rrbracket)$ coincide for all $n \in \mathbb{N}$. By iterating this process we obtain a bi-infinite snake (ω, ζ) . \square

This result implies that if a tiling graph admits no snakes, it will fail to tile any snake longer than a certain length. Therefore, if we have a procedure to test snakes of increasing length, we have a semi-algorithm to test if a tiling graph does not admit an infinite snake.

Corollary 3.1.5. *If G has decidable word problem, the Infinite Snake Problem is in Π_1^0 .*

Proof. Let $\Gamma = (A, B)$ be a tiling graph for (G, S) . We create a recursive process that tests larger and larger snakes. Define $\mathfrak{F}^{(0)} = \{\omega_0\}$ where $\omega_0 : \{0\} \rightarrow \{\epsilon\}$, and let \mathfrak{S} be the set of snakes (ω_0, ζ) with $\zeta : \{0\} \rightarrow V_\Gamma$. Our recursive procedure will take skeletons in $\mathfrak{F}^{(n)}$ and try to tile them without mismatches. All the snakes that we obtain with this procedure define the set $\mathfrak{S}^{(n)}$. We proceed as follows:

- For every $\omega \in \mathfrak{F}^{(n)}$, we create functions $\omega_{s,t} : \llbracket -n-1, n+1 \rrbracket \rightarrow S^{2n+1}$ for every $s, t \in S$, by

$$\omega_{s,t}(i) = \begin{cases} \omega(i) & \text{if } i \in \llbracket -n, n \rrbracket \\ \omega(-n)s & \text{if } i = -n-1 \\ \omega(n)t & \text{if } i = n+1 \end{cases} .$$

By using the algorithm for the word problem, we select those functions such that $\omega_{s,t}(\pm(n+1))$ do not create new factors that evaluate to the identity, and add them to $\mathfrak{F}^{(n+1)}$.

- Next, for every $\omega \in \mathfrak{F}^{(n+1)}$ we test all possible tilings of $\omega(\llbracket -n-1, n+1 \rrbracket)$ and add the pairs that are correctly tiled to $\mathfrak{S}^{(n+1)}$.

Thus, we can algorithmically enumerate the sets of finite snakes $\mathfrak{S}^{(n)}$. We can conclude that the Infinite Snake Problem is Π_1^0 as Proposition 3.1.4 tells us that there is no bi-infinite Γ -snake if and only if there exists $n \in \mathbb{N}$ such that $\mathfrak{S}^{(n)} = \emptyset$. \square

Remark 3.1.6. In the case of strong snakes, the three statements in Proposition 3.1.4 are equivalent to the existence of an infinite connected subset P of G that is correctly tiled by Γ . Then, the proof of Corollary 3.1.5 can be adapted to show that the strong Infinite Snake Problem is in Π_1^0 for groups with decidable word problem.

A similar process can be done for the Ouroboros Problem.

Proposition 3.1.7. *If G has decidable word problem, the Ouroboros Problem is in Σ_1^0 .*

Proof. Let Γ be a tileset graph for (G, S) . For each $n \geq 1$, we test each word of length n to see if it defines a simple loop and if it admits a valid tiling. More precisely, for $w \in S^n$, we use the word problem algorithm to check if w is G -reduced and evaluates to 1_G . If it is reduced, we test all possible tilings by Γ of the path defined by following the generators in w . If we find a valid tiling, we accept. If not, we keep iterating with the next word length n and eventually with words of length $n + 1$.

If there is a Γ -ouroboros, this process will halt and accept. Similarly, if the process halts we have found a Γ -ouroboros. Finally, if there is no Γ -ouroboros the process continues indefinitely. \square

Lemma 3.1.8. *Let (G, S) be a finitely generated group, (H, T) a finitely generated subgroup of G and $w \in S^+$. Then,*

- *The Infinite Snake, Ouroboros and Reachability Problems in (H, T) many one-reduce to their respective analogues in $(G, S \cup T)$, for both the strong and normal versions.*
- *The Infinite Snake, Ouroboros and Reachability Problems in (G, S) many one-reduce to their respective analogues in $(G, S \cup \{w\})$, for both the strong and normal versions.*

Proof. Any tileset graph for (H, T) is a tileset graph for $(G, S \cup T)$, and any tileset graph for (G, S) is a tileset graph for $(G, S \cup \{w\})$. Finally, adjacency in the Cayley graph of (H, T) is preserved in the Cayley graph of $(G, S \cup T)$, so strong snakes are preserved. \square

3.2 Ossuary

An important part of the complexity of snakes comes from the paths they trace on the underlying group. It stands to reason that understanding the structure of all possible injective bi-infinite paths on the group can shed light on the computability of the Infinite Snake Problem. Let G be a finitely generated group with S a generating set. The **skeleton** of G with respect to S is defined as

$$\mathbb{X}_{G,S} = \{x \in S^{\mathbb{Z}} \mid \forall w \sqsubseteq x, w \notin \text{WP}(G, S)\}.$$

This subshift is the set of all possible skeletons; recall from Definition 3.1.1 that for any skeleton ω we can define $d\omega : \mathbb{Z} \rightarrow S$ as $d\omega_i = \omega(i)^{-1}\omega(i+1)$. Then, for any infinite snake (ω, ζ) , $d\omega \in \mathbb{X}_{G,S}$, as ω is injective,.

Example 3.2.1. Take \mathbb{Z}^2 with its standard generating set $S = \{\mathbf{a}^{\pm 1}, \mathbf{b}^{\pm 1}\}$. Its skeleton is given by

$$\mathbb{X}_{\mathbb{Z}^2,S} = \{x \in S^{\mathbb{Z}} \mid \forall w \sqsubseteq x, \|w\|_{\mathbf{a}} \neq 0 \vee \|w\|_{\mathbf{b}} \neq 0\},$$

where $\|w\|_s$ is the sum of exponents of the generator s .

Example 3.2.2. Let \mathcal{D}_∞ be the infinite dihedral group. The skeletons of this group can be radically different depending on the generating set. For instance, if we take the presentation

$$\mathcal{D}_\infty = \langle \mathbf{a}, \mathbf{b} \mid \mathbf{a}^2, \mathbf{b}^2 \rangle,$$

the corresponding skeleton is the finite subshift $\{(\mathbf{ab})^\infty, (\mathbf{ba})^\infty\}$. On the other hand, if we take the presentation,

$$\mathcal{D}_\infty = \langle \mathbf{r}, \mathbf{s} \mid \mathbf{s}^2, \mathbf{srsr} \rangle,$$

the skeleton is infinite: for every $n \in \mathbb{Z}$ it contains a configuration x defined by $x(n) = \mathbf{s}$ and $x(k) = \mathbf{r}$ for all $k \neq n$.

In the next chapter we do an in depth study of the skeleton, and explore of how the algebraic and geometric properties of the underlying group influence the combinatorial and dynamical properties of its skeleton.

This formalism allows us to introduce variations of the Infinite Snake Problem where we ask for additional properties on the skeleton. We say a subset $Y \subseteq \mathbb{X}_{G,S}$ is **skeletal** if it is shift-invariant. In particular, all subshifts of $\mathbb{X}_{G,S}$ are skeletal.

Definition 3.2.3. Let Y be a skeletal subset. The **Y -Snake Problem** asks, given a tileset graph Γ , does there exist a bi-infinite Γ -snake (ω, ζ) such that $d\omega \in Y$?

3.2.1 Skeletons and decidability

A snake (ω, ζ) can be seen as two walks that follow the same labels: ω is a self-avoiding walk on the Cayley graph of the group, and ζ a walk on the tileset graph. Therefore, if we find a bi-infinite walk, $x \in S^{\mathbb{Z}}$, that avoids cycles on the Cayley graph and represents a valid walk on the tileset graph, we have found a snake.

For a finitely generated group (G, S) , and a tileset graph Γ , we denote by $X_{\Gamma} \subseteq S^{\mathbb{Z}}$ the subshift whose configurations are the labels of bi-infinite paths over Γ . This definition makes X_{Γ} a sofic subshift (see Section 1.1.5).

Proposition 3.2.4. *Let (G, S) be a finitely generated group, Γ a tileset graph, and Y a non-empty skeletal subset. Then, the subshift $X = Y \cap X_{\Gamma}$ is non-empty if and only if there is a bi-infinite Γ -snake (ω, ζ) with $d\omega \in Y$. In addition, if Y is an effective/sofic subshift, then X is an effective/sofic subshift.*

Proof. Let $\Gamma = (A, B)$ be a tileset graph for G , with generating set S . Let X be the intersection $Y \cap X_{\Gamma}$. Assume we have a bi-infinite snake (ω, ζ) such that $d\omega \in Y$. As the pair is a Γ -snake, for all $i \in \mathbb{Z}$ the transition from $\zeta(i)$ to $\zeta(i+1)$ is an edge on Γ labeled by $d\omega_i$. Therefore $d\omega \in X_{\Gamma}$, and as a consequence $d\omega \in X$. Conversely, suppose there exists $x \in X$. Let $i : \mathbb{Z} \rightarrow A$ be the function that gives us the initial vertex of every traversed edge. That is, $i(i)$ is the departure vertex for the edge traversed by x_i in Γ . Then, define the snake (ω_x, ζ_x) with scales $\zeta_x(i) = i(i)$, and skeleton $\omega_x : \mathbb{Z} \rightarrow G$ by $\omega_x(i) = x_{[0,i]}$ when $i \geq 0$ and $(x_{[i,0]})^{-1}$ when $i < 0$. This skeleton satisfies $d\omega_x(i) = x_i$ and therefore $d\omega_x \in Y$. Furthermore, because $Y \subseteq \mathbb{X}_{G,S}$ we have that $w_x(\mathbb{Z}) \subseteq G$ is injective. Finally, because X_{Γ} is sofic, X will be an effective (resp. sofic) subshift when Y is an effective (resp. sofic) subshift, as this classes are closed under intersections. \square

Proposition 3.2.4 reduces the problem of finding an infinite Y -snake, to the problem of emptiness of the intersection of two one-dimensional subshifts. Determining if a subshift is empty is co-recursively enumerable for effective subshifts, and decidable for sofics. Because in these cases $X = X_{\Gamma} \cap Y$ can be effectively constructed from the tileset graph, we can provide a semi-algorithm when the skeleton is effective. This is true for the class of recursively presented groups. Because these groups have recursively enumerable word problem, $WP(G, S)$ is recursively enumerable for all finite generating sets (Proposition 1.3.15). This enumeration gives us an enumeration of the forbidden patterns of our subshift.

Proposition 3.2.5. *Let G be a recursively presented group. Then, $\mathbb{X}_{G,S}$ is effective for every generating set S .*

This allows us to state the following proposition.

Proposition 3.2.6. *Let Y be a skeletal subshift. Then, if Y is sofic (resp. effective) the Y -snake problem is decidable (resp. in Π_1^0). In particular, if G is recursively presented, the Infinite Snake Problem is in Π_1^0 for any generating set.*

In Theorem 4.4.9 from Chapter 4 we will characterize which groups admit a sofic skeleton.

Remark 3.2.7. The converse of the first statement of the previous proposition does not hold in general: there are pairs (G, S) that have decidable Infinite Snake Problem but whose skeleton is not sofic. Take \mathbb{Z} with the generating set $\{\pm 2, \pm 3\}$, where the generators are denoted s and t respectively. As we see in Proposition 4.4.4, the skeleton of \mathbb{Z} with respect to this generating set is not sofic. Nevertheless, we will see in Section 3.5 that $(\mathbb{Z}, \{2, 3\})$ has decidable Infinite Snake Problem.

Remark 3.2.8. Proposition 3.2.6 relies on the fact that certain classes of languages are stable under intersections with a regular language. It is reasonable to ask what happens to the decidability of the problem if Y is defined by a language in such a class. There are two ways to do this. We can either ask for Y to be defined by a set of forbidden patterns belonging to the class, in which case Y would be a subshift, or we can ask for Y itself to be a language (of infinite words) in the class, in which case Y may not be closed.

For instance, take the classes defined by blind multicounter automata. Blind multicounter automata are a special case of G -automata, where the group G is \mathbb{Z}^d for some $d \geq 1$. A G -automaton is a finite deterministic automaton along with a map that associates a group element to each transition. A word is accepted by the automaton if it arrives at an accepting state and the group element obtained by right-multiplying the elements associated to each transition, is the identity (see [Yuy23] for more information on G -automata and [Gre78] for blind multi-counter automata). In particular, this class of languages is closed under intersection with a regular language.

Let us see that in the cases where Y is defined by a set of forbidden patterns accepted by a blind multicounter automaton, the Y -snake problem may be undecidable. Notice that $\text{WP}(G, S)$ is accepted by a G -automaton. Because $\mathbb{X}_{G,S} = \mathcal{K}_{\text{WP}(G,S)}$, the skeleton subshift for (G, S) is defined by a set of forbidden patterns that is accepted by a G -automaton. In particular, $\mathbb{X}_{\mathbb{Z}^2,S}$ is defined by a set of forbidden patterns that is accepted by a blind 2-counter automaton and has undecidable snake problem by Theorem 3.1.3.

Nevertheless, if we ask for the configurations from Y to be accepted synchronously by blind multicounter automata, as introduced in [FS08], the problem becomes decidable. By [FS08, Theorem 4.2] we know that the intersection between a regular language and a language accepted synchronously by a blind multicounter automaton is a language accepted synchronously by a blind multicounter automaton. In addition, the automaton that accepts the intersection is constructed effectively. Thus, we can effectively obtain the blind multicounter automata synchronously accepting the intersection of X_Γ and Y . Finally, because the emptiness problem for this class of languages is decidable [FS08, Theorem 3.3], the Y -snake problem is decidable by Proposition 3.2.4.

Theorem 3.2.9. *The Infinite Snake Problem in \mathbb{Z}^2 restricted to 2 or 3 directions among $\mathbf{a}, \mathbf{a}^{-1}, \mathbf{b}, \mathbf{b}^{-1}$, where $\{\mathbf{a}, \mathbf{b}\}$ is the standard generating set for \mathbb{Z}^2 , is decidable.*

Proof. The set of skeletons of snakes restricted to 3 directions, for instance left, right and up (denoted by \mathbf{a}^{-1} , \mathbf{a} and \mathbf{b} respectively), is the subshift $Y_3 \subseteq \{\mathbf{a}, \mathbf{a}^{-1}, \mathbf{b}\}^{\mathbb{Z}}$ where the only forbidden words are $\mathbf{a}\mathbf{a}^{-1}$ and $\mathbf{a}^{-1}\mathbf{a}$. As Y_3 is a skeletal SFT of $\mathbb{X}_{\mathbb{Z}^2, \{\mathbf{a}^{\pm 1}, \mathbf{b}^{\pm 1}\}}$, by Proposition 3.2.6, the Y_3 -Snake Problem is decidable. The case of two directions is analogous as Y_2 is either the full shift on the two generators \mathbf{a} and \mathbf{b} or $\{\mathbf{a}^\infty, (\mathbf{a}^{-1})^\infty\}$. \square

A natural variation of the Infinite Snake Problem, from the point of view of group theory, is asking if there is an infinite snake whose skeleton defines a geodesic. These skeletons are captured by the **geodesic skeleton**; a subshift of $\mathbb{X}_{G,S}$ comprised exclusively of bi-infinite geodesic rays. Formally,

$$\mathbb{X}_{G,S}^g = \{x \in \mathbb{X}_{G,S} \mid \forall w \sqsubseteq x, w' =_G w : |w| \leq |w'|\}.$$

This subshift can be equivalently defined by the set of forbidden patterns given by the complement of $\text{Geo}(G, S)$, the set of geodesic words. As is the case for the skeleton, in the next chapter we look closer at the geodesic skeleton to study its dynamical properties and entropy.

Proposition 3.2.10. *Let (G, S) be a finitely generated group. If $\text{Geo}(G, S)$ is regular, then $\mathbb{X}_{G,S}^g$ is sofic.*

Because the complement of a regular language is regular, when $\text{Geo}(G, S)$ is regular, $\mathbb{X}_{G,S}^g$ is defined by a regular set of forbidden words, and is therefore sofic. We know that $\text{Geo}(G, S)$ is regular for all generating sets in abelian groups [NS95] and hyperbolic groups [Eps+92]. Also, there exists at least one generating set such that $\text{Geo}(G, S)$ is regular for virtually abelian groups [NS95], Coxeter groups [How93] and other classes [CM04; HR12; AC16]. Proposition 3.2.4 implies that the Geodesic Infinite Snake Problem is decidable for all such (G, S) ; most notably for \mathbb{Z}^2 with its standard generating set.

Theorem 3.2.11. *The Geodesic Snake Problem is decidable for any finitely generated group (G, S) such that $\text{Geo}(G, S)$ is regular. In particular, it is decidable for abelian and hyperbolic groups for all generating sets.*

What happens with skeletal subsets that are not closed and/or not effective? Ebbinghaus showed examples of skeletal subsets whose Y -Snake Problem is outside of the arithmetical hierarchy [Ebb87]. If we define Y to be the skeletal subset of $(\mathbb{Z}^2, \{a, b\})$ of skeletons that are not eventually a straight line, then, Y is not closed, and deciding if there exists a Y -skeleton snake is Σ_1^1 -complete. Similarly, if we take the Y to be the set of non-computable skeletons of \mathbb{Z}^2 , the Y -skeleton problem is Σ_1^1 -complete.

3.3 Snake embeddings

Let us introduce a suitable notion of embedding, that guarantees the reduction of snake problems. To do this, we make use of a specific class of finite-state transducer called **invertible-reversible transducer**, that translates generators from one group to another in an automatic manner.

Definition 3.3.1. An invertible-reversible transducer \mathcal{A} is a tuple $(Q, S, T, q_0, \delta, \eta)$ where,

- Q is a finite set of states,
- S, T are finite alphabets,
- $q_0 \in Q$ is an initial state,
- $\delta : Q \times S \rightarrow Q$ is a transition function,
- $\eta : Q \times S \rightarrow T$ is such that $\eta(q, \cdot)$ is an injective function for all $q \in Q$,

such that for all $q \in Q$ and $s \in S$ there exists a unique q' such that $\delta(q', s) = q$.

We also ask for both maps, η and δ , to manage inverses of S by $\eta(q, s^{-1}) = \eta(q', s)^{-1}$ and $\delta(q, s^{-1}) = q'$, where q' is the unique state satisfying $\delta(q', s) = q$. Furthermore, we denote by q_w the state of \mathcal{A} reached after reading the word $w \in S^*$ starting from q_0 . We introduce the function $f_{\mathcal{A}} : S^* \rightarrow T^*$ recursively defined as $f_{\mathcal{A}}(\epsilon) = \epsilon$ and $f_{\mathcal{A}}(ws^{\pm 1}) = f_{\mathcal{A}}(w)\eta(q_w, s^{\pm 1})$.

Definition 3.3.2. Let (G, S) and (H, T) be two finitely generated groups. A map $\phi : G \rightarrow H$ is called a **snake-embedding** if there exists a transducer \mathcal{A} such that

- ϕ is injective,
- $\phi(\bar{w}) = \overline{f_{\mathcal{A}}(w)}$ for all $w \in S^*$.

Remark 3.3.3. A straightforward argument shows that if $\phi : (G, S) \rightarrow (H, T)$ is a snake-embedding, then $h * g = h\phi(g)$ is a translation-like action (see Section 1.3.7). The converse is not true: there are translation-like actions that are not defined by snake-embeddings. For instance, from Definition 3.3.2 we see that there is a snake embedding from \mathbb{Z} to a group G if and only if \mathbb{Z} is a subgroup of G . Nevertheless, infinite torsion groups admit translation-like actions from \mathbb{Z} , as shown by Seward in [Sew14], but do not contain \mathbb{Z} as a subgroup.

Proposition 3.3.4. *Let (G, S) and (H, T) be two finitely generated groups such that there exists a snake-embedding $\phi : G \rightarrow H$. Then, the Infinite Snake (resp. Ouroboros) Problem on (G, S) many-one reduces to the Infinite Snake (resp. Ouroboros) Problem on (H, T) .*

The reduction consists in taking a tiling graph for (G, S) and using the transducer to create a tiling graph for (H, T) that is consistent with the structure of G . Because the transducer is locally invertible, we have a computable way to transform a bi-infinite snake from one group to the other.

Proof. Let $\Gamma = (A, B)$ be a tiling graph for (G, S) . We define $\tilde{\Gamma}$, a tiling graph for (H, T) by using the transducer \mathcal{A} given by the snake embedding. The set of vertices is given by $\tilde{A} = A \times Q$, and there is an edge from (u, q_1) to (v, q_2) labeled by t if and only if there is an edge (u, v) in B labeled by s , in addition to $\delta(q_1, s) = q_2$ and $\eta(q_1, s) = t$. Because B is finite and \mathcal{A} is a finite automaton, the reduction is computable.

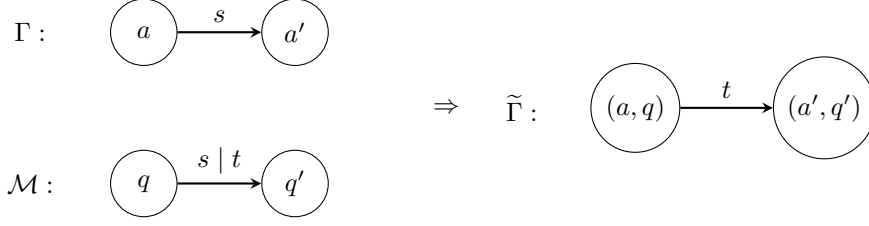

Figure 3.4: Reducing snake problems using a snake-embedding.

Now, let (ω, ζ) be a Γ -snake. We define $(\tilde{\omega}, \tilde{\zeta})$ on (H, T) by $\tilde{\omega}(i) = \phi(\omega(i))$ and $\tilde{\zeta}(i) = (\zeta(i), q_{p(i)})$, where $p(i) = d\omega_0 \dots d\omega_{i-1} \in S^*$. As both ω and ϕ are injective, $\tilde{\omega}$ is injective. Furthermore, by definition there is an edge in $\tilde{\Gamma}$ from $\tilde{\zeta}(i)$ to $\tilde{\zeta}(i+1)$, as there is one from $\zeta(i)$ to $\zeta(i+1)$ in Γ , $\delta(q_{\omega(i)}, d\omega(i)) = q_{\omega(i+1)}$ and $\eta(q_{\omega(i)}, d\omega(i)) = d\tilde{\omega}(i)$. Thus, $(\tilde{\omega}, \tilde{\zeta})$ is a $\tilde{\Gamma}$ -snake.

Conversely, let $(\tilde{\omega}, \tilde{\zeta})$ be a $\tilde{\Gamma}$ -snake such that $\tilde{\omega}(0) = 1_H$. Our objective is to find a Γ -snake (ω, ζ) such that $\tilde{\omega} = \phi(\omega)$. To do this, we introduce some notation. Let us denote $\tilde{\zeta}(i) = (q(i), u_i)$. Also, for any $q \in Q$, we denote by $\theta_q : \eta(q, S) \rightarrow S$ the inverse of the function $\eta(q, \cdot) : S \rightarrow \eta(q, S)$, which is well-defined by the injectivity of $\eta(q, \cdot)$. As $q(0)$ may not necessarily be q_0 , let $w \in S^*$ such that $q_w = q(0)$ and g the element w represents in G . Without loss of generality we can change our snake $(\tilde{\omega}, \tilde{\zeta})$ so that $\tilde{\omega}(0) = \phi(g)$. Now, define ω recursively by $\omega(0) = g$ and $\omega(i+1) = \omega(i) \cdot \theta_{q(i+1)}(d\tilde{\omega}(i))$.

Claim: $q(i) = q_{wd\omega(0)\dots d\omega(i-1)}$ and $\tilde{\omega}(i) = \phi(\omega(i))$.

We prove the claim by induction on $i \geq 0$, as the case for $i < 0$ works analogously. The base case is clear by definition, as we imposed that $q_w = q(0)$ and $\phi(\omega(0)) = \tilde{\omega}(0)$. Next, assume our hypothesis is true for all integers up to i . Because $\tilde{\zeta}(i)$ is placed next to $\tilde{\zeta}(i+1)$ along the generator $d\tilde{\omega}(i) \in T$, and we defined $d\omega(i)$ to be $\theta_{q(i+1)}(d\tilde{\omega}(i))$, the transition function δ sends $q(i)$ to $q(i+1)$ when reading $d\omega(i)$. By the induction hypothesis, $q(i)$ is the state at which we arrive after reading the word $wd\omega(0) \dots d\omega(i-1)$, and therefore $q(i+1)$ is the state at which we arrive after reading $wd\omega(0) \dots d\omega(i-1)d\omega(i)$. Finally, we have

$$\begin{aligned} \phi(\omega(i+1)) &= \phi(\omega(i) \cdot d\omega(i)) \\ &= \phi(d\omega(0) \cdot \dots \cdot d\omega(i-1) \cdot d\omega(i)) \\ &= f_{\mathcal{A}}(d\omega(0) \cdot \dots \cdot d\omega(i-1) \cdot d\omega(i)) \\ &= \phi(\omega(i))\eta(q(i+1), d\omega(i)) \\ &= \tilde{\omega}(i)\eta(q(i+1), d\omega(i)). \end{aligned}$$

As we chose $d\omega(i) = \theta_{q(i+1)}(d\tilde{\omega}(i))$, we have $\eta(q(i+1), d\omega(i)) = d\tilde{\omega}(i)$. Thus,

$$\phi(\omega(i+1)) = \tilde{\omega}(i)d\tilde{\omega}(i) = \tilde{\omega}(i+1).$$

The Claim shows that ω is injective, as ϕ is injective. Finally, we set $\zeta(i) = u_i$, that is, the second element of the ordered pair $\tilde{\zeta}(i)$. Consequently, (ω, ζ) is a Γ -snake. An analogous proof shows the result for the Ouroboros Problem. \square

Using snake-embeddings we prove that non- \mathbb{Z} finitely generated free abelian groups have undecidable snake problems.

Proposition 3.3.5. *The Infinite Snake and Ouroboros Problems on \mathbb{Z}^d with $d \geq 2$ are undecidable for all generating sets.*

Proof. Let $S = \{v_1, \dots, v_n\}$ be a generating set for \mathbb{Z}^d . As S generates the group, there are two generators v_{i_1} and v_{i_2} , such that $\mathbb{Z}v_{i_1} \cap \mathbb{Z}v_{i_2} = \{1_{\mathbb{Z}^d}\}$. Then, $H = \langle v_{i_1}, v_{i_2} \rangle \simeq \mathbb{Z}^2$ and there is a snake-embedding from \mathbb{Z}^2 to H . Finally, by Lemma 3.1.8, the Infinite Snake and Ouroboros Problems are undecidable for (\mathbb{Z}^d, S) . \square

3.4 Virtually nilpotent groups

Through the use of snake-embeddings and skeleton subshifts, we extend undecidability results from abelian groups to the strictly larger class of virtually nilpotent groups. The next lemma is stated for a class of groups that contain nilpotent groups. Recall that the **center** of a group G , $Z(G)$, is the set of elements that commute with every other element of the group (see Section 1.3.2).

Lemma 3.4.1. *Let (G, S) be a finitely generated group that contains a torsion-free element g in its center, such that $G/\langle g \rangle$ is not a torsion group. Then, there is a snake embedding from $(\mathbb{Z}^2, \{a, b\})$ into $(G, S \cup \{g\})$, where $\{a, b\}$ is the standard generating set for \mathbb{Z}^2 .*

The idea of the proof is finding a distorted copy of \mathbb{Z}^2 within $(G, S \cup \{g\})$. One of the copies of \mathbb{Z} is given by $\langle g \rangle \simeq \mathbb{Z}$. The other is obtained through the skeleton. Let us look at how to obtain this latter copy, before the proof of the lemma.

Proposition 3.4.2. *Let (G, S) be a finitely generated group. Then, G is a torsion group if and only if $\mathbb{X}_{G,S}$ is aperiodic.*

This result uses a particular case of Proposition 4.3.16, that we prove in the next chapter. Nevertheless, we include the proof of our current proposition for completeness.

Proof. Let $g \in G$ be a torsion-free element with the smallest word length. Let w be a geodesic representing g . Notice w is cyclically reduced, if not, the cyclic reduction of w would represent a shorter torsion-free element. Let us prove that w^n is G -reduced by induction over $n \geq 2$.

For the base case, suppose there exists a strict factor $w' \sqsubseteq w^2$ such that $w' =_G 1_G$. Because w is a geodesic, it does not contain factors that evaluate to the identity. Therefore, $w' = uv$ with $w = w_u u = v w_v$ for two words $w_u, w_v \in S^*$. Suppose u and v have different lengths, for instance $|v| < |u|$. Because $u =_G v^{-1}$, we have $w =_G w_u v^{-1}$ and $|w| > |w_u v^{-1}|$, which contradicts the fact that w is a geodesic. Thus, $|u| = |v|$. If their lengths are strictly bigger than $\frac{1}{2}|w|$, then the word obtained by deleting w' from w^2 will represent a torsion-free element of length strictly smaller than $|w|$. Therefore $|u| = |v| \leq \frac{1}{2}|w|$. Then, w can be written as $w = urv$ for some $r \in S^*$. But, because $v =_G u^{-1}$ we have $w =_G uru^{-1}$ which is a contradiction. This means w^2 is G -reduced.

Next, assume w^n is G -reduced for $n > 2$. Suppose there is a strict factor $w' = uw^{n-1}v \sqsubseteq w^{n+1}$ with $u, v \in S^*$, such that $w' =_G 1_G$. Because w' is a strict factor, either $|u| < |w|$ or $|v| < |w|$. Without loss of generality we assume the former. We tackle two cases separately:

- If $v = w$, we have $w' = uw^n$. Then $u =_G w^{-n}$ is torsion-free and $|u| < |w|$, which is a contradiction.
- If $|v| < |w|$, let us write $w = w_u u = v w_v$ for two words $w_u, w_v \in S^+$. Then, w' can be written as $w' = uv(w_v v)^{n-2}$. Because $w = v w_v$ is torsion-free, $w_v v$ also is, and consequently $uv =_G (w_v v)^{-(n-2)}$ is torsion-free. Notice that uv is G -reduced as it is a factor of w^2 . Because w is the smallest-torsion free element, $|u| + |v| = |uv| \geq |w|$. Similarly, as $w' =_G 1_G$ we know $w_u w_v =_G w^{n+1}$ is torsion-free and G -reduced (also a factor of w^2). Yet, we know $|w^2| = |w_u| + |u| + |v| + |w_v|$ which means $|w_u w_v| \leq |w|$. As w is the smallest torsion-free element, $|w| = |w_u| + |w_v| = |u| + |v|$. By using the fact that $w = w_u u = v w_v$, we inevitably have $w = uv$. This implies $w' = uv(w_v v)^{n-2} = w^n$, which is a contradiction.

As w^n is always G -reduced, the configuration w^∞ contains no factors that evaluate to the identity and is therefore in $\mathbb{X}_{G,S}$.

Suppose G is a torsion group and let $x \in \mathbb{X}_{G,S}$ be a periodic configuration that infinitely repeats the word w . Let $g = \bar{w}$. By definition of the skeleton subshift, $g^n = \bar{w}^n \neq 1_G$ for all $n \in \mathbb{N}$. This contradicts the fact that G is a torsion group. \square

We now prove Lemma 3.4.1 using $g \in Z(G)$ and a periodic point from the previous proposition we construct the snake-embedding.

Proof of Lemma 3.4.1. Let us take G and g as in the statement, as well as $\mathbb{Z}^2 = \langle a, b \mid [a, b] \rangle$. Because $G/\langle g \rangle = \langle S \rangle$ is not a torsion group, by Proposition 3.4.2 there exists $w \in S^*$ such that $w^\infty \in \mathbb{X}_{G/\langle g \rangle, S}$. In other words, no factors of the infinite configuration w^∞ evaluates to g^n for some $n \in \mathbb{Z}$. We construct the snake-embedding by defining the invertible-reversible transducer \mathcal{A} as follows. The set of states is $Q = \{q_0, \dots, q_{m-1}\}$, where $m = |w|$, with transition function δ such that $\delta(q_i, a) = q_i$ and $\delta(q_i, b) = q_{(i+1) \bmod m}$. The transducer is given by $\eta(q_i, a) = g$ and $\eta(q_i, b) = w_i$. These definitions guarantee that \mathcal{A} is a transducer (see Figure 3.5).

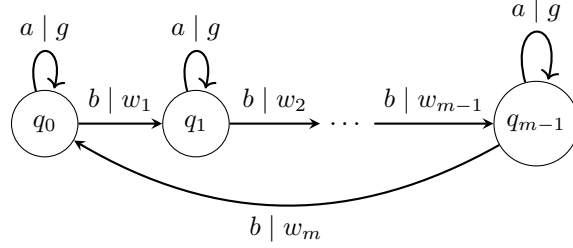

Figure 3.5: The transducer \mathcal{A} that embeds \mathbb{Z}^2 into $(G, S \cup \{g\})$. The notation $s \mid t$ represents $\eta(q, s) = t$ for the corresponding state.

Let $f = f_{\mathcal{A}}$ be the function associated to \mathcal{A} . Take $v \in \{a, b, a^{-1}, b^{-1}\}^*$. As \mathbb{Z}^2 is abelian, we can express v in the normal form $v =_{\mathbb{Z}^2} a^k b^l$ with $k = |v|_a - |v|_{a^{-1}}$ and $l = |v|_b - |v|_{b^{-1}}$. If we prove that $f_{\mathcal{A}}(v) =_G f_{\mathcal{A}}(a^k b^l)$, then the function $\phi(g) = f_{\mathcal{A}}(v)$, for any v representing $g \in \mathbb{Z}^2$, defines a snake-embedding. Indeed, because any two words v_1 and v_2 are equal in \mathbb{Z}^2 if and only if they have the same normal form, if we have such identity, ϕ will be well-defined and injective.

Let $x = w^\infty$ be the periodic configuration that specifies one of copies of \mathbb{Z} in G . By the transducer's definition, $f_{\mathcal{A}}(a^k b^l) = g^k x_{[0, l-1]}$. We will show that $f_{\mathcal{A}}(v) =_G g^k x_{[0, l-1]}$ through induction on the length of v . If $v = \epsilon$, then $f_{\mathcal{A}}(\epsilon) =_G 1_G$. Next, suppose the equality is true for all words u such that $|u| \leq n$. We arrive at different cases:

- If $v = v'a$ and v' has normal form $a^k b^l$, then $f_{\mathcal{A}}(v) = f_{\mathcal{A}}(v')\eta(q_{l \bmod m}, a) = f_{\mathcal{A}}(v')g$. By induction, we know $f_{\mathcal{A}}(v') = g^k x_{[0, l-1]}$ and thus $f_{\mathcal{A}}(v) = g^k x_{[0, l-1]}g$. But, as g is in the center of G , we can make it commute with $x_{[0, l-1]}$ arriving at $f_{\mathcal{A}}(v) =_G g^{k+1} x_{[0, l-1]}$.
- If $v = v'b$ and v' has normal form $a^k b^l$, then $f_{\mathcal{A}}(v) = f_{\mathcal{A}}(v')\eta(q_{(l+1) \bmod m}, b) = f_{\mathcal{A}}(v')w_{l \bmod m}$. By induction, we know $f_{\mathcal{A}}(v') = g^k x_{[0, l-1]}$ and thus $f_{\mathcal{A}}(v) = g^k x_{[0, l-1]}w_{l \bmod m}$. But, $x_{[0, l]} = x_{[0, l-1]}w_{l \bmod m}$, and therefore $f_{\mathcal{A}}(v) =_G g^{k+1} x_{[0, l]}$.

□

Proposition 3.4.3. *Let (G, S) be a finitely generated group that contains a torsion-free element g in its center and $G/\langle g \rangle$ is not a torsion group. Then, $(G, S \cup \{g\})$ has undecidable Infinite Snake and Ouroboros Problems.*

Proof. By Lemma 3.4.1, there is a snake-embedding from \mathbb{Z}^2 to $(G, S \cup \{g\})$. Combining Proposition 3.3.4 and Theorem 3.1.3, we conclude that both problems are undecidable on $(G, S \cup \{g\})$. □

Theorem 3.4.4. *Let (G, S) be a finitely generated non-virtually \mathbb{Z} nilpotent group. Then there exists g such that $(G, S \cup \{g\})$ has undecidable Infinite Snake and Ouroboros Problems.*

Proof. Let G be a finitely generated nilpotent group that is not virtually cyclic. Because G is nilpotent, there exists a torsion-free element $g \in Z(G)$. Furthermore, no quotient of G is an infinite torsion group (see [CMZ17]). Because G is not virtually cyclic, $G/\langle g \rangle$ is not finite. Therefore, by Proposition 3.4.3, both problems are undecidable on $(G, S \cup \{g\})$. □

Example 3.4.5. Let us look at the case where our group is the Heisenberg group H_3 with generating set $\{x^{\pm 1}, y^{\pm 1}\}$, for which we have the presentation

$$H_3 = \langle x, y \mid [x, [x, y]], [y, [x, y]] \rangle.$$

In this case, its center is given by $Z(H_3) = \langle [x, y] \rangle$. Then, if we call $z = [x, y]$, we can take the word xy that verifies $(xy)^n \notin Z(H_3)$ for all $n \neq 0$. If we follow the proof of Lemma 3.4.1, we obtain the transducer from Figure 3.6.

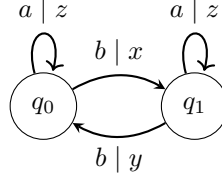

Figure 3.6: The transducer that defines a snake embedding from $(\mathbb{Z}^2, \{a^{\pm 1}, b^{\pm 1}\})$ into $(H_3, \{x^{\pm 1}, y^{\pm 1}, z^{\pm 1}\})$.

By the previous theorem, $(H_3, \{x^{\pm 1}, y^{\pm 1}, z^{\pm 1}\})$ has undecidable Infinite Snake and Ouroboros Problem.

Through Lemma 3.1.8 we obtain undecidability for virtually nilpotent groups.

Corollary 3.4.6. *Let G be a finitely generated non virtually \mathbb{Z} , virtually nilpotent group. Then there exists a finite generating set S such that (G, S) has undecidable Infinite Snake and Ouroboros Problems.*

This corollary can also be obtained from Lemma 3.1.8 but using the fact that all non virtually \mathbb{Z} virtually nilpotent groups contain \mathbb{Z}^2 as a subgroup. This same argument proves the following.

Proposition 3.4.7. *Let G be a finitely generated non virtually \mathbb{Z} , virtually nilpotent group. Then there exists a finite generating set S such that (G, S) has undecidable strong Infinite Snake and strong Ouroboros Problems.*

3.5 Snakes and logic

We want to express snake problems as formulae that can be shown to be satisfied for a large class of Cayley graphs. To do this we use Monadic Second-Order (MSO) logic, as has been previously been done for the Domino Problem. Our formalism is inspired by [Bar22].

Let $\Lambda = (V, E)$ be an S -labeled graph with root v_0 . MSO consists of variables P, Q, R, \dots that represent subsets of vertices of Λ , along with the constant set $\{v_0\}$; as well as an operation for each $s \in S$, $P \cdot s$, representing all vertices reached when traversing an edge labeled by s from a vertex in P . In addition, we can use the relation \subseteq , Boolean operators \wedge, \vee, \neg and quantifiers \forall, \exists . For instance, we can express set equality by the formula $(P = Q) \equiv (P \subseteq Q \wedge Q \subseteq P)$ and emptiness by $(P = \emptyset) \equiv \forall Q (P \subseteq Q)$. We can also manipulate individual vertices, as being a singleton is expressed by

$$(|P| = 1) \equiv P \neq \emptyset \wedge \forall Q \subseteq P (Q = \emptyset \vee P = Q).$$

For example, $\forall v \in P$ is shorthand notation for the expression $\forall Q (Q \subseteq P \wedge |Q| = 1)$. Notably, we can express non-connectivity of a subset $P \subseteq V$ by the formula $\text{NC}(P)$ defined as

$$\exists Q \subseteq P, \exists v, v' \in P (v \in Q \wedge v' \notin Q \wedge \forall u, w \in P (u \in Q \wedge \text{edge}(u, w) \Rightarrow w \in Q)),$$

where $\text{edge}(u, w) \equiv \bigvee_{s \in S} u \cdot s = w$. The set of formulas without free variables obtained with these operations is denoted by $\text{MSO}(\Lambda)$. We say Λ has **decidable** MSO logic, if the problem of determining if given a formula in $\text{MSO}(\Lambda)$ is satisfied is decidable.

The particular instance we are interested in is when Λ is the Cayley graph of a finitely generated group G labeled by S a symmetric finite set of generators. In this case, the root of our graph is the identity $v_0 = 1_G$. As mentioned in the previous chapter, a landmark result in the connection between MSO logic and tiling problems comes from Muller and Schupp [MS83; MS85], as well as Kuskey and Lohrey [KL05], who showed that virtually free groups have decidable MSO logic. In particular, the Domino Problem can be expressed in MSO logic. Given a tileset graph $\Gamma = (A, B)$, the formula

$$\text{DP}(\Gamma) \equiv \exists \{P_a\}_{a \in A} \left(V = \prod_{a \in A} P_a \wedge \bigwedge_{(a, a', s) \notin B} P_a \cdot s \cap P_{a'} = \emptyset \right),$$

is satisfied if and only if Λ can be tiled by Γ . The sets P_a represent vertices tiled by a . The expression $V = \prod_{a \in A} P_a$ represents the fact that we tile the whole group, and the expression $\bigwedge_{(a, a', s) \notin B} P_a \cdot s \cap P_{a'} = \emptyset$ that there are no forbidden patterns in the tiling. As a consequence of this formulation the Domino Problem is decidable on virtually free groups.

To express infinite paths and loops, given a tileset graph $\Gamma = (A, B)$, we partition a subset $P \subseteq V$ into subsets $P_{s,a}$ indexed by S and A , such that $P_{s,a}$ contains all vertices with the tile a that point through s to the continuation of the snake. First, we express the property of always having a successor within P as

$$N(P, \{P_{s,a}\}) \equiv \bigwedge_{s \in S, a \in A} (P_{s,a} \cdot s \subseteq P).$$

We also want for this path to not contain any loops by asking for a unique predecessor for each vertex:

$$\begin{aligned} \text{up}(v) &\equiv \exists! s \in S, a \in A : v \in P_{s,a} \cdot s, \\ &\equiv \left(\bigvee_{\substack{s \in S \\ a \in A}} v \in P_{s,a} \cdot s \right) \wedge \left(\bigwedge_{\substack{(a,s), (a',t) \in A \times S \\ (a,s) \neq (a',t)}} \neg((v \in P_{s,a} \cdot s) \wedge (v \in P_{t,a'} \cdot t)) \right). \end{aligned}$$

Then, for a one-way infinite path

$$\text{UP}(P, \{P_{s,a}\}) \equiv \forall v \in P \left((v = v_0 \wedge \bigwedge_{s \in S, a \in A} v \notin P_{s,a} \cdot s) \vee (v \neq v_0 \wedge \text{up}(v)) \right),$$

Bringing the previous expressions together, the property of having an infinite path is as follows:

$$\infty\text{RAY}(P, \{P_{s,a}\}) \equiv \left(v_0 \in P \wedge P = \prod_{\substack{s \in S \\ a \in A}} P_{s,a} \wedge N(P, \{P_{s,a}\}) \wedge \text{UP}(P, \{P_{s,a}\}) \right).$$

We express the property of having a simple loop within P by slightly changing the previous expressions. The only caveat comes when working with the symmetric finite generating set of some group, as we must avoid trivial loops such as ss^{-1} . The formula for this is

$$\ell(P, \{P_{s,a}\}) \equiv \forall v \in P, \text{up}(v) \wedge \bigwedge_{s \in S, a, a' \in A} (P_{s,a} \cdot s \cap P_{s^{-1}, a'} = \emptyset).$$

This way, admitting a simple loop is expressed as

$$\begin{aligned} \text{LOOP}(P, \{P_{s,a}\}) &\equiv \left(v_0 \in P \wedge P = \prod_{s \in S, a \in A} P_{s,a} \wedge N(P, \{P_{s,a}\}) \wedge \ell(P, \{P_{s,a}\}) \right) \\ &\quad \wedge \forall Q \subseteq P, \forall \{Q_{s,a}\} (\neg \infty\text{RAY}(Q, \{Q_{s,a}\})). \end{aligned}$$

Lemma 3.5.1. *Let $P \subseteq V$. Then,*

1. *If there exists a partition $\{P_{s,a}\}_{s \in S, a \in A}$ such that $\infty\text{RAY}(P, \{P_{s,a}\})$ is satisfied, P contains an infinite injective path. Conversely, if P is the support of an injective infinite path rooted at v_0 , there exists a partition $\{P_{s,a}\}_{s \in S, a \in A}$ such that $\infty\text{RAY}(P, \{P_{s,a}\})$ is satisfied.*
2. *If there exists a partition $\{P_{s,a}\}_{s \in S, a \in A}$ such that $\text{LOOP}(P, \{P_{s,a}\})$ is satisfied, P contains a simple loop. Conversely, if P is the support of a simple loop based at v_0 , there exists a partition $\{P_{s,a}\}_{s \in S, a \in A}$ such that $\text{LOOP}(P, \{P_{s,a}\})$ is satisfied.*

Proof. 1. Suppose $\infty\text{RAY}(P, \{P_{s,a}\})$ is satisfied for some partition $\{P_{s,a}\}$. We recursively define an injective 1-Lipschitz function $f : \mathbb{N} \rightarrow P$ that gives us our path. Start by setting $f(0) = v_0$. Because the formula is satisfied, there exists a unique $s \in S$ such that $v_0 \cdot s \in P$, and we define $f(1) = v_0 \cdot s$. Now, suppose we have already defined $f(n)$. Then, there exists a unique $s' \in S$ such that $f(n) \cdot s' \in P$; so we set $f(n+1) = f(n) \cdot s'$. Thus, f is well-defined. In addition, f is injective because if there were $n, m \in \mathbb{N}$ such that $v = f(n) = f(m)$, v would have two distinct predecessors.

Next, if P supports an infinite injective path given by $f : \mathbb{N} \rightarrow P$ with $f(0) = v_0$, for all $n \in \mathbb{N}$, there exists $s_n \in S$ such that $f(n+1) = f(n) \cdot s_n$. We define the sets $P_{s,a} = \{f(n) \mid s_n = s\}$ for a fixed $a \in A$, which partition P . Finally, as f is injective, every $v \in P$ has a unique predecessor and therefore $\infty\text{RAY}(P, \{P_{s,a}\})$ is satisfied.

2. Suppose $\text{LOOP}(P, \{P_{s,a}\})$ is satisfied for some partition $\{P_{s,a}\}$. Then, as we did for the infinite path case, we can define the function $l : \llbracket 0, n \rrbracket \rightarrow P$ with $l(0) = l(n) = v_0$, for some $n \geq 3$. This is done by using the fact that P satisfies $N(P, \{P_{s,a}\})$ (starting from v_0 we can always find a successor), and that for every subset $Q \subseteq P$ the formula $\forall \{Q_{s,a}\} \neg \infty\text{RAY}(Q, \{Q_{s,a}\})$ is satisfied (which tells us that P cannot contain the support of an infinite ray) we know such an n must exist. As before, we know l defines a simple loop because P satisfies $\ell(P, \{P_{s,a}\})$.

Finally, suppose P supports a simple loop defined by $l : \llbracket 0, n \rrbracket \rightarrow P$ with $l(0) = l(n) = v_0$. By definition, for every $i \in \llbracket 0, n-1 \rrbracket$, there exists $s_i \in S$ such that $l(i+1) = l(i) \cdot s_i$. Thus, the partition defined by the sets $P_{s,a} = \{l(i) \mid s_i = s\}$ for a fixed $a \in A$ satisfies the required properties, in virtue of P being a non-trivial simple loop. □

Remark 3.5.2. Notice that when defining $P_{s,a}$ in the previous proof, the set did not depend on a . This fact will be exploited later to tackle the strong version of these problems.

To these two structure-detecting formulas, we add the constraint that P partitions in a way compatible with the input tiling of the problem, in the direction of the snake. This is captured by the formula

$$D_\Gamma(\{P_{s,a}\}) \equiv \bigwedge_{(a,a',s) \notin B} \bigwedge_{s' \in S} P_{a,s} \cdot s \cap P_{a',s'} = \emptyset.$$

Theorem 3.5.3. *Let Λ be a Cayley graph of generating set S . The Infinite Snake Problem, the Reachability problem and the Ouroboros Problem can be expressed in MSO(Λ).*

Proof. Let $\Gamma = (A, B)$ be a tiling graph for Λ . By Lemma 3.5.1, it is clear that the two formulas

$$\infty\text{-SNAKE}(\Gamma) \equiv \exists P \exists \{P_{s,a}\} (\infty\text{RAY}(P, \{P_{s,a}\}) \wedge D_\Gamma(\{P_{s,a}\})),$$

$$\text{OUROBOROS}(\Gamma) \equiv \exists P \exists \{P_{s,a}\} (\text{LOOP}(P, \{P_{s,a}\}) \wedge D_\Gamma(\{P_{s,a}\})),$$

exactly capture the properties of admitting a one-way infinite Γ -snake and Γ -ouroboros respectively. Remember that Proposition 3.1.4 tells us that admitting a one-way infinite snake is equivalent to admitting a bi-infinite

snake. Finally, for Reachability, verifying the formula $\text{REACH}(\Gamma, p, q)$ defined as

$$\exists P \exists \{P_{s,a}\} \left(p, q \in P \wedge \neg \text{NC}(P) \wedge P = \prod_{\substack{s \in S \\ a \in A}} P_{s,a} \wedge UP(P, \{P_{s,a}\}) \wedge D_\Gamma(\{P_{s,a}\}) \right),$$

is equivalent to P containing the support of a Γ -snake that connects p to q . \square

As previously mentioned, virtually free groups have decidable MSO logic for all generating sets. Thus, we state the following corollary.

Corollary 3.5.4. *Both the normal and seeded versions of the Infinite Snake, Reachability and Ouroboros Problems are decidable on virtually free groups, independently of the generating set.*

Proof. Let $\Gamma = (A, B)$ be a tiling graph with $a_0 \in A$ the targeted tile. Then adding the clause $\bigvee_{s \in S} v_0 \in P_{s,a_0}$ to the formulas of any of the problems in question, we obtain a formula that expresses its corresponding seeded version. \square

For the strong versions of these problems; recall from Remark 3.5.2 that the structure detecting formulas do not really use the fact that the partition is indexed by A . Therefore, Lemma 3.5.1 holds for the formulas $\infty\text{RAY}(P)$ and $\text{LOOP}(P)$ that include an existential quantifier for a partition of P by subsets indexed only by S . By modifying the Domino Problem formula, $\text{DP}(\Gamma)$, to a formula $\text{DP}(\Gamma, P)$ that partitions P instead of the whole vertex set we obtain,

$$\begin{aligned} \text{STRONG-}\infty\text{-SNAKE}(\Gamma) &\equiv \exists P (\infty\text{RAY}(P) \wedge \text{DP}(\Gamma, P)), \\ \text{STRONG-OURO}(\Gamma) &\equiv \exists P (\text{LOOP}(P) \wedge \text{DP}(\Gamma, P)), \\ \text{STRONG-REACH}(\Gamma, p, q) &\equiv \exists P (p, q \in P \wedge \neg \text{NC}(P) \wedge \text{DP}(\Gamma, P)). \end{aligned}$$

Corollary 3.5.5. *Both the normal and seeded versions of the strong Infinite Snake, strong Reachability and strong Ouroboros Problems are decidable on virtually free groups, independently of the generating set.*

3.6 Discussion and open questions

In the presented results, the snake problems on a group are always defined with respect to a fixed generating set. This is not usually the case for decision problems of similar nature. Both the computability of the Domino Problem and its variants from Chapter 2 are independent of the generating set. We have seen some classes of groups for which the snake problems have this property (\mathbb{Z}^d in Proposition 3.3.5 and virtually free groups in Corollary 3.5.4), but it is not clear if this is always the case.

Question 3.6.1. Is the decidability of snake problems on a group independent of the generating set?

In [Kar02], the undecidability of the Infinite Snake Problem on \mathbb{Z}^2 is obtained through a reduction from the Domino Problem. We notice that in the presented results, the status of the Infinite Snake Problem always corresponds to that of the Domino Problem (undecidable for non-virtually \mathbb{Z} virtually nilpotent groups and decidable for virtually free groups). Is this always the case?

Question 3.6.2. Is there a group with undecidable Domino Problem and decidable Infinite Snake Problem? Is there a group where the inverse holds?

Chapter 4

Self-Avoiding Walks

Let G be a finitely generated group along with a set of generators S . In the previous chapter we defined the **skeleton** of G with respect to S as the subshift

$$\mathbb{X}_{G,S} = \{x \in S^{\mathbb{Z}} \mid \forall w \sqsubseteq x, w \notin \text{WP}(G, S)\} = \mathcal{X}_{\text{WP}(G,S)},$$

and saw that its properties influence the decidability of the Infinite Snake Problem. It turns out, the skeleton is an interesting object in itself, as it is the set of labels of bi-infinite self-avoiding walks on the Cayley graph $\Gamma(G, S)$. This is precisely the point of view we take in this chapter to study its properties.

A **self-avoiding walk** is a path on a graph that visits a vertex at most once. Figure 4.1 shows an example of a self-avoiding walk on the hexagonal grid. These walks were originally introduced by Flory for the study of long-chain polymers [Flo49]. Although his setting was the infinite square grid, self-avoiding walks are now studied in the context of infinite quasi-transitive graphs, intersecting areas such as combinatorics, probability and statistical physics. The fundamental problem in this area is the study of the asymptotic growth rate of the number of self-avoiding walks of a given length, called the connective constant. See [GL19] for a recent survey on this problem. Recently, there has been increasing interest in the study of the set of self-avoiding walks on edge-labeled graphs from the point of view of formal language theory [LW20; LL23]. We take this study further by focusing on both bi-infinite self-avoiding walks and bi-infinite geodesics on Cayley graphs of finitely generated groups.

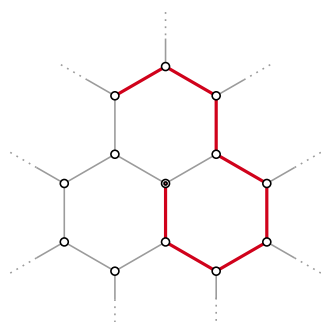

Figure 4.1: A self-avoiding walk, marked in red, on the hexagonal grid.

The skeleton is also present in Rufus Bowen's notebook of problems [Bow17, Problem 108], where he asks what can be said about $\mathbb{X}_{G,S}$, what is its entropy, and if it is intrinsically ergodic. In Section 4.2.2 we tackle the question of entropy. Further still, the skeleton is inserted in the larger project started by Jeandel and Vanier [JV19], of understanding the analogies between multidimensional subshifts and finitely generated groups, as seen in Section 1.6. The skeleton is an attempt to establish these analogies explicitly by using the generators

as an alphabet, and $WP(G, S)$ as the set of forbidden patterns. Throughout the chapter, we see that some of these analogies hold, and some do not (see Table 1.1):

- The skeleton of the free group of rank n is not the full-shift on n symbols, as it contains forbidden patterns of the form ss^{-1} for each generator.
- \mathbb{Z}^2 is a finitely presented group, but its skeleton is never an SFT. In fact, groups that admit SFT skeletons are strictly included in the class of virtually free groups (Theorem 4.3.6).
- As we saw in Proposition 3.2.5, recursively presented groups define effectively closed subshifts.
- In [BM00], Burger and Mozes give an example of a finitely presented simple torsion-free group. Nonetheless, none of its skeletons are minimal (Proposition 4.3.21).
- The skeleton of a quotient is a subgroup of the groups skeleton (Lemma 4.3.19).
- If H is a subgroup of G induced by a subset of a generating set for G , then the skeleton of H is the full-restriction (see Definition 1.6.2) of the skeleton of G (Lemma 4.3.19).

The rest of chapter is organized as follows. Section 4.1 is devoted to definitions and background on self-avoiding walks. Section 4.2 surveys general properties of the skeleton subshift, and shows how its entropy corresponds to the logarithm of the connective constant of the corresponding Cayley graph. In Section 4.3 we investigate how dynamical and computational properties of the skeleton subshift – existence of periodic configurations in $\mathbb{X}_{G,S}$, minimality of $\mathbb{X}_{G,S}$, being SFT or effective – relate to properties on the group G . Next, in Section 4.4 we provide a characterization of groups that admit sofic skeletons. To do this we work with notions from the study of thin ends, thick ends, and automorphisms of graphs. In Section 4.5 we use the skeleton to get new results on entropy and connective constants. We begin by looking at graph height functions and bridges, and their relation to periodicity in the skeleton. Then, we use Rosenfeld’s counting method to provide lower bounds on the connective constant of infinite free Burnside groups. Finally, Section 4.6 is devoted to the study of the geodesic skeleton and the geodesic connective constant.

Chapter specific notation Because in this chapter we are working exclusively with \mathbb{Z} -subshifts, we use different notation. First off, letters in a configuration will be represented by subscripts, that is, for $x \in A^{\mathbb{Z}}$, $x_k = x(k)$. Instead of patterns and sub-patterns we say that a **factor** v of a word w is a contiguous subword of w , which we denote by $v \sqsubseteq w$. For a bi-infinite word $x \in A^{\mathbb{Z}}$, given $i, j \in \mathbb{Z}$, $x_{[i,j]}$ denotes the word $x_i x_{i+1} \dots x_j$, $x_{[j,+\infty)}$ the infinite word starting at j , and $x_{(-\infty,i]}$ the infinite word finishing at i . For a word $w \in A^*$, the expression w^∞ denotes the infinite word obtained by repeating w .

4.1 Cayley graphs and self-avoiding walks

Let G be a finitely generated group along with a finite symmetric generating set S . Recall from Section 1.3.5 that the **Cayley graph** $\Gamma(G, S)$ is defined by the set of vertices $V_\Gamma = G$ and the set of labeled edges

$$E_\Gamma = \{(g, s, gs) \mid g \in G, s \in S\} \subseteq G \times S \times G,$$

where each edge $e = (g, s, h) \in E_\Gamma$ has an initial vertex $i(e) = g$, a terminal vertex $t(e) = h$ and a label $\lambda(e) = s$. If a generator has order 2, that is, if $s \in S$ satisfies $s^2 = 1_G$, we take a unique edge between g and gs for every $g \in G$. The group G acts by translation on $\Gamma(G, S)$ by left multiplication. In other words, the action of $g \in G$ over a vertex $h \in V_\Gamma$ is given by $g \cdot h = gh$. Through this action, we can identify G with a subgroup of the automorphism group of the Cayley graph.

A path π on $\Gamma(G, S)$ is a **self-avoiding walk** (SAW) if it never visits the same vertex twice. We define the language of self-avoiding walks over $\Gamma(G, S)$ as the set

$$L_{SAW}(G, S) = \{\lambda(\pi) \mid \pi \text{ is a SAW with } i(\pi) = 1_G\},$$

where $i(\pi)$ is the initial vertex of π . Remark that the language remains the same if we change the initial vertex from the identity to any other group element due to the transitivity of the graph. Furthermore, because Cayley graphs are deterministically labeled, no two SAWs share the same label. A **bi-infinite SAW** centered at $g \in G$ is a sequence of edges $\pi = (e_i)_{i \in \mathbb{Z}} \in E^{\mathbb{Z}}$ such that $i(e_{i+1}) = t(e_i)$, and $g = i(e_0)$ such that π never visits the same vertex twice. We can thus state the following.

Lemma 4.1.1. *Let G be a group and S a generating set. Then,*

$$\begin{aligned} \mathbb{X}_{G,S} &= \{\lambda(\pi) \in S^{\mathbb{Z}} \mid \pi \text{ is a bi-infinite SAW centered at } 1_G\}, \\ &= \mathcal{X}_{L_{SAW}(G,S)}^c. \end{aligned}$$

Moreover, $\mathcal{L}_{loc}(\mathbb{X}_{G,S}) = L_{SAW}(G,S)$.

Proof. This is a direct consequence of the definitions. □

Once again, as the graph is transitive, we can change the center for any other element of the group. Notice that any finite subwalk of a bi-infinite SAW is a SAW. The converse is not always true, that is, there are SAWs that do not appear in any bi-infinite SAW (see Figure 4.2).

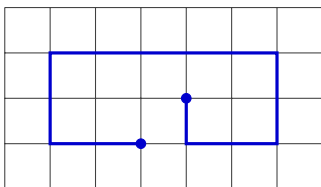

Figure 4.2: On \mathbb{Z}^2 with standard generating set: a finite SAW that does not appear in a bi-infinite SAW.

Remark 4.1.2. For the undirected Cayley graph $\hat{\Gamma}(G,S)$ we can define a labelling function λ' from the set of self-avoiding walks over $\hat{\Gamma}(G,S)$ to S^* . Take a self-avoiding walk π that passes through the sequence of vertices (g_0, g_1, \dots, g_n) , its label $\lambda'(\pi) = s_0 \dots s_{n-1}$ is such that $s_i = g_i^{-1}g_{i+1}$. This way, both $L_{SAW}(G,S)$ and $\mathbb{X}_{G,S}$ are equal to the corresponding labels of self-avoiding walks on the *undirected* Cayley graph. Because of this, in what follows we do not distinguish between the directed and undirected Cayley graphs.

4.1.1 Connective constants

Let c_n be the number of self-avoiding walks of length $n \in \mathbb{N}$ in the Cayley graph $\Gamma(G,S)$ starting at the identity. This sequence is submultiplicative, i.e. $c_{n+m} \leq c_n c_m$ for all $m, n \in \mathbb{N}$. By Fekete's Lemma, the limit of $\sqrt[n]{c_n}$ exists;

$$\mu(G,S) = \lim_{n \rightarrow \infty} \sqrt[n]{c_n} = \inf_{n \in \mathbb{N}} \sqrt[n]{c_n} \in [1, \infty).$$

This limit is known as the **connective constant** of the Cayley graph. For general quasi-transitive graphs, the limit was proven to be independent of the starting vertex by Hammersly and Morton [HM54].

In general, connective constants are hard to compute. Nevertheless, the exact value of some connective constants is known. For instance, for the hexagonal grid (which as we saw in Example 1.3.29, is a Cayley graph of the group \tilde{A}_2) its value is $\sqrt{2 + \sqrt{2}}$ [DS12], for the bi-infinite ladder (as in Figure 1.12) it is the golden mean $\frac{1}{2}(1 + \sqrt{5})$ [AJ90], and for some Cayley graphs of free products of finite groups it is the root of a polynomial [GM17]. On the other hand, giving a closed form for the connective constant of \mathbb{Z}^2 with standard generators is still an open problem. The best estimate as of writing is

$$\mu(\mathbb{Z}^2) \approx 2.63815853032790(3),$$

obtained by Jacobsen, Scullard, and Guttman [JSG16].

There are, however, bounds on the connective constant. We translate the following results from Grimmet and Li – which were stated for larger classes of graphs – to our Cayley graph context.

Theorem 4.1.3 ([GL14; GL15]). *Let G be a finitely generated group and S a generating set.*

- $\mu(G, S) \geq \sqrt{|S| - 1}$,
- For $w \neq_G 1_G$ and N its normal closure in G , $\mu(G/N, S) < \mu(G, S)$,
- For $g \notin S$ a non-identity element of G and $S' = S \cup \{g^\pm\}$, $\mu(G, S) < \mu(G, S')$.

For more bounds and details, see [GL19].

4.2 General properties

Let us begin by establishing properties of the skeleton that are common to many groups and generating sets.

4.2.1 Bi-infinite SAWs through group elements and computability

A first observation is that $\mathbb{X}_{G,S} = \emptyset$ if and only if G is a finite group; this is a consequence of König's Lemma (see [Wat86]). As we only consider infinite finitely generated groups, unless explicitly stated, the skeletons are never empty. Next, if $\pi = (e_i)_{i \in \mathbb{Z}}$ is a bi-infinite SAW on the Cayley graph $\Gamma(G, S)$, its inverse $\pi^{-1} = (e_i^{-1})_{i \in \mathbb{Z}}$ is also a bi-infinite SAW. Therefore, for each configuration $x \in \mathbb{X}_{G,S}$, its inverse configuration $x_k^{-1} = (x_k)^{-1}$ belongs to $\mathbb{X}_{G,S}$.

By definition, configurations in the skeleton $\mathbb{X}_{G,S}$ avoid words from the word problem $\text{WP}(G, S)$. But is it true that a non trivial group element necessarily appears as a word on S in $\mathcal{L}(\mathbb{X}_{G,S})$? For every finitely generated group G and every group element $g \in G$, one can find a generating set S such that this is true.

Proposition 4.2.1. *Let G be a finitely generated group. Then there exists S a generating set for G such that for every non trivial group element $g \in G$, there exists a word $w \in S^*$ such that $\bar{w} = g$ and $w \in \mathcal{L}(\mathbb{X}_{G,S})$.*

Proof. A theorem by Seward [Sew14, Theorem 1.8] states that for every finitely generated group G , there exists a finite generating set S such that the Cayley graph $\Gamma(G, S)$ has a regular spanning tree. In particular, this tree has no leaves. Therefore, each path leading to a vertex can be extended (see Figure 4.3). Consider S the generating set from the theorem, and its associated regular spanning tree for $\Gamma(G, S)$. Take a non trivial element $g \in G$ and consider the path connecting the identity 1_G to g in the regular spanning tree. Then, this finite simple path can be extended to an infinite simple path inside the spanning tree, leading to an infinite simple path going through 1_G and g . Translating this path into a bi-infinite sequence of elements from S gives a configuration of the skeleton $\mathbb{X}_{G,S}$.

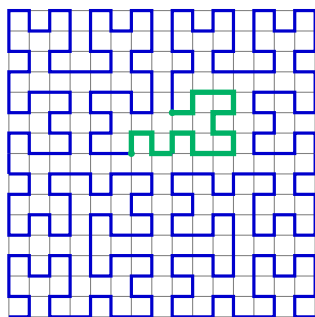

Figure 4.3: In blue, an example of regular spanning tree of degree 2 – thus a bi-infinite Hamiltonian path – for \mathbb{Z}^2 with its standard presentation. In green a path from $(0,0)$ to $(2,2)$ extracted from this regular spanning tree. Note that this path is highly non-geodesic.

□

This proposition can be made stronger for one and two ended groups. Recall from Section 1.3.5 that a Cayley graph $\Gamma = \Gamma(G, S)$ has k ends if k is the supremum of the number of infinite connected components of the induced subgraph $\Gamma[V_\Gamma \setminus A]$ over every finite subset $A \subseteq V$.

Proposition 4.2.2. *Let G be a finitely generated group with one or two ends, with S a generating set. Consider the set $S' = \{g \in G \mid \|g\|_S \leq 3\}$. Then, for every non trivial group element $g \in G$, there exists a word $w \in (S')^*$ such that $\bar{w} = g$ and $w \in \mathcal{L}(\mathbb{X}_{G,S'})$.*

Proof. In [Car23, Theorem 1.3] Carrasco-Vargas showed that for one and two ended groups, Seward's Theorem holds for S' , that is, there is a Hamiltonian path on the Cayley graph $\Gamma(G, S')$. This directly implies our statement. \square

By joining Lemmas 4.4 and 3.7 from [Car23], we state a result on the decidability of the language of the skeleton for specific generating sets.

Proposition 4.2.3. *Let G be a finitely generated group with one or two ends, with S a generating set. Suppose G has decidable word problem, and define $S' = \{g \in G \mid \|g\|_S \leq 3\}$. Then, $\mathcal{L}(\mathbb{X}_{G,S'})$ is computable.*

For a skeleton, having a computable language means that there is an algorithm that determines if a finite SAW is bi-infinitely extendable. A particular class of subshifts that have computable language are sofic subshifts. In Sections 4.3 and 4.4 we explore when skeletons belong to this class.

4.2.2 Entropy

As seen in Lemma 4.1.1, the skeleton is the set of labels of bi-infinite SAWs over a Cayley graph. Consequently, its complexity function counts the number of infinitely bi-extendable SAWs of length n , with $\alpha^\infty(\mathbb{X}_{G,S})$ being their asymptotic growth rate. Furthermore, the number of locally admissible words of length n is exactly c_n , the number of finite SAWs of length n . Therefore, by Theorem 1.4.16 we obtain the following.

Lemma 4.2.4. *For a finitely generated group G and a generating set S , $h(\mathbb{X}_{G,S}) = \log(\mu(G, S))$.*

This equality can also be deduced from [GHP14], where Grimmett et al. showed that the connective constant is equal to the growth rate of infinitely bi-extendable SAWs.

Let G be a finitely generated group, along with a generating set S , and $\gamma_{G,S} : \mathbb{N} \rightarrow \mathbb{N}$ its growth function. We define the group's asymptotic growth rate with respect to S , as the value

$$\mathfrak{H}_{G,S} = \lim_{n \rightarrow \infty} \frac{1}{n} \log(\gamma_{G,S}(n)).$$

As the growth function is sub-multiplicative (see [CC10]), $\mathfrak{H}_{G,S}$ exists by Fekete's Lemma.

Remark 4.2.5. An alternative way to look at the growth of a group is the **strict growth function** $\sigma_{G,S}$, where $\sigma_{G,S}(n)$ is the number of elements of length *exactly* n . As is the case for the growth function, $\sigma_{G,S}$ is sub-multiplicative. Its asymptotic growth rate is the same as that of $\gamma_{G,S}$, namely $\mathfrak{H}_{G,S}$. This can be seen through their generating functions. Take $F, f : \mathbb{C} \rightarrow \mathbb{C}$ defined as

$$F(z) = \sum_{n \in \mathbb{N}} \gamma_{G,S}(n) z^n, \quad f(z) = \sum_{n \in \mathbb{N}} \sigma_{G,S}(n) z^n.$$

By the Cauchy-Hadamard theorem we know that the asymptotic growth rate of $\gamma_{G,S}$ (resp. $\sigma_{G,S}$) is the reciprocal of the radius of convergence of F (resp. f). Strict growth can be expressed as $\sigma_{G,S}(n) = \gamma_{G,S}(n) - \gamma_{G,S}(n-1)$, with the convention that $\gamma_{G,S}(-1) = 0$, we get that $f(x) = (1-x)F(x)$. As the term $(1-x)$ does not change the radius of convergence of the series, we have that

$$\lim_{n \rightarrow \infty} \frac{\log(\sigma_{G,S}(n))}{n} = \mathfrak{H}_{G,S}.$$

Proposition 4.2.6. *Let G be a finitely generated group with S a generating set. Then,*

$$\mathfrak{H}_{G,S} \leq h(\mathbb{X}_{G,S}) \leq \log(|S| - 1).$$

Proof. Let $p(n)$ be the complexity function for $\mathbb{X}_{G,S}$ and $k = |S|$. For the upper bound, notice that the total number of reduced words of length n over S is exactly the number of elements of length n in free group \mathbb{F}_m , with $m = \lceil \frac{k}{2} \rceil$. Therefore,

$$p(n) \leq \gamma_{\mathbb{F}_m}(n) - \gamma_{\mathbb{F}_m}(n-1) = k(k-1)^{n-1}.$$

On the other hand, every element of length n has a geodesic representative of length n , which by definition is G -reduced. In particular, this representative is a SAW of length n . Thus, $\sigma_{G,S}(n) \leq c_n$ and

$$\mathfrak{H}_{G,S} = \lim_{n \rightarrow \infty} \frac{\log(\sigma_{G,S}(n))}{n} \leq \log(\mu(G, S)).$$

□

Remark 4.2.7. The bounds from Proposition 4.2.6 are tight in general, as free groups with free generating sets satisfy $\mathfrak{H}_{\mathbb{F}_m,S} = h(\mathbb{X}_{\mathbb{F}_m,S}) = \log(2m-1)$. Nevertheless, by Theorem 4.1.3 we know that for non-free groups $h(\mathbb{X}_{G,S}) < \log(2m-1)$ for all generating sets. This same theorem also tells us that for groups with polynomial growth the lower bound is strict, as

$$0 = \mathfrak{H}_{G,S} < \frac{1}{2} \log(|S| - 1) \leq h(\mathbb{X}_{G,S}).$$

Another straightforward bound we find from algebraic considerations is the following.

Proposition 4.2.8. *Take G a finitely generated group and S generating set. If $\{s_1, \dots, s_n\} \subseteq S$ is a subset of generators such that there induced semigroup $\langle s_1, \dots, s_n \rangle_+$ does not contain the identity, then $h(\mathbb{X}_{G,S}) \geq \log(n)$.*

Proof. If $\langle s_1, \dots, s_n \rangle_+$ does not contain the identity, any combination of these generators will give a word that does not contain factors that evaluate to the identity. In other words, the skeleton contains the full-shift $\{s_1, \dots, s_n\}^{\mathbb{Z}}$. Consequently, $h(\mathbb{X}_{G,S_n}) \geq \log(n)$. □

Example 4.2.9. Take \mathbb{Z}^2 with its standard generating set $\{\mathbf{a}^\pm, \mathbf{b}^\pm\}$. Then, the semigroup generated by \mathbf{a} and \mathbf{b} does not contain the identity. Then, $h(\mathbb{X}_{\mathbb{Z}^2, \{\mathbf{a}^\pm, \mathbf{b}^\pm\}}) \geq \log(2)$. Similarly, if we take the discrete Heisenberg group H_3 with generating set $\{\mathbf{a}^\pm, \mathbf{b}^\pm, \mathbf{c}^\pm\}$ through the presentation,

$$H_3 = \langle \mathbf{a}, \mathbf{b}, \mathbf{c} \mid [\mathbf{a}, \mathbf{c}], [\mathbf{b}, \mathbf{c}], [\mathbf{a}, \mathbf{b}]\mathbf{c}^{-1} \rangle,$$

the semigroup given by the three generators \mathbf{a}, \mathbf{b} and \mathbf{c} does not contain the identity. Then, by the previous proposition $h(\mathbb{X}_{H_3, \{\mathbf{a}^\pm, \mathbf{b}^\pm, \mathbf{c}^\pm\}}) \geq \log(3)$.

Remark 4.2.10. Given a group G , the entropy of its skeleton can be made arbitrarily large. This is done by taking larger and larger generating sets and using the lower bound $\sqrt{|S|} - 1$ given by Theorem 4.1.3. This can also be done in torsion-free groups by taking a torsion-free element $g \in G$, a generating set containing $\{g, g^2, \dots, g^n\}$ and using the previous proposition.

In Section 4.5 we look at methods to approximate entropy and connective constants for different classes of groups.

4.3 Dynamic and computational aspects

The goal of this section is to explore the multiple dynamical and computational properties of skeletons, and how they interact with the algebraic properties of the underlying group. We look at groups that admits SFT, sofic, effective or minimal skeletons, as well as their periodic points.

A subshift can be defined by various different sets of forbidden patterns. We saw from its definition and Lemma 4.1.1 that $\mathbb{X}_{G,S}$ is defined by at least two different sets, namely $L_{SAW}(G, S)$ and $WP(G, S)$. We begin by describing an additional set that helps us better understand the structure of forbidden patterns.

We begin by looking at the set of patterns that define simple cycles (also called embedded cycles) in the Cayley graph. We define the set of labels of simple cycles of a group G with respect to a finite generating set S as

$$\begin{aligned} \mathcal{O}_{G,S} &= \{w \in WP(G, S) \mid w \text{ defines a simple cycle in } \Gamma(G, S)\} \\ &= \{w \in WP(G, S) \mid \forall w' \sqsubseteq w, w' \notin WP(G, S)\}. \end{aligned}$$

Example 4.3.1. Consider \mathbb{Z}^2 with its standard presentation $\langle a, b \mid [a, b] \rangle$. Then the word $aba^{-3}b^{-1}abab^{-1}$ is in $WP(\mathbb{Z}^2, \{a, b\})$ but not in $\mathcal{O}_{\mathbb{Z}^2, \{a, b\}}$ since there are repeated vertices in the path it represents in $\Gamma(\mathbb{Z}^2, \{a, b\})$.

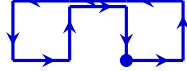

We call elements of $\mathcal{O}_{G,S}$ **self-avoiding polygons** (SAPs) of the Cayley graph of $\Gamma(G, S)$.

Remark 4.3.2. The set $\mathcal{O}_{G,S}$ is the analog of the skeleton for the ouroboros problem (see Section 3.1), in the sense that for any ouroboros, (ω, ζ) , the word representing its path $d\omega$ is in $\mathcal{O}_{G,S}$.

Lemma 4.3.3. *Let $\mathcal{F} = \mathcal{O}_{G,S} \cup \{ss^{-1} \mid s \in S\}$. Then, $\mathbb{X}_{G,S} = \mathcal{X}_{\mathcal{F}}$.*

Proof. Since $\mathcal{O}_{G,S} \subseteq WP(G, S)$ and $\{ss^{-1} \mid s \in S\} \subseteq WP(G, S)$, we have that $\mathcal{F} \subseteq WP(G, S)$. So, the subshifts defined by two sets respect the reciprocal inclusion, and we have $\mathbb{X}_{G,S} \subseteq \mathcal{X}_{\mathcal{F}}$.

Reciprocally, take some configuration $x \in \mathcal{X}_{\mathcal{F}}$ and assume it contains some pattern $w \in WP(G, S)$. Without loss of generality we assume that $w = s_1 \dots s_n$ for some $n \in \mathbb{N}$, so that $\bar{s}_1 \dots \bar{s}_n = 1_G$. Consider the group elements g_i defined by $g_i = \bar{s}_1 \dots \bar{s}_i$ for $i \in \{1 \dots n\}$ and $g_0 = 1_G$. Since $x \in \mathcal{X}_{\mathcal{F}}$ the pattern w does not belong to $\mathcal{O}_{G,S} \cup \{ss^{-1} \mid s \in S\}$. So necessarily $n > 1$ and there are some repetitions among the g_i 's in addition to $g_0 = g_n$. Take two indices i, j such that $i < j$, $\{i, j\} \neq \{0\}, \{n\}, \{0, n\}$ (at least one of the two indices is neither 0 nor n), $g_i = g_j$, and i, j are minimal for this property. Then the word $s_i \dots s_j$ defines a cycle in $\Gamma(G, S)$, which contradicts our original assumption. Finally, $x \in \mathbb{X}_{G,S}$, which concludes the proof. \square

This alternative set of forbidden patterns for $\mathbb{X}_{G,S}$ will be particularly helpful in the proof of Theorem 4.3.6, where we characterize groups G which admit a generating set S such that $\mathbb{X}_{G,S}$ is an SFT and also in Section 4.5.2.

4.3.1 SFT skeletons

To find SFTs, we start with a warm-up lemma that contains the central idea used in our classification.

Lemma 4.3.4. *$\mathbb{X}_{\mathbb{Z}^d, S}$ is not an SFT for $d \geq 2$ and any generating set S .*

Proof. Let S be a generating set for \mathbb{Z}^d and suppose \mathcal{F}' is a finite set of forbidden patterns such that $\mathbb{X}_{\mathbb{Z}^d, S} = \mathcal{X}_{\mathcal{F}'}$. Then, as S generates the group, there must exist $s_1, s_2 \in S$ such that $\langle s_1 \rangle \cap \langle s_2 \rangle = \{1_{\mathbb{Z}^d}\}$, and $\langle s_1, s_2 \rangle \simeq \mathbb{Z}^2$. Let us denote $N = \max_{w \in \mathcal{F}'} |w|$. Take the SAP defined by the square of length $2N$ on the first two generators $w = s_1^{2N} s_2^{2N} s_1^{-2N} s_2^{-2N}$. Notice that no factors of w^2 of length N belong to \mathcal{F}' as they are all globally admissible in $\mathbb{X}_{\mathbb{Z}^d, S}$. Let $x = w^\infty$. Clearly $x \notin \mathbb{X}_{\mathbb{Z}^d, S}$, as it contains w which satisfies $\bar{w} = 1_G$. Nevertheless, no factor of x of length N is contained in \mathcal{F}' . Therefore $x \in \mathcal{X}_{\mathcal{F}'}$, which is a contradiction. \square

The main idea of this lemma is using arbitrarily large cycles that are locally self-avoiding. This way, it is not possible to detect that the path eventually crosses itself using a finite window. Which groups admit generating sets that define SFT skeletons then? Let us show that this is the case of a specific class of virtually free groups.

Definition 4.3.5. A group G is **plain** if there exist finite groups $\{G_i\}_{i=1}^k$ and $m \in \mathbb{N}$ such that G is isomorphic to the free product,

$$\left(\bigstar_{i=1}^k G_i \right) * \mathbb{F}_m.$$

We say a generating set S for G is **standard** if it is the disjoint union $S = S_1 \cup \dots \cup S_k \cup S_{k+1}$ where S_i is a generating set for G_i and S_{k+1} is a free generating set for \mathbb{F}_m .

Theorem 4.3.6. *Let G be a finitely generated group. Then, there exists a finite generating set S such that $\mathbb{X}_{G,S}$ is an SFT if and only if G is a plain group.*

In order to prove this theorem we use a characterization of plain groups with respect to their simple cycles. The **diameter** of a simple cycle is the greatest distance between two vertices in the cycle. A vertex v in $\Gamma(G, S)$ is said to be a **cut vertex** if $\Gamma(G, S) \setminus \{v\}$ is disconnected. A graph is said to be **2-connected** if it contains no cut vertices. A maximal 2-connected subgraph is called a **block**.

Theorem 4.3.7 ([Har83]). *Let G be a group and $m \in \mathbb{N}$. Then, the following are equivalent*

- G admits a finite generating set S such that all simple cycles in the undirected Cayley graph $\Gamma(G, S)$ have diameter at most m ,
- G admits a finite generating set S such that all blocks in the undirected Cayley graph $\Gamma(G, S)$ have diameter at most m ,
- G is a plain group.

Proofs of this Theorem can be found in [Har83; EP22].

Proof of Theorem 4.3.6. Let G be a plain group decomposed as $\left(\bigstar_{i=1}^k G_i \right) * \mathbb{F}_m$ with $S = S_1 \cup \dots \cup S_{k+1}$ a standard generating set. Due to its free product structure, any word $w \in S^*$ can be uniquely decomposed as $w = w_1 w_2 \dots w_r$ where,

- $w_j \in S_i^*$ for some i , for all $j \in \{1, \dots, r\}$;
- w_j and w_{j+1} are words over different alphabets for all $j \in \{1, \dots, r-1\}$.

If $\bar{w} = 1_G$, by our decomposition, $\bar{w}_j = 1_G$ for every j . This means every SAP from G must be entirely contained in one of the finite groups G_i , as \mathbb{F}_m has no SAPs with its free generating set. Therefore, $\mathcal{O}_{G,S}$ is finite because the number of SAPs in each finite group is finite. By Lemma 4.3.3, $\mathbb{X}_{G,S}$ is an SFT.

Now, let G be a finitely generated group with S such that $\mathbb{X}_{G,S}$ is an SFT, defined by the finite set of forbidden patterns \mathcal{F} . If G is not a plain group, by Theorem 4.3.7, the Cayley graph $\Gamma(G, S)$ contains arbitrarily large simple cycles, and therefore arbitrarily large SAPs. Next, we can assume without loss of generality that every word in \mathcal{F} has the same length, say $N \geq 1$. If $\mathcal{F} \subseteq \text{WP}(G, S)$, take a SAP W of length greater than $N + 1$. Because SAPs contain no strict factors that belong to $\text{WP}(G, S)$ and every cyclic permutation of the word defining a SAP is itself a SAP, the configuration $x = W^\infty$ does not contain any word from \mathcal{F} . Therefore $x \in \mathcal{X}_{\mathcal{F}} \setminus \mathbb{X}_{G,S}$, which is a contradiction. Suppose there are elements in \mathcal{F} that are not in $\text{WP}(G, S)$. As \mathcal{F} contains forbidden patterns and $\mathcal{X}_{\mathcal{F}} = \mathbb{X}_{G,S}$, for every word $w \in \mathcal{F}$ there exists $N_w \in \mathbb{N}$ such that either for every $v \in S^{N_w}$ the word wv contains a factor from $\text{WP}(G, S)$, or for every $v \in S^{N_w}$ the word vw contains a factor from $\text{WP}(G, S)$. Let $M = \max_{w \in \mathcal{F}} N_w$ and take W a SAP of length $M + N + 2$. Once again, because every SAP contains no strict factors that belong to $\text{WP}(G, S)$ and every cyclic permutation of the word defining

the SAP is itself a SAP, the configuration $x = W^\infty$ contains no factors from \mathcal{F} . Indeed, if there is a $w \in \mathcal{F}$ such that $w \sqsubseteq W$ we can take the cyclic permutation of W such that w is a prefix. Thus, w can be extended by a word v of length $M + 1$ such that wv contains no factor in $\text{WP}(G, S)$. As a consequence $x \in \mathcal{X}_{\mathcal{F}} \setminus \mathbb{X}_{G,S}$, which is a contradiction. \square

As plain groups admit SFT skeletons, we have an effective procedure to calculate the connective constant of their Cayley graphs. As mentioned in Section 1.4.2, entropies of SFTs are non-negative rational multiples of logarithms of Perron numbers (see Theorem 4.4.4 [LM21]). Thus, we can slightly improve Corollary 3.4 from [GM17] in the case of (plain) groups.

Corollary 4.3.8. *Let G be a plain group with S a standard set of generators. Then, $\mu(G, S)$ is a non-negative rational power of a Perron number.*

Let us sketch how to compute the connective constant using SFTs. Let $\mathbb{X}_{G,S}$ be the skeleton of the plain group $G = (\star_{i=1}^k G_i) * \mathbb{F}_m$ and \mathcal{F} be the finite set of patterns defining it. Recall from Theorem 4.3.6 that this set corresponds to the SAPs on each individual group G_i as well as the words ss^{-1} for all $s \in S$. Let N be the length of the biggest word in \mathcal{F} . We can extend \mathcal{F} to \mathcal{F}' so that all words have length N . The Rauzy graph $R_N(G, S)$ of order N of $\mathbb{X}_{G,S}$ is the finite directed graph whose vertices are labeled by the language of size N of the skeleton $\mathcal{L}_N(\mathbb{X}_{G,S})$, and edges are labeled with $\mathcal{L}_{N+1}(\mathbb{X}_{G,S})$. There is an edge labeled by w from u to v if u is the prefix of length N of w and v is the suffix of length N of w . We denote the adjacency matrix of the graph R_N by M_N , that is, if $\mathcal{L}_N(\mathbb{X}_{G,S}) = \{u_1, \dots, u_\ell\}$, the entry $M_N(i, j)$ represents the number of edges in R_N from u_i to u_j . Then the connective constant of $\Gamma(G, S)$ is the logarithm of the dominant eigenvalue of M_N , which exists by Perron-Frobenius' Theorem.

Example 4.3.9. Take S_3 the symmetric group on 3 elements with generating set $\mathbf{s}_1 = (1\ 2)$ and $\mathbf{s}_2 = (1\ 3)$, and the cyclic group $\mathbb{Z}/3\mathbb{Z} = \langle \mathbf{t} \rangle$. Then, the skeleton of the plain group $G = S_3 * \mathbb{Z}/3\mathbb{Z}$ with respect to $S = \{\mathbf{s}_1, \mathbf{s}_2, \mathbf{t}^{\pm 1}\}$ is defined by the forbidden patterns,

$$\mathcal{F} = \{\mathbf{s}_1^2, \mathbf{s}_2^2, (\mathbf{s}_1\mathbf{s}_2)^3, \mathbf{t}^3, \mathbf{t}\mathbf{t}^{-1}, \mathbf{t}^{-1}\mathbf{t}\}.$$

We obtain that the connective constant $\mu = \mu(G, \{\mathbf{s}_1, \mathbf{s}_2, \mathbf{t}^{\pm 1}\})$ is the solution of the polynomial equation

$$x^7 - 4x^5 - 8x^4 - 8x^3 - 8x^2 - 8x - 4 = 0,$$

obtained from the characteristic polynomial of the matrix described above, which is approximately $\mu \approx 2.8698315$.

The skeletons of plain groups with respect to their standard generating sets also have nice dynamical properties. We say a subshift $X \subseteq A^{\mathbb{Z}}$ is **irreducible** if for every $w_1, w_2 \in \mathcal{L}(X)$, there exists some $w \in \mathcal{L}(X)$ such that $w_1 w w_2 \in \mathcal{L}(X)$.

Proposition 4.3.10. *Let G be a plain group with standard generating set S . Then, $\mathbb{X}_{G,S}$ is irreducible.*

Proof. Decompose G as $(\star_{i=1}^k G_i) * \mathbb{F}_m$ with $S = S_1 \cup \dots \cup S_{k+1}$ a standard generating set. Take $w_1, w_2 \in \mathcal{L}(\mathbb{X}_{G,S})$ appearing at position 0 of the configurations $x^{(1)}, x^{(2)} \in \mathbb{X}_{G,S}$ respectively. There is a unique decomposition for each word: $w_i = w_1^i w_2^i \dots w_{r_i}^i$, where

- $w_j^i \in S_i^*$ for some l , for all $j \in \{1, \dots, r_i\}$;
- w_j^i and w_{j+1}^i are words over different alphabets for all $j \in \{1, \dots, r_i - 1\}$.

If $w_{r_1}^1, w_1^2 \in S_i^*$, take any generator $s \in S_j$ for $j \neq i$ and define $x = x_{(-\infty, 0]}^{(1)} w_1 s w_2 x_{[|w_2|, +\infty)}^{(2)}$. Because we chose a generator that does not belong to G_i , and $x^{(1)}$ and $x^{(2)}$ belong to the skeleton, x must also belong to the skeleton. This implies, $w_1 s w_2 \in \mathcal{L}(\mathbb{X}_{G,S})$. If instead $w_{r_1}^1 \in S_i^*$ and $w_1^2 \in S_j^*$ for $i \neq j$, take $s \in S_j$ and $s' \in S_i$ to define $y = x_{(-\infty, 0]}^{(1)} w_1 s s' w_2 x_{[|w_2|, +\infty)}^{(2)}$. As before, y must belong to $\mathbb{X}_{G,S}$. This means, $w_1 s s' w_2 \in \mathcal{L}(\mathbb{X}_{G,S})$. \square

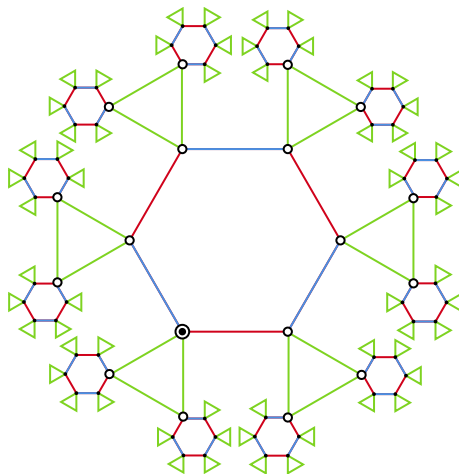

Figure 4.4: A portion of the Cayley graph of the plain group $S_3 * \mathbb{Z}/3\mathbb{Z}$. The two generators for S_3 are pictured in red and blue; the generator for $\mathbb{Z}/3\mathbb{Z}$ is pictured in green.

Corollary 4.3.11. *For G a plain group with standard generating set S , the set of periodic configurations of $\mathbb{X}_{G,S}$ is dense in $\mathbb{X}_{G,S}$. In other words, any bi-infinitely extendable SAW on $\Gamma(G, S)$ appears in a periodic bi-infinite SAW. Furthermore,*

$$\mu(G, S) = \lim_{n \rightarrow \infty} \sqrt[n]{e_n},$$

where e_n denotes the number of periodic points in $\mathbb{X}_{G,S}$ of period $n \in \mathbb{N}$.

This corollary states a general property of irreducible subshifts of finite type, namely, its set of periodic configurations is dense and its entropy is approximated through its periodic points [LM21]. We obtain a similar expression for the connective constants of Cayley graphs whose skeletons is not an SFT in Section 4.5.

4.3.2 Effective skeletons

Let us briefly look at the case of effective skeletons. We know that recursively presented groups have recursively enumerable word problem (Proposition 1.3.15). $\text{WP}(G, S)$ is thus recursively enumerable for all finite generating sets. This enumeration gives us an enumeration of the forbidden patterns of our skeleton.

We already saw in Proposition 3.2.5 that every skeleton of a recursively presented group is effective. A particular consequence of this, is that for recursively presented groups $\mu(G, S)$ is a right computable real number (Theorem 1.4.19).

In order to approach a characterization, we give a computational upper bound of the word problem of the group in terms of the computability of finite SAWs on the Cayley graph.

Lemma 4.3.12. *The word problem for G with respect to a generating set S is decidable given an algorithm for $L_{\text{SAW}}(G, S)^c$.*

Proof. We describe a procedure to compute the word problem of G given an algorithm that determines if a word belongs to $L = L_{\text{SAW}}(G, S)^c$. We begin with an algorithm that computes all words $w \in S^{\leq n}$ such that $w \in \text{WP}(G, S)$ given n . This algorithm, which we call \mathcal{M} , is shown in Algorithm 2.

Let us show the output of \mathcal{M} on n is $\text{WP}(G, S) \cap S^{\leq n}$. Let T_i be the set T in the algorithm after the first i iterations of the **for** loop, for $i \in \{2, \dots, n\}$. We claim $T_i = \text{WP}(G, S) \cap S^{\leq i}$. First off, every non-self avoiding path of length two must represent the identity. Thus, $T_2 = \text{WP}(G, S) \cap S^2$. Now, suppose we have the equality for T_i . Take $w \in \text{WP}(G, S) \cap S^{i+1}$. This implies $w \in L$, and as seen in Lemma 4.3.3, it must represent a simple cycle, contain a shorter simple cycle, or a word of the form ss^{-1} . In the first case, w contains no factors from

Algorithm 2: \mathcal{M}

```

Input:  $n \geq 2$ 
 $T \leftarrow \emptyset$ ;
for  $w \in S^2$  do
    if  $w \in L$  then
         $T \leftarrow T \cup \{w\}$ ;
    end
end
for  $i \in \{3, \dots, n\}$  do
    for  $w \in S^i$  do
        if  $w \in L$  then
            if  $w$  contains no factors from  $T$  then
                 $T \leftarrow T \cup \{w\}$ ;
            end
            for  $v \in T$  do
                Delete  $v$  from  $w$  if present, to obtain  $w'$ ;
                if  $w' \in T$  then
                     $T \leftarrow T \cup \{w\}$ ;
                end
            end
        end
    end
end
return  $T$ ;
    
```

T_i and is therefore added to T_{i+1} . In the other two cases, it contains a factor from T_i that after being deleted creates a word that belongs to $\text{WP}(G, S) \cap S^{\leq i} = T_i$. Therefore, $w \in T_{i+1}$. Conversely, if $w' \in T_{i+1} \setminus T_i$ we know $w \in L$. If w was added to T_{i+1} because it contains no factors from T_i , it must represent a simple loop and is therefore in $\text{WP}(G, S)$. On the other hand, if w was added after deleting a factor from T_i , w is made up of a word representing the identity with a factor representing the identity inserted into it. This means, $w \in \text{WP}(G, S)$ and therefore $T_{i+1} = \text{WP}(G, S) \cap S^{\leq i+1}$.

Finally, to determine if a given word w belongs to $\text{WP}(G, S)$, we run \mathcal{M} on the input $|w|$, and see if it is present in T . \square

As a consequence, if $L_{SAW}(G, S)$ is co-recursively enumerable, the word problem of G must be in Δ_2^0 on the arithmetical hierarchy (see Definition 1.2.12). This is the case when $\mathbb{X}_{G^*H, S}$ is effective for H any finitely generated group, and $S = S_G \cup S_H$ with S_G, S_H generating sets for G and H respectively.

Conjecture 4.3.13. A group is recursively presented if and only if there exists a finite generating set S such that $\mathbb{X}_{G, S}$ is effective.

Even though recursively presented groups define subshifts that are effective, if the structure of the underlying group is computationally complex, the configurations of the skeleton may be uncomputable. We say a configuration $x \in S^{\mathbb{Z}}$ is **computable** if there is an algorithm that on input $n \in \mathbb{Z}$ computes $x_n \in S$.

Definition 4.3.14. A finitely generated group G and generating set S are said to be **algorithmically finite** if for every $L \subseteq \mathbb{F}_S$ recursively enumerable set, there exist infinitely many pairs of distinct words $u, v \in L$ such that $\pi(u) = \pi(v)$, where $\pi : \mathbb{F}_S \rightarrow G$ is the canonical projection. We say G is a **Dehn Monster** if it is infinite, recursively presented and algorithmically finite.

This class of groups was introduced by Myasnikov and Osin in [MO11], where they showed that Dehn Monsters exist. Furthermore, they showed that being algorithmically finite does not depend on the generating set.

Proposition 4.3.15. *Let G be a Dehn Monster. Then $\mathbb{X}_{G,S}$ is effective for any finite generating set S , but no configuration in $\mathbb{X}_{G,S}$ is computable.*

Proof. As the properties of being infinite, recursively presented and algorithmically finite are independent of the generating set, we take any generating set S for G . If there existed a computable configuration $x \in \mathbb{X}_{G,S}$, we could recursively enumerate the set of words $L = \{x_{[0,n-1]} \in S^* \mid n \geq 1\}$. Then for any $u, v \in L$, $\pi(u) \neq \pi(v)$. If not, we would arrive at $x_{[0,n-1]} =_G x_{[0,m-1]}$ for some $n > m \geq 1$, which implies $x_{[n,m-1]} =_G \varepsilon$. Therefore, any pair of elements in L maps to a different element through π , which contradicts the algorithmic finiteness of G . \square

4.3.3 Periodic configurations

Configurations of particular importance in the study of subshifts are periodic configurations. Recall that a configuration $x \in \mathbb{X}_{G,S}$ is periodic if there exists $k \in \mathbb{Z} \setminus \{0\}$ such that $x_{i+k} = x_i$ for all $i \in \mathbb{Z}$. Such a configuration has a rigid structure, if we take $w = x_{[0,k-1]}$ the configuration is the bi-infinite repetition of w , i.e. $x = w^\infty$. We will see that the existence of periodic points in the skeleton imposes strong restrictions on the structure of the underlying group.

In Proposition 3.4.2 we showed that for any finitely generated group with a torsion-free element, the skeleton contains a periodic point. The periodic configuration was obtained by iterating any geodesic of the torsion-free element with the smallest length in the group. By re-interpreting the proof of [Hal73, Theorem 7] we obtain the following generalization.

Proposition 4.3.16. *Let G be a finitely generated group. Take a generating set S , a torsion-free element $g \in G$, and $k = \operatorname{argmin}\{\|g^n\|_S \mid n \geq 1\}$. Then, for any geodesic $w \in S^*$ representing g^k , the configuration w^∞ belongs to $\mathbb{X}_{G,S}$ and is a bi-infinite geodesic.*

Proof. Fix a generating set S and $g \in G$ torsion-free. Let $k \geq 1$ be as in the statement of the result, and denote $h = g^k$. Take a geodesic $w \in S^*$ for h and let $\pi = (e_0, \dots, e_{n-1})$ be the (self-avoiding) walk starting at the identity in the Cayley graph, of label w and $|w| = n$. Let Π be the bi-infinite walk made by concatenating the paths $h^m \cdot \pi$, for all $m \in \mathbb{Z}$. Thus, $\lambda(\Pi) = w^\infty$. We claim Π is self-avoiding. Suppose it is not, and take the smallest $m \in \mathbb{N}$ such that w^m does not represent a SAW. Let π_i denote the walk $h^i \cdot \pi$ where $i(\pi_i) = h^i$ and $t(\pi_i) = h^{i+1}$. As m is minimal, we know the concatenated walks $\pi_0 \dots \pi_{m-1}$ and $\pi_1 \dots \pi_m$ are self-avoiding, and therefore the first intersection must occur between π_0 and π_m . Then, there exists $v, u \sqsubseteq w$ prefixes, and $f \in \pi_0 \cap \pi_m$ such that $f = \bar{v} = h^{m-1}\bar{u}$. Once again, because m is minimal, $f \neq h, h^{m-1}$. If we compute the distance,

$$d_S(f, h^{m-1}f) = d_S(\bar{u}, \bar{v}) \leq |w|,$$

as k was chosen to minimize $\|g^k\|_S$, the distance between f and $h^{m-1}f$ must be $|w|$. As both vertices are in π_m , this is only possible if $f = h^m$ and $h^{m-1}f = h^{m-1}$. Thus $h^m = 1_G$, which is a contradiction as h is torsion-free. Therefore, $w^\infty \in \mathbb{X}_{G,S}$. Finally, as we chose k to minimize the distance to the identity of powers of g , w^n must be a geodesic for all $n \in \mathbb{N}$. \square

We re-state and re-prove Proposition 3.4.2 for completion.

Theorem 4.3.17. *Let G be a finitely generated group. Then, G is a torsion group if and only if $\mathbb{X}_{G,S}$ is aperiodic for every (any) generating set.*

Proof. Suppose G is a torsion group and let $x \in \mathbb{X}_{G,S}$ be a periodic configuration that infinitely repeats the word w . Let $g = \bar{w}$. By definition of the skeleton, $g^n = \bar{w}^n \neq 1_G$ for all $n \in \mathbb{N}$. This contradicts the fact that G is a torsion group. Conversely, if G has a torsion-element, by Proposition 4.3.16, $\mathbb{X}_{G,S}$ contains a periodic point. \square

Corollary 4.3.18. *If G is a finitely generated torsion group, then for all generating sets $X_{G,S}$ is not sofic.*

Proof. If G is a finitely generated torsion group, Theorem 4.3.17 tells us that none of its skeletons contain periodic configurations. Because non-empty sofic shifts always contain periodic configurations, no skeleton of G can be sofic. \square

4.3.4 Minimality

Our next objective is to find sufficient and necessary properties for the skeleton to be minimal. We begin by identifying possible subshifts of $X_{G,S}$.

Lemma 4.3.19. *Let G be a finitely generated group. Then,*

- *For a symmetric subset $S' \subseteq S$ and $H = \langle S' \rangle$, $X_{H,S'}$ is a subshift of $X_{G,S}$.*
- *For $N \trianglelefteq G$ a normal subgroup, $X_{G/N,S'}$ is a subshift of $X_{G,S}$, where $S' = S \setminus N^1$.*

Proof. The first statement follows from the fact that any configuration from $X_{H,S'}$ avoids all words from $\text{WP}(G,S)$, as H is a subgroup of G . For the second statement, let $x \in X_{G/N,S}$ and $\{w_i\}_i \subseteq S^*$ a set of generators for N . Then, no factor $w \sqsubseteq x$ belongs to $\text{WP}(G/N,S)$, which is obtained as concatenations of conjugates of elements from $\text{WP}(G,S) \cup \{w_i\}_i$. In particular, it does not belong to $\text{WP}(G,S)$. Therefore, $x \in X_{G,S}$. \square

Because every non-finite quotient gives us a non-empty subshift of $X_{G,S}$, if we want to find a minimal skeleton, it is reasonable to look at the class of just infinite groups. A group G is said to be **just infinite** if it is infinite and every proper quotient is finite.

Proposition 4.3.20. *Let G be a finitely generated group with a generating set S . If $X_{G,S}$ is minimal, then G is a just infinite group.*

Proof. If $X_{G,S}$ is minimal, every subshift of the form $X_{G/N,S}$ must be either empty or equal to $X_{G,S}$. Let N be a proper normal subgroup, that is, non trivial and not equal to G . By Theorem 4.1.3, the connective constants satisfy $\mu(G/N,S) < \mu(G,S)$. Thus, the entropy of $X_{G/N,S}$ is strictly less than that of $X_{G,S}$, so they cannot be equal. This implies $X_{G/N,S} = \emptyset$, meaning G/N is finite. Therefore, G is just infinite. \square

Proposition 4.3.21. *Let G be a finitely generated group with a generating set S . If $X_{G,S}$ is minimal, for every symmetric subset $S' \subsetneq S$, the subgroup $\langle S' \rangle$ is finite. In particular, torsion-free groups do not admit minimal skeletons.*

Proof. If $X_{G,S}$ is minimal, every subshift of the form $X_{H,S'}$, for $H = \langle S' \rangle$, must be either empty or equal to $X_{G,S}$. If $H = G$, then by Theorem 4.1.3, $\mu(G,S') < \mu(G,S)$ meaning $X_{G,S'}$ is empty, which is a contradiction. Therefore, $H \leq G$. Now, take $s \in S \setminus H$ and $x \in X_{H,S'}$. Define $x' = x_{(-\infty,-1]} s x_{[0,+\infty)} \in S^{\mathbb{Z}}$. Because x is in H 's skeleton, we know neither $x_{(-\infty,-1]}$ nor $x_{[0,+\infty)}$ contain subwords from $\text{WP}(G,S)$. Next, if there exists $i, j \in \mathbb{N}$ such that $x_{[i,-1]} s x_{[0,j]} \in \text{WP}(G,S)$, then $s =_G (x_{[i,-1]})^{-1} (x_{[0,j]})^{-1}$ which implies $s \in H$. This is a contradiction. Therefore, $x' \in X_{G,S} \setminus X_{H,S'}$. As $X_{G,S}$ is minimal, $X_{H,S'} = \emptyset$ and thus H is finite. Finally, if a group is torsion-free, each generator generates \mathbb{Z} which is not possible if the skeleton is minimal. \square

Remark 4.3.22. Both conditions are not sufficient to characterize minimal skeletons. Take the group \tilde{A}_2 with generating set $\{a, b, c\}$ as defined in Example 1.3.29. This group is just infinite [MV24], every pair of different generators generates a subgroup isomorphic to the finite group S_3 , and every generator generates a copy of $\mathbb{Z}/2\mathbb{Z}$. Nonetheless, its skeleton is not minimal. Take the periodic configuration $x = (\text{abcb})^\infty$ which belongs to the skeleton. Then, the closure of the orbit of x is finite and contains exactly periodic configurations defined by cyclic permutations of abcb . But, the skeleton also contains the periodic configuration $y = (\text{bcac})^\infty$, which is not one of the cyclic permutations.

¹Formally, the generators for G/N should be $\pi(S)$ for the quotient map $\pi : G \rightarrow G/N$ nevertheless, as we are looking for subshifts over the alphabet S , we identify $\pi(S)$ with $S \setminus N$.

As the remark shows, if a minimal skeleton contains periodic configurations, it must be finite. This is the case of \mathcal{D}_∞ with generating set $\{\mathbf{a}, \mathbf{b}\}$, as seen on Example 3.2.2, which defines a minimal skeleton.

4.4 Sofic skeletons

Let us tackle the question of which groups admit skeletons that are sofic. Since SFTs are sofic subshifts, from Theorem 4.3.6 we already know that plain groups admit sofic skeletons. But, are there groups that admit sofic skeletons which are not SFTs? The first naive strategy would be to ask when the word problem of the group is regular, as this is the set of forbidden patterns used in the definition of the skeleton. Unfortunately, Anisimov showed in [An71] that $\text{WP}(G, S)$ is regular if and only if G is a finite group. We must therefore find other sets of forbidden patterns to study. Lemma 4.1.1 tells us that we can look at the classes of groups where the language of SAWs is regular. The class of groups with such property have already been classified.

Theorem 4.4.1 ([LW20]). *Let G be a f.g. group with S a finite generating set. Then, $L_{\text{SAW}}(G, S)$ is regular if and only if $\Gamma(G, S)$ has more than one end and all ends are thin of size 1.*

As Lindorfer and Woess show, if $\Gamma(G, S)$ has only thin ends of size 1 its blocks are finite [LW20, Lemma 5.3]. Combining this fact with Haring-Smith's characterization of plain groups (Theorem 4.3.7), we see that groups where $L_{\text{SAW}}(G, S)$ is regular are exactly plain groups. Nevertheless, when considering bi-infinitely extendable SAWs, the situation is different.

Lemma 4.4.2. *The group $G = \mathbb{Z} \times \mathbb{Z}/2\mathbb{Z}$ given by the presentation $\langle s, t \mid s^2, [t, s] \rangle$ has a sofic skeleton.*

Proof. We exhibit a regular set of forbidden patterns for $\mathbb{X}_{G,S}$, with $S = \{s^{\pm 1}, t^{\pm 1}\}$. Take the set of forbidden patterns

$$\mathcal{F} = \{st^{\pm n}st^{\mp 1} \mid n \in \mathbb{N}\} \cup \{t^{\pm 1}st^{\mp n}s \mid n \in \mathbb{N}\} \cup \{s^2, t^{\pm 1}t^{\mp 1}\}.$$

It is a simple exercise to show that \mathcal{F} is a regular language. Let us show $\mathbb{X}_{G,S} = \mathcal{X}_{\mathcal{F}}$. Suppose there is a configuration $x \in \mathbb{X}_{G,S} \setminus \mathcal{X}_{\mathcal{F}}$. Because x is in the skeleton, we know it does not contain factors of the form s^2 or $t^{\pm 1}t^{\mp 1}$. Therefore it must contain a factor of the form $st^{\pm n}st^{\mp 1}$ or $t^{\pm 1}st^{\mp n}s$. Suppose, x contains the word $w = st^ns t^{-1}$, for some $n \in \mathbb{N}$. There is no way to extend this word to the right, as ws contains the factor $tst^{-1}s$ which evaluates to the identity, extending by t^{-k} with $k \geq n$ creates the factor $st^ns t^{-n}$ which evaluates to the identity, and extending by $t^{-k}s$ with $k \leq n - 1$ creates the factor $t^k st^{-k}s$ which also evaluates to the identity. This leads to a contradiction. The other cases being analogous, we have $\mathbb{X}_{G,S} \subseteq \mathcal{X}_{\mathcal{F}}$.

Now, suppose there is a configuration $x \in \mathcal{X}_{\mathcal{F}} \setminus \mathbb{X}_{G,S}$. By Lemma 4.3.3 and the definition of \mathcal{F} , x must contain a SAP. Nevertheless, all SAPs in G are cyclic permutations of words of the form $st^ns t^{-n}$ for some $n \in \mathbb{N}$. Thus, each SAP contains a factor from \mathcal{F} , leading to a contradiction and proving $\mathcal{X}_{\mathcal{F}} \subseteq \mathbb{X}_{G,S}$. \square

The Cayley graph of $\mathbb{Z} \times \mathbb{Z}/2\mathbb{Z}$ with respect to the aforementioned generating set is the bi-infinite ladder, which is a graph with two thin ends of size 2. An analogous proof can be done of the Cayley graph of \mathbb{Z} (which is a plain group) with respect to the generating set $\{\pm 1, \pm 2\}$, which also has thin ends of size 2.

To characterize groups which admit sofic skeletons we make use of the fact that the language of a sofic subshift is regular (Proposition 1.1.28). Our main tool in this regard will be the following version of the Pumping Lemma.

Lemma 4.4.3 (Pumping Lemma). *Let L be a regular language. Then, there exists $p > 0$ such that every word $w \in L$ with $|w| \geq p$ can be decomposed as $w = w'uv$ with $|u| > 1$ and $|uv| \leq p$, such that for all $n \in \mathbb{N}$, $w'u^n v \in L$.*

This allows us to show that being sofic is a property of skeletons that depends on the generating set.

Proposition 4.4.4. *Every group G admits a generating set S such that $\mathbb{X}_{G,S}$ is not sofic.*

Proof. By Corollary 4.3.18, if G is a torsion group, no skeleton is sofic. We can therefore suppose G has a torsion-free element. Let S' be any generating set for G , and g a torsion-free element. We denote $s = g^2$, $t = g^3$, and define $S = S' \cup \{s, t\}$. Suppose $\mathbb{X}_{G,S}$ is sofic. Then, its language $\mathcal{L}(\mathbb{X}_{G,S})$ is regular. Take $p > 0$ given by the Pumping Lemma. The word $w = ts^{p+1}t^{-1}s^{-p}$ is contained in $\mathcal{L}(\mathbb{X}_{G,S})$ as it is globally admissible through the configuration $s^\infty ts^{p+1}t^{-1}s^{-p}t^{-1}(s^{-1})^\infty$ (see Figure 4.5).

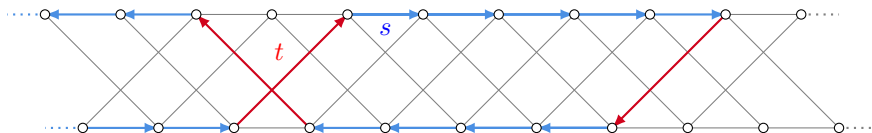

Figure 4.5: The configuration used for the Pumping Lemma (with $p = 4$) depicted in the Cayley graph of the subgroup $\langle s, t \rangle$. The blue edges represent s and the red edges t .

Now, by the Pumping Lemma we can decompose w as $w = w'uv$ with $|uv| \leq p$. Thus, $u = s^{-k}$ with $k \geq 1$. Therefore, the word $w'u^2v = ts^{p+1}t^{-1}s^{-(p+k)}$ belongs to $\mathcal{L}(\mathbb{X}_{G,S})$, which is a contradiction as $ts^{p+1}t^{-1}s^{-(p+1)} =_G \varepsilon$. We conclude that $\mathbb{X}_{G,S}$ is not sofic. \square

4.4.1 Ends and automorphisms

To go towards a characterization we take a brief detour through the theory of ends and automorphisms of infinite quasi-transitive graphs. Let us begin by taking a look at the theory of ends of connected graphs as introduced by Halin [Hal64].

For a connected graph $\Gamma = (V_\Gamma, E_\Gamma)$, and a subset of vertices $A \subseteq V_\Gamma$ we denote by $\Gamma \setminus A$ the graph obtained by removing the vertices from A and all their incident edges. We define a **ray** ρ to be an infinite sequence of distinct vertices $\pi = (v_0, v_1, \dots) \in V_\Gamma^{\mathbb{N}}$ such that there is an edge between v_i and v_{i+1} . Analogously, a **double ray** is a bi-infinite sequence of distinct vertices $\pi = (\dots, v_{-1}, v_0, v_1, \dots) \in V_\Gamma^{\mathbb{Z}}$ such that each successive vertex is connected by an edge. Two rays are said to be **equivalent** if for any finite set $A \subseteq V_\Gamma$ all but finitely many of their vertices are contained in the same connected component of $\Gamma \setminus A$. The equivalence classes of this relation are called the **ends** of the graph. The number of ends defined in Section 1.3.5 is exactly the number of equivalence classes of rays. Given an end ω and a finite set $A \subseteq V_\Gamma$, we define $C(\omega, A)$ to be the connected component of $\Gamma \setminus A$ where all the rays defining ω eventually end up in.

A **defining sequence** for an end ω is a sequence of finite subsets $(A_i)_{i \in \mathbb{N}}$ such that $A_i \cup C(\omega, A_i) \subseteq C(\omega, A_{i-1})$ for all $i \geq 1$. We say that an end ω is **thin** if there exist $m \geq 1$ and a defining sequence $(A_i)_{i \in \mathbb{N}}$ such that $|A_i| = m$ for all $i \in \mathbb{N}$. The smallest m verifying this condition is called the **size** of ω . An end is called **thick** if its size is infinite. Thomassen and Woess [TW93] showed using Menger's Theorem that an end of size $m \in \mathbb{N} \cup \{\infty\}$, seen as an equivalence class of rays, contains a maximum of m vertex disjoint rays.

Let $\text{Aut}(\Gamma)$ denote the set of automorphisms of Γ , that is, bijections $f : V_\Gamma \rightarrow V_\Gamma$ that preserve edge adjacency. We say a subgroup $G \leq \text{Aut}(\Gamma)$ acts **quasi-transitively** on Γ if the set of orbits of the action $G \curvearrowright \Gamma$ is finite. We say G acts transitively if there is a unique orbit. In our setting, all Cayley graphs $\Gamma(G, S)$ are transitive under the action of the group G by left translations. Furthermore, this action preserves the labeling given by the generating set. Freudenthal and Hopf independently showed [Fre44; Hop43] that a quasi-transitive graph has either 0, 1, 2 or an infinite amount of ends.

Take Γ to be locally finite and connected. We can classify automorphisms of Γ into three classes. An automorphism $g \in \text{Aut}(\Gamma)$ is,

- **elliptic** if it fixes a finite subset of V_Γ ,
- **parabolic** if it fixes a unique end, and
- **hyperbolic** if it fixes a unique pair of distinct ends.

Halin showed [Hal73] that for a non-elliptic automorphism $g \in \text{Aut}(\Gamma)$ and vertex $v \in V$ the sequence $(v, g \cdot v, g^2 \cdot v, \dots)$ uniquely defines and fixes an end which we call the **direction** of g , and denote $D(g)$.

Theorem 4.4.5 (Halin, [Hal73] Theorem 9). *Let g be a non-elliptic automorphism acting on a connected locally finite graph Γ . Then,*

- $D(g)$ and $D(g^{-1})$ have the same size m .
- $D(g) \neq D(g^{-1})$ if and only if $m < \infty$. In this case g is hyperbolic.
- There are m disjoint double rays $\{\pi_i\}_{i=1}^m$ that are invariant by some positive power of g .
- If g is hyperbolic, there exists a set $A \subseteq V_\Gamma$ of size m and $k \in \mathbb{N}$ such that $(g^{kn} \cdot A)_{n \in \mathbb{N}}$ and $(g^{-kn} \cdot A)_{n \in \mathbb{N}}$ are defining sequences for $D(g)$ and $D(g^{-1})$ respectively, that intersect each π_i in exactly one vertex.

To precisely understand thin ends, we study the following graphs.

Definition 4.4.6. A connected locally finite graph is called a **strip** if it is two ended and quasi-transitive.

We present general facts about strips that can be found in [LW20] and can be partly deduced from Theorem 4.4.5. For every strip Q , there exists a hyperbolic automorphism $g \in \text{Aut}(Q)$ that fixes both ends ω^+ and ω^- . Both ends have the same size, for instance m , which entails the existence of a finite set A of size m such that $(g^n \cdot A)$ and $(g^{-n} \cdot A)$ are defining sequence for ω^+ and ω^- respectively. In addition, there are m disjoint double rays intersecting every $g^n \cdot A$ at exactly one vertex. We call such a strip a g -strip of size m . When working with a g -strip, up to taking a power of g , we can assume that the subgraph induced by $C(\omega^+, A) \setminus C(\omega^+, g \cdot A)$, which we call $P(\omega^+)$, is connected and finite.

The following results show that quasi-transitive graphs contain strips, under conditions on their ends and automorphisms.

Lemma 4.4.7 (Lindorfer, Woess, [LW20] Lemma 3.3). *Let Γ be a connected and locally finite graph where $G \leq \text{Aut}(\Gamma)$ acts quasi-transitively. If Γ has a thin end of size m , then it contains a g -strip of size m for some $g \in G$.*

Lemma 4.4.8 (Lindorfer, Woess, [LW20] Lemma 3.4). *Let Γ be a connected and locally finite graph where $G \leq \text{Aut}(\Gamma)$ acts quasi-transitively. If G contains a parabolic element, then for every $m \geq 1$, Γ contains a g -strip of size at least m for some $g \in G$.*

4.4.2 Characterizing sofic skeletons

We provide the following characterization.

Theorem 4.4.9. *Let G be a finitely generated group. There exists S such that $\mathbb{X}_{G,S}$ is sofic if and only if G is a plain group, $\mathbb{Z} \times \mathbb{Z}/2\mathbb{Z}$ or $\mathcal{D}_\infty \times \mathbb{Z}/2\mathbb{Z}$.*

The idea of the proof is as follows. First, we use the same constructions of Lindorfer and Woess [LW20] to find ladder-like structures on strips that will allow us to use the Pumping Lemma, and then conclude that all ends of the graph must be thin and of size at least 2. Next, by using similar ideas, we show that if the graph has an end of size two and the skeleton is sofic, then the group must be virtually \mathbb{Z} . Finally, we characterize virtually \mathbb{Z} groups with sofic skeletons, completing the proof.

Lemma 4.4.10. *Let G be a finitely generated group with a generating set S , such that $\Gamma(G, S)$ contains an g -strip Q for some $g \in G$. If $\mathbb{X}_{G,S}$ is sofic, then Q has size at most 2.*

Proof. Suppose Q is of size greater or equal than 3. Then, Q contains three disjoint double rays which we call $\pi_1 = (v_i)_{i \in \mathbb{Z}}$, $\pi_2 = (u_i)_{i \in \mathbb{Z}}$ and $\pi_3 = (v'_i)_{i \in \mathbb{Z}}$, that are g -invariant. Recall we took our subgraph $P(\omega^+)$ to be connected and finite. Therefore, there is a path p_1 that connects two of the rays. Suppose without loss of

generality that p_1 connects π_1 and π_2 from v_0 to u_0 with no other vertices from π_i for $i \in \{1, 2, 3\}$. Analogously, $g \cdot P(\omega^+)$ will connect π_3 with another of the ways through a path p_2 . Up to rearranging indices, suppose p_2 connects π_2 to π_3 starting at u_k and ending at v'_k , for some $k \in \mathbb{N}$ such that there are no other vertices from π_i for $i \in \{1, 2, 3\}$. Because the vertex set of every element of the sequence $(g^n \cdot P(\omega^+))_{n \in \mathbb{N}}$ is pairwise disjoint, no walks in $\{g^{2n} \cdot p_1 \mid n \in \mathbb{Z}\} \cup \{g^{2n} \cdot p_2 \mid n \in \mathbb{Z}\}$ intersect. This way, the subgraph induced by the three paths $\{\pi_i\}_{i=1}^3$ and all $g^{2n} \cdot p_1$ and $g^{2n} \cdot p_2$, $Q' \subseteq Q$ is a periodic subdivision of the bi-infinite 3-ladder (see Figure 4.6).

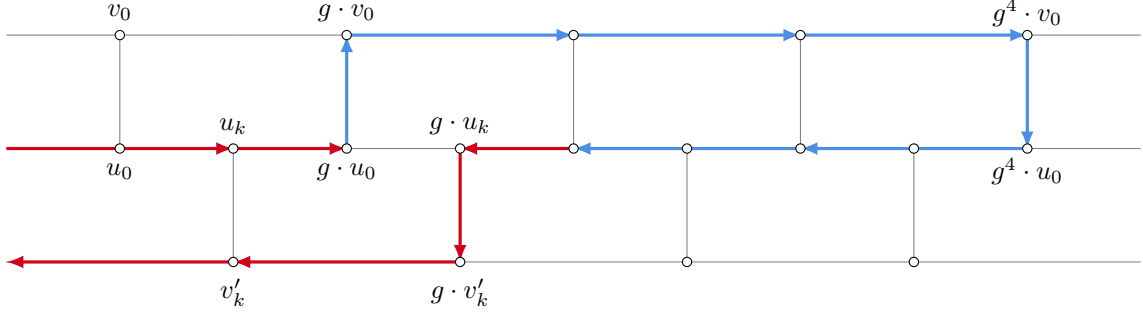

Figure 4.6: The periodic subdivision of the 3-ladder with the configuration x highlighted in red and blue. The word $\lambda_3 \lambda_4^3 \lambda_3^{-1} \lambda_1^{-2}$ is marked in blue, whereas the infinite prefix and suffix of x are marked in red.

Now, let us give names to the labels of the different portions of the subdivision. Denote λ_1 the label from u_k to $g \cdot u_k$, λ_2 the label from u_k to $g \cdot u_0$, λ_3 the label from u_0 to v_0 , λ_4 the label from v_0 to $g \cdot v_0$, λ_5 the label from u_k to v'_k , and finally λ_6 the label from $g \cdot v'_k$ to v'_k . Then, for every $n \geq 1$ and $k < n$ the configuration

$$x = \lambda_1^\infty \lambda_2 \cdot \lambda_3 \lambda_4^n \lambda_3^{-1} \lambda_1^{-k} \lambda_2^{-1} \lambda_5 \lambda_6^\infty,$$

belongs to the skeleton (See Figure 4.6). Thus, $\lambda_3 \lambda_4^n \lambda_3^{-1} \lambda_1^{-k} \in \mathcal{L}(\mathbb{X}_{G,S})$ for every $n \geq 1$ and $k < n$. Notice that the language $L = \{\lambda_3 \lambda_4^n \lambda_3^{-1} \lambda_1^{-k} \in S^* \mid k, n \in \mathbb{N}\}$ is regular. If $\mathbb{X}_{G,S}$ is sofic, its language $\mathcal{L}(\mathbb{X}_{G,S})$ is regular. Then by the closure properties of regular languages

$$L' = L \cap \mathcal{L}(\mathbb{X}_{G,S}) = \{\lambda_3 \lambda_4^n \lambda_3^{-1} \lambda_1^{-k} \in S^* \mid k < n\},$$

is regular. By the Pumping Lemma, there exists a pumping length $p > 0$. Take $\lambda_3 \lambda_4^{p+1} \lambda_3^{-1} \lambda_1^{-p} \in L'$. This word decomposes as $\tilde{w} w w'$ such that $|w w'| \leq p$. By the structure of our word, $w w'$ is a suffix of λ_1^p . Next, $\tilde{w} w^2 w'$ belongs to L' and therefore has the form

$$\tilde{w} w^2 w' = \lambda_3 \lambda_4^n \lambda_3^{-1} \lambda_1^{-k} = \lambda_3 \lambda_4^{p+1} \lambda_3^{-1} w_1 w^2 w',$$

for some $k, l \in \mathbb{N}$ and $w_1 \in S^*$. Because we are working over a Cayley graph, the labels of different edges starting from u_0 must be different and thus the first generators for λ_4 and λ_3^{-1} are different. Therefore, $n = p + 1$. This means, $\lambda_1^{-k} = w_1 w^2 w'$. Finally, as λ_1^{-k} is strictly longer than λ_1^{-p} , $k \geq p + 1$. But, this would imply $\lambda_3 \lambda_4^{p+1} \lambda_3^{-1} \lambda_1^{-k}$ belongs to $\mathcal{L}(\mathbb{X}_{G,S})$ and is not self-avoiding, which is a contradiction. \square

Proposition 4.4.11. *Let G be a finitely generated group. If there exists S such that $\mathbb{X}_{G,S}$ is sofic, then G has more than one end, and $\Gamma(G, S)$ only has thin ends of size at most 2.*

Proof. Let G be a finitely generated group with generating set S such that $\mathbb{X}_{G,S}$ is sofic. By Theorem 4.3.17, G is not a torsion group and therefore contains non-elliptic elements when seen as a subgroup of $\text{Aut}(\Gamma(G, S))$. If G is one-ended, then $\Gamma(G, S)$ has one end, which by Lemmas 4.4.8 and 4.4.10 is a contradiction. Thus, $\Gamma(G, S)$ has at least one thin end. By Lemma 4.4.7, every thin end of size m implies the existence of a strip of size m in $\Gamma(G, S)$. By Lemma 4.4.10, these strips – and consequently their corresponding ends – must have size at most 2. Finally, if $\Gamma(G, S)$ had a thick end, from the proof of Theorem 4.1 in [LW20] we know it contains a one-ended subgraph. As before, this contradicts Lemmas 4.4.8 and 4.4.10. \square

The converse of this proposition is not true: the group $\mathbb{F}_2 \times \mathbb{Z}/2\mathbb{Z}$ with generating set $S = \{a^{\pm 1}, b^{\pm 1}, s\}$, given by the presentation $\langle a, b, s \mid s^2, [a, s], [b, s] \rangle$, has thin ends of size two, but its skeleton is not sofic. Similar to what we did in Proposition 4.4.4, we can use the Pumping Lemma on the words $sa^{n+1}sa^{-n}$, with $n \in \mathbb{N}$, which are in $\mathcal{L}(\mathbb{X}_{G,S})$ through the configuration $b^\infty sa^{n+1}sa^{-n}b^\infty$. The next Lemma captures this idea in the general setting.

Lemma 4.4.12. *Let G be a finitely generated group. If there exists S such that $\mathbb{X}_{G,S}$ is sofic and $\Gamma(G, S)$ has an end of size 2, then G is virtually \mathbb{Z} .*

Proof. Suppose $\Gamma(G, S)$ has more than two ends, and take ω^+ the end of size 2. By Lemma 4.4.7, there exists $g \in G$ and Q a g -strip of size 2. Then, there exist two g -invariant disjoint double rays $\pi_1 = (v_i)_{i \in \mathbb{Z}}$ and $\pi_2 = (u_i)_{i \in \mathbb{Z}}$. In the induced subgraph $P(\omega^+)$ we can find a path p linking, without loss of generality, v_0 and u_0 with no other vertices from π_1 and π_2 . Furthermore, the walks belonging to $\{g^n \cdot p \mid n \in \mathbb{Z}\}$ do not intersect each other. This way, the graph spanned by π_1 , π_2 and p is a periodic subdivision of the infinite 2-ladder, $Q' \subseteq Q$. Now, take an end $\omega_1 \neq \omega^\pm$ and $\pi_3 = (v'_i)_{i \in \mathbb{N}}$ a ray defining ω_1 . As π_3 defines an end different from ω^+ there exists a smallest $N \in \mathbb{N}$ such that $v'_i \notin Q'$ for all $i > N$. Because $\Gamma(G, S)$ is transitive, we can take without loss of generality v'_N to be equal to some u_k with $k \in \mathbb{N}$, placed between $g \cdot u_0$ and $g^2 \cdot u_0$. This is all represented in Figure 4.7.

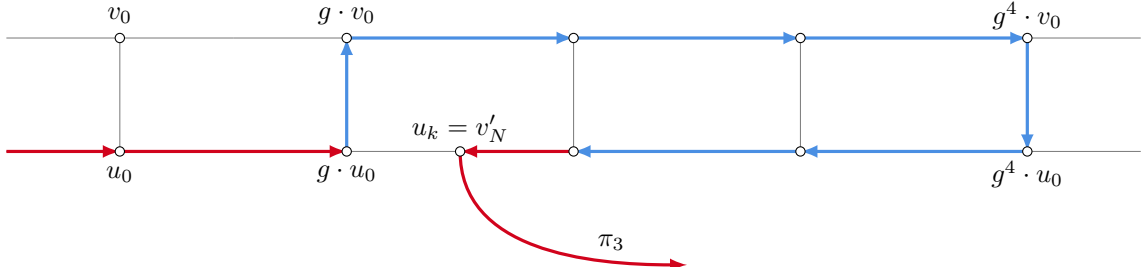

Figure 4.7: The periodic subdivision of the 2-ladder with the configuration x highlighted in red and blue. The word $\lambda_2 \lambda_3^3 \lambda_2^{-1} \lambda_1^{-2}$ is marked in blue, whereas the infinite prefix and suffix of x are marked in red.

Let us label the different sections of the bi-infinite ladder. We denote by λ_1 the label of the path from u_0 to $g \cdot u_0$, λ_2 the label from u_0 to v_0 , λ_3 the label from v_0 to $g \cdot v_0$, λ_4 the label from $g^2 \cdot u_0$ to u_k , and $\lambda \in S^{\mathbb{N}}$ the label of the ray $(v'_{N+i})_{i \in \mathbb{N}}$. Then, for every $n \in \mathbb{N}$ and $k < n$ the configuration

$$x = \lambda_1^\infty \cdot \lambda_2 \lambda_3^n \lambda_2^{-1} \lambda_1^{-k} \lambda_4 \lambda \in S^{\mathbb{Z}},$$

belongs to the skeleton. Then, $\lambda_2 \lambda_3^n \lambda_2^{-1} \lambda_1^{-k} \in \mathcal{L}(\mathbb{X}_{G,S})$ for all $k < n$. Notice that the language given defined as $L = \{\lambda_2 \lambda_3^n \lambda_2^{-1} \lambda_1^{-k} \mid n, k \in \mathbb{N}\}$ is regular. Therefore, $L' = L \cap \mathcal{L}(\mathbb{X}_{G,S})$ is regular as we assume $\mathbb{X}_{G,S}$ is sofic. Take $p > 0$ the pumping length of L' given by the Pumping Lemma. If we pump the word $\lambda_2 \lambda_3^{p+1} \lambda_2^{-1} \lambda_1^{-p}$ is in L' as we did in the proof of Lemma 4.4.10, we conclude that there must exist $n, k \in \mathbb{N}$ with $k \geq n$ such that $\lambda_2 \lambda_3^n \lambda_2^{-1} \lambda_1^{-k} \in L'$, which is a contradiction as it is not self-avoiding. \square

Virtually \mathbb{Z} groups have a very rigid structure. Epstein and Wall [Eps61; Wal67] (see [LG13] for our current formulation) showed that a group is virtually \mathbb{Z} if and only if it is of one of the following forms:

1. $\mathbb{Z} \rtimes_\phi F$, for some finite group F and $\phi \in \text{Aut}(F)$,
2. $G_1 *_F G_2$, for G_1, G_2 and F finite groups such that $[G_1 : F] = [G_2 : F] = 2$.

Groups of the second type, $G_1 *_F G_2$, are isomorphic to $\mathcal{D}_\infty \rtimes_\psi F$ for some homomorphism $\psi : \mathcal{D}_\infty \rightarrow \text{Aut}(F)$ (see [Gil22, Section 1.3]). Furthermore, every element $g \in \mathbb{Z} \rtimes_\phi F$ can be uniquely expressed as ft^n with $f \in F$, $n \in \mathbb{Z}$ and t the free generator of \mathbb{Z} . Similarly, every element $g \in \mathcal{D}_\infty \rtimes_\psi F$ can be uniquely expressed as $f \mathbf{r}^n \mathbf{s}^b$ with $f \in F$, $n \in \mathbb{Z}$, $b \in \{0, 1\}$, and \mathbf{r} and \mathbf{s} generators for $\mathcal{D}_\infty = \langle \mathbf{r}, \mathbf{s} \mid \mathbf{s}^2, \mathbf{r} \mathbf{s} \mathbf{r} \mathbf{s} \rangle$.

Lemma 4.4.13. *Let $G = H \rtimes_{\phi} F$ be a group such that F is a finite group, and H is either \mathbb{Z} or \mathcal{D}_{∞} . Then, for any generating set S the ends of the Cayley graph $\Gamma(G, S)$ have size at least $|F|$.*

Proof. Take G as in the hypothesis. We will tackle the case when $H = \mathbb{Z}$ and $H = \mathcal{D}_{\infty}$ separately.

Case 1: $H = \mathbb{Z}$:

Let S be a generating set for G . Then, there must exist at least one generator that does not belong to F , which we call s . This generator must have the form $s = gt^n$ for some $g \in F$ and $n \in \mathbb{Z}$, and is thus a torsion-free element of the group. For each element $f \in F$ we define the ray $\pi_f = (f, fs, \dots, fs^i, \dots)$. These rays are all pair-wise disjoint because s is torsion-free. Therefore, the end $D(s)$ has size at least $|F|$.

Case 2: $H = \mathcal{D}_{\infty}$:

Let S be a generating set for G . As before, there must exist at least one generator that does not belong to F , which we call s . If s is of the form gr^n , it is a torsion free element, and by the argument for the previous case, $D(s)$ has size at least $|F|$. Suppose then that all elements $S \setminus F$ are of the form $gr^n\mathbf{s}$. Because S is a generating set, $S \setminus F$ must contain at least two elements which we will name $s = gr^n\mathbf{s}$ and $s' = g'r^m\mathbf{s}$. Without loss of generality take $n > m$. Then, ss' is the torsion-free element g_1r^{n-m} for some $g_1 \in F$. As before, for each $f \in F$ define the ray $\pi_f = (f, fs, fss', \dots, f(ss')^i, \dots)$. Let us prove these rays are disjoint. If $f(ss')^k = f'(ss')^l$ for $f, f' \in F$ and $k, l \in \mathbb{N}$, then $(ss')^{k-l} \in F$ has torsion, which is a contradiction. On the other hand, if $f(ss')^k s = f'(ss')^l$ for $f, f' \in F$ and $k, l \in \mathbb{N}$, then $r^{(n-m)(k+l)+n}\mathbf{s} \in F$, which is also a contradiction. Thus, the rays π_f are disjoint and therefore $D(ss')$ has size at least $|F|$. \square

Proposition 4.4.14. *Let G be a virtually \mathbb{Z} group. Then, there exists S such that $\mathbb{X}_{G,S}$ is sofic if and only if G is either \mathbb{Z} , $\mathbb{Z} \times \mathbb{Z}/2\mathbb{Z}$, $\mathcal{D}_{\infty} \times \mathbb{Z}/2\mathbb{Z}$ or \mathcal{D}_{∞} .*

Proof. Let G be a virtually \mathbb{Z} group. Then, G is of the form $H \rtimes_{\phi} F$ for $H \in \{\mathbb{Z}, \mathcal{D}_{\infty}\}$ and F a finite group. Joining Lemma 4.4.13 and Lemma 4.4.10, if $\mathbb{X}_{G,S}$ is sofic for some generating set S , $|F| \leq 2$. If $|F| = 1$, then G is either \mathbb{Z} or \mathcal{D}_{∞} . If $|F| = 2$, then $F \simeq \mathbb{Z}/2\mathbb{Z}$ and ϕ is the trivial automorphism. In this case G is either $\mathbb{Z} \times \mathbb{Z}/2\mathbb{Z}$ or $\mathcal{D}_{\infty} \times \mathbb{Z}/2\mathbb{Z}$.

Conversely, we already know \mathbb{Z} and \mathcal{D}_{∞} admit sofic skeletons as they are plain groups. Similarly, $\mathbb{Z} \times \mathbb{Z}/2\mathbb{Z}$ admits a sofic skeleton by Lemma 4.4.2. Finally, if we take the presentation $\langle a, b, s \mid a^2, b^2, s^2, (sa)^2, (sb)^2 \rangle$ of $\mathcal{D}_{\infty} \times \mathbb{Z}/2\mathbb{Z}$, the corresponding Cayley graph is the bi-infinite ladder, and therefore Lemma 4.4.2 can be adapted to show its skeleton is sofic. \square

We now have all the ingredients to characterize groups that admit a sofic skeleton.

Proof of Theorem 4.4.9. Let G be a finitely generated group that admits a sofic skeleton through the generating set S . From Lemma 4.7, $\Gamma(G, S)$ has only thin ends, all of size at most 2. If all ends are of size 1, G is a plain group. Next, if G has at least one end of size 2, it is virtually \mathbb{Z} by Lemma 4.4.12. Then, by Proposition 4.4.14 G is either $\mathbb{Z} \times \mathbb{Z}/2\mathbb{Z}$ or $\mathcal{D}_{\infty} \times \mathbb{Z}/2\mathbb{Z}$. For the other direction, if G is a plain group by Theorem 4.3.6 it admits a sofic skeleton (as SFTs are sofic). Finally, if G is either $\mathbb{Z} \times \mathbb{Z}/2\mathbb{Z}$ or $\mathcal{D}_{\infty} \times \mathbb{Z}/2\mathbb{Z}$, Proposition 4.4.14 tells us G admits a sofic skeleton. \square

4.5 Approximating entropy and connective constants

4.5.1 Bridges and periodic points

We saw in Corollary 4.3.11 that the connective constant of SFT skeletons of plain groups can be approximated by their periodic points. This is also the case of irreducible sofic shifts [LM21, Theorem 4.3.6.]. The natural question that follows is if this is possible for skeletons that are not sofic. Clisby showed [Cli13] that this is the case for \mathbb{Z}^d with standard generating set, which by Theorem 4.4.9 do not define sofic skeletons. Instead of periodic configurations, Clisby used the term *endless SAWs*. By using the notion of **bridges**, introduced

by Hammersley and Welsh [HW62] and latter expanded upon by Grimmett and Li [GL18], we generalize this result to any Cayley graph admitting a particular kind of graph height function.

Definition 4.5.1. Let Γ be an infinite connected locally finite quasi-transitive graph. A **graph height function** (h, H) is composed of a function $h : V_\Gamma \rightarrow \mathbb{Z}$ and a subgroup $H \leq \text{Aut}(\Gamma)$ acting quasi-transitively on Γ such that

- (H -difference-preserving) for all $u, v \in V_\Gamma$ and $g \in H$

$$h(g \cdot v) - h(g \cdot u) = h(v) - h(u),$$

- for all $u \in V_\Gamma$, there exists $v, v' \in V_\Gamma$ adjacent to u such that $h(v) < h(u) < h(v')$.

A **bridge** with respect to the height function (h, H) is a self-avoiding walk $\pi = (e_0, \dots, e_{n-1})$ that verifies

$$h(i(e_0)) < h(t(e_i)) \leq h(t(e_{n-1})),$$

for all $i \in \{0, \dots, n-1\}$.

Example 4.5.2. Take $G = \mathbb{Z}^2$ with the standard generating set $\{\mathbf{a}^\pm, \mathbf{b}^\pm\}$. If we look at the generators as $\mathbf{a} = (1, 0)$ and $\mathbf{b} = (0, 1)$, we define the map $h(g) = m$ for $g = (m, n) \in \mathbb{Z}^2$. This function defines a graph height function with respect to $H = \mathbb{Z}^2$ acting by left-translations. Further still, any elementary amenable group admits a graph height function [GL18].

Lemma 4.5.3. *Let G be a finitely generated group with generating set S . If $\Gamma(G, S)$ admits a graph height function (h, H) , then $\mathbb{X}_{G,S}$ contains periodic configurations. Moreover, if π is a bridge such that $i(\pi)$ and $t(\pi)$ lie in the same H -orbit, then $\lambda(\pi)^\infty \in \mathbb{X}_{G,S}$.*

Proof. Let π and π' be two bridges such that $t(\pi) = i(\pi')$. Then, the concatenation of both paths, $\pi\pi'$, is a bridge. Furthermore, for every $g \in H$, $g \cdot \pi$ is also a bridge, as the function h is H -difference-preserving.

Now, let R be a finite right transversal for the action of H on $\Gamma(G, S)$. Consider a bridge π such that $i(\pi), t(\pi) \in H \cdot r$ with $r \in R$. If $i(\pi) = h_1 \cdot r$ and $t(\pi) = h_2 \cdot r$, because h is H -difference-preserving, $h_2 h_1^{-1} \cdot \pi$ is a bridge starting at $h_2 \cdot r$. We can then concatenate π with $h_2 h_1^{-1} \cdot \pi$ to create a bridge, which we denote by π^2 , whose label is given by $\lambda(\pi)^2$. This process can be iterated indefinitely to obtain a bi-infinite SAW whose label is given by $\lambda(\pi)^\infty$.

Next, take a bridge π such that $i(\pi) \in H \cdot r_1$ and $t(\pi) \in H \cdot r_2$, with $r_1, r_2 \in R$ distinct representatives. Up to translation by an element from H , we can take any bridge starting at a vertex in $H \cdot r_2$, say π_1 and concatenate to π to obtain a new bridge $\pi\pi_1$. Such a bridge exists by the definition of a graph height function as there must exist at least one vertex v next to r_2 such that $h(r_2) < h(v)$. Similarly, we can take any bridge in the H -orbit of $t(\pi_1)$, which we denote π_2 , and concatenate it –up to translation by H – to $\pi\pi_1$. Iterating this process, for all $n \in \mathbb{N}$ we obtain a bridge $\pi\pi_1 \dots \pi_n$. Because there is a finite number of H -orbits, we will have $i \leq j$ such that $i(\pi_i), t(\pi_j)$ belong to the same H -orbit. Then, as previously stated $\pi' = \pi_i \pi_{i+1} \dots \pi_j$ is a bridge that can be iterated to obtain the periodic point $\lambda(\pi')^\infty$. \square

We saw in Theorem 4.3.17 that torsion groups have aperiodic skeletons. By the previous lemma, graph height functions imply the existence of periodic points. Combining these two facts we can state the following.

Theorem 4.5.4. *The Cayley graphs of infinite torsion f.g. groups do not admit graph height functions.*

This generalizes a result from Grimmett and Li who showed that the Grigorchuk group (which is an infinite torsion group) does not admit a graph height function, and more generally, Cayley graphs of torsion groups with certain conditions on the stabilizer of the identity [GL17b]. However, the converse of the previous theorem does not hold, as they also showed that the Higman group, which is torsion-free [Hig51], does not admit graph height functions.

Bridges are particularly useful to compute the connective constant of graphs, and have been used to obtain exact expressions for the constant (for instance, in [DS12]). Let us denote by $b_{n,g}$ the number of bridges of length n starting at $g \in G$, and $b_n = \min_{g \in G} b_{n,g}$. As stated in the proof of Lemma 4.5.3, we can concatenate bridges with corresponding endpoints. Then, $b_n b_m \leq b_{n+m}$ and by Fekete's Sub-additive Lemma, there exists a constant $\beta(\Gamma, h)$, where $\Gamma = \Gamma(G, S)$, such that

$$\beta(\Gamma, h) = \lim_{n \rightarrow \infty} \sqrt[n]{b_n}.$$

This process is done for a larger class of graphs [GL18], and helps us compute connective constants.

Theorem 4.5.5 (General Bridge Theorem [Lin20]). *Let Γ be an infinite, connected, locally finite, quasi-transitive graph. Then, if Γ admits a graph height function (h, H) ,*

$$\mu(\Gamma) = \max\{\beta(\Gamma, h), \beta(\Gamma, -h)\}.$$

Using this result, we can find conditions under which periodic SAWs approximate the connective constant. In other words, periodic points from $\mathbb{X}_{G,S}$ approximate its entropy.

Theorem 4.5.6. *Let G be a finitely generated group and S a finite generating set. If $\Gamma(G, S)$ admits a graph height function (h, H) such that H acts transitively on $\Gamma(G, S)$, then*

$$\mu(G, S) = \lim_{n \rightarrow \infty} \sqrt[n]{e_n},$$

where e_n denotes the number of periodic points of period $n \in \mathbb{N}$ in $\mathbb{X}_{G,S}$.

Proof. Let us denote by \bar{b}_n the minimum over all $g \in G$ of the number of bridges of length n starting at g for the graph height function $(H, -h)$. Because H acts transitively on $\Gamma(G, S)$, there is a single H -orbit. Thus, by Lemma 4.5.3, every bridge for h or $-h$ can be iterated to obtain a periodic point. This means,

$$\max\{b_n, \bar{b}_n\} \leq e_n \leq c_n.$$

By taking the n th root and limit, Theorem 4.5.5 implies,

$$\mu(G, S) = \max\{\beta(\Gamma, h), \beta(\Gamma, -h)\} \leq \lim_{n \rightarrow \infty} \sqrt[n]{e_n} \leq \mu(G, S).$$

□

Examples of Cayley graphs with a graph height function (h, H) such that H acts transitively are given by Cayley graphs that admit *strong* graph height function where $H = G$. Strong graph height functions are graph functions where we also ask for H to be a finite index subgroup of G , and to act by left translations [GL17b]. A class of groups that admit such functions are groups with strictly positive first Betty number [GL17a]. Other sufficient conditions can be found in [GL20].

4.5.2 Lower bounds with self-avoiding polygons

What other methods can we use when graph height functions are not available? We make use of a counting argument popularized by Rosenfeld [Ros20] to find lower bounds on the connective constant by studying the sets of forbidden patterns defining the skeleton. Rosenfeld found the following criterion for subshifts.

Theorem 4.5.7 ([Ros22], Corollary 12). *Let A be a finite alphabet and $\mathcal{F} \subseteq A^+$ a set of connected forbidden patterns. If there exists a positive real number $\beta > 1$ such that*

$$|A| \geq \beta + \sum_{n \geq 0} f_n \beta^{1-n},$$

then $\alpha(\mathcal{X}_{\mathcal{F}}) \geq \beta$, where f_n is the number of forbidden patterns of length n , that is, $f_n = |\mathcal{F} \cap A^n|$.

Therefore, we can use the different forbidden patterns we have found so far for the skeleton to find lower bounds for the connective constant. From Lemma 4.3.3, we know the set of SAPs along with words of the form ss^{-1} define a set of forbidden patterns for the skeleton.

Proposition 4.5.8. *Let (G, S) be a finitely generated group. If there exists a positive real number β such that*

$$|S| - 1 \geq \beta + \sum_{n \geq 0} \rho_n \beta^{1-n},$$

then $\mu(G, S) \geq \beta$, where ρ_n the number of SAPs of length n , that is, $\rho_n = |\mathcal{O}_{G,S} \cap S^n|$.

The proof of the proposition is essentially the same as the one from [Ros22], and the core ideas of the proof are also found in the next section.

This approach is different from the usual use of self-avoiding polygons to approximate $\mu(G, S)$ in the literature. We define the asymptotic growth rate for SAPs through

$$\mu_{SAP} = \limsup_{n \rightarrow \infty} \sqrt{\rho_n}.$$

It has been shown that $\mu_{SAP} = \mu(G, S)$ for Euclidean lattices [Ham61; Kes63], but $\mu_{SAP} < \mu(G, S)$ for many non-euclidean lattices, including some Cayley graphs of surface groups [Pan19].

4.5.3 Free Burnside groups

A class of groups where we can use Rosenfeld's method to obtain lower bounds on the connective constant are free Burnside groups. These groups were first introduced in the context of the Burnside Problem, which asks if there exist infinite finitely generated torsion group, where the order of every element is the same.

Given two natural numbers $m, n \geq 1$, the **free Burnside group** $B(m, n)$, is the group generated by m generators $S = \{s_1^{\pm}, \dots, s_m^{\pm}\}$, and relations w^n for every word $w \in S^*$. It was shown that these groups are finite for $n \in \{1, 2, 3, 4, 6\}$ independently of m [Bur02; San40; Hal58]. Nevertheless, Adian and Novikov showed that $B(m, n)$ is infinite for odd $n \geq 4381$ and any $m \geq 2$ [AN68]. Since then, this lower bound has been improved multiple times [Iva94; Lys96], and is currently sitting at $n \geq 8000$ for even exponents, and $n \geq 557$ for odd ones [ART23]. It is an open problem to determine the smallest n for which the group is infinite.

Theorem 4.5.9. *Let $B(m, n)$ be the free Burnside group for $m, n > 1$. If $B(m, n)$ is infinite and $\beta > 1$ satisfies*

$$\frac{\beta}{\beta^{n-1} - 1} + \beta \leq 2m - 1,$$

then $\mu(B(m, n), S) \geq \beta$.

Proof. Let L_k be the set of SAWs of length $k \in \mathbb{N}$. We will prove by induction that $|L_k| \geq \beta |L_{k-1}|$, for $\beta > 1$ as in the statement. Notice $|L_0| = 1$ as it only contains the empty word, and $|L_1| = |S| = 2m$. By hypothesis, $\beta \leq 2m$, and therefore $|L_1| \geq \beta |L_0|$.

Suppose our statement is true up to some $n > 0$. In particular, for $k \leq n$

$$|L_{k-j}| \leq \frac{|L_k|}{\beta^j}.$$

Now, because every SAW from L_k can be extended in $|S| - 1 = 2m - 1$ ways, we have that

$$|L_{k+1}| = (2m - 1)|L_k| - |B|,$$

where B is the set of SAWs that when extended generate a path of length $k + 1$ that self-intersects. Notice that if $u \in B$, it can be written in the form $u = u'v^n$. We define the sets $B_i = \{u \in B \mid u = u'v^n, |v| = i\}$ to obtain

the upper bound $|B| \leq \sum_{i \geq 1} |B_i|$. Then, every word in B_i is determined by a word from $L_{k+1-(n-1)i}$, namely $u'v$. Therefore,

$$|B_i| \leq |L_{k+1-(n-1)i}| \leq \frac{|L_k|}{\beta^{(n-1)i-1}},$$

and consequently,

$$|B| \leq |L_k| \sum_{i \geq 1} \beta^{1-(n-1)i}$$

Because $\beta > 1$, we have a geometric series:

$$|B| \leq \frac{|L_k|\beta}{\beta^{n-1} - 1}.$$

Finally, joining all the formulas we obtain

$$|L_{k+1}| \geq \left(2m - 1 - \frac{\beta}{\beta^{n-1} - 1}\right) |L_k| \geq \beta |L_k|.$$

Our induction proven, we can iterate the identity to obtain $|L_k| \geq \beta^k$, and thus $\mu(B(m, n), S) \geq \beta$. \square

Corollary 4.5.10. *If $B(m, n)$ is infinite and $0 < \gamma < 1$ satisfies*

$$2m - 1 \geq (\gamma(1 - \gamma)^{\frac{1}{n-1}})^{-1}, \quad (4.1)$$

then $\mu(B(m, n), S) \geq \gamma(2m - 1)$. In particular, for $n > 3$ and $m > 1$,

$$\mu(B(m, n), S) \geq \frac{n-1}{n}(2m-1) > \sqrt{2m-1}.$$

Proof. Let us take $0 < \gamma < 1$ satisfying (4.1) and denote $M = 2m - 1$. By rearranging terms from (4.1) we obtain:

$$1 \leq (1 - \gamma)\gamma^{n-1}M^{n-1}.$$

Then, multiplying the expression by $-M$ and rearranging terms we obtain

$$\begin{aligned} -M &\geq (\gamma^n - \gamma^{n-1})M^n, \\ &\geq \gamma^n M^n - \gamma^{n-1}M^n + \gamma M - \gamma M, \\ &\geq \gamma M(\gamma^{n-1}M^{n-1} - 1) - \gamma^{n-1}M^n + \gamma M. \end{aligned}$$

Next, we rearrange terms to obtain

$$(\gamma^{n-1}M^{n-1} - 1)M \geq \gamma M(\gamma^{n-1}M^{n-1} - 1) + \gamma M.$$

Finally, as $\gamma < 1$ satisfies (4.1), we also know $\gamma^{n-1}M^{n-1} - 1 > 0$. Thus,

$$M \geq \gamma M + \frac{\gamma M}{\gamma^{n-1}M^{n-1} - 1}.$$

By Theorem 4.5.9, $\mu(B(m, n), S) \geq \gamma(2m - 1)$. Finally, $\gamma = \frac{n-1}{n}$ satisfies (4.1) and $\gamma(2m - 1) > \sqrt{2m - 1}$ for $n > 3$ and $m > 1$. \square

4.6 Geodesic skeletons

A geodesic is always a self-avoiding walk. It is then natural to see what changes when we restrict a group's skeleton to bi-infinite geodesics. Recall from Chapter 3, that the geodesic skeleton of G with respect to S is defined by

$$\mathbb{X}_{G,S}^g = \{x \in \mathbb{X}_{G,S} \mid \forall w \sqsubseteq x, w' =_G w : |w| \leq |w'|\}.$$

This subshift is contained in the skeleton $\mathbb{X}_{G,S}$, and the locally admissible language given by its defining forbidden patterns is $\text{Geo}(G,S)$. In particular, it is generated by taking $\text{Geo}(G,S)^c$ as the set of forbidden patterns. As was the case with the skeleton, $\mathbb{X}_{G,S}^g$ is empty if and only if the group is finite; this is due to Watkins who showed that every transitive infinite graph contains a bi-infinite geodesic [Wat86].

SFT geodesics We have a sufficient condition for the geodesic skeleton to be an SFT coming from a result by Gilman, Hermiller, Holt and Rees [Gil+07] that characterizes virtually free groups. They showed that for a finitely generated group G , there exists a finite generating set S such that $\text{Geo}(G,S)$ is k -locally excluding, that is, there exists a set F of words of length k such that a word $w \in S^*$ is geodesic if no factor of length k belongs to F , if and only if G is virtually free. An immediate consequence is the following.

Proposition 4.6.1. *Let G be a virtually free group. Then, there exists S such that $\mathbb{X}_{G,S}^g$ is a SFT.*

Effective geodesics

Lemma 4.6.2. *Let G be a finitely generated recursively presented group. Then, $\mathbb{X}_{G,S}^g$ is effective for every generating set S .*

Proof. We describe a co-semi-algorithm for $\text{Geo}(G,S)$. By using an enumeration for the word problem, we can test every word w' of length $|w'| < |w|$ to see if they define the same group element, i.e. $w'w^{-1} =_G 1_G$. If one such $w'w^{-1}$ appears in the enumeration, we know w is not geodesic and accept. If w is not geodesic, $w'w^{-1}$ will eventually be enumerated, for some w' of shorter length. When $w \in \text{Geo}(G,S)$ the algorithm never stops. \square

In other words, the effectiveness of $\mathbb{X}_{G,S}^g$ is a consequence of the fact that a recursively enumerable word problem implies that the language of geodesics is co-recursively enumerable.

Sofic geodesics As we saw in Proposition 3.2.10 from the previous chapter, $\mathbb{X}_{G,S}^g$ is sofic when $\text{Geo}(G,S)$ is regular. In order to find a characterization of groups that admit a geodesic skeleton that is sofic, we must look at geodesics that are not extendable. These elements are precisely the ones known as dead-ends. An element $g \in G$ is a **dead-end** with respect to the generating set S if for all $s \in S$ we have $d(1_G, gs) \leq d(1_G, g)$.

Proposition 4.6.3. *Let G be a finitely generated group along with a generating set S . Then, $\mathbb{X}_{G,S}^g$ is sofic and the language of geodesics defining dead-ends is regular if and only if $\text{Geo}(G,S)$ is regular.*

Proof. Let us denote by D the language of geodesics defining dead-ends. The language of prefixes of a regular language is regular and the language of inverses of a regular language is regular. Then, if D is regular, the languages pD and pD' denoting the set of prefixes of D and the set of inverses of prefixes of D respectively, are regular. If $\text{Geo}(G,S)$ is regular, then D is regular: it suffices to take the minimal deterministic finite state automaton with a single sink state for $\text{Geo}(G,S)$ and only keep accepting states where every outgoing transition goes to the sink state. Take the union $L = \mathcal{L}(\mathbb{X}_{G,S}^g) \cup pD \cup pD'$. This language is regular, as the union of regular languages is regular. Let us show $L = \text{Geo}(G,S)$. The first inclusion $L \subseteq \text{Geo}(G,S)$ is direct as $\mathcal{L}(\mathbb{X}_{G,S}^g) \subseteq \text{Geo}(G,S)$, inverses of geodesics are geodesic and prefixes of geodesics are geodesics.

Next, take $w \in \text{Geo}(G,S)$. If w is bi-infinitely extendable as a geodesic, then $w \in \mathcal{L}(\mathbb{X}_{G,S}^g) \subseteq L$. If w is not bi-extendable, it can fail to be extended to the right or to the left. Suppose it is not extendable to the right. Then there exists $v \in S^*$ such that $wv \in \text{Geo}(G,S)$ and $wvs \notin \text{Geo}(G,S)$ for all $s \in S$. This means w is a

prefix of the dead-end \overline{wv} , and therefore $w \in pD \subseteq L$. Finally, if w is not extendable to the left, there exists $v \in S^*$ such that $vw \in \text{Geo}(G, S)$ and $svw \notin \text{Geo}(G, S)$ for all $s \in S$. This is the same as, $w^{-1}v^{-1} \in \text{Geo}(G, S)$ and $w^{-1}v^{-1}s \notin \text{Geo}(G, S)$ for all $s \in S$. This means w is the inverse of a prefix of the dead-end represented by $w^{-1}v^{-1}$, and thus $w \in pD' \subseteq L$. \square

Corollary 4.6.4. *Let G be a finitely generated group with generating set S , and $\mathbb{Z} = \langle t \rangle$. Then, $\mathbb{X}_{G*\mathbb{Z}, S \cup \{t^{\pm 1}\}}^g$ is sofic if and only if $\text{Geo}(G, S)$ is regular.*

Proof. The language of dead-ends of $G * \mathbb{Z}$ is empty as any geodesic can be extended by $t^{\pm 1}$. Furthermore, any geodesic in $G * \mathbb{Z}$ can be decomposed as geodesics on G separated by factors of the form $t^{\pm n}$. Therefore, $\text{Geo}(G * \mathbb{Z}, S \cup \{t^{\pm 1}\})$ is regular if and only if $\text{Geo}(G, S)$ is regular. By Proposition 4.6.3 this happens if and only if $\mathbb{X}_{G*\mathbb{Z}, S \cup \{t^{\pm 1}\}}^g$ is sofic. \square

We pose the following question for sofic geodesic skeleton.

Question 4.6.5. Is $\mathbb{X}_{G,S}^g$ sofic if and only if $\text{Geo}(G, S)$ is regular?

Periodic geodesics As was the case for the skeleton (Theorem 4.3.17), the aperiodicity of the geodesic skeleton also characterizes torsion groups.

Theorem 4.6.6. *Let G be a finitely generated group. Then, G is a torsion group if and only if $\mathbb{X}_{G,S}^g$ is aperiodic for every (any) generating set S .*

Proof. Suppose G contains a torsion-free element g . Then, by Proposition 4.3.16 for any generating set S , there exists $k \geq 1$ and $w \in S^*$ a geodesic for g^k such that $w^\infty \in \mathbb{X}_{G,S}^g$, which is a periodic configuration. Conversely, if there exists a periodic configuration $x = w^\infty \in \mathbb{X}_{G,S}^g$ for some generating set S , then $g = \overline{w}$ is a torsion-free element. \square

4.6.1 Entropy and connective constant for geodesics

The objective of this section is to define an analog of the connective constant for geodesics. This relies on finding the asymptotic growth rate of geodesics of a given length. The **geodesic growth** of G with respect to S is the map $\Gamma_{G,S} : \mathbb{N} \rightarrow \mathbb{N}$ given by

$$\Gamma_{G,S}(n) = |\{w \in \text{Geo}(G, S) \mid |w| \leq n\}|.$$

The geodesic growth of groups has been extensively studied, especially in the case of virtually nilpotent groups [Bri+12; BE22; Bis21; Bod23]. Because this function is sub-multiplicative we can define the **geodesic connective constant** of the Cayley graph $\Gamma(G, S)$ as

$$\mu^g(G, S) = \lim_{n \rightarrow \infty} \sqrt[n]{\Gamma_{G,S}(n)}.$$

An argument analogous to the one in Remark 4.2.5 shows that $\mu^g(G, S)$ is equal to the growth rate of the number of geodesics of length exactly n . Thus, the geodesic growth is an upper bound on the complexity of $\mathbb{X}_{G,S}^g$. Because $\text{Geo}(G, S)$ is the set of locally admissible words for the geodesic skeleton, we use Lemma 1.4.16 to obtain an expression for the entropy.

Lemma 4.6.7. *Let G be a finitely generated group along with a generating set S . Then,*

$$h(\mathbb{X}_{G,S}^g) = \log(\mu^g(G, S)).$$

In other words, the geodesic connective constant is equal to the connective constant of bi-extendable geodesics.

Same as with the connective constant, the geodesic version is a non-negative rational power of a Perron number when $\mathbb{X}_{G,S}^g$ is sofic, and a right-computable number when $\mathbb{X}_{G,S}^g$ is effective. It is also a lower bound of the connective constant, that is, $\mu^g(G, S) \leq \mu(G, S)$. This inequality may be strict: graphs may have geodesic connective constant equal to 1 without being finite. As shown in [Bri+12], the virtually \mathbb{Z}^2 group $H = \langle \mathbf{a}, \mathbf{t} \mid [\mathbf{a}, \mathbf{t}\mathbf{a}\mathbf{t}^{-1}], \mathbf{t}^2 \rangle$, has geodesic growth of order $O(n^3)$ and therefore,

$$\mu^g(H, \{\mathbf{a}, \mathbf{t}\}) = 1 < \sqrt{3} \leq \mu(H, \{\mathbf{a}, \mathbf{t}\}).$$

This is also the case for lattices with known (or well-approximated) connective constants.

Proposition 4.6.8. *The geodesic connective constants of the square grid, ladder graph and hexagonal grid are as follows:*

- $\mu^g(\mathbb{Z}^2) = 2$,
- $\mu^g(\mathbb{L}) = 1$,
- $\mu^g(\mathbb{H}) = \sqrt{2}$.

Proof. • For the square lattice, we know that $\Gamma_{\mathbb{Z}^2, \{\mathbf{a}, \mathbf{b}\}}(n) \leq 2^{n+3}$ which implies $h(\mathbb{X}_{\mathbb{Z}^2, \{\mathbf{a}, \mathbf{b}\}}^g) = \log(2)$, as $\mathbb{X}_{G,S}^g$ contains the full-shift $\{\mathbf{a}, \mathbf{b}\}^{\mathbb{Z}}$.

- Recall that the ladder graph \mathbb{L} is the Cayley graph of $\mathbb{Z} \times \mathbb{Z}/2\mathbb{Z}$ with generating set $\{\mathbf{t}, \mathbf{s}\}$, where $\mathbf{s}^2 =_G \varepsilon$ and \mathbf{t} is the generator for \mathbb{Z} . In this case, the geodesic growth is given by $\Gamma(n) = n^2 + 3n$ when $n \geq 2$. Thus, the geodesic connective constant is 1.
- Also recall that the hexagonal grid \mathbb{H} is the Cayley graph of the Coxeter group \tilde{A}_2 with generating set $\{\mathbf{a}, \mathbf{b}, \mathbf{c}\}$ (see Example 1.3.29). From [Ava04] we know that the generating function for the geodesic growth of \tilde{A}_2 in this case is given by

$$f(z) = \frac{2z^3 + z^2 + z + 1}{(1-z)(1-2z^2)}.$$

Thus, the geodesic connective constant is given by the reciprocal of the smallest zero of the denominator, which is $\sqrt{2}$. □

On the other hand, if we take the infinite dihedral group \mathcal{D}_∞ with the generating set $S = \{\mathbf{a}, \mathbf{b}\}$ as seen in Example 3.2.2, we have that $\mu(\mathcal{D}_\infty, S) = \mu^g(\mathcal{D}_\infty, S) = 1$.

Question 4.6.9. Under which conditions $\mu(G, S) = \mu^g(G, S)$? Under which conditions is the inequality strict?

Part III

Aperiodicity

Chapter 5

Strong Aperiodicity, Weak Aperiodicity and Everything In Between

The theory of aperiodic tilings sprung to life following Berger's construction of the first aperiodic tileset in his proof of the undecidability of the Domino Problem [Ber66]. He constructed a set of 20426 Wang tiles that define a strongly aperiodic subshift of finite type, that is, every tiling of the plane by this tileset is aperiodic. This discovery launched a rich theory intersecting different areas such as symbolic dynamics [Rie22], computability [Jea10], and quasi-crystals [BG13], to mention a few.

Concerning Wang tiles, Robinson found an aperiodic Wang tileset of only 56 tiles that greatly simplified the proof of the undecidability of the Domino Problem [Rob71]. Many other aperiodic Wang tilesets were constructed by Amman in the 70s [GS87]. In 1996, Kari and Culik constructed a set of 13 tiles by coding orbits of piecewise linear functions [Kar96; Cul96]. This quest culminated in Jeandel and Rao's work [JR21], who showed that the smallest aperiodic Wang tileset is of size 11 (see Figure 5.1).

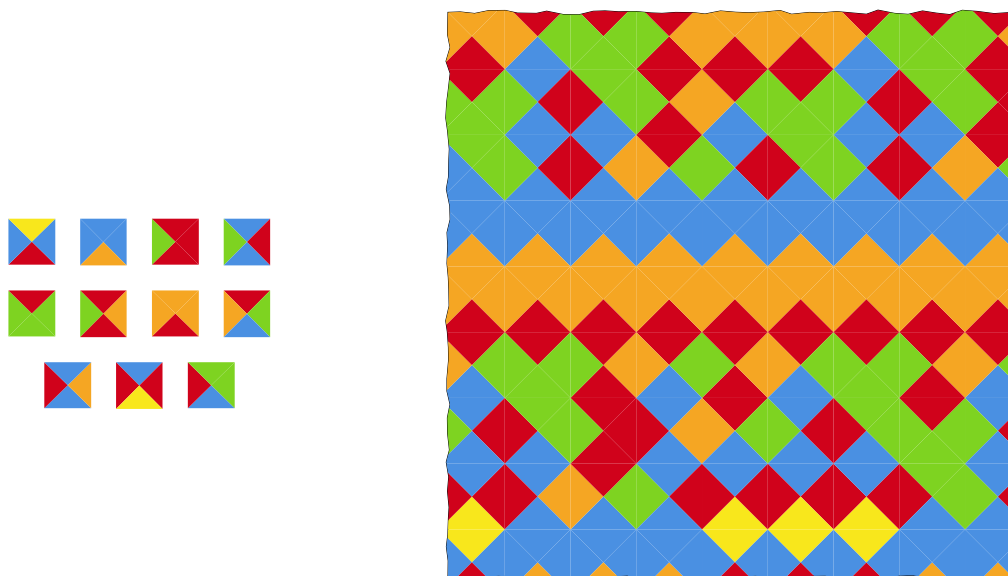

Figure 5.1: The Jeandel-Rao tileset. This tileset has the smallest possible size for an aperiodic Wang tileset.

The theory of aperiodic tilings has also grown to study aperiodic tilings on Riemannian manifolds other than the Euclidean plane. In this context, a tiling is aperiodic if it is fixed-point free by symmetries from the

isometry group of the manifold. When leaving the plane, there is an interesting phenomenon that occurs: there are two non-equivalent notions of aperiodicity. This was observed by Mozes, who introduced the notions of weak and strong aperiodicity [Moz97]. Since then, many manifolds have been shown to admit weakly and strongly aperiodic tilings, although most of them are of geometric nature, many of them can be seen as tilings of the fundamental group of the space. For instance, Penrose constructed a weakly aperiodic tiling on the hyperbolic plane [Pen79], Kari and Culik constructed weakly and strongly aperiodic tilings on Euclidean spaces of dimension $d > 2$ [CK95], Block and Weinberg constructed weakly aperiodic tilings for many spaces, that include non-amenable manifolds [BW92], Mozes constructed weakly and strongly aperiodic tilings on certain classes of Lie groups [Moz97], Goodman-Strauss constructed strongly aperiodic tilings on the hyperbolic plane [Goo05], and Marcinkowski and Nowak constructed weakly aperiodic tilings on many manifolds and groups, including the Grigorchuk group [MN14].

In this chapter we explore aperiodic tilings from the point of view of symbolic dynamics, viewing them as weakly and strongly aperiodic subshifts of finite type. In this field, the study of periodicity goes back to its origins, as it informs many properties of symbolic spaces. For instance, in their foundational article [MH38], Morse and Hedlund showed that a \mathbb{Z} -subshift X is periodic if and only if its complexity function satisfies $p_X(n) \leq n$ for some $n \in \mathbb{N}$. The formulation of aperiodicity in terms of subshifts first appeared in [KS88], where Kitchens and Schmidt made explicit links between Wang tilings and SFTs. They observed that, because every non-empty \mathbb{Z} -SFT has periodic points (see [LM21]), \mathbb{Z} does not admit aperiodic subshifts of finite type of any kind. This study was later expanded to other finitely generated groups by Piantadosi, who showed the existence of weakly aperiodic SFTs on free groups [Pia08]. The current project is to understand which geometric and algebraic conditions allow for the existence of weakly and strongly aperiodic subshifts of finite type.

The objective of this chapter is to explore the state of the art on the existence of both weakly and strongly aperiodic SFTs. We begin by looking at the strongly aperiodic case in Section 5.1. We then move on to the weakly aperiodic case in Section 5.2, where after revisiting the current state of the art, we prove new connections between the Domino Problem and weakly aperiodic SFTs, as well as exploring connections with percolation theory, the Angel Game, and the dynamics of cellular automata. Next, in Section 5.3, we take the study of (a)periodicity of subshifts of finite type further by looking at exactly which subgroups can be obtained as stabilizers of configurations in SFTs. In Section 5.4 we look at the class of periodically rigid groups, that is, groups that exhibit the same aperiodicity phenomenon as \mathbb{Z}^2 : every weakly aperiodic SFT must be strongly aperiodic.

5.1 Strongly aperiodic SFTs

Recall that a subshift $X \subseteq A^G$ is said to be **strongly aperiodic** if it is non-empty and the shift action of the group on X is free, i.e. $\text{stab}(x) = \{1_G\}$ for every $x \in X$.

There are several structural and algorithmic necessary conditions that a group must satisfy in order to allow a strongly aperiodic SFT. The first of these is due to Jeandel, and relates aperiodicity to the word problem of the group.

Theorem 5.1.1 (Jeandel [Jea15a]). *Let G be a finitely generated group. If G admits a strongly aperiodic SFT, then $\text{WP}(G) \leq_e \text{coWP}(G)$. In particular, if G is recursively presented it has decidable word problem.*

Recall from Remark 1.2.16 that a set satisfying $A \leq_e \text{co}A$ is called co-total. Thus, Jeandel's theorem states that the existence of strongly aperiodic SFTs implies that the word problem of the group is co-total.

The next restriction is due to Cohen, who related the existence of strongly aperiodic SFTs to the large scale structure of the group, specifically the amount of ends.

Theorem 5.1.2 (Cohen [Coh17]). *If G is a finitely generated group with at least two ends, then it does not admit a strongly aperiodic SFT.*

The proof of this result relies on what are known as n -axial elements of the group. The original proof of the existence of such elements contained some mistakes that were later patched by Salo and Genevois [Sal; Gen]. For completion's sake, let us give an alternative proof using the theory of ends by Halin, that we introduced in Section 4.4.1.

Definition 5.1.3. Let G be a finitely generated group with generating set S .

- Take three finite subsets F_0 , F_1 and F_2 of G that induce connected subgraphs in the Cayley graph $\Gamma(G, S)$. We say F_1 **separates** F_0 from F_2 if F_0 and F_2 lie in different connected components of $\Gamma(G, S) \setminus F_1$.
- For $n \in \mathbb{N}$ we say $g \in G$ is n -**axial** if for every $i < j < k$ the set $g^j \cdot B_S(n)$ separates $g^i \cdot B_S(n)$ from $g^k \cdot B_S(n)$.

Lemma 5.1.4. *Let G be a finitely generated group with generating set S . If G has two or more ends, there exists $N_G \in \mathbb{N}$ such that for all $n \geq N_G$ there exists an n -axial element.*

Recall from Section 4.4.1 that an end ω of $\Gamma(G, S)$ is **thin** if there exists $m \in \mathbb{N}$ such that there are at most m disjoint rays defining the end. The end is **thick** otherwise. Furthermore, any graph with more than two ends has a thin end (see [Hal73]).

Proof. Let G be a group as in the statement. As G has at least two ends, its Cayley graph has a thin end of size m for some $m \in \mathbb{N}$. Then, by Lemma 4.4.7, $\Gamma(G, S)$ contains a strip of size m , defined by a torsion-free group element $g \in G$ and $A \subseteq G$ such that $(g^n \cdot A)$ and $(g^{-n} \cdot A)$ are defining sequences for the ends $D(g)$ and $D(g^{-1})$ respectively. Furthermore, A separates $D(g)$ from $D(g^{-1})$ in the sense that no connected component from $\Gamma(G, S) \setminus A$ contains rays defining different ends. Because $\Gamma(G, S)$ is transitive, we can assume without loss of generality that $1_G \in A$.

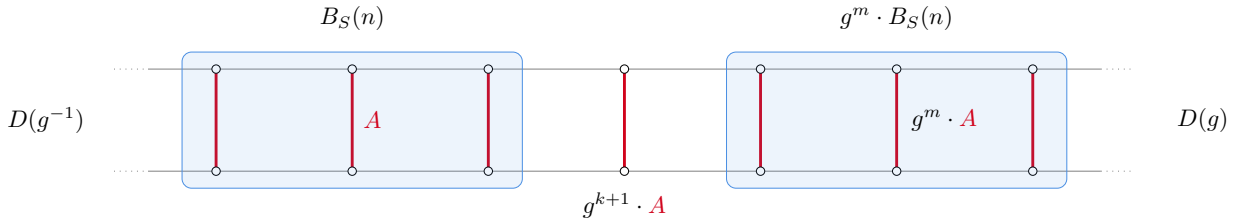

Figure 5.2: An example of a g -strip of size 2 with defining set A , in red. We can separate translates of the ball $B_S(n)$ provided we take a sufficiently large exponent for g .

Let N_G be the smallest $N \in \mathbb{N}$ such that $A \subseteq B_S(N)$. Next, take $n \geq N_G$ and let $k = k(n) \in \mathbb{N}$ be the maximum exponent such that either $g^k \cdot A \cap B_S(n) \neq \emptyset$ or $g^{-k} \cdot A \cap B_S(n) \neq \emptyset$. Thus, for $m \geq 2(k+1)$ we have that $g^m \cdot B_S(n) \cap B_S(n) = \emptyset$ and $g^{-m} \cdot B_S(n) \cap B_S(n) = \emptyset$ as they are separated by $g^{-(k+1)} \cdot A$ and $g^{k+1} \cdot A$ respectively (see Figure 5.2). Therefore, g^m is an n -axial element. \square

With an axial element at hand, Cohen simulates the behavior of \mathbb{Z} in the group, and is able to recreate the proof of the non-existence of aperiodic SFTs on \mathbb{Z} .

By combining Jeandel and Cohen's results, we arrive at the following conjecture.

Conjecture 5.1.5. Let G be a finitely generated group. G admits a strongly aperiodic SFT if and only if G is one ended and has decidable word problem.

Notice however that Jeandel’s Theorem does not rule out the existence of groups with undecidable word problem that satisfy $\text{WP}(G) \leq_e \text{coWP}(G)$ and admit a strongly aperiodic SFT. In fact, some researchers believe such groups exist¹. So far, the conjecture has been shown to hold for the following classes of finitely generated groups:

- Virtually polycyclic groups [Jea15b],
- Solvable Baumslag-Solitar groups, originally obtained in [EM22a] with an alternative proof in [AS24],
- The Ivanov monster group, for which every element is cyclic and contains a finite number of conjugacy classes, and the Osin monster groups, which contains two conjugacy classes [Jea15a],
- Surface groups [CG17], and more generally hyperbolic groups [CGR22],
- Groups of the form $\mathbb{Z}^2 \rtimes_{\phi} H$ where H has decidable word problem [BS19]. An independent proof also exists for the particular case of the Heisenberg group [SSU21],
- Groups of the form $G \times H \times K$ where each group has decidable word problem [Bar19]. This includes finitely generated branch groups with decidable word problem such as the Grigorchuk group,
- Self-simulable groups with decidable word problem [BSS21]. Self-simulable groups include the direct product of any two non-amenable groups as well as Thompson’s group V , Burger-Mozes simple finitely presented group, braid groups on more than 7 strands, some RAAGs, among others,
- Groups of the form $H \times N$ where both groups have decidable word problem and N is non-amenable [BSS23]. This includes some groups who were previously known to admit strongly aperiodic SFTs such as $\mathbb{Z} \times V$, $\mathbb{Z} \times T$ and $\mathbb{Z} \times PSL_2(\mathbb{Z})$ where V and T are Thompson’s groups [Jea15a],
- the Lamplighter group [BS24].

In the next chapter we add generalized Baumslag-Solitar groups to the list, which in particular contain all Baumslag-Solitar groups.

A particularly important property of strong aperiodicity is that it is a geometric property for finitely presented groups.

Theorem 5.1.6 (Cohen [Coh17]). *Let G and H be two quasi-isometric finitely presented groups. Then, G admits a strongly aperiodic SFT if and only if H does.*

A similar invariance result for finitely generated groups has been obtained for commensurable groups.

Theorem 5.1.7 (Carroll, Penland [CP15]). *Let G and H be two finitely generated groups which are commensurable. Then, G admits a strongly aperiodic SFT if and only if H does.*

As we saw in Section 1.3.6, commensurability implies quasi-isometry, but the converse does not always hold.

To finish this section, let us comment on what happens when one alleviates the restrictions of finite type or finite generation. Gao, Jackson and Seward showed that every countable group admits a strongly aperiodic subshift [GJS09]. This was later improved upon by Aubrun, Barbieri and Thomassé who in addition to finding an alternative proof for the result using the Lovász Local Lemma, showed that when the group is recursively presented the constructed strongly aperiodic subshift is effectively closed [ABT19].

On the side of non-finitely generated groups, Barbieri characterized groups that admit strongly aperiodic SFT in terms of their finitely generated subgroups.

¹Sebastián Barbieri, personal communication.

Theorem 5.1.8 (Barbieri [Bar23a]). *A group G admits a strongly aperiodic SFT if and only if there exists a finitely generated subgroup $H \leq G$ and a non-empty H -SFT X such that for every $g \in G \setminus \{1_G\}$ there exists $t \in G$ and $n \in \mathbb{N}$ such that $tg^n t^{-1} \in H \setminus \bigcup_{x \in X} \text{stab}(x)$.*

The strongly aperiodic shift comes from taking the free extension of X onto G (see Definition 1.5.1). This allowed Barbieri to show that groups such as \mathbb{Q}^2 admit strongly aperiodic SFT, and to find an alternative proof for the existence of such SFTs on the Osin monster group.

5.2 Weakly aperiodic SFTs

Recall that a subshift X is **weakly aperiodic** if it is non-empty and every orbit under the group action is infinite.

Our first observation is that for infinite groups, any strongly aperiodic SFT is weakly aperiodic, as the orbit of any configuration is in bijection to the quotient of the group by the corresponding stabilizer. This already gives us a number of examples of groups that admit weakly aperiodic SFTs. Nevertheless, there are groups that admit weakly aperiodic SFTs, but not strongly aperiodic ones, such as free groups (by Theorem 5.1.2). In 2015, Carroll and Penland showed that the only virtually nilpotent groups that do not admit weakly aperiodic SFTs are virtually \mathbb{Z} groups [CP15]. This motivated them to propose the following conjecture.

Conjecture 5.2.1. *Let G be a finitely generated group. Then, G admits a weakly aperiodic SFT if and only if it is not virtually \mathbb{Z} .*

At the time of writing, the following classes of finitely generated groups have been shown to satisfy this conjecture:

- Virtually nilpotent groups [BS18; CP15], and more generally virtually polycyclic groups [Jea15b],
- Baumslag-Solitar groups [AK13],
- Hyperbolic groups [CP06; Gro87],
- Non amenable groups [Jea15c; BW92],
- Non residually finite groups [Jea15c],
- Infinite finitely generated p -groups [Jea15c; MN14],
- Groups of the form $G_1 \times G_2$ where both groups are infinite [Jea15c]. This shows the Grigorchuk group admits a weakly aperiodic SFT, which was also obtained in [MN14],
- The Lamplighter group [Coh20].

In the next chapter we show generalized Baumslag-Solitar groups and Artin Groups also satisfy the conjecture.

There are also many properties satisfied by groups which do admit weakly aperiodic SFTs. We summarize these properties in the following proposition.

Proposition 5.2.2. *Let G be a finitely generated group. The following hold,*

- *If G is commensurable to H , and H admits a weakly aperiodic SFT, then so does G [CP15],*
- *If a subgroup $H \leq G$ admits a weakly aperiodic SFT, then so does G (see Lemma 1.5.4),*
- *For a finitely generated normal subgroup $N \trianglelefteq G$, if G/N admits a weakly aperiodic SFT, then so does G (see Proposition 5.3.9),*

- If a finitely presented group H acts translation-like on G , and H admits a weakly aperiodic SFT, then so does G [Jea15c].

Furthermore, if G does not admit a weakly aperiodic SFT,

- For every $n \in \mathbb{N}$ there must exist a finite index subgroup $H \leq G$ such that n divides $[G : H]$ [Jea15c, Corollary 3.3] (see also [MN14]),
- If G is finitely presented, then it must contain a finite index subgroup H that surjects into \mathbb{Z} [Coh20] (groups with this property are called **virtually indicable**),
- If G is finitely presented and is quasi-isometric to a finite presented group H , then there must exist $G_0 \leq G$ and $H_0 \leq H$ finite index subgroups such that H_0 is isomorphic to a quotient of G_0 by a finite subgroup [Coh17].

In the following sections we will add properties of groups that admit weakly aperiodic SFTs related to computability, and explore problems with similar conjectures and behavior to Carroll and Penland's conjecture.

5.2.1 Connections with decision problems and computability

There has always been an intuitive sense that the undecidability of the Domino Problem is linked to aperiodicity. In this section we establish a direct connection for groups where we can recursively enumerate finite quotients. This is done through Wang's algorithm: we test in parallel if the subshift is empty and if there is a periodic point.

Lemma 5.2.3. *If a recursively presented group G has undecidable Domino Problem, and the Periodic Domino Problem is in Σ_1^0 , then it admits a weakly aperiodic SFT.*

Proof. Suppose G does not admit weakly aperiodic SFTs. This means that every SFT contains a periodic point. Let S be a finite generating set for G and \mathcal{F} a set of nearest neighbor patterns over an alphabet A . Under these conditions, Wang's Algorithm provides a decision procedure for the Domino Problem on G . More precisely, because the group is recursively presented the Domino Problem on G is in Π_1^0 , that is, there is a procedure that given \mathcal{F} accepts if and only if $X_{\mathcal{F}}$ is empty. Therefore, what we do is run the Π_1^0 procedure for the Domino Problem, and the Σ_1^0 procedure for the Periodic Domino Problem in parallel. This way, $X_{\mathcal{F}}$ is empty if and only if the Domino Problem procedure stop, and $X_{\mathcal{F}}$ is non-empty if and only if the procedure for the Periodic Domino Problem stops, as every non-empty SFT has a periodic point under our assumptions. This procedure shows the Domino Problem on G is decidable, which contradicts our assumption. \square

This lemma allows us to connect the Domino Problem with aperiodicity for certain groups, as stated below.

Theorem 5.2.4. *Let G be a finitely presented group with decidable word problem. If G has undecidable Domino Problem, it admits a weakly aperiodic SFT.*

Proof. Finitely presented groups with decidable word problem have CFQ, as explained in Section 2.3.1. By Proposition 2.3.4, the Periodic Domino Problem for G is in Σ_1^0 . Finally, as G has undecidable Domino Problem, it admits a weakly aperiodic SFT by Lemma 5.2.3. \square

Another aspect of subshifts linked to aperiodicity is the computability of its configurations. Let $X \subseteq A^G$ be a subshift over a finitely generated group with generating set S . We say a configuration $x \in X$ is **computable** if there is an algorithm that given $w \in S^*$ outputs $x(\bar{w}) \in A$. We say a subshift is **uncomputable** if it contains no computable configurations. The first examples of an uncomputable SFT was given by Hanf and Myers on \mathbb{Z}^2 [Han74; Mye74]. In the next proposition we link uncomputable SFTs to weak aperiodicity.

Proposition 5.2.5. *Let G be a finitely generated group and $X \subseteq A^G$ an SFT. If X is uncomputable, then it is weakly aperiodic.*

Proof. Fix a generating set S . Suppose X is not weakly aperiodic. Then, there exists a periodic configuration $x \in X$, that is, a configuration such that $[G : \text{stab}(x)] < +\infty$. Let $N \trianglelefteq G$ be a finite index normal subgroup contained in $\text{stab}(x)$, and $\rho : G/N \rightarrow G$ a section. Because x is periodic, every element coset $N\rho(h)$ maps to the same letter $a_h \in A$, for all $h \in G/N$. Now, let $\pi : S \rightarrow G/N$ be the map over the generating set S that extends to the quotient map $G \rightarrow G/N$. The algorithm to compute x is as follows; given $w \in S^*$ compute its image $\pi(w) = \pi(w_1)\dots\pi(w_n) \in G/N$, and the output the letter $a_{\pi(w)}$. Therefore, X has a computable point. \square

The previous proposition also shows that every SFT on a virtually \mathbb{Z} group contains a computable point. Are this the only groups where this occurs?

Question 5.2.6. Which finitely generated groups admit uncomputable SFTs?

5.2.2 Analogies: percolation, angels and cellular automata

The problem of determining which groups admit weakly aperiodic SFTs resembles problems from probability theory, combinatorics and topological dynamics. In this section, we briefly explain these problems and look at possible strategies towards a resolution of Carroll and Penland’s conjecture.

Percolation

The first comparison we make is with the theory of percolation. From its origin in the field of statistical physics [BH57], the theory of percolation now comprises over 60 years of research in probability theory, combinatorics and graph theory [Dum18]. We only touch on this topic briefly, and will not go deeper on many aspects of the theory. For a comprehensive background on percolation see [BR06; Gri89].

Let $\Gamma = (V, E)$ be an infinite connected graph. We represent subgraphs of Γ through function $\gamma : E \rightarrow \{0, 1\}$, where $\gamma(e) = 1$ represents the fact that the edge e belongs to the subgraph. **Bernoulli bond percolation** is a model for random subgraphs of Γ , where each edge belongs to a subgraph with probability $p \in [0, 1]$. That is, $(\gamma(e))_{e \in E}$ form a family of i.i.d. Bernoulli variables of parameter p . This induces a probability measure \mathbb{P}_p on the subgraphs of Γ . The **critical parameter** of Γ is the quantity,

$$p_c(\Gamma) = \inf\{p \in [0, 1] \mid \mathbb{P}_p(\exists \text{ infinite connected component in } \Gamma) > 0\}.$$

One of the main problems in percolation theory is to determine under which conditions Γ satisfies $p_c(\Gamma) < 1$. We are interested in the particular case where Γ is the Cayley graph of a finitely generated group. Here, the fact that the critical parameter is strictly less than 1 is independent of the generating set (it is in fact invariant under quasi-isometries [LP16, Theorem 7.15]), so we can talk about *the* critical parameter of the group. In their celebrated 1996 article, Benjamini and Schramm proposed the following conjecture for percolation on Cayley graphs.

Conjecture 5.2.7 ([BS96]). For any finitely generated group G , $p_c(G) < 1$ if and only if G is not virtually \mathbb{Z} .

The conjecture was initially solved for finitely presented groups [BB99], groups with polynomial growth, and groups with exponential growth [Lyo95]. This left the case of intermediate groups open. For such groups, it was shown that Grigorchuk groups [MP01] and indicable groups [RY17] verify the conjecture. The conjecture was finally proven by Duminil-Copin, Goswami, Raoufi, Severo and Yadin through the use of Gaussian Free Fields [Dum+20].

The similarities between the conjecture for the critical parameter and the conjecture for weakly aperiodic SFTs was first noted by Jeandel in [Jea15c]. He also noted that the problems have similar inheritance properties:

- If $H \leq G$ with $p_c(H) < 1$, then $p_c(G) < 1$,
- If Q is a quotient of G with $p_c(Q) < 1$, then $p_c(G) < 1$

- If H acts translation-like on G and $p_c(H) < 1$, then $p_c(G) < 1$.

Question 5.2.8. Is there an explicit link between percolation and weakly aperiodic SFTs?

Even if there is no explicit link between the two problems, it could be fruitful to understand which structural properties of different groups account for the results in percolation, and how they can be exploited to obtain weakly aperiodic SFTs.

The Angel Game

The next comparison we draw is with **the Angel Game**. This game consists on two players, the **angel** and the **devil**, who take turns to play on a locally finite connected infinite graph $\Gamma = (V, E)$. The angel has a fixed power $p \in \mathbb{N}$ and begins on a fixed **root** $r \in V$. We call such an angel a p -angel. On their turn, the angel can jump to any vertex at distance at most p from its current position. On the devil's turn, the devil **burns** a vertex of the graph that is not the one on which the angel is currently standing on. Once a vertex has been burned, it remains burnt and it cannot be visited by the angel. The objective of the angel is to **escape**, that is, to eventually leave any ball around the root.

The current formulation of the Angel Game was introduced in [BCG82, Chapter 19], and expanded to infinite graphs by Conway in [Con96]. The original problem was to determine if there exists a power p such that the p -angel escapes on \mathbb{Z}^2 . This question was answered positively by Kloster [Klo07], Máthé [Mát07] and Bowditch [Bow07]. It was also answered positively by Kutz [Kut05], Bollobás and Leader [BL06] in the case of \mathbb{Z}^3 . These last works on three dimensions prompted Bowditch to generalize the problem to locally finite graphs. He proposed the following definition.

Definition 5.2.9. A locally finite connected infinite graph Γ is said to be **diabolical** if the devil traps the angel of any power, independently of the starting position. A group G is **diabolical** if it admits a diabolical Cayley graph.

Bowditch sketched proofs for the fact that being diabolical is invariant under quasi-isometries and noted that if an angel escapes on a subgraph, it must escape on the whole graph. Furthermore, he asked if the only diabolical groups are virtually \mathbb{Z} groups. We restate this question in the form of a conjecture.

Conjecture 5.2.10. A finitely generated group is diabolical if and only if is virtually \mathbb{Z} .

To tackle this conjecture, let us introduce some notation. What follows is unpublished joint work with Eduardo Silva on the Angel Game on graphs and groups.

Let $\Gamma = (V, E)$ be a locally finite connected infinite graph, and let $d : V \times V \rightarrow \mathbb{N}$ denote its combinatorial distance. We call the starting position of the angel, $r \in V$, the **root** of Γ , and we write $B_\Gamma(n)$ for the ball of radius $n \in \mathbb{N}$ centered at r . The location of the angel at time n will be denoted by $\sigma(n) \in V$, the vertex the devil burns at time n by $b(n)$, and the set of all vertices burned at time n by $\Delta(n)$. This way, we can represent the fact that:

- the angel starts at the root by $\sigma(0) = r$,
- the angel never visits a burnt vertex by $\sigma(n) \notin \Delta(n-1)$,
- the graph begins without burnt vertices by $\Delta(0) = \emptyset$.

If the angel has power p , then $d(\sigma(n), \sigma(n+1)) \leq p$. Finally, because the devil burns one vertex per turn, we have that $|\Delta(n)| = n$ and $\Delta(n+1) = \Delta(n) \cup \{b(n+1)\}$.

Given a graph Γ and a root r , we say the rooted graph (Γ, r) is diabolical, if the angel starting at r can't escape. The following proposition shows that being diabolical is independent of the root.

Proposition 5.2.11. *Let $\Gamma = (V, E)$ be an infinite locally finite connected graph. The following are equivalent.*

1. *For some $r \in V$, the rooted graph (Γ, r) is diabolical.*
2. *For every $r \in V$, the rooted graph (Γ, r) is diabolical.*

Proof. It is straightforward that (2) implies (1), so we only need to prove the reverse implication. Suppose that (Γ, r) is diabolical for some $r \in V$, and looking for a contradiction suppose there exists $r' \in V$ such that (Γ, r') is not diabolical. That is, there exists $p \geq 1$ such that an angel of power p has a winning strategy in (Γ, r') . If we consider the angel of power $p + d(r, r')$ in (Γ, r) , we see that they have a winning strategy: the angel wins by moving exactly as the angel in (Γ, r') does. This is of course a contradiction since we had supposed that (Γ, r) was diabolical. \square

Let us establish some invariance and inheritance properties satisfied by diabolical graphs and groups. Notice that if the angel can escape in a graph Γ , it can escape in any graph that contains Γ as a subgraph by simply ignoring vertices that are not from Γ . In other words,

Lemma 5.2.12. *Let Γ be a graph and $\Gamma' \subseteq \Gamma$ a subgraph. If Γ is diabolical, then Γ' is diabolical.*

We can do something similar for groups and their quotients.

Lemma 5.2.13. *Let G be a finitely generated group and Q a quotient of G . If Q is not diabolical, then G is not diabolical.*

Proof. Let S be a generating set for G . For Q , take the generating set $\pi(S)$ where $\pi : G \rightarrow Q$ is the canonical surjection. This way, π is a 1-Lipschitz map between the corresponding word metrics, i.e. $d_{\pi(S)}(\pi(g_1), \pi(g_2)) \leq d_S(g_1, g_2)$. Because Q is not diabolical, there exists some power p such that the p -angel escapes in Q . We call this angel the Q -angel, and denote its strategy by σ_Q .

Consider a p -angel in G . Its strategy begins by looking at the first step of the Q -angel, $\sigma_Q(1) = \overline{\pi(s_1) \dots \pi(s_m)}$ where $\pi(s_1) \dots \pi(s_m)$ is a geodesic path, and jumps to $\sigma(1) = \overline{s_1 \dots s_m}$. Now, suppose that the first n steps of the game have already taken place. At time $n + 1$ the angel looks at what the Q -angel does when the Q -devil burns $\pi(b(n)) \in Q$. If the Q -angel moves to a vertex linked by a geodesic path $\pi(s_1) \dots \pi(s_{m'})$, that is, $\sigma_Q(n + 1) = \sigma_Q(n) \overline{\pi(s_1) \dots \pi(s_{m'})}$, then the angel moves to $\sigma(n + 1) = \sigma(n) \overline{s_1 \dots s_{m'}}$. This way, if the devil in G manages to trap the angel in ball of radius ρ , it would imply that the Q -devil in manages to trap the Q -angel within $B_Q(\rho)$. This contradict our hypothesis that Q is not diabolical. \square

The property of being diabolical also behaves well with quasi-isometries and translation-like actions.

Proposition 5.2.14. *Being diabolical is a quasi-isometry invariant.*

Proof. Let Γ_1 and Γ_2 be two graphs along with a (λ, c) -quasi-isometry $f : \Gamma_1 \rightarrow \Gamma_2$. We proceed by contradiction. Suppose Γ_1 is not diabolical. Then, there exist p and $r \in V_1$ such that the p -angel starting from r escapes on Γ_1 . We call this angel the Γ_1 -angel, and denote its strategy by σ_1 . Let us show the angel starting from $f(r)$ of power $\lambda p + c$ escapes in Γ_2 . The first step the angel takes is given by $\sigma(1) = f(\sigma_1(1))$. Next, if at step $n \in \mathbb{N}$ the devil burns $b(n) = f(v) \in f(\Gamma_1)$, we move to $\sigma(n + 1) = f(\sigma_1(n + 1))$, where $\sigma_1(n + 1)$ is the vertex to which the Γ_1 -angel moves when the Γ_1 -devil burns $v \in \Gamma_1$. If on the other hand, the devil burns $b(n) \in \Gamma_2 \setminus f(\Gamma_1)$, the angel simply stays where it is. Because f is a quasi-isometry:

$$\begin{aligned} d(\sigma(n), \sigma(n + 1)) &= d(f(\sigma_1(n)), f(\sigma_1(n + 1))) \\ &\leq \lambda d(\sigma_1(n), \sigma_1(n + 1)) + c \\ &\leq \lambda p + c. \end{aligned}$$

Finally, if the devil manages to trap the angel on a ball $B_{\Gamma_1}(\rho)$ it means that the Γ_1 -devil traps the Γ_1 -angel in the ball $B_{\Gamma_2}(\lambda(\rho + c))$, which is a contradiction. \square

The previous proposition gives us a simple proof of one of the directions of the conjecture.

Proposition 5.2.15. *Any virtually \mathbb{Z} group is diabolical.*

Proof. Because any virtually \mathbb{Z} group is quasi-isometric to \mathbb{Z} , by Proposition 5.2.14 it suffices to see that \mathbb{Z} is diabolical. If we have an angel of power p starting at 0, it suffices for the devil to burn the intervals $[-2p^2 - p, -2p^2] \cup [2p^2, 2p^2 + p]$. The $2p^2$ term ensures that the angel does not have enough time to reach the sections being burned. \square

Proposition 5.2.16. *Let G be a finitely generated group and Γ be a graph such that G acts translation-like on Γ . Then, if G is not diabolical, Γ is not diabolical.*

Proof. Let S be a finite set of generators for G . Let us define $D_s = \{d(v, v * s) \mid v \in V_\Gamma\}$ for $s \in S$. These sets are bounded as the action is translation-like. Let $M > 0$ be a uniform bound for all D_s .

Because G is not diabolical, there exists p such that the p -angel starting from 1_G escapes in the Cayley graph $\Gamma(G, S)$. We call this angel the G -angel, and denote its strategy by σ_G . Let $r \in V_\Gamma$ be any starting point. We show that the angel of power pM escapes in Γ . The angel's strategy begins by moving to $\sigma(1) = r * \sigma_G(1)$. Next, if at step $n \in \mathbb{N}$ the devil burns $b(n) = r * g \in r * G$, we move to $\sigma(n+1) = \sigma(n) * h$, where $h = \sigma_G(n)^{-1} \sigma_G(n+1)$ and $\sigma_G(n+1)$ is where the G -angel moves when the G -devil burns $g \in G$. On the other hand, if the devil burns $b(n) \in \Gamma \setminus r * G$, the angel stays where it is. Because G acts translation-like, we have

$$\begin{aligned} d(\sigma(n), \sigma(n+1)) &= d(r * \sigma_G(n), r * \sigma_G(n+1)) \\ &= d(r * \sigma_G(n), (r * \sigma_G(n)) * h) \\ &\leq Mp, \end{aligned}$$

as $h \in B_S(p)$. Finally, if the devil traps the angel in $B_\Gamma(\rho)$, then the G -devil would trap the G -angel in the ball $B_S(\lfloor \frac{\rho}{M} \rfloor)$ which is a contradiction. Therefore, the angel escapes in Γ . \square

With these pieces in place we can prove the following.

Proposition 5.2.17. *Let Γ be a quasi-transitive graph with superlinear polynomial growth. Then, Γ is not diabolical.*

Proof. As Γ is quasi-transitive and has polynomial growth by Trofimov's Theorem [Tro84] (see also [Woe00, Theorem 5.11]), it is quasi-isometric to a group with polynomial growth. Then by Gromov's Theorem (Theorem 1.3.19), it is quasi-isometric to a nilpotent group G . Furthermore, as Γ has superlinear growth, G is not virtually \mathbb{Z} . Finally, G contains \mathbb{Z}^2 as a subgroup, which by Lemma 5.2.12 means it is not diabolical. We conclude Γ is not diabolical by Proposition 5.2.14. \square

On the other side of the growth spectrum we have the free group \mathbb{F}_2 . It is easy to see that on the 4-regular tree the 1-angel escapes: at each step the angel moves to a subtree with no burnt vertices. This fact will help us tackle the conjecture on the following class of graphs.

Definition 5.2.18. A graph Γ is **non-amenable** if there exists a constant $C > 0$ such that for all finite subsets $F \subseteq V$,

$$C|F| \leq |\partial F|,$$

where ∂F is the set of vertices spanned by edges with one vertex in F and one vertex outside.

The infimum over all constants C that verify the previous definition is known as the **Cheeger constant** of the graph. Thus, a graph is non-amenable if and only if it has a strictly positive Cheeger constant. For trees with bounded degree we can characterize non-amenability even further.

Lemma 5.2.19. *Let T be an infinite tree with bounded degree. The following are equivalent:*

1. T is non-amenable,
2. T has exponential growth,

3. there is a uniform bound on the length of unbranching paths in T .

The proof of the equivalence between 1. and 2. comes from [Ger88], and the proof of the equivalence between 1. and 3. from [Ger86] (see also [MR20]).

Non-amenable locally finite graphs can also be characterized through translation-like actions.

Theorem 5.2.20 (Whyte, Theorem 6.1 [Why99]). *A locally finite graph is non-amenable if and only if it admits a translation-like action from \mathbb{F}_2 .*

Theorem 5.2.21. *Let G be a finitely generated group of exponential growth. Then, G is not diabolical.*

Proof. We use an idea by Lyons [Lyo95] to find a tree of exponential growth within any Cayley graph of the group. Let S be a generating set for G . Every group element g has a unique geodesic of minimal lexicographic length which we denote by $\ell(g) \in S^*$. We define the geodesic spanning tree of $\Gamma(G, S)$, T , as the graph with vertex set G , where g is adjacent to h if $\|h\|_S = \|g\|_S + 1$ and $\ell(h)$ is a prefix of $\ell(g)$. From [Lyo95] we know that the growth rate of T is equal to the growth rate of the group. Then, as T has exponential growth rate and bounded degree it is non-amenable by Lemma 5.2.19, and by Theorem 5.2.20, admits a translation-like action from \mathbb{F}_2 . We conclude from Proposition 5.2.16 and Lemma 5.2.12 that G is not diabolical. \square

The combination of Proposition 5.2.17 and Theorem 5.2.21 shows that the cases that remain in order to prove the conjecture are groups of intermediate growth. This is a similar situation to the one Benjamini and Schramm's percolation conjecture found itself in before it was proven. As was done for that conjecture, we use Proposition 5.2.16 and the fact that \mathbb{Z}^2 acts translation-like on the direct product of two infinite groups [MP01] to state the following.

Proposition 5.2.22. *Groups of the form $G_1 \times G_2$ where each group is infinite are not diabolical. In particular, this implies the Grigorchuk group is not diabolical.*

Once again, the properties satisfied by diabolical groups resemble the ones satisfied groups with weakly aperiodic SFTs.

Question 5.2.23. Is there an explicit connection between the Angel Game and weakly aperiodic SFTs? Is there one between the Angel Game and percolation?

The strategies employed in this problem could shed light on how to construct weakly aperiodic SFTs on new classes of groups.

Sensitivity and equicontinuity of cellular automata

Our final comparison comes from the theory of cellular automata as dynamical systems.

Definition 5.2.24. Let (X, d) be a metric space along with a continuous function $f : X \rightarrow X$. We say,

- $x \in X$ is an **equicontinuous point** if for every $\varepsilon > 0$ there exists $\delta > 0$ such that for all $y \in X$ and $n \in \mathbb{N}$, we have that $d(x, y) < \delta$ implies $d(f^n(x), f^n(y)) < \varepsilon$.
- (X, f) is **sensitive** if there exists ε such that for all $\delta > 0$ and $x \in X$ there exists $y \in X$ and $n \in \mathbb{N}$ such that $d(x, y) < \delta$ and $d(f^n(x), f^n(y)) < \varepsilon$.

Given a group G , we define the class \mathcal{E}_{qu} of G -CA that have equicontinuous points, and the class \mathcal{S}_{ens} of sensitive G -CA. By definition the two classes are disjoint. However, there may exist CA that do not belong to any of the two. K urka showed that in \mathbb{Z} , every CA is either in \mathcal{E}_{qu} or \mathcal{S}_{ens} [K ur97]. On the other hand, Sablik and Theyssier showed that in \mathbb{Z}^d , with $d \geq 2$, this is no longer the case: there exist \mathbb{Z}^d -CA that have no equicontinuous points and are not sensitive [ST11]. Due to this difference in behavior, they asked what happens for other groups.

Conjecture 5.2.25 (G. Theyssier²). Let G be a finitely generated group. Every G -CA is either in \mathcal{E}_{qu} or \mathcal{S}_{ens} if and only if G is virtually \mathbb{Z} .

Question 5.2.26. Is there an explicit connection between a group admitting a weakly aperiodic SFT and it satisfying this CA behavioral dichotomy?

It is straightforward to show that a G -shift is an SFT if and only if it is the set of fixed points of some G -CA, and that the space-time shift of a G -CA is a $(G \times \mathbb{Z})$ -SFT. These two facts could provide an explicit connection, although at the time of writing no such studies have been made.

5.3 Subgroup Realizability: How I Learned to Stop Worrying and Love Periodicity

How much control do we have over the stabilizers of an SFT? Could we replace the trivial subgroup in strongly aperiodic SFTs with any other subgroup? The aim of this section is to explore this question. We will see that there are both algebraic and computational restrictions to the realizability of subgroups as stabilizers.

We denote the space of subgroups of a group G by $\text{Sub}(G)$. Similarly, we denote the set of stabilizers of a G -subshift as $\text{stab}(X) = \{\text{stab}(x) \mid x \in X\} \subseteq \text{Sub}(G)$.

Definition 5.3.1. We say a family of subgroups $\mathcal{G} \subseteq \text{Sub}(G)$ is **realizable** if there exists a non-empty G -SFT X such that $\text{stab}(X) = \mathcal{G}$. We say $H \in \text{Sub}(G)$ is realizable if the singleton $\{H\}$ is realizable.

Question 5.3.2. Which subsets of $\text{Sub}(G)$ are realizable?

First off, a simple cardinality argument shows that no group allows for all subsets of $\text{Sub}(G)$ to be realizable: $\mathcal{P}(\text{Sub}(G))$ is uncountable while the number of SFTs is countable.

A natural starting then is the realizability of a single subgroup. This question is non-trivial as the realization of the trivial subgroup is equivalent to finding a strongly aperiodic SFT. Even if we ask for the realization of subgroups isomorphic to \mathbb{Z} on \mathbb{Z}^d , the problem is non-trivial.

Lemma 5.3.3. *In \mathbb{Z}^2 , the subgroup $p\mathbb{Z} \times \{0\}$ is not realizable. In particular, for any SFT $X \subseteq A^{\mathbb{Z}^2}$, if $p\mathbb{Z} \times \{0\} \in \text{stab}(X)$, then there exists $0 < q \leq |A|^p + 1$ such that $p\mathbb{Z} \times q\mathbb{Z} \in \text{stab}(X)$.*

Proof. Take X a nearest neighbor \mathbb{Z}^2 -SFT and $x \in X$ such that $\text{stab}(x) = p\mathbb{Z} \times \{0\}$. Denote $w^k = x|_{[0,p-1] \times \{k\}}$. Because of x 's periodicity, for all $k \in \mathbb{Z}$, the restriction $x|_{\mathbb{Z} \times \{k\}}$ is the periodic configuration $(w^k)^\infty$. Now, by the pigeonhole principle, there exist $k \geq 0$ and $0 < q \leq |A|^{p+1}$ such that $w^k = w^{k+q}$. Let $sq : [0, p-1] \times [0, q-1] \rightarrow A$ be the rectangular pattern defined by $sq(i, j) = (w^{k+j})_i$. Define $y \in A^{\mathbb{Z}^2}$ by $y(i, j) = sq(i \bmod p, j \bmod q)$. By construction, y belongs to X and its stabilizer is $p\mathbb{Z} \times q\mathbb{Z}$ and belongs to X . \square

We generalize this phenomenon to find more examples of non-realizable subgroups in the subsequent sections.

5.3.1 General properties

We saw in Section 1.5 that every SFT is conjugate to a nearest neighbor SFT. This result allows us to restrict the scope of the SFTs we consider, as stabilizers are preserved under conjugacies.

Lemma 5.3.4. *Let X be topologically conjugate to Y . Then, $\text{stab}(X) = \text{stab}(Y)$.*

We can also quickly rule out the realizability of non-normal subgroups.

Lemma 5.3.5. *Let X be a non-empty subshift and $H \in \text{Sub}(G)$ a subgroup such that $H \in \text{stab}(X)$. Then, for all $g \in G$, $gHg^{-1} \in \text{stab}(X)$. In particular, subgroups that are not normal are not realizable.*

²Personal communication.

Proof. Let $x \in X$ be a configuration such that $\text{stab}(x) = H$. Then, for any $g \in G$,

$$\text{stab}(g \cdot x) = gHg^{-1}.$$

Thus, $gHg^{-1} \in \text{stab}(X)$. If H is not normal, there exist $g_0 \in G$ and $h \in H$ such that $g_0hg_0^{-1} \notin H$. Suppose H were realizable by X . Then, for any $x \in X$, $\text{stab}(g_0 \cdot x) \neq H$, which is a contradiction. \square

Remark 5.3.6. For any group G , there is a natural action of G on its space of subgroup by conjugation, that is, $g \cdot H = gHg^{-1}$. The previous lemma shows that $\text{stab} : X \rightarrow \text{Sub}(G)$ is a G -invariant map. Furthermore, if we take an alphabet A of size at least 2, $\text{stab}(A^G) = \text{Sub}(G)$. Let $a, b \in A$ be two distinct letters. For a subgroup $H \in \text{Sub}(G)$ we can define $x \in X$ by $x(h) = a$ if $h \in H$, and b otherwise. Then, $\text{stab}(x) = H$.

In contrast to non-normal subgroups, finite index normal subgroups are always realizable. A normal finite index subgroup N is realized by its corresponding N -locked shift as shown in Lemma 6.3.2.

Lemma 5.3.7. *Finite index normal subgroups are always realizable.*

Through operations between subshifts we can combine realizable subsets obtain new ones. One such operation is the direct product. The **direct product** of two subshifts $X \subseteq A^G$ and $Y \subseteq B^G$ is the subshift

$$X \times Y = \{(x, y) \mid x \in X, y \in Y\} \subseteq (A \times B)^G.$$

If X is defined by the set of forbidden patterns \mathcal{F}_X and Y by the set \mathcal{F}_Y , the direct product is the subshift of $(A \times B)^G$ defined by the set of forbidden patterns

$$\left(\bigcup_{p \in \mathcal{F}_X} \{p\} \times B^{\text{supp}(p)} \right) \cup \left(\bigcup_{q \in \mathcal{F}_Y} A^{\text{supp}(q)} \times \{q\} \right).$$

In particular, the direct product of two SFTs is an SFT. Finally, we define the subgroup-wise intersection of two subsets as

$$\mathcal{G}_1 \sqcap \mathcal{G}_2 = \{H_1 \cap H_2 \mid H_1 \in \mathcal{G}_1, H_2 \in \mathcal{G}_2\}.$$

Proposition 5.3.8. *Let I be a finite set of indices and $(\mathcal{G}_i)_i$ realizable subsets. Then,*

1. $\bigcup_{i \in I} \mathcal{G}_i$ is realizable,
2. $\bigcap_{i \in I} \mathcal{G}_i$ is realizable.

Proof. We will prove the case of $|I| = 2$, the general case follows directly. Let X_i be the SFT that realizes \mathcal{G}_i for $i = 1, 2$.

1. Assuming the alphabets of X_1 and X_2 are disjoint, take $Y = X_1 \cup X_2$. This new subshift is an SFT as the finite union of SFTs is an SFT. Every configuration of both X_1 and X_2 is contained in Y , and therefore $\mathcal{G}_1 \cup \mathcal{G}_2 \subseteq \text{stab}(Y)$. It is straightforward that $\text{stab}(y) \in \mathcal{G}_1 \cup \mathcal{G}_2$ for all $y \in Y$.
2. Define $Y = X_1 \times X_2$. Once again, Y is an SFT as the product of two SFTs in a SFT. Take a subgroup $H = H_1 \cap H_2 \in \mathcal{G}_1 \sqcap \mathcal{G}_2$ and $x_i \in X_i$ such that $\text{stab}(x_i) = H_i$ for $i \in \{1, 2\}$. Take $x = (x_1, x_2) \in Y$ and $g \in \text{stab}(x)$. By definition, g must stabilize both x_1 and x_2 . Thus, $g \in \text{stab}(x_1) \cap \text{stab}(x_2)$. Conversely, if an element $g \in G$ stabilizes both x_1 and x_2 , it stabilizes x . Therefore, $\text{stab}(x) = \text{stab}(x_1) \cap \text{stab}(x_2)$. An analogous procedure shows that the stabilizer of any $x \in Y$ is the intersection of the stabilizers of its coordinates. \square

Particular instances of this lemma have already appeared in the literature with the purpose of finding strongly aperiodic SFTs. For example in [CGR22, Proposition 3.4] and [Jea15b, Proposition 2.3].

5.3.2 Quotients and realizability

Let $N \trianglelefteq G$ be a non-trivial finitely generated normal subgroup. We want to study how realizable families in the quotient G/N influence realizable families in G , and vice-versa.

Given a section $\rho : G/N \rightarrow G$, a set S of generators for G/N , and T a set of generators of N , the set $\rho(S) \cup T$ is a finite generating set for G . Recall from Section 1.5 that starting from a subshift $X \subseteq A^{G/N}$ we can define its **pull-back** $\pi^*(X) \subseteq A^G$, where $\pi : G \rightarrow G/N$ is the quotient map. We will use the pull-back shift to go from realizability in the quotient to realizability in the starting group. Furthermore, when X is a nearest neighbor SFT over S the pull-back is a nearest-neighbor SFT over $\rho(S) \cup T$ (see Lemma 1.5.16).

We make extensive use of the fact that for all $k_1, k_2, k \in G/N$ we have that $\rho(k_1 k_2) = \rho(k_1) \rho(k_2) h$ and $\rho(k^{-1}) = \rho(k)^{-1} h'$ for some $h, h' \in N$.

Proposition 5.3.9. *Let $N \trianglelefteq G$ be a finitely generated normal subgroup. Let X be a G/N -subshift, and $\pi^*(X)$ its pull-back. Then, $\text{stab}(\pi^*(X)) = \rho(\text{stab}(X))N$, where $\rho : G/N \rightarrow G$ is any section. In particular, if \mathcal{G} is realizable in G/N , then $\rho(\mathcal{G})N = \{\rho(H)N \mid H \in \mathcal{G}\}$ is realizable in G .*

Proof. Fix a section $\rho : G/N \rightarrow G$, take $y \in \pi^*(X)$ and define $x_g = y_{\rho(g)}$ for $g \in G/N$. By Lemma 1.5.21, $x \in X$. Take $g \in \text{stab}(y)$, with $k \in G/H$ and $h \in N$ such that $g = \rho(k)h$. For all $k' \in G/N$,

$$\begin{aligned} x(k') &= y(\rho(k')) = (g \cdot y)(\rho(k')) = y(h^{-1} \rho(k)^{-1} \rho(k')) \\ &= y(h' \rho(k^{-1} k)) \text{ for some } h' \in N \\ &= y(\rho(k^{-1} k')) = x(k^{-1} k') \\ &= (k \cdot x)(k'). \end{aligned}$$

Therefore, $k \in \text{stab}(x)$ and $\text{stab}(y) \subseteq \rho(\text{stab}(x))N$. Conversely, if $g = \rho(k)h \in \rho(\text{stab}(x))N$, for any $k' \in G/N$ and $h' \in N$,

$$\begin{aligned} (g \cdot y)(\rho(k')h') &= y(h^{-1} \rho(k)^{-1} \rho(k')h') \\ &= y(h \rho(k^{-1} k')) \text{ for some } h \in N \\ &= y(\rho(k^{-1} k')) = x(k^{-1} k') \\ &= x(k') = y(\rho(k')) \\ &= y(\rho(k')h'). \end{aligned}$$

Thus, $\text{stab}(y) = \rho(\text{stab}(x))N$. This, in turn, implies that $\text{stab}(\pi^*(X)) \subseteq \rho(\mathcal{G})N$. To see that they are equal, given $x \in X$ we define $y(\rho(k)h) = x(k)$ for all $k \in G/N$ and $h \in N$. Retracing the steps above we can confirm $\rho(\mathcal{G})N = \text{stab}(\pi^*(X))$.

Finally, if $X \subseteq A^{G/N}$ is a non-empty SFT that realizes $\mathcal{G} \subseteq \text{Sub}(G/N)$; by Lemma 1.5.16 we know $\pi^*(X)$ is a non-empty SFT and realizes $\rho(\mathcal{G})N$. \square

We can also state restrictions in the other direction by making use of the **push-forward** subshift (see Section 1.5.4).

Proposition 5.3.10. *Let $N \trianglelefteq G$ be a finitely generated normal subgroup. Let $X \subseteq \text{Fix}_A(N)$ be a G -SFT and $\rho^*(X)$ its push-forward, for any section $\rho : G/N \rightarrow G$. Then, $\text{stab}(\rho^*(X)) = \text{stab}(X)/N$. In particular, if \mathcal{G} is realizable in G such that $N \subseteq \bigcap_{H \in \mathcal{G}} H$, then $\mathcal{G}/N = \{K/N \mid K \in \mathcal{G}\}$ is realizable in G/N .*

Proof. For any configuration $y \in \rho^*(X)$, there exists $x \in X$ such that $y = x \circ \rho$. Let us now show that

$\text{stab}(y) = \text{stab}(x)/N$. Indeed, given $k \in \text{stab}(y)$, for any $k' \in G/N$ and $h \in N$ we have that

$$\begin{aligned} (\rho(k) \cdot x)(\rho(k')h) &= x(\rho(k)^{-1}\rho(k')h) \\ &= x(h'\rho(k^{-1}k)) \text{ for some } h' \in N \\ &= x(\rho(k^{-1}k')) = y(k^{-1}k') \\ &= y(k') = x(\rho(k')) \\ &= x(\rho(k')h). \end{aligned}$$

In other words, $\rho(k) \in \text{stab}(x)$ and consequently $k \in \text{stab}(x)/N$. Now, let $k \in \text{stab}(x)/N$ (equivalently $\rho(k) \in \text{stab}(x)$). For any $k' \in G/N$ we have

$$\begin{aligned} (k \cdot y)(k') &= y(k^{-1}k') \\ &= x(\rho(k^{-1}k)) = x(h'\rho(k)^{-1}\rho(k)) \text{ for some } h' \in N \\ &= x(\rho(k)^{-1}\rho(k')) = x(\rho(k')) \\ &= y(k'). \end{aligned}$$

Therefore, $\text{stab}(y) = \text{stab}(x)/N$. Finally, if we take $x \in X$ we can define $y \in \rho^*(X)$ by $y(k) = x(\rho(k))$, by retracing the previous steps we obtain that $\text{stab}(\rho^*(X)) = \mathcal{G}/N$.

Finally, if $X \subseteq A^G$ is a non-empty SFT that realizes \mathcal{G} ; because $N \subseteq H$ for all $H \in \mathcal{G}$, $X \subseteq \text{Fix}_A(N)$. Furthermore, by Lemma 5.3.4 we can take X to be a nearest neighbor SFT with respect to the generating set $\rho(S) \cup T$. By Lemma 1.5.20, $\rho^*(X)$ is a non-empty SFT that realizes \mathcal{G}/N . \square

Combining both propositions we obtain a characterization of realizable finitely generated normal subgroups.

Theorem 5.3.11. *Let $N \trianglelefteq G$ be a non-trivial finitely generated normal subgroup. Then, N is realizable in G if and only if G/N admits a strongly aperiodic SFT.*

Proof. If N is realizable by a G -SFT X , by Proposition 5.3.10, its push-forward shift $\rho^*(X)$ realizes $\{1_{G/N}\}$. Conversely, if $\{1_{G/N}\}$ is realized by a G/N -SFT Y , then by Proposition 5.3.9 its pull-back $\pi^*(Y)$ realizes N . \square

As a consequence, we find many examples of non-realizable subgroups.

Corollary 5.3.12. *Let G be a finitely generated group, and a finitely generated normal subgroup $N \trianglelefteq G$. If G/N is virtually free, then N is not realizable in G . In particular, every torsion-free nilpotent group has normal subgroups that are not realizable.*

A particular class where this occurs is in the class of **indicable** groups. A group G is said to be indicable if it admits an epimorphism $G \rightarrow \mathbb{Z}$. By the previous corollary, if G is indicable and the kernel of the epimorphism is finitely generated, the kernel is not realizable. For example, finitely generated torsion-free nilpotent groups are indicable [Hig40], and all of their subgroups are finitely generated. Similarly, if an indicable group does not contain the free semi-group on two generators, the kernel of the epimorphism will be finitely generated (see [Ben12, Lemma 3]). On the other hand, in the case of just infinite groups all non-trivial normal subgroups are realizable, as they all have finite index.

5.3.3 No restrictions

As we have seen, being an SFT imposes heavy restrictions on realizability. But what happens if we just ask for a subshift? By combining our previous results with the existence of strongly aperiodic subshifts on every countable group, we can answer the question.

Proposition 5.3.13. *Let G be a finitely generated group and take a subgroup $H \leq G$. There exists a G -subshift that realizes H if and only if H is normal.*

Proof. By Lemma 5.3.5, if H is not normal it is not realizable. Suppose H is a normal subgroup. By [ABT19, Theorem 2.4], we know every countable group admits a strongly aperiodic subshift. In particular, there exists a G/H -subshift $X_{G/H}$ that realizes $\{1_{G/H}\}$. By Proposition 5.3.9 the pull-back shift, $\pi^*(X)$, realizes H . \square

5.3.4 Computational restrictions

Recall from Theorem 5.1.1 that if a finitely generated recursively presented group G admits a strongly aperiodic SFT, $\text{WP}(G)$ must be decidable. We show that a similar result can be obtained for the realizability of subgroups.

Let G be a finitely generated group of rank n , and $\pi : \mathbb{F}_n \rightarrow G$ the canonical epimorphism. For a G -subshift $X \subseteq A^G$, let $\pi^*(X) \subseteq A^{\mathbb{F}_n}$ be its pull-back, where for all $y \in \pi^*(X)$ there exists $x \in X$ such that $y = x \circ \pi$. As $\ker(\pi)$ is not necessarily finitely generated, $\pi^*(X)$ may not be an SFT. Nevertheless, it is an effective subshift when G is recursively presented.

Lemma 5.3.14 ([Jea15b] Prop. 1.3 and Prop. 1.7). *Let G be a finitely generated recursively presented group. Given an effective set of forbidden patterns \mathcal{F} through an enumeration, there is a semi-algorithm that halts if and only if $\mathcal{X}_{\mathcal{F}} = \emptyset$.*

We link the realizability of a subgroup to its subgroup membership problem.

Definition 5.3.15. Let G be a finitely generated group and S a generating set. The **subgroup membership problem of H in G** asks, given a set of words $u, w_i \in S^*$ for $i \in \{1, \dots, k\}$ such that $H = \langle \bar{w}_1, \dots, \bar{w}_k \rangle$, whether $\bar{u} \in H$.

Notice that this decision problem differs from the subgroup membership problem of the *group*, as defined in Definition 2.4.2. In this case, the input requires that the words w_i generate a specific subgroup.

Lemma 5.3.16. *Let H be a finitely generated group of a recursively presented group G . Then, there is a semi-algorithm for the subgroup membership problem of H in G .*

Proof. Because G is recursively presented we know $\text{WP}(G)$ can be enumerated (Proposition 1.3.15). Now given an input $u, w_i \in S^*$ for the subgroup membership problem of H , we know $\bar{u} \in H$ if and only if there exists a word $w \in \{w_1^{\pm 1}, \dots, w_n^{\pm 1}\}^*$ such that $uw^{-1} =_G \varepsilon$. The semi-algorithm consists in enumerating all such words w and seeing if uw^{-1} appears in the enumeration of $\text{WP}(G)$. \square

Theorem 5.3.17. *Let G be a finitely generated recursively presented group and H a finitely generated subgroup. If H is realizable, then the subgroup membership problem of H in G is decidable.*

Proof. Let X be a G -SFT that realizes H and $Y = \pi^*(X)$ its pull-back to \mathbb{F}_n , where n is the rank of G . From Proposition 5.3.9 we know that for every $y \in Y$, $\text{stab}(y) = \pi^{-1}(H)$. Now, let $u, w_i \in S^*$ be an input to the subgroup membership problem for H in G . By reducing u we can suppose that $u \in \mathbb{F}_n$. We define the \mathbb{F}_n -SFT,

$$Z = \{x \in A^{\mathbb{F}_n} \mid \forall g \in \mathbb{F}_n, u \cdot x(g) = x(g)\}.$$

This way, $Y \cap Z = \emptyset$ if and only if $u \notin \pi^{-1}(H)$, i.e. u does not belong to H in G . Because Y is effective and Z is an SFT, by Lemma 5.3.14 there is a semi-algorithm to determine if $Y \cap Z$ is empty. Thus, there is a semi-algorithm to determine if an element does not belong to a group. Paired with Lemma 5.3.16, this implies the subgroup membership problem of H in G is decidable. \square

Example 5.3.18. Using Rip's construction [Rip82] with a finitely presented group with undecidable word problem, it is possible to obtain a hyperbolic group with a finitely generated normal subgroup with undecidable subgroup membership problem. This argument is usually attributed to Sela [Gro93].

Example 5.3.19. It is possible to find subgroup with undecidable membership problem within $\mathbb{F}_n \times \mathbb{F}_n$, due to an argument by Mihailova [Mih68]. Given a finitely generated group G of rank n , we define its Mihailova subgroup as

$$M(G) = \{(w_1, w_2) \in \mathbb{F}_n \times \mathbb{F}_n \mid w_1 =_G w_2\}.$$

Notice that if G is finitely presented by a set of generators S and relations R , the set of generators including $\{(s, s)\}_{s \in S}$ and $\{(1, r)\}_{r \in R}$ are a generating set for $M(G)$. Then, the subgroup membership problem for $M(G)$ in $\mathbb{F}_n \times \mathbb{F}_n$ is decidable if and only if G has decidable word problem.

Restrictions on \mathbb{Z}^d

There are other types of computational restrictions on realizability that do not involve membership problems. A particular family of these restrictions comes from the study of periodicity on \mathbb{Z}^d -SFTs.

We say two element $u, v \in \mathbb{Z}^2$ are equivalent, which we denote by $v \sim u$, if there exists $\lambda \neq 0$ such that $v = \lambda u$. We call equivalence classes under \sim , **slopes**, and denote them by $[v]$. We denote the set of all slopes in \mathbb{Z}^d by $S(\mathbb{Z}^d)$. Given a \mathbb{Z}^d -SFT X , we define its set of slopes as

$$Sl(X) = \{[v] \in S(\mathbb{Z}^d) \mid \exists x \in X, \text{stab}(x) = v\mathbb{Z}\}.$$

Jeandel, Moutot and Vanier showed that the set of slopes of \mathbb{Z}^2 -SFTs are exactly Σ_1^0 subsets of $S(\mathbb{Z}^2)$, and that the set of slopes of \mathbb{Z}^3 -SFTs are exactly Σ_2^0 subsets of $S(\mathbb{Z}^3)$ [JMV20]. There are further restrictions in the case of \mathbb{Z}^2 if we encode the stabilizers differently. For X a \mathbb{Z}^2 -SFT, we define,

- the set of **full-periods** of X as $\mathfrak{P}(X) = \{n \in \mathbb{Z} \mid \exists x \in X, \text{stab}(x) = (n\mathbb{Z})^2\}$,
- the set of **1-periods** of X as $\mathfrak{P}_1(X) = \{v \in \mathbb{Z} \times \mathbb{N} \setminus \{(0, 0)\} \mid \exists x \in X, \text{stab}(x) = v\mathbb{Z}\}$,
- the set of **horizontal periods** of X as $\mathfrak{P}_h(X) = \{n \in \mathbb{Z} \mid \exists x \in X, \text{stab}(x) = k\mathbb{Z} \times \{0\}\}$.

Given sets $F \subseteq \mathbb{N}$ and $F' \subseteq \mathbb{Z} \times \mathbb{N}$ we define their corresponding languages as $un(F) = \{a^n \mid n \in F\}$ and $un(F') = \{a^p b^q \mid (p, q) \in F'\} \cup \{a^p c^q \mid (-p, q) \in F'\}$. Jeandel and Vanier showed that a set $F \subseteq \mathbb{N}$ is the set of full-periods of an SFT if and only if $un(F) \in \mathbf{NP}$, that a set $F' \subseteq \mathbb{Z} \times \mathbb{N}$ is the set of 1-periods of an SFT if and only if $un(F') \in \mathbf{NSPACE}(n)$, and that $F'' \subseteq \mathbb{N}$ is the set of horizontal periods of an SFT if and only if $un(F'') \in \mathbf{NSPACE}(n)$ [JV15].

Do these restrictions provide a full description of realizable subsets $\mathcal{G} \subseteq \text{Sub}(\mathbb{Z}^2)$? The answer is no. It suffices to take the singleton $\mathcal{G} = \{(p, 0)\mathbb{Z}\}$ for any non-trivial $p \in \mathbb{Z}$, which satisfies all the previous conditions but is not realizable by Lemma 5.3.3. In the next section we will see that this can be taken further: if \mathcal{G} consists exclusively of one dimensional subspaces it is not realizable.

5.4 Periodic rigidity

There is a strange phenomenon with regards to aperiodicity in \mathbb{Z}^2 . As we saw in Lemma 5.3.3, if there is a configuration with a horizontal period on a \mathbb{Z}^2 -SFT, there must be a periodic configuration within the SFT. This is part of a larger phenomenon, where no non-trivial family of subgroups where every subgroup has infinite index is realizable.

Lemma 5.4.1. *Every weakly aperiodic \mathbb{Z}^2 -SFT is strongly aperiodic.*

Proof. Let $X \subseteq A^{\mathbb{Z}^2}$ be a weakly aperiodic nearest neighbor SFT on \mathbb{Z}^2 . If X is not strongly aperiodic, there exists a configuration $x \in X$ stabilized by a non-trivial element $v = (p, q) \in \mathbb{Z}^2$. Suppose without loss of generality that $q > 0$ and consider the portion of the plane P given by the strip $\mathbb{Z} \times \{0, \dots, q-1\}$. Because x is stabilized by v we have $x|_P = x|_{v+P}$. Now, if we cut P into blocks of width $|p|$, and look at their tiling $B_i = x|_{\{i, \dots, i+|p|-1\} \times \{0, \dots, q-1\}}$, there must exist i_1 and i_2 such that $B_{i_1} = B_{i_2}$ as the alphabet is finite. Define

$B = x|_{\{i_1, \dots, i_2-1\} \times \{0, \dots, q-1\}}$ and the configuration $y \in A^{\mathbb{Z}^2}$ which contains the bi-infinite repetition of B on the strip P , and is completed by stacking strips with the appropriate shift by a multiple of p (see Figure 5.3). Because X is a nearest neighbor SFT, y belong to X and is stabilized by the subgroup $(i_2 - i_1)\mathbb{Z} \times p\mathbb{Z}$. This contradicts the fact that X is weakly aperiodic. \square

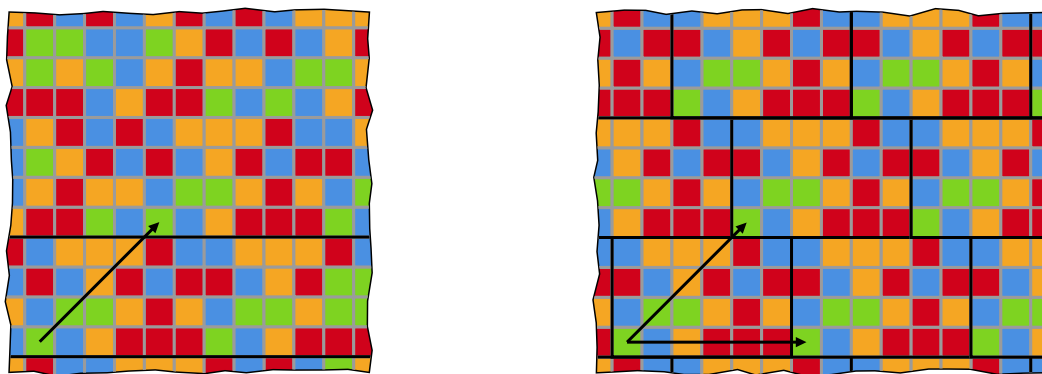

Figure 5.3: For SFTs in \mathbb{Z}^2 , having a configuration with non-trivial stabilizer (on the left) implies the existence of a periodic configuration (on the right). This is done by finding a repeating motif on the strip defined by the period vector, and repeating this motif in a way compatible with the forbidden patterns of the nearest neighbor SFT.

For which other groups does this hold? Although there have been examples of groups which have weakly aperiodic SFTs that are not strongly aperiodic in the past, for \mathbb{Z}^d with $d \geq 3$ for example [CK95], the first explicit construction is due to Moutot and Esnay for Baumslag-Solitar groups [EM22a]. In this section we study necessary and sufficient conditions for groups to exhibit this behavior.

Definition 5.4.2. We say a group G is **periodically rigid** if every weakly aperiodic G -SFT is strongly aperiodic.

This is equivalent to saying that the only non-empty SFT X such that all stabilizers have infinite index, are those such that $\text{stab}(X) = \{1\}$. In particular, if G is periodically rigid, then no infinite index non-trivial subgroup is realizable. By Lemma 5.4.1, \mathbb{Z}^2 is periodically rigid. In addition, by vacuity, all virtually \mathbb{Z} groups are periodically rigid.

Although not with our terminology, Pytheas-Fogg posed the following question.

Question 5.4.3 ([Pyt22]). Is a finitely generated group periodically rigid if and only if it is either virtually \mathbb{Z} or virtually \mathbb{Z}^2 ?

It has already been shown that some classes of groups admit weakly but not strongly aperiodic SFTs. These are the following:

- \mathbb{Z}^d for $d > 2$,
- Baumslag-Solitar groups $BS(m, n)$ with $|n|, |m| \neq 1$ [EM22a],
- Free groups, [Pia08],
- Hyperbolic groups [Gro87; CP06],
- Groups with two or more ends [Coh17],
- the Lamplighter group [Coh20],

Let us establish some inheritance properties of periodically rigid groups.

Proposition 5.4.4. *Take G a torsion-free group, and $H \leq G$ a finite index subgroup. If H is periodically rigid, then G is periodically rigid.*

Proof. Suppose there exists $X \subseteq A^G$ a weakly but not strongly aperiodic G -SFT. For a set of right coset representatives R , take the R -higher power shift $X^{[R]}$. By Lemma 1.5.11, $X^{[R]}$ is an H -SFT. Furthermore, if we take $y \in X^{[R]}$ and its corresponding configuration $x \in X$, we have that $\text{stab}(y) \subseteq \text{stab}(x)$.

Now, because X is not strongly aperiodic, there exists $g \in G \setminus \{1_G\}$ and $x \in X$ such that $g \in \text{stab}(x)$. As H is of finite index, and G is torsion-free there exists $n \geq 1$ such that $g^n \in H \setminus \{1_G\}$. Define $y \in X^{[R]}$ by $y(h)(r) = x(hr)$ for all $h \in H$ and $r \in R$. Then,

$$\begin{aligned} (g^n \cdot y)(h)(r) &= y(g^{-n}h)(r) = x(g^{-n}hr) \\ &= x(hr) = y(h)(r), \end{aligned}$$

and thus $g^n \in \text{stab}(y)$. Because H is periodically rigid, this means that there exists $z \in X^{[R]}$ such that $\text{stab}(z)$ has finite index in H . If we denote $x \in X$ the configuration such that $z(h)(r) = x(hr)$, $\text{stab}(x)$ contains a finite index subgroup and is therefore a finite index subgroup itself. Thus, x is a periodic configuration of X . This is a contradiction, as X was supposed to be weakly periodic. \square

Example 5.4.5. The fundamental group of the Klein bottle, which is given by

$$\pi_1(K) = BS(1, -1) = \langle a, b \mid abab^{-1} \rangle,$$

is torsion-free virtually \mathbb{Z}^2 and therefore periodically rigid by the previous proposition.

This last example shows Pytheas-Fogg's question is incomplete, and allows us to state the following conjecture.

Conjecture 5.4.6. A finitely generated group is periodically rigid if and only if it is either virtually \mathbb{Z} or torsion-free virtually \mathbb{Z}^2 .

Remark 5.4.7. Notice that the previous conjecture implies Conjecture 5.2.1 concerning weakly aperiodic SFTs. Indeed, if there existed a non-virtually \mathbb{Z} group that does not admit a weakly aperiodic SFT, it would be periodically rigid.

What can we say about the periodic rigidity of a group, from the periodic rigidity of its subgroups or quotients? To answer this question, we use of a result by Barbieri, that links stabilizing elements in the free-extension of a shift to the stabilizing elements of the shift. Let us introduce some notation. Given an element $g \in G$, we define its **conjugacy class** as

$$\text{Cl}(g) = \{tgt^{-1} \mid t \in G\}.$$

Next, we define the set of **roots** of a subgroup $K \leq G$ as

$$R_G(K) = \{g \in G \mid \exists n \in \mathbb{N}, g^n \in K\}.$$

Finally, given a G -subshift X , we define the set of **free elements** of the group action as

$$\text{Free}(X) = G \setminus \bigcup_{x \in X} \text{stab}(x) = \{g \in G \mid g \cdot x \neq x, \forall x \in X\}.$$

With all these elements at hand, we state Barbieri's result that characterizes how the stabilizers of the free extension of a subshift behave. It also holds for non-finitely generated groups.

Theorem 5.4.8 ([Bar23a]). *Take a group G , a subgroup $H \leq G$, and an H -subshift X . Then, $g \in \text{Free}(X^\dagger)$ if and only if $\text{Cl}(g) \cap R_G(\text{Free}(X)) \neq \emptyset$.*

As a consequence of Lemma 1.5.4, the free extension of a weakly aperiodic SFT is weakly aperiodic. We will use the previous theorem to determine when the free extension is not strongly aperiodic, to find properties of periodically rigid groups.

Proposition 5.4.9. *Let G be a finitely generated group with a torsion-free subgroup $H \leq G$ that admits a weakly aperiodic SFT, and $g \in G \setminus H$ with torsion. Then, G is not periodically rigid.*

Proof. As H is torsion-free we have that for all $m \in \mathbb{N}$, $g^m \notin H \setminus \{1\}$, as every power of an element with torsion has torsion. Furthermore, for all $t \in G$ and $m \in \mathbb{N}$, $tg^mt^{-1} \notin H \setminus \{1\}$, as every conjugate of an element with torsion has torsion. Because $\text{Free}(X) \subseteq H \setminus \{1\}$, we arrive at $\text{Cl}(g) \cap R_G(\text{Free}(X)) = \emptyset$. Then, by Theorem 5.4.8, $g \notin \text{Free}(X^\uparrow)$. As X being weakly aperiodic implies X^\uparrow is weakly aperiodic, but $\text{Free}(X^\uparrow) \neq G \setminus \{1\}$, G is not periodically rigid. \square

Proposition 5.4.10. *Let G_1 be an infinite finitely generated group that admits a weakly aperiodic SFT. If G_2 is another finitely generated group, then $G_1 \times G_2$ is not periodically rigid.*

Proof. Let us denote $G = G_1 \times G_2$ and H_1 and H_2 the subgroups of G such that $H_i \simeq G_i$. Let X be a weakly aperiodic H_1 -SFT and $Y = X^\uparrow$ its free extension to G . Y is a weakly aperiodic G -SFT. As G is a semi-direct product, $H_1 \cap H_2 = \{1\}$. By taking $g \in H_2 \setminus \{1\}$, we know that for any $t \in G$ and $n \geq 1$ we have $tg^nt^{-1} \notin H_1 \setminus \{1\}$, as H_1 is normal. This means $\text{Cl}(g) \cap R_G(\text{Free}(X))$ is empty because $\text{Free}(X) \subseteq H_1 \setminus \{1\}$. By Theorem 5.4.8, there exists $y \in Y$ such that $g \in \text{stab}(y)$. Thus, Y is not strongly aperiodic. \square

Lemma 5.4.11. *Let $N \trianglelefteq G$ be a non-trivial finitely generated normal subgroup. Then, if G/N admits a weakly aperiodic SFT, G is not periodically rigid.*

Proof. Let $X \subseteq A^{G/N}$ be a weakly aperiodic SFT, and let $\pi^*(X) \subseteq A^G$ be its pull-back. From Proposition 5.3.9, we know that $\text{stab}(\pi^*(X)) = \rho(\text{stab}(X))N$, for any section $\rho : G/N \rightarrow G$.

Suppose there is $y \in \pi^*(X)$ such that $\text{stab}(y)$ has finite index. Then, $x \in X$ defined as $x(k) = y(\rho(k))$ for every $k \in G/N$, would have stabilizer $\text{stab}(y)/N$ of finite index, which is a contradiction. Finally, $\text{stab}(y)$ is non-trivial as it contains N . \square

Lemma 5.4.12. *Let G be a group that admits an exact sequence given by*

$$1 \rightarrow N \rightarrow G \rightarrow H \rightarrow 1,$$

where N admits a weakly aperiodic SFT and H has a torsion-free element³. Then, G is not periodically rigid.

Proof. Let X be a weakly aperiodic N -SFT and $g \in G$ an element that maps to a free generator of the quotient $G/N \simeq H$. Then, $g^k \notin N$ for all $k \neq 0$, and furthermore $tg^kt^{-1} \notin N$ for all $t \in G$, as N is normal. This fact can be translated to the expression $\text{Cl}(g) \cap R_G(N \setminus \{1\}) = \emptyset$, which by Theorem 5.4.8 means there exists $y \in X^\uparrow$ such that $g \in \text{stab}(y)$. Therefore, X^\uparrow is a weakly but not strongly aperiodic G -SFT. \square

5.4.1 Virtually nilpotent and polycyclic groups

In this section we prove that all polycyclic groups and all virtually nilpotent groups verify Conjecture 5.4.6. To do this, we make an induction over the Hirsch length of a group (see Section 1.3.2), as was done in [Jea15b] for strongly aperiodic SFTs.

Theorem 5.4.13. *Finitely generated infinite nilpotent groups are periodically rigid if and only if they are not virtually \mathbb{Z} , or \mathbb{Z}^2 .*

³That is, there exists an injective morphism $\phi : N \rightarrow G$ and a surjective morphism $\pi : G \rightarrow H$ such that $\text{Im}(\phi) = \ker(\pi)$.

Proof. Let G be a nilpotent group that is neither virtually \mathbb{Z} , nor \mathbb{Z}^2 . We prove the statement by induction on its Hirsch length $h(G)$. Starting off, suppose $h(G) = 2$. This means G is virtually \mathbb{Z}^2 (Proposition 1.3.22), but not \mathbb{Z}^2 by our hypothesis. If G is torsion-free, then it is abelian, as all torsion-free virtually abelian nilpotent groups are abelian (see [Kob10, Lemma 3.1]). Because the only torsion-free virtually \mathbb{Z}^2 abelian group is \mathbb{Z}^2 , G must not be torsion-free. Thus, G has torsion and contains a torsion-free subgroup H isomorphic to \mathbb{Z}^2 . By Proposition 5.4.9, G is not periodically rigid.

Next, let G be a nilpotent group with $h(G) > 2$. Being nilpotent, G contains a torsion-free finite index nilpotent subgroup, so once again by Proposition 5.4.9 we can suppose that G is torsion-free. In addition, G contains a normal subgroup isomorphic to \mathbb{Z} in its center, which we call H . So, $h(G/H) = h(G) - h(H) \geq 2$, and by induction, G/H is not periodically rigid. G/H is also not virtually \mathbb{Z} . Finally, by Lemma 5.4.11, G is not periodically rigid. \square

Corollary 5.4.14. *Finitely generated virtually nilpotent groups are periodically rigid if and only if they are not virtually \mathbb{Z} or torsion-free virtually \mathbb{Z}^2 .*

Proof. Let G be a periodically rigid virtually nilpotent group, and H a finite index torsion-free nilpotent group. If G is torsion-free, by Proposition 5.4.4, H has to be periodically rigid. Then, by Theorem 5.4.13 H is virtually \mathbb{Z} or \mathbb{Z}^2 , which means G is virtually \mathbb{Z} or torsion-free virtually free \mathbb{Z}^2 . Suppose G is not torsion-free and not virtually \mathbb{Z} . Then, by [Bri+12, Lemma 13], there exists an epimorphism $f : H \rightarrow \mathbb{Z}^2$. By Proposition 5.2.2 H admits a weakly aperiodic SFT, and thus by Lemma 5.4.11, G is not periodically rigid. This contradicts our assumption that G was periodically rigid. Therefore G must be virtually \mathbb{Z} . \square

Theorem 5.4.15. *Finitely generated polycyclic groups are periodically rigid if and only if they are not virtually \mathbb{Z} or torsion-free virtually \mathbb{Z}^2 .*

Proof. Let G be a polycyclic group that is neither virtually \mathbb{Z} nor torsion-free virtually \mathbb{Z}^2 . We proceed one again by induction on the Hirsch length of G , $h(G)$. If $h(G) = 2$, then G is virtually \mathbb{Z}^2 and has torsion elements. Thus, by Proposition 5.4.9, G is not periodically rigid.

Now, let $h(G) = n > 2$. As G is polycyclic, it contains a torsion-free polycyclic subgroup of finite index. Therefore, by Proposition 5.4.9, we can assume G is torsion-free. In addition, as G is polycyclic, it contains a normal subgroup isomorphic to $N = \mathbb{Z}^k$ for $k > 0$. If $k \geq 2$, take a normal subgroup H isomorphic to \mathbb{Z}^2 . Then, G satisfies the exact sequence

$$1 \rightarrow \mathbb{Z}^2 \rightarrow G \rightarrow G/H \rightarrow 1,$$

where $h(G/H) = n - 2 > 0$. By Lemma 5.4.12, G is not periodically rigid because G/H contains a torsion-free element. Finally, if $k = 1$, then $h(G/N) = h(G) - h(N) = n - 1 \geq 2$ and G is not periodically rigid by the induction hypothesis and Lemma 5.4.11. \square

5.5 A graphical summary

Throughout this chapter we have seen different concepts around the notion of aperiodicity and how they relate to numerous decision problems. We proceed to give a brief summary of these results with Table 5.1 as a guide⁴.

- Within the class of groups with decidable word problem and decidable Domino Problem, virtually \mathbb{Z} are the only groups known not to admit weakly nor strongly aperiodic SFTs. Virtually free groups are the only known to admit weakly aperiodic SFTs but not strongly aperiodic ones. It remains an open question if there are groups in this category which admit strongly aperiodic SFTs. A positive answer would disprove both Conjecture 5.1.5 and Conjecture 2.0.1.
- Among groups with decidable word problem and undecidable Domino Problem we have the Lamplighter group, hyperbolic groups, polycyclic groups and Baumslag-Solitar groups. All of these groups verify

⁴Table 5.1 is an updated of version of the tables from the PhD theses of Etienne Moutot [Mou20] and Solène Esnay [Esn22].

Conjecture 5.4.6. Also among groups with decidable word problem and undecidable Domino Problem, torsion-free virtually \mathbb{Z}^2 groups are the only known to be periodically rigid. Any group with undecidable Domino Problem and more than 2 ends ($\mathbb{Z}^2 * \mathbb{Z}$ for example) admits weakly aperiodic SFTs, but not strongly aperiodic ones. It is an open question if there are groups in this category that do not admit weakly aperiodic SFTs. From Theorem 5.2.4, we know that no groups with ReFQ (finitely presented groups in particular, see Definition 2.3.3) can have this property. A positive answer to this question would disprove Conjecture 5.2.1.

- Not much is known for groups with undecidable word problem and undecidable Domino Problem. From Theorem 5.1.1 we know that groups where $WP(G)$ is not co-total (recursively presented groups in particular) in this category cannot admit strongly aperiodic SFTs. We also know that there are groups with undecidable word problem and infinite ends that admit weakly aperiodic SFTs, but not strongly aperiodic SFTs. An example of such a group is $\mathbb{Z}^2 * \mathfrak{J}$, where \mathfrak{J} is a finitely generated group with undecidable word problem (see Theorem 1.3.14). Finally, it is not known if there are any groups that do not admit aperiodic SFTs in this category. As before, their existence would disprove Conjecture 5.2.1.

# of ends = 1				
DP \ Aperiodic	$\exists WA \not\Rightarrow \exists SA$	$\exists WA \Rightarrow \exists SA$	$\not\exists SA, \exists WA$	$\not\exists SA, \not\exists WA$
Decidable WP Decidable DP	?	?	virt. \mathbb{F}_n	virt. \mathbb{Z}
Decidable WP Undecidable DP	Hyperbolic, polycyclic, $BS(m, n), \mathbb{Z}/2\mathbb{Z} \wr \mathbb{Z}$	t-f virt. \mathbb{Z}^2	$\mathbb{Z}^2 * \mathbb{Z}$?
Undecidable WP Undecidable DP	?	?	$\mathbb{Z}^2 * \mathfrak{J}$?

Table 5.1: A summary of the state of the art concerning the Domino Problem, aperiodicity and periodic rigidity. The blue section represents the absence of recursively presented groups, and the red section the absence of groups with ReFQ (see Definition 2.3.3). The group \mathfrak{J} is a finitely generated group with undecidable word problem as given by the Novikov-Boone theorem (see Theorem 1.3.14)

Chapter 6

Aperiodic SFTs on Generalized Baumslag-Solitar Groups

Baumslag-Solitar groups were introduced by Baumslag and Solitar [BS62] as examples of non-Hopfian groups¹. They are simple cases of one relator groups, HNN extensions, and have decidable word problem. They have nonetheless provided many discriminating examples in both combinatorial and geometric group theory [BDD18, Chapter 5]. Given $m, n \in \mathbb{Z}$, the Baumslag-Solitar group $BS(m, n)$ is defined by the presentation,

$$BS(m, n) = \langle a, t \mid t^{-1}a^m t = a^n \rangle.$$

These groups were some of the first non-abelian groups to be studied from the point of view of the Domino Problem and aperiodic subshifts of finite type. Aubrun and Kari showed that they have undecidable Domino Problem and admit weakly aperiodic SFTs [AK13]. These results were improved by Esnay and Moutot who showed that Aubrun and Kari's construction was strongly aperiodic for $BS(1, n)$, where $n \neq \pm 1$, and constructed strongly aperiodic SFTs for $BS(n, n)$ [EM22a]. This left the case where $1 < |m| < |n|$ open.

In this chapter we tackle this final case by showing that all non- \mathbb{Z} generalized Baumslag-Solitar groups admit strongly aperiodic SFTs. This class of groups was introduced by Kropholler as a generalization of the behavior of both Baumslag-Solitar groups and torus knot groups [Kro90]. It is defined as the class of groups that act on trees with infinite cyclic edge and vertex stabilizers. Equivalently, they are defined as the fundamental group of a graph of groups where every edge and vertex group is \mathbb{Z} . As the name suggests, this class includes all Baumslag-Solitar groups, torus knot groups, as well as all their combinations through amalgamated free products and HNN extensions.

The chapter is organized as follows. In Section 6.1 we present graphs of groups and generalized Baumslag-Solitar groups, in Section 6.2 we show the existence of weakly aperiodic SFTs and the undecidability of the Domino Problem for GBS groups and Artin groups, who are closely related. Section 6.3 is devoted to the construction of Carroll and Penland who show how to obtain a strongly aperiodic SFT from a finite index subgroup that admits such an SFT. This section also includes an Erratum on a previous version of these results. Next, Section 6.5 is devoted to the construction of a minimal, strongly aperiodic and horizontally expansive \mathbb{Z}^2 -SFT, that will be used later for $\mathbb{F}_n \times \mathbb{Z}$. This construction is a small adaptation of an existing construction by Labbé [Lab21a; Lab21b; Lab21c] and Labbé, Mann, and McLoud-Mann [LMM23].

In Section 6.6 we present the key idea for our constructions: the path-folding technique in the case of $\mathbb{F}_n \times \mathbb{Z}$. The key idea is to fold a \mathbb{Z}^2 -SFT along a flow on \mathbb{F}_n to obtain an SFT on $\mathbb{F}_n \times \mathbb{Z}$ that shares some dynamical properties with the original \mathbb{Z}^2 -SFT. In particular, strong aperiodicity and minimality are preserved. In Section 6.7 we explain how to adapt the path-folding method to the Baumslag-Solitar group $BS(2, 3)$ in order to construct a strongly aperiodic SFT in this group. Instead of lifting an aperiodic subshift from \mathbb{Z}^2 , we codify orbits of a simple dynamical system that ultimately grants the aperiodicity. Consequently, we are able to establish that all non-solvable Baumslag-Solitar groups admit a strongly aperiodic SFT.

¹Particular cases of these groups were defined some years prior by Higman [Hig51].

6.1 Graphs of groups and GBS groups

A common strategy in the study of group theoretical properties is to decompose groups into simpler components and looking at the properties on these simpler groups. HNN-extensions and amalgamated free products are examples of these decompositions (see Section 1.3.4). The Dunwoody-Stallings theorem gives a powerful tool in this regard.

Theorem 6.1.1 (Dunwoody-Stallings [Dun85]). *Every finitely presented group is the fundamental group of a graph of groups where all edge groups are finite, and vertex groups are either 0 or 1-ended.*

This approach seems relevant regarding the problems of characterizing groups which admit strongly aperiodic SFTs or which have decidable Domino Problem. Examples of this proof technique for characterization of virtually free groups can be seen in [Gen08; Khu23].

6.1.1 Definition

For the purposes of this section, we define a graph Γ as a tuple (V_Γ, E_Γ) , where V_Γ is the set of vertices and $E_\Gamma \subseteq V_\Gamma^2$ is a set of edges, such that the graph is locally finite. We also associate the graph with two functions $i, t : E_\Gamma \rightarrow V_\Gamma$ that give the initial and terminal vertex of an edge, respectively. Given an edge $e \in E_\Gamma$, we denote by \bar{e} the edge pointing in the opposite direction to e , i.e. $t(\bar{e}) = i(e)$ and $i(\bar{e}) = t(e)$.

Definition 6.1.2. A **graph of groups** (Γ, \mathcal{G}) is a connected graph Γ , along with a collection of groups and monomorphisms, denoted \mathcal{G} , that includes:

- a vertex group G_v for each $v \in V_\Gamma$,
- an edge group G_e for each $e \in E_\Gamma$, where $G_e = G_{\bar{e}}$,
- a set of monomorphisms $\{\alpha_e : G_e \rightarrow G_{t(e)} \mid e \in E_\Gamma\}$.

The main interest of this object is its fundamental group. As its name suggests, this group is obtained through a precise definition of paths on the graph of groups. Luckily there is an explicit expression for the fundamental group, which allows us to skip the formal definition. A complete treatment of the concept can be found in [Lym20; Ser03].

Theorem 6.1.3. *Let $T \subseteq \Gamma$ be a spanning tree. The group $\pi_1(\Gamma, \mathcal{G}, T)$ is isomorphic to a quotient of the free product of the vertex groups, with the free group on the set E_Γ of oriented edges. That is,*

$$\left(\bigast_{v \in V_\Gamma} G_v * \mathbb{F}_{E_\Gamma} \right) / R,$$

where R is the normal closure of the subgroup generated by the following relations

- $\alpha_{\bar{e}}(h)e = e\alpha_e(h)$, where e is an oriented edge of Γ , $h \in G_e$,
- $\bar{e} = e^{-1}$, where e is an oriented edge of E_Γ ,
- $e = 1$ if e is an oriented edge of T .

We omit \mathcal{G} and T when the context allows it. Furthermore, the fundamental group does not depend on the spanning tree, up to isomorphism.

Proposition 6.1.4 (Proposition 20, [Ser03]). *The fundamental group of a graph of groups does not depend on the spanning tree.*

Let us look at how traditional operations of geometric group theory are viewed as fundamental groups of graph of groups. The amalgamated free product $G *_K H$ is viewed as the fundamental group $\pi_1(\Gamma_1)$:

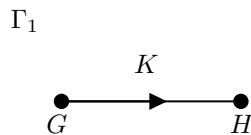

Similarly, an HNN-extension $G*_\phi$ can be seen as the fundamental group $\pi_1(\Gamma_2)$:

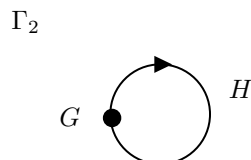

with H a subgroup of G , $\alpha_e = \text{id}$, and $\alpha_{\bar{e}} = \phi : H \rightarrow \phi(H)$ an isomorphism. In this sense, the concept of graph of groups can be seen as the natural generalization of these concepts.

As previously mentioned, this chapter is concerned with the particular case where every group is \mathbb{Z} .

Definition 6.1.5. A group G is said to be a **generalized Baumslag-Solitar group** (GBS group) if it is the fundamental group of a finite graph of groups where all the vertex and edge groups are \mathbb{Z} .

For an extensive introduction to this class of groups, we point the reader to [Lev15; Rob15] and the references therein.

6.1.2 Torus knot groups

The (n, m) -torus knot group is given by the presentation

$$\Lambda(n, m) = \langle a, b \mid a^n b^{-m} \rangle.$$

These groups are a particular case of the generalized Baumslag-Solitar groups defined by the amalgamated free product $\mathbb{Z} *_\mathbb{Z} \mathbb{Z}$, along with the inclusions $1 \mapsto n$ and $1 \mapsto m$. Their name comes from the fact that they are the knot groups of torus knots [Rol03].

Remark that $\Lambda(n, m) \simeq \Lambda(m, n)$, and that if n or m is equal to one, $\Lambda(n, m) \simeq \mathbb{Z}$. This last case is the only case where the group is amenable. This can also be seen as a consequence of the following lemma.

Lemma 6.1.6. $\Lambda(n, m)$ has a finite index normal subgroup isomorphic to $\mathbb{F}_{(n-1)(m-1)} \times \mathbb{Z}$.

This fact is deduced from the short exact sequence

$$1 \rightarrow \mathbb{Z} \rightarrow \Lambda(n, m) \rightarrow \mathbb{Z}/n\mathbb{Z} \times \mathbb{Z}/m\mathbb{Z} \rightarrow 1.$$

As we will later see, these groups are part of a larger subclass of GBS groups having this property, called **unimodular**.

Proposition 6.1.7. For $n, m \geq 2$, $\Lambda(n, m)$ has undecidable Domino Problem.

This is a consequence of the fact that these groups contain isomorphic copies of \mathbb{Z}^2 , namely $\langle a^n, ba \rangle$.

6.1.3 Baumslag-Solitar groups

Recall that the Baumslag-Solitar group $BS(m, n)$ is defined by the presentation:

$$BS(m, n) = \langle a, t \mid t^{-1}a^mt = a^n \rangle.$$

Along with torus knot groups they are the simplest examples of GBS groups. As mentioned in Section 1.3.4, they are HNN extensions $\mathbb{Z} *_\theta$ for the isomorphism θ that maps $m \mapsto n$.

Furthermore, $BS(1, 1) = \mathbb{Z}^2$ and $BS(m, n) \simeq BS(-m, -n)$. Baumslag-Solitar groups may behave radically differently: the groups $BS(1, n)$ are solvable and amenable, while the $BS(m, n)$ groups with $m, n > 1$ contain free subgroups and are consequently non-amenable. This dichotomy is also present in the classification of Baumslag-Solitar groups up to quasi-isometry. On the one hand groups $BS(1, n)$ and $BS(1, n')$ are quasi-isometric if and only if n and n' are powers of a common integer [FM99] –and in this case, the two groups are even commensurable. On the other hand groups $BS(m, n)$ and $BS(m', n')$ are quasi-isometric as soon as $2 \leq m < n$ and $2 \leq m' < n'$ [Why01].

6.2 Weak aperiodicity and the Domino Problem

Proposition 6.2.1. *Let (Γ, \mathcal{G}) be a graph of groups. If at least one vertex group admits a weakly aperiodic SFT, then $\pi_1(\mathcal{G})$ admits a weakly aperiodic SFT.*

Proof. Theorem 6.1.3 tells us that for every $v \in V_\Gamma$, there is a natural injective homomorphism $G_v \hookrightarrow \pi_1(\mathcal{G})$. Because there is at least one G_v that admits a weakly aperiodic SFT, and weakly aperiodic SFTs can be lifted from subgroups, we conclude that $\pi_1(\mathcal{G})$ admits a weakly aperiodic SFT. \square

One case that does not fall within the hypothesis of Proposition 6.2.1 is when all vertices of the graph have \mathbb{Z} as their vertex group, which is known not to admit any weakly aperiodic SFT. But a careful study shows that in this case, weakly aperiodic SFT can nevertheless be constructed unless the group is \mathbb{Z} itself.

Proposition 6.2.2. *If \mathcal{G} is a graph of \mathbb{Z} 's such that $\pi_1(\mathcal{G})$ is not \mathbb{Z} , then $\pi_1(\mathcal{G})$ has a weakly aperiodic SFT and undecidable Domino Problem.*

Proof. Let G be a GBS group with its corresponding graph of groups Γ . Because G is not \mathbb{Z} , at least one edge, $e \in E_\Gamma$, satisfies $\alpha_e \neq \pm 1$. If this edge is a loop, from the previous remarks we know that G contains a non- \mathbb{Z} Baumslag-Solitar group. These groups are known to admit weakly aperiodic SFTs [AK13], and by Proposition 5.2.2 so does G . Similarly, if the edge is in the spanning tree $T \subseteq \Gamma$ such that $G = \pi_1(\Gamma, T)$, then G contains a torus knot group $\Lambda(n, m)$, which admits a weakly aperiodic SFT by virtue of containing \mathbb{Z}^2 as a subgroup.

The last case is when all edges in the spanning tree satisfy $\alpha_{e'} \equiv \pm 1$, and there are no loops. Let e be an edge such that $\alpha_e, \alpha_{\bar{e}} \neq \pm 1$, and v, u its end points. Because T is spanning, we know that $v, u \in V_T$, and therefore if $G_v = \langle a \rangle$ and $G_u = \langle b \rangle$ we have that in G , $a = b^{\pm 1}$. Then, the relation given by the edge e is,

$$a^{\alpha_e(1)}e = eb^{\alpha_{\bar{e}}(1)} \iff a^{\alpha_e(1)}e = ea^{\pm\alpha_e(1)}.$$

This means G contains the non- \mathbb{Z} Baumslag-Solitar group $BS(\alpha_e(1), \pm\alpha_{\bar{e}}(1))$, which as mentioned before, admits a weakly aperiodic SFT. In all of the previous cases, the group we found within G had undecidable Domino Problem, so by Proposition 2.0.8 so does G . \square

The same proof scheme can be utilized for the class of Artin groups, which are another example of groups generated from a graph structure.

Let $\Gamma = (V, E, \lambda)$ be an edge labeled graph with labels $\lambda : E \rightarrow \{2, 3, \dots\}$. We define the **Artin group** of Γ through the presentation:

$$A(\Gamma) = \langle V \mid \underbrace{abab\dots}_{\lambda(e)} = \underbrace{baba\dots}_{\lambda(e)}, \forall e = (a, b) \in E \rangle.$$

Let us call Γ_n the graph of 2 vertices a and b , and an edge connecting them labeled by n . Artin groups defined as $A(\Gamma_n)$ are known as **dihedral**. Notice that $A(\Gamma_2) \simeq \mathbb{Z}^2$. Furthermore, for $n \geq 3$, $A(\Gamma_n)$ is virtually $\mathbb{F}_m \times \mathbb{Z}$ for some $m \geq 2$ (see [Cri05]). This fact also follows from the proof of the next proposition.

Proposition 6.2.3. *Let $A(\Gamma)$ be an Artin group. Then,*

- if $A(\Gamma)$ is not free, it has undecidable Domino Problem,
- if $A(\Gamma)$ is not \mathbb{Z} , it admits weakly aperiodic SFT.

Proof. Let $A(\Gamma)$ be the Artin group defined from $\Gamma = (V, E, \lambda)$. If E is empty then $A(\Gamma)$ is the free group of rank $|V| \geq 2$, which is known to admit weakly aperiodic SFTs by [Pia08].

Let $e = (a, b)$ be an edge in E . Notice that $A(\Gamma_n) \simeq \langle a, b \rangle \leq A(\Gamma)$. Because both weakly aperiodic SFTs and the undecidability of the Domino Problem are inherited from subgroups, it suffices to show that $A(\Gamma_n)$ admits a weakly aperiodic SFT for every $n \in \mathbb{N}$. We identify two cases:

- **Case 1:** $n = 2k$, $k \geq 1$. Here, $A(\Gamma_{2k})$ is the one-relator group

$$A(\Gamma_{2k}) = \langle a, b \mid (ab)^k = (ba)^k \rangle = \langle a, b \mid (ab)^k = b(ab)^k b^{-1} \rangle.$$

We apply Tietze transformations to the presentation, as follows:

$$\begin{aligned} A(\Gamma_{2k}) &\simeq \langle a, b, c \mid (ab)^k = b(ab)^k b^{-1}, c = ab \rangle \\ &\simeq \langle b, c \mid b^{-1} c^k b = c^k \rangle \\ &= BS(k, k) \end{aligned}$$

Therefore, $A(\Gamma_{2k})$ admits a weakly aperiodic SFT and has undecidable Domino Problem.

- **Case 2:** $n = 2k + 1$, $k \geq 1$. Once again, $A(\Gamma_{2k+1})$ is the one-relator group:

$$A(\Gamma_{2k+1}) = \langle a, b \mid (ab)^k a = (ba)^k b \rangle = \langle a, b \mid (ab)^k a = b(ab)^k \rangle.$$

By doing an analogous procedure through Tietze transformations, we arrive at $A(\Gamma_{2k+1}) \simeq \Lambda(2, 2k + 1)$. Therefore, $A(\Gamma_{2k+1})$ also admits a weakly aperiodic SFT and has undecidable Domino Problem. □

6.3 Lifting strongly aperiodic subshifts

To obtain aperiodic SFTs on groups from their finite index subgroups, we will make use of a construction by Carroll and Penland [CP15], which we explain in detail.

Definition 6.3.1. For a finite index normal subgroup N we define the N -locked subshift L as the G -subshift $\text{Fix}_R(N) \cap \Sigma$, where R is a set of right coset representatives with $1_G \in R$, and Σ is the subshift defined by the the finite set of forbidden patterns

$$\{p : \{1_G, r\} \rightarrow R \mid r \in R \setminus \{1_G\}, p(1_G) = p(r)\}.$$

Lemma 6.3.2. *The N -locked subshift L is a non-empty G -SFT. In addition, $\text{stab}(x) = N$ for all $x \in L$.*

Proof. Notice L is an SFT, as it is the intersection of two SFTs. To see it is non-empty we define $y \in R^G$ by $y(nr) = r$. If we take $n' \in N$,

$$(n' \cdot y)(nr) = y(n'^{-1}nr) = r = y(nr).$$

Thus, $y \in \text{Fix}_R(N)$ and in particular $N \subseteq \text{stab}(y)$. Next, we take $r' \in R$ and see that

$$y(nr) = (n^{-1} \cdot y)(r) = y(r) \neq y(rr') = (n^{-1} \cdot y)(rr') = y(nrr').$$

This way, $y \in \Sigma$, and therefore $y \in L$. Finally, if we take $x \in L$ and $g = nr \in \text{stab}(x)$, that is, $g \cdot x = x$, then

$$x = nr \cdot x = r(r^{-1}nr) \cdot x = r \cdot x.$$

With this, $x(1) = x(r^{-1}r) = (r \cdot x)(r) = x(r)$. Because $x \in \Sigma$, $r = 1_G$ and thus $g = n \in N$. □

Remark 6.3.3. An alternative way to see the N -locked subshift is a subshift of finite type when N is normal and has finite index, is by Lemma 1.5.16 along with the fact that this subshift is the pull-back of the full-shift $R^{G/N}$.

We now have all the ingredients to prove the result.

Proposition 6.3.4. *Let G be a finitely generated group and H a finite index normal subgroup. If H admits a strongly aperiodic SFT, then G also does.*

Proof. Let $X \subseteq A^H$ be a strongly aperiodic SFT over H . Given a set R of right coset representatives with $1 \in R$, we define the G -SFT $Y = X^\uparrow \times L$, where L is the H -locked shift over R , and X^\uparrow the free extension of X . Let us see that Y is the subshift we are looking for. Suppose there is a $y \in Y$ and $g \in G \setminus \{1_G\}$ such that $g \cdot y = y$. Due to Lemma 6.3.2 we know that $g \in H$. Then, for $x = y|_H \in X$, $g \cdot x = x$ which contradicts the aperiodicity of X . □

6.3.1 Erratum to *Strongly Aperiodic SFTs on generalized Baumslag-Solitar groups*

Section 6.3 has been modified from its original presentation in [ABH24]. Sadly, the proof of Proposition 3.5 which states that ‘For G a finitely generated group and H a finite index normal subgroup, if H admits a minimal strongly aperiodic SFT, then so does G ’, is incorrect. Given a minimal strongly aperiodic H -SFT X , the proof begins by defining the set

$$\hat{X} = \{y \in A^G \mid \exists x \in X, \forall (h, r) \in H \times R, y(hr) = x(h)\},$$

where R is a set of right coset representatives for H such that $1 \in R$.

Erratum 1. There exists a group G and an H -SFT X such that \hat{X} is not shift invariant.

Proof. Let $G = \mathbb{F}_2 \rtimes_\phi \mathbb{Z}/2\mathbb{Z}$ with $\phi \in \text{Aut}(\mathbb{F}_2)$ defined as by $\phi(a) = b$ and $\phi(b) = a$ for $\{a, b\}$ a free generating set for \mathbb{F}_2 , and $H = \mathbb{F}_2$. We denote the generator of $\mathbb{Z}/2\mathbb{Z}$ by s , and take the set of right coset representatives $R = \{1_G, s\}$. Define the SFT X through the tileset graph Γ shown in Figure 6.1. Take $x \in X$ and suppose

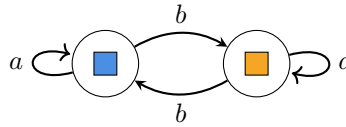

Figure 6.1: Tileset graph Γ defining the SFT X that shows \hat{X} is not shift invariant.

without loss of generality that $x(1_G) = \blacksquare$. Define $y \in \hat{X}$ by $y(ws) = y(w) = x(w)$ for all $w \in \mathbb{F}_2$. Then,

$$(s \cdot y)(w) = y(sw) = y(\phi(w)s) = x(\phi(w)),$$

for all $w \in \mathbb{F}_2$. Nevertheless, $x \circ \phi \notin X$ because $x \circ \phi(1_G) = x(1_G) = \blacksquare$ and $x \circ \phi(a) = x(b) = \blacklozenge$ which is not allowed in Γ . Therefore, $s \cdot y \notin \hat{X}$. \square

Using a similar idea, we can show this happens even when X is strongly aperiodic. To do this we use the notion of automorphism-free SFTs introduced by Jeandel [Jea15b]. Given a shift $X \subseteq A^G$ and a configuration $x \in X$ we define the set $I(x, X) = \{\phi \in \text{Aut}(G) \mid x \circ \phi \in X\}$. We say the shift X is **automorphism-free** if $I(x, X)$ is trivial for all $x \in X$.

Proposition 6.3.5 (Prop. A.2 & A.3 [Jea15b]). *Take $G = \mathbb{Z}^d$ with $d \geq 2$. Then the following hold:*

- *There exists an automorphism-free G -SFT,*
- *Every automorphism-free G -SFT is strongly aperiodic.*

We use this result to state the following.

Erratum 2. There exists a virtually abelian group G and a strongly aperiodic H -SFT X such that \hat{X} is not shift invariant.

Proof. Take $H = \mathbb{Z}^2$ and $G = \mathbb{Z}^2 \rtimes_{\phi} \mathbb{Z}/2\mathbb{Z}$ with $\phi(a) = b$ and $\phi(b) = a$ for the canonical generating set $\{a, b\}$ of \mathbb{Z}^2 . As we did before, denote the generator of $\mathbb{Z}/2\mathbb{Z}$ by s , and take the set of right coset representatives $R = \{1_G, s\}$. Let X be the strongly aperiodic automorphism-free \mathbb{Z}^2 -SFT given by Proposition 6.3.5. Take $x \in X$ and define $y \in \hat{X}$ by $y(gs) = y(g) = x(g)$ for all $g \in \mathbb{Z}^2$. Then,

$$(s \cdot y)(g) = y(sg) = y(\phi(g)s) = x(\phi(g)),$$

for all $g \in \mathbb{Z}^2$. But, $x \circ \phi \notin X$ as X is automorphism-free. Therefore, $s \cdot y \notin \hat{X}$. \square

Even if \hat{X} turned out to be a subshift – as is the case when G is abelian – we can still show that the proof does not work.

Erratum 3. Let G and H be such that $[G : H] \geq 3$. Then, the H -locked subshift, L , is not minimal. As a consequence $\hat{X} \times L$ is not minimal.

Proof. Let R be the set of right coset representatives used to define \hat{X} , and $L \subseteq R^G$ the H -locked subshift. By its construction, every configuration from L contains a different letter from R on each right H -coset. This fact can be expressed as a permutation $\sigma_x : R \rightarrow R$ for $x \in L$ defined by $\sigma_x(r) = x(r)$. Because $|R| \geq 3$ we can take two non-trivial distinct coset representatives $r_1 \neq r_2$. Take $x \in L$ the configuration defining the trivial permutation $\sigma_x(r) = r$. Next take x' the configuration that is exactly like x except it exchanges r_1 and r_2 , i.e. $\sigma_{x'}(r_1) = r_2$ and $\sigma_{x'}(r_2) = r_1$. Suppose there exists a sequence $h_n r_n \in G$ such that $h_n r_n \cdot x \rightarrow x'$. Because $L \subseteq \text{Fix}_R(H)$, and H is normal, $h_n r_n \cdot x = r_n \cdot x$. Finally, because $x'(1_G) = 1_G$, for sufficiently big n we have that $(r_n \cdot x)(1_G) = 1_G$. This in turn, implies that $r_n = 1_G$ for sufficiently large n , which contradicts the fact that $x \neq x'$. \square

This previous fact shows that even with the proof of Proposition 6.3.4, which uses the free extension instead of \hat{X} , cannot prove the statement as it implies that $X^\uparrow \times L$ is not minimal.

6.4 Strong aperiodicity for GBS groups

In order to construct strongly aperiodic SFTs on GBS groups, we exploit their large scale structure, which is well understood.

Theorem 6.4.1 (Whyte [Why01]). *If Γ is a graph of \mathbb{Z} 's, then for $G = \pi_1(\Gamma)$ exactly one of the following is true:*

1. G contains a finite index subgroup isomorphic to $\mathbb{F}_n \times \mathbb{Z}$ (these groups are called **unimodular**),
2. $G = BS(1, n)$ for some $n > 1$,
3. G is quasi-isometric to $BS(2, 3)$.

Remark 6.4.2. In the case of unimodular GBS it can even be proven that G contains $\mathbb{F}_n \times \mathbb{Z}$ as a normal subgroup of finite index [DRT17, Lemma 4].

The strategy consists on finding a strongly aperiodic SFT for a representative of each of the three classes, and then Theorem 5.1.6 on the invariance of strong aperiodicity under quasi-isometries for finitely presented groups to conclude. In Section 6.6 we provide an example of a minimal strongly aperiodic SFT on $\mathbb{F}_n \times \mathbb{Z}$ for all $n \geq 2$, which implies the existence of strongly aperiodic SFTs for all unimodular GBS groups. The case of groups quasi-isometric to $BS(2, 3)$ is also treated in this chapter: in Section 6.7 we explain how to construct a strongly aperiodic SFT on $BS(2, 3)$. Groups $G = BS(1, n)$ for some $n > 1$ are already known to possess a minimal strongly aperiodic SFT [AS24]. In total, we are able to construct strongly aperiodic SFTs for all GBS.

6.5 A minimal, strongly aperiodic and horizontally expansive SFT on \mathbb{Z}^2

In this section we present a construction of a strongly aperiodic SFT on \mathbb{Z}^2 with additional properties, that will be useful in Section 6.6.2. We begin by presenting the notion of expansive subspaces or directions as introduced in [BL97]. Let F be a subspace of \mathbb{R}^2 and $v \in \mathbb{R}^2$. We define

$$\text{dist}(v, F) = \inf\{\|v - w\| : w \in F\},$$

where $\|\cdot\|$ denotes the Euclidean norm on \mathbb{R}^2 . For $t > 0$ we define the **thickening** of F by t as the set

$$F^t = \{v \in \mathbb{Z}^2 : \text{dist}(v, F) \leq t\}.$$

We say a subspace F is **expansive** for a subshift X if there exists $t > 0$ such that for any two configurations $x, y \in X$, $x|_{F^t} = y|_{F^t}$ implies $x = y$. Conversely, F is said to be **non-expansive** if for all $t > 0$ there exist distinct $x, y \in X$ such that $x|_{F^t} = y|_{F^t}$.

As we are working with two dimensions, non-trivial subspaces can be represented by directions. Thus we speak of expansive and non-expansive directions.

For our purposes, a subshift $X \subset A^{\mathbb{Z}^2}$ is **horizontally expansive** (resp. **vertically expansive**) if for every pair of configurations x, y in X , $x|_{\mathbb{Z} \times \{0\}} = y|_{\mathbb{Z} \times \{0\}}$ (resp. $x|_{\{0\} \times \mathbb{Z}} = y|_{\{0\} \times \mathbb{Z}}$) implies $x = y$. Stated otherwise, one single row entirely determines the global configuration in the subshift. To construct our sought after SFT, we can make use of the following construction.

Theorem 6.5.1 (Labbé, Mann, McLoud-Mann [LMM23], Labbé [Lab21b; Lab21a; Lab21c]). *There exists an aperiodic, minimal \mathbb{Z}^2 -SFT X_0 such that its non-expansive directions are exactly the ones given by the lines of slope $\{0, \varphi + 3, 2 - 3\varphi, \frac{5}{2} - \varphi\}$, where $\varphi = \frac{1+\sqrt{5}}{2}$ is the golden mean.*

In particular, this result tells us that the vertical line is an expansive direction for X_0 . It suffices to convert this expansive direction into horizontal expansivity to get the desired SFT, as we show in what follows. Notice that we can take X_0 to be a Wang tile SFT by taking a higher block shift. This process preserves expansive directions as stated in the next result.

Lemma 6.5.2 ([LMM23]). *Let X and Y be two conjugate \mathbb{Z}^2 -subshifts and $v \in \mathbb{R}^2$. Then, v is a non-expansive direction for X if and only if it is non-expansive for Y .*

Moreover, up to another conjugacy –a higher block again in this case– we also impose that the thickening t of an expansive direction is zero. We then get the following.

Lemma 6.5.3. *Let X be a \mathbb{Z}^2 -subshift and $v \in \mathbb{R}^2$ an expansive direction for X . Then there exists Y a \mathbb{Z}^2 -subshift conjugate to X such that Y is expansive in direction v with thickening $t = 0$.*

Now that the SFT X_0 from Theorem 6.5.1 has been converted, thanks to Lemma 6.5.3, into a conjugate vertically expansive Wang tile SFT Y_0 , we can rotate its Wang tiles (and thus its configurations) by $\frac{\pi}{2}$ (see Figure 6.2). This rotated tileset defines an SFT, called the **rotation by $\frac{\pi}{2}$** of Y_0 .

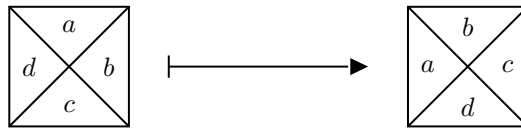

Figure 6.2: A Wang tile and its rotation by $\frac{\pi}{2}$.

Lemma 6.5.4. *Let X be a minimal, strongly aperiodic and vertically expansive Wang tile SFT. Then its rotation by $\frac{\pi}{2}$ is a minimal, strongly aperiodic and horizontally expansive Wang tile SFT.*

The proof of Lemma 6.5.4 does not pose any specific difficulties and is thus omitted. Combining this result with Theorem 6.5.1 we conclude that there exists a minimal, strongly aperiodic and horizontally expansive Wang tile SFT. This result will be used in Section 6.6.3.

Proposition 6.5.5. *There exists a minimal, strongly aperiodic and horizontally expansive Wang tile SFT.*

6.6 The path-folding technique on $\mathbb{F}_n \times \mathbb{Z}$

In this section we present a technique to convert a subshift on \mathbb{Z}^2 into a subshift on $\mathbb{F}_n \times \mathbb{Z}$ that shares some of its properties: the **path-folding** technique. In our case the properties that are proven to be preserved are: being of finite type (SFT), strong aperiodicity and minimality. In this section we use π_1 as the projection onto the first coordinate, and not as a fundamental group.

As we will see later, this technique has a broader scope. In its most abstract version it consists on the following steps:

1. Find a regular tree-like structure in the group. In the case of $BS(2, 3)$ we take its Bass-Serre tree, and in the case we of $\mathbb{F}_n \times \mathbb{Z}$ simply take \mathbb{F}_n .
2. Define the flow shift on the tree: using an alphabet of arrows of the same size as the degree of the vertices, we define a local rule demanding that, for every vertex, only one of its neighbors has an arrow pointing away from the vertex, and the rest pointing towards. This allows us to make a correspondence between the elements of the flow shift and the boundary of the tree.
3. Finally, fold configurations from other structures along the directions provided by the flow shift. In the case of $BS(2, 3)$ we fold configurations from the hyperbolic plane, and for $\mathbb{F}_n \times \mathbb{Z}$ we fold configurations from \mathbb{Z}^2 .

6.6.1 The flow SFT

Let us begin by introducing the **flow shift** over $\mathbb{F}_n \times \mathbb{Z}$, which we denote as Y_f . We define this shift from tiles representing different directions. Let $S = \{s_1, \dots, s_n\}$ be a set of generators of \mathbb{F}_n and $\mathbb{Z} = \langle t \rangle$. We understand the group through the finite presentation

$$\mathbb{F}_n \times \mathbb{Z} = \langle t, s_1, \dots, s_n \mid [t, s_i], \forall i \in \{1, \dots, n\} \rangle.$$

We define the flow shift over the alphabet $A = S \cup S^{-1}$. We can interpret these tiles as pointing in the direction specified by a generator or its inverse.

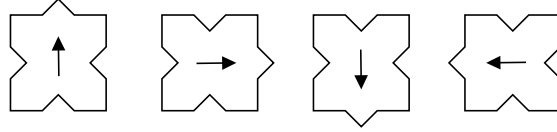

Figure 6.3: Flow tiles for \mathbb{F}_2 .

To define Y_f , we demand that a configuration $y \in A^{\mathbb{F}_n \times \mathbb{Z}}$ satisfies:

$$y(g) = s \implies \begin{cases} y(gs) \neq s^{-1} \\ y(gs') = s'^{-1}, \forall s' \in A \setminus \{s\} \\ y(gt) = s. \end{cases}$$

Notice that fixing a tile at the identity completely determines the tiling of the $2n - 1$ subtrees of \mathbb{F}_n the tile does not point towards. Then, this leaves $2n - 1$ possible tiles for the unspecified neighbour. In addition, the last rule makes sure that each \mathbb{Z} -coset contains the same tile.

This allows us to describe each configuration with an infinite word W . Given $y \in Y_f$, we recursively define $W(y) \in A^{\mathbb{N}}$ by setting $W_0 = y(1)$ and setting $W_{n+1} = y(W_0 \dots W_n)$.

Due to the local rules, this correspondence between configurations and infinite words effectively creates a bijection W between Y_f and $\partial_\infty \mathbb{F}_n$, the boundary of \mathbb{F}_n .

Proposition 6.6.1. *If $y \in Y_f$ has period $g \in \mathbb{F}_n$, then $W(y)$ is either the infinite word $g^{\mathbb{N}}$ or the infinite word $(g^{-1})^{\mathbb{N}}$.*

Proof. Let $y \in Y_f$ be a configuration with a period $g \in \mathbb{F}_2$, that is, $g \cdot y = y$. We get right away that $y(1) = y(g)$. Let us write g as a reduced word $g_1 \dots g_k$ on $\{s_1^{\pm 1}, \dots, s_n^{\pm 1}\}$. If we assume that $y(1) \neq g_1^{\pm 1}$, then following the path from 1 to g , we get that $y(g_1) = g_1^{-1}$, $y(g_1 g_2) = g_2^{-1}$, \dots as well as that $y(g) = g_k$, $y(g_1 \dots g_{k-1}) = g_{k-1}$ and so on, by following the path in the opposite direction. So there necessarily exists an index i such that $y(g_1 \dots g_i) = g_i^{-1}$ and $y(g_1 \dots g_i) = g_i$, which is not possible, hence $y(1) = g_1^{\pm 1}$. Iterating this process we conclude that either $y(g_1 \dots g_i) = g_i^{-1}$ for each $i = 1, \dots, k$ or $y(g_1 \dots g_i) = g_i$ for each $i \in \{1, \dots, k\}$. Thus $W(g)$ has either g or g^{-1} as a prefix. By applying the same reasoning to $g \cdot y, g^2 \cdot y, \dots$, all of which also admit g as a period, we conclude that either $W(y) = g^{\mathbb{N}}$ or $W(y) = (g^{-1})^{\mathbb{N}}$. \square

6.6.2 The structure of a path-folding SFT

Let $X \subseteq B^{\mathbb{Z}^2}$ be an horizontally expansive, strongly aperiodic nearest neighbor SFT on \mathbb{Z}^2 ; for instance, the SFT detailed in Proposition 6.5.5. Without loss of generality we assume X to be a nearest neighbor SFT. We want to "fold" each configuration along the path defined by the infinite word of a configuration in Y_f . Let Z be the subshift of the direct product² $B^{\mathbb{F}_n \times \mathbb{Z}} \times Y_f$, given by the following set of allowed patterns:

²see Section 5.3.1.

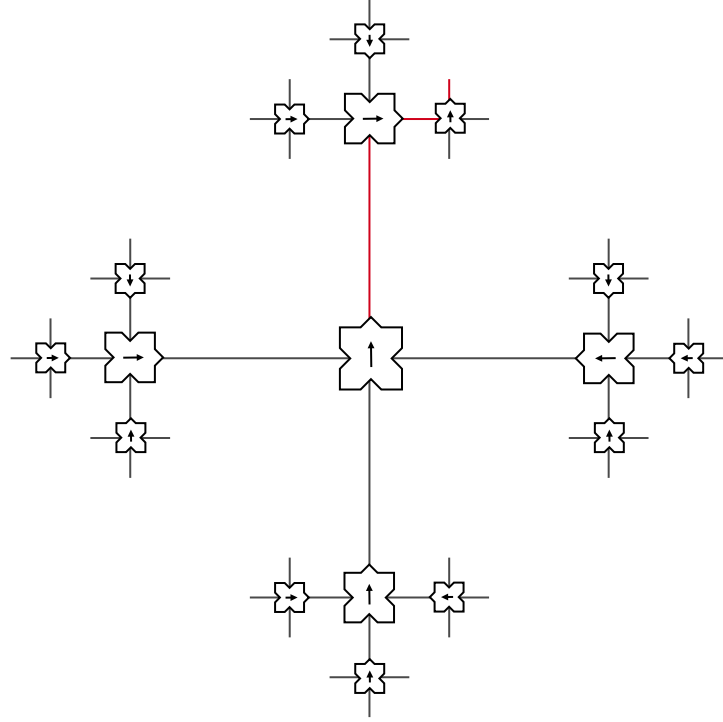

Figure 6.4: If we look at the configuration in $\mathbb{F}_2 = \langle a, b \rangle$ as shown, the prefix of its infinite word is given by bab .

- For each valid pattern H of support $\{(0, 0), (1, 0)\}$ in X , we define the pattern P of support $\{1, t\}$ by:

$$P(1) = (H_{(0,0)}, d), \quad P(t) = (H_{(1,0)}, d)$$

where $d \in A$.

- For each valid pattern V of support $\{(0, 0), (0, 1)\}$ in X , we define the patterns Q of support $\{1, s\}$ by:

$$Q(1) = (V_{(0,0)}, s), \quad Q(s) = (V_{(1,0)}, s')$$

where $s' \in A \setminus \{s^{-1}\}$.

Proposition 6.6.2. *The configurations in Z have the following structure:*

$$x \otimes y : wt^i \rightarrow (x(i, j), y(w)),$$

where $w \in \mathbb{F}_n$, $x \in X$, $y \in Y_f$ defined by the word W , with

$$j = 2 \max\{|w'| \mid w' \sqsubseteq_p w \wedge w' \sqsubseteq_p W\} - |w|,$$

where $u \sqsubseteq_p v$ denotes u being a prefix of v .

Proof. Let us have $y \in Y_f$ and $x \in X$. We begin by showing that $x \otimes y \in Z$. We know the second coordinate satisfies the allowed patterns by definition, so we must look at the first.

Let $g = wt^i \in \mathbb{F}_n \times \mathbb{Z}$, then

$$(x \otimes y)(g) = (x(i, j), y(w)),$$

as in the definition. We begin by looking at the support $\{1, t\}$. We have that $gt = wt^{i+1}$. Because w doesn't change when adding t , j does not change and $y(wt^{i+1}) = y(wt^i)$. Therefore,

$$\{(x \otimes y)(g), (x \otimes y)(gt)\} = \{(x(i, j), y(w)), (x(i+1, j), y(w))\}$$

is allowed for all $g \in \mathbb{F}_n \times \mathbb{Z}$. For patterns of support $\{1, s\}$, with $s \in S \cup S^{-1}$, we have $gs = wst^i$. Let us denote $u = \operatorname{argmax}\{|w'| \mid w' \sqsubseteq_p w \wedge w' \sqsubseteq_p W\}$, $j = 2|u| - |w|$ and $\pi_1(x \otimes y)(gs) = x(i, j')$. If it happens that $y(w) = s$, we have two cases:

- $u = w$. Then, by applying s we continue on the configurations path, i.e. $ws \sqsubseteq_p W$. Therefore, $j' = j + 1$
- $u \sqsubset w$. Then, because of the local rules defining Y_f , the last letter in w must be s^{-1} . Then $|ws| = |w| - 1$ and therefore $j' = j + 1$.

This means $\{(x \otimes y)(g), (x \otimes y)(gs)\} = \{(x(i, j), y(w)), (x(i, j+1), y(ws))\}$ is allowed. If on the other hand, $y(w) \neq s$, we have that

$$\operatorname{argmax}\{|w'| \mid w' \sqsubseteq_p ws \wedge w' \sqsubseteq_p W\} = u.$$

Thus, $j' = 2|u| - |ws| = j - 1$. Once again, this means

$$\{(x \otimes y)(g), (x \otimes y)(gs)\} = \{(x(i, j), y(w)), (x(i, j-1), y(ws))\},$$

is allowed. We conclude that $x \otimes y \in Z$.

Now, let us have $z \in Z$. We can easily obtain $y \in Y_f$ linked to a word W through the recursive method mentioned above. To find x , we begin by setting:

$$x(i, 0) = \pi_1(z(t^i)), \quad \forall i \in \mathbb{Z}.$$

Next, we define the path function $\rho : \mathbb{Z} \rightarrow G$ as follows:

$$\rho_W(j) = \begin{cases} W_0 \dots W_j, & \text{if } j \geq 0 \\ (W_0)^j & \text{if } j < 0 \end{cases}.$$

We continue looking our configuration y by defining the group elements $\{g_{i,j}\}_{i,j \in \mathbb{Z}}$ as $g_{i,j} = \rho_W(j)t^i$. Finally, we set

$$x(i, j) = \pi_1(z(g_{i,j})).$$

Claim: $x \in X$.

Let us take a look at two cases:

- $\exists(i, j) \in \mathbb{Z}^2$: $\{x(i, j), x(i+1, j)\}$ is forbidden in X . This would mean that the pattern $\{z(g_{i,j}), z(g_{i,j}t)\}$ would be forbidden in Z , which is a contradiction.
- $\exists(i, j) \in \mathbb{Z}^2$: $\{x(i, j), x(i, j+1)\}$ is forbidden in X .

Notice that, $g_{r,n+1} = g_{r,n}W_{n+1}$. This would mean that the pattern $\{z(g_{i,j}), z(g_{i,j}W_{n+1})\}$ would be forbidden in Z , which is a contradiction.

Claim: $z = x \otimes y$.

Because of the way y was obtained, it suffices to check the first coordinate. Let us have $g = wt^i$ and $\pi_1(x \otimes y)(g) = x(i, j)$ as in the proposition statement. In addition, let

$$u = \operatorname{argmax}\{|w'| \mid w' \sqsubseteq_p w \wedge w' \sqsubseteq_p W\},$$

and $N = |u|$. As we have seen, this means that

$$\pi_1(z(h)) = x(0, N),$$

because $u = \rho_W(N)$. Now, if we have $w = ww_0 \dots w_m$, we can see that $y(u)$ is not in the direction of the flow. Thus, we can deduce from the allowed local rules that the second coordinate of x must decrease by 1 when applying w_0 . Now, because X is expansive, we know that x is the only configuration with the pattern $x|_{\mathbb{Z} \times \{N\}}$ on $\mathbb{Z} \times \{N\}$. This allows us to say,

$$\pi_1(z(hw_0)) = x(0, N - 1),$$

By repeating the same argument for w_1 up to w_m , we obtain:

$$\pi_1(z(w)) = \pi_1(z(hw_0 \dots w_m)) = x(0, N - (m - N)) = x(0, j)$$

we can conclude,

$$\pi_1(z(g)) = \pi_1(z(wt^i)) = x(i, j).$$

□

Theorem 6.6.3. *There exists a strongly aperiodic SFT on $\mathbb{F}_n \times \mathbb{Z}$.*

Proof. We proceed by contradiction to prove that the SFT Z is strongly aperiodic. Let $z \in Z$ be such that there exists $g \in \mathbb{F}_n \times \mathbb{Z} \setminus \{1\}$ satisfying $g \cdot z = z$. We decompose g^{-1} as wt^i , with $w \in \mathbb{F}_n$ and $i \in \mathbb{Z}$. In addition, let us have $x \in X$ and $y \in Y_f$ such that $z = x \otimes y$.

By Proposition 6.6.1, $W = W(y)$ is a periodic word given by either $w^{\mathbb{N}}$ or $(w^{-1})^{\mathbb{N}}$. Let us call $l = |w|$, and suppose without loss of generality that $W = w^{\mathbb{N}}$.

Claim: $(-i, -l) \cdot x = x$.

Let $(\alpha, \beta) \in \mathbb{Z}^2$ and let $h = \rho_W(\beta)t^\alpha$. Then, $x(\alpha, \beta) = \pi_1(z(h))$.

If we call $\pi_1((g \cdot z)(h)) = \pi_1(z(g^{-1}h)) = x(\alpha', \beta')$, it is straightforward to see that $\alpha' = \alpha + i$. For the second coordinate, notice that for $g^{-1}h$ the greatest prefix this element has in common with W is given by $w\rho_W(\beta)$, due to the definition of W . This means that, $\beta' = \beta + l$, and thus $x \in X$ is periodic in the direction $(-i, -l)$, which is a contradiction. □

As a consequence, because unimodular groups contain $\mathbb{F}_n \times \mathbb{Z}$ as a finite index normal subgroup, Proposition 6.3.4 tells us that they admit strongly aperiodic SFTs. In particular, both torus knot groups and $BS(n, n)$ admit this kind of subshift, as they are unimodular.

Corollary 6.6.4. *Unimodular GBS groups admit strongly aperiodic SFTs. In particular, both $\Lambda(n, m)$ and $BS(n, n)$ admit strongly aperiodic SFTs.*

6.6.3 Minimality

We would like to see if properties from the aperiodic SFT X over \mathbb{Z}^2 can be lifted to our new aperiodic subshift Z . In particular, we are interested in preserving minimality. Recall that a \mathbb{Z}^2 -SFT of the sought after characteristics is shown to exist in Proposition 6.5.5.

The idea is as follows. First, we show that the flow shift Y_f is minimal. The idea here is, for configurations defined by words W' and W , to shift the first configuration progressively obtaining configurations whose defining word is $W_0W_1 \dots W_n e_n W'$, where e_n is an error term of length 1. Second, we couple this minimality with that of X to establish the sought after result.

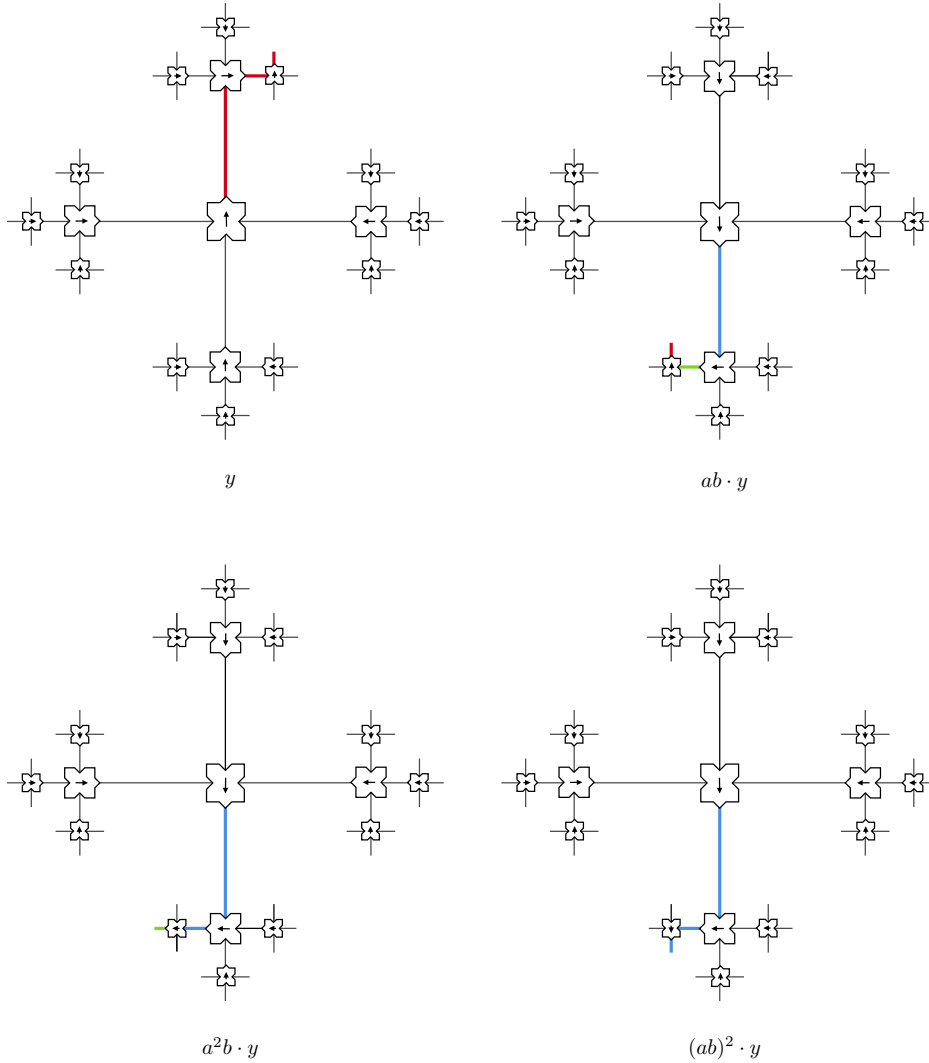

Figure 6.5: The first three steps to go from the word $(ba)^\infty$ to $(b^{-1}a^{-1})^\infty$, with error term $e_n = a^{-1}$ for all n . The original word is marked in red, the new one in blue, and the error term in green.

Lemma 6.6.5. *Let $y, y' \in Y_f$ be two configurations defined by the words W and W' respectively. Then, there exists a sequence $\{g_n\}_{n \in \mathbb{N}}$ in $\mathbb{F}_n \times \mathbb{Z}$ such that*

$$\lim_{n \rightarrow \infty} g_n^{-1} \cdot y' = y,$$

and $|g_{n+1}| = |g_n| + 1$ for all $n \in \mathbb{N}$.

Proof. We would like to find g_n such that $W(g_n^{-1} \cdot y') = W_0 \dots W_n e_n W'$, with $|e_n| = 1$. We add the error term so we avoid forbidden flow patterns (we must avoid $W_n = (W'_0)^{-1}$ at every point) and for the size of the new word to increase by exactly 1 at each step. This term will disappear upon taking the limit.

We begin by introducing the directions involved in the error term:

$$a_i = \begin{cases} s_i^{-1} & \text{if } W'_0 = s_i \\ s_i & \text{if not} \end{cases}.$$

Then, we define $g_0 = a_i W_0^{-1}$ for $W_0 \in (S \cup S^{-1}) \setminus \{s_i, s_i^{-1}\}$. This way, we arrive at $W(g_0^{-1} \cdot y') = W_0 e_0 W'$, where e_0 is the arrow we added as padding to avoid W_0 conflicting with W'_0 . Next, we recursively define $g_n = a_i (W_0 \dots W_n)^{-1}$ for $W_n \in (S \cup S^{-1}) \setminus \{s_i, s_i^{-1}\}$. This way, we have

$$W(g_n^{-1} \cdot y') = W_0 \dots W_n e_n W',$$

where e_n is the error term of size 1. Therefore,

$$\lim_{n \rightarrow \infty} g_n^{-1} \cdot y' = y.$$

□

Theorem 6.6.6. *There exists a minimal strongly aperiodic SFT on $\mathbb{F}_n \times \mathbb{Z}$.*

Proof. We prove that the SFT Z satisfies the statement of the theorem. Let us take two configurations $x' \otimes y'$ and $x \otimes y$ in Z . Because X is minimal, there exists a sequence $\{(i_n, j_n)\}_{n \in \mathbb{N}}$ in \mathbb{Z}^2 with $(j_n)_{n \in \mathbb{N}}$ increasing, such that

$$\lim_{n \rightarrow \infty} (i_n, j_n) \cdot x' = x.$$

Let $\{g_n\}_{n \in \mathbb{N}}$ be the sequence from Lemma 6.6.5, that is,

$$\lim_{n \rightarrow \infty} g_n^{-1} \cdot y' = y.$$

Let $M \in \mathbb{N}$ be such that $j_M \geq 2$. Next, let $\{n_k\}_{k \geq M}$ be the increasing subsequence satisfying $n_k + 1 = j_k$. Then,

$$(g_{n_k} t^{i_k})^{-1} \cdot (x' \otimes y') = (x'_{(-i_k, -j_k)}, W_0).$$

It follows that,

$$(g_{n_k} t^{i_k})^{-1} \cdot (x' \otimes y') = ((i_k, j_k) \cdot x') \otimes (g_{n_k}^{-1} \cdot y'),$$

and thus,

$$\lim_{k \rightarrow \infty} (g_{n_k} t^{i_k})^{-1} \cdot (x' \otimes y') = x \otimes y.$$

This shows that Z is minimal. □

6.7 Adaptation to the Baumslag-Solitar group $BS(2, 3)$

Amenable Baumslag-Solitar groups $BS(1, n)$ are known to have strongly aperiodic SFTs [EM22a] and even minimal strongly aperiodic SFTs [AS24]. The case of $BS(m, n)$ for $m \neq n$ and $m, n > 1$ has remained unsolved until now. Since all these groups are quasi-isometric [Why01], it is enough to focus on $BS(2, 3)$. A weakly aperiodic SFT is known to exist on this group [AK13] and we prove here that thanks to the path-folding technique, this construction can be modified to get strong aperiodicity. In a few words, the weakly aperiodic SFT relies on an embedding of $BS(2, 3)$ into \mathbb{R}^2 that fails to be injective, and this injectivity default irremediably produces some periods in the SFT. We modify the embedding so that it now depends on an infinite path in the group, such that the choice of the path allows to break the existing periods.

6.7.1 The group $BS(2, 3)$

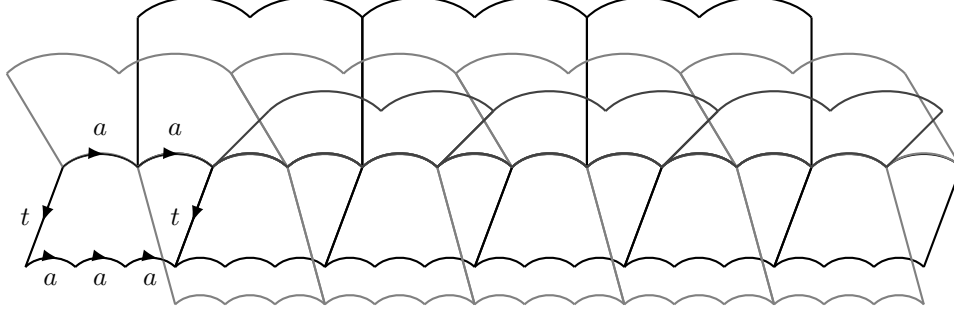

Figure 6.6: The Cayley graph of $BS(2, 3) = \langle a, t \mid t^{-1}a^2t = a^3 \rangle$

Since $BS(2, 3)$ is an HNN-extension, by Lemma 1.3.28 we have a normal form for elements of $BS(2, 3)$.

Lemma 6.7.1 (Normal form). *Every element $g \in BS(2, 3)$ can be uniquely decomposed as $g = wa^k$, where w is a freely reduced word over the alphabet $\{t, at, t^{-1}, at^{-1}, a^2t^{-1}\}$ and $k \in \mathbb{Z}$.*

Proof. Lemma 1.3.28 states that every element $g \in BS(2, 3)$ has the form

$$g = a^N t^{e_1} a^{m_1} \dots t^{e_n} a^{m_n},$$

where $N \in \mathbb{Z}$ and $e_i = \pm 1$, such that if $e_i = 1$ then $m_i \in \{0, 1\}$, if $e_i = -1$ then $m_i \in \{0, 1, 2\}$, and we never have a subword of the form $t^\pm a^0 t^\mp$.

Notice that if $g = a^N$, it is already in the form we are looking for. Next, if we have $g = a^N t$, we can decompose $N = 2d + r$, where $0 \leq r < 2$ in order to change the order of the generators,

$$g = a^N t = a^{2d+r} t = a^r t a^{3d}.$$

Analogously, if $g = a^N t^{-1}$, we decompose $N = 3d + r$ with $0 \leq r < 3$ and arrive at

$$g = a^N t^{-1} = a^{3d+r} t^{-1} = a^r t^{-1} a^{2d}.$$

Finally, for an arbitrary g , we simply iterate the two preceding procedures to arrive at an expression for g in the sought after form. \square

6.7.2 The orbit coding construction

In this section we briefly overview the key ideas in the construction originally found by Kari for \mathbb{Z}^2 [Kar96] and then generalized to $BS(m, n)$ [AK13; AK21b]. We start with an overview of the original construction on \mathbb{Z}^2 from a group theoretical point of view to set the scene for generalizations to $BS(m, n)$. For details and proofs we refer to the original article [Kar96]. Consider the standard presentation $\langle a, t \mid at = ta \rangle$ for \mathbb{Z}^2 . The idea of Kari is to start with a rational piecewise affine map $f : I \subseteq \mathbb{R} \rightarrow \mathbb{R}$ such that all $x \in I$ are immortal, meaning that for every $k \in \mathbb{Z}$ the k -th iteration $f^k(x)$ lies inside I , and f is aperiodic. Then he defines an SFT X_f such that

1. Each configuration of the SFT encodes the orbit of an immortal point by f ;
2. Within a configuration, each $\langle a \rangle$ -coset encodes a real number $x \in I$. This is done thanks to the Beatty sequence $(B_k(x))_{k \in \mathbb{Z}}$ of x given by $B_k(x) = \lfloor (k+1)x \rfloor - \lfloor kx \rfloor$, that is, a bi-infinite sequence that alternates between the two integers $\lfloor x \rfloor$ and $\lfloor x \rfloor + 1$, and that in average converges to x ;

3. The computation of f follows the t -direction: if the real number x is encoded on $t^k \cdot \langle a \rangle$ for some $k \in \mathbb{Z}$, then the real number $f(x)$ is encoded on $t^{k+1} \cdot \langle a \rangle$ (see Figure 6.7 on the left). For $g = a^j t^k \in \mathbb{Z}^2$, the integer $k \in \mathbb{Z}$ is called the height of g ;
4. The function f is computed locally from one coset to the next one. This local computation is exact up to some bounded error, in a way such that globally the errors compensate and vanish making the global computation is exact.
5. The aperiodicity of each configuration is a consequence of the aperiodicity of f .

The main difficulty in this construction is to ensure that only finitely many letters are needed in the alphabet of the SFT. Since we choose a rational piecewise affine map, the coefficients used as colors on the Wang tiles are certainly also rational numbers. The nature of the different encodings (both of the real numbers and of the local computation) ensures that there are a finite amount of Wang tiles and the corresponding SFT X_f is non-empty (see [Kar07] for more details).

The same construction may be adapted to $BS(m, n)$ as presented in [AK13; AK21b]. There are some technicalities to synchronize the different sheets of $BS(m, n)$, but the general idea is the same. The main difference with \mathbb{Z}^2 is that in this construction, the real number $f^k(x)$ is encoded not only on a unique \mathbb{Z} -coset but on infinitely many of them. With the presentation $\langle a, t \mid t^{-1} a^m t = a^n \rangle$ every coset $g \cdot \langle a \rangle$ with $g \in BS(m, n)$ encodes the real number $f^k(x)$, provided that g can be represented by a word w on $\{a, a^{-1}, t, t^{-1}\}$ such that $|w|_t - |w|_{t^{-1}} = k$. Similarly to \mathbb{Z}^2 , the number k plays the role of the height of g (see Figure 6.7 in the middle). The construction provides a weakly aperiodic SFT, but since a same real number $f^k(x)$ is encoded on infinitely many $\langle a \rangle$ -cosets, this SFT is not strongly aperiodic.

We modify the construction for $BS(m, n)$ so that the computation of f no longer follows the generator t , but rather a direction given by a flow SFT similar to the flow of Section 6.6.1 (see Figure 6.7 on the right). Figure 6.7 sums up how the Kari's construction on \mathbb{Z}^2 , the construction on $BS(m, n)$ as presented in [AK21b] and our construction on $BS(m, n)$ are similar, but also how our construction differs from the one of [AK21b] and thus provides strong aperiodicity instead of weak aperiodicity only.

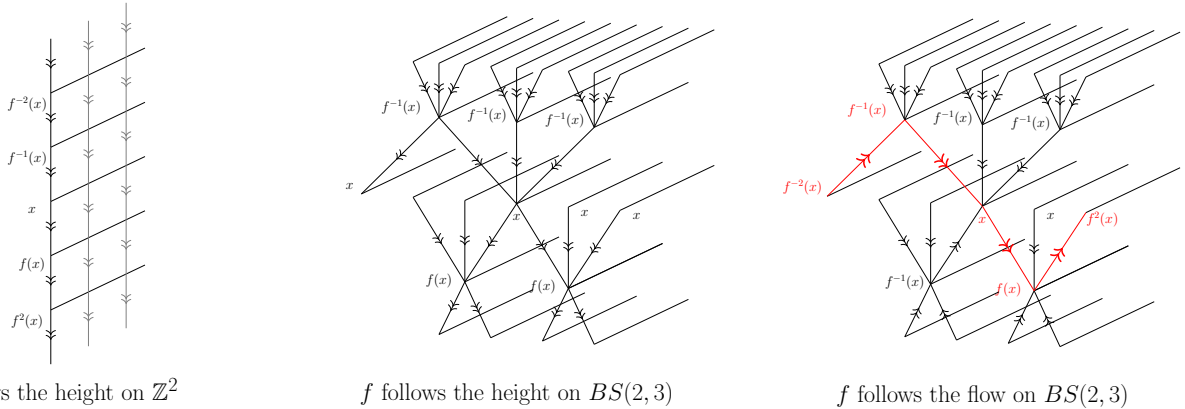

Figure 6.7: On the left the Cayley graph of $\mathbb{Z}^2 = \langle a, t \mid at = ta \rangle$ where is pictured how an orbit for f is encoded. In the middle the equivalent picture for $BS(2, 3) = \langle a, t \mid t^{-1} a^2 t = a^3 \rangle$. For these two pictures, edges corresponding to generator t in the Cayley graphs are pictured with a double arrow. On the right, edges with double arrows represent the direction given by the flow SFT on $BS(2, 3)$.

6.7.3 A flow SFT on $BS(2, 3)$

Consider the alphabet $A = \{t, at, t^{-1}, at^{-1}, a^2 t^{-1}\}$ and the SFT $Y_{\text{flow}} \subset A^{BS(2,3)}$ defined by the following local rules: for every group element $g \in BS(2, 3)$ and every configuration $y \in Y_{\text{flow}}$,

- $y(g) = y(g \cdot a^2)$ if $y(g) \in \{t, at\}$
- $y(g) = y(g \cdot a^3)$ if $y(g) \in \{t^{-1}, at^{-1}, a^2t^{-1}\}$
- if $y(g) = u \in A$ then for every $v \in A \setminus \{u^{-1}\}$ we have $y(g \cdot v^{-1}) = v$

This SFT can be equivalently, and in a more visual way, defined through the finite patterns with support $\{1, a, a^2, t, ta, ta^2, ta^3\} \cup A$ pictured below.

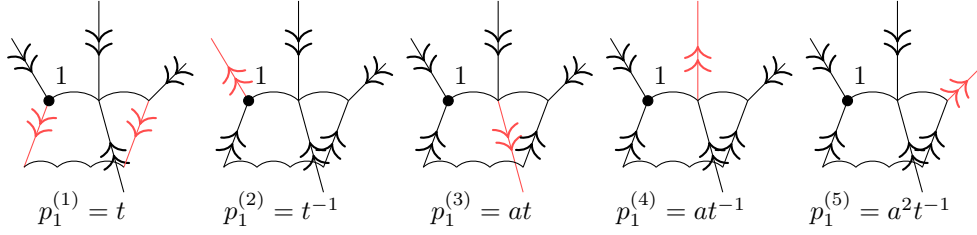

Figure 6.8: The allowed patterns $p_1^{(1)}$ to $p_1^{(5)}$ for the flow SFT on $BS(2,3)$. For more readability the outgoing edges are pictured in red.

Notice that for each flow configuration $y \in Y_{\text{flow}}$ and for every $g \in BS(2,3)$, the restriction of y to $g \cdot a^{\mathbb{Z}}$ is necessarily periodic, with this period being either a^2 or a^3 . More precisely the coset $g \cdot a^{\mathbb{Z}}$ is a^2 -periodic if $y(g) \in \{t, at\}$ and a^3 -periodic if $y(g) \in \{t^{-1}, at^{-1}, a^2t^{-1}\}$. Consequently we may represent y just by a flow on the Bass-Serre tree of $BS(2,3)$, that is to say an edge coloring of the complete tree of degree 5 where each vertex has a single outgoing arrow and four incoming arrows (see Figure 6.9).

In the same fashion as in Section 6.6.1, we can express flow configurations from Y_{flow} as infinite words.

Proposition 6.7.2. *There is a bijective corresponding between configurations of Y_{flow} and semi-infinite words on the alphabet $A = \{t, at, t^{-1}, at^{-1}, a^2t^{-1}\}$.*

Proof. If $y \in Y_{\text{flow}}$ we denote by $W(y)$ the word in $A^{\mathbb{N}}$ given by the recursion starting with $W_0 = y(1)$ and proceeding with $W_n = y(W_0 \dots W_{n-1})$.

Reciprocally if W is a word in $A^{\mathbb{N}}$ we define a flow configuration Y_{flow} . We set $y(W_0 \dots W_{n-1}) = W_n$ for all $n \geq 0$. Next, we can determine all other values through the use of the periodicity of a -cosets and the third rule defining the flow SFT, as shown by the definition of Y_{flow} (see Figure 6.8). \square

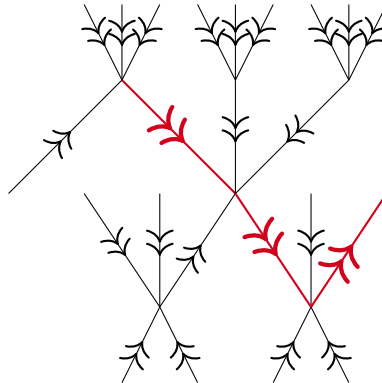

Figure 6.9: A configuration in the flow SFT on $BS(2,3)$, pictured on the Bass-Serre tree only. Starting from the upper-left corner, this configuration is represented by a word with prefix tta^2t^{-1}

Proposition 6.7.3. *If $y \in Y_{\text{flow}}$ has period $g \in BS(2, 3)$ with normal form decomposition $g^{-1} = wa^k$, then $W(y)$ is either the infinite word $w^{\mathbb{N}}$ or the infinite word $(w^{-1})^{\mathbb{N}}$.*

Proof. The proof is analogous to the proof of Proposition 6.6.1. □

6.7.4 Embedding $BS(2, 3)$ into \mathbb{R}^2 along a flow configuration

We define an embedding of $BS(2, 3)$ into \mathbb{R}^2 from a flow configuration $y \in Y_{\text{flow}}$, denoted $\Phi_y : BS(2, 3) \rightarrow \mathbb{R}^2$, that is recursively defined on finite words w on the alphabet $B = \{a, t, a^{-1}, t^{-1}\}$.

We define $\Phi_y(w) = (\alpha(w), h_y(w))$ recursively, coordinate by coordinate. Let ε denote the empty word. The second coordinate is such that, for $u \in \{t, at, a^2t, t^{-1}, at^{-1}\}$

$$\begin{aligned} h_y(\varepsilon) &= 0 \\ h_y(w.u) &= h_y(w) + 1 \text{ if } y(w) = u \\ &= h_y(w) - 1 \text{ otherwise} \\ h_y(w.a) &= h_y(w) = h_y(w.a^{-1}). \end{aligned}$$

This coordinate $h_y(g)$ represents how far the $\langle a \rangle$ -cosets of a group element g are from $\langle a \rangle$ (the $\langle a \rangle$ -coset of the identity) if we follow the flow configuration y from the identity. In our construction this corresponds to the simulated height in the original Kari's SFT, and we call it the y -height of g in the sequel. The first coordinate is:

$$\begin{aligned} \alpha(\varepsilon) &= 0 \\ \alpha(w.t) &= \alpha(w.t^{-1}) = \alpha(w) \\ \alpha(w.a) &= \alpha(w) + \left(\frac{2}{3}\right)^{\beta(w)} \\ \alpha(w.a^{-1}) &= \alpha(w) - \left(\frac{2}{3}\right)^{\beta(w)}. \end{aligned}$$

where $\beta(w) := \|w\|_t = |w|_t - |w|_{t^{-1}}$ counts the contribution of the generator t to w . This first coordinate $\alpha(w)$ is exactly the first coordinate of the Φ embedding given in [AK21b]. The difference with Φ_y lies in the second coordinate, $h_y(w)$, that no longer follows the generator t but the path induced by the flow configuration y instead.

Proposition 6.7.4. *For every $g \in BS(2, 3)$ the value of $h_y(w)$ does not depend on the choice of the word w that represents g , hence h_y is well-defined on $BS(2, 3)$.*

Proof. We prove this by induction on the size of the normal form of Lemma 6.7.1. Since $h_y(w.a^{\pm 1}) = h_y(w)$ we can get rid of the last term, a^k , in the writing of the normal form; it does not contribute to h_y . Assume every h_y is well-defined for all group elements that can be written with n letters from alphabet $A = \{t, at, t^{-1}, at^{-1}, a^2t^{-1}\}$. Let $g \in BS(2, 3)$ be an element with normal form $w \in A^{n+1}$. Denote g' the group element with normal form $w_0 \dots w_{n-1} \in A^n$. Then

$$h_y(g) = h_y(w_0 \dots w_n).$$

There are two cases, depending on whether $w_n = y(g')$ or $w_n \neq y(g')$. In the first case

$$\begin{aligned} h_y(g) &= h_y(w_0 \dots w_n) + 1 \\ &= h_y(g') + 1 \text{ by induction hypothesis,} \end{aligned}$$

and in the second case

$$\begin{aligned} h_y(g) &= h_y(w_0 \dots w_n) - 1 \\ &= h_y(g') - 1 \text{ by induction hypothesis,} \end{aligned}$$

so that $h_y(g)$ does not depend on the chosen word. \square

Proofs of analogous results for α and β can be performed in a similar way. Again following [AK21b] we define $\lambda : BS(2, 3) \rightarrow \mathbb{R}$ as

$$\lambda(g) = \frac{1}{2} \left(\frac{3}{2} \right)^{\beta(g)} \alpha(g).$$

Proposition 6.7.5. *Let g be an element of $BS(2, 3)$. Then for $i = 0, \dots, 2$:*

1. $\beta(g \cdot ta^i) = \beta(g) + 1$;
2. $\lambda(g \cdot ta^i) = \frac{3}{2}\lambda(g) + \frac{i}{2}$.

Proof. The first point is a direct application of the rules that define β . For the second point we have that

$$\begin{aligned} \lambda(g \cdot ta^i) &= \frac{1}{2} \left(\frac{3}{2} \right)^{\beta(g \cdot ta^i)} \alpha(g \cdot ta^i) \\ &= \frac{1}{2} \left(\frac{3}{2} \right)^{\beta(g)+1} \alpha(g \cdot ta^i) \\ &= \frac{1}{2} \left(\frac{3}{2} \right)^{\beta(g)+1} \left(\alpha(g) + i \cdot \left(\frac{2}{3} \right)^{\beta(g \cdot t)} \right) \\ &= \frac{3}{2}\lambda(g) + \frac{i}{2} \left(\frac{3}{2} \right)^{\beta(g)+1} \left(\frac{2}{3} \right)^{\beta(g)+1} \\ \lambda(g \cdot ta^i) &= \frac{3}{2}\lambda(g) + \frac{i}{2}. \end{aligned}$$

\square

6.7.5 A strongly aperiodic SFT on $BS(2, 3)$

To construct an aperiodic SFT we will add a new layer of tiles to the flow shift. These new tiles are Wang tiles for $BS(2, 3)$ that encode a piecewise linear function.

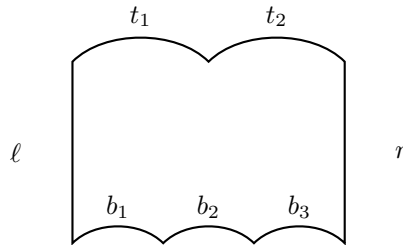

Figure 6.10: A Wang tile for $BS(2, 3)$

Each tile consists 7-tuple of integers $s = (t_1, t_2, l, b_1, b_2, b_3, r)$, as shown in Figure 6.10. Let τ be a set of these Wang tiles. We say a that a configuration $z \in \tau^{BS(2,3)}$ is a valid tiling if the colors of neighboring tiles

match. More explicitly, for every $g \in BS(2, 3)$ we must have:

$$\begin{aligned} z(g)(r) &= z(g \cdot a^2)(\ell) \\ z(g)(b_i) &= z(g \cdot a^{i-1}t)(t_1) \text{ for } i = 1, 2, 3 \\ z(g)(b_i) &= z(g \cdot a^{i-2}t)(t_2) \text{ for } i = 1, 2, 3. \end{aligned}$$

We say that a Wang tile for $BS(2, 3)$ computes a function $f : I \subset \mathbb{R} \rightarrow I$ if

$$f\left(\frac{t_1 + t_2}{2}\right) + \ell = \frac{b_1 + b_2 + b_3}{3} + r.$$

If this equality holds for f , we say that the tile computes f along the generator t . If f is invertible and the tiles computes f^{-1} , we say that the tiles computes f against the generator t .

Let us define the circle $I = [\frac{1}{10}; \frac{5}{2}] / \frac{1}{10} \sim \frac{5}{2}$. We introduce $T : I \rightarrow I$ the piecewise linear map defined by

$$T : x \mapsto \begin{cases} \frac{5}{2}x & \text{if } x \in [\frac{1}{10}; 1] \\ \frac{1}{10}x & \text{if } x \in]1; \frac{5}{2}[\end{cases}$$

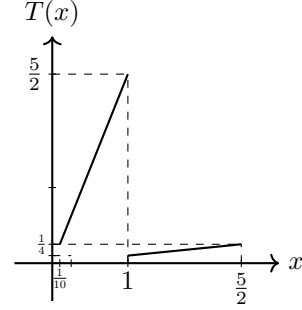

This linear map is invertible with inverse

$$T^{-1} : x \mapsto \begin{cases} 10x & \text{if } x \in]\frac{1}{10}; \frac{1}{4}[\\ \frac{2}{5}x & \text{if } x \in [\frac{1}{4}; \frac{5}{2}] \end{cases}$$

It is not difficult to see that T admits immortal points, i.e. reals numbers x such that for every $k \in \mathbb{Z}$, $T^k(x)$ lies in I . It is also easy to check, since 5 and 2 are coprime, that T is aperiodic, meaning that for every $x \in I$ if $T^k(x) = x$ for some integer $k \in \mathbb{Z}$, then $k = 0$.

We do not use the same function as in [Kar96] to construct a strongly aperiodic SFT on \mathbb{Z}^2 and in [AK13] to construct a weakly aperiodic SFT on $BS(3, 2)$, because it may cause trouble in our construction. Indeed a careful observation of how tiles are built (see [AK21a] for the bounds on the values for ℓ) shows that the tilename corresponding to the piece of the function given by $x \mapsto \frac{2}{3}x$ is empty! It is safer to use a piecewise linear function where no multiplicative coefficient matches $\frac{2}{3}$, hence our choice for T . More generally for $BS(m, n)$ no multiplicative coefficient should match $\frac{m}{n}$.

Thanks to the machinery presented in [AK13; AK21b], we can define from the function T two tilesets: first τ_T that computes T along t then $\tau_{T^{-1}}$ that computes T^{-1} along t –or equivalently computes T against t . We thus define the following quantities that depend on three parameters: a function f , that can be either T or T^{-1} in our case, a real number $x \in [\frac{1}{10}; \frac{5}{2}]$ and a group element $g \in BS(2, 3)$.

$$\begin{aligned} t_k(x, g) &= \lfloor (2\lambda(g) + k)x \rfloor - \lfloor (2\lambda(g) + (k-1))x \rfloor \text{ for } k = 1, 2 \\ b_k(f, x, g) &= \lfloor (3\lambda(g) + k)f(x) \rfloor - \lfloor (3\lambda(g) + (k-1))f(x) \rfloor \text{ for } k = 1, 2, 3 \\ \ell(f, x, g) &= \frac{1}{2}f(\lfloor 2\lambda(g)x \rfloor) - \frac{1}{3}\lfloor 3\lambda(g)f(x) \rfloor \\ r(f, x, g) &= \frac{1}{2}f(\lfloor (2\lambda(g) + 2)x \rfloor) - \frac{1}{3}\lfloor (3\lambda(g) + 3)f(x) \rfloor \end{aligned} \tag{6.1}$$

We gather τ_T and $\tau_{T^{-1}}$, that are both finite by [AK21a, Proposition 8], into a single tiling τ which is thus finite and combine it with the flow SFT Y_{flow} to define the SFT Y_T over the alphabet $A \times \tau$ as follows: every configuration $z \in Y_T$, which we denote $z(g) = (y(g), \tau(g))$ for every $g \in BS(2, 3)$, satisfies:

- if $y(g) = t$ then $\tau(g) \in \tau_T$;
- if $y(g) \in \{at, t^{-1}, t^{-1}, at^{-1}, a^2t^{-1}\}$ then $\tau(g) \in \tau_{T^{-1}}$.

These two conditions impose that the computation of iterates of T follows the flow: we put tiles that compute T on outgoing arrows and tiles that computes T^{-1} on incoming arrows (see Figure 6.11).

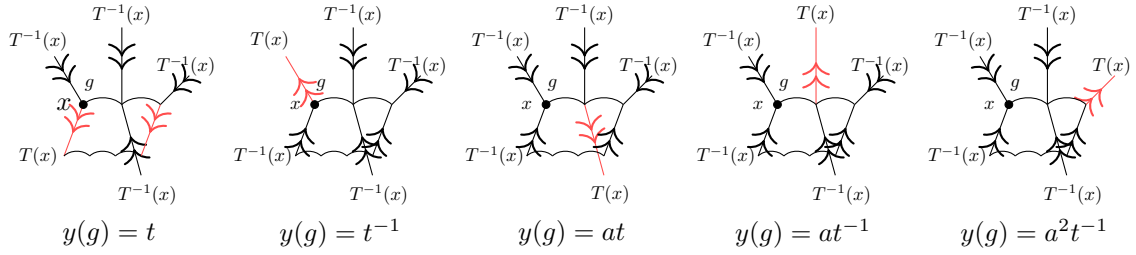

Figure 6.11: The flow configuration drives the choice for computing T or T^{-1} in the different sheets of $BS(2, 3)$.

Combining the formulas from (6.1) and the patterns from Figure 6.8 we can picture Wang tiles from τ as below.

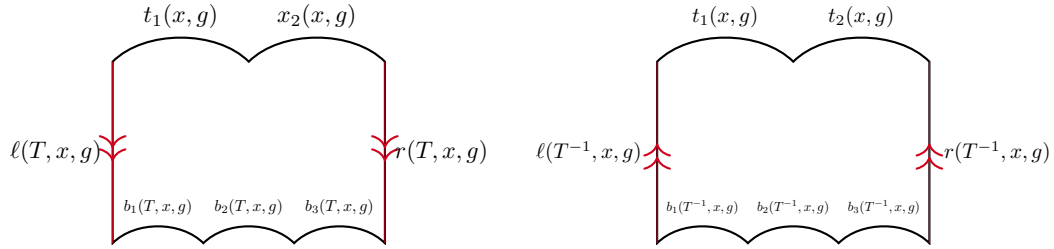

Figure 6.12: Wang tiling τ that computes T along a flow configuration for $BS(2, 3)$.

Proposition 6.7.6. *The tile pictured on the left of Figure 6.12 computes T along t , and the tile on the right computes T^{-1} along t (or T against t).*

Proof. The tiles are a simplified version of the tiles in [AK21b], since we have a one-dimensional function T or T^{-1} instead of a two-dimensional one, and our functions are linear and not affine. The calculations are left to the reader: the main idea is that terms on top and bottom telescope and the left and right carries precisely compensate the remaining terms. \square

Remark 6.7.7. The proof of Proposition 6.7.6 does not depend on the choice for the function λ .

Proposition 6.7.8. *There exists a configuration in Y_T .*

Proof. The proof follows the proof of Lemma 9 from [AK21b], since the function T we have chosen has immortal points. Fix a flow configuration $y \in Y_{\text{flow}}$ and choose x an immortal point for T . For every $g \in BS(2, 3)$ we put the tile $\tau(f, T^{h_y(g)}(x), g)$ in g , where $f = T$ if $y(g) = t$ and $f = T^{-1}$ otherwise. This defines a configuration z in $\tau^{BS(2, 3)}$. It remains to check that it is indeed in the SFT Y_T . We need to check that the three matching rules conditions on page 145 are satisfied.

1. $z(g)(r) = z(g \cdot a^2)(\ell)$? We distinguish two cases, depending on whether $y(g) = t$ or not. If this is the case, then $z(g)(r)$ is $r(T, T^{h_y(g)}(x), g)$:

$$z(g)(r) = \frac{1}{2}T \left(\lfloor (2\lambda(g) + 2) T^{h_y(g)}(x) \rfloor \right) - \frac{1}{3} \lfloor (3\lambda(g) + 3) T^{h_y(g)+1}(x) \rfloor.$$

In this case, by the definition of Y_{flow} (see Figure 6.8), we also have that $y(g \cdot a^2) = t$. Thus $z(g \cdot a^2)(\ell)$ is $\ell(T, T^{h_y(g \cdot a^2)}(x), g \cdot a^2)$ and since $h_y(g \cdot a^2) = h_y(g)$ we get:

$$z(g \cdot a^2)(\ell) = \frac{1}{2}T \left(\lfloor 2\lambda(g \cdot a^2) T^{h_y(g)}(x) \rfloor \right) - \frac{1}{3} \lfloor 3\lambda(g \cdot a^2) T^{h_y(g)+1}(x) \rfloor.$$

It suffices to use the fact that $\lambda(g \cdot a^2) = \lambda(g) + 1$ to conclude.

In the second case, $y(g) \neq t$, $z(g)(r)$ is $r(T^{-1}, T^{h_y(g)}(x), g)$ and the allowed patterns of Figure 6.8 impose that $y(g \cdot a^2) \neq t$. Thus $z(g \cdot a^2)(\ell)$ is equal to $\ell(T^{-1}, T^{h_y(g \cdot a^2)}(x), g \cdot a^2)$. The equalities $\lambda(g \cdot a^2) = \lambda(g) + 1$ and $h_y(g \cdot a^2) = h_y(g)$ give that $z(g)(r) = z(g \cdot a^2)(\ell)$.

2. $z(g)(b_{i+1}) = z(g \cdot ta^i)(t_1)$ for $i = 0, 1, 2$?

If $y(g) = t$, then

$$\begin{aligned} z(g)(b_{i+1}) &= b_{i+1}(T, T^{h_y(g)}(x), g) \\ &= \lfloor (3\lambda(g) + i + 1) T^{h_y(g)+1}(x) \rfloor - \lfloor (3\lambda(g) + i) T^{h_y(g)+1}(x) \rfloor. \end{aligned}$$

On the other hand,

$$\begin{aligned} z(g \cdot ta^i)(t_1) &= t_1(T^{h_y(g \cdot ta^i)}(x), g \cdot ta^i) \\ &= \lfloor (2\lambda(g \cdot ta^i) + 1) T^{h_y(g \cdot ta^i)}(x) \rfloor - \lfloor (2\lambda(g \cdot ta^i)) T^{h_y(g \cdot ta^i)}(x) \rfloor. \end{aligned}$$

Using results from Proposition 6.7.5 we get that

$$\begin{aligned} z(g \cdot ta^i)(t_1) &= \lfloor \left(2 \left(\frac{3}{2}\lambda(g) + \frac{i}{2} \right) + 1 \right) T^{h_y(g)+1}(x) \rfloor - \lfloor \left(2 \left(\frac{3}{2}\lambda(g) + \frac{i}{2} \right) \right) T^{h_y(g)+1}(x) \rfloor \\ &= \lfloor (3\lambda(g) + i + 1) T^{h_y(g)+1}(x) \rfloor - \lfloor (3\lambda(g) + i) T^{h_y(g)+1}(x) \rfloor \\ &= z(g)(b_{i+1}). \end{aligned}$$

If $y(g) \neq t$, the calculations are quite similar, except that T is replaced by T^{-1} in the expression of $z(g)(b_{i+1})$, which is compensated by the fact that, in that case, $h_y(g \cdot ta^i) = h_y(g) - 1$.

3. $z(g)(b_{i+1}) = z(g \cdot ta^{i-1})(t_2)$ for $i = 0, 1, 2$?

This part is very similar to what precedes and left to the reader, since $t_2(x, g)$ is just a *shift* of $t_1(x, g)$. □

Let $(x_i)_{i \in \mathbb{Z}}$ be a bi-infinite sequence on the alphabet $\{k, k + 1\}$ for some integer $k \in \mathbb{Z}$. Then $(x_i)_{i \in \mathbb{Z}}$ is a representation of a real number x if arbitrarily long sub-sequences have averages arbitrarily close to x . For instance a given real number x its Beatty sequence $(B_k(x))_{k \in \mathbb{Z}}$ where $B_k(x) = \lfloor (k + 1)x \rfloor - \lfloor kx \rfloor$ is a representation of x . A compactness argument shows that any bi-infinite sequence $(x_i)_{i \in \mathbb{Z}}$ represents at least one real number, but it may also represent different reals.

Proposition 6.7.9. *The SFT Y_T is strongly aperiodic.*

Proof. Let $z = (y, \tau)$ be a configuration in Y_T and assume it possesses a period $g \in BS(2, 3)$. Thus for every $k \in \mathbb{Z}$ one has that

$$z(a^k) = z(g^{-1} \cdot a^k)$$

so that the two $\langle a \rangle$ -cosets at 1 and g^{-1} are the same. If we denote by x one real number represented by τ on the $\langle a \rangle$ -coset of the identity, we get that

$$T^{h_y(g)}(x) = x.$$

But the periodicity of z also constrains the flow configuration y . Necessarily by Proposition 6.7.3, if we decompose g into its normal form $g = wa^p$, we have that y is characterized by either the infinite word $w^{\mathbb{N}}$ or $(w^{-1})^{\mathbb{N}}$. Without loss of generality we take $W(y) = w^{\mathbb{N}}$, which in particular implies that $h_y(w) = h_y(g) = |g|_t + |g|_{t-1}$. Hence we can rewrite $T^{h_y(g)}(x) = x$ as

$$T^{|g|_t + |g|_{t-1}}(x) = x$$

which in turn implies, by the aperiodicity of T , that $|g|_t + |g|_{t-1} = 0$. Because the two terms are positive they are necessarily zero. The period g is therefore a power of a that we denote a^{-N} for some $N \in \mathbb{Z}$. We now know that for every group element $h \in BS(2, 3)$

$$z(h) = z(a^N \cdot h),$$

so that each $\langle a \rangle$ -coset in the configuration y wears a N -periodic bi-infinite word. Since there are only finitely many possible words of length N , by following the flow component of y , there must exist two distinct integers k, k' such that $T^k(x) = T^{k'}(x)$. Again the aperiodicity of T implies that $k = k'$, which contradicts our initial assumption. We conclude that z has no period. \square

Combining Proposition 6.7.8 and Proposition 6.7.9 gives the existence of a strongly aperiodic SFT on $BS(2, 3)$. Since all non-residually finite Baumslag-Solitar groups are finitely presented, torsion free and quasi-isometric between them, Theorem 5.1.6 of [Coh17] applies and we conclude that all the $BS(m, n)$ with $m, n > 1$ and $m \neq n$ admit strongly aperiodic SFTs.

Theorem 6.7.10. *Non-residually finite Baumslag-Solitar groups $BS(m, n)$ with $m, n > 1$ and $m \neq n$ admit strongly aperiodic SFTs.*

Corollary 6.7.11. *All non- \mathbb{Z} GBS groups admit a strongly aperiodic SFT.*

6.8 Consequences

Through the machinery provided by Theorem 5.1.6, we can push the result to a broader class of groups, namely those obtained as the fundamental group of a graph of virtual \mathbb{Z} 's. This structure is the same as in Definition 6.1.5 but all vertex groups are virtually \mathbb{Z} instead of just \mathbb{Z} .

Theorem 6.8.1 ([MSW03]). *A group G is quasi-isometric to a GBS group if and only if it is the fundamental group of a graph of virtual \mathbb{Z} 's.*

This way, Corollary 6.7.11 implies the following result.

Corollary 6.8.2. *Let G be the fundamental group of a graph of virtual \mathbb{Z} 's. If G is not virtually \mathbb{Z} it admits a strongly aperiodic SFT.*

Part IV

Substitutive Tools

Chapter 7

Substitutions and Hierarchical Structures

As we explained in the introduction to this thesis, symbolic dynamics was largely conceived to represent general dynamical systems through symbolic sequences, by coding orbits on a discretized space. Over time, this approach has been applied to study various families of dynamical systems. Notable examples include linear recurrent systems [DHS99], Toeplitz flows [GJ00], interval exchange transformations [GJ02], dendric sequences [GL22], and general minimal systems [HPS92].

One commonly used coding method, introduced in [Fer96; LV92], involves the use of infinite sequences of morphisms, or substitutions, known as **directive sequences** or **S -adic representations**. Recent research has shown that understanding the underlying S -adic structures of some subshifts sheds light on their dynamical properties, such as the recognizability of morphisms [Ber+19], dimension groups [Ber+21], connections between finite rank and non-superlinear complexity [Don+21], automorphism groups [EM22b], symbolic factors [Esp23a], and more [ÁD23; ÁDE23]. A recent result by Espinoza even goes as far as to obtain a S -adic representations of subshifts with sublinear complexity [Esp23b]. This answers what is known as the **S -adic conjecture**. The conjecture, often attributed to B. Host, claims the existence of an S -adic characterization of such class of subshifts. Moreover, the S -adic formalism provides representations through Kakutani-Rokhlin partitions. Systems admitting such partitions with a uniform bound for the number of towers are of zero topological entropy [Dur10], have an explicit description of their ergodic invariant probability measures [Bez+13] and there exist necessary and sufficient conditions for a complex number to be a continuous or measurable eigenvalue [BDM10; DFM19].

Considering the previous studies and acknowledging the effectiveness of the S -adic framework as a tool for proving general theorems and constructing subshifts with interesting dynamical and computational behavior, it is natural to ask whether this setting is useful beyond the one-dimensional case. However, extending it even to the multidimensional case presents important challenges, particularly in defining the types of morphisms involved. Consequently, research in this direction has been very limited. Some advances have been made to study the connections with sofic subshifts [AS14], as a generalization of the substitutive case proved in [Moz89], but these are restricted to cases where the morphisms have a rectangular support. Nevertheless, these substitutions have allowed for the construction of new aperiodic SFTs on \mathbb{Z}^2 and given novel proofs of the undecidability of the Domino Problem through self-similarity [DRS12] (see also [JV20]).

In [Cab23], Cabezas introduced the notion of constant-shape substitutions; a multidimensional analog of the well-studied constant-length substitutions. This has been one of the first attempts to study multidimensional substitutions in a broader class than those defined solely by rectangular and square supports, and has already provided interesting examples of multidimensional subshifts and their properties [CP23; CL24]. However, despite some progress, there is currently no established formalism for multidimensional non constant-length substitutions. There has nevertheless been some important research in this direction. For instance, Kari and Jolivet looked at non-constant-shape two dimensional substitutions where, in addition to the images of the substitutions, a list of ways of concatenating the images is given [JK12]. There have also been works on the substitutive structure of the minimal subsystem of the Jeandel-Rao aperiodic tiling [Lab21c] and metallic mean

Wang tiles [Lab23; Lab24]. See [Fra08] for a survey on symbolic and geometric substitutive tilings on the Euclidean plane. Furthermore, exploration in other contexts, such as general countable group actions, is even more limited. There have been generalizations of substitutive systems for the hyperbolic plane [BH13], solvable Baumslag-Solitar groups [Sil20], the semigroup on two generators – aptly named *streetutions* – [BL21; BL23], and locally finite groups of the form $\bigoplus_{n \in \mathbb{N}} F$, where F is a finite group [BS24]. The most robust generalization comes from Beckus, Hartnick and Pogorzelski who defined substitutions for lattices on a large class of non-abelian nilpotent Lie groups [BHP21], with the objective of understanding the spectrum of the discrete Schrödinger operators on substitutive systems [Ten24].

The objective of this chapter is to serve as an introduction for an S -adic framework for general countable group actions. An important distinction from the one-dimensional case is that, for general groups, defining such morphisms heavily relies on the geometry inherent to these groups.

S -adic sequences and S -decomposable groups We begin by generalizing S -adic sequences in their broadest sense to groups that admit a hierarchical decomposition that is compatible with the sequence. We call the class of groups that admit such a decomposition, S -decomposable groups, and introduce them in Section 7.1, as well as their corresponding S -adic subshifts. Because the definitions are quite abstract, we present plenty of examples from the one and two dimensional cases of these sequences.

Constant-shape S -adic sequences and ccc groups Next, we focus our attention on a more restrictive type of sequence, namely S -adic sequence where each morphism has uniform support. Groups that admit a decomposition compatible with these sequences are already present in the literature, in the form of ccc groups and congruent monotileable groups. In Section 7.2, we introduce these classes of groups and their corresponding constant-shape S -sequences. We also present examples of these systems on solvable Baumslag-Solitar groups and locally finite groups.

Constant-shape substitutions and monoform groups Finally, we introduce monoform groups in Section 7.3. These groups allow for the iteration of a single constant-shape substitution, effectively generalizing many constructions from [Cab23]. We show many groups are monoform, including groups that admit expanding endomorphisms and free groups. We also provide examples of these constant-shape systems.

The various hierarchical structures are summarized in the following diagram

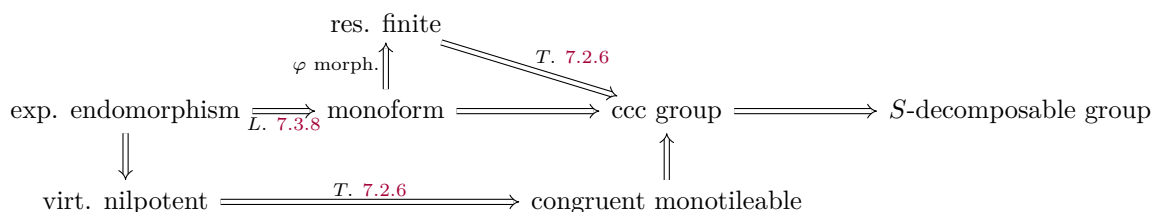

The chapter finishes with some dynamical properties of these systems. We study minimality for general systems, and entropy and unique ergodicity for congruent monotileable groups.

7.1 A general framework for S -adic representations

An S -adic sequence on \mathbb{Z} is a sequence of morphisms $\tau = (\tau_n)_{n \in \mathbb{N}}$ and alphabets $(A_n)_{n \in \mathbb{N}}$ such that for all $n \in \mathbb{N}$ $\tau_n : A_{n+1} \rightarrow A_n^*$. The n -th image of a letter $a \in A_n$ by τ is defined as the composition

$$\tau_{[0,n]}(a) = \tau_0 \circ \tau_1 \circ \dots \circ \tau_{n-1}(a).$$

When composing the morphisms, the order in which images are placed is implicit by the geometry of \mathbb{Z} , that is, the image of ab is given by $\tau_i(a)\tau_i(b)$.

The \mathbb{Z} -subshift associated to τ is given by

$$X_\tau = \{x \in A_0^\mathbb{Z} \mid \forall w \sqsubseteq x, w \sqsubseteq \tau_{[0,n)}(a), \text{ for some } n \in \mathbb{N}, a \in A_n\}.$$

As mentioned in the chapter's introduction, these sequences and their corresponding subshifts have provided many examples of \mathbb{Z} -subshifts with interesting dynamical properties. Due to this reason, we want to generalize S -adic sequences to general groups. In this section we give a general definition for groups that allow a hierarchical decomposition compatible with S -adic sequences. The definition is quite technical and encompasses great generality. We will later provide examples that illustrate the mechanics of the definition.

The main idea is as follows: for each $n \in \mathbb{N}$ we take a finite number of finite subsets, which we call **tiles**. Then, we ask for each tile of level $n+1$ to be partitioned into translates of tiles of level n . The idea is that tiles of level n will be the supports of the images of the n th composition of our S -adic sequence. For this purpose, we also ask for the union over tiles of all levels to be the whole group.

7.1.1 Decomposing infinite countable groups

Definition 7.1.1. We say an infinite countable group G is **S -decomposable** if there exists a sequence of finite sets $(A_n)_{n \in \mathbb{N}}$, and a sequence of finite subsets of G , $(F_{n,a})_{n \in \mathbb{N}, a \in A_n}$, such that

- $F_{0,a} = \{1_G\}$ for all $a \in A_0$,
- (**locally polytileable**) there exist finite subsets $\{C_{n,a,b} \mid n \in \mathbb{N}, a \in A_{n+1}, b \in A_n\}$ of G such that,

$$F_{n+1,a} = \prod_{b \in A_n} \prod_{c \in C_{n,a,b}} cF_{n,b},$$

- (**centered**) for all $n \in \mathbb{N}$, and all $a \in A_n$, $1_G \in F_{n,a}$,
- (**exhaustive**) for any sequence $(a_n)_{n \in \mathbb{N}, a_n \in A_n}$, we have that $\bigcup_{n \in \mathbb{N}} F_{n,a_n} = G$.

The sequence $\{C_{n,a,b} \mid n \in \mathbb{N}, a \in A_{n+1}, b \in A_n\}$ will be referred as the **polytiling sequence** associated with $(F_{n,a})_{n \in \mathbb{N}, a \in A_n}$. We allow for $C_{n,a,b}$ to be empty, as will be seen in the examples.

Example 7.1.2. Consider $G = \mathbb{Z}^2$. Let us look at the first three levels of an S -decomposition of \mathbb{Z}^2 . We begin with $A_0 = \{a\}$ and $F_{0,a} = \{(0,0)\}$. Next, for $A_1 = \{a, b\}$ we define $F_{1,a} = \{(0,0), (1,0), (0,1)\}$ and $F_{0,b} = \{(0,0)\}$. Graphically

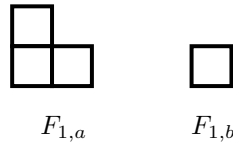

Thus, $C_{0,a,a} = \{(0,0), (1,0), (0,1)\}$ and $C_{0,b,a} = \{(0,0)\}$. For $A_2 = \{a, b, c\}$ we take

- for a : $C_{1,a,a} = \{(0,0)\}$ and $C_{1,a,b} = \{(1,1)\}$,
- for b : $C_{1,b,a} = \{(0,0), (1,1)\}$ and $C_{1,b,b} = \{(0,2), (2,0), (2,2)\}$,
- for c : $C_{1,c,a} = \emptyset$ and $C_{1,c,b} = \{(0,0), (1,0)\}$.

This way, the sets $F_{2,a}$, $F_{2,b}$ and $F_{2,c}$ can be seen graphically as

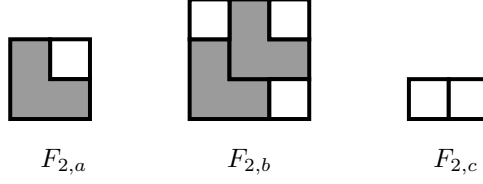

For $A_3 = \{a, b\}$, take $C_{2,a,a} = C_{2,b,a} = \{(0,1)\}$, $C_{2,a,b} = C_{2,b,b} = \{(2,0)\}$, and $C_{2,a,c} = C_{2,b,c} = \{(0,0)\}$. The tiles $F_{3,a}$ and $F_{3,b}$ are equal and are given by:

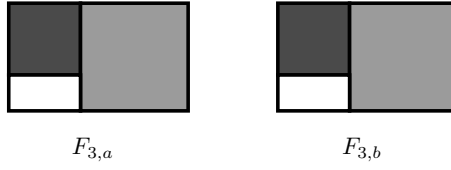

Remark 7.1.3. A S -decomposable group G where $|F_{n,a}|$ have the same cardinality for all $a \in A_n$ is known as a **poly-ccc** group, as introduced by Seward [Sew14, Theorem 6.1]. We look beyond this class of groups as we want the freedom to have different sized supports the elements of our directive sequences. We see this in the next section.

Notice that we partition every level with translates of tiles from any lower level. By induction it is possible to obtain for $j > i$ and $a \in A_j$,

$$F_{j,a} = \prod_{b_{j-1} \in A_{j-1}} \prod_{b_{j-2} \in A_{j-2}} \cdots \prod_{b_i \in A_i} C_{j-1,a,b_{j-1}} \cdot C_{j-2,b_{j-1},b_{j-2}} \cdot \cdots \cdot C_{i,b_{i+1},b_i} F_{i,b_i}.$$

To alleviate the notation, for $a \in A_j$ and $b \in A_i$ we write

$$\mathcal{C}_{[i,j]}(a,b) = \prod_{(b_{j-1}, \dots, b_{i+1}) \in A_{j-1} \times \cdots \times A_{i+1}} C_{j-1,a,b_{j-1}} \cdot C_{j-2,b_{j-1},b_{j-2}} \cdot \cdots \cdot C_{i,b_{i+1},b_i}.$$

This way, the previous identity becomes

$$F_{j,a} = \prod_{b \in A_i} \mathcal{C}_{[i,j]}(a,b) F_{i,b}.$$

Lemma 7.1.4. Let G be a countable group and $\{F_{n,a}\}_{n \in \mathbb{N}, a \in A_n}$ be an exhaustive locally polytileable sequence of G . Then, for every $n \in \mathbb{N}$, $\{F_{n,a}\}_{a \in A_n}$ partitions G by translates, where the set of translates is given by

$$\hat{C}_{n,a} = \bigcup_{m \geq n} \bigcup_{b \in A_m} \mathcal{C}_{[n,m]}(b,a).$$

Proof. Note that for any $m > n \in \mathbb{N}$ and $a \in A_m$, we have that

$$F_{m,b} = \prod_{c \in \mathcal{C}_{[m,n]}(b,a)} c F_{n,a},$$

for all $b \in A_m$. We then conclude by the exhaustiveness of locally polytileable sequence. \square

The generality of this definition allows us to capture a wide range of countable groups.

Theorem 7.1.5 (Theorem 6.1 [Sew14]). *Every finitely generated group is poly-ccc, and therefore S -decomposable.*

In Section 7.2 we look at examples of S -decomposable groups that are not finitely generated.

7.1.2 S -adic systems

Now, we proceed to define S -adic subshifts for countable groups.

Definition 7.1.6. Let G be an S -decomposable group, with $(F_{n,a})_{n \in \mathbb{N}, a \in A_n}$ a decomposition. A **directive sequence** $\tau = (\tau_n)_{n \in \mathbb{N}}$ is a sequence of substitutions $\tau_n : A_{n+1} \rightarrow A_n^{*G}$ such that for any $a \in A_n$,

$$\text{supp}(\tau_n(a)) = \coprod_{b \in A_n} C_{n,a,b},$$

and for any $c \in C_{n,a,b}$, $\tau_n(a)|_c = b$.

Intuitively, $C_{n,a,b}$ is the set of positions on which we find the letter b in the image of a through τ_n . Therefore, the family of sets $\{C_{n,a,b} \mid n \in \mathbb{N}, a \in A_{n+1}, b \in A_n\}$ completely determines the directive sequence.

We always assume that for any $n \in \mathbb{N}$ and $a \in A_{n+1}$, $1_G \in \text{supp}(\tau_n(a))$. For two indices $0 \leq i \leq j$, we denote by $\tau_{[i,j]}$ the concatenation of substitutions $\tau_i \circ \tau_{i+1} \circ \cdots \circ \tau_{j-1} : A_j \rightarrow A_i^{*G}$. Since for any $a \in A_1$, we have

$$F_{1,a} = \coprod_{b \in A_0} C_{0,a,b},$$

by induction we have that for any $n \geq 1$ and $a \in A_{n+1}$, $\text{supp}(\tau_{[0,n]}(a)) = F_{n+1,a}$.

The **language of a directive sequence** is defined as the collection of all the patterns occurring in $\tau_{[0,n]}(a)$, for some $n \in \mathbb{N}$ and $a \in A_n$, i.e.,

$$\mathcal{L}(\tau) = \{\mathfrak{p} \in A_0^{*G} \mid \mathfrak{p} \sqsubseteq \tau_{[0,n]}(a) \text{ for some } a \in A_n \text{ and } n \in \mathbb{N}\}.$$

With the language, we define the **G -subshift associated to a directive sequence τ** , denoted X_τ , as the subshift in A_0^G generated by the language $\mathcal{L}(\tau)$, that is,

$$X_\tau = \{x \in A_0^G \mid \forall u \sqsubseteq x, u \in \mathcal{L}(\tau)\}.$$

Remark 7.1.7. The concatenation $\tau_{[0,n]}$ can be extended from A_n to configurations from the full-shift A_n^G . Recall from Lemma 7.1.4 that each level of tiles $F_{n,a}$ partitions G . Specifically, for each $g \in G$ there exists a unique $c \in \hat{C}_n$, $a \in A_n$ and $f \in F_{n,a}$ such that $g = cf$. With this decomposition, the image of a configuration $x \in A_n^G$ is defined as

$$\tau_{[0,n]}(x)(cf) = \tau_{[0,n]}(x(c))(f).$$

With this extension we can defined the limit set,

$$\bigcap_{n \in \mathbb{N}} \tau_{[0,n]}(A_n^G).$$

This set is always contained in X_τ , but its closure in both the dynamical and topological sense usually differ from X_τ . This happens even in the one-dimensional case (see [Ber+19]).

To get a better understanding on the mechanics of S -decomposable groups and their directive sequences work, let us look at classic examples of substitutive and S -adic systems.

Example 7.1.8. The **Fibonacci substitution** is defined by

$$\sigma_F : \begin{array}{l} a \mapsto ab \\ b \mapsto a \end{array},$$

It is an example of a non-constant length substitution. Using the previously defined formalism, the decomposition for the directive sequence associated to iterations of σ_F is given by

- For a : $C_{n,a,a} = \{0\}$, $C_{n,a,b} = \{\mathbf{f}_{n+1}\}$, and $F_{n,a} = \{0, \dots, \mathbf{f}_{n+1} - 1\}$,
- For b : $C_{n,b,a} = \{0\}$, $C_{n,b,b} = \emptyset$, and $F_{n,b} = \{0, \dots, \mathbf{f}_n - 1\}$,

where \mathbf{f}_n is the n th number of the Fibonacci sequence starting with $\mathbf{f}_0 = \mathbf{f}_1 = 1$. Then, the directive sequence τ_F is given by substitutions τ_n such that $\text{supp}(\tau_n(a)) = \{0, \mathbf{f}_n\}$ and $\text{supp}(\tau_n(b)) = \{0\}$ where

$$\tau_n(a)(0) = a, \quad \tau_n(a)(\mathbf{f}_n) = b, \quad \text{and} \quad \tau_n(b)(0) = a.$$

This way, $\tau_{[0,n)} = \sigma_F^n$.

When working with one-dimensional substitutions it is not necessary to explicitly give the placement of each letter, as is done by the sets $C_{n,a,b}$. This is because the concatenation of images is implicit. This is no longer the case when working with multi-dimensional substitution that are not constant-shape. In these cases, either the placement of each image has to be specified by the sets $C_{n,a,b}$, or a rule that specifies how to concatenate the differently shaped supports have to be given. These are known as **concatenation rules**, and were introduced by Jolivet and Kari [JK12].

Example 7.1.9. Let σ_{F^2} be the two-dimensional substitution given by

$$\sigma_{F^2} : \left\{ \begin{array}{l} \square \mapsto \begin{array}{|c|c|} \hline \text{orange} & \text{blue} \\ \hline \text{white} & \text{red} \\ \hline \end{array} \\ \text{orange} \mapsto \begin{array}{|c|c|} \hline \text{white} & \text{red} \\ \hline \end{array} \\ \text{red} \mapsto \begin{array}{|c|} \hline \text{orange} \\ \hline \text{white} \\ \hline \end{array} \\ \text{blue} \mapsto \begin{array}{|c|} \hline \text{white} \\ \hline \end{array} \end{array} \right.$$

This substitution is known as the **Fibonacci direct product** substitution. Its concatenation rules are:

$$\begin{array}{cc} \begin{array}{|c|} \hline \text{orange} \\ \hline \text{white} \\ \hline \end{array} \mapsto \begin{array}{|c|c|} \hline \text{white} & \text{red} \\ \hline \text{orange} & \text{blue} \\ \hline \text{white} & \text{red} \\ \hline \end{array} & \begin{array}{|c|c|} \hline \text{white} & \text{red} \\ \hline \end{array} \mapsto \begin{array}{|c|c|c|} \hline \text{orange} & \text{blue} & \text{orange} \\ \hline \text{white} & \text{red} & \text{white} \\ \hline \end{array} \\ \begin{array}{|c|} \hline \text{blue} \\ \hline \text{red} \\ \hline \end{array} \mapsto \begin{array}{|c|} \hline \text{white} \\ \hline \text{orange} \\ \hline \text{white} \\ \hline \end{array} & \begin{array}{|c|c|} \hline \text{orange} & \text{blue} \\ \hline \end{array} \mapsto \begin{array}{|c|c|c|} \hline \text{orange} & \text{blue} & \text{orange} \\ \hline \text{white} & \text{red} & \text{white} \\ \hline \end{array} \end{array}$$

With our formalism, the sets $C_{n,a,b}$ are as follows:

- For \square : $C_{n,\square,\square} = \{(0, 0)\}$, $C_{n,\square,\text{orange}} = \{(0, \mathbf{f}_{n+1})\}$, $C_{n,\square,\text{blue}} = \{(\mathbf{f}_{n+1}, \mathbf{f}_{n+1})\}$, $C_{n,\square,\text{red}} = \{(\mathbf{f}_{n+1}, 0)\}$.
- For orange : $C_{n,\text{orange},\square} = \{(0, 0)\}$, $C_{n,\text{orange},\text{orange}} = C_{n,\text{orange},\text{blue}} = \emptyset$, $C_{n,\text{orange},\text{red}} = \{(\mathbf{f}_{n+1}, 0)\}$.
- For red : $C_{n,\text{red},\square} = \{(0, 0)\}$, $C_{n,\text{red},\text{orange}} = \{(0, \mathbf{f}_{n+1})\}$, $C_{n,\text{red},\text{blue}} = C_{n,\text{red},\text{red}} = \emptyset$.
- For blue : $C_{n,\text{blue},\square} = \{(0, 0)\}$, $C_{n,\text{blue},\text{orange}} = C_{n,\text{blue},\text{blue}} = C_{n,\text{blue},\text{red}} = \emptyset$.

By Definition 7.1.6 these sets completely determine the directive sequence $(\tau_n)_{n \in \mathbb{N}}$. Figure 7.1 shows an example of the application of the directive sequence.

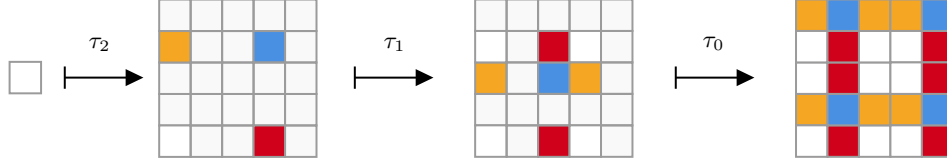

Figure 7.1: Applying the concatenation of elements of the directive sequence, namely $\tau_{[0,3]}$, to \square which generates a pattern of support $F_{3,\square} = \{0, \dots, 5\}^2$.

The problem with concatenation rules is that the resulting substitution may fail to be **consistent**, that is, depending on the sequence of concatenations a letter may have multiple images, or fail to be **non-overlapping**, that is, the image of a pattern may contain more than one letter at a given position. Furthermore, it is undecidable to determine if a substitution is consistent from its set of concatenation rules, and it is also undecidable to determine if a consistent substitution is non-overlapping from its concatenation rules [JK12].

A particular case we are interested in is when every substitution in a directive sequence has the same support. In other words, for each $n \in \mathbb{N}$ there exists C_n such that

$$C_n = \coprod_{b \in A_n} C_{n,a,b},$$

for all $a \in A_{n+1}$. This would imply our substitutions are maps $\tau_n : A_{n+1} \rightarrow A_n^{C_n}$, and for all $a, b \in A_n$, $F_{n,a} = F_{n,b}$.

Example 7.1.10. Take two substitutions, $\sigma_1 : \{a, b\} \rightarrow \{c, d\}^2$ and $\sigma_2 : \{c, d\} \rightarrow \{a, b\}^3$ defined by

$$\sigma_1 : \begin{array}{l} a \mapsto cd \\ b \mapsto dc \end{array}, \quad \sigma_2 : \begin{array}{l} c \mapsto aba \\ d \mapsto bab \end{array}.$$

Let us define a directive sequence $(\tau_n)_{n \in \mathbb{N}}$ that describes the S -adic system generated by alternating these two substitutions, with the final one being σ_2 , such that $\tau_{[0,2k]} = (\sigma_2 \sigma_1)^k$ and $\tau_{[0,2k+1]} = \sigma_2 (\sigma_1 \sigma_2)^k$. For $k \in \mathbb{N}$ define:

- $C_{2k} = \{0, 2^k 3^k, 2^{k+1} 3^k\}$,

$$\tau_{2k}(c)(i) = \begin{cases} a & \text{if } i \in \{0, 2^{k+1} 3^k\} \\ b & \text{if } i = 2^k 3^k \end{cases}, \quad \tau_{2k}(d)(i) = \begin{cases} b & \text{if } i \in \{0, 2^{k+1} 3^k\} \\ a & \text{if } i = 2^k 3^k \end{cases}.$$

- $C_{2k+1} = \{0, 2^k 3^{k+1}\}$ and

$$\tau_{2k+1}(a)(i) = \begin{cases} c & \text{if } i = 0 \\ d & \text{if } i = 2^k 3^{k+1} \end{cases}, \quad \tau_{2k+1}(b)(i) = \begin{cases} c & \text{if } i = 0 \\ a & \text{if } i = 2^k 3^{k+1} \end{cases},$$

This way, the support of the concatenation of the first n levels is independent of the chosen letter. Explicitly, the concatenations are $\tau_{[0,2k]} : \{a, b\} \rightarrow \{a, b\}^{F_{2k}}$ and $\tau_{[0,2k+1]} : \{c, d\} \rightarrow \{a, b\}^{F_{2k+1}}$, where $F_{2k} = \{0, \dots, 2^k 3^k\}$ and $F_{2k+1} = \{0, \dots, 2^k 3^{k+1}\}$. As an example:

$$\begin{array}{cccccccccccccccc} c & \xrightarrow{\tau_2} & a & \text{---} & b & \text{---} & a & \text{---} & \text{---} & \text{---} & \text{---} & \text{---} & \text{---} & \text{---} & \text{---} & \text{---} & \text{---} \\ \xrightarrow{\tau_1} & c & \text{---} & d & \text{---} & d & \text{---} & c & \text{---} & c & \text{---} & d & \text{---} & \text{---} & \text{---} & \text{---} & \text{---} \\ \xrightarrow{\tau_0} & a & b & a & b & a & b & b & a & b & a & b & a & b & a & b & a & b. \end{array}$$

Thus, $\tau_{[0,3]}(c) = abababbababababab = \sigma_2(\sigma_1(\sigma_2(c)))$.

The next section is devoted to groups that allow for such a decompositions permitting the definition of constant shape S -adic sequences.

We can further restrict this type of substitution to allow for a single constant-shape substitution.

Example 7.1.11. The **Thue-Morse substitution** is defined by

$$\sigma_{\text{TM}} : \begin{array}{l} a \mapsto ab \\ b \mapsto ba \end{array}$$

To write the substitutive systems defined by this substitution with our formalism, we define $C_n = \{0, 2^n\}$ and

$$\tau_n(a)(i) = \begin{cases} a & \text{if } i = 0 \\ b & \text{if } i = 2^k \end{cases}, \quad \tau_n(b)(i) = \begin{cases} b & \text{if } i = 0 \\ a & \text{if } i = 2^k \end{cases}.$$

As before, this implies, $\tau_{[0,n]} = \sigma_{\text{TM}}^n$. What is particular about this case is that by defining the function $\varphi(k) = 2k$, we can write $C_n = \varphi^n(C_0)$, where $C_0 = \{0, 1\}$ is a set of coset representatives for $\varphi(\mathbb{Z}) = 2\mathbb{Z}$. Furthermore, this allows us to define our directive sequence by $\tau_n(\cdot)(\varphi(i)) = \sigma_{\text{TM}}(\cdot)(i)$.

As the Thue-Morse example shows, if we find a map $\varphi : G \rightarrow G$ with nice properties we can define constant-shape substitutions. For multidimensional substitutions, this idea was formulated by Cabezas [Cab23].

Example 7.1.12. Take $L \in GL(d, \mathbb{Z})$ of norm $\|L\| > 1$ and $\|L^{-1}\| < 1$, and let $F \subseteq \mathbb{Z}^d$ be a **fundamental domain** for $L(\mathbb{Z}^d)$ such that $0 \in F$. That is, F is a finite set such that $L(\mathbb{Z}^d) + F = \mathbb{Z}^d$. Given a finite alphabet A , a constant-shape substitution ζ with respect to L and F is a map $\zeta : A \rightarrow A^F$ (see Figure 7.2).

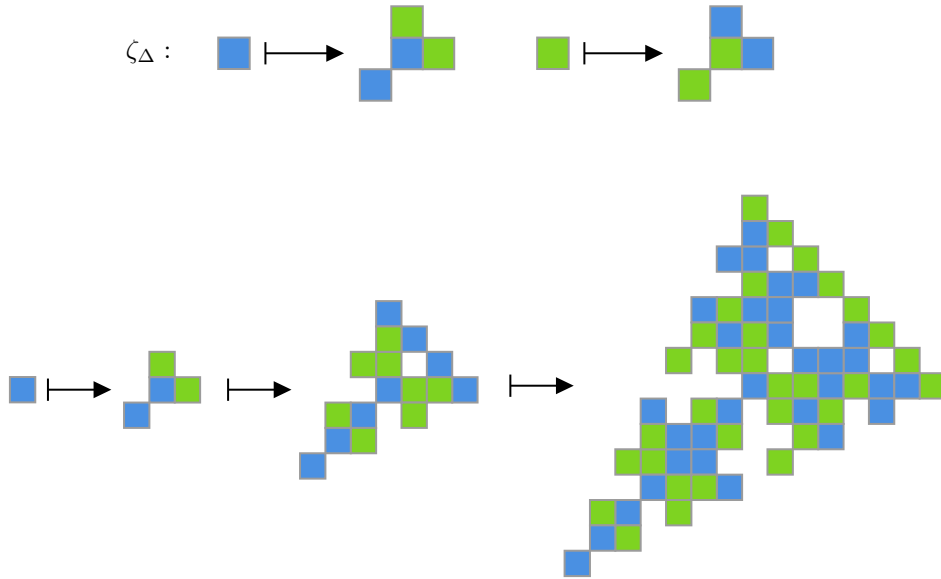

Figure 7.2: An example of a two-dimensional constant-shape substitution with map $L = 2I$, where I is the identity matrix, and fundamental domain is $F = \{(0, 0), (1, 0), (0, 1), (-1, -1)\}$. This substitution is known as the **triangular Thue-Morse substitution**.

The iterates of this substitution are given by $\zeta^n : A \rightarrow A^{F_n}$, where $F_1 = F$ and $F_n = L(F_{n-1}) + F_1$. For any given $v \in F_n$, we can decompose $v = L(w) + u$ with $w \in F_{n-1}$ and $u \in F_1$, and define:

$$\zeta^n(a)_{L(w)+u} = \zeta(\zeta^{n-1}(a)_w)_u.$$

If we take $C_n = L^n(F)$ and substitutions $\tau_n(\cdot)(L(v)) = \zeta(\cdot)(v)$, the directive sequence $(\tau_n)_{n \in \mathbb{N}}$ is the same as the substitutive system generated by ζ . In other words, $\tau_{[0,n)} = \zeta^n$.

In Section 7.3 we study the class of groups that allow for the definition of constant-shape substitutions.

7.2 Constant-shape S -adic representations

Let us add constraints on the decomposition of groups to allow for more rigid types of S -adic systems. Our goal is to define such systems where the support of each substitution on our directive sequence is uniform, as we saw in Example 7.1.10.

With this goal in mind, we begin by looking at some notions of group tileability already present in the literature. These notions have been used in the study of hyperfinite relations [GJS16] and realizations of Choquet simplices as invariant probability measures of minimal subshifts [CC19; CCG23].

7.2.1 Group tileability

Definition 7.2.1. Let F and E be two subsets of a group G . We say that F is a (left) **monotile** for E if there exists a subset $C \subseteq G$, with $|C| > 1$, such that $\{cF \mid c \in C\}$ is a partition of E .

This notion was originally introduced in [Wei01] due to its relationship to the Rokhlin Lemma from measurable dynamics [OW80]. For our purposes, we need the following definitions.

Definition 7.2.2. Let G be a countable group. A sequence of sets $(F_n)_{n \in \mathbb{N}}$ is said to be **locally monotileable** if $F_0 = \{1_G\}$ and F_n is a monotile for F_{n+1} for all $n \in \mathbb{N}$.

If $(F_n)_{n \in \mathbb{N}}$ is a locally monotileable sequence, for every level $n \in \mathbb{N}$, we denote C_n the set of translates that partition F_{n+1} into translated copies of F_n , that is, $F_{n+1} = \coprod_{c \in C_n} cF_n$. The sequence $(C_n)_{n \in \mathbb{N}}$ will be referred to as the **tiling sequence** associated to $(F_n)_{n \in \mathbb{N}}$.

Definition 7.2.3. Let G be a countable group and $(F_n)_{n \in \mathbb{N}}$ be a locally monotileable sequence of finite subsets of G . We say that the sequence is

- **congruent** if $1_G \in C_n$ for each $n \in \mathbb{N}$,
- **exhaustive** if $G = \bigcup_{n \in \mathbb{N}} F_n$.

Note that a congruent sequence $(F_n)_{n \in \mathbb{N}}$ is increasing, that is, $F_n \subseteq F_{n+1}$ for every $n \in \mathbb{N}$, and moreover $C_n \subseteq C_{n+1}$ for every $n \in \mathbb{N}$. The converse is not true in general (see [Dik+22, Example 3.4]).

Definition 7.2.4. Let G be a countable group, we say that G is

- **locally monotileable** if it admits a locally monotileable sequence,
- **ccc group** if it admits an exhaustive congruent locally monotileable sequence,
- **congruent monotileable** if it is amenable and ccc group, where the locally monotileable sequence is a right Følner sequence.

Remark 7.2.5. The notion of ccc groups was originally introduced by Gao, Jackson and Seward with a different, nonetheless equivalent, definition (see [GJS16, Lemma 4.3.1]). In fact, the name comes from their notions of **coherent**, **cofinal** and **centered** tiling sequences, which roughly correspond to the notions of locally monotileable, exhaustive and congruent respectively.

Many natural classes of groups admit such hierarchical structures, but it is not known whether all countable groups are ccc (or if all amenable groups are congruent monotileable).

Theorem 7.2.6. *The following groups are ccc groups (and congruent monotileable if they are amenable).*

- residually finite groups [GJS16; CP14],
- locally finite groups [GJS16; Dik+22],
- virtually nilpotent groups [GJS16; CC19],
- solvable groups with a polycyclic commutator [GJS16].

In addition, ccc groups are closed under free sums, direct sums and direct products. Furthermore, virtually ccc groups are also ccc groups.

The following result corresponds to the evolution of the tiling sequence for a locally monotileable sequence. The proof is straightforward, but we include it for the sake of completeness.

Lemma 7.2.7. *Let G be a ccc group with the sequence $(F_n)_{n \in \mathbb{N}}$ of congruent left monotiles. Then, for every $m > n \in \mathbb{N}$, the collection $\{c_{m-1} \cdots c_n F_n \mid c_i \in C_i, \text{ for every } n \leq i < m\}$ is a partition of F_m . Furthermore, $\{cF_n \mid c \in \hat{C}_n\}$ partitions G where,*

$$\hat{C}_n = \bigcup_{m \geq n} C_{m-1} \cdots C_n.$$

Proof. The first statement follows from a direct induction. For the second statement, take $g \in G$. By exhaustivity, there exists $M \in \mathbb{N}$ such that for all $m \geq M$, $g \in F_m$. In particular, if we take the smallest such m that is also greater than n , we have $F_m = C_{m-1} \cdots C_n F_n$. Then, there exist $c \in C_{m-1} \cdots C_n \subseteq \hat{C}_n$ and $f \in F_n$ such that $g = cf$. Thus $G = \hat{C}_n F_n$. To see that it is a partition, take $c_1, c_2 \in \hat{C}_n$. There exist $m_1, m_2 \in \mathbb{N}$ such that $c_i \in C_{m_i-1} \cdots C_n$ for $i = 1, 2$. Take $m \geq \max\{m_1, m_2\}$. As F_m is partitioned by cF_n with $c \in C_{m-1} \cdots C_n$ and $c_1, c_2 \in C_{m-1} \cdots C_n$, we have that $c_1 F_n \cap c_2 F_n = \emptyset$. \square

Furthermore, when working with countable amenable groups the notion of local monotileability coincides with the existing one of congruent monotileability when working with Følner sequences, i.e, for amenable groups, from a locally monotileable Følner sequence $(F_n)_{n \in \mathbb{N}}$, we can obtain another locally monotileable Følner sequence $(H_n)_{n \in \mathbb{N}}$ that is congruent and exhaustive, as shown by Dikranjan et al. [Dik+22, Proposition 3.14].

7.2.2 Constant-shape S -adic systems on ccc groups

Let G be a ccc group with associated decomposition $(F_n)_{n \in \mathbb{N}}$ and tiling sequence $(C_n)_{n \in \mathbb{N}}$. A **constant-shape directive sequence** $\tau = (\tau_n)_{n \in \mathbb{N}}$ is a sequence of substitutions $\tau_n : A_{n+1} \rightarrow A_n^{C_n}$, where $(A_n)_{n \in \mathbb{N}}$ is a sequence of finite alphabets.

As we defined in Section 7.1.2, the language associated to τ is given by

$$\mathcal{L}(\tau) = \{\mathbf{p} \in A_0^{*G} \mid \mathbf{p} \sqsubseteq \tau_{[0,n]}(a) \text{ for some } a \in A_n \text{ and } n \in \mathbb{N}\}.$$

which in turn defines the associated G -subshift as

$$X_\tau = \{x \in A_0^G \mid \forall u \sqsubseteq x, u \in \mathcal{L}(\tau)\}.$$

Let us look at some examples of these directive sequences.

Solvable Baumslag-Solitar groups

In his master thesis, Silva defined substitutions for solvable Baumslag-Solitar groups [Sil20]. Let us see that his substitutions are particular cases of directive sequences on ccc groups.

Recall that the solvable Baumslag-Solitar groups $BS(1, N)$ are defined by the presentation¹

$$BS(1, N) = \langle \mathbf{a}, \mathbf{t} \mid \mathbf{t}\mathbf{a}\mathbf{t}^{-1} = \mathbf{a}^N \rangle.$$

Being residually finite and amenable, these groups are congruent monotileable (Theorem 7.2.6). Furthermore, the group's decomposition can be made explicit. For $m \in \mathbb{N}$ define,

$$R_m = \{\mathbf{a}^j \mathbf{t}^k \mid 0 \leq j < N^m, 0 \leq k < m\}.$$

Lemma 7.2.8 ([Sil20]). *The sequence of finite sets $(R_m)_{m \in \mathbb{N}}$ is a Følner sequence for $BS(1, N)$.*

To decompose the group, we will use $F_n = R_{2^{n-1}m}$ for some fixed $m \geq 1$, where $F_0 = \{1_G\}$ and $C_0 = R_m$. The corresponding tiling sequence is defined as the set

$$C_n = \left\{ \mathbf{a}^{iN^{2^{n-1}m}} \mid 0 \leq i < N^{2^{n-1}m} \right\} \cup \left\{ \prod_{k=1}^{2^{n-1}m} \mathbf{a}^{i_k} \mathbf{t} \mid 0 \leq i_1, \dots, i_{2^{n-1}m} < N \right\}.$$

A straightforward calculation shows $F_{n+1} = C_n F_n$ (see [Sil20, Proposition 3.5]).

Silva's definition for a substitution consists in taking a map $\sigma : A \rightarrow A^{R_m}$ and defining its iterations $\sigma^{n+1} : A \rightarrow A^{F_{n+1}}$ by

$$\sigma^{n+1}(a)(g) = \begin{cases} \sigma^n(\sigma^n(a)(\mathbf{a}^i))(f) & \text{if } g = \mathbf{a}^{iN^{2^{n-1}m}} f, \\ \sigma^n\left(\sigma^n(a)\left(\left(\prod_{k=1}^{2^{n-1}m} \mathbf{a}^{i_k} \mathbf{t}\right) \mathbf{t}^{-1}\right)\right)(f) & \text{if } g = \left(\prod_{k=1}^{2^{n-1}m} \mathbf{a}^{i_k} \mathbf{t}\right) f, \end{cases}$$

where $f \in F_n$. Using our formulation, we obtain the same substitutive system through the directive sequence:

$$\tau_n(a)(g) = \begin{cases} \tau_{[0,n)}(a)(\mathbf{a}^i) & \text{if } g = \mathbf{a}^{iN^{2^{n-1}m}}, \\ \tau_{[0,n)}(a)\left(\left(\prod_{k=1}^{2^{n-1}m} \mathbf{a}^{i_k} \mathbf{t}\right) \mathbf{t}^{-1}\right) & \text{if } g = \prod_{k=1}^{2^{n-1}m} \mathbf{a}^{i_k} \mathbf{t}, \end{cases}$$

with $\tau_0 = \sigma$. This results in the equality $\tau_{[0,n)} = \sigma^n$.

Example 7.2.9. Take the group $BS(1, 2)$ and the substitution σ with support

$$R_2 = \{1_{BS(1,2)}, \mathbf{a}, \mathbf{a}^2, \mathbf{a}^3, \mathbf{t}, \mathbf{t}\mathbf{a}, \mathbf{a}\mathbf{t}, \mathbf{a}\mathbf{t}\mathbf{a}\},$$

given by,

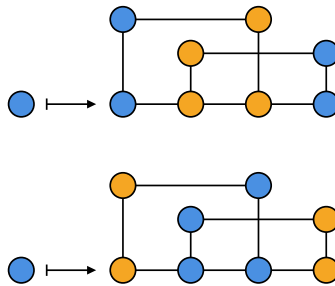

¹The attentive reader will note that this is not exactly the same presentation as the one in Chapter 6. We use this alternative presentation, where the relation begins with \mathbf{t} instead of \mathbf{t}^{-1} , to simplify what follows.

We denote the corresponding directive sequence by $(\tau_n)_{n \in \mathbb{N}}$. The composition $\tau_{[0,2]}$ of support $F_2 = R_4$ is depicted in Figure 7.3. Its application begins with τ_1 , which has support $C_1 = \{1_{BS(1,2)}, \mathbf{a}^4, \mathbf{a}^8, \mathbf{a}^{12}, \mathbf{t}^2, \mathbf{tat}, \mathbf{at}^2, (\mathbf{at})^2\}$, and then $\tau_0 = \sigma$ on each point from C_1 .

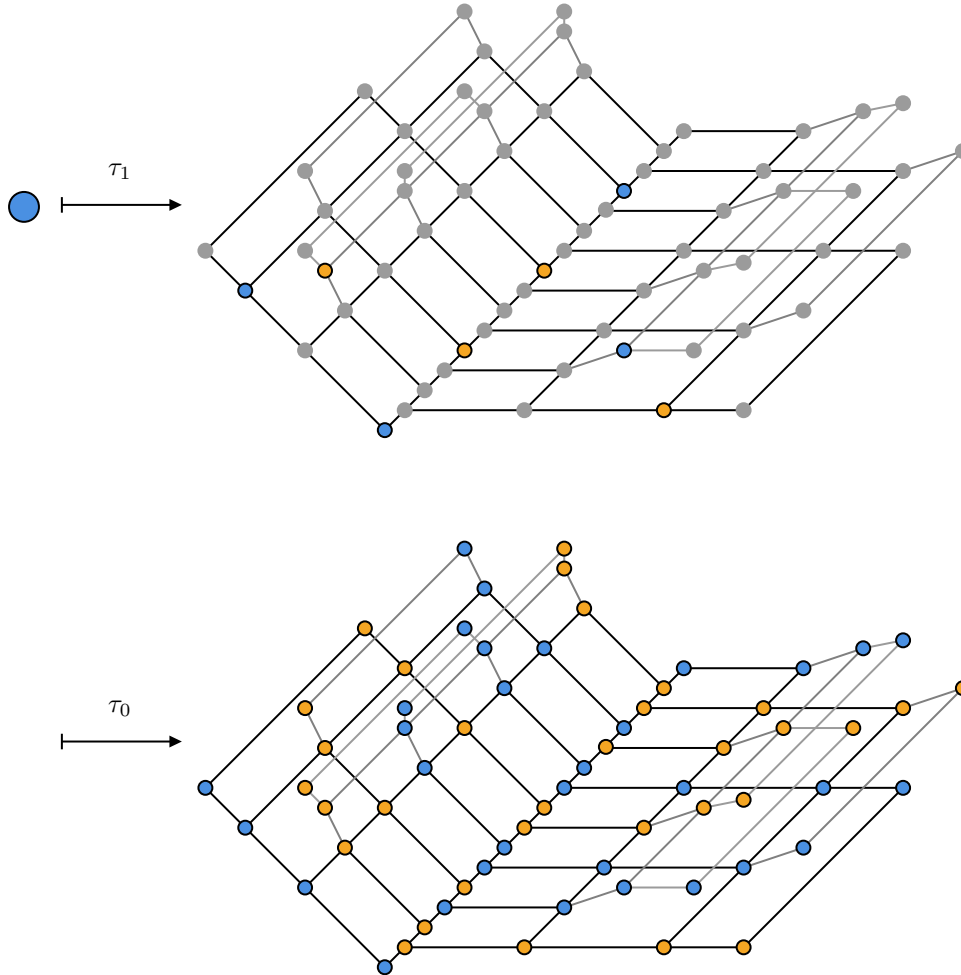

Figure 7.3: A depiction of the application of $\tau_{[0,2]}$ on the Cayley graph of $BS(1,2)$. It begins by applying τ_1 , which has support C_1 , and then applying $\tau_0 = \sigma$ to each point on C_1 . This implies leaves a support of $F_2 = R_4$.

Locally finite groups

An important class of congruent monotileable groups is the class of locally finite groups. A group is said to be **locally finite** if the subgroup generated by any finite subset is finite. Notice that any locally finite finitely generated group is finite.

Let G be a countable infinite locally finite group. We enumerate its elements by $G = \{g_0, g_1, g_2, \dots\}$ where $g_0 = 1_G$. If we take the finite subgroups $F_n = \langle g_1, \dots, g_n \rangle$ we obtain a locally monotileable, exhaustive, congruent Følner sequence.

Example 7.2.10. Consider the locally finite group $G = \mathbb{Q}/\mathbb{Z}$. For $n \in \mathbb{N}$, we define $m(n) = \text{lcm}(2, \dots, n)$ and

$d(n) = m(n)/m(n+1) \in \mathbb{N}$. Our tiles are

$$F_n = \left\langle \frac{1}{2}, \dots, \frac{1}{m(n)} \right\rangle = \left\langle \frac{1}{m(n)} \right\rangle = \left\{ \frac{k}{m(n)} \mid 0 \leq k < m(n) \right\},$$

with $F_0 = \{0\}$. The associated tiling sequence $(C_n)_{n \in \mathbb{N}}$ is

$$C_n = \left\{ \frac{j}{m(n+1)} \mid 0 \leq j < d(n) \right\}.$$

Thus, $(F_n)_{n \in \mathbb{N}}$ is a locally monotileable, exhaustive, centered Følner sequence. Consider the substitutions $\tau_0 : \{a, b\} \rightarrow \{a, b\}^{C_0}$ and $\tau_1 : \{a, b\} \rightarrow \{a, b\}^{C_1}$ defined by

$$\begin{array}{ll} \tau_0(a) = \begin{array}{c} a \qquad b \\ | \qquad | \\ \hline 0 \qquad \frac{1}{2} \end{array} \quad & \tau_1(a) = \begin{array}{c} a \qquad b \qquad b \\ | \qquad | \qquad | \\ \hline 0 \qquad \frac{1}{6} \qquad \frac{1}{3} \qquad \frac{1}{2} \qquad \frac{2}{3} \qquad \frac{5}{6} \end{array} \\ \tau_0(b) = \begin{array}{c} b \qquad a \\ | \qquad | \\ \hline 0 \qquad \frac{1}{2} \end{array} \quad & \tau_1(b) = \begin{array}{c} b \qquad a \qquad a \\ | \qquad | \qquad | \\ \hline 0 \qquad \frac{1}{6} \qquad \frac{1}{3} \qquad \frac{1}{2} \qquad \frac{2}{3} \qquad \frac{5}{6} \end{array} \end{array}$$

Then, the application of $\tau_{[0,2]} : \{a, b\} \rightarrow \{a, b\}^{F_2}$ on a is given by

$$\begin{array}{l} a \xrightarrow{\tau_1} \begin{array}{c} a \qquad b \qquad b \\ | \qquad | \qquad | \\ \hline 0 \qquad \frac{1}{6} \qquad \frac{1}{3} \qquad \frac{1}{2} \qquad \frac{2}{3} \qquad \frac{5}{6} \end{array} \\ \xrightarrow{\tau_0} \begin{array}{c} a \qquad b \qquad b \qquad b \qquad a \qquad a \\ | \qquad | \qquad | \qquad | \qquad | \qquad | \\ \hline 0 \qquad \frac{1}{6} \qquad \frac{1}{3} \qquad \frac{1}{2} \qquad \frac{2}{3} \qquad \frac{5}{6} \end{array} \end{array}$$

In the next section we look at more examples of ccc groups, where the substitutive systems are even more rigid.

7.3 Constant-shape substitutions for groups

7.3.1 Monoform groups

In this section, we introduce the notion of monoform groups. Monoform groups are locally monotileable groups, where the tiling sequence is defined through the iteration of a map from the group to itself.

Definition 7.3.1. We say that a countable group G is **monoform** with a **localization map** φ and $F_1 \subseteq G$ such that $1_G \in F_1$, if $\varphi : G \rightarrow G$ is an injective map with $\varphi(1_G) = 1_G$ such that

1. The sets F_n defined as the union of disjoint sets $\{\varphi^n(f)F_{n-1} : f \in F_1\}$ for every $n \in \mathbb{N}$, form an exhaustive locally monotileable sequence of finite sets.
2. For any $n \in \mathbb{N}$, and $g_0, \dots, g_{n-1} \in F_1$, we have that

$$\varphi(\varphi^{n-1}(g_{n-1}) \dots \varphi(g_1)g_0) = \varphi^n(g_{n-1}) \dots \varphi^2(g_1)\varphi(g_0).$$

Monoform groups are ccc groups: they are decomposed by the sequence $(F_n)_{n \in \mathbb{N}}$, where $F_0 = \{1_G\}$ whose associated tiling sequence is $C_n = \varphi^n(F_1)$, for every $n \in \mathbb{N}$. Since 1_G is in F_1 , the sequence is congruent.

Note that, condition 2 and exhaustiveness imply that for every $n \in \mathbb{N}$, $G = \varphi^n(G)F_n$. Indeed, if for an element $g \in G$ there exists n such that $g \in F_n$. By Lemma 7.2.7, there exists $f_0, f_1, \dots, f_{n-1} \in F_1$ such that $g = \varphi^{n-1}(f_{n-1}) \cdots \varphi(f_1)f_0$. In particular $g = \varphi(h)f_0$ for some $h \in G$. A direct induction proves it for every $n \in \mathbb{N}$.

Remark 7.3.2. Note that the intersection of all $\varphi^n(G)$ is trivial. Indeed, if $g \neq 1_G$ is in the intersection, there exists a sequence $(g_n)_{n \in \mathbb{N}}$ such that $g = \varphi^n(g_n)$ for every $n \in \mathbb{N}$. By exhaustiveness, for any $n \in \mathbb{N}$, there exists $m(n) \in \mathbb{N}$ such that $g, g_n \in F_{m(n)}$. This implies the existence of two sets of elements $f_0, f_1, \dots, f_{m-1} \in F_1$ and $g_{n,0}, g_{n,1}, \dots, g_{n,m(n)-1} \in F_1$ such that $g = \varphi^{m(n)-1}(f_{m(n)-1}) \cdots \varphi(f_1)f_0$ and $g_n = \varphi^{m(n)-1}(g_{n,m(n)-1}) \cdots \varphi(g_{n,1})g_{n,0}$. Since $g = \varphi^n(g_n)$, we have

$$\begin{aligned} g &= \varphi^{m(n)-1}(f_{m(n)-1}) \cdots \varphi(f_1)f_0, \\ &= \varphi^{m(n)+n-1}(g_{n,m(n)}) \cdots \varphi^{m(n)}(g_{n,1})\varphi^{m(n)-1}(g_{n,0}). \end{aligned}$$

The last one corresponds to the representation of g in $F_{m(n)+n-1}$. Since these representations are unique, we conclude that $f_0 = f_1 = \dots = f_{m(n)-1} = 1_G$, i.e., $g = 1_G$.

The map $\varphi : G \rightarrow G$ cannot have periodic points other than identity. Furthermore, since φ is injective and

$$F_2 = \coprod_{f \in F_1} \varphi(f)F_1,$$

then $|F_2|$ is equal to $|F_1|^2$. In fact, for every $n \in \mathbb{N}$, we have that $|F_n| = |F_1|^n$. In particular, non-trivial finite groups are not monoform.

Furthermore, if $\varphi : G \rightarrow G$ is a group endomorphism, then the property of having an exhaustive sequence of finite sets $(F_n)_{n \in \mathbb{N}}$ such that $\{\varphi^n(f)F_n : f \in F_1\}$ partitions F_{n+1} , implies that the endomorphism must be injective. Indeed, if $\varphi(g) = \varphi(h)$, then $\varphi(g)1_G = \varphi(h)1_G$, which implies $\{\varphi(f)F_1 : f \in G\}$ is not a partition of G . Along with Remark 7.3.2, this is a proof for the following proposition.

Proposition 7.3.3. *If G is a monoform group with $\varphi : G \rightarrow G$ being an endomorphism, then G is residually finite.*

In this particular case, for every $n \in \mathbb{N}$ the set F_n is a set of representatives of right cosets of $\varphi^n(G)$. Furthermore, $\varphi(G) \simeq G$ which means the group is scalable (see Definition 2.4.6), and because the intersection of the successive iterations $\varphi^n(G)$ is trivial, these groups are **strongly scale invariant** as defined by Nekrashevych and Pete [NP11].

Nevertheless, not all monoform groups are residually finite, as shown in the next example.

Example 7.3.4 (A non-residually finite monoform group). Consider the 2-Prüfer group given by

$$G = \mathbb{Z}[\frac{1}{2}]/\mathbb{Z} = \bigcup_{n \geq 0} \left\{ \frac{k}{2^n} : 0 \leq k \leq 2^n - 1 \right\}.$$

Since G is divisible, that is, for every $g \in G$ there exist $h \in G$ and $n \in \mathbb{N}$ such that $h^n = g$, it is not residually finite [CC10, Proposition 2.1.8]. Nevertheless, G is monoform. Indeed, consider the map

$$\begin{aligned} \varphi : G &\rightarrow G \\ g &\mapsto \frac{g}{2}. \end{aligned}$$

It is clear that $\varphi(G)$ is not a subgroup of G . Take $F_1 = \{0, 1/2\}$. A straightforward computation shows condition 2 from Definition 7.3.5 is satisfied, and for every $n \in \mathbb{N}$,

$$F_n = \left\{ \frac{k}{2^n} : 0 \leq k \leq 2^n - 1 \right\},$$

so $\bigcup_{n \in \mathbb{N}} F_n = G$, $\{\varphi^n(f)F_n : f \in F_1\}$ is a partition of F_{n+1} and $\{\varphi^n(g)F_n : g \in G\}$ is a partition of G .

One of the main tools to find monoform groups in finitely generated groups are expansive endomorphisms.

Definition 7.3.5. We say that a finitely generated group G **admits an expanding endomorphism** if there exists a finite generating set S , an endomorphism $\varphi : G \rightarrow G$ and $\lambda > 1$ such that $[G : \varphi(G)] < +\infty$ and for all $g \in G$

$$d_S(1_G, \varphi(g)) \geq \lambda \cdot d_S(1_G, g).$$

Notice that such an endomorphism must be injective and satisfies $\bigcap_{n \in \mathbb{N}} \varphi^n(G) = \{1_G\}$, so the group is residually finite. If we take a set F of left coset representatives of $\varphi(G)$ containing 1_G , we can define the sequence $F_n = \varphi^n(F)F_{n-1}$, for any $n \geq 1$ with $F_0 = \{1_G\}$ and $F_1 = F$. Thus, F_n is a set of left coset representatives for $\varphi^n(G)$ and F_n partitions F_{n+1} . However, this sequence is not necessarily exhaustive. Nevertheless, up to multiplying by a finite set and taking its images under power of the endomorphism φ , they cover the group. This property is explained in the following proposition. It is similar to the notion of remainder in numeration theory and will be technically useful, and the proof is inspired by the Euclidean Division Algorithm.

Proposition 7.3.6. *Let G be a finitely generated group that admits an expanding endomorphism φ . Then, the set K_φ given by*

$$K_\varphi = \{g \in G : \exists m \in \mathbb{N}, g = \varphi^m(g)f, f \in F_m\}$$

is finite and $G = \bigcup_{n \in \mathbb{N}} \varphi^n(K_\varphi)F_n$.

Proof. Let S be a finite generating set for G . For every $g \in G$, we have that $g = \varphi(g_0)f_0$ for some $g_0 \in G$, $f_0 \in F$. Then, we recursively define the sequence $g_n = \varphi(g_{n+1})f_{n+1}$ for some $g_{n+1} \in G$ and $f_{n+1} \in F$. Now, note that

$$\begin{aligned} \|g_{n+1}\|_S &\leq \frac{1}{\lambda} \|\varphi(g_{n+1})\|_S = \frac{1}{\lambda} \|g_n f_{n+1}^{-1}\|_S, \\ &\leq \frac{1}{\lambda} (\|f_{n+1}^{-1}\|_S + d_S(f_{n+1}^{-1}, g_n f_{n+1}^{-1})), \\ &= \frac{1}{\lambda} (\|f_{n+1}^{-1}\|_S + \|g_n\|_S). \end{aligned}$$

By iterating this process, we get that

$$\|g_n\|_S \leq \frac{1}{\lambda^n} \|g\|_S + \frac{\|F\|_S(1 - \lambda^{-n})}{\lambda - 1}. \quad (7.1)$$

Then, for sufficiently large n , $\|g_n\|_S \leq \|F\|_S/(\lambda - 1) + 1$. Since G is finitely generated, the ball of radius $\|F\|_S/(\lambda - 1) + 1$ is finite. Therefore, there is at least one element of the sequence $\{g_n\}_{n \geq 1}$ that repeats. Say $g_n = g_{n+k}$ for some $k, n \geq 1$. Then, $g_n = \varphi^k(g_n)f$ with $f \in F_k$, meaning $g_n \in K_\varphi$. This implies that we can decompose $g = \varphi^n(g_n)f'$ for some $f' \in F_n$ as we were looking for.

Finally, to see that K_φ is finite, take $g \in K_\varphi$ and $k \in \mathbb{N}$ such that $g = \varphi^k(g)f$, with $f \in F_k$. As before, we begin an iterative process defining $g_1 \in G$ by $g = \varphi(g_1)f_1$ and so on. Because φ is injective and F_k is a set of coset representatives for the quotient $G/\varphi^k(G)$, we have that $g = g_{mk}$ for all $m \in \mathbb{N}$. Plugging this into equation (7.1) we obtain for all $m \in \mathbb{N}$,

$$\|g\|_S = \|g_{mk}\|_S \leq \frac{1}{\lambda^{mk}} \|g\|_S + \frac{\|F\|_S(1 - \lambda^{-mk})}{\lambda - 1}.$$

Taking the limit when m goes to infinite, we get that $\|g\|_S \leq \frac{\|F\|_S}{\lambda - 1}$. Thus, K_φ is finite. \square

A group with expanding endomorphism is monoform for the map φ and domain F_1 when $K_\varphi = \{1_G\}$.

Example 7.3.7. Let us look at the affine Coxeter group \tilde{A}_2 from Example 1.3.29. Recall that this group is given by the presentation,

$$\tilde{A}_2 = \langle \mathbf{a}, \mathbf{b}, \mathbf{c} \mid \mathbf{a}^2, \mathbf{b}^2, \mathbf{c}^2, (\mathbf{ab})^3, (\mathbf{bc})^2, (\mathbf{ac})^3 \rangle.$$

This group admits an expanding endomorphism ϕ defined through its action on its generators by $\phi(\mathbf{a}) = \mathbf{aba}$, $\phi(\mathbf{b}) = \mathbf{cac}$ and $\phi(\mathbf{c}) = \mathbf{bcb}$. If we take the set of representatives $F = \{1_{\tilde{A}_2}, \mathbf{a}, \mathbf{b}, \mathbf{c}\}$, it is possible to see that $K_\phi = \{1_{\tilde{A}_2}\}$.

Given an expanding endomorphism φ with a fundamental domain F_1 , there exists a power of φ that has another fundamental domain, which makes the group monoform, as proved in the following result.

Lemma 7.3.8. *Let G be a finitely generated group with an expanding endomorphism $\varphi : G \rightarrow G$ and let F_1 be a fundamental domain of $\varphi(G)$. Then, there exists $k \in \mathbb{N}$ such that G is monoform with φ^k and a fundamental domain of $\varphi^k(G)$ in G .*

To prove this result we need a similar result to [Cab23, Proposition 2.12], which is useful to use sets satisfying particular properties.

Proposition 7.3.9. *Let G be a finitely generated group that admits an expanding endomorphism φ , and F_1 a set of right coset representatives containing 1_G . Take $P \subseteq G$ and $F \subseteq G$ containing F_1 . There exists a set $Q \subseteq G$ such that*

1. $PFQ \subseteq \varphi(Q)F_1$. Furthermore, for any $n > 0$, $\varphi^n(PFQ)F_n \subseteq \varphi^{n+1}(Q)F_n$.
2. The sequence of sets $\{\varphi^n(Q)F_n\}_{n \geq 0}$ is nested.
3. $\|Q\|_S \leq (\|PF\|_S + \|F_1\|_S)/(\lambda_\varphi - 1)$.

Proof. The proof is done by induction. We define two sequences of sets $(P_n)_{n \in \mathbb{N}}, (Q_n)_{n \in \mathbb{N}}$ of G in the following way: Set $P_0 = PF$ and $Q_0 = \{h \in G : \exists g \in P_0, f \in F_1, g = \varphi(h)f\}$. Then, for each $n \geq 0$ we define the sets $P_{n+1} = PFQ_n$ and $Q_{n+1} = \{h \in G : \exists g \in P_{n+1}, f \in F_1, g = \varphi(h)f\}$. Note that, because 1_G belongs to F_1 and thus P and F , $Q_n \subseteq Q_{n+1}$. Now, for $g' \in Q_{n+1}$, there exists $g \in PF$, $h \in Q_n$ and $f \in F_1$ such that $gh = \varphi(g')f$. Since φ is expanding we have that

$$\begin{aligned} \|g'\|_S &\leq \frac{1}{\lambda} \|ghf^{-1}\|_S \\ &\leq \frac{1}{\lambda} (\|PF\|_S + \|Q_n\|_S + \|F_1^{-1}\|_S) \end{aligned}$$

Note that $\|F_1^{-1}\|_S = \|F_1\|_S$, so $\|Q_{n+1}\|_S \leq 1/\lambda (\|PF\|_S + \|Q_n\|_S + \|F_1\|_S)$. This implies that

$$\|Q_n\|_S \leq \frac{\|PF\|_S}{\lambda^n} + \frac{(\|PF\|_S + \|F_1\|_S)(1 - \lambda^{-n})}{\lambda - 1}.$$

Given that λ is greater than 1, the sets $(Q_n)_{n \in \mathbb{N}}$ are bounded. Furthermore, because G is finitely generated, the ball of radius $(\|PF\|_S + \|F_1\|_S)/(\lambda - 1)$ is finite. Coupled with the fact that $\{Q_n\}_{n \in \mathbb{N}}$ is a nested sequence, there exists $m \in \mathbb{N}$ such that $Q_m = Q_n$ for all $n \geq m$. We conclude the proof by choosing $Q = Q_m$. \square

Now, we proceed to prove Lemma 7.3.8.

Proof of Lemma 7.3.8. Let G be a countable group admitting an expanding endomorphism φ and F_1 be a fundamental domain of $\varphi(G)$ in G containing 1_G . Consider the set K_φ given by Lemma 7.3.6. We take an appropriate power $\phi = \varphi^j$ such that

$$K_\varphi = \{g \in G : \exists f \in F_j, g = \phi(g)f\}.$$

Set $P_0 = K_\varphi$ and $Q_0 = K_\varphi K_\varphi^{-1} K_\varphi F_1$. Then, for any $n \geq 1$ we define

$$P_{n+1} = \{t \in G : \exists b \in Q_n, f \in F_1, b = \phi(t)f\},$$

and $Q_{n+1} = K F_1 Q_n Q_n^{-1}$. Note that for any $n \in \mathbb{N}$, $Q_n \subseteq Q_{n+1}$. Using similar arguments from the proof of Proposition 7.3.9 we obtain a finite set P , containing K_φ , such that $K F_1 P P^{-1} \subseteq \phi(P) F_1$.

Consider a power ϕ^n of ϕ such that any element in P are different in F_n , that is, if $t_1 \neq t_2 \in P$ and $t_1 = \phi^n(b_{t_1})f_{t_1}$, $t_2 = \phi^n(b_{t_2})f_{t_2}$, for some $b_{t_1}, b_{t_2} \in P$, then $f_{t_1} \neq f_{t_2}$.

Define $H_0 = \{1_G\}$ and H_1 as the following: for any $t \in P P^{-1}$, we replace $f_t \in F_n$, by $t \in P P^{-1}$. The rest remains the same. We then inductively define for any $m \geq 0$, $H_{m+1} = \varphi^n(H_1)H_m$. Hence, the sequence $(H_m)_{m \geq 0}$ is locally monotileable. We prove that is exhaustive.

Recall that $\bigcup_{k \geq 0} \varphi^{nk}(K_\varphi)F_{nk} = G$. Set $p \geq 0$ and consider $g \in \varphi^{np}(K_\varphi)F_{np}$, i.e., there exists $k \in K_\varphi$ and $f \in F_{np}$ such that $g = \varphi^{np}(k)f$. We can write $f = \varphi^{n(p-1)}(f_{p-1}) \cdots \varphi^n(f_1)f_0$ for some $f_0, f_1, \dots, f_{p-1} \in F_n$. If none of them are of the form f_t for some $t \in P P^{-1}$, then f_0, f_1, \dots, f_{p-1} are in H_1 and we conclude that $g \in \bigcup_{m \geq 0} H_m$. Suppose there exists $0 \leq i < p-1$ such that $f_i = f_t$ for some $t \in P P^{-1}$. Take i minimal that satisfies it. We recall that $f_t = \varphi^n(b_t^{-1})t$, for a unique $t \in P P^{-1}$. Then

$$\begin{aligned} f &= \varphi^{n(p-1)}(f_{p-1}) \cdots \varphi^{n(i+1)}(f_{i+1})\varphi^{ni}(f_i) \cdots \varphi^n(f_1)f_0 \\ &= \varphi^{n(p-1)}(f_{p-1}) \cdots \varphi^{n(i+1)}(f_{i+1}b_t^{-1})\varphi^{ni}(t) \cdots \varphi^n(f_1)f_0 \end{aligned}$$

We note that $f_{i+1}b_t^{-1} \in F_n P^{-1}$. This implies there exists $t_1 \in P$ and $f' \in F_n$ such that $f_{i+1}b_t^{-1} = \varphi^n(t_1)f'$. Then, we have that

$$f = \varphi^{n(p-1)}(f_{p-1}) \cdots \varphi^{n(i+1)}(f_{i+2}t_1)\varphi^{n(i+1)}(f')\varphi^{ni}(t) \cdots \varphi^n(f_1)f_0.$$

If $f' \in H_1$, then we repeat the previous process with $f_{i+2}t_1 \in F_n P$. If not, there exists $t_{f'} \in P P^{-1}$ and $b_{f'} \in A$ such that $f' = \varphi^n(b_{f'}^{-1})t_{f'}$. Hence

$$f = \varphi^{n(p-1)}(f_{p-1}) \cdots \varphi^{n(i+1)}(f_{i+2}t_1 b_{f'}^{-1})\varphi^{n(i+1)}(t_{f'})\varphi^{ni}(t) \cdots \varphi^n(f_1)f_0.$$

Noting that $f_{i+2}t_1 b_{f'}^{-1} \in F_n P P^{-1}$, we can repeat this process until $p-1$ and conclude there exists elements $h_0, h_1, \dots, h_{p-1} \in H_1$, $t_p, b_p \in P$ such that

$$f = \varphi^{np}(b_p t_p^{-1}) \cdots \varphi^n(h_1)h_0.$$

This proves that $g = \varphi^{np}(k)\varphi^{np}(t_p b_p^{-1})\varphi^{n(p-1)}(h_{p-1}) \cdots \varphi^n(h_1)h_0$. Since $kt_p b_p^{-1} \in K P P^{-1}$, there exists $t_{p+1} \in P$ and $g_p \in F_n$ such that $kt_p b_p^{-1} = \varphi^n(t_{p+1})g_p$. If $g_p \in H_1$, we conclude that $g \in H_{p+1}$. If not, there exists $b_{p+1} \in P$ and $t_{p+2} \in P P^{-1}$ such that $g = \varphi^n(b_{p+1}^{-1})t_{p+2}$. Hence

$$g = \varphi^{n(p+1)}(t_{p+1} b_{p+1}^{-1})\varphi^{np}(t_{p+2}) \cdots \varphi^n(h_1)h_0.$$

Since $t_{p+1} b_{p+1}^{-1} \in H_1$, we have that $g \in H_{p+1}$, which implies that G is monoform with $\phi = \varphi^n$ by the sequence of sets $(H_m)_{m \in \mathbb{N}}$. \square

Example 7.3.10. The discrete Heisenberg group of upper triangular 3×3 matrices with 1s in the diagonal, H_3 , given by the presentation

$$H_3 = \langle x, y, z \mid [x, z], [y, z], [x, y]z^{-1} \rangle,$$

admits the expansive endomorphism ϕ defined on the generators as $\phi(x) = x^2$, $\phi(y) = y^2$ and $\phi(z) = z^4$. By the previous lemma, it is monoform.

Although these endomorphisms give us a good control in terms of their tiling sequence, as a consequence of some multiple results [Fra70; Far81; Gel95; Gro81], only finitely generated virtually nilpotent groups admit expanding endomorphisms.

Some properties of monoform groups

In the rest of this section, we study some basic properties of monoform groups.

Proposition 7.3.11. *Let G_1, G_2 be two monoform groups. Then $G_1 \times G_2$ is a monoform group.*

Proof. Consider $\varphi_i : G_i \rightarrow G_i$, the injective maps and $(F_{n,i})_{n \in \mathbb{N}}$ the exhaustive locally monotileable sequences of finite sets $(F_{n,i})_{n \in \mathbb{N}}$ such that G_1, G_2 are monoform. Define $\varphi : G_1 \times G_2 \rightarrow G_1 \times G_2$ as $\varphi(g) = (\varphi_1(g), \varphi_2(g))$ and $F_1 = F_{1,1} \times F_{1,2}$. It is clear that, for any $g \in G, f \in F_1$, the equality $\varphi(\varphi(g) \cdot f) = \varphi^2(g) \cdot \varphi(f)$ holds. Define, for any $n \in \mathbb{N}$, $F_n = F_{n,1} \times F_{n,2}$. Since, for every $n \in \mathbb{N}$, $F_{n+1,i} = \coprod_{f \in F_{n,i}} \varphi_i^n(f) F_{n,i}$, we have that $F_{n+1} = \coprod_{f \in F_n} \varphi^n(g) F_n$. Hence the sequence $(F_n)_{n \in \mathbb{N}}$ is locally monotileable. The exhaustiveness of $(F_n)_{n \in \mathbb{N}}$ is a direct consequence of the exhaustiveness of $(F_{n,i})_{n \in \mathbb{N}}$ for $i = 1, 2$. We conclude that $G_1 \times G_2$ is a monoform group. \square

Now, we prove that free groups are monoform. Recall that, for $n \geq 2$ an integer, \mathbb{F}_n denotes the free group on n generators, and \mathbb{F}_ω the free group on countably infinitely many generators. This proof is based on the one given by Gao, Jackson and Seward where they proved that free groups are ccc groups [GJS16, Theorem 4.5.4]. We follow their notation.

Let \mathcal{T} be the Cayley graph of $G = \mathbb{F}_n$ for some $n \geq 2$ or $G = \mathbb{F}_\omega$ with respect to a free generating set, which is a tree. In the case $G = \mathbb{F}_n$ two elements g and h of G are linked by an edge if either $g = hx_i$ or $g = hx_i^{-1}$, where $x_i \in S$, for some $1 \leq i \leq n$. Hence, every node has degree $2n$ (∞ if $G = \mathbb{F}_\omega$). We consider \mathcal{T} as a **rooted tree** with its root being $g = 1_G$. For $g \in G$, the **depth** of g is the distance from g to 1_G in \mathcal{T} , and we denote it $d(g)$. When $G = \mathbb{F}_n$, we have that $d(g) = \|g\|_S$, for the free generating set S . The **children** of a vertex $g \in G$ are the vertices adjacent to g of depth $d(g) + 1$. The **parent** of $g \neq 1_G$ is the unique vertex adjacent to g with depth $d(x) - 1$. We say that $T \subseteq \mathcal{T}$ is a **subtree** if $1_G \in T$ and T is closed under the parent relation. We make use of the following lemma.

Lemma 7.3.12 (Lemma 4.5.5 [GJS16]). *Let $T \subseteq G$ be a subtree of the free group G . Then T is a monotile for G .*

We are now ready to prove the following result.

Theorem 7.3.13. *Every free group \mathbb{F}_n or \mathbb{F}_ω is a monoform group.*

Proof. Let G be a free group, and \mathcal{T} be the corresponding Cayley graph as above. Let $1_G = g_0, g_1, \dots$ be an enumeration of the elements in G . In the case that G is finitely generated, we can consider the enumeration given by the lexicographic geodesic order \leq_S : given a total order on S , we define by $\ell_S(g)$ the unique geodesic for g . Then, $g \leq_S h$ if $\|g\|_S < \|h\|_S$ or $\|g\|_S = \|h\|_S$ and $\ell_S(g)$ is lexicographically smaller than $\ell_S(h)$. Let $T_0 = 1_G$ and $T_1 \subseteq \mathcal{T}$ be an arbitrary subtree of \mathcal{T} , such that $|T_1| > 1$. Let $T_1 = \{f_0, \dots, f_{|T_1|-1}\}$ be an enumeration of the subtree T_1 . We are going to recursively define a localization map $\varphi : G \rightarrow G$, and an exhaustive locally monotileable sequence of finite sets $(T_n)_{n \in \mathbb{N}}$ that will be compatible with φ .

To define T_2 , take g to be the smallest element in the enumeration such that $g \notin T_1$, but the parent g' of g is in T_1 . Then $g = g's$ or $g = g's^{-1}$, for some generator $s \in S$. Suppose $g = g's$ (the other case is analogous). Note that g' , written as a reduced word, does not end in s^{-1} . Let $k \in \mathbb{N}$ be such that $(s^{-1})^k \in T_1$, but $(s^{-1})^{k+1} \notin T_1$ and consider $h_1 = g \cdot s^k$. Then, T_1 and $h_1 T_1$ are disjoint, as $g \notin T_1$ and subtrees are closed for parents. Furthermore, $g \in h_1 T_1$ and $T_1 \cup h_1 T_1$ is a subtree of \mathcal{T} . Repeating this process $|T_1|$ times in total, we get $h_0, \dots, h_{|T_1|-1} \in G$, where $h_0 = 1_G$, such that

$$T_2 = \prod_{i=0}^{|T_1|-1} h_i T_1$$

is a subtree of \mathcal{T} . For each $i \in \{0, \dots, |T_1| - 1\}$, we set $\varphi(f_i) = h_i$.

Suppose that at step n we obtain a subtree T_n of \mathcal{T} from the sequence of subtrees $T_1 \subseteq T_2 \subseteq \dots \subseteq T_{n-1}$ such that

- For $i \in \{1, \dots, n\}$, the set T_i is a disjoint union of $|T_1|$ copies of T_{i-1} .
- For $i \in \{1, \dots, n\}$, consider $h_0^i, \dots, h_{|T_1|-1}^i$ such that

$$T_i = \coprod_{j=0}^{|T_1|-1} h_j^i T_{i-1}.$$

- Any $g \in T_i$, can be written as $g = h_{j_i}^i \cdots h_{j_1}^1$, with $(j_k)_{k=1}^i \in \{0, \dots, |T_1| - 1\}$. Consequently, $\varphi(g)$ is defined as $h_{j_i}^{i+1} \cdots h_{j_1}^2$.

To define T_{n+1} , we do a process analogous to the one we did for T_2 , but starting from T_n . We get that

$$T_{n+1} = \coprod_{j=0}^{|T_1|-1} h_j^{n+1} T_n,$$

with $h_0^{n+1} = 1_G$ and $h_1^{n+1}, \dots, h_{|T_1|-1}^{n+1} \in G$. Once again, by taking any $g \in T_n$, we have $g = h_{j_n}^n \cdots h_{j_1}^1$, for some $j_1, \dots, j_n \in \{0, \dots, |T_1| - 1\}$. In turn, this defines $\varphi(g) = h_{j_n}^{n+1} \cdots h_{j_1}^2$.

This process eventually covers the whole group, that is $G = \bigcup_{n \in \mathbb{N}} T_n$. So, $(T_n)_{n \in \mathbb{N}}$ is an exhaustive locally monotileable sequence of finite sets, where the tiling sequence is $\varphi^n(T_1)$. To finish the proof, note that the map φ is well-defined. Indeed, if $g \in T_n$, then $g \in T_m$ for all $m \geq n$, and the representation of g is equal to

$$g = 1_G \cdots 1_G \cdot h_{j_n}^n \cdots h_{j_1}^1,$$

so $\varphi(g) = \varphi(1_G \cdots 1_G \cdot h_{j_n}^n \cdots h_{j_1}^1) = 1_G \cdots 1_G \cdot h_{j_n}^{n+1} \cdots h_{j_1}^2 = h_{j_n}^{n+1} \cdots h_{j_1}^2$. Also, a straightforward computation shows that for any $n \in \mathbb{N}$ and $g_{n-1}, \dots, g_0 \in F_1$ we have that

$$\varphi(\varphi^{n-1}(g_{n-1}) \cdots \varphi(g_1)g_0) = \varphi^n(g_{n-1}) \cdots \varphi^2(g_1)\varphi(g_0).$$

We conclude that free groups are monoform. □

Remark 7.3.14. Finitely generated free groups are another example of monoform group where the localization map cannot be an endomorphism, even though they are residually finite. This is because, $\varphi(\mathbb{F}_n)$ would be a finite index subgroup of \mathbb{F}_n , which is not possible by the Nielsen-Schreier Formula which states that $[\mathbb{F}_n : \mathbb{F}_k] = m$ if and only if $k = 1 + m(n - 1)$.

Let us look at an example of the process described in the proof for $\mathbb{F}_2 = \langle \mathbf{a}, \mathbf{b} \rangle$. We order the group through lexicographic geodesic order induced by $\mathbf{a} < \mathbf{b} < \mathbf{a}^{-1} < \mathbf{b}^{-1}$. Take $T_1 = \{1_{\mathbb{F}_2}, \mathbf{b}\}$. Following the procedure in the proof, we obtain for:

- Step 2: $h_1^1 = \mathbf{a}$ and $T_2 = T_1 \cup \mathbf{a}T_1 = \{1_{\mathbb{F}_2}, \mathbf{b}\} \cup \{\mathbf{a}, \mathbf{ab}\}$. This defines $\varphi(1_G) = 1_G$ and $\varphi(\mathbf{b}) = \mathbf{a}$,
- Step 3: $h_1^2 = \mathbf{a}^{-2}$ and $T_3 = T_2 \cup \mathbf{a}^{-2}T_2$. This defines $\varphi(\mathbf{a}) = \mathbf{a}^{-2}$,
- Step 4: $h_1^3 = \mathbf{b}^{-2}$ and $T_4 = T_3 \cup \mathbf{b}^{-2}T_3$. This defines $\varphi(\mathbf{a}^{-2}) = \mathbf{b}^{-2}$,

and so on. Figure 7.4 shows a depiction of these subtrees.

Remark 7.3.15. For the finitely generated case, the procedure is effective, meaning that from an order on the generating set S , it is possible to compute $C_n = \varphi^n(T_1)$ starting from $n \in \mathbb{N}$.

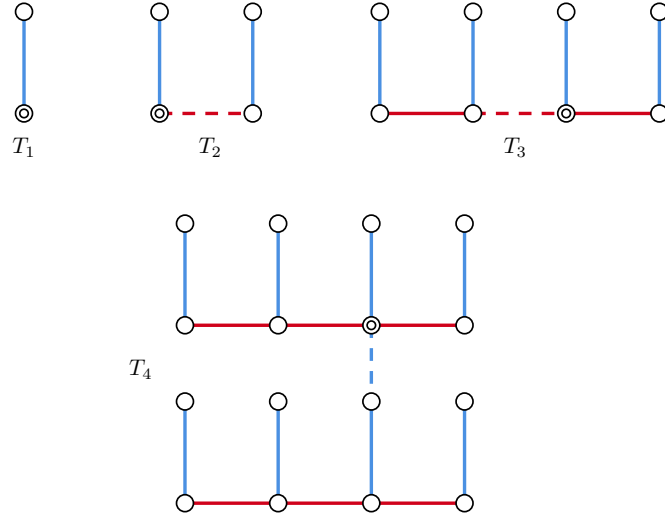

Figure 7.4: The successive construction of the first 4 steps of the monofrom decomposition of the free group \mathbb{F}_2 , as explained in Theorem 7.3.13, starting from the subtree $T_1 = \{1_{\mathbb{F}_2}, \mathbf{b}\}$. The identity is represented by a double circle, edges corresponding to \mathbf{a} are colored red, and edges representing \mathbf{b} are colored blue.

7.3.2 Constant-shape substitutions on monofrom groups

Let G be a monofrom group, with map φ and $(F_n)_{n \in \mathbb{N}}$ be an exhaustive locally monotileable sequence of finite sets $(F_n)_{n \in \mathbb{N}}$ with $F_0 = \{1_G\}$, $1_G \in F_1$. A **constant-shape substitution** is a map $\zeta : A \rightarrow A^{F_1}$. The set F_1 will be called the **support** of the substitution. We define a directive sequence $\tau_\zeta = (\tau_n)_{n \in \mathbb{N}}$ associated to ζ by $\tau_0 = \zeta$ and

$$\tau_n(a)(\varphi^n(f)) = \zeta(a)(f),$$

with $f \in F_1$. This allows us to define the iterations of ζ as $\zeta^n = \tau_{[0,n]} : A \rightarrow A^{F_n}$. Notice that these iterations are constant-shape substitutions in themselves with localization map φ^n and set F_n .

Given a constant-shape substitution ζ , we denote φ_ζ its map and F_1^ζ its support. Since any element $g \in G$ can be expressed in a unique way as $g = \varphi_\zeta(h)f$, with $h \in G$ and $f \in F_1^\zeta$, we consider the substitution map $\zeta : A^G \rightarrow A^G$, given by

$$\zeta(x)(\varphi_\zeta(h)f) = \zeta(x(h))(f).$$

A **fixed point** for ζ is a configuration $x \in A^G$ such that $\zeta(x) = x$. The **language** of ζ , denoted $\mathcal{L}(\zeta)$, is the set of factors of the patterns $\zeta^n(a)$ for some $n \geq 0$ and $a \in A$, i.e.,

$$\mathcal{L}(\zeta) = \{\mathbf{p} : \mathbf{p} \sqsubseteq \zeta^n(a), \text{ for some } n > 0, a \in A\}.$$

Using the language, we define the subshift X_ζ associated with a substitution ζ as the set of all sequences $x \in A^G$ such that every pattern occurring in x is in $\mathcal{L}(\zeta)$. We say that the substitution ζ is **aperiodic** if the G -substitutive subshift that it defines is strongly aperiodic.

Example 7.3.16. Take the monofrom group \tilde{A}_2 from Example 7.3.7 with $F_1 = \{1_{\tilde{A}_2}, \mathbf{a}, \mathbf{b}, \mathbf{c}\}$ and localization map ϕ defined by $\phi(\mathbf{a}) = \mathbf{aba}$, $\phi(\mathbf{b}) = \mathbf{cac}$ and $\phi(\mathbf{c}) = \mathbf{bcb}$. Consider the substitution $\zeta : \{\mathbf{a}, \mathbf{b}, \mathbf{c}\} \rightarrow \{\mathbf{a}, \mathbf{b}, \mathbf{c}\}^{F_1}$ given by

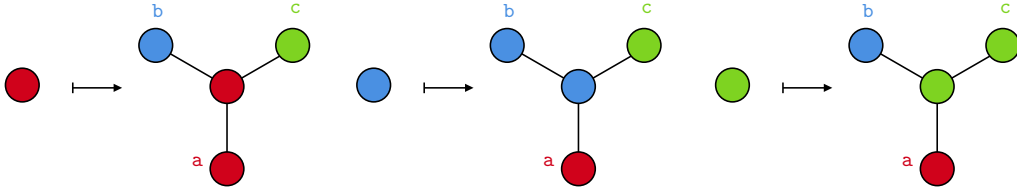

where a is represented by a red circle, b by a blue one, and c a green one. Applying ζ^3 to b we obtain:

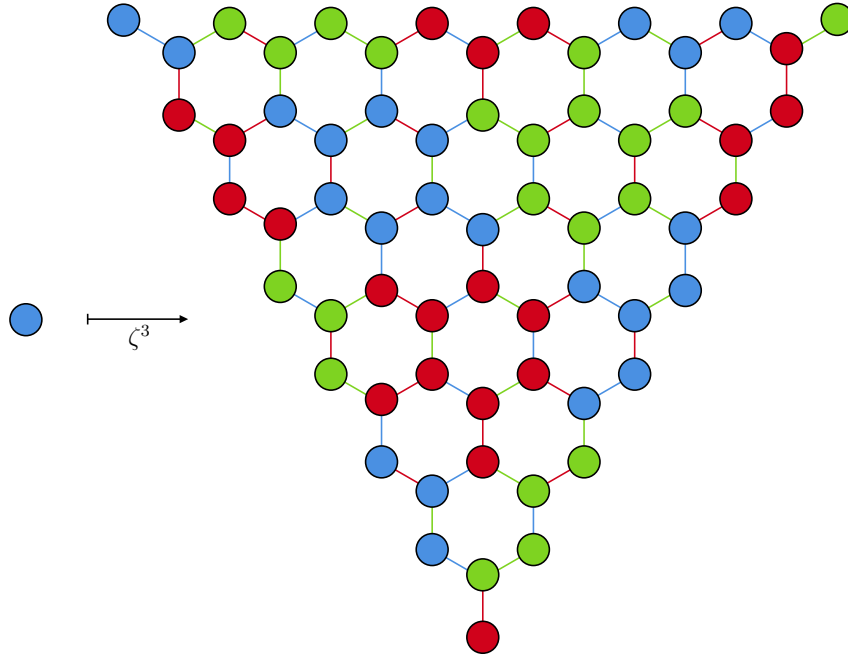

7.4 Dynamical properties

7.4.1 Minimality

Definition 7.4.1. We say a directive sequence $\tau = (\tau_n)_{n \in \mathbb{N}}$ is **weakly primitive** if for every $i \in \mathbb{N}$, there exists $j \geq i$ such that for every $a \in A_i$ and $b \in A_j$ we have $a \sqsubseteq \tau_{[i,j]}(b)$.

In the case where the group is monoform and τ is generated by a constant shape substitution $\zeta : A \rightarrow A^F$ weak primitivity takes a simpler form. We say ζ is **primitive** if there exists $n \in \mathbb{N}$ such that for all we have $a, b \in A$, $a \sqsubseteq \zeta^n(b)$.

Proposition 7.4.2. *If $\tau = (\tau_n)_{n \in \mathbb{N}}$ is weakly primitive, then X_τ is minimal.*

Proof. We prove $X = X_\tau$ is minimal by showing it is uniformly recurrent. Let $u \in \mathcal{L}(X)$ be a pattern appearing in our subshift. By definition there exists $i \in \mathbb{N}$ and $a \in A_i$ such that $u \sqsubseteq \tau_{[0,i]}(a)$. Because τ is weakly primitive there exists $j \geq i$ such that $a \sqsubseteq \tau_{[i,j]}(b)$ for all $b \in A_j$.

Take a subset $W \in G$ that is sufficiently large to contain F_j . Then for any $x \in X$, there exists some $b \in A_j$ such that

$$\tau_{[0,i]}(a) \sqsubseteq \tau_{[0,j]}(b) \sqsubseteq x_W.$$

Therefore, X_τ is minimal. □

7.4.2 Entropy

Proposition 7.4.3. *Let G be a congruent monotileable group with Følner decomposition $(F_n)_{n \in \mathbb{N}}$ and corresponding tiling sequence $(C_n)_{n \in \mathbb{N}}$. For a directive sequence $\tau = (\tau_n)_{n \in \mathbb{N}}$ defined by $\tau_n : A_{n+1} \rightarrow A_n^{C_n}$, we have*

$$h(X_\tau) \leq \inf_{n \geq 0} \frac{\log(|A_n|)}{|F_n|}.$$

In particular, if the alphabets are uniformly bounded, $h(X_\tau) = 0$.

Proof. Fix $n \in \mathbb{N}$ and define the set of all n th level images by $I_n = \{\tau_{[0,n]}(a) \mid a \in A_n\}$. Take a pattern $P \in \mathcal{L}(X_\tau)$. By definition, there exists $m \in \mathbb{N}$ and $a_0 \in A_m$ such that $P \sqsubseteq \tau_{[0,m]}(a_0)$. Decomposing $\tau_{[0,m]}(a_0)$ into images of the n th level, we get that P is a factor of the concatenation of $c \cdot Q_c$ where $c \in C_{m-1} \cdot \dots \cdot C_n$ and $Q_c \in I_n$. Now, any factor of P of support F_N for some $N \in \mathbb{N}$ must be a factor of concatenation of patterns of the form $c \cdot Q_c$, where this time $c \in \{g \in C_{m-1} \cdot \dots \cdot C_n \mid gF_n \cap hF_N \neq \emptyset\}$, and h is the position of the factor. If we denote this set by B , the factor will appear in the concatenation of $|B|$ patches from I_n . If $g \in B$, then $g \in hF_N F_n^{-1}$. From this we deduce that

$$|B| \leq |hF_N F_n^{-1}| = |F_N F_n^{-1}| = |C_{n-1} \cdot \dots \cdot C_n| = |F_n|/|F_n|.$$

As there are at most $|A_n|^{\frac{|F_N|}{|F_n|}}$ patterns of support B , we have that

$$\frac{\log(p_{X_\tau}(N))}{|F_N|} \leq \inf_{n \geq 0} \frac{\log(|A_n|)}{|F_n|}.$$

□

7.4.3 Unique ergodicity

The goal of this section is to prove unique ergodicity for many subshifts defined from directed sequences over congruent monotileable groups under assumptions on the growth of the sequence $(|A_n|)_{n \in \mathbb{N}}$ of sizes of the alphabets, and the tiling sequence. With this in mind, we make extensive use of the following definitions.

Definition 7.4.4. Let E, F be two subsets of G . We define

- the E -interior of F as the set

$$F^{-E} := \{g \in G \mid gE \subseteq F\} = \bigcap_{e \in E} Fe^{-1},$$

- the E -closure of F as

$$F^{+E} := \{g \in G \mid gE \cap F \neq \emptyset\} = \bigcup_{e \in E} Fe^{-1} = FE^{-1},$$

- the E -boundary of F as $\partial_E F = F^{+E} \setminus F^{-E}$.

Note that for any $h \in G$, $(hF)^{-E} = h(F^{-E})$, $(hF)^{+E} = h(F^{+E})$ and $\partial_E(hF) = h\partial_E F$.

Proposition 7.4.5 (Proposition 5.4.4 [CC10]). *A sequence of finite subsets $(F_n)_{n \in \mathbb{N}}$ is a right Følner sequence if and only if for every finite subset $E \Subset G$, we have that*

$$\lim_{n \rightarrow \infty} \frac{|\partial_E F_n|}{|F_n|} = 0.$$

Let X be a G -subshift and consider \mathfrak{F} the Borel σ -algebra of X . A probability measure μ on (X, \mathfrak{F}) is said to be **invariant** or preserved by the G -action, if for any $A \in \mathfrak{F}$, and $g \in G$, $\mu(g^{-1}A) = \mu(A)$ and we say that (X, \mathcal{F}, μ, G) is a **measure-preserving system**. We say that (X, \mathcal{F}, μ, G) is **ergodic** (or just that μ is ergodic, when the G -subshift is clear) if for any $A \in \mathfrak{F}$, we have that

$$[\forall g \in G, \mu(g^{-1}A\Delta A) = 0] \implies \mu(A) = 0 \vee \mu(A) = 1.$$

For a G -subshift, we define $\mathcal{M}(X, S, G)$ the set of all invariant probability measures. This set is convex and compact on the weak-* topology. We say that (X, S, G) is **uniquely ergodic** if $|\mathcal{M}(X, S, G)| = 1$, and **strictly ergodic** if it is minimal and uniquely ergodic. We recall that if G is amenable, by the Krylov–Bogolyubov theorem [KB37; Ano94], $|\mathcal{M}(X, S, G)| \geq 1$.

Towards Ergodicity

Given a directive sequence $(\tau_n)_{n \in \mathbb{N}}$ on a congruent monotileable group, we can study the number of occurrences of letters under the substitution through the notion of abelianization.

Definition 7.4.6. Let $\tau : A \rightarrow B^F$ be a substitution. We define its **abelianization** as the matrix $M(\tau)$ of dimension $|B| \times |A|$, where $M(\sigma)_{b,a}$ is the number of occurrences of the letter b in $\tau(a)$.

If we have a directive sequence that witnesses a finite number of different abelianizations, we can find a vector of frequencies through a generalization of the Perron-Frobenius theorem. Given a sequence of matrices $(M_n)_n$ we use the notation $M_{[i,j]} = M_i \cdot M_{i+1} \cdot \dots \cdot M_{j-1}$.

Theorem 7.4.7 ([Fur60]). *Let $(M_n)_n$ be a sequence of non-negative integer matrices. If there exists a matrix M' and a sequence of indices $i_k < j_k$ with $j_k \leq i_{k+1}$ such that $M' = M_{[i_k, j_k]}$, then there exists a positive vector $v \in \mathbb{R}_+^d$ such that*

$$\bigcap_{n \in \mathbb{N}} M_{[0,n]} \mathbb{R}_+^d = \mathbb{R}_+ v.$$

Equipped with this result, we prove that some directive sequences define uniquely ergodic subshifts.

Theorem 7.4.8. *Let $\tau = (\tau_n)_n$ be a directive sequence on a congruent monotileable group. If $|A_n|$ and $|C_n|$ are uniformly bounded, and τ is weakly primitive, then X_τ is strictly ergodic.*

The proof of this theorem relies on several key lemmas that will progressively show the existence of pattern frequencies that are independent of the underlying configuration and Følner sequence. This proof closely resembles the proof of Lee, Moody and Solomyak on the unique ergodicity of primitive geometric substitutive systems [LMS03; Sol97].

Lemma 7.4.9. *Let $\tau = (\tau_n)_n$ be a weakly primitive directive sequence on a congruent monotileable group, with associated Følner sequence $\{F_n\}_n$. Take $x \in \bigcap_{n \in \mathbb{N}} \tau_{[0,n]}(A_n^G)$ and a pattern $P \in \mathcal{L}(X_\tau)$. Then,*

1. *There exist $\gamma, n_0 > 0$, that depend only on P , such that $|x_{hF_n}|_P \geq \gamma|F_n|$ for all $n > n_0$.*
2. *We have that*

$$\lim_{n \rightarrow \infty} \frac{|x_{\partial_E h F_n}|_P}{|x_{h F_n}|_P} = 0,$$

uniformly on $h \in G$ and x , where $E = \text{supp}(P)$.

Proof. As P is a pattern on X_τ , there exists $k \in \mathbb{N}$ and $a \in A_k$ such that $P \sqsubseteq \tau_{[0,k]}(a)$. Because τ is weakly primitive, there exists $l \geq k$ such that for all $b \in A_l$, $a \sqsubseteq \tau_{[k,l]}(b)$. In particular, $P \sqsubseteq \tau_{[0,l]}(b)$ for all $b \in A_l$.

Now, recall that $G = \prod_{c \in \hat{C}_l} cF_l$, with $\hat{C}_l = \bigcup_{m \geq l} C_{m-1} \cdot \dots \cdot C_l$ (see Lemma 7.2.7). As there exists $y \in A_0^G$ such that $x = \tau_{[0,l]}(y)$, for any $F \in G$ and $h \in G$, the number of occurrences of P in x_{hF} will be at least the

number of elements $c \in \hat{C}_l$ such that $cF_l \subseteq hF$, that is, $|\hat{C}_l \cap (hF)^{-F_l}|$. In addition, there exists $m > l$ such that $hF \subseteq F_m$ and F_m partitions in copies of F_l . Thus,

$$hF \subseteq \{g \in \hat{C}_l \mid g \in (hF)^{+F_l}\} \cdot F_l. \quad (7.2)$$

Take $n > l$ and let $M = |\{g \in \hat{C}_l \mid g \in \partial_{F_l} hF_n\}|$ and $N = |\{g \in \hat{C}_l \mid g \in (hF_n)^{-F_l}\}|$. By (7.2),

$$N \cdot |F_l| \geq |F_n| - M \cdot |F_l| \geq |F_n| - |\partial_{F_l} F_n| \cdot |F_l|.$$

By the Følner condition, there exists $n_0 > l$ such that $|\partial_{F_l} F_n| < \varepsilon |F_l|^{-1} |F_n|$, for all $n \geq n_0$. Therefore,

$$|x_{hF_n}|_P \cdot |F_l| \geq N \cdot |F_l| \geq (1 - \varepsilon) |F_n|.$$

This proves (1). For our second point, we have that for $n > n_0$,

$$\frac{|x_{\partial_E hF_n}|_P}{|x_{hF_n}|_P} \leq \frac{|\partial_E F_n|}{\gamma |F_n|},$$

which converges to 0 by the Følner condition. \square

Lemma 7.4.10. *Let $\tau = (\tau_n)_n$ be a weakly primitive directive sequence on a congruent monotileable group, with associated Følner sequence $\{F_n\}_n$, such that $|A_n|$ and $|C_n|$ are uniformly bounded. Take a pattern $P \in \mathcal{L}(X_\tau)$. Then,*

$$f_P := \lim_{n \rightarrow \infty} \frac{|x_{F_n}|_P}{|F_n|},$$

exists and is equal for all $x \in \bigcap_{n \in \mathbb{N}} \tau_{[0,n]}(A_n^G)$.

Proof. Because $|A_n|$ and $|C_n|$ are uniformly bounded, there are a finite amount of abelianizations $M_n = M(\tau_n)$. Thus, in the sequence $(M_n)_{n \in \mathbb{N}}$ one of the matrices repeats infinitely often. By Theorem 7.4.7, for every $k \in \mathbb{N}$ there exists $v^{(k)} \in \mathbb{R}_+^{|A_k|}$ such that

$$\bigcap_{n \geq k} M_{[k,n]} \mathbb{R}_+^{|A_n|} = \mathbb{R}_+ v^{(k)}, \quad (7.3)$$

We take $v^{(k)}$ such that the sum of its coordinates is 1. Notice that the abelianization for $\tau_{[k,n]}$ is given by $M_{[k,n]}$, which means that for all $a \in A_n$,

$$\sum_{b \in A_k} (M_{[k,n]})_{b,a} = \sum_{b \in A_k} |\tau_{[n,k]}(a)|_b = |\text{supp} \tau_{[n,k]}(a)| = \frac{|F_n|}{|F_k|}.$$

Therefore, by (7.3)

$$\lim_{n \rightarrow \infty} \frac{(M_{[k,n]})_{b,a_n}}{|F_n|} = \frac{v_b^{(k)}}{|F_k|}, \quad (7.4)$$

for every sequence $(a_n)_n$ defining an element in $\bigcap_{n \in \mathbb{N}} \tau_{[0,n]}(A_n^G)$.

Now, take $x \in \bigcap_{n \in \mathbb{N}} \tau_{[0,n]}(A_n^G)$ and let $a_n \in A_n$ be such that $x_{F_n} = \tau_{[0,n]}(a_n)$. Furthermore, let $k \in \mathbb{N}$ be such that $|x_{\partial_E hF_k}|_P \leq \varepsilon |x_{hF_k}|_P$ for every $h \in G$, which exists by Lemma 7.4.9. As we want to take a limit, we can suppose $n > k$. Then, we approximate the occurrences of P in x_{F_n} by looking at the subdivision of F_n into copies of F_k as follows,

$$\sum_{c \in C_{n-1} \cdots C_k} |x_{cF_k}|_P \leq |x_{F_n}|_P = |\tau_{[0,n]}(a_n)|_P \leq (1 + \varepsilon) \sum_{c \in C_{n-1} \cdots C_k} |x_{cF_k}|_P,$$

which can be re-written as

$$\sum_{b \in A_k} |\tau_{[0,k]}(b)|_P(M_{[k,n]})_{b,a_n} \leq |\tau_{[0,n]}(a_n)|_P \leq (1 + \varepsilon) \sum_{b \in A_k} |\tau_{[0,k]}(b)|_P(M_{[k,n]})_{b,a_n}.$$

Dividing by $|F_n|$ and using (7.4),

$$\limsup_{n \rightarrow \infty} \frac{|x_{F_n}|_P}{|F_n|} - \liminf_{n \rightarrow \infty} \frac{|x_{F_n}|_P}{|F_n|} \leq \frac{\varepsilon}{|F_k|} \sum_{b \in A_k} |\tau_{[0,k]}(b)|_P \cdot v_b^{(k)} \leq \varepsilon,$$

as $|\tau_{[0,k]}(b)|_P \leq |F_k|$. Thus, f_P exists as ε was arbitrary. Furthermore, f_P is the same for every x as

$$\sum_{b \in A_k} |\tau_{[0,k]}(b)|_P \frac{v_b^{(k)}}{|F_k|} \leq f_P \leq (1 + \varepsilon) \sum_{b \in A_k} |\tau_{[0,k]}(b)|_P \frac{v_b^{(k)}}{|F_k|},$$

and k is independent of x . □

Lemma 7.4.11. *Let $\tau = (\tau_n)_n$ be a weakly primitive directive sequence on a congruent monotileable group, with associated Følner sequence $\{F_n\}_n$, such that $|A_n|$ and $|C_n|$ are uniformly bounded. Then, for all $\varepsilon > 0$ and sufficiently big k*

$$\left| \frac{|\tau_{[0,k]}(b)|_P}{|F_k|} - f_P \right| < \varepsilon,$$

for all $b \in A_k$.

Proof. We proceed by contradiction; suppose there exists $\varepsilon > 0$ such that for all $k \in \mathbb{N}$, there exists $\varphi(k) \geq k$ and $b^k \in A_{\varphi(k)}$ such that

$$\left| \frac{|\tau_{[0,\varphi(k)]}(b^k)|_P}{|F_{\varphi(k)}|} - f_P \right| > \varepsilon.$$

By compactness, there exists a subsequence of $\varphi, \psi(k)$ such that $\tau_{[0,\psi(k)]}(b^{\psi(k)})$ converges to a configuration x from $\bigcap_{n \in \mathbb{N}} \tau_{[0,n]}(A_n^G)$. Then, by Lemma 7.4.10, for sufficiently big k ,

$$\left| \frac{|\tau_{[0,\psi(k)]}(b^{\psi(k)})|_P}{|F_{\psi(k)}|} - f_P \right| = \left| \frac{|x_{F_{\psi(k)}}|_P}{|F_{\psi(k)}|} - f_P \right| < \varepsilon,$$

which is a contradiction. □

Lemma 7.4.12. *Let $\tau = (\tau_n)_n$ be a weakly primitive directive sequence on a congruent monotileable group, with associated Følner sequence $\{F_n\}_n$, such that $|A_n|$ and $|C_n|$ are uniformly bounded. Take $x \in \bigcap_{n \in \mathbb{N}} \tau_{[0,n]}(A_n^G)$ and a pattern $P \in \mathcal{L}(X_\tau)$. Then, for any Følner sequence $\{F'_n\}_n$,*

$$\lim_{n \rightarrow \infty} \frac{|x_{hF'_n}|_P}{|F'_n|} = f_P,$$

uniformly on $h \in G$.

Proof. We approximate the occurrences of P on $x_{hF'_n}$ by counting the occurrences of P on subdivisions of support F_k that intersect hF'_n . We define,

$$I_{n,k} = \hat{C}_k \cap (hF'_n)^{-F_k} = \{g \in \hat{C}_k \mid gF_k \subseteq hF'_n\},$$

and

$$J_{n,k} = \hat{C}_k \cap (hF'_n)^{+F_k} = \{g \in \hat{C}_k \mid gF_k \cap hF'_n \neq \emptyset\}.$$

This allows us to approximate $|x_{F'_n}|_P$ as

$$\sum_{c \in I_{n,k}} |x_{cF_k}|_P \leq |x_{hF'_n}| \leq \sum_{c \in J_{n,k}} |x_{cF_k}|_P + |x_{\partial_E cF_k}|_P.$$

Because $x \in \bigcap_{n \in \mathbb{N}} \tau_{[0,n]}(A_n^G)$, for every $c \in \hat{C}_k$ there exists $b^c \in A_k$ such that $x_{cF_k} = \tau_{[0,k]}(b^c)$. Now, from Lemmas 7.4.9 and 7.4.11 we take $k \in \mathbb{N}$ such that $|x_{c\partial_E F_k}|_P \leq \varepsilon |x_{cF_k}|_P$ and

$$\left| \frac{|\tau_{[0,k]}(b)|_P}{|F_k|} - f_P \right| < \varepsilon,$$

for all $b \in A_k$. We arrive at

$$(f_P - \varepsilon)|I_{n,k}| \cdot |F_k| \leq |x_{hF'_n}| \leq (1 + \varepsilon)(f_P + \varepsilon)|J_{n,k}| \cdot |F_k|.$$

Notice that $|I_{n,k}| \cdot |F_k| \geq |hF'_n| - |F_k| \cdot |\partial_{F_k} hF'_n|$ and $|J_{n,k}| \leq |hF'_n| + |F_k| \cdot |\partial_{F_k} hF'_n|$. As $\{F'_n\}_n$ is a Følner sequence, we take n sufficiently big such that $|F'_n| \leq \varepsilon |F_k|^{-1} |\partial_{F_k} F'_n|$. Thus,

$$(1 - \varepsilon)(f_P - \varepsilon) \leq \frac{|x_{hF'_n}|_P}{|F'_n|} \leq (1 + \varepsilon)^2 (f_P + \varepsilon).$$

Therefore, we have the sought after limit whose convergence is independent of h . \square

Our final ingredient comes from the point-wise ergodic theorem for amenable groups. This theorem relies on special kinds of Følner sequences.

Definition 7.4.13. A Følner sequence $\{F_n\}_{n \in \mathbb{N}}$ is said to be **tempered** if there exists $D > 0$ such that

$$\left| \bigcup_{i=1}^{n-1} F_i^{-1} F_n \right| \leq D |F_n|,$$

for all $n \geq 2$.

The general point-wise convergence theorem is stated for probability measure preserving actions, for our purposes, we only need ergodic systems. For a full proof of the theorem see [KL16, Theorem 4.28].

Theorem 7.4.14. Let $G \curvearrowright (X, \mu)$ be an ergodic system. Then, for any tempered (right) Følner sequence $\{F_n\}_{n \in \mathbb{N}}$ and $f \in L^1(X)$,

$$\frac{1}{|F_n|} \sum_{g \in F_n} f(g^{-1} \cdot x) \xrightarrow{n \rightarrow \infty} \int_X f d\mu, \quad \mu\text{-a.e.}$$

Proof of Theorem 7.4.8. By the previous theorem, the action $G \curvearrowright X_\tau$ is uniquely ergodic if for any $L^1(X)$ function $f : X_\tau \rightarrow \mathbb{R}$ and any (right) Følner sequence $\{F_n\}_n$,

$$(I_{F_n} f)(x) = \frac{1}{|F_n|} \sum_{g \in F_n} f(g^{-1} \cdot x) \xrightarrow{n \rightarrow \infty} c(f), \quad (7.5)$$

where $c(f)$ is a constant and the convergence is uniform on $x \in X_\tau$.

Let us take $z \in \bigcap_{n \in \mathbb{N}} \tau_{[0,n]}(A_n^G)$. Because X_τ is minimal by Proposition 7.4.2, $\{h \cdot z \mid h \in G\}$ is dense in X_τ . Therefore, it suffices to prove that (7.5) for $h \cdot z$ uniformly on h . Furthermore, $(I_{F_n} f)(h \cdot z) = (I_{h^{-1}F_n} f)(z)$. Because we can approximate f by step-functions over cylinders, it suffices to study $(I_{h^{-1}F_n} f)(z)$ where f is the characteristic function of a cylinder. By taking a cylinder $X_\tau \cap [P]_{g'}$ and denoting $H_n := h^{-1}F_n$ we have:

$$\sum_{g \in H_n} f(g^{-1} \cdot x) = |\{g \in H_n \mid x_{gg'E} = P\}|,$$

where $E = \text{supp}P$. If we index all occurrences of P in z by $\{g_j\}_{j \in \mathbb{N}}$, that is, $x_{g_j E} = P$ for all $j \in \mathbb{N}$, we obtain

$$\begin{aligned} \sum_{g \in H_n} f(g^{-1} \cdot x) &= |\{g \in H_n \mid \exists j \in \mathbb{N}, gg' = g_j\}|, \\ &= |\{j \in \mathbb{N} \mid g_j(g')^{-1} \in H_n\}|. \end{aligned}$$

Then, if the j -th occurrence of P is contained in $x_{H_n g'}$, then $g_j(g')^{-1} \in H_n$. On the other hand, if the j -th occurrence of P is in $x_{G \setminus H_n g'}$, then $g_j(g')^{-1} \notin H_n$. Therefore,

$$|x_{H_n g'}|_P \leq \sum_{g \in H_n} f(g^{-1} \cdot x) \leq |x_{(H_n g')^+ E}|_P \leq |x_{H_n g'}|_P + |\partial_E H_n g'|.$$

Because $F_n g'$ is a right Følner sequence, by Lemma 7.4.12 we have that $(I_{F_n} f)(h \cdot z)$ converges to f_P uniformly on h . \square

7.5 Perspectives and questions

As was pointed out in the introduction to this chapter, substitutions and their subshifts have provided key tools in the study of the Domino Problem and aperiodic tilings. These contributions are usually done through the notion of **recognizability** and **SFT covers** of substitutive systems. Let us explore these two ideas.

Recognizability

Definition 7.5.1. Let G be a monoform group. We say a primitive substitution $\zeta : A \rightarrow A^{F_1}$ is **recognizable in the sense of Mossé** on a fixed point $x \in X_\zeta$, if there exists a finite subset $F \subseteq G$ with $F_1 \subseteq F$ such that for any $g, h \in G$, $x|_{\varphi(g)F} = x|_{hF}$ implies $h \in \varphi(G)$.

This property's name comes from the work of Mossé [Mos92]. For an introduction to this notion see [Ber+19]. Just for this section, we say that such a substitution is recognizable.

For monoform groups where φ is a morphism, we can find an example of a recognizable substitution. Let G be a monoform group with localization morphism φ and monotile F_1 . Up to taking an appropriate power of φ , we assume $|F_1| \geq 3$. Take as alphabet $A = F_1 \setminus \{1_G\}$. We define the substitution $\zeta_{\varphi, F_1} : A \rightarrow A^{F_1}$ as follows²:

$$(\forall a \in A), \zeta_{\varphi, F_1}(a)(f) = \begin{cases} a & \text{when } f = 1_G \\ f & \text{when } f \neq 1_G. \end{cases}$$

Note that all the patterns $\zeta_{\varphi, F_1}(a)$ coincide in every position except at the identity, where the letter is uniquely determined. It is direct to check that this substitution is primitive. Moreover, it has exactly $|F_1| - 1$ fixed points $\{x^f \mid f \in F_1 \setminus \{1_G\}\}$, determined by the elements in $F_1 \setminus \{1_G\}$, such that for any $x^{f_1}(1_G) = f_1$ and for any $f_1 \neq f_2 \in F_1 \setminus \{1_G\}$ and any $g \in G \setminus \{1_G\}$, $x^{f_1}(g) = x^{f_2}(g)$. The value at this coordinate can be computed: for any fixed point $\bar{x} \in X$, we consider $n_g \in \mathbb{N}$ as the minimal exponent such that $g = \varphi^{n_g+1}(h)\varphi^{n_g}(f)$, for some $h \in G$ and $f \in F_1 \setminus \{0\}$. Then $\bar{x}(g) = f$.

An example of this substitution is shown in Example 7.3.16 for the Coxeter group \tilde{A}_2 .

Lemma 7.5.2. *The substitution ζ_{φ, F_1} is recognizable on its fixed points.*

Proof. Consider $x \in X_\zeta$ a fixed point. Since $|F_1| \geq 3$, we consider $f \in F_1 \setminus \{1_G\}$ such that $hf \notin \varphi(G)$. Note that $x(\varphi(g)f) = f$ and if $hf = \varphi(h_1)f_1$, for some $h_1 \in G$, then $x(hf) = x(\varphi(h_1)f_1) = f_1$. Hence $f = f_1$, and then $h = \varphi(h_1)$. \square

²This substitution is inspired by the substitution defined in [CP23, Lemma 4.2].

The key property of recognizability is that it implies aperiodicity for suitable groups.

Lemma 7.5.3. *Let G be an abelian monoform group such that the localization map φ is a morphism. If a primitive substitution is recognizable on a fixed point, then it is aperiodic.*

Proof. Let $\zeta : A \rightarrow A^{F_1}$ be a primitive constant-shape substitution, $x \in X_\zeta$ the fixed point on which it is recognizable and F the corresponding set. We begin by proving that $\zeta^n : A \rightarrow A^{F_n}$ is recognizable on x . This is done by induction on $n \in \mathbb{N}$ for the set $\tilde{F}_n = \varphi^{n-1}(F) \cdot \dots \cdot \varphi(F)F$. The base case is given by hypothesis. Next, suppose ζ^n is recognizable and take $g, h \in G$ such that

$$x|_{\varphi^{n+1}(g)\tilde{F}_{n+1}} = x|_{h\tilde{F}_{n+1}}.$$

Because $1_G \in F$, this can be re-written as $x|_{\varphi^n(\varphi(g))\tilde{F}_n} = x|_{h\tilde{F}_n}$. Then, because ζ^n is recognizable, there exists $h' \in G$ such that $h = \varphi^n(h')$. We once again re-write the previous expression to obtain

$$x|_{\varphi^n(\varphi(g)F)\tilde{F}_n} = x|_{\varphi^n(h'F)\tilde{F}_n}.$$

As $F_n \subseteq \tilde{F}_n$, we can use the fact that x is a fixed point for ζ^n to de-substitute and obtain $x|_{\varphi(g)F} = x|_{h'F}$. By the recognizability of ζ , $h' \in \varphi(G)$ and thus $h \in \varphi^{n+1}(G)$.

To prove the strong aperiodicity of X_ζ , we first show x is aperiodic. For any $g \in \text{stab}(x)$ we have

$$x|_{\tilde{F}_n} = (g \cdot x)|_{\tilde{F}_n} = x|_{g^{-1}\tilde{F}_n},$$

for all $n \in \mathbb{N}$. By the recognizability of ζ^n , this implies g^{-1} is in the intersection of all $\varphi^n(G)$, which is trivial. Therefore, $\text{stab}(x) = \{1_G\}$.

Finally, consider $x' \in X_\zeta$. Because ζ is primitive, by Proposition 7.4.2, X_ζ is minimal. We therefore have a sequence $(g_m)_{m \in \mathbb{N}}$ such that $g_m \cdot x' \rightarrow x$. Take an element $g \in \text{stab}(x')$. Because the shift is continuous and G is abelian

$$x = \lim_{m \rightarrow \infty} g_m \cdot x' = \lim_{m \rightarrow \infty} g_m g \cdot x' = g \cdot \lim_{m \rightarrow \infty} g_m \cdot x' = g \cdot x.$$

Therefore, $g = \{1_G\}$ and X_ζ is strongly aperiodic. □

The previous lemma was proven in two steps: first we prove recognizability for all powers of the substitution, and then we prove this implies aperiodicity. The first step uses the fact that φ is a morphism, and the second that G is an abelian group. Can these restrictions be avoided?

Question 7.5.4. What is the class of monoform groups where recognizability imply aperiodicity?

SFT covers

An important class of results in the study of substitutive subshifts are **simulation theorems**. Their general form is the following: a substitutive or S -adic subshift, where the directive sequence is computable, is sofic. The first of these theorems is due to Mozes who showed that every substitutive \mathbb{Z}^2 -subshift with rectangular support is sofic. This result was later expanded upon by Aubrun and Sablik who showed this theorem holds for S -adic sequences with rectangular support on \mathbb{Z}^2 , whose directive sequence is computable. Similar theorems have also been obtained for geometric substitutions (see [FO10]). In contrast, no such theorem is possible for \mathbb{Z} -substitutions. Indeed, there exist primitive aperiodic substitutions on \mathbb{Z} (for example, the Thue-Morse substitution from Example 7.1.11), whereas every non-empty sofic \mathbb{Z} -subshift must contain periodic points.

To find an easy simulation result, we look at a class of groups introduced by Barbieri, Sablik and Salo, where the "self-simulable" aspect is intrinsic to the group's geometry.

Definition 7.5.5 ([BSS21]). A group G is said to be **self-simulable** if every effectively closed G -action on $\{0, 1\}^{\mathbb{N}}$ is the factor of a G -SFT. In particular, every effectively closed G -subshift is sofic.

Examples of this groups are the direct product of two non-amenable groups, braid groups of more than 7 braids, some RAAGs with conditions over the underlying graph, non-amenable branch groups, Thompson's V , $GL(n, \mathbb{Z})$, $SL(n, \mathbb{Z})$, $\text{Aut}(\mathbb{F}_n)$, and $\text{Out}(\mathbb{F}_n)$ for $n \geq 5$. Also, no amenable group can be self-simulable.

Definition 7.5.6. Let G be an S -decomposable group and $\tau = (\tau_n)_{n \in \mathbb{N}}$ a directive sequence. We say τ is **computable** if

- The function $n \mapsto A_n$ is computable.
- The function that given $n \in \mathbb{N}$, $a \in A_{n+1}$ and $b \in A_n$ computes a set of words $W_{n,a,b}$ that contains a unique representative for each element in $C_{n,a,b}$, is computable.

Proposition 7.5.7. Let G be a self-simulable group. For $\tau = (\tau_n)_{n \in \mathbb{N}}$ a computable directive sequence, X_τ is sofic.

Proof. If we show X_τ is effectively closed, by the self-simulability of G it will be sofic. Let us construct a set of enumerable pattern codings for X_τ . For each $n \in \mathbb{N}$ we encode the images of $\tau_{[0,n]} : A_{n+1} \rightarrow A_0^*G$.

For $n = 1$, compute A_0 and A_1 . Then, for each $a \in A_1$ and $b \in A_0$ compute $W_{0,a,b}$. Define the pattern codings,

$$p(a, 1) = \{(b, w) \mid b \in A_0, w \in W_{0,a,b}\}$$

Now, suppose we have enumerated the pattern codings $\{p(b, n)\}_{b \in A_{n-1}}$ for some $n \in \mathbb{N}$. These pattern codings represent all images of $\tau_{[0,n]}$. To obtain the next step, for each $a \in A_{n+2}$ we compute

$$p(a, n+1) = \{(b, w_1w_2) \mid (b, w_2) \in p(c, n), w_1 \in W_{n+1,a,c}\}.$$

Using these pattern codings we can compute the set of pattern codings of the same support but are not representing images of the directive sequence. This new set defines X_τ , making it an effectively closed shift. Finally, X_τ is sofic because G is self-simulable. \square

Example 7.5.8. Take the group $G = \mathbb{F}_2 \times \mathbb{F}_2$. This group is self-simulable (product of two non-amenable groups) and monoform. If we take the set $T_1 = \{1_{\mathbb{F}_2}, \mathbf{a}, \mathbf{b}\}$ and construct its corresponding function φ from Theorem 7.3.13. Then, as seen in Proposition 7.3.11, $\mathbb{F}_2 \times \mathbb{F}_2$ is monoform with localization map $\psi = (\varphi, \varphi)$ and set $F_1 = T_1 \times T_1$. As mentioned in Remark 7.3.15, φ is computable. By the previous proposition the subshift $X_{\zeta_{\psi, F_1}}$ is sofic, as the localization map determines the tilling sequence $\{C_n\}_{n \in \mathbb{N}}$.

Question 7.5.9. For which S -decomposable groups does every computable directive sequence define a sofic subshift?

Bringing all together, suppose that for a monoform group G we had a version of Lemma 7.5.3 and Proposition 7.5.7. If both φ and F_1 were computable, the subshift defined by the substitution ζ_{φ, F_1} would be the factor of a strongly aperiodic G -SFT. This could provide new examples of groups which admit these SFTs.

Bibliography

- [AL74] Stal O Aanderaa and Harry R Lewis. «Linear Sampling and the $\forall\exists\forall$ Case of the Decision Problem». In: *The Journal of Symbolic Logic* 39.3 (1974), pp. 519–548 (cit. on p. 41).
- [Adl+09] Leonard Adleman, Jarkko Kari, Lila Kari, and Dustin Reishus. «The undecidability of the infinite ribbon problem: implications for computing by self-assembly». In: *SIAM J. Comput.* 38.6 (2009), pp. 2356–2381. ISSN: 0097-5397,1095-7111. DOI: [10.1137/080723971](https://doi.org/10.1137/080723971) (cit. on pp. iii, xiii, 54, 59, 61).
- [Ady57] Sergeĭ I. Adyan. «Unsolvability of some algorithmic problems in the theory of groups». In: *Trudy Moskov. Mat. Obšč.* 6 (1957), pp. 231–298. ISSN: 0134-8663 (cit. on p. 45).
- [Ady58] Sergeĭ I. Adyan. «On algorithmic problems in effectively complete classes of groups». In: *Dokl. Akad. Nauk SSSR* 123 (1958), pp. 13–16. ISSN: 0002-3264 (cit. on p. 45).
- [AD00] Sergeĭ I. Adyan and Valeriĭ G. Durnev. «Algorithmic problems for groups and semigroups». In: *Uspekhi Mat. Nauk* 55.2(332) (2000), pp. 3–94. ISSN: 0042-1316,2305-2872 (cit. on p. 18).
- [AN68] Sergeĭ I. Adyan and Petr S. Novikov. «Infinite periodic groups. I». In: *Izv. Akad. Nauk SSSR Ser. Mat.* 32 (1968), pp. 212–244. ISSN: 0373-2436 (cit. on p. 96).
- [AJ90] Sven Erick Alm and Svante Janson. «Random self-avoiding walks on one-dimensional lattices». In: *Stochastic Models* 6.2 (1990), pp. 169–212 (cit. on p. 77).
- [Alo90] Juan M. Alonso. «Inégalités isopérimétriques et quasi-isométries». In: *C. R. Acad. Sci. Paris Sér. I Math.* 311.12 (1990), pp. 761–764. ISSN: 0764-4442 (cit. on p. 25).
- [Anĭ71] Anatoliĭ V. Anĭsimov. «The group languages». In: *Kibernetika (Kiev)* 4 (1971), pp. 18–24. ISSN: 0023-1274 (cit. on p. 88).
- [Ano94] Dmitriĭ V. Anosov. «On N. N. Bogolyubov’s contribution to the theory of dynamical systems». In: *Uspekhi Mat. Nauk* 49.5(299) (1994), pp. 5–20. ISSN: 0042-1316,2305-2872 (cit. on p. 173).
- [Ant11] Yago Antolín. «On Cayley graphs of virtually free groups». In: *Groups Complex. Cryptol.* 3.2 (2011), pp. 301–327. ISSN: 1867-1144,1869-6104. DOI: [10.1515/gcc.2011.012](https://doi.org/10.1515/gcc.2011.012) (cit. on p. 17).
- [AC16] Yago Antolín and Laura Ciobanu. «Finite generating sets of relatively hyperbolic groups and applications to geodesic languages». In: *Transactions of the American Mathematical Society* 368.11 (2016), pp. 7965–8010 (cit. on p. 65).
- [ÁD23] Felipe Árbulu and Fabien Durand. «Dynamical properties of minimal Ferenczi subshifts». In: *Ergodic Theory Dynam. Systems* 43.12 (2023), pp. 3923–3970. ISSN: 0143-3857. DOI: [10.1017/etds.2023.7](https://doi.org/10.1017/etds.2023.7) (cit. on p. 151).
- [ÁDE23] Felipe Árbulu, Fabien Durand, and Bastián Espinoza. «The Jacobs–Keane theorem from the \mathcal{S} -adic viewpoint». In: *arXiv preprint arXiv:2307.10663* (2023) (cit. on p. 151).
- [ART23] Agatha Atkarskaya, Eliyahu Rips, and Katrin Tent. «The Burnside problem for odd exponents». In: *arXiv preprint arXiv:2303.15997* (2023) (cit. on p. 96).

- [Aub21] Nathalie Aubrun. «Dynamique symbolique sur des groupes: une approche informatique». 82 pages. Habilitation à diriger des recherches. Université Paris-Saclay, Apr. 2021 (cit. on p. 28).
- [ABJ18] Nathalie Aubrun, Sebastián Barbieri, and Emmanuel Jeandel. «About the domino problem for subshifts on groups». In: *Sequences, groups, and number theory*. Trends Math. Birkhäuser/Springer, Cham, 2018, pp. 331–389. ISBN: 978-3-319-69152-7; 978-3-319-69151-0. DOI: [10.1007/978-3-319-69152-7_9](https://doi.org/10.1007/978-3-319-69152-7_9) (cit. on pp. iii, xiii, 11, 28, 32, 42–45).
- [ABM19] Nathalie Aubrun, Sebastián Barbieri, and Etienne Moutot. «The domino problem is undecidable on surface groups». In: *44th International Symposium on Mathematical Foundations of Computer Science*. Vol. 138. LIPIcs. Leibniz Int. Proc. Inform. Schloss Dagstuhl. Leibniz-Zent. Inform., Wadern, 2019, Art. No. 46, 14. ISBN: 978-3-95977-117-7 (cit. on p. 42).
- [ABS17] Nathalie Aubrun, Sebastián Barbieri, and Mathieu Sablik. «A notion of effectiveness for subshifts on finitely generated groups». In: *Theoret. Comput. Sci.* 661 (2017), pp. 35–55. ISSN: 0304-3975,1879-2294. DOI: [10.1016/j.tcs.2016.11.033](https://doi.org/10.1016/j.tcs.2016.11.033) (cit. on pp. 26–28).
- [ABT19] Nathalie Aubrun, Sebastián Barbieri, and Stéphan Thomassé. «Realization of aperiodic subshifts and uniform densities in groups». In: *Groups, Geometry, and Dynamics* 13.1 (2019), pp. 107–129. DOI: [10.4171/ggd/487](https://doi.org/10.4171/ggd/487) (cit. on pp. 106, 118).
- [AK13] Nathalie Aubrun and Jarkko Kari. «Tiling problems on Baumslag-Solitar groups». In: *Proceedings: Machines, Computations and Universality 2013*. Vol. 128. Electron. Proc. Theor. Comput. Sci. (EPTCS). EPTCS, 2013, pp. 35–46. DOI: [10.4204/EPTCS.128.12](https://doi.org/10.4204/EPTCS.128.12) (cit. on pp. ix, xx, 42, 107, 125, 128, 139–141, 145).
- [AK21a] Nathalie Aubrun and Jarkko Kari. «Addendum to " Tilings problems on Baumslag-Solitar groups" ». In: *arXiv preprint arXiv:2101.12470* (2021) (cit. on pp. 145, 146).
- [AK21b] Nathalie Aubrun and Jarkko Kari. «On the domino problem of the Baumslag-Solitar groups». In: *Theoretical Computer Science* 894 (2021). Building Bridges – Honoring Nataša Jonoska on the Occasion of Her 60th Birthday, pp. 12–22. ISSN: 0304-3975 (cit. on pp. 140, 141, 143–146).
- [AS13] Nathalie Aubrun and Mathieu Sablik. «Simulation of effective subshifts by two-dimensional subshifts of finite type». In: *Acta Appl. Math.* 126 (2013), pp. 35–63. ISSN: 0167-8019,1572-9036. DOI: [10.1007/s10440-013-9808-5](https://doi.org/10.1007/s10440-013-9808-5) (cit. on pp. 31, 36).
- [AS14] Nathalie Aubrun and Mathieu Sablik. «Multidimensional effective \mathcal{S} -adic subshifts are sofic». In: *Unif. Distrib. Theory* 9.2 (2014), pp. 7–29. ISSN: 1336-913X (cit. on pp. iv, xiv, 151).
- [AS24] Nathalie Aubrun and Michael Schraudner. «Tilings of the hyperbolic plane of substitutive origin as subshifts of finite type on Baumslag-Solitar groups $BS(1, n)$ ». In: *Comptes Rendus. Mathématique* 362.G5 (2024), pp. 553–580 (cit. on pp. 106, 132, 139).
- [Aus67] Louis Auslander. «On a problem of Philip Hall». In: *Ann. of Math. (2)* 86 (1967), pp. 112–116. ISSN: 0003-486X. DOI: [10.2307/1970362](https://doi.org/10.2307/1970362) (cit. on p. 19).
- [Ava04] Agneta Avasjö. «Automata and growth functions of Coxeter groups». PhD thesis. Matematik, 2004 (cit. on p. 100).
- [BG13] Michael Baake and Uwe Grimm. *Aperiodic order. Vol. 1*. Vol. 149. Encyclopedia of Mathematics and its Applications. A mathematical invitation, With a foreword by Roger Penrose. Cambridge University Press, Cambridge, 2013, pp. xvi+531. ISBN: 978-0-521-86991-1. DOI: [10.1017/CB09781139025256](https://doi.org/10.1017/CB09781139025256) (cit. on pp. i, xi, 103).
- [BB99] Eric Babson and Itai Benjamini. «Cut sets and normed cohomology with applications to percolation». In: *Proc. Amer. Math. Soc.* 127.2 (1999), pp. 589–597. ISSN: 0002-9939,1088-6826. DOI: [10.1090/S0002-9939-99-04995-3](https://doi.org/10.1090/S0002-9939-99-04995-3) (cit. on p. 109).
- [BJ08] Alexis Ballier and Emmanuel Jeandel. «Tilings and model theory». In: *First Symposium on Cellular Automata "Journées Automates Cellulaires" (JAC 2008), Uzès, France, April 21-25, 2008. Proceedings*. MCCME Publishing House, Moscow, 2008, pp. 29–39 (cit. on pp. 36, 42).

- [BS18] Alexis Ballier and Maya Stein. «The domino problem on groups of polynomial growth». In: *Groups Geom. Dyn.* 12.1 (2018), pp. 93–105. ISSN: 1661-7207,1661-7215. DOI: [10.4171/GGD/439](https://doi.org/10.4171/GGD/439). URL: <https://doi.org/10.4171/GGD/439> (cit. on pp. [iii](#), [xiii](#), [30](#), [34](#), [42](#), [107](#)).
- [BL21] Alexandre Baraviera and Renaud Leplaideur. «Substreetutions and more on trees». In: *arXiv preprint arXiv:2112.05242* (2021) (cit. on pp. [iv](#), [xiv](#), [152](#)).
- [BL23] Alexandre Baraviera and Renaud Leplaideur. «The Jacaranda tree is strongly aperiodic and has zero entropy». In: *arXiv preprint arXiv:2304.08039* (2023) (cit. on p. [152](#)).
- [Bar19] Sebastián Barbieri. «A geometric simulation theorem on direct products of finitely generated groups». In: *Discrete Analysis* 09 (2019). ISSN: 2397-3129. DOI: [10.19086/da.8820](https://doi.org/10.19086/da.8820) (cit. on pp. [31](#), [106](#)).
- [Bar21] Sebastián Barbieri. «On the entropies of subshifts of finite type on countable amenable groups». In: *Groups Geom. Dyn.* 15.2 (2021), pp. 607–638. ISSN: 1661-7207,1661-7215. DOI: [10.4171/GGD/608](https://doi.org/10.4171/GGD/608) (cit. on pp. [30](#), [32](#)).
- [Bar23a] Sebastián Barbieri. «Aperiodic subshifts of finite type on groups which are not finitely generated». In: *Proc. Amer. Math. Soc.* 151.9 (2023), pp. 3839–3843. ISSN: 0002-9939,1088-6826. DOI: [10.1090/proc/16379](https://doi.org/10.1090/proc/16379) (cit. on pp. [107](#), [121](#)).
- [BS19] Sebastián Barbieri and Mathieu Sablik. «A generalization of the simulation theorem for semidirect products». In: *Ergodic Theory Dynam. Systems* 39.12 (2019), pp. 3185–3206. ISSN: 0143-3857,1469-4417. DOI: [10.1017/etds.2018.21](https://doi.org/10.1017/etds.2018.21) (cit. on pp. [31](#), [106](#)).
- [BSS21] Sebastián Barbieri, Mathieu Sablik, and Ville Salo. «Groups with self-simulable zero-dimensional dynamics». In: *arXiv preprint arXiv:2104.05141* (2021) (cit. on pp. [31](#), [106](#), [178](#)).
- [BSS23] Sebastián Barbieri, Mathieu Sablik, and Ville Salo. «Soficity of free extensions of effective subshifts». In: *arXiv preprint arXiv:2309.02620* (2023) (cit. on pp. [30](#), [106](#)).
- [Bar17] Sebastián Andrés Barbieri Lemp. «Shift spaces on groups: computability and dynamics». PhD thesis. Université de Lyon, 2017 (cit. on p. [12](#)).
- [Bar18] Laurent Bartholdi. «Amenability of groups and G -sets». In: *Sequences, groups, and number theory*. Trends Math. Birkhäuser/Springer, Cham, 2018, pp. 433–544. ISBN: 978-3-319-69152-7; 978-3-319-69151-0. DOI: [10.1007/978-3-319-69152-7_11](https://doi.org/10.1007/978-3-319-69152-7_11) (cit. on p. [20](#)).
- [Bar22] Laurent Bartholdi. «Monadic second-order logic and the domino problem on self-similar graphs». In: *Groups Geom. Dyn.* 16.4 (2022), pp. 1423–1459. ISSN: 1661-7207,1661-7215. DOI: [10.4171/ggd/689](https://doi.org/10.4171/ggd/689) (cit. on pp. [45](#), [70](#)).
- [Bar23b] Laurent Bartholdi. «The domino problem for hyperbolic groups». In: *arXiv preprint arXiv:2305.06952* (2023) (cit. on pp. [42](#), [44](#)).
- [BS22] Laurent Bartholdi and Ville Salo. «Simulations and the lamplighter group». In: *Groups Geom. Dyn.* 16.4 (2022), pp. 1461–1514. ISSN: 1661-7207,1661-7215. DOI: [10.4171/ggd/692](https://doi.org/10.4171/ggd/692) (cit. on p. [44](#)).
- [BS24] Laurent Bartholdi and Ville Salo. «Shifts on the lamplighter group». In: *arXiv preprint arXiv:2402.14508* (2024) (cit. on pp. [iv](#), [xiv](#), [30](#), [34](#), [42](#), [106](#), [152](#)).
- [Bas72] H. Bass. «The degree of polynomial growth of finitely generated nilpotent groups». In: *Proc. London Math. Soc. (3)* 25 (1972), pp. 603–614. ISSN: 0024-6115,1460-244X. DOI: [10.1112/plms/s3-25.4.603](https://doi.org/10.1112/plms/s3-25.4.603) (cit. on p. [19](#)).
- [BS62] Gilbert Baumslag and Donald Solitar. «Some two-generator one-relator non-Hopfian groups». In: *Bulletin of the American Mathematical Society* 68.3 (1962), pp. 199–201 (cit. on p. [125](#)).
- [BHP21] Siegfried Beckus, Tobias Hartnick, and Felix Pogorzelski. «Symbolic substitution systems beyond abelian groups». In: *arXiv preprint arXiv:2109.15210* (2021) (cit. on pp. [iv](#), [xiv](#), [152](#)).

- [BDD18] Marianna C. Bonanome, Margaret H. Dean, and Judith Putnam Dean. *A sampling of remarkable groups*. Compact Textbooks in Mathematics. Thompson's, self-similar, Lamplighter, and Baumslag-Solitar. Birkhäuser/Springer, Cham, 2018, pp. xii+188. ISBN: 978-3-030-01976-1; 978-3-030-01978-5. DOI: [10.1007/978-3-030-01978-5](https://doi.org/10.1007/978-3-030-01978-5) (cit. on p. 125).
- [Boo59] William W Boone. «The word problem». In: *Annals of mathematics* (1959), pp. 207–265 (cit. on p. 18).
- [BH74] William W. Boone and Graham Higman. «An algebraic characterization of groups with soluble word problem». In: *J. Austral. Math. Soc.* 18 (1974), pp. 41–53 (cit. on pp. 18, 36).
- [Bow07] Brian H. Bowditch. «The angel game in the plane». In: *Combin. Probab. Comput.* 16.3 (2007), pp. 345–362. ISSN: 0963-5483,1469-2163. DOI: [10.1017/S0963548306008297](https://doi.org/10.1017/S0963548306008297) (cit. on p. 110).
- [Bow17] Rufus Bowen. *Problem 108, Rufus Bowen's Notebook*. <https://bowen.pims.math.ca/problems/108>. Pacific Insititute for the Mathematical Sciences. 2017 (cit. on p. 75).
- [BL97] Mike Boyle and Douglas Lind. «Expansive subdynamics». In: *Transactions of the American Mathematical Society* 349.1 (1997), pp. 55–102 (cit. on p. 132).
- [BDM10] Xavier Bressaud, Fabien Durand, and Alejandro Maass. «On the eigenvalues of finite rank Bratteli-Vershik dynamical systems». In: *Ergodic Theory Dynam. Systems* 30.3 (2010), pp. 639–664. ISSN: 0143-3857 (cit. on p. 151).
- [Bri93] Stephen G. Brick. «Quasi-isometries and ends of groups». In: *J. Pure Appl. Algebra* 86.1 (1993), pp. 23–33. ISSN: 0022-4049,1873-1376. DOI: [10.1016/0022-4049\(93\)90150-R](https://doi.org/10.1016/0022-4049(93)90150-R) (cit. on p. 25).
- [Bri+12] Martin R Bridson, José Burillo, Murray Elder, and Zoran Šunić. «On groups whose geodesic growth is polynomial». In: *International Journal of Algebra and Computation* 22.05 (2012), p. 1250048 (cit. on pp. 99, 100, 123).
- [Bri+10] Martin R Bridson, Daniel Groves, Jonathan A Hillman, and Gaven J Martin. «Cofinitely Hopfian groups, open mappings and knot complements». In: *Groups, Geometry, and Dynamics* 4.4 (2010), pp. 693–707 (cit. on p. 56).
- [BH99] Martin R. Bridson and André Haefliger. *Metric spaces of non-positive curvature*. Vol. 319. Grundlehren der mathematischen Wissenschaften [Fundamental Principles of Mathematical Sciences]. Springer-Verlag, Berlin, 1999, pp. xxii+643. ISBN: 3-540-64324-9. DOI: [10.1007/978-3-662-12494-9](https://doi.org/10.1007/978-3-662-12494-9) (cit. on p. 25).
- [Bri00] Peter Brinkmann. «Hyperbolic automorphisms of free groups». In: *Geometric and Functional Analysis* 10.5 (2000), pp. 1071–1089 (cit. on p. 44).
- [BH57] S. R. Broadbent and John M. Hammersley. «Percolation processes. I. Crystals and mazes». In: *Proc. Cambridge Philos. Soc.* 53 (1957), pp. 629–641. ISSN: 0008-1981. DOI: [10.1017/s0305004100032680](https://doi.org/10.1017/s0305004100032680) (cit. on p. 109).
- [Büc62] J. Richard Büchi. «Turing-machines and the Entscheidungsproblem». In: *Math. Ann.* 148 (1962), pp. 201–213. ISSN: 0025-5831,1432-1807. DOI: [10.1007/BF01470748](https://doi.org/10.1007/BF01470748) (cit. on pp. iii, xiii, 45).
- [BM00] Marc Burger and Shahar Mozes. «Lattices in product of trees». In: *Inst. Hautes Études Sci. Publ. Math.* 92 (2000), pp. 151–194. ISSN: 0073-8301,1618-1913 (cit. on p. 76).
- [Bur02] William Burnside. «On an unsettled question in the theory of discontinuous groups». In: *Quart. J. Pure and Appl. Math.* 33 (1902), pp. 230–238 (cit. on p. 96).
- [Cab23] Christopher Cabezas. «Homomorphisms between multidimensional constant-shape substitutions». In: *Groups Geom. Dyn.* 17.4 (2023), pp. 1259–1323. ISSN: 1661-7207,1661-7215. DOI: [10.4171/ggd/726](https://doi.org/10.4171/ggd/726) (cit. on pp. iv, xiv, 151, 152, 158, 166).
- [CL24] Christopher Cabezas and Julien Leroy. «Decidability of the isomorphism problem between multidimensional substitutive subshifts». In: *arXiv preprint arXiv:2403.11357* (2024) (cit. on pp. iv, xiv, 151).

- [CP23] Christopher Cabezas and Samuel Petite. «Large normalizers of \mathbb{Z}^d -odometers systems and realization on substitutive subshifts». In: *arXiv preprint arXiv:2309.10156* (2023) (cit. on pp. [iv](#), [xiv](#), [151](#), [177](#)).
- [CH22] Antonin Callard and Benjamin Hellouin de Menibus. «The aperiodic Domino problem in higher dimension». In: *39th International Symposium on Theoretical Aspects of Computer Science*. Vol. 219. LIPIcs. Leibniz Int. Proc. Inform. Schloss Dagstuhl. Leibniz-Zent. Inform., Wadern, 2022, Art. No. 19, 15. ISBN: 978-3-95977-222-8 (cit. on pp. [45](#), [51](#), [53](#)).
- [CSV24] Antonin Callard, Léo Paviet Salomon, and Pascal Vanier. «Computability of extender sets in multidimensional subshifts». In: *arXiv preprint arXiv:2401.07549* (2024) (cit. on p. [31](#)).
- [Car23] Nicanor Carrasco-Vargas. «The geometric subgroup membership problem». In: *arXiv preprint arXiv:2303.14820* (2023) (cit. on p. [79](#)).
- [Car24] Nicanor Carrasco-Vargas. «Undecidability of dynamical properties of SFTs and sofic subshifts on \mathbb{Z}^2 and other groups». In: *arXiv preprint arXiv:2401.10347* (2024) (cit. on pp. [vii](#), [xviii](#), [53](#)).
- [CP15] David Carroll and Andrew Penland. «Periodic points on shifts of finite type and commensurability invariants of groups». In: *New York J. Math.* 21 (2015), pp. 811–822. ISSN: 1076-9803 (cit. on pp. [ix](#), [xix](#), [30](#), [32](#), [33](#), [106](#), [107](#), [129](#)).
- [CKZ21] Montserrat Casals-Ruiz, Ilya Kazachkov, and Alexander Zakharov. «Commensurability of Baumslag-Solitar groups». In: *Indiana Univ. Math. J.* 70.6 (2021), pp. 2527–2555. ISSN: 0022-2518,1943-5258. DOI: [10.1512/iumj.2021.70.9496](#) (cit. on p. [25](#)).
- [CC10] Tullio Ceccherini-Silberstein and Michel Coornaert. *Cellular Automata and Groups*. en. Springer Monographs in Mathematics. Berlin, Heidelberg: Springer Berlin Heidelberg, 2010. ISBN: 978-3-642-14033-4. DOI: [10.1007/978-3-642-14034-1](#) (cit. on pp. [6](#), [17](#), [20](#), [37](#), [79](#), [164](#), [172](#)).
- [CC12] Tullio Ceccherini-Silberstein and Michel Coornaert. «On the density of periodic configurations in strongly irreducible subshifts». In: *Nonlinearity* 25.7 (2012), pp. 2119–2131. ISSN: 0951-7715,1361-6544. DOI: [10.1088/0951-7715/25/7/2119](#) (cit. on p. [38](#)).
- [CC19] Paulina Cecchi and María Isabel Cortez. «Invariant measures for actions of congruent monotileable amenable groups». In: *Groups, Geometry, and Dynamics* 13.3 (2019), pp. 821–839 (cit. on pp. [ix](#), [xx](#), [159](#), [160](#)).
- [CCG23] Paulina Cecchi Bernales, María Isabel Cortez, and Jaime Gómez. «Invariant measures of Toeplitz subshifts on non-amenable groups». In: *arXiv preprint arXiv:2305.09835* (2023) (cit. on p. [159](#)).
- [CM04] Ruth Charney and John Meier. «The language of geodesics for Garside groups». In: *Mathematische Zeitschrift* 248.3 (2004), pp. 495–509 (cit. on p. [65](#)).
- [CLL22] Laura Ciobanu, Alex Levine, and Alan D Logan. «Post’s correspondence problem for hyperbolic and virtually nilpotent groups». In: *arXiv preprint arXiv:2211.12158* (2022) (cit. on p. [54](#)).
- [CL21] Laura Ciobanu and Alan D Logan. «Variations on the Post correspondence problem for free groups». In: *International Conference on Developments in Language Theory*. Springer, 2021, pp. 90–102 (cit. on p. [54](#)).
- [CMZ17] Anthony E. Clement, Stephen Majewicz, and Marcos Zyman. «Introduction to Nilpotent Groups». In: *The Theory of Nilpotent Groups*. Springer International Publishing, 2017, pp. 23–73. DOI: [10.1007/978-3-319-66213-8_2](#) (cit. on p. [69](#)).
- [Cli13] Nathan Clisby. «Endless self-avoiding walks». In: *Journal of Physics A: Mathematical and Theoretical* 46.23 (2013), p. 235001 (cit. on p. [93](#)).
- [Coh17] David Bruce Cohen. «The large scale geometry of strongly aperiodic subshifts of finite type». In: *Advances in Mathematics* 308 (2017), pp. 599–626 (cit. on pp. [iii](#), [xiv](#), [18](#), [44](#), [105](#), [106](#), [108](#), [120](#), [148](#)).

- [Coh20] David Bruce Cohen. «Lamplighters admit weakly aperiodic SFTs». In: *Groups, Geometry, and Dynamics* 14.4 (2020), pp. 1241–1252 (cit. on pp. 107, 108, 120).
- [CG17] David Bruce Cohen and Chaim Goodman-Strauss. «Strongly aperiodic subshifts on surface groups». In: *Groups, Geometry, and Dynamics* 11.3 (2017), pp. 1041–1059 (cit. on p. 106).
- [CGR22] David Bruce Cohen, Chaim Goodman-Strauss, and Yo’av Rieck. «Strongly aperiodic subshifts of finite type on hyperbolic groups». In: *Ergodic Theory and Dynamical Systems* 42.9 (2022), pp. 2740–2783 (cit. on pp. 106, 115).
- [CP19] David Bruce Cohen and Mark Pengitore. «Translation-like actions of nilpotent groups». In: *J. Topol. Anal.* 11.2 (2019), pp. 357–370. ISSN: 1793-5253,1793-7167. DOI: [10.1142/S179352531950016X](https://doi.org/10.1142/S179352531950016X) (cit. on p. 26).
- [Con96] John H. Conway. «The angel problem». In: *Games of no chance (Berkeley, CA, 1994)*. Vol. 29. Math. Sci. Res. Inst. Publ. Cambridge Univ. Press, Cambridge, 1996, pp. 3–12. ISBN: 0-521-57411-0 (cit. on p. 110).
- [CP06] Michel Coornaert and Athanase Papadopoulos. *Symbolic dynamics and hyperbolic groups*. Springer, 2006 (cit. on pp. 107, 120).
- [CP08] María Isabel Cortez and Samuel Petite. «G-odometers and their almost one-to-one extensions». In: *Journal of the London Mathematical Society* 78.1 (2008), pp. 1–20 (cit. on pp. ix, xx).
- [CP14] María Isabel Cortez and Samuel Petite. «Invariant measures and orbit equivalence for generalized Toeplitz subshifts». In: *Groups, Geometry, and Dynamics* 8.4 (2014), pp. 1007–1045 (cit. on p. 160).
- [CN08] Ethan M. Coven and Zbigniew H. Nitecki. «On the genesis of symbolic dynamics as we know it». In: *Colloq. Math.* 110.2 (2008), pp. 227–242. ISSN: 0010-1354,1730-6302. DOI: [10.4064/cm110-2-1](https://doi.org/10.4064/cm110-2-1) (cit. on pp. ii, xii).
- [Cra53] William Craig. «On axiomatizability within a system». In: *J. Symbolic Logic* 18 (1953), pp. 30–32. ISSN: 0022-4812,1943-5886. DOI: [10.2307/2266324](https://doi.org/10.2307/2266324) (cit. on p. 16).
- [Cri05] John Crisp. «Automorphisms and abstract commensurators of 2-dimensional Artin groups». In: *Geometry & Topology* 9.3 (2005), pp. 1381–1441 (cit. on p. 129).
- [CPW22] Toby Cubitt, David Perez-Garcia, and Michael M. Wolf. «Undecidability of the spectral gap». In: *Forum Math. Pi* 10 (2022), Paper No. e14, 102. ISSN: 2050-5086. DOI: [10.1017/fmp.2021.15](https://doi.org/10.1017/fmp.2021.15) (cit. on pp. i, xi, 54).
- [Cul96] Karel Culik II. «An aperiodic set of 13 Wang tiles». In: *Discrete Math.* 160.1-3 (1996), pp. 245–251. ISSN: 0012-365X,1872-681X. DOI: [10.1016/S0012-365X\(96\)00118-5](https://doi.org/10.1016/S0012-365X(96)00118-5) (cit. on p. 103).
- [CK95] Karel Culik II and Jarkko Kari. «An aperiodic set of Wang cubes». In: *J. UCS* 1.10 (1995), pp. 675–686. ISSN: 0948-695X,0948-6968 (cit. on pp. 104, 120).
- [DY08] François Dahmani and Ashi Yaman. «Symbolic dynamics and relatively hyperbolic groups». In: *Groups Geom. Dyn.* 2.2 (2008), pp. 165–184. ISSN: 1661-7207,1661-7215. DOI: [10.4171/GGD/35](https://doi.org/10.4171/GGD/35) (cit. on p. 28).
- [Deh11] Max Dehn. «Über unendliche diskontinuierliche Gruppen». In: *Math. Ann.* 71.1 (1911), pp. 116–144. ISSN: 0025-5831,1432-1807. DOI: [10.1007/BF01456932](https://doi.org/10.1007/BF01456932) (cit. on p. 17).
- [DRT17] Alberto L. Delgado, Derek J. S. Robinson, and Mathew Timm. «Cyclic normal subgroups of generalized Baumslag–Solitar groups». In: *Communications in Algebra* 45.4 (2017), pp. 1808–1818. DOI: [10.1080/00927872.2016.1226859](https://doi.org/10.1080/00927872.2016.1226859) (cit. on p. 132).
- [DR22] Julien Destombes and Andrei Romashchenko. «Resource-bounded Kolmogorov complexity provides an obstacle to soficness of multidimensional shifts». In: *J. Comput. System Sci.* 128 (2022), pp. 107–134. ISSN: 0022-0000,1090-2724. DOI: [10.1016/j.jcss.2022.04.002](https://doi.org/10.1016/j.jcss.2022.04.002) (cit. on p. 28).

- [Dik+22] Dikran Dikranjan, Antongiulio Fornasiero, Anna Giordano Bruno, and Flavio Salizzoni. «The addition theorem for locally monotileable monoid actions». In: *Journal of Pure and Applied Algebra* 227.1 (2022), p. 107113 (cit. on pp. 159, 160).
- [Don+21] Sebastián Donoso, Fabien Durand, Alejandro Maass, and Samuel Petite. «Interplay between finite topological rank minimal Cantor systems, \mathcal{S} -adic subshifts and their complexity». In: *Trans. Amer. Math. Soc.* 374.5 (2021), pp. 3453–3489. ISSN: 0002-9947,1088-6850. DOI: [10.1090/tran/8315](https://doi.org/10.1090/tran/8315) (cit. on pp. iv, xiv, 151).
- [DFR16] Tomasz Downarowicz, Bartosz Frej, and Pierre-Paul Romagnoli. «Shearer’s inequality and infimum rule for Shannon entropy and topological entropy». In: *Dynamics and numbers*. Vol. 669. Contemp. Math. Amer. Math. Soc., Providence, RI, 2016, pp. 63–75. ISBN: 978-1-4704-2020-8 (cit. on p. 29).
- [DK18] Cornelia Druțu and Michael Kapovich. *Geometric group theory*. Vol. 63. American Mathematical Society Colloquium Publications. With an appendix by Bogdan Nica. American Mathematical Society, Providence, RI, 2018, pp. xx+819. ISBN: 978-1-4704-1104-6. DOI: [10.1090/co11/063](https://doi.org/10.1090/co11/063) (cit. on p. 25).
- [Dum18] Hugo Duminil-Copin. «Sixty years of percolation». In: *Proceedings of the International Congress of Mathematicians—Rio de Janeiro 2018. Vol. IV. Invited lectures*. World Sci. Publ., Hackensack, NJ, 2018, pp. 2829–2856. ISBN: 978-981-3272-93-4; 978-981-3272-87-3 (cit. on p. 109).
- [Dum+20] Hugo Duminil-Copin, Subhajit Goswami, Aran Raoufi, Franco Severo, and Ariel Yadin. «Existence of phase transition for percolation using the Gaussian free field». In: *Duke Math. J.* 169.18 (2020), pp. 3539–3563. ISSN: 0012-7094,1547-7398. DOI: [10.1215/00127094-2020-0036](https://doi.org/10.1215/00127094-2020-0036) (cit. on p. 109).
- [DS12] Hugo Duminil-Copin and Stanislav Smirnov. «The connective constant of the honeycomb lattice equals $\sqrt{2 + \sqrt{2}}$ ». In: *Annals of Mathematics* (2012), pp. 1653–1665 (cit. on pp. 77, 95).
- [Dun85] Martin J. Dunwoody. «The accessibility of finitely presented groups». In: *Invent. Math.* 81.3 (1985), pp. 449–457. ISSN: 0020-9910,1432-1297. DOI: [10.1007/BF01388581](https://doi.org/10.1007/BF01388581) (cit. on p. 126).
- [DRS12] Bruno Durand, Andrei Romashchenko, and Alexander Shen. «Fixed-point tile sets and their applications». In: *Journal of Computer and System Sciences* 78.3 (2012), pp. 731–764 (cit. on pp. iv, xiv, 31, 36, 41, 151).
- [Dur10] Fabien Durand. «Combinatorics on Bratteli diagrams and dynamical systems». In: *Combinatorics, automata and number theory*. Vol. 135. Encyclopedia Math. Appl. Cambridge Univ. Press, Cambridge, 2010, pp. 324–372 (cit. on p. 151).
- [DFM19] Fabien Durand, Alexander Frank, and Alejandro Maass. «Eigenvalues of minimal Cantor systems». In: *J. Eur. Math. Soc. (JEMS)* 21.3 (2019), pp. 727–775. ISSN: 1435-9855. DOI: [10.4171/JEMS/849](https://doi.org/10.4171/JEMS/849) (cit. on p. 151).
- [DHS99] Fabien Durand, Bernard Host, and Christian Skau. «Substitutional dynamical systems, Bratteli diagrams and dimension groups». In: *Ergodic Theory Dynam. Systems* 19.4 (1999), pp. 953–993. ISSN: 0143-3857. DOI: [10.1017/S0143385799133947](https://doi.org/10.1017/S0143385799133947) (cit. on p. 151).
- [Dys74] Verena Huber Dyson. «A family of groups with nice word problems». In: *J. Austral. Math. Soc.* 17 (1974), pp. 414–425 (cit. on p. 37).
- [Ebb82] Heinz-Dieter Ebbinghaus. «Undecidability of some domino connectability problems». In: *Mathematical Logic Quarterly* 28.22-24 (1982), pp. 331–336 (cit. on pp. iii, xiii, 59, 61).
- [Ebb87] Heinz-Dieter Ebbinghaus. *Domino threads and complexity*. ed. by Egon Börger. Vol. 270. Lecture Notes in Computer Science. Berlin, Heidelberg: Springer Berlin Heidelberg, 1987, pp. 131–142. ISBN: 978-3-540-18170-5. DOI: [10.1007/3-540-18170-9_161](https://doi.org/10.1007/3-540-18170-9_161). URL: http://link.springer.com/10.1007/3-540-18170-9%5C_161 (cit. on pp. 59, 66).
- [EP22] Murray Elder and Adam Piggott. «Rewriting systems, plain groups, and geodetic graphs». In: *Theoret. Comput. Sci.* 903 (2022), pp. 134–144. ISSN: 0304-3975,1879-2294. DOI: [10.1016/j.tcs.2021.12.022](https://doi.org/10.1016/j.tcs.2021.12.022) (cit. on p. 82).

- [Eps61] David B. A. Epstein. «Factorization of 3-manifolds». In: *Comment. Math. Helv.* 36 (1961), pp. 91–102. ISSN: 0010-2571,1420-8946. DOI: [10.1007/BF02566894](https://doi.org/10.1007/BF02566894) (cit. on p. 92).
- [Eps+92] David B. A. Epstein, James W. Cannon, Derek F. Holt, Silvio V. F. Levy, Michael S. Paterson, and William P. Thurston. *Word processing in groups*. Jones and Bartlett Publishers, Boston, MA, 1992, pp. xii+330. ISBN: 0-86720-244-0 (cit. on p. 65).
- [Esn22] Solene Esnay. «Limitation of the Complexity of Some Invariants of Subshifts by Dynamical and Structural Constraints». PhD thesis. Université Paul Sabatier-Toulouse III, 2022 (cit. on p. 123).
- [EM22a] Solène J Esnay and Etienne Moutot. «Aperiodic SFTs on Baumslag-Solitar groups». In: *Theoretical Computer Science* 917 (2022), pp. 31–50 (cit. on pp. [viii](#), [xix](#), [106](#), [120](#), [125](#), [139](#)).
- [EGL23] Louis Esperet, Ugo Giocanti, and Clément Legrand-Duchesne. «The structure of quasi-transitive graphs avoiding a minor with applications to the domino problem». In: *arXiv preprint arXiv:2304.01823* (2023) (cit. on p. 42).
- [Esp23a] Bastián Espinoza. «Symbolic factors of \mathcal{S} -adic subshifts of finite alphabet rank». In: *Ergodic Theory Dynam. Systems* 43.5 (2023), pp. 1511–1547. ISSN: 0143-3857. DOI: [10.1017/etds.2022.21](https://doi.org/10.1017/etds.2022.21) (cit. on p. 151).
- [Esp23b] Bastián Espinoza. «The structure of low complexity subshifts». In: *arXiv preprint arXiv:2305.03096* (2023) (cit. on pp. [iv](#), [xiv](#), [151](#)).
- [EM22b] Bastián Espinoza and Alejandro Maass. «On the automorphism group of minimal \mathcal{S} -adic subshifts of finite alphabet rank». In: *Ergodic Theory Dynam. Systems* 42.9 (2022), pp. 2800–2822. ISSN: 0143-3857. DOI: [10.1017/etds.2021.64](https://doi.org/10.1017/etds.2021.64) (cit. on p. 151).
- [Etz91] Yael Etzion. «On the Solvability of Domino Snake Problems». MA thesis. Rehovot, Israel: Dept. of Applied Math. and Computer Science, Weizmann Institute of Science, 1991 (cit. on p. 59).
- [EHM94] Yael Etzion-Petruschka, David Harel, and Dale Myers. «On the solvability of domino snake problems». In: *Theoretical Computer Science* 131.2 (1994), pp. 243–269 (cit. on pp. 59, 61).
- [FM99] Benson Farb and Lee Mosher. «Quasi-isometric rigidity for the solvable Baumslag-Solitar groups. II». In: *Invent. Math.* 137.3 (1999), pp. 613–649. ISSN: 0020-9910,1432-1297. DOI: [10.1007/s002220050337](https://doi.org/10.1007/s002220050337) (cit. on p. 128).
- [Far81] Daniel R. Farkas. «Crystallographic groups and their mathematics». In: *Rocky Mountain J. Math.* 11.4 (1981), pp. 511–551. ISSN: 0035-7596,1945-3795. DOI: [10.1216/RMJ-1981-11-4-511](https://doi.org/10.1216/RMJ-1981-11-4-511) (cit. on p. 167).
- [Fek23] Michael Fekete. «Über die Verteilung der Wurzeln bei gewissen algebraischen Gleichungen mit ganzzahligen Koeffizienten». In: *Math. Z.* 17.1 (1923), pp. 228–249. ISSN: 0025-5874,1432-1823. DOI: [10.1007/BF01504345](https://doi.org/10.1007/BF01504345) (cit. on p. 29).
- [Fer96] Sébastien Ferenczi. «Rank and symbolic complexity». In: *Ergodic Theory Dynam. Systems* 16.4 (1996), pp. 663–682. ISSN: 0143-3857. DOI: [10.1017/S0143385700009032](https://doi.org/10.1017/S0143385700009032) (cit. on pp. [iv](#), [xiv](#), [151](#)).
- [FS08] Henning Fernau and Ralf Stiebe. «Blind counter automata on ω -words». In: *Fund. Inform.* 83.1-2 (2008), pp. 51–64. ISSN: 0169-2968,1875-8681 (cit. on p. 65).
- [FO10] Thomas Fernique and Nicolas Ollinger. «Combinatorial substitutions and sofic tilings». In: *arXiv preprint arXiv:1009.5167* (2010) (cit. on p. 178).
- [Fio09] Francesca Fiorenzi. «Periodic configurations of subshifts on groups». In: *Internat. J. Algebra Comput.* 19.3 (2009), pp. 315–335. ISSN: 0218-1967,1793-6500. DOI: [10.1142/S02181967090005123](https://doi.org/10.1142/S02181967090005123) (cit. on p. 38).
- [Flo49] Paul J Flory. «The configuration of real polymer chains». In: *The Journal of Chemical Physics* 17.3 (1949), pp. 303–310 (cit. on p. 75).

- [Fog02] N. Pytheas Fogg. *Substitutions in dynamics, arithmetics and combinatorics*. Ed. by Valérie Berthé, S. Ferenczi, C. Mauduit, and A. Siegel. Vol. 1794. Lecture Notes in Mathematics. Springer-Verlag, Berlin, 2002, pp. xviii+402. ISBN: 3-540-44141-7. DOI: [10.1007/b13861](https://doi.org/10.1007/b13861) (cit. on p. 5).
- [Føl55] Erling Følner. «On groups with full Banach mean value». In: *Math. Scand.* 3 (1955), pp. 243–254. ISSN: 0025-5521,1903-1807. DOI: [10.7146/math.scand.a-10442](https://doi.org/10.7146/math.scand.a-10442) (cit. on p. 25).
- [Fra08] Natalie Priebe Frank. «A primer of substitution tilings of the Euclidean plane». In: *Expo. Math.* 26.4 (2008), pp. 295–326. ISSN: 0723-0869,1878-0792. DOI: [10.1016/j.exmath.2008.02.001](https://doi.org/10.1016/j.exmath.2008.02.001) (cit. on p. 152).
- [Fra70] John Franks. «Anosov diffeomorphisms». In: *Global Analysis (Proc. Sympos. Pure Math., Vols. XIV, XV, XVI, Berkeley, Calif., 1968)*. Vol. XIV-XVI. Proc. Sympos. Pure Math. Amer. Math. Soc., Providence, RI, 1970, pp. 61–93 (cit. on p. 167).
- [Fre98] Michael H. Freedman. «Limit, logic, and computation». In: *Proc. Natl. Acad. Sci. USA* 95.1 (1998), pp. 95–97. ISSN: 0027-8424,1091-6490. DOI: [10.1073/pnas.95.1.95](https://doi.org/10.1073/pnas.95.1.95) (cit. on p. 54).
- [Fre99] Michael H. Freedman. « k -SAT on groups and undecidability». In: *STOC '98 (Dallas, TX)*. ACM, New York, 1999, pp. 572–576 (cit. on pp. iii, vii, xiii, xviii, 54).
- [Fre44] Hans Freudenthal. «Über die enden diskreter räume und gruppen». In: *Commentarii Mathematici Helvetici* 17.1 (1944), pp. 1–38 (cit. on pp. 23, 89).
- [Fur60] Harry Furstenberg. *Stationary processes and prediction theory*. Vol. No. 44. Annals of Mathematics Studies. Princeton University Press, Princeton, NJ, 1960, pp. x+283 (cit. on p. 173).
- [GJS09] Su Gao, Steve Jackson, and Brandon Seward. «A coloring property for countable groups». In: *Math. Proc. Cambridge Philos. Soc.* 147.3 (2009), pp. 579–592. ISSN: 0305-0041,1469-8064. DOI: [10.1017/S0305004109002655](https://doi.org/10.1017/S0305004109002655) (cit. on p. 106).
- [GJS16] Su Gao, Steve Jackson, and Brandon Seward. «Group colorings and Bernoulli subflows». In: *Mem. Amer. Math. Soc.* 241.1141 (2016), pp. vi+241. ISSN: 0065-9266,1947-6221. DOI: [10.1090/memo/1141](https://doi.org/10.1090/memo/1141) (cit. on pp. ix, xx, 159, 160, 168).
- [Gel95] Götz Gelbrich. «Self-similar tilings and expanding homomorphisms of groups». In: *Arch. Math. (Basel)* 65.6 (1995), pp. 481–491. ISSN: 0003-889X,1420-8938. DOI: [10.1007/BF01194164](https://doi.org/10.1007/BF01194164) (cit. on p. 167).
- [Gen] Anthony Genevois. *Existence of n -axial elements in groups with at least 2 ends*. MathOverflow. (version: 2019-09-19). URL: <https://mathoverflow.net/q/341991> (cit. on p. 105).
- [Gen08] Thanos Gentimis. «Asymptotic dimension of finitely presented groups». In: *Proc. Amer. Math. Soc.* 136.12 (2008), pp. 4103–4110. ISSN: 0002-9939,1088-6826. DOI: [10.1090/S0002-9939-08-08973-9](https://doi.org/10.1090/S0002-9939-08-08973-9) (cit. on p. 126).
- [Ger86] Peter Gerl. «Eine isoperimetrische Eigenschaft von Bäumen». In: *Österreich. Akad. Wiss. Math.-Natur. Kl. Sitzungsber. II* 195.1-3 (1986), pp. 49–52. ISSN: 0723-9319,1728-0540 (cit. on p. 113).
- [Ger88] Peter Gerl. «Random walks on graphs with a strong isoperimetric property». In: *J. Theoret. Probab.* 1.2 (1988), pp. 171–187. ISSN: 0894-9840,1572-9230. DOI: [10.1007/BF01046933](https://doi.org/10.1007/BF01046933) (cit. on p. 113).
- [GL22] France Gheeraert and Julien Leroy. « \mathcal{S} -adic characterization of minimal dendric shifts». In: *arXiv preprint arXiv:2206.00333* (2022) (cit. on p. 151).
- [GH90] É. Ghys and P. de la Harpe, eds. *Sur les groupes hyperboliques d'après Mikhael Gromov*. Vol. 83. Progress in Mathematics. Papers from the Swiss Seminar on Hyperbolic Groups held in Bern, 1988. Birkhäuser Boston, Inc., Boston, MA, 1990, pp. xii+285. ISBN: 0-8176-3508-4. DOI: [10.1007/978-1-4684-9167-8](https://doi.org/10.1007/978-1-4684-9167-8) (cit. on p. 25).
- [Gil22] Martín Gilabert Vio. «Subshifts sobre grupos virtualmente cíclicos». MA thesis. Santiago, Chile: Facultad de Ciencias Físicas y Matemáticas, Universidad de Chile, 2022 (cit. on p. 92).

- [GM17] Lorenz A Gilch and Sebastian Müller. «Counting self-avoiding walks on free products of graphs». In: *Discrete Mathematics* 340.3 (2017), pp. 325–332 (cit. on pp. 77, 83).
- [Gil14] Pierre Gillibert. «The finiteness problem for automaton semigroups is undecidable». In: *Internat. J. Algebra Comput.* 24.1 (2014), pp. 1–9. ISSN: 0218-1967,1793-6500. DOI: [10.1142/S0218196714500015](https://doi.org/10.1142/S0218196714500015) (cit. on p. 54).
- [Gil+07] Robert H Gilman, Susan Hermiller, Derek F Holt, and Sarah Rees. «A characterisation of virtually free groups». In: *Archiv der Mathematik* 89.4 (2007), pp. 289–295 (cit. on p. 98).
- [GJ00] Richard Gjerde and Ørjan Johansen. «Bratteli-Vershik models for Cantor minimal systems: applications to Toeplitz flows». In: *Ergodic Theory Dynam. Systems* 20.6 (2000), pp. 1687–1710. ISSN: 0143-3857. DOI: [10.1017/S0143385700000948](https://doi.org/10.1017/S0143385700000948) (cit. on p. 151).
- [GJ02] Richard Gjerde and Ørjan Johansen. «Bratteli-Vershik models for Cantor minimal systems associated to interval exchange transformations». In: *Math. Scand.* 90.1 (2002), pp. 87–100. ISSN: 0025-5521. DOI: [10.7146/math.scand.a-14363](https://doi.org/10.7146/math.scand.a-14363) (cit. on p. 151).
- [Goo05] Chaim Goodman-Strauss. «A strongly aperiodic set of tiles in the hyperbolic plane». In: *Invent. Math.* 159.1 (2005), pp. 119–132. ISSN: 0020-9910,1432-1297. DOI: [10.1007/s00222-004-0384-1](https://doi.org/10.1007/s00222-004-0384-1) (cit. on p. 104).
- [GHV18] Anael Grandjean, Benjamin Hellouin de Menibus, and Pascal Vanier. «Aperiodic point in \mathbb{Z}^2 -subshifts». In: *45th International Colloquium on Automata, Languages, and Programming*. Vol. 107. LIPIcs. Leibniz Int. Proc. Inform. Schloss Dagstuhl. Leibniz-Zent. Inform., Wadern, 2018, Art. No. 128, 13. ISBN: 978-3-95977-076-7 (cit. on pp. iii, xiii, 45, 51).
- [GT23] Rachel Greenfeld and Terence Tao. «Undecidability of translational monotilings». In: *arXiv preprint arXiv:2309.09504* (2023) (cit. on p. 54).
- [Gre78] Sheila A. Greibach. «Remarks on blind and partially blind one-way multicounter machines». In: *Theoret. Comput. Sci.* 7.3 (1978), pp. 311–324. ISSN: 0304-3975,1879-2294. DOI: [10.1016/0304-3975\(78\)90020-8](https://doi.org/10.1016/0304-3975(78)90020-8) (cit. on p. 65).
- [GS24] Rostislav Grigorchuk and Ville Salo. «SFT covers for actions of the first Grigorchuk group». In: *arXiv preprint arXiv:2403.06480* (2024) (cit. on p. 34).
- [Gri89] Geoffrey R. Grimmett. *Percolation*. Springer-Verlag, New York, 1989, pp. xii+296. ISBN: 0-387-96843-1 (cit. on p. 109).
- [GHP14] Geoffrey R. Grimmett, Alexander E Holroyd, and Yuval Peres. «Extendable self-avoiding walks». In: *Annales de l'Institut Henri Poincaré D* 1.1 (2014), pp. 61–75 (cit. on p. 79).
- [GL14] Geoffrey R. Grimmett and Zhongyang Li. «Strict inequalities for connective constants of transitive graphs». In: *SIAM Journal on Discrete Mathematics* 28.3 (2014), pp. 1306–1333 (cit. on p. 78).
- [GL15] Geoffrey R. Grimmett and Zhongyang Li. «Bounds on connective constants of regular graphs». In: *Combinatorica* 35.3 (2015), pp. 279–294 (cit. on p. 78).
- [GL17a] Geoffrey R. Grimmett and Zhongyang Li. «Connective constants and height functions for Cayley graphs». In: *Transactions of the American Mathematical Society* 369.8 (2017), pp. 5961–5980 (cit. on p. 95).
- [GL17b] Geoffrey R. Grimmett and Zhongyang Li. «Self-Avoiding Walks and Amenability». In: *The Electronic Journal of Combinatorics* (2017), P4–38 (cit. on pp. 94, 95).
- [GL18] Geoffrey R. Grimmett and Zhongyang Li. «Locality of connective constants». In: *Discrete Math.* 341.12 (2018), pp. 3483–3497. ISSN: 0012-365X,1872-681X. DOI: [10.1016/j.disc.2018.08.013](https://doi.org/10.1016/j.disc.2018.08.013) (cit. on pp. 94, 95).

- [GL19] Geoffrey R. Grimmett and Zhongyang Li. «Self-avoiding walks and connective constants». In: *Sojourns in probability theory and statistical physics. III. Interacting particle systems and random walks, a Festschrift for Charles M. Newman*. Vol. 300. Springer Proc. Math. Stat. Springer, Singapore, 2019, pp. 215–241. ISBN: 978-981-15-0302-3; 978-981-15-0301-6. DOI: [10.1007/978-981-15-0302-3_8](https://doi.org/10.1007/978-981-15-0302-3_8) (cit. on pp. 75, 78).
- [GL20] Geoffrey R. Grimmett and Zhongyang Li. «Cubic graphs and the golden mean». In: *Discrete Math.* 343.1 (2020), pp. 111638, 32. ISSN: 0012-365X,1872-681X. DOI: [10.1016/j.disc.2019.111638](https://doi.org/10.1016/j.disc.2019.111638) (cit. on p. 95).
- [Gro81] Mikhael Gromov. «Groups of polynomial growth and expanding maps». In: *Inst. Hautes Études Sci. Publ. Math.* 53 (1981), pp. 53–73. ISSN: 0073-8301,1618-1913 (cit. on pp. 19, 167).
- [Gro87] Mikhael Gromov. «Hyperbolic groups». In: *Essays in group theory*. Springer, 1987, pp. 75–263 (cit. on pp. 25, 107, 120).
- [Gro93] Mikhael Gromov. «Asymptotic invariants of infinite groups». In: *Geometric group theory, Vol. 2 (Sussex, 1991)*. Vol. 182. London Math. Soc. Lecture Note Ser. Cambridge Univ. Press, Cambridge, 1993, pp. 1–295. ISBN: 0-521-44680-5 (cit. on p. 118).
- [GS87] Branko Grünbaum and G. C. Shephard. *Tilings and patterns*. W. H. Freeman and Company, New York, 1987, pp. xii+700. ISBN: 0-7167-1193-1 (cit. on p. 103).
- [Gui+19] Pierre Guillon, Emmanuel Jeandel, Jarkko Kari, and Pascal Vanier. «Undecidable word problem in subshift automorphism groups». In: *Computer science—theory and applications*. Vol. 11532. Lecture Notes in Comput. Sci. Springer, Cham, 2019, pp. 180–190. ISBN: 978-3-030-19955-5; 978-3-030-19954-8. DOI: [10.1007/978-3-030-19955-5_16](https://doi.org/10.1007/978-3-030-19955-5_16) (cit. on p. 18).
- [Gui70] Yves Guivarc’h. «Groupes de Lie à croissance polynomiale». In: *C. R. Acad. Sci. Paris Sér. A-B* 271 (1970), A237–A239. ISSN: 0151-0509 (cit. on p. 19).
- [GK72] Yu Gurevich and Koryakov. «Remarks on Berger’s paper on the domino problem». In: *Siberian Mathematical Journal* 13.2 (1972), pp. 319–321 (cit. on pp. 45, 51).
- [Had98] Jacques S. Hadamard. «Les surfaces à courbures opposées et leurs lignes géodésique». In: *Journal de Mathématiques Pures et Appliquées* 4 (1898), pp. 27–73 (cit. on pp. ii, xii).
- [Hal64] Rudolf Halin. «Über unendliche wege in graphen». In: *Mathematische Annalen* 157.2 (1964), pp. 125–137 (cit. on p. 89).
- [Hal65] Rudolf Halin. «Über die Maximalzahl fremder unendlicher Wege in Graphen». In: *Math. Nachr.* 30 (1965), pp. 63–85. ISSN: 0025-584X,1522-2616. DOI: [10.1002/mana.19650300106](https://doi.org/10.1002/mana.19650300106) (cit. on p. 42).
- [Hal73] Rudolf Halin. «Automorphisms and endomorphisms of infinite locally finite graphs». In: *Abh. Math. Sem. Univ. Hamburg* 39 (1973), pp. 251–283. ISSN: 0025-5858,1865-8784. DOI: [10.1007/BF02992834](https://doi.org/10.1007/BF02992834) (cit. on pp. 86, 90, 105).
- [Hal58] Marshall Hall Jr. «Solution of the Burnside problem for exponent six». In: *Illinois J. Math.* 2 (1958), pp. 764–786. ISSN: 0019-2082 (cit. on p. 96).
- [Ham61] John M. Hammersley. «The number of polygons on a lattice». In: *Mathematical Proceedings of the Cambridge Philosophical Society*. Vol. 57. 3. Cambridge University Press. 1961, pp. 516–523 (cit. on p. 96).
- [HM54] John M. Hammersley and K William Morton. «Poor man’s Monte Carlo». In: *Journal of the Royal Statistical Society: Series B (Methodological)* 16.1 (1954), pp. 23–38 (cit. on p. 77).
- [HW62] John M. Hammersley and D. J. A. Welsh. «Further results on the rate of convergence to the connective constant of the hypercubical lattice». In: *Quart. J. Math. Oxford Ser. (2)* 13 (1962), pp. 108–110. ISSN: 0033-5606,1464-3847. DOI: [10.1093/qmath/13.1.108](https://doi.org/10.1093/qmath/13.1.108) (cit. on p. 94).
- [Han74] William Hanf. «Nonrecursive tilings of the plane. I». In: *J. Symbolic Logic* 39 (1974), pp. 283–285. ISSN: 0022-4812,1943-5886. DOI: [10.2307/2272640](https://doi.org/10.2307/2272640) (cit. on pp. iii, xiii, 108).

- [Har85] David Harel. «Recurring dominoes: making the highly undecidable highly understandable». In: *Topics in the theory of computation (Borgholm, 1983)*. Vol. 102. North-Holland Math. Stud. North-Holland, Amsterdam, 1985, pp. 51–71. ISBN: 0-444-87647-2 (cit. on pp. [iii](#), [xiii](#), [15](#), [45](#)).
- [Har86] David Harel. «Effective transformations on infinite trees, with applications to high undecidability, dominoes, and fairness». In: *J. Assoc. Comput. Mach.* 33.1 (1986), pp. 224–248. ISSN: 0004-5411,1557-735X. DOI: [10.1145/4904.4993](#) (cit. on p. [45](#)).
- [Har83] Robert H Haring-Smith. «Groups and simple languages». In: *Transactions of the American Mathematical Society* 279.1 (1983), pp. 337–356 (cit. on p. [82](#)).
- [Hed69] Gustav A. Hedlund. «Endomorphisms and automorphisms of the shift dynamical system». In: *Math. Systems Theory* 3 (1969), pp. 320–375. ISSN: 0025-5661. DOI: [10.1007/BF01691062](#) (cit. on p. [6](#)).
- [HM20] Benjamin Hellouin de Menibus and Hugo Maturana Cornejo. «Necessary conditions for tiling finitely generated amenable groups». In: *Discrete Contin. Dyn. Syst.* 40.4 (2020), pp. 2335–2346. ISSN: 1078-0947,1553-5231. DOI: [10.3934/dcds.2020116](#) (cit. on p. [49](#)).
- [HPS92] Richard H. Herman, Ian F. Putnam, and Christian Skau. «Ordered Bratteli diagrams, dimension groups and topological dynamics». In: *Internat. J. Math.* 3.6 (1992), pp. 827–864. ISSN: 0129-167X. DOI: [10.1142/S0129167X92000382](#) (cit. on p. [151](#)).
- [HS08] Peter Hertling and Christoph Spandl. «Shifts with decidable language and non-computable entropy». In: *Discrete Mathematics & Theoretical Computer Science* 10.Automata, Logic and Semantics (2008) (cit. on p. [29](#)).
- [Hig40] Graham Higman. «The units of group-rings». In: *Proceedings of the London Mathematical Society* 2.1 (1940), pp. 231–248 (cit. on p. [117](#)).
- [Hig51] Graham Higman. «A finitely related group with an isomorphic proper factor group». In: *Journal of the London Mathematical Society* 1.1 (1951), pp. 59–61 (cit. on pp. [94](#), [125](#)).
- [Hig61] Graham Higman. «Subgroups of finitely presented groups». In: *Proc. Roy. Soc. London Ser. A* 262 (1961), pp. 455–475. ISSN: 0962-8444,2053-9169. DOI: [10.1098/rspa.1961.0132](#) (cit. on p. [16](#)).
- [HNN49] Graham Higman, B. H. Neumann, and Hanna Neumann. «Embedding theorems for groups». In: *J. London Math. Soc.* 24 (1949), pp. 247–254. ISSN: 0024-6107,1469-7750. DOI: [10.1112/jlms/s1-24.4.247](#) (cit. on p. [21](#)).
- [Hoc09] Michael Hochman. «On the dynamics and recursive properties of multidimensional symbolic systems». In: *Invent. Math.* 176.1 (2009), pp. 131–167. ISSN: 0020-9910,1432-1297. DOI: [10.1007/s00222-008-0161-7](#) (cit. on pp. [26](#), [31](#), [36](#)).
- [HM10] Michael Hochman and Tom Meyerovitch. «A characterization of the entropies of multidimensional shifts of finite type». In: *Ann. of Math. (2)* 171.3 (2010), pp. 2011–2038. ISSN: 0003-486X,1939-8980. DOI: [10.4007/annals.2010.171.2011](#) (cit. on pp. [iii](#), [xiii](#), [29](#), [30](#)).
- [HR12] Derek F Holt and Sarah Rees. «Artin groups of large type are shortlex automatic with regular geodesics». In: *Proceedings of the London Mathematical Society* 104.3 (2012), pp. 486–512 (cit. on p. [65](#)).
- [Hop43] Heinz Hopf. «Enden offener Räume und unendliche diskontinuierliche Gruppen». In: *Commentarii Mathematici Helvetici* 16.1 (1943), pp. 81–100 (cit. on pp. [23](#), [89](#)).
- [How93] Robert B Howlett. *Miscellaneous facts about Coxeter groups*. School of Mathematics and Statistics, University of Sydney, 1993 (cit. on p. [65](#)).
- [HO13] Michael Hull and Denis Osin. «Conjugacy growth of finitely generated groups». In: *Adv. Math.* 235 (2013), pp. 361–389. ISSN: 0001-8708,1090-2082. DOI: [10.1016/j.aim.2012.12.007](#) (cit. on p. [25](#)).
- [Iva94] Sergei V Ivanov. «The free Burnside groups of sufficiently large exponents». In: *International Journal of Algebra and Computation* 4.01n02 (1994), pp. 1–308 (cit. on p. [96](#)).

- [JSG16] Jesper Lykke Jacobsen, Christian R. Scullard, and Anthony J. Guttmann. «On the growth constant for square-lattice self-avoiding walks». In: *J. Phys. A* 49.49 (2016), pp. 494004, 18. ISSN: 1751-8113,1751-8121. DOI: [10.1088/1751-8113/49/49/494004](https://doi.org/10.1088/1751-8113/49/49/494004) (cit. on p. 77).
- [Jea10] Emmanuel Jeandel. «The periodic domino problem revisited». In: *Theoret. Comput. Sci.* 411.44-46 (2010), pp. 4010–4016. ISSN: 0304-3975,1879-2294. DOI: [10.1016/j.tcs.2010.08.017](https://doi.org/10.1016/j.tcs.2010.08.017) (cit. on pp. iii, xiii, 45, 51, 103).
- [Jea15a] Emmanuel Jeandel. «Aperiodic subshifts of finite type on groups». In: *arXiv preprint arXiv:1501.06831* (2015) (cit. on pp. iii, xiv, 104, 106).
- [Jea15b] Emmanuel Jeandel. «Aperiodic subshifts on polycyclic groups». In: *arXiv preprint arXiv:1510.02360* (2015) (cit. on pp. 30, 34, 42, 106, 107, 115, 118, 122, 131).
- [Jea15c] Emmanuel Jeandel. «Translation-like actions and aperiodic subshifts on groups». In: *arXiv preprint arXiv:1508.06419* (2015) (cit. on pp. iv, xiv, 26, 30, 44, 107–109).
- [Jea17] Emmanuel Jeandel. «Enumeration reducibility in closure spaces with applications to logic and algebra». In: *2017 32nd Annual ACM/IEEE Symposium on Logic in Computer Science (LICS)*. IEEE, [Piscataway], NJ, 2017, p. 11. ISBN: 978-1-5090-3018-7 (cit. on pp. 16, 36).
- [JMV20] Emmanuel Jeandel, Etienne Moutot, and Pascal Vanier. «Slopes of multidimensional subshifts». In: *Theory Comput. Syst.* 64.1 (2020), pp. 35–61. ISSN: 1432-4350,1433-0490. DOI: [10.1007/s00224-019-09931-1](https://doi.org/10.1007/s00224-019-09931-1) (cit. on p. 119).
- [JR21] Emmanuel Jeandel and Michaël Rao. «An aperiodic set of 11 Wang tiles». In: *Adv. Comb.* (2021), Paper No. 1, 37. ISSN: 2517-5599. DOI: [10.19086/aic.18614](https://doi.org/10.19086/aic.18614) (cit. on pp. iii, xiii, 103).
- [JV15] Emmanuel Jeandel and Pascal Vanier. «Characterizations of periods of multi-dimensional shifts». In: *Ergodic Theory Dynam. Systems* 35.2 (2015), pp. 431–460. ISSN: 0143-3857,1469-4417. DOI: [10.1017/etds.2013.60](https://doi.org/10.1017/etds.2013.60) (cit. on p. 119).
- [JV19] Emmanuel Jeandel and Pascal Vanier. «A characterization of subshifts with computable language». In: *36th International Symposium on Theoretical Aspects of Computer Science (STACS 2019)*. Schloss Dagstuhl-Leibniz-Zentrum fuer Informatik, 2019 (cit. on pp. vii, xvii, 31, 36, 75).
- [JV20] Emmanuel Jeandel and Pascal Vanier. «The undecidability of the Domino Problem». In: *Substitution and tiling dynamics: introduction to self-inducing structures*. Vol. 2273. Lecture Notes in Math. Springer, Cham, 2020, pp. 293–357. ISBN: 978-3-030-57666-0; 978-3-030-57665-3. DOI: [10.1007/978-3-030-57666-0_6](https://doi.org/10.1007/978-3-030-57666-0_6) (cit. on pp. iv, xiv, 41, 151).
- [Jen77] Margaret Jennings. «Tutivillus: The literary career of the recording demon». In: *Studies in Philology* 74.5 (1977), pp. 1–95 (cit. on pp. vi, xvi).
- [Jia17] Yongle Jiang. «Translation-like actions yield regular maps». In: *arXiv preprint arXiv:1703.09253* (2017) (cit. on p. 26).
- [JK12] Timo Jolivet and Jarkko Kari. «Consistency of multidimensional combinatorial substitutions». In: *Theoret. Comput. Sci.* 454 (2012), pp. 178–188. ISSN: 0304-3975,1879-2294. DOI: [10.1016/j.tcs.2012.03.050](https://doi.org/10.1016/j.tcs.2012.03.050) (cit. on pp. iv, xiv, 151, 156, 157).
- [KMW62] Andrew S. Kahr, Edward F. Moore, and Hao Wang. «Entscheidungsproblem reduced to the $\forall\exists\forall$ case». In: *Proc. Nat. Acad. Sci. U.S.A.* 48 (1962), pp. 365–377. ISSN: 0027-8424. DOI: [10.1073/pnas.48.3.365](https://doi.org/10.1073/pnas.48.3.365) (cit. on pp. iii, xiii, 45).
- [Kar90] Jarkko Kari. «Reversibility of 2D cellular automata is undecidable». In: vol. 45. 1-3. Cellular automata: theory and experiment (Los Alamos, NM, 1989). 1990, pp. 379–385. DOI: [10.1016/0167-2789\(90\)90195-U](https://doi.org/10.1016/0167-2789(90)90195-U) (cit. on pp. i, xi, 54, 59).
- [Kar92] Jarkko Kari. «The nilpotency problem of one-dimensional cellular automata». In: *SIAM J. Comput.* 21.3 (1992), pp. 571–586. ISSN: 0097-5397. DOI: [10.1137/0221036](https://doi.org/10.1137/0221036) (cit. on pp. i, xi).

- [Kar94] Jarkko Kari. «Reversibility and surjectivity problems of cellular automata». In: *J. Comput. System Sci.* 48.1 (1994), pp. 149–182. ISSN: 0022-0000,1090-2724. DOI: [10.1016/S0022-0000\(05\)80025-X](https://doi.org/10.1016/S0022-0000(05)80025-X) (cit. on pp. [i](#), [xi](#), [54](#), [59](#)).
- [Kar96] Jarkko Kari. «A small aperiodic set of Wang tiles». In: *Discrete Math.* 160.1-3 (1996), pp. 259–264. ISSN: 0012-365X,1872-681X. DOI: [10.1016/0012-365X\(95\)00120-L](https://doi.org/10.1016/0012-365X(95)00120-L) (cit. on pp. [iii](#), [xiii](#), [103](#), [140](#), [145](#)).
- [Kar02] Jarkko Kari. «Infinite snake tiling problems». In: *International Conference on Developments in Language Theory*. Springer. 2002, pp. 67–77 (cit. on pp. [iii](#), [xiii](#), [59](#), [61](#), [62](#), [73](#)).
- [Kar07] Jarkko Kari. «The tiling problem revisited». In: *International Conference on Machines, Computations, and Universality*. Springer. 2007, pp. 72–79. DOI: http://dx.doi.org/10.1007/978-3-540-74593-8_6 (cit. on pp. [41](#), [42](#), [141](#)).
- [KL16] David Kerr and Hanfeng Li. *Ergodic theory*. Springer Monographs in Mathematics. Independence and dichotomies. Springer, Cham, 2016, pp. xxxiv+431. ISBN: 978-3-319-49845-4; 978-3-319-49847-8. DOI: [10.1007/978-3-319-49847-8](https://doi.org/10.1007/978-3-319-49847-8) (cit. on pp. [28](#), [176](#)).
- [Kes63] Harry Kesten. «On the number of self-avoiding walks». In: *Journal of Mathematical Physics* 4.7 (1963), pp. 960–969 (cit. on p. [96](#)).
- [Kha81] O. G. Kharlampovič. «A finitely presented solvable group with unsolvable word problem». In: *Izv. Akad. Nauk SSSR Ser. Mat.* 45.4 (1981), pp. 852–873, 928. ISSN: 0373-2436 (cit. on p. [18](#)).
- [Khu23] Ana Khukhro. «A characterisation of virtually free groups via minor exclusion». In: *Int. Math. Res. Not. IMRN* 15 (2023), pp. 12967–12976. ISSN: 1073-7928,1687-0247. DOI: [10.1093/imrn/rnac184](https://doi.org/10.1093/imrn/rnac184) (cit. on p. [126](#)).
- [KS88] Bruce Kitchens and Klaus Schmidt. «Periodic points, decidability and Markov subgroups». In: *Dynamical systems (College Park, MD, 1986–87)*. Vol. 1342. Lecture Notes in Math. Springer, Berlin, 1988, pp. 440–454. ISBN: 3-540-50174-6. DOI: [10.1007/BFb0082845](https://doi.org/10.1007/BFb0082845) (cit. on pp. [41](#), [104](#)).
- [Klo07] Oddvar Kloster. «A solution to the angel problem». In: *Theoret. Comput. Sci.* 389.1-2 (2007), pp. 152–161. ISSN: 0304-3975,1879-2294. DOI: [10.1016/j.tcs.2007.08.006](https://doi.org/10.1016/j.tcs.2007.08.006) (cit. on p. [110](#)).
- [Kob10] Thomas Koberda. «On some of the residual properties of finitely generated nilpotent groups». In: *arXiv preprint arXiv:1002.3203* (2010) (cit. on p. [123](#)).
- [KLZ16] Daniel König, Markus Lohrey, and Georg Zetsche. «Knapsack and subset sum problems in nilpotent, polycyclic, and co-context-free groups». In: *Algebra and computer science*. Vol. 677. Contemp. Math. Amer. Math. Soc., Providence, RI, 2016, pp. 129–144. ISBN: 978-1-4704-2303-2. DOI: [10.1090/conm/677](https://doi.org/10.1090/conm/677) (cit. on p. [54](#)).
- [Kri07] Fabrice Krieger. «Le lemme d’Ornstein-Weiss d’après Gromov». In: *Dynamics, ergodic theory, and geometry*. Vol. 54. Math. Sci. Res. Inst. Publ. Cambridge Univ. Press, Cambridge, 2007, pp. 99–111. ISBN: 978-0-521-87541-7. DOI: [10.1017/CB09780511755187.004](https://doi.org/10.1017/CB09780511755187.004) (cit. on p. [28](#)).
- [Kro90] Peter H. Kropholler. «Baumslag-Solitar groups and some other groups of cohomological dimension two». In: *Comment. Math. Helv.* 65.4 (1990), pp. 547–558. ISSN: 0010-2571,1420-8946. DOI: [10.1007/BF02566625](https://doi.org/10.1007/BF02566625) (cit. on p. [125](#)).
- [KB37] Nicolas Kryloff and Nicolas Bogoliouboff. «La théorie générale de la mesure dans son application à l’étude des systèmes dynamiques de la mécanique non linéaire». In: *Ann. of Math. (2)* 38.1 (1937), pp. 65–113. ISSN: 0003-486X,1939-8980. DOI: [10.2307/1968511](https://doi.org/10.2307/1968511) (cit. on p. [173](#)).
- [Kûr97] Petr Kûrka. «Languages, equicontinuity and attractors in cellular automata». In: *Ergodic Theory Dynam. Systems* 17.2 (1997), pp. 417–433. ISSN: 0143-3857,1469-4417. DOI: [10.1017/S014338579706985X](https://doi.org/10.1017/S014338579706985X) (cit. on p. [113](#)).
- [KL05] Dietrich Kuske and Markus Lohrey. «Logical aspects of Cayley-graphs: the group case». In: *Ann. Pure Appl. Logic* 131.1-3 (2005), pp. 263–286. ISSN: 0168-0072,1873-2461. DOI: [10.1016/j.apal.2004.06.002](https://doi.org/10.1016/j.apal.2004.06.002) (cit. on pp. [iii](#), [xiii](#), [42](#), [71](#)).

- [Kut05] Martin Kutz. «Conway’s angel in three dimensions». In: *Theoret. Comput. Sci.* 349.3 (2005), pp. 443–451. ISSN: 0304-3975,1879-2294. DOI: [10.1016/j.tcs.2005.08.034](https://doi.org/10.1016/j.tcs.2005.08.034) (cit. on p. 110).
- [Kuz58] Alexander V Kuznetsov. «Algorithms as operations in algebraic systems». In: *Uspekhi Matematicheskikh Nauk* 13.3 (1958), p. 81 (cit. on p. 18).
- [Lab21a] Sébastien Labbé. «Markov partitions for toral \mathbb{Z}^2 -rotations featuring Jeandel–Rao Wang shift and model sets». In: *Annales Henri Lebesgue* 4 (2021), pp. 283–324 (cit. on pp. [iv](#), [ix](#), [xiv](#), [xix](#), [125](#), [132](#)).
- [Lab21b] Sébastien Labbé. «Rauzy induction of polygon partitions and toral \mathbb{Z}^2 -rotations». In: *J. Mod. Dyn.* 17 (2021), pp. 481–528. ISSN: 1930-5311,1930-532X. DOI: [10.3934/jmd.2021017](https://doi.org/10.3934/jmd.2021017) (cit. on pp. [ix](#), [xix](#), [125](#), [132](#)).
- [Lab21c] Sébastien Labbé. «Substitutive structure of Jeandel–Rao aperiodic tilings». In: *Discrete Comput. Geom.* 65.3 (2021), pp. 800–855. ISSN: 0179-5376,1432-0444. DOI: [10.1007/s00454-019-00153-3](https://doi.org/10.1007/s00454-019-00153-3) (cit. on pp. [ix](#), [xix](#), [125](#), [132](#), [151](#)).
- [Lab23] Sébastien Labbé. «Metallic mean Wang shifts I: self-similarity, aperiodicity and minimality». In: *arXiv preprint arXiv:2312.03652* (2023) (cit. on pp. [iv](#), [xiv](#), [152](#)).
- [Lab24] Sébastien Labbé. «Metallic mean Wang tiles II: the dynamics of an aperiodic computer chip». In: *arXiv preprint arXiv:2403.03197* (2024) (cit. on p. [152](#)).
- [LMM23] Sébastien Labbé, Casey Mann, and Jennifer McLoud-Mann. «Nonexpansive directions in the Jeandel–Rao Wang shift». In: *Discrete and Continuous Dynamical Systems* 43.9 (2023), pp. 3213–3250. DOI: [10.3934/dcds.2023046](https://doi.org/10.3934/dcds.2023046) (cit. on pp. [ix](#), [xix](#), [125](#), [132](#), [133](#)).
- [LMS03] Jeong-Yup Lee, Robert V. Moody, and Boris Solomyak. «Consequences of Pure Point Diffraction Spectra for Multiset Substitution Systems». en. In: *Discrete & Computational Geometry* 29.4 (June 2003), pp. 525–560. ISSN: 1432-0444. DOI: [10.1007/s00454-003-0781-z](https://doi.org/10.1007/s00454-003-0781-z). URL: <https://doi.org/10.1007/s00454-003-0781-z> (visited on 03/20/2023) (cit. on p. [173](#)).
- [LL23] Florian Lehner and Christian Lindorfer. «Self-avoiding walks and multiple context-free languages». In: *Comb. Theory* 3.1 (2023), Paper No. 18, 50. ISSN: 2766-1334. DOI: [10.5070/c63160431](https://doi.org/10.5070/c63160431) (cit. on p. [75](#)).
- [Lev15] Gilbert Levitt. «Generalized Baumslag–Solitar groups: rank and finite index subgroups». In: *Ann. Inst. Fourier (Grenoble)* 65.2 (2015), pp. 725–762. ISSN: 0373-0956,1777-5310 (cit. on p. [127](#)).
- [Lew79] Harry R. Lewis. *Unsolvable classes of quantificational formulas*. Addison-Wesley Publishing Co., Reading, MA, 1979, pp. xv+198. ISBN: 0-201-04069-7 (cit. on p. [41](#)).
- [Lig03] Samuel J. Lightwood. «Morphisms from non-periodic \mathbb{Z}^2 -subshifts. I. Constructing embeddings from homomorphisms». In: *Ergodic Theory Dynam. Systems* 23.2 (2003), pp. 587–609. ISSN: 0143-3857,1469-4417. DOI: [10.1017/S014338570200130X](https://doi.org/10.1017/S014338570200130X) (cit. on p. [38](#)).
- [LG13] Daciberg Lima Gonçalves and John Guaschi. *The classification of the virtually cyclic subgroups of the sphere braid groups*. SpringerBriefs in Mathematics. Springer, Cham, 2013, pp. x+102. ISBN: 978-3-319-00256-9; 978-3-319-00257-6. DOI: [10.1007/978-3-319-00257-6](https://doi.org/10.1007/978-3-319-00257-6) (cit. on p. [92](#)).
- [Lin84] Douglas Lind. «The entropies of topological Markov shifts and a related class of algebraic integers». In: *Ergodic Theory Dynam. Systems* 4.2 (1984), pp. 283–300. ISSN: 0143-3857,1469-4417. DOI: [10.1017/S0143385700002443](https://doi.org/10.1017/S0143385700002443) (cit. on p. [29](#)).
- [Lin04] Douglas Lind. «Multi-dimensional symbolic dynamics». In: *Symbolic dynamics and its applications*. Vol. 60. Proc. Sympos. Appl. Math. Amer. Math. Soc., Providence, RI, 2004, pp. 61–79. ISBN: 0-8218-3157-7. DOI: [10.1090/psapm/060/2078846](https://doi.org/10.1090/psapm/060/2078846) (cit. on pp. [iii](#), [xiii](#)).
- [LM21] Douglas Lind and Brian Marcus. *An Introduction to Symbolic Dynamics and Coding*. Second. Cambridge Mathematical Library. Cambridge University Press, Cambridge, 2021, pp. xix+550. ISBN: 978-1-108-82028-8. DOI: [10.1017/9781108899727](https://doi.org/10.1017/9781108899727) (cit. on pp. [ii](#), [xii](#), [11](#), [12](#), [38](#), [83](#), [84](#), [93](#), [104](#)).

- [Lin20] Christian Lindorfer. «A general bridge theorem for self-avoiding walks». In: *Discrete Math.* 343.12 (2020), pp. 112092, 11. ISSN: 0012-365X,1872-681X. DOI: [10.1016/j.disc.2020.112092](https://doi.org/10.1016/j.disc.2020.112092) (cit. on p. 95).
- [LW20] Christian Lindorfer and Wolfgang Woess. «The language of self-avoiding walks». In: *Combinatorica* 40.5 (2020), pp. 691–720 (cit. on pp. viii, xviii, 75, 88, 90, 91).
- [LV92] A. N. Livshits and Anatoliĭ M. Vershik. «Adic models of ergodic transformations, spectral theory, substitutions, and related topics». In: *Representation theory and dynamical systems*. Vol. 9. Adv. Soviet Math. Amer. Math. Soc., Providence, RI, 1992, pp. 185–204 (cit. on pp. iv, xiv, 151).
- [Löh17] Clara Löh. *Geometric group theory*. Universitext. An introduction. Springer, Cham, 2017, pp. xi+389. ISBN: 978-3-319-72253-5; 978-3-319-72254-2. DOI: [10.1007/978-3-319-72254-2](https://doi.org/10.1007/978-3-319-72254-2) (cit. on pp. 23, 25).
- [Loh14] Markus Lohrey. *The compressed word problem for groups*. SpringerBriefs in Mathematics. Springer, New York, 2014, pp. xii+153. ISBN: 978-1-4939-0747-2; 978-1-4939-0748-9. DOI: [10.1007/978-1-4939-0748-9](https://doi.org/10.1007/978-1-4939-0748-9) (cit. on p. 18).
- [Loh20] Markus Lohrey. «Knapsack in hyperbolic groups». In: *J. Algebra* 545 (2020), pp. 390–415. ISSN: 0021-8693,1090-266X. DOI: [10.1016/j.jalgebra.2019.04.008](https://doi.org/10.1016/j.jalgebra.2019.04.008) (cit. on p. 54).
- [Loh23] Markus Lohrey. «Subgroup membership in $GL(2, \mathbb{Z})$ ». In: *Theory of Computing Systems* (2023), pp. 1–26 (cit. on p. 56).
- [Lym20] Rylee Alanza Lyman. «Train Tracks on Graphs of Groups and Outer Automorphisms of Hyperbolic Groups». In: *arXiv:2005.00164 [math]* (May 2020). URL: <http://arxiv.org/abs/2005.00164> (cit. on p. 126).
- [LS77] Roger C. Lyndon and Paul E. Schupp. *Combinatorial group theory*. Vol. Band 89. Ergebnisse der Mathematik und ihrer Grenzgebiete [Results in Mathematics and Related Areas]. Springer-Verlag, Berlin-New York, 1977, pp. xiv+339. ISBN: 3-540-07642-5 (cit. on p. 21).
- [Lyo95] Russell Lyons. «Random walks and the growth of groups». In: *C. R. Acad. Sci. Paris Sér. I Math.* 320.11 (1995), pp. 1361–1366. ISSN: 0764-4442 (cit. on pp. 109, 113).
- [LP16] Russell Lyons and Yuval Peres. *Probability on trees and networks*. Vol. 42. Cambridge Series in Statistical and Probabilistic Mathematics. Cambridge University Press, New York, 2016, pp. xv+699. ISBN: 978-1-107-16015-6. DOI: [10.1017/9781316672815](https://doi.org/10.1017/9781316672815) (cit. on p. 109).
- [Lys96] Igor Geront’evich Lysenok. «Infinite Burnside groups of even exponent». In: *Izvestiya: Mathematics* 60.3 (1996), p. 453 (cit. on p. 96).
- [Mal40] Anatoly I Mal’cev. «On isomorphic matrix representations of infinite groups». In: *Rec. Math. [Mat. Sbornik] N.S.* 8/50 (1940), pp. 405–422 (cit. on p. 37).
- [Mal56] Anatoly I Mal’cev. «On certain classes of infinite solvable groups». In: *Amer. Math. Soc. Transl. (2)* 2 (1956), pp. 1–21 (cit. on p. 19).
- [Mal58] Anatoly I Mal’cev. «On homomorphisms onto finite groups». In: *Fluchen. Zap. Ivanovskogo Gos. Ped. Inst* 18 (1958), pp. 49–60 (cit. on p. 37).
- [MN14] Michał Marcinkowski and Piotr W Nowak. «Aperiodic tilings of manifolds of intermediate growth». In: *Groups, Geometry, and Dynamics* 8.2 (2014), pp. 479–483 (cit. on pp. iii, xiii, 104, 107, 108).
- [Mar08] Maurice Margenstern. «The domino problem of the hyperbolic plane is undecidable». In: *Theoret. Comput. Sci.* 407.1-3 (2008), pp. 29–84. ISSN: 0304-3975,1879-2294. DOI: [10.1016/j.tcs.2008.04.038](https://doi.org/10.1016/j.tcs.2008.04.038) (cit. on p. 42).
- [Mát07] András Máthé. «The angel of power 2 wins». In: *Combin. Probab. Comput.* 16.3 (2007), pp. 363–374. ISSN: 0963-5483,1469-2163. DOI: [10.1017/S0963548306008303](https://doi.org/10.1017/S0963548306008303) (cit. on p. 110).

- [McK43] J. C. C. McKinsey. «The decision problem for some classes of sentences without quantifiers». In: *J. Symbolic Logic* 8 (1943), pp. 61–76. ISSN: 0022-4812,1943-5886. DOI: [10.2307/2268172](https://doi.org/10.2307/2268172) (cit. on pp. 37, 52).
- [MR20] Marcus Michelen and Josh Rosenberg. «The frog model on non-amenable trees». In: *Electron. J. Probab.* 25 (2020), Paper No. 49, 16. ISSN: 1083-6489. DOI: [10.1214/20-ejp454](https://doi.org/10.1214/20-ejp454) (cit. on p. 113).
- [Mih68] K. A. Mihailova. «The occurrence problem for free products of groups». In: *Mat. Sb. (N.S.)* 75(117) (1968), pp. 199–210. ISSN: 0368-8666 (cit. on pp. 55, 119).
- [MV24] Philip Möller and Olga Varghese. «On quotients of Coxeter groups». In: *Journal of Algebra* 639 (2024), pp. 516–531 (cit. on p. 87).
- [MH38] Marston Morse and Gustav A. Hedlund. «Symbolic Dynamics». In: *Amer. J. Math.* 60.4 (1938), pp. 815–866. ISSN: 0002-9327,1080-6377. DOI: [10.2307/2371264](https://doi.org/10.2307/2371264) (cit. on pp. ii, xii, 104).
- [MH40] Marston Morse and Gustav A. Hedlund. «Symbolic dynamics II. Sturmian trajectories». In: *Amer. J. Math.* 62 (1940), pp. 1–42. ISSN: 0002-9327. DOI: [10.2307/2371431](https://doi.org/10.2307/2371431) (cit. on pp. ii, xii).
- [MSW03] Lee Mosher, Michah Sageev, and Kevin Whyte. «Quasi-actions on trees I. Bounded valence». In: *Annals of mathematics* (2003), pp. 115–164 (cit. on p. 148).
- [Mos92] Brigitte Mossé. «Puissances de mots et reconnaissabilité des points fixes d’une substitution». In: *Theoret. Comput. Sci.* 99.2 (1992), pp. 327–334. ISSN: 0304-3975,1879-2294. DOI: [10.1016/0304-3975\(92\)90357-L](https://doi.org/10.1016/0304-3975(92)90357-L) (cit. on p. 177).
- [Mos66] A. Włodzimierz Mostowski. «On the decidability of some problems in special classes of groups». In: *Fund. Math.* 59 (1966), pp. 123–135. ISSN: 0016-2736,1730-6329. DOI: [10.4064/fm-59-2-123-135](https://doi.org/10.4064/fm-59-2-123-135) (cit. on p. 37).
- [Mou20] Etienne Moutot. «Autour du problème du domino». PhD thesis. ENS de Lyon, 2020 (cit. on p. 123).
- [Moz89] Shahar Mozes. «Tilings, substitution systems and dynamical systems generated by them». In: *J. Analyse Math.* 53 (1989), pp. 139–186. ISSN: 0021-7670. DOI: [10.1007/BF02793412](https://doi.org/10.1007/BF02793412) (cit. on pp. iv, xiv, 151).
- [Moz97] Shahar Mozes. «Aperiodic tilings». In: *Invent. Math.* 128.3 (1997), pp. 603–611. ISSN: 0020-9910,1432-1297. DOI: [10.1007/s002220050153](https://doi.org/10.1007/s002220050153) (cit. on pp. i, iii, xi, xiii, xiv, 104).
- [MP01] Roman Muchnik and Igor Pak. «Percolation on Grigorchuk groups». In: *Comm. Algebra* 29.2 (2001), pp. 661–671. ISSN: 0092-7872,1532-4125. DOI: [10.1081/AGB-100001531](https://doi.org/10.1081/AGB-100001531) (cit. on pp. 109, 113).
- [MS83] David E. Muller and Paul E. Schupp. «Groups, the theory of ends, and context-free languages». In: *Journal of Computer and system sciences* 26.3 (1983), pp. 295–310 (cit. on p. 71).
- [MS85] David E. Muller and Paul E. Schupp. «The theory of ends, pushdown automata, and second-order logic». In: *Theoret. Comput. Sci.* 37.1 (1985), pp. 51–75. ISSN: 0304-3975,1879-2294. DOI: [10.1016/0304-3975\(85\)90087-8](https://doi.org/10.1016/0304-3975(85)90087-8) (cit. on pp. iii, xiii, 42, 71).
- [MNU14] Alexei Myasnikov, Andrey Nikolaev, and Alexander Ushakov. «The Post correspondence problem in groups». In: *Journal of Group Theory* 17.6 (2014), pp. 991–1008 (cit. on p. 54).
- [MO11] Alexei Myasnikov and Denis Osin. «Algorithmically finite groups». In: *Journal of Pure and Applied Algebra* 215.11 (2011), pp. 2789–2796 (cit. on pp. 54, 86).
- [Mye74] Dale Myers. «Nonrecursive tilings of the plane. II». In: *J. Symbolic Logic* 39 (1974), pp. 286–294. ISSN: 0022-4812,1943-5886. DOI: [10.2307/2272641](https://doi.org/10.2307/2272641) (cit. on pp. iii, xiii, 108).
- [Mye79] Dale Myers. «Decidability of the tiling connectivity problem. Abstract 79T-E42». In: *Notices Amer. Math. Soc* 195.26 (1979), pp. 177–209 (cit. on pp. 45, 59).
- [NP11] Volodymyr Nekrashevych and Gábor Pete. «Scale-invariant groups». In: *Groups Geom. Dyn.* 5.1 (2011), pp. 139–167. ISSN: 1661-7207,1661-7215. DOI: [10.4171/GGD/119](https://doi.org/10.4171/GGD/119) (cit. on pp. 56, 164).

- [NS95] Walter D Neumann and Michael Shapiro. «Automatic structures, rational growth, and geometrically finite hyperbolic groups». In: *Inventiones mathematicae* 120.1 (1995), pp. 259–287 (cit. on p. 65).
- [Nov58] Petr S. Novikov. «Algorithmic Unsolvability of the Word Problem in Group Theory». In: (1958) (cit. on p. 18).
- [Nyb22] Carl-Fredrik Nyberg-Brodda. «The Adian–Rabin Theorem—An English translation». In: *arXiv preprint arXiv:2208.08560* (2022) (cit. on p. 45).
- [OIS80a] A. Yu. Ol’Shanskii. «An infinite group with subgroups of prime orders». In: *Izv. Akad. Nauk SSSR Ser. Mat.* 44.2 (1980), pp. 309–321, 479. ISSN: 0373-2436 (cit. on p. 20).
- [OIS80b] A. Yu. Ol’Shanskii. «On the question of the existence of an invariant mean on a group». In: *Uspekhi Mat. Nauk* 35.4(214) (1980), pp. 199–200. ISSN: 0042-1316 (cit. on p. 20).
- [OW80] Donald S. Ornstein and Benjamin Weiss. «Ergodic theory of amenable group actions. I. The Rohlin lemma». In: *Bull. Amer. Math. Soc. (N.S.)* 2.1 (1980), pp. 161–164. ISSN: 0273-0979. DOI: [10.1090/S0273-0979-1980-14702-3](https://doi.org/10.1090/S0273-0979-1980-14702-3) (cit. on pp. 28, 159).
- [Pan19] Christoforos Panagiotis. «Self-avoiding walks and polygons on hyperbolic graphs». In: *arXiv preprint arXiv:1908.00127* (2019) (cit. on p. 96).
- [Par64] William Parry. «Intrinsic Markov chains». In: *Trans. Amer. Math. Soc.* 112 (1964), pp. 55–66. ISSN: 0002-9947,1088-6850. DOI: [10.2307/1994009](https://doi.org/10.2307/1994009) (cit. on pp. ii, xii).
- [Pav12] Ronnie Pavlov. «Approximating the hard square entropy constant with probabilistic methods». In: *Ann. Probab.* 40.6 (2012), pp. 2362–2399. ISSN: 0091-1798,2168-894X. DOI: [10.1214/11-AOP681](https://doi.org/10.1214/11-AOP681) (cit. on p. 8).
- [Pen79] Roger Penrose. «Pentaplexity: a class of nonperiodic tilings of the plane». In: *Math. Intelligencer* 2.1 (1979), pp. 32–37. ISSN: 0343-6993,1866-7414. DOI: [10.1007/BF03024384](https://doi.org/10.1007/BF03024384) (cit. on pp. iii, xiii, 104).
- [Pia49] Alexandre Piankoff. «Une Représentation rare sur l’une des chapelles de Toutânkhamon». In: *The Journal of Egyptian Archaeology* 35.1 (1949), pp. 113–116 (cit. on p. 59).
- [Pia08] Steven T. Piantadosi. «Symbolic dynamics on free groups». In: *Discrete Contin. Dyn. Syst.* 20.3 (2008), pp. 725–738. ISSN: 1078-0947,1553-5231. DOI: [10.3934/dcds.2008.20.725](https://doi.org/10.3934/dcds.2008.20.725) (cit. on pp. iii, xiii, 9, 42, 49, 51, 104, 120, 129).
- [Pyt22] N. Pytheas-Fogg. *GroupeGroupes*. 2022. URL: <https://pytheas.math.cnrs.fr/index.php/PytheasFogg/GroupeGroupes> (visited on 07/06/2022) (cit. on p. 120).
- [Rab58] Michael O Rabin. «Recursive unsolvability of group theoretic problems». In: *Annals of Mathematics* 67.1 (1958), pp. 172–194 (cit. on p. 45).
- [RY17] Aran Raoufi and Ariel Yadin. «Indicable groups and $p_c < 1$ ». In: *Electron. Commun. Probab.* 22 (2017), Paper No. 13, 10. ISSN: 1083-589X. DOI: [10.1214/16-ECP40](https://doi.org/10.1214/16-ECP40) (cit. on p. 109).
- [Rau22] Emmanuel Rauzy. «Computability of finite quotients of finitely generated groups». In: *J. Group Theory* 25.2 (2022), pp. 217–246. ISSN: 1433-5883,1435-4446. DOI: [10.1515/jgth-2020-0029](https://doi.org/10.1515/jgth-2020-0029) (cit. on pp. vii, xviii, 52, 53).
- [Ray23] Jade Raymond. «Shifts of finite type on locally finite groups». In: *Ergodic Theory and Dynamical Systems* (2023), pp. 1–34 (cit. on pp. 11, 30, 32).
- [Ree15] Dana Michael Reemes. «The Egyptian Ouroboros: An iconological and theological study». PhD thesis. 2015 (cit. on p. 59).
- [Rie22] Yo’av Rieck. «Strongly aperiodic SFTs on hyperbolic groups: where to find them and why we love them». In: *arXiv preprint arXiv:2202.00212* (2022) (cit. on pp. iii, xiv, 103).
- [Rip82] Eliyahu Rips. «Subgroups of small cancellation groups». In: *Bull. London Math. Soc.* 14.1 (1982), pp. 45–47. ISSN: 0024-6093,1469-2120. DOI: [10.1112/blms/14.1.45](https://doi.org/10.1112/blms/14.1.45) (cit. on pp. 55, 118).

- [Rob15] Derek J. S. Robinson. «Generalized Baumslag-Solitar groups: a survey of recent progress». In: *Groups St Andrews 2013*. Vol. 422. London Math. Soc. Lecture Note Ser. Cambridge Univ. Press, Cambridge, 2015, pp. 457–468. ISBN: 978-1-107-51454-6 (cit. on p. 127).
- [Rob71] Raphael M Robinson. «Undecidability and nonperiodicity for tilings of the plane». In: *Inventiones mathematicae* 12.3 (1971), pp. 177–209 (cit. on pp. iii, xiii, 41, 103).
- [Rol03] Dale Rolfsen. *Knots and links*. Vol. 346. American Mathematical Soc., 2003 (cit. on p. 127).
- [Ros20] Matthieu Rosenfeld. «Another approach to non-repetitive colorings of graphs of bounded degree». In: *Electron. J. Combin.* 27.3 (2020), Paper No. 3.43, 16. ISSN: 1077-8926. DOI: 10.37236/9667 (cit. on p. 95).
- [Ros22] Matthieu Rosenfeld. «Finding lower bounds on the growth and entropy of subshifts over countable groups». In: *arXiv preprint arXiv:2204.00394* (2022) (cit. on pp. viii, xviii, 29, 95, 96).
- [ST11] Mathieu Sablik and Guillaume Theyssier. «Topological dynamics of cellular automata: dimension matters». In: *Theory Comput. Syst.* 48.3 (2011), pp. 693–714. ISSN: 1432-4350,1433-0490. DOI: 10.1007/s00224-010-9255-x (cit. on p. 113).
- [SSU21] Ayşe A. Şahin, Michael Schraudner, and Ilie Ugarcovici. «A strongly aperiodic shift of finite type on the discrete Heisenberg group using Robinson tilings». In: *Illinois J. Math.* 65.3 (2021), pp. 655–686. ISSN: 0019-2082,1945-6581. DOI: 10.1215/00192082-9446050 (cit. on p. 106).
- [Sal] Ville Salo. *Existence of n -axial elements in groups with at least 2 ends*. MathOverflow. (version: 2019-09-19). URL: <https://mathoverflow.net/q/341991> (cit. on p. 105).
- [San40] I. N. Sanov. «Solution of Burnside’s problem for exponent 4». In: *Leningrad State Univ. Annals [Uchenye Zapiski] Math. Ser.* 10 (1940), pp. 166–170 (cit. on p. 96).
- [SW79] Peter Scott and Terry Wall. «Topological methods in group theory». In: *Homological group theory (Proc. Sympos., Durham, 1977)*. Vol. 36. London Math. Soc. Lecture Note Ser. Cambridge Univ. Press, Cambridge-New York, 1979, pp. 137–203. ISBN: 0-521-22729-1 (cit. on p. 23).
- [Seg83] Daniel Segal. *Polycyclic groups*. Vol. 82. Cambridge Tracts in Mathematics. Cambridge University Press, Cambridge, 1983, pp. xiv+289. ISBN: 0-521-24146-4. DOI: 10.1017/CB09780511565953 (cit. on pp. 19, 20).
- [Ser03] Jean-Pierre Serre. *Trees*. Springer Monographs in Mathematics. Translated from the French original by John Stillwell, Corrected 2nd printing of the 1980 English translation. Springer-Verlag, Berlin, 2003, pp. x+142. ISBN: 3-540-44237-5 (cit. on p. 126).
- [Sew14] Brandon Seward. «Burnside’s Problem, spanning trees and tilings». In: *Geom. Topol.* 18.1 (2014), pp. 179–210. ISSN: 1465-3060,1364-0380. DOI: 10.2140/gt.2014.18.179 (cit. on pp. 25, 26, 66, 78, 154).
- [Shp24] Vladimir Shpilrain. «Complexity of some algorithmic problems in groups: a survey». In: *arXiv preprint arXiv:2401.09218* (2024) (cit. on p. 18).
- [Sil20] Eduardo Alejandro Silva Müller. «Subshifts en los grupos de Baumslag-Solitar solubles no-abelianos». MA thesis. Santiago, Chile: Facultad de Ciencias Físicas y Matemáticas, Universidad de Chile, 2020 (cit. on pp. 152, 161).
- [Sip96] Michael Sipser. «Introduction to the Theory of Computation». In: *ACM Sigact News* 27.1 (1996), pp. 27–29 (cit. on p. 12).
- [Sma67] Stephen Smale. «Differentiable dynamical systems». In: *Bull. Amer. Math. Soc.* 73 (1967), pp. 747–817. ISSN: 0002-9904. DOI: 10.1090/S0002-9904-1967-11798-1 (cit. on pp. ii, xii).
- [Soa16] Robert I Soare. *Turing computability: Theory and applications*. Vol. 300. Springer, 2016 (cit. on pp. 12, 15).
- [Sol97] Boris Solomyak. «Dynamics of self-similar tilings». In: *Ergodic Theory Dynam. Systems* 17.3 (1997), pp. 695–738. ISSN: 0143-3857,1469-4417. DOI: 10.1017/S0143385797084988 (cit. on p. 173).

- [Sta68] John R. Stallings. «On torsion-free groups with infinitely many ends». In: *Ann. of Math. (2)* 88 (1968), pp. 312–334. ISSN: 0003-486X. DOI: [10.2307/1970577](https://doi.org/10.2307/1970577) (cit. on p. 24).
- [Sta71] John R. Stallings. *Group theory and three-dimensional manifolds*. Vol. 4. Yale Mathematical Monographs. A James K. Whittemore Lecture in Mathematics given at Yale University, 1969. Yale University Press, New Haven, Conn.-London, 1971, pp. v+65 (cit. on p. 24).
- [Swa67] Richard G. Swan. «Representations of polycyclic groups». In: *Proc. Amer. Math. Soc.* 18 (1967), pp. 573–574. ISSN: 0002-9939,1088-6826. DOI: [10.2307/2035503](https://doi.org/10.2307/2035503) (cit. on p. 19).
- [Ten24] Lior Tenenbaum. «Approximations of symbolic substitution systems in one dimension». In: *arXiv preprint arXiv:2402.19151* (2024) (cit. on p. 152).
- [TW93] Carsten Thomassen and Wolfgang Woess. «Vertex-transitive graphs and accessibility». In: *Journal of Combinatorial Theory, Series B* 58.2 (1993), pp. 248–268 (cit. on p. 89).
- [Tho80] Richard J. Thompson. «Embeddings into finitely generated simple groups which preserve the word problem». In: *Word problems, II (Conf. on Decision Problems in Algebra, Oxford, 1976)*. Vol. 95. Stud. Logic Found. Math. North-Holland, Amsterdam-New York, 1980, pp. 401–441. ISBN: 0-444-85343-X (cit. on p. 18).
- [Tro84] V. I. Trofimov. «Graphs with polynomial growth». In: *Mat. Sb. (N.S.)* 123(165).3 (1984), pp. 407–421. ISSN: 0368-8666 (cit. on p. 112).
- [Tur36] Alan Mathison Turing. «On computable numbers, with an application to the Entscheidungsproblem». In: *J. of Math* 58.345-363 (1936), p. 5 (cit. on pp. 12, 14).
- [Wal67] Charles T. C. Wall. «Poincaré complexes. I». In: *Ann. of Math. (2)* 86 (1967), pp. 213–245. ISSN: 0003-486X. DOI: [10.2307/1970688](https://doi.org/10.2307/1970688) (cit. on p. 92).
- [Wan61] Hao Wang. «Proving theorems by pattern recognition—II». In: *Bell system technical journal* 40.1 (1961), pp. 1–41 (cit. on pp. i, xi, 41, 45).
- [Wat86] Mark E Watkins. «Infinite paths that contain only shortest paths». In: *Journal of Combinatorial Theory, Series B* 41.3 (1986), pp. 341–355 (cit. on pp. 78, 98).
- [Wei73] Benjamin Weiss. «Subshifts of finite type and sofic systems». In: *Monatsh. Math.* 77 (1973), pp. 462–474. ISSN: 0026-9255,1436-5081. DOI: [10.1007/BF01295322](https://doi.org/10.1007/BF01295322) (cit. on p. 11).
- [Wei01] Benjamin Weiss. «Monotileable amenable groups». In: *Translations of the American Mathematical Society-Series 2* 202 (2001), pp. 257–262 (cit. on p. 159).
- [Why01] K. Whyte. «The large scale geometry of the higher Baumslag-Solitar groups». In: *Geom. Funct. Anal.* 11.6 (2001), pp. 1327–1343. ISSN: 1016-443X,1420-8970. DOI: [10.1007/s00039-001-8232-6](https://doi.org/10.1007/s00039-001-8232-6) (cit. on pp. ix, xix, 25, 128, 132, 139).
- [Why99] Kevin Whyte. «Amenability, bi-Lipschitz equivalence, and the von Neumann conjecture». In: *Duke Math. J.* 99.1 (1999), pp. 93–112. ISSN: 0012-7094,1547-7398. DOI: [10.1215/S0012-7094-99-09904-0](https://doi.org/10.1215/S0012-7094-99-09904-0) (cit. on pp. 25, 26, 113).
- [Woe89] Wolfgang Woess. «Graphs and groups with tree-like properties». In: *J. Combin. Theory Ser. B* 47.3 (1989), pp. 361–371. ISSN: 0095-8956,1096-0902. DOI: [10.1016/0095-8956\(89\)90034-8](https://doi.org/10.1016/0095-8956(89)90034-8) (cit. on p. 25).
- [Woe00] Wolfgang Woess. *Random walks on infinite graphs and groups*. Vol. 138. Cambridge Tracts in Mathematics. Cambridge University Press, Cambridge, 2000, pp. xii+334. ISBN: 0-521-55292-3. DOI: [10.1017/CB09780511470967](https://doi.org/10.1017/CB09780511470967) (cit. on p. 112).
- [Yuy23] Takao Yuyama. «Groups whose word problems are accepted by abelian G -automata». In: *Developments in language theory*. Vol. 13911. Lecture Notes in Comput. Sci. Springer, Cham, 2023, pp. 246–257. ISBN: 978-3-031-33263-0; 978-3-031-33264-7. DOI: [10.1007/978-3-031-33264-7_20](https://doi.org/10.1007/978-3-031-33264-7_20) (cit. on p. 65).

Personal Bibliography

- [AB23] Nathalie Aubrun and Nicolás Bitar. «Domino Snake Problems on Groups». In: *International Symposium on Fundamentals of Computation Theory*. Springer Nature Switzerland, 2023, pp. 46–59. DOI: [10.1007/978-3-031-43587-4_4](https://doi.org/10.1007/978-3-031-43587-4_4) (cit. on pp. [v](#), [xv](#)).
- [AB24a] Nathalie Aubrun and Nicolás Bitar. «Computability of Domino Snake Problems on Finitely Generated Groups». In: *Preprint submitted to the Journal of Computer and System Sciences* (2024) (cit. on pp. [v](#), [xv](#)).
- [AB24b] Nathalie Aubrun and Nicolás Bitar. «Self-Avoiding Walks on Cayley Graphs Through the Lens of Symbolic Dynamics». In: *arXiv preprint arXiv:2402.13944* (2024) (cit. on pp. [v](#), [xv](#)).
- [ABH24] Nathalie Aubrun, Nicolás Bitar, and Sacha Huriot-Tattegrain. «Strongly aperiodic SFTs on generalized Baumslag–Solitar groups». In: *Ergodic Theory and Dynamical Systems* 44.5 (2024), pp. 1209–1238. DOI: [10.1017/etds.2023.44](https://doi.org/10.1017/etds.2023.44) (cit. on pp. [v](#), [ix](#), [xvi](#), [xix](#), [130](#)).
- [Bit24a] Nicolás Bitar. «Contributions to the Domino Problem: Seeding, Recurrence and Satisfiability». In: *41st International Symposium on Theoretical Aspects of Computer Science (STACS 2024)*. Vol. 289. Leibniz International Proceedings in Informatics (LIPIcs). Dagstuhl, Germany: Schloss Dagstuhl – Leibniz-Zentrum für Informatik, 2024, 17:1–17:18. ISBN: 978-3-95977-311-9. DOI: [10.4230/LIPIcs.STACS.2024.17](https://doi.org/10.4230/LIPIcs.STACS.2024.17) (cit. on pp. [v](#), [xv](#)).
- [Bit24b] Nicolás Bitar. «Realizability of Subgroups by Subshifts of Finite Type». In: *arXiv:2406.04132* (2024) (cit. on pp. [v](#), [xvi](#)).

Index

Symbols

G -automaton	65
blind-multicounter	65
R -higher power	32, 47, 121
Σ_1^1	15
k -SAT problem	55

A

Angel Game	110
arithmetical hierarchy	14

C

cellular automaton	6, 113
commensurability	107
computable function	13
configuration	3
aperiodic	7
computable	85, 108
periodic	7
connective constant	77
geodesic	99
cylinder	3

D

dead-end	98
directive sequence	
computable	179
weakly primitive	171
Domino Problem	42, 71, 108, 123
Aperiodic	53
conjecture	42
Periodic	52, 108
Recurring	46
Seeded	45

E

emptiness problem	43
end	89
defining sequence	89
number of ends	105

thin	89, 105
entropy	28, 32, 79, 95, 99, 172

F

free product	21, 82
amalgamated	21, 92, 126, 127

G

geodesic	
growth	99
language	65, 98
graph	
automorphism	89
diabolical	110
height function	94
non-amenable	112
quasi-transitive	89
group	
S -decomposable	153
algorithmically finite	85
amenable	20, 159, 172
ccc group	159
congruent monotileable	159
diabolical	110
free Burnside	96
generalized Baumslag-Solitar	127
indicable	108, 117
just infinite	87, 117
locally finite	162
monoform	163
nilpotent	18, 68, 107, 122
non-amenable	107
periodically rigid	120
plain	82
poly-ccc	154
polycyclic	19, 106, 107, 123
presentation	16
residually finite	37, 107
self-simulable	106, 178
torsion-free	17

Index

virtually free 17, 71, 98	skeletal set 64
H	H
HNN-extension 21, 127, 128	skeleton 63, 75
I	geodesic 65, 98
Infinite Snake Problem 61	snake 60
Y-Snake 64	ouroboros 61, 81
Geodesic 66	snake embedding 66
L	strong 60
language	Snake Reachability Problem 61
co-recursively enumerable 13	stabilizer 7
co-total 15, 104	subgroup membership problem 55
complete 15	of H 118
decidable 13	undecidable 118
recursively enumerable 13	subshift 4
undecidable 13	N -fixed 34, 116, 129
M	N -locked 115, 129, 131
Monadic Second Order logic 70	direct product 115
morphism 5	effectively closed 64, 84
conjugacy 6, 114	forbidden patterns 4
factor map 6	free extension 30, 47, 122, 130
sliding-block code 5	higher block 7
O	higher block 33
Ouroboros Problem 61	irreducible 83
P	language 5
pattern 3	minimal 8, 87, 133, 137
uniformly recurrent 8	pull-back 116, 118, 122
percolation 109	push-forward 116
Perron number 29, 83	residually periodic 37
pull-back 34, 130	SFT 8, 81
Pumping Lemma 88	sofic 11, 64, 88
push-forward 35	strongly aperiodic 7, 104
Q	strongly irreducible 8, 38
quasi-isometry 106, 111	uncomputable 108
R	weakly aperiodic 7, 107
realizable subgroup 114	substitution 5
reduction	primitive 171
enumeration 15	recognizable 177
many-one 15	T
positive 15	tileset graph 60, 130
Turing 15	transducer 66
S	translation-like action 25, 44, 66, 108, 110, 112
self-avoiding polygon 81, 96	Turing machine 12
self-avoiding walk 76	W
bridge 94	Wang
	algorithm 41, 108
	tiles 41
	word problem 17, 84, 123
	decidable 62