



HAL
open science

Pharmacogenomic identification of small molecules promoting oligodendrogenesis and myelin repair

Jean-Baptiste Huré

► **To cite this version:**

Jean-Baptiste Huré. Pharmacogenomic identification of small molecules promoting oligodendrogenesis and myelin repair. *Neurons and Cognition [q-bio.NC]*. Sorbonne Université, 2022. English. NNT : 2022SORUS595 . tel-04648659

HAL Id: tel-04648659

<https://theses.hal.science/tel-04648659>

Submitted on 15 Jul 2024

HAL is a multi-disciplinary open access archive for the deposit and dissemination of scientific research documents, whether they are published or not. The documents may come from teaching and research institutions in France or abroad, or from public or private research centers.

L'archive ouverte pluridisciplinaire **HAL**, est destinée au dépôt et à la diffusion de documents scientifiques de niveau recherche, publiés ou non, émanant des établissements d'enseignement et de recherche français ou étrangers, des laboratoires publics ou privés.

Sorbonne Université

École doctorale 158 - Cerveau, cognition, comportement (3C)

Institut du cerveau (ICM) / Equipe « Développement du cerveau », Bassem Hassan

Pharmacogenomic identification of small molecules promoting oligodendrogenesis and myelin repair

Par Jean-Baptiste HURÉ

Thèse soutenue le 29 avril 2022, pour obtenir le titre de Docteur en Neurosciences de Sorbonne Université

Présentée devant un jury composé de :

Dr. Marie Claude Potier: présidente du jury
Dr Elisabeth Traiffort, rapportrice
Pr Anna Williams, rapportrice
Pr Pierre Gressens, examinateur
Dr Brahim Nait-Oumesmar, examinateur
Dr Carlos Parras, directeur de thèse

Remerciements

Mes remerciements s'adressent tout d'abord à mon jury de thèse pour l'honneur qu'ils m'ont fait en acceptant d'évaluer mes travaux. Je tiens à exprimer ma gratitude envers Elisabeth Traiffort et Anna Williams, mes rapportrices, ainsi qu'à Pierre Gressens et Brahim Nait-Oumesmar, mes examinateurs. Merci également à Jean Livet, évaluateur de suivi de ma thèse, et à Marie-Claude Potier, présidente du jury, pour leur précieuse contribution et leur bienveillance tout au long de ces années.

Je remercie Bassem Hassan pour m'avoir accueilli chaleureusement au sein de l'équipe et pour son soutien dans le développement de mon projet. Ton sens critique et tes qualités scientifiques ont été précieux pour l'avancement de ma thèse et formateurs pour ma carrière. Merci également pour ton humour et les moments partagés, qui ont rendu ces années particulièrement enrichissantes.

Un grand merci à Carlos Parras pour m'avoir offert l'opportunité de démarrer ce projet et pour son accompagnement tout au long de ces années. Tu m'as permis de m'épanouir sur un projet translationnel en parfaite adéquation avec mes aspirations scientifiques. J'ai beaucoup appris grâce à toi sur la biologie des oligodendrocytes, le développement et la réparation du cerveau. Ton encouragement à persévérer et ta patience ont été précieux. Travailler à tes côtés a été une chance, et je te remercie également pour ton soutien humain. Ton dévouement, ton enseignement et ta bienveillance ont fait de cette aventure une expérience exceptionnelle. Grâce à toi, j'espère avoir évolué de la petite cellule souche immature à un lignage plus mature jusqu'à l'achèvement de ce manuscrit.

Cette expérience n'aurait pas été aussi formidable sans le reste de la « Parras team ». Un grand merci à Corentine Marie pour ton expertise précieuse et tes conseils, ainsi que pour ton soutien dans les moments difficiles, tu m'as évité bien des accidents corporels. Tu as tenu le choc et je te remercie pour ta grande patience. Emeric Merour, merci pour ta sagesse apparente, de m'avoir épaulé tout le long et pour tous ces moments de folie passés ensemble. Quelle bonne coïncidence d'avoir commencé ma thèse en même temps que toi. Tu as été une source de motivation par ta ténacité, autant à tenir au travail que dans les bars ! Merci à Morgane et Pierre-Henry également d'avoir contribué à l'ambiance de l'équipe et pour leur présence chaleureuse. Je vous souhaite le meilleur pour la suite et plein de bonheur. Je remercie également ma cohorte de souris pour leur implication et leur travail formidable au cours de cette étude.

Un grand merci à tous les membres de l'équipe pour tous ces bons moments passés ensemble, vos conseils, vos échanges scientifiques, votre esprit d'équipe et votre humour. Vous avez grandement contribué à mon plaisir de venir à l'ICM tous les jours pour partager cette aventure avec vous. Merci à Natasha d'illuminer autant mes journées par ta bienveillance et ton sourire, Dania la très douce Kim Jong, Julien mon grand concurrent du relou-mètre, Lucie pour tous ces moments de folie et de bagarre. Un grand merci à Marlène, la personnalité paradoxalement la plus imposante de l'équipe, pour ton humour, tes conseils et ces moments sympathiques passés ensemble. Je remercie Maheva, Irina et Mechi ainsi que les anciens membres Irini, Nicola, Natalia, Tingting et Tengweng pour ces nombreuses discussions scientifiques, pour leur aide et leur gentillesse. Enfin, un grand merci à tata Dahbia de m'avoir supporté au bureau toutes ces années, pour tous ces échanges passionnants ainsi que la gestion et le support autour de mon projet.

Mon manuscrit de thèse se serait limité à une longue introduction sans le soutien des plateformes de culture cellulaire, d'histologie, d'animalerie, de microscopie, de bio-informatique et de séquençage. Un grand merci aux responsables des plateformes Annick Prigent, Dominique Langui, David Akhbar, Laetitia Strehl, Nadège Sarrazin, Yannick Marie, ainsi qu'à leurs associés Bineta, Célia, Nicolas, Aymeric, Claire, Asha, Basile, Agnès. Merci pour votre accueil, votre réactivité, votre gentillesse et votre expertise technique. Votre capacité à vous adapter à mes besoins, votre passion à transmettre de nouvelles techniques et votre dévouement à proposer le meilleur ont été inestimables. J'ai pris beaucoup de plaisir à vous solliciter, parfois à vous embêter, et je suis bien content, après quelques frayeurs, de ne pas jamais avoir trop détruit vos lieux de travail.

Je remercie également l'équipe Thomas avec qui nous avons partagé d'excellents moments, notamment Laurent Jacob pour m'avoir initié aux neurosciences et encadré en stage, mais aussi pour ton sens de l'humour et pour ta capacité à me remotiver dans les moments les plus durs (notamment lors du terrible problème de congélateur). Merci à Jean-Léon Thomas pour ton accueil, ton énergie et ton enthousiasme ainsi qu'à tous les autres membres de l'équipe : Michel, Boris, Catherine, Annie, Karim, José, Juliette, Madison, Julie, et Esther. Florine, merci pour ton soutien, tes taquineries et ton humour. Je remercie également nos chers voisins et amis de l'équipe Lubetzki, notamment Mélina, Rémi, Giorgos, Thomas, Emilie, Vassiliki et Pauline avec qui nous avons pu partager d'intenses déjeuners, discussions et moments de plaisir mais aussi d'entraide. Elisa, je suis très chanceux de t'avoir rencontrée lors de nos tout premiers débuts à l'ICM. Merci pour ton aide et pour le coaching afin d'en arriver jusque-là, et surtout pour tous ces moments incroyables et improbables passés ensemble. Un grand merci à Marie-Stéphane Aigrot, ton aide pour finaliser mon projet a été très précieuse, et quelle joie de te voir au quotidien !

Je remercie la direction des applications à la recherche et l'iPEPS, particulièrement Julien Elric et Louise Remigereau que j'ai rencontrés dès mon arrivée, pour m'avoir grandement aidé lors de la compétition iGEM, ainsi que pour tous ces conseils et moments passés ensemble. Merci à Alexis Genin, Athanasia Liabotis, Valérie Fonteny, Fanny Audibert pour votre soutien intellectuel, humain et financier, ainsi que de m'avoir permis, grâce aux projets Carnot, de finaliser ce projet.

Patricia Oliviero, je te remercie chaleureusement pour tout ce que tu m'as apporté, autant d'un point de vue personnel que professionnel. Merci d'avoir donné autant d'énergie et de rayonnement dans les activités que l'on a pu partager ensemble, je te souhaite plein de bonheur pour la retraite. Merci également à Nicolas et Isabelle pour avoir grandement contribué à la communication et à notre vie quotidienne.

Je tiens à remercier infiniment mes grands amis et collègues de l'ICM pour tous ces grands moments de joie, de galères et de longs traquenards. Un grand merci à Lucas pour ta générosité, ton aide pour achever ma thèse : la relecture, les tranches de cerveau et les nombreux levers de coude à la tête ailleurs ; ainsi que pour ta force de proposition et d'organisation (on n'a pas tout fait, on en garde pour la suite !). Agnès, tu avais déjà quitté l'équipe lorsque je suis arrivé, mais tu as été une des premières rencontres formidables de l'institut. Merci à Oriana pour ces moments de butinage et de folie passés ensemble et également à Lindsay, Delphine, Agnès, Morwena, Ben, Alex, Alizée, Julie pour ces moments de folie, Jean Karim pour sa supervision constante, ainsi qu'à tous les autres que je n'ai pas mentionnés dans cette aventure.

Je remercie amicalement Emelyne Lecuyer, car ma première expérience de stage à tes côtés m'a très rapidement convaincu et motivé à m'orienter vers la recherche. Merci pour ta gentillesse, ton encadrement et tous ces très bons moments passés ensemble. Je remercie dans la continuité de mes

expériences passées Romain Fontaine, Thomas Rouille et Sarah Guegan pour m'avoir orienté vers le domaine thérapeutique et cette longue aventure.

Un grand merci à mes amis proches Inès, Mehdi, Yasmine, Yannis, Raysi et Camille. On a grandi et fait nos 400 coups ensemble, il me faudrait également une thèse pour raconter nos histoires et ces moments mémorables que nous avons vécus et à venir. Merci à tous les autres bons vieux (Cassandra, Donia, Jordan, Sandra, Marjo, Camille, Caroline, Thomas, Tof et les Martinez brothers) d'avoir toujours été présents. Leila et Laetitia, je suis très chanceux de vous avoir rencontré dès les tout débuts à la fac, un des plus grands succès lors de cette aventure, merci pour ces moments de bonheur, crises de rire, galères et bagarres; ainsi qu'à Kevin, Aurélien, Elie, la team apoptose, et la Schlagance. Merci à la famille Tapprest, en particulier à Jean-François, Sirpa et Daniela, pour votre accueil et gentillesse pendant ces années passées aux Gobelins.

Je tiens à exprimer une profonde reconnaissance envers mes grands-parents : l'amour, l'éducation et le soutien qu'ils m'ont apporté a forgé un des piliers essentiels de ma réussite. Vous m'avez laissé des souvenirs inestimables après votre passage. Un merci tout particulier à ma vieille denrée Sophie, à ma tante Liliane, ainsi qu'à mes cousins Nicolas, Laetitia et Juliette, pour leur présence et leur affection. Enfin, je n'en serais pas là aujourd'hui sans le soutien inestimable de mes parents, Isabelle et Jean-Pierre. Merci pour le bonheur que vous m'apportez, pour ces moments de joie partagés et cette solidarité qui m'ont accompagné tout au long de cette aventure. Marie-Laure, je suis extrêmement chanceux de t'avoir au quotidien. Ton soutien, nos moments de rires, d'entraide et de partage, ainsi que ton courage et ta force, ont été une source d'endurance et de bonheur. Merci pour tout ce que tu fais, de m'avoir poussé à persévérer dans les moments difficiles et à finaliser ce manuscrit, et à tout simplement d'être une présence si précieuse dans ma vie.

Pour conclure ces remerciements succins et avant de vous plonger dans le vif du sujet et vous parler de ces oligodendrocytes, en espérant tenir le choc jusqu'au bout, je tiens à vous dire combien ma vie n'aurait jamais été aussi heureuse et épanouie sans vous avoir tous rencontrés. Merci infiniment à chacun d'entre vous. Je vous souhaite à toutes et à tous plein de bonheur, santé, amour et réussite. Maintenant, place au contenu !

À mes regrettés grands-parents,
Madeleine et Jean Gauthier, Lucienne et Jean Huré

TABLE OF CONTENTS

GLOSSARY	11
TABLE OF FIGURES	13
INTRODUCTION	15
CHAPTER I- THE EXPANDING CELLULAR DIVERSITY DURING CNS DEVELOPMENT	16
CENTRAL NERVOUS SYSTEM: A KEY ROLE DURING EVOLUTION	16
NEURAL GENESIS: EXPLORING THE DEVELOPMENT OF THE CENTRAL NERVOUS SYSTEM	19
NEURAL STEM CELLS GENERATE NEURAL CELL DIVERSITY.....	21
<i>Genetic Choreography: Intrinsic Regulation of Neural Stem Cell Activity</i>	<i>23</i>
<i>Extrinsic regulations of Neural Stem Cell activity: influence of the niche.....</i>	<i>25</i>
<i>Neural cell types</i>	<i>26</i>
CHAPTER II: OLIGODENDROCYTE BIOLOGY AND GENERATION	30
OLIGODENDROCYTES PRECURSORS CELLS	30
<i>OPC Functions</i>	<i>31</i>
<i>OPC Generation</i>	<i>34</i>
OLIGODENDROCYTES	35
<i>Saltatory conduction.....</i>	<i>35</i>
<i>Trophic support</i>	<i>36</i>
<i>Synaptic plasticity.....</i>	<i>37</i>
MULTIPLE SIGNALING PATHWAYS REGULATE OLIGODENDROGENESIS	38
MYELINATION	45
REMYELINATION.....	47
CHAPTER III- OLIGODENDROGLIAL AND MYELIN IMPLICATION IN DISEASES	49
PRETERM BIRTH.....	49
<i>Origin, diagnostic and treatments.....</i>	<i>49</i>
<i>Consequences on brain</i>	<i>50</i>
MULTIPLE SCLEROSIS	54
<i>Origin and diagnostic.....</i>	<i>55</i>
<i>Inflammatory mechanisms.....</i>	<i>56</i>
SHARED OL DISRUPTION SIGNATURE UNVEILED IN DIVERSE BRAIN DISORDERS	58

CHAPTER IV- FROM ESTABLISHED STRATEGIES TO PHARMACOGENOMIC DRUG REPURPOSING	61
PHARMACOLOGICAL MODULATION OF OLIGODENDROCYTE SIGNALING	61
<i>Calcium signaling.....</i>	<i>62</i>
<i>G-coupled protein receptors signaling.....</i>	<i>64</i>
<i>Metabolism.....</i>	<i>66</i>
<i>Hormones.....</i>	<i>67</i>
<i>Growth factors</i>	<i>68</i>
<i>Vitamins.....</i>	<i>69</i>
MANAGING INFLAMMATORY RESPONSES	70
REPROGRAMMING.....	73
DRUG REPURPOSING	74
AIM OF THE DISSERTATION	78
MATERIAL & METHODS.....	81
<i>General overview of the bioinformatic strategy.....</i>	<i>82</i>
<i>Data collection and processing for oligodendroglial gene-sets enrichment.....</i>	<i>82</i>
<i>Gene ontology and cell specific enrichment analysis.....</i>	<i>85</i>
<i>Pharmacogenomic strategy: Expert curation, scoring and validation</i>	<i>86</i>
<i>Pharmacogenomics identification and selection of small molecules.....</i>	<i>87</i>
<i>Pharmacological analyses.....</i>	<i>87</i>
<i>Selected drugs.....</i>	<i>88</i>
<i>Animals</i>	<i>89</i>
<i>Neonatal neural progenitor cultures</i>	<i>89</i>
<i>Oligodendrocyte precursor cells sorting and cultures.....</i>	<i>89</i>
<i>Cerebellar organotypic cultures.....</i>	<i>90</i>
<i>Intracerebral injection of lysolecithin induced demyelination in adult mice</i>	<i>90</i>
<i>Neonatal hypoxia</i>	<i>91</i>
<i>Immunofluorescence staining</i>	<i>92</i>
<i>Image acquisition and analysis.....</i>	<i>93</i>
<i>Electron microscopy and analysis.....</i>	<i>94</i>
<i>Statistics and representations.....</i>	<i>94</i>
ADDITIONAL METHODS FOR IN-SILICO ANALYSIS.....	96

RESULTS	121
PATENT: ORGANIC MOLECULES FOR TREATING MYELIN DISEASE (IBIO-2221/EP)	122
ARTICLE: PHARMACOGENOMIC SCREENING IDENTIFIES AND REPURPOSES DYCLONINE AND LEUCOVORIN AS PRO-OLIGODENDROGENIC AND PRO-MYELINATING COMPOUNDS	122
<i>Generation of a transcriptional signature and associated “hub genes” defining oligodendrogenesis.</i>	126
<i>Identification and expert curation of compounds acting on oligodendroglial-associated genes</i>	127
<i>Pro-oligodendrogenic activity of selected compounds in neonatal neural progenitor cells</i>	128
<i>Cell-autonomous effect of selected compounds in OPC differentiation</i>	129
<i>Selected compounds promote oligodendrocyte differentiation and myelination ex vivo in cerebellar explant cultures</i>	130
<i>Dyclonine and leucovorin promote oligodendroglial regeneration in a mouse model of preterm birth brain injury</i>	131
<i>Dyclonine and leucovorin promote OPC differentiation while maintaining the OPC pool in a mouse model of adult demyelination</i>	133
<i>Dyclonine and leucovorin accelerate oligodendrocyte formation and remyelination in a mouse model of adult demyelination</i>	134
<i>Dyclonine and leucovorin accelerate myelin clearance and microglial transition from pro-inflammatory to pro-regenerative profiles in a mouse model of adult demyelination</i>	135
DISCUSSION	193
PERSPECTIVES	202
REFERENCES	206
RESUMÉ EN FRANÇAIS	257

GLOSSARY

ACH: Acetylcholine
ADMET: Absorption, Distribution, Metabolism, Excretion, and Toxicity
AMPA: Alpha-Amino-3-Hydroxy-5-Methyl-4-Isioxazolepropionic Acid
ASCL1: Achaete-Scute Complex-Like 1
BDNF: Brain-Derived Neurotrophic Factor
BHLH: Basic Helix-Loop-Helix
BBB: Blood Brain Barrier
BMPs: Bone Morphogenetic Proteins
CC: Corpus callosum
CCL: C-C Motif Chemokine Ligand
CDK: Cyclin Dependent Kinase
ChIP-seq: Chromatin Immunoprecipitation Sequencing
CHD: Chromodomain Helicase DNA Binding Protein
CMAP: Connectivity Map
CNS: Central Nervous System
CNP: 2',3'-Cyclic Nucleotide Phosphodiesterase
CSF: Cerebrospinal Fluid
COX2: Cyclooxygenase 2
CSPG4: Chondroitin Sulfate Proteoglycan 4 (NG2)
DHFR: Dihydrofolate Reductase
EAE: Experimental Autoimmune Encephalomyelitis
ECM: Extracellular Matrix
E12.5: Embryonic Day 12.5
FDA: Food and Drug Administration
EDNR: Endothelin Receptor
EdU: 5-Ethynyl-2'-deoxyuridine
FGF: Fibroblast Growth Factor
FR α : Folate Receptor Alpha
GABA: Gamma-Aminobutyric Acid
GALC: Galactosylceramidase
GDNF: Glial-Derived Neurotrophic Factor
GF: Growth Factors
GFP: Green Fluorescent Protein
GO: Gene Ontology
GOF: Gain-Of-Function
GPR17: G-Protein-Coupled Receptor 17
GW: Gestational Week
HDAC3: Histone Deacetylase 3
IFN γ : Interferon-Gamma
IGF-1: Insulin-Like Growth Factor 1
IL-1 β : Interleukin 1 Beta
iNOS: Inducible Nitric Oxide Synthase
iOLs: Immature Oligodendrocytes
KD: Knockdown
KO: Knockout

LOF: Loss-Of-Function
LPC: Lysolecithin (or LysoPhosphatidylCholine)
LRP1: Low-Density Lipoprotein Receptor-Related Protein 1
LTP: Long-Term Potentiation
MAG: Myelin-Associated Glycoprotein
MBP: Myelin Basic Protein
mGluR: Metabotropic Glutamate Receptor
MHC: Major Histocompatibility Complex
MOG: Myelin Oligodendrocyte Glycoprotein
mOL: Mature Oligodendrocytes
MS: Multiple Sclerosis
mTORC1: Mammalian Target of Rapamycin Complex 1
MYRF: Myelin Regulatory Factor
NADPH: Nicotinamide Adenine Dinucleotide Phosphate
NG2: Chondroitin sulfate proteoglycan (or CSPG4)
NGF: Nerve Growth Factor
NFIA: Nuclear Factor I/A
NRF2: Nuclear Respiratory Factor 2
NMDA: N-Methyl-D-Aspartate
NPC/NSC: Neural Precursor/Stem Cells
OL: Oligodendrocyte
OMG: Oligodendrocyte Myelin Glycoprotein
OPCs: Oligodendrocyte Precursor Cells
PDGFR α : Platelet-Derived Growth Factor Receptor Alpha
P: Postnatal age
PBI: Preterm-Birth Brain Injury
PCFT: Proton-Coupled Folate Transporter
PLP: Proteolipid Protein
PNS: Peripheral Nervous System
PTB: Preterm Birth
RG: Radial Glia
RT: Room Temperature
SHH: Sonic Hedgehog
SPIED: Searchable Platform-Independent Expression Database
5-HT: Serotonin
SOX10: SRY-Box Transcription Factor 10
STAT3: Signal Transducer and Activator of Transcription 3
SVZ: Subventricular Zone
TFs: Transcription Factors
TGF- β : Transforming Growth Factor-Beta
THC: Tetrahydrocannabinol
TNF α : Tumor Necrosis Factor Alpha
TRAIL: Tumor Necrosis Factor-Related Apoptosis-Inducing Ligand
TRL: Technology Readiness Level
T3: Triiodothyronine
WM: White Matter
Wnt1: Wingless-Type MMTV Integration Site Family, Member

TABLE OF FIGURES

- Figure 1:** Illustration of the nervous systems diversity between species.
- Figure 2:** Variability of brain size and external topography.
- Figure 3:** ARHGAP11B increases fetal primate neocortex size and folding.
- Figure 4:** Steps of development of the nervous system from the neural tube.
- Figure 5:** Identification and illustration of neuroglial stem cells.
- Figure 6:** Schematic representation of the NSCs activity during brain development.
- Figure 7:** Regulation of the adult hippocampal neurogenesis by the niche.
- Figure 8:** Scheme illustrating the cellular brain diversity and how much cells are interconnected
- Figure 9:** Scheme of the neural cells diversity, illustrating how PA is generated inside the synapse.
- Figure 10:** Astrocyte morphology and functions.
- Figure 11:** Microglia morphology and regulation of their phenotype during inflammation.
- Figure 12:** Scheme illustrating SVZ forming NSC diversity during development.
- Figure 13:** OPCs perform multiple functions in the CNS.
- Figure 14:** Illustration of the different waves of OPC generated during development.
- Figure 15:** Oligodendrocyte biology and functions.
- Figure 16:** Action potential conduction along myelinated fibers.
- Figure 17:** Axonal factors regulating myelin plasticity.
- Figure 18:** Illustration of the mains cellular and genetic complexity regulating oligodendrogenesis.
- Figure 19:** Illustration of the mains expression marker / regulators of the oligodendroglial lineage.
- Figure 20:** Model of oligodendrogenesis regulation by chromatin remodeler/ transcription factors
- Figure 21:** Structure of the myelin sheath in the CNS.
- Figure 22:** Comparison between humans and rodent myelination.
- Figure 23:** Schematic model of the axo-glial interaction, OPCs differentiation and myelination.
- Figure 24:** Schematic representation of the remyelination process
- Figure 25:** Illustration showing the coincidence of PTB vulnerability during oligodendrogenesis.
- Figure 26:** Multiple Sclerosis is clinically classified depending on disease progression.
- Figure 27:** Scheme illustrating biomarkers used for MS diagnosis.
- Figure 28:** Immune cell regulation in and outside the CNS during MS.
- Figure 29:** Genes altered in neurological disorders are expressed by oligodendroglial cells.
- Figure 30:** Pharmacological approaches and pathways regulating oligodendrogenesis.
- Figure 31:** Pharmacological modulation of GPCR/calcium signaling is crucial for OLgenesis.
- Figure 32:** Comparison between classical drug development and drug repurposing.
- Figure 33:** Principle of connectivity map (dataset coverage, signature generation, data access).

INTRODUCTION

CHAPTER I- THE EXPANDING CELLULAR DIVERSITY DURING CNS DEVELOPMENT

CENTRAL NERVOUS SYSTEM: A KEY ROLE DURING EVOLUTION

The nervous system is a highly complex organ coordinating perception, motor actions and processing transmission of electrical signals throughout the body. In mammals the nervous system is divided into the central (CNS, brain and spinal cord) and the peripheral (PNS, autonomic and somatic nervous system). Whereas the autonomic system regulates physiological processes such as heart rate, digestion or respiration, the somatic system voluntarily controls movements through skeletal muscles. The adult human brain weighs on average about 1.2–1.4 kg (2% of the total weight) but require roughly 20% of the total energy (Sieber et al. 1989; Magistretti et al. 1999) crucial for performing highly complex functions (e.g. sensory information, learning or memory). Evolutionary mechanisms empower an incredible diversification of neural structures (e.g. size, complexity and associated functions) to respond and adapt tasks to the environment (Fig. 1).

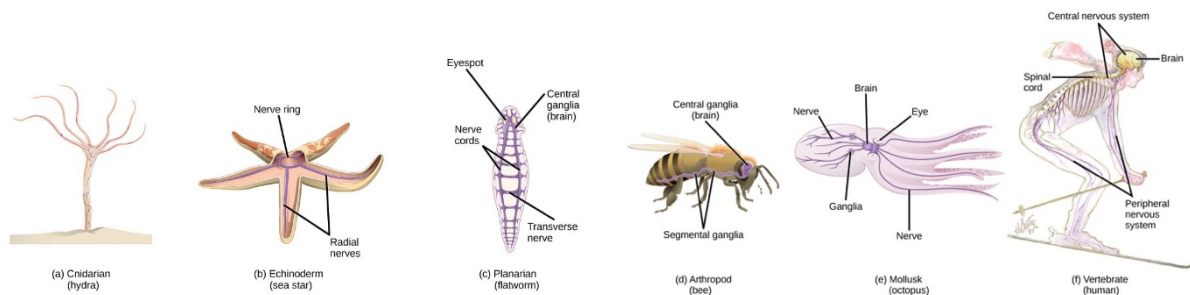
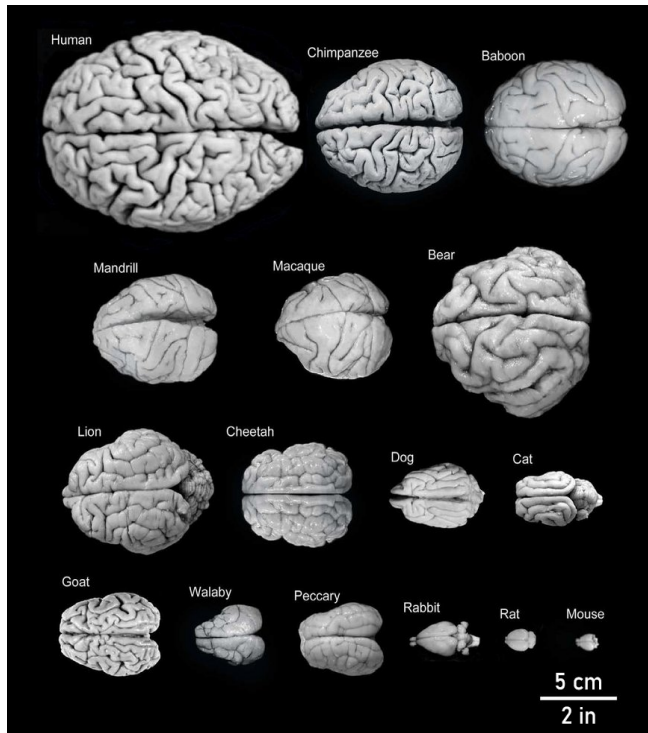

Figure 1: Illustration of the nervous systems diversity between species. Decentralized nerve net in cnidarians (a), nerves and radial fibers in echinoderms (b), neuronal clusters centralized in the anterior brain in planarians (c), a ventral nerve cord containing peripheral ganglia with clusters of nerve cell bodies associated to a central brain in arthropods (d), a complex brain including millions of neurons in mollusk (e), a CNS and a PNS in vertebrates (f). (adapted from Connie Rye et al, 2016)

Cnidarians have primitive neural structures considered as diffuse and simple neural networks without neural centralization, including a large nerve net to swim and a small one to control feeding and spasm response (Fig. 1a). Nevertheless, neural cell types are already diverse, including sensory neurons allowing chemical detection and sensory response, and intermediate neurons transmitting activity signals to the motor neurons for body contractions. Primitive, evolutionarily old nervous structures in bilaterian form appeared during the Cambrian period about 550 to 600 million years ago (Balavoine 2003). Bilaterians are characterized by a nerve cord and a large ganglion that is the premise of the brain structure. For instance, the annelid flatworm contains a primitive bilobed brain made of

two cerebral ganglia with clusters of nerve cells projecting sensory and motor nerve fibers (Fig. 1c). In vertebrates and Cephalopoda, nerve cells are centralized in the anterior region (heads), allowing body coordination and to perform more complex functions such as hunting or escaping from the predator (Fig. 1e,f).



Vertebrates (or craniates) are characterized by a protection of the head by a skull, with a brain size correlated to the metabolism needs and to the complexity of the cognitive functions (Fig. 2). Seven million years separate monkeys from the first Homo sapiens, a slow evolution which has notably resulted in the increase in brain size and structure, marked by the expansion of the cerebral neocortex (about 3 times bigger than a chimpanzee).

Figure 2: Variability of brain size and external topography. Pictures illustrating changes in brain size between species. Scale bar: 5 cm. (DeFelipe 2011)

Several studies have examined brain differences to explain our more advanced cognitive abilities. Distinctions are anatomical, as the human brain has undergone more rapid expansion compared to the primates with about three times the size of a primate's brain (Striedter 2006). Human brains are characterized by a massive prefrontal cortex controlling self-awareness and pronounced convolution of the cortex (Luders et al. 2008). Structural asymmetry is also an important characteristic, as 90% of the human left hemisphere controls language, manual skills and spatial attention (Corballis 2014). Other anatomical regions differ from monkeys, such as superior temporal sulcus (Leroy et al. 2015), a folding of the cortex related to social cognition and speech. On the other hand, regulation of gene expression during brain development depends on species and individuality. Although humans and chimps share 98.8% of DNA identity, timing and level of gene expression differs, particularly during embryonic brain development. Indeed, during the early period of brain formation, primary neurogenesis occurs allowing neuronal generation from neural progenitors, with well documented discrepancies in term of cell behavior (Lui, Hansen, et Kriegstein 2011; Geschwind et Rakic 2013; Taverna, Götz, et Huttner 2014; Suntsova et Buzdin 2020). For instance, a team recently demonstrated that 1 million years after species divergence, a single genetic substitution (C to a G) induced a lack of 55 nucleotides in ARHGAP11B and the loss of Rho guanosine triphosphatase

activating protein activity. This tiny DNA change was enough to promote basal progenitor amplification and to contribute to the evolutionary expansion of the human neocortex (M. Florio et al. 2015; Marta Florio et al. 2016; Heide et al. 2020).

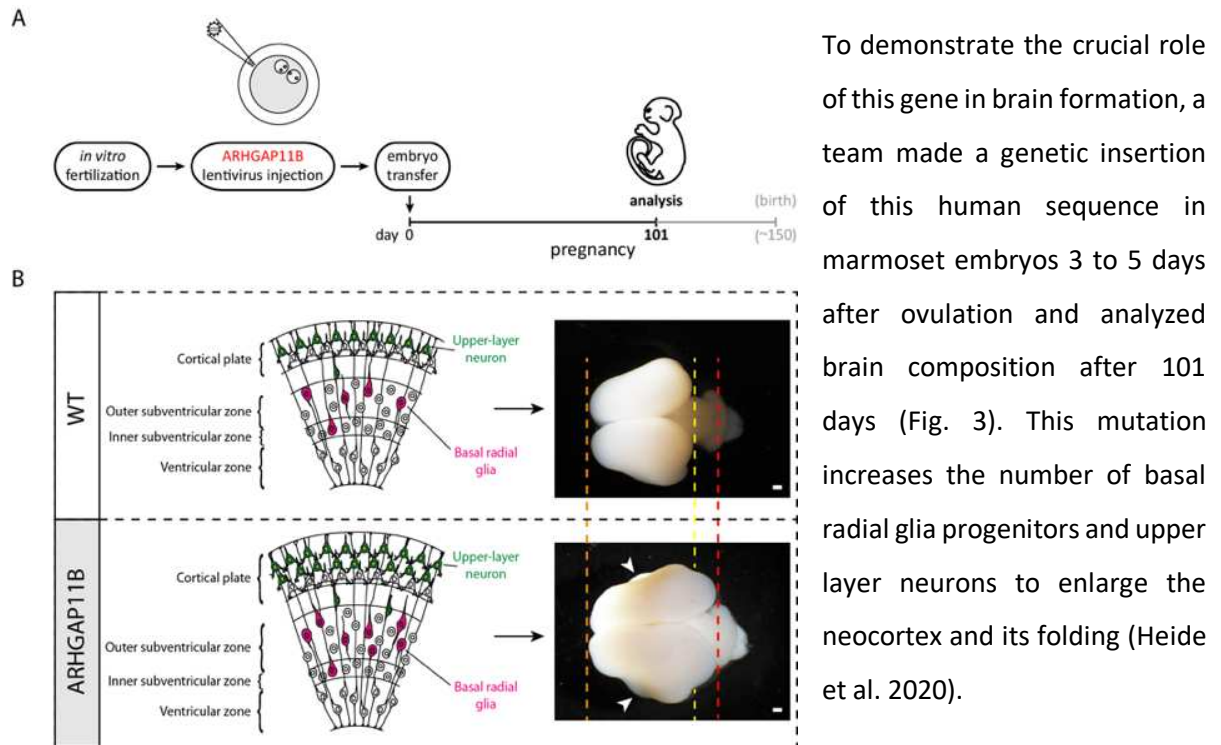

Figure 3: ARHGAP11B increases fetal primate neocortex size and folding. (A) Generation of ARHGAP11B-transgenic fetal marmosets. (B) Cellular changes in upper layer neurons and basal radial glia composition occurs between WT and ARHGAP11B-transgenic fetal marmoset. Scale bars, 1 mm.

Temporal regulation of genetics is also another crucial step for brain formation, particularly along embryogenesis during which genetic programs dynamically change to regulate neurogenesis and cell differentiation. Mathematical modeling of neurogenesis has shown that cell proliferation occurs earlier in the human cerebral cortex compared to the adult great apes, with nearly twice time of neurons in the adult human (Benito-Kwiecinski et al. 2021)(Benito-Kwiecinski et al. 2021)(Benito-Kwiecinski et al. 2021). One of these temporal gene regulators is Zeb2, able to delay morphological transition of neuroepithelial cells, shortening cell cycle length as a “cell growth switch”. Thus, delaying the effects of Zeb2 in gorillas increases their brain growth, demonstrating that temporal expression of a gene is crucial to give a functional identity during development for a cell and to allow brain formation (Benito-Kwiecinski et al. 2021).

Amazingly, the brain originates from a restricted population of embryonic cells generating minutely billions of cells, particularly during the first postconceptional weeks in humans. This mechanism involves a succession of processes described below.

Human brain development starts early after conception and continues until young adulthood under both genetic and environmental control. This developmental procedure requires hundreds of processes (e.g. proliferation, migration, differentiation, survival, vascularization, synaptogenesis, myelination). To better understand the basis of human CNS development, morphogenic studies of sectioned embryos from the Carnegie collection identified 23 distinct developmental stages. Processes start at the 3rd week of gestation (GW) in the 1mm embryo when the blastula made of bilaminar inner cell mass changes in three embryonic germ layers called “gastrula” (triploblastic gastrulation) (Fig. 4A). These layers include ectoderm (forming the skin, nervous system and neural crest), endoderm (for digestive and respiratory systems, liver and pancreas) and mesoderm (forming muscle, bones, connective tissue and skeletal systems). In 1924, Hans Spemann and Hilde Mangold using experiments of transplantation in *Xenopus* tadpoles, discovered that cell fate depends on the microenvironment, particularly on the competence to receive a signal and to respond (Spemann et Mangold 2001; De Robertis 2009). Then, neural induction is triggered in response to the interaction between the node and the surrounding embryonic tissues, spatially regulated by molecular gradients along the axes of the neural tube. Those gradients include Notch regulating competence, Goosecoid, Wingless 1 (Wnt1), Insulin Growth Factor (IGF), basic Fibroblast Growth Factor (bFGF) and retinoic acid (Cho et al. 1991; Y. Chen et al. 1992; Crease, Dyson, et Gurdon 1998; Ille et Sommer 2005; Revinski et al. 2010). Thus, the neuroepithelium contains specific cells called neuroectodermal cells responding to various stimuli provided by their local environment, leading to a progressive differentiation and maturation of neural structures (Fig. 4B).

Primary neurulation occurs at 3-4GW with pseudo-stratification of the neuroectoderm to form under symmetrical divisions the neural plate and the neural tube along the neuraxis of the neuroepithelium (Schoenwolf et Alvarez 1989; Colas et Schoenwolf 2001). Growth on both sides of the neural tube give rise to the future somites (mesoderm). This processes by regulated by Fgf8 from the primary endoderm, Wnt along the antero posterior axis, bone morphogenetic protein (BMP), chordin and noggin from the node and mesendoderm, and transforming growth factor beta (TGFβ) secreted by the lateral ectoderm (Muñoz-Sanjuán et Brivanlou 2002; Wittler et Kessel 2004; Vieira et al. 2010; Niehrs 2010; Leung, Kent Morest, et Li 2013; 2013). Around 3 to 4GW, closure of the lumen of the neural tube generate the embryonic brain vesicles forebrain (prosencephalon), midbrain (mesencephalon), and hindbrain (rhombencephalon) (Behrman et al. 2007). This step is followed by neural crest cell migration through the embryo to form the PNS (e.g. melanocytes, sympathetic ganglia, dorsal root, adrenal medulla...) (Loring, Barker, et Erickson 1988; Bronner 2012). Then,

cephalic and cervical flexures divide the forebrain into respectively telencephalon and diencephalon, whereas the segmentation of the caudal spinal cord creates the hindbrain (Fig. 4C) (Pombero et Martinez 2009).

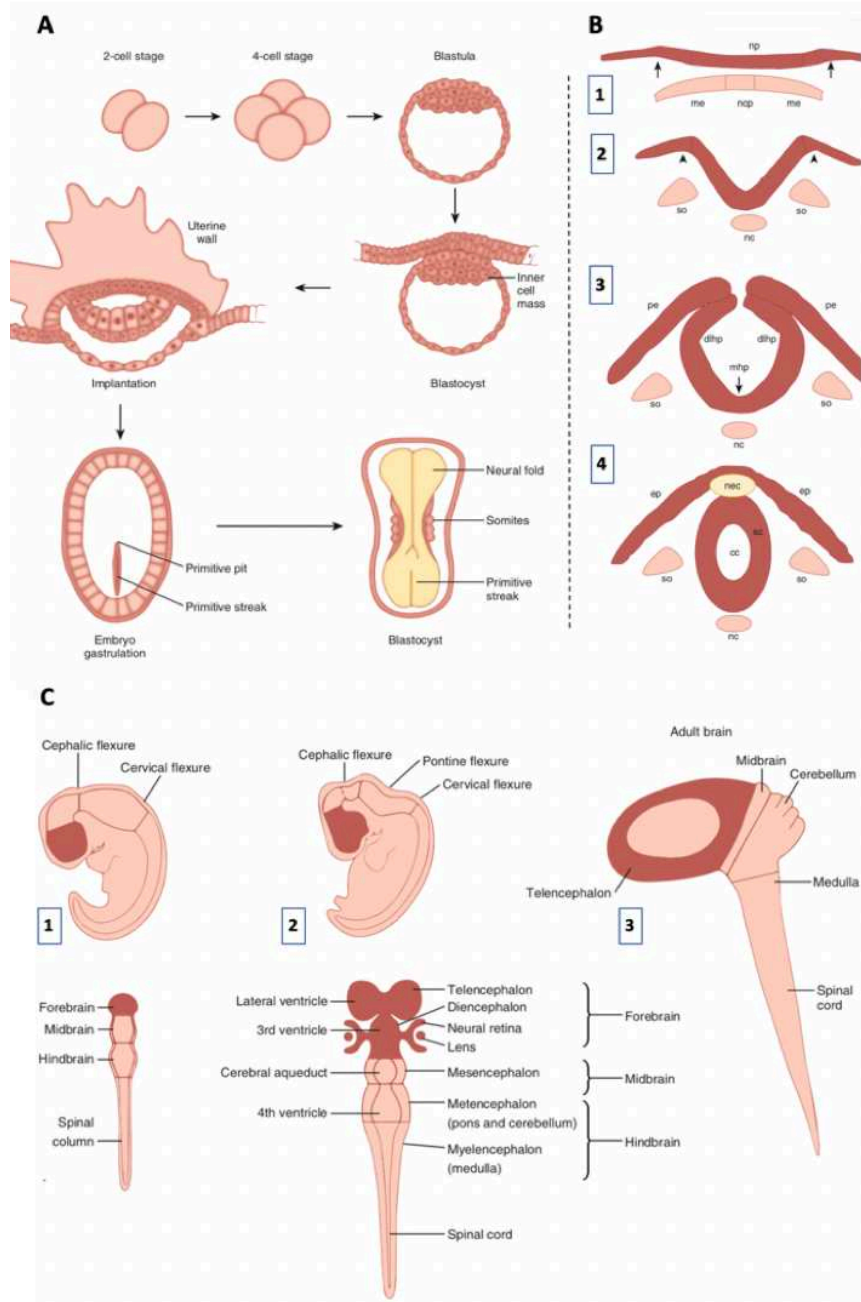
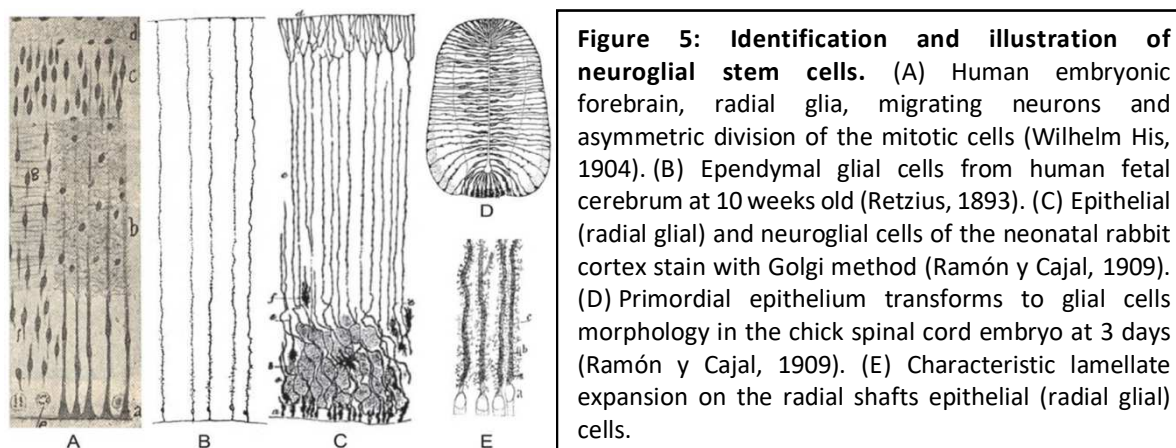

Figure 4: Steps of development of the nervous system from the neural tube. (A) Early development of the human embryo occurs including gastrulation, followed by (B) neural tube closure and (C) flexions (cephalic and cervical) generating the brain and spinal cord structures. cc, Central canal; ep, epidermis; me, mesoderm; nc, notochord; ncp, notochordal plate; nec, neural crest; np, neural plate; pe, presumptive epidermis; sc, spinal cord; so, somites. (Adapted from Sanes DH, Reh TA, Harris WA, editors: Polarity and segmentation).

These steps of development are highly regulated through microenvironmental factors and genetics, and defects on these mechanisms can lead to severe defects such as CNS malformation such as anencephaly when the neural tubes fail to close.

One of the main discoveries in neuroscience remains the identification of neural stem cells (NSCs) in the second half of the 19th century, with the emergence of concepts related to “multipotent dividing cells”. Initially, a Swiss neurologist Wilhelm His demonstrated using histological methods that some dividing cells close to the human ventricular surface stop to divide upon neuronal commitment before migrating to their final position. Later, Ramon Y Cajal identified with silver impregnation method in the embryonic human brain an initial bipolar neuroepithelial cells transforming into a fetal glioblast producing astrocytes (Fig. 5) (Choi 1981; Kolliker 2007; Breunig, Haydar, et Rakic 2011; Gil, Nocentini, et del RÃ-o 2014). They divide asymmetrically to generate either one daughter cell remaining on the ventral surface and one migrating cell producing either neurons and glial cells (Retzius, 1893a, 1893b). These historical discoveries emerging from NSCs quickly bring new hope for therapy through cell regeneration.



A century later, their observation of these cells was confirmed using electronic microscopy characterized by the expression of glial fibrillary acidic protein (GFAP) (Levitt et Rakic 1980). These cells are located in the subventricular (SVZ) walls and are highly proliferative, mitotic and pluripotent (Pilz et al. 2013; Malatesta et Götz 2013). They divide asymmetrically to ensure self-renewal and differentiation, allowing cortical expansion (Kriegstein, Noctor, et Martínez-Cerdeño 2006; Fish et al. 2008). Following early neurogenesis, NSCs extend their processes and acquire a radial glial (RG) cell morphology (Aaku-Saraste et al. 1997). Indeed, they expand numerous endfeet at the pial surface with vessels to create the link between the apical side of the ventricle (Campbell et Götz 2002). This interaction is crucial for neuronal migration and for the interaction with endothelial cells (Rakic 1972; Mission et al. 1991). They are characterized by expression of Nestin, BLBP, Glast, Tenascin C and Vimentin, and are morphologically similar to GFAP+ astrocytes (Levitt et Rakic 1980; Hartfuss et al. 2001; Morest et Silver 2003). During early embryogenesis, they divide symmetrically, amplifying the pool and start neurogenesis through asymmetric division generating neuronal precursors and early

neurons (2-4GW). These cells migrate through the layer of the brain where they differentiate to perform synaptogenesis (6 months to 3 years). Then, a gliogenic switch occurs around the second trimester of gestation to produce the glial cells: astrocytes and oligodendrocytes precursors cells (OPCs) (Fig. 6) (McConnell 1995; Temple 2001; Noctor et al. 2004; Kriegstein et Alvarez-Buylla 2009).

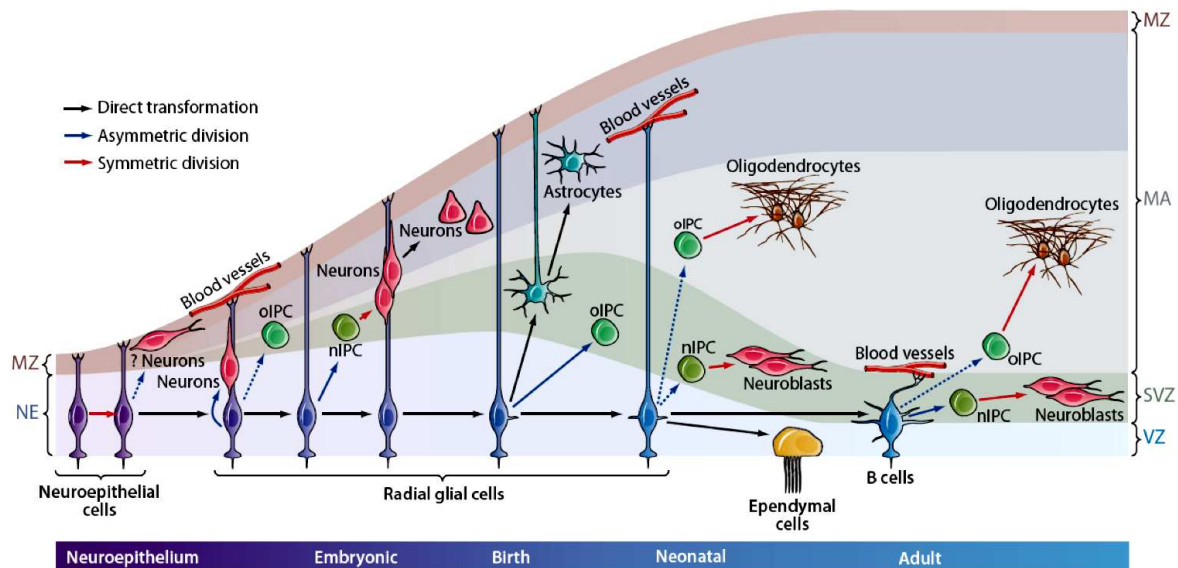

Figure 6: Schematic representation of the NSCs activity during brain development. During early embryogenesis, neuroepithelial cells divide symmetrically and convert into RG cells generating early neurons through asymmetric division. Later, RG generates glial cells (astrocytes and OPCs) and maintains a pool of NSCs during life (SVZ astrocytes, type B cells). IPC: intermediate progenitor cell, MA: mantle, MZ: marginal zone, NE: neuroepithelium, (n/o)IPC : neuronal/ oligogenic IPCs, RG : radial glia, SV: subventricular zone (Kriegstein et Alvarez-Buylla 2009)

Since the 1960s, the capacity of adults to generate new neurons has been strongly debated. In the adult brain of mammals, neurogenesis was identified in two neurogenic germinal zones: the subgranular zone (SGZ) of the dentate gyrus in the hippocampus and the SVZ of the lateral ventricles (B. A. Reynolds et Weiss 1992; Richards, Kilpatrick, et Bartlett 1992; Suh, Deng, et Gage 2009). Adult NSCs, or Type B1 cells are considered a subpopulation of SVZ astrocytes with similar radial morphology and expressing GFAP (Doetsch et al. 1999; Laywell et al. 2000; Noctor et al. 2002). They retract their interaction with the pial surface and generate intermediate precursor cells, also called transiently amplifying progenitors (TAPs). They are identifiable with short-term BrdU/EdU labeling, and express the transcription factor Achaete-Scute Family BHLH Transcription Factor 1 (Ascl1) (Carlos M Parras et al. 2004) crucial for the generation of the postmitotic neuroblasts and OPCs (Carlos M Parras et al. 2004; C. M. Parras et al. 2007; Sugimori et al. 2007; 2008). These cells migrate along the rostral migratory stream into the olfactory bulb and generate olfactory interneurons (K. M. Young et al. 2007). Their activity is regulated by either intrinsic and extrinsic factors from the surrounding niche regulating their division, differentiation, maintenance, and behavior (Doetsch 2003; Alvarez-Buylla et Lim 2004; Moyse et al. 2008)

NSC activity depends on intrinsic mechanisms regulating their ability to proliferate, differentiate, and maintain their stem cell state. Pluripotent embryonic stem cell (ESC) cultures have demonstrated that specific gene expression programs drive the formation of distinct cell fates (specification), followed by their specialization and acquisition of functional identity (differentiation). Each cell type can be distinguished by the expression of a particular set of genes, markers, and functions. Despite all cells in an organism sharing the same genetic content, their unique gene expression profiles define their identities. Thus, intrinsic regulation of cell development relies on DNA expression, RNA transcription, and translation into a specific set of proteins. Genetics plays a pivotal role in this regulation, with genes and their associated “products” such as proteins and non-coding RNAs leading to a myriad of cellular processes that directly influence NSC behavior.

The Human Genome and Its Influence: The human genome comprises 46 chromosomes (23 pairs, versus 20 in mice), encompassing approximately 6 billion base pairs of nucleotides and about two meters of DNA. In total, approximately 20,000 to 25,000 protein-coding genes are responsible for producing proteins that carry out essential functions in the body such as growth, development, metabolism, and immune response. In addition to protein-coding genes, the human genome also includes non-coding regulatory elements (non-coding RNAs, introns) which play crucial roles in gene expression regulation. Non-coding elements include microRNAs (miRNAs) regulating gene expression post-transcriptionally, long non-coding RNAs (lncRNAs) involved in transcriptional and chromatin structure regulation and mRNA maturation. Together, these coding and non-coding elements form a complex and highly regulated system driving cell development.

Gene expression is regulated through the activation or repression of gene sets in response to temporal and environmental changes. The conformation of chromatin (DNA and its associated proteins, including histones) is crucial in controlling this expression. Non-active DNA forms (heterochromatin) are condensed into a 30 nm fiber, while transcriptionally active forms (euchromatin) are decondensed into a more accessible 11 nm fiber. This switch in DNA compaction, and thus gene expression, is mediated by the activity of enzymes (writers) that induce modifications of histone proteins (epigenetic marks) and other proteins (readers) that bind to specific histone marks to induce chromatin conformation changes (chromatin remodelers). Understanding how a cell acquires its specific gene expression profile (transcriptome) and particular set of proteins (proteome) is key for establishing new therapeutic strategies in pathological contexts.

Transcription Factors are essential proteins that bind DNA and regulate gene expression. They are crucial for maintaining the pluripotent state of NSCs and facilitating their differentiation into specific cell types within the nervous system. For instance, Sox2 is crucial for NSC proliferation and preventing premature differentiation (Graham et al. 2003), while Oct4 maintains the undifferentiated

state of NSCs (Cimadamore et al. 2011). The expression and activity of these transcription factors are tightly regulated to ensure a balance between proliferation and differentiation. The pioneering work of Yamanaka and colleagues in reprogramming somatic cells to induced pluripotent stem cells (iPSCs) demonstrated the importance of TF in cellular identity and plasticity.

Signaling pathways, such as Notch, Wnt, and Hedgehog, also play significant roles in controlling NSC activity. These pathways relay external signals and modulate the expression of target genes. For example, activation of the Notch pathway promotes NSC maintenance by preventing differentiation (Louvi, A., & Artavanis-Tsakonas, S. 2006), whereas inhibition of this pathway allows for neuronal differentiation. Notch mutations can lead to abnormal NSC proliferation and differentiation, contributing to neurodegenerative diseases or brain tumors.

MicroRNAs (miRNAs) are small non-coding RNAs that regulate gene expression post-transcriptionally by targeting messenger RNAs for degradation or inhibiting their translation. MiRNAs are crucial for NSC regulation. For instance, miRNA-9 has been implicated in regulating NSC proliferation and differentiation into neurons (Zhao, C. 2009).

Genetic variations, such as single nucleotide polymorphisms (SNPs) and mutations, can influence NSC activity by altering the expression or function of key regulatory genes. For example, mutations in the PTEN gene, which encodes a phosphatase involved in regulating cell proliferation, can result in uncontrolled NSC proliferation and contribute to brain tumor formation. Similarly, polymorphisms in genes encoding growth signal receptors can affect NSC responses to environmental cues, impacting their maintenance and differentiation.

Master Regulators of Neurogenesis: One of the master regulators of vertebrate neurogenesis is Ascl1 (also known as Mash1). Ascl1 acts as a pioneering transcription factor that regulates neural progenitor cell (NPC) behavior and neurogenesis in the ventral telencephalon (Guillemot et al. 1993; Casarosa, Fode, et Guillemot 1999; Castro et Guillemot 2011). The transcriptional activity of Ascl1 is cell cycle-dependent and is repressed by cyclin-dependent kinases through its phosphorylation. It is also regulated by Hairy and Enhancer of Split 1 (Hes1), which oscillates in response to Notch Intracellular Domain (NICD)/Rbpj interaction (Kageyama et al. 2009). Overexpression of Hes1 in NSCs inhibits Ascl1, leading to NSC quiescence, similar to the conditional deletion of Ascl1 in adult NSCs (Urbán et al. 2016; Sueda et al. 2019). Ascl1 is unstable and actively degraded via polyubiquitination by the E3 ligase HUWE1/UREB1/MULE through the proteasome. Other regulators of quiescence include inhibitors of DNA-binding protein Id4 (Blomfield et al. 2019) and pathways such as PI3-kinase-Akt-mTOR1 and cyclin D1, which promote cell cycle progression (LiCausi et Hartman 2018).

While the detailed mechanisms of genetic regulation are complex, we will meticulously explore later the transcriptional factors involved in the oligodendrocytes development, providing a deeper understanding of their role in neural development.

Balance between NSCs activation and quiescence depends on cell-mediated contacts and secreted ligands in the cerebrospinal fluid (CSF) from the choroid plexus, and the vasculature (such as the adult hippocampal neurogenesis Fig. 7). Interestingly, physical exercise promotes angiogenesis and neurogenesis in the hippocampus, as vessels are crucial to regulate oxygen tension influencing NSC activity (Van der Borgh et al. 2009; K. Zhang, Zhu, et Fan 2011). Indeed, reduced cerebral oxygen promotes neurogenesis in the adult DG (K. Zhang, Zhu, et Fan 2011; K. Zhang et al. 2015). Changes in oxidative metabolism also regulate NSC behavior, and inhibition of fatty acid oxidation enzymes trigger NSC quiescence (Beckervordersandforth et al. 2017).

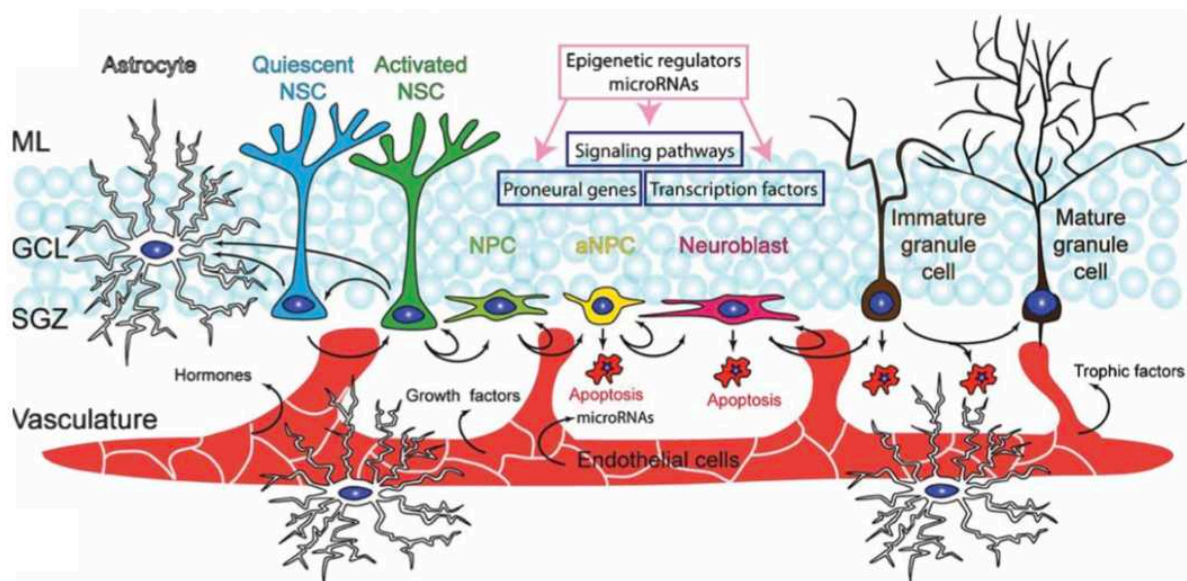

Figure 7: Regulation of the adult hippocampal neurogenesis by the niche. Neurogenic niche is a complex environment including multiple cell types, the vasculature and cues regulating proximal and distal communication. (Bielefeld et al. 2017)

Ligand secreted molecules: Several growth factors drive NSCs proliferation, survival and activity, identified through their ability to generate spontaneous NSC neurospheres in-vitro, including bFGF, EGF, VEGF, Wnt, Shh, and Notch (Gritti et al. 1996; Tropepe et al. 1999; Calvo et al. 2011; Pei et al. 2012; Martínez et al. 2013; Kristoffersen et al. 2013). Adult quiescence is regulated by Wnt, BMP, EGF, Shh, and its receptor Patched (Bowman et al. 2013; Qu et al. 2013; Yi Zhou et al. 2018; Urbán, Blomfield, et Guillemot 2019; Gonzalez-Reyes et al. 2019). Neurotransmitters also regulate neurogenesis, including serotonin (5HT), acetylcholine (Ach), dopamine, glutamate (Glu), N-méthyl-D-aspartique (NMDA), norepinephrine or gamma-aminobutyric acid (GABA) (Cameron, McEwen, et Gould 1995; Brezun et Daszuta 1999; Abrous et al. 2002; D. D. Wang, Krueger, et Bordey 2003; Brazel et al. 2005; Jhaveri et al. 2010; Berg et al. 2013).

Cell mediated contact: Extracellular matrix (ECM) is a scaffolding structure helping to maintain molecule gradients regulating NSC activity, proliferation, and differentiation. For instance, deletion of β 1-integrin reduces neurogenesis and deplete the radial NSC population, demonstrating its role to support the structural integrity of the NSC niche (Brooker et al. 2016). Signaling mediated by cell contacts requires the interaction between the Notch receptor expressed in the apical side of the RGC with its ligand Jagged1 expressed in NPCs (Del Bene et al. 2008). This interaction triggers Notch intracellular domain (NICD) release in the cytoplasm, followed by nuclear translocation to complex with Rbpj and regulate NSC transcription activity.

NEURAL CELL TYPES

After reviewing 150 years of studies estimating the abundance of different cell types in the human brain, Herculano's team found that the ratio of glia to neurons number is about 1:1, with roughly 86 billion neurons and 85 billion non-neuronal cells including glial and endothelial (Herculano-Houzel 2005). Neurons are cells electrically excitable and their activity depends on their interaction and cooperation with blood vessels and glial cells. Indeed, in a neuro-centric vision of the brain, the other cell types act as support for neurons, permitting numerous processes including generation, migration, immunity, modulation, trophic support, saltatory propagation, synaptogenesis and plasticity. The concept of glial cells emerged in 1846 when Virchow identified a connective structure, or glue (Fig. 8). Cell type proportions depend on age, species, and region of interest, with on average

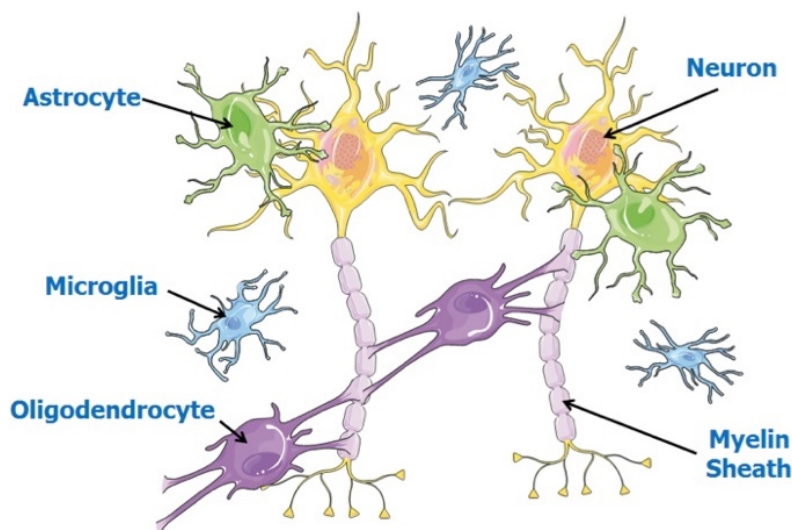

in the human cortex being constituted by 42% of OLS, 40% of neurons, 12% of astrocytes, 3% of microglia and 3% of OPCs (Pelvig et al. 2008).

Figure 8: Scheme illustrating the cellular brain diversity and how much cells are interconnected (google image)

NEURONAL CELLS are highly diverse (Fig. 9A,B) in terms of structure (unipolar, bipolar, multipolar) and family (motor, sensory, interneurons). They contain a cell body (soma) with dendrites collecting electrical influx and sending an electrical impulse (action potential, PA) along a single axon

until the terminal axon in the synapses contacts others. Length of the axons depend on species and can reach several meters in the squid. Electrical transmission requires conversion of a chemical message into an electrical signal through opening of voltage-gated channels and vice-versa. For instance, at the presynaptic part, Ca^{2+} increases in the cytosol triggering fusion and release of vesicles containing neurotransmitters to the synaptic cleft (Fig. 9C) (Rusakov 2006; Curti et O'Brien 2016). Thus, neurotransmitters bind to the receptors on the membrane of the postsynaptic cells, followed by a recycling of the neurotransmitters in excess by neurons and glial cells. Binding changes ion permeability and membrane potential to the postsynaptic compartment, generating PA in the plasma membrane depending on its magnitude. Indeed, the resting potential is initially at $-60m$ and depolarization will result from a net increase of $110mV$ to reach $+50mV$, followed by a rapid repolarization to return to the membrane resting potential value. Transient PA are very frequent (every $4ms$), fast (until $100m/s$) and depend on the presence of myelinated segments and nodes of Ranvier. Nodes are short unmyelinated segments regulating PA generation and propagation, flanked by myelin structures called paranode, juxtaparanode, and internode with distinct molecular features. Nodes contain a rich density of Na^+ channels, juxtaparanodes are enrich in clustering of K^+ channels, several adhesion molecules (Nrcam and Nf186), and cytoskeletal adaptor proteins (ankyrin G, spectrin βIV) (Poliak et Peles 2003).

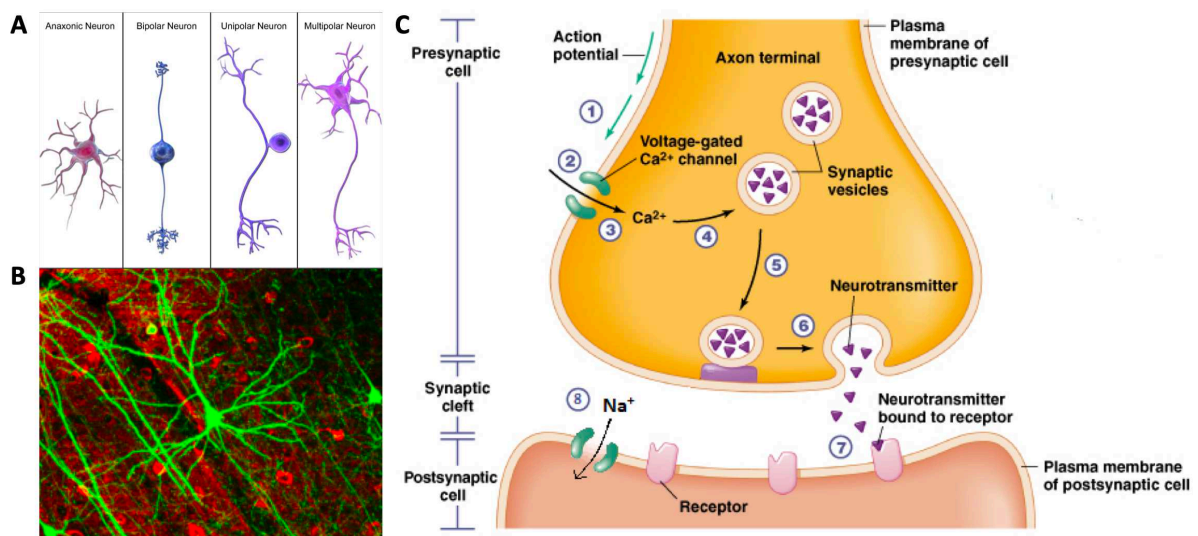

Figure 9: Scheme of the neural cells diversity, illustrating how PA is generated inside the synapse. (A) Neuronal cell diversity: multipolar interneurons, motor and sensory neurons (Vedantu). (B) Pyramidal neurons in mouse cerebral cortex expressing green fluorescent protein (PLoS Biology). (C) Release of the neurotransmitter at the neuronal synaptic compartment and process of transmission (Enzo Lescure, 2020)

ASTROCYTES have endfeets ensheathing CNS vasculature and they also interact bidirectionally through thousands of process extensions with other CNS cell types, particularly neurons (Fig. 10). They contact nodes of Ranvier, having a role in nodal length modulation and in ionic buffering (Waxman 1986; Butt, Duncan, et Berry 1994; Serwanski, Jukkola, et Nishiyama 2017; Lubetzki, Sol-Foulon, et Desmazières 2020). They appear during the onset of synaptogenesis and rapidly establish contact with immature neurons helping them to initiate synapse formation in response to secreted thrombospondins and glypicans (N. J. Allen et Eroglu 2017). Astrocytes contribute to metabolic support and homeostasis, regulating bioenergetic through mitochondrial carbon metabolism, neurotransmitter homeostasis and redox balance (Turner et Adamson 2011; MacVicar et Choi 2017; Deitmer et al. 2019; Rose et al. 2020). They also promote neuronal survival with their antioxidant properties eliminating reactive oxygen species (ROS) through the master antioxidant NRF2 (nuclear factor-erythroid 2-related factor-2) (Pyka et al. 2011; Jimenez-Blasco et al. 2015). Astrocytes also have a crucial role in maintaining BBB integrity by secreting factors and for endothelial cell adhesion, and are active regulators of neuroinflammation (Cabezas et al. 2014; Colombo et Farina 2016; Sanmarco et al. 2021).

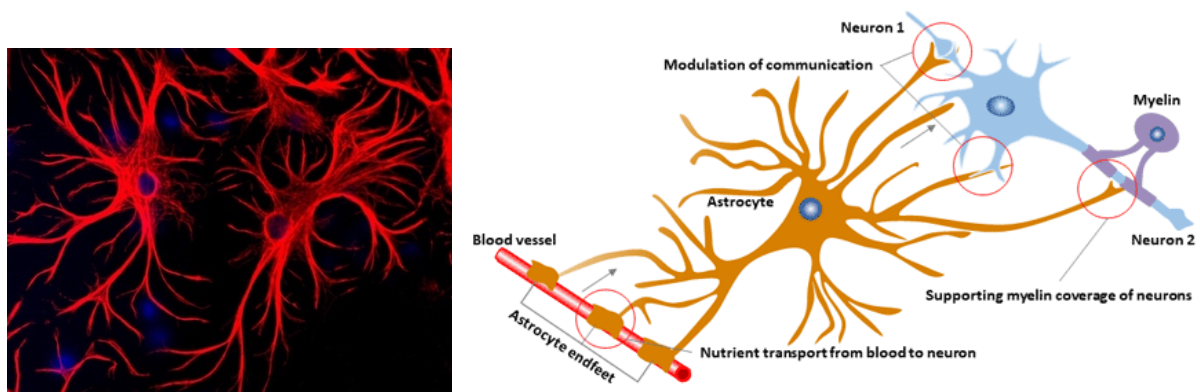

Figure 10: Astrocyte morphology and functions. Source: Antibodies, Cusabio website

MICROGLIAL CELLS are highly ramified cells with a small cell body and dense branched processes present throughout the brain (Fig.11). They are generated from the yolk sac at early embryonic stages (day E7.5 in the mouse) during hematopoiesis (Tavian et Peault 2005). Under physiologic conditions, they constitute the primary immune surveillance of their micro environment, ensuring remodeling and homeostasis after injury. Indeed, they have the ability to clear debris and apoptotic cells by phagocytosis, regulating neuronal survival (Kierdorf et Prinz 2017). They also influence neurogenesis as well as synaptic pruning during maturation of the developing brain (Casano et Peri 2015; Reemst et al. 2016; N. J. Allen et Lyons 2018). Infections, injury and autoimmune disease are generally associated with increased numbers of immune cells, pro-inflammatory factors (LPS, tumor necrosis factor alpha, TNF or interferon gamma, IFN γ). In this context, microglial changes

morphology and switches into the “proinflammatory M1 phenotype”. They secrete several pro-inflammatory cytokines (IL-1 α and β ; IL-6, 12, 23; TNF- α), chemokines, stress associated molecules and express co-stimulation protein CD40 or MHC-II inducing N -methyl- d-aspartate (NMDA)-mediated excitotoxicity (Colton et Wilcock 2010; Boche, Perry, et Nicoll 2013). Then, mediation is followed by resolution and a switch into the “M2 anti-inflammatory phenotype” associated with the secretion of anti-inflammatory cytokines IL4, IL10 and IL13 and several neurotrophic pro-stimulating factors (NGF, IGF-1, GDNF, FGF, BDNF, NT) (Jurga, Paleczna, et Kuter 2020).

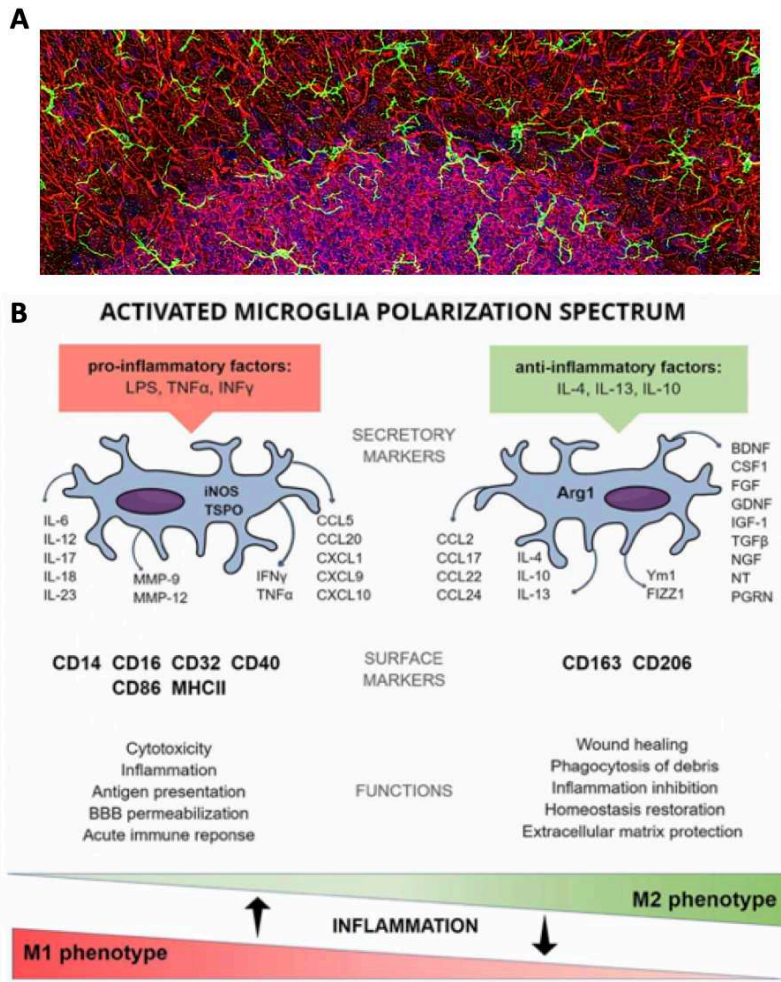

Figure 11: Microglia morphology and regulation of their phenotype during inflammation. Microglia (stained in the mouse brain with Iba1 staining, green) can activate through M1 pro-inflammatory phenotype, and switch into a resolution M2 anti-inflammatory phenotype. These 2 phenotypes are identifiable through expression of different secretory and surface markers having opposite functions. Source: antibodies, (Jurga, Paleczna, et Kuter 2020)

CHAPTER II: OLIGODENDROCYTE BIOLOGY AND GENERATION

Oligodendroglial development occurs following the specification process when OPCs are generated from SVZ progenitors early during development, whereas differentiation arises later through generation of the immature OLs (iOLs) from OPCs. Finally, the last step is OL maturation and myelin formation mostly during postnatal life (Fig. 12). These steps are tightly regulated during development by different transcription factors, signaling pathways and post-translational modifications. During this chapter we will discuss functions of the oligodendroglial cells and the regulation of all of these stages.

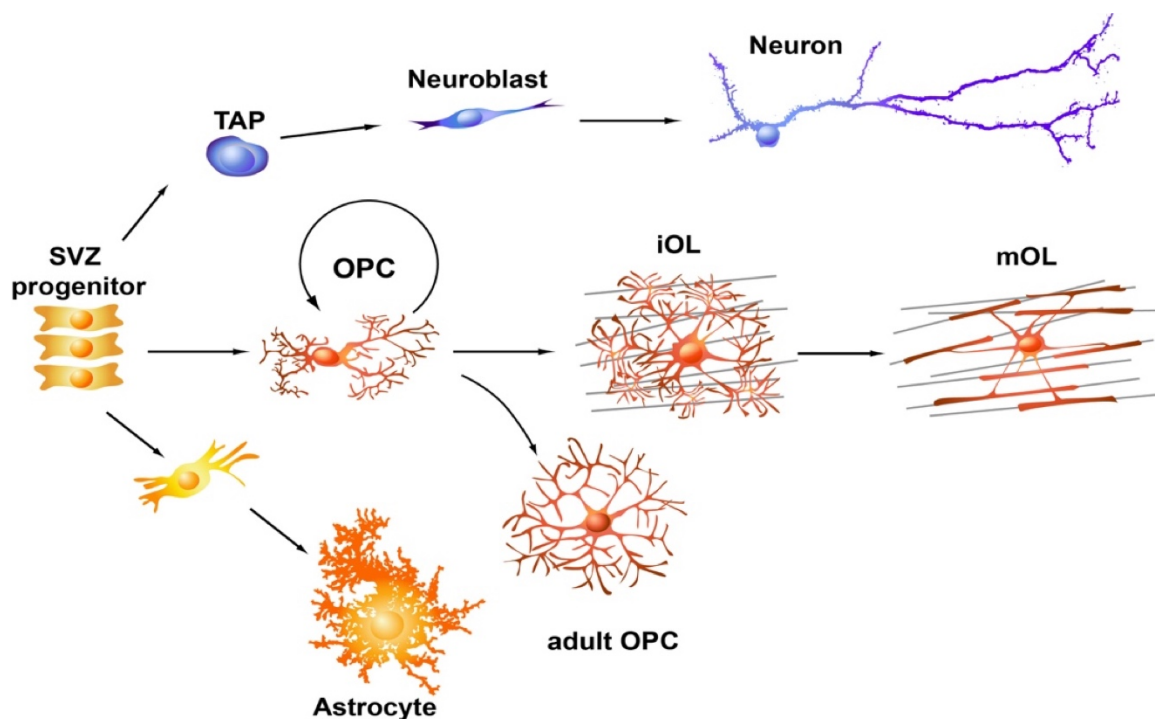

Figure 12: Scheme illustrating SVZ forming NSC diversity during development. (Dr. Parras, unpublished).

OLIGODENDROCYTES PRECURSORS CELLS

Also called polydendrocytes based on their numerous process extensions, these cells represent the fourth major glial cell type, representing on average ~5% of brain cells, excluding the vessels (Scolding 1998; J. M. Levine, Reynolds, et Fawcett 2001; Dawson 2003). However, they are less dense in gray matter (2-3%) than in white matter (5 to 8%) (E. G. Hughes et al. 2013). They emerge from NSCs and radial glial cells under specific mechanisms (Merkle et al. 2004). OPCs express specific markers such as PDGFR α (platelet derived growth factor receptor α), NG2 (or chondroitin sulfate

proteoglycan 4, CSPG4) and transcriptomic factors OLIG1, OLIG2, ASCL1 and SOX10 (Kuhlbrodt et al. 1998; Q. R. Lu et al. 2000; Takebayashi et al. 2002; Q. Zhou et Anderson 2002; Castro et al. 2011). Sex-associated differences have been found in terms of functions and transcriptomes associated with OPCs. Whereas OPCs from females proliferate more and are less sensitive to glucose deprivation, OPCs from males have higher capacity to differentiate and myelinate (Abi Ghanem et al. 2017; Yasuda et al. 2020). Interestingly, androgen levels are higher in males than females during the first 10 postnatal days, and use of androgen receptor antagonists demonstrated their crucial role in masculinizing myelin (Abi Ghanem et al. 2017).

OPCs are highly proliferative cells, with a cell cycle length depending on the stage of development and their location through the brain. Indeed, in mice at P21, white matter OPCs have an estimated cell cycle of 3 days, versus 10 days at P60, and in gray matter, timing is longer (particularly the early G1 phase) with 19 and 36 days at P21 and P60, respectively (Kaylene M. Young et al. 2013). Proliferative capacity as well as their differentiation rate declines during postnatal and adult life (Simon, Götz, et Dimou 2011). Indeed, they rapidly expand, migrate at embryonic stages and then reduce their proliferation rates during postnatal life, but remain the largest proliferating cells in the adult brain excluding the SVZ (Dawson 2003).

OPC FUNCTIONS

OPCs generate OLs, the myelinating cell of the CNS, but given their stable pool covering all the CNS and their heterogeneity, they are involved in other functions, including the regulation of electrical activity, survival, metabolism and neuroinflammation (Fig. 13) (Dimou et Simons 2017).

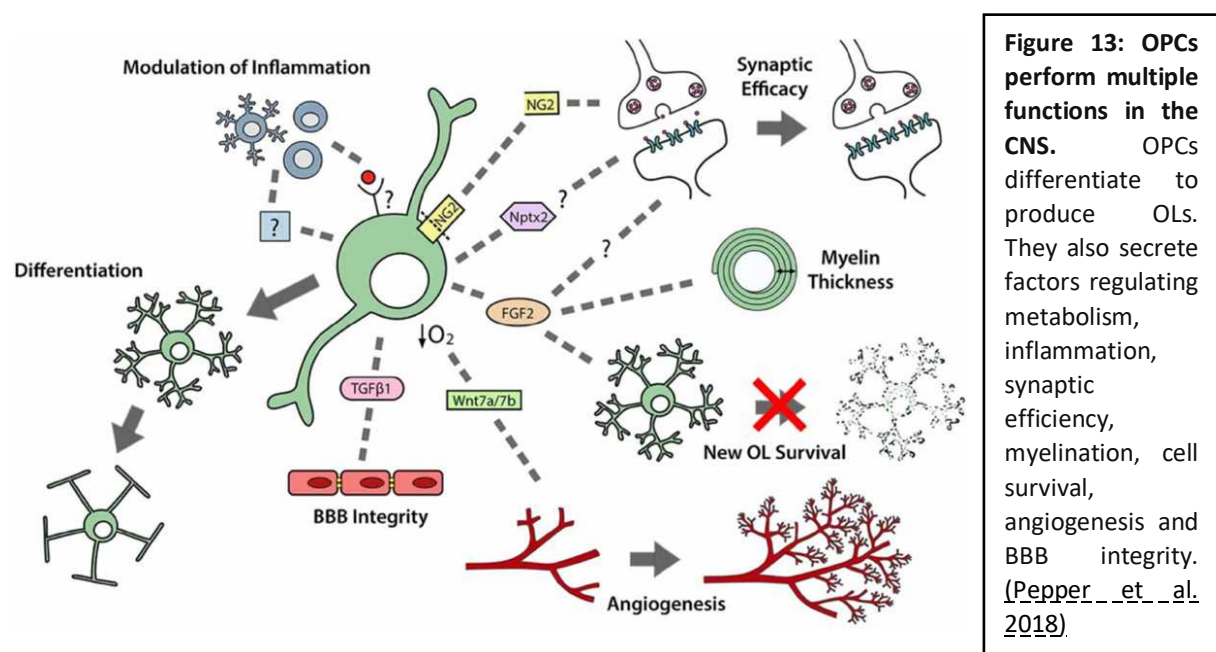

OPCS DERIVED CELL TYPES. OPCs are known for their ability to proliferate and differentiate into mature OLs with a peak between P7 and P14 in rodents (Rivers et al. 2008; S. H. Kang et al. 2010). Although this contribution is still debated and controversial, OPCs have been reported to generate, under exogenous conditions, small contributions of other cell types such as neurons in the cortex and hypothalamus (Belachew et al. 2003; Rivers et al. 2008; F. Guo et al. 2010; Robins et al. 2013). OPCs are electrically excitable and weakly express several NPCs markers (Sox2, Ascl1, Pax6, and doublecortin), that may switch competence for neuronal differentiation or reverse to a NPC phenotype in response to external signals. Those results are not consistent within research groups who didn't find generation of neuronal cells when analyzing OPC progeny using a knock-in mice expressing Cre-inducible recombinase (CreERT) in the *Pdgfra* locus (S. H. Kang et al. 2010; Zhu et al. 2011). *In vitro* experiments using OPCs isolated from rat optic nerve also demonstrated their ability to generate also astrocytes (called type 2A) under specific medium such as fetal calf serum, BMPs and IFN γ (Raff, Miller, et Noble 1983; Temple et Raff 1985; Bogler et al. 1990; Tanner, Cherry, et Mayer-Proschel 2011). Finally, differentiation is regulated by developmental associated specific factors, as OPC transplantation at P7 in the mouse telencephalon generate GALC+ OLs whereas at 6-month generates majority of GFAP+ astrocytes (Sawamura et al. 1995). In OPCs, cytoplasmic translocation of Olig2 as well as pre-binding of Sox3 and Sox9 to astrocyte-specific genes can lead to an astrocytic cell fate (J.-W. Zhao et al. 2009; Klum et al. 2018). Interestingly, deletion of Olig2 in NG2 cells in the neocortex induce a cell fate switch into protoplasmic astrocytes, but this capacity decrease over the third postnatal weeks (Zuo et al. 2018). Moreover, histone deacetylase 3 (Hdac3) cooperates with histone acetyltransferase (p300) to prime and maintain OL identity, whereas inhibition of NFIA and Stat3- promote astrogliogenesis (Liguo Zhang et al. 2016).

OPCS RESPOND AND MODULATE ELECTRICAL ACTIVITY. Neurons are known to promote oligodendrogenesis and myelination through the secretions of different factors, including BDNF, nerve growth factor NGF, Neuroligin-Neurexin (Chan et al. 2004; Scott 2013; Ramos-Cejudo et al. 2015). Indeed, OPCs express several ion channels, including metabotropic glutamate receptors (mGluR) and receptors for GABA, NMDA and AMPA, allowing them to detect synaptic input from neurons through glutamate secreted at the synapse, thus triggering exosome secretion mediated by Ca $^{2+}$ entry and influencing (re)myelination (Bergles et al. 2000; R. Káradóttir et Attwell 2007; Gautier et al. 2015; Pablo M. Paez et Lyons 2020). Moreover, optogenetic stimulation of the premotor cortex in awake mice demonstrated that electrical activity promoted myelination and myelin plasticity, improving motor function (Gibson et al. 2014). OPCs are also sensitive to histamine, glycine, adenosine or dopamine, increasing intracellular calcium levels (Kastritsis et McCarthy 1993; Stevens et al. 2002). Thus, neuronal activity is considered as a new strategy to enhance myelin repair in the

context of demyelinating diseases (Ortiz et al. 2019). OPCs also have the ability to modulate neuronal activity, suggested by NG2 immunoreactivity at the synapse junction, and associated contacts at the nodes of Ranvier (Ong et Levine 1999; Butt et al. 1999; Bergles et al. 2000). Moreover, monosynaptic tracing showed that some OPCs are able to integrate functional cortico-thalamic signals and trigger LTP (Mount et al. 2019). In this line, electrophysiology recording demonstrated among 232 OPCs (P7) that 46% have voltage-gated Na⁺ and K⁺ currents, thus able to generate spontaneous and evoked action potentials (Ragnhildur Káradóttir et al. 2008). Direct demonstration on presynaptic specialization and neuronal activity was performed after ablation of OPCs in the mice prefrontal cortex, leading to a reduction in glutamatergic signaling generated in pyramidal neurons inducing a depress-like behavior phenotype (Tanaka et al. 2009; Birey et al. 2015). Also, a recent study performed in the optic tectum of the larval Zebrafish has shown that OPCs rarely differentiate, control RGC arborizations and function of neural circuits involved in visual processing (Y. Xiao et al. 2022)

OPCS REGULATE NEUROINFLAMMATION. OPCs are able to survey their microenvironment, present antigens and release immunomodulatory molecules, thus regulating neuroinflammation (Falcão et al. 2018; Y. Liu et Aguzzi 2020). For instance, in EAE or spinal cord injury model, OPCs located in peri-lesion present thicken and shorten processes extension, express CD11b with an ameboid morphology (Nishiyama, Chang, et Trapp 1999; Lytle, Vicini, et Wrathall 2006). In human traumatic spinal cord injury, OPCs express CD68, usually expressed by immune microglial and macrophage cells and involved in phagocytosis, to ensure myelin debris clearance (Buss et al. 2009; Falcão et al. 2018). OPCs attract peripheral immune cells through secretion of IL1 β , CCL2 during their migration in the lesion site (Moyon et al. 2015). They are also responsive to inflammatory cytokines IFN γ and TNF α , inhibiting their differentiation and survival (W. Lin et al. 2006; Su et al. 2011). Importantly, stimulation of tumor necrosis factor-related apoptosis-inducing ligand (TRAIL) with inflammatory cytokine (TNF- α /IFN- γ) and/or oxygen and glucose deprivation significantly increase its expression in primary neurons and OPCs, leading to subsequent toxicity, thus underlying its contribution in neonatal brain injury (Kichev et al. 2014). In both mouse models and MS tissue, OPCs also express Toll-like receptor 3, Serpine gene family and MHC class II (Falcão et al. 2018). In addition, conditional deletion of Low density lipoprotein receptor-related protein 1 (LRP1) in Olig1⁺ cells reduce the inflammatory response (CD8⁺ proliferation) and increase myelination in EAE and cuprizone models (Fernández-Castañeda et al. 2020).

OPC GENERATION

In the developing mouse forebrain and spinal cord, OPC production occurs in three distinct waves to colonize the entire brain from SVZ progenitors located into the neuroepithelial zones surrounding ventricles (Fig. 14) (Kessaris et al. 2006; Rowitch et Kriegstein 2010; Zuo et Nishiyama 2013; van Tilborg et al. 2018).

The first OPC wave starts at E12.5 from Nkx2.1+ progenitors located in the ventral forebrain in the medial ganglionic eminence and in the anterior entopeduncular area. Ventral morphogen Shh signaling is important to specify cells toward an oligodendroglial lineage, through generation of ventral OPCs migrating to colonize the entire embryonic telencephalon, including the cerebral cortex (Tekki-Kessaris et al. 2001; Kessaris et al. 2006). Later in development at E15.5, a second wave of OPCs emerges without Shh signaling from Genetic-screened homeobox 2 (Gsh2+) progenitors located in the lateral and/or caudal ganglionic eminence area and migrate to the dorsal cortex (J. Cai et al. 2005; Vallstedt, Klos, et Ericson 2005; Klämbt 2009). Specification process is driven by FGF activating Dbx1 and Ascl1 inhibiting BMP signal (Fogarty, Richardson, et Kessaris 2005; Sugimori et al. 2008).

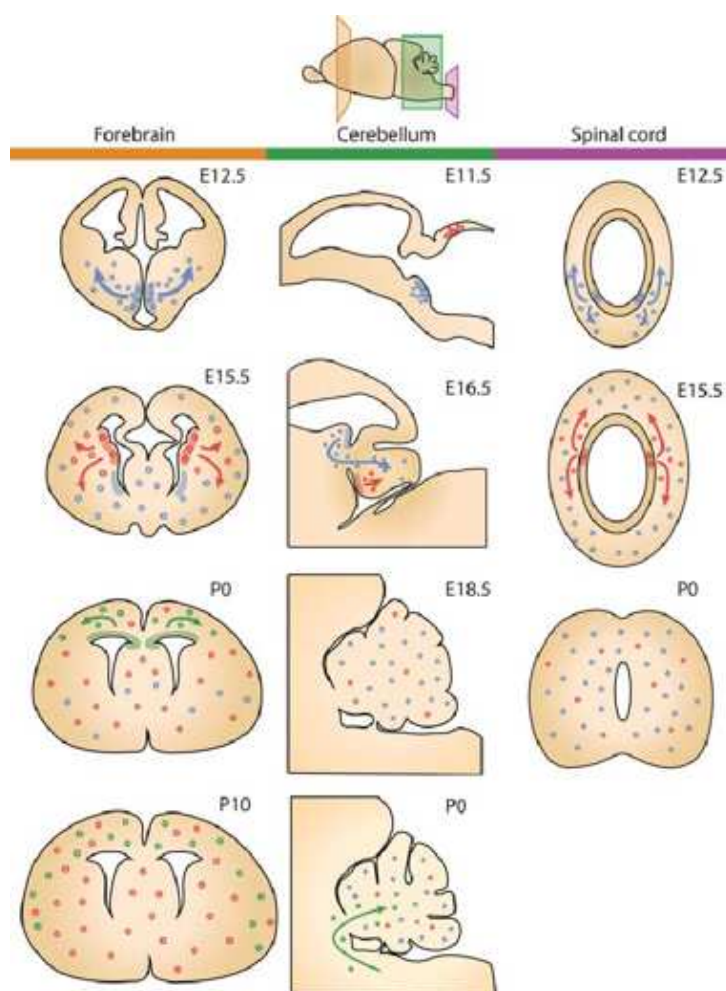

Around birth, a third wave of OPC production occurs from the dorsal germinal compartment expressing homeobox protein Emx1, generating OPCs migrating tangentially to colonize the cortex. Thus, OPCs generated from Emx1 progenitors will totally replace OPCs generated ventrally during the first wave, whereas similar proportions of Emx1 and Gsh2 were found from P10 to P80 in mice (Vallstedt, Klos, et Ericson 2005; Kessaris et al. 2006)

Figure 14 : Illustration of the different waves of OPC generated during development. OPCs originate from different niches during development, represented by different colored arrows (blue at E12.5, red at E15.5 and green at P0 (van Tilborg et al. 2018)

OLIGODENDROCYTES

OLs are characterized by their smaller nucleus with dense chromatin and identifiable with the expression of myelin proteins, including CNP (2',3'-Cyclic Nucleotide 3' Phosphodiesterase), MBP (Myelin Basic Protein), PLP (Proteolipid Protein), MAG (Myelin Associated Glycoprotein), MOG (Myelin Oligodendrocyte Glycoprotein) and GalC (Galactosylceramidase). They extend numerous processes with large networks of microtubules of 25 nm ensuring their stability (Lunn, Baas, et Duncan 1997). They produce many myelin segments (60 on average) ensheathing neighboring axonal segments in the CNS, whereas Schwann cells, the myelinating cells of the PNS, only ensheath one axon (Martini, Groh, et Bartsch 2010). Myelination is essential for cerebral activity to regulate saltatory impulse propagation, provide trophic support and respond to synaptic plasticity (Demerens et al. 1996; McKenzie et al. 2014; Gibson et al. 2014).

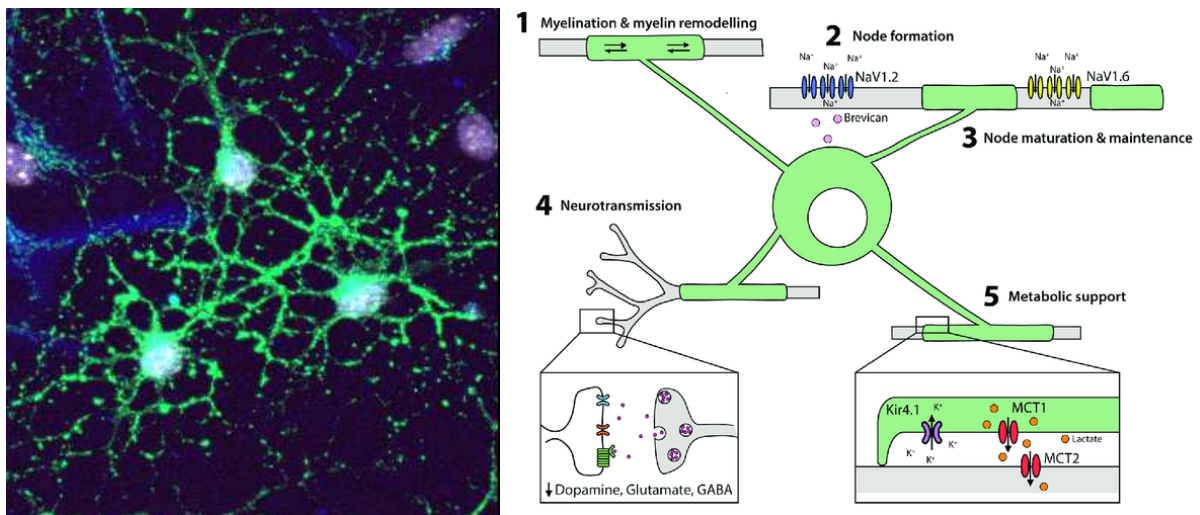
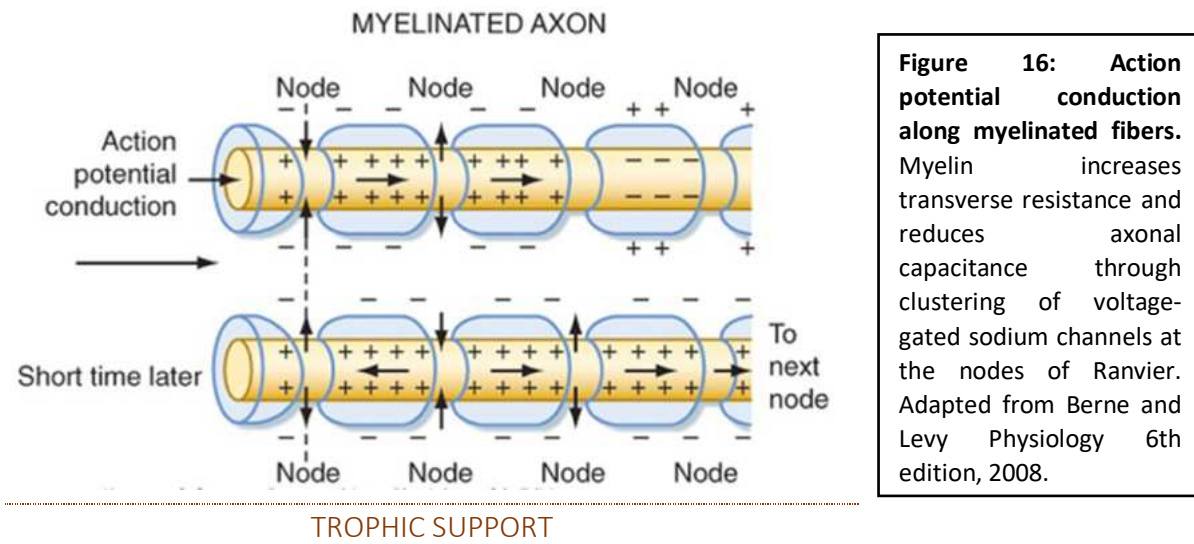

Figure 15: Oligodendrocyte biology and functions. OLs (stained for PLP in green) ensure myelination in the CNS (1), contribute to nodal maturation (2) and maintenance (3), modulate neurotransmission (4) and also provide metabolic support to neurons (5) (Pepper et al. 2018)

SALTATORY CONDUCTION

Myelin emerged in cartilaginous fish more than 500 million years ago, increasing their motor, sensory and cognitive capacities, particularly in the context of hunt and predation (Zalc, Goujet, et Colman 2008). Myelination improves electricity impulse propagation through the insulation of axons, accelerating nerve conduction by 20-100 fold (up to 100 m/s) compared with unmyelinated axons of the same diameter (Franz et Iggo 1968; Hartline et Colman 2007). Myelin is not continuous through axons with unmyelinated gap segments called nodes of Ranvier necessary for saltatory propagation (Tasaki 1939). Myelin sheath reduces the transverse capacitance through ATP-dependent Na⁺/K⁺

exchange, to maintain and restrict the PA to the axonal membrane (Fig.16) (Hartline et Colman 2007). However, a theoretical calculation of the energy balance in the optic nerve suggests that more ATP is used for myelin biogenesis than save (Harris et Attwell 2012). Interestingly, distribution of myelinated tracts along the axon is not uniform, particularly in the superficial layer with diversified profiles where myelinated segments are separated with long, unmyelinated tracts (Tomassy et al. 2014; Hill, Li, et Grutzendler 2018).



TROPHIC SUPPORT

Trophic supply plays an important role in metabolism and neuronal survival, particularly due to their high energy needs to maintain the activity of the Na^+/K^+ channels. Indeed, neurons are not efficient enough to produce pyruvate and ATP through glycolysis metabolism and oxidative phosphorylation in the mitochondria (A. Almeida et al. 2001). To cooperate, astrocytes accumulate glucose as glycogen (Kasischke et al. 2004). Interestingly, activity dependent glutamate release was found correlated with pyruvate and lactate production in astrocytes, providing energy to the neurons through monocarboxylate transporters (MCT) (Lerchundi et al. 2015). OLs also express MCT1 and GLUT1 transporters to provide lactate and glucose respectively through the cytoplasmic channels toward the periaxonal space, essential for axonal transmission and survival (Rinholm et al. 2011; Y. Lee et al. 2012; Fünfschilling et al. 2012; Meyer et al. 2018). Indeed, in-vivo inhibition of MCT1 led to motor neuron death, triggering axonal injury in organotypic spinal cord slice cultures, whereas cell death was rescued by adding L-lactate to the culture medium. OLs also secrete different factors promoting cell survival such as glial cell line-derived neurotrophic factor (GDNF), brain-derived neurotrophic factor (BDNF), nerve growth factor (NGF), insulin-like growth factor-1 (IGF-1) or transforming growth factor- β (TGF- β) (Byravan et al. 1994; Strelau et Unsicker 1999; Wilkins, Chandran, et Compston 2001; Wilkins et al. 2003)

SYNAPTIC PLASTICITY

Modulation of oligodendrogenesis and myelination depend on activity and experience-driven mechanisms. They depend on the release of glutamate and GF from electrically active neurons, for motor and cognitive learning or sensory experience. Myelination can occur independently through physical and mechanical properties of the extracellular environment (cellular density, axonal diameter, ECM) (Bonetto et al. 2020). Environment is crucial for regulation of oligodendrogenesis and myelination. Indeed, increasing enrichment in young rats promotes OL numbers (27%-33%) in the occipital cortex, as well as myelinated axons in the corpus callosum (Szeligo et Leblond 1977; Juraska et Kopcik 1988). Social isolation or reduced experience are well known to reduce sheath numbers and cells (Makinodan et al. 2012; J. Liu et al. 2012; 2016). Moreover, neuronal activity correlates with OPCs proliferation, generation of mOLs and myelination (Scholz et al. 2009; Sampaio-Baptista et al. 2013; R. G. Almeida et Lyons 2017). Thus, practicing piano, exercise or motor skill learning increases OLs number, myelination and subsequent integration of information through modifications in synaptic plasticity (Bengtsson et al. 2005; McKenzie et al. 2014). On the other hand, OLs express dendritic post synaptic proteins PSD95 and Cadm1b allowing them to respond and regulate electrical activity and also to regulate this process (A. N. Hughes et Appel 2019). OLs modulate axonal outgrowth through secretion of neurotrophic factors GDNF and BDNF crucial for longer axonal circuitry (Wilkins et al. 2003; Bagayogo et Dreyfus 2009). Deletion of MYRF leading to OL loss affects mice ability to perform complex tasks (McKenzie et al. 2014). Besides OLs, OPCs have a clear role in the regulation of neuronal activity, mentioned before. Blood vessels also have a role to regulate myelin plasticity through endothelin signaling, demonstrated with the pro-myelinating effect of agonist receptors, or the detrimental effect of endothelin Ednrb loss (Yuen et al. 2013).

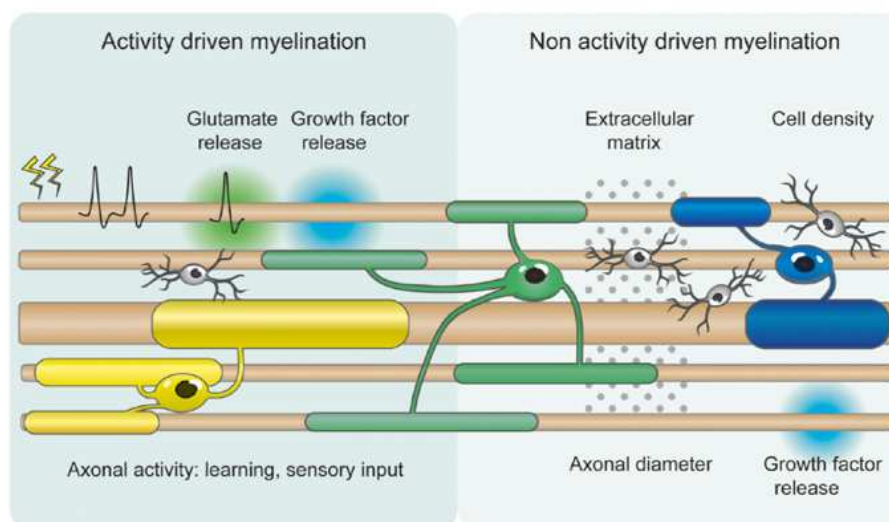

Figure 17. Axonal factors regulating myelin plasticity. Scheme illustrating activity driven myelination (including glutamate/ GF release and axonal activity) and non activity driven myelination processes (depending on ECM, cell density, axonal diameter and GF release) (Bonetto et al. 2020).

Both in humans and rodents, the neonatal period is a time of active oligodendrogenesis, myelination, and axonal organization in the developing subcortical white matter. Understanding the factors regulating oligodendrogenesis from endogenous forebrain NSCs represents a goal for translational strategies. Diverse secreted factors and signaling molecules produced by different CNS cell types regulate oligodendrogenesis through autocrine and paracrine manners (see: regulation of the niche). They include growth factors, hormones, cytokines, enzymes, extracellular matrix components and different signaling pathways (summarized Fig. 18) representing putative targets for manipulating oligodendrogenesis in health and disease.

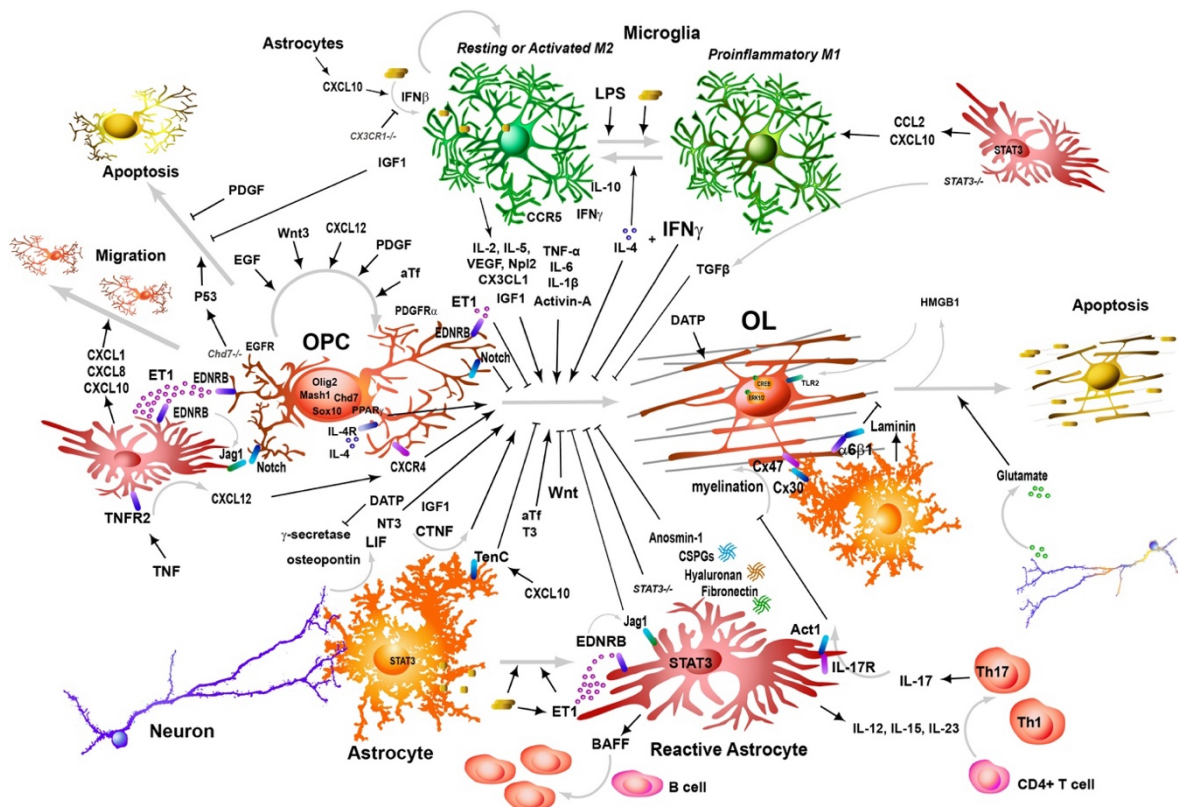

Figure 18. Illustration of the main cellular and genetic complexity regulating oligodendrogenesis. Differentiation is regulated by cell intrinsic mechanisms and from other cells, particularly those involved during inflammation. (Dr Parras, unpublished)

In this part we will discuss the main transcription factors regulating oligodendrogenesis (Fig. 19) including SOX (SRY-related HMG-box: Sox,5,6,8,9,10), Basic helix-loop-helix (bHLH: Olig1, Olig2, Ascl1), repressors of differentiation (Id2, Id4), and Zinc finger proteins (Znf488, Znf536) (Wegner et Stolt 2005; S.-Z. Wang et al. 2006; J. C. Dugas et al. 2006; Emery 2010).

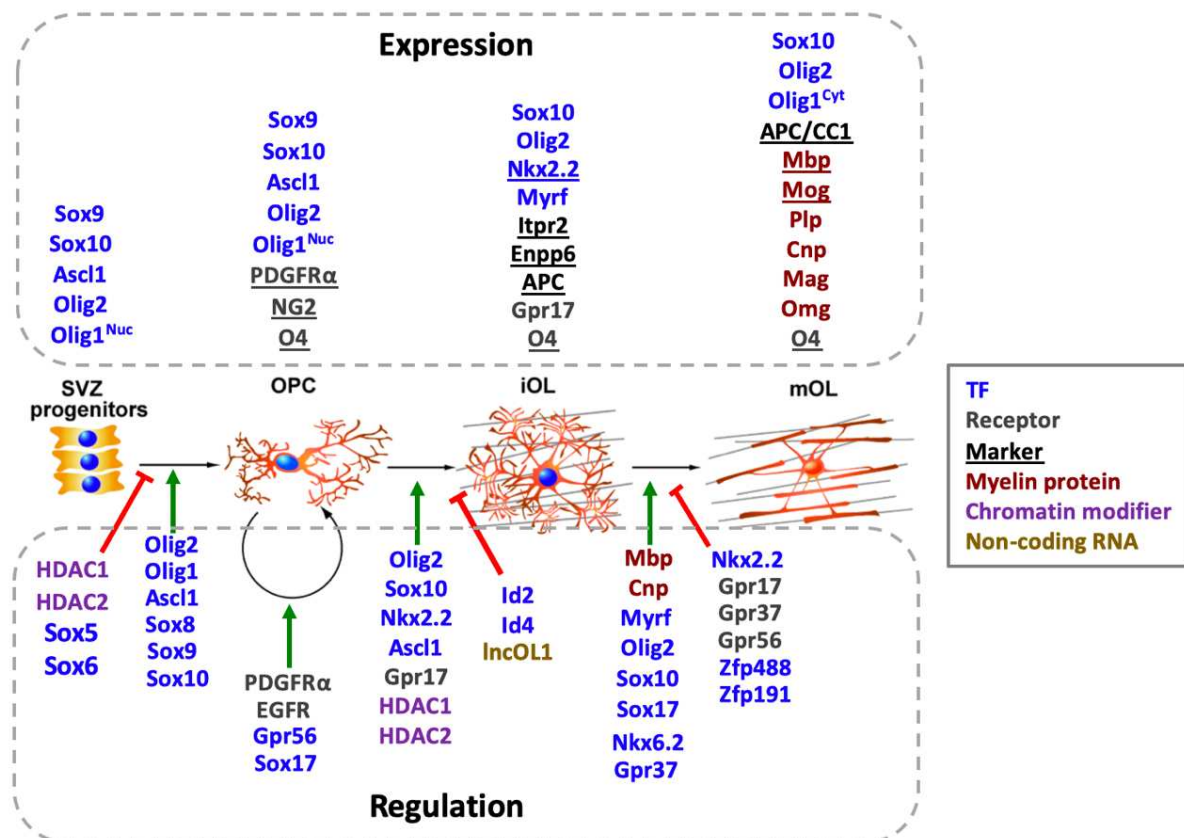

Figure 19: Illustration of the main expression marker and regulators of the oligodendroglial lineage. Main expression markers, transcription factors and proteins (up) and regulators (down) of the oligodendroglial lineage, with their positive (green arrows) or negative influence (red arrows). Adapted from Dr Marie and Parras (unpublished)

OLIG1 AND OLIG2 (BASIC HELIX–LOOP–HELIX FAMILY, BHLH) are transcription factors binding to specific DNA target sites, called E-boxes. Olig1 and Olig2 are strongly expressed in the oligodendroglial lineage, during both OPC specification and differentiation processes (Q. R. Lu et al. 2000; Q. Zhou et Anderson 2002). They are induced through Sonic hedgehog signaling in the embryonic ventral neural tube, regulating NSC progeny through their oligodendrogenic and neurogenic role by promoting motor neuron (MN) generation (Q. R. Lu et al. 2000; Q. Zhou, Wang, et Anderson 2000; Q. Zhou et Anderson 2002; Q. R. Lu et al. 2002). This was demonstrated using *Olig2* knockout mice, showing that *Olig2* deletion drastically affects not only MN generation in the hindbrain and spinal cord but almost all oligodendroglial cells in the CNS (Q. Zhou et Anderson 2002; Q. R. Lu et al. 2002; Takebayashi et al. 2002). Moreover, overexpression of Olig1 or Olig2 in the precursors (Nestin+ cells) from E8.5 to E12.5 using a doxycycline inducible model is sufficient to promote OPCs generation in the spinal cord (Maire et al. 2010). Nevertheless, Olig1 is able to compensate for Olig2 loss to partially rescue OPC generation in the hindbrain (Q. R. Lu et al. 2002). There different *Olig1* KO mice has been reported with different penetrance in the requirement in oligodendrogenesis, with the later study suggesting that Olig1-deletion leads to a decrease in OPC numbers in the brain but not in the spinal cord (Rowitch et al.

2002; Arnett et al. 2004; Dai et al. 2015). In the MN domain of mouse developing spinal cord, a simple model of Olig2 function in cell fate choices has been proposed, where Olig2 phosphorylation of Olig2 in the Serine 147 by the protein kinase A, would induce Olig2 homodimers incapable of binding DNA, allowing Neurog2 (Ngn2) to induce MN generation, whereas a later expression of a phosphatase would dephosphorylate Olig2 allowing it to heterodimerize (likely with an E-protein) to induce OPC generation (H. Li et al. 2011). Interestingly, at postnatal stages, gain of function of Olig2 in Sox10+ oligodendroglial cells is able to accelerate OL differentiation and myelination (Wegener et al. 2015). Conditional deletion of Olig2 restricted to the dorsal telencephalon leads to a strong dysmyelination suggesting an Olig2 requirement for cortical OPC differentiation into myelinating OLs (Yue et al., 2006). Furthermore, conditional deletion of Olig2 at postnatal stages using *Cnp-Cre* driver (expressed in some OPCs and early in OLs) inhibit their differentiation and myelination process, but not when deleted in mature OLs using the *Pip-CreER^T* driver, that accelerated OL maturation and (re)myelination, partially by upregulation of Olig1, suggesting stage dependent roles for Olig2 in oligodendrogenesis (F. Mei et al. 2013). During human remyelination, Olig1 is crucial for repair (Arnett et al. 2004). Finally, Olig2 restrain OPCs to the oligodendroglial lineage, as Olig2 conditional deletion using the *NG2-Cre* driver shifts differentiation toward astrocyte lineage (Zhu et al. 2012).

ACHAETE-SCUTE COMPLEX-LIKE 1 (Ascl1 bHLH) is a proneural factor homolog to Acheate and Scute TFs with are expressed in neuroectoderm of *Drosophila* embryo and are required for the formation of NPCs from undifferentiated neuroectodermal cells (Bertrand, Castro, et Guillemot 2002). During neurogenesis, *Ascl1* acts as a pioneer factor to open the chromatin state and regulate target genes involved in proliferation and differentiation of NPCs (Raposo et al. 2015). *Ascl1* knockout mice have a strong reduction not only of neurons but also of OPCs in the olfactory bulb at birth, suggesting a dual role for *Ascl1* in neurogenesis and oligodendrogenesis (Carlos M Parras et al. 2004). Indeed, *Mash1/Ascl1* is also expressed in embryonic and neonatal OPCs in both the brain (Kondo and Raff, 2000a; Parras et al., 2004; Parras et al., 2007; Wang et al., 2001) and spinal cord (Sugimori et al., 2007; Sugimori et al., 2008). Furthermore, *Ascl1* is expressed in embryonic OPCs at the time of their specification and it is required for the generation of an early population of OPCs both in the brain and spinal cord (Parras et al., 2007; Sugimori et al., 2007). In addition, *Ascl1* function in oligodendroglial specification involves a genetic interaction with *Olig2* since loss of a single copy of *Ascl1* have no effect on OPC numbers, whereas combined deletion of one copy of *Olig2* and *Ascl1* significantly aggravates the mild reduction of OPC numbers found in *Olig2*-heterozygous animals in the telencephalon (Parras et al., 2007). Beyond its specification role in the ventral brain and spinal cord during embryogenesis, *Ascl1* is also required for normal generation of OPCs from the postnatal brain, given that conditional *Ascl1* deletion in neonatal SVZ cells strongly reduces oligodendroglia (Nakatani et al., 2013). Moreover, specific *Ascl1* deletion in postnatal OPCs leads to a reduced OPC differentiation into OLs

to the benefit of an increased OPC proliferation, suggesting that in the balance between OPC proliferation and differentiation, *Ascl1* favors differentiation and therefore myelination (Nakatani et al., 2013). In the context of adult brain remyelination, using a focal demyelination mouse model, it has been shown that *Ascl1* levels are upregulated both in the adult SVZ and OPCs close to the demyelinated region in cells co-expressing *Olig2* and *Nkx2.2* suggesting that these transcription factors could be part of a common transcriptional code promoting remyelination (Nakatani et al., 2013). Indeed, during OL regeneration, *Ascl1* function is also important for OPC differentiation during remyelination as shown by the reduced OPC differentiation found when *Ascl1* is specifically deleted in adult OPCs before inducing a brain demyelination (Nakatani et al., 2013). Interestingly, *ASCL1* expression in the human brain is found in the remyelinating area of Multiple Sclerosis chronic active lesions suggesting that the function of *Ascl1* in remyelination is conserved between rodents and humans (Nakatani et al., 2013). Finally, *Ascl1*, *Hes1*, and *Olig2* expression oscillate into NSCs, regulating NSC behavior, with a model proposing that sustained expression of these factors promoting, *Ascl1* neurogenesis, *Olig2* oligodendrogenesis and *Hes1* astrogenesis (Imayoshi et al., 2013). During differentiation, *Ascl1* downregulates its expression, and conditional deletion decreases myelination on the postnatal brain and during remyelination of the adult (Nakatani et al., 2013).

SRY-RELATED HMG-BOX (SOX) TRANSCRIPTIONAL FACTOR FAMILY such as SOXE proteins (*SOX8*, *SOX9*, *SOX10*) promote oligodendrogenesis whereas SOXD proteins (*SOX5* and *SOX6*) inhibits specification and differentiation by interfering with SOXE family (Kuhlbrodt et al. 1998; C. C. Stolt 2002; 2003; C. Claus Stolt et al. 2006; Turnescu et al. 2018). *Sox9* is expressed in NSCs and glial precursors and deletion reduces OLs in the spinal cord at E12.5 through loss of NFIA necessary for activating gliogenesis (P. Kang et al. 2012). *Sox10* is exclusively expressed in the oligodendroglial lineage, particularly in iOLs (C. C. Stolt 2002). *Sox10* KO completely impairs OL differentiation and maturation (Stolt et al., 2002). However, *Sox9* and *Sox10* have partially redundant functions in OL specification, as *Sox9* partially compensate for OPC numbers in mice with *Sox10* deletion, whereas *Sox9/Sox10* double KO impairs OPC generation (Finzsch et al. 2008). *Sox8* is required in OPC specification in the spinal cord as shown by a small reduction of OPCs in *Sox8* KO mice only in this region, while in the brain the role is mainly played by *Sox9* and *Sox10* (C. Claus Stolt et al. 2004). On the contrary, in mature OLs, *Sox8* and *Sox10* are partially redundant, with only the compound *Sox8/Sox10* KO presenting defects in myelin maintenance. *Sox17*, a member of the SoxF subfamily, promotes OPC expansion and OL maturation through activation of the myelin gene promoter in OPCs (Sohn 2006). Moreover, Notch maintains OPC maintenance through *Sox17* mediated *Tcf7l2* regulation (Li-Jin Chew et al. 2019). In the context of demyelination, *Sox17* upregulates its expression in newly generated OLs, playing a critical role in their differentiation and repair (Moll et al. 2013). Nevertheless, opposite results were found about its function depending on the developmental stage, using an

inducible overexpression model of Sox17 in oligodendroglial cells (Ming et al., 2013; Moll et al., 2013). One explanation is that Sox17 switches from a negative to a positive differentiation factor at later stages of CNS development (Fauveau et al. 2018). SoxD proteins bind to DNA as dimers but due to the lack of a transactivation or repression domain cannot regulate transcription on their own (Reiprich and Wegner, 2015). Sox5 and Sox6 SoxD proteins were shown to be negative regulators of OPC specification and differentiation, antagonizing the regulatory activity of SoxE proteins by competing for common binding sites or interaction partners (Stolt et al., 2006). As already observed for SoxE proteins, SoxD proteins function in a largely redundant manner in oligodendroglia. They counterbalance Sox9 during OPC specification, as they were generated prematurely and in higher numbers from the pMN domain in the spinal cord of Sox5/Sox6-deficient mice than in WT littermates. Moreover, at later stages, loss of both SoxD proteins leads to altered migration of OPCs and premature expression of mature myelin genes such as Mbp and Plp (Stolt et al., 2006).

G-PROTEIN COUPLED RECEPTOR. Gpr17 is specifically expressed into the oligodendroglial cells, and negatively regulates their differentiation and maturation through activation of Id2/Id4 protein (Ying Chen et al. 2009). Gpr17 downregulates its expression during the peak period of myelination, and deletion enhances remyelination in-vivo following LPC-mediated demyelination in the spinal cord (C. Lu et al. 2018). Another repressor called Gpr37 increases expression during differentiation, as deletion promotes OL numbers and leads to hypermyelination through Raf-MAPK-ERK1/2 pathway (H.-J. Yang et al. 2016). To finish, Gpr56 positively regulates OPC proliferation through RhoA activity, as well as OL maturation and myelination in the corpus callosum (Ackerman et al. 2015; Giera et al. 2015).

GROWTH FACTORS PDGF interact with PDGFR α expressed at the OPC membrane, inducing their proliferation (Pringle et al. 1992). Indeed, PDGF overexpression induces OPC proliferation, whereas PDGF-KO leads to hypomyelination in the spinal cord and cerebellum and to a phenotype like tremors (Calver et al. 1998; Fruttiger et al. 1999). FGF maintains PDGFR expression on O2A cells (McKinnon et al. 1990; Armstrong et al. 2002), whereas EGF induces OPC symmetrical division and maturation (Sugiarto et al. 2011; Vinukonda et al. 2016).

SMALL NON CODING RNAs regulate post transcription during proliferation, differentiation, survival or stress (Stefani et Slack 2008). Dicer1 is required for myelination, whereas long non-coding RNAs IncOL1 affect differentiation by repressing OPC genes (Jason C. Dugas et al. 2010a; He et al. 2017). MicroRNAs (miR138/219/335/338) that are important regulators of OL differentiation repress expression of Sox6 and Hes5 to promote OL differentiation (X. Zhao et al. 2010; Jason C. Dugas et al. 2010b). In addition, activation of miR335 and miR338 was shown to be mediated by Sox10, reducing Sox9 protein levels post transcriptionally (Reiprich et al. 2017).

EPIGENETIC transcriptional regulation mainly consist in DNA methylation, mostly 5-methyl-Cytosine (5mC) but also the recently described in mammal N6-methyl-Adenine (N6mA) (Wu et al., 2016), and histone modification by methylation, acetylation, phosphorylation and ubiquitination that modulate chromatin compaction and thus accessibility of TFs and RNA Pol II (Kouzarides, 2007). Epigenetics play an important role for cell fate specification and differentiation, involving posttranslational modifications and different chromatin remodeling events as histone modifications (Hsieh et Gage 2005). Histone deacetylase (HDAC) 1 and 2 removes acetyl groups from histone lysine tails, leading to chromatin condensation, thus promoting OL differentiation through the induction of Olig2 and regulation of b-catenin translocation (Ying Chen et al. 2009). For instance, inhibitors Trichostatin-A (HDAC1/2) or valproic Acid (HDAC1) inhibits OPC differentiation, maturation and lead to strong hypomyelination in postnatal rats (Shen, Li, et Casaccia-Bonnel 2005; Conway et al. 2012). Histone methyltransferases catalyze the addition of methyl groups to histones. Methylation at H3K27 by Ezh2, an enzymatic factor of the Polycomb complex, plays a role in the selection of the oligodendrocyte lineage. Overexpression of Ezh2 in NSCs triggers oligodendrocyte fate choice, while Ezh2 silencing causes the opposite (Sher et al., 2008). The dynamic changes in activation and repression of promoter and enhancers occurring during the process of OPCs differentiation and myelination was recently studied by genome wide positioning (ChIP-seq) of H3K4me3 and H3K27ac marks in different OL lineage stages: OPCs, immature oligodendrocytes and myelinating oligodendrocytes (Yu et al., 2013). Modulation of chromatin structure by histone modifications and ATP-dependent remodeling plays an important role in oligodendrogenesis. Pioneering work has recently showed that Olig2 recruits Brg1, the central catalytic subunit of SWI/SNF-like chromatin-modifying complexes, and that this recruitment is essential for initial differentiation process from OPC to establish OL identity (Yu et al., 2013). The CHD (Chromodomain helicase DNA-binding) factors are the central catalytic subunit of certain chromatin remodeler complexes and they present lineage- and stage-specific expression patterns. In a search of Olig2, Mash1 and Brg1 targeted genes, our team identified CHD7, the main gene responsible for CHARGE syndrome associated with cognitive impairment (Basson and van Ravenswaaij-Arts, 2015), as their common target during OL development. A first study (He et al., 2016) showed that Chd7 is required for the onset of (re)myelination by regulating together with Sox10 a set of common target genes involved in myelinogenesis. Furthermore, combining Chd7/Chd8 chromatin binding profiles from *in vivo* OPCs with transcriptome and chromatin accessibility analyses of Chd7-deleted OPCs, it was demonstrated that mechanistically, Chd7 promotes OPC survival via chromatin-closing and transcriptional repression of p53/Trp53, while conversely, Chd7 binding is required for chromatin-opening and transcriptional activation of key regulators of OPC differentiation, including Sox10, Nkx2.2, and Gpr17 (Marie et al., 2018). Finally, integration of genome-wide occupancy

repertoires and associated epigenetic signals from OL lineage cells suggests that Chd7/Chd8 remodelers and Olig2/Sox10 TFs cooperate to activate oligodendroglia stage-specific genes (Marie et al., 2018). To investigate Chd8 function in oligodendrogenesis, Chd8 has been deleted using the *Olig1*-Cre driver (*Chd8cKO*), and similar to *Brg1cKO* mice, *Chd8cKO* mice presents a severe dysmyelination, seizures by P14, and death by P21 (Zhao et al., 2018). Remarkably, there is an absence of oligodendroglial cells (*Mbp*⁺, *Plp1*⁺) in the spinal cord and cerebellum, and a reduction in the forebrain. The reduced OL generation in *Chd8cKO* also leads to a lack of axonal myelination in the optic nerve, spinal cord, and to a lesser extent in the corpus callosum (Zhao et al., 2018), suggesting that Chd8 requirement depends on the CNS region. Confirming the requirement of Chd8 in OL differentiation, another study performing *Chd8* knockdown in neonatal brain-derived NSC differentiating cultures found reduced (by 36%) OL differentiation without changes in OPC numbers (Marie et al., 2018). Together, these observations indicate a spatiotemporal specific role of Chd8 in regulating CNS myelination (reviewed in Parras et al., 2020, Fig. 20).

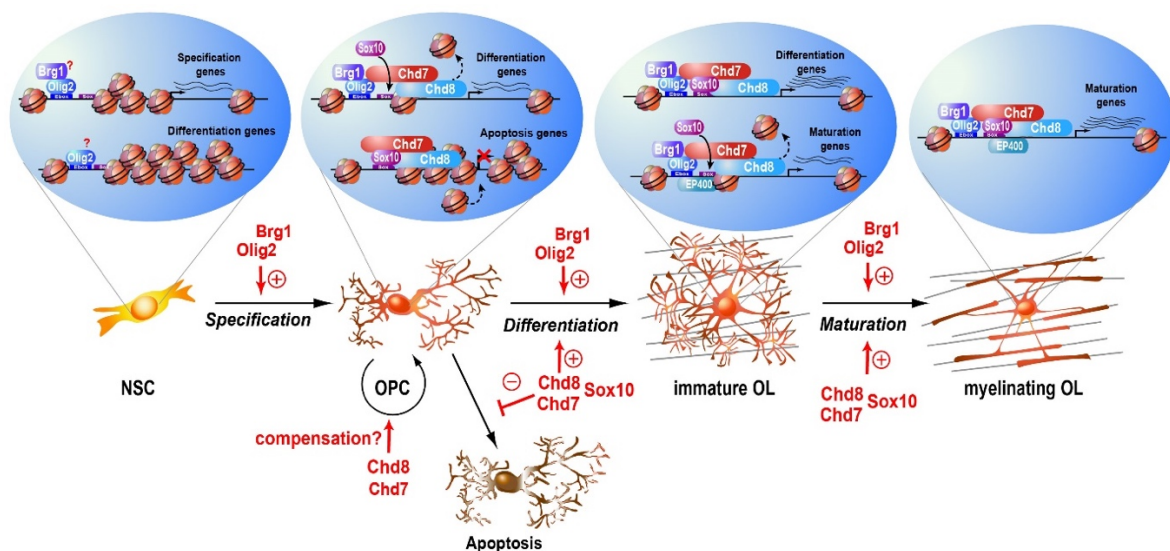

Figure 20: Model of regulation of oligodendrogenesis by chromatin remodelers and transcription factors.

In red, factors function in each process. Activation is depicted with a positive circle and inhibition by a negative circle. Blue ellipses represent the cell nuclei highlighting the genes involved in each step of oligodendrogenesis. Question marks indicate a hypothetical function still not addressed. NSC, neural stem cell; OPC, oligodendrocyte precursor cell; OL, oligodendrocyte (Adapted from Parras et al., 2020).

INHIBITOR OF DNA-BINDING (ID) PROTEINS. Like all members of the HLH family Id (inhibitors of differentiation or inhibitors of DNA-binding) factors are able to form heterodimers with other HLH proteins but lacking the basic domain, Id proteins form heterodimers unable to bind DNA (Benezra et al., 1990; Norton et al., 1998). Initial in vitro studies have shown that Id2 and Id4 play an inhibitory role in the timing of OL differentiation (Kondo and Raff, 2000b; Wang et al., 2001). Furthermore, the capacity of BMP4 to inhibit oligodendrogenesis in culture was shown to result from Id2/4-mediated

sequestration of Olig1/2 proteins in the cytoplasm (Samanta and Kessler, 2004). Id2 and Id4 also repress the Notch effector Hey1, regulating oligodendrogenesis through subsequent activation of Olig2 (Havrda et al. 2014). For instance, interaction between Id2 and Olig2 regulates OL differentiation through BMP and Gpr17. Moreover, expression of Id2 during OPC differentiation is regulated by Wnt and Hdac, and inhibition of OL differentiation by Id4 occurs through regulation of the expression of myelin proteins (Marin-Husstege et al. 2006; X.-S. Chen et al. 2012). Nevertheless, they are not the major regulators of differentiation during early CNS development (H. Huang et al. 2022).

MYELINATION

Myelin (Fig.21) is a fatty lipid-rich substance composed by 40% of water versus 60% of dry mass (60-75% lipid with a molar ratio of approximately 2:2:1:1 for cholesterol, phospholipids, galactolipids, and plasmalogens respectively and 15-25% of myelin proteins (Norton et Poduslo 1973).

Whereas myelination occurs at the postnatal stage in mice, this process occurs in humans earlier, during the 3rd trimester and until about 2 years of age (Hüppi et al. 1998; Inder et Huppi 2000).

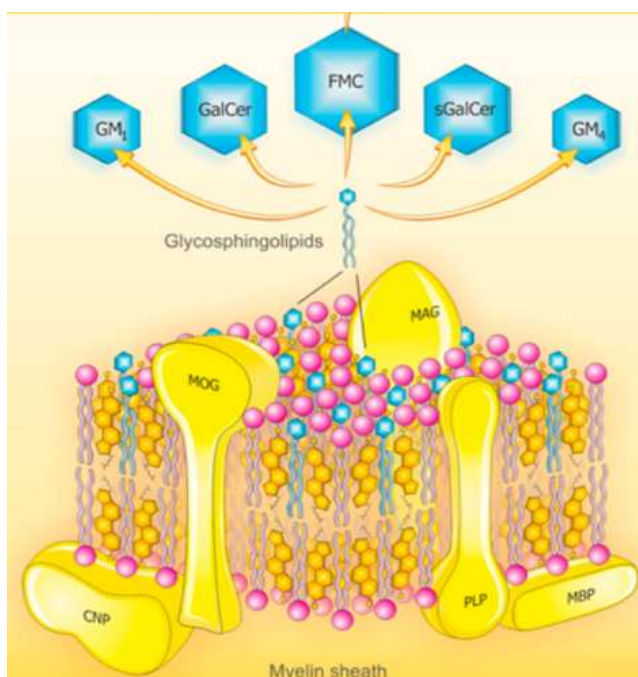

Myelination is sequentially regionalized: from central to peripheral, caudal to rostral, and dorsal to ventral (Fig. 22). T1-weighted MRI scans show that myelination starts in the brainstem (necessary for reflex behavior and survival), followed by cerebellum, basal ganglia, cerebrum until the frontal and temporal lobes (van Tilborg et al. 2018). Interestingly, myelination occurs earlier in females associated with speech areas and thus their learning abilities for language (Yurgelun-Todd, Killgore, et Young 2002; Karrass et al. 2002)

Figure 21: Structure of the myelin sheath in the CNS. Architecture and 3D-molecular composition of the myelin sheath, with complex lipids (cholesterol, PLs and GLs) and most abundant proteins (PLP, MBP). Proteins (yellow), cholesterol (orange), PLs (pink) and glycosphingolipids (blue). (Podbielska et al. 2013)

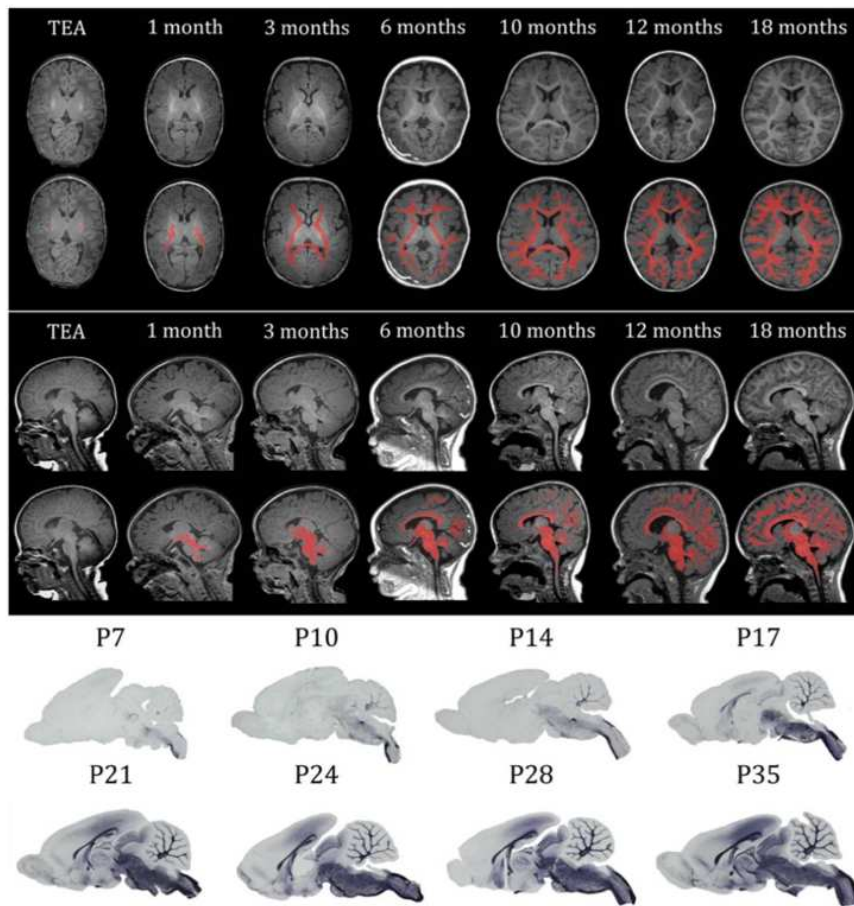

Figure 22: Comparison between humans and rodent myelination. Myelination is already initiated before birth and continues until 18 months in humans, whereas this process occurs between P7 and P35 in rats. T1-weighted MRI scans at different ages representing human transverse sections (top), sagittal sections (middle). Myelinated of the white matter is manually colored in red. Sagittal sections of rats brains are represented at different ages and stained for MBP (bottom). Evolution of the myelination process is similar between humans and rodents. (van Tilborg et al. 2018)

MAINS STEPS OF MYELINATION

Myelination process is initiated by axo-glia contact, followed by ensheathment and compaction of myelin sheath (Fig. 23). Initial contacts are performed by OPCs to reach and select an axonal segment, followed by stabilization of the interaction and cell polarization (Baron et al. 2015). This stage trigger several molecular rearrangements such as PIP2 and PIP3 recruitment at the membrane, inclusion of the tyrosine-kinase FYN in the lipid-rich membrane and reduction of RhoA activity (Baer et al. 2009; S. Goebbels et al. 2010; Czopka, ffrench-Constant, et Lyons 2013; Snaidero et al. 2014; Sandra Goebbels et al. 2017). Membrane growth quickly at the rate of $5,000 \mu\text{m}^2$ per day through lateral and radial expansion and recruitment of myelin lipids and proteins (PLP, P0 in the PNS) with high affinity for cholesterol-rich membrane microdomain (Werner et al. 2013; Saher et al. 2009). Maturation occurs through changes in lipid compositions from O1 galactocerebroside to O4 (Sommer et Schachner 1981; Bansal et al. 1989). Membranes include almost 160 layers with internodes intervals of 1.7 mm in the CNS (Hildebrand et al. 1993; Hildebrand, Bowe, et Remahl 1994). Ensheathment requires assembly of actin filaments by the Arp2/3 complex, while wrapping takes place during actin cytoskeleton disassembly via gelsolin and cofilin (A. Liu et al. 2003; Zuchero et al. 2015; Schanila Nawaz et al. 2015). At the transcriptional level, Olig2 and Sox10 enhancer activity

regulate MYRF, leading to the upregulation of MBP, PLP1, MAG, CNP and MOG (Emery et al. 2009). Proteolipids PLP sequester cholesterol to maintain a threshold level in the secretory pathway (Werner et al. 2013). Then, compaction of myelin layers occurs from the abaxonal layers toward the adaxonal inner tongue (Hildebrand et al. 1993; Snaidero et al. 2014). To do so, MBP is recruited through its strong affinity to bind and neutralize negatively charged PIP2 phospholipids, leading to the fusion of bilayers membrane into a main dense line (Harauz et Libich 2009; S. Nawaz et al. 2009; Aggarwal et al. 2013).

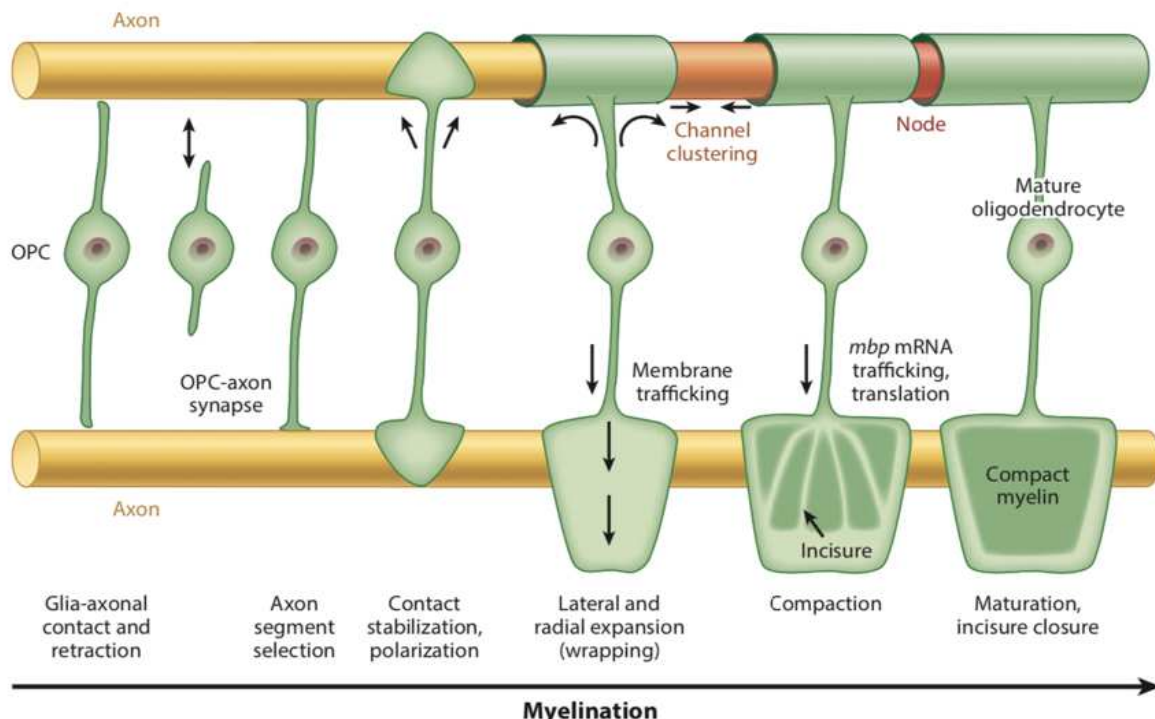

Figure 23: Schematic model of the axo-glial interaction, OPCs differentiation and myelination process. (Nave et Werner 2014)

REMYELINATION

Demyelination triggers massive OL, myelin and neuronal loss, associated with a pro-inflammatory environment involving immune cell reactivity. Following demyelination, a spontaneous process of remyelination occurs to mediate the inflammatory environment and repair the lesion site (Fig. 24). First, such molecules as Semaphorin 3A induce OPCs activation, migration and proliferation to colonize the lesion site where they differentiate into new myelinating OLs (Prineas et al. 1989; Chari et Blakemore 2002; Piaton et al. 2011; Duncan et al. 2018). OPCs also have the ability to generate Schwann cells, normally derived from the embryonic neural crest and restricted to the PNS (Zawadzka et al. 2010). At the genetic level, OPCs upregulate Olig2 or Nkx2.2 but this process can be affected by age (Shields et al. 1999; Sim et al. 2002). Indeed, overexpression of Olig2 was shown to accelerate the remyelination process, and myelination at the postnatal stage (Maire et al. 2010; Wegener et al.

2015). Interestingly, in both LPC induced demyelination and in MS lesions, *Ascl1* is upregulated in OPCs and remyelinating OLs to promote differentiation and remyelination (Nakatani et al. 2013). Importantly, *Olig1* plays a crucial role during remyelination, as KO prevents this process in both models of LPC and cuprizone induced demyelination (Arnett et al. 2004). Nevertheless, newly generated myelin sheath is thinner and remyelinated internodes segments are shorter than those in the normal white matter (Bunge, Bunge, et Ris 1961; K. J. Smith, Blakemore, et McDonald 1979; Karttunen et al. 2017). Prior to and during remyelination, nodal clusters regenerate to ensure correct saltatory conduction. However, the inflammatory environment remains the main cause of failure in remyelination (Kuhlmann et al. 2008; Boyd, Zhang, et Williams 2013).

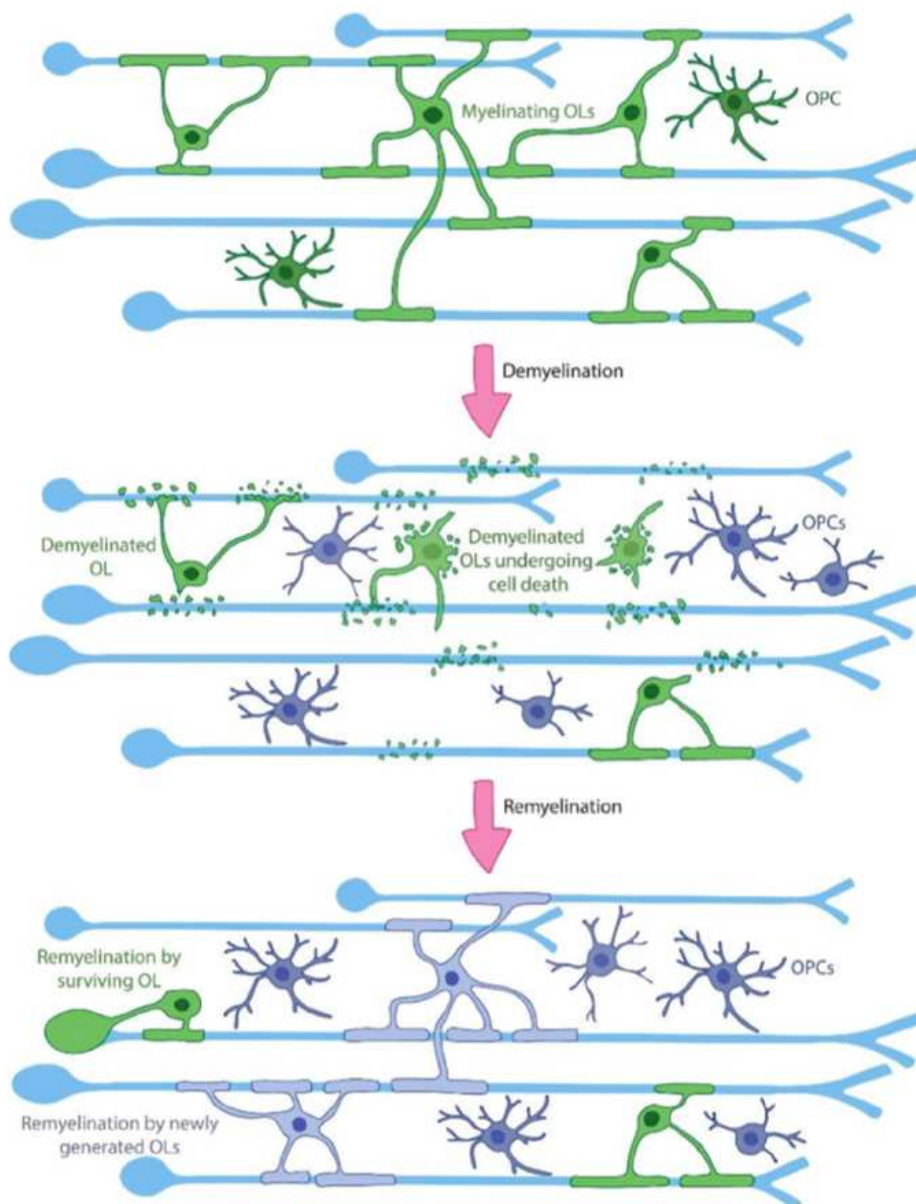

Figure 24: Schematic representation of the remyelination process. Different steps follow demyelination, characterized by OPC recruitment, axonal remyelination, with decreasing ability for the surviving OLs to remyelinate. (Franklin, Frisén, et Lyons 2021)

CHAPTER III- OLIGODENDROGLIAL AND MYELIN IMPLICATION IN DISEASES

PRETERM BIRTH

Preterm birth (PTB) is the leading cause of death and disability worldwide in children younger than 5 years, threatening 15 million infants yearly born before 37 GW. Overall, PTB affected 10.6% of all live births in 2014 depending on the country, with a rate of 13.4% in North Africa versus 8.7% in Europe (Blencowe et al. 2013; Chawanpaiboon et al. 2019). A classification of severity has been proposed depending on the degree of prematurity, from moderate PTB (32- 36 GW) to very (28- 31 GW) and extreme PTB (<28 GW) (Moutquin 2003). Although the level of survival increases in high-income countries for those born at very low birth weight, more than one million die shortly after birth because of a lack of adequate newborn care in developing countries.

PTB is an important public health concern as many surviving children show significant increased risk of morbidities, proportional to their gestational age (Glass et al. 2015). PTB affects cardiovascular and cerebrovascular systems, leading to hypertension, type 2 diabetes, chronic kidney disease, and asthma (Kajantie et al. 2010; A. B. Shah et al. 2015; Cabral et al. 2017; Naumburg et Söderström 2019; Harer et al. 2020; Pierrat et al. 2021). The pulmonary system is also highly vulnerable to PTB, with development starting very early at 4GW but the complete formation of the alveolar system happening before birth. In PTB, 80 % of babies born before 27GW show alteration of lung development and maturation with a lack of alveoli, breath, and surfactant that start normally at 30-32 GW. Thus, they develop respiratory distress syndrome, bronchopulmonary dysplasia and asthma, leading to hypoxia (Landry et Menzies 2011). Therefore, hypoxia increases risk of neurodevelopmental disorders, associated with behavioral and psychological sequelae (detailed below). Beside consequences on health, PTB increases socioeconomic inequalities and represent important health care costs (e.g. \$25.2 billion cost in US in 2016, mean cost of \$64,815 per PTB) (Moster, Lie, et Markestad 2008; Waitzman, Jalali, et Grosse 2021).

ORIGIN, DIAGNOSTIC AND TREATMENTS

Several factors impact PTB risk, such as cesarean deliveries, extremes in maternal age, multiple pregnancies, short cervical length and uterine abnormalities, diabetes, hypertension and use of fertility drugs (Catov et al. 2008; Berghella 2012; Fuchs et Senat 2016; Leader et al. 2018; Sanders et al. 2021). Other environmental factors impact PTB such as nutrition, low socioeconomic status,

smoking and alcohol abuse (N. R. Shah et Bracken 2000; Filicori et al. 2005; Gómez et al. 2010; Stylianou-Riga et al. 2018; L. Li et al. 2020). In addition, hormone dysregulation, through early stimulation of the hypothalamic pituitary adrenal axis and pro-inflammatory pathways is also responsible for the initiation of parturition (Challis et al. 2001). Geographic factors explaining disparities in PTB include infections, malaria, HIV, and high adolescent pregnancy rates (P.-L. Xiao et al. 2015; Chua et al. 2021).

Early diagnosis can partially predict a risk of PTB through cervical length measurements (L. D. Levine et al. 2019), monitoring of uterine activity or vaginal bleeding, as well as detection of different biochemical markers such as fetal fibronectin, IL-6, estriol (McGregor et al. 1995; Foster et Shennan 2014; Leños-Miranda et al. 2021). Several treatments exist to delay pregnancy, such as corticosteroid and progesterone given to stop contractions and avoid delivery. After early delivery, synthetic corticosteroids dexamethasone or betamethasone improve fetal survival, intraventricular hemorrhage, respiratory distress syndrome and mortality (Jane Elizabeth Norman et al. 2016; Jane E. Norman 2020). They also improve lung function through arrest of alveolar growth and increased maturation (Olson 1979; Fatusić 2004). They also have a potent action to mediate inflammatory response through interaction with nuclear factor NFkB (Bolt et al. 2001; Bartko et al. 2016). However, such treatments are not able to reduce PTB severity, and overexposure is associated with low weight and cardiovascular disease during adult life (R. M. Reynolds 2013). Another alternative in case of early delivery is therapeutic hypothermia that has been shown to reduce mortality, encephalopathy and improves early neurologic outcome after HI injury in neonates (Montaldo et al. 2019). For instance, reduction by 1°C decreases cerebral energy consumption by approximately 6 to 5%, as well as the appearance of cerebral lesions, caused by abnormal metabolism and lack of oxygen. Hypothermia should be initiated within 6 hours, but significant neurologic deficits and learning disability persist into childhood, as cell death and inflammation are initiated before treatment. Thus, for extreme PTB babies, diagnosis is crucial to predict motor impairment and initiate early therapy with techniques of neuroimaging (cranial ultrasound abnormalities, tomography, and magnetic resonance imaging) or evaluation of the movements at 1 month.

CONSEQUENCES ON BRAIN

Most PTB injuries include periventricular leukomalacia (PVL) associated with white matter injury (PWMD), intraventricular (IVH) or intraparenchymal hemorrhage (IPH). They are characterized by focal cystic necrotic lesions, diffuse cerebral WM lesions, hypomyelination and abnormal synaptic connectivity. Factors that predispose to PVL include prematurity, hypoxia, ischemia, inflammation, vascular system, and more vulnerable pre-OL populations (Back et Rivkees 2004). Moreover, some regions are more vulnerable to injury such as the highly vascular germinal matrix eminence area and

the white matter around ventricles, associated with difficulties to autoregulate cerebral blood flow (de Vries et Groenendaal 2002). PT babies also present a smaller brain size (corpus callosum, deep gray structures), less-developed myelination in the posterior limb of the internal capsule, and more immature gyral folding than those associated with full-term birth (Walsh et al. 2014). During adolescence, reduction in volume and size of frontotemporal and hippocampus regions in extreme PTB has been correlated to defects in intelligence quotient (Bjaland et al. 2014). PVL affects 3 to 20% of preterm babies born at very low weight, at early prematurity and is strongly associated with motor, visual, preceptory, behavioral, and cognitive failure. 90% of cerebral palsy are triggered by PWMD characterized by focal lesions in the deep white matter and necrosis of axons, OLs, and astrocytes (Wood et al. 2000; Hack 2000; Blumenthal 2004). Through increases level of hypoxia and neuroinflammation, PTB increase risk for neurodegenerative disorders (epilepsy, autism spectrum, mental retardation and attention-deficit), particularly for babies born at early stage (Luu, Rehman Mian, et Nuyt 2017). Indeed, 43% of babies born very early (22-24 GW) has an increased risk of developing neurocognitive impairment: 50% with learning disabilities, 10% with spastic motor deficits of cerebral palsy and 2.2 to 10% with epilepsy (Back et Rivkees 2004; Vesoulis et al. 2014; Younge et al. 2017; on behalf of ELGAN Study Group et al. 2019). They also have a 3 to 4 fold increased risk of developing psychiatric disorders (Burnett et al. 2011). Thus, a PTB behavioral phenotype is characterized by attention deficit hyperactivity disorder, lowering their academic achievement, social integration and speech development (Johnson et Marlow 2011). PT babies present an overall 35.8% risk of developing retinopathy of prematurity (before 28GW) (Şahin et al. 2014), 11% risk of developing hearing impairment (before 25GW) (McMahon, Wintermark, et Lahav 2012; Lahav et Skoe 2014; Baldoli et al. 2015), altering cortical maturation and development of language perception area.

HYPOXIA AFFECTS CNS DIVERSITY

The brain accounts for 20% of total body oxygen consumption, but brain oxygen levels are lower than atmospheric gas (2%–5% in the cortex, 0.4% in pons, 3%–4% in hippocampus). Moreover, oxygen levels are lower in the fetal brain (0.076–7.6 mmHg) compared to the adult (11.4–53.2 mmHg) (Erecińska et Silver 2001; Mohyeldin, Garzón-Muvdi, et Quiñones-Hinojosa 2010). During injury, cell death and compression of the vasculature lead to an edema, stroke or subarachnoid hemorrhage disrupting blood flow and oxygen levels (Bader 2006; Masamoto et Tanishita 2009). The oxygen level is crucial for brain development during the perinatal period to regulate NSCs activity, OL maturation, and myelination within the developing subcortical WM (Studer et al. 2000; Morrison et al. 2000; Panchision 2009). Hypoxia can also induce neuronal apoptosis, autophagy and unregulated necrosis

in specific areas responsible for sensorimotor integration and movement control (Merrill et al. 1993; Mitrovic et al. 1995; Rosenberg et al. 2002; A. I. Boullerne, Nedelkoska, et Benjamins 2008).

A potential endogenous biomarker called hypoxia-inducible factor-1 α (HIF-1 α) is normally degraded by the proteasome after hydroxylation and ubiquitination by the VHL E3 ubiquitin ligase (Groulx et Lee 2002). In the context of hypoxia, process of hydroxylation is inhibited, leading to the stabilization of HIF accumulating to modulate glycolysis enzymes allowing ATP synthesis, VEGF-mediated angiogenesis or modulate chromatin methylation (Batie et al. 2019). Interestingly, hypoxia induces erythropoietin (EPO) having a neuroprotective effect, improving cognition, neuronal progenitors proliferation, neuronal plasticity and long term potentiation (Shingo et al. 2001; Adamcio et al. 2008). Indeed, intermittent exposure (4h/day) of neonatal mice at 2000m of altitude during 3-4 weeks promotes phosphorylation of CREB, long term potentiation, synaptogenesis as well as spatial learning and memory (J.-X. Zhang et al. 2005). Nevertheless, hypoxia strongly influence NSC behavior through negative regulation of NPCs differentiation, repression of BMP/ Smad1/5/8 and Wnt/ β -catenin, and activation of Hes1 (Gustafsson et al. 2005; Pistollato et al. 2007; Maiti et al. 2008; Večeřa et al. 2020).

HYPOXIA AFFECTS OLIGODENDROGENESIS

Initiation of OL differentiation and myelination coincide with PTB and hypoxia, making late progenitors (or early immature OLs, O4⁺/O1⁺ cells) vulnerable to hypoxia (Fig. 25), whereas OPCs and mOLs are highly resistant. Differentiation is restricted in the white matter during the high risk period for PVL, explaining their selective vulnerability (Back et al. 2001). Thus, a study using a neonatal rat model of hypoxic-ischemia found that diffuse lesions, characterized by injury to pre-OLs and deficiency of cerebral myelination, contain 72 \pm 6% pre-OL cell death at this stage (Back et al. 2001; 2002). Late progenitors (NG2⁺/O4⁺) represent a minor population between 18-27GW (9.9 \pm 2.1%), mostly differentiating during 29-41GW (30.9 \pm 2.1%). This vulnerability is dependent to oxidative stress increasing peroxides and radicals and leading to caspase-mediated cell death in those cells containing low levels of anti-oxidants and radical scavengers (Back et al. 1998; Fern et Möller 2000; Back et al. 2002; Fragoso et al. 2004). Inflammatory response is highly upregulated in the cerebrospinal fluid (CSF) from preterm babies during hypoxia, with significant upregulation of IL-1b, IL-2, IL-4, IL-9, IL-17A, MIP-1a, MMP8, SPP1, TGFb, and TNFb (Boardman et al. 2018). Another study found in post-asphyxiated CSF infants that TRAIL (tumor necrosis factor-related apoptosis inducing ligand), IL-6 and 8 are enrich and correlated to poor neurodevelopmental outcome (Leifsdottir et al. 2018). In the preterm human fetus, increased levels of ROS, H₂O₂, nitrogen metabolites and iron-mediated oxygen radical are also found in their periventricular white matter (Saugstad 2003; Lembo,

Buonocore, et Perrone 2021). Furthermore, cerebrovascular immaturity associated with a defect of cerebral autoregulation predispose periventricular white matter to injury, particularly in the arterial end and border zones (Takashima et Tanaka 1978; Nakamura, Okudera, et Hashimoto 1994).

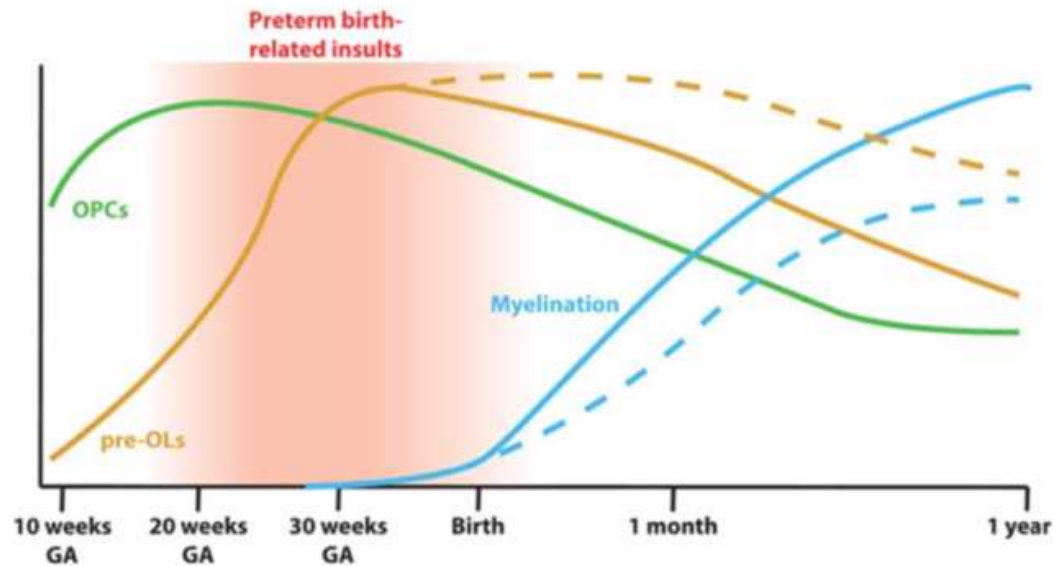

Figure 25: Illustration showing the coincidence of PTB vulnerability during oligodendrogenesis. OPCs proliferate between 15-20 GW (green) and differentiation into pre-OLs peaks between 30-40 GW (orange), whereas myelination is initiated before birth and occurs during the first year of life (blue). PTB windows affect the peak of pre-OLs (red area), leading to vulnerability (OL death), fail to differentiate and reduced myelination levels in WM (dashed orange and blue lines) (van Tilborg et al. 2018)

MULTIPLE SCLEROSIS

MS is a debilitating chronic inflammatory disease of the CNS, leading to demyelination and diffuse neurodegeneration in the brain and spinal cord. MS was characterized in 1868 by Jean-Martin Charcot finding numerous glial scars (sclerae) and developing plaques in the white matter (WM) of the brain and spinal cord. In 2020, about 2.8 million people suffer from MS, representing 35.9 case prevalence per 100.000, with the highest levels in North America, Western Europe, and Australia (>100 cases) (Walton et al. 2020). MS is mainly diagnosed in adults between 20-40 years, and affects 2 to 4 times more women (Jobin et al. 2010). Lesions are initiated by focal demyelination, inflammation and gliosis followed by axonal damage and neuronal loss (Stadelmann, Wegner, et Brück 2011). Depending on their location in the CNS, WM lesions can trigger muscular, somatosensory, or neurocognitive disabilities. For instance, lesions located in the frontal and temporal lobes induce cognitive and psychiatric symptoms (Denier et al. 2007). Furthermore, life expectancy is on average 5 to 10 years lower than the normal population. The 4 main types of MS are clinically isolated syndrome (CIS), relapsing-remitting MS (RRMS), secondary (SPMS) and primary progressive MS (PPMS) (Fig. 26).

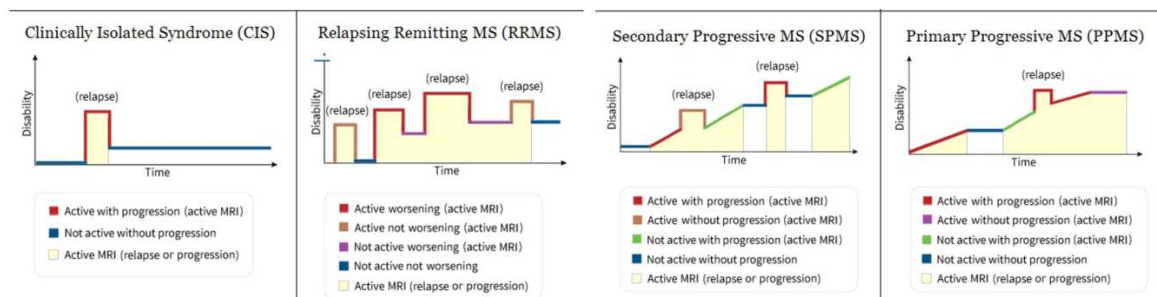

Figure 26: Multiple Sclerosis is clinically classified depending on disease progression. 4 types of MS exist: clinically isolated syndrome (CIS), relapsing-remitting MS (RRMS), secondary (SPMS) and primary progressive MS (PPMS).

CIS are the first evidence of MS characterized by a single episode of MS-like symptoms during 24h or longer. The most common type of MS (80%–85%) is RRMS with patients presenting attacks (or relapses) and neurological symptoms between remission periods (partial or complete recovery). Relapsing forms are discrete episodes of neurological dysfunction and enhanced inflammation followed by partial, complete, or no remission (generally associated with remyelination). When they are not treated, RRMS can eventually convert into SPMS. PPMS occurs in almost 10% of MS patients when the brain contains two or more lesions in the spinal cord associated with a high level of immune system activity.

MS causes are not clearly identified, depending on genetic and environmental factors (alimentation, metabolism or viral infections). Sex hormonal differences (prolactin, estrogen, progesterone, or testosterone levels) can explain a more pronounced vulnerability for women. For instance, MS lesions show an increase of GPCR signaling and Sphingosine-1-phosphate receptor 2 expression, associated with increased levels of blood vessel receptor regulating invasion of immune inflammatory cells (Cruz-Orengo et al. 2014). This year, a retrospective study based on 10 million young US military personnel found a 32 fold time increase risk to trigger MS with Epstein-Barr herpes virus (Hassani et al. 2018; Bjornevik et al. 2022). Thus, EB virus present in latent B lymphocytes located in MS lesions is an important factor in demyelination through an immune-mediated process but not sufficient to trigger MS given that ~95% of the general population have been exposed to this virus and only less than 1% develop MS (Serafini et al. 2007). In addition, a study in 2020 identified from 73 untreated MS cases (and 97 healthy controls) 200 single-nucleotide polymorphisms associated with 129 distinct genes from purified immune cell types (Gresle et al. 2020)

Evolution of MS is dependent on early diagnosis, established with evidence of inflammatory injury and presence of clinical symptoms (>24h). The most important paraclinical test is magnetic resonance imaging (MRI) performed after intravenous injection of contrast agent gadolinium useful to detect active lesions, BBB breakdown and inflammation, whereas microglia activation is detected by two positron emission tomography imaging (PET) (Fig. 27) (Ku et al. 2018). Glutamate excitotoxicity is detected by magnetic resonance spectroscopy (MRS). Demyelination is characterized by magnetization transfer imaging (MTR), diffusion-weighted imaging (DWI) and PET scan. Measures of brain atrophy are performed using MTR electrophysiological tests (visual and somatosensory evoked potentials) to assess conduction of the visual pathways from the retina to the occipital cortex. In addition, CSF lumbar puncture, microbiological tests, and cytological evaluation are also used for MS diagnosis. Overall, these markers significantly improve clinical trials, combining the evolution of clinical signs, measure of BBB integrity, immune cell activity, remyelination in lesion sites (PET), microstructural damage for quantification of the changes in fractional anisotropy and mean diffusivity with MRI (Ricigliano et al. 2022).

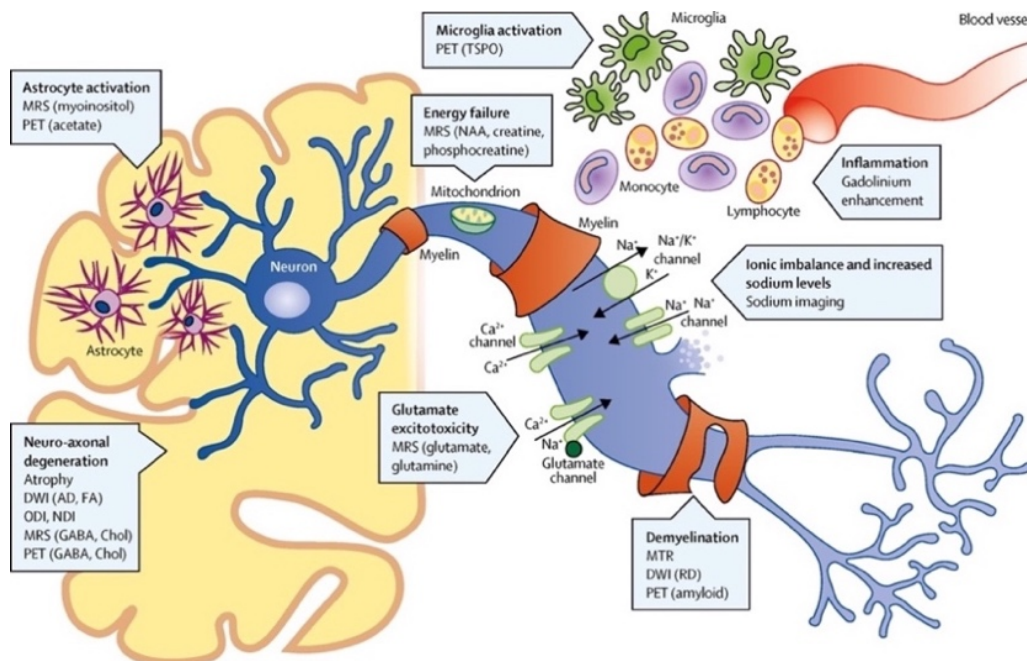

Figure 27: Scheme illustrating biomarkers used for MS diagnosis. Different biomarkers are used to diagnose different aspects of MS pathology, including inflammation through astrocyte and microglia activation, demyelination, energy failure or neuro-axonal degeneration. DWI=diffusion-weighted imaging. AD=axial diffusivity. FA=fractional anisotropy. ODI=orientation dispersion index. (Thompson et al. 2018)

INFLAMMATORY MECHANISMS

BBB is the first physical barrier against neuroinflammation, preventing immune cell infiltration (Zlokovic 2008). Neuroinflammation is associated with BBB disruption, peripheral immune cells invasion and microglia activation, leading to a massive release of cytokines and chemokines (Bhalala, Koehler, et Kannan 2015). In RRMS, the peripheral immune system is highly activated, particularly on the spleen, as experiments of splenectomy reduce cell infiltration and decrease damage after ischemia and stroke (H. Jiang et al. 2007; A. Chauhan et al. 2018). Inflammation involves B and T cells, and activation of the CD8-T cells subset is sufficient to drive demyelination and neuronal death (Huseby et al. 2012). Indeed, activated myeloid and T cells enter the CNS to secrete IL1 β , leading to the activation of Th17 cells proliferating and activating microglia (Fig. 28). Thus, microglia switch into the M1 phenotype secreting pro-inflammatory cytokines (e.g. TNF- α , IL-1 β , IL-6, INF- γ , GMCSF) and superoxide radicals inducing a cascade of excitotoxicity and oxidative damage (Nakajima et Kohsaka 2001). In addition, microglia stop secreting trophic factors IGF-1 and ciliary neurotrophic factor promoting OL differentiation (Mayer, Bhakoo, et Noble 1994; Pang et al. 2007). Astrocyte reactivity also occurs with secretion of metalloproteases and cytokines aggravating BBB disruption, inflammation and excitotoxicity (Ponath, Park, et Pitt 2018; Siracusa, Fusco, et Cuzzocrea 2019; Soung et S. Klein 2020). In brain and CSF from MS patients, increase levels in glutamate and expression of its receptor GluR1 are found in OLs located in active lesion borders (Pitt, Werner, et Raine 2000; Sarchielli et al. 2003; Newcombe et al. 2008). Excitotoxicity also increases excitatory postsynaptic currents

during the early phase of EAE as well as levels of oxidative reactions in neurons and OLs (Centonze et al. 2009). Activated microglia present myelin antigen to T cells, leading to the secretion of inflammatory molecules (IL17, GMCSF, IFN γ and TNF), as well as ROS and NOS damaging myelin, OLs and neurons (McGinley et al. 2018). Following inflammation and resolution, microglia can switch into the M2 anti-inflammatory phenotype allowing remodeling and repair through clearance of ROS, phagocytosis of debris, production of neurotrophic factor (IGF1, BDNF and NGF), and secretion of anti-inflammatory cytokines (IL-10, TGF- β 1, IL-4) (Varnum et Ikezu 2012; Peferoen et al. 2015). Therefore, different strategies try to switch the M1 phenotype into an M2 pro-regenerative phenotype (Kobayashi et al. 2013; Lang, Li, et Han 2021).

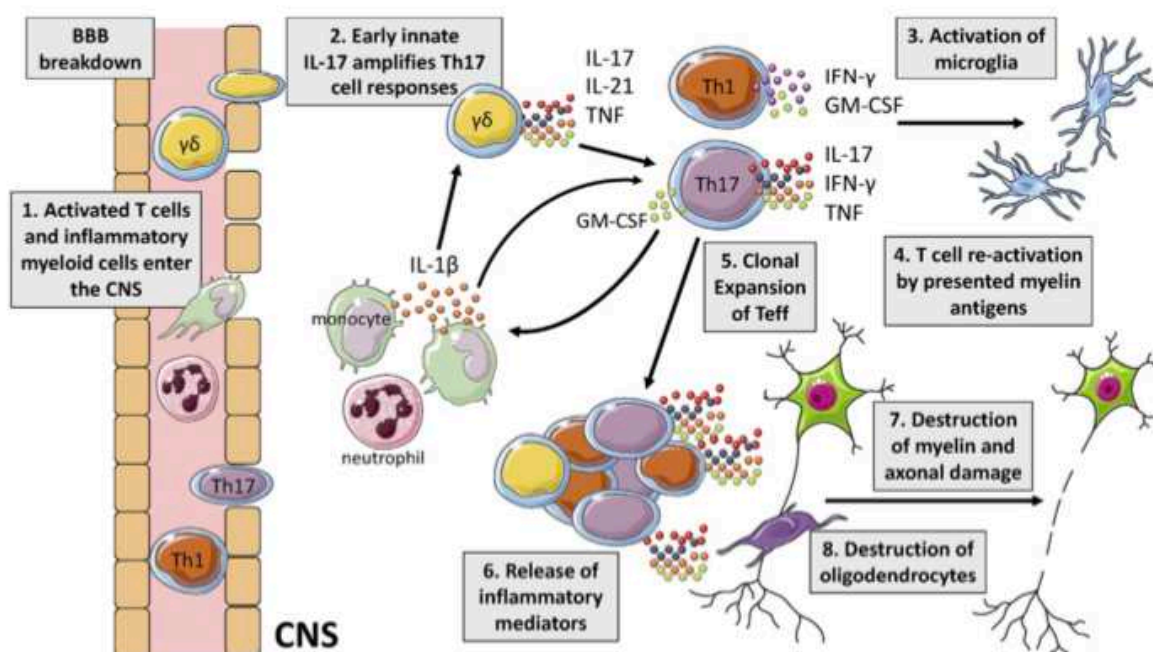

Figure 28 : Immune cell regulation in and outside the CNS during MS. During EAE and MS, BBB breakdown occurs, allowing activated myeloid and T cells to migrate inside the brain (1) to produce IL-17 and IL-21 increasing Th17 cell responses (2). Thus, Th1 and Th17 cells activate resident microglia(3) presenting myelin antigens to T cells (4), inducing clonal expansion of Th1 and Th17 and release of inflammatory mediators IL-17, GM-CSF, IFN-g and TNF, ROS and NOS promoting the destruction of myelin, leading to demyelination, neuronal death and neurological impairment. (McGinley et al. 2018)

At the histological level during pathogenesis, inflammation leads to myelin degradation, OL death, axonal dysfunction, and neurodegeneration. Alteration in OL differentiation is a major determinant of remyelination failure in chronic MS lesions (Kuhlmann et al. 2008; Saraswat et al. 2021). Following demyelination, endogenous remyelination depends on the OPC ability to migrate, proliferate, and differentiate in the lesion site. OPC recruitment is affected in chronically demyelinated lesions where 37% of the lesions fail to remyelinate increasing chemorepellent Sema3A (A. Williams et al. 2007; Piaton et al. 2011; Boyd, Zhang, et Williams 2013). Notch1, Wnt, Bmp and FGF2 signaling are enriched in OPCs from MS lesions, and their expression decreases during

remyelination (Sabo et Cate 2013). Moreover, *in vitro* and *in vivo* activation of Wnt in OPCs delay maturation, leading to remyelination failure (Soomro, Jie, et Fu 2018). Other cues alter OPC migration such as growth factors (PDGF, FGF), guidance molecules (Semaphorins or Netrins), chemokines (CXCL1) or ECM (Jarjour et Kennedy 2004).

SHARED OL DISRUPTION SIGNATURE UNVEILED IN DIVERSE BRAIN DISORDERS

Whereas most studies highlighted the role of inflammation in neuronal and gray matter degeneration; recent discoveries have shed new light on WM dysfunctions or myelination process for their implication in a wide range of neurodegenerative disorders. Myelination is crucial for neuronal signaling to carry out cognitive functions such as attention, learning and memory (Fields 2005). In humans, this process occurs mostly until adulthood during which the maximum incidence of neuropsychiatric troubles arise. Altered myelination has been related to defects in dopaminergic and glutamatergic circuitry (Höistad 2009; N. Takahashi et al. 2011). Moreover, many genetic mutations or proteomic alterations found in diseases are expressed in the oligodendroglial lineage (Y. Zhang et al. 2014) (Fig. 29). These alterations can autonomously affect OL development, or indirectly via the regulation from other cell types (e.g. inflammation, neuronal degeneration). Here, we will briefly review recent evidence suggesting potential OLs consequences or contribution beside MS and PTB, including amyotrophic lateral sclerosis, schizophrenia, Alzheimer, gliomas, and Huntington.

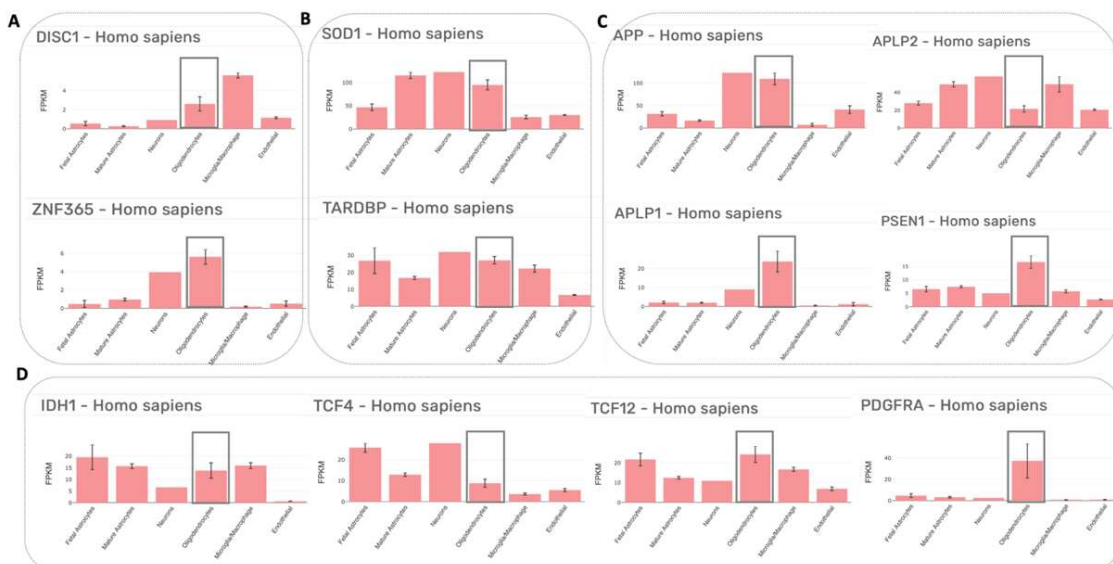

Figure 29: Genes altered in neurological disorders are expressed by oligodendroglial cells. Gene expression detected in human neural cell types from Barres transcriptomic database (Zhang et al. 2014). Data shows that OLs mostly express the genes mutated or altered involved in (A) Schizophrenia (DISC1, DBZ/ZNF365), (B) Amyotrophic lateral sclerosis (SOD1, TARDBP/TDP43), (C) Alzheimer disease (APP, APLP1, APLP2, PSEN), (D) Glioblastoma (IDH1, TCF4, TCF12, PDGFRA).

AMYOTROPHIC LATERAL SCLEROSIS (ALS) is characterized by progressive motor neuron loss, gray matter demyelination, reactive changes of OPCs and impaired OL maturation in spinal cord and motor cortex from postmortem patients (S. H. Kang et al. 2013; Philips et al. 2013). Thus, the contribution of gray matter OLs in neuronal degeneration is still in debate, and several findings argue for the hypothesis of OL degeneration prior to motor neurons. Indeed, conditional depletion of OLs is sufficient to induce progressive motor deficits, axonal damage and tremors (Ghosh et al. 2011; Oluich et al. 2012). Mutation for superoxide dismutase 1 (SOD1 gene, involved in ALS) in OLs contributes to neuronal death associated with reduction of secreted lactate *in vitro* (Ferraiuolo et al. 2016; Wilkins et al. 2003). Alteration in metabolism play a crucial role in neurodegeneration, and deficiency in myelin-derived trophic support such as GDNF or IGF-1 contribute to axonal degeneration and cell death (Bjartmar et Trapp 2003; Wilkins, Chandran, et Compston 2001; Wilkins et al. 2003). Moreover, downregulation of the metabolic transporter MCT1 was found in the motor cortex of patients, and selective depletion in OLs induces axonal degeneration in the optic nerve (Y. Lee et al. 2012).

SCHIZOPHRENIA patients present abnormal WM development, myelination pattern and defects in oligodendrogenesis (Hof et al. 2003; Tkachev et al. 2003; Flynn et al. 2003; Kubicki, McCarley, et Shenton 2005; Dracheva et al. 2006; N. Takahashi et al. 2011; Miyata et al. 2015; Tønnesen et al. 2018). In the context of schizophrenia, genetic risk factors including DISC1 (disrupted-in-Schizophrenia-1) and DBZ (DISC1 binding zinc finger) are expressed in OLs and respectively inhibit or promotes OL differentiation (Miyoshi et al. 2003; Shimizu et al. 2014; Hattori et al. 2014).

HUNTINGTON'S DISEASE (HD) patients present WM abnormalities and hypomyelination (Jin et al. 2015; Phillips et al. 2016; Bourbon-Teles et al. 2019). A team found the downregulation of several oligodendroglial TFs (NKX2.2, OLIG2, SOX10, MYRF) in bipotential glial progenitor cells derived from human mutant Huntingtin embryonic stem cells (Osipovitch et al. 2019). Experiment of selective Huntingtin knock-in (HTT, mutation involve in HD) in mouse OLs lead to progressive neurological symptoms with tremors, locomotor and behavioral deficits as well as a reduction of myelin sheath thickness in the striatum (B. Huang et al. 2015; Bardile et al. 2018).

ALZHEIMER DISEASE (AD) is the most common cause of dementia associated with a strong cognitive and memory decline, characterized by deposits of amyloid plaques and tau/neurofibrillary tangles. Many genetic risk factors including amyloid precursor protein (APP), presenilin, and tau are expressed in the OL lineage (Fig. 29). An MRI study performed on 179 AD patients found correlation with WM lesions and hippocampal atrophy (de Leeuw, Barkhof, et Scheltens 2004). Moreover, amyloid β deposit and accumulation exerts direct toxic effects in OL lineage, leading to cell death, inflammation and myelin alterations (Xu et al. 2001; de Leeuw, Barkhof, et Scheltens 2004; J.-T. Lee et al. 2004; A. D. Roth et al. 2005). To examine OL contribution in the establishment of AD, experiment

using triple-transgenic AD mice model (harboring APP, presenilin, tau mutation) identified region-specific alterations in myelination patterns prior to amyloid and tau pathology (Desai et al. 2009). Thus, myelination defects can contribute to neuronal vulnerability, oxidation, inflammation in AD.

GLIOMA OPCs are known to promote neovascularization in glioma and vascular remodeling through PDGFR α /PDGF-CC signaling axis, leading to the BBB disruption and aberrant tumor angiogenesis (Y. Huang et al. 2014). Gliomas are associated with disruption in signaling pathways involved in OPC proliferation, increasing PDGF/PDGFR α activity in up to 33% of adult GBM patients (Brennan et al. 2009; Ozawa et al. 2010). As a consequence, trying to inhibit OPC proliferation as well as promoting their differentiation into functional mOLs can be a promising strategy in this context.

In summary, disruption of OL function and myelination is a shared feature across a variety of neurodegenerative and psychiatric disorders. Myelination is essential for efficient neuronal communication and cognitive functions, and disruption leads to significant neural network inefficiencies. The interplay between OLs and neural cells means that OL dysfunction can have widespread effects, exacerbated by metabolic deficits and reduced trophic support. Environmental factors, such as early life stress and epigenetic modifications influence OL differentiation and myelination, highlighting the impact of external conditions on neural health. Understanding the roles of OLs and the factors influencing their function is crucial for developing comprehensive and effective treatments for a wide range of neurological disorders. Advanced imaging techniques to visualize myelination patterns in vivo facilitate early diagnosis and monitoring therapeutic efficacy. In mosts ND, neuronal death is exacerbated and correlated with alterations in WM composition, with strong defects in either OL generation or myelination. For instance, in ALS, vulnerability arises particularly from motor neuron degeneration, as these cells are highly dependent on myelin-derived trophic support. Also common mechanisms, such as defects in calcium and GPCR signaling have been detected in AD, HD and PD (Pchitskaya, Popugaeva, et Bezprozvanny 2018). Whether it is the cause or the consequence, myelination defects should strengthen therapeutic approaches towards combinatorial treatments promoting immune regulation and repair. Therapeutic strategies enhancing myelination, combined with anti-inflammatory and neuroprotective approaches, offer a promising avenue for broad treatments. Although most current therapies target the immune system to limit neuronal degeneration in MS (e.g., β -interferons, natalizumab, and teriflunomide) (Haghikia et al., 2013), they are not efficient in ensuring CNS repair (Zhang et al., 2013). This leads us to focus on treatment strategies and modulation of myelination as a promising perspective for addressing a broad spectrum of diseases related to oligodendroglial inefficiency. Therefore, in the next chapter, we will dissect pharmacological mechanisms and promising molecules, as well as anti-inflammatory molecules regulating oligodendrogenesis for promoting brain repair.

CHAPTER IV- FROM ESTABLISHED STRATEGIES TO PHARMACOGENOMIC DRUG REPURPOSING

PHARMACOLOGICAL MODULATION OF OLIGODENDROCYTE SIGNALING

Numerous strategies and drugs were found in the last decade to promote OL development and myelination in the context of MS, regulating different processes such as inflammation, cell survival, metabolism, and oxidation (Fig. 30). Nevertheless, few candidates are currently under clinical trials to evaluate their safety, tolerability or systemic adverse effects, more or less advanced during their clinical development stage. Among them, the anti-histaminic clemastine is a well-known candidate with a potent perspective to foster (re)myelination. In addition, numerous immunomodulatory treatments reducing inflammation and damage are already on the market for MS, but there are actually no remyelination-enhancing therapies approved.

Advances in medical imaging have greatly improved clinical study protocols, because many clinical studies for MS were based on the evaluation of clinical signs or disease progression, without the ability to detect the effect of a compound on remyelination. Currently, the imaging techniques and biomarkers discussed above allow us to better assess remyelination, BBB disruption and immune cell activity. Thus, the design of the clinical trial remains crucial to evaluate the effectiveness of certain treatments. For example, although clemastine has a clinical effect in improving visual evoked potentials (VEPs) in patients with optic neuritis (Green et al. 2017; Moghaddasi et al. 2020), the MTR analyses were not well designed, taking into account an average recordings from baseline and screening for comparison with final outcomes, instead of analyzing the effect by cubic voxels. Furthermore, it is necessary to use the best markers to evaluate the efficacy of a treatment, and to correlate this with voxel-specific analysis.

Therefore, these new technological advances in the evaluation of treatments coupled with validation in preclinical animal models should make it possible in the coming years to bring to the market molecules capable of promoting remyelination. Finally, MS being a disease with an inflammatory component, a combination with an immunosuppressive treatment seems essential to definitively stop the relapses of the disease. In this chapter, we will review our current knowledge on the pharmacological modulation of oligodendrogenesis.

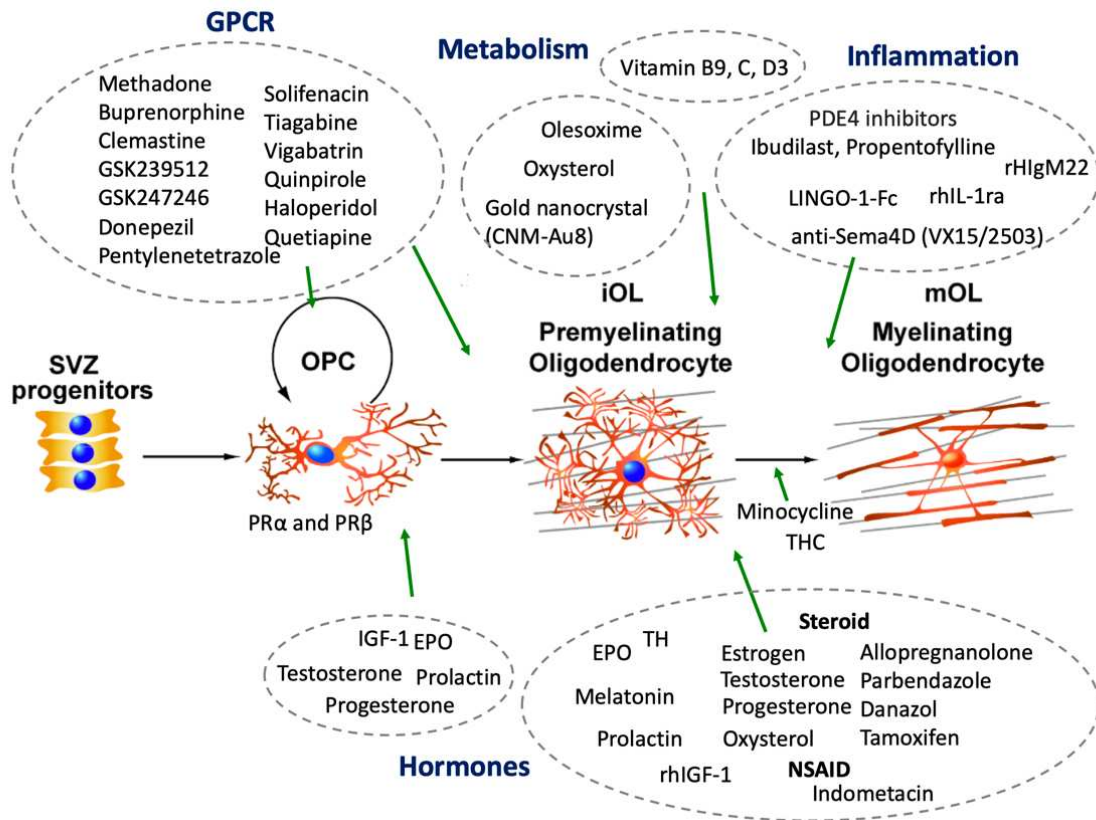

Figure 30: Pharmacological approaches and pathways regulating oligodendrogenesis. Mains strategies effective to foster OL generation and (re)myelination includes regulation of GPCR signaling, metabolism, inflammatory or hormonal pathways. Green arrow represents positive regulation. (Huré)

CALCIUM SIGNALING

G-coupled protein receptors GPCRs are 7-transmembrane integral membrane proteins, and constitute the more important family of proteins, with about 1000 members crucial for cell signaling (Fredriksson et al. 2003). Indeed, they are able to sense a huge diversity of extracellular stimuli (ligand or agonist) such as neurotransmitters, hormones, chemokines, metabolites and others acting mostly through GPCR (B. L. Roth et Kroeze 2015; Mogha, D’Rozario, et Monk 2016; J. A. Allen et Roth 2011). Importantly, 40% of the actual drug regulates the GPCR signaling (R. Zhang et Xie 2012). However, their activation can affect several signaling pathways regulating various processes, and lead to secondary effects (hormonal dysregulation, cell proliferation, inflammation, or cardiovascular disease). Thus, modulation of GPCR should be carefully monitored in long-term studies. Briefly, ligand binding mediates the activation of the adenylyl cyclase converting ATP into cAMP. Then cAMP activates its downstream effector PKA to induce cell response (Yong, Dooley, et Noble 1994).

GPCR are usually coupled with regulation of iCa^{2+} : AMPc increases phospholipase C activity, leading to the cleavage of PIP2 (phosphatidylinositol 4,5-bisphosphate) into inositol trisphosphate (IP3) and

diacylglycerol (DAG)(Nash et al. 2001). Thus, an increase in IP₃ levels activates receptors on the endoplasmic reticulum membrane, triggering calcium release.

Calcium regulation is important for OL biogenesis, having a role in several processes such as myelin sheaths formation, stimulation of OPC migration and differentiation (Agresti et al. 2005). For instance, *in vivo* live imaging demonstrated that myelination is also dependent on transient and local calcium waves (Lev-Ram et Grinvald 1987; Baraban, Koudelka, et Lyons 2018). Numerous receptors and signaling modulate calcium levels such as voltage gated Ca²⁺ channels, NMDA, AMPA, metabotropic glutamate, GABA, purinergic or muscarinic receptors and their expression and functions in the oligodendroglial lineage was reviewed recently (Pablo M. Paez et Lyons 2020). Importantly, 90% of the L-type voltage-gated calcium channels (Cav1.2 and Cav1.3) regulate calcium exchange in OPCs, and KO for Cav1.2 in OPCs induced significant hypomyelination and disrupted remyelination *in vivo* (P. M. Paez et al. 2010; Cheli et al. 2016; Santiago González et al. 2017). As previously mentioned, OPCs established synaptic connections with neurons to collect glutamatergic and GABAergic synaptic input regulating calcium levels (S. Lin et Bergles 2004; Kukley, Capetillo-Zarate, et Dietrich 2007). Indeed, glutamate activates NMDA receptors, thus increasing intracellular Ca²⁺ influx in OPCs and mature OLs (R. Káradóttir et Attwell 2007). Moreover, subsequent activation of mGluR3,4,5 promotes cell survival and OPCs differentiation (Luyt et al. 2006; Niswender et Conn 2010; Spampinato et al. 2015). At the transcriptomic level, Ca²⁺-dependent phosphatase calcineurin regulates the nuclear factor of activated T cells (NFAT) important for regulation of differentiation and myelination (Hogan et al. 2003). In addition, NFAT was demonstrated to cooperate with Sox10 during this process and is downregulated in active MS lesions (Weider et al. 2018). However, it is not clear how variations in calcium regulate oligodendrogenesis and how much this signaling is implicated in neurodegenerative disorders. As described previously, regulation of calcium signaling through GABA-R activation mediate glutamate induced excitotoxicity through activation of Ca²⁺ proteases (e.g. calpain) and induction of ER stress, highly contributing to OL vulnerability during PTB hypoxia, affecting cognitive development and myelin sheath function (Salmaso et al. 2014) (Baraban et al. 2018) (Lin & Popko 2009) (Weil et al. 2016). While high calcium concentrations seem to be detrimental to cell survival and are implicated in myelin destruction, a basal threshold (or even an oscillation) seems crucial in the regulation of myelination. From the pharmacological modulation of GPCRs, we can stipulate that at least a repression of calcium signaling seems to be crucial for the differentiation process (Fig. 31). Moreover, neuronal death and microglial cells exacerbate calcium levels through increase in inflammation, and manipulating those external factors can contribute to restore physiological levels of calcium and benefit directly to cell survival, differentiation and myelination.

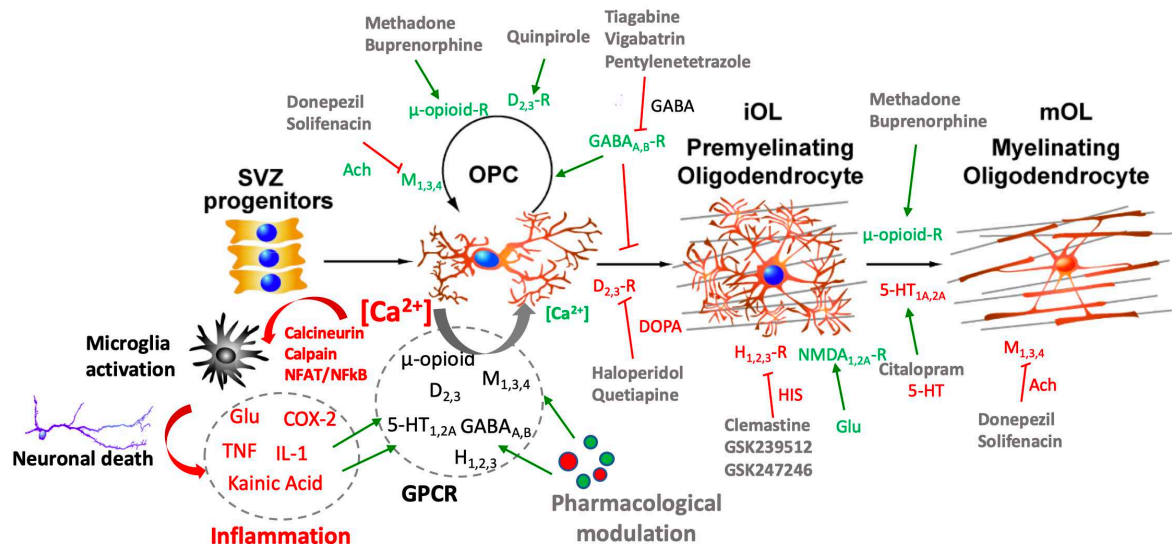

Figure 31: Pharmacological modulation of GPCR/calcium signaling is crucial for oligodendrogenesis. GPCR signaling is regulated through numerous receptors expressed in the oligodendroglial lineage (M: muscarinic, D: dopaminergic, H: histaminic, 5-HT: serotonergic, GABA/NMDA: glutamatergic and opioid receptors). Moreover, their regulation using different agonists or antagonists brings the evidence that calcium signaling favors OPC proliferation and later stages of myelination, whereas higher concentration of calcium disrupts OL differentiation and survival. External cues exacerbate calcium levels such as microglia/ astrocyte activation, neuronal death increasing inflammation through release of glutamate, kainic acid, cytokines (e.g. IL-1, TNF) and under COX-2 induction. Therefore, targeting inflammation indirectly may reduce calcium level and influence cell survival. (Hur )

G-COUPLED PROTEIN RECEPTORS SIGNALING

Acetylcholine (ACh) is one of the main neurotransmitters in the CNS, important for neuron-glia interaction binding either to nicotinic and muscarinic receptors. Muscarinic receptors subunits M1, M3, and M4 are expressed in OPCs but downregulated during differentiation (Cohen et Almazan 1994; Rogers et al. 2001). In several studies, subsequent activation of ACh increases iCa^{2+} from L-type voltage-dependent Ca^{2+} channels (Simeone, Kimball, et Mulholland 1996; Nitschke et al. 2001; Sharma et Vijayaraghavan 2001). Their activation promotes OPCs proliferation and survival but inhibits OL differentiation (De Angelis et al. 2012). This was demonstrated by the use of the antagonist drugs (Donepezil and Solifenacin) acting as acetylcholinesterase inhibitors. Treatment stimulates OL differentiation and maturation in a model of neonatal mice transplanted with human OPC, whereas OPC proliferation and survival are not affected (Maruyama et al. 2008).

Serotonin (5-HT) is a monoamine neurotransmitter crucial for early neural development, and involved in the modulation of cognition, mood, learning and memory. 5-HT increases intracellular Ca^{2+} through L-type calcium channels (Homma et al. 2006). Receptors 1A and 2A subtypes are expressed along all the oligodendroglial lineages and tend to increase during differentiation, and exposure to 5-HT in purified oligodendroglial rat cultures negatively regulated OL differentiation, leading to aberrant

process outgrowth and reduced MBP expression (Fan et al. 2015). Moreover, neonatal rat exposure with serotonin reuptake inhibitors (antidepressants) increasing 5-HT extracellular level in the synapse negatively impact cognitive function and social interactions, as also found in ASD patients with hyperserotonemia (Rodriguez-Porcel et al. 2011). Another compound, Citalopram used during perinatal development, negatively affects cortical network, social behavior, OL development and myelination of callosal axons (Simpson et al. 2011). Thus, high 5-HT levels appear to exert an inhibitory effect on OL differentiation and myelination.

γ -aminobutyric acid (GABA) is the main inhibitory neurotransmitter able to hyperpolarize neurons. GABA_A receptors are expressed in OPCs and subsequent activation increases intracellular calcium and subsequent depolarization (Kirchhoff et Kettenmann 1992; M.-H. Lin et al. 1994; Constantin et al. 2010). GABA_B activation promotes OPC proliferation and migration (Luyt et al. 2007). Axo-glial interactions maintain their expression in mature OLS, playing a potential role in myelination (Arellano et al. 2016). In a murine model of neonatal hypoxia, treatment with different GABA transporter inhibitors (Tiagabine and Vigabatrin) reduces OPCs proliferation and promotes OL maturation (Zonouzi et al. 2015). Moreover, inhibition using Pentylentetrazole promotes a 40% increase of myelin sheaths in the zebrafish ventral spinal cord (Mensch et al. 2015).

Catecholamines neurotransmitters include dopamine and norepinephrine involved in motor control, cognition, emotion, reward, memory processing, and endocrine modulation. Dopamine is synthesized from phenylalanine and tyrosine and is the direct precursor of norepinephrine. Dopamine regulated intracellular AMPc and dopaminergic calcium (Ghiani et al. 1999; Fischer, Scheffler, et Lohr 2020). Dopamine is known to regulate neuronal growth and maturation through BDNF and receptors D2 and D3 expressed in the oligodendroglial cells (Hasbi et al. 2009). Their activation using Quinpirole promotes OPC proliferation instead of differentiation, whereas antagonist Haloperidol suppresses this effect and favors differentiation (Bongarzone et al. 1998). Moreover, stimulation of dopamine receptors promotes OL survival induced by glutamate and oxygen or glucose deprivation (Avenell et al. 1998; 1999; Rosin et al. 2005). In the context of schizophrenia, non-selective Quetiapine treatment, that is antagonist of either D2-R and 5HT-2A receptors promote OL differentiation, myelination and prevent cortical demyelination and spatial working memory impairment in the cuprizone model (Riedel et al. 2007; L. Xiao et al. 2008).

Histamine is a neuro-inflammatory modulator and neurotransmitter playing a role in motivation, reward, cognition and memory. Histamine 3 receptors (H3R) are expressed during OPC differentiation, transiently upregulated in iOLs and then downregulated. Reduction of H3R levels through knockdown or H3R antagonists in OPCs favors OL differentiation and maturation (Yongfeng Chen et al. 2017). Moreover, selective HR2 deletion in differentiating OLS improves their

differentiation, remyelination and recovery in a model of neonatal hypoxic-ischemic white matter injury (L. Jiang et al. 2021). Mechanistically, histamine interacts with Axin2, up-regulates Wnt/ β -catenin signaling, and induces Ca^{2+} influx leading to hyperpolarization (Fioretti et al. 2009). Clemastine (H1 inhibitors) was found to promote OL maturation and remyelination in mouse spinal cord lesion models, and protect from axonal degeneration when treatment is combined with exercise (Jensen et al. 2018). Thus, several candidates such as GSK239512, GSK247246 (H3 inhibitors) as well as clemastine are currently in clinical trial (ReBUILD in 2017; ReCOVER in progress) demonstrating efficiency to repair myelin in a small cohort clinical study (Green et al. 2017).

Mu-opioid receptors modulate synaptic plasticity, pain, reward, and addictive behaviors. Opioid receptors coupled to Gi or Go, inhibit the adenylyl cyclase and Ca^{2+} channels (Sese, Vega, et Soto 2014). These receptors are expressed in OPCs and iOLs but downregulated during maturation (Tryoen-Toth, Gavriaux-Ruff, et Labourdette 2000). Selective kappa opioid receptor agonists were found in a drug screening for its ability to promote OPC proliferation, differentiation, and myelin wrapping (Feng Mei et al. 2016). Other agonists Methadone and Buprenorphine increase OPC proliferation and early myelination during perinatal exposure of rats (Eschenroeder et al. 2012; Vestal-Laborde et al. 2014).

Cyclooxygenase 2 (COX2) is an enzyme for prostaglandin synthesis essential for brain functions, synaptic activity, and memory. They are associated with pro-inflammatory activities and are induced by calcium increase in fibroblasts (Ogata et al. 2006). COX2 are express in dying OLs at the onset of demyelination in MS models, and overexpression in OLs increase by 8 fold the excitotoxicity mediated vulnerability in a model of kainate induced excitotoxic death, whereas their inhibition decreases demyelination (Carlson et al. 2010).

Nitric-oxide (NO) is a cell-penetrant neurotransmitter regulating through guanylyl cyclase and NO synthase activity (iNOS) different functions such as metabolism, dendritic growth, long term potentiation (LTP), and survival (Kakizawa, Yamazawa, et Iino 2013). NO is induced by calcium signaling, and is enriched in inflammatory MS lesions leading to demyelination, OL and axonal injury via glutamate induced toxicity (Anne I. Boullerne et Benjamins 2006). In EAE models, inhibiting iNOS activity was found to decrease disease severity (Giovannoni et al. 1998).

METABOLISM

Defects in glucose and ATP metabolism are a contributing cause of pathogenesis, particularly due to a massive cell vulnerability and apoptosis. Briefly, aerobic glycolysis occurs through pyruvate degradation, acetyl coenzyme A and nicotinamide adenine dinucleotide hydride (NADPH) production, increasing ATP concentrations. This mechanism enhances the capacity for OLs to differentiate and to

myelinate axons. However, during MS, defect in carbohydrate metabolism and ATP synthesis was associated with several markers of metabolic stress affecting OL differentiation (Mathur et al. 2017; Rosko et al. 2019). Moreover, *in vitro* OPCs cultures treated with low glucose media reduce glycolytic activity, inhibit their differentiation but instead favor their survival (Rone et al. 2016). Metabolism of the cholesterol biosynthesis pathway was found to be a key mechanism promoting OL formation, through the accumulation of the 8,9-unsaturated sterol, whereas analogous sterols have no effects (Hubler et al. 2018). Thus, manipulating metabolism and oxidative processes is a key strategy to promote OL differentiation.

Clean-surfaced gold nanocrystals particles of 13 nm (CNM-Au8) have been developed to induce NAD⁺ oxidation necessary for glycolysis. Thus, this approach succeeded to promote OPCs differentiation in purified OPCs cultures, and increased remyelination with functional motor recovery in the cuprizone-treated rodent model through enhancement of NAD⁺, ATP and lactate levels (Robinson et al. 2020).

Olesoxime is a cholesterol-like neuroprotectant targeting mitochondria to decrease ROS level and prevent motor neuron cell death. Olesoxime accelerates OPC differentiation as well as OL myelination in co-cultures of OLs with dorsal root ganglion neurons, without affecting survival or proliferation (Martin 2010; Magalon et al. 2012). In addition, olesoxime is efficient to promote remyelination and repair with consequent functional improvement in the mouse model of demyelination (Magalon et al. 2012). Olesoxime is safe and well tolerated when co-administered with interferon beta (NCT01808885).

HORMONES

Thyroid hormones (triiodothyronine T3 and thyroxine T4) are produced by the thyroid gland and are crucial for neural cell development. T3 strongly promotes OPC cell cycle exit to differentiate and myelinate (Farsetti et al. 1991; Bernal 2002; Zoeller et al. 2004). In 2016, a pilot clinical study (NCT02760056) was performed in a cohort of 15 MS patients to investigate safety and tolerability, without showing serious adverse events. However, TH regulation on the balance between proliferation and differentiation should be monitored for the long term to assess potential failure to remyelinate, due to OPC pool depletion. Moreover, TH present potential side effects (e.g. cardiovascular, osteoporosis), particularly during brain development and early adulthood (Klein et al. 2001; Rodondi et al. 2010).

Melatonin is an antioxidant neuro-hormone derived from tryptophan and mostly produced by the pineal gland (Reiter et al. 2016). Melatonin is neuroprotective against white matter damage and improves memory function after ischemia through the activation of ERK1/2 pathway (Olivier et

al. 2009; B. H. Chen et al. 2018). After demyelination in the EAE mouse model, melatonin promotes remyelination, reduces proinflammatory cytokines (IL-1 β , TNF- α) and increases IL-4 and IL-10, thus improving clinical recovery (Ghareghani et al. 2019). A clinical trial (NCT03498131) was performed to assess melatonin effect in a cohort of 25 MS patients, however treatment failed to improve clinical and functional recovery (Roostaei et al. 2015).

Steroid class of hormones include glucocorticoids and sex hormones (estradiol, progesterone, and testosterone) synthesized through the cholesterol biosynthesis pathway in the adrenal glands. Steroid hormones regulate reproduction, stress, metabolism, neurogenesis and gliogenesis. Steroid treatment is a strategy to inhibit inflammation against neuroinflammation in Alzheimer, Parkinson and Hypoxia brain injury. Thus, steroid danazol, allopregnanolone, and parbendazole were found to promote myelin repair through increase in oligodendrogenesis (Warringa et al. 1987; Faroni et Magnaghi 2011). Interestingly, differences between males and females in their white matter density have been associated to sex hormones regulating oligodendrogenesis (van Hemmen et al. 2016; Abdel Mouman Ghomari et al. 2020). Ovaries produces estrogens family interacting with receptors ER α , β and GPR30 express in the oligodendroglial lineage and promoting OL maturation and remyelination in the cuprizone model (Takao et al. 2004; Okada et al. 2008). Thus, selective modulation of ER using Bazedoxifene promotes oligodendrogenesis and reduces the inflammatory response in rat spinal cord injury (Rankin et al. 2019; Kim et al. 2021). Tamoxifen promotes OL maturation through the activation of PI3K/AKT/mTOR pathway (Bostner et al. 2013). Activation of progesterone receptors (PR α and PR β) also stimulates OPC proliferation, differentiation and myelination in organotypic slice cultures of 7-day-old rodent cerebellum (Gago et al. 2001; A. M. Ghomari et al. 2003; A.M. Ghomari, Baulieu, et Schumacher 2005). Testosterone can also influence proliferation and (re)myelination processes through PI3K/AKT and MAPK/ERK pathways (Hussain et al. 2013). Oxysterol promotes OL maturation and remyelination through cholesterol metabolism (Meffre et al. 2015). Moreover, non-steroidal drug Indomethacin promotes OL differentiation and myelination of cerebellar slice cultures, as well as remyelination after cuprizone treatment (Preisner et al. 2015). However, use of such treatment particularly during development should be carefully monitored given their wide range of action, side effects, and potential crosstalk with others during brain development.

GROWTH FACTORS

Insulin Growth Factor-1 (IGF-1) promotes survival of neuronal and glial cells through PI3K inhibition of caspase-3 (McMorris et al. 1986; Zeger et al. 2007). As previously mentioned, IGF-1 enhances OPC proliferation, differentiation and myelination; and is an interesting candidate to treat MS (Chesik, Wilczak, et De Keyser 2007). IGF-1 also attenuates BBB disruption, promotes anti-

inflammation and reduces demyelination in EAE (X. Liu, Yao, et Webster 1995; Yao et al. 1995; Cusick et al. 2014). Low levels of serum IGF-1 is associated with MS susceptibility (NCT00125190), cognitive impairment and fatigue in MS (Shahbazi et al. 2017; Nageeb, Hashim, et Fawzy 2018). Thus, compensated deficiency using recombinant Human IGF-1 (rhIGF-1) was well tolerated in a small cohort of MS patients but did not alter the progression of the disease (Frank et al. 2002). Nevertheless, further studies with rhIGF-1 or in combination with other therapies are currently ongoing.

Prolactin is an amino acid peptide hormone important during pregnancy and regulating neurogenesis in the maternal mouse forebrain, as well as OPC proliferation, differentiation and remyelination following lysolecithin-induced demyelination of the mouse spinal cord (Gregg et al. 2007). However, prolactin also induces a proinflammatory pathway through NFkB activation, TNFa and IL12 secretion (Brand et al. 2004). To tackle inflammation and keep benefits from prolactin, a team performed a combinatory treatment of prolactin and IFN- β , thus improving the clinical signs of EAE (Zhornitsky et al. 2015). Patients suffering from MS and neuromyelitis optica cohorts show hyperprolactinemia, particularly during relapse rather than remission (Turkoglu et al. 2016; Alwakil et al. 2020).

Erythropoietin (Epo) is a growth factor produced by the kidney, stimulating NPC proliferation and differentiation as well as neuron survival through its anti-inflammatory, anti-excitotoxic, antioxidant properties. Epo promotes OL development in the context of prenatal systemic hypoxic–ischemic brain injury, and myelination through lipid metabolism (Jantzie, Miller, et Robinson 2013; Gyetvai et al. 2017). A clinical trial (PENUT, NCT01378273) was performed to assess the effect of high dose Epo to extremely preterm infants from 1 day after birth until 32 weeks, but did not decrease the risk of severe neurodevelopmental impairment, or death at 2 years (Juul et al. 2020). Another clinical study demonstrated its inefficiency in PPMS patients (NCT01144117) as well as to improve neuroprotection in the visual pathways after optic neuritis (NCT01962571) (Schreiber et al. 2017; Lagrèze et al. 2021).

VITAMINS

Vitamin B9 (folic acid) is a coenzyme essential for cellular one-carbon metabolism and is crucial during pregnancy and lactation (James A Greenberg et al, 2011). Folic acid is known to play an important role in CNS development, promoting neuronal differentiation and axon regrowth (Iskandar et al. 2010). Folic acid plays a role in calcium regulation, regulating dihydrofolate reductase (DHFR) enzyme and AMPK to accelerate OL differentiation and myelination (Sid et al. 2015; Weng et al. 2017). For instance, folate receptor 1 mutations disrupt folate transport in the brain and cause white matter hypomyelination, as well as deficiency during rat brain development through defects in lipid

metabolism and methylation levels (Steinfeld et al. 2009; Silva et al. 2014). Folic acid has a potent anti-inflammatory role, inhibiting TNF- α , IL-1 β and iNOS dependent NO in LPS activated BV-2 cell microglia, and dose-dependently upregulating the anti-inflammatory cytokine IL-10 through SOCS1 and SOCS3 (Cianciulli et al. 2016). Interestingly, MS patients show a lack of folate and vitamin B12 found in meat, fish and eggs. Combined treatment with B12 and folic acid induced a significant increase of MBP expression in cortical extract associated with tissue repair in cuprizone-treated mice (Parchizadeh et Salehi-Eskandari 2021). Combined treatment has shown promising results in a clinical study (IRCT2015100313678N7) performed with 50 RRMS patients, reducing their homocysteine levels in the plasma (contributing to MS pathology) and improved life quality of MS patients (Nozari, Ghavamzadeh, et Razazian 2019). However, this study did not distinguish specific contributions related to folic acid or Vitamin B12 use, and did not assess their remyelinating effects. In addition, a study including 12 patients (6: MS, 4: neuromyelitis optica, and 2: Sjogren's syndrome myelopathy) showed that high-dose methotrexate with leucovorin (folinic acid) rescue was safe and highly effective treatment leading to a rapid and near complete cessation of disease activity and a durable remission in the majority of the cohort (Nozari, Ghavamzadeh, et Razazian 2019). Interestingly, a molecule related to the folic cycle called folinic acid, also has anti-inflammatory properties in traumatic brain injury models, by inhibiting serum level of homocysteine, TNF α , IL-10 and HMGB1 expression (Tommy et al. 2021).

Vitamin C and D promote OL generation and remyelination respectively in cuprizone and LPC inducing demyelination models (de la Fuente et al. 2015; Y. Guo et al. 2018; Gomez-Pinedo et al. 2020). Vitamin D3 (1,25-VitD3) is a potent neuroprotective and immune-suppressor promoting the anti-inflammatory phenotype (secreting IL-4 and TGF) and reducing proinflammatory levels (IL-6, TNF, and MCSF). In the context of ischemic stroke, 1,25-VitD3 also reduces pro-inflammation (IL-6, IL-1 β , IL-23a, TGF- β and NADPH oxidase-2) (Evans et al. 2018). During demyelination mediated by EAE, activation of its receptors mediates inflammation, and also favors either neuronal and OL generation, survival and remyelination (Lemire et Archer 1991; Miclea et al. 2020).

MANAGING INFLAMMATORY RESPONSES

Clinical treatments used to slow down MS inflammation. They regulate immune cell function (Betaferon, Extavia, Avonex, Rebif, Copaxone) and are administered intramuscularly or subcutaneously and do not present major long-term side effects (influenza-like syndrome and skin reactions) (Tintore, Vidal-Jordana, et Sastre-Garriga 2019). They promote production of immunosuppressive cytokines to modulate immune cells and reduce the production of pro-inflammatory cytokines (Weber, Hohlfeld, et Zamvil 2007). They reduce the frequency of relapses by

30 to 50%, accumulation of new lesions, and frequency of active inflammatory lesions depending on the patient's response. For instance, dimethyl fumarate (Tecfidera®) induces anti-inflammatory cytokines synthesis and proliferation of dendritic cells, improving neuronal protection against oxidative stress, and promoting apoptosis of activated T lymphocytes (Mills et al. 2018). Another monoclonal antibody natalizumab (Tysabri) is injected intravenously every 4 weeks reduce the frequency of relapses by 80 to 90%, targeting $\alpha 4\beta 1$ and $\alpha 4\beta 7$ integrin to block T lymphocytes entrance in the CNS through the BBB (Papeix et Lubetzki 2009). The other one, Gilenya restricts lymphocytes in the lymphatic ganglions, reducing by 70% their circulating numbers through blood patients. A new monoclonal antibodies Alemtuzumab (Lemtrada) and ocrelizumab are given intravenously to increase remissions in PPMS patient, by targeting glycoprotein CD52 expressed by a subgroups of active lymphocytes B CD20⁺, triggering cytotoxicity and cell death (Gelfand, Cree, et Hauser 2017; Brown et al. 2019). Finally, Teriflunomide (or Aubagio) is an immunosuppressive drug inhibiting dihydroorotate dehydrogenase enzyme in the mitochondria, thus stopping proliferation of activated lymphocytes (Malla et al. 2020).

Several mediators of inflammation include IL-1 β , TNF- α and IFN β . For instance, IFN β was one of the first treatments for MS, reducing relapse rates and delaying the onset of disability (Ebers 1998). IL-1 β expression increases in the margin of active MS plaques, stimulating immune cells activation and invasion (Bona et al. 1999; Cannella et Raine 1995). Thus, IL-1 receptor antagonists (rhIL-1ra) were developed and able to protect against focal cerebral ischemia, rescue MBP loss and promote remyelination (Loddick et Rothwell 1996; Yiting Zhou et al. 2017). Thus, systemic IL-1 inhibition needs further studies to monitor long-term effects, particularly during relapses. TNF- α is a key mediator of inflammation enriched within active CNS lesions from EAE mouse model and MS patients (Iskandar et al. 2010). Selective inhibition of soluble brain TNF induced remyelination through activation of microglial phagocytosis of myelin debris but did not improve OL survival (Karamita et al. 2017). Thus, anti-TNF- α (XPro1595 and Etanercept) reduced peripheral immune invasion and improved functional outcome in the focal cerebral ischemia model (Barone et al. 1997; Clausen et al. 2014). However, treatment was abandoned regarding the solubility of anti-TNF- α and its ability to cross the BBB, as well as its side effects: lymphoma, infections, heart failure and induction of demyelination (Dogra et Khullar 2013; Hare et al. 2014; Kemanetzoglou et Andreadou 2017).

Phosphodiesterases (PDE4) are enzymes involved in cAMP/cGMP elimination, leading to inflammation and affecting cognition in MS (Richter et al. 2013). Thus, PDE4 inhibitors such as Ibudilast show anti-inflammatory roles either *in vitro* or *in vivo* through their ability to rescue cAMP levels. Indeed, Ibudilast reduced inflammation and neuronal necrosis induced by LPS and IFN in a co-culture with microglial cells (Mizuno et al. 2004). Moreover, treatment suppressed NO, ROS, IL1b, IL-6, and TNF α production and increased IL-10, NGF, GDNF and NT-4 in activated microglia. Another PDE

inhibitor Propentofylline also increases adenosine levels to promote cell survival, and remyelination from either OLs and the schwann cell (Fernandes Bondan et al. 2014). In a demyelinating context mediated by toxins, PDE4 inhibition enhances OPC differentiation and remyelination through increase of MAPK signaling and cAMP (Syed et al. 2013). Thus, PDE inhibitors constitute a promising alternative for neurological diseases, including MS, stroke, PD and AD. A clinical studies evaluated in 2008 Ibudilast effect in a cohort of 297 MS patients (SPRINT-MS, NCT01982942), finding neuroprotective effect in relapsing-remitting MS and reducing brain atrophy (by 48%) to improve disability progression. Even if Ibudilast did not reduce the MRI activity and the relapse rate, treatment is currently under phase III study (Sormani, Tur, et Barkhof 2021).

Monoclonal antibodies (rlgM22) are recombinant human monoclonal IgM targeting OLs and myelin, improving OL survival, differentiation and remyelination in a mouse model of cuprizone mediating demyelination (Warrington et al. 2007; Mullin et al. 2017; Cui et al. 2018). This potential treatment (patent WO2016073963A1) has interest for WM disease or injury in the context of MS and neonatal hypoxia to alleviate neurodevelopmental deficits.

Leucine rich repeat and Immunoglobulin-like domain-containing protein 1 (LINGO1) is a functional component of Nogo (neurite outgrowth inhibitor) and antagonist BIIB033 has demonstrated a positive effect in the regulation of neuronal survival after injury (Agúndez et al. 2015). OLs express LINGO-1, negatively regulating their differentiation through RhoA activity (Mi et al. 2005). Thus, inhibition through neutralizing antibodies (LINGO-1-Fc) of cocultures with OLs and neurons increases axonal myelination and their integrity. A clinical study (NCT03222973) assessing Opicinumab (BIIB033) in RRMS patients demonstrated its safety and tolerability, but did not show a significant dose-linear improvement in disability (NCT01864148) (Cadavid et al. 2019).

Semaphorin 4D belongs to the members of class IV of the semaphorin family, playing a role in immune regulation, neurogenesis, angiogenesis and axon guidance. They participate in multiple brain disorders, especially through the breakdown of BBB, microglial activation and inhibition of OPC migration (E. S. Smith et al. 2015). They are secreted by OLs and negatively regulate myelination, as demonstrated by conditional overexpression in OPCs (H.-L. Zhang, Wang, et Tang 2014). Thus, knockdown in OPCs in a model of spinal cord injury promotes functional recovery and BBB integrity. Development of antibodies neutralizing Sema4D constitutes a promising approach by reducing EAE severity and apoptosis, promoting OPC number, migration and remyelination in the lesion site (E. S. Smith et al. 2015). First clinical trial (NCT01764737) to test anti-Sema4D (VX15/2503) demonstrated safety and tolerability in MS patients and currently assess remyelination effects (LaGanke et al. 2017).

Cannabinoid (Δ^9 -Tetrahydrocannabinol, THC) is the main bioactive compound in the plant *Cannabis sativa*, with potent neuroprotective and anti-inflammatory properties through interaction

with cannabinoid receptors CB2- GPCR expressed in microglial cells (Turcotte et al. 2016; Nichols et Kaplan 2020). THC stops OPC proliferation to promote oligodendrogenesis and myelination in the subcortical WM through mTORC1 pathway (Hueriga-Gómez et al. 2021). Preclinical studies suggest that therapy combined with cannabinoids help to treat neuropathic pain in MS, although with a potent risk of cognitive dysfunction, thus requiring long term monitoring to assess effect on disease progression.

Antibiotic minocycline is a potent candidate for neurological diseases through their anti-inflammatory, anti-apoptotic, and neuroprotective properties demonstrated in several models of cerebral hemorrhage, hypoxia ischemia, spinal cord injury (Z. Cai et al. 2006; Shultz et Zhong 2017; P. Chauhan et al. 2021). Indeed, minocycline inhibits microglia and IL-1 β release during ischemia, and improves OPC proliferation as well as differentiation in preterm neonatal rats (Z. Cai et al. 2006). Moreover, minocycline reduces the risk of conversion from the CIC to MS patients (NCT00666887) at 6 months, but not over 2 years (Metz et al. 2017).

Given the high failure rate for the clinical validation of molecules promoting oligodendrogenesis, and the long term monitoring required to detect potential side effects, a more direct approach is to reprogram cells into OPCs for human transplantation. Indeed, OPCs can be generated through in-vitro conversion from embryonic stem cells (ESCs), induced pluripotent stem cells (iPSCs), and cells from patients. Thus, reprogramming is also a potential alternative avenue for the treatment of myelin diseases.

REPROGRAMMING

Since the identification of factors inducing reprogramming of mouse embryonic or adult fibroblasts into pluripotent stem cells (K. Takahashi et Yamanaka 2006), cell fate reprogramming rapidly expanded for therapeutic perspectives. Thus, a targeted overexpression of 3 to 8 pro-glial TFs including Sox10, Nkx6.2 and Olig2 is enough to drive conversion from mouse embryonic and lung fibroblasts into OPCs (Najm et al. 2013; Chanoumidou et al. 2021). In addition, transduction with Sox10 alone in NSCs is enough to generate human OPCs, having a similar bipolar morphology, gene expression profile and proliferative response (N. Yang et al. 2013; García-León et al. 2018). Thus, several protocols have been developed to produce myelinating OLs in 2D and 3D culture systems (Douvaras et Fossati 2015; Ehrlich et al. 2017). Experiments of neonatal engraftment in hypomyelination shiverer *Mbp^{shi/shi}Rag^{-/-}* mice using OPCs converted from hiPSC and hESCs demonstrated their functionality through their ability for axonal ensheathment, to generate a compact myelin, and increase mice survival (S. Wang et al. 2013; Ehrlich et al. 2017). Therapeutic

interest of transplanted cells was demonstrated in other rodent models such as traumatic injury, hereditary leukodystrophies (Goldman 2011; Windrem et al. 2008). Interestingly, transplantation of induced neural stem cells (iNSCs) into chronically demyelinated corpus callosum ameliorates motor deficits (Sullivan et al. 2020). Clinical trials are currently perform (NCT03269071) to assess effect of neural stem cell transplantation in MS patients, whereas bone marrow hematopoietic cells has should be used as a second line of treatment (Soelberg Sorensen 2016; H. Lee et al. 2017). One of the major interests of reprogramming remains to tackle the ethical regulation around the use of ESCs However, this strategy remains time consuming, highly expensive and associated with a genetic instability generated by insertional mutagenesis mediated by AAV use.

DRUG REPURPOSING

De novo drug development is a very long process (13-15 years) with a low success rate (<10%) and very expensive costs of 2 Billions \$ per drug (Pizzorno et al. 2019). Drug development normally includes five stages: discovery, preclinical research, clinical research, approval, and market/safety monitoring (Fig. 32). In contrast, drug repositioning, also known as '*old drugs for new uses*', is a strategy highly effective (>30%), economical (with lower expenses for preclinical and phase I/II) and riskless with safety and tolerability well determined. Thus, development is significantly reduced (5-11 years), with identification and validation through computational, experimental, or mixed approaches. In terms of regulatory considerations, intellectual property is generally limited for repositioning based on the possibility of engaging patents for a new repurposed medical use.

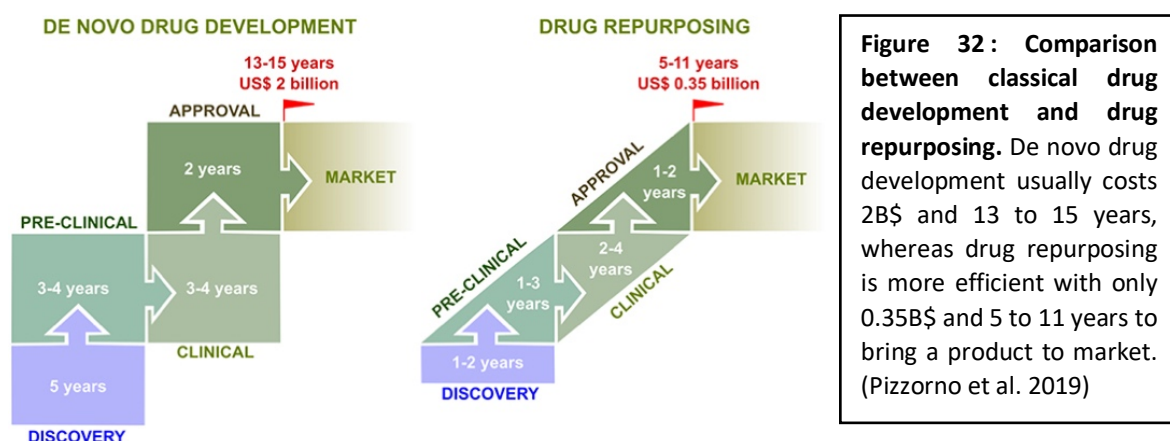

Last decade, the expansion of artificial intelligence and big data, associated with massive transcriptomics studies and bioinformatics approaches, increased the time and rate of success of drug identification. This step is required to start with extraction of transcriptomic datasets from healthy or pathological contexts provided by publications or databases such as Gene Expression Omnibus (Edgar 2002). Then manipulation and data analysis is mainly performed by bioinformatics interfaces using

Python or R-Studio to isolate, using different criteria of gene expression, a list of genes corresponding to a transcriptional signature of interest.

Application of drug repurposing in screening approaches: High-throughput screening using libraries of chemical compounds have been performed to identify therapeutic compounds enhancing (re)myelination. In 2015, Tesar's team randomly tested 727 drugs from a library (US National Institutes of Health Clinical Collection I and II libraries) using culture of mouse stem-cell-derived OPCs for their ability to accelerate OL differentiation and maturation (Najm et al. 2015). They identified in their *in vitro* screening seven efficient drugs, including Clobetasol, corticosteroids, Benztropine or Miconazole. They validated the efficiency of miconazole and Clobetasol to promote OL generation and (re)myelination using organotypic cerebellar slice cultures, models of focal demyelination and the EAE mouse model of chronic progressive MS. In parallel, Jonah Chan lab developed tools for high-throughput screening based on micropillar arrays to automatically assess the ability of 1000 compounds to promote myelination. Their ability to ensheath some artificially designed cone-like structures resolved on pure in-vitro culture the cell-autonomous effects (Feng Mei et al. 2014). Using this strategy, they identified a cluster of eight FDA-approved antimuscarinic compounds promoting myelination, including atropine, oxybutynin, quetiapine, benztropine and clemastine. Thus, finding drugs associated with similar mechanisms of action is also helpful to discover new targets regulating OL development. Furthermore, a common mechanism of action between clemastine, benztropine, miconazole and ketoconazole was found to promote OL numbers and remyelination through regulation of unsaturated sterols pathway (Hubler et al. 2018).

Even if high-throughput screening strategies are effective to identify several compounds, they nevertheless remain untargeted and random, which limits their success when passing through preclinical models or in humans. Another approach is to use knowledge-driven studies using the transcriptional changes, or pharmacogenetic variations in response to a given treatment, a strategy that could provide a more rational approach in order to target a specific cell type.

Principle of connectivity map: A consortium was created through NIH's Library of Integrated Network-Based Cellular Signatures (LINCS), containing numerous tools for improving drug identification and their success rate. Those data have been extracted from all publicly available gene expression datasets to create the Connectivity Map (Cmap) interface. Cmap allows us to create and analyze large perturbational datasets to deepen our knowledge of the mechanisms underlying a cellular process, as well as to find potential drug/target interactions (Lamb et al. 2006). The principle is to compare transcriptomic signature of a disease, or healthy phenotype with the signature of a drug treatment (signature matching). This procedure gives rise to an output list with a positive and negative correlation between genes regulated with a drug treatment and a disease. This correlation also

indicates a potential drug effect to activate or reverse a subset of genes involved in a disease. The primary version of Cmap built in 2006 contained 6,100 differentially expressed profiles (Affymetrix GeneChips) obtained from 1,309 compounds tested on five different cell lines and at different concentrations. In 2017, a huge update and a more powerful approach for drug repurposing was performed, including over a 1,000-fold increase in datasets. 1.3 million of profiles (Fig.33) were obtained from the gene expression profile of 25,200 ‘*perturbagens*’, including 19,811 small molecule (NIH LINCS) tested across 3 to 77 variable cell lines, shRNAs/siRNAs/GOF/LOF experiments for 5,075 genes, and 314 biologics (including consolidating replicates) (Subramanian et al. 2017). In terms of technology, CMap 2 used Luminex bead arrays to test the expression of 978 “*landmark*” genes, with expression levels of another 11,350 genes inferred computationally. Similarly, users query the platform with gene expression signatures to obtain compounds of interest with their associated “connectivity score” indicating the level of connectivity between the expression profiles. Cmap was used and validated in several context studies. In 2016, a team identified 11 compounds to delay aging, and validated their ability to improve overall lifespan and healthspan in the worm *C. elegans* (Calvert et al. 2016), for oxidative stress (Ye et al. 2014). Cmap was applied in the context of lung cancer, with identification of 17-AAG showing anti- adenocarcinoma activity by inhibiting cell growth, promoting apoptosis and cell cycle arrest (G. Wang et al. 2011). Cmap was applied in the context of COVID-19 (Mousavi, Rahmanian, et Sami 2020), breast cancer (Thillaiyampalam et al. 2017), to reduce inflammation in lung smokers (Vanderstocken et al. 2018), for cystic fibrosis (Malcomson et al. 2016), lymphoma (Luo et al. 2018), Huntington's (Smalley et al. 2016) and gastric cancer (Li Zhang et al. 2019).

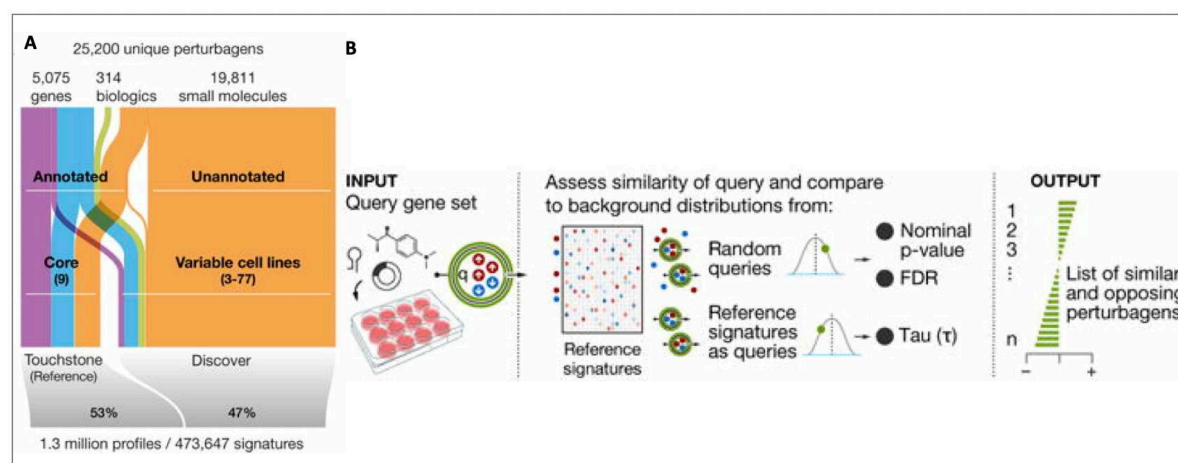

Figure 33: Principle of connectivity map (L1000 dataset coverage, signature generation, and data access). (A) The database contains 25.200 unique perturbagens (19.811 compounds, 5.075 genes and 314 biologics). (B) Modes of access to analysis tools and data. The clue.io software platform enables computational biologists to query using a set of DEGs genes. Then, similarities between the query and all signatures in CMap are computed and ranked. An output is given containing the list of perturbagens sorted positively (similar) and negatively (opposite), associated with their p-value/ FDR. (Subramanian et al. 2017)

Predict drug target interaction: In-silico software and applications are necessary to predict changes in cellular processes, and to visualize interaction networks between drugs and their associated target genes. To do so, Pathway Studio and Cytoscape allows network modelisation (Nikitin et al. 2003; Shannon et al. 2003), gene ontology analysis are facilitated using Panther, Metascape, Kyoto (Encyclopedia of Genes and Genomes) or EnrichR (Kanehisa 2000; Thomas et al. 2006; Yingyao Zhou et al. 2019). Moreover, drug and disease tools including LINCS, DrugBank, ChemBank allow analysis of drug properties and characteristics (Wishart et al. 2006; Seiler et al. 2007; G. Williams 2012; 2013; Duan et al. 2014; Koleti et al. 2018). Finally, exploring connections between drugs and targets through these tools increases success for identifying new candidates.

AIM OF THE DISSERTATION

OBJECTIVES: Given the main vulnerability of OLs and myelination defects in MS and PTB, and the lack of current treatment promoting (re)myelination in patients, identifying new strategies to foster those aspects remain a major focus for our laboratory. Controlling the fate of stem cells is a key therapeutic strategy in regenerative medicine using small molecules, without the need to introduce complex genetic methods. This strategy is facilitated by the neonatal period permissive for NSCs recruitment, activation and for the integration of newborn cells into existing cell networks. Moreover, through the OPC ability to differentiate and to (re)myelinate during adulthood (Azim, Berninger, et Raineteau 2016). During this project, we applied a mixed strategy of drug repurposing, combining an in-silico bioinformatic analysis with an experimental procedure to identify gene networks and small bioactive molecules promoting oligodendrogenesis. Altogether, this multiscale analysis brings important knowledge on the transcriptional mechanisms regulating neural development, OL generation and repair through the identification of hubs genes and molecules regulating (re)myelination.

I- IN-SILICO ANALYSIS: The expansion of omics technologies in recent years have enriched our knowledge of the genetics and proteomics mechanisms involved in oligodendrogenesis. However, there is no retrospective study combining these data to identify global signaling pathways involved in this process. A first pilot analysis identified the transcriptional network heterogeneity during postnatal development involved in OL specification and differentiation in the germinal region for connectivity map analysis (Azim et al. 2017). Therefore, those data combined with bulk and single cell RNA-seq performed on neural cells during CNS development should **foster our knowledge about the transcriptional control of oligodendrogenesis**, particularly through the identification and functional characterization of new hubs genes. We developed an in-silico approach harnessing the transcriptional changes associated with oligodendroglial development including their expression in dorsal NSC/NPCs that actively promote oligodendrogenesis at neonatal stages (1), combined with enriched expression in oligodendroglial cells, compared to other brain cell-types (2). Then, using generated gene sets (3) and a knowledge-driven curation gene sets (6), we performed a pharmacogenomic analysis to identify hub genes (4) and a list of 626 small bioactive molecules food and drug administration (FDA)-approved that could potentially foster oligodendrogenesis (5). This stage was achieved using bioinformatics tools (e.g. connectivity map, searchable cross-platform gene expression database). Given the large number of hits obtained by these approaches and in order to evaluate their impact in oligodendrogenesis, we introduced a knowledge-driven scoring procedure (6) based on functional studies demonstrating the requirement of a given gene in different aspects of

oligodendrogenesis (OPC specification, proliferation, migration, survival, differentiation, myelination, and remyelination), by curating more than 2000 publications implicating around 400 genes. Pharmacogenomics analysis of this curated gene set allowed us to identify 393 small molecules promoting different aspects of oligodendrogenesis (7), with 221 of them also regulating our larger oligodendroglial-enriched gene sets. Levering our scoring procedure, we ranked molecules based on their impact on curated target-genes in different processes of oligodendrogenesis (8) and selected 40 novel molecules. Pharmacological analyses (pharmacokinetics/dynamics, including ability to cross BBB, safety, toxicity, tolerability) led us to rank and **select 11 promising drugs regulating oligodendrogenesis** (9).

II- EXPERIMENTAL VALIDATION: To validate the potential of 11 drugs selected to foster oligodendrogenesis, we started with neonatal NSCs cultures (10) to analyze their **effect in oligodendroglial specification, differentiation and potential side effects** in other cell types. We also included in our study positive controls currently under clinical trials (Gingele and Stangel, 2020), such as thyroid hormone (T3) or the antihistaminic drug clemastine (Mei et al., 2014; Green et al., 2017) to compare their pro oligodendrogenic activity. We selected 6 molecules having the highest potential to complement our study using purified neonatal OPCs cultures (11) to assess their **cell autonomous effect** in OL differentiation. To validate the potential of such molecules requires further experimental procedures before translation into clinical trials. Thus, we opted for an intermediate and faster experimental model of cerebellar slices explants (12) taking in account **cell interactions** and eventual side effects to **select 2 most promising drugs** through their differentiation and myelination index. Finally, **we selected dyclonine hydrochloride (sm5) and folinic acid (sm11), and validated their effect, optimal posology and administration** in-vivo using neonatal chronic hypoxia (13) and adult de/remyelination model (14) mimicking certain aspects of PTB injury and adult demyelination in MS. Altogether, we successfully repurposed dyclonine and folinic acid for their ability to promote brain repair for next clinical studies including PTB and MS.

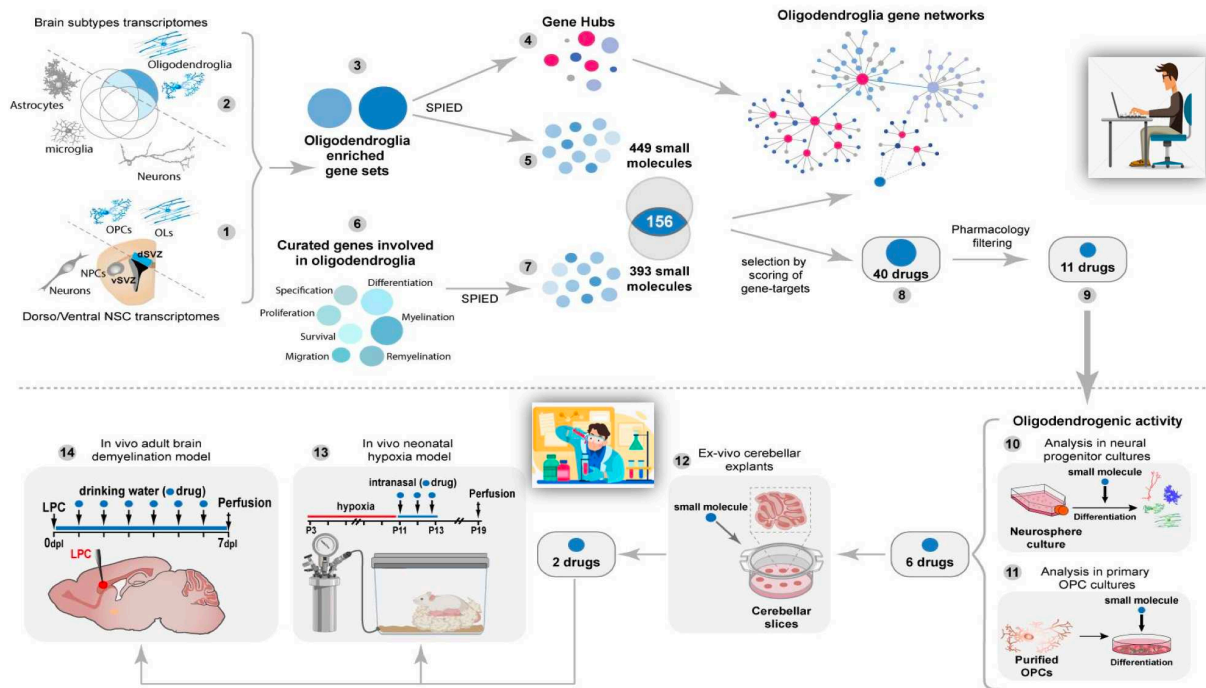

Summary of the strategy employed to identify gene networks and pro-oligodendrogenic drugs Numbers in gray circles indicate the different steps of the project.

MATERIAL & METHODS

GENERAL OVERVIEW OF THE BIOINFORMATIC STRATEGY

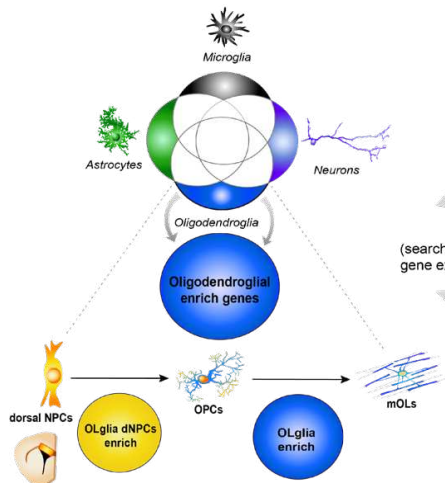

We used recent genome-wide expression datasets, leveraging the power of mouse genetic tools, to generate oligodendroglial genes subsets. To do so, we combined transcriptomic datasets from NSCs and transient-amplifying-progenitors (TAPs) with oligodendroglial enriched transcriptomes generated at distinct differentiation stages (Fig. 1). Thus, we obtained transcriptomic changes involved in specification and differentiation, from precursors to mOLs.

Figure 1. Summary of the bio-informatic strategy identifying genes regulating oligodendrogenesis

DATA COLLECTION AND PROCESSING FOR OLIGODENDROGLIAL GENE-SETS ENRICHMENT

Transcriptomic datasets were selected from single-cell and bulk-transcriptomic generated in neural cell types during mice development at the embryonic, postnatal and adult stages (Zhang et al., 2014; Marques et al., 2016; Falcão et al., 2018; Marques et al., 2018; Saunders et al., 2018; Jäkel et al., 2019). Raw sequencing data were downloaded from GEO (<https://www.ncbi.nlm.nih.gov/geo/>). Methods table 2 summarize the information about all datasets used, the criteria for selecting DEGs, p-values and fold-changes used as threshold, GSE numbers and details each type of data (i.e., expression microarrays, bulk RNA-seq, and single cell RNA-seq). We mostly used the supplementary tables published to select enriched genes either differentially expressed (DEGs ≥ 1.5 -fold change compared to other cell types) or showing significant enriched expression in each cell type (p-value < 0.05). We provide below more detailed methods used in some dataset analyses.

Transcriptional signature of postnatal dorsal NSCs and TAPs: we used data published by Raineteau's lab (GSE60905). The cells of interest (neural stem cells, NSCs, and transit amplifying precursors, TAPs) were isolated at P4 from two regions (dorsal and lateral) of the VSZ, using transgenic mice and specific markers for each cell type (i.e., *Hes5::GFP* and *prominin-1* mice for NSCs and *Ascl1::GFP* mice for TAPs). The microarray data is processed in two phases (see "dNSCs/dTAPs" script). A normalization phase to clean up the data and limit variation between biological replicas in order to make them comparable. We used the Robust Multi-array Averaging (RMA) method from the 'affy' package. The second phase corresponds to differential analysis, which is used to identify genes that are differentially expressed between two conditions. To do this, we performed a Limma (linear models

for microarray data) analysis. We applied a filter (Fold change, $FC > 1.2$ and $p < 0.05$) to identify the DEGs in TAPs and NSCs from the dorsal region, compared with those from the lateral region.

Transcriptional signature of the OL lineage from postnatal brain cell types: we used RNA-Seq data published by Ben Barres' team from purified cells (GSE 52564). The aim of this analysis was to identify genes specific to the oligodendrocyte lineage, compared with the neuronal and astrocyte lineages (see "OL lineage" script). In this study, all cells were isolated from transgenic mice at early postnatal stages, i.e. P7 for astrocytes and neurons, P17 for oligodendrocyte lineage cells. We applied a filter (Fragments Per Kilobase Million, $FPKM > 0.5$; Max FPKM of all), which enabled us to eliminate genes weakly expressed in the different cell types studied. A final filter was used to identify genes overexpressed/repressed in the oligodendrocyte lineage ($FC < 1.2$ to $FC < 9.2$ Max Oligo vs Max non-Oligo). The "dNSCs/TAPs" transcriptional signature was then combined with the "OL lineage" transcriptional signatures to obtain lists of intersection genes ("OL specification" signature) and exclusion genes ("OL differentiation" signature) (see results section).

Transcriptional signature of single cell RNA-seq oligodendroglial clusters: we used the supplemental table from Marques et al; 2016 presenting 50 DEGs per cluster (average expression comparing groups within each junction), allowing us to pool a total list of 532 genes expressed in the entire oligodendroglial lineage. To extract more information from their datasets, we process their raw data from 5072 cells with Seurat package v2 (using the following criteria: min.cells = 10; min.genes = 500; number of UMI > 5100; max genes < 200; mitochondrial percentage > 0.10, analysis in 20 dimensions with a resolution of 0.9) identifying 1598 DEGs. These details are included in the Figure 2.

To summarize, we enriched gene expression in the oligodendroglial cells (Fig. 3) using microarray sequencing generated from mouse brain cell types at P7 and 17 (Zhang et al., 2014). We identified 3393 genes with an expression higher than 3 FPKM in oligodendroglial cells (OPC, iOLs or mOLs clusters); and those having a differential ratio expression higher than 1.5 compared to other cell types (neurons and astrocytes). We increased the stringency of expression by applying a 2.1 fold ratio of gene expression with other cell types to find 1998 genes; and using the top 500 of gene expression in oligodendroglial cell types (1500 genes). Then, we used single cell datasets generated from the hypothalamus (Chen, 2017) to identify 1390 genes express during OL differentiation (expression higher than 3 FPKM in OPCs, iOLs, mOLs; with at least 4 times higher expression compared to other cell types). We used single-cell datasets capturing the heterogeneity in the OL lineage to extract 532 DEGs (Marques, 2016 #3417). We combined these datasets in a final subset of 4478 oligodendroglial-enriched genes (subset 1). On the other hand, we also generated a list of 3519 genes express in neurons and astrocytes (expression > 3 FPKM in neurons and astrocytes, < 3 FPKM in OPCs, iOLs or mOLs, and a level of expression in neurons or astrocytes higher than OLs).

Gene subset	CNS region / Developmental stage	Methodology and criteria used	Datasets	References	
Transcriptomics comparison of different brain cell subtypes & oligodendroglial stages- 4462 genes	Oligodendroglial enriched genes: 4478 genes	Expression profiling from neurons, astrocytes, OPCs, newly formed oligodendrocytes, myelinating oligodendrocytes, microglia, endothelial cells, and pericytes from mouse cerebral cortex (P7 and P17)	Expression > 3 FPKM in oligodendroglial cells (OPC, iOLs or mOLs) + differential ratio of expression compared to neurons and astrocytes: 1.5 fold ratio (3393 genes), 2.1 fold ratio (1998 genes), or top 500 of gene expression in oligodendroglia (1500 genes)	Microarray sequencing : GSE52564	Zhang et al., 2014
		Expression profiling from mouse hypothalamus underlying OL differentiation (adult)	1390 DEGs (expression > 3 FPKM in OPCs, iOLs, mOLs; 4 fold ratio of differential expression compared to neurons & astrocytes)	Single-cell RNA-sequencing : GSE87544	Chen et al., 2017
		Expression profiling of OLs from spinal cord, substantia nigra-ventral tegmental area, striatum, amygdala, hypothalamic nuclei, zona incerta, hippocampus, and somatosensory cortex of male and female mice (P21 and adult P90)	532 DEGs (using criteria: min.cells = 10, min.genes = 500, thresh.use = 0.25, min.pct = 0.25)	Single-cell RNA-sequencing : GSE75330	Marques et al., 2016
	Differential expression during oligodendroglial development: 4517 genes	Expression profiling from mouse forebrain and spinal cord OPCs (E13.5 and P7)	2368 DEGs (OPC1a, b, cydic, committed progenitors and newly formed OLs, P value < 0.01)	Bulk & Single-cell RNA-sequencing : GSE95194; GSE95093	Marques et al., 2018
		Expression profiling of OLs isolated from spinal cord, substantia nigra-ventral tegmental area, striatum, amygdala, hypothalamic nuclei, zona incerta, hippocampus, and somatosensory cortex of male and female mice (P21 and adult P90)	1598 DEGs (using criteria: min.cells = 10, min.genes = 500, thresh.use = 0.6, min.pct = 0.25)	Single-cell RNA-sequencing : GSE75330	Marques et al., 2016
Expression profiling of the OL lineage cells from the spinal cord of mice (adult)		1775 DEGs (differential expression of 1.5 with other cell types)	Single-cell RNA-sequencing : GSE113973	Falcão et al., 2018	
	Transcriptomic profile of cells from nine different brain regions (Frontal and Posterior Cortex, Hippocampus, Thalamus, Cerebellum, Striatum, Globus Pallidus externus/Nucleus Basalis, Entopeduncular / Subthalamic Nuclei, & Substantia Nigra / Ventral Tegmental Area) (adult)	1130 DEGs (expressed between OPCs and mature OLs)	Single-cell RNA-sequencing : GSE116470	Saunders et al., 2018	
Oligodendroglial enriched genes- 3372 genes	Lineage enrichment: 1919 genes expressed in progenitors versus 2139 in more differentiating/ maturing cell)	Forebrain subventricular zone (P4, P8 and P11)	3354 genes (transcriptomes of dorsal and lateral progenitors (NSCs, TAPs) genes expressed in progenitors generating oligodendroglia of the neonatal dorsal SVZ (P.val< 0.05, FC > 1.2). By comparing with 4462 genes: 1898 genes (progenitors-enriched), 2099 genes (differentiation/maturation- enriched), 3372 genes (all oligodendroglial enriched)	Microarray sequencing : GSE60905, GSE9566, GSE18765	Azim et al., 2015; Azim et al., 2017

Figure 2. Main methodology and selection criteria for oligodendroglial gene set enrichment

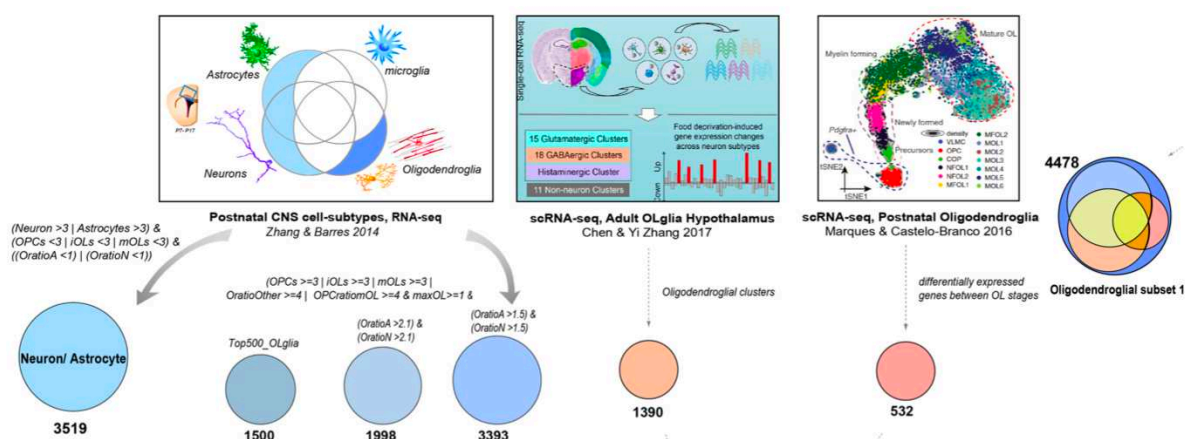

Figure 3. Data used for oligodendroglial gene enrichment. We generated 3 genesets of 1500, 1998, 3393 oligodendroglial genes from postnatal cells types (Barres et al, 2014), combined with 1390 genes from scRNA seq generated in the adult hypothalamus (Chen et al, 2017) and 532 genes extracted from scRNAseq at postnatal stage (Marques, 2016). Finally, we generated a group of 4478 oligodendroglial genes.

We performed another approach (Fig. 4) taking in account genes expressed during mouse development at different stages (embryonic, postnatal and adult), including DEGs expressed by other cell types. We started by identifying 2368 genes expressed in oligodendroglial clusters (with P value < 0.01 in OPC1a,b, cyc, COP, NFOL cluster) from single-cell transcriptomic datasets generated at embryonic and postnatal stages (Marques, 2018 #4717). Then we reanalyzed the single-cell RNA-Sequencing generated at the postnatal and adult stages (Marques, 2016 #3417) using the Seurat package to get 1598 differentially expressed genes (see data processing methods for criteria). We used single-cell transcriptomic analysis generated from adult mice spinal cord and brain to obtain 1775 DEGs expressed in oligodendroglial cells (with differential expression of 1.5 with other cell types)(Falcão, 2018 #4785). Finally, we used transcriptomic datasets from 690.000 cells sampled from 9 regions of the adult mouse brain (Saunders, 2018 #4711) to find 1130 genes expressed between OPCs and mature OLs. Thus, we obtained a total list of 4517 DEGs expressed during development.

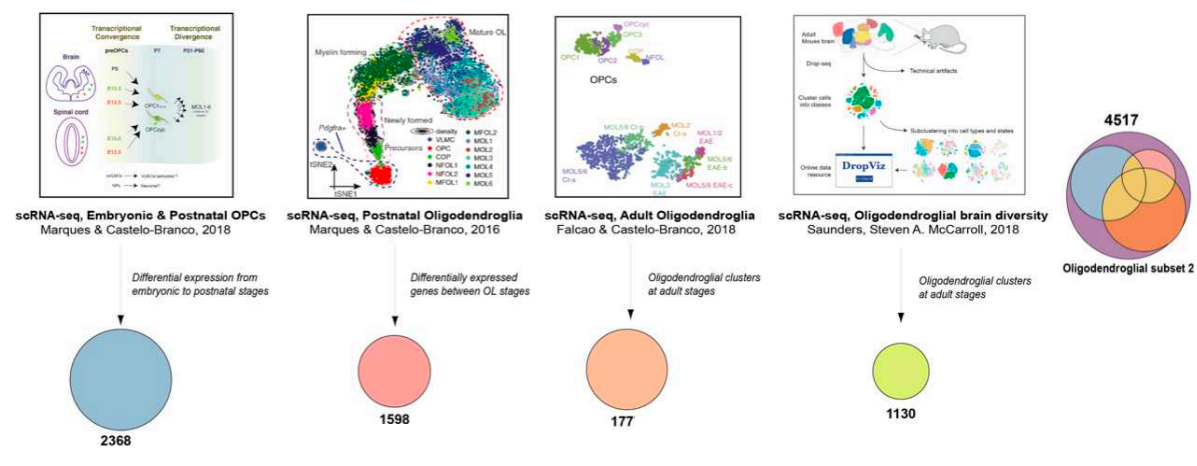

Figure 4. Data used for the identification of genes differentially expressed during development. We identified 2368 oligodendroglial genes expressed from the embryonic to postnatal stage (Marques et al, 2018), combined with 1598 differentially expressed genes from single cell RNAseq at the postnatal stage. Finally, we generated a group of 4478 oligodendroglial genes

GENE ONTOLOGY AND CELL SPECIFIC ENRICHMENT ANALYSIS

Cell type expression analysis was performed using the CSEA tool (Xiaoxiao Xu et al, 2014). The values in the tables are the Fisher's Exact p-values, followed by the Benjamini-Hochberg (BH) corrected values in parentheses. The bulls-eye plot size is scaled to the number of genes specific to a cell type at increasing levels of specificity. The FDR-adjusted hypergeometric test p-value is plotted for each level of specificity, with unenriched groups colored gray. Cell type bulls-eye plots are arranged by hierarchical distance of their specific gene expression levels. GO analysis of selected genes was performed using the Cluster Profiler R-package (2012), Metascape (<https://metascape.org>; Zhou et

al., 2019)), EnrichR (<https://maayanlab.cloud/Enrichr>) (Chen et al., 2013) and Panther (<http://pantherdb.org>) (Mi et al., 2019; Thomas et al., 2022).

PHARMACOGENOMIC STRATEGY: EXPERT CURATION, SCORING AND VALIDATION

We used a knowledge-driven scoring procedure through curation of more than 1000 publications involving functional studies and demonstrating the requirement of a given gene in different processes of oligodendrogenesis (OPC specification, proliferation, migration, survival, differentiation, myelination, and remyelination), either in physiological or pathological conditions. This curation implicated 430 genes scored for each process from 1-3 (low, medium, strong), either positively or negatively, depending on the requirement or evidence of their function in that process. To share our expert curation scoring strategy, we established a user-friendly platform (OligoScore; <https://oligoscore.icm-institute.org>) evaluating regulatory impact on transcriptional programs implicated in oligodendrogenesis and (re)myelination.

We validated the OligoScore strategy using either genes enriched in specific oligodendroglial stages (gene list) or genes deregulated in OPCs upon perturbations (list of genes and their fold-changes). First, we queried OligoScore with genes enriched either in OPCs or in myelinating oligodendrocytes (mOLs), obtained from transcriptomes of purified brain cells (Zang et al., 2014, RNAseq) by sorting the genes by the expression ratio between OPCs and mOL respectively. We perform a similar analysis using genes enriched in OPCs (genes enriched more than 0.5 log₂ fold-change in OPC and cycling OPC clusters versus MOL1 and MOL2 clusters) versus myelinating oligodendrocytes (mOLs, genes enriched more than 0.5 logarithmic fold-change (logFC) in mOL1 and mOL2 clusters versus OPC and cycling OPC clusters) using oligodendroglial single cells transcriptomes (Marques et al., 2016, 2018). In both cases, we obtained similar results highlighting that, while genes enriched in OPCs are involved in several processes of oligodendrogenesis (specification, promoting proliferation, differentiation, and (re)myelination; Fig. 2 extended data 2A, C), genes enriched in mOLs are mainly promoting differentiation and myelination (Fig. 2 extended data 2B, D). Second, we queried OligoScore (genes and fold-changes) using transcriptomic comparisons of differentially expressed genes (DEGs) from OPCs upon genetic (genes deregulated at p-value < 0.01 upon Chd7-deletion in P7 OPCs; Marie et al., 2018), or from OPCs upon environmental (genes deregulated at FDR < 0.05 in P10 OPCs in the systemic IL1 β -mediated neonatal neuroinflammatory model, Schang et al., 2022) perturbation, identifying affected processes found in these studies, that is, reduced survival and differentiation of Chd7-iKO OPCs (Fig. 2 extended data 2E), and increased proliferation and reduced differentiation of OPCs at P10 in the IL1 β -model (Fig. 2 extended data 2F). In addition, this analysis also provides mechanistic insights identifying genes responsible for the deregulation of each oligodendroglial process.

PHARMACOGENOMICS IDENTIFICATION AND SELECTION OF SMALL MOLECULES

The transcriptional signatures obtained were used to query the CMAP 2.0 database via the wSPIED platform (a searchable platform-independent expression database III; <http://spied.org.uk/cgi-bin/HGNC-SPIED3.1plus.cgi>; GeneHubs and CmapG function). The Broad CMAP 2.0 (CMAP2.0) database consists of the transcriptional profiles corresponding to the effects of small molecules at various concentrations and treatment times using panels (~100) of human cell lines. This enables the identification of therapeutic molecules capable of inducing transcriptional changes similar to those observed during oligodendrogenesis. The query files are simple text files (.txt files). The first column contains the gene IDs and the second column indicates their enrichment/repression by a value +1 or - 1, respectively. The output table contains the identifiers of the small therapeutic molecules identified (correlative and anti-correlative molecules), ranked according to their Z-score (obtained by Pearson-type regression analysis), and their p-value. To generate a list of hub genes, we uploaded gene symbols corresponding to the large oligodendroglial gene subset (3372 genes). To generate a list of small molecules, we uploaded gene symbols corresponding to either the large oligodendroglial gene sets (1898, 2099 and 3372 genes) and to the oligodendroglial curated gene sets for each process regulating oligodendrogenesis. The 156 compounds obtained in common between both approaches were scored using OligoScore and ranked by their scores in the curated target genes for each process of oligodendrogenesis. We also performed a systematic analysis based on gene ontology databases and cell specific enrichment (see methods for GO analysis) to exclude compounds showing potential side effects (e.g., effects onto other lineages and/or cell death). Finally, we also selected compounds based on their functional properties and signaling pathways modulated using publicly available drug repositories websites (www.DrugBank.ca/; www.genome.jp/kegg/drug/; <http://www.genecards.org/>)

PHARMACOLOGICAL ANALYSES

The ADMET parameters have been calculated by the ACD/Percepta software (v.2019.1.2 built 3200) <https://www.acdlabs.com/products/percepta-platform/>. Predictive models for BBB permeability are based on log PS (rate of brain penetration) and log BB (extent of brain penetration) constants and were built by using non-linear least squares regression validated by an internal validation set, and two other experimental external validation sets (Kalvass et al., 2007; Summerfield et al., 2008). Physicochemical properties like lipophilicity (Log P), the number of hydrogen bond acceptors and donors, the ion form fraction at pH 6.5, and McGowan volume were calculated with the ACD/Labs Algorithm Builder 1.8 development platform and used for the modeling. The combination of brain/plasma equilibration rate (Log (PS * fraction unbound, brain)) with the partitioning of compounds at equilibrium (Log BB) classifies compounds as either active or inactive on the CNS; the

model is validated using experimental data of more than 1500 compounds having a CNS activity (Adenot and Lahana, 2004). This software uses a human expert rules system (Kazius et al., 2005; Benigni and Bossa, 2006; Kazius et al., 2006) to predict mutagenicity, clastogenicity, carcinogenicity and reproductive toxicity. The model predicting “health effects on particular organs or organs systems” is based on RTECS and ESIS databases for more than 100.000 compounds. The experimental data have been collected from RTECS and ESIS databases, and diverse publications. Health effects predictions are known to be very sensitive as evidenced by the high prediction values for many of our molecules, we thus decided to reduce the weight of these predictions in our selection strategy for the 11 molecules. These results are completed by a reliability index (RI) ranging from 0 to 1, where 0 is unreliable for the prediction and 1 is a fully reliable prediction. This RI value tends to zero in two cases: i) when the overall similarity between the tested compound 1 or 2 and the most similar compounds used for the correction of the global model is weak, because the predicted values of each of these compounds (obtained by bootstrapping the training set 100 times) weakly correlate with those of 1 or 2, ii) when an inconsistent variability between the predicted and the experimental values was observed among the most similar compounds to the tested compound 1 or 2. The validation sets were used to evaluate result accuracy by computing the Root Mean Square Error (RMSE) between the studied parameter experimental value and its final predicted value. The results with a reliability index under 0.3 (cut-off value) should be discarded without any consideration to the result. 11 compounds were finally selected. The list can be found in supplementary table 8.

SELECTED DRUGS

Nomenclature	Drug	CAS number	Formule	Provider
Sm1	Meticrane (Arresten)	1084-65-7	C ₁₀ H ₁₃ NO ₄ S ₂	Sigma-Aldrich
Sm2	Heptaminol	543-15-7	C ₈ H ₂₀ CINO	Sigma-Aldrich
Sm3	melatonin	73-31-4	C ₁₃ H ₁₆ N ₂ O ₂	Sigma-Aldrich
Sm4	Naringenin	67604-48-2	C ₁₅ H ₁₂ O ₅	Sigma-Aldrich
Sm5	Prestwick-674 (Dyclonine HCl)	536-43-6	C ₁₈ H ₂₇ NO ₂ · HCl	Merck
Sm6	Ginkgolide A	15291-75-5	C ₂₀ H ₂₄ O ₉	Selleckchem
Sm7	Levonorgestrel	797-63-7	C ₂₁ H ₂₈ O ₂	Merck
Sm8	Medrysone	2668-66-8	C ₂₂ H ₃₂ O ₃	Merck
Sm9	Thioperamide	106243-16-7	C ₁₅ H ₂₄ N ₄ S	Aobious
Sm10	Trihexyphenidyl	144-11-6	C ₂₀ H ₃₁ NO	Selleckchem
Sm11	Calcium folinate	1492-18-8	C ₂₀ H ₂₁ CaN ₇ O ₇	Merck
Clem	Clemastine	17-7-4	C ₂₁ H ₂₆ CINO · C ₄ H ₄ O ₄	SelleckChem
T3	Triiodothyronine	55-06-1	C ₁₅ H ₁₁ I ₃ NO ₄ · Na	Sigma-Aldrich

Figure 5. Table of the drugs used and their nomenclature associated during the study

ANIMALS

We used *PLP^{GFP}* (Zalc et al., 2011), RjOrl:SWISS mice (Janvier) and OF1 mice (Charles Rivers; France). Females and males were included in the study. Mice were maintained in standard conditions with food and water ad libitum in the ICM animal facilities. All animal studies were conducted following protocols approved by local ethical committees and French regulatory authorities (#03860.07, Committee CELYNE APAFIS#187 & 188, APAFIS#5516-2016053017288535, APAFIS #38705-2022092718027606).

NEONATAL NEURAL PROGENITOR CULTURES

NPC proliferating medium was prepared with DMEM/F12 GlutaMAX™ supplement (life technology, 31331028), 0.6% glucose (Sigma, G8769), 1% penicillin/streptomycin (life technology, 15140122), 5mM HEPES buffer (life technology, 15630056), 1% N2 supplement (life technology, 17502048), 2% B27 supplement (life technology, 17504044), 20µg/ml Insulin (Sigma, I6634), 20ng/ml EGF (Peprotech, AF-100-15) and 10ng/ml FGF-basic (Peprotech, 100-18B). Mice brains were collected from RjOrl:SWISS mice (Janvier) at P0-P1 and washed 3 times in PBS-1X (Invitrogen, 14080055). SVZs were dissected, transferred in fresh NPC medium and dissociated with pipette. Cells were amplified and maintained in a humidified atmosphere at 37 °C and 5% CO₂. Three days later, floating neurospheres were collected by centrifugation at 500g for 5min, dissociated before adding proliferating NPC medium. After 2 passages, 30.000 cells were plated in 24 well plates adherent on coverslips, beforehand coated with poly-L-ornithine (sigma, P4957). Compounds were added at different ranges of concentration (250nM, 500nM and 750nM), including positive controls: 3,3',5-Triiodo-L-thyronine sodium salt (Sigma, T6397) at 30mM and clemastine fumarate (Sigma, SML0445) at 500nM and their respective vehicle (DMSO, or PBS). Medium (including compounds or vehicle) was changed every 2 days. After 4 days with proliferation factors, a differentiation medium (without supplemented growth factors) was added for two days. Cells were washed once in PBS-1X, fixed 10 minutes in 4% PBS-paraformaldehyde (Electron Microscopy Sciences, 50-980-495) and washed 3 times in PBS-1X.

OLIGODENDROCYTE PRECURSOR CELLS SORTING AND CULTURES

Brains were collected from P4 mice, and cortex and corpus callosum were dissected and dissociated using a neural tissue dissociation kit (P) (Miltenyi biotec, 130-092-628) with gentleMACS Octo Dissociator (Miltenyi Biotec, 130-096-427). OPC magnetic cell sorting was performed using anti-PDGFR α -coupled-beads (CD140a-PDGFR α MicroBead Kit, Miltenyi biotec, 130-101-502) and MultiMACS Cell24 Separator Plus (Miltenyi biotec, 130-095-691). 40,000 cells were plated on

coverslips coated with poly-L-ornithine (sigma, P4957) and amplified for two-three days in a proliferating medium containing DMEM High Glucose (Dutscher, L0103-500), Ham's Nutrient Mixture F12 (Merck, 51651C), L-Glutamine (Thermo, 200 mM), Hormone mix (Gritti, A., et al., 2001), Penicillin/Streptomycin (life technology, 15140122, 1X), 20ng/ml EGF (PeproTech, AF-100-15), 10ng/ml FGF-basic (PeproTech, 100-18B) and 10ng/ml PDGF-AA (PeproTech, 100-13A). Successively, for 3 days of differentiation (without growth factors), compounds were added to the medium at 750nM. T3 (3,3',5-Triiodo- L-thyronine sodium salt, Sigma, T6397) at 30nM or clemastine fumarate (Sigma, SML0445) at 500nM were used as positive controls and their respective vehicles (DMSO, PBS) were used as negative controls. Cells were fixed for 10 minutes in 4% PBS-paraformaldehyde (Electron Microscopy Sciences, 50-980-495) and washed 3 times in PBS-1X.

CEREBELLAR ORGANOTYPIC CULTURES

We prepared cerebellar organotypic cultures from newborn (P0) RjOrl:SWISS mice as previously described in (Bousslama-Oueghlani et al., 2003). Briefly, cerebellar parasagittal slices (350 μ m thick) were cut on a McIlwain tissue chopper and transferred onto 30 mm diameter Millipore culture inserts with 0,4 μ m pores (Millicell, Millipore, PIHP03050). Slices were maintained in incubators at 37°C, under a humidified atmosphere containing 5% CO₂ in six-well-plates containing 1 ml of slice culture medium, containing basal Earle's salts medium (BME, sigma, MFCD00217343), 25% Hanks' balanced salt solution (Sigma, H9394), 27mM glucose (Sigma, G8769), 1% penicillin/streptomycin (life technology, 15140122), 1mM glutamine (Sigma, 228034) and 5% horse serum (New Zealand origin, heat inactivated; ThermoFisher, 16050122). Medium was renewed every 2 days for 7 days, reaching the appropriate culture periods to study OPC differentiation and myelination. At this time point, small molecules were added daily for 3 days, including Sm1, Sm2, Sm5, Sm6, Sm7, Sm11 at 750nM, and their respective vehicle (DMSO or PBS), triiodothyronine (T3; Sigma, T6397-100MG) at 30nM or clemastine (SelleckChem, Houston, TX) at 500nM. Slices were collected and fixed for 1 h at RT in 4% PBS-paraformaldehyde (Electron Microscopy Sciences, 50-980-495) and incubated 20 min at 4°C in Clark's solution (95% ethanol/5% acetic acid), then washed 3 times in PBS 1X.

INTRACEREBRAL INJECTION OF LYSOLECITHIN INDUCED DEMYELINATION IN ADULT MICE

To induce recombination in adult OPCs, tamoxifen (Sigma) was orally administered (gavage to *Pdgfra-CreER^T; Rosa26^{stop-YFP}* mice for five consecutive days (210 g/kg per day, dissolved in corn oil at 20 mg/ml), 10 days before lesion induction to optimize the YFP-labelling newly-generated OLs in the lesion area. Before surgery, 4-month-old RjOrl:SWISS mice (Janvier) and *Pdgfra-CreER^T; Rosa26^{stop-YFP}* mice were administered buprenorphine (30 mg/g) to prevent postsurgical pain. Once mice were

anesthetized with isoflurane (ISO-VET), an eye protector (Ocrygel, Tvm) and cream lidocaine (Anesderm 5%) were applied to prevent eye dryness and pain caused by the ear bars. A small incision was performed on the head and a few drops of liquid lidocaine were put on the site. We induced focal demyelinated lesions by injecting 0.5 μ l of a solution of 1% lysolecithin (L- α -lysophosphatidylcholine, Sigma L4129) diluted in 0.9% NaCl into the corpus callosum. To do so, a glass capillary connected to a 10 μ l Hamilton syringe was fixed and oriented through stereotaxic apparatus (coordinates: 1 mm lateral, 1.3 mm rostral to Bregma, 1.7mm deep to brain surface). Animals were left to recover for a few hours in a warm chamber. Dyclonine/Sm5 (5 mg/kg) and Leucovorin/Sm11 (0.5 mg/kg) were administered daily in 5% glucose drinking water according to the reported oral administration in adult mice (dyclonine; Sahdeo et al; 2014; Okazaki et al; 2018) and humans (leucovorin; Frye et al., 2018; Rossignol and Frye, 2021). Given the reported solubility in water and half-life of these compounds, we dilute them in the drinking water and renew the treatment daily. Given that a 40 g mouse drinks approximately 6mL per day, we diluted respectively 0.2 mg of dyclonine/Sm5 (0.2 mg in 40 g = 5 mg/kg) and 0.02 mg of leucovorin/Sm11 (0.02 mg in 40 g = 0.5 mg/kg) in 6mL, scaling these drug concentrations to a total volume of 200mL per bottle. We added 5% glucose to the preparation to increase the appetite of the mice. Importantly, we monitored the intake volume, and found no differences in the amount of drinking intake per day between the different treatments, as indicated in Fig. 7 extended data 2b, thus confirming the daily oral posology of 5mg/kg of dyclonine/Sm5 and 0.5mg/kg of leucovorin/Sm11, per mouse. The volume of oral consumption was measured daily. Mice were perfused 7 dpl and 10 dpl with 25 ml of 2% PBS-paraformaldehyde freshly prepared from 32% PFA solution (Electron Microscopy Sciences, 50-980-495). Perfused brains were dissected out, dehydrated in 10% sucrose, followed by 20% sucrose overnight, and embedded in OCT (BDH) before freezing and sectioning (14 μ m thickness) in a sagittal plane with a cryostat microtome (Leica).

NEONATAL HYPOXIA

P3 OF1 mice were placed for 8 days until P11 in a hypoxic rearing chamber maintained at 10% O₂ concentration by displacement with N₂ as previously described (Fagel et al., 2006). A separate group was maintained in a normal atmosphere (normoxic group). Compounds were administered intranasally according to the oral administration in adult humans of sm5 at 5 mg/kg and sm11 at 0,5 mg/kg. Mucus was first permeabilized using type IV hyaluronidase, 790 then 10 μ l of compounds (Sigma) were administered 3 times, 1 time a day from P11 to P13 (starting at the end of the hypoxic period, then every 24 hours) in sterile PBS (control). For proliferation analysis, mice were injected with EdU (Sigma) to label cells in an actively cycling state in S-phase, then perfused 1 hour later at P13. For analysis of OL maturation, mice were perfused at P19. All perfusions were performed with Ringer, followed by ice-cold solution of 4% paraformaldehyde (Thermo Fisher). Mice were sacrificed at P13 or P19 by an intraperitoneal overdose of pentobarbital followed by perfusion with Ringer's

lactate solution and 4% paraformaldehyde (PFA; Sigma) dissolved in 0.1M phosphate buffer (PB; pH 7.4). Brains were removed and post-fixed for 24 hours at 4°C in 4% PFA and sectioned in 50µm thick coronal serial free-floating sections.

IMMUNOFLUORESCENCE STAINING

For coated-coverslip, blocking was performed in a moist chamber for 30 min at room temperature in a blocking solution of 0.05% Triton X-100 and 10% normal goat serum NGS (Eurobio, CAECHVOO-OU) in PBS. Then, coverslips were incubated for 30 min at room temperature with the primary antibodies. Following 3 washing in 0.05% Triton X-100/PBS, coverslips were incubated 30 min at room temperature in dark with appropriate secondary antibodies conjugated with Alexa Fluor 488, 594 and 647 (Molecular Probes or Thermo Fisher) and DAPI (Sigma-Aldrich®, D9542). Coverslip were washed 3 times in 0.05% Triton X-100 in PBS and mounted with Fluoromount-G® (SouthernBiotech, Inc. 15586276).

For ex-vivo cerebellar slices, slices were incubated 20 min at 4°C in Clark's solution (95% ethanol/5% acetic acid) and washed 3 times in PBS. Then, sections were incubated for 1 hour in a blocking solution (0.2% Triton X-100, 4% bovine serum albumin, 4% donkey serum in PBS). Slices were incubated for 2 hours with primary antibodies at room temperature. Then, slices were washed 3 times in 0.1% Triton X-100 in PBS and incubated in blocking solution in dark at room temperature for 2 hours with appropriate secondary antibodies conjugated with Alexa Fluor 488, 594 and 647 (Molecular Probes or Thermo Fisher) and DAPI (Sigma-Aldrich®, D9542). Finally, slices were washed 3 times in 0.1% Triton X-100 in PBS and mounted in Fluoromount-G® (SouthernBiotech, Inc. 15586276). For in-vivo cryosections (14-µm thick) of lesions, immunohistochemistry was performed after 30 min drying at room temperature. For MOG staining, ethanol treatment (100%) was performed for 10 min at room temperature. Sections were permeabilized and blocked in a blocking solution (0.05% Triton X-100, 10% normal goat serum in PBS) for 1 hour. Then, cryosections were incubated overnight with primary antibodies at 4°C. Sections were washed 3 times in 0.05% Triton X-100 in PBS and incubated 1 hour at room temperature with appropriate secondary antibodies conjugated with Alexa Fluor 488, 594 and 647 (Molecular Probes or Thermo Fisher) and DAPI (Sigma-Aldrich®, D9542). Sections were washed 3 times in 0.05% Triton X-100 in PBS and mounted with Fluoromount-G® (SouthernBiotech, Inc. 15586276).

For forebrain sections following neonatal hypoxia, 50µm coronal sections in free floating were collected. Antigen retrieval was performed for 20 min in citrate buffer (pH 6.0) at 80°C, then cooled for 20 min at room temperature and washed in 0.1M PB. Sections were incubated with primary antibodies overnight at 4°C with gentle shaking. Blocking was performed in a TNB buffer (0.1 M PB;

0.05% Casein; 0.25% Bovine Serum Albumin; 0.25% TopBlock) with 0.4% triton-X (TNB-Tx). Sections were incubated overnight at 4°C with gentle shaking. Following extensive washing in 0.1 M PB with 0.4% triton-X (PB-Tx), sections were incubated with appropriate secondary antibodies conjugated with Alexa Fluor 488 or 555 (1:500; Jackson or Invitrogen) for 2 hours at room temperature. Sections were washed and counterstained with Dapi (1:5000 from working solution at 5mg/ml; Life Technologies; D1306). Revelation of EdU was done using Click-it™, EdU cell proliferation Kit for imaging, Alexa fluor™ 647 dye (Thermo Fisher scientific). The list of primary and secondary antibodies used can be found in Methods table 4 and 5.

Primary Antibody				
Target	Host	Supplier	Reference	Dilution
Arginase-I	chicken	Sigma Aldrich	ABS535	1/250
Bcas1	rabbit	Synaptic Systems	445003	1/500
β-3 Tubulin	rabbit	BABCO	PRB-435P	1/1000
Calbindin	rabbit	Swant	CB-38	1/1000
CC1 (APC)	m IgG2b	Calbiochem	OP80	1/100
CD68	rat	AbD SEROTEC	MCA1957	1/400
CNPase	m IgG1	millipore	MAB326R	1/250
Cox2	rabbit	Abcam	Ab15191	1/500
dMBP	rabbit	Sigma Aldrich	AB5864	1/800
GFP	chicken	AVES	GFP10-20	1/1000
GFAP	chicken	Avelabs	75-240	1/500
GSTπ	rabbit	Enzo	ADI-MSA-102-E	1/2000
GSTπ	m IgG1	BD biosciences	610718	1/500
Iba1	rabbit	Wako Fujifilm	019-19741	1/500
iNOS	m IgG2a	BD Biosciences	610329	1/100
MBP	rat	Abcam	ab7349	1/200
MCM2	mIgG1	BD Biosciences	610701	1/500
MOG	mIgG1	Lubetzki team (ICM)	Hybridoma	1/20
Olig1	m IgG1	NeuroMab	75-180	1/500
Olig2	rabbit	Millipore	AB9610	1/500
Olig2	m IgG2a	Millipore	MABN50	1/500
PDGFRα	rat	BD Biosciences	558774	1/250
Sox10	rabbit	Proteintech	10422	1/1000
Sox10	goat	R&D systems	AF2864	1/100

Secondary Antibody					
Target	Host	Conjugate	Supplier	Reference	Dilution
goat	donkey	Alexa405	Abcam	AB175665	1/750
mouse	goat	Alexa 488	Molecular Probes	A-11029	1/1000
mouse IgG1	goat	Alexa 488	Molecular Probes	A-11029	1/1000
rabbit	goat	Alexa 488	Molecular Probes	A-11034	1/1000
rat	goat	Alexa 488	Molecular Probes	A-11006	1/1000
rabbit	donkey	Alexa 488	Thermo Fisher Scientific	A-21206	1/1000
mouse	donkey	Alexa 488	Invitrogen	A32766	1/500
rabbit	donkey	Alexa 488	Jackson	711-545-152	1/500
chicken	donkey	FITC	Jackson	703-095-155	1/500
rat	donkey	TRITC	Thermo Fisher Scientific	A24548	1/1000
mouse IgG2b	goat	Alexa 555	Thermo Fisher Scientific	A-21147	1/500
rabbit	goat	Alexa 568	Molecular Probes	A-11036	1/1000
mouse IgG2a	goat	Alexa 568	Thermo Fisher Scientific	A-21134	1/1000
rat	goat	Cy5	Jackson	112-175-167	1/1000
rat	goat	Alexa 647	Molecular Probes	A21247	1/1000
chicken	goat	Alexa 647	Thermo Fisher Scientific	A32933TR	1/1000
mouse IgG1	goat	Alexa 647	Molecular Probes	A21240	1/1000
mouse IgG2a	goat	Alexa 647	Molecular Probes	A-21241	1/1000
mouse IgG2b	goat	Alexa 647	Molecular Probes	A21242	1/1000
mouse	donkey	Alexa 647	Thermo Fisher Scientific	A-31571	1/1000
rabbit	donkey	Alexa 647	Invitrogen	A31573	1/500

Figure 6. List of primary and secondary antibodies used during the study

IMAGE ACQUISITION AND ANALYSIS

Visualization and acquisitions for cryosections and ICC was performed using Zeiss® Axio Imager M2 microscope with Zeiss® Apotome system at 20X/0.8 NA dry objective (Plan-apochromat, including deconvolution and Z-stack. Acquisition for cerebellar slices was done using a confocal SP8 X white light laser (Leica, Nanterre, France), at ×40 magnification with a range of 10–15 μm (z axis), four fields (1024 × 1024) before merging them into a mosaic. For in vivo sections of neonatal hypoxia, Quantifications were performed on coronal sections by automatic quantifications of Olig2 signal, into manually defined corpus callosum and cortex (based on DAPI counterstaining), using QuPath software (V0.3.0). Analysis was performed using ZEN (Zeiss) and ImageJ (Fiji) software packages, with macros for ex vivo experiments to determine myelination and differentiation index (methods previously described in (Baudouin et al., 2021). Quantifications were performed on coronal sections by counting the number of cells from z stack confocal images on ImageJ-Win-64. Quantifications were performed on coronal sections by automatic quantifications of Olig2 signal, into manually defined corpus callosum and cortex (based on DAPI counterstaining), using QPath software (V0.3.0). In vivo images

of lesions were quantified in a double-blinded manner. Illustrations were performed using Illustrator and Adobe Photoshop (Adobe System, Inc).

ELECTRON MICROSCOPY AND ANALYSIS

Mice were perfused with 2.5% glutaraldehyde in 0.1M sodium cacodylate buffer 0.1M pH 7.4 (Caco buffer). After dissection, brains were left for one night in the fixative at 4°C. After rinsing in Caco buffer, brains were sliced at 1mm thickness. Sections were selected and washed 3 times. It was then post-fixed with 2% osmium tetroxide in Caco buffer for 1h at room temperature. After an extensive wash (3x10 min) with distilled water they were incubated overnight in 2% aqueous uranyl acetate. They were then dehydrated in a graded series of ethanol solutions (2x5min each): 30%, 50%, 70%, 80%, 90%, and 100% (X3). Final dehydration was performed twice in 100% acetone for 20 min. Samples were then progressively infiltrated with an epoxy resin, Epon 812® (EMS, Souffelweyersheim, France): 2 nights in 50% resin 50%acetone at 4°C in an airtight container. Then twice 2h in pure fresh resin at RT. They were embedded in molds and put at 56°C for 48h in a dry oven for polymerization of the resin. Blocks were cut with an UC7 ultramicrotome (Leica, Leica 29 Microsystemes SAS, Nanterre, France). Semi-thin sections (0.5µm thick) were stained with 1% toluidine blue in 1% borax. Ultra-thin sections (70nm thick) of the region were recovered on copper grids (200 mesh, EMS, Souffelweyersheim, France) and contrasted with Reynold's lead citrate (Reynolds, ES (1963)). Ultrathin sections were observed with a Hitachi HT7700 electron microscope (Milexiaé, Verrière-le-Buisson, France) operating at 100 kV. Pictures (2048x2048 pixels) were taken with an AMT41B camera. Axons were quantified using Fiji software packages. Plot visualizations and statistics were performed in R. Script use are available on demand.

STATISTICS AND REPRESENTATIONS

All analyses were done using GraphPad Prism 6.00 (San Diego California, www.graphpad.com). Data distribution was assumed to be normal, but this was not formally tested. Statistical significance was determined using one-way ANOVA by multiple comparisons, pairwise comparisons following Dunnett's post-hoc test, or unpaired t tests. Data are presented as Mean ± SEM. Significance was set as * for p-value < 0.05, ** for p-value < 0.01, and *** p-value < 0.001 and **** p-value < 0.0001. A summary of tests used, number of replicates and p-values can be found in Methods table 3.

	Statistical test applied	Number of replicates (N)	Descriptive stats	P value
Fig. 3C	Linear mixed-effects modelling to account for paired-measurements acquired from same batch of cells across the treatment groups (one measure per batch in each treatment). Significance of the treatment effect was assessed by Type II Wald chi-square test, followed by comparisons of the treatment groups versus the vehicle groups using the Tukey's method as performed with <i>emmeans</i> R package.	N= 5	normalized fold change (FC)	Sm8 : P < 0.05; Sm1, Sm2, Sm3, Sm4, Sm5, Sm6, Sm7, Sm11 : P < 0.01; Sm9, Sm10 : P < 0.001
Fig. 3D		N= 5		ns
Fig. 3E		N= 4		Sm9, Sm11 : P < 0.05
Fig. 3F		N= 5		ns
Fig. 3G		N= 5		Sm8 : P < 0.05; Sm1, Sm2, Sm3, Sm4, Sm5, Sm6, Sm7, Sm11 : P < 0.01; Sm9, Sm10 : P < 0.001
Fig. 3I	Statistical unpaired bilateral Wilcoxon Mann Whitney test	N= 6	mean ± s.e.m.	Sm1, Sm2, Sm3, Sm6, Sm8, Sm9, Sm10, Sm11 : P < 0.05 ; Sm4, Sm5, T3 : P < 0.01
Fig. S-3		N= 4 (250nM), N= 3 (500nM), N= 6 (750nM)		Sm1, Sm2, Sm3, Sm6, Sm8, Sm9, Sm10, Sm11 : P < 0.05 (750nM); Sm4, Sm5 : P < 0.01 (750nM); Sm7: P < 0.001 (500nM)
Fig. 4C	one-way ANOVA with Dunnett post hoc test	N=3	mean ± s.e.m.	ns
Fig. 4D		N=3		Sm1, Sm2, Sm5 : P < 0.05; Sm6, Sm11, T3, Clem : P < 0.01
Fig. 5C	Statistical unpaired bilateral Wilcoxon Mann Whitney test	N= 5 (n=1-3 for each cerebellum)	mean ± s.e.m.	Sm1 : P < 0.05; Sm5, Sm11, Clem : P < 0.01; Sm2 : P < 0.001
Fig. 5E		N= 5 (n=1-3 for each cerebellum)		Sm2 : P < 0.05; Sm5, T3 : P < 0.01; Sm11 : P < 0.001
Fig. 6C	unpaired t-test statistical tests	N= 5	mean ± s.e.m.	Nx vs Hx, Nx vs (Hx+Dycl), Nx vs (Hx+Leuc) : P < 0.01
Fig. 6D		N= 5		Hx vs (Hx+Leuc) : P < 0.05; Hx vs (Hx+ Dycl) : P < 0.001
Fig. 6F		N= 5		Nx vs (Hx+Dycl), Hx vs (Hx+ leuc) : P < 0.01; Nx vs (Hx + Leuc) : P < 0.01
Fig. 6H		N= 10		Nx vs Hx : P < 0.01; Hx vs (Hx+Leuc) : P < 0.05
Fig. 6J		N= 10		Nx vs Hx; Hx vs (Hx+Leuc) : P < 0.001; Hx vs (Hx+ Dycl) : P = 0.088
Fig. 6L		N= 10		Hx vs (Hx+Leuc) : P < 0.01; Nx vs Hx : P < 0.001
Fig. 6M		N= 5		Nx vs (Hx + Dycl) : P < 0.001
Fig. S-6C		N= 5		ns
Fig. S-6G		N= 5		ns
Fig. 7F		one-way ANOVA with Dunnett post hoc test		N= 13 (vehicle), N= 14 (Dycl), N= 9 (Leuc)
Fig. 7G	N= 13 (vehicle), N= 14 (Dycl), N= 9 (Leuc)		ns	
Fig. 7H	N= 13 (vehicle), N= 14 (Dycl), N= 9 (Leuc)		Leuc : P < 0.01	
Fig. 7I	N= 13 (vehicle), N= 14 (Dycl), N= 9 (Leuc)		Dycl : P < 0.01 ; Leuc : P < 0.0001	
Fig. 7M	N= 5		Dycl : P < 0.05 ; Leuc : P < 0.01	
Fig. 7N	N= 13 (vehicle), N= 13 (Dycl), N= 9 (Leuc)		Dycl : P < 0.05; Leuc : P < 0.0001	
Fig. 7O	N= 5		Dycl : P < 0.05; Leuc : P < 0.001	
Fig. S-7B	one-way ANOVA with Dunnett post hoc test	N= 5 cages (vehicle), N= 5 cages (Dycl), N= 4 cages (Leuc)	mean ± s.e.m.	ns
Fig. S-7E		N=5 (vehicle), N= 4 (Dycl), N= 4 (Dycl*2), N= 3 (Leuc), N= 5 (Leuc*10), N= 5 (Clem)		Dycl, Dycl*2 : P < 0.01; Leuc, Leuc*10, Clem : P < 0.001
Fig. S-7F		N=5 (vehicle), N= 4 (Dycl), N= 4 (Dycl*2), N= 3 (Leuc), N= 5 (Leuc*10), N= 5 (Clem)		ns
Fig. S-7G		N=5 (vehicle), N= 4 (Dycl), N= 4 (Dycl*2), N= 3 (Leuc), N= 5 (Leuc*10), N= 5 (Clem)		Leuc, Leuc*10 : P < 0.05
Fig. S-7H		N=5 (vehicle), N= 4 (Dycl), N= 4 (Dycl*2), N= 3 (Leuc), N= 5 (Leuc*10), N= 5 (Clem)		Dycl, Dycl*2 : P < 0.05; Leuc, Leuc*10, Clem : P < 0.001
Fig. 8B	one-way ANOVA with Dunnett post hoc test	N=6 (vehicle), N= 4 (Clem), N= 5 (Dycl), N= 5 (Leuc)	mean ± s.e.m.	Clem : P < 0.05; Dycl : P < 0.01; Leuc : P < 0.001
Fig. 8C		N=5 (vehicle), N= 4 (Clem), N= 6 (Dycl), N= 5 (Leuc)		ns
Fig. 8G		N=4		
Fig. 8H		N=4		Leuc (from 1 to 1.5µm) : P < 0.05; Leuc (above 1µm) : P < 0.01
Fig. 9B	one-way ANOVA with Dunnett post hoc test	N=9 (vehicle), N= 10 (Dycl), N= 10 (Leuc)	mean ± s.e.m.	Leuc : P < 0.01
Fig. 9C		N=10		Dycl : P < 0.05; Leuc : P < 0.001
Fig. 9D		N=5 (vehicle), N= 6 (Dycl), N= 5 (Leuc)		Leuc : P < 0.05
Fig. 9E		N=5 (vehicle), N= 6 (Dycl), N= 5 (Leuc)		Leuc : P < 0.05 ; Dycl : P < 0.01
Fig. 9G		N= 5 (vehicle), N= 4 (Dycl), N= 3 (Leuc)		Dycl : P < 0.05; Leuc : P < 0.001
Fig. 9H		N= 5 (vehicle), N= 6 (Dycl), N= 5 (Leuc)		Dycl, Leuc : P < 0.001
Fig. 9J		N= 12 (vehicle), N= 14 (Dycl), N= 8 (Leuc)		Leuc : P < 0.05 ; Dycl : P < 0.001

Figure 7. Statistic table

1- VALIDATION GENE AND CELL TYPE ENRICHMENT ANALYSIS

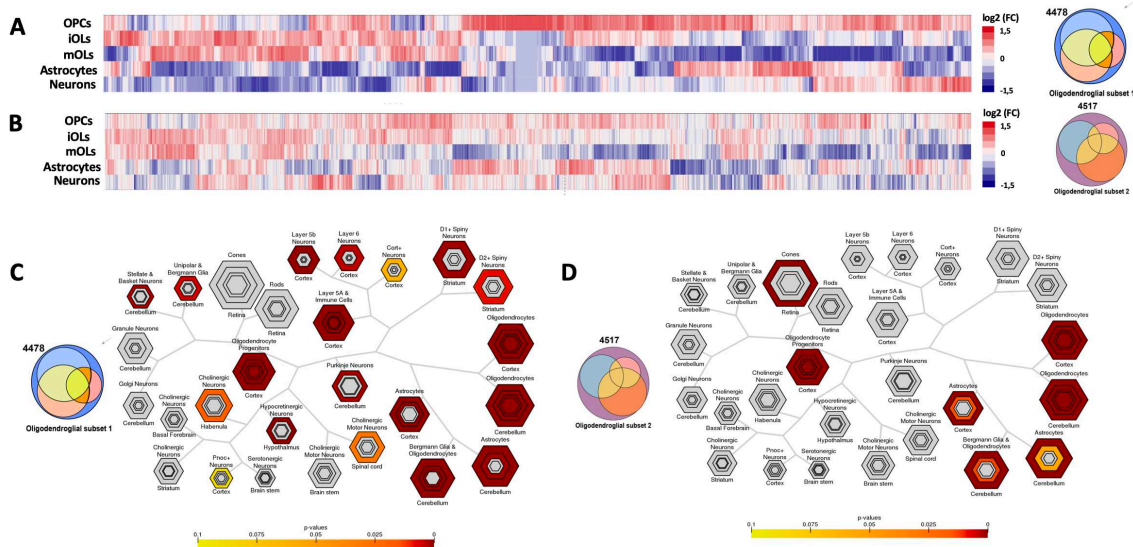

Figure 1: Validation of the gene enrichment based on the genes expressed in neural cell types. (A) Oligodendroglial enrichment obtained in the subset of 4478 genes and (B) 4517 genes, represented using a log₂ fold-change heat map representation from the expression of a neural cell type database (Zhang et al, 2014). Each bar represent a gene highly express (red) or not (blue) in neural cell types, including oligodendroglial cells (OPCs, iOLs and mOLs), neurons and astrocytes. (C) Cell type-specific expression analysis (CSEA) perform in the group of 4478 and (D) 4517 gene set. The bulls-eye plot size is scaled to the number of genes specific to a cell type at increasing levels of specificity (Xu et al., 2014). The FDR-adjusted hypergeometric test p-value is plotted for each level of specificity, with unenriched groups colored gray. Cell type bulls-eye plots are arranged by hierarchical distance of their specific gene expression levels.

Genes subset 1 (4478 genes) are highly enriched into the oligodendroglial lineage and particularly into OPCs (Fig. 1A). Residual gene expression is also shared with astrocytes and neurons, mostly related to precursor/ stem cells, crucial for either neuronal and glial cell development (e.g. cell cycle, quiescence, cell fate lineage). Cell types associated with this gene subset (Fig. 1C) are OPCs (Cortex/Pdgfra+, FDR:4.661e-26), OLs (Cerebellum/Cnp+, FDR:3.609e-32 and Cortex/Cnp+, FDR:4.099e-32) and neurons (Cortex/Etv1+, FDR:2.813e-10). List of 4517 genes is less enriched in the oligodendroglial lineage, with numerous genes expressed in neurons and astrocytes (Fig. 1B), mostly expressed during CNS development at the embryonic stage in precursor cells and crucial for regulating OPC specification. Surprisingly, cell expression enrichment analysis shows more restricted cell specificity to OLs compared to the first strategy (Fig. 1D), with clusters enriched in OPCs (Cortex/Pdgfra+, FDR: 1.984e-18) and OLs (Cerebellum/Cnp+, FDR: 5.960e-31; Cortex/Cnp+, FDR: 5.069e-31).

2- COMPARISON GO PROCESSES REGULATED DURING EMBRYONIC, POSTNATAL AND ADULT STAGES

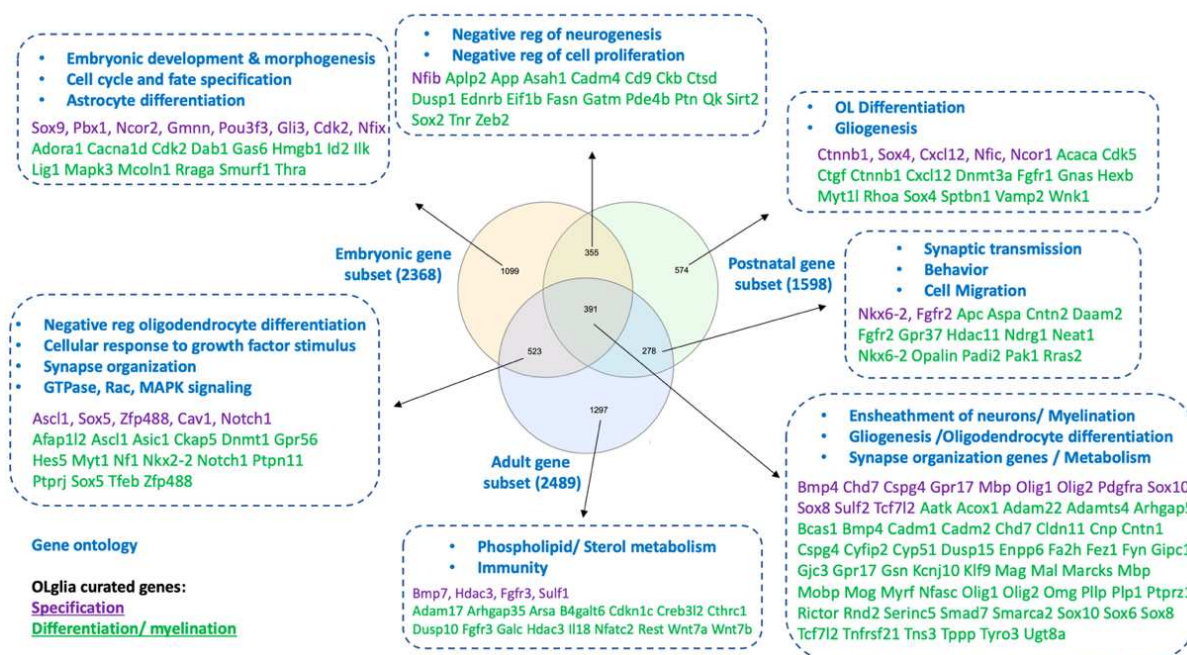

Figure 2: Expression in the oligodendroglial gene subset at different stages (4517 genes) correlates with processes associated during brain development. Venn-diagram showing how differential expression during development affects gene ontology (GO) processes (Panther) regulating oligodendrogenesis from the embryonic, postnatal and adult stages (subset of 4517 genes)

Comparison of oligodendroglial genes-set expressed during development (4517 genes) shows 1099, 574 and 1297 stages-specific genes respectively expressed during embryonic, postnatal and adult stages (Fig. 2). In total, 1547/6455 genes shared common expression. Particularly, 391 genes that are expressed between all stages, involved in oligodendrogenesis (e.g. *Klf9*, *Rnd2*, *Gjc3*, *Mal*, *Adam22*, *Olig2*, *Fez1*, *Olig1*, *Serinc5*, *Rictor*, *Mog*, *Bcas1*, *Pdgfra*, *Nfasc*, *Ugt8a*, *Plip*, *Cyfip2*, *Fa2h*, *Cd200*, *Sox10*, *Kcnj10*, *Aatk*, *Smad7*, *Cadm1*, *Ptporz1*, *Mobp*, *Tcf7l2*, *Cyp51*, *Bmp4*, *Plp1*, *Omg*, *Mag*, *Sulf2*, *Fyn*, *Chd7*, *Sox6*, *Gipc1*, *Smarca2*, *Enpp6*, *Arhgap5*, *Gsn*, *Tnfrsf21*, *Cldn11*, *Myrf*, *Cnp*, *Dusp15*, *Sox8*, *Gpr17*, *Tns3*, *Cntn1*, *Tyro3*, *Marck*, *Ccnd1*, *Acox1*, *Gria*, *Tppp*, *Cspg4*, *Cadm2*, *Adamts4*, *Mbp*). Gene restricted to the embryogenesis stage are associated with regulation of specification (e.g. *Pou3f3*, *Pbx1*, *Cdk2*, *Sox9*, *Ncor2*, *Gmnn*, *Nfix*, *Gli3*, *Hey1*, *Hes5*, *Ascl1*, *Id2*, *Zic1*, *Vegfa*), cell proliferation (e.g. *Mki67*, *Mcm6*, *Dusp6*, *Cdk1*, *Cdk2*, *Fn1*, *Mapk3*, *Id2*), embryogenesis and regulation of neurogenesis. Postnatal stage is associated with gliogenesis, OL differentiation and myelination (e.g. *Cxcl12*, *Dnmt3a*, *Myt1l*, *Cdk5*, *Ctnnb1*, *Ctgf*, *Sptbn1*, *Wnk1*, *Sox4*, *Rhoa*, *Gnas*, *Acaca*, *Vamp2*, *Fgfr1*). At the adult stages: majority of the processes enriched are involved in synaptic transmission, behavior, migration, metabolism, sterols and immunity.

3- METHODOLOGY DEVELOPED TO ANALYZE OLIGODENDROGLIAL ENRICHMENT

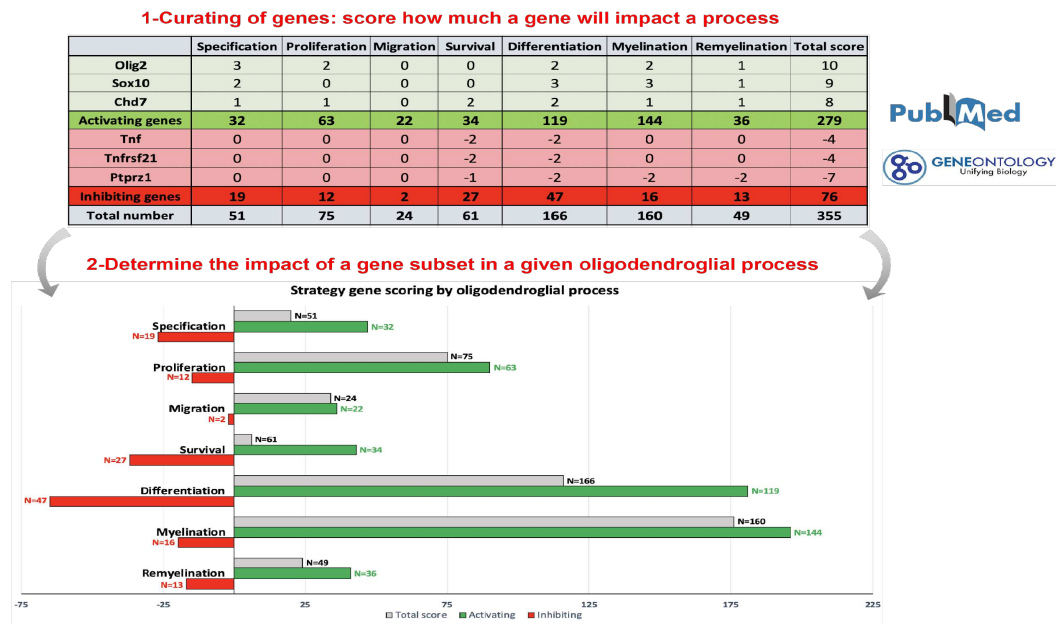

Figure 3. Curation strategy established to determine the impact of a gene subset in a given oligodendroglial process. 1-Table exemplifying few genes scored for their positive (green) or negative (red) implication in different processes regulating oligodendrogenesis, obtained from the bibliographic curation of functional studies. 2- Graphic representation of the number of genes promoting (green) or inhibiting (red) oligodendrogenesis.

Although GO processes can be informative for fast interrogation, they are not sufficiently resolute and accurate for applying our strategy (particularly using lists >2000 genes), with defects in their relevance (including housekeeping genes). Thus, we established a strategy of gene curation to determine relevancy of gene enrichment in a given process regulating oligodendrogenesis (OPC specification, proliferation, migration, survival, differentiation and (re)myelination) (Fig. 3). To do so, we curated more than 2.000 publications involving functional studies demonstrating the requirement of a given gene in a physiological or pathological context. This curation implicated about 400 genes scored for each process from 1-3 (low, medium, strong), either positively or negatively, depending on the requirement or evidence of their function in that process. Thus, we found 51 regulating specification, 75 for proliferation, 24 for migration, 61 for survival, 166 for differentiation, 160 for myelination and 49 for remyelination. These genes are not necessarily expressed in the OL lineage, taking into account oligodendroglial regulation from other cells (NPCs, neurons, astrocytes, endothelial or microglial cells). Most of the genes studied are linked to the process of differentiation and (re) myelination, highlighting the fact that most of the research strategies focus on identifying new targets to promote OL differentiation.

4-APPLICATION OF THE SCORING TO COMPARE OLIGODENDROGLIAL GENE SET

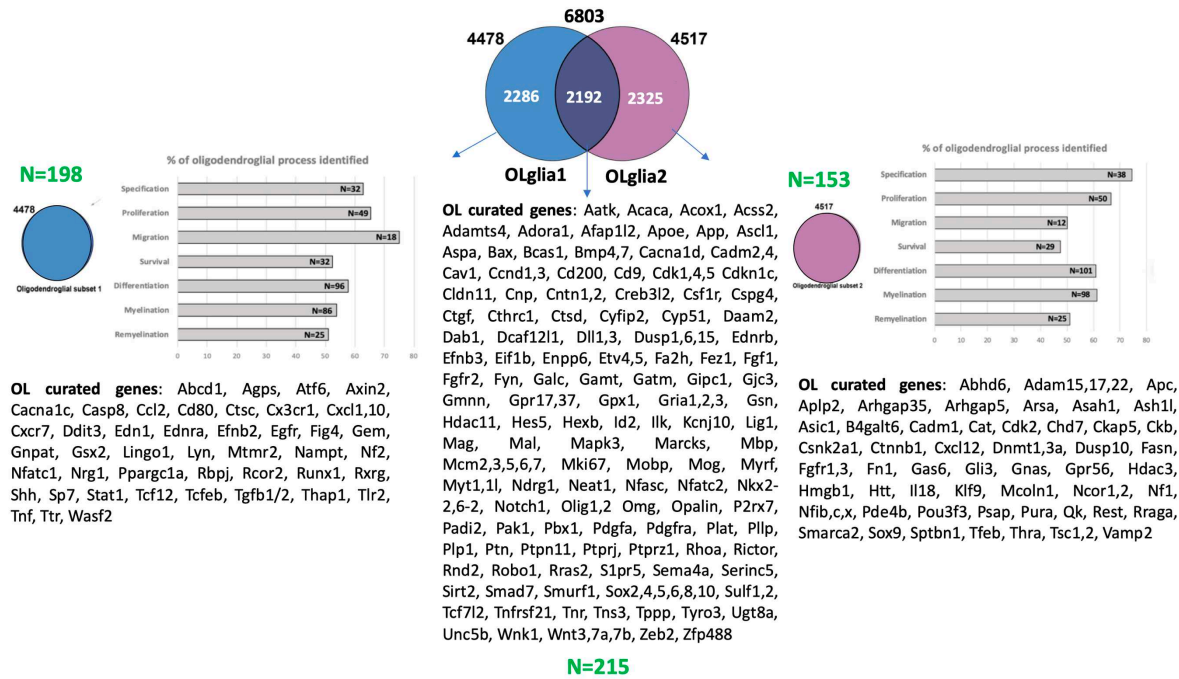

Figure 4. Application of the curated gene scoring to compare oligodendroglial gene subsets. Venn-diagram comparing the number of oligodendroglial genes shared between the 2 lists of 4478 and 4517 genes and their associated number of curated genes (in green). Number of oligodendroglial curated genes are represented in green. Each processes regulating oligodendrogenesis are represented with histograms showing percent of processes, including the number of oligodendroglial curated genes regulating these processes.

Using two independent approaches (Fig. 4), we obtained a group of 4478 genes (including 198 curated genes) and 4517 genes (including 153 curated genes), representing 6803 genes in total and almost 1/3 of genes in common (2192 genes, including 215 curated genes). Most of the oligodendroglial curated genes are expressed in the intersection (215 in total), validating our strategy for data selection and gene-sets enrichment. Thus, all the oligodendroglial processes are highly represented in both complementary strategies (between 50% to 80% identified) without major differences. However, using lists of genes of this order of magnitude is not possible for the next steps of the project, especially for querying the SPIED/ Connectivity map platform (generating a list of hubs genes and small molecules), which does not give results beyond 4000 genes, so we refined these lists from these intersections based on their expression as well as the curated genes.

5-STRATEGY TO COMPARE, REFINE AND VALIDATE GENE LIST FOR SPIED ANALYSIS

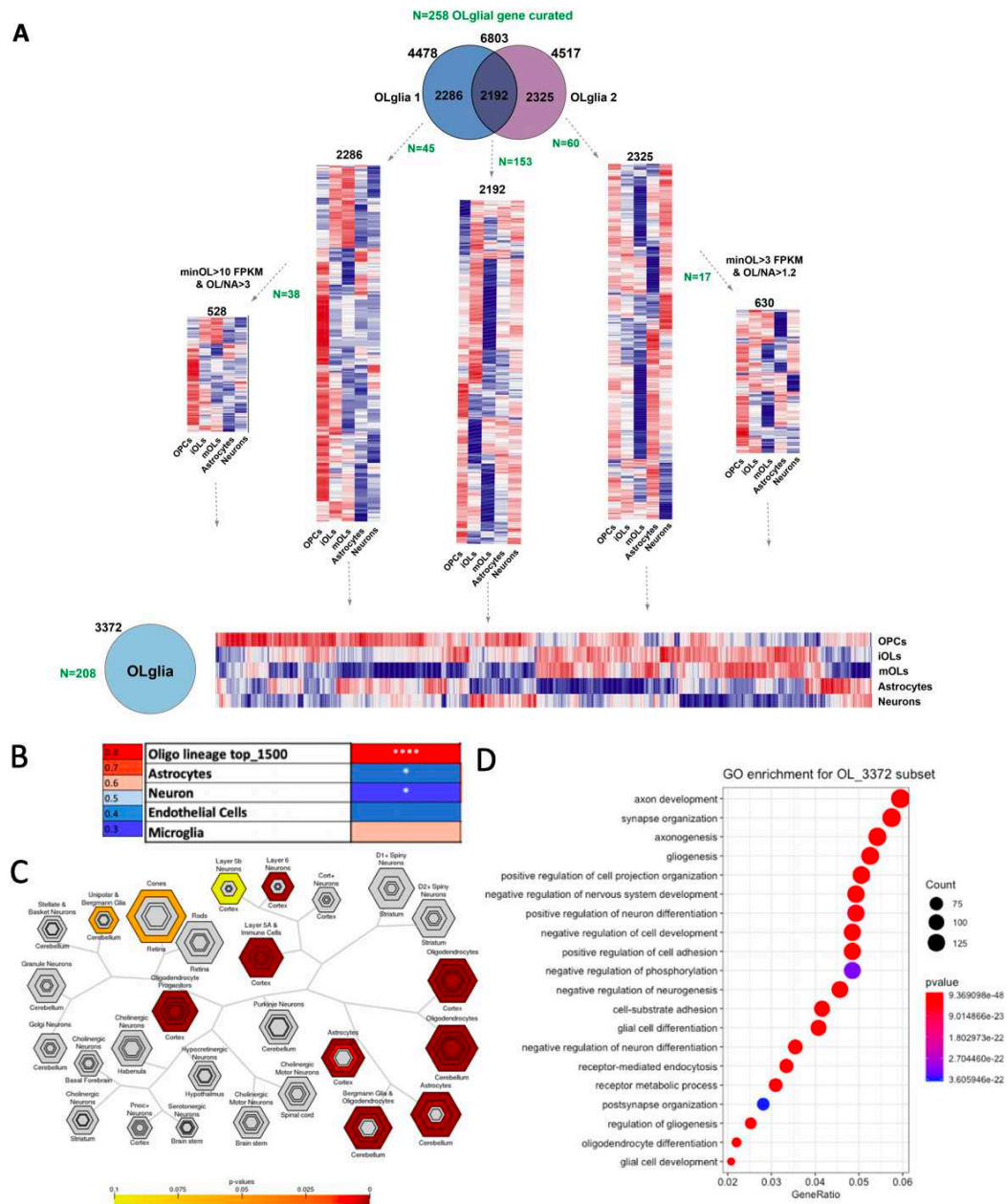

Figure 5. Strategy to compare, refine and validate gene list of 3372 genes for SPIED analysis

(A) Heat map representation performed on the lists of 2286, 2192, 2325, 528, 630 and the refined subset of 3372 genes, represented as a log₂ fold-change gene expression from the expression of neural cell type database (Zhang et al, 2014). Each bar represents a gene highly expressed (red) or not (blue) in oligodendroglial cells (OPCs, iOLs and mOLs), neurons and astrocytes. In green are represented the number of oligodendroglial curated genes included in the lists. Bioinformatics criteria based on gene expression are also indicated. **(B)** Cell type enrichment obtained in the subset of 3372 genes using top 500 of gene expression from brain cell type database (Zhang et al, 2014) *Pval 0.05 **, Pval: 0.01 ;*** Pval 0.001; Pval: 0.0001. Blue: <30%, Red:>80% specificity enrichment). **(C)** Cell type-specific expression analysis (CSEA). The bulls-eye plot size is scaled to the number of genes specific to a cell type at increasing levels of specificity (Xu et al., 2014). The FDR-adjusted hypergeometric test p-value is plotted for each level of specificity, with unenriched groups colored gray. Cell type bulls-eye plots are arranged by hierarchical distance of their specific gene expression levels. **(D)** GO enrichment analysis: Dot plot represents functional pathways involved in OL biology (q-adjusted two-sided hypergeometric test, Padj < 0.05) sorted by Count levels. Gene ratio dot size represents the percent of genes for each GO term differentially expressed and the color represents the corrected p-value (p.adjust).

In order to manipulate reasonable gene lists for connectivity map analysis (Fig. 5A), we refined genes subsets (exclusion 2286 and 2325 genes) using combination of curated genes scoring, heatmaps, gene ontology analysis and different criteria of gene expression (expression higher than 10 or 3FPKM; and 3 or 1.2 times higher than in neurons or astrocytes, respectively for the list of 2286 and 2325 genes). Note that we mostly enriched gene expression in the OPCs cell type using this criteria. From these exclusions, we obtained 528 and 630 genes highly expressed into the oligodendroglial lineage to make an intermediate list of 3372 oligodendroglial genes (including 208 curated genes) manipulable for connectivity map analysis. The subset of 3372 genes is enriched in genes expressed in oligodendroglial cells (Fig. 5B), when comparing the Top500 of gene expression by cell types (established from the Zhang database). Moreover, cells type significantly enriched (Fig. 5.C) are OPCs (Cortex/Pdgfra+, FDR: 5.200e-24) and OLs (Cerebellum/Cnp+, FDR: 1.985e-38, Cortex/Cnp+, FDR: 5.583e-38). Finally, GO processes associated with the group of 3372 genes (Fig. 6D) are associated with glial cell development, gliogenesis and OL differentiation. Moreover, processes related to axonal development and synapse organization are highly enriched, and those processes obtained can be also considered as an indirect consequence of the oligodendroglial activity.

We have now generated an intermediate cluster of 3372 genes with high enrichment in oligodendroglial expression that can be used to query the SPIED platform. We will also use oligodendroglial lineage data (Azim et al, 2016) to identify which of our oligodendroglial gene are expressed dorsally in precursors and which are expressed later in the post-mitotic stages of cell differentiation and maturation.

6- IDENTIFY GENES EXPRESS IN PRECURSORS / POSTMITOTIC CELLS DURING OLIGODENDROGENESIS

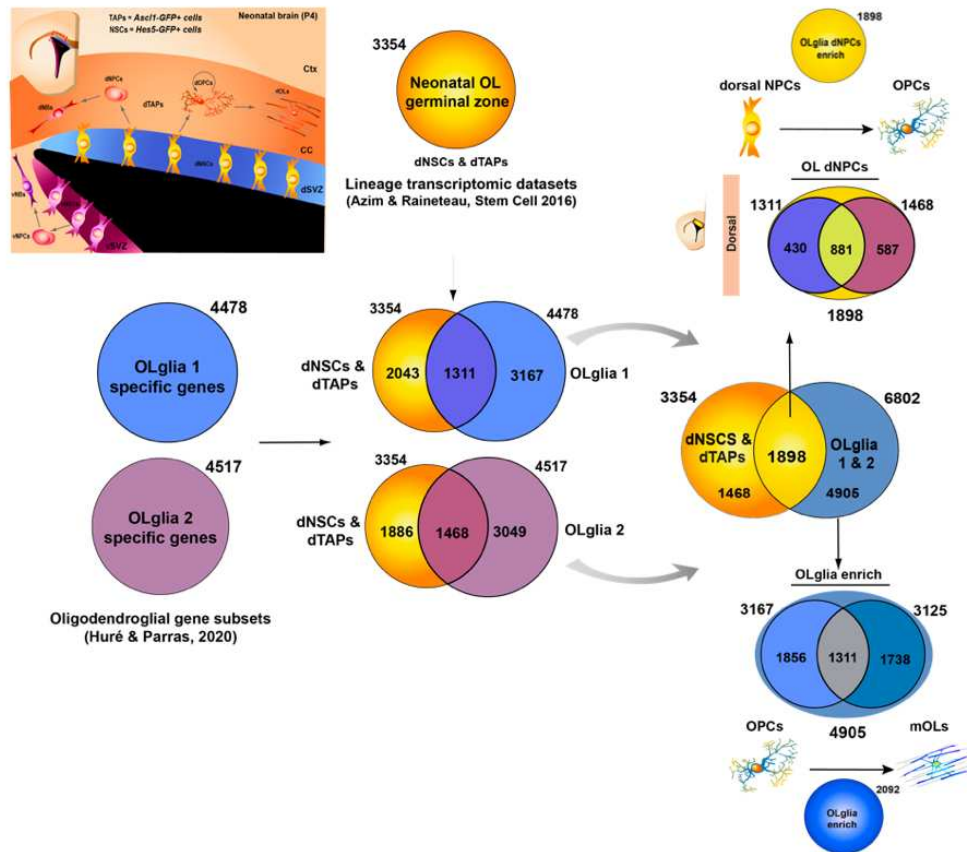

Figure 6. Strategy applied to delimitate genes expressed in precursors and postmitotic cells during oligodendrogenesis. Oligodendroglial gene subsets of 4478 and 4517 genes were compared with transcriptomes from dorsal precursors, NSCs and TAPs, representing a list of 3354 genes (Azim et al, 2016). Thus, we obtained 1898 oligodendroglial genes regulated dorsally, whereas 2092 are not regulated and regulated post mitotically during OL differentiation, maturation and myelination.

For lineage enrichment (Fig 6), we crossed genes expressed in progenitors generating oligodendroglia with transcriptomes of dorsal and lateral progenitors (dNPCs: NSCs, TAPs) of the neonatal dorsal SVZ ($P_{val} < 0.05$, $FC > 1.2$) (Azim, 2015 #3226; Azim, 2017 #4169). Thus, we found 3354 genes expressed in dNPCs supposed to promote gliogenesis, versus 3458 genes expressed in lateral NSCs & TAPs (INPCs). By crossing our lists of 4462 and 4629 genes with those expressed into dNPCs, we obtained respectively 1898 regulated genes (1311 and 1468 genes respectively for OL strategy 1 & 2), whereas we found 4905 oligodendroglial genes that are not regulated into NPCs (with 3167 and 3049 genes from oligodendroglial gene subsets). This procedure allowed us to delineate 1919 genes enriched in dorsal SVZ progenitors versus 2139 that were not, likely corresponding to postmitotic oligodendroglial cells.

7- OLIGODENDROCYTES GENES REGULATED INTO DORSAL NPCS

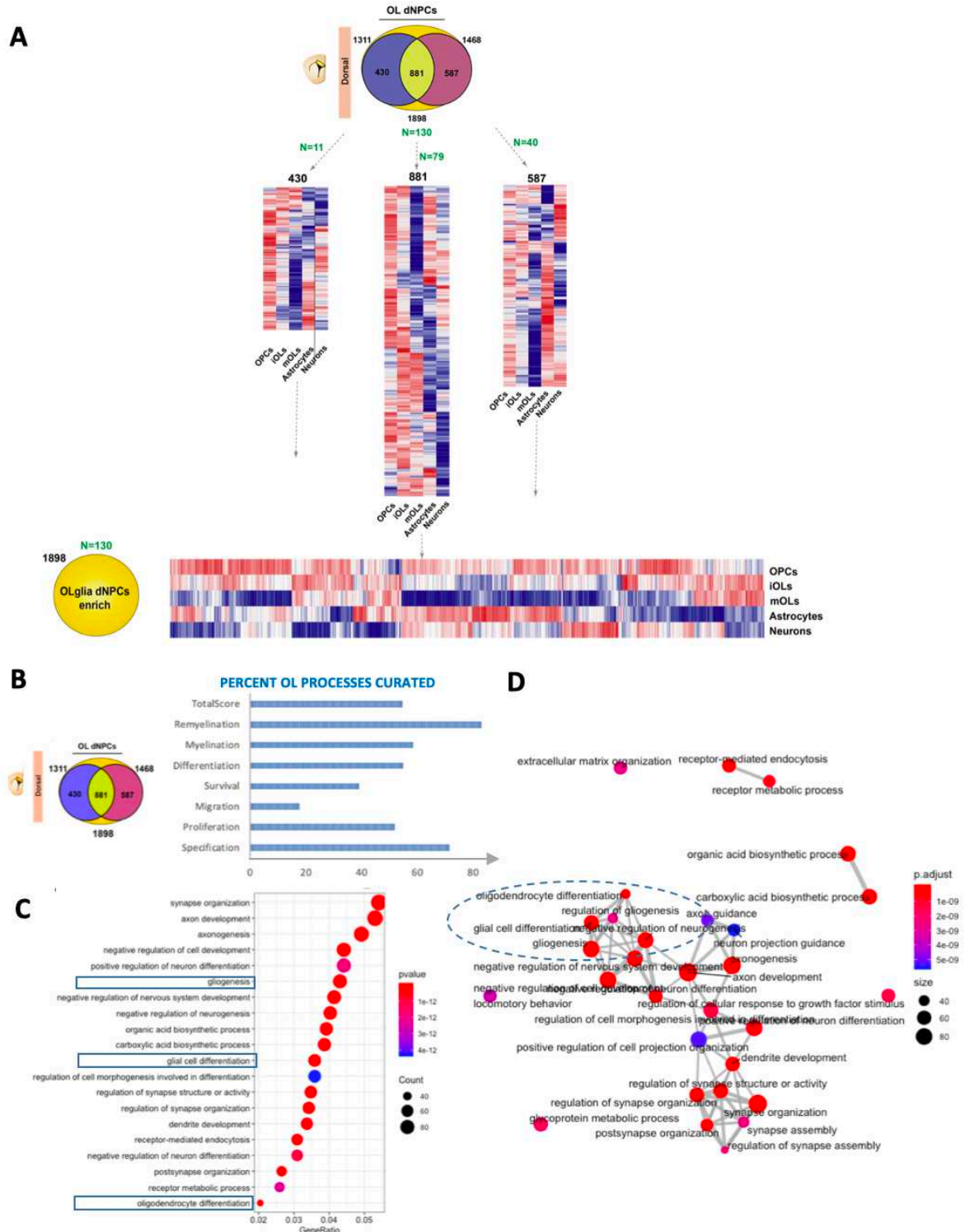

Figure 7. Analysis of oligodendroglial gene expression regulated into dorsal NPCs. (A) Oligodendroglial gene enrichment analysis obtained from the lists of 430, 881, 587 and 1898 genes, represented using a log2 fold-change heat map representation from the expression of the neural cell type database (Zhang et al, 2014). Each bar represents a gene highly expressed (red) or not (blue) in neural cell types, including oligodendroglial cells (OPCs, iOLs and mOLs), neurons and astrocytes. In green are represented the number of oligodendroglial curated genes included. **(B)** Percent of the oligodendroglial curated processes in the list of 1898 genes **(C)** GO enrichment analysis generated using Cluster Profiler and **(D)** network associated

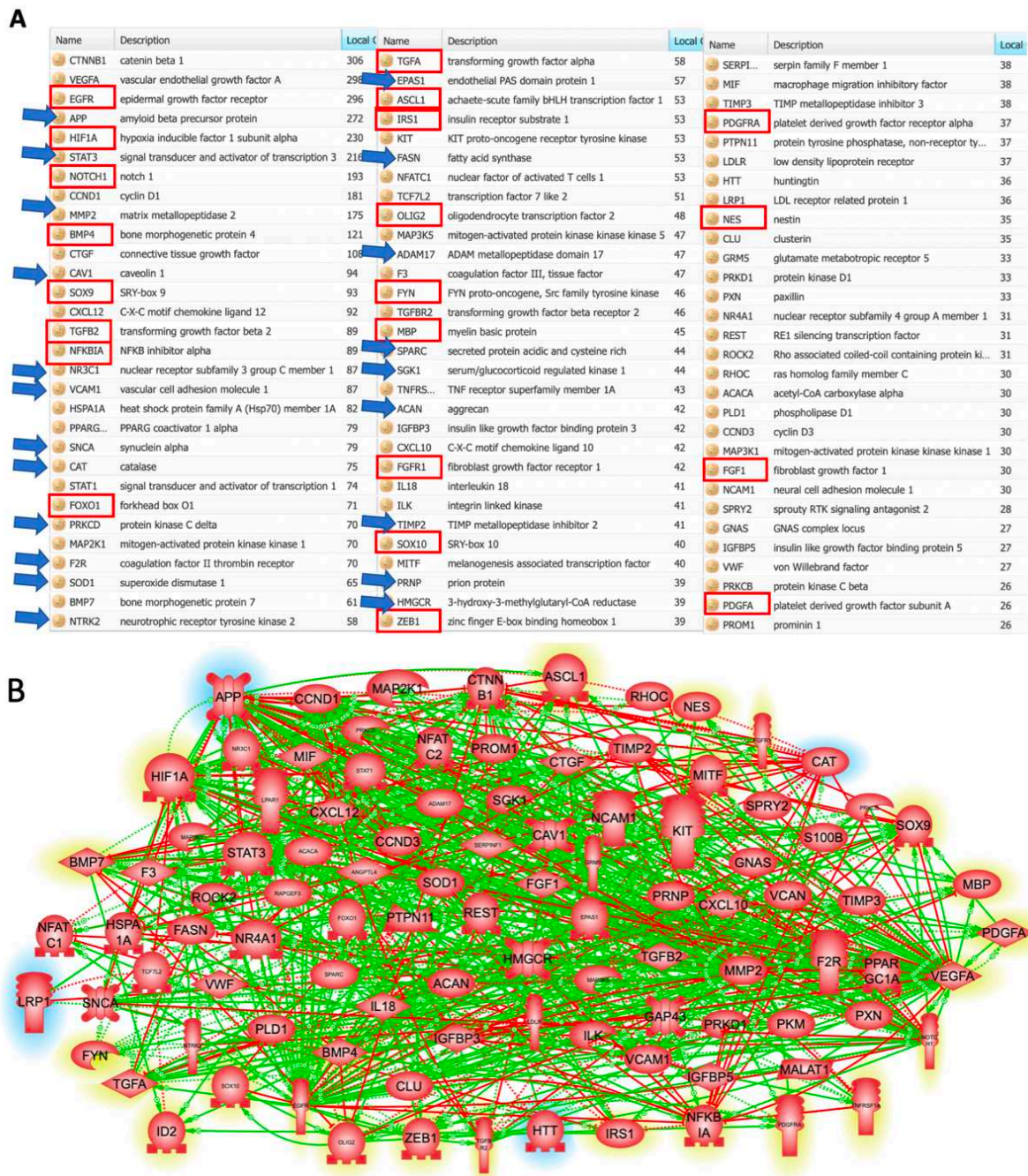

Figure 7". Reconstruction of gene networks involved in dorsal specification of oligodendrogenesis.

(A) Key regulatory genes sorted by their local connectivity using Pathway studio (Elsevier). The genes framed in red are those known to regulate oligodendrogenesis, while the blue arrows indicate some of them that are not really characterized. **(B)** Gene network associated with the group of 1898 genes. In green and red are represented respectively a positive or negative regulation/ interaction between genes. We highlighted in yellow key regulatory genes that are known to regulate oligodendrogenesis, whereas those in blue are not really characterized.

We generated heatmaps for each oligodendroglial gene subsets regulated dorsally into dNPCs (Fig. 7.A). As expected, intersection containing 881 genes is highly expressed in oligodendroglial lineage (particularly in OPCs) with a low expression in neuron/ astrocytes (N/A) cell types. Whereas the strategy to generate the group 4478 genes is mostly restricted to the oligodendroglial lineage

(with 430 excluded genes expressed in OPCs), the second approach in identifying 4517 genes predominantly expressed precursors genes expression in N/A (list of 587 genes), expressed during embryonic development for cell fate specification process. In this group of 1898 genes, 130 curated genes are involved in the process of oligodendrogenesis: specification (*Bmp7, Bmpr1a, Cav1, Gem, Gli3, Gsx2, Ncor1, Ncor2, Nfib, Nfic, Nfix, Pdgfra, Pou3f3, Sox9, Sulf2*), specification and differentiation (*Ascl1, Bmp4, Chd7, Cspg4, Ctnnb1, Cxcl12, Fgfr3, Gpr17, Mbp, Notch1, Olig1, Olig2, Sox10, Sox8, Tcf7l2*) and differentiation (*Aatk, Adam22, Afap1l2, Apc, Arhgap35, Axin2, Bcas1, Cacna1d, Cdkn1c, Cntn1, Creb3l2, Ctgf, Cthrc1, Cyfip2, Cyp51, Daam2, Dab1, Dnmt3a, Dusp15, Ednrb, Egfr, Enpp6, Fgfr1, Fyn, Gnas, Gpr37, Gsn, Id2, Ilk, Klf9, Lingo1, Myt1, Nfatc1, Nfatc2, Nkx2-2, Pde4b, Ptn, Ptpn11, Ptpri, Ptpnz1, Rest, Sirt2, Smarca2, Sox6, Tgfb2, Tns3, Tyro3*). Interestingly, genes express in dNPCs (Fig. 7B) are not restricted to the specification process (70%) and genes involved in re-myelination are also highly expressed in precursors cells. An example that we found is MBP involved in later process of maturation/ myelination), but its pattern of expression does not following its timing of expression with high level of expression in OPCs. GO processes are enriched in gliogenesis, OL differentiation, axonogenesis or synapse organisation, and associated with a negative regulation of neurogenesis, suggesting that genes that we selected are involve in cell fate specification choice (Fig. 7C,D). Thus, based on the OL expression enrichment and representativity (OL curated and processes associated), we selected the entire group of 1898 genes expressed dorsally into NPCs for further analysis.

We next interrogated Pathway Studio (Elsevier) to reconstruct gene networks and identify potential hub genes based on their level of connectivity (Fig. 7"). We found among the most connected entities (Fig. 7"A,B) numerous regulators of oligodendrogenesis (e.g. Egfr, Notch1, Bmp4, Sox9, Ascl1, Olig2, Fyn, Mbp, Zeb1, Pdgfra...), and some of them highly connected but not well known regarding their role in the regulation of oligodendrogenesis (e.g. App, Mmp2, Cav1, Vcam1, Prkcd, F2r, Sod1, Ftrk2...).

8-OLIGODENDROGLIAL GENES THAT ARE NOT REGULATED INTO DORSAL NPCS

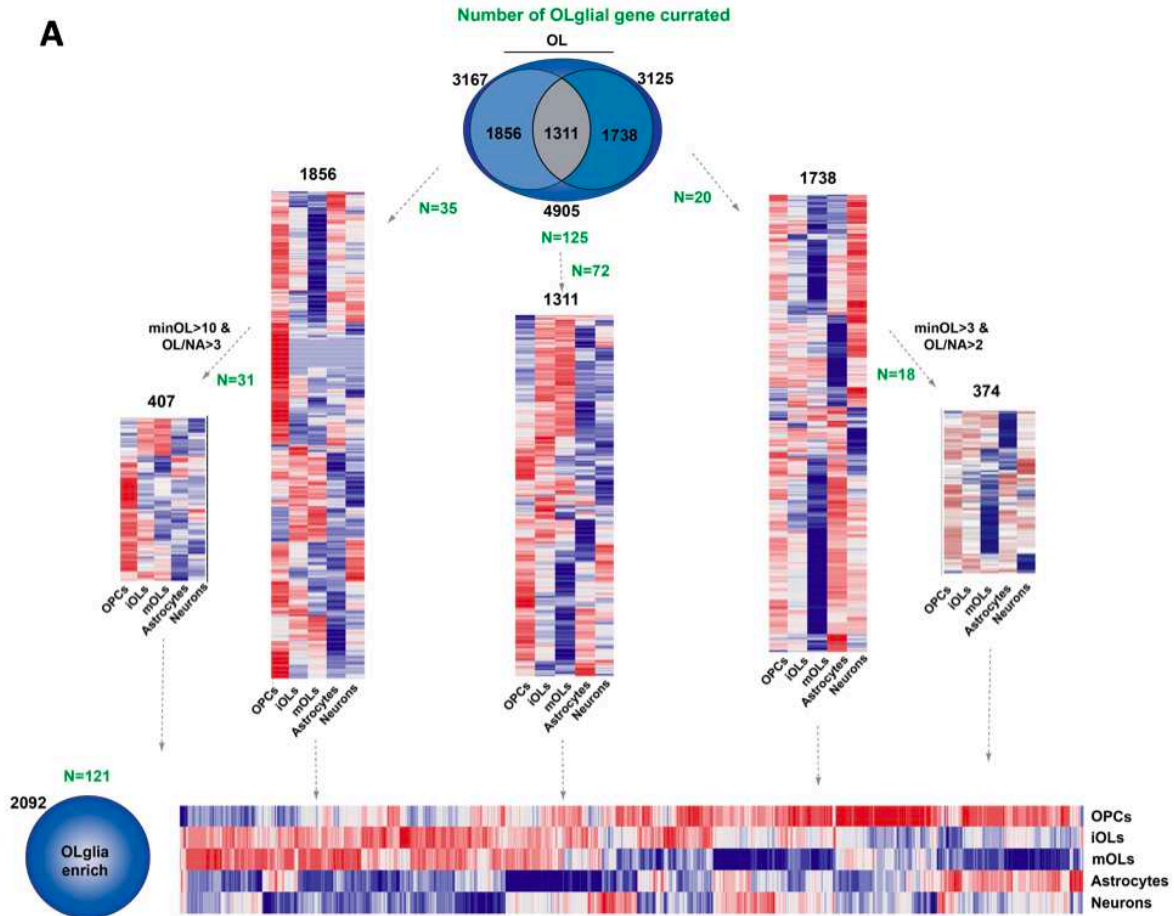

B PERCENT OL PROCESSES CURATED

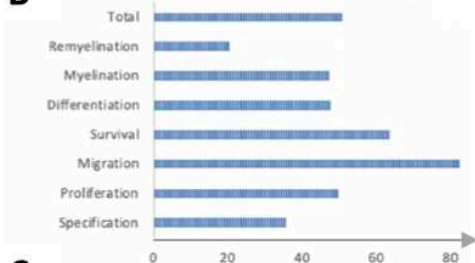

C

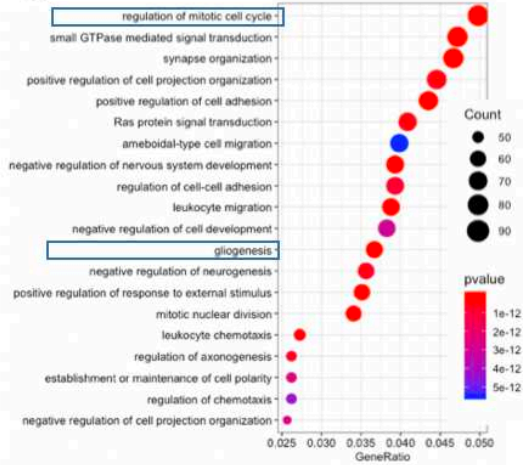

D

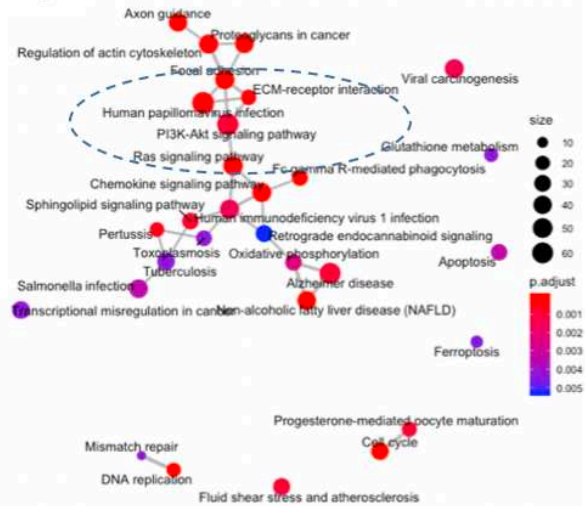

Figure 8. Analysis of oligodendroglial gene expression not regulated into dorsal NPCs

(A) Oligodendroglial gene enrichment analysis obtained from the lists of 1856, 407, 1311, 1738, 374 and 2092 genes, represented using a log2 fold-change heat map representation from the expression of neural cell type database (Zhang et al, 2014). Each bar represents a gene highly expressed (red) or not (blue) in neural cell types, including oligodendroglial cells (OPCs, iOLs and mOLs), neurons and astrocytes. In green are represented the number of oligodendroglial curated genes included in the different lists. **(B)** Percent of the oligodendroglial curated processes represented in the list of 2092 genes **(C)** GO enrichment analysis generated using Cluster Profiler and **(D)** GO network associated

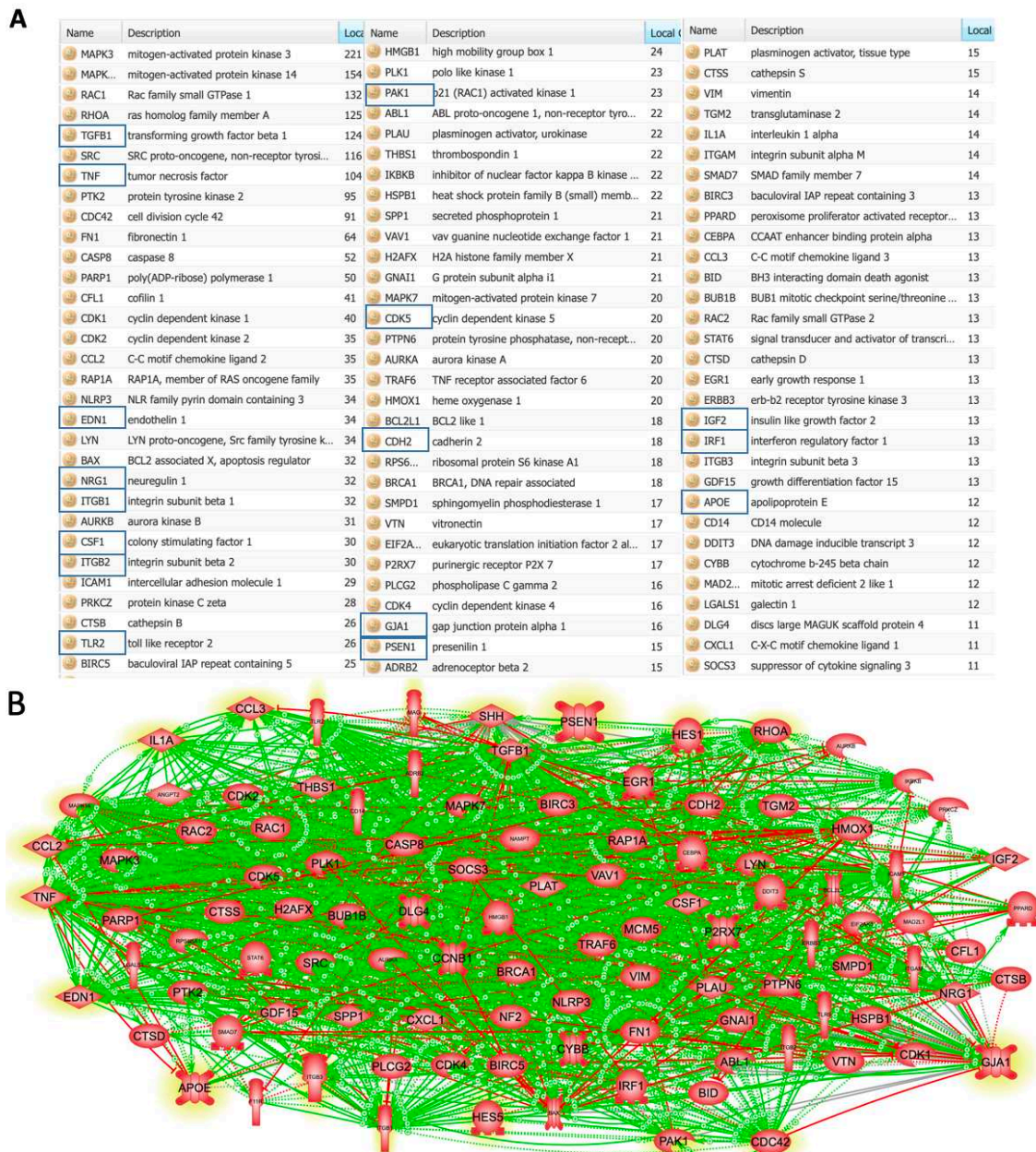

Figure 8". Reconstruction of gene network involved during postmitotic OL generation

(A) Key regulatory genes sorted by local connectivity using Pathway studio (Elsevier). The genes framed in blue are those known to regulate oligodendrogenesis. **(B)** Gene network associated with the group of 2092 genes. In green and red are represented respectively a positive or negative interaction between genes. We highlighted in yellow key regulatory genes that are known to regulate oligodendrogenesis

Given the important size of oligodendroglial gene subset (4905 genes) that make impossible further analysis, we refined this list. Only 1311 genes are common in both strategies (30%) and highly expressed in the oligodendroglial lineage. Using different criteria of gene expression (1856 genes: expression higher than 10 FPKM, 1738 genes: expression higher than 3 FPKM, as well as a ratio of expression respectively 3 and 2 fold time compared to N/A expression), we obtained 407 and 374 genes respectively. These lists (Fig. 8B) contain genes associated with OL development (e.g. *Bcam*, *Bmp6*, *Gad2*, *Pak2*, *Rara*, *Slit1*, *Casp3*, *Cdk2*, *Chd5*, *Enpp5*, *Emx2*, *Gas6*, *Gsk3b*, *Nkx6.2*, *Pak3*, *Prox1*, *Thra*, *Tsc1*, *Tsc2*, *Vangl1*, *Vangl2*). The final list contain 2092 genes, with 121 OL curated genes involved in oligodendrogenesis, specification (e.g. *Gmnn*, *Nampt*, *Nkx6-2*, *Pbx1*, *Rbpj*, *Rcor2*, *Shh*, *Sulf1*), either specification and differentiation (e.g. *Cdk2*, *Cx3cr1*, *Fgfr2*, *Hdac3*, *Sox4*, *Sox5*, *Zfp488*) and differentiation (e.g. *Adora1*, *Aspa*, *Cdk5*, *Ctsd*, *Cxcl1*, *Cxcr7*, *Dnmt1*, *Dusp10*, *Edn1*, *Ednra*, *Fez1*, *Gas6*, *Hdac11*, *Hes5*, *Hmgb1*, *Lig1*, *Mapk3*, *Mcoln1*, *Myrf*, *Myt1l*, *Neat1*, *Nf1*, *Opalin*, *Padi2*, *Pak1*, *Rhoa*, *Rictor*, *Rnd2*, *Rxrg*, *Smad7*, *Smurf1*, *Sox2*, *Sp7*, *Tcf7b*, *Tfeb*, *Tfeb*, *Tgfb1*, *Thap1*, *Thra*, *Tlr2*, *Tnf*, *Tnfrsf21*, *Tnr*, *Wnk1*, *Wnt7a*, *Wnt7b*, *Zeb2*). Most of the processes associated (Fig. 8C,D) are related to cell cycle, mitosis, DNA replication migration and cell survival. Moreover, some process are associated with Akt, Ras signaling (regulating OL development), (L.-J. Chew et al. 2010). Interestingly, gene enrichment is also associated with significant enrichment in Alzheimer disease and oxidative phosphorylation.

We next interrogated Pathway Studio (Elsevier) to reconstruct gene networks and identify potential hub genes based on their level of connectivity (Fig. 8”A,B). We found among the most connected entities (Fig. 8”A,B) some regulators of oligodendrogenesis (e.g. *Tgfb1*, *Tnf*, *Edn1*, *Nrg1*, *Itgb1*, *Tlr2*, *Pak1*...).

Therefore, we finally refined oligodendroglial gene subsets into more handy gene sets of 3372, 1898 and 2092 genes for interrogating the SPIED database. This intermediate group of 3372 genes contain 221 OL curated genes whereas the refined subsets contained 251 OL curated genes (difference include *Adam17* *Afap1l2* *Arhgap5* *Asah1* *Ash1l* *B4galt6* *Cacna1d* *Cdkn1c* *Ckap5* *Creb3l2* *Csf1r* *Csnk2a1* *Cx3cr1* *Dcaf12l1* *Dnmt3a* *Eif1b* *Fa2h* *Gem* *Myt1l* *P2rx7* *Pde4b* *Pou3f3* *Ppargc1a* *Qk* *Rest* *S1pr5* *Sema4a* *Tcf7l2* *Ttr* *Ugt8a* *Unc5b* *Wnt7a* *Wnt7b*).

9-GENERATE A LIST OF KEY GENES HUBS REGULATING OLIGODENDROGENESIS

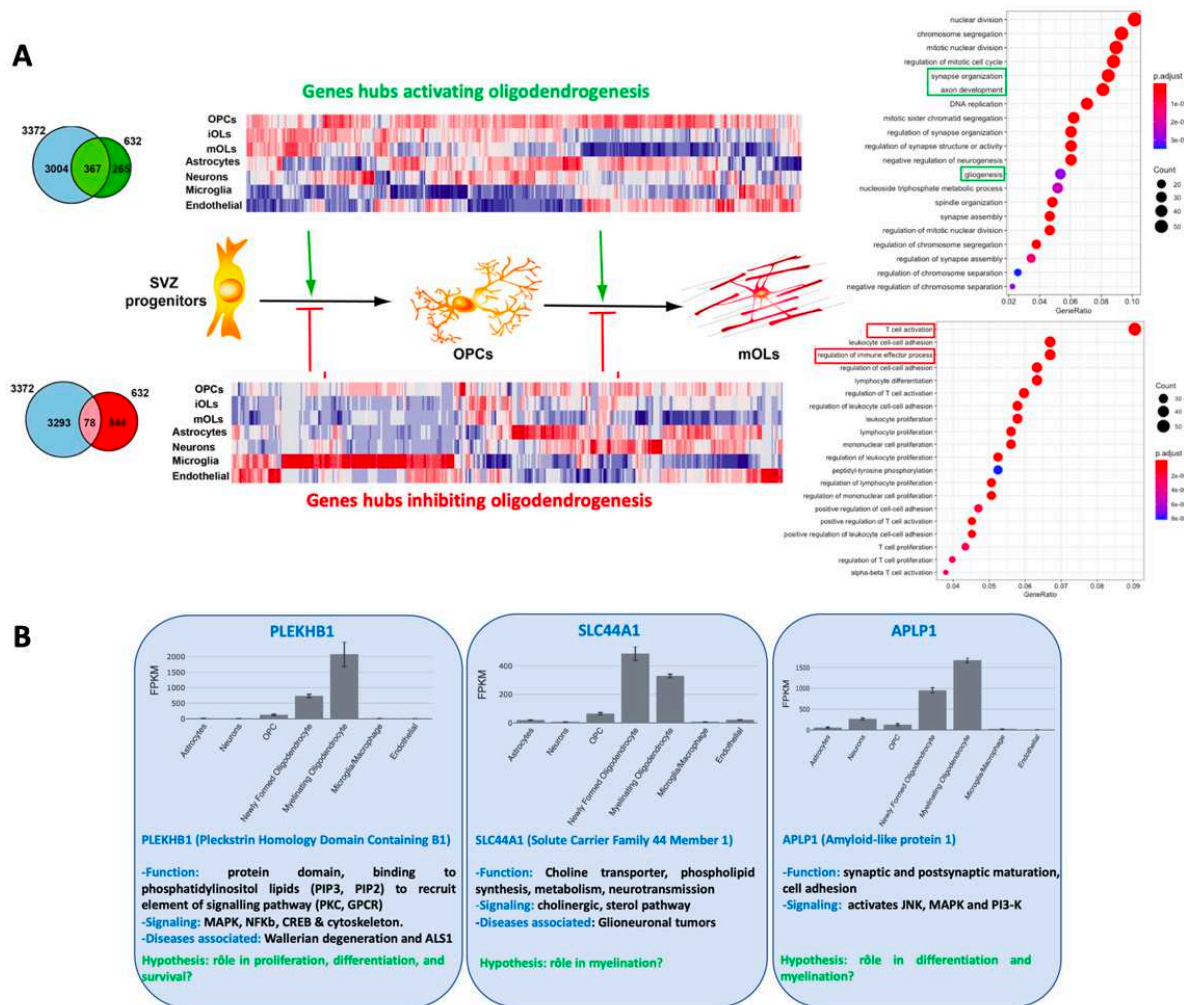

Figure 9: Generate a list of key regulators oligodendroglial hub genes using SPIED

(A) Hub genes regulating oligodendrogenesis, obtained from the SPIED platform, including correlated (up) and anti-correlated (down) genes. Heatmap representation (log₂ fold-change) of the 632 hub genes correlated (top) or anticorrelated (down), established from the expression of a neural cell type database (Zhang et al, 2014). Each bar represents a gene highly expressed (red) or not (blue) in neural cell types, including oligodendroglial cells (OPCs, iOLs and mOLs), neurons and astrocytes, microglia and endothelial cells. Analysis was complemented with GO enrichment analysis using Cluster Profiler.

(B) An example of unknown correlated hub genes (e.g. *Plekhh1*, *Slc44a1* and *Aplp1*), including their expression in brain cell types (Zhang et al, 2014) and their hypothetical regulation of oligodendrogenesis.

The correlated genes are highly express in oligodendrocyte lineage, with 367 hub genes include in our oligodendroglial lists, associated with oligodendroglial development, myelination, and axonal ensheathment (Fig. 9A). Corelated hub genes include numerous oligodendroglial curated genes (e.g. *Aatk*, *App*, *Arhgap5*, *Ash1l*, *Cadm2*, *Cdk1*, *Cdk4*, *Ckap5*, *Ckb*, *Cldn11*, *Cnp*, *Cntn1*, *Cntn2*, *Daam2*, *Dnmt1*, *Ednrb*, *Enpp6*, *Etv5*, *Fez1*, *Gmnn*, *Gpr17*, *Gpr37*, *Gria1*, *Gria2*, *Gria3*, *Kcnj10*, *Klf9*, *Lig1*, *Mag*, *Mbp*, *Mcm2*, *Mcm3*, *Mcm5*, *Mcm6*, *Mcm7*, *Mki67*, *Mobp*, *Mog*, *Myrf*, *Nfib*, *Nkx2-2*, *Nkx6-2*, *Olig1*, *Olig2*, *Opalin*, *Plp1*, *Ppargc1a*, *Psap*, *Ptprz1*, *Rest*, *Rhoa*, *Rictor*, *Sox10*, *Sox2*, *Sox8*, *Sptbn1*, *Stat1*, *Tnr*,

Tppp). On the other hand, the anticorrelated genes are interestingly expressed in microglial cells (only 76 genes are include in the down gene hubs, including *Arhgap5, Ash1l, Rest, Ppargc1a, Stat1, Rictor, Klf9*). Interestingly, they are associated with inflammatory mechanisms and immune cell activation (IL12, IFN γ , ROS production). Remarkably, most hub genes promoting oligodendrogenesis have enriched-expression in oligodendroglia, while those inhibiting it are enriched in microglia (and less importantly in astrocyte and endothelial cells). GO processes are associated with T cell receptor signaling pathway (including *Vav1, Cd8a, Zap70, Cd3g, Cd3e, Lcp2, Grap2, Cd3d, Ptpn6, Icos, Lat, Cd8b1, Ptprc, Lck, Cblb, Raf1, Il4, Akt1, Map2k7, Mapk13, Mapk14, Map2k1, Cdk4, Rhoa, Il10, Csf2, Mapk9, Grb2, Map3k14, Nfkbia, Fos, Pak2, Gsk3b, Cd4, Nfkbie, Map3k8, Tnf, Rela, Chuk, Hras, Ctla4, Cd28, Pcd1, Prkca, Pik3ca, Il2, Nras, Nfkb1, Bcl10, Ppp3r2, Pik3r3, Kras, Nfkbib, Pak1, Cd40lg, Ikbkb, Pik3r2, Pik3cb, Vav3, Map3k7, Il5, mCG_125315, Pak7, Malt1, Mapk3, Ppp3ca, Cdc42, Pik3r1, Vav2, Ifng, Dlg1, Mapk1, Sos1, Tec, Nfatc2, Ppp3cc, Card11, Nck2, Mapk11, Mapk12, Pak6, Fyn, Plcg1, Rasgrp1, Ppp3r1, Pdpk1, Pik3cd, Jun, Akt2, Itk, Nfatc3, Akt3, Mapk8, Mapk10, Pak3, Ikbkg, Nck1, Map2k2, Cd247, Ppp3cb, Nfatc1, Sos2*). Interestingly, this list contain expression of IFN-induced genes (*Adar Bst2 Egr1 Gbp2 Hla-A Hla-B Hla-C Hla-E Hla-F Hla-G Ifi27 Ifi35 Ifi6 Ifit1 Ifit2 Ifit3 Ifit5 Ifitm1 Ifitm2 Ifitm3 Ip6K2 Irf1 Irf2 Irf3 Irf4 Irf5 Irf6 Irf7 Irf8 Irf9 Isg15 Isg20 Mx1 Mx2 Oas1 Oas2 Oas3 Oasl Psmb8 Rnasel Rsad2 Samhd1 Stat1 Stat2 Xaf1*).

Thus, these unknown hub genes provide new avenues for functional characterization. We analyzed their potential through their gene expression in mouse and human cells using different transcriptomic databases, as well as their related properties (literature associated). We found as an example 3 genes (Fig. 9B) showing potential for gene characterization: *Aplp1, Slc44a1, Plekhhb1*.

Aplp1 is a member of the highly conserved amyloid precursor protein gene family. The encoded protein is a membrane-associated glycoprotein cleaved by secretases in a manner similar to amyloid beta A4 precursor protein. This cleavage liberates an intracellular cytoplasmic fragment that may act as a transcriptional activator, and also to play a role in synaptic maturation during cortical development. Given its specificity of expression during OL differentiation, particularly at the mature stage, *Aplp1* may have a role in differentiation and myelination. Moreover, this marker should represent a marker of OL differentiation.

Slc44a1 (Solute Carrier Family 44 Member 1) is a choline transporter (CTL1) involve in membrane synthesis and myelin production, and is associated with the onset of neurodegeneration through its role in metabolism and phospholipase D signaling pathway (Fagerberg et al. 2020). *Slc44a1* is associated with some diseases such as papillary glioneuronal tumors and schizophrenia. This gene encodes a member of the high-affinity glutamate transporters, and plays an essential role in transporting glutamate across plasma membranes and terminating the postsynaptic action, thus

representing an interesting candidate for pharmacological modulation (Hu et al. 2020). *Slc44a1* is strongly expressed in iOLs cell types, and LOF could potentially affect OL maturation and myelination.

Plekhb1 (Pleckstrin Homology Domain containing B1) is present in various proteins domains (intracellular signaling and cytoskeleton), able to bind and recruit phosphatidylinositol lipids to interact with other components of the signal transduction pathways (Mapk and Nfkb inflammatory pathway). Thus, *Plekhb1* should be a mediator of calcium signaling, having a role in oligodendrogenesis detailed in chapter 4. Moreover, *Plekhb1* is activated in an additive manner by SOX9 and SOX10 (Klum et al. 2018). Diseases associated include Wallerian Degeneration and ALS. Finally, a close member of its family *Plekha1/Tapp1* is known to inhibit OPC differentiation through suppression of the Mek/Erk pathway (Yidan Chen et al. 2015). In this paper, *Plekha1/Tapp1* was found selectively expressed in differentiating OPCs and its knockdown promoted OL differentiation and myelin gene expression in culture. Conversely, its over-expression in immature OPCs suppressed their differentiation. Thus, based on these data, *Plekhb1* may have a role in regulation of differentiation and survival.

Crossing lists of anti-correlated genes (associated with inflammatory processes) with those regulated in the context of MS can help to identify new targets negatively regulating oligodendrogenesis. For example, a study identified single-nucleotide polymorphisms (SNPs) associated with MS risk, expressed in monocytes, natural killer, B cells, CD4 and CD8 lymphocytes (Gresle et al. 2020). Comparison with those anti-correlated genes identified *CCDC88B*, *IKZF1*, *CD6*, *AVIL*, *CD37*, *SP140*, *TNFRSF14*, *CD5*, *SLC9A8*, *AGBL2*. (W.-H. Lee et al. 2001; Okamura et al. 2009; Kennedy et al. 2014; Karaky et al. 2018). Thus, those genes that are expressed in microglia/macrophages (Y. Zhang et al. 2014) could negatively affect oligodendrogenesis in the context of MS.

10-PROPERTIES OF THE SELECTED SMALL MOLECULES

Drug	Application/ candidate	Properties	target	Ogilia evidence	Score	FDA?	Patent associated
Metricrane	Diuretic	Diuretic	inhibits sodium and chloride ion	X	70	No	US 2013/0196946 A1 (Cyclodextrin-based Polymers For Therapeutic Delivery)
Heptaminol	Cardiac stimulant	Anti-inflammatory	antagonist to catecholamine/ raises intracellular free calcium level	X	70	No	WO 2008/156654 A2 (Methods And Compositions For Treating Metabolic Disorders); US 2017/0224758 A1 (Compositions And Methods Of Treating Muscular Dystrophy); US 10329301 B2 (Benzodiazepine Derivatives, Compositions, And Methods For Treating Cognitive Impairment)
Melatonin	Mental retardation, autism, cerebral palsy, primary insomnia, anxiety, prostate cancer or solid tumors	Neuroprotective/ antioxidant/ anti-apoptotic/ anti-inflammatory	agonist melatonin receptor (type 1A, B)/ antagonist estrogen receptor alpha/ interaction with calcitriol and calmodulin	Ghareghani et al, 2016	37	Yes	WO 2019/246262 A2 (Methods Of Treating Or Inhibiting Onset Of Huntington's Disease); EP 2691086 B1 (Compositions For The Treatment Of Neurologic Disorders)
Naringenin	Alzheimer, cancer, depression	Neuroprotective/ antioxidant	non-selective opioid receptor antagonist/ glutamate receptor/ acetylcholinergic system/ amyloid β metabolism/ Tau phosphorylation/ MAPK/P38 pathway	Rong et al. 2017	42	No	US 2015/0037263 A1 (Treatment Of Multiple Sclerosis With Combination Of Laquinimod And Fingolimod); US 2006/0025337 A1 (Sirtuin related therapeutics and diagnostics for neurodegenerative diseases)
Dyclonine Hydrochloride	Oral anesthetic, Friedreich's ataxia	Antimicrobial/ anticancer/ neuroprotective/ antioxidative/ anti-apoptotic	inhibit voltage-dependent Na channels/ modulate calcium signaling/ inhibit transient receptor potential channels vanilloid-3 TRPV/ mediate antioxidant responsive elements (Nrf2-ARE pathway)	X	56	Yes	US 2014/0142095 A1 - Agents Useful For Treating Friedreich's Ataxia And Other Neurodegenerative Diseases
Ginkgolide A	Various inflammatory contexts	Anti-inflammatory/ BBB protection/ anti-excitotoxic/ antioxidant/ regulation metabolism/ anti-apoptotic	antagonists of platelet-activating factor (PAF)/ inhibit NOS production/ suppressed caspase 3 cleavage through PI3K/Akt signaling pathway	Gk8: Yin et al. 2020	80	No	WO 2002/011745 A1 (Composition Containing Ginkgo Biloba That Inhibit Angiogenesis And Matrix Metalloproteinase); EP 2077821 B1 (Compositions And Methods For Modulating Immune Responses)
Levonorgestrel	Contraception and hormonal therapy	Neuroprotective / anti-inflammatory	progesterone/ estrogen receptor alpha/ glucocorticoid receptor/ inhibitor of alpha-steroid 4-dehydrogenase 1	X	65	Yes	AU 2010/308308 B2 (Neuroprotection And Myelin Repair Using Nestorone*); US 8658627 B2 (Pregnancy Hormone Combination For Treatment Of Autoimmune Diseases)
Medrysone	Ophthalmology	Neuroprotective role, anti-inflammatory	glucocorticoid receptor/ activation of phospholipase A2 inhibitory proteins	X	75	No	US 9446051 B2 (Neuroprotection And Myelin Repair Using Nestorone*), US 2014/0011791 A1 (Myelin Regeneration With Androgens)
Thioperamide	Schizophrenia and parkinson disease (clinical trials)	Antioxidant, role in learning and memory disorders, protects against PTZ-induced seizures	Histamine receptor antagonist (selective HRH1,3,4 subunits)/ CREB/BDNF pathways	X	58	No	US 10493080 B2 (Directed Differentiation Of Oligodendrocyte Precursor Cells To A Myelinating Cell Fate); US 2003/0113309 A1 (Method For Treatment Of Neurodegenerative Diseases And Effects Of Aging)
Trihexyphenidyl	Parkinson's disease, anticonvulsant, seizures	Antispasmodic	Antimuscarinic agent (subunits M1, M2, M3, M4, M5)/ antihistaminic/ anticholinergics	X	53	Yes	US 2019/0336490 A1 (COMPOSITIONS AND METHODS FOR INCREASING REMYELINATION)
Folic acid/ Leucovorin	Treatment of various cancers in combination with 5-FU, antidote to folic acid antagonists such as methotrexate	Folic acid: Anti-inflammation, antioxidant	JNK phosphorylation/ NF- κ B complex activation /upregulation of p38 MAPK phosphorylation	Folic acid: Q. Weng et al, 2017	59	Yes	WO 2019/013615 A1 (Method For Treating Traumatic Brain Injury); US 6903100 B2 (Use Of Regularly Scheduled High Dose Intravenous Methotrexate Therapy, With Interim Administration Of Immunomodulatory Agents, To Treat Multiple Sclerosis And Other Diseases Of The Central Nervous System)

Figure 10: Summary of the 11 selected drugs in the literature. This table includes properties of the selected drugs, including their current application or potential in patients, their associated properties, main targets, and pharmacogenetic scoring that we established. We also listed potential implications in oligodendrogenesis (evidence in the literature, also about their family members having a close pharmacological structure). We also listed their food and drug approval and patent associated. Note that this table was updated throughout the project. The table is described below.

Metricrane (Sm1) is a diuretic medication marketed in Japan under the trade name Arresten and is used to lower blood pressure. Metricrane is also a sulfonamide-derivative with thiazide-like diuretic activity. Metricrane inhibits sodium and chloride ion reabsorption in the distal convoluted tubule. There is no information related to medicine, but we know that inhibition of Na⁺, Ca²⁺ and K⁺ improves EAE disease animal model of MS, thus representing putative targets for MS by increasing neuronal survival, inhibiting ion channels on T cells, which may provide immunomodulation (Cherchi et al. 2021). Pharmacogenetic score found using the target genes of metricrane is 69, with significant stimulation of genes involved in differentiation and myelination. GO processes are enriched in OL differentiation.

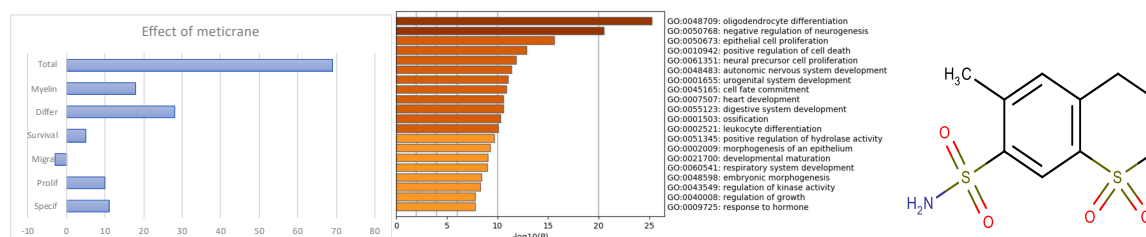

Heptaminol (Sm2) is an amino alcohol classified as a cardiac stimulant (positive inotropic action) as a doping substance. Heptaminol is a vasodilator used in the treatment of low blood pressure as a potent positive inotrope (improving cardiac contraction). Effects of heptaminol may result from alterations in cell membrane properties and possibly from an increase in intracellular free calcium ion concentration. This regulation of calcium signaling can contribute to promote OL maturation and remyelination after demyelinating episodes in the brain (Peineau et al. 1992). Heptaminol is a general antagonist to catecholamine release and uptake that also raises intracellular free calcium levels (Grobecker et Grobecker 1976). Moreover, heptaminol inhibits skin inflammation in an NO-dependent manner (Chung et al. 2016). Pharmacogenetic score found using the target genes of heptaminol is 70, with significant regulation of genes involved in differentiation. GO processes are enriched in gliogenesis and myelination.

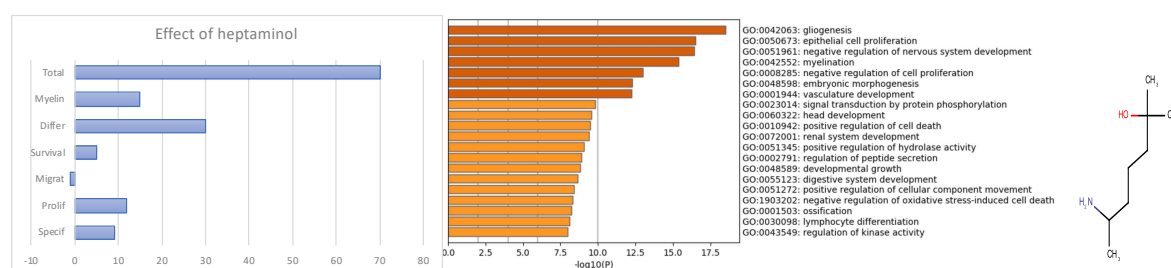

Melatonin (Sm3) is a treatment used in various conditions, such as mental retardation, autism, cerebral palsy, primary insomnia, anxiety, prostate cancer or solid tumors. Melatonin is safe for administration during pregnancy or for the newborn, and can reduce WM brain injury under conditions of chronic fetal hypoxia (Yawno et al. 2017). Melatonin is a neuroprotective agent, with potent antioxidant, anti-apoptotic and anti-inflammatory properties (Esposito et Cuzzocrea 2010; J. G. Lee et al. 2019). Melatonin acts as an agonist of melatonin receptor type 1A and 1B, through nuclear receptor ROR-beta, and is an antagonist of estrogen receptor alpha, interacting with calretinin and calmodulin. Pharmacogenetic score found using the target genes of melatonin is 37, with significant stimulation of genes involved in differentiation and myelination. GO are enriched in gliogenesis.

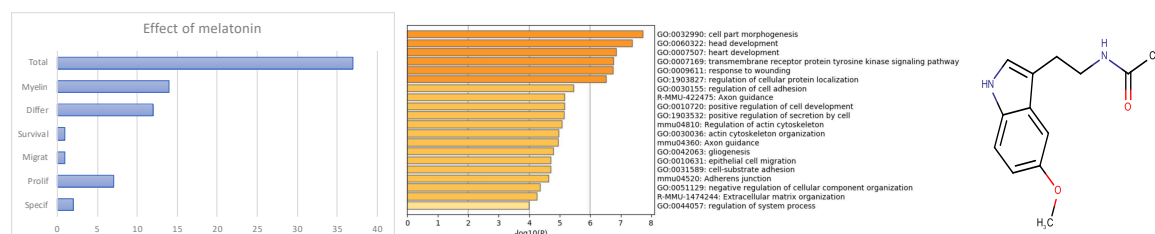

Naringenin (Sm4) is a potential treatment for Alzheimer's disease, cancer, and depression. Naringenin improves memory and reduces amyloid / tau proteins in a mouse model of Alzheimer's disease (Ghofrani et al. 2015; Meng et al. 2021). Naringenin are flavonoids with neuroprotective and

anti-oxidative properties (Raza et al. 2013). These effects occur through its action on non-selective opioid receptor antagonism, glutamate receptor, acetylcholinergic system, amyloid β metabolism, tau hyperphosphorylation, and may also involve MAPK/P38 pathway. Naringenin has a beneficial role during remyelination after spinal cord injury (Rong et al. 2017) Naringenin also increases production of BDNF-dependent antidepressant-like effects in mice (Yi et al. 2014). Pharmacogenetic score found using the target genes of naringenin is 42. GO processes are enriched in myelination.

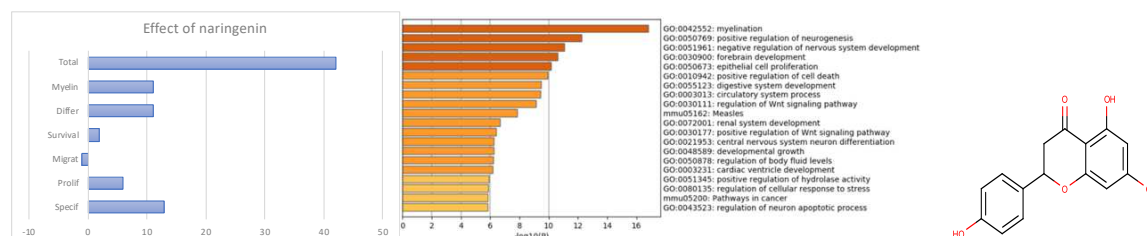

Dyclonine Hydrochloride/ Prestwick-674 (Sm5) is a local oral anesthetic used for 50 years, associated with antimicrobial, anticancer, and neuroprotective properties. Recommended doses in humans are 2-3mg/kg/2h preventing neurodegeneration and neuronal loss (associated with protein misfolding/ aggregation). Dyclonine reversibly binds and inhibits voltage-dependent Na channels on the neuronal membrane, modulating calcium signaling through potent inhibition of transient receptor potential channels vanilloid-3 TRPV (Q. Liu et al. 2021). TRPV are widely expressed in glial cells and considered as potential therapeutic targets in brain disorders (Cornillot, Giacco, et Hamilton 2019). Whereas TRPV3 is not describe in oligodendrogenesis, TRPV4 Inhibition improve myelination and reduced glial reactivity, and inflammation through the NF- κ B signaling pathway in a cuprizone-induced mouse model of demyelination (M. Liu et al. 2018). Dyclonine is a potent treatment for Friedreich's ataxia, by increasing frataxin levels and thus through rescue of frataxin deficiency (Sahdeo et al. 2014; Clark et al. 2018). Moreover, dyclonine protects against diamide-induced oxidative stress and improves motor coordination in mice through the Nrf2-ARE pathway activating antioxidant responsive elements (Rufini et al. 2022). NRF2 function has been shown to be suppressed in mitochondria-related disorders, leading to defects in the respiratory electron transport chain. Thus, dyclonine rescued the NRF2 defect and enhanced synaptic activity in cultured hippocampal neurons (Varkuti et al. 2020). Pharmacogenetic score found using the target genes of dyclonine is 57, with significant stimulation of genes and processes involved in OL differentiation.

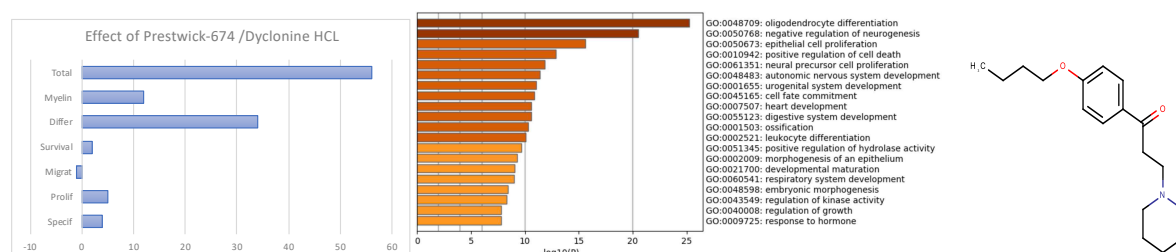

Ginkgolide A (Sm6) was isolated from the leaves of the Ginkgo biloba tree. They are highly active antagonists of platelet-activating factor (PAF) promoting cell death in cultured astrocytes and OLs through upregulation of caspase-3 (Hostettler, Knapp, et Carlson 2002). Ginkgolide A shows potential in a wide variety of inflammatory disorders, inhibiting NOS production and protecting BBB integrity (Sarkar et al. 2020). Their neuroprotective effects modulate excitotoxicity, inflammation, oxidation, metabolism or apoptosis. Indeed, bilobalide suppressed caspase 3 cleavage through PI3K/Akt signaling pathway (Shi et al. 2010) Finally, another member of GK family (GkB) was found to promote generation of NG2 OPCs, reducing TLR4, NF- κ B, iNOS, IL-1 β , and TNF- α , whereas increasing Arg-1 and neurotrophic factors production (Yin et al. 2020). Pharmacogenetic score found using the target genes of ginkgolideA is 79, with significant stimulation of genes and processes involved in OL differentiation and gliogenesis.

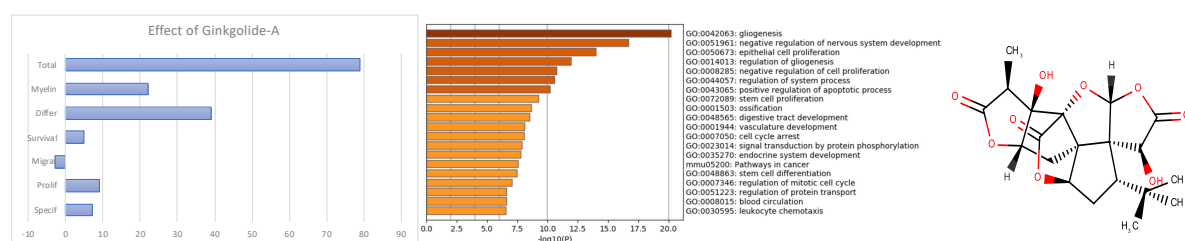

Levonorgestrel (Sm7) is a synthetic progestogen used in contraception and hormone therapy, initially FDA approved in 1982. Levonorgestrel is a modulator of progesterone receptor, estrogen receptor alpha, glucocorticoid receptor inhibitor of alpha-steroid 4-dehydrogenase 1, that may have a direct role in oligodendrogenesis and neuroinflammation (Jure, De Nicola, et Labombarda 2019). Pharmacogenetic score found using the target genes of levonorgestrel is 66, with significant stimulation of genes and processes involved in OL gliogenesis and GPCR.

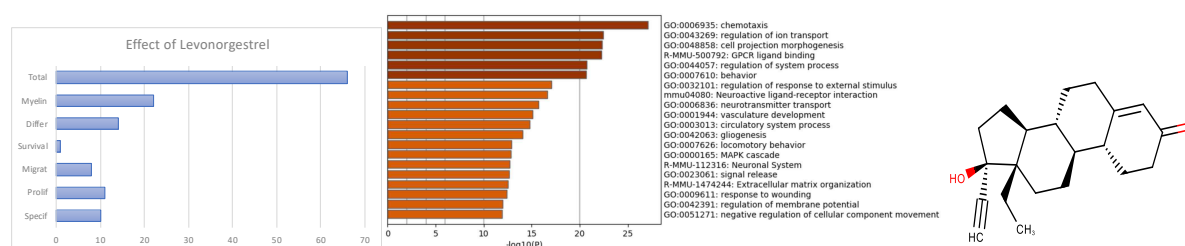

Medrysone (Sm8) is a corticosteroid used in ophthalmology, binding glucocorticoid receptor in the cytosol and activating phospholipase A2 inhibitory proteins (lipocortins) with neuroprotective and anti-inflammatory role (Y. Yang et al. 1997; Minghetti et al. 1999). Indeed, lipocortin controls biosynthesis of potent mediators of inflammation such as prostaglandins and leukotrienes by inhibiting arachidonic acid release by phospholipase A2. Corticoids inhibit phagocytic migration of the acute inflammatory response, as well as macrophage differentiation toward pro-inflammatory

phenotype (Xie et al. 2019). Pharmacogenetic score found using the target genes of medrysone is 75, with significant stimulation of genes and processes involved in gliogenesis and myelination.

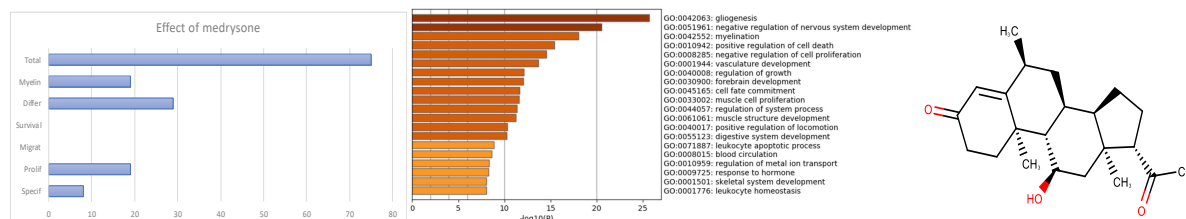

Thioperamide (Sm9) is a potent histamine receptor antagonist (selective HRH1,3,4 subunits), and protects against PTZ-induced seizures in mice. Thioperamide increases histamine, promoting neuronal protection through reduction of oxidative damage in a rat model of neonatal hypoxic-ischemic encephalopathy, acting in combination with postsynaptic H1 receptors (Jia et al. 2013). Thioperamide protects primary neurons against OGD-induced injury and promotes the proliferation of NSCs in DG and SVZ regions through CREB/BDNF pathways, thereby improving cognitive deficit (N. Wang et al. 2020). Pharmacogenetic score found using the target genes of thioperamide is 58, with significant stimulation of genes and processes involved in OL differentiation, and myelination.

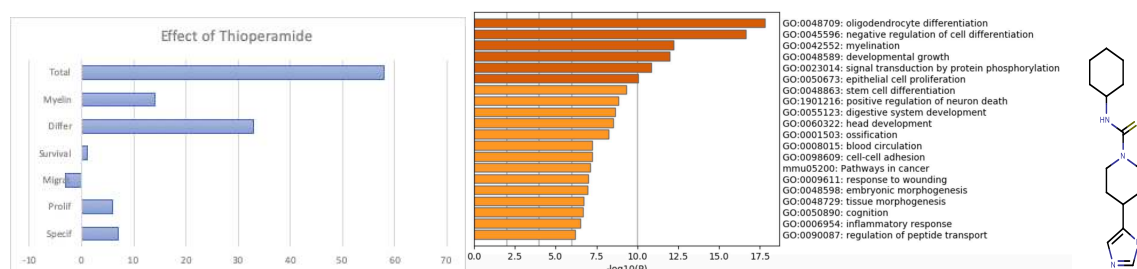

Trihexyphenidyl (Sm10) is used to treat the symptoms of Parkinson's disease and is an anticonvulsant treatment against seizures capable of terminating seizure activity (Shih, Duniho, et McDonough 2003). Sm10 is a potent antimuscarinic agent (subunits M1, M2, M3, M4, M5), with antihistaminic, anticholinergics effects. Pharmacogenetic score found using the target genes of thioperamide is 54, with significant stimulation of genes and processes involved in OL differentiation, and myelination.

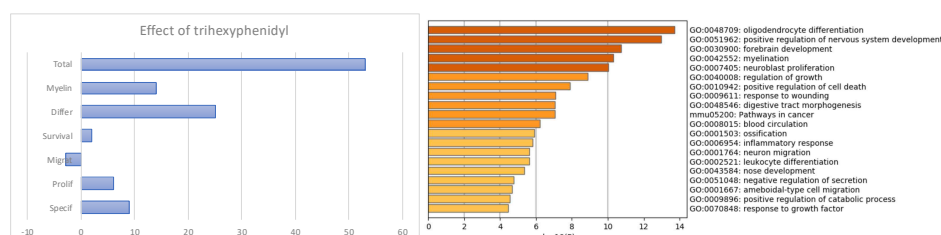

Folinic acid/ Calcium folinate/ Leucovorin (Sm11) is a medication used in the treatment of various cancers in combination with 5-FU, used as an antidote to folic acid antagonists such as methotrexate. Folinic acid is different from folic acid (folates, vitamin B9), playing a role as a coenzyme

for cellular one-carbon metabolism of amino acids (homocysteine, methionine and glycine) essential for DNA synthesis. Folinic acid has an anti-inflammatory role described in traumatic brain injury models, by inhibiting serum levels of homocysteine (increase in MS patients), TNF α , IL-10 and HMGB1 expression (Tommy et al. 2021). There is almost no information related to folinic acid, whereas folic acid is a well-known agent used in several applications. Given their similar structures, we wondered whether there is a process of enzymatic conversion between these molecules.

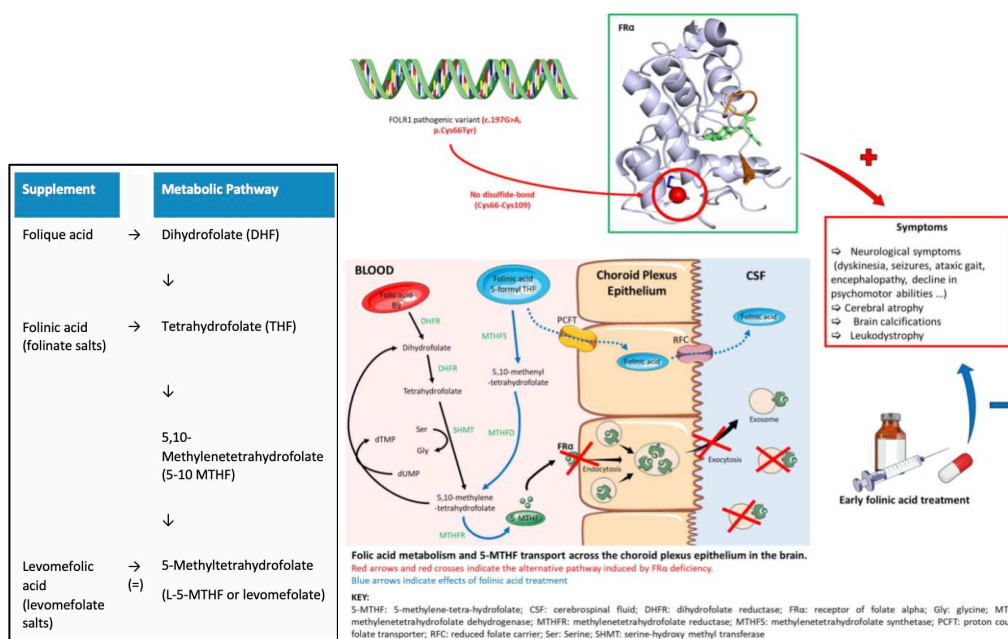
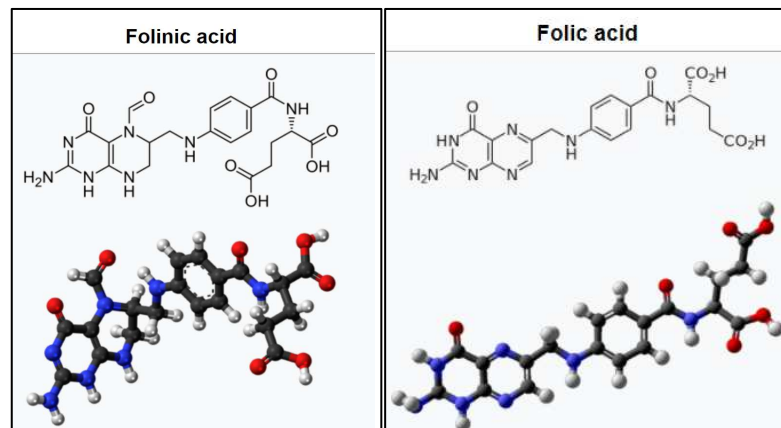
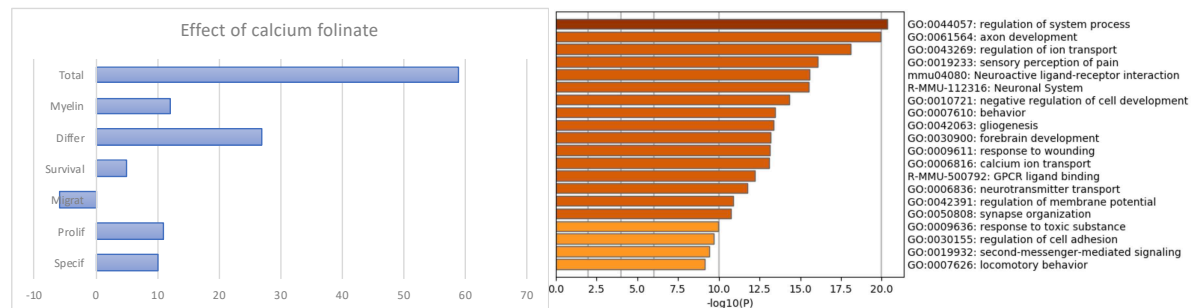

Figure 11: Comparison of the pharmacological structure and action in the metabolism pathway.

We did not find an enzymatic transformation between folinic acid and folic acid. They converge into 5,10-CH₂-THF but it is not clear if they have effects by the same pathway and/or parallel pathway. Folinic acid can either be immediately available for metabolic processes or be converted into 5,10-methylene-THF consecutive activities of MTHF synthetase and MTHF-dehydrogenase (Scaglione et Panzavolta 2014). During the conversion of 5-MTHF to THF, a methyl group is released. This group is used for the homocysteine remethylation leading to methionine which is the precursor of S-adenosyl-

methionine (SAM), the universal one-carbon donor involved in the methylation of DNA, RNA, lipids, proteins and neurotransmitters. Pharmacogenetic score found using the target genes of calcium folinate is 59, with significant stimulation of genes and processes involved in gliogenesis, GPCR signaling, and OL differentiation.



11- GENERATE DRUGS USING CORRELATED AND ANTI-CORRELATED GENE HUBS:

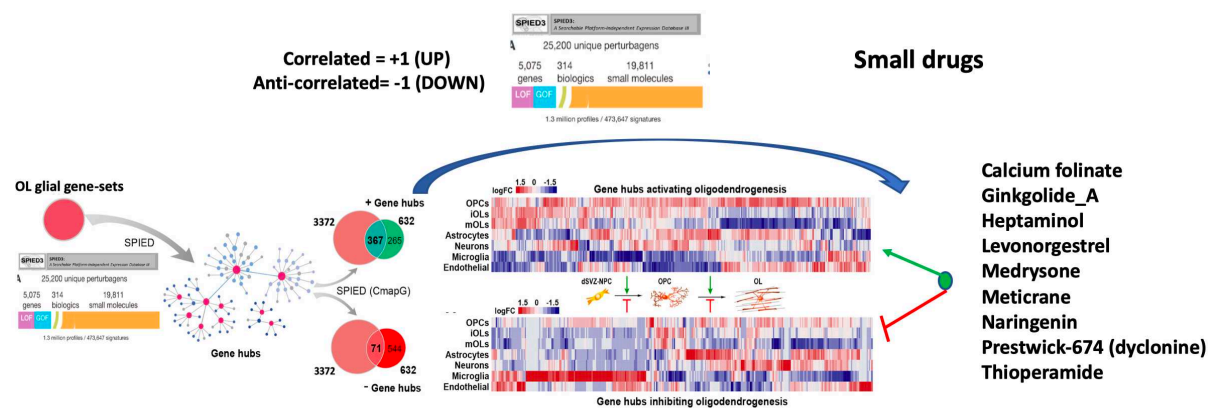

Figure 12: Interrogation of the SPIED platform to obtain drugs regulating hub genes.

We previously found that correlated genes hubs are associated with promotion of oligodendrogenesis, synapse organization, OL differentiation, neurogenesis, contrary to the anti-correlated genes repressing oligodendrogenesis, associated with inflammation, Tcell activation, immune response, IFN γ and IL12 production.

We interrogated independently SPIED platform using those list of 632 correlated and anti-correlated hubs genes with a positive or negative input coefficient respectively. Interestingly, we found that drugs that we selected also regulates these hub genes (including calcium folinate, ginkgolide A, heptaminol, levonorgestrel, medrysone, metricrane, naringenin, Prestwick-674, thioperamide). Therefore, by also regulating negatively the anti-correlated genes hubs, we are expecting to repress indirectly inflammatory associated processes. This is consistent with the fact that

the drugs are mostly also anti-inflammatory based on their target genes. As an example, Sm11 regulates genes involved in the immune system (including regulation of *Calm3*, *Capzb*, *Cblb*, *Cd3g*, *Cd8a*, *Cd8b*, *Cd81*, *Cdc20*, *Ap2m1*, *Cyba*, *Klcl1*, *Kif22*, *Cd99*, *Psmb3*, *Psmid1*, *Psmid2*, *Ubc*, *Ube2b*, *Ube3a*, *Ywhab*, *Zbtb16*, *Vamp8*, *Ube2l6*, *Grp2*, *Kif23*, *Tuba1b*, *Tubb3*, *Tubb4b*, *Kif2c*, *Ube2c*, *Ubr2*, *Ptpn22*, *Trem12*, *Trim9*, *Tubb2b*, *Sae1*, *Ambp*, *Cnot4*, *Usp2*, *Ubd*, *Oga*, *Cela2a*, *Sumo2*, *Klhl24*, *Cdca3*) and T Cell Activation (*E.G* *Cblb*, *Cd3g*, *Cd8a*, *Cd8b*, *Ddost*, *Dpp4*, *Lcp1*, *Rora*, *Rorc*, *Ebi3*, *Ptpn22*, *Stoml2*, *Il23a*, *Trem12*, *Actb*, *Cd81*, *F2*, *Hrg*, *Kars1*, *Slamf1*, *Ikzf1*, *Ubd*, *Hpx*, *Ighm*, *Igkc*, *Igllc1*, *Vamp8*, *Ikbke*, *Colec11*, *Hcls1*, *Ptprz1*, *Top2a*, *Zbtb16*, *Ncapg2*). Thus, we can expect that our selected drugs will also have the potential to regulate inflammation.

12- FOLINIC ACID AND DYCLONINE REGULATE OLIGODENDROGENESIS THROUGH CALCIUM SIGNALING

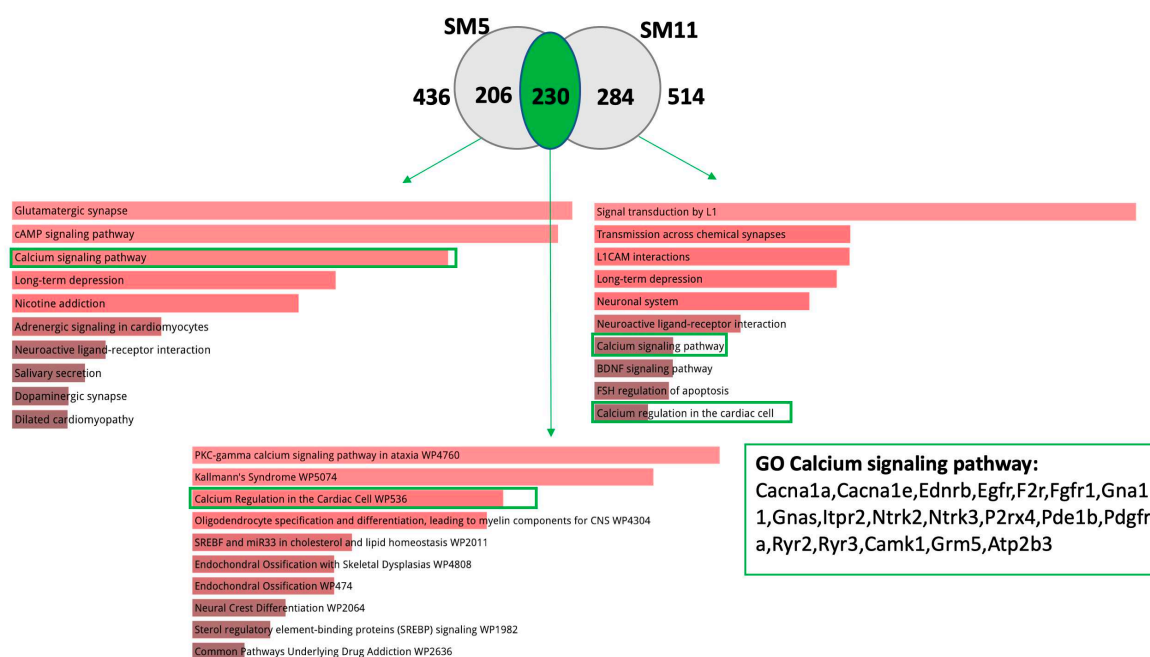

Figure 13: Comparison of the pathways regulated in common between folinic acid and dyclonine. KEGG (Kyoto Encyclopedia of Genes and Genomes) analysis of the common target genes regulated by folinic acid and dyclonine shows that drugs share a potent calcium signaling pathway regulation

By analyzing target genes regulated by folinic acid and dyclonine (KEGG analysis), we suggest that those drugs promote oligodendrogenesis through one of the mechanisms regulating calcium signaling. Indeed, respective and common target genes are all related to this regulation, which can help to understand their mechanism of action through probably GPCR, in addition to our on-going transcriptomic study (see perspectives).

RESULTS

Jean-Baptiste Huré, Carlos Parras, Olivier Raineteau, Louis Foucault



Europäisches
Patentamt

European
Patent Office

Office européen
des brevets

Acknowledgement of receipt

We hereby acknowledge receipt of your request for grant of a European patent as follows:

Submission number	1000506170	
Application number	EP22305345.5	
File No. to be used for priority declarations	EP22305345	
Date of receipt	23 March 2022	
Your reference	IBIO-2221/EP	
Applicant	ICM (INSTITUT DU CERVEAU ET DE LA MOELLE ÉPINIÈRE)	
Country	FR	
Title	ORGANIC MOLECULES FOR TREATING MYELIN PATHOLOGIES	
Documents submitted	package-data.xml application-body.xml SPECEPO-1.pdf 2221 EP.pdf (42 p.)	ep-request.xml ep-request.pdf (5 p.) f1002-1.pdf (1 p.)
Submitted by	CN=Manon Bonneton 63478	
Method of submission	Online	
Date and time receipt generated	23 March 2022, 15:37:36 (CET)	
Official Digest of Submission	C5:0A:6B:4B:37:29:A3:7D:0F:86:47:A4:FB:C2:68:CB:90:6E:BD:09	

ORGANIC MOLECULES FOR TREATING MYELIN PATHOLOGIES

FIELD OF INVENTION

[0001] The present invention relates to the use of small organic molecules for treating or preventing myelin pathologies, such as, for example, multiple sclerosis and myelin pathologies associated with preterm birth.

ARTICLE: PHARMACOGENOMIC SCREENING IDENTIFIES AND REPURPOSES DYCLONINE AND LEUCOVORIN AS PRO-OLIGODENDROGENIC AND PRO-MYELINATING COMPOUNDS

Status: under revision in Nature Communication

Pharmacogenomic screening identifies and repurposes leucovorin and dyclonine as pro- oligodendrogenic compounds in brain repair

Jean-Baptiste Huré¹, Louis Foucault², Litsa Maria Ghayad¹, Corentine Marie¹, Nicolas Vachoud², Lucas Baudouin¹, Rihab Azmani², Natalija Ivjanin¹, Alvaro Arevalo-Nuevo¹, Morgane Pigache¹, Lamia Bouslama-Oueghlani¹, Julie-Anne Chemelle³, Marie-Aimée Dronne⁴, Raphaël Terreux³, Bassem Hassan¹, François Gueyffier⁴, Olivier Raineteau², Carlos Parras¹

¹ Paris Brain Institute, Sorbonne Université, Inserm U1127, CNRS UMR 7225, Hôpital Pitié-Salpêtrière, 75013 Paris, France.

² Univ Lyon, Université Claude Bernard Lyon1, Inserm, Stem Cell and Brain Research Institute U1208, 69500 Bron, France

³ Équipe ECMO, Laboratoire de Biologie Tissulaire et d'Ingénierie (LBTI), UMR5305, Université Lyon 1, Lyon 69367, France

⁴ Claude Bernard University, UMR5558 Laboratoire de Biométrie et Biologie Evolutive, CNRS, Villeurbanne, France

Abstract

Oligodendrocytes are the myelin-forming cells of the central nervous system (CNS), with oligodendroglial pathologies leading to strong disabilities, from early preterm-birth brain injury (PBI) to adult multiple sclerosis (MS). No medication presenting convincing repair capacity in humans has been approved for these pathologies so far. Here, we present a pharmacogenomic approach leading to the identification of small bioactive molecules with a large pro-oligodendrogenic activity, selected through an expert curation scoring strategy (OligoScore) of their large impact on transcriptional programs controlling oligodendrogenesis and (re)myelination. We demonstrate the pro-oligodendrogenic activity of these compounds in vitro, using neural and oligodendrocyte progenitor cell (OPC) cultures, as well as ex vivo, using organotypic cerebellar explant cultures. Focusing on the two most promising molecules, i.e. leucovorin and dyclonine, we tested their therapeutic efficacy using a mouse model of neonatal chronic hypoxia, which faithfully mimics aspects of PBI. In this model, both compounds promoted proliferation and oligodendroglial fate acquisition from neural stem/progenitor cells, with leucovorin also promoting their differentiation. We extended these findings to an adult focal de/remyelination mouse MS model, in which both compounds improved lesion repair by promoting OPC differentiation while maintaining the pool of OPCs, and in parallel, by accelerating the transition from pro-inflammatory to pro-regenerative microglial profiles and myelin debris clearance. This study paves the way for clinical trials aimed at repurposing these FDA-approved compounds to treat myelin pathologies such as PBI and MS.

Introduction

Preterm birth brain injury (PBI) is the most common cause of death and disability in children under 5 years, affecting 15 million infants yearly born before 37 gestational weeks. Rates of PBI are increasing in developing countries (e.g., 7% in France and the UK, 13% in the US), and are associated with a high level of morbidity and neonatal encephalopathies, leading to persistent cognitive and neuropsychiatric deficits (such as autism spectrum, attention-deficit disorders, and epilepsy) (Harrison and Goldenberg, 2016; Luu et al., 2017; Walani, 2020). Alterations of oxygen concentrations and perinatal neuroinflammation of PBI dramatically affect the survival and maturation of oligodendrocyte precursor cells (OPCs) (Back et al., 2001; Volpe, 2009), resulting in hypomyelination, abnormal connectivity, and synaptopathies. Indeed, in both humans and rodents, the perinatal period is a time of active oligodendrogenesis, myelination, and axonal growth within the developing subcortical white matter (Fletcher et al., 2021). Given the severity of long-term consequences and the absence of current treatment, there is an urgent need to develop novel therapeutic approaches for promoting perinatal brain repair through oligodendrocyte (OL) regeneration.

Another myelin pathology affecting many adults (3 million people) is multiple sclerosis (MS), a chronic autoimmune-mediated disease characterized by focal demyelinated lesions of the central nervous system (CNS) (Lassmann, 2018; Reich et al., 2018). Although current immunomodulatory therapies can reduce the frequency and severity of relapses, they show limited impact on disease progression and are inefficient in lesion repair (Hauser and Cree, 2020). Therefore, complementary strategies to protect OLs and induce the generation of new remyelinating OLs are urgently needed to promote repair and eventually end and even reverse MS progression. Accordingly, animal models have demonstrated that remyelination can reestablish fast saltatory conduction velocity (Smith et al., 1979), prevent axonal loss, and exert neuroprotection (Irvine and Blakemore, 2008), resulting in functional clinical recovery (Jeffery and Blakemore, 1997; Duncan et al., 2009). Brain remyelination is thought to result mainly from differentiation of parenchymal OPCs, in regions close to the lateral ventricles, also from adult SVZ-NSC derived OPCs (Xing et al., 2014; Samanta et al., 2015), and to a lesser extent from mature OLs (Duncan et al., 2018; Yeung et al., 2019; Bacmeister et al., 2020; Mzydlo et al., 2023). The incomplete

remyelination in MS patients (Bodini et al., 2016) is attributed to a variety of oligodendroglia-associated intrinsic as well as lesion-environment-related extrinsic factors (Galloway et al., 2020), and the extent of remyelination differs considerably between individual patients and lesion location, declining with disease progression (Patrikios et al., 2006). Despite some factors and small molecules (compounds) being shown to improve myelination in cell cultures, as well as remyelination in animal models, so far, no medication presenting convincing remyelinating capacity in humans has been approved for MS patients so far, with clemastine and analogs of thyroid hormone still having to complete phase III clinical trials (Rodriguez-Pena, 1999; Schoonover et al., 2004; Mei et al., 2014; Liu et al., 2016). Thus, enhancing (re)myelination remains an unmet medical need both in the context of preterm birth brain injury and MS patients.

Owing to their diverse etiologies, onset ages and potential repair mechanisms, the discovery of new treatments for treating myelin pathologies should aim at globally stimulating endogenous oligodendrogenesis, known to spontaneously increase following injury, at multiple levels, i.e. from the specification of new OPCs from neural progenitor cells (NPCs), to the maturation of pre-existing ones within the parenchyma. A promising drug discovery strategy is to use connectivity maps to identify compounds able to induce transcriptional signatures similar to those observed in a given cell lineage. This approach lies behind the connectivity-map initiative, which has been extensively used in various tissues [reviewed in (Lamb, 2007)]. This strategy has resulted in successful drug repurposing in several contexts [e.g., dietary restriction (Calvert et al., 2016); aging and oxidative stress (Ye et al., 2014; Ziehm et al., 2017)], also allowing to discover new modes of actions for compounds, as well as predicting off-target or side effects.

While most previous studies have followed a gene/pathway candidate approach, we aimed here at using a more comprehensive strategy (Fig. 1 extended data 1). To this end, we developed an in-silico approach combining both unbiased identification of transcriptional signatures associated with oligodendroglial formation (i.e., transcriptomes) and knowledge- driven curation of transcriptional changes associated with oligodendrogenesis (i.e., OligoScore). We then conducted a pharmacogenomics analysis to identify small bioactive molecules (compounds) capable of globally mimicking this transcriptional signature. Using a scoring strategy based on genes involved in oligodendrogenesis as well as

pharmacogenetics/pharmacokinetics criteria, we ranked and selected the most promising compounds. Finally, after validating their pro-oligodendrogenic activity in vitro and ex vivo, we selected the top two compounds, leucovorin and dyclonine, and demonstrated their capacity to promote oligodendrogenesis and myelin repair in vivo, using both neonatal and adult murine models of myelin pathologies.

Results

GENERATION OF A TRANSCRIPTIONAL SIGNATURE AND ASSOCIATED “HUB GENES” DEFINING OLIGODENDROGENESIS

We first set out to generate a broad transcriptional signature of oligodendrocyte lineage cells (Supplementary Table 1) by comparing the transcriptome of these cells at different developmental stages, using recently published single cell- and bulk-transcriptomic datasets from mouse brain cells (Zhang et al., 2014; Marques et al., 2016; Falcão et al., 2018; Marques et al., 2018; Saunders et al., 2018; Jäkel et al., 2019). Given that oligodendroglial cells are robustly generated in mice from the dorsal aspect of the ventricular-subventricular zone (V- SVZ) at neonatal stages (Suzuki and Goldman, 2003; Kessaris et al., 2006), we integrated the transcriptional signature obtained by comparing dorsal vs. lateral neonatal subventricular progenitors (Supplementary Table 2) (Azim et al., 2015; Azim et al., 2017) to include the transcriptional changes contributing to OL specification from NPCs. Using this strategy, we obtained oligodendroglial transcriptional signatures (Supplementary Table 3) enriched either in progenitor cells (1898 genes) or in more mature stages (2099 genes), which we refined to 3372 genes (Supplementary Table 4) using further selection criteria (Methods). This oligodendroglial signature was indeed enriched in oligodendroglia compared to other neural cells, as illustrated by its expression profile in postnatal brain cells (Fig. 1b) and its enrichment in gene ontology (GO) terms related to OL differentiation, gliogenesis, and glial cell differentiation (Fig. 1c, Supplementary Table 4), together with processes linked to neuronal development, synaptic and dendritic organization, known to be modulated by oligodendroglial-dependent brain plasticity and adaptive myelination (Foster et al., 2019; Buchanan et al., 2021; Pease-Raissi and Chan, 2021; Xiao et al., 2022).

To identify “hub genes” involved in oligodendrogenesis, we used our oligodendroglial signature to query the SPIED platform (Fig. 1d), which provides fast and simple quantitative interrogation of publicly available gene expression datasets (Williams, 2013). This analysis resulted in the identification of hub genes correlated (632 genes) and anticorrelated (623 genes) with our oligodendroglial transcriptional signature (Supplementary Tables 5 and 6). Correlated hub genes contained numerous key regulators of oligodendrogenesis (including Olig1, Olig2, Sox8, Sox10, Nkx2-2), as well as commonly used oligodendroglial markers (such as Cnp, Mag, Mbp, Mobp, Mog, Opalin, Plp1; Supplementary Table 5). Their expression pattern was enriched in oligodendroglia compared to other brain cells (Fig. 1e) and their associated biological processes enriched in gliogenesis, CNS myelination, and OL differentiation (Supplementary Table 5), thus validating the efficiency of our strategy. Notably, while many correlated hub genes (367/632 genes) were included in our oligodendroglial signature, only a few anti-correlated ones (71/623) were present (Fig. 1e). Interestingly, a large fraction of anti-correlated hub genes (150/623) was expressed in microglia (Fig. 1f) and enriched in GO terms associated with inflammation and immune cell activation (such as IL12, IFN γ or ROS production; Supplementary Table 6), known to inhibit OL generation. Altogether, these results indicate that this methodology constitutes an efficient approach to identify a large oligodendroglial transcriptional signature, and to infer hub genes positively or negatively associated with oligodendrogenesis.

IDENTIFICATION AND EXPERT CURATION OF COMPOUNDS ACTING ON OLIGODENDROGLIAL-ASSOCIATED GENES

We then queried SPIED with our oligodendroglial signature to obtain small bioactive molecules (compounds) inducing similar transcriptional changes and found a large number (449) of positively associated compounds. To rank them by the impact of genes involved in oligodendrogenesis, we introduced a knowledge-driven scoring procedure that we named OligoScore (here provided for the community as a resource; Fig. 2 extended data 1; <https://oligoscore.icm-institute.org>). This curation strategy included more than 430 genes for which loss-of-function and gain-of-function studies have demonstrated their requirement in the main processes of oligodendrogenesis (that we categorized in specification, proliferation, migration, survival, differentiation, myelination, and remyelination). Genes were scored in each process from 1 to 3 (low, medium, strong) either positively or negatively (promoting or inhibiting, respectively),

depending on the severity of gain- or loss-of-function phenotypes. For example, Olig2 and Sox10, key regulators of oligodendrogenesis (Lu et al., 2002; Stolt et al., 2002; Stolt and Wegner, 2010; Yu et al., 2013), have the highest positive values in specification and differentiation, respectively, while Tnf (Nakazawa et al., 2006; Minchenberg et al., 2015) or Tlr2 (Sloane et al., 2010) have negative values in processes such as survival and differentiation (Fig. 2a). We validated the efficacy of the OligoScore strategy by querying it with genes differentially expressed in OPCs upon either a genetic (Chd7 specific deletion in OPCs, Marie et al., 2018) or environmental perturbation (systemic injection of the pro-inflammatory cytokine IL1 β , Schang et al., 2022). Our analysis confirmed that OligoScore accurately predicted the deregulation of oligodendrogenesis-related processes identified in these studies (Fig. 2 extended data 2, and Methods). Then, using these curated gene sets involved in oligodendrogenesis (Fig. 2b), we interrogated SPIED, finding a large number (393) of positively associated compounds, with 156 in common with those obtained using our broad oligodendroglial signature (Fig. 2c). Focusing on these common 156 compounds, we next used OligoScore to rank them by their total scores (sum of each process' score, defined as pharmacogenomic score) thus selecting those with broader pro-oligodendrogenic activities (Fig. 2d-f; Supplementary Table 7). Validating the pertinence of our strategy, among the top-ranked compounds, we found molecules reported to promote oligodendrogenesis, including liothyronine (thyroid hormone), clemastine (Mei et al., 2014; Green et al., 2017), clomipramine (Faissner et al., 2017), piperidolate (Abiraman et al., 2015), luteolin (Barbierato et al., 2015), ifenprodil (Hubler et al., 2018), and propafenone (Najm et al., 2015). For further analyses, we selected the top 40 compounds ranked by their pharmacogenomic scores and therefore by their broader putative pro-oligodendrogenic activities, excluding those already known for their implication in oligodendrogenesis. After studying their pharmacological properties (summarized in Method Table 8), we then selected the top 11 compounds (Sm1- Sm11; Methods Table 1) for having high pharmacogenomic scores (Fig. 2d), the ability to cross the BBB, and low potential toxicity (Fig. 2g, h)

PRO-OLIGODENDROGENIC ACTIVITY OF SELECTED COMPOUNDS IN NEONATAL NEURAL PROGENITOR CELLS

To evaluate the activity of selected pro-oligodendrogenic compounds in the context of different neural cell types, we first used mixed neural progenitor cell (NPC) cultures obtained from the neonatal V-SVZ (postnatal day 0 to 1, P0-P1) and amplified

using the neurosphere protocol (Reynolds and Weiss, 1992; Parras et al., 2004) (Fig. 3a). We assessed the dose effect of selected compounds to promote NPC differentiation into Sox10⁺ oligodendroglia using three different concentrations (250nM, 500nM, and 750nM) based on the previous reports (Mei et al., 2014; Najm et al., 2015; Eleuteri et al., 2017). Automatic quantification of Sox10⁺ cells indicated that all selected compounds presented the strongest effects to promote Sox10⁺ oligodendroglia at 750nM (Fig. 3 extended data 1). We thus used this concentration for the following in vitro studies. To assess the capacity of compounds to promote NPC differentiation into oligodendroglia, compounds were supplemented in both proliferation and differentiation media, and clemastine and thyroid hormone were included as positive controls for comparison, given their demonstrated activities on OPC differentiation and myelin formation (Rodriguez-Pena, 1999; Schoonover et al., 2004; Mei et al., 2014; Liu et al., 2016). Remarkably, immunofluorescence labeling of neurons (β -III-tubulin), astrocytes (GFAP), and oligodendroglia (combining PDGFR α and CNP) showed that all 11 selected compounds increased by ~1.5-fold the number of oligodendroglial cells compared to vehicle (DMSO or PBS, Methods), as illustrated for Sm11 (Fig. 3b, c). In contrast, this increase in oligodendroglia was not found with T3 or clemastine treatment (Fig. 3c), known to only promote OPC differentiation (Barres et al., 1994; Bernal, 2002; Mei et al., 2014). Remarkably, the increased number of oligodendroglial cells fostered by our selected compounds was not accompanied by reductions in the number of neurons and astrocytes, nor by changes in overall cell density (Fig. 3d-f). It was rather paralleled by a reduction of undifferentiated NPCs (i.e. unlabeled cells; marker negative cells, Fig. 3g), suggesting that selected compounds foster NPC differentiation towards the oligodendroglial fate, with Sm9 and Sm11 also showing a positive effect on neurogenesis (Fig. 3e). To determine their effect on OL differentiation, we quantified the number of immature OLs (iOLs, Sox10^{high} cells being PDGFR α ⁺ and MBP⁻), and found a ~2-fold increase in iOLs (Sox10^{high} cells) for T3 and all the selected compounds at 750nM, as illustrated for Sm5 (Fig. 3h, i and Fig. 3 extended data 1). Altogether, these results confirm that our selected compounds have a pro-oligodendrogenic effect in NPC differentiation cultures, without negative impacts on the number of neurons and astrocytes.

CELL-AUTONOMOUS EFFECT OF SELECTED COMPOUNDS IN OPC DIFFERENTIATION

Given that NPC cultures include several neural cell types, and thus do not allow the evaluation of the direct, cell-autonomous effects, of the compounds on OL

differentiation/maturation, we turned to primary OPC cultures purified from neonatal (P4) mouse cortices through magnetic cell sorting (MACS). We treated OPCs for three days in the presence of six compounds, for which we did not find any evidence for ongoing research related to oligodendrogenesis (Fig. 4a). Interestingly, automatic quantifications of total cells in each culture (Figure 4 extended data 1) showed that, while no significant changes were seen in the variable density of PDGFR α + OPCs (Fig. 4b, c), except for Sm7, both T3, clemastine, and all tested compounds (Sm1, Sm2, Sm5, Sm6, and Sm11) increased the number of MBP+ OLs compared to vehicle-treated controls (Fig. 4b, d). These results demonstrate the capacity of most selected compounds to cell-autonomously foster OPC differentiation.

SELECTED COMPOUNDS PROMOTE OLIGODENDROCYTE DIFFERENTIATION AND MYELINATION EX VIVO IN CEREBELLAR EXPLANT CULTURES

Validation of these compounds as a potential treatment for (re)myelination requires further proof of concept before translation into pre-clinical animal models. To this end, we used cerebellar slices (Baudouin et al., 2021) to identify the best compounds having pro-oligodendrogenic and pro-myelinating activities ex vivo. This model allowed us to better assess the effect of the selected compounds on OL maturation, myelination, and cytotoxicity in a richer cellular system, also containing immune cells (microglia/macrophages) that are known to influence oligodendrogenesis and (re)myelination (Miron et al., 2013; Hagemeyer et al., 2017; Kirby et al., 2019; Lloyd et al., 2019; Hughes and Appel, 2020; Nemes-Baran et al., 2020; Shen et al., 2021). The onset of myelination in this model takes place after 7 days in culture (Fig. 5a). Therefore, we incubated the cerebellar explants for three days (7-10 days in vitro, DIV) in the presence of the six compounds showing the highest pro-oligodendrogenic activity in culture (Sm1, Sm2, Sm5, Sm6, Sm7, Sm11), as well as two positive controls (T3 and clemastine), and their associated negative control (vehicle). We analyzed the effect on OL numbers (CC1+/Sox10+ cells) and myelination (CaBP+ Purkinje cell axons co-labeled with MBP), by immunodetection of all four markers in the same sections. A 'differentiation index' was calculated as the ratio of Sox10+ cells being CC1+, and the 'myelination index' as the ratio of CaBP+ axons being MBP+ (Baudouin et al., 2021; Fig. 5 extended data 1b). Remarkably, all compounds presented an increased differentiation index compared to their negative

controls, but only Sm1, Sm2, Sm5, Sm11, and clemastine reached statistical significance (Fig. 5b, c). Moreover, Sm2, Sm5, and Sm11 also induced a robust increase in the myelination index, comparable to the effect of T3 (Fig. 5d, e). Therefore, these results show the pro-oligodendrogenic and pro-myelinating activities of Sm2, Sm5, and Sm11 in cerebellar explant cultures, and together with previous results, demonstrate the pro-oligodendrogenic capacity of these compounds, in different brain regions (cerebral cortex and cerebellum). Altogether, based on the global effects of these molecules combining our in vitro and ex vivo experiments (summarized in Fig. 5 extended data 1a), and their intended clinical application, we selected Sm5 (dyclonine) and Sm11 (leucovorin) as the best candidates to test their efficiency to promote oligodendrogenesis in pre-clinical models of myelin pathologies

DYCLONINE AND LEUCOVORIN PROMOTE OLIGODENDROGLIAL REGENERATION IN A MOUSE MODEL OF PRETERM BIRTH BRAIN INJURY

Chronic hypoxia is a well-established clinically relevant model of very early preterm birth (Jablonska et al., 2012; Scafidi et al., 2013; Salmaso et al., 2014). It is induced by subjecting pups to a low (i.e. 10%) oxygen environment from P3 to P11 (Fig. 6a), which results in diffuse grey and white matter brain injuries, albeit without eliciting a drastic inflammatory response. This period of chronic neonatal hypoxia induces marginal cell death of both neuronal and glial cells along with a delay of OL maturation that persists into adulthood (Scafidi et al., 2009). We assessed the effects of dyclonine (Sm5) and leucovorin (Sm11), as pro-oligodendroglial treatments, by performing intranasal administration of these compounds immediately following the period of hypoxia (i.e. from P11 to P13, see Methods; Fig. 6a and Fig. 6 extended data 1a). This strategy represents a very promising noninvasive technique for drug administration, that was already demonstrated to impact brain cell behavior and eventually their proliferation (Scafidi et al., 2013; Azim et al., 2017). To examine the impact of dyclonine and leucovorin on proliferation, brains were analyzed at P13, corresponding to the end of the treatment period, after EdU administration one hour before sacrifice to label cells in S-phase. Quantification of EdU+ cell density within the dorsal V-SVZ revealed an overall increase in proliferation following hypoxia, with no marked additive effects of the treatment (Fig. 6b, c). Notably, the proportion of Olig2+ cells labeled with EdU was significantly increased upon dyclonine and leucovorin treatment (Fig. 6d, e), suggesting an increase in the proliferation of oligodendroglial committed progenitors. Furthermore, the proportion of EdU+ cells expressing Olig2

was increased by dyclonine and leucovorin treatment (Fig. 6h), suggesting that these compounds also promote the oligodendroglial fate acquisition from NPCs, in line with their pro-oligodendrogenic activity in neonatal NPC cultures (Fig.3). We then investigated the capacity of dyclonine and leucovorin to rescue the reduction in OL differentiation and maturation induced by hypoxia (Scafidi et al., 2013). To this end, OL density and maturation were analyzed within the cortex six days following the end of the treatment, at P19, when the rate of cortical OL maturation and myelination is highest. While the density of oligodendroglial cells (Olig2+ cells) was similar between normoxic (Nx; control condition) and hypoxic groups, with no major effects attributable to compounds administration (Fig. 6 extended data 1b, c), their differentiation into CC1+/Olig2+ OLs was impaired by hypoxia but rescued by both dyclonine and leucovorin treatments (Fig. 6g, h). We next assessed the effect of hypoxia and treatments on the number of myelinating OLs (mOLs), identified as Olig2+ cells expressing GST π , a marker restricted to mOLs [(Zhou et al., 2021); Fig. 6i, j, and Fig. 6 extended data 1d, e]. Quantification of Olig2+/GST π + cell density revealed a marked effect of hypoxia on OL maturation that was fully rescued by leucovorin treatment, while dyclonine showed more mitigated effects. In order to substantiate these observations, we extended this analysis by automatically quantifying Olig2+/GST π + cells to other forebrain regions. At this age, mOLs showed the highest density in ventral brain regions such as the thalamus and hypothalamus when compared to dorsal regions such as the isocortex (Fig. 6k). Further, normalized Olig2+/GST π + cell densities on Nx mice (Fig. 6l) revealed a stronger effect of hypoxia on OL maturation in ventral brain regions. We confirmed these qualitative observations by performing a manual quantification within the hypothalamus (Fig. 6l). Those confirmed a stronger effect of hypoxia on OL maturation in the hypothalamic lateral zone, compared to cortical region, as well as a full rescue by leucovorin treatment (Fig. 6i-l). In contrast, in this region again, dyclonine treatment did not increase Olig2+/GST π + cells density when compared to hypoxic mice (Fig. 6k, l). We finally investigated the effect of treatments on MBP immunoreactivity within this ventral region (Fig. 6k). Whereas MBP levels have been shown to be reduced following hypoxia at P11 in several brain regions (Foucault et al., 2024; Chourrout et al., 2022), our results show a return to baseline by P19 in the hypothalamus (Fig. 6 extended data 1f, g). Analyses of MBP optical density and Olig2+/GST π + cell densities suggest an increase of MBP expression per mOL following dyclonine treatment, while the MBP/mOLs ratio was back to normal in leucovorin-treated

animals (Fig. 6m). These results, in line with our previous *in vitro* and *ex vivo* results, confirm the therapeutic capacity of dyclonine and leucovorin to promote oligodendrogenesis in a model of preterm birth brain injury, validate the intranasal approach to administer these compounds and their capacity to cross the blood- brain barrier (BBB). Further, our results show superior capacity of leucovorin to promote OL maturation restoring normal myelinating OL numbers following injury.

DYCLONINE AND LEUCOVORIN PROMOTE OPC DIFFERENTIATION WHILE MAINTAINING THE OPC POOL IN A MOUSE MODEL OF ADULT DEMYELINATION

To further assess the pro-oligodendrogenic capacity of dyclonine (Sm5) and leucovorin (Sm11) *in vivo* in the context of myelin pathologies occurring later in life, we used the mouse model of adult focal de/remyelination induced by lysolecithin (LPC) injection into the corpus callosum (Fig. 7a). Compounds were administered via drinking water (see Methods section), in line with oral administration protocols previously used in adult mice and humans (Sahdeo et al., 2014; Frye et al., 2018; Okazaki et al., 2018; Rossignol and Frye, 2021). Notably, no alterations in the drinking behavior of treated mice were observed, ensuring the expected intake of compounds (Fig. 7 extended data 1b). We first analyzed the lesions at 7 days post-lesion (7 dpi) induction, when newly formed OLs have started to remyelinate the lesion (Nait-Oumesmar et al., 1999; Nakatani et al., 2013). The lesion area was identified by the high cellular density (DAPI staining), abundance of microglia/macrophages (Iba1+ cells), and reduction of myelin content (using myelin oligodendrocyte glycoprotein, MOG) (Fig. 1 extended data 1c). We determined the effect of the compounds to promote oligodendrogenesis at the lesion site by combinatory immunodetection of Olig2, CC1, and Olig1, allowing to distinguish OPCs (Olig2^{high}/CC1⁻/Olig1^{nuclear-cyto} cells) and three stages in OL differentiation (Nakatani et al., 2013; Marie et al., 2018): immature OL (iOL) 1 (iOL1, Olig2^{high}/CC1^{high}/Olig1⁻ cells), iOL2 (Olig2^{high}/CC1^{high}/Olig1^{high-cyto} cells), and mOL (Olig2^{low}/CC1^{low}/Olig1^{low} cells; Fig. 7b, c). First, we found that dyclonine, and to a greater extent, leucovorin, increased the number of oligodendroglial cells (Olig2⁺ cells) in and around the lesion (Fig. 7c-e1, f). Quantification of oligodendroglial stages showed that while the administration of these compounds did not change the density of OPCs (Olig2^{high}/CC1⁻/Olig1^{nuclear-cyto} cells) within the lesion area (Fig. 7g), both compounds increased the number of immature OLs. Specifically, leucovorin increased the number of iOL1s (Fig. 7c, h), while both leucovorin and dyclonine

increased iOL2s (Fig. 7c, i). Given that both compounds increased the number of differentiating OLs without diminishing the pool of OPCs in the lesion area, we looked at the proliferative status of OPCs, using Mcm2 proliferation marker (Fig. 7i-l), and found that both compounds promote a two-fold increase in the density of proliferative OPCs (Fig. 7m). Finally, calculation of the differentiation ratio (number of iOL2 per OPC) showed that whereas this ratio was 1 OL for 4 OPCs in the vehicle-treated lesions, it increased by 2-fold in dyclonine-treated (2 OLs for 4 OPCs) and by more than 3-fold in leucovorin-treated (3 OLs for 4 OPCs) lesions (Fig. 7n). We then performed an additional experiment to assess for possible improved effects using higher doses of the compounds (10-fold for leucovorin and 2-fold for dyclonine) and to compare their efficacy with that of clemastine, a pro-myelinating compound (Mei et al., 2014). At either dose, we observed a similar increase in oligodendroglial (Olig2+ cells) and immature OL (iOL1 and iOL2) densities, suggesting that we had reached an optimal dose for eliciting the pro- oligodendrogenic effects of our compounds in this model (Fig. 7 extended data 1d-h). Moreover, while clemastine induced an increase in iOL2 density similar to dyclonine and leucovorin (Fig. 7 extended data 1h), both leucovorin and dyclonine additionally increased the density of proliferating OPCs (Fig. 7m, o), an effect that was absent for clemastine (Fig. 7o).

DYCLONINE AND LEUCOVORIN ACCELERATE OLIGODENDROCYTE FORMATION AND REMYELINATION IN A MOUSE MODEL OF ADULT DEMYELINATION

To obtain further proof that the increase in newly formed OLs contributes to accelerated remyelination, we fluorescently labeled adult OPCs and their progeny (OPCs and OLs) by administering tamoxifen to *Pdgfra-CreERT; Rosa26stop-YFP* mice for five consecutive days before inducing the LPC lesion (Fig 8a), and quantified at 10 dpl the number of YFP+ oligodendroglia expressing GST π , a marker restricted to myelinating OLs (Zhou et al., 2021). This analysis showed that, similar to clemastine, dyclonine and leucovorin increased more than 2-fold the number of newly formed myelinating OLs (YFP+/GST π + cells) in the lesion area (Fig. 8b, d) without significant reduction of the lesion volume at this time point likely due to lesion variability (Fig 8c). Performing electron microscopy imaging, we confirmed by ultrastructural analysis the increase in myelinating OLs (identified by their round- or oval-shape nucleus having densely packed chromatin and processes wrapping around myelinated axons) in animals treated with leucovorin, dyclonine, and clemastine compared to vehicle-treated animals (Fig. 8e). Moreover, quantification of

myelinated axons in the lesion area showed a tendency to decrease the g-ratio of axons in leucovorin-, dyclonine-, and clemastine-treated animals compared to vehicle-treated controls, suggesting an increased remyelination (more wrapping) induced by the compound treatment, that reach significance in the case of leucovorin treatment on axons larger than 1 μ m (Fig. 8f, g). Altogether, these results show that, similar to clemastine, leucovorin and dyclonine promote OL differentiation and remyelination in vivo in the context of adult brain demyelination, with leucovorin showing the strongest effect. Moreover, the increased number of oligodendroglial cells in the lesion area together with the increase in OPC proliferation indicate that in the context of adult demyelinating lesions, these compounds are capable of promoting OL differentiation while maintaining the pool of OPCs by fostering their proliferation, an effect not found with clemastine (Fig. 7o).

DYCLONINE AND LEUCOVORIN ACCELERATE MYELIN CLEARANCE AND MICROGLIAL TRANSITION FROM PRO-INFLAMMATORY TO PRO-REGENERATIVE PROFILES IN A MOUSE MODEL OF ADULT DEMYELINATION

Finally, given the recognized pro-remyelinating properties of microglia (Lloyd and Miron, 2019) and the capacity of our compounds to repress inflammatory genes such as Interferon gamma (Fig. 2d), we investigated their potential anti-inflammatory and pro-regenerative activity mediated by microglia/macrophages (Iba1+ cells). We assessed various microglial profiles, including phagocytic (CD68+/Iba1+ cells), pro-inflammatory (Cox2+ and iNOS+ cells), and pro-regenerative (Arg1+/Iba1+ cells) microglia, known to follow the dynamics of lesion repair in this model (Miron et al., 2013; Lloyd et al., 2019). Interestingly, within the lesion area at 7 dpl, there was a reduction in the fraction of phagocytic microglia/macrophages (CD68+ cells; Fig. 9a, c) and a reduction in the area of myelin debris labeled by dMBP (Shen et al., 2021) accompanied by an increased proportion of the dMBP phagocytosed by CD68+ cells (Fig. 9a, d, e), suggesting faster myelin clearance. Furthermore, we found a decrease in Cox2+ and iNOS+ pro-inflammatory microglial profiles (Fig. 9f-h), paralleled by a strong increase in pro-regenerative microglial phenotype (Arg1+ cells; Fig. 9i, j), suggesting that both dyclonine and leucovorin promote an earlier transition between these microglia/macrophage profiles.

In summary, these results demonstrate that in the context of adult brain de/remyelination, oral administration of dyclonine and leucovorin promotes the

generation of newly formed OLs while preserving the OPC pool size. Furthermore, in addition to their direct effects on OLs, these compounds also appear to improve lesion repair by accelerating myelin clearance and promoting the transition from pro-inflammatory to pro-regenerative microglial profiles.

Discussion

To date, no medication demonstrating convincing remyelination efficacy in humans has been approved for treating myelin pathologies, including preterm-birth brain injuries (PBI) and multiple sclerosis (MS). While most previous studies have followed a gene/pathway candidate approach, here we used a more comprehensive strategy to fill this gap. Leveraging transcriptomic datasets through a pharmacogenomics analysis and developing an expert curation of genes previously involved in oligodendroglial biology (provided as a resource for the scientific community: OligoScore, <https://oligoscore.icm-institute.org>), we identified and ranked novel small bioactive molecules (compounds) fostering transcriptional programs associated with various aspects of oligodendrogenesis, including OPC proliferation, differentiation, and (re)myelination. We then demonstrated the pro-oligodendrogenic activity of some of these compounds in mice using several approaches: i.e. (1) *in vitro*, in cultures of neural progenitor cells and primary oligodendroglial progenitors, (2) *ex vivo*, in cerebellar explant cultures, and (3) *in vivo*, using both a model of perinatal chronic hypoxia and a model of adult focal demyelination with spontaneous remyelination. Compounds repurposed to promote remyelination in MS currently in phase III clinical trials, such as clemastine and thyroid hormone analogs (Mei et al., 2014; Green et al., 2017; Gingele and Stangel, 2020), generate OLs at the expense of OPCs, thus potentially depleting OPCs in the long term. Remarkably, the compounds we identified here, leucovorin and dyclonine, promote the generation of new OLs while maintaining stable the pool of OPCs by inducing their concomitant proliferation and differentiation, an effect not found using clemastine (figure 7). The dual capacity of leucovorin and dyclonine to promote at the same time OPC proliferation and differentiation in the context of adult remyelination, is supported by our pharmacogenomics analysis predicting that both leucovorin and dyclonine induce the expression of Olig2, Ascl1, Sox2, and Myt1 (Supplemental Tables S7, S11, S12), key transcription factors promoting both proliferation and differentiation programs

(Nielsen et al., 2004; Ligon et al., 2007; Nakatani et al., 2013; Zhang et al., 2018; Vue et al., 2020). Finally, in the context of an adult demyelination model, leucovorin and dyclonine also improve lesion repair by promoting in parallel a microglia-mediated myelin debris clearance, and a faster transition from pro-inflammatory to pro-regenerative microglial profiles. Therefore, these compounds represent promising candidates for a more comprehensive and sustained regenerative response in various oligodendroglial pathologies, with leucovorin showing the largest beneficial effects in all conditions tested here.

Selected for their broad transcriptional effects, leucovorin and dyclonine may increase oligodendrogenesis and (re)myelination by targeting multiple cell types and mechanisms. Concerning targeted cell types, our results obtained in neonatal neural progenitor cultures and in the neonatal hypoxia model *in vivo*, indicate that leucovorin and dyclonine act onto neural progenitor cells to promote their differentiation into oligodendroglial cells. Second, using purified OPC primary cultures, we demonstrate that they can act cell-autonomously in OPCs to promote their differentiation/maturation, in agreement with a recent study showing that folic acid, also involved in folate metabolism, can enhance oligodendrocyte differentiation (Weng et al., 2017). Third, in the *in vivo* context of a neonatal hypoxia model of PBI, both compounds can promote oligodendroglial proliferation, with only leucovorin efficiently restoring the number of myelinating OLs (figure 6). It is interesting to note that whereas dyclonine did not recover normal myelinating OL density, myelination however returned to baseline as revealed by optical density measurement of MBP expression. This suggests that dyclonine did not impede compensatory myelin production by the remaining OLs. The long-term consequences of this incomplete recovery and the possible increase in myelination capacity of individual OLs upon dyclonine treatment would need further investigation. Fourth, in the *in vivo* model of adult focal demyelination with spontaneous remyelination, both leucovorin and dyclonine accelerate the generation of newly formed and remyelinating OLs, while maintaining the pool of OPCs by increasing their proliferation (figures 7 and 8). This capacity to maintain the pool of adult OPCs, not found using clemastine, has important implications for the long-term treatment of MS patients, whose remyelination capacity decreases with age and disease progression (Neumann et al., 2019a; Neumann et al., 2019b). Finally, leucovorin and dyclonine also target microglia/macrophages, accelerating their phagocytosis of myelin debris and their transition from pro-

inflammatory (Cox2+ and iNOS+ cells) to pro-regenerative (Arg1+/Iba1+ cells) profiles. These effects, which have been have also been described in clemastine treatments (Apolloni et al., 2016; Su et al., 2018)., are known to favor OPC differentiation and remyelination in this model (Miron et al., 2013; Hagemeyer et al., 2017; Kirby et al., 2019; Lloyd et al., 2019; Van Steenwinckel et al., 2019; Hughes and Appel, 2020; Nemes-Baran et al., 2020; Shen et al., 2021).

Dyclonine and leucovorin have been approved by the FDA in 1955 and 1952, respectively. Dyclonine has been used as an oral anesthetic administered in throat lozenges and is known to inhibit Nav1.8, a voltage-dependent Na channel primarily expressed on small, unmyelinated peripheral sensory neurons, most of which are nociceptors (Akopian et al., 1996). Recent findings identified dyclonine's ability to enhance synaptic activity in cultured hippocampal mouse neurons, with chronic treatment of mice over several months in their drinking water leading to increased respiration and ATP production in brain mitochondria (Varkuti et al., 2020). In a study of drug repositioning in the context of Friedreich Ataxia, dyclonine was found to confer protection against diamide-induced oxidative stress through binding to the transcription factor NRF2 (nuclear respiratory factor 2) and activation of the NRF2 pathway (Rufini et al., 2022). Finally, dyclonine may also mediate pro-oligodendrogenic effects through its suggested regulation of different hormones, including estrogen receptors, thyroid hormone receptor β , and the androgen receptor (Varkuti et al., 2020) which represent possible therapeutic targets in MS (Zahaf et al., 2023).

Leucovorin (aka folinic acid or folinate), is a naturally occurring folate (from Latin folia, foliage), a general term designing molecularly-related metabolites participating in the folate cycle, a metabolic pathway that depending on cell requirements can lead to nucleotide synthesis, mitochondrial tRNA modification, or methylation, respectively impacting proliferation, mitochondrial respiration, and epigenetic regulation (Zheng and Cantley, 2018). Abnormal folate metabolism has been causally linked to a myriad of diseases, but it is often unclear which biochemical processes and cellular functions are affected in each disease (Zheng and Cantley, 2018). Molecularly different from folic acid, a synthetic folate, leucovorin has a different entrance and metabolism in the folate cycle. Both leucovorin and folic acid can be transformed by different enzymes into 5-methyl-tetrahydro-folate, which efficiently crosses the BBB using the folate receptor alpha (FR α) transporter, and is

thought to be the main active folate in the CNS (Scaglione and Panzavolta, 2014). Leucovorin has the advantage over folic acid of using other transporters present in the choroid plexus to get into the CNS, i.e., the proton-coupled folate transporter (PCFT) and the reduced folate carrier (RFC) (Mafi et al., 2020). Moreover, folic acid must be metabolized by dihydrofolate reductase (DHFR) to enter the folate cycle, with this reaction being slow and easily reaching saturation, thus limiting the therapeutic use of high doses of folic acid (Scaglione and Panzavolta, 2014; Menezo et al., 2022). For these reasons, leucovorin has been used to treat epileptic patients having mutations in the folate receptor alpha gene, FOLR1 (Mafi et al., 2020), as well as in the context of cancer chemotherapy to decrease the toxic effects of methotrexate, an inhibitor of the DHFR. Our results showing that leucovorin increases oligodendrogenesis and (re)myelination both in vitro and in vivo suggest that it promotes these processes at least in part by fostering high levels of folate metabolism. Moreover, the current clinical administration of leucovorin to adults for large periods guarantees its long-term administration to MS patients without major side effects. Finally, some studies point out that molecules involved in the folate cycle can reduce the inflammatory response by either inhibiting TNF α , IL-1 β , or iNOS-dependent NO production (Cianciulli et al., 2016; Tommy et al., 2021). These anti-inflammatory effects parallel our pharmacogenomics strategy indicating that leucovorin downregulates the gene coding for Interferon gamma (IFNG), a key inflammatory cytokine, and our results in adult remyelinating lesions indicating that leucovorin acts in microglia/macrophages accelerating the transition from pro-inflammatory to pro-regenerative profiles. Altogether, our current understanding of dyclonine and leucovorin activities warrants the broad pro-regenerative activities found in our mouse models of myelin pathologies, with superior effects of leucovorin. Nevertheless, future studies will be required to elucidate the specific mechanisms of action of these compounds in oligodendroglial development, remyelination, and lesion repair.

In conclusion, our study underscores pharmacogenomic analysis as an efficient and low-cost approach to identify pro-oligodendrogenic compounds. By developing a scoring system for genes implicated in oligodendrogenesis (OligoScore), we could rank the most promising compounds to demonstrate their pro-oligodendrogenic and pro-myelinating activities using both in vitro and ex vivo murine culture systems. This resulted in the selection of leucovorin and dyclonine, two FDA-approved compounds, which we demonstrated to have brain repair and pro-

oligodendrogenic activities in both preterm birth brain injury and adult demyelination mouse models, with leucovorin demonstrating broader beneficial effects. This work paves the way to clinical trials repurposing these compounds to promote brain repair in the context of both early- and late-life-onset myelin pathologies such as PBI and MS.

Limitations of the study

Despite the cellular (neural precursor cells, oligodendroglia, and microglia) and molecular mechanisms (folate cycle and anti-oxidative stress metabolism) underlying the beneficial effects of leucovorin and dyclonine in oligodendrogenesis and myelin repair shown here, follow up studies are crucial to unravel the particular mechanisms underlying the effects of each compound in each pathological context, and in cell types, including neurons and astrocytes. For clinical translation in treating preterm birth brain injuries, the capacities of leucovorin and dyclonine to rescue other aspects of preterm birth brain injury, such as inflammation and malnutrition, will need further investigation. Also, the increase in OPC proliferation and numbers mediated by dyclonine in the hypoxia model do not rescue the density of myelinating OLs, contrasting with its effects in adult brain de/remyelination, calling for a better understanding of the environmental differences of each pathological model, such as microglial involvement. The proposed increased myelination capacity per OL (e.g. increased number of internodes) mediated by dyclonine treatment in the hypoxia model will require direct experimental evidence. Finally, further studies are needed to explore the capacity of leucovorin and dyclonine to induce myelin repair in the context of the aging brain, which is only obtained with clemastine or T3 treatment when combined with metformin (Neumann et al., 2019a). Thus, considering the possible synergy between leucovorin and dyclonine with metformin in the context of the aging brain constitutes an essential follow-up pre-clinical research before starting clinical trials in the context of MS lesion repair.

Methods

Data processing and oligodendroglial gene enrichment

Transcriptomic datasets were selected from single-cell and bulk-transcriptomic generated in neural cell types during mice development at the embryonic, postnatal, and adult stages (Zhang et al., 2014; Marques et al., 2016; Falcão et al., 2018; Marques et al., 2018; Saunders et al., 2018; Jäkel et al., 2019). Methods Table 2 summarizes the information about all datasets used, the criteria for selecting DEGs, p-values, and fold-changes used as a threshold, GSE numbers, and details of the data used (i.e., expression microarrays, bulk RNA-seq, and single-cell RNA-seq). For most of the datasets, the supplementary tables provided in the publication were used to select enriched genes that are either differentially expressed (DEGs ≥ 1.5 -fold change compared to other cell types) or showing enriched expression in each cell type (p-value < 0.05). We provide below more detailed methods used in some dataset analyses.

Transcriptional signature of postnatal dorsal NSCs and TAPs: we used data previously generated and published by Raineteau's lab (GSE60905). The cells of interest (neural stem cells, NSCs, and transit amplifying precursors, TAPs) were isolated at P4 from two regions (dorsal and lateral) of the SVZ, using transgenic mice and specific markers for each cell type (i.e., Hes5::GFP and prominin-1 mice for NSCs and Ascl1::GFP mice for TAPs). The microarray data is processed in two phases (see 'dNSCs/TAPs' script). Using R, we set a normalization phase to clean up the data and limit variation between biological replicas to make them comparable. We used the Robust Multiarray Averaging (RMA) method (Irizarry et al., 2003). from the 'affy' package. The second phase corresponds to differential analysis, which is used to identify genes that are differentially expressed between two conditions. To do this, we performed a Limma (linear models for microarray data) analysis (Ritchie et al., 2015). We applied a filter (Fold change, FC > 1.2 and $p < 0.05$) to identify the DEGs in TAPs and NSCs from the dorsal region, compared to those from the lateral region.

Transcriptional signature of the OL lineage from postnatal brain cell types: we used data previously generated and published by Ben Barres' team, obtained by RNA sequencing (RNA-Seq) from purified cells (GSE52564). This analysis aimed at

identifying genes specific to the oligodendrocyte lineage, compared to the neuronal and astrocyte lineages (see "OL lineage" script). In this study, all cells were isolated from transgenic mice at early postnatal stages, i.e. P7 for astrocytes and neurons, and P17 for oligodendrocyte lineage cells. We applied a filter (Fragments Per Kilobase Million, FPKM>0.5; Max FPKM of all), which enabled us to eliminate genes weakly expressed in the different cell types studied. A final filter was used to identify genes overexpressed/repressed in the oligodendrocyte lineage ($FC > 1.2$ to $FC < 9.2$ Max Oligo vs Max non-Oligo). The 'dNSCs/TAPs' transcriptional signature was then combined with the 'OL lineage' transcriptional signatures to obtain lists of intersection genes ('OL specification' signature) and exclusion genes ('OL differentiation' signature) (see results section).

Transcriptional signature of single-cell RNA-seq oligodendroglial clusters: We used the supplemental table from Marques et al; 2016 presenting 50 DEGs per cluster (average expression per cluster of cell types when comparing groups within each junction), allowing us to pool a total list of 532 genes expressed in the entire oligodendroglial lineage. To extract more information from their datasets, we process their raw data from 5072 cells with Seurat package v2 (Stuart et al., 2019) (using the following criteria: min.cells = 10; min.genes = 500; number of UMI >5100; max genes <200; mitochondrial percentage >0.10, analysis in 20 dimensions with a resolution of 0.9) identifying 1598 DEGs. These details have been added to the Methods Table 2.

Pharmacogenomics using SPIED platform

The transcriptional signatures obtained were used to query the CMAP 2.0 database via the wSPIED platform. The Broad CMAP 2.0 (CMAP2.0) database consists of the transcriptional profiles corresponding to the effects of small molecules at various concentrations and treatment times using panels (~100) of human cell lines. This enables the identification of therapeutic molecules capable of inducing transcriptional changes similar to those observed during oligodendrogenesis. The query files are simple text files (.txt files). The first column contains the gene IDs and the second column indicates their enrichment/repression by a value +1 or - 1, respectively. The output table contains the identifiers of the small therapeutic molecules identified (correlative and anti-correlative molecules), ranked according to their Z- score (obtained by Pearson-type regression analysis), and their p-value.

Gene ontology and cell-specific enrichment analysis

GO analysis of selected genes was performed using the Cluster Profiler R-package (2012), Metascape (<https://metascape.org>; (Zhou et al., 2019)), EnrichR (<https://maayanlab.cloud/Enrichr>) (Chen et al., 2013) , and Panther (<http://pantherdb.org>) (Mi et al., 2019; Thomas et al., 2022).

Expert curation and scoring of genes regulating oligodendrogenesis

We used a knowledge-driven scoring procedure through the curation of more than 1000 publications involving functional studies and demonstrating the requirement of a given gene in different processes of oligodendrogenesis (OPC specification, proliferation, migration, survival, differentiation, myelination, and remyelination), either in physiological or pathological conditions. This curation implicated 430 genes scored for each process from 1 to 3 (low, medium, strong), either positively or negatively, depending on the requirement or evidence of their function in that process. To share our expert curation scoring strategy, we established a user-friendly platform (OligoScore; <https://oligoscore.icm-institute.org>) evaluating the regulatory impact on transcriptional programs implicated in oligodendrogenesis and (re)myelination.

Validation of OligoScore strategy

We validated the OligoScore strategy using (1) genes enriched in specific oligodendroglial stages (gene list) and (2) genes deregulated in OPCs upon perturbations (list of genes with their logarithmic fold-changes, logFC). First, we queried OligoScore with top 2000 genes enriched in OPCs and in myelinating oligodendrocytes (mOLs), obtained by comparing their transcriptomes from purified brain cells (Zhang et al., 2014, RNAseq) and sorting them by their expression ratio between OPCs and mOL respectively. Using oligodendroglial single cell transcriptomes (Marques et al., 2016, 2018), we performed a similar analysis using genes enriched in OPCs (723 genes, logFC bigger than 0.5 [$\log_{2}FC > 0.5$] in OPC and cycling OPC clusters versus MOL1 and MOL2 clusters) and in mOLs (1428 genes, $\log_{2}FC > 0.5$ in MOL1 and MOL2 clusters versus OPC and cycling OPC clusters). In both cases, results confirm the expectations, highlighting that, genes enriched in OPCs are involved in several processes of oligodendrogenesis (specification, proliferation, differentiation, and (re)myelination; Fig. 2 extended data 2a, c), while genes enriched in mOLs are mainly involved in differentiation and myelination (Fig. 2 extended data 2b, d). Second, we queried OligoScore with genes differentially

expressed (gene and logFC) in OPCs upon a genetic (P7 Chd7-deleted OPCs, p-value < 0.01; Marie et al., 2018), or an environmental perturbation (P10 OPCs in the systemic IL1 β -mediated neonatal neuroinflammatory model, FDR < 0.05; Schang et al., 2022), identifying the affected processes found in these studies, that is, reduced survival and differentiation of Chd7-iKO OPCs (Fig. 2 extended data 2e), and increased proliferation and reduced differentiation of P10 OPCs in the IL1 β -model (Fig. 2 extended data 2f). In addition, this analysis also provides mechanistic insights identifying genes responsible for the deregulation of each oligodendroglial process.' Gene sets to query OligoScore and obtain the full set of results are provided in the Excel file named 'OligoScore validation tables'.

Hub genes and small molecules list generation

To obtain either hub genes or small molecules, we interrogated SPIED3 version (a searchable platform-independent expression database III; <http://spied.org.uk/cgi-bin/HGNC-SPIED3.1plus.cgi>; GeneHubs and CmapG function). To interrogate SPIED3 for generating a list of hub genes, we uploaded gene symbols corresponding to the large oligodendroglial gene subset (3372 genes). To generate a list of small molecules, we uploaded gene symbols corresponding to either the large oligodendroglial gene sets (1898, 2099 and 3372 genes) and to oligodendroglial curated gene sets for each process regulating oligodendrogenesis (with their positive or negative score attributed for their respective influence in each process). Output for a hub gene or a compound contains either a similarity score (correlation score with the query) and a statistical significance of the similarity score, associated with a probability of finding the same genetic association.

Pharmacogenomic analysis

The 156 compounds obtained in common between both approaches were scored using OligoScore and ranked by their scores in the curated target genes for each process of oligodendrogenesis. We also performed a systematic analysis based on gene ontology databases and cell-specific enrichment (see methods for GO analysis) to exclude compounds showing potential side effects (e.g., effects onto other lineages and/or cell death). Finally, we also selected compounds based on their functional properties and signaling pathways modulated using publicly available drug repository websites (www.DrugBank.ca /; www.genome.jp/kegg/drug/ ; <http://www.genecards.org/>).

Pharmacological analyses

The ADMET parameters have been calculated by the ACD/Percepta software (v.2019.1.2 built 3200) <https://www.acdlabs.com/products/percepta-platform/>. Predictive models for BBB permeability are based on log PS (rate of brain penetration) and log BB (extent of brain penetration) constants and were built by using non-linear least squares regression validated by an internal validation set, and two other experimental external validation sets (Kalvass et al., 2007; Summerfield et al., 2008). Physicochemical properties like lipophilicity (Log P), the number of hydrogen bond acceptors and donors, the ion form fraction at pH 6.5, and McGowan volume were calculated with the ACD/Labs Algorithm Builder 1.8 development platform and used for the modeling. The combination of brain/plasma equilibration rate (Log (PS * fraction unbound, brain)) with the partitioning of compounds at equilibrium (Log BB) classifies compounds as either active or inactive on the CNS; the model is validated using experimental data of more than 1500 compounds having a CNS activity (Adenot and Lahana, 2004). This software uses a human expert rules system (Kazius et al., 2005; Benigni and Bossa, 2006; Kazius et al., 2006) to predict mutagenicity, clastogenicity, carcinogenicity, and reproductive toxicity. The model predicting “health effects on particular organs or organs systems” is based on RTECS and ESIS databases for more than 100.000 compounds. The experimental data have been collected from RTECS and ESIS databases, and diverse publications. Health effects predictions are known to be very sensitive as evidenced by the high prediction values for many of our molecules, we thus decided to reduce the weight of these predictions in our selection strategy for the 11 molecules. These results are completed by a reliability index (RI) ranging from 0 to 1, where 0 is unreliable for the prediction and 1 is a fully reliable prediction. This RI value tends to zero in two cases: i) when the overall similarity between the tested compound 1 or 2 and the most similar compounds used for the correction of the global model is weak, because the predicted values of each of these compounds (obtained by bootstrapping the training set 100 times) weakly correlate with those of 1 or 2, ii) when an inconsistent variability between the predicted and the experimental values was observed among the most similar compounds to the tested compound 1 or 2. The validation sets were used to evaluate result accuracy by computing the Root Mean Square Error (RMSE) between the studied parameter experimental value and its final predicted value. The results with a reliability index under 0.3 (cut-off value) should be discarded without any

consideration of the result. 11 compounds were finally selected. The list can be found in supplementary Table 8.

Animals

We used RjOrl:SWISS mice (Janvier), OF1 mice (Charles Rivers; France) and Pdgfra-CreERT⁺; Rosa26stop-floxed-YFP mice (RRID:IMSR_JAX:018280; RRID:IMSR_JAX:006148). Females and males were included in the study. Mice were maintained in standard conditions with food and water ad libitum in the ICM animal facilities. All animal studies were conducted following protocols approved by local ethical committees and French regulatory authorities (#03860.07, Committee CELYNE APAFIS#187 & 188, APAFIS#5516-2016053017288535, APAFIS #38705-2022092718027606).

Neonatal neural progenitor cultures

NPC proliferating medium was prepared with DMEM/F12 GlutaMAX™ supplement (life technology, 31331028), 0.6% glucose (Sigma, G8769), 1% penicillin/streptomycin (life technology, 15140122), 5mM HEPES buffer (life technology, 15630056), 1% N2 supplement (life technology, 17502048), 2% B27 supplement (life technology, 17504044), 20µg/ml Insulin (Sigma, I6634), 20ng/ml EGF (Peprotech, AF-100-15) and 10ng/ml FGF-basic (Peprotech, 100-18B). Mice brains were collected from RjOrl:SWISS mice (Janvier) at P0-P1 and washed 3 times in PBS-1X (Invitrogen, 14080055). SVZs were dissected, transferred in fresh NPC medium and dissociated with pipette. Cells were amplified and maintained in a humidified atmosphere at 37 °C and 5% CO₂. Three days later, floating neurospheres were collected by centrifugation at 500g for 5minutes, and dissociated before adding proliferating NPC medium. After 2 passages, 30.000 cells were plated in 24 well plates adherent on coverslips, beforehand coated with poly-L-ornithine (sigma, P4957). Compounds were added at different ranges of concentration (250nM, 500nM and 750nM), including positive controls: 3,3',5-Triiodo-L-thyronine sodium salt (Sigma, T6397) at 30mM and clemastine fumarate (Sigma, SML0445) at 500nM and their respective vehicle (DMSO, or PBS). Medium (including compounds or vehicles) was changed every 2 days. After 4 days with proliferation factors, a differentiation medium (without supplemented growth factors) was added for two days. Cells were washed once in PBS-1X, fixed for 10 minutes in 4% PBS-paraformaldehyde (Electron Microscopy Sciences, 50-980-495), and washed 3 times in PBS-1X.

Oligodendrocyte precursor cell sorting and cultures

Brains were collected from P4 mice, and cortex and corpus callosum were dissected and dissociated using a neural tissue dissociation kit (P) (Miltenyi biotec, 130-092-628) with gentleMACS Octo Dissociator (Miltenyi Biotec, 130-096-427). OPC magnetic cell sorting was performed using anti-PDGFR α -coupled-beads (CD140a-PDGFR α MicroBead Kit, Miltenyi biotec, 130-101-502) and MultiMACS Cell24 Separator Plus (Miltenyi biotec, 130-095-691). 40,000 cells were plated on coverslips coated with poly-L-ornithine (sigma, P4957) and amplified for two-three days in a proliferating medium containing DMEM High Glucose (Dutscher, L0103-500), Ham's Nutrient Mixture F12 (Merck, 51651C), L-Glutamine (Thermo, 200 mM), Hormone mix (Gritti, A., et al., 2001), Penicillin/Streptomycin (life technology, 15140122, 1X), 20ng/ml EGF (Peprotech, AF-100-15), 10ng/ml FGF-basic (Peprotech, 100-18B) and 10ng/ml PDGF-AA (PeproTech, 100-13A). Successively, for 3 days of differentiation (without growth factors), compounds were added to the medium at 750nM. T3 (3,3',5-Triiodo- L-thyronine sodium salt, Sigma, T6397) at 30nM or clemastine fumarate (Sigma, SML0445) at 500nM were used as positive controls and their respective vehicles (DMSO, PBS) were used as negative controls. Cells were fixed for 10 minutes in 4% PBS-paraformaldehyde (Electron Microscopy Sciences, 50-980-495) and washed 3 times in PBS-1X.

Cerebellar organotypic cultures

We prepared cerebellar organotypic cultures from newborn (P0) RjOrl:SWISS mice as previously described (Bousslama-Oueghlani et al., 2003). Briefly, cerebellar parasagittal slices (350 μ m thick) were cut on a McIlwain tissue chopper and transferred onto 30 mm diameter Millipore culture inserts with 0,4 μ m pores (Millicell, Millipore, PIHP03050). Slices were maintained in incubators at 37°C, under a humidified atmosphere containing 5% CO₂ in six- well-plates containing 1 ml of slice culture medium, containing basal Earle's salts medium (BME, sigma, MFCD00217343), 25% Hanks' balanced salt solution (Sigma, H9394), 27mM glucose (Sigma, G8769), 1% penicillin/streptomycin (life technology, 15140122), 1mM glutamine (Sigma, 228034) and 5% horse serum (New Zealand origin, heat inactivated; ThermoFisher, 16050122). Medium was renewed every 2 days to 7 days, reaching the appropriate culture periods to study OPC differentiation and myelination. At this time point, small molecules were added daily for 3 days, including Sm1, Sm2,

Sm5, Sm6, Sm7, and Sm11 at 750nM, and their respective vehicle (DMSO or PBS), triiodothyronine (T3; Sigma, T6397- 100MG) at 30nM or clemastine (SelleckChem, Houston, TX) at 500nM. Slices were collected and fixed for 1 hour at RT in 4% PBS-paraformaldehyde (Electron Microscopy Sciences, 50- 980-495) and incubated for 20 minutes at 4°C in Clark's solution (95% ethanol/5% acetic acid), then washed 3 times in PBS 1X.

Compounds nomenclature

Small molecule (Sm)

Nomenclature	Compound
Sm1	Meticrane (Arresten)
Sm2	Heptaminol
Sm3	melatonin
Sm4	Naringenin
Sm5	Prestwick-674 (Dyclonine HCl)
Sm6	Ginkgolide A
Sm7	Levonorgestrel
Sm8	Medrysone
Sm9	Thioperamide
Sm10	Trihexyphenidyl
Sm11	Calcium folinate

Neonatal hypoxia

P3 OF1 mice were placed for 8 days until P11 in a hypoxic rearing chamber maintained at 10% O₂ concentration by displacement with N₂ as previously described (Fagel et al., 2006). A separate group was maintained in a normal atmosphere (normoxic group). Compounds were administered intranasally according to the oral administration in adult humans of sm5 at 5 mg/kg and sm11 at 0,5 mg/kg. Mucus was first permeabilized using type IV hyaluronidase, then 10 µl of compounds (Sigma) were administered 3 times, 1 time a day from P11 to P13 (starting at the end of the hypoxic period, then every 24 hours) in sterile PBS (control). For proliferation analysis, mice were injected with EdU (Sigma) to label cells in an actively cycling state in S-phase, then perfused 1 hour later at P13. For analysis of OL maturation, mice were perfused at P19. All perfusions were performed with Ringer, followed by ice-cold solution of 4% paraformaldehyde (Thermo Fisher). Mice were sacrificed at P13 or P19 by an intraperitoneal overdose of pentobarbital followed by perfusion with Ringer's

lactate solution and 4% paraformaldehyde (PFA; Sigma) dissolved in 0.1M phosphate buffer (PB; pH 7.4). Brains were removed and post-fixed for 24 hours at 4°C in 4% PFA and sectioned in 50µm thick coronal serial free-floating sections.

Intracerebral injections of lysolecithin in the adult mouse

To induce recombination in adult OPCs, tamoxifen (Sigma) was orally administered (gavage) to *Pdgfra-CreERT*; *Rosa26stop-YFP* mice for five consecutive days (210 g/kg per day, dissolved in corn oil at 20 mg/ml), 10 days before lesion induction to optimize the YFP-labelling newly-generated OLs in the lesion area. Before surgery, 4-month-old *RjOrl:SWISS* mice (Janvier) and *Pdgfra-CreERT*; *Rosa26stop-YFP* mice were administered buprenorphine (30 mg/g) to prevent postsurgical pain. Once mice were anesthetized with isoflurane (ISO-VET), an eye protector (Ocrygel, Tvm) and cream lidocaine (Anesderm 5%) were applied to prevent eye dryness and pain caused by the ear bars. A small incision was performed on the head and a few drops of liquid lidocaine were put on the site. We induced focal demyelinated lesions by injecting 0.5µl of a solution of 1% lysolecithin (L- α -lysophosphatidylcholine, Sigma L4129) diluted in 0.9% NaCl into the corpus callosum. To do so, a glass capillary connected to a 10µl Hamilton syringe was fixed and oriented through stereotaxic apparatus (coordinates: 1 mm lateral, 1.3 mm rostral to Bregma, 1.7mm deep to brain surface). Animals were left to recover for a few hours in a warm chamber. Dyclonine/Sm5 (5 mg/kg) and Leucovorin/Sm11 (0.5 mg/kg) were administered daily in 5% glucose drinking water according to the reported oral administration in adult mice (dyclonine; Sahdeo et al; 2014; Okazaki et al; 2018) and humans (leucovorin; Frye et al., 2018; Rossignol and Frye, 2021). Given the reported solubility in water and half-life of these compounds, we dilute them in the drinking water and renew the treatment daily. Given that a 40 g mouse drinks approximately 6mL per day, we diluted respectively 0.2 mg of dyclonine/Sm5 (0.2 mg in 40 g = 5 mg/kg) and 0.02 mg of leucovorin/Sm11 (0.02 mg in 40 g = 0.5 mg/kg) in 6mL, scaling these drug concentrations to a total volume of 200mL per bottle. We added 5% glucose to the preparation to increase the appetite of the mice. Importantly, we monitored the intake volume, and found no differences in the amount of drinking intake per day between the different treatments, as indicated in Fig. 7 extended data 2b, thus confirming the daily oral posology of 5mg/kg of dyclonine/Sm5 and 0.5mg/kg of leucovorin/Sm11, per mouse. The volume of oral consumption was measured daily. Mice were perfused 7 dpl and 10 dpl with 25 ml of 2% PBS-paraformaldehyde freshly prepared from 32% PFA solution

(Electron Microscopy Sciences, 50-980-495). Perfused brains were dissected out, dehydrated in 10% sucrose, followed by 20% sucrose overnight, and embedded in OCT (BDH) before freezing and sectioning (14µm thickness) in a sagittal plane with a cryostat microtome (Leica).

Immunofluorescence staining

For coated-coverslips, blocking was performed in a moist chamber for 30 min at room temperature in a blocking solution of 0.05% Triton X-100 and 10% normal goat serum NGS (Eurobio, CAECHVOO-OU) in PBS. Then, coverslips were incubated for 30 min at room temperature with the primary antibodies. Following 3 washes in 0.05% Triton X-100/PBS, coverslips were incubated for 30 min at room temperature in the dark with appropriate secondary antibodies conjugated with Alexa Fluor 488, 594, and 647 (Molecular Probes or Thermo Fisher) and DAPI (Sigma-Aldrich®, D9542). Coverslips were washed 3 times in 0.05% Triton X-100 in PBS and mounted with Fluoromount-G® (SouthernBiotech, Inc. 15586276).

For ex vivo cerebellar slices, slices were incubated for 20 min at 4°C in Clark's solution (95% ethanol/5% acetic acid) and washed 3 times in PBS. Then, sections were incubated for 1 hour in a blocking solution (0.2% Triton X-100, 4% bovine serum albumin, and 4% donkey serum in PBS). Slices were incubated for 2 hours with primary antibodies at room temperature. Then, they were washed 3 times in 0.1% Triton X-100 in PBS and incubated in blocking solution in the dark at room temperature for 2 hours with appropriate secondary antibodies conjugated with Alexa Fluor 488, 594 and 647 (Molecular Probes or Thermo Fisher) and DAPI (Sigma-Aldrich®, D9542). Finally, slices were washed 3 times in 0.1% Triton X-100 in PBS and mounted in Fluoromount-G® (SouthernBiotech, Inc. 15586276).

For in vivo cryosections (14-µm thick) of lesions, immunohistochemistry was performed after 30 min drying at room temperature. For MOG staining, ethanol treatment (100%) was performed for 10 minutes at room temperature. Sections were permeabilized and blocked in a blocking solution (0.05% Triton X-100, 10% normal goat serum in PBS) for 1 hour. Then, cryosections were incubated overnight with primary antibodies at 4°C. Sections were washed 3 times in 0.05% Triton X-100 in PBS and incubated 1 hour at room temperature with appropriate secondary antibodies conjugated with Alexa Fluor 488, 594, and 647 (Molecular Probes or Thermo Fisher) and DAPI (Sigma-Aldrich®, D9542). Sections were washed 3 times in 0.05% Triton X-100 in PBS and mounted with Fluoromount-G® (SouthernBiotech, Inc. 15586276).

For forebrain sections following neonatal hypoxia, 50µm free-floating coronal sections were collected. Antigen retrieval was performed for 20 minutes in citrate buffer (pH 6.0) at 80°C, then cooled for 20 minutes at room temperature and washed in 0.1M PB. Blocking was performed in a TNB buffer (0.1 M PB; 0.05% Casein; 0.25% Bovine Serum Albumin; 0.25% TopBlock) with 0.4% triton-X (TNB-Tx). Sections were incubated with primary antibodies overnight at 4°C under constant agitation. Following extensive washing in 0.1 M PB with 0.4% triton-X (PB-Tx), sections were incubated with appropriate secondary antibodies conjugated with Alexa Fluor 488 or 555 (1:500; Jackson or Invitrogen) for 2 hours at room temperature. Sections were washed and counterstained with DAPI (1:5000 from working solution at 5mg/ml; Life Technologies; D1306). Revelation of EdU was done using Click-it, EdU cell proliferation Kit for imaging, Alexa Fluor 647 dye (Thermo Fisher scientific). The list of primary and secondary antibodies used can be found in Methods Tables 4 and 5.

Image acquisition and analysis

Visualization and acquisitions for cryosections and ICC were performed using Zeiss® Axio Imager M2 microscope with Zeiss® Apotome system at 20X/0.8 NA dry objective (Plan- apochromat), including deconvolution and Z-stack. Acquisition for cerebellar slices was done using a confocal SP8 X white light laser (Leica, Nanterre, France), at ×40 magnification with a range of 10–15 µm (z axis), four fields (1024 × 1024) before merging them into a mosaic. For in vivo sections of neonatal hypoxia, quantifications were performed on coronal sections by automatic quantifications of Olig2 signal, into manually defined corpus callosum and cortex (based on DAPI counterstaining), using QuPath software (V0.3.0). Analysis was performed using ZEN (Zeiss) and ImageJ (Fiji) software packages, with macros for ex vivo experiments to determine myelination and differentiation index (methods previously described in (Baudouin et al., 2021)). Quantifications were performed on coronal sections by counting the number of cells from z-stack confocal images on ImageJ-Win-64. For section wide quantifications of Olig2/GSTπ positive cells, Olig2+ cell detections were performed on five equally spaced coronal sections (50 µm, 250 µm apart) by automatic detection of Olig2+ cells. Next, a classifier was used to detect Olig2+ cells expressing the mOL marker GSTπ positive cells into manually defined regions covering the entire forebrain, i.e. Isocortex, Olfactory areas, Striatum, Fiber tracts, Cortical subplate, Thalamus, Hypothalamus, as defined by the Allen adult mouse brain reference atlas (CCF v3). Subsequently, manual quantification was done on z-stack confocal images acquired from the

hypothalamic lateral zone, using ImageJ-Win-64. In vivo, images of lesions were quantified in a double-blinded manner. Illustrations were performed using Illustrator and Adobe Photoshop (Adobe System, Inc).

Electron microscopy and analysis

Mice were perfused with 2.5% glutaraldehyde in 0.1M sodium cacodylate buffer 0.1M pH 7.4 (Caco buffer). After dissection, brains were left for one night in the fixative at 4°C. After rinsing in Caco buffer, brains were sliced at 1mm thickness. Sections were selected and washed 3 times. It was then post-fixed with 2% osmium tetroxide in Caco buffer for 1h at room temperature. After an extensive wash (3x10 min) with distilled water they were incubated overnight in 2% aqueous uranyl acetate. They were then dehydrated in a graded series of ethanol solutions (2x5min each): 30%, 50%, 70%, 80%, 90%, and 100% (X3). Final dehydration was performed twice in 100% acetone for 20 min. Samples were then progressively infiltrated with an epoxy resin, Epon 812® (EMS, Souffelweyersheim, France): 2 nights in 50%resin 50%acetone at 4°C in an airtight container. Then twice 2h in pure fresh resin at room temperature. They were embedded in molds and put at 56°C for 48h in a dry oven for polymerization of the resin. Blocks were cut with an UC7 ultramicrotome (Leica, Leica Microsystems SAS, Nanterre, France). Semi-thin sections (0.5µm thick) were stained with 1% toluidine blue in 1% borax. Ultra-thin sections (70nm thick) of the region were recovered on copper grids (200 mesh, EMS, Souffelweyersheim, France) and contrasted with Reynold's lead citrate (Reynolds, ES (1963)). Ultrathin sections were observed with a Hitachi HT7700 electron microscope (Milexiaé, Verrière-le-Buisson, France) operating at 100 kV. Pictures (2048x2048 pixels) were taken with an AMT41B camera. Axons were quantified using Fiji software packages. Plot visualizations and statistics were performed in R. Script use are available on demand.

Statistics and representations

All analyses were done using GraphPad Prism 6.00 (San Diego California, www.graphpad.com). Data distribution was assumed to be normal, but this was not formally tested. Statistical significance was determined using one-way ANOVA by multiple comparisons, pairwise comparisons following Dunnett's post-hoc test, or unpaired t-tests. Data are presented as Mean ± SEM. Significance was set as * for p-value < 0.05, ** for p-value < 0.01, *** p-value < 0.001, and **** p-value < 0.0001. A

summary of tests used, number of replicates, and p-values can be found in Methods Table 3.

Acknowledgements

This work was supported by funding from the Agence Nationale de la Recherche [ANR NeoRepair (ANR-17-CE16-0009) and ANR NeoReGen (ANR-22-CE17-0029) grants], the French Multiple Sclerosis Foundation (ARSEP-1284), and the ICM Carnot projects (#137, #142, and #148). The research leading to these results has received funding from the national program “Investissements d’avenir” ANR-10- IAIHU-0006 and from the national program “Investissements d’avenir” ANR-11- INBS-0011 – NeurATRIS: Translational Research Infrastructure for Biotherapies in Neurosciences. OR lab is supported by Fondation pour la Recherche Médicale (FRM: EQU202203014658) as well as by the LABEX CORTEX (ANR-11- LABX-0042) of Université de Lyon, within the program "Investissements d'Avenir" (decision n° 2019-ANR-LABX-02) operated by the French National Research Agency (ANR). We thank Severine Candelier and Mathilde Lannes for creating the Website of OligoScore, François Xavier Lejeune for monitoring the statistical analysis. We thank the following ICM (Paris Brain Institute) core facilities: PHENOPARC, ICV-3C, Histomics, and ICM.Quant, and all personnel involved for their contribution and support.

References

- (2012) clusterProfiler: an R Package for Comparing Biological Themes Among Gene Clusters. *OMICS: A Journal of Integrative Biology* 16:284-287.
- Abiraman K, Pol SU, O'Bara MA, Chen G-D, Khaku ZM, Wang J, Thorn D, Vedia BH, Ekwegbalu EC, Li J-X, Salvi RJ, Sim FJ (2015) Anti-Muscarinic Adjunct Therapy Accelerates Functional Human Oligodendrocyte Repair. *The Journal of Neuroscience* 35:3676-3688.
- Adenot M, Lahana R (2004) Blood-Brain Barrier Permeation Models: Discriminating between Potential CNS and Non-CNS Drugs Including P-Glycoprotein Substrates. *Journal of Chemical Information and Computer Sciences* 44:239-248.
- Akopian AN, Sivilotti L, Wood JN (1996) A tetrodotoxin-resistant voltage-gated sodium channel expressed by sensory neurons. *Nature* 379:257-262.
- Apolloni S, Fabbriozio P, Parisi C, Amadio S, Volonté C (2016) Clemastine Confers Neuroprotection and Induces an Anti-Inflammatory Phenotype in SOD1G93A Mouse Model of Amyotrophic Lateral Sclerosis. *Molecular Neurobiology* 53:518-531.
- Azim K, Hurtado-Chong A, Fischer B, Kumar N, Zweifel S, Taylor V, Raineteau O (2015) Transcriptional Hallmarks of Heterogeneous Neural Stem Cell Niches of the Subventricular Zone. *Stem Cells* 33:2232-2242.
- Azim K, Angonin D, Marcy G, Pieropan F, Rivera A, Donega V, Cantù C, Williams G, Berninger B, Butt AM, Raineteau O (2017) Pharmacogenomic identification of small molecules for lineage specific manipulation of subventricular zone germinal activity. *PLOS Biology* 15:e2000698.
- Back SA, Luo NL, Borenstein NS, Levine JM, Volpe JJ, Kinney HC (2001) Late Oligodendrocyte Progenitors Coincide with the Developmental Window of Vulnerability for Human Perinatal White Matter Injury. *The Journal of Neuroscience* 21:1302-1312.
- Bacmeister CM, Barr HJ, McClain CR, Thornton MA, Nettles D, Welle CG, Hughes EG (2020) Motor learning promotes remyelination via new and surviving oligodendrocytes. *Nature Neuroscience* 23:819-831.
- Barbierato M, Facci L, Marinelli C, Zusso M, Argentini C, Skaper SD, Giusti P (2015) Co-ultramicrozoned Palmitoylethanolamide/Luteolin Promotes the Maturation of Oligodendrocyte Precursor Cells. *Scientific Reports* 5:16676.
- Barres BA, Lazar MA, Raff MC (1994) A novel role for thyroid hormone, glucocorticoids and retinoic acid in timing oligodendrocyte development. *Development* 120:1097-1108.
- Baudouin L, Adès N, Kanté K, Czarnecki A, Bachelin C, Baskaran A, Langui D, Millécamps A, Gurchenkov B, Velut Y, Duarte K, Barnier J-V, Nait Oumesmar B, Bouslama-Oueghlani L (2021) Co-culture of exogenous oligodendrocytes with unmyelinated cerebella: Revisiting ex vivo models and new tools to study myelination. *Glia* 69:1916-1931.
- Benigni R, Bossa C (2006) Structural Alerts of Mutagens and Carcinogens. *Current Computer-Aided Drug Design* 2:169-176.
- Bernal J (2002) Action of thyroid hormone in brain. *Journal of Endocrinological Investigation* 25:268-288.
- Bodini B, Veronese M, García-Lorenzo D, Battaglini M, Poirion E, Chardain A, Freeman L, Louapre C, Tchikviladze M, Papeix C, Dollé F, Zalc B, Lubetzki C, Bottlaender M, Turkheimer F, Stankoff B (2016) Dynamic Imaging of Individual Remyelination Profiles in Multiple Sclerosis. *Annals of Neurology* 79:726-738.
- Bouslama-Oueghlani L, Wehrle R, Sotelo C, Dusart I (2003) The developmental loss of the ability of Purkinje cells to regenerate their axons occurs in the absence of myelin: an in vitro model to prevent myelination. *J Neurosci* 23:8318-8329.
- Buchanan J et al. (2021) Oligodendrocyte precursor cells prune axons in the mouse neocortex. [bioRxiv:2021.05.20.2029.446047](https://doi.org/10.1101/2021.05.20.2029.446047).
- Calvert S, Tacutu R, Sharifi S, Teixeira R, Ghosh P, de Magalhães JP (2016) A network pharmacology approach reveals new candidate caloric restriction mimetics in *C. elegans*. *Aging Cell* 15:256-266.
- Chen EY, Tan CM, Kou Y, Duan Q, Wang Z, Meirelles GV, Clark NR, Ma'ayan A (2013) Enrichr: interactive and collaborative HTML5 gene list enrichment analysis tool. *BMC bioinformatics* 14:128.
- Cianciulli A, Salvatore R, Porro C, Trotta T, Panaro MA (2016) Folic Acid Is Able to Polarize the Inflammatory Response in LPS Activated Microglia by Regulating Multiple Signaling Pathways. *Mediators of inflammation* 2016:5240127.
- Duncan ID, Brower A, Kondo Y, Curlee JF, Schultz RD (2009) Extensive remyelination of the CNS leads to functional recovery. *Proceedings of the National Academy of Sciences* 106:6832-6836.

- Duncan ID, Radcliff AB, Heidari M, Kidd G, August BK, Wierenga LA (2018) The adult oligodendrocyte can participate in remyelination. *Proceedings of the National Academy of Sciences* 115:E11807-E11816.
- Eleuteri C, Olla S, Veroni C, Umeton R, Mechelli R, Romano S, Buscarinu MC, Ferrari F, Calò G, Ristori G, Salvetti M, Agresti C (2017) A staged screening of registered drugs highlights remyelinating drug candidates for clinical trials. *Scientific Reports* 7:45780.
- Faissner S, Mishra M, Kaushik DK, Wang J, Fan Y, Silva C, Rauw G, Metz L, Koch M, Yong VW (2017) Systematic screening of generic drugs for progressive multiple sclerosis identifies clomipramine as a promising therapeutic. *Nature communications* 8:1990.
- Falcão AM, van Bruggen D, Marques S, Meijer M, Jäkel S, Agirre E, Samudyata, Floriddia EM, Vanichkina DP, ffrench-Constant C, Williams A, Guerreiro-Cacais AO, Castelo-Branco G (2018) Disease-specific oligodendrocyte lineage cells arise in multiple sclerosis. *Nature Medicine* 24:1837-1844.
- Fletcher JL, Makowiecki K, Cullen CL, Young KM (2021) Oligodendrogenesis and myelination regulate cortical development, plasticity and circuit function. *Seminars in Cell & Developmental Biology* 118:14-23.
- Foster AY, Bujalka H, Emery B (2019) Axoglial interactions in myelin plasticity: Evaluating the relationship between neuronal activity and oligodendrocyte dynamics. *Glia* 0.
- Frye RE, Slattery J, Delhey L, Furgerson B, Strickland T, Tippett M, Sailey A, Wynne R, Rose S, Melnyk S, Jill James S, Sequeira JM, Quadros EV (2018) Folinic acid improves verbal communication in children with autism and language impairment: a randomized double-blind placebo-controlled trial. *Molecular Psychiatry* 23:247-256.
- Galloway DA, Gowing E, Setayeshgar S, Kothary R (2020) Inhibitory milieu at the multiple sclerosis lesion site and the challenges for remyelination. *Glia* 68:859-877.
- Gentleman RC et al. (2004) Bioconductor: open software development for computational biology and bioinformatics. *Genome Biol* 5:R80.
- Gingele S, Stangel M (2020) Emerging myelin repair agents in preclinical and early clinical development for the treatment of multiple sclerosis. *Expert Opinion on Investigational Drugs* 29:583-594.
- Green AJ, Gelfand JM, Cree BA, Bevan C, Boscardin WJ, Mei F, Inman J, Arnow S, Devereux M, Abounasr A, Nobuta H, Zhu A, Friessen M, Gerona R, von Büdingen HC, Henry RG, Hauser SL, Chan JR (2017) Clemastine fumarate as a remyelinating therapy for multiple sclerosis (ReBUILD): a randomised, controlled, double-blind, crossover trial. *The Lancet* 390:2481-2489.
- Gritti, A., Galli, R., Vescovi, A.L. (2001). Cultures of Stem Cells of the Central Nervous System. In: Fedoroff, S., Richardson, A. (eds) *Protocols for Neural Cell Culture*. Springer Protocols Handbooks. Humana Press. <https://doi-org/10.1385/1-59259-207-4:173>.
- Hagemeyer N, Hanft K-M, Akriditou M-A, Unger N, Park ES, Stanley ER, Staszewski O, Dimou L, Prinz M (2017) Microglia contribute to normal myelinogenesis and to oligodendrocyte progenitor maintenance during adulthood. *Acta Neuropathologica* 134:441-458.
- Harrison MS, Goldenberg RL (2016) Global burden of prematurity. *Seminars in Fetal and Neonatal Medicine* 21:74-79.
- Hauser SL, Cree BAC (2020) Treatment of Multiple Sclerosis: A Review. *The American Journal of Medicine* 133:1380-1390.e1382.
- Hubler Z et al. (2018) Accumulation of 8,9-unsaturated sterols drives oligodendrocyte formation and remyelination. *Nature*.
- Hughes AN, Appel B (2020) Microglia phagocytose myelin sheaths to modify developmental myelination. *Nature Neuroscience*.
- Irizarry RA, Hobbs B, Collin F, Beazer-Barclay YD, Antonellis KJ, Scherf U, Speed TP (2003) Exploration, normalization, and summaries of high density oligonucleotide array probe level data. *Biostatistics* 4:249- 264.
- Irvine KA, Blakemore WF (2008) Remyelination protects axons from demyelination-associated axon degeneration. *Brain* 131:1464-1477.
- Jablonska B, Scafidi J, Aguirre A, Vaccarino F, Nguyen V, Borok E, Horvath TL, Rowitch DH, Gallo V (2012) Oligodendrocyte Regeneration after Neonatal Hypoxia Requires FoxO1-Mediated p27Kip1 Expression. *The Journal of Neuroscience* 32:14775-14793.
- Jäkel S, Agirre E, Falcão AM, van Bruggen D, Lee KW, Knuesel I, Malhotra D, ffrench-Constant C, Williams A, Castelo-Branco G (2019) Altered human oligodendrocyte heterogeneity in multiple sclerosis. *Nature*.
- Jeffery ND, Blakemore WF (1997) Locomotor deficits induced by experimental spinal cord demyelination are abolished by spontaneous remyelination. *Brain* 120:27-37.

- Kalvass JC, Maurer TS, Pollack GM (2007) Use of Plasma and Brain Unbound Fractions to Assess the Extent of Brain Distribution of 34 Drugs: Comparison of Unbound Concentration Ratios to in Vivo P-Glycoprotein Efflux Ratios. *Drug Metabolism and Disposition* 35:660-666.
- Kazius J, McGuire R, Bursi R (2005) Derivation and Validation of Toxicophores for Mutagenicity Prediction. *Journal of Medicinal Chemistry* 48:312-320.
- Kazius J, Nijssen S, Kok J, Bäck T, Ijzerman AP (2006) Substructure Mining Using Elaborate Chemical Representation. *Journal of Chemical Information and Modeling* 46:597-605.
- Kessar N, Fogarty M, Iannarelli P, Grist M, Wegner M, Richardson WD (2006) Competing waves of oligodendrocytes in the forebrain and postnatal elimination of an embryonic lineage. *Nat Neurosci* 9:173-179.
- Kirby L, Jin J, Cardona JG, Smith MD, Martin KA, Wang J, Strasburger H, Herbst L, Alexis M, Karnell J, Davidson T, Dutta R, Goverman J, Bergles D, Calabresi PA (2019) Oligodendrocyte precursor cells present antigen and are cytotoxic targets in inflammatory demyelination. *Nature communications* 10:3887.
- Lamb J (2007) The Connectivity Map: a new tool for biomedical research. *Nature Reviews Cancer* 7:54-60. Lassmann H (2018) Multiple Sclerosis Pathology. *Cold Spring Harbor Perspectives in Medicine* 8.
- Ligon KL, Huillard E, Mehta S, Kesari S, Liu H, Alberta JA, Bachoo RM, Kane M, Louis DN, Depinho RA, Anderson DJ, Stiles CD, Rowitch DH (2007) Olig2-regulated lineage-restricted pathway controls replication competence in neural stem cells and malignant glioma. *Neuron* 53:503-517.
- Liu J, Dupree JL, Gacias M, Frawley R, Sikder T, Naik P, Casaccia P (2016) Clemastine Enhances Myelination in the Prefrontal Cortex and Rescues Behavioral Changes in Socially Isolated Mice. *The Journal of Neuroscience* 36:957-962.
- Lloyd AF, Miron VE (2019) The pro-remyelination properties of microglia in the central nervous system. *Nature Reviews Neurology* 15:447-458.
- Lloyd AF, Davies CL, Holloway RK, Labrak Y, Ireland G, Carradori D, Dillenburg A, Berger E, Soong D, Richardson JC, Kuhlmann T, Williams A, Pollard JW, des Rieux A, Priller J, Miron VE (2019) Central nervous system regeneration is driven by microglia necroptosis and repopulation. *Nature Neuroscience* 22:1046-1052.
- Lu QR, Sun T, Zhu Z, Ma N, Garcia M, Stiles CD, Rowitch DH (2002) Common developmental requirement for Olig function indicates a motor neuron/oligodendrocyte connection. *Cell* 109:75-86.
- Luu TM, Rehman Mian MO, Nuyt AM (2017) Long-Term Impact of Preterm Birth: Neurodevelopmental and Physical Health Outcomes. *Clinics in Perinatology* 44:305-314.
- Mafi S, Laroche-Raynaud C, Chazelas P, Lia A-S, Derouault P, Sturtz F, Baaj Y, Froget R, Rio M, Benoist J-F, Poumeaud F, Favreau F, Faye P-A (2020) Pharmacoresistant Epilepsy in Childhood: Think of the Cerebral Folate Deficiency, a Treatable Disease. *Brain Sciences* 10:762.
- Marie C, Clavairoly A, Frah M, Hmidan H, Yan J, Zhao C, Van Steenwinckel J, Daveau R, Zalc B, Hassan B, Thomas J-L, Gressens P, Ravassard P, Moszer I, Martin DM, Lu QR, Parras C (2018) Oligodendrocyte precursor survival and differentiation requires chromatin remodeling by Chd7 and Chd8. *Proceedings of the National Academy of Sciences* 115 (35).
- Marques S, van Bruggen D, Vanichkina DP, Floriddia EM, Munguba H, Våremo L, Giacomello S, Falcão AM, Meijer M, Björklund ÅK, Hjerling-Leffler J, Taft RJ, Castelo-Branco G (2018) Transcriptional Convergence of Oligodendrocyte Lineage Progenitors during Development. *Developmental Cell* 46:504-517.e507.
- Marques S et al. (2016) Oligodendrocyte heterogeneity in the mouse juvenile and adult central nervous system. *Science* 352:1326-1329.
- Mei F, Fancy SPJ, Shen Y-AA, Niu J, Zhao C, Presley B, Miao E, Lee S, Mayoral SR, Redmond SA, Etxeberria A, Xiao L, Franklin RJM, Green A, Hauser SL, Chan JR (2014) Micropillar arrays as a high-throughput screening platform for therapeutics in multiple sclerosis. *Nat Med* 20:954-960.
- Menezo Y, Elder K, Clement A, Clement P (2022) Folic Acid, Folinic Acid, 5 Methyl TetraHydroFolate Supplementation for Mutations That Affect Epigenesis through the Folate and One-Carbon Cycles. *Biomolecules* 12.
- Mi H, Muruganujan A, Huang X, Ebert D, Mills C, Guo X, Thomas PD (2019) Protocol Update for large-scale genome and gene function analysis with the PANTHER classification system (v.14.0). *Nature Protocols* 14:703-721.
- Minchenberg S, LaRocca D, Massa P (2015) Induction of arginase-1 by TNF- α in oligodendrocytes is controlled by
- SHP-1 (BA3P.119). *The Journal of Immunology* 194:47.24-47.24.

- Miron VE, Boyd A, Zhao J-W, Yuen TJ, Ruckh JM, Shadrach JL, van Wijngaarden P, Wagers AJ, Williams A, Franklin RJM, French-Constant C (2013) M2 microglia and macrophages drive oligodendrocyte differentiation during CNS remyelination. *Nat Neurosci* advance online publication.
- Nait-Oumesmar B, Decker L, Lachapelle F, Avellana-Adalid V, Bachelin C, Baron-Van Evercooren A (1999) Progenitor cells of the adult mouse subventricular zone proliferate, migrate and differentiate into oligodendrocytes after demyelination. *Eur J Neurosci* 11:4357-4366.
- Najm FJ et al. (2015) Drug-based modulation of endogenous stem cells promotes functional remyelination in vivo. *Nature* advance online publication.
- Nakatani H, Martin E, Hassani H, Clavairoly A, Maire CL, Viadieu A, Kerninon C, Delmas A, Frah M, Weber M, Nakafuku M, Zalc B, Thomas JL, Guillemot F, Nait-Oumesmar B, Parras C (2013) *Ascl1/Mash1* Promotes Brain Oligodendrogenesis during Myelination and Remyelination. *J Neurosci* 33:9752-9768.
- Nakazawa T, Nakazawa C, Matsubara A, Noda K, Hisatomi T, She H, Michaud N, Hafezi-Moghadam A, Miller JW, Benowitz LI (2006) Tumor Necrosis Factor- α Mediates Oligodendrocyte Death and Delayed Retinal Ganglion Cell Loss in a Mouse Model of Glaucoma. *The Journal of Neuroscience* 26:12633-12641.
- Nemes-Baran AD, White DR, DeSilva TM (2020) Fractalkine-Dependent Microglial Pruning of Viable Oligodendrocyte Progenitor Cells Regulates Myelination. *Cell Reports* 32.
- Neumann B, Segel M, Chalut KJ, Franklin RJM (2019a) Remyelination and ageing: Reversing the ravages of time. *Multiple Sclerosis Journal* 25:1835-1841.
- Neumann B, Baror R, Zhao C, Segel M, Dietmann S, Rawji KS, Foerster S, McClain CR, Chalut K, van Wijngaarden P, Franklin RJM (2019b) Metformin Restores CNS Remyelination Capacity by Rejuvenating Aged Stem Cells. *Cell Stem Cell* 25:473-485.e478.
- Nielsen JA, Berndt JA, Hudson LD, Armstrong RC (2004) Myelin transcription factor 1 (*Myt1*) modulates the proliferation and differentiation of oligodendrocyte lineage cells. *Mol Cell Neurosci* 25:111-123.
- Okazaki S, Shintani S, Hirata Y, Suina K, Semba T, Yamasaki J, Umene K, Ishikawa M, Saya H, Nagano O (2018) Synthetic lethality of the *ALDH3A1* inhibitor dyclonine and xCT inhibitors in glutathione deficiency-resistant cancer cells. *Oncotarget* 9:33832-33843.
- Parras CM, Galli R, Britz O, Soares S, Galichet C, Battiste J, Johnson JE, Nakafuku M, Vescovi A, Guillemot F (2004) *Mash1* specifies neurons and oligodendrocytes in the postnatal brain. *Embo J* 23:4495-4505.
- Patrikios P, Stadelmann C, Kutzelnigg A, Rauschka H, Schmidbauer M, Laursen H, Sorensen PS, Bruck W, Lucchinetti C, Lassmann H (2006) Remyelination is extensive in a subset of multiple sclerosis patients. *Brain* 129:3165-3172.
- Pease-Raissi SE, Chan JR (2021) Building a rapport between neurons and oligodendroglia: Reciprocal interactions underlying adaptive myelination. *Neuron* 109:1258-1273.
- Reich DS, Lucchinetti CF, Calabresi PA (2018) Multiple Sclerosis. *New England Journal of Medicine* 378:169-180.
- Reynolds BA, Weiss S (1992) Generation of neurons and astrocytes from isolated cells of the adult mammalian central nervous system. *Science* 255:1707-1710.
- Ritchie ME, Phipson B, Wu D, Hu Y, Law CW, Shi W, Smyth GK (2015) limma powers differential expression analyses for RNA-sequencing and microarray studies. *Nucleic Acids Research* 43:e47-e47.
- Rodriguez-Pena A (1999) Oligodendrocyte development and thyroid hormone. *J Neurobiol* 40:497-512.
- Rossignol DA, Frye RE (2021) Cerebral Folate Deficiency, Folate Receptor Alpha Autoantibodies and Leucovorin (Folinic Acid) Treatment in Autism Spectrum Disorders: A Systematic Review and Meta-Analysis. In: *Journal of Personalized Medicine*.
- Rufini A, Malisan F, Condò I, Testi R (2022) Drug Repositioning in Friedreich Ataxia. *Front Neurosci* 16:814445.
- Salmaso N, Jablonska B, Scafidi J, Vaccarino FM, Gallo V (2014) Neurobiology of premature brain injury. *Nature Neuroscience* 17:341-346.
- Sahdeo S, Scott BD, McMackin MZ, Jasoliya M, Brown B, Wulff H, Perlman SL, Pook MA, Cortopassi GA (2014) Dyclonine rescues frataxin deficiency in animal models and buccal cells of patients with Friedreich's ataxia. *Hum Mol Genet* 23:6848-6862.
- Samanta J, Grund EM, Silva HM, Lafaille JJ, Fishell G, Salzer JL (2015) Inhibition of *Gli1* mobilizes endogenous neural stem cells for remyelination. *Nature* 526:448-452.
- Saunders A, Macosko EZ, Wysoker A, Goldman M, Krienen FM, de Rivera H, Bien E, Baum M, Bortolin L, Wang S, Goeva A, Nemesh J, Kamitaki N, Brumbaugh S, Kulp D, McCarroll SA (2018) Molecular Diversity and Specializations among the Cells of the Adult Mouse Brain. *Cell* 174:1015-1030.e1016.

- Scafidi J, Fagel DM, Ment LR, Vaccarino FM (2009) Modeling premature brain injury and recovery. *International Journal of Developmental Neuroscience* 27:863-871.
- Scafidi J, Hammond TR, Scafidi S, Ritter J, Jablonska B, Roncal M, Szigeti-Buck K, Coman D, Huang Y, McCarter RJ, Hyder F, Horvath TL, Gallo V (2013) Intranasal epidermal growth factor treatment rescues neonatal brain injury. *Nature advance online publication*.
- Scaglione F, Panzavolta G (2014) Folate, folic acid and 5-methyltetrahydrofolate are not the same thing. *Xenobiotica* 44:480-488.
- Schang A-L, Van Steenwinckel J, Ioannidou ZS, Lipecki J, Rich-Griffin C, Woolley-Allen K, Dyer N, Le Charpentier T, Schäfer P, Fleiss B, Ott S, Sabéran-Djoneidi D, Mezger V, Gressens P (2022) Epigenetic priming of immune/inflammatory pathways activation and abnormal activity of cell cycle pathway in a perinatal model of white matter injury. *Cell Death & Disease* 13:1038.
- Schoonover CM, Seibel MM, Jolson DM, Stack MJ, Rahman RJ, Jones SA, Mariash CN, Anderson GW (2004) Thyroid Hormone Regulates Oligodendrocyte Accumulation in Developing Rat Brain White Matter Tracts. *Endocrinology* 145:5013-5020.
- Shen K, Reichelt M, Kyauk RV, Ngu H, Shen Y-AA, Foreman O, Modrusan Z, Friedman BA, Sheng M, Yuen TJ (2021) Multiple sclerosis risk gene *Mertk* is required for microglial activation and subsequent remyelination. *Cell Reports* 34.
- Sloane JA, Batt C, Ma Y, Harris ZM, Trapp B, Vartanian T (2010) Hyaluronan blocks oligodendrocyte progenitor maturation and remyelination through TLR2. *Proc Natl Acad Sci U S A* 107:11555-11560.
- Smith KJ, Blakemore WF, McDonald WI (1979) Central remyelination restores secure conduction. *Nature* 280:395-396.
- Stolt CC, Wegner M (2010) SoxE function in vertebrate nervous system development. *The International Journal of Biochemistry & Cell Biology* 42:437-440.
- Stolt CC, Rehberg S, Ader M, Lommès P, Riethmacher D, Schachner M, Bartsch U, Wegner M (2002) Terminal differentiation of myelin-forming oligodendrocytes depends on the transcription factor Sox10. *Genes Dev* 16:165-170.
- Stuart T, Butler A, Hoffman P, Hafemeister C, Papalexi E, Mauck WM, Hao Y, Stoeckius M, Smibert P, Satija R (2019) Comprehensive Integration of Single-Cell Data. *Cell* 177:1888-1902.e1821.
- Su W-J, Zhang T, Jiang C-L, Wang W (2018) Clemastine Alleviates Depressive-Like Behavior Through Reversing the Imbalance of Microglia-Related Pro-inflammatory State in Mouse Hippocampus. *Frontiers in Cellular Neuroscience* 12.
- Summerfield SG, Lucas AJ, Porter RA, Jeffrey P, Gunn RN, Read KR, Stevens AJ, Metcalf AC, Osuna MC, Kilford PJ, Passchier J, Ruffo AD (2008) Toward an improved prediction of human in vivo brain penetration. *Xenobiotica* 38:1518-1535.
- Suzuki SO, Goldman JE (2003) Multiple cell populations in the early postnatal subventricular zone take distinct migratory pathways: a dynamic study of glial and neuronal progenitor migration. *J Neurosci* 23:4240-4250.
- Thomas PD, Ebert D, Muruganujan A, Mushayahama T, Albu L-P, Mi H (2022) PANTHER: Making genome-scale phylogenetics accessible to all. *Protein Science* 31:8-22.
- Tommy T, Islam AA, Hatta M, Bukhari A, Nasrullah, Adhimarta W, Aminuddin, Zainuddin AA (2021) Effect of folic acid on serum homocysteine, TNF α , IL-10, and HMGB1 gene expression in head injury model. *Annals of medicine and surgery* 65:102273.
- Van Steenwinckel J et al. (2019) Decreased microglial Wnt/ β -catenin signalling drives microglial pro-inflammatory activation in the developing brain. *Brain* 142:3806-3833.
- Varkuti BH, Kepiro M, Liu Z, Vick K, Avchalumov Y, Pacifico R, MacMullen CM, Kamenecka TM, Puthanveetil SV, Davis RL (2020) Neuron-based high-content assay and screen for CNS active mitotherapeutics. *Science Advances* 6:eaaw8702.
- Volpe JJ (2009) Brain injury in premature infants: a complex amalgam of destructive and developmental disturbances. *The Lancet Neurology* 8:110-124.
- Vue TY, Kollipara RK, Borromeo MD, Smith T, Mashimo T, Burns DK, Bachoo RM, Johnson JE (2020) ASCL1 regulates neurodevelopmental transcription factors and cell cycle genes in brain tumors of glioma mouse models. *Glia* 68:2613-2630.
- Walani SR (2020) Global burden of preterm birth. *International Journal of Gynecology & Obstetrics* 150:31-33.
- Weng Q, Wang J, Wang J, Tan B, Wang J, Wang H, Zheng T, Lu QR, Yang B, He Q (2017) Folate Metabolism Regulates Oligodendrocyte Survival and Differentiation by Modulating AMPK α Activity. *Scientific Reports* 7:1705.
- Williams G (2013) SPIEDw: a searchable platform-independent expression database web tool. *BMC Genomics* 14:765.

- Xiao Y, Petrucco L, Hoodless LJ, Portugues R, Czopka T (2022) Oligodendrocyte precursor cells sculpt the visual system by regulating axonal remodeling. *Nature Neuroscience*.
- Xing YL, Röth PT, Stratton JAS, Chuang BHA, Danne J, Ellis SL, Ng SW, Kilpatrick TJ, Merson TD (2014) Adult Neural Precursor Cells from the Subventricular Zone Contribute Significantly to Oligodendrocyte Regeneration and Remyelination. *The Journal of Neuroscience* 34:14128-14146.
- Ye X, Linton JM, Schork NJ, Buck LB, Petrascheck M (2014) A pharmacological network for lifespan extension in *Caenorhabditis elegans*. *Aging Cell* 13:206-215.
- Yeung MSY, Djelloul M, Steiner E, Bernard S, Salehpour M, Possnert G, Brundin L, Frisén J (2019) Dynamics of oligodendrocyte generation in multiple sclerosis. *Nature*.
- Yu Y, Chen Y, Kim B, Wang H, Zhao C, He X, Liu L, Liu W, Wu Lai Man N, Mao M, Chan Jonah R, Wu J, Lu QR (2013) Olig2 Targets Chromatin Remodelers to Enhancers to Initiate Oligodendrocyte Differentiation. *Cell* 152:248-261.
- Zahaf A, Kassoussi A, Hutteau-Hamel T, Mellouk A, Marie C, Zoupi L, Tsouki F, Mattern C, Bobé P, Schumacher M, Williams A, Parras C, Traiffort E (2023) Androgens show sex-dependent differences in myelination in immune and non-immune murine models of CNS demyelination. *Nature communications* 14:1592.
- Zhang S, Zhu X, Gui X, Croteau C, Song L, Xu J, Wang A, Bannerman P, Guo F (2018) Sox2 is essential for oligodendroglial proliferation and differentiation during postnatal brain myelination and CNS remyelination. *The Journal of Neuroscience*:1291-1217.
- Zhang Y, Chen K, Sloan SA, Bennett ML, Scholze AR, O'Keefe S, Phatnani HP, Guarnieri P, Caneda C, Ruderisch N, Deng S, Liddelow SA, Zhang C, Daneman R, Maniatis T, Barres BA, Wu JQ (2014) An RNA-Sequencing Transcriptome and Splicing Database of Glia, Neurons, and Vascular Cells of the Cerebral Cortex. *The Journal of Neuroscience* 34:11929-11947.
- Zheng Y, Cantley LC (2018) Toward a better understanding of folate metabolism in health and disease. *Journal of Experimental Medicine* 216:253-266.
- Zhou X, Shin S, He C, Zhang Q, Rasband MN, Ren J, Dai C, Zorrilla-Veloz RI, Shingu T, Yuan L, Wang Y, Chen Y, Lan F, Hu J (2021) Qki regulates myelinogenesis through Srebp2-dependent cholesterol biosynthesis. *eLife* 10:e60467.
- Zhou Y, Zhou B, Pache L, Chang M, Khodabakhshi AH, Tanaseichuk O, Benner C, Chanda SK (2019) Metascape provides a biologist-oriented resource for the analysis of systems-level datasets. *Nature communications* 10:1523.
- Ziehm M, Kaur S, Ivanov DK, Ballester PJ, Marcus D, Partridge L, Thornton JM (2017) Drug repurposing for aging research using model organisms. *Aging Cell* 16:1006-1015.

Graphical abstract

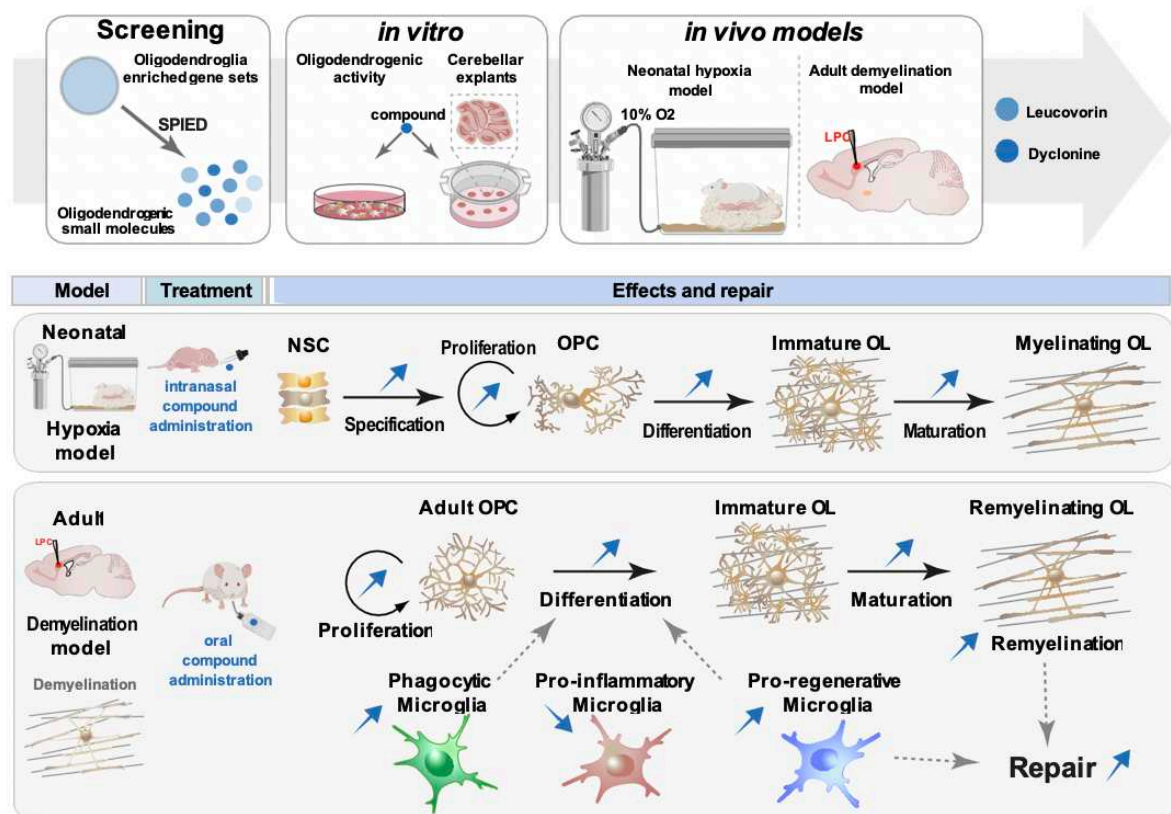

Pharmacogenomic screening identifies and repurposes dyclonine and leucovorin as pro-oligodendrogenic and pro-myelinating compounds. Schematics of the pharmacogenomic approach leading to the identification of small bioactive molecules (compounds) with potential pro-oligodendrogenic activity, followed by the *in vitro* validation of the top compounds using neural and oligodendrocyte progenitor cell (OPC) cultures as well as organotypic cerebellar explants. The therapeutic efficacy of the top two compounds, leucovorin and dyclonine, both approved by the Food and Drug Administration (FDA), was assessed *in vivo* using two clinically relevant mouse models of myelin pathologies. In the neonatal hypoxia mouse model, mimicking some aspects of preterm brain injury, both leucovorin and dyclonine promoted neural stem cell (NSC) differentiation into OPCs and OPC proliferation, with leucovorin additionally restoring the density of myelinating OLs found in normoxic conditions. In an adult focal de/remyelination mouse model of multiple sclerosis, both compounds significantly improved lesion repair in adult mice by promoting OPC differentiation while preserving the pool of OPCs, and by accelerating myelin debris clearance and shifting microglia from pro-inflammatory to pro-regenerative profiles.

Figure 1

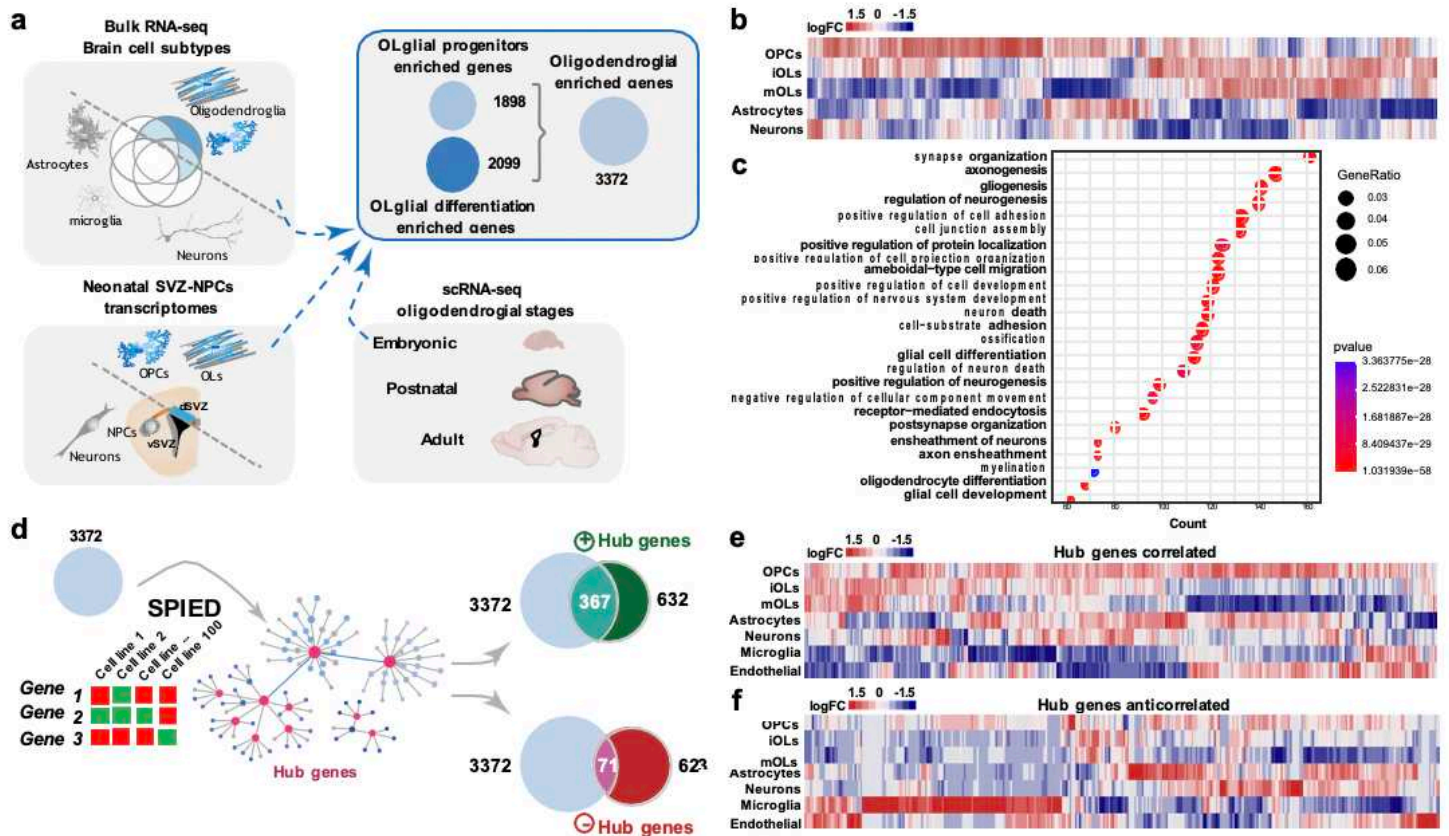

Figure 1. In-silico strategy to generate oligodendroglial-enriched gene sets and their use in pharmacogenomics to identify new hub genes. (a) Use of both bulk and single-cell RNA-seq datasets from different brain cell types and oligodendroglial stages, together with transcriptomic comparison of dorsal (gliogenic) vs. ventral (neurogenic) neonatal forebrain progenitors to identify gene sets enriched either in progenitors, more mature cells, or both, depicted as circles indicating the number of genes. (b) Heat map showing the differential expression of the 3372 gene set in different neural cell types. (c) Top gene ontology biological processes related to the 3372 genes. (d) Schematics representing the interrogation of the SPIED platform with the 3372 genes to identify hub genes correlated (positive hub genes) or anti-correlated (negative hub genes). Note that most of the positively correlated hub genes are included in the 3372 gene set, whereas only a few of the anti-correlated ones. (e, f) Heatmap visualization of the expression of correlated- (e) and anticorrelated- hub genes (f) in different brain cells indicates that most of the correlated genes are expressed in oligodendroglia while many anticorrelated hub genes are enriched in microglia, astrocytes, and endothelial cells.

Figure 1 extended data 1

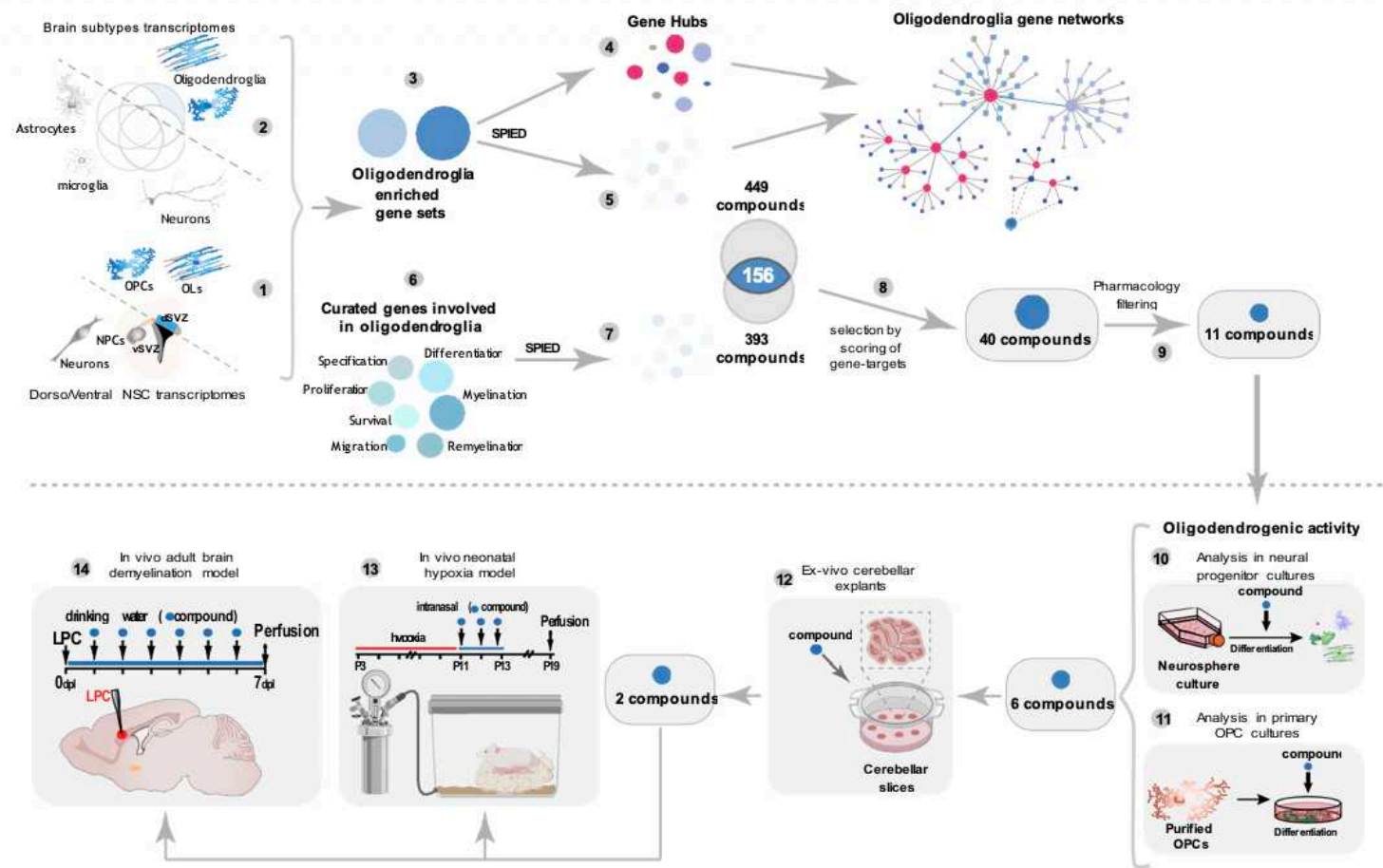

Figure 1 extended data 1. Summary scheme of the screening strategy and compound selection process. Schematics representing the in-silico (top) and wet-lab (bottom) strategies. In-silico bioinformatic strategy allowed the generation of a large oligodendroglial transcriptional signature (steps 1-3) and gene hubs of the oligodendroglial gene-networks (step 4) used to generate a list of compounds with putative pro-oligodendrogenic and (re)myelinating activities (step 5). Compounds were ranked by their large pro-oligodendrogenic activities through expert curation of their regulated target genes (steps 6-8), and then by their pharmacological properties (step 9), with a final selection of the top 11 compounds. Wet-lab strategy to assess the pro-oligodendrogenic activity of the selected compounds in the culture of neural progenitor cells (step 10) and OPCs (step 11), resulting in 6 compounds being selected for further activity assessment in ex vivo cerebellar explant cultures (step 12). Finally, the top two compounds were used in vivo in a model of preterm birth injury (neonatal hypoxia, step 13) and a model of adult de/remyelination (step 14). Numbers in grey circles indicate the different steps of the project as detailed in the main text.

Figure 2

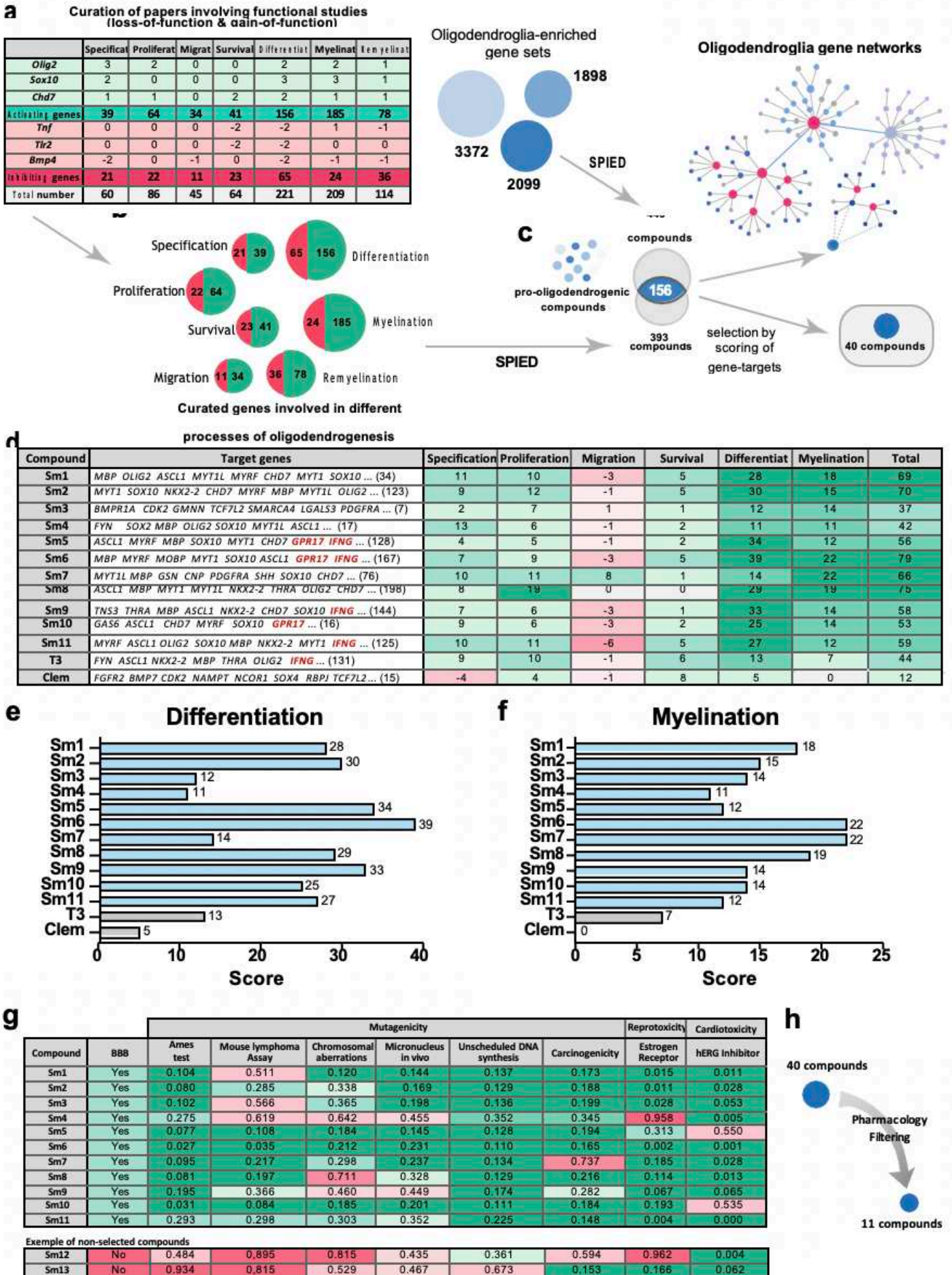

Figure 2. Expert curation ranking and selection of small molecules. (a) Table illustrating the scoring of selected genes for their regulation in different oligodendrogenesis processes (positive in green or negative in red), based on bibliographic curation of functional studies. (b) Curated genes subsets promoting (green) or inhibiting (red) each oligodendrogenesis process. (c) Using both curated and oligodendroglial-enriched gene sets to interrogate the SPIED platform and generate a list of small molecules /compounds regulating their expression. Shared compounds were then ranked by the scoring of their curated gene signatures, in order to select 40 compounds with novel pro- oligodendrogenic transcriptional activity. (d) Table listing the top 11 small molecules (Sm) alongside two positive controls (T3 and clemastine) exemplifying some of their curated gene targets and their corresponding scoring values (green: positive, red: negative) for each oligodendrogenesis process. (e, f) Barplots illustrating the score of selected compounds in the differentiation (e) and myelination (f) processes, respectively. (g) Table and (h) schematics illustrating the pharmacological filtering criteria (BBB permeability, mutagenicity, reprotoxicity, cardiotoxicity, etc.) used to select the top 11 compounds. Green to red gradient highlights the probability values from positive to negative activity on each pharmacological parameter. BBB: Blood-Brain-Barrier, hERG: ether-a-go-go related gene potassium channel.

Figure 2 extended data 1. OligoScore, a new web resource to evaluate gene sets for their involvement in oligodendrogenesis. Schematics illustrating the OligoScore resource, a curation strategy currently encompassing over 430 genes and 1000 publications that report the functional implication (either by loss-of-function or gain-of-function experiments) of a given gene in each aspect (process) of oligodendrogenesis (i.e., specification, proliferation, migration, survival, differentiation, myelination, and remyelination). Detailed statistics obtained either from queries using either (1) a gene set (i.e, list of genes) or (2) a list of deregulated genes (i.e, genes and logarithmic fold-changes, logFC) are provided as barplots.

Figure 2 extended data 2

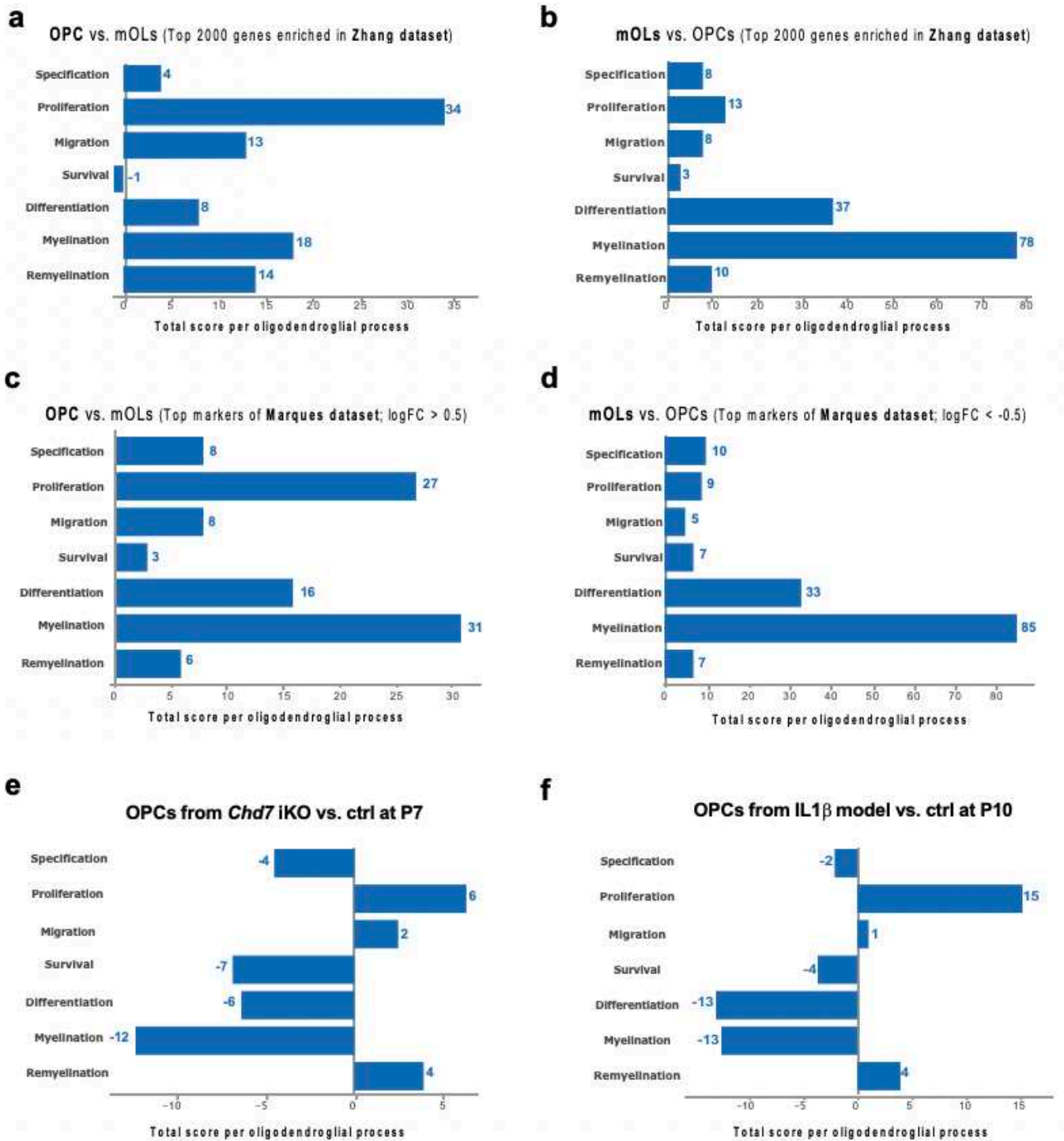

Figure 2 extended data 2. OligoScore validation using expression and deregulated transcriptional signatures. (a-d) Querying of OligoScore with genes enriched in OPC vs. myelinating OLs (mOLs), and vice versa, using either (a) postnatal purified brain cell transcriptomes (Zhang et al., 2024) or (c) oligodendroglial single-cells transcriptomes (Marques et al., 2016, 2018; see also Methods and OligoScore_validation_tables file). In both cases, OligoScore highlights that while OPC gene programs are involved in several processes of oligodendrogenesis, including specification, proliferation, migration, differentiation, and myelination (a, c), mOL-enriched genes are mainly involved in differentiation and myelination (b, d). (e, f) Querying OligoScore (genes and fold-changes) with genes dysregulated in OPCs upon a genetic (postnatal day 7 OPCs with an induced knockout for Chd7, compared to controls; Marie et al., 2018), or an environmental (P10 OPCs in the systemic IL1 β - mediated neonatal neuroinflammatory model, Schang et al., 2022) perturbation. This analysis highlights the deregulated processes identified in these studies, such as reduced survival, and differentiation of Chd7 iKO OPCs (e), and increased proliferation and reduced differentiation of OPCs in the IL1 β -model (f).

Figure 3

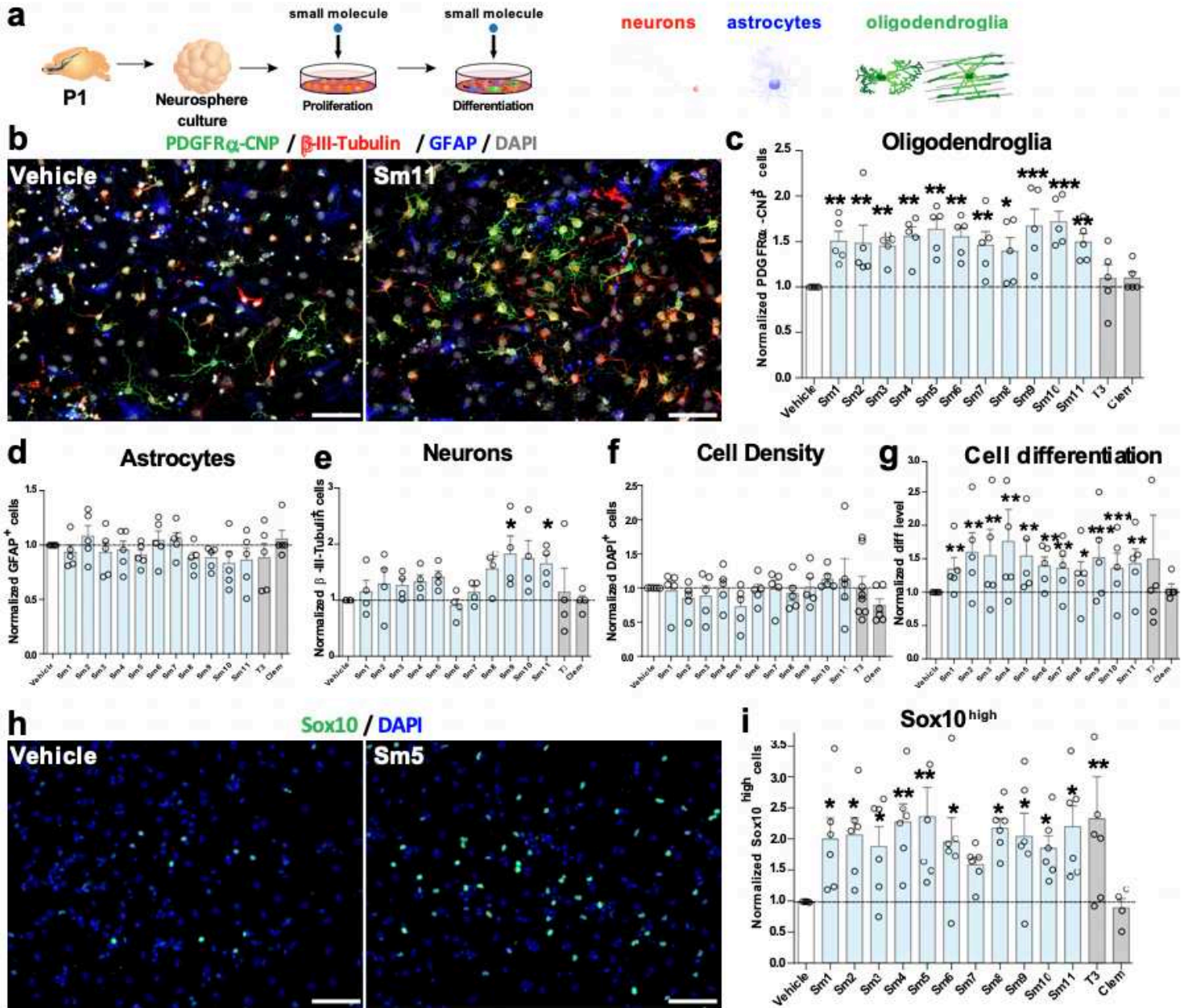

Figure 3. Pro-oligodendrogenic activity of small molecules in neonatal neural progenitor cultures. (a) Schematics representing the protocol of neurosphere-derived neural progenitor cell cultures and small molecule administration. (b) Representative images illustrating the immunodetection of neurons (β -III-tubulin⁺ cells, red), astrocytes (GFAP⁺ cells, blue), and oligodendroglia (PDGFR α ⁺ OPCs and CNP⁺ OLs, green) in vehicle vs. Sm11 treated cultures after 2 days of differentiation. Note the increase of oligodendroglial cells in the Sm11-treated condition. (c-g) Quantifications showing the increase of oligodendroglial cells (PDGFR α ⁺ and CNP⁺ cells) in cultures treated with each of the selected compounds, but not upon T3 and clemastine treatment (c), no changes in the number of astrocytes (GFAP⁺ cells) (d), neuronal cells (β -III-tubulin⁺ cells, e), or in cell density (f), with an increase in cell differentiation (more cells labeled by any of the markers and less DAPI-only cells) for most selected compounds (g). (h) Representative images of the immunofluorescence for Sox10^{high} (iOLs, green) and DAPI (blue) illustrating the increase in treated cultures (Sm5) compared to vehicle cultures after 2 days differentiation. (i) Quantification showing the increase of Sox10^{high} cells in most compound-treated cultures, including T3. Data are presented as mean \pm SEM of fold change normalized to vehicle. N > 5 replicates. *p < 0.05; **p < 0.01; ***p < 0.001. Statistical analysis used linear mixed-effects models followed by Type II Wald chi-square tests (ANOVA). Scale bars: b, 20 μ m; h, 50 μ m.

Figure 3 extended data 1

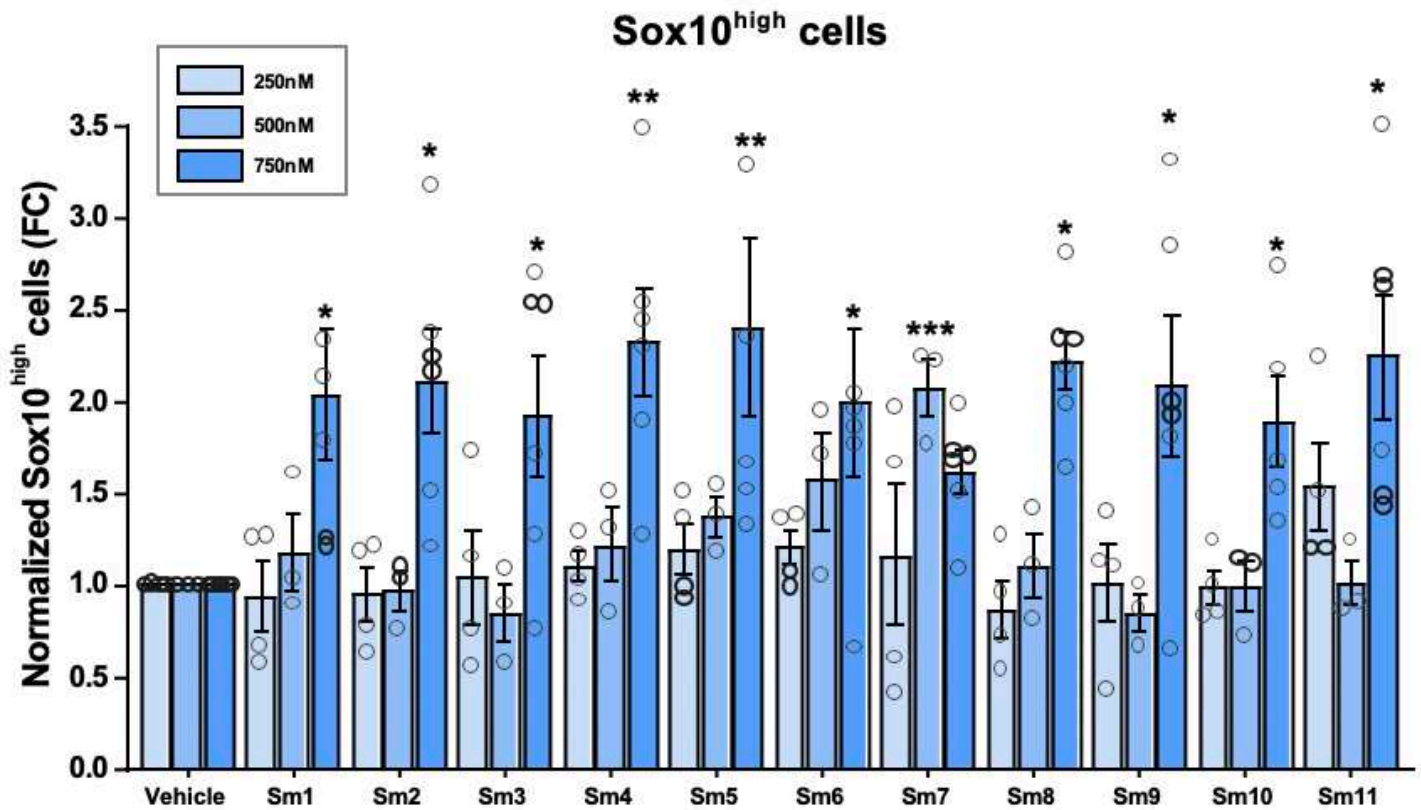

Figure 3 extended data 1. Dose effect of compounds' pro-oligodendrogenic activity in neonatal neural progenitor cultures. Quantifications of Sox10^{high} cells (iOLs) in cultures treated with compounds at 250nM (N=4), 500nM (N=3) and 750nM (N=6), showing the best effect at 750nM. Data are presented as mean \pm SEM of fold change normalized to vehicle. * $p < 0.05$; ** $p < 0.01$; *** $p < 0.001$. Statistical analysis used linear mixed-effects models followed by Type II Wald chi-square tests (ANOVA).

Figure 4

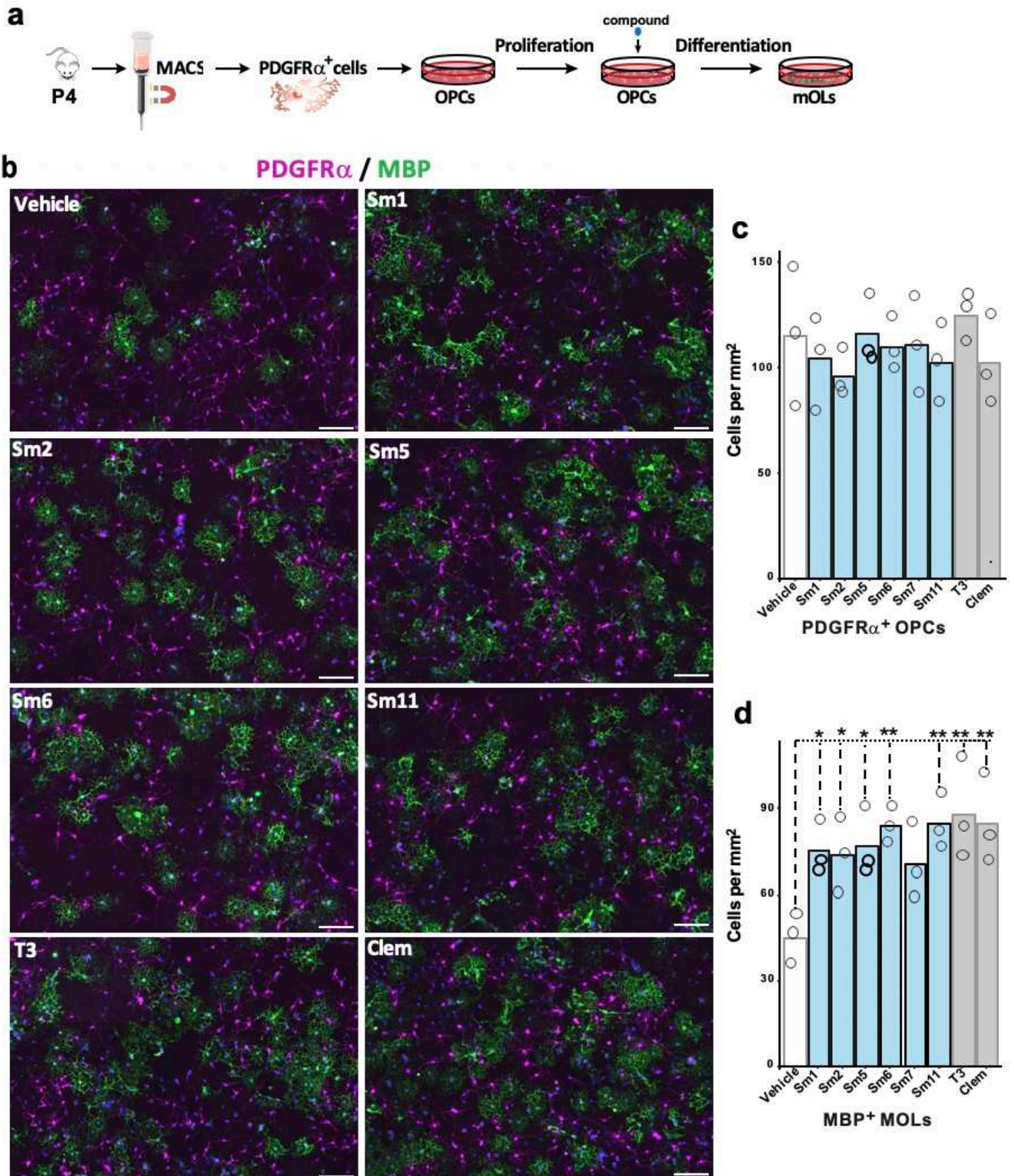

Figure 4. Cell-autonomous effect of selected compounds in OPC differentiation. (a) Schematic representing the protocol of OPC purification, culture, and compound treatment. (b) Representative images illustrating the immunodetection of OPCs (PDGFR α + cells, magenta) and differentiating OLs (MBP+ cells, green). (c, d) Quantification of the number of OPCs (PDGFR α + cells, c) and number of OLs (MBP+ cells, d) per mm² in different treated conditions, showing that most compounds present a significant increase in the number of differentiating OLs compared to the vehicle treatment. Data are presented as mean \pm SEM from 3 independent experiments. * $p < 0.05$, ** $p < 0.01$. ANOVA with Dunnett's post hoc test. Scale bars: 20 μ m.

Figure 4 extended data 1

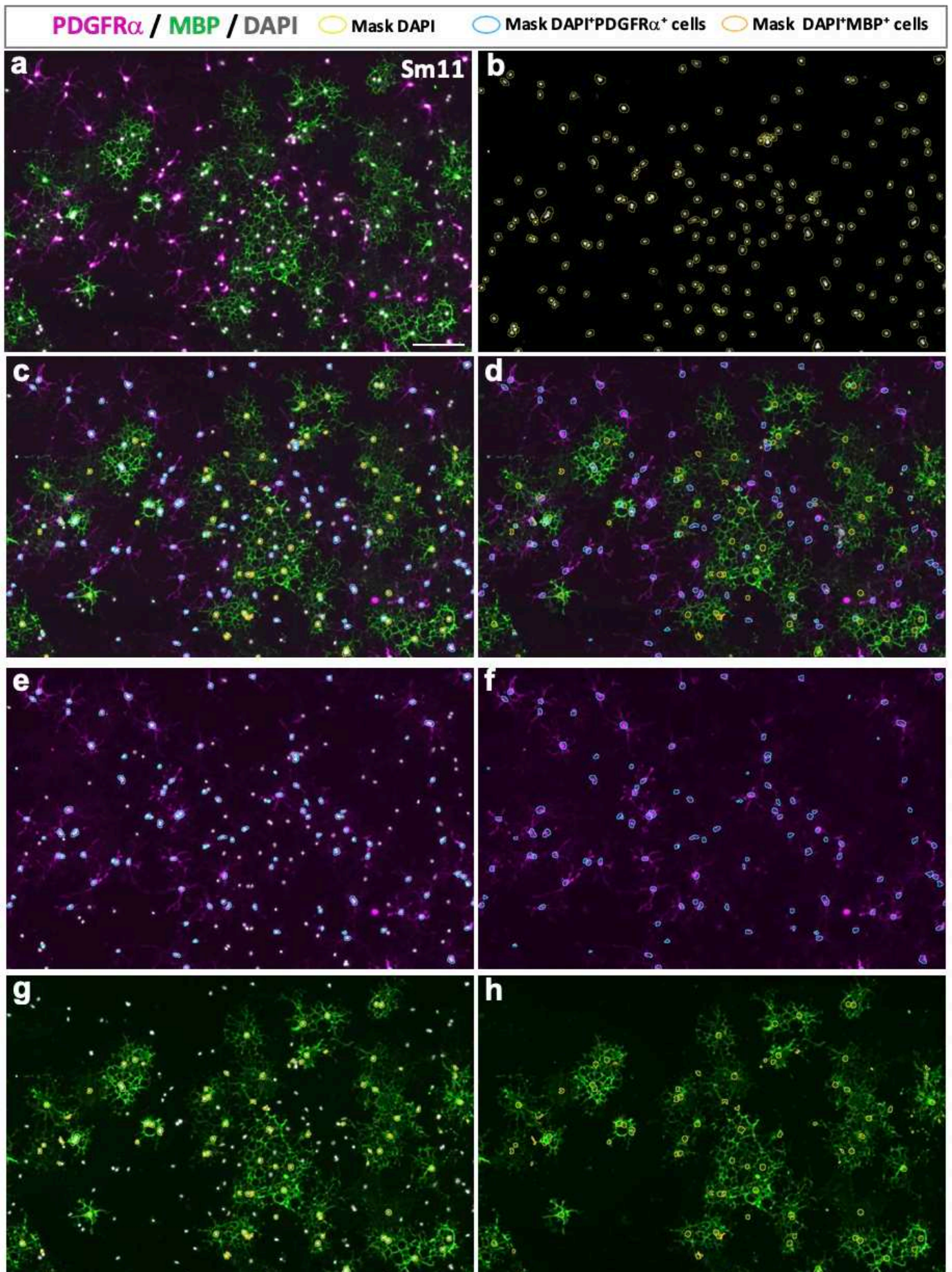

Figure 4 extended data 1. Automatic quantification of OPC differentiation cultures. (a) Representative image illustrating the immunodetection of OPCs (PDGFR α + cells, magenta) and differentiating OLs (MBP+ cells, green) together with nuclear DAPI staining (grey) from OPC differentiation cultures, used to illustrate automatic segmentation and quantification shown in following panels. (b) Image illustrating with yellow masks the segmentation of DAPI nuclei (grey) used for automatic quantification. (c-h) Images illustrating with cyan masks the automatic identification of OPCs, DAPI nuclei having PDGFR α labeling (magenta), and with orange marks the identification of OLs, DAPI nuclei having MBP labeling (green), shown with (c, e, g) or without the DAPI channel (d, f, h), and showing PDGFR α and MBP labeling together (c, d) or as separate channels (e-h) to facilitate mask visualization.

Figure 5

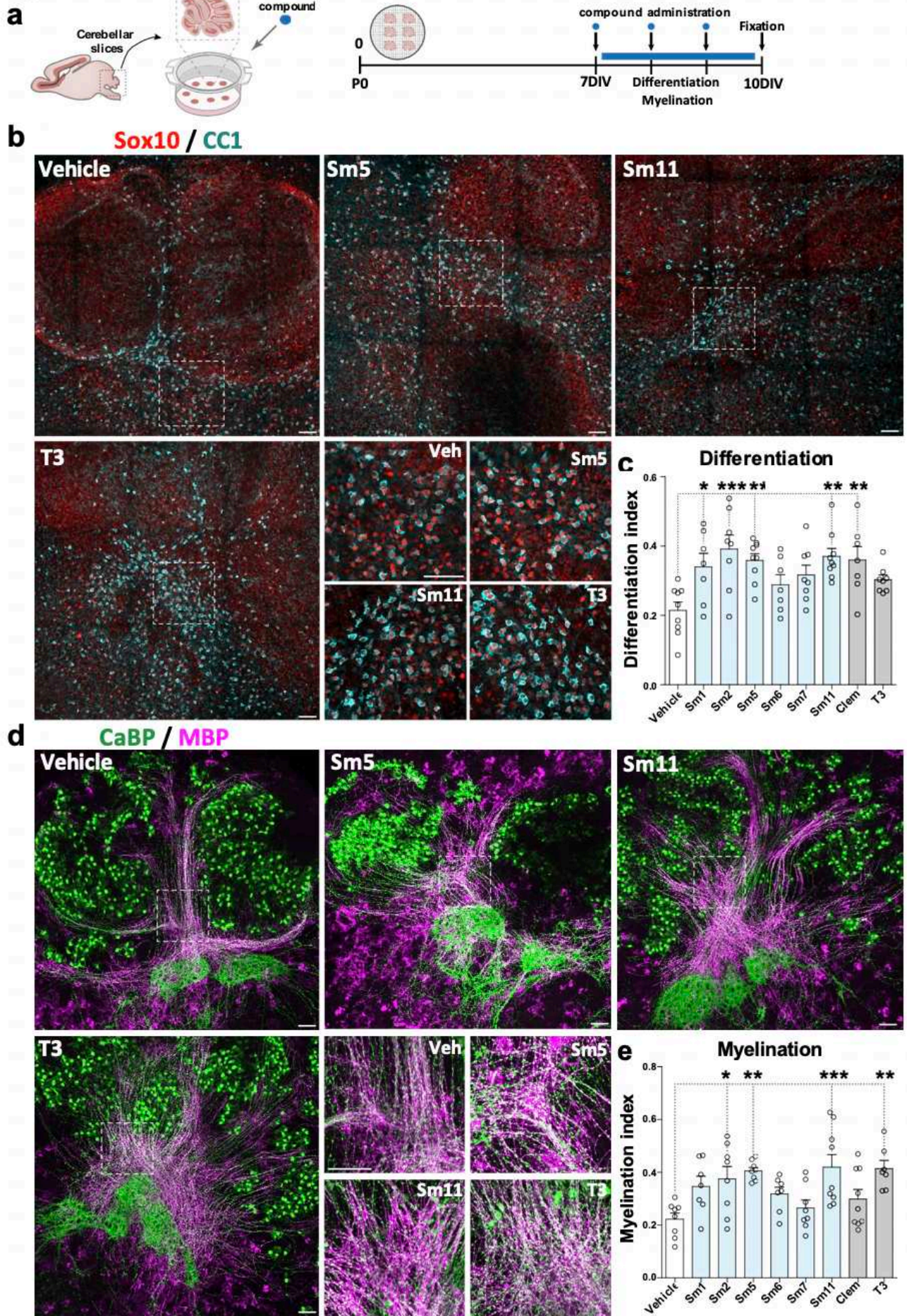
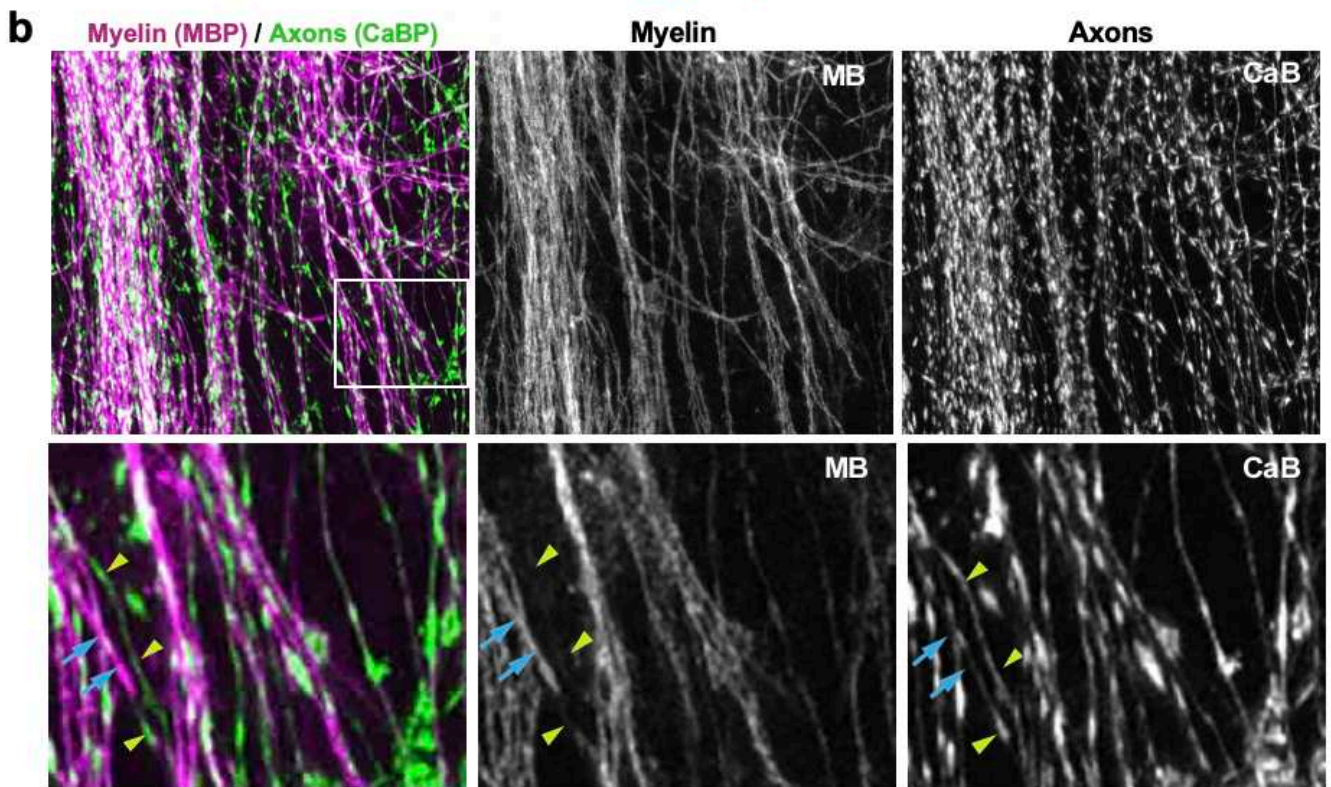
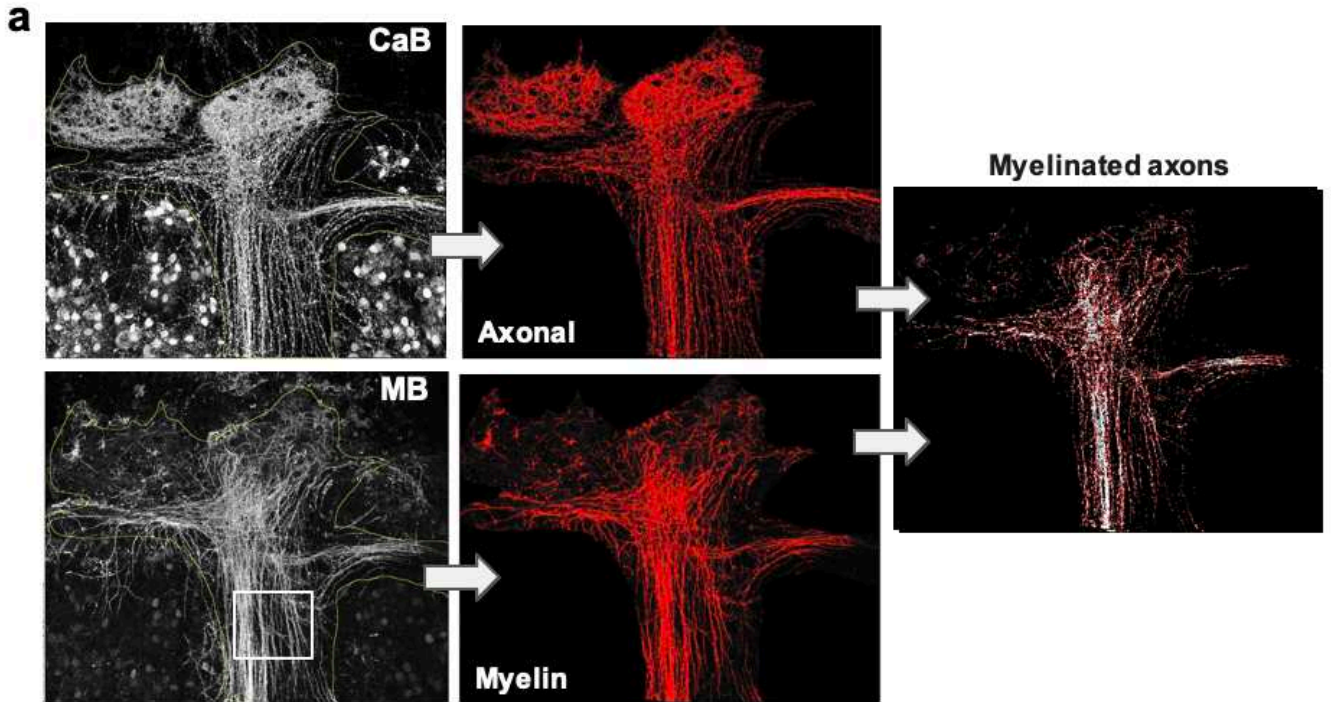

Figure 5. Selected compounds promote oligodendrocyte differentiation and myelination ex vivo in cerebellar explant cultures. (a) Schematic illustrating the protocol of the cerebellar explant culture model and timing of compound administration. (b) Images of explants illustrating effects of compounds (Sm5, Sm11, and T3) on oligodendrocyte differentiation by immunodetection of Sox10+ oligodendroglia (red) and CC1+ OLs (blue). (c) Quantification of the differentiation index (SOX10+CC1+/SOX10+ cells) showing an increase following treatment with Sm1, Sm2, Sm5, Sm11, and clemastine compounds. (d) Immunofluorescence of explants illustrating compound effects (Sm5, Sm11, and T3) on myelination of Purkinje axons by immunodetection of CaBP+ axons/cells (green) and MBP (pink). (e) Quantification of the myelination index (surface MBP+ CaBP+/ surface CaBP+) showing an increase following treatment with Sm2, Sm5, Sm11, and T3 compounds. Data are presented as mean \pm SEM. N= 5 independent experiments (1-3 confocal acquisitions for each cerebellum). *p < 0.05; **p < 0.01; ***p < 0.001. Statistical unpaired bilateral Wilcoxon Mann Whitney test. Scale bars: 100 μ m.

Figure 5 extended data 1



c

	Neonatal neural progenitors cultures						OPC cultures	Organotypic cerebellar slices		Rank
	iOLs diff	Oligodendroglia	Astrocyte	Neuron	Cell diff	Cell density	OL morphology	Differentiation	Myelination	
	SOX10 ⁺	PDGFRα ⁺ CNP ⁺	GFAP ⁺	β-III-tub ⁺	marker ⁺	DAPI	Cell surface (μm ²)	SOX10 ⁺ CC1 ⁺ /SOX10 ⁺	CaBP ⁺ /MBP ⁺	
Sm5	2.41	1.63	0.91	1.41	1.54	0.74	2.05	1.67	1.72	1
Sm11	2.24	1.47	0.86	1.65	1.43	1.01	2.04	1.30	1.84	2
Sm2	2.11	1.48	1.08	1.29	1.61	0.86	1.69	1.83	1.59	3
Sm1	2.04	1.50	0.93	1.15	1.35	0.87	1.83	1.59	1.47	4
T3	2.37	1.08	0.89	1.15	1.5	0.82	1.44	1.07	1.81	5
Sm7	1.62	1.46	1.05	1.14	1.36	0.95	1.37	1.48	1.12	6
Sm6	1.99	1.55	1.04	0.90	1.40	0.96	1.37	1.34	1.35	7
Clem	0.91	1.25	1.14	0.98	1.05	0.69	NA	1.67	1.26	8

Scale
>2
1.5-2
1-1.5
0.9-1.1
0.6-0.9

Figure 5 extended data 1. Automatic quantification of differentiation and myelination index in ex vivo cerebellar cultures, with a ranking of selected drugs for their pro-oligodendrogenic effects. (a) Illustration images of the automatic quantification approach to obtain the myelinating index (as optimized in Baudouin et al., 2021). (b) High magnification images illustrating the overlap between myelin, MBP immunodetection (magenta), and Purkinje neuronal axon immunodetected with CaBP antibody (green). Examples of myelinated- (blue arrows) and non-myelinated (yellow arrowheads) axonal segments are indicated in the lower panel. (c) Table integrating and ranking the effects of selected compounds on oligodendrogenesis. Biological effects of the small molecules and positive controls (T3, clem) determined through in vitro and ex vivo systems allow ranking them for their pro- oligodendrogenic activity to select the top two candidates for in vivo analysis. Data are presented as fold change compared to their respective vehicle. diff: differentiation; NA: not assessed; Clem, clemastine.

Figure 6

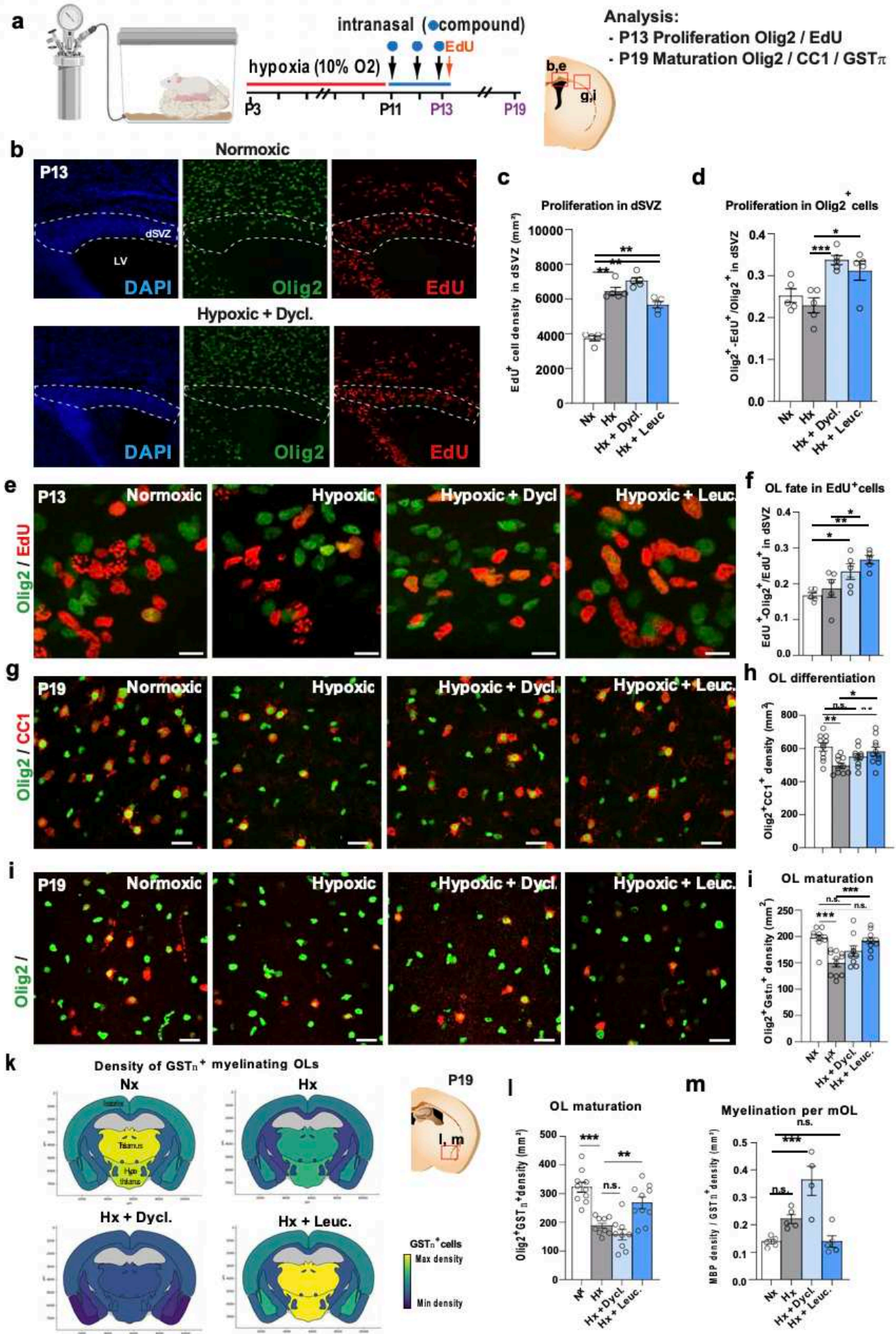

Figure 6. Dyclonine and leucovorin promote oligodendroglial regeneration in a mouse model of preterm birth brain injury. (a) Schematic illustrating the workflow used to assess the capacity of dyclonine and leucovorin to promote OPC proliferation and rescue OL maturation following neonatal chronic hypoxia. (b) Images of dorsal SVZ at P13, delimited by DAPI counterstaining, showing Olig2 and EdU immunodetection in brain sections of control animals (i.e., normoxic) and following hypoxia and dyclonine treatment. (c) Quantification of EdU+ cell density (i.e., proliferative cells) in the dorsal SVZ at P13, illustrating the increase in proliferation observed following hypoxia with or without treatment. (d-f) Olig2/EdU immunodetection and corresponding quantifications showing that dyclonine and leucovorin increase (d) the ratio of proliferative OPCs (Olig2+EdU+ cells) and (f) the OL fate of EdU+ cells in the dorsal SVZ at P13. (g) Olig2 and CC1 immunodetection and quantification (h) showing that dyclonine and leucovorin rescue OL differentiation (CC1+ cells) following neonatal chronic hypoxia within the cortex at P19. (i) Olig2 and GST π immunodetection and quantification (j) showing that only leucovorin rescues the density of myelinating OLs (GST π + cells) following hypoxia within the cortex at P19. (k) Heatmap representations depicting quantifications of Olig2+/GST π + cell density in distinct regions of P19 coronal brain sections. Note the reduced density induced by hypoxia (Hx) in most brain regions with a pronounced effect in the thalamus and hypothalamus, compared to normoxic (Nx) control brains, and the rescue of Olig2+/GST π + cell density following leucovorin (Hx + Leuc.) but not dyclonine (Hx + Dycl.) treatment. (l) Quantification of Olig2+GST π + cells in the hypothalamic lateral zone of P19 animals confirming that leucovorin, but not dyclonine, treatment rescues the reduced density of hypoxic animals. (m) Quantification of the ratio between MBP immunodetection (shown in Fig. 6 extended data f, g) and GST π + cell density showing an increased myelination per mOL in dyclonine- treated animals. Dyc., dyclonine; Leuc., leucovorin; Data are presented as Mean \pm SEM. *p < 0.05; **p < 0.01; ***p < 0.001, n.s., non-significant; scale bars: 100 μ m in b, 10 μ m in e; 20 μ m in g and i.

Figure 6 extended data 1

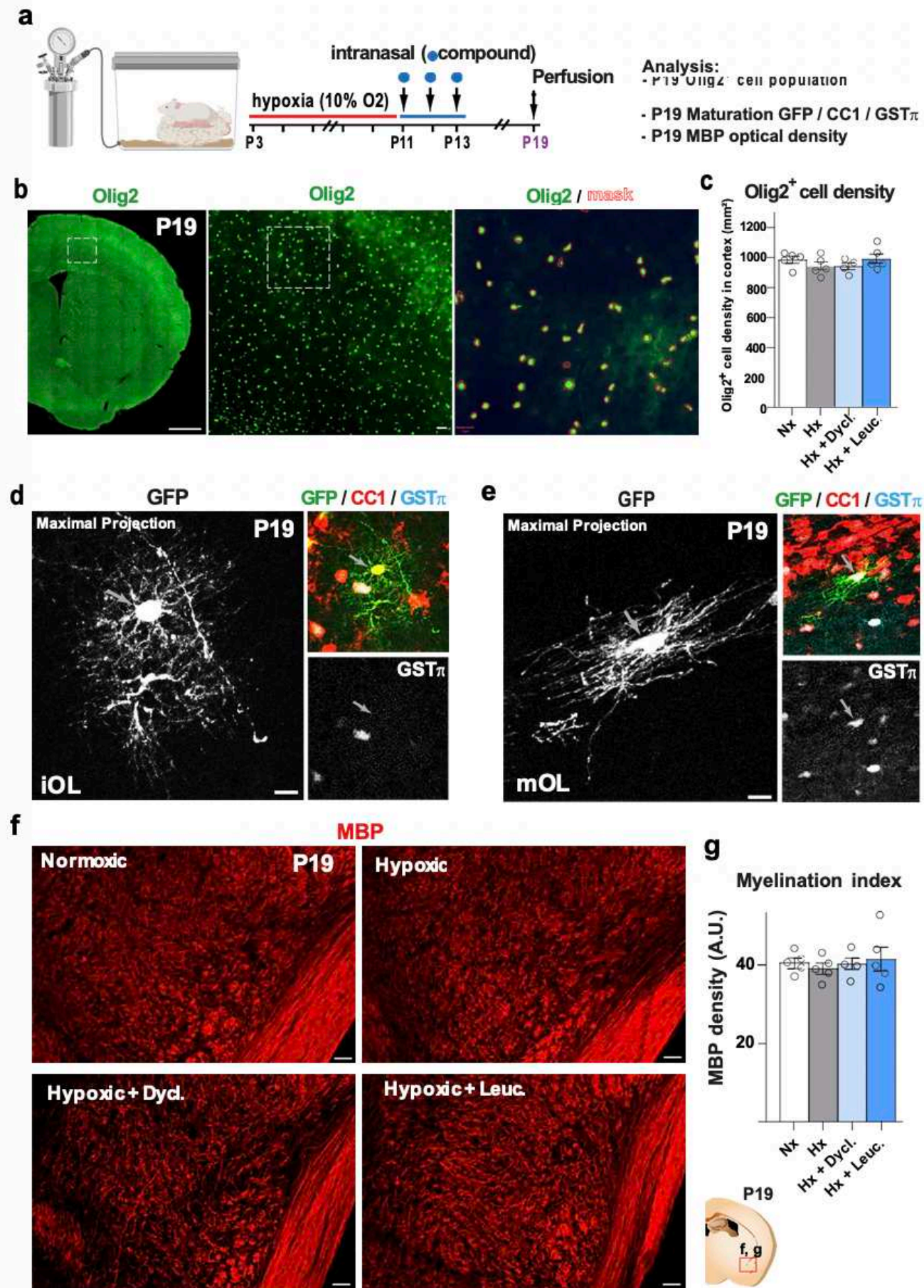

Figure 6 extended data 1: Dyclonine and leucovorin promote oligodendroglial regeneration in a mouse model of preterm birth brain injury. (a) Schematic illustrating the workflow used to assess the capacity of dyclonine and leucovorin to promote OPC proliferation and rescue OLs maturation following neonatal chronic hypoxia. (b, c) Olig2 immunodetection and quantification showing that the density of OLs is not changed by hypoxia nor by treatment within the cortex at P19 (c). Quantification was performed via automated detections (QPath) as illustrated by the mask used for cellular segmentation in the third illustration (mask). (d, e) Illustrations validating the use of CC1 and GST π markers to identify OLs and mature/myelinating OLs respectively. Note that during OL differentiation, immature OLs (labeled with GFP) present a stellar morphology and are positive for CC1 but not for GST π (d), while mature/myelinating OLs having myelin segments co-express CC1 and GST π (e). (f, g) Representative images illustrating myelination by MBP immunodetection in the hypothalamic lateral zone, showing no difference between groups at P19 (f) and quantification of MBP immunofluorescence in this zone is represented in arbitrary units (A.U.) (g). $N \geq 4$; Data are presented as Mean \pm SEM. Scale bars: 100 μm in b left panel, 20 μm in b right panel, and f; e; 4 μm in d and e.

Figure 7

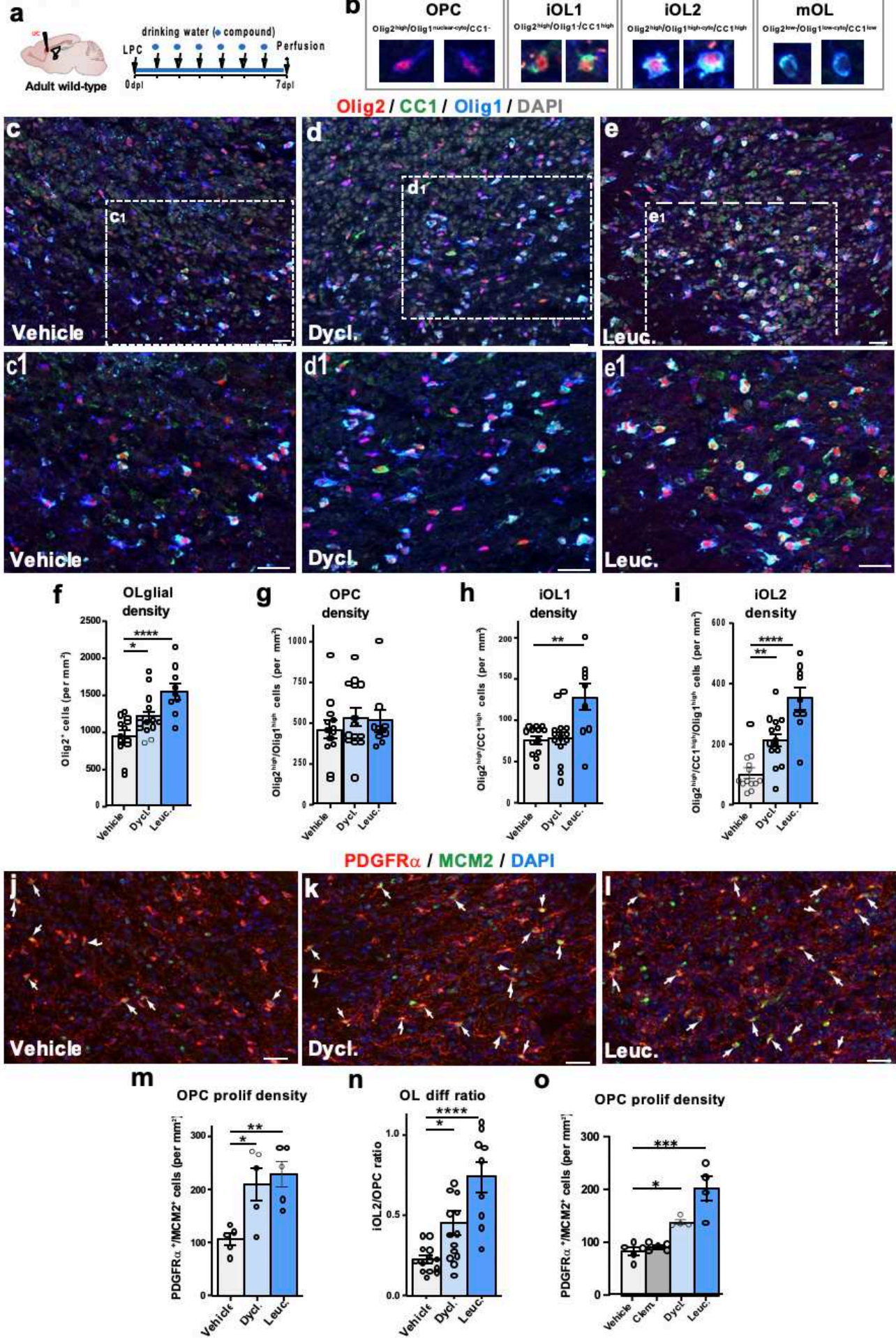

Figure 7. Dyclonine and leucovorin promote both OPC proliferation and differentiation in a mouse model of adult demyelination. (a) Schematics illustrating the protocol for LPC demyelination in the corpus callosum, the timing of compound administration in drinking water and analysis. (b) Images illustrating the 4 oligodendroglial stages obtained combining Olig2/CC1/Olig1 immunofluorescence: OPCs (Olig2^{high}/Olig1^{high}), iOL1 (Olig2^{high}/CC1^{high}/Olig1^{high}), iOL2 (Olig2^{high}/CC1^{high}/Olig1^{high}) and mOLs (Olig2^{low}/CC1^{low}/Olig1^{low}). (c-e1) Representative images of Olig2/CC1/Olig1 immunofluorescence in the lesion site (depicted by the high cellularity with DAPI) in control mice (c,c1, N=13), dyclonine-treated (d,d1, N=14), and leucovorin-treated (e,e1, N=9) representative of the quantifications shown in f-i. (f-i) Quantification showing the increase in the density of Olig2⁺ oligodendroglia in dyclonine- and leucovorin-treated lesions (f), no changes in OPC density (g), the increase in iOL1 density only in leucovorin treated lesions (h), and the increased iOL2 density in dyclonine- and leucovorin-treated lesions (i). (j-l) Representative images showing the increase in proliferation (Mcm2⁺ cells, green) of OPCs (PDGFR α ⁺ cells, red) in the lesion area in dyclonine-treated (k) and leucovorin-treated (l) compared to vehicle controls (j) (N=5 per group). White arrow indicates proliferating OPCs (PDGFR α ⁺/Mcm2⁺ cells). (m) Quantification of the proliferating OPC density showing a 2-fold increase in the compound treated groups. (n) Quantification of the OL differentiation ratio showing 2 to 3 times differentiation increase in dyclonine- and leucovorin-treated lesions respectively. (o) Quantification of proliferating OPC density in a replicated experiment comparing with clemastine, showing that contrary to clemastine, both dyclonine and leucovorin increase the OPC proliferation density in the lesion. Dycl., dyclonine; Leuc., leucovorin; Clem., clemastine. Data are presented as Mean \pm SEM. *p < 0.05; **p < 0.01; ***p < 0.001. One-way ANOVA statistical test. Scale bars: 20 μ m.

Figure 7 extended data 1

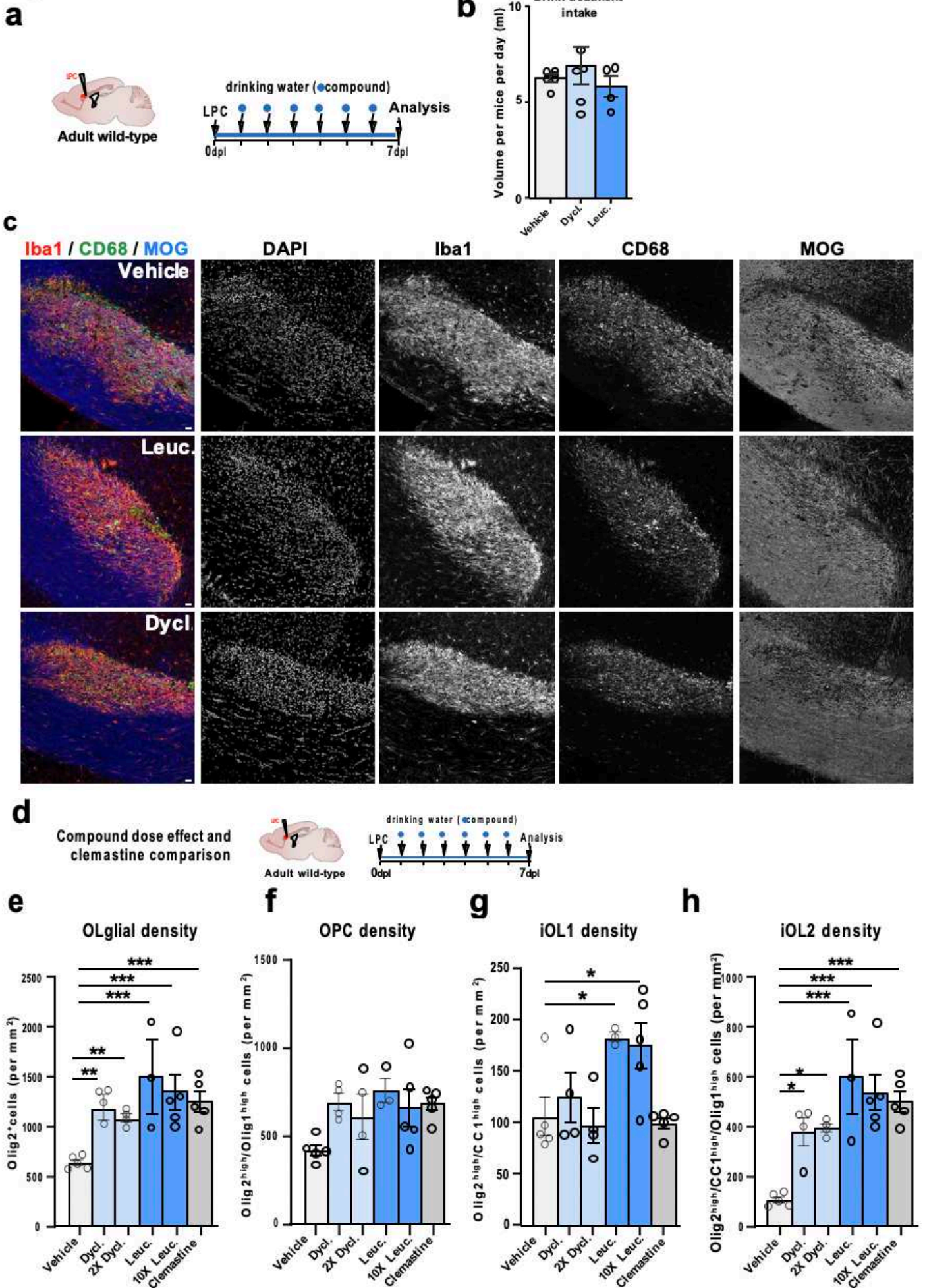

Figure 7 Extended data 1. Dyclonine and leucovorin promote both OPC proliferation and differentiation in a mouse model of adult demyelination. (a) Schematics illustrating the protocol for LPC demyelination in the corpus callosum, the timing of compound administration in drinking water and analysis. (b) Quantification of drinking intake per day (ml) during treatment showing no difference between groups and thus confirming expected compound dose administration. (c) Single channel panels for the immunofluorescence in the lesion site identified by cell density (DAPI), microglia/macrophages (Iba1+ cells, red) and their phagocytic profile (CD68+ cells, green), and the reduction in myelin immunodetection (MOG, blue) in different treatment conditions. (d) Schematics illustrating the protocol of a replicated experiment to compare different doses of leucovorin and dyclonine, and clemastine as a pro-oligodendrogenic positive control. (e-h). Quantification of Olig2+ oligodendroglial density (e), OPC density (f), iOL1 density (g) and iOL2 density (h) showing a similar increase at both doses tested of leucovorin and dyclonine in the density of oligodendroglia (Olig2+ cells), iOL1s (only increased by leucovorin treatment), and iOL2s. Note that clemastine induces a similar effect to dyclonine, with only leucovorin increasing the density of iOL1s. Dycl., dyclonine; Leuc., leucovorin; 2X Dycl. 2-fold dyclonine dose; 10X Leuc., 10-fold leucovorin dose; Clem., clemastine. Scale bars: 20 μ m.

Figure 8

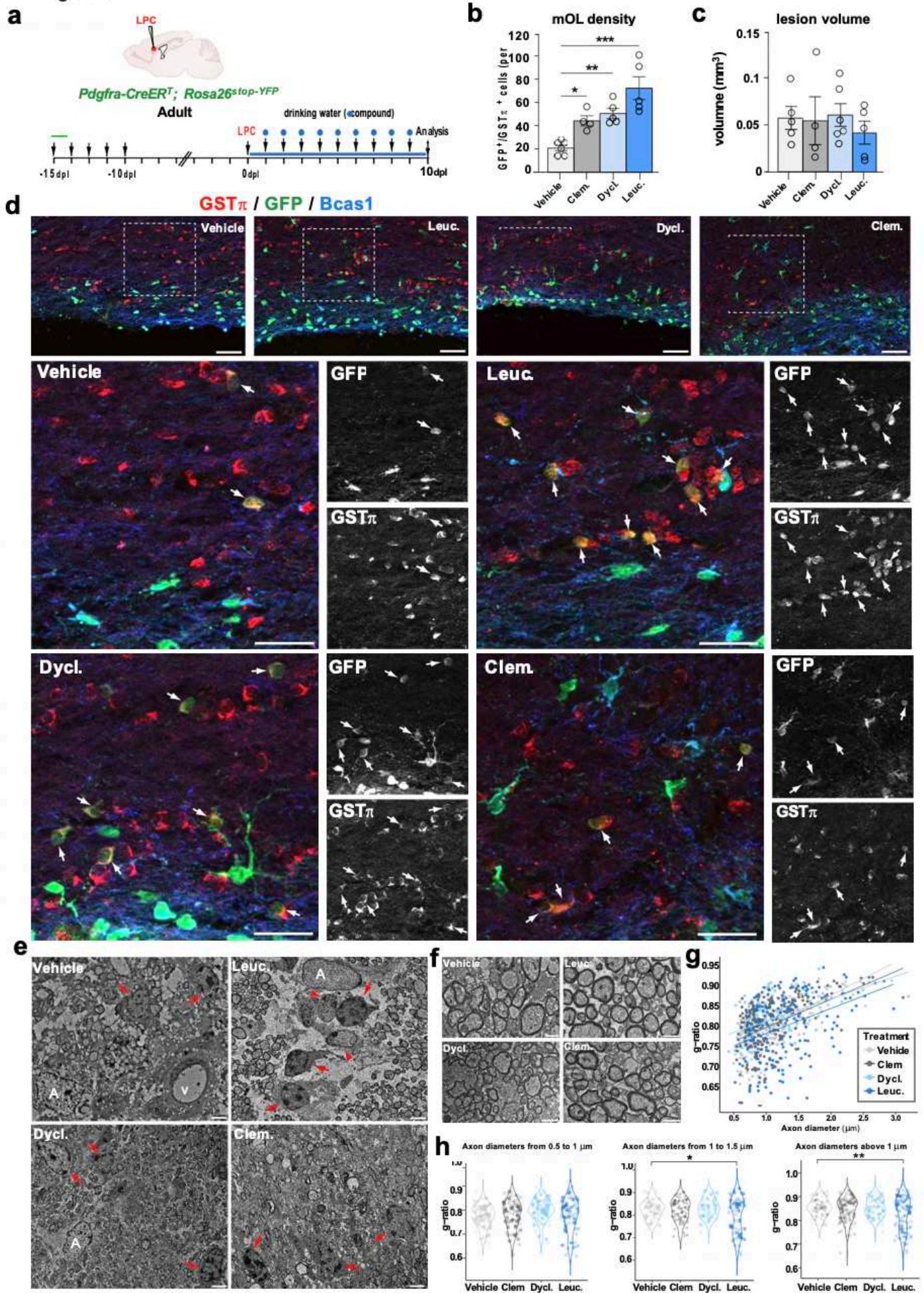

Figure 8. Leucovorin and dyclonine accelerate oligodendrocyte formation and remyelination in a mouse model of adult demyelination. (a) Schematics illustrating the protocol used for tracing OPCs and newly formed OLs by YFP-reporter induction prior to LPC demyelination by tamoxifen mediated Cre-recombination of a stop cassette in *Pdgfra-CreERT*; *Rosa26stop-YFP* mice, followed by compounds' administration in the drinking water and analysis at 10 days post-lesion (dpl). (b) Quantification of the density of newly formed (GFP+) myelinating OLs (GST α +), showing that dyclonine and leucovorin, alike clemastine, increase the generation of remyelinating OLs compared to vehicle. (c) Quantification of the lesion volume indicating no major reduction at 10 dpl in treated animals. (d) Representative images of adult generated YFP+ immature OLs (Bcas1+ cells, blue) or myelinating OLs (GST α + cells, red). (e) Electron microscopy images at 10 dpl illustrating the increase in mOLs (red arrows) identified by their typical ultrastructural traits (round- or oval-shape nucleus having densely packed chromatin and processes wrapping around) in compounds' treated lesions compared to controls (Vehicle). Note that leucovorin-treated lesions have more frequent iOLs (arrowheads) in the lesion area, characterized by showing less densely packed chromatin. (f) Representative micrographs illustrating remyelinated axons in the lesion area in different treatments. (g) Scatter plot representing the quantification of myelin sheath thickness (g-ratio) per axon diameter in the lesion area of vehicle- (light grey), clemastine- (grey), dyclonine- (light blue), and leucovorin-treated (blue) animals indicating a tendency to increase myelin thickness (lower g-ratios) in compound-treated animals compared to vehicle, with leucovorin-treated animals showing the strongest effect. (h) Violin plots quantifications of g-ratios in axons with different thicknesses indicating a significant decrease in g-ratio (thicker myelin) of axons above one micrometer in the lesion area of leucovorin-treated animals. A, astrocytes. V, vessel. Clem., clemastine; Dycl., dyclonine; Leuc., leucovorin. Data are presented as Mean \pm SEM. *p < 0.05; **p < 0.01; ***p < 0.001. One-way ANOVA statistical test. Scale bars: 20 μ m.

Figure 9

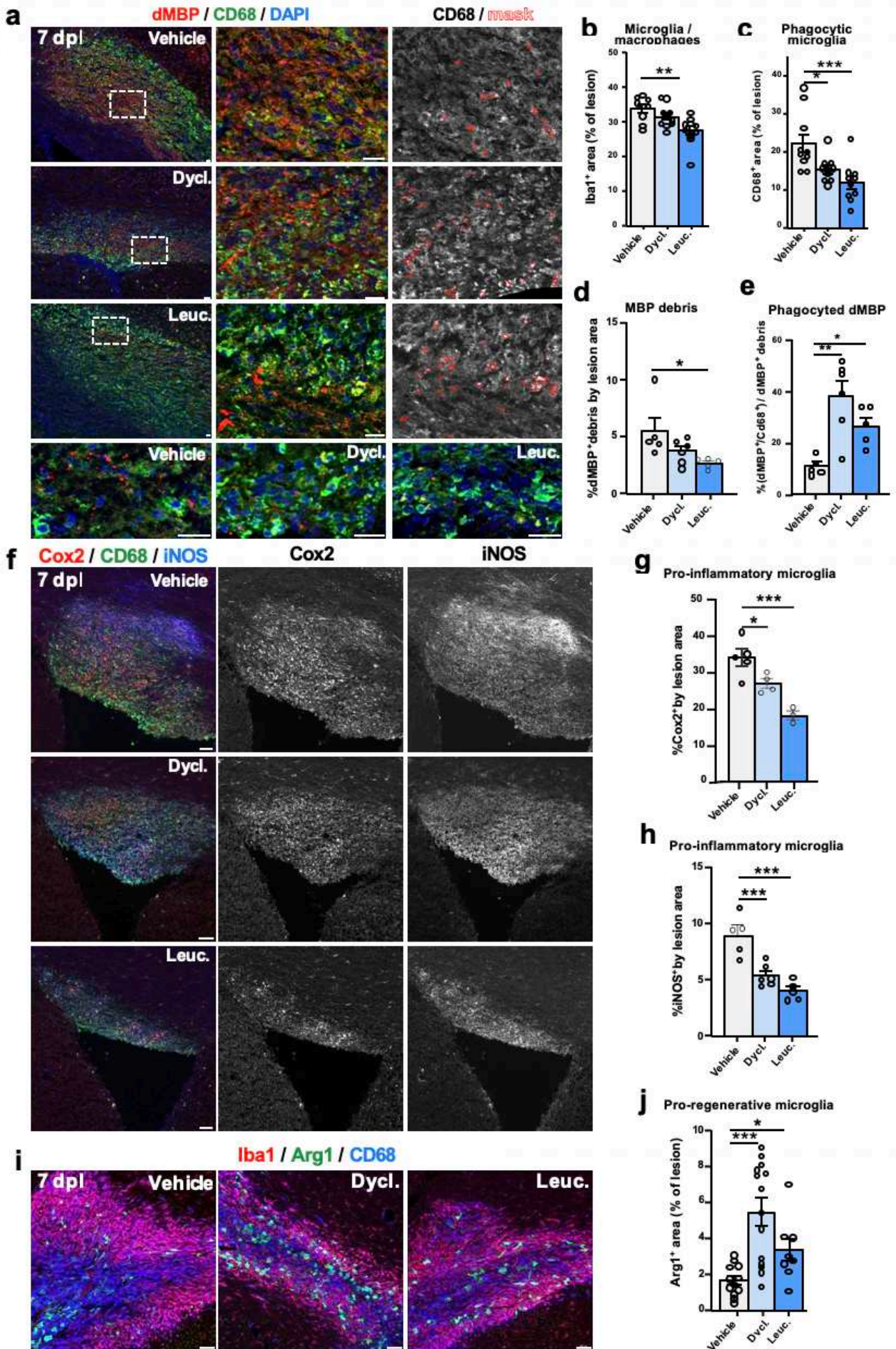

Figure 9. Leucovorin and dyclonine accelerate myelin clearance and microglial transition from pro-inflammatory to a pro-regenerative profiles in a mouse model of adult demyelination. (a) Representative images of the lesion territory immunodetecting myelin debris with MBP (dMBP, red) and phagocytic microglia with CD68 (green), showing increased dMBP signal inside CD68+ cells in dyclonine- and leucovorin-treated lesions (yellow dots) and vs. more dMBP outside CD68+ cells (red dots) in vehicle-treated lesions at 7 days post-lesion (dpl). Right panel illustrate the mask of automatic quantification for CD68 and dMBP colocalization (red labels). Bottom panel are higher magnification images for dMBP dot visualization in different treated lesions. (b-e) Barplots and dotplots representing the quantification in the lesion of Iba1+ microglial area (b), CD68+ phagocytic area (c), myelin debris as percentage of dMBP area (d), and phagocytosed myelin debris as the percentage of dMBP area inside CD68+ cells from the total dMBP area (e). Note the strong increase of phagocytosed myelin debris within dyclonine- and leucovorin-treated lesions. (f) Representative pictures showing immunodetection of microglia/macrophages (CD68+ cells, green) in the lesion area expressing inflammatory markers (Cox2 in red, and iNOS in blue). (g-h) Quantification of the percentage of lesion area labeled by Cox2 (g) and iNOS (h) immunofluorescence, in dyclonine-treated (N=5) and leucovorin-treated (N=4) mice compared to vehicle (N=5). Note the decrease in the pro-inflammatory profiles of microglia in leucovorin and dyclonine-treated conditions. (i) Representative pictures showing immunodetection of microglia/macrophages (Iba1+ cells, red) in the lesion area presenting phagocytic (CD68+ cells, blue) and pro-regenerative (Arg1+ cells, green) profiles. Note the increase in the pro-regenerative profiles of microglia in leucovorin and dyclonine-treated conditions. (j) Histograms representing the density of pro-regenerative microglia, in dyclonine-treated and leucovorin-treated mice compared to vehicle. Data are presented as Mean \pm SEM. * $p < 0.05$; ** $p < 0.01$; *** $p < 0.001$. One-way ANOVA statistical test. Scale bars: 20 μ m.

DISCUSSION

Note that the global discussion of the manuscript below complements the one presented in the paper, avoiding redundancy.

Bioinformatic identification of gene networks involved in oligodendrogenesis

We successfully identified gene-sets involved in oligodendrogenesis through the selection of robust transcriptomic datasets generated on CNS cell types by different laboratories (Ben Barres, Gonzalo Castelo-Branco, Olivier Raineteau). We performed gene enrichment based on their level of expression, combined with differential expression from other brain cell types, which are also involved for OL development. Complementarity of those datasets is crucial, including different developmental stages and areas from germinal regions generating OLs. Nevertheless, this gene enrichment presents some limits and aspects that can be improved. First, the intermediate subset of 3372 genes was refined based on the CNS cell types expression (Y. Zhang et al. 2014), probably eliminating some transcripts differentially expressed in other cell types enriched during the second strategy. Thus, we also kept for further analysis the oligodendroglial lists of 1898 and 2092 genes, respectively expressed in precursors and postmitotic cells. Contrary to what one could have expected, the function of oligodendroglial genes expressed in precursors cannot be restricted to the specification process, because many genes involved during differentiation are already expressed on these cells, and seem upregulated at early stages to prepare for later processes. Secondly, we did not include datasets from humans or in the pathological context, due to difficulties in accessing neonatal tissue and lack of transcriptomic data at this stage and thus focusing on mammalian OL development. Thirdly, we did not performed meta-analysis by combining our data with genome wide oligodendroglia-specific binding (ChIP-seq) of key regulators (e.g *Olig2*, *Brg1*, *Ascl1*, *Sox10* and *Chd7*) and their epigenetic marks (H3K27ac, H3K4me1, H3K4me3). Nevertheless, given the successful enrichment that we obtain, the idea to transpose this strategy for identifying genes expressed during neurogenesis seems promising, for repurposing treatments promoting neuroblast differentiation, or elicit quiescent NSC activation toward neuronal lineage in the context of neurodegeneration.

Increase success rate of drug repurposing

This work was facilitated using different user-friendly but expensive software (such as Pathway Studio, Elsevier), allowing generation and modelization of gene regulatory networks, study

of drug/gene interactions, obtention of hubs genes /small molecules catalogs, and gene ontology processes. However, these tools are mainly based on text mining, requiring in addition our knowledge on genetics and oligodendrogenesis to draw solid conclusions and decisions. For instance, we started our analysis using Pathway Studio (Elsevier), allowing us to build gene networks based on the literature through the known interactions between entities, but also constituting a bias for identifying new hub genes (e.g. APP was on top of the list because this gene is highly studied in the most common neurodegenerative disease). Concerning drug discovery, almost all of the queried drugs obtained using Pathway Studio were unknown, and did not permit integrating them in gene networks and concluding on their influence on a given gene network. On the contrary, we did not find this bias using co-expression datasets provided by the SPIED approach. However, this last type of data may include co-expression of genes involved in ubiquitous processes (e.g housekeeping β -actin, β -tubulin Gapdh, or cyclin family) that are essential for general cell development and not informative for identifying new candidates promoting oligodendrogenesis. The gene ontology (GO) analysis that we primarily used (e.g Metascape, Panther, EnrichR) were useful for investigating the the processes related in the obtained gene sets, but one need to be careful about the genes reported for each category, which are sometimes ubiquitous and not informative for a particular process (e.g Sox10 and Mbp are given involve in neurogenesis process). Moreover, GO tools are also updated through text mining and not often manually curated, and queries are mostly limited to 2000 genes, which are not enough for the main genes expressed by a cell. We found that EnrichR was one of the most useful tools, providing enrichment in gene ontologies (processes/ molecular pathways, cell types or diseases) and various sets of similarly expressed data associated with the queried gene-set (co-expression in GEO datasets, in cell types, in diseases, etc.). To evaluate the strength of our selected datasets, and to select the most promising drugs based on their regulated target genes, we established a strategy of gene curation of genes involved by loss-of-function (LOF) or gain-of-function (GOF) published studies in the different aspects of oligodendrocyte biology. Thus, we obtained a list of more than 400 genes regulating the different processes of oligodendrogenesis that we subdivided in specification, proliferation, migration, survival, differentiation, myelination, and remyelination. We are currently developing a Web-based interface for quick queries for the community. By using this tool, evaluating the functional implication of a given drug or a gene set in oligodendrogenesis becomes an easy task through the known aspects already reported by reliable studies.

Discover new hubs genes regulating oligodendrogenesis

We identified a list of novel hub genes of significant interest for future functional discovery of new direct or indirect regulators of oligodendrogenesis. Particularly genes that are negatively correlated mostly expressed by microglial cells and related to the inflammatory processes, containing only 7 oligodendroglial curated genes out of 623 (e.g. *Arhgap5*, *Ash1l*, *Rest*, *Ppargc1a*, *Stat1*, *Rictor*, *Klf9*). To identify new targets and regulators of inflammation, crossing the anti-correlated hubs genes that we identified with genes expressed in immune cells and contributing to MS pathology can bring new targets and regulators of oligodendrogenesis, in order to slow down OL vulnerability and myelin attack. In line with this approach, a study identified 200 single-nucleotide polymorphisms (SNPs) enriched in MS, particularly in B/ T cells, macrophages and natural killer cells involved during disease (Gresle et al. 2020). Interestingly, some of them are included among our anti-correlated genes list (e.g. *SLC9A8*, *AVIL*, *AGBL2*, *IKZF1*, *CD37*, *TNFRSF14*, *SP140*, *CD5*, *CD6*, *CCDC88B*). In the context of EAE (Falcão et al. 2018), 16 genes are expressed among the list of MHC susceptibility genes in microglia (e.g. *RHOH*, *IRF8*, *AFF1*, *RREB1*, *CBLB*, *LPP*, *SLC9A8*, *CD48*, *ZC3HAV1*, *GRAP2*, *ATXN1*, *IKZF1*, *CD37*, *NLRC5*, *LCK*, *CCDC88B*). Thus, inhibition of the anti-correlated genes *SLC9A8* or *CD37* may positively affect oligodendrogenesis in the context of inflammation. One of the weaknesses of the SPIED platform is that there are no indications about the strength of their regulation, even if they are statistically regulated. In our lab, we aim to focus on those lists of unknown correlated genes (54 major known oligodendroglial curated genes are included inside the list of correlated hubs genes). To do so, we scored their potential through their level of expression, signaling regulated or diseases associated using different interfaces and databases (Castelo-Branco Lab, Linnarsson Lab, Zhang Lab, Genecards, Pubmed). Thus, we found a list of genes and regulators expressed in the oligodendroglial lineage potentially providing a list of new specific markers (such as *Plekhb1* selectively and highly expressed during OL differentiation).

Discover new small molecules promoting oligodendrogenesis

Strategy to identify new drugs using SPIED is effective and validated for different applications, including a previous study from our collaborators (Azim et al. 2017). Moreover, most drugs that we found are related to CNS disorders (Parkinson, Alzheimer, epilepsy, neuro-inflammation), with 20% of them already identified to promote OL differentiation (e.g. clemastine, thyroid hormone/liothyronine, and quetiapine). However, the interface to understand how these drugs or hub genes are generated is very limited, particularly the algorithms behind levels of correlation obtained, which was the reason that we did not consider it as the most important parameter to select molecules, and gave priority to their target genes. Unfortunately, we restricted our queries using SPIED to the drugs

provided by the connectivity map, which was the only interface providing regulated target genes. As previously described, our curated scoring strategy for target genes allowed us to select drugs by favoring genes associated with the differentiation process. However, it is necessary to note that the interpretation of these target genes provided from SPIEDs is made on the basis of molecules tested from various cell types (human or animal) and not representative of the potential direct activity in oligodendroglia. We can nevertheless find a logic in the genetic response, through the activation of a set of oligodendrogenic processes (activation of a set of genes involved in myelination or differentiation). For this reason, we are currently evaluating the direct transcriptomic changes induced by the molecules directly in acute purified oligodendroglial cells (see perspectives). We will then be able to validate the majority of the signatures predicted by SPIED, and possibly provide new mechanisms or pathways regulating oligodendrogenesis.

In order to select the most interesting molecules, our collaboration with pharmacologists allowed us to analyze their pharmacokinetic and pharmacodynamic properties, also including their capacity to enter the CNS through the BBB, their potential side effects and toxicity risks. We systematically eliminated those already known to promote any aspect of oligodendrogenesis, or having evidence of toxicity. Despite the fact that some of them are poorly documented in the literature (e.g. heptaminol, meticrane, folic acid), we found molecules mostly regulate oligodendrogenic pathways described chapter 4 (e.g. muscarinic, histamine receptors), and also shows neuroprotective and anti-inflammatory properties. These molecules may therefore be of differential interest depending on the context, but the possibility that a molecule combine pro-oligodendrogenic and anti-inflammatory properties will increase their attractiveness and success rate for application in MS or PTB. One of the closely related molecules of the calcium folinate that we selected is folic acid, with several evidence of its action on oligodendrogenesis. Indeed, folic acid deficiency correlates with myelination defects and MS pathology, and regulation of folate metabolism was found to regulate oligodendrogenesis (Weng et al. 2017). In spite of closely related molecular structures, there is no enzymatic conversion between folic acid and calcium folinate, being a non-natural active form. Given the strong capacity of this molecule to promote oligodendrogenesis that we found with our models, we can wonder ourselves what is the contribution of supplemented calcium in the formulation of leucovorin, given the involvement of calcium signaling in oligodendrogenesis (discussed in chapter 4). Indeed, it has been shown that specific deletion of calcium-sensing receptors induces a significant decrease in myelin basic protein levels in the cerebellum during mouse development.

Validation of the pro-oligodendrogenic activity using in-vitro and ex-vivo models

To directly assess the pro-oligodendrogenic activity of these selected small molecules, we use different systems allowing us to evaluate at different levels of cellular complexity their efficiency. Using neonatal cultures of NSCs, we found that most of the drugs promote oligodendrogenesis without affecting the generation of neurons and astrocytes, a crucial step of selection taking into account interaction between these neural cell types and oligodendrogenesis, and that the neonatal period is still very active in the generation of the three neural cell types. In contrast, we found drugs decrease NSCs numbers while in parallel increase the number of differentiating cells

In contrast, we found drugs decrease NSCs numbers while in parallel increasing the number of differentiating cells. Therefore, we suggest that drugs may increase NPC activation and promote cell cycle exit to differentiate. Another possibility is that drugs increase proliferation of neuroblasts or OPCs, thus increasing CNS numbers. Thus, to verify this hypothesis, we can test if drugs regulate their quiescent state through detection of EGFR signaling, demonstrated to be sufficient to stimulate qNSC cell cycle entry, or to use NSCs expressing a GFP reporter for Nestin (Cochard et al. 2021). Interestingly, we found that thioperamide (sm9) and folinic acid (sm11) also promote neurogenesis, which increases the number of neuronal cells, but we did not have time to study this in more detail. In agreement with our results, thioperamide has been recently reported to increase the amount of neuroblast in a dose-dependent manner, both in the subventricular and subgranular zone, and to have neuroprotective properties (Liao et al. 2019; N. Wang et al. 2020). Therefore, these molecules potentially present a double interest by promoting both neurogenesis and oligodendrogenesis. The comparison between their target genes can provide new understanding on the genetic mechanisms involved in the genesis of these neural cell types.

One of the major problems that we met using this *in vitro* system, despite the efforts to standardize our protocol, was the variability. Indeed, several parameters change the development of the cell such as cell density, batches in the media used, edge effects, incubator, or mouse litter. Moreover, we had to limit the number of replicates analyzed due to its time-consuming methodology and impossibility to perform automatic quantification on these cell types (manual quantification of the 3 cell types including up to 5 fields per condition, 1000 cells). We therefore adapted the statistical analyses with the advice from statisticians, by applying a respective contrast matrix to the vehicles, taking into account the repeated effects of a measure within each independent experiment, before applying an ANOVA analysis.

To explore compound effects, we roughly examined dose response relationship with compounds using a drug concentration range (250nM, 500nM, and 750nM) usually apply on the other

drug screenings, and to avoid possible drug cytotoxicity (Feng Mei et al. 2014; Najm et al. 2015; Eleuteri et al. 2017). However, we may have ruled out an optimal effect at higher concentrations, or on the contrary saturated our system with compounds effective at few nM that can alter another process regulating oligodendrogenesis (e.g survival, morphology). This is the case for clemastine or benztropine, effective at 500nM but promoting differentiation as low as 10 nM (Feng Mei et al. 2014).

Finally, we excluded some molecules because they were reported to be patented for a similar application: thioperamide (sm9; US 10493080 B2; US 2003/0113309 A1), melatonin (sm3; WO 2019/246262 A2; EP 2691086 B1; (Ghareghani et al. 2017), trihexyphenidyl (sm10, US 2019/0336490 A1), naringenin (sm4, US 2015/0037263 A1; US 2006/0025337 A1), hydroxyprogesterone (sm8, medrysone, US 9446051 B2; US 2014/0011791 A1). Thus, we considered those molecules as positive controls for *in-vitro* NPCs experiments, confirming our strategy and preliminary results obtained. We analyzed their effect specifically into the oligodendroglial lineage, particularly on the maturation process using purified cultures of OPCs, and we found a clear increase in their morphology, suggesting their effect on OL maturation, at a similar or higher level compared to thyroid hormone (excepted for sm7, levonorgestrel). Nevertheless, this direct contribution on OPC purified cultures does not rule out the possibility of also indirectly impacting oligodendrogenesis through stimulation from other cell types (found using NSCs). We did not restrict our analysis to these limited *in-vitro* models in the study of cellular interactions, especially to assess changes in immune cells activity in response to the molecules.

To reduce the risk of translational failure in humans, we have complexified our level of analyses by using an *ex-vivo* model of organotypic neonatal cerebellar slices, convenient to examine the pro-myelination activity of this molecules, also taking in account the influence of microglia, even though we did not look for their activity here. Therefore, this model allowed us to restrict our selection to two molecules, dyclonine hydrochloride and calcium folinate having higher effects in the differentiation and myelination indexes. Heptaminol is also of great interest to promote oligodendrogenesis, but restricted ourselves to these two compounds for *in vivo* experiments.

Validation of the pro-oligodendrogenic activity of the drugs in the pathological context

We next analyzed dyclonine hydrochloride and calcium folinate effects *in-vivo* through the induction of demyelination in adults and chronic neonatal hypoxia. We rule out potential side effects and predicted concentration based on literature, pharmacological datasets and from a limited range of experimental analysis. Nevertheless, not knowing the half-life of these molecules, we have limited this risk by adding daily-resuspended molecules in the medium of the cells, or in the drinking water

of the animals. First, this in-vivo system allowed us to validate the potential of these molecules to cross the blood-brain barrier. In spite of a clear variability in the size of the lesions, we were able to quantify the impact of the molecules on the OL lineage in the context of lesions. It was not possible to quantify differences in remyelination at 7 days post-lesion through the measurement of MOG, a process that can be quantified over longer periods. From 10 days onwards, we could have detected an initiation of these changes, but the effect on differentiation and detection of the iOL2 population would have been less detectable, as the majority of new immature OLs will become mature, joining those that have survived to the demyelination.

Interestingly, unlike the majority of actual candidates (e.g clemastine or T3), we found that dyclonine and calcium folinate promote OL differentiation and maintain OPC proliferation in lesions, that may correlate with regulation of targeted genes involved during proliferation (Sm5: *Gria1*, *Sox2*, *Mki67*, *Cdk1*, *Klf9*, *Mcm7*; Sm11: *Olig2*, *Mcm5*, *Gria1*, *Mki67*, *Mcm3*). We can note that major receptors involved in OPC proliferation including PDGFR α or EGFR β are not regulated, maybe also explaining their effect on keeping the balance between proliferation and differentiation. In comparison with T3, only proliferation genes OLIG2 and SOX2 are regulated, and their inhibition may explain the negative effect on proliferation (or absence of promotion). On the other hand, their pro-oligodendrogenic effect that we found in this model of adult myelin insult is consistent with those obtained by our collaborators using the chronic neonatal hypoxia model. This model, mimicking changes of oxygen concentration faced by the preterm births, induces a partial but significant deficit in OL differentiation. Remarkably, Sm5 allows beyond normoxia to promote OL differentiation, this period of development being more favorable and reactive to differentiation signals. However, compared to our adult model of demyelination, there are differences in their ability to regulate the number of oligodendroglial cells at this stage through the proliferation. Indeed, the hypoxia model does not detect changes in Olig2 cell numbers, although assays combining proliferation (EdU) are under quantification. Differences in oligodendroglial cell numbers may suggest a different capacity to respond to the molecules depending on the stage. These differences can be explained at 3 weeks in mice by a preponderant pro-differentiation signaling. Indeed, this model induces a small activation of these cells, currently being characterized by our collaborators, accompanied by changes in their morphology. Interestingly, we detected variations in the immune populations (microglia and macrophages) and a reduction in the population of active phagocytic cells, suggesting an acceleration of the repair process, which is currently under characterization (see perspectives). Contrary to the lysolecithin induced demyelination, the EAE model is more adapted to study drug effects in the context of inflammatory levels found in MS.

Through this study, we were able to identify a catalog of compounds potentially promoting oligodendrogenesis, as we had to restrict our study to 11 molecules, while many others such as heptaminol could also produce similar or higher effects found with sm5 and sm11, particularly for combined anti-inflammatory and pro-regenerative regulation in the pathologic context. We have now been able to repurpose two FDA-approved molecules as candidates for myelin diseases, while waiting to be able to characterize the effect of heptaminol in these models as well, and to complete our study with other approaches (see perspectives).

Regulation of the molecules on the oligodendroglial lineage

Contrary to the majority of the most promising molecules identified for promoting (re)myelination (e.g. clemastine or T3), there are actually very few treatments able to promote both aspects. Among those discussed in the pharmacological section, stimulation of kappa opioid receptors (e.g. Methadone and Buprenorphine), progesterone, testosterone, IGF, erythropoietin or prolactin are for instance able to promote differentiation, maturation as well as proliferation (or without negatively affecting this process). Thus, T3 and clemastine do not maintain a pool of precursors necessary for the maintenance of oligodendrocyte lineage during life. Given the significant side effects identified with T3, in particular an increased risk of hormonal dysregulation in pediatric use, combination with T3 is not preferable with one of our molecules for further clinical examination. Thus, the ability of Sm5 and Sm11 to promote these myelinating and proliferative aspects do not require a combined use.

Sm5 and Sm11 present a dual effect on oligodendroglial proliferation and differentiation, depending on the developmental context, particularly at the adult stage in the context of demyelination. While the neonatal hypoxia model does not detect an increase in OPCs proliferation levels in response to Sm5 and Sm11 treatments at 3 weeks of development, we observe a significant increase in the proportion of proliferative OPCs in the context of adult lesions. Therefore, the response to pro-differentiation signals is predominant over differentiation signals at 3 weeks of development. In the adult and in the context of lesions, the recruitment of OPCs combined with the induction of their proliferation and maturation defect can explain an increased response and sensitivity to proliferative signals. Moreover, the effect on OPC proliferation observed in-vivo in adults could be indirectly regulated via stimulation from other cell types (e.g. neuroprotective effect and release of BDNF or IGF1). In our in-vitro purified neonatal OPC cultures, the regulation maturation is direct in response to Sm5 and Sm11, but we did not find any changes in the proportion of OPCs in response to drug treatment. Although we quantified an increase in oligodendroglial specification from

our NPC culture, we did not distinguish precursors from mature cells. Thus, potential effect of Sm5 and Sm11 on proliferation status should be determined by quantifying the number of PDGFR α ⁺ cells expressing the proliferative marker MCM2. At the transcriptional level, we have selected molecules promoting genes involved and expressed during OL differentiation. Thus, the direct effect of the molecules must therefore be perceived and validated at the transcriptional level (see perspectives).

Interest of drug repurposing

With Neorepair, funded by the French National Research Agency (ANR), we propose new therapeutic candidates promoting brain repair in the context of PTB and MS (technology readiness level, TRL 1). This project has a potential positive impact on health, society (reinforce integration of patients) and on the economy (cost reduction of healthcare services). These molecules that we identified using an in-silico pharmacogenetic approach (TRL 2) were functionally validated for their pro-oligodendrogenic potential in various experimental conditions and models (in-vitro and ex-vivo, TRL 3). After having validated the TRL 4 phase (experimental proof of concept demonstrated in-vivo on two pathological contexts), we filed a European patent and accelerated these technology transfer steps thanks to the iPEPs incubator of the institute, with the objective of accelerating the setting up of a clinical study (TRL 6). Indeed, the pre-clinical evaluation phase (TRL 5) of the compounds was carried out to evaluate and demonstrate the absence of toxicity and major side effects of dyclonine and folinic acid (compounds already FDA approved). Thus, if the two molecules are successful, we could expect a significant reduction in costs and delays in the level of technological advancement with an approximate duration of 4 to 5 years until the marketing phase and market introduction. This project has required, through our expertise and collaborations, many key activities: in-silico computational analysis, research and development, molecule repositioning, pharmacology, experimentation, molecule screening, intellectual property (patent and publications), communication. Therefore, their potential could allow to establish a licensing agreement with the pharmaceutical industry.

PERSPECTIVES

Identify mechanistics through signaling pathways and targets genes regulated by dyclonine hydrochloride and calcium folinate

Since these molecules have not been manufactured to target a defined process (receptor, molecule), understanding their mode of action is crucial. Given the fact that those two molecules are not well described in the literature, particularly their mechanisms explaining the regulation of oligodendrogenesis, understanding their mode of action and signaling regulation is crucial. Firstly, applying a reverse approach from the therapeutic to the fundamental can help us to understand how physiological development occurs in cells. Secondly, to predict possible side effects through dysregulation in signaling essential to the functioning of other cell types (e.g detrimental activity associated with trophic factors production such as GDNF could affect neuronal biology). Thirdly, we aim to validate the transcriptomic effect of these molecules predicted by SPIED, particularly the regulation of the pro-oligodendrogenic and pro-myelinating genes detected in other cell types. Thus, examination of their differentially expressed genes is currently on-going through RNA-sequencing performed in MACs purified OPCs cultures treated with calcium folinate and dyclonine during 2 days of differentiation. We will examine the ability of these compounds to regulate pathways involved during oxidation, survival, inflammation, and metabolism.

Validation of drug targets and activity

Given the role of folinic acid in the dihydrofolate (DHF) metabolic pathway, it would be important to validate the activity of the molecule on this pathway. The exogenous contribution of this molecule does not guarantee transcriptional changes associated with this target, and it would be more reasonable to validate drug effect at the proteomic scale by western blot performed on brain lysate. Another target activated downstream of this pathway is THF (tetrahydrofolate) also activated by folinic acid. Concerning dyclonine, the activation of the Nrf2 pathway and antioxidant responsive elements has been identified (Alessandra Rufini et al, 2022), as well as its inhibitory role on TRPV3 channel (Qiang Liu et al, 2021). Thus, detection of the protein expression levels of Nrf2 and TRPV3 would validate the biological activity of SM5.

Examine the anti-inflammatory role of dyclonine hydrochloride and calcium folinate

Another main point that remains unexplored is drug anti-inflammatory activity, currently assumed from the regulation of inflammatory target genes, literature, and their ability to regulate microglial and macrophagic populations (Iba1/CD68). To investigate a potential anti-inflammatory role, we are currently evaluating astrocyte reactivity (GFAP+), microglial pro-inflammation (iNOS+), pro-regeneration (Arg1+), phagocytosis (CD68+) activity combine with Iba1 at 7 dpl. This effect should also be studied at other time points to follow the dynamic of the immune cell process in response to drug treatment (such a 3 and 10 dpl). On the other hand, LPC demyelination does not reflect MS disease state involving immune-mediation (Bieber, Kerr, et Rodriguez 2003), without behavioral phenotype and a lack of functional deficit that can be reversed by therapeutics as in the EAE-model. Thus, evaluating the efficiency of folinic acid and dyclonine hydrochloride in the context of EAE present a real interest for applications in MS, particularly for the ability to reverse severity and improve their clinical score. Finally, drug combination is something that we also have to consider in case of moderate or in the absence of anti-inflammatory effect, in order to combine drugs promoting oligodendrogenesis and anti-inflammatory processes (Bulusu et al. 2016).

Complement our study in other animal models mimicking PTB alterations

Our current model of chronic neonatal hypoxia mimics an aspect of PTB, particularly inducing defects in OL numbers and differentiation processes. Thus, through collaboration with the laboratory of Pierre Gressens and Olivier Raineateau, we will assess efficiency of the drugs in complementary mouse models resulting in dysmyelination but through distinct mechanisms involving inflammation or metabolic perturbation (intrauterine growth restriction), reproducing all histopathological features of the equivalent human conditions. Indeed, myelination and brain function are significantly altered in the model of fetal growth restriction, where pregnant dams are fed in an isocaloric 9% protein diet during their complete gestational period, thus affecting inflammation and cell cycle in both oligodendroglia and microglia (Novais et al, 2016). Moreover, a mouse model of perinatal systemic inflammation was optimized by Pierre Gressens laboratory, generated through repetitive intraperitoneal injections of recombinant IL-1 β from P1-P5 in mouse pups, also inducing defects in OL differentiation and myelination, induced by microglia-mediated inflammation and caused by reduced Wnt-signaling in these cells (Steenwinckel et al, 2019). Thus, we will explore the capacity of the drugs to promote oligodendrogenesis through distinct mechanisms (proliferation versus maturation) and investigate their potential side effects on the other cell types (neurons and astrocytes) as well as on the long-term germinal activity of the forebrain.

Validate drug activity on human cells

We must also take into account that many treatments fail during the human clinical phase. This success is unpredictable, depending on the translational capacity between animal and human

models. Thus, to reduce the risk of failure in humans, we will provide the proof of concept that drugs have similar activities in human cells, using 3D cultures (i.e. forebrain organoids/assembloids) favoring human iPSCs differentiation into ventral and dorsal forebrain promoting oligodendroglia and myelin formation. Indeed, expertise in 2D and 3D NPC cultures mimicking human neocortical development have been optimized in our institute for generating brain organoids or assembloid by merging dorsalized (cortical, mostly glutamatergic neurogenesis) and ventralized area (providing interneurons and oligodendroglia). In order to assess the effects of sm5 and sm11 administration in oligodendrogenesis and myelin formation on human forebrain assembloids, drugs will be added to the medium from day 24 at the assembloid stage, continuously until the date of analysis (45 and 90 days in culture). Organoids will be cryoprotected and cryosectioned to perform immunofluorescence for SOX10, MBP, and CNP to label respectively oligodendroglial lineage cells (SOX10), myelin sheaths (MBP, CNP), the cell body (CNP) and processes of mature oligodendrocytes (CNP, MBP). We will measure the proportion of oligodendroglial cells (SOX10+/DAPI ratio) versus the proportion of mature oligodendroglial cells (MBP+CNP+/SOX10+ ratio) at both stages at 45 and 90 days in myelination medium. Myelin thickness and the structural organization of myelinated axons into discrete subdomains can be used to assess the maturity of myelinated axons. Thus, we will assess myelinated axon organization by immunofluorescence analyses with CASPR/CLAUDIN-11 labeling the paranodes together with MBP to label the myelin (internodes). Increase in myelin volume will be assessed at the cell and organoid levels using MBP/CNP 3D reconstructions using BDNF as a positive control to foster myelin formation. DMSO (vehicle), BDNF and Clemastine (positive controls), and the two FDA-approved drugs will be tested in parallel. Possible side effects of the treatment on other neural lineages will be addressed by immunostaining with cell-type specific markers (GFAP/S100 β /Aldh1L1 for astroglia and Dcx/NeuN for neurons). We will also investigate drug effect at the transcriptomic level through single-cell RNA sequencing performed on cells dissociated from organoids at 7 and 14 days post-drug administration. Thus, we will study the different biological processes and molecular pathways impacted, as well as the kinetics of these changes.

Translation in humans

Although we are not yet in the stage to start a clinical study, the next steps mentioned above could lead quickly to this stage. The tolerability and toxicity evaluation steps having been completed for these two FDA approved drugs, we can now think about what a clinical study in humans would look like. Clinical trials of remyelination should preferably be performed on subjects in the early remitting and active phase and thus require stratification of patients according to their remyelination potential to test compounds in similar inflammatory conditions and reduce variability. Since the costs associated with a conventional study require highly expensive costs and numerous patients, thus a recruitment of 30 patients for each arm (placebo and treated) may be more reasonable. In addition,

the doses of administration and efficacy in humans have been determined, reducing the margin of error when choosing the treatment concentration. The evaluation of this study would make it possible by combining the evolution of clinical signs with quantification of remyelination in lesion sites using two positron emission tomography imaging. Several radiotracers can be used to detect myelin in imaging, including thioflavin [11C]-PIB identifiable within a short time window during remyelination. To detect an effect, the correlation between remyelinating voxels and clinical scales is an argument for the neuroprotective effect induced by remyelination in vivo (Ricigliano et al. 2022). Indeed, detection with magnetic resonance imaging to follow microstructural damage allows quantification of the changes in fractional anisotropy and mean diffusivity. In addition, several markers should be used to monitor BBB integrity and the activity of immune cells. Among them, TSPO including [18F]DPA is a macromolecular complex localized in the outer mitochondrial membrane mainly expressed by activated innate immune cells allowing their individual mapping.

REFERENCES

- Aaku-Saraste, Eeva, Björn Oback, Andrea Hellwig, et Wieland B Huttner. 1997. « Neuroepithelial Cells Downregulate Their Plasma Membrane Polarity Prior to Neural Tube Closure and Neurogenesis ». *Mechanisms of Development* 69 (1-2): 71-81. [https://doi.org/10.1016/S0925-4773\(97\)00156-1](https://doi.org/10.1016/S0925-4773(97)00156-1).
- Abi Ghanem, Charly, Cindy Degerny, Rashad Hussain, Philippe Liere, Antoine Pianos, Sophie Tourpin, René Habert, Wendy B. Macklin, Michael Schumacher, et Abdel M. Ghomari. 2017. « Long-Lasting Masculinizing Effects of Postnatal Androgens on Myelin Governed by the Brain Androgen Receptor ». Édité par Bruce McEwen. *PLOS Genetics* 13 (11): e1007049. <https://doi.org/10.1371/journal.pgen.1007049>.
- Abrous, Djoher Nora, Walter Adriani, Marie-Françoise Montaron, Catherine Aourousseau, Geneviève Rougon, Michel Le Moal, et Pier Vincenzo Piazza. 2002. « Nicotine Self-Administration Impairs Hippocampal Plasticity ». *The Journal of Neuroscience* 22 (9): 3656-62. <https://doi.org/10.1523/JNEUROSCI.22-09-03656.2002>.
- Ackerman, Sarah D., Cynthia Garcia, Xianhua Piao, David H. Gutmann, et Kelly R. Monk. 2015. « The Adhesion GPCR Gpr56 Regulates Oligodendrocyte Development via Interactions with Gα12/13 and RhoA ». *Nature Communications* 6 (1): 6122. <https://doi.org/10.1038/ncomms7122>.
- Adamcio, Bartosz, Derya Sargin, Alicja Stradomska, Lucian Medrihan, Christoph Gertler, Fabian Theis, Mingyue Zhang, et al. 2008. « Erythropoietin Enhances Hippocampal Long-Term Potentiation and Memory ». *BMC Biology* 6 (1): 37. <https://doi.org/10.1186/1741-7007-6-37>.
- Aggarwal, Shweta, Nicolas Snaidero, Gesa Pähler, Steffen Frey, Paula Sánchez, Markus Zweckstetter, Andreas Janshoff, et al. 2013. « Myelin Membrane Assembly Is Driven by a Phase Transition of Myelin Basic Proteins Into a Cohesive Protein Meshwork ». Édité par Ben A. Barres. *PLoS Biology* 11 (6): e1001577. <https://doi.org/10.1371/journal.pbio.1001577>.
- Agresti, C., M.E. Meomartini, S. Amadio, E. Ambrosini, C. Volonté, F. Aloisi, et S. Visentin. 2005. « ATP Regulates Oligodendrocyte Progenitor Migration, Proliferation, and Differentiation: Involvement of Metabotropic P2 Receptors ». *Brain Research Reviews* 48 (2): 157-65. <https://doi.org/10.1016/j.brainresrev.2004.12.005>.
- Agúndez, José AG, Félix Javier Jiménez-Jimenez, Hortensia Alonso-Navarro, et Elena García-Martín. 2015. « The Potential of LINGO-1 as a Therapeutic Target for Essential Tremor ». *Expert Opinion on Therapeutic Targets* 19 (8): 1139-48. <https://doi.org/10.1517/14728222.2015.1028360>.
- Allen, John A., et Bryan L. Roth. 2011. « Strategies to Discover Unexpected Targets for Drugs Active at G Protein-Coupled Receptors ». *Annual Review of Pharmacology and Toxicology* 51 (1): 117-44. <https://doi.org/10.1146/annurev-pharmtox-010510-100553>.
- Allen, Nicola J., et Cagla Eroglu. 2017. « Cell Biology of Astrocyte-Synapse Interactions ». *Neuron* 96 (3): 697-708. <https://doi.org/10.1016/j.neuron.2017.09.056>.
- Allen, Nicola J., et David A. Lyons. 2018. « Glia as Architects of Central Nervous System Formation and Function ». *Science* 362 (6411): 181-85. <https://doi.org/10.1126/science.aat0473>.
- Almeida, A., J. Almeida, J. P. Bolanos, et S. Moncada. 2001. « Different Responses of Astrocytes and Neurons to Nitric Oxide: The Role of Glycolytically Generated ATP in Astrocyte Protection ». *Proceedings of the National Academy of Sciences* 98 (26): 15294-99. <https://doi.org/10.1073/pnas.261560998>.
- Almeida, Rafael G., et David A. Lyons. 2017. « On Myelinated Axon Plasticity and Neuronal Circuit Formation and Function ». *The Journal of Neuroscience* 37 (42): 10023-34. <https://doi.org/10.1523/JNEUROSCI.3185-16.2017>.
- Alvarez-Buylla, Arturo, et Daniel A Lim. 2004. « For the Long Run ». *Neuron* 41 (5): 683-86. [https://doi.org/10.1016/S0896-6273\(04\)00111-4](https://doi.org/10.1016/S0896-6273(04)00111-4).

- Alwakil, Hoda A., Ayman M. Al-Malt, Osama A. Ragab, Muhammed T. Abdel Ghafar, et Elsayed A. Tageldin. 2020. « Serum Prolactin in Patients with Relapsing Remitting Multiple Sclerosis ». *The Egyptian Journal of Neurology, Psychiatry and Neurosurgery* 56 (1): 77. <https://doi.org/10.1186/s41983-020-00211-1>.
- Arellano, Rogelio O., María Victoria Sánchez-Gómez, Elena Alberdi, Manuel Canedo-Antelo, Juan Carlos Chara, Aitor Palomino, Alberto Pérez-Samartín, et Carlos Matute. 2016. « Axon-to-Glia Interaction Regulates GABA Receptor Expression in Oligodendrocytes ». *Molecular Pharmacology* 89 (1): 63-74. <https://doi.org/10.1124/mol.115.100594>.
- Armstrong, Regina C., Tuan Q. Le, Emma E. Frost, Rosemary C. Borke, et Adam C. Vana. 2002. « Absence of Fibroblast Growth Factor 2 Promotes Oligodendroglial Repopulation of Demyelinated White Matter ». *The Journal of Neuroscience* 22 (19): 8574-85. <https://doi.org/10.1523/JNEUROSCI.22-19-08574.2002>.
- Arnett, Heather A., Stephen P. J. Fancy, John A. Alberta, Chao Zhao, Sheila R. Plant, Sovann Kaing, Cedric S. Raine, David H. Rowitch, Robin J. M. Franklin, et Charles D. Stiles. 2004. « BHLH Transcription Factor Olig1 Is Required to Repair Demyelinated Lesions in the CNS ». *Science* 306 (5704): 2111-15. <https://doi.org/10.1126/science.1103709>.
- Avenell, Kim Y., Izzy Boyfield, Martyn C. Coldwell, Michael S. Hadley, Maureen A.M. Healy, Philip M. Jeffrey, Christopher N. Johnson, et al. 1998. « Fused Aminotetralins: Novel Antagonists with High Selectivity for the Dopamine D3 Receptor ». *Bioorganic & Medicinal Chemistry Letters* 8 (20): 2859-64. [https://doi.org/10.1016/S0960-894X\(98\)00512-5](https://doi.org/10.1016/S0960-894X(98)00512-5).
- Avenell, Kim Y., Izzy Boyfield, Michael S Hadley, Christopher N Johnson, David J Nash, Graham J Riley, et Geoffrey Stemp. 1999. « Heterocyclic Analogues of 2-Aminotetralins with High Affinity and Selectivity for the Dopamine D3 Receptor ». *Bioorganic & Medicinal Chemistry Letters* 9 (18): 2715-20. [https://doi.org/10.1016/S0960-894X\(99\)00454-0](https://doi.org/10.1016/S0960-894X(99)00454-0).
- Azim, Kasum, Diane Angonin, Guillaume Marcy, Francesca Pieropan, Andrea Rivera, Vanessa Donega, Claudio Cantù, et al. 2017. « Pharmacogenomic Identification of Small Molecules for Lineage Specific Manipulation of Subventricular Zone Germinal Activity ». Édité par Heather Cameron. *PLOS Biology* 15 (3): e2000698. <https://doi.org/10.1371/journal.pbio.2000698>.
- Azim, Kasum, Benedikt Berninger, et Olivier Raineteau. 2016. « Mosaic Subventricular Origins of Forebrain Oligodendrogenesis ». *Frontiers in Neuroscience* 10 (mars). <https://doi.org/10.3389/fnins.2016.00107>.
- Back, Stephen A., Xiaodong Gan, Ya Li, Paul A. Rosenberg, et Joseph J. Volpe. 1998. « Maturation-Dependent Vulnerability of Oligodendrocytes to Oxidative Stress-Induced Death Caused by Glutathione Depletion ». *The Journal of Neuroscience* 18 (16): 6241-53. <https://doi.org/10.1523/JNEUROSCI.18-16-06241.1998>.
- Back, Stephen A., Byung Hee Han, Ning Ling Luo, Charlene A. Chricton, Steve Xanthoudakis, John Tam, Kara L. Arvin, et David M. Holtzman. 2002. « Selective Vulnerability of Late Oligodendrocyte Progenitors to Hypoxia-Ischemia ». *The Journal of Neuroscience* 22 (2): 455-63. <https://doi.org/10.1523/JNEUROSCI.22-02-00455.2002>.
- Back, Stephen A., Ning Ling Luo, Natalya S. Borenstein, Joel M. Levine, Joseph J. Volpe, et Hannah C. Kinney. 2001. « Late Oligodendrocyte Progenitors Coincide with the Developmental Window of Vulnerability for Human Perinatal White Matter Injury ». *The Journal of Neuroscience* 21 (4): 1302-12. <https://doi.org/10.1523/JNEUROSCI.21-04-01302.2001>.
- Back, Stephen A., et Scott A. Rivkees. 2004. « Emerging Concepts in Periventricular White Matter Injury ». *Seminars in Perinatology* 28 (6): 405-14. <https://doi.org/10.1053/j.semperi.2004.10.010>.
- Bader, Mary Kay. 2006. « Recognizing and Treating Ischemic Insults to the Brain: The Role of Brain Tissue Oxygen Monitoring ». *Critical Care Nursing Clinics of North America* 18 (2): 243-56. <https://doi.org/10.1016/j.ccell.2006.01.003>.
- Baer, Alexandra S., Yasir A. Syed, Sung Ung Kang, Dieter Mitteregger, Raluca Vig, Charles French-Constant, Robin J. M. Franklin, Friedrich Altmann, Gert Lubec, et Mark R. Kotter. 2009. « Myelin-Mediated Inhibition of

- Oligodendrocyte Precursor Differentiation Can Be Overcome by Pharmacological Modulation of Fyn-RhoA and Protein Kinase C Signalling ». *Brain* 132 (2): 465-81. <https://doi.org/10.1093/brain/awn334>.
- Bagayogo, Issa P, et Cheryl F Dreyfus. 2009. « Regulated Release of BDNF by Cortical Oligodendrocytes Is Mediated Through Metabotropic Glutamate Receptors and the PLC Pathway ». *ASN Neuro* 1 (1): AN20090006. <https://doi.org/10.1042/AN20090006>.
- Balavoine, G. 2003. « The Segmented Urbilateria: A Testable Scenario ». *Integrative and Comparative Biology* 43 (1): 137-47. <https://doi.org/10.1093/icb/43.1.137>.
- Baldoli, Cristina, Elisa Scola, Pasquale Antony Della Rosa, Silvia Pontesilli, Roberta Longaretti, Antonella Poloniato, Roberta Scotti, et al. 2015. « Maturation of Preterm Newborn Brains: A FMRI-DTI Study of Auditory Processing of Linguistic Stimuli and White Matter Development ». *Brain Structure and Function* 220 (6): 3733-51. <https://doi.org/10.1007/s00429-014-0887-5>.
- Bansal, R., A. E. Warrington, A. L. Gard, B. Ranscht, et S. E. Pfeiffer. 1989. « Multiple and Novel Specificities of Monoclonal Antibodies O1, O4, and R-MAb Used in the Analysis of Oligodendrocyte Development ». *Journal of Neuroscience Research* 24 (4): 548-57. <https://doi.org/10.1002/jnr.490240413>.
- Baraban, Marion, Sigrid Koudelka, et David A. Lyons. 2018. « Ca²⁺ Activity Signatures of Myelin Sheath Formation and Growth in Vivo ». *Nature Neuroscience* 21 (1): 19-23. <https://doi.org/10.1038/s41593-017-0040-x>.
- Bardile, Costanza Ferrari, Marta Garcia-Miralles, Nicholas Caron, Sarah Langley, Roy Tang Yi Teo, Enrico Petretto, Michael R Hayden, et Mahmoud A Pouladi. 2018. « A43 Intrinsic mutant HTT-mediated defects in oligodendroglia cells contribute to myelin deficits and behavioural abnormalities in huntington disease ». In *Pathogenic mechanisms*, A15.3-A16. BMJ Publishing Group Ltd. <https://doi.org/10.1136/jnnp-2018-EHDN.41>.
- Baron, Wia, Hande Ozgen, Bert Klunder, Jenny C. de Jonge, Anita Nomden, Annechien Plat, Elisabeth Trifilieff, Hans de Vries, et Dick Hoekstra. 2015. « The Major Myelin-Resident Protein PLP Is Transported to Myelin Membranes via a Transcytotic Mechanism: Involvement of Sulfatide ». *Molecular and Cellular Biology* 35 (1): 288-302. <https://doi.org/10.1128/MCB.00848-14>.
- Barone, F. C., B. Arvin, R. F. White, A. Miller, C. L. Webb, R. N. Willette, P. G. Lysko, et G. Z. Feuerstein. 1997. « Tumor Necrosis Factor- α : A Mediator of Focal Ischemic Brain Injury ». *Stroke* 28 (6): 1233-44. <https://doi.org/10.1161/01.STR.28.6.1233>.
- Bartko, Johann, Leopold Stiebellehner, Ulla Derhaschnig, Christian Schoergenhofer, Michael Schwameis, Helmut Prosch, et Bernd Jilma. 2016. « Dissociation between Systemic and Pulmonary Anti-inflammatory Effects of Dexamethasone in Humans ». *British Journal of Clinical Pharmacology* 81 (5): 865-77. <https://doi.org/10.1111/bcp.12857>.
- Batie, Michael, Julianty Frost, Mark Frost, James W. Wilson, Pieta Schofield, et Sonia Rocha. 2019. « Hypoxia Induces Rapid Changes to Histone Methylation and Reprograms Chromatin ». *Science* 363 (6432): 1222-26. <https://doi.org/10.1126/science.aau5870>.
- Bayas, Antonios, et Ralf Gold. 2003. « Lessons from 10 years of interferon beta-1b (Betaferon®/Betaseron®) treatment ». *Journal of Neurology* 250 (0): 1-1. <https://doi.org/10.1007/s00415-003-1402-8>.
- Beckervordersandforth, Ruth, Birgit Ebert, Iris Schäffner, Jonathan Moss, Christian Fiebig, Jaehoon Shin, Darcie L. Moore, et al. 2017. « Role of Mitochondrial Metabolism in the Control of Early Lineage Progression and Aging Phenotypes in Adult Hippocampal Neurogenesis ». *Neuron* 93 (6): 1518. <https://doi.org/10.1016/j.neuron.2017.03.008>.
- Behrman, Richard E, Butler, Adrienne Stith, Institute of Medicine (U.S.), et Committee on Understanding Premature Birth and Assuring Healthy Outcomes. 2007. *Preterm Birth: Causes, Consequences, and Prevention*. Washington, D.C.: National Academies Press. <http://site.ebrary.com/id/10172661>.
- Belachew, Shibeshih, Ramesh Chittajallu, Adan A. Aguirre, Xiaoqing Yuan, Martha Kirby, Stacie Anderson, et

- Vittorio Gallo. 2003. « Postnatal NG2 Proteoglycan–Expressing Progenitor Cells Are Intrinsically Multipotent and Generate Functional Neurons ». *Journal of Cell Biology* 161 (1): 169-86. <https://doi.org/10.1083/jcb.200210110>.
- Bengtsson, Sara L, Zoltán Nagy, Stefan Skare, Lea Forsman, Hans Forssberg, et Fredrik Ullén. 2005. « Extensive Piano Practicing Has Regionally Specific Effects on White Matter Development ». *Nature Neuroscience* 8 (9): 1148-50. <https://doi.org/10.1038/nn1516>.
- Benito-Kwiecinski, Silvia, Stefano L. Giandomenico, Magdalena Sutcliffe, Erlend S. Riis, Paula Freire-Pritchett, Iva Kelava, Stephanie Wunderlich, et al. 2021. « An Early Cell Shape Transition Drives Evolutionary Expansion of the Human Forebrain ». *Cell* 184 (8): 2084-2102.e19. <https://doi.org/10.1016/j.cell.2021.02.050>.
- Berg, Daniel A., Laure Belnoue, Hongjun Song, et Andrés Simon. 2013. « Neurotransmitter-Mediated Control of Neurogenesis in the Adult Vertebrate Brain ». *Development* 140 (12): 2548-61. <https://doi.org/10.1242/dev.088005>.
- Berghella, Vincenzo. 2012. « Universal Cervical Length Screening for Prediction and Prevention of Preterm Birth ». *Obstetrical & Gynecological Survey* 67 (10): 653-57. <https://doi.org/10.1097/OGX.0b013e318270d5b2>.
- Bergles, Dwight E., J. David B. Roberts, Peter Somogyi, et Craig E. Jahr. 2000. « Glutamatergic Synapses on Oligodendrocyte Precursor Cells in the Hippocampus ». *Nature* 405 (6783): 187-91. <https://doi.org/10.1038/35012083>.
- Bernal, J. 2002. « Action of Thyroid Hormone in Brain ». *Journal of Endocrinological Investigation* 25 (3): 268-88. <https://doi.org/10.1007/BF03344003>.
- Bertrand, Nicolas, Diogo S. Castro, et François Guillemot. 2002. « Proneural Genes and the Specification of Neural Cell Types ». *Nature Reviews Neuroscience* 3 (7): 517-30. <https://doi.org/10.1038/nrn874>.
- Bhalala, Utpal S., Raymond C. Koehler, et Sujatha Kannan. 2015. « Neuroinflammation and Neuroimmune Dysregulation after Acute Hypoxic-Ischemic Injury of Developing Brain ». *Frontiers in Pediatrics* 2 (janvier). <https://doi.org/10.3389/fped.2014.00144>.
- Bieber, Allan J., Scott Kerr, et Moses Rodriguez. 2003. « Efficient Central Nervous System Remyelination Requires T Cells ». *Annals of Neurology* 53 (5): 680-84. <https://doi.org/10.1002/ana.10578>.
- Birey, Fikri, Michelle Kloc, Manideep Chavali, Israa Hussein, Michael Wilson, Daniel J. Christoffel, Tony Chen, et al. 2015. « Genetic and Stress-Induced Loss of NG2 Glia Triggers Emergence of Depressive-like Behaviors through Reduced Secretion of FGF2 ». *Neuron* 88 (5): 941-56. <https://doi.org/10.1016/j.neuron.2015.10.046>.
- Bjartmar, Carl, et Bruce D. Trapp. 2003. « Axonal Degeneration and Progressive Neurologic Disability in Multiple Sclerosis ». *Neurotoxicity Research* 5 (1-2): 157-64. <https://doi.org/10.1007/BF03033380>.
- Bjornevik, Kjetil, Marianna Cortese, Brian C. Healy, Jens Kuhle, Michael J. Mina, Yumei Leng, Stephen J. Elledge, et al. 2022. « Longitudinal Analysis Reveals High Prevalence of Epstein-Barr Virus Associated with Multiple Sclerosis ». *Science* 375 (6578): 296-301. <https://doi.org/10.1126/science.abj8222>.
- Bjuland, Knut J., Lars M. Rimol, Gro C.C. Løhaugen, et Jon Skranes. 2014. « Brain Volumes and Cognitive Function in Very-Low-Birth-Weight (VLBW) Young Adults ». *European Journal of Paediatric Neurology* 18 (5): 578-90. <https://doi.org/10.1016/j.ejpn.2014.04.004>.
- Blencowe, Hannah, Simon Cousens, Doris Chou, Mikkel Oestergaard, Lale Say, Ann-Beth Moller, Mary Kinney, Joy Lawn, et the Born Too Soon Preterm Birth Action Group (see acknowledgement for full list). 2013. « Born Too Soon: The Global Epidemiology of 15 Million Preterm Births ». *Reproductive Health* 10 (S1): S2. <https://doi.org/10.1186/1742-4755-10-S1-S2>.
- Blomfield, Isabelle Maria, Brenda Rocamonde, Maria del Mar Masdeu, Eskeatnaf Mulugeta, Stefania Vaga, Debbie LC van den Berg, Emmanuelle Huillard, François Guillemot, et Noelia Urbán. 2019. « Id4 Promotes the Elimination of the Pro-Activation Factor Ascl1 to Maintain Quiescence of Adult Hippocampal Stem Cells ». *ELife* 8 (septembre): e48561. <https://doi.org/10.7554/eLife.48561>.

- Blumenthal, Ivan. 2004. « Periventricular Leucomalacia: A Review ». *European Journal of Pediatrics* 163 (8). <https://doi.org/10.1007/s00431-004-1477-y>.
- Boardman, James P., Graeme Ireland, Gemma Sullivan, Rozalia Pataky, Bobbi Fleiss, Pierre Gressens, et Veronique Miron. 2018. « The Cerebrospinal Fluid Inflammatory Response to Preterm Birth ». *Frontiers in Physiology* 9 (septembre): 1299. <https://doi.org/10.3389/fphys.2018.01299>.
- Boche, D., V. H. Perry, et J. A. R. Nicoll. 2013. « Review: Activation Patterns of Microglia and Their Identification in the Human Brain: Microglia in Human Brain ». *Neuropathology and Applied Neurobiology* 39 (1): 3-18. <https://doi.org/10.1111/nan.12011>.
- Bogler, O., D. Wren, S. C. Barnett, H. Land, et M. Noble. 1990. « Cooperation between Two Growth Factors Promotes Extended Self-Renewal and Inhibits Differentiation of Oligodendrocyte-Type-2 Astrocyte (O-2A) Progenitor Cells. » *Proceedings of the National Academy of Sciences* 87 (16): 6368-72. <https://doi.org/10.1073/pnas.87.16.6368>.
- Bolt, Roel J., M.M. van Weissenbruch, H.N. Lafeber, et H.A. Delemarre-van de Waal. 2001. « Glucocorticoids and lung development in the fetus and preterm infant ». *Pediatric Pulmonology* 32 (1): 76-91. <https://doi.org/10.1002/ppul.1092>.
- Bona, Elsa, Anna-Lena Andersson, Klas Blomgren, Eric Gilland, Malgorzata Puka-Sundvall, Katarina Gustafson, et Henrik Hagberg. 1999. « Chemokine and Inflammatory Cell Response to Hypoxia-Ischemia in Immature Rats ». *Pediatric Research* 45 (4, Part 1 of 2): 500-509. <https://doi.org/10.1203/00006450-199904010-00008>.
- Bonetto, Giulia, Yasmine Kamen, Kimberley Anne Evans, et Ragnhildur Thóra Káradóttir. 2020. « Unraveling Myelin Plasticity ». *Frontiers in Cellular Neuroscience* 14 (juin): 156. <https://doi.org/10.3389/fncel.2020.00156>.
- Bongarzone, Ernesto R., Sherrel G. Howard, Vilma Schonmann, et Anthony T. Campagnoni. 1998. « Identification of the Dopamine D3 Receptor in Oligodendrocyte Precursors: Potential Role in Regulating Differentiation and Myelin Formation ». *The Journal of Neuroscience* 18 (14): 5344-53. <https://doi.org/10.1523/JNEUROSCI.18-14-05344.1998>.
- Bostner, Josefine, Elin Karlsson, Muneeswaran J. Pandiyan, Hanna Westman, Lambert Skoog, Tommy Fornander, Bo Nordenskjöld, et Olle Stål. 2013. « Activation of Akt, MTOR, and the Estrogen Receptor as a Signature to Predict Tamoxifen Treatment Benefit ». *Breast Cancer Research and Treatment* 137 (2): 397-406. <https://doi.org/10.1007/s10549-012-2376-y>.
- Boullerne, A. I., L. Nedelkoska, et J. A. Benjamins. 2008. « Synergism of Nitric Oxide and Iron in Killing the Transformed Murine Oligodendrocyte Cell Line N20.1 ». *Journal of Neurochemistry* 72 (3): 1050-60. <https://doi.org/10.1046/j.1471-4159.1999.0721050.x>.
- Boullerne, Anne I., et Joyce A. Benjamins. 2006. « Nitric Oxide Synthase Expression and Nitric Oxide Toxicity in Oligodendrocytes ». *Antioxidants & Redox Signaling* 8 (5-6): 967-80. <https://doi.org/10.1089/ars.2006.8.967>.
- Bourbon-Teles, José, Sonya Bells, Derek K. Jones, Elizabeth Coulthard, Anne Rosser, et Claudia Metzler-Baddeley. 2019. « Myelin Breakdown in Human Huntington's Disease: Multi-Modal Evidence from Diffusion MRI and Quantitative Magnetization Transfer ». *Neuroscience* 403 (avril): 79-92. <https://doi.org/10.1016/j.neuroscience.2017.05.042>.
- Bowman, A. N., R. van Amerongen, T. D. Palmer, et R. Nusse. 2013. « Lineage Tracing with Axin2 Reveals Distinct Developmental and Adult Populations of Wnt/ -Catenin-Responsive Neural Stem Cells ». *Proceedings of the National Academy of Sciences* 110 (18): 7324-29. <https://doi.org/10.1073/pnas.1305411110>.
- Boyd, Amanda, Hui Zhang, et Anna Williams. 2013. « Insufficient OPC Migration into Demyelinated Lesions Is a Cause of Poor Remyelination in MS and Mouse Models ». *Acta Neuropathologica* 125 (6): 841-59. <https://doi.org/10.1007/s00401-013-1112-y>.
- Brand, Jörg-Matthias, Christoph Frohn, Katharina Cziupka, Christian Brockmann, Holger Kirchner, et Jürgen

- Luhm. 2004. « Prolactin Triggers Pro-Inflammatory Immune Responses in Peripheral Immune Cells ». *European Cytokine Network* 15 (2): 99-104.
- Brazel, C.Y., J.L. Nuñez, Z. Yang, et S.W. Levison. 2005. « Glutamate Enhances Survival and Proliferation of Neural Progenitors Derived from the Subventricular Zone ». *Neuroscience* 131 (1): 55-65. <https://doi.org/10.1016/j.neuroscience.2004.10.038>.
- Brennan, Cameron, Hiroyuki Momota, Dolores Hambardzumyan, Tatsuya Ozawa, Adesh Tandon, Alicia Pedraza, et Eric Holland. 2009. « Glioblastoma Subclasses Can Be Defined by Activity among Signal Transduction Pathways and Associated Genomic Alterations ». Édité par Chad Creighton. *PLoS ONE* 4 (11): e7752. <https://doi.org/10.1371/journal.pone.0007752>.
- Breunig, Joshua J., Tarik F. Haydar, et Pasko Rakic. 2011. « Neural Stem Cells: Historical Perspective and Future Prospects ». *Neuron* 70 (4): 614-25. <https://doi.org/10.1016/j.neuron.2011.05.005>.
- Brezun, J.M, et A Daszuta. 1999. « Depletion in Serotonin Decreases Neurogenesis in the Dentate Gyrus and the Subventricular Zone of Adult Rats ». *Neuroscience* 89 (4): 999-1002. [https://doi.org/10.1016/S0306-4522\(98\)00693-9](https://doi.org/10.1016/S0306-4522(98)00693-9).
- Bronner, Marianne E. 2012. « Formation and Migration of Neural Crest Cells in the Vertebrate Embryo ». *Histochemistry and Cell Biology* 138 (2): 179-86. <https://doi.org/10.1007/s00418-012-0999-z>.
- Brooker, Sarah M., Allison M. Bond, Chian-Yu Peng, et John A. Kessler. 2016. « B1-Integrin Restricts Astrocytic Differentiation of Adult Hippocampal Neural Stem Cells: B1-Integrin Regulates Hippocampal NSC Fate ». *Glia* 64 (7): 1235-51. <https://doi.org/10.1002/glia.22996>.
- Brown, J. William L., Alasdair Coles, Dana Horakova, Eva Havrdova, Guillermo Izquierdo, Alexandre Prat, Marc Girard, et al. 2019. « Association of Initial Disease-Modifying Therapy With Later Conversion to Secondary Progressive Multiple Sclerosis ». *JAMA* 321 (2): 175. <https://doi.org/10.1001/jama.2018.20588>.
- Bulusu, Krishna C., Rajarshi Guha, Daniel J. Mason, Richard P.I. Lewis, Eugene Muratov, Yasaman Kalantar Motamedi, Murat Cokol, et Andreas Bender. 2016. « Modelling of Compound Combination Effects and Applications to Efficacy and Toxicity: State-of-the-Art, Challenges and Perspectives ». *Drug Discovery Today* 21 (2): 225-38. <https://doi.org/10.1016/j.drudis.2015.09.003>.
- Bunge, Mary Bartlett, Richard P. Bunge, et Hans Ris. 1961. « ULTRASTRUCTURAL STUDY OF REMYELINATION IN AN EXPERIMENTAL LESION IN ADULT CAT SPINAL CORD ». *The Journal of Biophysical and Biochemical Cytology* 10 (1): 67-94. <https://doi.org/10.1083/jcb.10.1.67>.
- Burnett, A. C., P. J. Anderson, J. Cheong, L. W. Doyle, C. G. Davey, et S. J. Wood. 2011. « Prevalence of Psychiatric Diagnoses in Preterm and Full-Term Children, Adolescents and Young Adults: A Meta-Analysis ». *Psychological Medicine* 41 (12): 2463-74. <https://doi.org/10.1017/S003329171100081X>.
- Buss, Armin, Katrin Pech, Byron A Kakulas, Didier Martin, Jean Schoenen, Johannes Noth, et Gary A Brook. 2009. « NG2 and Phosphacan Are Present in the Astroglial Scar after Human Traumatic Spinal Cord Injury ». *BMC Neurology* 9 (1): 32. <https://doi.org/10.1186/1471-2377-9-32>.
- Butt, A. M., A. Duncan, et M. Berry. 1994. « Astrocyte Associations with Nodes of Ranvier: Ultrastructural Analysis of HRP-Filled Astrocytes in the Mouse Optic Nerve ». *Journal of Neurocytology* 23 (8): 486-99. <https://doi.org/10.1007/BF01184072>.
- Butt, A. M., A. Duncan, M. F. Hornby, S. L. Kirvell, A. Hunter, J. M. Levine, et M. Berry. 1999. « Cells Expressing the NG2 Antigen Contact Nodes of Ranvier in Adult CNS White Matter ». *Glia* 26 (1): 84-91.
- Byravan, S, L M Foster, T Phan, A N Verity, et A T Campagnoni. 1994. « Murine Oligodendroglial Cells Express Nerve Growth Factor. » *Proceedings of the National Academy of Sciences* 91 (19): 8812-16. <https://doi.org/10.1073/pnas.91.19.8812>.
- Cabezas, Ricardo, Marcos Álvarez, Janneth Gonzalez, Ramon Santos El-Bachá, Eliana Bájiz, Luis Miguel Garcá-a-

- Segura, Juan Camilo Jurado Coronel, Francisco Capani, Gloria Patricia Cardona-Gomez, et George E. Barreto. 2014. « Astrocytic modulation of blood brain barrier: perspectives on Parkinsons disease ». *Frontiers in Cellular Neuroscience* 8 (août). <https://doi.org/10.3389/fncel.2014.00211>.
- Cabral, Estela, Henrique Soares, Hercília Guimarães, Rui Vitorino, Rita Ferreira, et Tiago Henriques-Coelho. 2017. « Prediction of Cardiovascular Risk in Preterm Neonates through Urinary Proteomics: An Exploratory Study ». *Porto Biomedical Journal* 2 (6): 287-92. <https://doi.org/10.1016/j.pbj.2017.04.002>.
- Cadavid, Diego, Michelle Mellion, Raymond Hupperts, Keith R Edwards, Peter A Calabresi, Jelena Drulović, Gavin Giovannoni, et al. 2019. « Safety and Efficacy of Opicinumab in Patients with Relapsing Multiple Sclerosis (SYNERGY): A Randomised, Placebo-Controlled, Phase 2 Trial ». *The Lancet Neurology* 18 (9): 845-56. [https://doi.org/10.1016/S1474-4422\(19\)30137-1](https://doi.org/10.1016/S1474-4422(19)30137-1).
- Cai, Jun, Yingchuan Qi, Xuemei Hu, Min Tan, Zijing Liu, Jianshe Zhang, Qun Li, Maik Sander, et Mengsheng Qiu. 2005. « Generation of Oligodendrocyte Precursor Cells from Mouse Dorsal Spinal Cord Independent of Nkx6 Regulation and Shh Signaling ». *Neuron* 45 (1): 41-53. <https://doi.org/10.1016/j.neuron.2004.12.028>.
- Cai, Z., S. Lin, L.-W. Fan, Y. Pang, et P.G. Rhodes. 2006. « Minocycline Alleviates Hypoxic–Ischemic Injury to Developing Oligodendrocytes in the Neonatal Rat Brain ». *Neuroscience* 137 (2): 425-35. <https://doi.org/10.1016/j.neuroscience.2005.09.023>.
- Calver, Andrew R, Anita C Hall, Wei-Ping Yu, Frank S Walsh, John K Heath, Christer Betsholtz, et William D Richardson. 1998. « Oligodendrocyte Population Dynamics and the Role of PDGF In Vivo ». *Neuron* 20 (5): 869-82. [https://doi.org/10.1016/S0896-6273\(00\)80469-9](https://doi.org/10.1016/S0896-6273(00)80469-9).
- Calvert, Shaun, Robi Tacutu, Samim Sharifi, Rute Teixeira, Pratul Ghosh, et João Pedro de Magalhães. 2016. « A Network Pharmacology Approach Reveals New Candidate Caloric Restriction Mimetics in *C. Elegans* ». *Aging Cell* 15 (2): 256-66. <https://doi.org/10.1111/accel.12432>.
- Calvo, Charles-Félix, Romain H. Fontaine, Jihane Soueid, Tuomas Tammela, Taija Makinen, Clara Alfaro-Cervello, Fabien Bonnaud, et al. 2011. « Vascular Endothelial Growth Factor Receptor 3 Directly Regulates Murine Neurogenesis ». *Genes & Development* 25 (8): 831-44. <https://doi.org/10.1101/gad.615311>.
- Cameron, Ha, Bs McEwen, et E Gould. 1995. « Regulation of Adult Neurogenesis by Excitatory Input and NMDA Receptor Activation in the Dentate Gyrus ». *The Journal of Neuroscience* 15 (6): 4687-92. <https://doi.org/10.1523/JNEUROSCI.15-06-04687.1995>.
- Campbell, Kenneth, et Magdalena Götz. 2002. « Radial Glia: Multi-Purpose Cells for Vertebrate Brain Development ». *Trends in Neurosciences* 25 (5): 235-38. [https://doi.org/10.1016/S0166-2236\(02\)02156-2](https://doi.org/10.1016/S0166-2236(02)02156-2).
- Cannella, Barbara, et Cedric S. Raine. 1995. « The Adhesion Molecule and Cytokine Profile of Multiple Sclerosis Lesions ». *Annals of Neurology* 37 (4): 424-35. <https://doi.org/10.1002/ana.410370404>.
- Carlson, Noel G, Monica A Rojas, Jonathan W Redd, Philip Tang, Blair Wood, Kenneth E Hill, et John W Rose. 2010. « Cyclooxygenase-2 Expression in Oligodendrocytes Increases Sensitivity to Excitotoxic Death ». *Journal of Neuroinflammation* 7 (1): 25. <https://doi.org/10.1186/1742-2094-7-25>.
- Casano, Alessandra Maria, et Francesca Peri. 2015. « Microglia: Multitasking Specialists of the Brain ». *Developmental Cell* 32 (4): 469-77. <https://doi.org/10.1016/j.devcel.2015.01.018>.
- Casarosa, S., C. Fode, et F. Guillemot. 1999. « Mash1 Regulates Neurogenesis in the Ventral Telencephalon ». *Development* 126 (3): 525-34. <https://doi.org/10.1242/dev.126.3.525>.
- Castro, Diogo S., et François Guillemot. 2011. « Old and New Functions of Proneural Factors Revealed by the Genome-Wide Characterization of Their Transcriptional Targets ». *Cell Cycle* 10 (23): 4026-31. <https://doi.org/10.4161/cc.10.23.18578>.
- Castro, Diogo S., Ben Martynoga, Carlos Parras, Vidya Ramesh, Emilie Pacary, Caroline Johnston, Daniela Drechsel, et al. 2011. « A Novel Function of the Proneural Factor Ascl1 in Progenitor Proliferation Identified by Genome-Wide Characterization of Its Targets ». *Genes & Development* 25 (9): 930-45.

<https://doi.org/10.1101/gad.627811>.

Catov, Janet M., Ellen Aagaard Nohr, Jorn Olsen, et Roberta B. Ness. 2008. « Chronic Hypertension Related to Risk for Preterm and Term Small for Gestational Age Births ». *Obstetrics & Gynecology* 112 (2): 290-96. <https://doi.org/10.1097/AOG.0b013e31817f589b>.

Centonze, D., L. Muzio, S. Rossi, F. CavaSinni, V. De Chiara, A. Bergami, A. Musella, et al. 2009. « Inflammation Triggers Synaptic Alteration and Degeneration in Experimental Autoimmune Encephalomyelitis ». *Journal of Neuroscience* 29 (11): 3442-52. <https://doi.org/10.1523/JNEUROSCI.5804-08.2009>.

Challis, J.R.G., D. Sloboda, S.G. Matthews, A. Holloway, N. Alfaidy, F.A. Patel, W. Whittle, M. Fraser, T.J.M. Moss, et J. Newnham. 2001. « The Fetal Placental Hypothalamic–Pituitary–Adrenal (HPA) Axis, Parturition and Post Natal Health ». *Molecular and Cellular Endocrinology* 185 (1-2): 135-44. [https://doi.org/10.1016/S0303-7207\(01\)00624-4](https://doi.org/10.1016/S0303-7207(01)00624-4).

Chan, Jonah R, Trent A Watkins, José M Cosgaya, ChunZhao Zhang, Lian Chen, Louis F Reichardt, Eric M Shooter, et Ben A Barres. 2004. « NGF Controls Axonal Receptivity to Myelination by Schwann Cells or Oligodendrocytes ». *Neuron* 43 (2): 183-91. <https://doi.org/10.1016/j.neuron.2004.06.024>.

Chanoumidou, Konstantina, Benjamín Hernández-Rodríguez, Farina Windener, Christian Thomas, Martin Stehling, Sabah Mozafari, Stefanie Albrecht, et al. 2021. « One-Step Reprogramming of Human Fibroblasts into Oligodendrocyte-like Cells by SOX10, OLIG2, and NKX6.2 ». *Stem Cell Reports* 16 (4): 771-83. <https://doi.org/10.1016/j.stemcr.2021.03.001>.

Chari, Divya M., et William F. Blakemore. 2002. « Efficient Recolonisation of Progenitor-Depleted Areas of the CNS by Adult Oligodendrocyte Progenitor Cells ». *Glia* 37 (4): 307-13.

Chauhan, Anjali, Abdullah Al Mamun, Gabriel Spiegel, Nia Harris, Liang Zhu, et Louise D. McCullough. 2018. « Splenectomy Protects Aged Mice from Injury after Experimental Stroke ». *Neurobiology of Aging* 61 (janvier): 102-11. <https://doi.org/10.1016/j.neurobiolaging.2017.09.022>.

Chauhan, Prerna, Ashish Kumar Kakkar, Harmanjit Singh, et C. S. Gautam. 2021. « Minocycline for the Management of Multiple Sclerosis: Repositioning Potential, Opportunities, and Challenges ». *Expert Review of Neurotherapeutics* 21 (1): 35-43. <https://doi.org/10.1080/14737175.2020.1838276>.

Chawanpaiboon, Saifon, Joshua P Vogel, Ann-Beth Moller, Pisake Lumbiganon, Max Petzold, Daniel Hogan, Sihem Landoulsi, et al. 2019. « Global, Regional, and National Estimates of Levels of Preterm Birth in 2014: A Systematic Review and Modelling Analysis ». *The Lancet Global Health* 7 (1): e37-46. [https://doi.org/10.1016/S2214-109X\(18\)30451-0](https://doi.org/10.1016/S2214-109X(18)30451-0).

Cheli, Veronica T., Diara A. Santiago González, Tenzing Namgyal Lama, Vilma Spreuer, Vance Handley, Geoffrey G. Murphy, et Pablo M. Paez. 2016. « Conditional Deletion of the L-Type Calcium Channel Cav1.2 in Oligodendrocyte Progenitor Cells Affects Postnatal Myelination in Mice ». *The Journal of Neuroscience* 36 (42): 10853-69. <https://doi.org/10.1523/JNEUROSCI.1770-16.2016>.

Chen, Bai Hui, Joon Ha Park, Yun Lyul Lee, Il Jun Kang, Dae Won Kim, In Koo Hwang, Choong-Hyun Lee, et al. 2018. « Melatonin Improves Vascular Cognitive Impairment Induced by Ischemic Stroke by Remyelination via Activation of ERK1/2 Signaling and Restoration of Glutamatergic Synapses in the Gerbil Hippocampus ». *Biomedicine & Pharmacotherapy* 108 (décembre): 687-97. <https://doi.org/10.1016/j.biopha.2018.09.077>.

Chen, Xing-Shu, Yu-Hang Zhang, Qi-Yan Cai, et Zhong-Xiang Yao. 2012. « ID2: A Negative Transcription Factor Regulating Oligodendroglia Differentiation ». *Journal of Neuroscience Research* 90 (5): 925-32. <https://doi.org/10.1002/jnr.22826>.

Chen, Y., L. Huang, A. F. Russo, et M. Solursh. 1992. « Retinoic Acid Is Enriched in Hensen's Node and Is Developmentally Regulated in the Early Chicken Embryo. » *Proceedings of the National Academy of Sciences* 89 (21): 10056-59. <https://doi.org/10.1073/pnas.89.21.10056>.

Chen, Yidan, Ruyi Mei, Peng Teng, Aifen Yang, Xuemei Hu, Zunyi Zhang, Mengsheng Qiu, et Xiaofeng Zhao. 2015. « TAPP1 Inhibits the Differentiation of Oligodendrocyte Precursor Cells via Suppressing the Mek/Erk Pathway ».

Neuroscience Bulletin 31 (5): 517-26. <https://doi.org/10.1007/s12264-015-1537-5>.

Chen, Ying, Heng Wu, Shuzong Wang, Hisami Koito, Jianrong Li, Feng Ye, Jenny Hoang, et al. 2009. « The Oligodendrocyte-Specific G Protein–Coupled Receptor GPR17 Is a Cell-Intrinsic Timer of Myelination ». *Nature Neuroscience* 12 (11): 1398-1406. <https://doi.org/10.1038/nn.2410>.

Chen, Yongfeng, Wei Zhen, Tony Guo, Yonggang Zhao, Ailian Liu, Justin P. Rubio, David Krull, Jill C. Richardson, Hongtao Lu, et Ryan Wang. 2017. « Histamine Receptor 3 Negatively Regulates Oligodendrocyte Differentiation and Remyelination ». Édité par Fernando de Castro. *PLOS ONE* 12 (12): e0189380. <https://doi.org/10.1371/journal.pone.0189380>.

Cherchi, Federica, Irene Bulli, Martina Venturini, Anna Maria Pugliese, et Elisabetta Coppi. 2021. « Ion Channels as New Attractive Targets to Improve Re-Myelination Processes in the Brain ». *International Journal of Molecular Sciences* 22 (14): 7277. <https://doi.org/10.3390/ijms22147277>.

Chesik, Daniel, Nadine Wilczak, et Jacques De Keyser. 2007. « The Insulin-like Growth Factor System in Multiple Sclerosis ». In *International Review of Neurobiology*, 79:203-26. Elsevier. [https://doi.org/10.1016/S0074-7742\(07\)79009-8](https://doi.org/10.1016/S0074-7742(07)79009-8).

Chew, Li-Jin, Xiaotian Ming, Brian McEllin, Jeffrey Dupree, Elim Hong, Mackenzie Catron, Melissa Fauveau, Brahim Nait-Oumesmar, et Vittorio Gallo. 2019. « Sox17 Regulates a Program of Oligodendrocyte Progenitor Cell Expansion and Differentiation during Development and Repair ». *Cell Reports* 29 (10): 3173-3186.e7. <https://doi.org/10.1016/j.celrep.2019.10.121>.

Chew, L.-J., W. Coley, Y. Cheng, et V. Gallo. 2010. « Mechanisms of Regulation of Oligodendrocyte Development by P38 Mitogen-Activated Protein Kinase ». *Journal of Neuroscience* 30 (33): 11011-27. <https://doi.org/10.1523/JNEUROSCI.2546-10.2010>.

Cho, Ken W.Y., Bruce Blumberg, Herbert Steinbeisser, et Eddy M. De Robertis. 1991. « Molecular Nature of Spemann's Organizer: The Role of the *Xenopus* Homeobox Gene *Goosecoid* ». *Cell* 67 (6): 1111-20. [https://doi.org/10.1016/0092-8674\(91\)90288-A](https://doi.org/10.1016/0092-8674(91)90288-A).

Choi, Ben H. 1981. « Radial Glia of Developing Human Fetal Spinal Cord: Golgi, Immunohistochemical and Electron Microscopic Study ». *Developmental Brain Research* 1 (2): 249-67. [https://doi.org/10.1016/0165-3806\(81\)90112-7](https://doi.org/10.1016/0165-3806(81)90112-7).

Chua, Caroline L. L., Wina Hasang, Stephen J. Rogerson, et Andrew Teo. 2021. « Poor Birth Outcomes in Malaria in Pregnancy: Recent Insights Into Mechanisms and Prevention Approaches ». *Frontiers in Immunology* 12 (mars): 621382. <https://doi.org/10.3389/fimmu.2021.621382>.

Chung, Jinhyuk F., Calvin J. Yoon, Seon Ah Cheon, Eun Seok Seo, Sung Ho Park, Jae Seung Yang, Bumju Kim, et al. 2016. « NO-Dependent Attenuation of TPA-Induced Immunoinflammatory Skin Changes in Balb/c Mice by Pindolol, Heptaminol or ATRA, but Not by Verapamil ». *Oncotarget* 7 (30): 47576-85. <https://doi.org/10.18632/oncotarget.10217>.

Cianciulli, Antonia, Rosaria Salvatore, Chiara Porro, Teresa Trotta, et Maria Antonietta Panaro. 2016. « Folic Acid Is Able to Polarize the Inflammatory Response in LPS Activated Microglia by Regulating Multiple Signaling Pathways ». *Mediators of Inflammation* 2016: 1-10. <https://doi.org/10.1155/2016/5240127>.

Clark, Elisia, Joseph Johnson, Yi Na Dong, Elizabeth Mercado-Ayon, Nathan Warren, Mattieu Zhai, Emily McMillan, Amy Salovin, Hong Lin, et David R. Lynch. 2018. « Role of Frataxin Protein Deficiency and Metabolic Dysfunction in Friedreich Ataxia, an Autosomal Recessive Mitochondrial Disease ». *Neuronal Signaling* 2 (4): NS20180060. <https://doi.org/10.1042/NS20180060>.

Clausen, Bettina Hjelm, Matilda Degn, Nellie Anne Martin, Yvonne Couch, Leena Karimi, Maria Ormhøj, Maria-Louise Bergholdt Mortensen, et al. 2014. « Systemically Administered Anti-TNF Therapy Ameliorates Functional Outcomes after Focal Cerebral Ischemia ». *Journal of Neuroinflammation* 11 (1): 203. <https://doi.org/10.1186/s12974-014-0203-6>.

- Cochard, Loïc M., Louis-Charles Levros, Sandra E. Joppé, Federico Pratesi, Anne Aumont, et Karl J. L. Fernandes. 2021. « Manipulation of EGFR-Induced Signaling for the Recruitment of Quiescent Neural Stem Cells in the Adult Mouse Forebrain ». *Frontiers in Neuroscience* 15 (mars): 621076. <https://doi.org/10.3389/fnins.2021.621076>.
- Cohen, R. I., et G. Almazan. 1994. « Rat Oligodendrocytes Express Muscarinic Receptors Coupled to Phosphoinositide Hydrolysis and Adenylyl Cyclase ». *European Journal of Neuroscience* 6 (7): 1213-24. <https://doi.org/10.1111/j.1460-9568.1994.tb00620.x>.
- Colas, Jean-François, et Gary C. Schoenwolf. 2001. « Towards a Cellular and Molecular Understanding of Neurulation ». *Developmental Dynamics* 221 (2): 117-45. <https://doi.org/10.1002/dvdy.1144>.
- Colombo, Emanuela, et Cinthia Farina. 2016. « Astrocytes: Key Regulators of Neuroinflammation ». *Trends in Immunology* 37 (9): 608-20. <https://doi.org/10.1016/j.it.2016.06.006>.
- Colton, Carol A., et Donna M. Wilcock. 2010. « Assessing Activation States in Microglia ». *CNS & Neurological Disorders - Drug Targets* 9 (2): 174-91. <https://doi.org/10.2174/187152710791012053>.
- Constantin, Stephanie, Christine L. Jasoni, Brandon Wadas, et Allan E. Herbison. 2010. « γ -Aminobutyric Acid and Glutamate Differentially Regulate Intracellular Calcium Concentrations in Mouse Gonadotropin-Releasing Hormone Neurons ». *Endocrinology* 151 (1): 262-70. <https://doi.org/10.1210/en.2009-0817>.
- Conway, Gregory D., Melanie A. O'Bara, Bansi H. Vedia, Suyog U. Pol, et Fraser J. Sim. 2012. « Histone Deacetylase Activity Is Required for Human Oligodendrocyte Progenitor Differentiation ». *Glia* 60 (12): 1944-53. <https://doi.org/10.1002/glia.22410>.
- Corballis, Michael C. 2014. « Left Brain, Right Brain: Facts and Fantasies ». *PLoS Biology* 12 (1): e1001767. <https://doi.org/10.1371/journal.pbio.1001767>.
- Cornillot, Marion, Vincenzo Giacco, et Nicola B. Hamilton. 2019. « The Role of TRP Channels in White Matter Function and Ischaemia ». *Neuroscience Letters* 690 (janvier): 202-9. <https://doi.org/10.1016/j.neulet.2018.10.042>.
- Crease, Devanand J., Steven Dyson, et J. B. Gurdon. 1998. « Cooperation between the Activin and Wnt Pathways in the Spatial Control of Organizer Gene Expression ». *Proceedings of the National Academy of Sciences of the United States of America* 95 (8): 4398-4403.
- Cruz-Orengo, Lillian, Brian P. Daniels, Denise Dorsey, Sarah Alison Basak, José G. Grajales-Reyes, Erin E. McCandless, Laura Piccio, et al. 2014. « Enhanced Sphingosine-1-Phosphate Receptor 2 Expression Underlies Female CNS Autoimmunity Susceptibility ». *Journal of Clinical Investigation* 124 (6): 2571-84. <https://doi.org/10.1172/JCI73408>.
- Cui, Charlene, Jing Wang, Ariana P. Mullin, Anthony O. Caggiano, Tom J. Parry, Raymond W. Colburn, et Elias Pavlopoulos. 2018. « The Antibody RHlgM22 Facilitates Hippocampal Remyelination and Ameliorates Memory Deficits in the Cuprizone Mouse Model of Demyelination ». *Brain Research* 1694 (septembre): 73-86. <https://doi.org/10.1016/j.brainres.2018.05.013>.
- Curti, Sebastian, et John O'Brien. 2016. « Characteristics and Plasticity of Electrical Synaptic Transmission ». *BMC Cell Biology* 17 (S1): 13. <https://doi.org/10.1186/s12860-016-0091-y>.
- Cusick, Matthew F., Jane E. Libbey, Nikolaus S. Trede, et Robert S. Fujinami. 2014. « Targeting Insulin-Like Growth Factor 1 Leads to Amelioration of Inflammatory Demyelinating Disease ». Édité par Christine Beeton. *PLoS ONE* 9 (4): e94486. <https://doi.org/10.1371/journal.pone.0094486>.
- Czopka, Tim, Charles French-Constant, et David A. Lyons. 2013. « Individual Oligodendrocytes Have Only a Few Hours in Which to Generate New Myelin Sheaths In Vivo ». *Developmental Cell* 25 (6): 599-609. <https://doi.org/10.1016/j.devcel.2013.05.013>.
- Dai, J., K. K. Bercury, J. T. Ahrends, et W. B. Macklin. 2015. « Olig1 Function Is Required for Oligodendrocyte Differentiation in the Mouse Brain ». *Journal of Neuroscience* 35 (10): 4386-4402.

<https://doi.org/10.1523/JNEUROSCI.4962-14.2015>.

Dawson, M. 2003. « NG2-Expressing Glial Progenitor Cells: An Abundant and Widespread Population of Cycling Cells in the Adult Rat CNS ». *Molecular and Cellular Neuroscience* 24 (2): 476-88. [https://doi.org/10.1016/S1044-7431\(03\)00210-0](https://doi.org/10.1016/S1044-7431(03)00210-0).

De Angelis, Federica, Antonietta Bernardo, Valerio Magnaghi, Luisa Minghetti, et Ada Maria Tata. 2012. « Muscarinic Receptor Subtypes as Potential Targets to Modulate Oligodendrocyte Progenitor Survival, Proliferation, and Differentiation ». *Developmental Neurobiology* 72 (5): 713-28. <https://doi.org/10.1002/dneu.20976>.

De Robertis, E.M. 2009. « Spemann's Organizer and the Self-Regulation of Embryonic Fields ». *Mechanisms of Development* 126 (11-12): 925-41. <https://doi.org/10.1016/j.mod.2009.08.004>.

Deitmer, Joachim W., Shefeeq M. Theparambil, Ivan Ruminot, Sina I. Noor, et Holger M. Becker. 2019. « Energy Dynamics in the Brain: Contributions of Astrocytes to Metabolism and pH Homeostasis ». *Frontiers in Neuroscience* 13 (décembre): 1301. <https://doi.org/10.3389/fnins.2019.01301>.

Del Bene, Filippo, Ann M. Wehman, Brian A. Link, et Herwig Baier. 2008. « Regulation of Neurogenesis by Interkinetic Nuclear Migration through an Apical-Basal Notch Gradient ». *Cell* 134 (6): 1055-65. <https://doi.org/10.1016/j.cell.2008.07.017>.

Demerens, C., B. Stankoff, M. Logak, P. Anglade, B. Allinquant, F. Couraud, B. Zalc, et C. Lubetzki. 1996. « Induction of Myelination in the Central Nervous System by Electrical Activity. » *Proceedings of the National Academy of Sciences* 93 (18): 9887-92. <https://doi.org/10.1073/pnas.93.18.9887>.

Denier, C., A. Orgibet, F. Roffi, E. Jouvent, C. Buhl, F. Niel, O. Boespflug-Tanguy, G. Said, et D. Ducreux. 2007. « ADULT-ONSET VANISHING WHITE MATTER LEUKOENCEPHALOPATHY PRESENTING AS PSYCHOSIS ». *Neurology* 68 (18): 1538-39. <https://doi.org/10.1212/01.wnl.0000260701.76868.44>.

Desai, Maya K., Kelly L. Sudol, Michelle C. Janelins, Michael A. Mastrangelo, Maria E. Frazer, et William J. Bowers. 2009. « Triple-Transgenic Alzheimer's Disease Mice Exhibit Region-Specific Abnormalities in Brain Myelination Patterns Prior to Appearance of Amyloid and Tau Pathology ». *Glia* 57 (1): 54-65. <https://doi.org/10.1002/glia.20734>.

Dimou, Leda, et Mikael Simons. 2017. « Diversity of Oligodendrocytes and Their Progenitors ». *Current Opinion in Neurobiology* 47 (décembre): 73-79. <https://doi.org/10.1016/j.conb.2017.09.015>.

Doetsch, Fiona. 2003. « A Niche for Adult Neural Stem Cells ». *Current Opinion in Genetics & Development* 13 (5): 543-50. <https://doi.org/10.1016/j.gde.2003.08.012>.

Doetsch, Fiona, Isabelle Caillé, Daniel A. Lim, Jose Manuel García-Verdugo, et Arturo Alvarez-Buylla. 1999. « Subventricular Zone Astrocytes Are Neural Stem Cells in the Adult Mammalian Brain ». *Cell* 97 (6): 703-16. [https://doi.org/10.1016/S0092-8674\(00\)80783-7](https://doi.org/10.1016/S0092-8674(00)80783-7).

Dogra, Sunil, et Geeti Khullar. 2013. « Tumor Necrosis Factor- α Antagonists: Side Effects and Their Management ». *Indian Journal of Dermatology, Venereology, and Leprology* 79 (7): 35. <https://doi.org/10.4103/0378-6323.115526>.

Douvaras, Panagiotis, et Valentina Fossati. 2015. « Generation and Isolation of Oligodendrocyte Progenitor Cells from Human Pluripotent Stem Cells ». *Nature Protocols* 10 (8): 1143-54. <https://doi.org/10.1038/nprot.2015.075>.

Dracheva, Stella, Kenneth L. Davis, Benjamin Chin, Derek A. Woo, James Schmeidler, et Vahram Haroutunian. 2006. « Myelin-Associated mRNA and Protein Expression Deficits in the Anterior Cingulate Cortex and Hippocampus in Elderly Schizophrenia Patients ». *Neurobiology of Disease* 21 (3): 531-40. <https://doi.org/10.1016/j.nbd.2005.08.012>.

Duan, Qiaonan, Corey Flynn, Mario Niepel, Marc Hafner, Jeremy L. Muhlich, Nicolas F. Fernandez, Andrew D.

- Rouillard, et al. 2014. « LINCS Canvas Browser: Interactive Web App to Query, Browse and Interrogate LINCS L1000 Gene Expression Signatures ». *Nucleic Acids Research* 42 (W1): W449-60. <https://doi.org/10.1093/nar/gku476>.
- Dugas, J. C., Y. C. Tai, T. P. Speed, J. Ngai, et B. A. Barres. 2006. « Functional Genomic Analysis of Oligodendrocyte Differentiation ». *Journal of Neuroscience* 26 (43): 10967-83. <https://doi.org/10.1523/JNEUROSCI.2572-06.2006>.
- Dugas, Jason C., Trinna L. Cuellar, Anja Scholze, Brandon Ason, Adiljan Ibrahim, Ben Emery, Jennifer L. Zamanian, Lynette C. Foo, Michael T. McManus, et Ben A. Barres. 2010a. « Dicer1 and MiR-219 Are Required for Normal Oligodendrocyte Differentiation and Myelination ». *Neuron* 65 (5): 597-611. <https://doi.org/10.1016/j.neuron.2010.01.027>.
- . 2010b. « Dicer1 and MiR-219 Are Required for Normal Oligodendrocyte Differentiation and Myelination ». *Neuron* 65 (5): 597-611. <https://doi.org/10.1016/j.neuron.2010.01.027>.
- Duncan, Ian D., Abigail B. Radcliff, Moones Heidari, Grahame Kidd, Benjamin K. August, et Lauren A. Wierenga. 2018. « The Adult Oligodendrocyte Can Participate in Remyelination ». *Proceedings of the National Academy of Sciences* 115 (50): E11807-16. <https://doi.org/10.1073/pnas.1808064115>.
- Ebers, George C. 1998. « Randomised Double-Blind Placebo-Controlled Study of Interferon β -1a in Relapsing/Remitting Multiple Sclerosis ». *The Lancet* 352 (9139): 1498-1504. [https://doi.org/10.1016/S0140-6736\(98\)03334-0](https://doi.org/10.1016/S0140-6736(98)03334-0).
- Edgar, R. 2002. « Gene Expression Omnibus: NCBI gene expression and hybridization array data repository ». *Nucleic Acids Research* 30 (1): 207-10. <https://doi.org/10.1093/nar/30.1.207>.
- Ehrlich, Marc, Sabah Mozafari, Michael Glatza, Laura Starost, Sergiy Velychko, Anna-Lena Hallmann, Qiao-Ling Cui, et al. 2017. « Rapid and Efficient Generation of Oligodendrocytes from Human Induced Pluripotent Stem Cells Using Transcription Factors ». *Proceedings of the National Academy of Sciences* 114 (11): E2243-52. <https://doi.org/10.1073/pnas.1614412114>.
- Eleuteri, C., S. Olla, C. Veroni, R. Umeton, R. Mechelli, S. Romano, Mc. Buscarinu, et al. 2017. « A Staged Screening of Registered Drugs Highlights Remyelinating Drug Candidates for Clinical Trials ». *Scientific Reports* 7 (1): 45780. <https://doi.org/10.1038/srep45780>.
- Emery, Ben. 2010. « Regulation of Oligodendrocyte Differentiation and Myelination ». *Science* 330 (6005): 779-82. <https://doi.org/10.1126/science.1190927>.
- Emery, Ben, Dritan Agalliu, John D. Cahoy, Trent A. Watkins, Jason C. Dugas, Sara B. Mulinyawe, Adiljan Ibrahim, Keith L. Ligon, David H. Rowitch, et Ben A. Barres. 2009. « Myelin Gene Regulatory Factor Is a Critical Transcriptional Regulator Required for CNS Myelination ». *Cell* 138 (1): 172-85. <https://doi.org/10.1016/j.cell.2009.04.031>.
- Erecińska, Maria, et Ian A. Silver. 2001. « Tissue Oxygen Tension and Brain Sensitivity to Hypoxia ». *Respiration Physiology* 128 (3): 263-76. [https://doi.org/10.1016/S0034-5687\(01\)00306-1](https://doi.org/10.1016/S0034-5687(01)00306-1).
- Eschenroeder, Andrew C., Allison A. Vestal-Laborde, Emilse S. Sanchez, Susan E. Robinson, et Carmen Sato-Bigbee. 2012. « Oligodendrocyte Responses to Buprenorphine Uncover Novel and Opposing Roles of μ -Opioid- and Nociceptin/Orphanin FQ Receptors in Cell Development: Implications for Drug Addiction Treatment during Pregnancy ». *Glia* 60 (1): 125-36. <https://doi.org/10.1002/glia.21253>.
- Esposito, Emanuela, et Salvatore Cuzzocrea. 2010. « Antiinflammatory Activity of Melatonin in Central Nervous System ». *Current Neuropharmacology* 8 (3): 228-42. <https://doi.org/10.2174/157015910792246155>.
- Evans, Megan A., Hyun Ah Kim, Yeong Hann Ling, Sandy Uong, Antony Vinh, T. Michael De Silva, Thiruma V. Arumugam, et al. 2018. « Vitamin D3 Supplementation Reduces Subsequent Brain Injury and Inflammation Associated with Ischemic Stroke ». *NeuroMolecular Medicine* 20 (1): 147-59. <https://doi.org/10.1007/s12017-018-8484-z>.

Fagerberg, Christina R, Adrian Taylor, Felix Distelmaier, Henrik D Schrøder, Maria Kibæk, Dagmar Wiczorek, Mark Tarnopolsky, et al. 2020. « Choline Transporter-like 1 Deficiency Causes a New Type of Childhood-Onset Neurodegeneration ». *Brain* 143 (1): 94-111. <https://doi.org/10.1093/brain/awz376>.

Falcão, Ana Mendanha, David van Bruggen, Sueli Marques, Mandy Meijer, Sarah Jäkel, Eneritz Agirre, Samudyata, et al. 2018. « Disease-Specific Oligodendrocyte Lineage Cells Arise in Multiple Sclerosis ». *Nature Medicine* 24 (12): 1837-44. <https://doi.org/10.1038/s41591-018-0236-y>.

Fan, Lir-Wan, Abhay Bhatt, Lu-Tai Tien, Baoying Zheng, Kimberly L. Simpson, Rick C. S. Lin, Zhengwei Cai, Praveen Kumar, et Yi Pang. 2015. « Exposure to Serotonin Adversely Affects Oligodendrocyte Development and Myelination *in Vitro* ». *Journal of Neurochemistry* 133 (4): 532-43. <https://doi.org/10.1111/jnc.12988>.

Faroni, Alessandro, et Valerio Magnaghi. 2011. « The Neurosteroid Allopregnanolone Modulates Specific Functions in Central and Peripheral Glial Cells ». *Frontiers in Endocrinology* 2. <https://doi.org/10.3389/fendo.2011.00103>.

Farsetti, A., T. Mitsuhashi, B. Desvergne, J. Robbins, et V. M. Nikodem. 1991. « Molecular Basis of Thyroid Hormone Regulation of Myelin Basic Protein Gene Expression in Rodent Brain ». *The Journal of Biological Chemistry* 266 (34): 23226-32.

Fatusić, Zlatan. 2004. « [The role of corticosteroids in the lungs' maturation in expected premature birth] ». *Medicinski Arhiv* 58 (4): 249-52.

Fauveau, Melissa, Baptiste Wilmet, Cyrille Deboux, Karelle Benardais, Corinne Bachelin, Ana C. Temporão, Christophe Kerninon, et Brahim Nait Oumesmar. 2018. « SOX17 Transcription Factor Negatively Regulates Oligodendrocyte Precursor Cell Differentiation ». *Glia* 66 (10): 2221-32. <https://doi.org/10.1002/glia.23483>.

Fern, Robert, et Thomas Möller. 2000. « Rapid Ischemic Cell Death in Immature Oligodendrocytes: A Fatal Glutamate Release Feedback Loop ». *The Journal of Neuroscience* 20 (1): 34-42. <https://doi.org/10.1523/JNEUROSCI.20-01-00034.2000>.

Fernandes Bondan, Eduardo, Maria de Fátima Monteiro Martins, Deborah Eileen Menezes Baliellas, Caio Fernando Monteiro Gimenez, Sandra Castro Poppe, et Maria Martha Bernardi. 2014. « Effects of Propentofylline on CNS Remyelination in the Rat Brainstem: Effects of Propentofylline on Remyelination ». *Microscopy Research and Technique* 77 (1): 23-30. <https://doi.org/10.1002/jemt.22308>.

Fernández-Castañeda, Anthony, Megan S. Chappell, Dorian A Rosen, Scott M. Seki, Rebecca M. Beiter, David M. Johanson, Delaney Liskey, et al. 2020. « The Active Contribution of OPCs to Neuroinflammation Is Mediated by LRP1 ». *Acta Neuropathologica* 139 (2): 365-82. <https://doi.org/10.1007/s00401-019-02073-1>.

Ferraiuolo, Laura, Kathrin Meyer, Thomas W. Sherwood, Jonathan Vick, Shibi Likhite, Ashley Frakes, Carlos J. Miranda, et al. 2016. « Oligodendrocytes Contribute to Motor Neuron Death in ALS via SOD1-Dependent Mechanism ». *Proceedings of the National Academy of Sciences* 113 (42): E6496-6505. <https://doi.org/10.1073/pnas.1607496113>.

Fields, R. Douglas. 2005. « Myelination: An Overlooked Mechanism of Synaptic Plasticity? » *The Neuroscientist* 11 (6): 528-31. <https://doi.org/10.1177/1073858405282304>.

Filicori, M., G.E. Cognigni, E. Gamberini, E. Troilo, L. Parmegiani, et S. Bernardi. 2005. « Impact of Medically Assisted Fertility on Preterm Birth: IMPACT OF MEDICALLY ASSISTED FERTILITY ON PRETERM BIRTH ». *BJOG: An International Journal of Obstetrics & Gynaecology* 112 (mars): 113-17. <https://doi.org/10.1111/j.1471-0528.2005.00598.x>.

Finzsch, Markus, C. Claus Stolt, Petra Lommès, et Michael Wegner. 2008. « Sox9 and Sox10 Influence Survival and Migration of Oligodendrocyte Precursors in the Spinal Cord by Regulating PDGF Receptor Aexpression ». *Development* 135 (4): 637-46. <https://doi.org/10.1242/dev.010454>.

Fioretti, Bernard, Luigi Catacuzzeno, Luigi Sforza, Francesco Aiello, Francesca Pagani, Davide Ragozzino, Emilia

- Castigli, et Fabio Franciolini. 2009. « Histamine Hyperpolarizes Human Glioblastoma Cells by Activating the Intermediate-Conductance Ca²⁺-Activated K⁺ Channel ». *American Journal of Physiology-Cell Physiology* 297 (1): C102-10. <https://doi.org/10.1152/ajpcell.00354.2008>.
- Fischer, Timo, Paula Scheffler, et Christian Lohr. 2020. « Dopamine-Induced Calcium Signaling in Olfactory Bulb Astrocytes ». *Scientific Reports* 10 (1): 631. <https://doi.org/10.1038/s41598-020-57462-4>.
- Fish, Jennifer L., Colette Dehay, Henry Kennedy, et Wieland B. Huttner. 2008. « Making Bigger Brains—the Evolution of Neural-Progenitor-Cell Division ». *Journal of Cell Science* 121 (17): 2783-93. <https://doi.org/10.1242/jcs.023465>.
- Florio, M., M. Albert, E. Taverna, T. Namba, H. Brandl, E. Lewitus, C. Haffner, et al. 2015. « Human-Specific Gene ARHGAP11B Promotes Basal Progenitor Amplification and Neocortex Expansion ». *Science* 347 (6229): 1465-70. <https://doi.org/10.1126/science.aaa1975>.
- Florio, Marta, Takashi Namba, Svante Pääbo, Michael Hiller, et Wieland B. Huttner. 2016. « A Single Splice Site Mutation in Human-Specific ARHGAP11B Causes Basal Progenitor Amplification ». *Science Advances* 2 (12): e1601941. <https://doi.org/10.1126/sciadv.1601941>.
- Flynn, S W, D J Lang, A L Mackay, V Goghari, I M Vavasour, K P Whittall, G N Smith, et al. 2003. « Abnormalities of Myelination in Schizophrenia Detected in Vivo with MRI, and Post-Mortem with Analysis of Oligodendrocyte Proteins ». *Molecular Psychiatry* 8 (9): 811-20. <https://doi.org/10.1038/sj.mp.4001337>.
- Fogarty, Matthew, William D. Richardson, et Nicoletta Kessar. 2005. « A Subset of Oligodendrocytes Generated from Radial Glia in the Dorsal Spinal Cord ». *Development (Cambridge, England)* 132 (8): 1951-59. <https://doi.org/10.1242/dev.01777>.
- Foster, Claire, et Andrew H Shennan. 2014. « Fetal Fibronectin as a Biomarker of Preterm Labor: A Review of the Literature and Advances in Its Clinical Use ». *Biomarkers in Medicine* 8 (4): 471-84. <https://doi.org/10.2217/bmm.14.28>.
- Fragoso, Gabriela, Ana Katherine Martinez-Bermudez, Hsueh-Ning Liu, Amani Khorchid, Sylvain Chemtob, Walter E. Mushynski, et Guillermina Almazan. 2004. « Developmental Differences in H₂O₂-Induced Oligodendrocyte Cell Death: Role of Glutathione, Mitogen-Activated Protein Kinases and Caspase 3 ». *Journal of Neurochemistry* 90 (2): 392-404. <https://doi.org/10.1111/j.1471-4159.2004.02488.x>.
- Frank, J A, N Richert, B Lewis, C Bash, T Howard, R Civil, R Stone, J Eaton, H McFarland, et T Leist. 2002. « A Pilot Study of Recombinant Insulin-like Growth Factor-1 in Seven Multiple Sclerosis Patients ». *Multiple Sclerosis Journal* 8 (1): 24-29. <https://doi.org/10.1191/1352458502ms768oa>.
- Franz, D. N., et A. Iggo. 1968. « Conduction Failure in Myelinated and Non-Myelinated Axons at Low Temperatures ». *The Journal of Physiology* 199 (2): 319-45. <https://doi.org/10.1113/jphysiol.1968.sp008656>.
- Fredriksson, Robert, Malin C. Lagerström, Lars-Gustav Lundin, et Helgi B. Schiöth. 2003. « The G-Protein-Coupled Receptors in the Human Genome Form Five Main Families. Phylogenetic Analysis, Paralogon Groups, and Fingerprints ». *Molecular Pharmacology* 63 (6): 1256-72. <https://doi.org/10.1124/mol.63.6.1256>.
- Fruttiger, M., L. Karlsson, A.C. Hall, A. Abramsson, A.R. Calver, H. Bostrom, K. Willetts, et al. 1999. « Defective Oligodendrocyte Development and Severe Hypomyelination in PDGF-A Knockout Mice ». *Development* 126 (3): 457-67. <https://doi.org/10.1242/dev.126.3.457>.
- Fuchs, F., et M.-V. Senat. 2016. « Multiple Gestations and Preterm Birth ». *Seminars in Fetal and Neonatal Medicine* 21 (2): 113-20. <https://doi.org/10.1016/j.siny.2015.12.010>.
- Fuente, Alerie Guzman de la, Oihana Errea, Peter van Wijngaarden, Ginez A. Gonzalez, Christophe Kerninon, Andrew A. Jarjour, Hilary J. Lewis, et al. 2015. « Vitamin D Receptor–Retinoid X Receptor Heterodimer Signaling Regulates Oligodendrocyte Progenitor Cell Differentiation ». *Journal of Cell Biology* 211 (5): 975-85. <https://doi.org/10.1083/jcb.201505119>.

Fünfschilling, Ursula, Lotti M. Supplie, Don Mahad, Susann Boretius, Aiman S. Saab, Julia Edgar, Bastian G. Brinkmann, et al. 2012. « Glycolytic Oligodendrocytes Maintain Myelin and Long-Term Axonal Integrity ». *Nature* 485 (7399): 517-21. <https://doi.org/10.1038/nature11007>.

Gago, Nathalie, Yvette Akwa, Nicole Sananès, Rachida Guennoun, Etienne Emile Baulieu, Martine El-Etr, et Michael Schumacher. 2001. « Progesterone and the Oligodendroglial Lineage: Stage-Dependent Biosynthesis and Metabolism: Progesterone and the Oligodendroglial Lineage ». *Glia* 36 (3): 295-308. <https://doi.org/10.1002/glia.1117>.

García-León, Juan Antonio, Manoj Kumar, Ruben Boon, David Chau, Jennifer One, Esther Wolfs, Kristel Eggermont, et al. 2018. « SOX10 Single Transcription Factor-Based Fast and Efficient Generation of Oligodendrocytes from Human Pluripotent Stem Cells ». *Stem Cell Reports* 10 (2): 655-72. <https://doi.org/10.1016/j.stemcr.2017.12.014>.

Gautier, Hélène O. B., Kimberley A. Evans, Katrin Volbracht, Rachel James, Sergey Sitnikov, Iben Lundgaard, Fiona James, et al. 2015. « Neuronal Activity Regulates Remyelination via Glutamate Signalling to Oligodendrocyte Progenitors ». *Nature Communications* 6 (1): 8518. <https://doi.org/10.1038/ncomms9518>.

Gelfand, Jeffrey M., Bruce A. C. Cree, et Stephen L. Hauser. 2017. « Ocrelizumab and Other CD20+ B-Cell-Depleting Therapies in Multiple Sclerosis ». *Neurotherapeutics* 14 (4): 835-41. <https://doi.org/10.1007/s13311-017-0557-4>.

Geschwind, Daniel H., et Pasko Rakic. 2013. « Cortical Evolution: Judge the Brain by Its Cover ». *Neuron* 80 (3): 633-47. <https://doi.org/10.1016/j.neuron.2013.10.045>.

Ghareghani, Majid, Heibatollah Sadeghi, Kazem Zibara, Nazanin Danaei, Hassan Azari, et Amir Ghanbari. 2017. « Melatonin Increases Oligodendrocyte Differentiation in Cultured Neural Stem Cells ». *Cellular and Molecular Neurobiology* 37 (7): 1319-24. <https://doi.org/10.1007/s10571-016-0450-4>.

Ghareghani, Majid, Linda Scavo, Yahya Jand, Naser Farhadi, Hossein Sadeghi, Amir Ghanbari, Stefania Mondello, Damien Arnoult, Sajjad Gharaghani, et Kazem Zibara. 2019. « Melatonin Therapy Modulates Cerebral Metabolism and Enhances Remyelination by Increasing PDK4 in a Mouse Model of Multiple Sclerosis ». *Frontiers in Pharmacology* 10 (février): 147. <https://doi.org/10.3389/fphar.2019.00147>.

Ghiani, C. A., A. M. Eisen, X. Yuan, R. A. DePinho, C. J. McBain, et V. Gallo. 1999. « Neurotransmitter Receptor Activation Triggers P27(Kip1) and P21(CIP1) Accumulation and G1 Cell Cycle Arrest in Oligodendrocyte Progenitors ». *Development (Cambridge, England)* 126 (5): 1077-90.

Ghofrani, Saeed, Mohammad-Taghi Joghataei, Simin Mohseni, Tourandokht Baluchnejadmojarad, Maryam Bagheri, Safoura Khamse, et Mehrdad Roghani. 2015. « Naringenin Improves Learning and Memory in an Alzheimer's Disease Rat Model: Insights into the Underlying Mechanisms ». *European Journal of Pharmacology* 764 (octobre): 195-201. <https://doi.org/10.1016/j.ejphar.2015.07.001>.

Ghosh, Aniket, Natalia Manrique-Hoyos, Aaron Voigt, Jörg B. Schulz, Mario Kreutzfeldt, Doron Merkler, et Mikael Simons. 2011. « Targeted Ablation of Oligodendrocytes Triggers Axonal Damage ». Édité par Ashley I. Bush. *PLoS ONE* 6 (7): e22735. <https://doi.org/10.1371/journal.pone.0022735>.

Ghoumari, A. M., C. Ibanez, M. El-Etr, P. Leclerc, B. Eychenne, B. W. O'Malley, E. E. Baulieu, et M. Schumacher. 2003. « Progesterone and Its Metabolites Increase Myelin Basic Protein Expression in Organotypic Slice Cultures of Rat Cerebellum: Progesterone and CNS Myelination ». *Journal of Neurochemistry* 86 (4): 848-59. <https://doi.org/10.1046/j.1471-4159.2003.01881.x>.

Ghoumari, Abdel Mouman, Charly Abi Ghanem, Narimène Asbelaoui, Michael Schumacher, et Rashad Hussain. 2020. « Roles of Progesterone, Testosterone and Their Nuclear Receptors in Central Nervous System Myelination and Remyelination ». *International Journal of Molecular Sciences* 21 (9): 3163. <https://doi.org/10.3390/ijms21093163>.

Ghoumari, A.M., E.E. Baulieu, et M. Schumacher. 2005. « Progesterone Increases Oligodendroglial Cell Proliferation in Rat Cerebellar Slice Cultures ». *Neuroscience* 135 (1): 47-58.

<https://doi.org/10.1016/j.neuroscience.2005.05.023>.

Gibson, Erin M., David Purger, Christopher W. Mount, Andrea K. Goldstein, Grant L. Lin, Lauren S. Wood, Ingrid Inema, et al. 2014. « Neuronal Activity Promotes Oligodendrogenesis and Adaptive Myelination in the Mammalian Brain ». *Science* 344 (6183): 1252304. <https://doi.org/10.1126/science.1252304>.

Giera, Stefanie, Yiyu Deng, Rong Luo, Sarah D. Ackerman, Amit Mogha, Kelly R. Monk, Yanqin Ying, et al. 2015. « The Adhesion G Protein-Coupled Receptor GPR56 Is a Cell-Autonomous Regulator of Oligodendrocyte Development ». *Nature Communications* 6 (1): 6121. <https://doi.org/10.1038/ncomms7121>.

Gil, Vanessa, Sara Nocentini, et JosÃ© A. del RÃ-o. 2014. « Historical first descriptions of Cajal "Retzius cells: from pioneer studies to current knowledge ». *Frontiers in Neuroanatomy* 8 (mai). <https://doi.org/10.3389/fnana.2014.00032>.

Giovannoni, G, S J.R. Heales, J M Land, et E J Thompson. 1998. « The Potential Role of Nitric Oxide in Multiple Sclerosis ». *Multiple Sclerosis Journal* 4 (3): 212-16. <https://doi.org/10.1177/135245859800400323>.

Glass, Hannah C., Andrew T. Costarino, Stephen A. Stayer, Claire M. Brett, Franklyn Cladis, et Peter J. Davis. 2015. « Outcomes for Extremely Premature Infants ». *Anesthesia & Analgesia* 120 (6): 1337-51. <https://doi.org/10.1213/ANE.0000000000000705>.

Goebbels, S., J. H. Oltrogge, R. Kemper, I. Heilmann, I. Bormuth, S. Wolfer, S. P. Wichert, et al. 2010. « Elevated Phosphatidylinositol 3,4,5-Trisphosphate in Glia Triggers Cell-Autonomous Membrane Wrapping and Myelination ». *Journal of Neuroscience* 30 (26): 8953-64. <https://doi.org/10.1523/JNEUROSCI.0219-10.2010>.

Goebbels, Sandra, Georg L. Wieser, Alexander Pieper, Sonia Spitzer, Bettina Weege, Kuo Yan, Julia M. Edgar, et al. 2017. « A Neuronal PI(3,4,5)P3-Dependent Program of Oligodendrocyte Precursor Recruitment and Myelination ». *Nature Neuroscience* 20 (1): 10-15. <https://doi.org/10.1038/nn.4425>.

Goldman, Steven A. 2011. « Progenitor Cell-Based Treatment of the Pediatric Myelin Disorders ». *Archives of Neurology* 68 (7): 848. <https://doi.org/10.1001/archneurol.2011.46>.

Gómez, Luis M., Mary D. Sammel, Dina H. Appleby, Michal A. Elovitz, Don A. Baldwin, Marjorie K. Jeffcoat, George A. Macones, et Samuel Parry. 2010. « Evidence of a Gene-Environment Interaction That Predisposes to Spontaneous Preterm Birth: A Role for Asymptomatic Bacterial Vaginosis and DNA Variants in Genes That Control the Inflammatory Response ». *American Journal of Obstetrics and Gynecology* 202 (4): 386.e1-386.e6. <https://doi.org/10.1016/j.ajog.2010.01.042>.

Gomez-Pinedo, Ulises, Jesús Adriel Cuevas, María Soledad Benito-Martín, Lidia Moreno-Jiménez, Noelia Esteban-García, Laura Torre-Fuentes, Jordi A. Matías-Guiu, Vanesa Pytel, Paloma Montero, et Jorge Matías-Guiu. 2020. « Vitamin D Increases Remyelination by Promoting Oligodendrocyte Lineage Differentiation ». *Brain and Behavior* 10 (1). <https://doi.org/10.1002/brb3.1498>.

Gonzalez-Reyes, Luis E., Chia-Chu Chiang, Mingming Zhang, Joshua Johnson, Manuel Arrillaga-Tamez, Nicholas H. Couturier, Neha Reddy, et al. 2019. « Sonic Hedgehog Is Expressed by Hilar Mossy Cells and Regulates Cellular Survival and Neurogenesis in the Adult Hippocampus ». *Scientific Reports* 9 (1): 17402. <https://doi.org/10.1038/s41598-019-53192-4>.

Green, Ari J, Jeffrey M Gelfand, Bruce A Cree, Carolyn Bevan, W John Boscardin, Feng Mei, Justin Inman, et al. 2017. « Clemastine Fumarate as a Remyelinating Therapy for Multiple Sclerosis (ReBUILD): A Randomised, Controlled, Double-Blind, Crossover Trial ». *The Lancet* 390 (10111): 2481-89. [https://doi.org/10.1016/S0140-6736\(17\)32346-2](https://doi.org/10.1016/S0140-6736(17)32346-2).

Gregg, C., V. Shikar, P. Larsen, G. Mak, A. Chojnacki, V. W. Yong, et S. Weiss. 2007. « White Matter Plasticity and Enhanced Remyelination in the Maternal CNS ». *Journal of Neuroscience* 27 (8): 1812-23. <https://doi.org/10.1523/JNEUROSCI.4441-06.2007>.

Gresle, Melissa M, Margaret A Jordan, Jim Stankovich, Tim Spelman, Laura J Johnson, Louise Laverick, Alison Hamlett, et al. 2020. « Multiple Sclerosis Risk Variants Regulate Gene Expression in Innate and Adaptive Immune Cells ». *Life Science Alliance* 3 (7): e202000650. <https://doi.org/10.26508/lsa.202000650>.

- Gritti, A, Ea Parati, L Cova, P Frolichsthal, R Galli, E Wanke, L Faravelli, et al. 1996. « Multipotential Stem Cells from the Adult Mouse Brain Proliferate and Self-Renew in Response to Basic Fibroblast Growth Factor ». *The Journal of Neuroscience* 16 (3): 1091-1100. <https://doi.org/10.1523/JNEUROSCI.16-03-01091.1996>.
- Grobecker, H., et H. Grobecker. 1976. « [On the mode of action of heptaminol (author's transl)] ». *Arzneimittel-Forschung* 26 (12): 2167-71.
- Groulx, Isabelle, et Stephen Lee. 2002. « Oxygen-Dependent Ubiquitination and Degradation of Hypoxia-Inducible Factor Requires Nuclear-Cytoplasmic Trafficking of the von Hippel-Lindau Tumor Suppressor Protein ». *Molecular and Cellular Biology* 22 (15): 5319-36. <https://doi.org/10.1128/MCB.22.15.5319-5336.2002>.
- Guillemot, François, Li-Ching Lo, Jane E. Johnson, Anna Auerbach, David J. Anderson, et Alexandra L. Joyner. 1993. « Mammalian Achaete-Scute Homolog 1 Is Required for the Early Development of Olfactory and Autonomic Neurons ». *Cell* 75 (3): 463-76. [https://doi.org/10.1016/0092-8674\(93\)90381-Y](https://doi.org/10.1016/0092-8674(93)90381-Y).
- Guo, F., Y. Maeda, J. Ma, J. Xu, M. Horiuchi, L. Miers, F. Vaccarino, et D. Pleasure. 2010. « Pyramidal Neurons Are Generated from Oligodendroglial Progenitor Cells in Adult Piriform Cortex ». *Journal of Neuroscience* 30 (36): 12036-49. <https://doi.org/10.1523/JNEUROSCI.1360-10.2010>.
- Guo, Yu-e, Na Suo, Xue Cui, Qianting Yuan, et Xin Xie. 2018. « Vitamin C Promotes Oligodendrocytes Generation and Remyelination ». *Glia* 66 (7): 1302-16. <https://doi.org/10.1002/glia.23306>.
- Gustafsson, Maria V., Xiaowei Zheng, Teresa Pereira, Katarina Gradin, Shaobo Jin, Johan Lundkvist, Jorge L. Ruas, Lorenz Poellinger, Urban Lendahl, et Maria Bondesson. 2005. « Hypoxia Requires Notch Signaling to Maintain the Undifferentiated Cell State ». *Developmental Cell* 9 (5): 617-28. <https://doi.org/10.1016/j.devcel.2005.09.010>.
- Gyetvai, Georgina, Trisha Hughes, Florence Wedmore, Cieron Roe, Lamia Heikal, Pietro Ghezzi, et Manuela Mengozzi. 2017. « Erythropoietin Increases Myelination in Oligodendrocytes: Gene Expression Profiling Reveals Early Induction of Genes Involved in Lipid Transport and Metabolism ». *Frontiers in Immunology* 8 (octobre): 1394. <https://doi.org/10.3389/fimmu.2017.01394>.
- Hack, Maureen. 2000. « Perinatal Brain Injury in Preterm Infants and Later Neurobehavioral Function ». *JAMA* 284 (15): 1973. <https://doi.org/10.1001/jama.284.15.1973>.
- Harauz, George, et David Libich. 2009. « The Classic Basic Protein of Myelin – Conserved Structural Motifs and the Dynamic Molecular Barcode Involved in Membrane Adhesion and Protein-Protein Interactions ». *Current Protein & Peptide Science* 10 (3): 196-215. <https://doi.org/10.2174/138920309788452218>.
- Hare, N. C., D. P. J. Hunt, K. Venugopal, G.-T. Ho, T. Beez, C. W. Lees, R. Gibson, B. Weller, et J. Satsangi. 2014. « Multiple Sclerosis in the Context of TNF Blockade and Inflammatory Bowel Disease ». *QJM* 107 (1): 51-55. <https://doi.org/10.1093/qjmed/hcr237>.
- Harer, Matthew W., Jennifer R. Charlton, Trent E. Tipple, et Kimberly J. Reidy. 2020. « Preterm Birth and Neonatal Acute Kidney Injury: Implications on Adolescent and Adult Outcomes ». *Journal of Perinatology* 40 (9): 1286-95. <https://doi.org/10.1038/s41372-020-0656-7>.
- Harris, J. J., et D. Attwell. 2012. « The Energetics of CNS White Matter ». *Journal of Neuroscience* 32 (1): 356-71. <https://doi.org/10.1523/JNEUROSCI.3430-11.2012>.
- Hartfuss, Eva, Rossella Galli, Nico Heins, et Magdalena Götz. 2001. « Characterization of CNS Precursor Subtypes and Radial Glia ». *Developmental Biology* 229 (1): 15-30. <https://doi.org/10.1006/dbio.2000.9962>.
- Hartline, D.K., et D.R. Colman. 2007. « Rapid Conduction and the Evolution of Giant Axons and Myelinated Fibers ». *Current Biology* 17 (1): R29-35. <https://doi.org/10.1016/j.cub.2006.11.042>.
- Hasbi, Ahmed, Theresa Fan, Mohammad Alijaniam, Tuan Nguyen, Melissa L. Perreault, Brian F. O'Dowd, et Susan R. George. 2009. « Calcium Signaling Cascade Links Dopamine D1–D2 Receptor Heteromer to Striatal

BDNF Production and Neuronal Growth ». *Proceedings of the National Academy of Sciences* 106 (50): 21377-82. <https://doi.org/10.1073/pnas.0903676106>.

Hassani, Asma, John R. Corboy, Suhail Al-Salam, et Gulfaraz Khan. 2018. « Epstein-Barr Virus Is Present in the Brain of Most Cases of Multiple Sclerosis and May Engage More than Just B Cells ». Édité par Luwen Zhang. *PLOS ONE* 13 (2): e0192109. <https://doi.org/10.1371/journal.pone.0192109>.

Hattori, Tsuyoshi, Shoko Shimizu, Yoshihisa Koyama, Hisayo Emoto, Yuji Matsumoto, Natsuko Kumamoto, Kohei Yamada, et al. 2014. « DISC1 (Disrupted-in-Schizophrenia-1) Regulates Differentiation of Oligodendrocytes ». Édité par Alexandre Hiroaki Kihara. *PLoS ONE* 9 (2): e88506. <https://doi.org/10.1371/journal.pone.0088506>.

Havrda, Matthew C., Brenton R. Paoella, Cong Ran, Karola S. Jering, Christina M. Wray, Jaclyn M. Sullivan, Audrey Nailor, Yasuyuki Hitoshi, et Mark A. Israel. 2014. « Id2 Mediates Oligodendrocyte Precursor Cell Maturation Arrest and Is Tumorigenic in a PDGF-Rich Microenvironment ». *Cancer Research* 74 (6): 1822-32. <https://doi.org/10.1158/0008-5472.CAN-13-1839>.

He, Danyang, Jincheng Wang, Yulan Lu, Yaqi Deng, Chuntao Zhao, Lingli Xu, Yinhuai Chen, Yueh-Chiang Hu, Wenhao Zhou, et Q. Richard Lu. 2017. « LncRNA Functional Networks in Oligodendrocytes Reveal Stage-Specific Myelination Control by an LncOL1 /Suz12 Complex in the CNS ». *Neuron* 93 (2): 362-78. <https://doi.org/10.1016/j.neuron.2016.11.044>.

Heide, Michael, Christiane Haffner, Ayako Murayama, Yoko Kurotaki, Haruka Shinohara, Hideyuki Okano, Erika Sasaki, et Wieland B. Huttner. 2020. « Human-Specific ARHGAP11B Increases Size and Folding of Primate Neocortex in the Fetal Marmoset ». *Science* 369 (6503): 546-50. <https://doi.org/10.1126/science.abb2401>.

Hemmen, J. van, I. M. J. Saris, P. T. Cohen-Kettenis, D. J. Veltman, P. J. W. Pouwels, et J. Bakker. 2016. « Sex Differences in White Matter Microstructure in the Human Brain Predominantly Reflect Differences in Sex Hormone Exposure ». *Cerebral Cortex*, mai, bhw156. <https://doi.org/10.1093/cercor/bhw156>.

Herculano-Houzel, S. 2005. « Isotropic Fractionator: A Simple, Rapid Method for the Quantification of Total Cell and Neuron Numbers in the Brain ». *Journal of Neuroscience* 25 (10): 2518-21. <https://doi.org/10.1523/JNEUROSCI.4526-04.2005>.

Hildebrand, C, C Bowe, et I Remahl. 1994. « Myelination and Myelin Sheath Remodelling in Normal and Pathological PNS Nerve Fibres ». *Progress in Neurobiology* 43 (2): 85-141. [https://doi.org/10.1016/0301-0082\(94\)90010-8](https://doi.org/10.1016/0301-0082(94)90010-8).

Hildebrand, C, S Remahl, H Persson, et C Bjartmar. 1993. « Myelinated Nerve Fibres in the CNS ». *Progress in Neurobiology* 40 (3): 319-84. [https://doi.org/10.1016/0301-0082\(93\)90015-K](https://doi.org/10.1016/0301-0082(93)90015-K).

Hill, Robert A., Alice M. Li, et Jaime Grutzendler. 2018. « Lifelong Cortical Myelin Plasticity and Age-Related Degeneration in the Live Mammalian Brain ». *Nature Neuroscience* 21 (5): 683-95. <https://doi.org/10.1038/s41593-018-0120-6>.

Hof, Patrick R, Vahram Haroutunian, Victor L Friedrich, William Byne, Cristian Buitron, Daniel P Perl, et Kenneth L Davis. 2003. « Loss and Altered Spatial Distribution of Oligodendrocytes in the Superior Frontal Gyrus in Schizophrenia ». *Biological Psychiatry* 53 (12): 1075-85. [https://doi.org/10.1016/S0006-3223\(03\)00237-3](https://doi.org/10.1016/S0006-3223(03)00237-3).

Hofman, F M, D R Hinton, K Johnson, et J E Merrill. 1989. « Tumor Necrosis Factor Identified in Multiple Sclerosis Brain. » *Journal of Experimental Medicine* 170 (2): 607-12. <https://doi.org/10.1084/jem.170.2.607>.

Hogan, Patrick G., Lin Chen, Julie Nardone, et Anjana Rao. 2003. « Transcriptional Regulation by Calcium, Calcineurin, and NFAT ». *Genes & Development* 17 (18): 2205-32. <https://doi.org/10.1101/gad.1102703>.

Höistad, Malin. 2009. « Linking white and grey matter in schizophrenia: Oligodendrocyte and neuron pathology in the prefrontal cortex ». *Frontiers in Neuroanatomy* 3. <https://doi.org/10.3389/neuro.05.009.2009>.

Homma, Kohei, Yoshiichiro Kitamura, Hiroto Ogawa, et Kotaro Oka. 2006. « Serotonin Induces the Increase in Intracellular Ca²⁺ That Enhances Neurite Outgrowth in PC12 Cells via Activation of 5-HT₃ Receptors and

- Voltage-Gated Calcium Channels ». *Journal of Neuroscience Research* 84 (2): 316-25. <https://doi.org/10.1002/jnr.20894>.
- Hostettler, Mary Ellen, Pamela E. Knapp, et Sonia L. Carlson. 2002. « Platelet-Activating Factor Induces Cell Death in Cultured Astrocytes and Oligodendrocytes: Involvement of Caspase-3 ». *Glia* 38 (3): 228-39. <https://doi.org/10.1002/glia.10065>.
- Hsieh, Jenny, et Fred H Gage. 2005. « Chromatin Remodeling in Neural Development and Plasticity ». *Current Opinion in Cell Biology* 17 (6): 664-71. <https://doi.org/10.1016/j.ceb.2005.09.002>.
- Hu, Chengliang, Lei Tao, Xizhi Cao, et Ligong Chen. 2020. « The Solute Carrier Transporters and the Brain: Physiological and Pharmacological Implications ». *Asian Journal of Pharmaceutical Sciences* 15 (2): 131-44. <https://doi.org/10.1016/j.ajps.2019.09.002>.
- Huang, Brenda, WenJie Wei, Guohao Wang, Marta A. Gaertig, Yue Feng, Wei Wang, Xiao-Jiang Li, et Shihua Li. 2015. « Mutant Huntingtin Downregulates Myelin Regulatory Factor-Mediated Myelin Gene Expression and Affects Mature Oligodendrocytes ». *Neuron* 85 (6): 1212-26. <https://doi.org/10.1016/j.neuron.2015.02.026>.
- Huang, Hao, Huihui Wu, Wanjun He, Fang Zhou, Xianxian Yu, Min Yi, Junqing Du, Binghua Xie, et Mengsheng Qiu. 2022. « Id2 and Id4 Are Not the Major Negative Regulators of Oligodendrocyte Differentiation during Early Central Nervous System Development ». *Glia* 70 (3): 590-601. <https://doi.org/10.1002/glia.24126>.
- Huang, Yujie, Caitlin Hoffman, Prajwal Rajappa, Joon-Hyung Kim, Wenhao Hu, Jason Huse, Zhongshu Tang, et al. 2014. « Oligodendrocyte Progenitor Cells Promote Neovascularization in Glioma by Disrupting the Blood–Brain Barrier ». *Cancer Research* 74 (4): 1011-21. <https://doi.org/10.1158/0008-5472.CAN-13-1072>.
- Hubler, Zita, Dharmaraja Allimuthu, Ilya Bederman, Matthew S. Elitt, Mayur Madhavan, Kevin C. Allan, H. Elizabeth Shick, et al. 2018. « Accumulation of 8,9-Unsaturated Sterols Drives Oligodendrocyte Formation and Remyelination ». *Nature* 560 (7718): 372-76. <https://doi.org/10.1038/s41586-018-0360-3>.
- Huerga-Gómez, Alba, Tania Aguado, Aníbal Sánchez-de la Torre, Ana Bernal-Chico, Carlos Matute, Susana Mato, Manuel Guzmán, Ismael Galve-Roperh, et Javier Palazuelos. 2021. « Tetrahydrocannabinol Promotes Oligodendrocyte Development and CNS Myelination in Vivo ». *Glia* 69 (3): 532-45. <https://doi.org/10.1002/glia.23911>.
- Hughes, Alexandria N., et Bruce Appel. 2019. « Oligodendrocytes Express Synaptic Proteins That Modulate Myelin Sheath Formation ». *Nature Communications* 10 (1): 4125. <https://doi.org/10.1038/s41467-019-12059-y>.
- Hughes, Ethan G, Shin H Kang, Masahiro Fukaya, et Dwight E Bergles. 2013. « Oligodendrocyte Progenitors Balance Growth with Self-Repulsion to Achieve Homeostasis in the Adult Brain ». *Nature Neuroscience* 16 (6): 668-76. <https://doi.org/10.1038/nn.3390>.
- Hüppi, Petra S, Stephan E Maier, Sharon Peled, Gary P Zientara, Patrick D Barnes, Ferenc A Jolesz, et Joseph J Volpe. 1998. « Microstructural Development of Human Newborn Cerebral White Matter Assessed in Vivo by Diffusion Tensor Magnetic Resonance Imaging ». *Pediatric Research* 44 (4): 584-90. <https://doi.org/10.1203/00006450-199810000-00019>.
- Huseby, Eric S., Priya G. Huseby, Shivane Shah, Rebecca Smith, et Brian D. Stadinski. 2012. « Pathogenic CD8 T Cells in Multiple Sclerosis and Its Experimental Models ». *Frontiers in Immunology* 3. <https://doi.org/10.3389/fimmu.2012.00064>.
- Hussain, Rashad, Abdel M. Ghomari, Bartosz Bielecki, Jérôme Steibel, Nelly Boehm, Philippe Liere, Wendy B. Macklin, et al. 2013. « The Neural Androgen Receptor: A Therapeutic Target for Myelin Repair in Chronic Demyelination ». *Brain* 136 (1): 132-46. <https://doi.org/10.1093/brain/aws284>.
- Ille, F., et L. Sommer. 2005. « Wnt Signaling: Multiple Functions in Neural Development ». *CMLS Cellular and Molecular Life Sciences* 62 (10): 1100-1108. <https://doi.org/10.1007/s00018-005-4552-2>.

- Inder, Terrie E., et Petra S. Huppi. 2000. « In Vivo Studies of Brain Development by Magnetic Resonance Techniques ». *Mental Retardation and Developmental Disabilities Research Reviews* 6 (1): 59-67. [https://doi.org/10.1002/\(SICI\)1098-2779\(2000\)6:1<59::AID-MRDD8>3.0.CO;2-E](https://doi.org/10.1002/(SICI)1098-2779(2000)6:1<59::AID-MRDD8>3.0.CO;2-E).
- Iskandar, Bermans J., Elias Rizk, Brenton Meier, Nithya Hariharan, Teodoro Bottiglieri, Richard H. Finnell, David F. Jarrard, et al. 2010. « Folate Regulation of Axonal Regeneration in the Rodent Central Nervous System through DNA Methylation ». *Journal of Clinical Investigation* 120 (5): 1603-16. <https://doi.org/10.1172/JCI40000>.
- Jantzie, Lauren L., Robert H. Miller, et Shenandoah Robinson. 2013. « Erythropoietin Signaling Promotes Oligodendrocyte Development Following Prenatal Systemic Hypoxic–Ischemic Brain Injury ». *Pediatric Research* 74 (6): 658-67. <https://doi.org/10.1038/pr.2013.155>.
- Jarjour, Andrew A., et Timothy E. Kennedy. 2004. « Oligodendrocyte Precursors on the Move: Mechanisms Directing Migration ». *The Neuroscientist* 10 (2): 99-105. <https://doi.org/10.1177/1073858403260751>.
- Jensen, Samuel K., Nathan J. Michaels, Slava Ilyntskyy, Michael B. Keough, Olga Kovalchuk, et V. Wee Yong. 2018. « Multimodal Enhancement of Remyelination by Exercise with a Pivotal Role for Oligodendroglial PGC1 α ». *Cell Reports* 24 (12): 3167-79. <https://doi.org/10.1016/j.celrep.2018.08.060>.
- Jhaveri, D. J., E. W. Mackay, A. S. Hamlin, S. V. Marathe, L. S. Nandam, V. A. Vaidya, et P. F. Bartlett. 2010. « Norepinephrine Directly Activates Adult Hippocampal Precursors via β -Adrenergic Receptors ». *Journal of Neuroscience* 30 (7): 2795-2806. <https://doi.org/10.1523/JNEUROSCI.3780-09.2010>.
- Jia, Feiyong, Lin Du, Yunpeng Hao, Shicheng Liu, Ning Li, et Huiyi Jiang. 2013. « Thioperamide Treats Neonatal Hypoxic-Ischemic Encephalopathy by Postsynaptic H1 Receptors ». *Neural Regeneration Research* 8 (19): 1814-22. <https://doi.org/10.3969/j.issn.1673-5374.2013.19.009>.
- Jiang, Hongchi, Fanqiang Meng, Wei Li, Liquan Tong, Haiquan Qiao, et Xueying Sun. 2007. « Splenectomy Ameliorates Acute Multiple Organ Damage Induced by Liver Warm Ischemia Reperfusion in Rats ». *Surgery* 141 (1): 32-40. <https://doi.org/10.1016/j.surg.2006.03.024>.
- Jiang, Lei, Li Cheng, Han Chen, Haibin Dai, Dadao An, Qianyi Ma, Yanrong Zheng, Xiangnan Zhang, Weiwei Hu, et Zhong Chen. 2021. « Histamine H2 Receptor Negatively Regulates Oligodendrocyte Differentiation in Neonatal Hypoxic-Ischemic White Matter Injury ». *Journal of Experimental Medicine* 218 (1): e20191365. <https://doi.org/10.1084/jem.20191365>.
- Jimenez-Blasco, D, P Santofimia-Castaño, A Gonzalez, A Almeida, et J P Bolaños. 2015. « Astrocyte NMDA Receptors' Activity Sustains Neuronal Survival through a Cdk5–Nrf2 Pathway ». *Cell Death & Differentiation* 22 (11): 1877-89. <https://doi.org/10.1038/cdd.2015.49>.
- Jin, Jing, Qi Peng, Zhipeng Hou, Mali Jiang, Xin Wang, Abraham J. Langseth, Michael Tao, et al. 2015. « Early White Matter Abnormalities, Progressive Brain Pathology and Motor Deficits in a Novel Knock-in Mouse Model of Huntington's Disease ». *Human Molecular Genetics* 24 (9): 2508-27. <https://doi.org/10.1093/hmg/ddv016>.
- Jobin, Céline, Catherine Larochelle, H  l  ne Parpal, Patricia K Coyle, et Pierre Duquette. 2010. « Gender Issues in Multiple Sclerosis: An Update ». *Women's Health* 6 (6): 797-820. <https://doi.org/10.2217/WHE.10.69>.
- Johnson, Samantha, et Neil Marlow. 2011. « Preterm Birth and Childhood Psychiatric Disorders ». *Pediatric Research* 69 (5 Part 2): 11R-18R. <https://doi.org/10.1203/PDR.0b013e318212faa0>.
- Juraska, Janice M., et John R. Kopcik. 1988. « Sex and Environmental Influences on the Size and Ultrastructure of the Rat Corpus Callosum ». *Brain Research* 450 (1-2): 1-8. [https://doi.org/10.1016/0006-8993\(88\)91538-7](https://doi.org/10.1016/0006-8993(88)91538-7).
- Jure, Ignacio, Alejandro F De Nicola, et Florencia Labombarda. 2019. « Progesterone Effects on the Oligodendrocyte Lineage: All Roads Lead to the Progesterone Receptor ». *Neural Regeneration Research* 14 (12): 2029. <https://doi.org/10.4103/1673-5374.262570>.
- Jurga, Agnieszka M., Martyna Paleczna, et Katarzyna Z. Kuter. 2020. « Overview of General and Discriminating Markers of Differential Microglia Phenotypes ». *Frontiers in Cellular Neuroscience* 14 (août): 198.

<https://doi.org/10.3389/fncel.2020.00198>.

Juul, Sandra E., Bryan A. Comstock, Rajan Wadhawan, Dennis E. Mayock, Sherry E. Courtney, Tonya Robinson, Kaashif A. Ahmad, et al. 2020. « A Randomized Trial of Erythropoietin for Neuroprotection in Preterm Infants ». *New England Journal of Medicine* 382 (3): 233-43. <https://doi.org/10.1056/NEJMoa1907423>.

Kageyama, Ryoichiro, Toshiyuki Ohtsuka, Hiromi Shimojo, et Itaru Imayoshi. 2009. « Dynamic Regulation of Notch Signaling in Neural Progenitor Cells ». *Current Opinion in Cell Biology* 21 (6): 733-40. <https://doi.org/10.1016/j.ceb.2009.08.009>.

Kajantie, Eero, Clive Osmond, David J. P. Barker, et Johan G. Eriksson. 2010. « Preterm Birth--a Risk Factor for Type 2 Diabetes? The Helsinki Birth Cohort Study ». *Diabetes Care* 33 (12): 2623-25. <https://doi.org/10.2337/dc10-0912>.

Kakizawa, Sho, Toshiko Yamazawa, et Masamitsu Iino. 2013. « Nitric Oxide-Induced Calcium Release: Activation of Type 1 Ryanodine Receptor by Endogenous Nitric Oxide ». *Channels* 7 (1): 1-5. <https://doi.org/10.4161/chan.22555>.

Kanehisa, M. 2000. « KEGG: Kyoto Encyclopedia of Genes and Genomes ». *Nucleic Acids Research* 28 (1): 27-30. <https://doi.org/10.1093/nar/28.1.27>.

Kang, Peng, Hyun Kyoung Lee, Stacey M. Glasgow, Meggie Finley, Tataka Donti, Zachary B. Gaber, Brett H. Graham, et al. 2012. « Sox9 and NFIA Coordinate a Transcriptional Regulatory Cascade during the Initiation of Gliogenesis ». *Neuron* 74 (1): 79-94. <https://doi.org/10.1016/j.neuron.2012.01.024>.

Kang, Shin H., Masahiro Fukaya, Jason K. Yang, Jeffrey D. Rothstein, et Dwight E. Bergles. 2010. « NG2+ CNS Glial Progenitors Remain Committed to the Oligodendrocyte Lineage in Postnatal Life and Following Neurodegeneration ». *Neuron* 68 (4): 668-81. <https://doi.org/10.1016/j.neuron.2010.09.009>.

Kang, Shin H, Ying Li, Masahiro Fukaya, Ileana Lorenzini, Don W Cleveland, Lyle W Ostrow, Jeffrey D Rothstein, et Dwight E Bergles. 2013. « Degeneration and Impaired Regeneration of Gray Matter Oligodendrocytes in Amyotrophic Lateral Sclerosis ». *Nature Neuroscience* 16 (5): 571-79. <https://doi.org/10.1038/nn.3357>.

Káradóttir, R., et D. Attwell. 2007. « Neurotransmitter Receptors in the Life and Death of Oligodendrocytes ». *Neuroscience* 145 (4): 1426-38. <https://doi.org/10.1016/j.neuroscience.2006.08.070>.

Káradóttir, Ragnhildur, Nicola B Hamilton, Yamina Bakiri, et David Attwell. 2008. « Spiking and Nonspiking Classes of Oligodendrocyte Precursor Glia in CNS White Matter ». *Nature Neuroscience* 11 (4): 450-56. <https://doi.org/10.1038/nn2060>.

Karaky, Mohamad, María Fedetz, Victor Potenciano, Eduardo Andrés-León, Anna Esteve Codina, Cristina Barrionuevo, Antonio Alcina, et Fuencisla Matesanz. 2018. « SP140 Regulates the Expression of Immune-Related Genes Associated with Multiple Sclerosis and Other Autoimmune Diseases by NF-KB Inhibition ». *Human Molecular Genetics*, septembre. <https://doi.org/10.1093/hmg/ddy284>.

Karamita, Maria, Christopher Barnum, Wiebke Möbius, Malú G. Tansey, David E. Szymkowski, Hans Lassmann, et Lesley Probert. 2017. « Therapeutic Inhibition of Soluble Brain TNF Promotes Remyelination by Increasing Myelin Phagocytosis by Microglia ». *JCI Insight* 2 (8): e87455. <https://doi.org/10.1172/jci.insight.87455>.

Karrass, Jan, Julia M. Braungart-Rieker, Jennifer Mullins, et Jennifer Burke Lefever. 2002. « Processes in Language Acquisition: The Roles of Gender, Attention, and Maternal Encouragement of Attention over Time ». *Journal of Child Language* 29 (3): 519-43. <https://doi.org/10.1017/S0305000902005196>.

Karttunen, Marja J., Tim Czopka, Marieke Goedhart, Jason J. Early, et David A. Lyons. 2017. « Regeneration of Myelin Sheaths of Normal Length and Thickness in the Zebrafish CNS Correlates with Growth of Axons in Caliber ». Édité par Fernando de Castro. *PLOS ONE* 12 (5): e0178058. <https://doi.org/10.1371/journal.pone.0178058>.

Kasischke, Karl A., Harshad D. Vishwasrao, Patricia J. Fisher, Warren R. Zipfel, et Watt W. Webb. 2004. « Neural

- Activity Triggers Neuronal Oxidative Metabolism Followed by Astrocytic Glycolysis ». *Science* 305 (5680): 99-103. <https://doi.org/10.1126/science.1096485>.
- Kastritsis, C. H., et Ken D. McCarthy. 1993. « Oligodendroglial Lineage Cells Express Neuroligand Receptors ». *Glia* 8 (2): 106-13. <https://doi.org/10.1002/glia.440080206>.
- Kemanetzoglou, Elissavet, et Elisabeth Andreadou. 2017. « CNS Demyelination with TNF- α Blockers ». *Current Neurology and Neuroscience Reports* 17 (4): 36. <https://doi.org/10.1007/s11910-017-0742-1>.
- Kennedy, James M., Nassima Fodil, Sabrina Torre, Silayuv E. Bongfen, Jean-Frédéric Olivier, Vicki Leung, David Langlais, et al. 2014. « CCDC88B Is a Novel Regulator of Maturation and Effector Functions of T Cells during Pathological Inflammation ». *Journal of Experimental Medicine* 211 (13): 2519-35. <https://doi.org/10.1084/jem.20140455>.
- Kessarlis, Nicoletta, Matthew Fogarty, Palma Iannarelli, Matthew Grist, Michael Wegner, et William D Richardson. 2006. « Competing Waves of Oligodendrocytes in the Forebrain and Postnatal Elimination of an Embryonic Lineage ». *Nature Neuroscience* 9 (2): 173-79. <https://doi.org/10.1038/nn1620>.
- Kichev, Anton, Catherine I. Rousset, Ana A. Baburamani, Steven W. Levison, Teresa L. Wood, Pierre Gressens, Claire Thornton, et Henrik Hagberg. 2014. « Tumor Necrosis Factor-Related Apoptosis-Inducing Ligand (TRAIL) Signaling and Cell Death in the Immature Central Nervous System after Hypoxia-Ischemia and Inflammation ». *Journal of Biological Chemistry* 289 (13): 9430-39. <https://doi.org/10.1074/jbc.M113.512350>.
- Kierdorf, Katrin, et Marco Prinz. 2017. « Microglia in Steady State ». *The Journal of Clinical Investigation* 127 (9): 3201-9. <https://doi.org/10.1172/JCI90602>.
- Kim, Yiyong, Eun Ji Roh, Hari Prasad Joshi, Hae Eun Shin, Hyemin Choi, Su Yeon Kwon, Seil Sohn, et Inbo Han. 2021. « Bazedoxifene, a Selective Estrogen Receptor Modulator, Promotes Functional Recovery in a Spinal Cord Injury Rat Model ». *International Journal of Molecular Sciences* 22 (20): 11012. <https://doi.org/10.3390/ijms222011012>.
- Kirchhoff, Frank, et Helmut Kettenmann. 1992. « GABA Triggers a Ca²⁺Increase in Murine Precursor Cells of the Oligodendrocyte Lineage ». *European Journal of Neuroscience* 4 (11): 1049-58. <https://doi.org/10.1111/j.1460-9568.1992.tb00131.x>.
- Klämbt, Christian. 2009. « Modes and Regulation of Glial Migration in Vertebrates and Invertebrates ». *Nature Reviews Neuroscience* 10 (11): 769-79. <https://doi.org/10.1038/nrn2720>.
- Klein, Irwin, et Kaie Ojamaa. 2001. « Thyroid Hormone and the Cardiovascular System ». Édité par Franklin H. Epstein. *New England Journal of Medicine* 344 (7): 501-9. <https://doi.org/10.1056/NEJM200102153440707>.
- Klum, Susanne, Cécile Zaouter, Zhanna Alekseenko, Åsa K Björklund, Daniel W Hagey, Johan Ericson, Jonas Muhr, et Maria Bergsland. 2018. « Sequentially Acting SOX Proteins Orchestrate Astrocyte- and Oligodendrocyte-specific Gene Expression ». *EMBO Reports* 19 (11). <https://doi.org/10.15252/embr.201846635>.
- Kobayashi, K, S Imagama, T Ohgomori, K Hirano, K Uchimura, K Sakamoto, A Hirakawa, et al. 2013. « Minocycline Selectively Inhibits M1 Polarization of Microglia ». *Cell Death & Disease* 4 (3): e525-e525. <https://doi.org/10.1038/cddis.2013.54>.
- Koleti, Amar, Raymond Terryn, Vasileios Stathias, Caty Chung, Daniel J Cooper, John P Turner, Dušica Vidović, et al. 2018. « Data Portal for the Library of Integrated Network-Based Cellular Signatures (LINCS) Program: Integrated Access to Diverse Large-Scale Cellular Perturbation Response Data ». *Nucleic Acids Research* 46 (D1): D558-66. <https://doi.org/10.1093/nar/gkx1063>.
- Kolliker, Albert von. 2007. *Grundriss der Entwicklungsgeschichte des Menschen und der h??heren Tiere f??r Studierende und ??rzte ; mit 299 Holzschnitten und einer Farbentafel*.
- Kriegstein, Arnold, et Arturo Alvarez-Buylla. 2009. « The Glial Nature of Embryonic and Adult Neural Stem

- Cells ». *Annual Review of Neuroscience* 32 (1): 149-84. <https://doi.org/10.1146/annurev.neuro.051508.135600>.
- Kriegstein, Arnold, Stephen Noctor, et Verónica Martínez-Cerdeño. 2006. « Patterns of Neural Stem and Progenitor Cell Division May Underlie Evolutionary Cortical Expansion ». *Nature Reviews Neuroscience* 7 (11): 883-90. <https://doi.org/10.1038/nrn2008>.
- Kristoffersen, Karina, Mette Villingshøj, Hans Skovgaard Poulsen, et Marie-Thérèse Stockhausen. 2013. « Level of Notch Activation Determines the Effect on Growth and Stem Cell-like Features in Glioblastoma Multiforme Neurosphere Cultures ». *Cancer Biology & Therapy* 14 (7): 625-37. <https://doi.org/10.4161/cbt.24595>.
- Ku, Min-Chi, Sonia Waiczies, Thoralf Niendorf, et Andreas Pohlmann. 2018. « Assessment of Blood Brain Barrier Leakage with Gadolinium-Enhanced MRI ». In *Preclinical MRI*, édité par María Luisa García Martín et Pilar López Larrubia, 1718:395-408. *Methods in Molecular Biology*. New York, NY: Springer New York. https://doi.org/10.1007/978-1-4939-7531-0_23.
- Kubicki, Marek, Robert W. McCarley, et Martha E. Shenton. 2005. « Evidence for White Matter Abnormalities in Schizophrenia ». *Current Opinion in Psychiatry* 18 (2): 121-34. <https://doi.org/10.1097/00001504-200503000-00004>.
- Kuhlbrodt, Kirsten, Beate Herbarth, Elisabeth Sock, Irm Hermans-Borgmeyer, et Michael Wegner. 1998. « Sox10, a Novel Transcriptional Modulator in Glial Cells ». *The Journal of Neuroscience* 18 (1): 237-50. <https://doi.org/10.1523/JNEUROSCI.18-01-00237.1998>.
- Kuhlmann, T., V. Miron, Q. Cuo, C. Wegner, J. Antel, et W. Bruck. 2008. « Differentiation Block of Oligodendroglial Progenitor Cells as a Cause for Remyelination Failure in Chronic Multiple Sclerosis ». *Brain* 131 (7): 1749-58. <https://doi.org/10.1093/brain/awn096>.
- Kukley, Maria, Estibaliz Capetillo-Zarate, et Dirk Dietrich. 2007. « Vesicular Glutamate Release from Axons in White Matter ». *Nature Neuroscience* 10 (3): 311-20. <https://doi.org/10.1038/nn1850>.
- LaGanke, Christopher, Lawrence Samkoff, Keith Edwards, Lily Jung Henson, Pavle Repovic, Sharon Lynch, Lael Stone, et al. 2017. « Safety/Tolerability of the Anti-Semaphorin 4D Antibody VX15/2503 in a Randomized Phase 1 Trial ». *Neurology - Neuroimmunology Neuroinflammation* 4 (4): e367. <https://doi.org/10.1212/NXI.0000000000000367>.
- Lagrèze, Wolf A, Sebastian Küchlin, Gabriele Ihorst, Birgit Grotejohann, Flemming Beisse, Martin Volkmann, Sven P Heinrich, et al. 2021. « Safety and Efficacy of Erythropoietin for the Treatment of Patients with Optic Neuritis (TONE): A Randomised, Double-Blind, Multicentre, Placebo-Controlled Study ». *The Lancet Neurology* 20 (12): 991-1000. [https://doi.org/10.1016/S1474-4422\(21\)00322-7](https://doi.org/10.1016/S1474-4422(21)00322-7).
- Lahav, Amir, et Erika Skoe. 2014. « An acoustic gap between the NICU and womb: a potential risk for compromised neuroplasticity of the auditory system in preterm infants ». *Frontiers in Neuroscience* 8 (décembre). <https://doi.org/10.3389/fnins.2014.00381>.
- Lamb, Justin, Emily D. Crawford, David Peck, Joshua W. Modell, Irene C. Blat, Matthew J. Wrobel, Jim Lerner, et al. 2006. « The Connectivity Map: Using Gene-Expression Signatures to Connect Small Molecules, Genes, and Disease ». *Science* 313 (5795): 1929-35. <https://doi.org/10.1126/science.1132939>.
- Landry, Jennifer S, et Dick Menzies. 2011. « Occurrence and Severity of Bronchopulmonary Dysplasia and Respiratory Distress Syndrome after a Preterm Birth ». *Paediatrics & Child Health* 16 (7): 399-403. <https://doi.org/10.1093/pch/16.7.399>.
- Lang, Guang-Ping, Can Li, et Ying-Ying Han. 2021. « Rutin Pretreatment Promotes Microglial M1 to M2 Phenotype Polarization ». *Neural Regeneration Research* 16 (12): 2499. <https://doi.org/10.4103/1673-5374.313050>.
- Laywell, E. D., P. Rakic, V. G. Kukekov, E. C. Holland, et D. A. Steindler. 2000. « Identification of a Multipotent Astrocytic Stem Cell in the Immature and Adult Mouse Brain ». *Proceedings of the National Academy of Sciences* 97 (25): 13883-88. <https://doi.org/10.1073/pnas.250471697>.

- Leader, Jordana, Amrit Bajwa, Andrea Lanes, Xiaolin Hua, Ruth Rennicks White, Natalie Rybak, et Mark Walker. 2018. « The Effect of Very Advanced Maternal Age on Maternal and Neonatal Outcomes: A Systematic Review ». *Journal of Obstetrics and Gynaecology Canada* 40 (9): 1208-18. <https://doi.org/10.1016/j.jogc.2017.10.027>.
- Leaños-Miranda, Alfredo, Ana Graciela Nolasco-Leaños, Reyes Ismael Carrillo-Juárez, Carlos José Molina-Pérez, Irma Isordia-Salas, et Karla Leticia Ramírez-Valenzuela. 2021. « Interleukin-6 in Amniotic Fluid: A Reliable Marker for Adverse Outcomes in Women in Preterm Labor and Intact Membranes ». *Fetal Diagnosis and Therapy* 48 (4): 313-20. <https://doi.org/10.1159/000514898>.
- Lee, Hyunwoo, Sridar Narayanan, Robert A Brown, Jacqueline T Chen, Harold L Atkins, Mark S Freedman, et Douglas L Arnold. 2017. « Brain Atrophy after Bone Marrow Transplantation for Treatment of Multiple Sclerosis ». *Multiple Sclerosis Journal* 23 (3): 420-31. <https://doi.org/10.1177/1352458516650992>.
- Lee, Jiunn-Tay, Jan Xu, Jin-Moo Lee, Grace Ku, Xianlin Han, Ding-I Yang, Shawei Chen, et Chung Y. Hsu. 2004. « Amyloid- β Peptide Induces Oligodendrocyte Death by Activating the Neutral Sphingomyelinase-Ceramide Pathway ». *Journal of Cell Biology* 164 (1): 123-31. <https://doi.org/10.1083/jcb.200307017>.
- Lee, Jung Goo, Young Sup Woo, Sung Woo Park, Dae-Hyun Seog, Mi Kyoung Seo, et Won-Myong Bahk. 2019. « The Neuroprotective Effects of Melatonin: Possible Role in the Pathophysiology of Neuropsychiatric Disease ». *Brain Sciences* 9 (10): 285. <https://doi.org/10.3390/brainsci9100285>.
- Lee, Won-Ha, Se-Hwa Kim, Yoon Lee, Byung Boong Lee, Byungsuk Kwon, Hebok Song, Byoung S. Kwon, et Jeong-Euy Park. 2001. « Tumor Necrosis Factor Receptor Superfamily 14 Is Involved in Atherogenesis by Inducing Proinflammatory Cytokines and Matrix Metalloproteinases ». *Arteriosclerosis, Thrombosis, and Vascular Biology* 21 (12): 2004-10. <https://doi.org/10.1161/hq1201.098945>.
- Lee, Youngjin, Brett M. Morrison, Yun Li, Sylvain Lengacher, Mohamed H. Farah, Paul N. Hoffman, Yiting Liu, et al. 2012. « Oligodendroglia Metabolically Support Axons and Contribute to Neurodegeneration ». *Nature* 487 (7408): 443-48. <https://doi.org/10.1038/nature11314>.
- Leeuw, F.-E. de, F. Barkhof, et P. Scheltens. 2004. « White Matter Lesions and Hippocampal Atrophy in Alzheimer's Disease ». *Neurology* 62 (2): 310-12. <https://doi.org/10.1212/01.WNL.0000103289.03648.AD>.
- Leifsdottir, Kristin, Huseyin Mehmet, Staffan Eksborg, et Eric Herlenius. 2018. « Fas-Ligand and Interleukin-6 in the Cerebrospinal Fluid Are Early Predictors of Hypoxic-Ischemic Encephalopathy and Long-Term Outcomes after Birth Asphyxia in Term Infants ». *Journal of Neuroinflammation* 15 (1): 223. <https://doi.org/10.1186/s12974-018-1253-y>.
- Lembo, Chiara, Giuseppe Buonocore, et Serafina Perrone. 2021. « Oxidative Stress in Preterm Newborns ». *Antioxidants* 10 (11): 1672. <https://doi.org/10.3390/antiox10111672>.
- Lemire, J M, et D C Archer. 1991. « 1,25-Dihydroxyvitamin D3 Prevents the in Vivo Induction of Murine Experimental Autoimmune Encephalomyelitis ». *Journal of Clinical Investigation* 87 (3): 1103-7. <https://doi.org/10.1172/JCI115072>.
- Lerchundi, Rodrigo, Ignacio Fernández-Moncada, Yasna Contreras-Baeza, Tamara Sotelo-Hitschfeld, Philipp Mächler, Matthias T. Wyss, Jillian Stobart, et al. 2015. « NH₄⁺ Triggers the Release of Astrocytic Lactate via Mitochondrial Pyruvate Shunting ». *Proceedings of the National Academy of Sciences* 112 (35): 11090-95. <https://doi.org/10.1073/pnas.1508259112>.
- Leroy, François, Qing Cai, Stephanie L. Bogart, Jessica Dubois, Olivier Coulon, Karla Monzalvo, Clara Fischer, et al. 2015. « New Human-Specific Brain Landmark: The Depth Asymmetry of Superior Temporal Sulcus ». *Proceedings of the National Academy of Sciences* 112 (4): 1208-13. <https://doi.org/10.1073/pnas.1412389112>.
- Leung, Alan W., D. Kent Morest, et James Y.H. Li. 2013. « Differential BMP Signaling Controls Formation and Differentiation of Multipotent Preplacodal Ectoderm Progenitors from Human Embryonic Stem Cells ». *Developmental Biology* 379 (2): 208-20. <https://doi.org/10.1016/j.ydbio.2013.04.023>.

- Levine, Joel M, Richard Reynolds, et James W Fawcett. 2001. « The Oligodendrocyte Precursor Cell in Health and Disease ». *Trends in Neurosciences* 24 (1): 39-47. [https://doi.org/10.1016/S0166-2236\(00\)01691-X](https://doi.org/10.1016/S0166-2236(00)01691-X).
- Levine, Lisa D., Katheryne L. Downes, Julie A. Romero, Hope Pappas, et Michal A. Elovitz. 2019. « Quantitative Fetal Fibronectin and Cervical Length in Symptomatic Women: Results from a Prospective Blinded Cohort Study ». *The Journal of Maternal-Fetal & Neonatal Medicine* 32 (22): 3792-3800. <https://doi.org/10.1080/14767058.2018.1472227>.
- Levitt, Pat, et Pasko Rakic. 1980. « Immunoperoxidase Localization of Glial Fibrillary Acidic Protein in Radial Glial Cells and Astrocytes of the Developing Rhesus Monkey Brain ». *The Journal of Comparative Neurology* 193 (3): 815-40. <https://doi.org/10.1002/cne.901930316>.
- Lev-Ram, V., et A. Grinvald. 1987. « Activity-Dependent Calcium Transients in Central Nervous System Myelinated Axons Revealed by the Calcium Indicator Fura-2 ». *Biophysical Journal* 52 (4): 571-76. [https://doi.org/10.1016/S0006-3495\(87\)83246-0](https://doi.org/10.1016/S0006-3495(87)83246-0).
- Li, Huiliang, Joana Paes de Faria, Paul Andrew, Justyna Nitarska, et William D. Richardson. 2011. « Phosphorylation Regulates OLIG2 Cofactor Choice and the Motor Neuron-Oligodendrocyte Fate Switch ». *Neuron* 69 (5): 918-29. <https://doi.org/10.1016/j.neuron.2011.01.030>.
- Li, Li, Yanhong Chen, Zhifeng Lin, Weiyan Lin, Yangqi Liu, Weilin Ou, Chengli Zeng, et Li Ke. 2020. « Association of Pre-Pregnancy Body Mass Index with Adverse Pregnancy Outcome among First-Time Mothers ». *PeerJ* 8 (octobre): e10123. <https://doi.org/10.7717/peerj.10123>.
- Liao, Rujia, Youchao Chen, Li Cheng, Lishi Fan, Han Chen, Yushan Wan, Yi You, et al. 2019. « Histamine H1 Receptors in Neural Stem Cells Are Required for the Promotion of Neurogenesis Conferred by H3 Receptor Antagonism Following Traumatic Brain Injury ». *Stem Cell Reports* 12 (3): 532-44. <https://doi.org/10.1016/j.stemcr.2019.01.004>.
- LiCausi, Francesca, et Nathaniel Hartman. 2018. « Role of MTOR Complexes in Neurogenesis ». *International Journal of Molecular Sciences* 19 (5): 1544. <https://doi.org/10.3390/ijms19051544>.
- Lin, Man-Hway, Masanori P. Takahashi, Yoshifumi Takahashi, et Tadaharu Tsumoto. 1994. « Intracellular Calcium Increase Induced by GABA in Visual Cortex of Fetal and Neonatal Rats and Its Disappearance with Development ». *Neuroscience Research* 20 (1): 85-94. [https://doi.org/10.1016/0168-0102\(94\)90025-6](https://doi.org/10.1016/0168-0102(94)90025-6).
- Lin, Shih-chun, et Dwight E Bergles. 2004. « Synaptic Signaling between GABAergic Interneurons and Oligodendrocyte Precursor Cells in the Hippocampus ». *Nature Neuroscience* 7 (1): 24-32. <https://doi.org/10.1038/nn1162>.
- Lin, Wensheng, April Kemper, Jeffrey L. Dupree, Heather P. Harding, David Ron, et Brian Popko. 2006. « Interferon- γ Inhibits Central Nervous System Remyelination through a Process Modulated by Endoplasmic Reticulum Stress ». *Brain* 129 (5): 1306-18. <https://doi.org/10.1093/brain/awl044>.
- Liu, Aixiao, Michela Muggironi, Mireya Marin-Husstege, et Patrizia Casaccia-Bonnel. 2003. « Oligodendrocyte Process Outgrowth in Vitro Is Modulated by Epigenetic Regulation of Cytoskeletal Severing Proteins ». *Glia* 44 (3): 264-74. <https://doi.org/10.1002/glia.10290>.
- Liu, Jia, Karen Dietz, Jacqueline M DeLoyht, Xiomara Pedre, Dipti Kelkar, Jasbir Kaur, Vincent Vialou, et al. 2012. « Impaired Adult Myelination in the Prefrontal Cortex of Socially Isolated Mice ». *Nature Neuroscience* 15 (12): 1621-23. <https://doi.org/10.1038/nn.3263>.
- Liu, Jia, Jeffrey L. Dupree, Mar Gacias, Rebecca Frawley, Tamjeed Sikder, Payal Naik, et Patrizia Casaccia. 2016. « Clemastine Enhances Myelination in the Prefrontal Cortex and Rescues Behavioral Changes in Socially Isolated Mice ». *The Journal of Neuroscience* 36 (3): 957-62. <https://doi.org/10.1523/JNEUROSCI.3608-15.2016>.
- Liu, Meiying, Xuan Liu, Lei Wang, Yu Wang, Fuxing Dong, Jian Wu, Xuebin Qu, et al. 2018. « TRPV4 Inhibition Improved Myelination and Reduced Glia Reactivity and Inflammation in a Cuprizone-Induced Mouse Model of Demyelination ». *Frontiers in Cellular Neuroscience* 12 (novembre): 392. <https://doi.org/10.3389/fncel.2018.00392>.

- Liu, Qiang, Jin Wang, Xin Wei, Juan Hu, Conghui Ping, Yue Gao, Chang Xie, et al. 2021. « Therapeutic Inhibition of Keratinocyte TRPV3 Sensory Channel by Local Anesthetic Dyclonine ». *ELife* 10 (avril): e68128. <https://doi.org/10.7554/eLife.68128>.
- Liu, X, D-L Yao, et Hde F. Webster. 1995. « Insulin-like Growth Factor I Treatment Reduces Clinical Deficits and Lesion Severity in Acute Demyelinating Experimental Autoimmune Encephalomyelitis ». *Multiple Sclerosis Journal* 1 (1): 2-9. <https://doi.org/10.1177/135245859500100102>.
- Liu, Yingjun, et Adriano Aguzzi. 2020. « NG2 Glia Are Required for Maintaining Microglia Homeostatic State ». *Glia* 68 (2): 345-55. <https://doi.org/10.1002/glia.23721>.
- Loddick, Sarah A., et Nancy J. Rothwell. 1996. « Neuroprotective Effects of Human Recombinant Interleukin-1 Receptor Antagonist in Focal Cerebral Ischaemia in the Rat ». *Journal of Cerebral Blood Flow & Metabolism* 16 (5): 932-40. <https://doi.org/10.1097/00004647-199609000-00017>.
- Loring, Jf, DI Barker, et Ca Erickson. 1988. « Migration and Differentiation of Neural Crest and Ventral Neural Tube Cells in Vitro: Implications for in Vitro and in Vivo Studies of the Neural Crest ». *The Journal of Neuroscience* 8 (3): 1001-15. <https://doi.org/10.1523/JNEUROSCI.08-03-01001.1988>.
- Lu, Changqing, Lihua Dong, Hui Zhou, Qianmei Li, Guojiao Huang, Shu jun Bai, et Linchuan Liao. 2018. « G-Protein-Coupled Receptor Gpr17 Regulates Oligodendrocyte Differentiation in Response to Lysolecithin-Induced Demyelination ». *Scientific Reports* 8 (1): 4502. <https://doi.org/10.1038/s41598-018-22452-0>.
- Lu, Q.Richard, Tao Sun, Zhimin Zhu, Nan Ma, Meritxell Garcia, Charles D. Stiles, et David H. Rowitch. 2002. « Common Developmental Requirement for Olig Function Indicates a Motor Neuron/Oligodendrocyte Connection ». *Cell* 109 (1): 75-86. [https://doi.org/10.1016/S0092-8674\(02\)00678-5](https://doi.org/10.1016/S0092-8674(02)00678-5).
- Lu, Q.Richard, Dong-in Yuk, John A Alberta, Zhimin Zhu, Inka Pawlitzky, Joanne Chan, Andrew P McMahon, Charles D Stiles, et David H Rowitch. 2000. « Sonic Hedgehog-Regulated Oligodendrocyte Lineage Genes Encoding BHLH Proteins in the Mammalian Central Nervous System ». *Neuron* 25 (2): 317-29. [https://doi.org/10.1016/S0896-6273\(00\)80897-1](https://doi.org/10.1016/S0896-6273(00)80897-1).
- Lubetzki, Catherine, Nathalie Sol-Foulon, et Anne Desmazières. 2020. « Nodes of Ranvier during Development and Repair in the CNS ». *Nature Reviews Neurology* 16 (8): 426-39. <https://doi.org/10.1038/s41582-020-0375-x>.
- Luders, E., K. L. Narr, R. M. Bilder, P. R. Szeszko, M. N. Gurbani, L. Hamilton, A. W. Toga, et C. Gaser. 2008. « Mapping the Relationship between Cortical Convolution and Intelligence: Effects of Gender ». *Cerebral Cortex* 18 (9): 2019-26. <https://doi.org/10.1093/cercor/bhm227>.
- Lui, Jan H., David V. Hansen, et Arnold R. Kriegstein. 2011. « Development and Evolution of the Human Neocortex ». *Cell* 146 (1): 18-36. <https://doi.org/10.1016/j.cell.2011.06.030>.
- Lunn, Katharine F., Peter W. Baas, et Ian D. Duncan. 1997. « Microtubule Organization and Stability in the Oligodendrocyte ». *The Journal of Neuroscience* 17 (13): 4921-32. <https://doi.org/10.1523/JNEUROSCI.17-13-04921.1997>.
- Luo, Bin, Yong-yao Gu, Xiao-dong Wang, Gang Chen, et Zhi-gang Peng. 2018. « Identification of Potential Drugs for Diffuse Large B-Cell Lymphoma Based on Bioinformatics and Connectivity Map Database ». *Pathology - Research and Practice* 214 (11): 1854-67. <https://doi.org/10.1016/j.prp.2018.09.013>.
- Luu, Thuy Mai, Muhammad Oneeb Rehman Mian, et Anne Monique Nuyt. 2017. « Long-Term Impact of Preterm Birth ». *Clinics in Perinatology* 44 (2): 305-14. <https://doi.org/10.1016/j.clp.2017.01.003>.
- Luyt, Karen, Timothy P. Slade, Jienchi J. Dorward, Claire F. Durant, Yue Wu, Ryuichi Shigemoto, Stuart J. Mundell, Anikó Váradi, et Elek Molnár. 2007. « Developing Oligodendrocytes Express Functional GABA_B Receptors That Stimulate Cell Proliferation and Migration ». *Journal of Neurochemistry* 100 (3): 822-40. <https://doi.org/10.1111/j.1471-4159.2006.04255.x>.

- Luyt, Karen, Anikó Váradi, Claire F. Durant, et Elek Molnár. 2006. « Oligodendroglial Metabotropic Glutamate Receptors Are Developmentally Regulated and Involved in the Prevention of Apoptosis ». *Journal of Neurochemistry* 99 (2): 641-56. <https://doi.org/10.1111/j.1471-4159.2006.04103.x>.
- Lytle, Judith M., Stefano Vicini, et Jean R. Wrathall. 2006. « Phenotypic Changes in NG2+Cells after Spinal Cord Injury ». *Journal of Neurotrauma* 23 (12): 1726-38. <https://doi.org/10.1089/neu.2006.23.1726>.
- MacVicar, Brian A., et Hyun Beom Choi. 2017. « Astrocytes Provide Metabolic Support for Neuronal Synaptic Function in Response to Extracellular K⁺ ». *Neurochemical Research* 42 (9): 2588-94. <https://doi.org/10.1007/s11064-017-2315-8>.
- Magalon, Karine, Celine Zimmer, Myriam Cayre, Joseph Khaldi, Clarisse Bourbon, Isabelle Robles, Gwenaëlle Tardif, et al. 2012. « Olesoxime Accelerates Myelination and Promotes Repair in Models of Demyelination ». *Annals of Neurology* 71 (2): 213-26. <https://doi.org/10.1002/ana.22593>.
- Magistretti, Pierre J., Luc Pellerin, Douglas L. Rothman, et Robert G. Shulman. 1999. « Energy on Demand ». *Science* 283 (5401): 496-97. <https://doi.org/10.1126/science.283.5401.496>.
- Maire, Cécile L., Amélie Wegener, Christophe Kerninon, et Brahim Nait Oumesmar. 2010. « Gain-of-Function of Olig Transcription Factors Enhances Oligodendrogenesis and Myelination ». *Stem Cells* 28 (9): 1611-22. <https://doi.org/10.1002/stem.480>.
- Maiti, Panchanan, Shashi B. Singh, Birendranath Mallick, Sangu Muthuraju, et Govindasami Ilavazhagan. 2008. « High Altitude Memory Impairment Is Due to Neuronal Apoptosis in Hippocampus, Cortex and Striatum ». *Journal of Chemical Neuroanatomy* 36 (3-4): 227-38. <https://doi.org/10.1016/j.jchemneu.2008.07.003>.
- Makinodan, Manabu, Kenneth M. Rosen, Susumu Ito, et Gabriel Corfas. 2012. « A Critical Period for Social Experience-Dependent Oligodendrocyte Maturation and Myelination ». *Science (New York, N.Y.)* 337 (6100): 1357-60. <https://doi.org/10.1126/science.1220845>.
- Malatesta, Paolo, et Magdalena Götz. 2013. « Radial Glia – from Boring Cables to Stem Cell Stars ». *Development* 140 (3): 483-86. <https://doi.org/10.1242/dev.085852>.
- Malcomson, Beth, Hollie Wilson, Eleonora Veglia, Gayathri Thillaiampalam, Ruth Barsden, Shauna Donegan, Amal El Banna, et al. 2016. « Connectivity Mapping (SsCMap) to Predict A20-Inducing Drugs and Their Antiinflammatory Action in Cystic Fibrosis ». *Proceedings of the National Academy of Sciences* 113 (26): E3725-34. <https://doi.org/10.1073/pnas.1520289113>.
- Malla, Bimala, Samuel Cotten, Rebecca Ulshoefer, Friedemann Paul, Anja E. Hauser, Raluca Niesner, Helena Bros, et Carmen Infante-Duarte. 2020. « Teriflunomide Preserves Peripheral Nerve Mitochondria from Oxidative Stress-Mediated Alterations ». *Therapeutic Advances in Chronic Disease* 11 (janvier): 204062232094477. <https://doi.org/10.1177/2040622320944773>.
- Marin-Husstege, Mireya, Ye He, Jiadong Li, Toru Kondo, Fred Sablitzky, et Patrizia Casaccia-Bonnel. 2006. « Multiple Roles of Id4 in Developmental Myelination: Predicted Outcomes and Unexpected Findings ». *Glia* 54 (4): 285-96. <https://doi.org/10.1002/glia.20385>.
- Martin, Lee J. 2010. « Olesoxime, a Cholesterol-like Neuroprotectant for the Potential Treatment of Amyotrophic Lateral Sclerosis ». *IDrugs: The Investigational Drugs Journal* 13 (8): 568-80.
- Martínez, Constanza, Víctor Hugo Cornejo, Pablo Lois, Tammy Ellis, Natalia P. Solis, Brandon J. Wainwright, et Verónica Palma. 2013. « Proliferation of Murine Midbrain Neural Stem Cells Depends upon an Endogenous Sonic Hedgehog (Shh) Source ». Édité par Arun Rishi. *PLoS ONE* 8 (6): e65818. <https://doi.org/10.1371/journal.pone.0065818>.
- Martini, Rudolf, Janos Groh, et Udo Bartsch. 2010. « Comparative biology of Schwann cells and oligodendrocytes ». In *The Biology of Oligodendrocytes*, édité par Patricia Armati et Emily Mathey, 19-48. Cambridge: Cambridge University Press. <https://doi.org/10.1017/CBO9780511782121.003>.

- Maruyama, Shuji, Hideo Tsukada, Shingo Nishiyama, Takeharu Kakiuchi, Dai Fukumoto, Naoto Oku, et Shizuo Yamada. 2008. « In Vivo Quantitative Autoradiographic Analysis of Brain Muscarinic Receptor Occupancy by Antimuscarinic Agents for Overactive Bladder Treatment ». *Journal of Pharmacology and Experimental Therapeutics* 325 (3): 774-81. <https://doi.org/10.1124/jpet.108.136390>.
- Masamoto, Kazuto, et Kazuo Tanishita. 2009. « Oxygen Transport in Brain Tissue ». *Journal of Biomechanical Engineering* 131 (7): 074002. <https://doi.org/10.1115/1.3184694>.
- Mathur, Deepali, Angela L. Riffo-Campos, Josefa Castillo, Jeffery D. Haines, Oscar G. Vidaurre, Fan Zhang, Francisco Coret-Ferrer, Patrizia Casaccia, Bonaventura Casanova, et Gerardo Lopez-Rodas. 2017. « Bioenergetic Failure in Rat Oligodendrocyte Progenitor Cells Treated with Cerebrospinal Fluid Derived from Multiple Sclerosis Patients ». *Frontiers in Cellular Neuroscience* 11 (juillet): 209. <https://doi.org/10.3389/fncel.2017.00209>.
- Mayer, M., K. Bhakoo, et M. Noble. 1994. « Ciliary Neurotrophic Factor and Leukemia Inhibitory Factor Promote the Generation, Maturation and Survival of Oligodendrocytes in Vitro ». *Development (Cambridge, England)* 120 (1): 143-53.
- McConnell, Susan K. 1995. « Constructing the Cerebral Cortex: Neurogenesis and Fate Determination ». *Neuron* 15 (4): 761-68. [https://doi.org/10.1016/0896-6273\(95\)90168-X](https://doi.org/10.1016/0896-6273(95)90168-X).
- McGinley, Aoife M., Sarah C. Edwards, Mathilde Raverdeau, et Kingston H.G. Mills. 2018. « Th17 Cells, $\gamma\delta$ T Cells and Their Interplay in EAE and Multiple Sclerosis ». *Journal of Autoimmunity* 87 (février): 97-108. <https://doi.org/10.1016/j.jaut.2018.01.001>.
- McGregor, James A., G.Marc Jackson, Gillian C.L. Lachelin, Thomas M. Goodwin, Raul Artal, Cheryl Hastings, et Vivian Dullien. 1995. « Salivary Estriol as Risk Assessment for Preterm Labor: A Prospective Trial ». *American Journal of Obstetrics and Gynecology* 173 (4): 1337-42. [https://doi.org/10.1016/0002-9378\(95\)91383-1](https://doi.org/10.1016/0002-9378(95)91383-1).
- McKenzie, I. A., D. Ohayon, H. Li, J. Paes de Faria, B. Emery, K. Tohyama, et W. D. Richardson. 2014. « Motor Skill Learning Requires Active Central Myelination ». *Science* 346 (6207): 318-22. <https://doi.org/10.1126/science.1254960>.
- McKinnon, Randall D., Toshimitsu Matsui, Monique Dubois-Dalcq, et Stuart A. Aaronson. 1990. « FGF Modulates the PDGF-Driven Pathway of Oligodendrocyte Development ». *Neuron* 5 (5): 603-14. [https://doi.org/10.1016/0896-6273\(90\)90215-2](https://doi.org/10.1016/0896-6273(90)90215-2).
- McMahon, Erin, Pia Wintermark, et Amir Lahav. 2012. « Auditory Brain Development in Premature Infants: The Importance of Early Experience: McMahon et Al. » *Annals of the New York Academy of Sciences* 1252 (1): 17-24. <https://doi.org/10.1111/j.1749-6632.2012.06445.x>.
- McMorris, F. A., T. M. Smith, S. DeSalvo, et R. W. Furlanetto. 1986. « Insulin-like Growth Factor I/Somatomedin C: A Potent Inducer of Oligodendrocyte Development. » *Proceedings of the National Academy of Sciences* 83 (3): 822-26. <https://doi.org/10.1073/pnas.83.3.822>.
- Meffre, Delphine, Ghjuvan'Ghjacumu Shackelford, Mehdi Hichor, Victor Gorgievski, Eleni T. Tzavara, Amalia Trousson, Abdel M. Ghomari, et al. 2015. « Liver X Receptors Alpha and Beta Promote Myelination and Remyelination in the Cerebellum ». *Proceedings of the National Academy of Sciences* 112 (24): 7587-92. <https://doi.org/10.1073/pnas.1424951112>.
- Mei, F., H. Wang, S. Liu, J. Niu, L. Wang, Y. He, A. Etxeberria, J. R. Chan, et L. Xiao. 2013. « Stage-Specific Deletion of Olig2 Conveys Opposing Functions on Differentiation and Maturation of Oligodendrocytes ». *Journal of Neuroscience* 33 (19): 8454-62. <https://doi.org/10.1523/JNEUROSCI.2453-12.2013>.
- Mei, Feng, Stephen P. J. Fancy, Yun-An A. Shen, Jianqin Niu, Chao Zhao, Bryan Presley, Edna Miao, et al. 2014. « Micropillar Arrays as a High-Throughput Screening Platform for Therapeutics in Multiple Sclerosis ». *Nature Medicine* 20 (8): 954-60. <https://doi.org/10.1038/nm.3618>.
- Mei, Feng, Sonia R. Mayoral, Hiroko Nobuta, Fei Wang, Caroline Desponts, Daniel S. Lorrain, Lan Xiao, et al. 2016. « Identification of the Kappa-Opioid Receptor as a Therapeutic Target for Oligodendrocyte

- Remyelination ». *The Journal of Neuroscience* 36 (30): 7925-35. <https://doi.org/10.1523/JNEUROSCI.1493-16.2016>.
- Meng, Xiangdong, Mingming Fu, Shoufeng Wang, Weida Chen, Jianjie Wang, et Ning Zhang. 2021. « Naringin ameliorates memory deficits and exerts neuroprotective effects in a mouse model of Alzheimer's disease by regulating multiple metabolic pathways ». *Molecular Medicine Reports* 23 (5): 332. <https://doi.org/10.3892/mmr.2021.11971>.
- Mensch, Sigrid, Marion Baraban, Rafael Almeida, Tim Czopka, Jessica Ausborn, Abdeljabbar El Manira, et David A Lyons. 2015. « Synaptic Vesicle Release Regulates Myelin Sheath Number of Individual Oligodendrocytes in Vivo ». *Nature Neuroscience* 18 (5): 628-30. <https://doi.org/10.1038/nn.3991>.
- Merkle, F. T., A. D. Tramontin, J. M. Garcia-Verdugo, et A. Alvarez-Buylla. 2004. « Radial Glia Give Rise to Adult Neural Stem Cells in the Subventricular Zone ». *Proceedings of the National Academy of Sciences* 101 (50): 17528-32. <https://doi.org/10.1073/pnas.0407893101>.
- Merrill, J. E., L. J. Ignarro, M. P. Sherman, J. Melinek, et T. E. Lane. 1993. « Microglial Cell Cytotoxicity of Oligodendrocytes Is Mediated through Nitric Oxide ». *Journal of Immunology (Baltimore, Md.: 1950)* 151 (4): 2132-41.
- Metz, Luanne M., David K.B. Li, Anthony L. Traboulsee, Pierre Duquette, Misha Eliasziw, Graziela Cerchiaro, Jamie Greenfield, et al. 2017. « Trial of Minocycline in a Clinically Isolated Syndrome of Multiple Sclerosis ». *New England Journal of Medicine* 376 (22): 2122-33. <https://doi.org/10.1056/NEJMoa1608889>.
- Meyer, Niklas, Nadine Richter, Zoya Fan, Gabrielle Siemonsmeier, Tatyana Pivneva, Philipp Jordan, Christian Steinhäuser, Marcus Semtner, Christiane Nolte, et Helmut Kettenmann. 2018. « Oligodendrocytes in the Mouse Corpus Callosum Maintain Axonal Function by Delivery of Glucose ». *Cell Reports* 22 (9): 2383-94. <https://doi.org/10.1016/j.celrep.2018.02.022>.
- Mi, Sha, Robert H Miller, Xinhua Lee, Martin L Scott, Svetlane Shulag-Morskaya, Zhaohui Shao, Jufang Chang, et al. 2005. « LINGO-1 Negatively Regulates Myelination by Oligodendrocytes ». *Nature Neuroscience* 8 (6): 745-51. <https://doi.org/10.1038/nn1460>.
- Miclea, Andrei, Maud Bagnoud, Andrew Chan, et Robert Hoepner. 2020. « A Brief Review of the Effects of Vitamin D on Multiple Sclerosis ». *Frontiers in Immunology* 11 (mai): 781. <https://doi.org/10.3389/fimmu.2020.00781>.
- Mills, Elizabeth A., Magdalena A. Ogrodnik, Andrew Plave, et Yang Mao-Draayer. 2018. « Emerging Understanding of the Mechanism of Action for Dimethyl Fumarate in the Treatment of Multiple Sclerosis ». *Frontiers in Neurology* 9 (janvier): 5. <https://doi.org/10.3389/fneur.2018.00005>.
- Minghetti, Luisa, Alessia Nicolini, Elisabetta Polazzi, Anita Greco, Mauro Perretti, Luca Parente, et Giulio Levi. 1999. « Down-Regulation of Microglial Cyclo-Oxygenase-2 and Inducible Nitric Oxide Synthase Expression by Lipocortin 1: Lipocortin 1 Regulates Microglial Activation ». *British Journal of Pharmacology* 126 (6): 1307-14. <https://doi.org/10.1038/sj.bjp.0702423>.
- Mission, Jean-Paul, Christopher P. Austin, Takao Takahashi, Constance L. Cepko, et Verne S. Caviness. 1991. « The Alignment of Migrating Neural Cells in Relation to the Murine Neopallial Radial Glial Fiber System ». *Cerebral Cortex* 1 (3): 221-29. <https://doi.org/10.1093/cercor/1.3.221>.
- Mitrovic, B., L.J. Ignarro, H.V. Vinters, M.-A. Akers, I. Schmid, C. Uittenbogaart, et J.E. Merrill. 1995. « Nitric Oxide Induces Necrotic but Not Apoptotic Cell Death in Oligodendrocytes ». *Neuroscience* 65 (2): 531-39. [https://doi.org/10.1016/0306-4522\(94\)00491-M](https://doi.org/10.1016/0306-4522(94)00491-M).
- Miyata, Shingo, Tsuyoshi Hattori, Shoko Shimizu, Akira Ito, et Masaya Tohyama. 2015. « Disturbance of Oligodendrocyte Function Plays a Key Role in the Pathogenesis of Schizophrenia and Major Depressive Disorder ». *BioMed Research International* 2015: 1-26. <https://doi.org/10.1155/2015/492367>.
- Miyoshi, K, A Honda, K Baba, M Taniguchi, K Oono, T Fujita, S Kuroda, T Katayama, et M Tohyama. 2003.

« Disrupted-In-Schizophrenia 1, a Candidate Gene for Schizophrenia, Participates in Neurite Outgrowth ». *Molecular Psychiatry* 8 (7): 685-94. <https://doi.org/10.1038/sj.mp.4001352>.

Mizuno, Tetsuya, Tohru Kurotani, Yukio Komatsu, Jun Kawanokuchi, Hideki Kato, Norimasa Mitsuma, et Akio Suzumura. 2004. « Neuroprotective Role of Phosphodiesterase Inhibitor Ibudilast on Neuronal Cell Death Induced by Activated Microglia ». *Neuropharmacology* 46 (3): 404-11. <https://doi.org/10.1016/j.neuropharm.2003.09.009>.

Mogha, Amit, Mitchell D'Rozario, et Kelly R. Monk. 2016. « G Protein-Coupled Receptors in Myelinating Glia ». *Trends in Pharmacological Sciences* 37 (11): 977-87. <https://doi.org/10.1016/j.tips.2016.09.002>.

Moghaddasi, Mehdi, Mona Nabovvati, Amin koushki, Mostafa Soltansanjari, Mahsa Sardarinia, Nafise Mohebi, et Seyedhossein Rabani. 2020. « Randomized Control Trial of Evaluation of Clemastine Effects on Visual Evoked Potential, Nerve Fiber Layer and Ganglion Cell Layer Complex in Patients with Optic Neuritis ». *Clinical Neurology and Neurosurgery* 193 (juin): 105741. <https://doi.org/10.1016/j.clineuro.2020.105741>.

Mohyeldin, Ahmed, Tomás Garzón-Muvdi, et Alfredo Quiñones-Hinojosa. 2010. « Oxygen in Stem Cell Biology: A Critical Component of the Stem Cell Niche ». *Cell Stem Cell* 7 (2): 150-61. <https://doi.org/10.1016/j.stem.2010.07.007>.

Moll, N. M., E. Hong, M. Fauveau, M. Naruse, C. Kerninon, V. Tepavcevic, A. Klopstein, et al. 2013. « SOX17 Is Expressed in Regenerating Oligodendrocytes in Experimental Models of Demyelination and in Multiple Sclerosis: Expression of SOX17 in Demyelinated Lesions ». *Glia* 61 (10): 1659-72. <https://doi.org/10.1002/glia.22547>.

Montaldo, Paolo, Peter J Lally, Vânia Oliveira, Ravi Swamy, Josephine Mendoza, Gaurav Atreja, Ujwal Kariholu, et al. 2019. « Therapeutic Hypothermia Initiated within 6 Hours of Birth Is Associated with Reduced Brain Injury on MR Biomarkers in Mild Hypoxic-Ischaemic Encephalopathy: A Non-Randomised Cohort Study ». *Archives of Disease in Childhood - Fetal and Neonatal Edition* 104 (5): F515-20. <https://doi.org/10.1136/archdischild-2018-316040>.

Morest, D. Kent, et Jerry Silver. 2003. « Precursors of Neurons, Neuroglia, and Ependymal Cells in the CNS: What Are They? Where Are They from? How Do They Get Where They Are Going? ». *Glia* 43 (1): 6-18. <https://doi.org/10.1002/glia.10238>.

Morrison, Sean J., Marie Csete, Andrew K. Groves, William Melega, Barbara Wold, et David J. Anderson. 2000. « Culture in Reduced Levels of Oxygen Promotes Clonogenic Sympathoadrenal Differentiation by Isolated Neural Crest Stem Cells ». *The Journal of Neuroscience* 20 (19): 7370-76. <https://doi.org/10.1523/JNEUROSCI.20-19-07370.2000>.

Moster, Dag, Rolv Terje Lie, et Trond Markestad. 2008. « Long-Term Medical and Social Consequences of Preterm Birth ». *New England Journal of Medicine* 359 (3): 262-73. <https://doi.org/10.1056/NEJMoa0706475>.

Mount, Christopher W, Belgin Yağın, Kennedy Cunliffe-Koehler, Shree Sundaresh, et Michelle Monje. 2019. « Monosynaptic Tracing Maps Brain-Wide Afferent Oligodendrocyte Precursor Cell Connectivity ». *ELife* 8 (octobre): e49291. <https://doi.org/10.7554/eLife.49291>.

Mousavi, Seyedeh Zahra, Mojdeh Rahmanian, et Ashkan Sami. 2020. « A Connectivity Map-Based Drug Repurposing Study and Integrative Analysis of Transcriptomic Profiling of SARS-CoV-2 Infection ». *Infection, Genetics and Evolution* 86 (décembre): 104610. <https://doi.org/10.1016/j.meegid.2020.104610>.

Moutquin, J. 2003. « Classification and Heterogeneity of Preterm Birth ». *BJOG: An International Journal of Obstetrics and Gynaecology* 110 (avril): 30-33. [https://doi.org/10.1016/S1470-0328\(03\)00021-1](https://doi.org/10.1016/S1470-0328(03)00021-1).

Moyon, S., A. L. Dubessy, M. S. Aigrot, M. Trotter, J. K. Huang, L. Dauphinot, M. C. Potier, et al. 2015. « Demyelination Causes Adult CNS Progenitors to Revert to an Immature State and Express Immune Cues That Support Their Migration ». *Journal of Neuroscience* 35 (1): 4-20. <https://doi.org/10.1523/JNEUROSCI.0849-14.2015>.

Moyse, Emmanuel, Stephanie Segura, Oliver Liard, Stephanie Mahaut, et Naguib Mechawar. 2008.

« Microenvironmental Determinants of Adult Neural Stem Cell Proliferation and Lineage Commitment in the Healthy and Injured Central Nervous System ». *Current Stem Cell Research & Therapy* 3 (3): 163-84. <https://doi.org/10.2174/157488808785740334>.

Mullin, Ariana P., Charlene Cui, Yu Wang, Jing Wang, Erika Troy, Anthony O. Caggiano, Tom J. Parry, Raymond W. Colburn, et Elias Pavlopoulos. 2017. « RHlgM22 Enhances Remyelination in the Brain of the Cuprizone Mouse Model of Demyelination ». *Neurobiology of Disease* 105 (septembre): 142-55. <https://doi.org/10.1016/j.nbd.2017.05.015>.

Muñoz-Sanjuán, Ignacio, et Ali H. Brivanlou. 2002. « Neural Induction, the Default Model and Embryonic Stem Cells ». *Nature Reviews Neuroscience* 3 (4): 271-80. <https://doi.org/10.1038/nrn786>.

Nageeb, Rania S., Noha A. Hashim, et Amal Fawzy. 2018. « Serum Insulin-like Growth Factor 1 (IGF-1) in Multiple Sclerosis: Relation to Cognitive Impairment and Fatigue ». *The Egyptian Journal of Neurology, Psychiatry and Neurosurgery* 54 (1): 25. <https://doi.org/10.1186/s41983-018-0026-y>.

Najm, Fadi J, Angela M Lager, Anita Zaremba, Krysta Wyatt, Andrew V Caprariello, Daniel C Factor, Robert T Karl, Tadao Maeda, Robert H Miller, et Paul J Tesar. 2013. « Transcription Factor–Mediated Reprogramming of Fibroblasts to Expandable, Myelinogenic Oligodendrocyte Progenitor Cells ». *Nature Biotechnology* 31 (5): 426-33. <https://doi.org/10.1038/nbt.2561>.

Najm, Fadi J., Mayur Madhavan, Anita Zaremba, Elizabeth Shick, Robert T. Karl, Daniel C. Factor, Tyler E. Miller, et al. 2015. « Drug-Based Modulation of Endogenous Stem Cells Promotes Functional Remyelination in Vivo ». *Nature* 522 (7555): 216-20. <https://doi.org/10.1038/nature14335>.

Nakajima, K., et S. Kohsaka. 2001. « Microglia: Activation and Their Significance in the Central Nervous System ». *Journal of Biochemistry* 130 (2): 169-75. <https://doi.org/10.1093/oxfordjournals.jbchem.a002969>.

Nakamura, Yasuhiro, Toshio Okudera, et Takeo Hashimoto. 1994. « Vascular Architecture in White Matter of Neonates: Its Relationship to Periventricular Leukomalacia ». *Journal of Neuropathology and Experimental Neurology* 53 (6): 582-89. <https://doi.org/10.1097/00005072-199411000-00005>.

Nakatani, H., E. Martin, H. Hassani, A. Clavairoly, C. L. Maire, A. Viadieu, C. Kerninon, et al. 2013. « Ascl1/Mash1 Promotes Brain Oligodendrogenesis during Myelination and Remyelination ». *Journal of Neuroscience* 33 (23): 9752-68. <https://doi.org/10.1523/JNEUROSCI.0805-13.2013>.

Nash, Mark S., Kenneth W. Young, R. A. John Challiss, et Stefan R. Nahorski. 2001. « Receptor-Specific Messenger Oscillations ». *Nature* 413 (6854): 381-82. <https://doi.org/10.1038/35096643>.

Naumburg, Estelle, et Lars Söderström. 2019. « Increased Risk of Pulmonary Hypertension Following Premature Birth ». *BMC Pediatrics* 19 (1): 288. <https://doi.org/10.1186/s12887-019-1665-6>.

Nawaz, S., A. Kippert, A. S. Saab, H. B. Werner, T. Lang, K.-A. Nave, et M. Simons. 2009. « Phosphatidylinositol 4,5-Bisphosphate-Dependent Interaction of Myelin Basic Protein with the Plasma Membrane in Oligodendroglial Cells and Its Rapid Perturbation by Elevated Calcium ». *Journal of Neuroscience* 29 (15): 4794-4807. <https://doi.org/10.1523/JNEUROSCI.3955-08.2009>.

Nawaz, Schanila, Paula Sánchez, Sebastian Schmitt, Nicolas Snaidero, Mišo Mitkovski, Caroline Velte, Bastian R. Brückner, et al. 2015. « Actin Filament Turnover Drives Leading Edge Growth during Myelin Sheath Formation in the Central Nervous System ». *Developmental Cell* 34 (2): 139-51. <https://doi.org/10.1016/j.devcel.2015.05.013>.

Newcombe, Jia, Alim Uddin, Rosamund Dove, Bela Patel, Lechoslaw Turski, Yukio Nishizawa, et Terence Smith. 2008. « Glutamate Receptor Expression in Multiple Sclerosis Lesions ». *Brain Pathology* 18 (1): 52-61. <https://doi.org/10.1111/j.1750-3639.2007.00101.x>.

Nichols, James M., et Barbara L.F. Kaplan. 2020. « Immune Responses Regulated by Cannabidiol ». *Cannabis and Cannabinoid Research* 5 (1): 12-31. <https://doi.org/10.1089/can.2018.0073>.

- Niehrs, Christof. 2010. « On Growth and Form: A Cartesian Coordinate System of Wnt and BMP Signaling Specifies Bilaterian Body Axes ». *Development* 137 (6): 845-57. <https://doi.org/10.1242/dev.039651>.
- Nikitin, A., S. Egorov, N. Daraselia, et I. Mazo. 2003. « Pathway Studio--the Analysis and Navigation of Molecular Networks ». *Bioinformatics* 19 (16): 2155-57. <https://doi.org/10.1093/bioinformatics/btg290>.
- Nishiyama, Akiko, Ansi Chang, et Bruce D. Trapp. 1999. « NG2+ Glial Cells: A Novel Glial Cell Population in the Adult Brain ». *Journal of Neuropathology and Experimental Neurology* 58 (11): 1113-24. <https://doi.org/10.1097/00005072-199911000-00001>.
- Niswender, Colleen M., et P. Jeffrey Conn. 2010. « Metabotropic Glutamate Receptors: Physiology, Pharmacology, and Disease ». *Annual Review of Pharmacology and Toxicology* 50 (1): 295-322. <https://doi.org/10.1146/annurev.pharmtox.011008.145533>.
- Nitschke, Roland, Anna Henger, Sigrid Ricken, Victoria Müller, Michael Köttgen, Martin Bek, et Hermann Pavenstädt. 2001. « Acetylcholine Increases the Free Intracellular Calcium Concentration in Podocytes in Intact Rat Glomeruli via Muscarinic M₅ Receptors ». *Journal of the American Society of Nephrology* 12 (4): 678-87. <https://doi.org/10.1681/ASN.V124678>.
- Noctor, Stephen C., Alexander C. Flint, Tammy A. Weissman, Winston S. Wong, Brian K. Clinton, et Arnold R. Kriegstein. 2002. « Dividing Precursor Cells of the Embryonic Cortical Ventricular Zone Have Morphological and Molecular Characteristics of Radial Glia ». *The Journal of Neuroscience* 22 (8): 3161-73. <https://doi.org/10.1523/JNEUROSCI.22-08-03161.2002>.
- Noctor, Stephen C, Verónica Martínez-Cerdeño, Lidija Ivic, et Arnold R Kriegstein. 2004. « Cortical Neurons Arise in Symmetric and Asymmetric Division Zones and Migrate through Specific Phases ». *Nature Neuroscience* 7 (2): 136-44. <https://doi.org/10.1038/nn1172>.
- Norman, Jane E. 2020. « Progesterone and Preterm Birth ». *International Journal of Gynecology & Obstetrics* 150 (1): 24-30. <https://doi.org/10.1002/ijgo.13187>.
- Norman, Jane Elizabeth, Neil Marlow, Claudia-Martina Messow, Andrew Shennan, Phillip R Bennett, Steven Thornton, Stephen C Robson, et al. 2016. « Vaginal Progesterone Prophylaxis for Preterm Birth (the OPPTIMUM Study): A Multicentre, Randomised, Double-Blind Trial ». *The Lancet* 387 (10033): 2106-16. [https://doi.org/10.1016/S0140-6736\(16\)00350-0](https://doi.org/10.1016/S0140-6736(16)00350-0).
- Norton, W. T., et Shirley E. Poduslo. 1973. « MYELINATION IN RAT BRAIN: CHANGES IN MYELIN COMPOSITION DURING BRAIN MATURATION ». *Journal of Neurochemistry* 21 (4): 759-73. <https://doi.org/10.1111/j.1471-4159.1973.tb07520.x>.
- Nozari, Ehsan, Saied Ghavamzadeh, et Nazanin Razazian. 2019. « The Effect of Vitamin B12 and Folic Acid Supplementation on Serum Homocysteine, Anemia Status and Quality of Life of Patients with Multiple Sclerosis ». *Clinical Nutrition Research* 8 (1): 36. <https://doi.org/10.7762/cnr.2019.8.1.36>.
- Ogata, Sachie, Yasutaka Kubota, Shinji Satoh, Shinich Ito, Hiroshi Takeuchi, Megumi Ashizuka, et Kanemitsu Shirasuna. 2006. « Ca²⁺ Stimulates COX-2 Expression through Calcium-Sensing Receptor in Fibroblasts ». *Biochemical and Biophysical Research Communications* 351 (4): 808-14. <https://doi.org/10.1016/j.bbrc.2006.10.098>.
- Okada, Makiko, Koichi Murase, Akihisa Makino, Mitsunari Nakajima, Teppei Kaku, Shoei Furukawa, et Yoshiko Furukawa. 2008. « Effects of Estrogens on Proliferation and Differentiation of Neural Stem/Progenitor Cells ». *Biomedical Research* 29 (3): 163-70. <https://doi.org/10.2220/biomedres.29.163>.
- Okamura, Daryl M., Subramaniam Pennathur, Katie Pasichnyk, Jesús M. López-Guisa, Sarah Collins, Maria Febbraio, Jay Heinecke, et Allison A. Eddy. 2009. « CD36 Regulates Oxidative Stress and Inflammation in Hypercholesterolemic CKD ». *Journal of the American Society of Nephrology* 20 (3): 495-505. <https://doi.org/10.1681/ASN.2008010009>.
- Olivier, Paul, Romain H. Fontaine, Gauthier Loron, Juliette Van Steenwinckel, Valérie Biran, Véronique

- Massonneau, Angela Kaindl, et al. 2009. « Correction: Melatonin Promotes Oligodendroglial Maturation of Injured White Matter in Neonatal Rats ». *PLoS ONE* 4 (10). <https://doi.org/10.1371/annotation/d6a43156-441c-4dac-ab10-ee85b6215b1e>.
- Olson, E. B. 1979. « Role of Glucocorticoids in Lung Maturation ». *Journal of Animal Science* 49 (1): 225-38. <https://doi.org/10.2527/jas1979.491225x>.
- Oluich, L.-J., J. A. S. Stratton, Y. Lulu Xing, S. W. Ng, H. S. Cate, P. Sah, F. Windels, T. J. Kilpatrick, et T. D. Merson. 2012. « Targeted Ablation of Oligodendrocytes Induces Axonal Pathology Independent of Overt Demyelination ». *Journal of Neuroscience* 32 (24): 8317-30. <https://doi.org/10.1523/JNEUROSCI.1053-12.2012>.
- on behalf of ELGAN Study Group, Rachana Singh, Laurie M. Douglass, T. Michael O'Shea, Carl E. Stafstrom, Elizabeth N. Allred, Stephen Engelke, et al. 2019. « Antecedents of Epilepsy and Seizures among Children Born at Extremely Low Gestational Age ». *Journal of Perinatology* 39 (6): 774-83. <https://doi.org/10.1038/s41372-019-0355-4>.
- Ong, W.Y., et J.M. Levine. 1999. « A Light and Electron Microscopic Study of NG2 Chondroitin Sulfate Proteoglycan-Positive Oligodendrocyte Precursor Cells in the Normal and Kainate-Lesioned Rat Hippocampus ». *Neuroscience* 92 (1): 83-95. [https://doi.org/10.1016/S0306-4522\(98\)00751-9](https://doi.org/10.1016/S0306-4522(98)00751-9).
- Ortiz, Fernando C., Chloé Habermacher, Mariana Graciarena, Pierre-Yves Houry, Akiko Nishiyama, Brahim Nait Oumesmar, et María Cecilia Angulo. 2019. « Neuronal Activity in Vivo Enhances Functional Myelin Repair ». *JCI Insight* 4 (9): e123434. <https://doi.org/10.1172/jci.insight.123434>.
- Osipovitch, Mikhail, Andrea Asenjo Martinez, John N. Mariani, Adam Cornwell, Simrat Dhaliwal, Lisa Zou, Devin Chandler-Militello, et al. 2019. « Human ESC-Derived Chimeric Mouse Models of Huntington's Disease Reveal Cell-Intrinsic Defects in Glial Progenitor Cell Differentiation ». *Cell Stem Cell* 24 (1): 107-122.e7. <https://doi.org/10.1016/j.stem.2018.11.010>.
- Ozawa, Tatsuya, Cameron W. Brennan, Lu Wang, Massimo Squatrito, Takashi Sasayama, Mitsutoshi Nakada, Jason T. Huse, et al. 2010. « PDGFRA Gene Rearrangements Are Frequent Genetic Events in PDGFRA -Amplified Glioblastomas ». *Genes & Development* 24 (19): 2205-18. <https://doi.org/10.1101/gad.1972310>.
- Paez, P. M., D. J. Fulton, V. Spreur, V. Handley, et A. T. Campagnoni. 2010. « Multiple Kinase Pathways Regulate Voltage-Dependent Ca²⁺ Influx and Migration in Oligodendrocyte Precursor Cells ». *Journal of Neuroscience* 30 (18): 6422-33. <https://doi.org/10.1523/JNEUROSCI.5086-09.2010>.
- Paez, Pablo M., et David A. Lyons. 2020. « Calcium Signaling in the Oligodendrocyte Lineage: Regulators and Consequences ». *Annual Review of Neuroscience* 43 (1): 163-86. <https://doi.org/10.1146/annurev-neuro-100719-093305>.
- Panchision, David M. 2009. « The Role of Oxygen in Regulating Neural Stem Cells in Development and Disease ». *Journal of Cellular Physiology* 220 (3): 562-68. <https://doi.org/10.1002/jcp.21812>.
- Pang, Yi, Baoying Zheng, Lir-Wan Fan, Philip G. Rhodes, et Zhengwei Cai. 2007. « IGF-1 Protects Oligodendrocyte Progenitors against TNF α -Induced Damage by Activation of PI3K/Akt and Interruption of the Mitochondrial Apoptotic Pathway ». *Glia* 55 (11): 1099-1107. <https://doi.org/10.1002/glia.20530>.
- Papeix, Caroline, et Catherine Lubetzki. 2009. « Anticorps monoclonaux dans la sclérose en plaques ». *médecine/sciences* 25 (12): 1113-15. <https://doi.org/10.1051/medsci/200925121113>.
- Parchizadeh, sahar, et Behrooz Salehi-Eskandari. 2021. « The Effect Of Vitamin B12 and Folic Acid on Multiple Sclerosis in Mice ». *International Journal of Advanced Biological and Biomedical Research* 9 (2). <https://doi.org/10.22034/ijabbr.2021.524303.1347>.
- Parras, C. M., C. Hunt, M. Sugimori, M. Nakafuku, D. Rowitch, et F. Guillemot. 2007. « The Proneural Gene Mash1 Specifies an Early Population of Telencephalic Oligodendrocytes ». *Journal of Neuroscience* 27 (16): 4233-42. <https://doi.org/10.1523/JNEUROSCI.0126-07.2007>.

Parras, Carlos M, Rossella Galli, Olivier Britz, Sylvia Soares, Christophe Galichet, James Battiste, Jane E Johnson, Masato Nakafuku, Angelo Vescovi, et François Guillemot. 2004. « Mash1 specifies neurons and oligodendrocytes in the postnatal brain ». *The EMBO Journal* 23 (22): 4495-4505. <https://doi.org/10.1038/sj.emboj.7600447>.

Pchitskaya, Ekaterina, Elena Popugaeva, et Ilya Bezprozvanny. 2018. « Calcium Signaling and Molecular Mechanisms Underlying Neurodegenerative Diseases ». *Cell Calcium* 70 (mars): 87-94. <https://doi.org/10.1016/j.ceca.2017.06.008>.

Peferoen, Laura A.N., Daphne Y.S. Vogel, Kimberley Ummenthum, Marjolein Breur, Priscilla D.A.M. Heijnen, Wouter H. Gerritsen, Regina M.B. Peferoen-Baert, Paul van der Valk, Christine D. Dijkstra, et Sandra Amor. 2015. « Activation Status of Human Microglia Is Dependent on Lesion Formation Stage and Remyelination in Multiple Sclerosis ». *Journal of Neuropathology & Experimental Neurology* 74 (1): 48-63. <https://doi.org/10.1097/NEN.000000000000149>.

Pei, Yanxin, Sonja N. Brun, Shirley L. Markant, William Lento, Paul Gibson, Makoto M. Taketo, Marco Giovannini, Richard J. Gilbertson, et Robert J. Wechsler-Reya. 2012. « WNT Signaling Increases Proliferation and Impairs Differentiation of Stem Cells in the Developing Cerebellum ». *Development* 139 (10): 1724-33. <https://doi.org/10.1242/dev.050104>.

Peineau, N., K.G. Mongo, J.-Y. Guennec, D. Garnier, et J.A. Argibay. 1992. « Alteration of the L-Type Calcium Current in Guinea-Pig Single Ventricular Myocytes by Heptaminol Hydrochloride ». *British Journal of Pharmacology* 107 (1): 104-8. <https://doi.org/10.1111/j.1476-5381.1992.tb14470.x>.

Pelvig, D.P., H. Pakkenberg, A.K. Stark, et B. Pakkenberg. 2008. « Neocortical Glial Cell Numbers in Human Brains ». *Neurobiology of Aging* 29 (11): 1754-62. <https://doi.org/10.1016/j.neurobiolaging.2007.04.013>.

Philips, Thomas, Andre Bento-Abreu, Annelies Nonneman, Wanda Haeck, Kim Staats, Veerle Geelen, Nicole Hersmus, et al. 2013. « Oligodendrocyte Dysfunction in the Pathogenesis of Amyotrophic Lateral Sclerosis ». *Brain* 136 (2): 471-82. <https://doi.org/10.1093/brain/aws339>.

Phillips, Owen R., Shantanu H. Joshi, Ferdinando Squitieri, Cristina Sanchez-Castaneda, Katherine Narr, David W. Shattuck, Carlo Caltagirone, Umberto Sabatini, et Margherita Di Paola. 2016. « Major Superficial White Matter Abnormalities in Huntington's Disease ». *Frontiers in Neuroscience* 10 (mai). <https://doi.org/10.3389/fnins.2016.00197>.

Piaton, Gabrièle, Marie-Stéphane Aigrot, Anna Williams, Sarah Moyon, Vanja Tepavcevic, Imane Moutkine, Julien Gras, et al. 2011. « Class 3 Semaphorins Influence Oligodendrocyte Precursor Recruitment and Remyelination in Adult Central Nervous System ». *Brain* 134 (4): 1156-67. <https://doi.org/10.1093/brain/awr022>.

Pierrat, Véronique, Laetitia Marchand-Martin, Stéphane Marret, Catherine Arnaud, Valérie Benhammou, Gilles Cambonie, Thierry Debillon, et al. 2021. « Neurodevelopmental Outcomes at Age 5 among Children Born Preterm: EPIPAGE-2 Cohort Study ». *BMJ*, avril, n741. <https://doi.org/10.1136/bmj.n741>.

Pilz, Gregor-Alexander, Atsunori Shitamukai, Isabel Reillo, Emilie Pacary, Julia Schwausch, Ronny Stahl, Jovica Ninkovic, et al. 2013. « Amplification of Progenitors in the Mammalian Telencephalon Includes a New Radial Glial Cell Type ». *Nature Communications* 4 (1): 2125. <https://doi.org/10.1038/ncomms3125>.

Pistollato, Francesca, Hui-Ling Chen, Philip H. Schwartz, Giuseppe Basso, et David M. Panchision. 2007. « Oxygen Tension Controls the Expansion of Human CNS Precursors and the Generation of Astrocytes and Oligodendrocytes ». *Molecular and Cellular Neuroscience* 35 (3): 424-35. <https://doi.org/10.1016/j.mcn.2007.04.003>.

Pitt, David, Peter Werner, et Cedric S. Raine. 2000. « Glutamate Excitotoxicity in a Model of Multiple Sclerosis ». *Nature Medicine* 6 (1): 67-70. <https://doi.org/10.1038/71555>.

Pizzorno, Andrés, Blandine Padey, Olivier Terrier, et Manuel Rosa-Calatrava. 2019. « Drug Repurposing Approaches for the Treatment of Influenza Viral Infection: Reviving Old Drugs to Fight Against a Long-Lived

- Enemy ». *Frontiers in Immunology* 10 (mars): 531. <https://doi.org/10.3389/fimmu.2019.00531>.
- Poliak, Sebastian, et Elior Peles. 2003. « The Local Differentiation of Myelinated Axons at Nodes of Ranvier ». *Nature Reviews Neuroscience* 4 (12): 968-80. <https://doi.org/10.1038/nrn1253>.
- Pombero, Ana, et Salvador Martinez. 2009. « Telencephalic Morphogenesis during the Process of Neurulation: An Experimental Study Using Quail-Chick Chimeras ». *The Journal of Comparative Neurology* 512 (6): 784-97. <https://doi.org/10.1002/cne.21933>.
- Ponath, Gerald, Calvin Park, et David Pitt. 2018. « The Role of Astrocytes in Multiple Sclerosis ». *Frontiers in Immunology* 9 (février): 217. <https://doi.org/10.3389/fimmu.2018.00217>.
- Preisner, Anna, Stefanie Albrecht, Qiao-Ling Cui, Stephanie Hucke, Julia Ghelman, Christine Hartmann, Makoto Mark Taketo, Jack Antel, Luisa Klotz, et Tanja Kuhlmann. 2015. « Non-Steroidal Anti-Inflammatory Drug Indometacin Enhances Endogenous Remyelination ». *Acta Neuropathologica* 130 (2): 247-61. <https://doi.org/10.1007/s00401-015-1426-z>.
- Prineas, J. W., E. E. Kwon, P. Z. Goldenberg, A. A. Ilyas, R. H. Quarles, J. A. Benjamins, et T. J. Sprinkle. 1989. « Multiple Sclerosis. Oligodendrocyte Proliferation and Differentiation in Fresh Lesions ». *Laboratory Investigation; a Journal of Technical Methods and Pathology* 61 (5): 489-503.
- Pringle, N.P., H.S. Mudhar, E.J. Collarini, et W.D. Richardson. 1992. « PDGF Receptors in the Rat CNS: During Late Neurogenesis, PDGF Alpha-Receptor Expression Appears to Be Restricted to Glial Cells of the Oligodendrocyte Lineage ». *Development* 115 (2): 535-51. <https://doi.org/10.1242/dev.115.2.535>.
- Pyka, Martin, Claudia Busse, Constanze Seidenbecher, Eckart D. Gundelfinger, et Andreas Faissner. 2011. « Astrocytes Are Crucial for Survival and Maturation of Embryonic Hippocampal Neurons in a Neuron-Glia Cell-Insert Coculture Assay ». *Synapse* 65 (1): 41-53. <https://doi.org/10.1002/syn.20816>.
- Qu, Qiuhaio, Guoqiang Sun, Kiyohito Murai, Peng Ye, Wendong Li, Grace Asuelime, Yuen-Ting Cheung, et Yanhong Shi. 2013. « Wnt7a Regulates Multiple Steps of Neurogenesis ». *Molecular and Cellular Biology* 33 (13): 2551-59. <https://doi.org/10.1128/MCB.00325-13>.
- Raff, Martin C., Robert H. Miller, et Mark Noble. 1983. « A Glial Progenitor Cell That Develops in Vitro into an Astrocyte or an Oligodendrocyte Depending on Culture Medium ». *Nature* 303 (5916): 390-96. <https://doi.org/10.1038/303390a0>.
- Rakic, Pasko. 1972. « Mode of Cell Migration to the Superficial Layers of Fetal Monkey Neocortex ». *The Journal of Comparative Neurology* 145 (1): 61-83. <https://doi.org/10.1002/cne.901450105>.
- Ramos-Cejudo, Jaime, María Gutiérrez-Fernández, Laura Otero-Ortega, Berta Rodríguez-Frutos, Blanca Fuentes, Maria Teresa Vallejo-Cremades, Teresa Navarro Hernanz, Sebastián Cerdán, et Exuperio Díez-Tejedor. 2015. « Brain-Derived Neurotrophic Factor Administration Mediated Oligodendrocyte Differentiation and Myelin Formation in Subcortical Ischemic Stroke ». *Stroke* 46 (1): 221-28. <https://doi.org/10.1161/STROKEAHA.114.006692>.
- Rankin, Kelsey A., Feng Mei, Kicheol Kim, Yun-An A. Shen, Sonia R. Mayoral, Caroline Desponts, Daniel S. Lorrain, et al. 2019. « Selective Estrogen Receptor Modulators Enhance CNS Remyelination Independent of Estrogen Receptors ». *The Journal of Neuroscience* 39 (12): 2184-94. <https://doi.org/10.1523/JNEUROSCI.1530-18.2019>.
- Raposo, Alexandre A.S.F., Francisca F. Vasconcelos, Daniela Drechsel, Corentine Marie, Caroline Johnston, Dirk Dolle, Angela Bithell, et al. 2015. « Ascl1 Coordinately Regulates Gene Expression and the Chromatin Landscape during Neurogenesis ». *Cell Reports* 10 (9): 1544-56. <https://doi.org/10.1016/j.celrep.2015.02.025>.
- Raza, S.S., M.M. Khan, A. Ahmad, M. Ashafaq, F. Islam, A.P. Wagner, M.M. Safhi, et F. Islam. 2013. « Neuroprotective Effect of Naringenin Is Mediated through Suppression of NF-KB Signaling Pathway in Experimental Stroke ». *Neuroscience* 230 (janvier): 157-71. <https://doi.org/10.1016/j.neuroscience.2012.10.041>.

- Reemst, Kitty, Stephen C. Noctor, Paul J. Lucassen, et Elly M. Hol. 2016. « The Indispensable Roles of Microglia and Astrocytes during Brain Development ». *Frontiers in Human Neuroscience* 10 (novembre). <https://doi.org/10.3389/fnhum.2016.00566>.
- Reiprich, Simone, Martina Cantone, Matthias Weider, Tina Baroti, Jan Wittstatt, Christian Schmitt, Melanie Küspert, Julio Vera, et Michael Wegner. 2017. « Transcription Factor Sox10 Regulates Oligodendroglial Sox9 Levels via MicroRNAs: Sox Proteins and MicroRNAs ». *Glia* 65 (7): 1089-1102. <https://doi.org/10.1002/glia.23146>.
- Reiter, Russel J., Juan C. Mayo, Dun-Xian Tan, Rosa M. Sainz, Moises Alatorre-Jimenez, et Lilan Qin. 2016. « Melatonin as an Antioxidant: Under Promises but over Delivers ». *Journal of Pineal Research* 61 (3): 253-78. <https://doi.org/10.1111/jpi.12360>.
- Revinski, Diego R., Alejandra R. Paganelli, Andrés E. Carrasco, et Silvia L. López. 2010. « Delta-Notch Signaling Is Involved in the Segregation of the Three Germ Layers in *Xenopus Laevis* ». *Developmental Biology* 339 (2): 477-92. <https://doi.org/10.1016/j.ydbio.2010.01.010>.
- Reynolds, Brent A., et Samuel Weiss. 1992. « Generation of Neurons and Astrocytes from Isolated Cells of the Adult Mammalian Central Nervous System ». *Science* 255 (5052): 1707-10. <https://doi.org/10.1126/science.1553558>.
- Reynolds, Rebecca M. 2013. « Glucocorticoid Excess and the Developmental Origins of Disease: Two Decades of Testing the Hypothesis – 2012 Curt Richter Award Winner ». *Psychoneuroendocrinology* 38 (1): 1-11. <https://doi.org/10.1016/j.psyneuen.2012.08.012>.
- Richards, L. J., T. J. Kilpatrick, et P. F. Bartlett. 1992. « De Novo Generation of Neuronal Cells from the Adult Mouse Brain. » *Proceedings of the National Academy of Sciences* 89 (18): 8591-95. <https://doi.org/10.1073/pnas.89.18.8591>.
- Richter, Wito, Frank S. Menniti, Han-Ting Zhang, et Marco Conti. 2013. « PDE4 as a Target for Cognition Enhancement ». *Expert Opinion on Therapeutic Targets* 17 (9): 1011-27. <https://doi.org/10.1517/14728222.2013.818656>.
- Ricigliano, Vito A. G., Matteo Tonietto, Mariem Hamzaoui, Émilie Poirion, Andrea Lazzarotto, Michel Bottlaender, Philippe Gervais, Elisabeth Maillart, Bruno Stankoff, et Benedetta Bodini. 2022. « Spontaneous Remyelination in Lesions Protects the Integrity of Surrounding Tissues over Time in Multiple Sclerosis ». *European Journal of Neurology*, février, ene.15285. <https://doi.org/10.1111/ene.15285>.
- Riedel, Michael, Norbert Müller, Martin Strassnig, Ilja Spellmann, Emanuel Severus, et Hans-Jürgen Möller. 2007. « Quetiapine in the Treatment of Schizophrenia and Related Disorders ». *Neuropsychiatric Disease and Treatment* 3 (2): 219-35. <https://doi.org/10.2147/ndt.2007.3.2.219>.
- Rinholm, J. E., N. B. Hamilton, N. Kessaris, W. D. Richardson, L. H. Bergersen, et D. Attwell. 2011. « Regulation of Oligodendrocyte Development and Myelination by Glucose and Lactate ». *Journal of Neuroscience* 31 (2): 538-48. <https://doi.org/10.1523/JNEUROSCI.3516-10.2011>.
- Rivers, Leanne E, Kaylene M Young, Matteo Rizzi, Françoise Jamen, Konstantina Psachoulia, Anna Wade, Nicoletta Kessaris, et William D Richardson. 2008. « PDGFRA/NG2 Glia Generate Myelinating Oligodendrocytes and Piriform Projection Neurons in Adult Mice ». *Nature Neuroscience* 11 (12): 1392-1401. <https://doi.org/10.1038/nn.2220>.
- Robins, Sarah C., Eric Trudel, Olivia Rotondi, Xiaohong Liu, Tina Djogo, Darya Kryzskaya, Charles W. Bourque, et Maia V. Kokoeva. 2013. « Evidence for NG2-Glia Derived, Adult-Born Functional Neurons in the Hypothalamus ». Édité par Martine Migaud. *PLoS ONE* 8 (10): e78236. <https://doi.org/10.1371/journal.pone.0078236>.
- Robinson, Andrew P., Joanne Zhongyan Zhang, Haley E. Titus, Molly Karl, Mikhail Merzliakov, Adam R. Dorfman, Stephen Karlik, et al. 2020. « Nanocatalytic Activity of Clean-Surfaced, Faceted Nanocrystalline Gold Enhances Remyelination in Animal Models of Multiple Sclerosis ». *Scientific Reports* 10 (1): 1936. <https://doi.org/10.1038/s41598-020-58709-w>.

- Rodondi, Nicolas, Wendy P. J. den Elzen, Douglas C. Bauer, Anne R. Cappola, Salman Razvi, John P. Walsh, Bjørn O. Åsvold, et al. 2010. « Subclinical Hypothyroidism and the Risk of Coronary Heart Disease and Mortality ». *JAMA* 304 (12): 1365. <https://doi.org/10.1001/jama.2010.1361>.
- Rodriguez-Porcel, Federico, Donald Green, Nidhi Khatri, Sharonda Swilley Harris, Warren L. May, Rick C.S. Lin, et Ian A. Paul. 2011. « Neonatal Exposure of Rats to Antidepressants Affects Behavioral Reactions to Novelty and Social Interactions in a Manner Analogous to Autistic Spectrum Disorders ». *The Anatomical Record: Advances in Integrative Anatomy and Evolutionary Biology* 294 (10): 1726-35. <https://doi.org/10.1002/ar.21402>.
- Rogers, S. W., N. Z. Gregori, N. Carlson, L. C. Gahring, et M. Noble. 2001. « Neuronal Nicotinic Acetylcholine Receptor Expression by O2A/Oligodendrocyte Progenitor Cells ». *Glia* 33 (4): 306-13.
- Rone, M. B., Q.-L. Cui, J. Fang, L.-C. Wang, J. Zhang, D. Khan, M. Bedard, et al. 2016. « Oligodendroglipathy in Multiple Sclerosis: Low Glycolytic Metabolic Rate Promotes Oligodendrocyte Survival ». *Journal of Neuroscience* 36 (17): 4698-4707. <https://doi.org/10.1523/JNEUROSCI.4077-15.2016>.
- Rong, Wei, Yong-wei Pan, Xu Cai, Fei Song, Zhe Zhao, Song-hua Xiao, et Cheng Zhang. 2017. « The Mechanism of Naringin-Enhanced Remyelination after Spinal Cord Injury ». *Neural Regeneration Research* 12 (3): 470. <https://doi.org/10.4103/1673-5374.202923>.
- Roostaei, Tina, Mohammad Ali Sahraian, Sara Hajeaghaee, Taha Gholipour, Mansoureh Togha, Bahaadin Siroos, Sepideh Mansouri, Zahra Mohammadshirazi, Maryam Aghazadeh Alasti, et Mohammad Hossein Harirchian. 2015. « Impact of Melatonin on Motor, Cognitive and Neuroimaging Indices in Patients with Multiple Sclerosis ». *Iranian Journal of Allergy, Asthma, and Immunology* 14 (6): 589-95.
- Rose, Jordan, Christian Brian, Aglaia Pappa, Mihalis I. Panayiotidis, et Rodrigo Franco. 2020. « Mitochondrial Metabolism in Astrocytes Regulates Brain Bioenergetics, Neurotransmission and Redox Balance ». *Frontiers in Neuroscience* 14 (novembre): 536682. <https://doi.org/10.3389/fnins.2020.536682>.
- Rosenberg, Paul A., Ya Li, Sanjida Ali, Nedret Altiok, Stephen A. Back, et Joseph J. Volpe. 2002. « Intracellular Redox State Determines Whether Nitric Oxide Is Toxic or Protective to Rat Oligodendrocytes in Culture ». *Journal of Neurochemistry* 73 (2): 476-84. <https://doi.org/10.1046/j.1471-4159.1999.0730476.x>.
- Rosin, Claudia, Sergio Colombo, Andrew A. Calver, Timothy E. Bates, et Stephen D. Skaper. 2005. « Dopamine D2 and D3 Receptor Agonists Limit Oligodendrocyte Injury Caused by Glutamate Oxidative Stress and Oxygen/Glucose Deprivation ». *Glia* 52 (4): 336-43. <https://doi.org/10.1002/glia.20250>.
- Rosko, Lauren, Victoria N. Smith, Reiji Yamazaki, et Jeffrey K. Huang. 2019. « Oligodendrocyte Bioenergetics in Health and Disease ». *The Neuroscientist* 25 (4): 334-43. <https://doi.org/10.1177/1073858418793077>.
- Roth, Alejandro D, Gigliola Ramírez, Rodrigo Alarcón, et Rommy Von Bernhardt. 2005. « Oligodendrocytes Damage in Alzheimer's Disease: Beta Amyloid Toxicity and Inflammation ». *Biological Research* 38 (4). <https://doi.org/10.4067/S0716-97602005000400011>.
- Roth, Bryan L., et Wesley K. Kroeze. 2015. « Integrated Approaches for Genome-Wide Interrogation of the Druggable Non-Olfactory G Protein-Coupled Receptor Superfamily ». *Journal of Biological Chemistry* 290 (32): 19471-77. <https://doi.org/10.1074/jbc.R115.654764>.
- Rowitch, David H., et Arnold R. Kriegstein. 2010. « Developmental Genetics of Vertebrate Glial-Cell Specification ». *Nature* 468 (7321): 214-22. <https://doi.org/10.1038/nature09611>.
- Rowitch, David H., Q. Richard Lu, Nicoletta Kassaris, et William D. Richardson. 2002. « An 'Oligarchy' Rules Neural Development ». *Trends in Neurosciences* 25 (8): 417-22. [https://doi.org/10.1016/S0166-2236\(02\)02201-4](https://doi.org/10.1016/S0166-2236(02)02201-4).
- Rufini, Alessandra, Florence Malisan, Ivano Condò, et Roberto Testi. 2022. « Drug Repositioning in Friedreich Ataxia ». *Frontiers in Neuroscience* 16 (février): 814445. <https://doi.org/10.3389/fnins.2022.814445>.
- Rusakov, Dmitri A. 2006. « Ca²⁺-Dependent Mechanisms of Presynaptic Control at Central Synapses ». *The*

- Neuroscientist* 12 (4): 317-26. <https://doi.org/10.1177/1073858405284672>.
- Sabo, Jennifer, et Holly Cate. 2013. « Signalling Pathways That Inhibit the Capacity of Precursor Cells for Myelin Repair ». *International Journal of Molecular Sciences* 14 (1): 1031-49. <https://doi.org/10.3390/ijms14011031>.
- Sahdeo, Sunil, Brian D. Scott, Marissa Z. McMackin, Mittal Jasoliya, Brandon Brown, Heike Wulff, Susan L. Perlman, Mark A. Pook, et Gino A. Cortopassi. 2014. « Dyclonine Rescues Frataxin Deficiency in Animal Models and Buccal Cells of Patients with Friedreich's Ataxia ». *Human Molecular Genetics* 23 (25): 6848-62. <https://doi.org/10.1093/hmg/ddu408>.
- Saher, G., S. Quintes, W. Mobius, M. C. Wehr, E.-M. Kramer-Albers, B. Brugger, et K.-A. Nave. 2009. « Cholesterol Regulates the Endoplasmic Reticulum Exit of the Major Membrane Protein P0 Required for Peripheral Myelin Compaction ». *Journal of Neuroscience* 29 (19): 6094-6104. <https://doi.org/10.1523/JNEUROSCI.0686-09.2009>.
- Şahin, Alparslan, Muhammed Şahin, Fatih Mehmet Türkcü, Abdullah Kürşat Cingü, Harun Yüksel, Yasin Çınar, Şeyhmus Arı, et İhsan Çaça. 2014. « Incidence of Retinopathy of Prematurity in Extremely Premature Infants ». *ISRN Pediatrics* 2014 (mars): 1-4. <https://doi.org/10.1155/2014/134347>.
- Sampaio-Baptista, C., A. A. Khrapitchev, S. Foxley, T. Schlagheck, J. Scholz, S. Jbabdi, G. C. DeLuca, et al. 2013. « Motor Skill Learning Induces Changes in White Matter Microstructure and Myelination ». *Journal of Neuroscience* 33 (50): 19499-503. <https://doi.org/10.1523/JNEUROSCI.3048-13.2013>.
- Sanders, Jessica N, Sara E Simonsen, Christina A Porucznik, Ahmad O Hammoud, Ken Smith, et Joseph Stanford. 2021. « Fertility Treatments and the Risk of Preterm Birth Among Women with Subfertility: A Linked-Data Retrospective Cohort Study ». Preprint. In Review. <https://doi.org/10.21203/rs.3.rs-206714/v1>.
- Sanmarco, Liliana M., Carolina M. Polonio, Michael A. Wheeler, et Francisco J. Quintana. 2021. « Functional Immune Cell–Astrocyte Interactions ». *Journal of Experimental Medicine* 218 (9): e20202715. <https://doi.org/10.1084/jem.20202715>.
- Santiago González, Diara A., Veronica T. Cheli, Norma N. Zamora, Tenzing N. Lama, Vilma Spreuer, Geoffrey G. Murphy, et Pablo M. Paez. 2017. « Conditional Deletion of the L-Type Calcium Channel Cav1.2 in NG2-Positive Cells Impairs Remyelination in Mice ». *The Journal of Neuroscience* 37 (42): 10038-51. <https://doi.org/10.1523/JNEUROSCI.1787-17.2017>.
- Saraswat, Darpan, Hani J. Shayya, Jessie J. Polanco, Ajai Tripathi, R. Ross Welliver, Suyog U. Pol, Richard A. Seidman, et al. 2021. « Overcoming the Inhibitory Microenvironment Surrounding Oligodendrocyte Progenitor Cells Following Experimental Demyelination ». *Nature Communications* 12 (1): 1923. <https://doi.org/10.1038/s41467-021-22263-4>.
- Sarchielli, Paola, Laura Greco, Ardesio Floridi, Alessandro Floridi, et Virgilio Gallai. 2003. « Excitatory Amino Acids and Multiple Sclerosis: Evidence From Cerebrospinal Fluid ». *Archives of Neurology* 60 (8): 1082. <https://doi.org/10.1001/archneur.60.8.1082>.
- Sarkar, Chandan, Cristina Quispe, Sarmin Jamaddar, Rajib Hossain, Pranta Ray, Milon Mondal, Zeinab Abdulwanis Mohamed, et al. 2020. « Therapeutic Promises of Ginkgolide A: A Literature-Based Review ». *Biomedicine & Pharmacotherapy* 132 (décembre): 110908. <https://doi.org/10.1016/j.biopha.2020.110908>.
- Saugstad, Ola Didrik. 2003. « Bronchopulmonary Dysplasia—Oxidative Stress and Antioxidants ». *Seminars in Neonatology* 8 (1): 39-49. [https://doi.org/10.1016/S1084-2756\(02\)00194-X](https://doi.org/10.1016/S1084-2756(02)00194-X).
- Sawamura, Shigeki, Makoto Sawada, Masafumi Ito, Toshiharu Nagatsu, Ikuko Nagatsu, Akio Suzumura, Masato Shibuya, Kenichiro Sugita, et Tohu Marunouchi. 1995. « The Bipotential Glial Progenitor Cell Line Can Develop into Both Oligodendrocytes and Astrocytes in the Mouse Forebrain ». *Neuroscience Letters* 188 (1): 1-4. [https://doi.org/10.1016/0304-3940\(95\)11378-A](https://doi.org/10.1016/0304-3940(95)11378-A).
- Scaglione, Francesco, et Giscardo Panzavolta. 2014. « Folate, Folic Acid and 5-Methyltetrahydrofolate Are Not the Same Thing ». *Xenobiotica* 44 (5): 480-88. <https://doi.org/10.3109/00498254.2013.845705>.
- Schoenwolf, G. C., et I. S. Alvarez. 1989. « Roles of Neuroepithelial Cell Rearrangement and Division in Shaping

of the Avian Neural Plate ». *Development (Cambridge, England)* 106 (3): 427-39.

Scholz, Jan, Miriam C Klein, Timothy E J Behrens, et Heidi Johansen-Berg. 2009. « Training Induces Changes in White-Matter Architecture ». *Nature Neuroscience* 12 (11): 1370-71. <https://doi.org/10.1038/nn.2412>.

Schreiber, Karen, Melinda Magyari, Finn Sellebjerg, Pernille Iversen, Ellen Garde, Camilla Gøbel Madsen, Lars Börnsen, et al. 2017. « High-Dose Erythropoietin in Patients with Progressive Multiple Sclerosis: A Randomized, Placebo-Controlled, Phase 2 Trial ». *Multiple Sclerosis Journal* 23 (5): 675-85. <https://doi.org/10.1177/1352458516661048>.

Scolding, N. 1998. « Oligodendrocyte progenitors are present in the normal adult human CNS and in the lesions of multiple sclerosis ». *Brain* 121 (12): 2221-28. <https://doi.org/10.1093/brain/121.12.2221>.

Scott, Lucas O.M. 2013. « Regulation of Oligodendrocyte Differentiation through Neuroligin-Neurexin Signalling ». <https://doi.org/10.11575/PRISM/27587>.

Seiler, K. P., G. A. George, M. P. Happ, N. E. Bodycombe, H. A. Carrinski, S. Norton, S. Brudz, et al. 2007. « ChemBank: A Small-Molecule Screening and Cheminformatics Resource Database ». *Nucleic Acids Research* 36 (Database): D351-59. <https://doi.org/10.1093/nar/gkm843>.

Serafini, Barbara, Barbara Rosicarelli, Diego Franciotta, Roberta Magliozzi, Richard Reynolds, Paola Cinque, Laura Andreoni, et al. 2007. « Dysregulated Epstein-Barr Virus Infection in the Multiple Sclerosis Brain ». *Journal of Experimental Medicine* 204 (12): 2899-2912. <https://doi.org/10.1084/jem.20071030>.

Serwanski, David R., Peter Jukkola, et Akiko Nishiyama. 2017. « Heterogeneity of Astrocyte and NG2 Cell Insertion at the Node of Ranvier: Frequency of Glial Insertion at the Node ». *Journal of Comparative Neurology* 525 (3): 535-52. <https://doi.org/10.1002/cne.24083>.

Sese, Emmanuel, Rosario Vega, et Enrique Soto. 2014. « Activation of opioid receptors inhibits calcium-currents in the vestibular afferent neurons of the rat through a cAMP dependent mechanism ». *Frontiers in Cellular Neuroscience* 8 (mars). <https://doi.org/10.3389/fncel.2014.00090>.

Shah, Ankur B., S. Sharukh Hashmi, Raj Sahulee, Hariyadarshi Pannu, et Monisha Gupta-Malhotra. 2015. « Characteristics of Systemic Hypertension in Preterm Children ». *The Journal of Clinical Hypertension* 17 (5): 364-70. <https://doi.org/10.1111/jch.12528>.

Shah, N. R., et M. B. Bracken. 2000. « A Systematic Review and Meta-Analysis of Prospective Studies on the Association between Maternal Cigarette Smoking and Preterm Delivery ». *American Journal of Obstetrics and Gynecology* 182 (2): 465-72. [https://doi.org/10.1016/s0002-9378\(00\)70240-7](https://doi.org/10.1016/s0002-9378(00)70240-7).

Shahbazi, Majid, Reza Abdolmohammadi, Hamid Ebadi, et Touraj Farazmandfar. 2017. « Novel Functional Polymorphism in IGF-1 Gene Associated with Multiple Sclerosis: A New Insight to MS ». *Multiple Sclerosis and Related Disorders* 13 (avril): 33-37. <https://doi.org/10.1016/j.msard.2017.02.002>.

Shannon, Paul, Andrew Markiel, Owen Ozier, Nitin S. Baliga, Jonathan T. Wang, Daniel Ramage, Nada Amin, Benno Schwikowski, et Trey Ideker. 2003. « Cytoscape: A Software Environment for Integrated Models of Biomolecular Interaction Networks ». *Genome Research* 13 (11): 2498-2504. <https://doi.org/10.1101/gr.1239303>.

Sharma, G., et S. Vijayaraghavan. 2001. « Nicotinic Cholinergic Signaling in Hippocampal Astrocytes Involves Calcium-Induced Calcium Release from Intracellular Stores ». *Proceedings of the National Academy of Sciences* 98 (7): 4148-53. <https://doi.org/10.1073/pnas.071540198>.

Shen, Siming, Jiadong Li, et Patrizia Casaccia-Bonnel. 2005. « Histone Modifications Affect Timing of Oligodendrocyte Progenitor Differentiation in the Developing Rat Brain ». *Journal of Cell Biology* 169 (4): 577-89. <https://doi.org/10.1083/jcb.200412101>.

Shi, Chun, Fengming Wu, David T. Yew, Jie Xu, et Yonghong Zhu. 2010. « Bilobalide Prevents Apoptosis through Activation of the PI3K/Akt Pathway in SH-SY5Y Cells ». *Apoptosis* 15 (6): 715-27.

<https://doi.org/10.1007/s10495-010-0492-x>.

Shields, Simon A., Jennifer M. Gilson, William F. Blakemore, et Robin J.M. Franklin. 1999. « Remyelination Occurs as Extensively but More Slowly in Old Rats Compared to Young Rats Following Gliotoxin-Induced CNS Demyelination ». *Glia* 28 (1): 77-83. [https://doi.org/10.1002/\(SICI\)1098-1136\(199910\)28:1<77::AID-GLIA9>3.0.CO;2-F](https://doi.org/10.1002/(SICI)1098-1136(199910)28:1<77::AID-GLIA9>3.0.CO;2-F).

Shih, Tsung-Ming, Steven M Duniho, et John H McDonough. 2003. « Control of Nerve Agent-Induced Seizures Is Critical for Neuroprotection and Survival ». *Toxicology and Applied Pharmacology* 188 (2): 69-80. [https://doi.org/10.1016/S0041-008X\(03\)00019-X](https://doi.org/10.1016/S0041-008X(03)00019-X).

Shimizu, Shoko, Yoshihisa Koyama, Tsuyoshi Hattori, Taro Tachibana, Tomohiko Yoshimi, Hisayo Emoto, Yuji Matsumoto, et al. 2014. « DBZ, a CNS-Specific DISC1 Binding Protein, Positively Regulates Oligodendrocyte Differentiation: DBZ Promotes Oligodendrocyte Differentiation ». *Glia* 62 (5): 709-24. <https://doi.org/10.1002/glia.22636>.

Shingo, Tetsuro, S. Todd Sorokan, Takuya Shimazaki, et Samuel Weiss. 2001. « Erythropoietin Regulates the *In Vitro* and *In Vivo* Production of Neuronal Progenitors by Mammalian Forebrain Neural Stem Cells ». *The Journal of Neuroscience* 21 (24): 9733-43. <https://doi.org/10.1523/JNEUROSCI.21-24-09733.2001>.

Shultz, Robert B, et Yinghui Zhong. 2017. « Minocycline Targets Multiple Secondary Injury Mechanisms in Traumatic Spinal Cord Injury ». *Neural Regeneration Research* 12 (5): 702. <https://doi.org/10.4103/1673-5374.206633>.

Sid, Victoria, Nan Wu, Lindsey K. Sarna, Yaw L. Siow, James D. House, et Karmin O. 2015. « Folic Acid Supplementation during High-Fat Diet Feeding Restores AMPK Activation via an AMP-LKB1-Dependent Mechanism ». *American Journal of Physiology-Regulatory, Integrative and Comparative Physiology* 309 (10): R1215-25. <https://doi.org/10.1152/ajpregu.00260.2015>.

Sieber, F. E., S. A. Derrer, C. D. Saudek, et R. J. Traystman. 1989. « Effect of Hypoglycemia on Cerebral Metabolism and Carbon Dioxide Responsivity ». *American Journal of Physiology-Heart and Circulatory Physiology* 256 (3): H697-706. <https://doi.org/10.1152/ajpheart.1989.256.3.H697>.

Silva, Robin P., Karen B. Kelly, Ala Al Rajabi, et René L. Jacobs. 2014. « Novel Insights on Interactions between Folate and Lipid Metabolism ». *BioFactors* 40 (3): 277-83. <https://doi.org/10.1002/biof.1154>.

Sim, Fraser J., Chao Zhao, Jacques Penderis, et Robin J. M. Franklin. 2002. « The Age-Related Decrease in CNS Remyelination Efficiency Is Attributable to an Impairment of Both Oligodendrocyte Progenitor Recruitment and Differentiation ». *The Journal of Neuroscience* 22 (7): 2451-59. <https://doi.org/10.1523/JNEUROSCI.22-07-02451.2002>.

Simeone, D. M., B. C. Kimball, et M. W. Mulholland. 1996. « Acetylcholine-Induced Calcium Signaling Associated with Muscarinic Receptor Activation in Cultured Myenteric Neurons ». *Journal of the American College of Surgeons* 182 (6): 473-81.

Simon, Christiane, Magdalena Götz, et Leda Dimou. 2011. « Progenitors in the Adult Cerebral Cortex: Cell Cycle Properties and Regulation by Physiological Stimuli and Injury ». *Glia* 59 (6): 869-81. <https://doi.org/10.1002/glia.21156>.

Simpson, K. L., K. J. Weaver, E. de Villiers-Sidani, J. Y.- F. Lu, Z. Cai, Y. Pang, F. Rodriguez-Porcel, I. A. Paul, M. Merzenich, et R. C. S. Lin. 2011. « Perinatal Antidepressant Exposure Alters Cortical Network Function in Rodents ». *Proceedings of the National Academy of Sciences* 108 (45): 18465-70. <https://doi.org/10.1073/pnas.1109353108>.

Siracusa, Rosalba, Roberta Fusco, et Salvatore Cuzzocrea. 2019. « Astrocytes: Role and Functions in Brain Pathologies ». *Frontiers in Pharmacology* 10 (septembre): 1114. <https://doi.org/10.3389/fphar.2019.01114>.

Smalley, Joshua L., Carlo Breda, Robert P. Mason, Gurdeep Kooner, Ruth Luthi-Carter, Timothy W. Gant, et Flaviano Giorgini. 2016. « Connectivity Mapping Uncovers Small Molecules That Modulate Neurodegeneration

- in Huntington's Disease Models ». *Journal of Molecular Medicine* 94 (2): 235-45. <https://doi.org/10.1007/s00109-015-1344-5>.
- Smith, Ernest S., Alan Jonason, Christine Reilly, Janaki Veeraraghavan, Terrence Fisher, Michael Doherty, Ekaterina Klimatcheva, et al. 2015. « SEMA4D Compromises Blood–Brain Barrier, Activates Microglia, and Inhibits Remyelination in Neurodegenerative Disease ». *Neurobiology of Disease* 73 (janvier): 254-68. <https://doi.org/10.1016/j.nbd.2014.10.008>.
- Smith, K. J., W. F. Blakemore, et W. I. McDonald. 1979. « Central Remyelination Restores Secure Conduction ». *Nature* 280 (5721): 395-96. <https://doi.org/10.1038/280395a0>.
- Snaidero, Nicolas, Wiebke Möbius, Tim Czopka, Liesbeth H.P. Hekking, Cliff Mathisen, Dick Verkleij, Sandra Goebbels, et al. 2014. « Myelin Membrane Wrapping of CNS Axons by PI(3,4,5)P3-Dependent Polarized Growth at the Inner Tongue ». *Cell* 156 (1-2): 277-90. <https://doi.org/10.1016/j.cell.2013.11.044>.
- Soelberg Sorensen, Per. 2016. « Haematopoietic Stem Cell Transplants Should Be a Second-Line Therapy for Highly Active MS – NO ». *Multiple Sclerosis Journal* 22 (10): 1260-63. <https://doi.org/10.1177/1352458516644341>.
- Sohn, J. 2006. « Identification of Sox17 as a Transcription Factor That Regulates Oligodendrocyte Development ». *Journal of Neuroscience* 26 (38): 9722-35. <https://doi.org/10.1523/JNEUROSCI.1716-06.2006>.
- Sommer, I., et M. Schachner. 1981. « Monoclonal Antibodies (O1 to O4) to Oligodendrocyte Cell Surfaces: An Immunocytological Study in the Central Nervous System ». *Developmental Biology* 83 (2): 311-27. [https://doi.org/10.1016/0012-1606\(81\)90477-2](https://doi.org/10.1016/0012-1606(81)90477-2).
- Soomro, Shahid Hussain, Jifu Jie, et Hui Fu. 2018. « Oligodendrocytes Development and Wnt Signaling Pathway ». Édité par Abdelmonem Awad Mustafa Hegazy. *International Journal of Human Anatomy* 1 (3): 17-35. <https://doi.org/10.14302/issn.2577-2279.ijha-18-2407>.
- Sormani, Maria Pia, Carmen Tur, et Frederik Barkhof. 2021. « Ibudilast: A Paradigm Shift for Progressive Multiple Sclerosis? » *Neurology* 96 (4): 141-42. <https://doi.org/10.1212/WNL.00000000000011312>.
- Soung, Allison, et Robyn S. Klein. 2020. « Astrocytes: Initiators of and Responders to Inflammation ». In *Glia in Health and Disease*, édité par Tania Spohr. IntechOpen. <https://doi.org/10.5772/intechopen.89760>.
- Spampinato, Simona Federica, Sara Merlo, Mariangela Chisari, Ferdinando Nicoletti, et Maria Angela Sortino. 2015. « Glial metabotropic glutamate receptor-4 increases maturation and survival of oligodendrocytes ». *Frontiers in Cellular Neuroscience* 8 (janvier). <https://doi.org/10.3389/fncel.2014.00462>.
- Spemann, H., et H. Mangold. 2001. « Induction of Embryonic Primordia by Implantation of Organizers from a Different Species. 1923 ». *The International Journal of Developmental Biology* 45 (1): 13-38.
- Stadelmann, Christine, Christiane Wegner, et Wolfgang Brück. 2011. « Inflammation, Demyelination, and Degeneration — Recent Insights from MS Pathology ». *Biochimica et Biophysica Acta (BBA) - Molecular Basis of Disease* 1812 (2): 275-82. <https://doi.org/10.1016/j.bbadis.2010.07.007>.
- Stefani, Giovanni, et Frank J. Slack. 2008. « Small Non-Coding RNAs in Animal Development ». *Nature Reviews Molecular Cell Biology* 9 (3): 219-30. <https://doi.org/10.1038/nrm2347>.
- Steinfeld, Robert, Marcel Grapp, Ralph Kraetzner, Steffi Dreha-Kulaczewski, Gunther Helms, Peter Dechent, Ron Wevers, Salvatore Grosso, et Jutta Gärtner. 2009. « Folate Receptor Alpha Defect Causes Cerebral Folate Transport Deficiency: A Treatable Neurodegenerative Disorder Associated with Disturbed Myelin Metabolism ». *The American Journal of Human Genetics* 85 (3): 354-63. <https://doi.org/10.1016/j.ajhg.2009.08.005>.
- Stevens, Beth, Stefania Porta, Laurel L. Haak, Vittorio Gallo, et R. Douglas Fields. 2002. « Adenosine: A Neuron-Glial Transmitter Promoting Myelination in the CNS in Response to Action Potentials ». *Neuron* 36 (5): 855-68. [https://doi.org/10.1016/s0896-6273\(02\)01067-x](https://doi.org/10.1016/s0896-6273(02)01067-x).
- Stolt, C. C. 2002. « Terminal differentiation of myelin-forming oligodendrocytes depends on the transcription

- factor Sox10 ». *Genes & Development* 16 (2): 165-70. <https://doi.org/10.1101/gad.215802>.
- Stolt et al, 2003. « The Sox9 Transcription Factor Determines Glial Fate Choice in the Developing Spinal Cord ». *Genes & Development* 17 (13): 1677-89. <https://doi.org/10.1101/gad.259003>.
- Stolt, C. Claus, Petra Lommes, Ralf P. Friedrich, et Michael Wegner. 2004. « Transcription Factors Sox8 and Sox10 Perform Non-Equivalent Roles during Oligodendrocyte Development despite Functional Redundancy ». *Development* 131 (10): 2349-58. <https://doi.org/10.1242/dev.01114>.
- Stolt, C. Claus, Anita Schlierf, Petra Lommes, Simone Hillgärtner, Torsten Werner, Thomas Kosian, Elisabeth Sock, et al. 2006. « SoxD Proteins Influence Multiple Stages of Oligodendrocyte Development and Modulate SoxE Protein Function ». *Developmental Cell* 11 (5): 697-709. <https://doi.org/10.1016/j.devcel.2006.08.011>.
- Strelau, Jens, et Klaus Unsicker. 1999. « GDNF Family Members and Their Receptors: Expression and Functions in Two Oligodendroglial Cell Lines Representing Distinct Stages of Oligodendroglial Development ». *Glia* 26 (4): 291-301. [https://doi.org/10.1002/\(SICI\)1098-1136\(199906\)26:4<291::AID-GLIA3>3.0.CO;2-P](https://doi.org/10.1002/(SICI)1098-1136(199906)26:4<291::AID-GLIA3>3.0.CO;2-P).
- Striedter, Georg F. 2006. « Principles of Brain Evolution ». *Behavioral and Brain Sciences* 29 (1): 1-12. <https://doi.org/10.1017/S0140525X06009010>.
- Studer, Lorenz, Marie Csete, Sang-Hun Lee, Nadine Kabbani, Jean Walikonis, Barbara Wold, et Ron McKay. 2000. « Enhanced Proliferation, Survival, and Dopaminergic Differentiation of CNS Precursors in Lowered Oxygen ». *The Journal of Neuroscience* 20 (19): 7377-83. <https://doi.org/10.1523/JNEUROSCI.20-19-07377.2000>.
- Stylianou-Riga, Paraskevi, Panayiotis Kouis, Paraskevi Kinni, Angelos Rigas, Thalia Papadouri, Panayiotis K. Yiallourous, et Mamas Theodorou. 2018. « Maternal Socioeconomic Factors and the Risk of Premature Birth and Low Birth Weight in Cyprus: A Case–Control Study ». *Reproductive Health* 15 (1): 157. <https://doi.org/10.1186/s12978-018-0603-7>.
- Su, Zhida, Yimin Yuan, Jingjing Chen, Yanling Zhu, Yang Qiu, Feng Zhu, Aijun Huang, et Cheng He. 2011. « Reactive Astrocytes Inhibit the Survival and Differentiation of Oligodendrocyte Precursor Cells by Secreted TNF- α ». *Journal of Neurotrauma* 28 (6): 1089-1100. <https://doi.org/10.1089/neu.2010.1597>.
- Subramanian, Aravind, Rajiv Narayan, Steven M. Corsello, David D. Peck, Ted E. Natoli, Xiaodong Lu, Joshua Gould, et al. 2017. « A Next Generation Connectivity Map: L1000 Platform and the First 1,000,000 Profiles ». *Cell* 171 (6): 1437-1452.e17. <https://doi.org/10.1016/j.cell.2017.10.049>.
- Sueda, Risa, Itaru Imayoshi, Yukiko Harima, et Ryoichiro Kageyama. 2019. « High Hes1 Expression and Resultant Ascl1 Suppression Regulate Quiescent vs. Active Neural Stem Cells in the Adult Mouse Brain ». *Genes & Development* 33 (9-10): 511-23. <https://doi.org/10.1101/gad.323196.118>.
- Sugiarto, Sista, Anders I. Persson, Elena Gonzalez Munoz, Markus Waldhuber, Chrystelle Lamagna, Noemi Andor, Patrizia Hanecker, et al. 2011. « Asymmetry-Defective Oligodendrocyte Progenitors Are Glioma Precursors ». *Cancer Cell* 20 (3): 328-40. <https://doi.org/10.1016/j.ccr.2011.08.011>.
- Sugimori, Michiya, Motoshi Nagao, Nicolas Bertrand, Carlos M. Parras, François Guillemot, et Masato Nakafuku. 2007. « Combinatorial Actions of Patterning and HLH Transcription Factors in the Spatiotemporal Control of Neurogenesis and Gliogenesis in the Developing Spinal Cord ». *Development* 134 (8): 1617-29. <https://doi.org/10.1242/dev.001255>.
- Sugimori, Michiya, Motoshi Nagao, Carlos M. Parras, Hiroko Nakatani, Mélanie Lebel, François Guillemot, et Masato Nakafuku. 2008. « Ascl1 Is Required for Oligodendrocyte Development in the Spinal Cord ». *Development* 135 (7): 1271-81. <https://doi.org/10.1242/dev.015370>.
- Suh, Hoonkyo, Wei Deng, et Fred H. Gage. 2009. « Signaling in Adult Neurogenesis ». *Annual Review of Cell and Developmental Biology* 25 (1): 253-75. <https://doi.org/10.1146/annurev.cellbio.042308.113256>.
- Sullivan, Genevieve M., Andrew K. Knutsen, Luca Peruzzotti-Jametti, Alexandru Korotcov, Asamoah Bosomtwi, Bernard J. Dardzinski, Joshua D. Bernstock, et al. 2020. « Transplantation of Induced Neural Stem Cells (INSCs) into Chronically Demyelinated Corpus Callosum Ameliorates Motor Deficits ». *Acta Neuropathologica*

Communications 8 (1): 84. <https://doi.org/10.1186/s40478-020-00960-3>.

Suntsova, Maria V., et Anton A. Buzdin. 2020. « Differences between Human and Chimpanzee Genomes and Their Implications in Gene Expression, Protein Functions and Biochemical Properties of the Two Species ». *BMC Genomics* 21 (S7): 535. <https://doi.org/10.1186/s12864-020-06962-8>.

Syed, Yasir A., Alexandra Baer, Matthias P. Hofer, Gínez A. González, Jon Rundle, Szymon Myrta, Jeffrey K. Huang, et al. 2013. « Inhibition of Phosphodiesterase-4 Promotes Oligodendrocyte Precursor Cell Differentiation and Enhances CNS Remyelination ». *EMBO Molecular Medicine* 5 (12): 1918-34. <https://doi.org/10.1002/emmm.201303123>.

Szeligo, F., et C. P. Leblond. 1977. « Response of the Three Main Types of Glial Cells of Cortex Nad Corpus Callosum in Rats Handled during Suckling or Exposed to Enriched, Control and Impoverished Environments Following Weaning ». *The Journal of Comparative Neurology* 172 (2): 247-63. <https://doi.org/10.1002/cne.901720205>.

Takahashi, Kazutoshi, et Shinya Yamanaka. 2006. « Induction of Pluripotent Stem Cells from Mouse Embryonic and Adult Fibroblast Cultures by Defined Factors ». *Cell* 126 (4): 663-76. <https://doi.org/10.1016/j.cell.2006.07.024>.

Takahashi, Nagahide, Takeshi Sakurai, Kenneth L. Davis, et Joseph D. Buxbaum. 2011. « Linking Oligodendrocyte and Myelin Dysfunction to Neurocircuitry Abnormalities in Schizophrenia ». *Progress in Neurobiology* 93 (1): 13-24. <https://doi.org/10.1016/j.pneurobio.2010.09.004>.

Takao, Toshihiro, Nicole Flint, Lan Lee, Xiaoyou Ying, Jean Merrill, et Karen J. Chandross. 2004. « 17beta-Estradiol Protects Oligodendrocytes from Cytotoxicity Induced Cell Death ». *Journal of Neurochemistry* 89 (3): 660-73. <https://doi.org/10.1111/j.1471-4159.2004.02370.x>.

Takashima, S., et K. Tanaka. 1978. « Development of Cerebrovascular Architecture and Its Relationship to Periventricular Leukomalacia ». *Archives of Neurology* 35 (1): 11-16. <https://doi.org/10.1001/archneur.1978.00500250015003>.

Takebayashi, Hirohide, Yoko Nabeshima, Shosei Yoshida, Osamu Chisaka, Kazuhiro Ikenaka, et Yo-ichi Nabeshima. 2002. « The Basic Helix-Loop-Helix Factor Olig2 Is Essential for the Development of Motoneuron and Oligodendrocyte Lineages ». *Current Biology* 12 (13): 1157-63. [https://doi.org/10.1016/S0960-9822\(02\)00926-0](https://doi.org/10.1016/S0960-9822(02)00926-0).

Tanaka, Yuichi, Yusuke Tozuka, Tetsuo Takata, Naoyuki Shimazu, Naoto Matsumura, Aya Ohta, et Tatsuhiro Hisatsune. 2009. « Excitatory GABAergic Activation of Cortical Dividing Glial Cells ». *Cerebral Cortex* 19 (9): 2181-95. <https://doi.org/10.1093/cercor/bhn238>.

Tanner, D. C., J. D. Cherry, et M. Mayer-Proschel. 2011. « Oligodendrocyte Progenitors Reversibly Exit the Cell Cycle and Give Rise to Astrocytes in Response to Interferon- γ ». *Journal of Neuroscience* 31 (16): 6235-46. <https://doi.org/10.1523/JNEUROSCI.5905-10.2011>.

Tasaki, Ichiji. 1939. « ELECTRIC STIMULATION AND THE EXCITATORY PROCESS IN THE NERVE FIBER ». *American Journal of Physiology-Legacy Content* 125 (2): 380-95. <https://doi.org/10.1152/ajplegacy.1939.125.2.380>.

Taverna, Elena, Magdalena Götz, et Wieland B. Huttner. 2014. « The Cell Biology of Neurogenesis: Toward an Understanding of the Development and Evolution of the Neocortex ». *Annual Review of Cell and Developmental Biology* 30 (1): 465-502. <https://doi.org/10.1146/annurev-cellbio-101011-155801>.

Tavian, Manuela, et Bruno Peault. 2005. « Embryonic Development of the Human Hematopoietic System ». *The International Journal of Developmental Biology* 49 (2-3): 243-50. <https://doi.org/10.1387/ijdb.041957mt>.

Tekki-Kessaris, N., R. Woodruff, A. C. Hall, W. Gaffield, S. Kimura, C. D. Stiles, D. H. Rowitch, et W. D. Richardson. 2001. « Hedgehog-Dependent Oligodendrocyte Lineage Specification in the Telencephalon ». *Development (Cambridge, England)* 128 (13): 2545-54.

- Temple, Sally. 2001. « The Development of Neural Stem Cells ». *Nature* 414 (6859): 112-17. <https://doi.org/10.1038/35102174>.
- Temple, Sally, et Martin C. Raff. 1985. « Differentiation of a Bipotential Glial Progenitor Cell in Single Cell Microculture ». *Nature* 313 (5999): 223-25. <https://doi.org/10.1038/313223a0>.
- Thillaiampalam, Gayathri, Fabio Liberante, Liam Murray, Chris Cardwell, Ken Mills, et Shu-Dong Zhang. 2017. « An Integrated Meta-Analysis Approach to Identifying Medications with Potential to Alter Breast Cancer Risk through Connectivity Mapping ». *BMC Bioinformatics* 18 (1): 581. <https://doi.org/10.1186/s12859-017-1989-x>.
- Thomas, P. D., A. Kejariwal, N. Guo, H. Mi, M. J. Campbell, A. Muruganujan, et B. Lazareva-Ulitsky. 2006. « Applications for Protein Sequence-Function Evolution Data: MRNA/Protein Expression Analysis and Coding SNP Scoring Tools ». *Nucleic Acids Research* 34 (Web Server): W645-50. <https://doi.org/10.1093/nar/gkl229>.
- Tilborg, Erik van, Caroline G. M. de Theije, Maurik van Hal, Nienke Wagenaar, Linda S. de Vries, Manon J. Benders, David H. Rowitch, et Cora H. Nijboer. 2018. « Origin and Dynamics of Oligodendrocytes in the Developing Brain: Implications for Perinatal White Matter Injury ». *Glia* 66 (2): 221-38. <https://doi.org/10.1002/glia.23256>.
- Tintore, Mar, Angela Vidal-Jordana, et Jaume Sastre-Garriga. 2019. « Treatment of Multiple Sclerosis — Success from Bench to Bedside ». *Nature Reviews Neurology* 15 (1): 53-58. <https://doi.org/10.1038/s41582-018-0082-z>.
- Tkachev, Dmitri, Michael L Mimmack, Margaret M Ryan, Matt Wayland, Tom Freeman, Peter B Jones, Michael Starkey, Maree J Webster, Robert H Yolken, et Sabine Bahn. 2003. « Oligodendrocyte Dysfunction in Schizophrenia and Bipolar Disorder ». *The Lancet* 362 (9386): 798-805. [https://doi.org/10.1016/S0140-6736\(03\)14289-4](https://doi.org/10.1016/S0140-6736(03)14289-4).
- Tomassy, Giulio Srubek, Daniel R. Berger, Hsu-Hsin Chen, Narayanan Kasthuri, Kenneth J. Hayworth, Alessandro Vercelli, H. Sebastian Seung, Jeff W. Lichtman, et Paola Arlotta. 2014. « Distinct Profiles of Myelin Distribution Along Single Axons of Pyramidal Neurons in the Neocortex ». *Science* 344 (6181): 319-24. <https://doi.org/10.1126/science.1249766>.
- Tommy, Thomas, Andi A. Islam, Mochammad Hatta, Agussalim Bukhari, Nasrullah, Willy Adhimarta, Aminuddin, et Andi Alfian Zainuddin. 2021. « Effect of Folinic Acid on Serum Homocysteine, TNF α , IL-10, and HMGB1 Gene Expression in Head Injury Model ». *Annals of Medicine and Surgery* 65 (mai): 102273. <https://doi.org/10.1016/j.amsu.2021.102273>.
- Tønnesen, Siren, Tobias Kaufmann, Nhat Trung Doan, Dag Alnæs, Aldo Córdova-Palomera, Dennis van der Meer, Jaroslav Rokicki, et al. 2018. « White Matter Aberrations and Age-Related Trajectories in Patients with Schizophrenia and Bipolar Disorder Revealed by Diffusion Tensor Imaging ». *Scientific Reports* 8 (1): 14129. <https://doi.org/10.1038/s41598-018-32355-9>.
- Tropepe, Vincent, Maria Sibilía, Brian G. Ciruna, Janet Rossant, Erwin F. Wagner, et Derek van der Kooy. 1999. « Distinct Neural Stem Cells Proliferate in Response to EGF and FGF in the Developing Mouse Telencephalon ». *Developmental Biology* 208 (1): 166-88. <https://doi.org/10.1006/dbio.1998.9192>.
- Tryoen-Toth, P., C. Gavriaux-Ruff, et G. Labourdette. 2000. « Down-Regulation of Mu-Opioid Receptor Expression in Rat Oligodendrocytes during Their Development in Vitro ». *Journal of Neuroscience Research* 60 (1): 10-20. [https://doi.org/10.1002/\(SICI\)1097-4547\(20000401\)60:1<10::AID-JNR2>3.0.CO;2-O](https://doi.org/10.1002/(SICI)1097-4547(20000401)60:1<10::AID-JNR2>3.0.CO;2-O).
- Turcotte, Caroline, Marie-Renée Blanchet, Michel Laviolette, et Nicolas Flamand. 2016. « The CB2 Receptor and Its Role as a Regulator of Inflammation ». *Cellular and Molecular Life Sciences* 73 (23): 4449-70. <https://doi.org/10.1007/s00018-016-2300-4>.
- Turkoglu, Recai, Murat Giris, Mehmet Gencer, Ugur Akcan, et Arda Orcen. 2016. « Serum Prolactin Levels in Multiple Sclerosis, Neuromyelitis Optica, and Clinically Isolated Syndrome Patients ». *Noro Psikiyatri Arsivi* 53 (4): 353-56. <https://doi.org/10.5152/npa.2016.16979>.
- Turner, Dennis A., et David Cory Adamson. 2011. « Neuronal-Astrocyte Metabolic Interactions: Understanding the Transition Into Abnormal Astrocytoma Metabolism ». *Journal of Neuropathology & Experimental Neurology*

70 (3): 167-76. <https://doi.org/10.1097/NEN.0b013e31820e1152>.

Turnescu, Tanja, Juliane Arter, Simone Reiprich, Ernst R. Tamm, Ari Waisman, et Michael Wegner. 2018. « Sox8 and Sox10 Jointly Maintain Myelin Gene Expression in Oligodendrocytes ». *Glia* 66 (2): 279-94. <https://doi.org/10.1002/glia.23242>.

Urbán, Noelia, Debbie L. C. van den Berg, Antoine Forget, Jimena Andersen, Jeroen A. A. Demmers, Charles Hunt, Olivier Ayrault, et François Guillemot. 2016. « Return to Quiescence of Mouse Neural Stem Cells by Degradation of a Proactivation Protein ». *Science* 353 (6296): 292-95. <https://doi.org/10.1126/science.aaf4802>.

Urbán, Noelia, Isabelle Maria Blomfield, et François Guillemot. 2019. « Quiescence of Adult Mammalian Neural Stem Cells: A Highly Regulated Rest ». *Neuron* 104 (5): 834-48. <https://doi.org/10.1016/j.neuron.2019.09.026>.

Vallstedt, Anna, Joanna M. Klos, et Johan Ericson. 2005. « Multiple Dorsoventral Origins of Oligodendrocyte Generation in the Spinal Cord and Hindbrain ». *Neuron* 45 (1): 55-67. <https://doi.org/10.1016/j.neuron.2004.12.026>.

Van der Borght, Karin, Dóra É. Kóbor-Nyakas, Karin Klauke, Bart J.L. Eggen, Csaba Nyakas, Eddy A. Van der Zee, et Peter Meerlo. 2009. « Physical Exercise Leads to Rapid Adaptations in Hippocampal Vasculature: Temporal Dynamics and Relationship to Cell Proliferation and Neurogenesis ». *Hippocampus* 19 (10): 928-36. <https://doi.org/10.1002/hipo.20545>.

Vanderstocken, Gilles, Anna Dvorkin-Gheva, Pamela Shen, Corry-Anke Brandsma, Ma'en Obeidat, Yohan Bossé, John A. Hassell, et Martin R. Stampfli. 2018. « Identification of Drug Candidates to Suppress Cigarette Smoke-Induced Inflammation via Connectivity Map Analyses ». *American Journal of Respiratory Cell and Molecular Biology* 58 (6): 727-35. <https://doi.org/10.1165/rcmb.2017-0202OC>.

Varkuti, Boglarka H., Miklos Kepiro, Ze Liu, Kyle Vick, Yosef Avchalumov, Rodrigo Pacifico, Courtney M. MacMullen, Theodore M. Kamenecka, Sathyanarayanan V. Puthanveetil, et Ronald L. Davis. 2020. « Neuron-Based High-Content Assay and Screen for CNS Active Mitotherapeutics ». *Science Advances* 6 (2): eaaw8702. <https://doi.org/10.1126/sciadv.aaw8702>.

Varnum, Megan M., et Tsuneya Ikezu. 2012. « The Classification of Microglial Activation Phenotypes on Neurodegeneration and Regeneration in Alzheimer's Disease Brain ». *Archivum Immunologiae et Therapiae Experimentalis* 60 (4): 251-66. <https://doi.org/10.1007/s00005-012-0181-2>.

Večeřa, Josef, Jiřina Procházková, Veronika Šumberová, Veronika Pánská, Hana Paculová, Martina Kohutková Lánová, Jan Mašek, Dáša Boháčiková, Emma Rachel Andersson, et Jiří Pacherník. 2020. « Hypoxia/Hif1 α Prevents Premature Neuronal Differentiation of Neural Stem Cells through the Activation of Hes1 ». *Stem Cell Research* 45 (mai): 101770. <https://doi.org/10.1016/j.scr.2020.101770>.

Vesoulis, Zachary A., Terrie E. Inder, Lianne J. Woodward, Bradley Buse, Claudine Vavasseur, et Amit M. Mathur. 2014. « Early Electrographic Seizures, Brain Injury, and Neurodevelopmental Risk in the Very Preterm Infant ». *Pediatric Research* 75 (4): 564-69. <https://doi.org/10.1038/pr.2013.245>.

Vestal-Laborde, Allison A., Andrew C. Eschenroeder, John W. Bigbee, Susan E. Robinson, et Carmen Sato-Bigbee. 2014. « The Opioid System and Brain Development: Effects of Methadone on the Oligodendrocyte Lineage and the Early Stages of Myelination ». *Developmental Neuroscience* 36 (5): 409-21. <https://doi.org/10.1159/000365074>.

Vieira, Claudia, Ana Pombero, Raquel Garcia-Lopez, Lourdes Gimeno, Diego Echevarria, et Salvador Martinez. 2010. « Molecular Mechanisms Controlling Brain Development: An Overview of Neuroepithelial Secondary Organizers ». *The International Journal of Developmental Biology* 54 (1): 7-20. <https://doi.org/10.1387/ijdb.092853cv>.

Vinukonda, Govindaiah, Furong Hu, Rana Mehdizadeh, Preeti Dohare, Ali Kidwai, Ankit Juneja, Vineet Naran, et al. 2016. « Epidermal Growth Factor Preserves Myelin and Promotes Astroglialosis after Intraventricular Hemorrhage: Epidermal Growth Factor and IVH ». *Glia* 64 (11): 1987-2004. <https://doi.org/10.1002/glia.23037>.

- Vries, Linda S. de, et Floris Groenendaal. 2002. « Neuroimaging in the Preterm Infant ». *Mental Retardation and Developmental Disabilities Research Reviews* 8 (4): 273-80. <https://doi.org/10.1002/mrdd.10050>.
- Waitzman, Norman J., Ali Jalali, et Scott D. Grosse. 2021. « Preterm Birth Lifetime Costs in the United States in 2016: An Update ». *Seminars in Perinatology* 45 (3): 151390. <https://doi.org/10.1016/j.semperi.2021.151390>.
- Walsh, Jennifer M., Lex W. Doyle, Peter J. Anderson, Katherine J. Lee, et Jeanie L. Y. Cheong. 2014. « Moderate and Late Preterm Birth: Effect on Brain Size and Maturation at Term-Equivalent Age ». *Radiology* 273 (1): 232-40. <https://doi.org/10.1148/radiol.14132410>.
- Walton, Clare, Rachel King, Lindsay Rechtman, Wendy Kaye, Emmanuelle Leray, Ruth Ann Marrie, Neil Robertson, et al. 2020. « Rising Prevalence of Multiple Sclerosis Worldwide: Insights from the Atlas of MS, Third Edition ». *Multiple Sclerosis Journal* 26 (14): 1816-21. <https://doi.org/10.1177/1352458520970841>.
- Wang, D. D., D. D. Krueger, et A. Bordey. 2003. « GABA Depolarizes Neuronal Progenitors of the Postnatal Subventricular Zone Via GABA_A Receptor Activation ». *The Journal of Physiology* 550 (3): 785-800. <https://doi.org/10.1113/jphysiol.2003.042572>.
- Wang, Guiping, Yun Ye, Xiaoqin Yang, Hongying Liao, Canguo Zhao, et Shuang Liang. 2011. « Expression-Based In Silico Screening of Candidate Therapeutic Compounds for Lung Adenocarcinoma ». Édité par Jörg Hoheisel. *PLoS ONE* 6 (1): e14573. <https://doi.org/10.1371/journal.pone.0014573>.
- Wang, Na, Jing Ma, Jing Liu, Jiangong Wang, Cuilan Liu, Hua Wang, Yong Liu, Haijing Yan, et Shujun Jiang. 2020. « Histamine H3 Receptor Antagonist Enhances Neurogenesis and Improves Chronic Cerebral Hypoperfusion-Induced Cognitive Impairments ». *Frontiers in Pharmacology* 10 (janvier): 1583. <https://doi.org/10.3389/fphar.2019.01583>.
- Wang, Shu-Zong, Jennifer Dulin, Heng Wu, Edward Hurlock, Sang-Eun Lee, Kyle Jansson, et Q. Richard Lu. 2006. « An Oligodendrocyte-Specific Zinc-Finger Transcription Regulator Cooperates with Olig2 to Promote Oligodendrocyte Differentiation ». *Development* 133 (17): 3389-98. <https://doi.org/10.1242/dev.02522>.
- Wang, Su, Janna Bates, Xiaojie Li, Steven Schanz, Devin Chandler-Militello, Corri Levine, Nimet Maherali, et al. 2013. « Human iPSC-Derived Oligodendrocyte Progenitor Cells Can Myelinate and Rescue a Mouse Model of Congenital Hypomyelination ». *Cell Stem Cell* 12 (2): 252-64. <https://doi.org/10.1016/j.stem.2012.12.002>.
- Warringa, Ruud A.J., Rob C. Hoeben, Jan W. Koper, Jane E.C. Sykes, Lambert M.G. van Golde, et Matthijs Lopes-Cardozo. 1987. « Hydrocortisone Stimulates the Development of Oligodendrocytes in Primary Glial Cultures and Affects Glucose Metabolism and Lipid Synthesis in These Cultures ». *Developmental Brain Research* 34 (1): 79-86. [https://doi.org/10.1016/0165-3806\(87\)90197-0](https://doi.org/10.1016/0165-3806(87)90197-0).
- Warrington, Arthur E., Allan J. Bieber, Bogoljub Ciric, Larry R. Pease, Virginia Van Keulen, et Moses Rodriguez. 2007. « A Recombinant Human IgM Promotes Myelin Repair after a Single, Very Low Dose ». *Journal of Neuroscience Research* 85 (5): 967-76. <https://doi.org/10.1002/jnr.21217>.
- Waxman, Stephen G. 1986. « The Astrocyte as a Component of the Node of Ranvier ». *Trends in Neurosciences* 9 (janvier): 250-53. [https://doi.org/10.1016/0166-2236\(86\)90069-X](https://doi.org/10.1016/0166-2236(86)90069-X).
- Weber, Martin S., Reinhard Hohlfeld, et Scott S. Zamvil. 2007. « Mechanism of Action of Glatiramer Acetate in Treatment of Multiple Sclerosis ». *Neurotherapeutics* 4 (4): 647-53. <https://doi.org/10.1016/j.nurt.2007.08.002>.
- Wegener, Amélie, Cyrille Deboux, Corinne Bachelin, Magali Frah, Christophe Kerninon, Danielle Seilhean, Matthias Weider, Michael Wegner, et Brahim Nait-Oumesmar. 2015. « Gain of Olig2 Function in Oligodendrocyte Progenitors Promotes Remyelination ». *Brain* 138 (1): 120-35. <https://doi.org/10.1093/brain/awu375>.
- Wegner, Michael, et C. Claus Stolt. 2005. « From Stem Cells to Neurons and Glia: A Soxist's View of Neural Development ». *Trends in Neurosciences* 28 (11): 583-88. <https://doi.org/10.1016/j.tins.2005.08.008>.
- Weider, Matthias, Laura Julia Starost, Katharina Groll, Melanie Küspert, Elisabeth Sock, Miriam Wedel, Franziska

Fröb, et al. 2018. « Nfat/Calcineurin Signaling Promotes Oligodendrocyte Differentiation and Myelination by Transcription Factor Network Tuning ». *Nature Communications* 9 (1): 899. <https://doi.org/10.1038/s41467-018-03336-3>.

Weng, Qinjie, Jiajia Wang, Jiaying Wang, Biqin Tan, Jing Wang, Haibo Wang, Tao Zheng, Q. Richard Lu, Bo Yang, et Qiaojun He. 2017. « Folate Metabolism Regulates Oligodendrocyte Survival and Differentiation by Modulating AMPK α Activity ». *Scientific Reports* 7 (1): 1705. <https://doi.org/10.1038/s41598-017-01732-1>.

Werner, Hauke B., Eva-Maria Krämer-Albers, Nicola Strenzke, Gesine Saher, Stefan Tenzer, Yoshiko Ohno-Iwashita, Patricia De Monasterio-Schrader, et al. 2013. « A Critical Role for the Cholesterol-Associated Proteolipids PLP and M6B in Myelination of the Central Nervous System ». *Glia* 61 (4): 567-86. <https://doi.org/10.1002/glia.22456>.

Wilkins, Alastair, Siddharthan Chandran, et Alastair Compston. 2001. « A Role for Oligodendrocyte-Derived IGF-1 in Trophic Support of Cortical Neurons ». *Glia* 36 (1): 48-57. <https://doi.org/10.1002/glia.1094>.

Wilkins, Alastair, Henry Majed, Robert Layfield, Alastair Compston, et Siddharthan Chandran. 2003. « Oligodendrocytes Promote Neuronal Survival and Axonal Length by Distinct Intracellular Mechanisms: A Novel Role for Oligodendrocyte-Derived Glial Cell Line-Derived Neurotrophic Factor ». *The Journal of Neuroscience* 23 (12): 4967-74. <https://doi.org/10.1523/JNEUROSCI.23-12-04967.2003>.

Williams, A., G. Piaton, M.-S. Aigrot, A. Belhadi, M. Theaudin, F. Petermann, J.-L. Thomas, B. Zalc, et C. Lubetzki. 2007. « Semaphorin 3A and 3F: Key Players in Myelin Repair in Multiple Sclerosis? » *Brain* 130 (10): 2554-65. <https://doi.org/10.1093/brain/awm202>.

Williams, Gareth. 2012. « A Searchable Cross-Platform Gene Expression Database Reveals Connections between Drug Treatments and Disease ». *BMC Genomics* 13 (1): 12. <https://doi.org/10.1186/1471-2164-13-12>.

———. 2013. « SPIEDw: A Searchable Platform-Independent Expression Database Web Tool ». *BMC Genomics* 14 (1): 765. <https://doi.org/10.1186/1471-2164-14-765>.

Windrem, Martha S., Steven J. Schanz, Min Guo, Guo-Feng Tian, Vaughn Washco, Nancy Stanwood, Matthew Rasband, et al. 2008. « Neonatal Chimerization with Human Glial Progenitor Cells Can Both Remyelinate and Rescue the Otherwise Lethally Hypomyelinated Shiverer Mouse ». *Cell Stem Cell* 2 (6): 553-65. <https://doi.org/10.1016/j.stem.2008.03.020>.

Wishart, David S., Craig Knox, An Chi Guo, Savita Shrivastava, Murtaza Hassanali, Paul Stothard, Zhan Chang, et Jennifer Woolsey. 2006. « DrugBank: A Comprehensive Resource for in Silico Drug Discovery and Exploration ». *Nucleic Acids Research* 34 (Database issue): D668-672. <https://doi.org/10.1093/nar/gkj067>.

Wittler, Lars, et Michael Kessel. 2004. « The Acquisition of Neural Fate in the Chick ». *Mechanisms of Development* 121 (9): 1031-42. <https://doi.org/10.1016/j.mod.2004.05.004>.

Wood, Nicholas S., Neil Marlow, Kate Costeloe, Alan T. Gibson, et Andrew R. Wilkinson. 2000. « Neurologic and Developmental Disability after Extremely Preterm Birth ». *New England Journal of Medicine* 343 (6): 378-84. <https://doi.org/10.1056/NEJM200008103430601>.

Woodroffe, M.N., et M.L. Cuzner. 1993. « Cytokine mRNA Expression in Inflammatory Multiple Sclerosis Lesions: Detection by Non-Radioactive in Situ Hybridization ». *Cytokine* 5 (6): 583-88. [https://doi.org/10.1016/S1043-4666\(05\)80008-0](https://doi.org/10.1016/S1043-4666(05)80008-0).

Xiao, L, H Xu, Y Zhang, Z Wei, J He, W Jiang, X Li, et al. 2008. « Quetiapine Facilitates Oligodendrocyte Development and Prevents Mice from Myelin Breakdown and Behavioral Changes ». *Molecular Psychiatry* 13 (7): 697-708. <https://doi.org/10.1038/sj.mp.4002064>.

Xiao, Peng-Lei, Yi-Biao Zhou, Yue Chen, Mei-Xia Yang, Xiu-Xia Song, Yan Shi, et Qing-Wu Jiang. 2015. « Association between Maternal HIV Infection and Low Birth Weight and Prematurity: A Meta-Analysis of Cohort Studies ». *BMC Pregnancy and Childbirth* 15 (1): 246. <https://doi.org/10.1186/s12884-015-0684-z>.

- Xiao, Yan, Luigi Petrucco, Laura J. Hoodless, Ruben Portugues, et Tim Czopka. 2022. « Oligodendrocyte Precursor Cells Sculpt the Visual System by Regulating Axonal Remodeling ». *Nature Neuroscience* 25 (3): 280-84. <https://doi.org/10.1038/s41593-022-01023-7>.
- Xie, Yufei, Sofie Tolmeijer, Jelle M. Oskam, Tijs Tonkens, Annemarie H. Meijer, et Marcel J. M. Schaaf. 2019. « Glucocorticoids Inhibit Macrophage Differentiation towards a Pro-Inflammatory Phenotype upon Wounding without Affecting Their Migration ». *Disease Models & Mechanisms*, janvier, dmm.037887. <https://doi.org/10.1242/dmm.037887>.
- Xu, Jan, Shawei Chen, S. Hinan Ahmed, Hong Chen, Grace Ku, Mark P. Goldberg, et Chung Y. Hsu. 2001. « Amyloid- β Peptides Are Cytotoxic to Oligodendrocytes ». *The Journal of Neuroscience* 21 (1): RC118-RC118. <https://doi.org/10.1523/JNEUROSCI.21-01-j0001.2001>.
- Yang, Hyun-Jeong, Anna Vainshtein, Galia Maik-Rachline, et Elior Peles. 2016. « G Protein-Coupled Receptor 37 Is a Negative Regulator of Oligodendrocyte Differentiation and Myelination ». *Nature Communications* 7 (1): 10884. <https://doi.org/10.1038/ncomms10884>.
- Yang, Nan, J Bradley Zuchero, Henrik Ahlenius, Samuele Marro, Yi Han Ng, Thomas Vierbuchen, John S Hawkins, Richard Geissler, Ben A Barres, et Marius Wernig. 2013. « Generation of Oligodendroglial Cells by Direct Lineage Conversion ». *Nature Biotechnology* 31 (5): 434-39. <https://doi.org/10.1038/nbt.2564>.
- Yang, Yuanhang, Michelle Leech, Paul Hutchinson, Stephen R. Holdsworth, et Eric F. Morand. 1997. « Antiinflammatory Effect of Lipocortin 1 in Experimental Arthritis ». *Inflammation* 21 (6): 583-96. <https://doi.org/10.1023/A:1027330021479>.
- Yao, D. L., X. Liu, L. D. Hudson, et H. D. Webster. 1995. « Insulin-like Growth Factor I Treatment Reduces Demyelination and up-Regulates Gene Expression of Myelin-Related Proteins in Experimental Autoimmune Encephalomyelitis. » *Proceedings of the National Academy of Sciences* 92 (13): 6190-94. <https://doi.org/10.1073/pnas.92.13.6190>.
- Yasuda, Ken, Takakuni Maki, Hisanori Kinoshita, Seiji Kaji, Masaru Toyokawa, Ryusei Nishigori, Yusuke Kinoshita, Yuichi Ono, Ayae Kinoshita, et Ryosuke Takahashi. 2020. « Sex-Specific Differences in Transcriptomic Profiles and Cellular Characteristics of Oligodendrocyte Precursor Cells ». *Stem Cell Research* 46 (juillet): 101866. <https://doi.org/10.1016/j.scr.2020.101866>.
- Yawno, Tamara, Mawin Mahen, Jingang Li, Michael C. Fahey, Graham Jenkin, et Suzanne L. Miller. 2017. « The Beneficial Effects of Melatonin Administration Following Hypoxia-Ischemia in Preterm Fetal Sheep ». *Frontiers in Cellular Neuroscience* 11 (septembre): 296. <https://doi.org/10.3389/fncel.2017.00296>.
- Ye, Xiaolan, James M. Linton, Nicholas J. Schork, Linda B. Buck, et Michael Petrascheck. 2014. « A Pharmacological Network for Lifespan Extension in *C Aenorhabditis Elegans* ». *Aging Cell* 13 (2): 206-15. <https://doi.org/10.1111/acel.12163>.
- Yi, Li-Tao, Bin-Bin Liu, Jing Li, Liu Luo, Qing Liu, Di Geng, Yue Tang, Yuan Xia, et Di Wu. 2014. « BDNF Signaling Is Necessary for the Antidepressant-like Effect of Naringenin ». *Progress in Neuro-Pharmacology and Biological Psychiatry* 48 (janvier): 135-41. <https://doi.org/10.1016/j.pnpbp.2013.10.002>.
- Yin, Jun-Jun, Yan He, Jun An, Qiang Miao, Ruo-Xuan Sui, Qing Wang, Jie-Zhong Yu, Bao-Guo Xiao, et Cun-Gen Ma. 2020. « Dynamic Balance of Microglia and Astrocytes Involved in the Remyelinating Effect of Ginkgolide B ». *Frontiers in Cellular Neuroscience* 13 (janvier): 572. <https://doi.org/10.3389/fncel.2019.00572>.
- Yong, V. W., N. P. Dooley, et P. G. Noble. 1994. « Protein Kinase C in Cultured Adult Human Oligodendrocytes: A Potential Role for Isoform γ As a Mediator of Process Outgrowth ». *Journal of Neuroscience Research* 39 (1): 83-96. <https://doi.org/10.1002/jnr.490390111>.
- Young, K. M., M. Fogarty, N. Kessaris, et W. D. Richardson. 2007. « Subventricular Zone Stem Cells Are Heterogeneous with Respect to Their Embryonic Origins and Neurogenic Fates in the Adult Olfactory Bulb ». *Journal of Neuroscience* 27 (31): 8286-96. <https://doi.org/10.1523/JNEUROSCI.0476-07.2007>.

- Young, Kaylene M., Konstantina Psachoulia, Richa B. Tripathi, Sara-Jane Dunn, Lee Cossell, David Attwell, Koujiro Tohyama, et William D. Richardson. 2013. « Oligodendrocyte Dynamics in the Healthy Adult CNS: Evidence for Myelin Remodeling ». *Neuron* 77 (5): 873-85. <https://doi.org/10.1016/j.neuron.2013.01.006>.
- Younge, Noelle, Ricki F. Goldstein, C. Michael Cotten, et Eunice Kennedy Shriver National Institute of Child Health and Human Development Neonatal Research Network. 2017. « Survival and Neurodevelopment of Periviable Infants ». *The New England Journal of Medicine* 376 (19): 1890-91. <https://doi.org/10.1056/NEJMc1703379>.
- Yuen, Tracy J., Kory R. Johnson, Veronique E. Miron, Chao Zhao, Jacqueline Quandt, Marie C. Harrisingh, Matthew Swire, et al. 2013. « Identification of Endothelin 2 as an Inflammatory Factor That Promotes Central Nervous System Remyelination ». *Brain* 136 (4): 1035-47. <https://doi.org/10.1093/brain/awt024>.
- Yurgelun-Todd, Deborah A., William D. S. Killgore, et Ashley D. Young. 2002. « Sex Differences in Cerebral Tissue Volume and Cognitive Performance during Adolescence ». *Psychological Reports* 91 (3): 743-57. <https://doi.org/10.2466/pr0.2002.91.3.743>.
- Zalc, B., D. Goujet, et D. Colman. 2008. « The Origin of the Myelination Program in Vertebrates ». *Current Biology* 18 (12): R511-12. <https://doi.org/10.1016/j.cub.2008.04.010>.
- Zawadzka, Malgorzata, Leanne E. Rivers, Stephen P.J. Fancy, Chao Zhao, Richa Tripathi, Françoise Jamen, Kaylene Young, et al. 2010. « CNS-Resident Glial Progenitor/Stem Cells Produce Schwann Cells as Well as Oligodendrocytes during Repair of CNS Demyelination ». *Cell Stem Cell* 6 (6): 578-90. <https://doi.org/10.1016/j.stem.2010.04.002>.
- Zeger, Martha, Greg Popken, Jihui Zhang, Shouhong Xuan, Q. Richard Lu, Markus H. Schwab, Klaus-Armin Nave, David Rowitch, A. Joseph D'Ercole, et Ping Ye. 2007. « Insulin-like Growth Factor Type 1 Receptor Signaling in the Cells of Oligodendrocyte Lineage Is Required for Normal In Vivo Oligodendrocyte Development and Myelination ». *Glia* 55 (4): 400-411. <https://doi.org/10.1002/glia.20469>.
- Zhang, Hong-Lei, Jing Wang, et Long Tang. 2014. « Sema4D Knockdown in Oligodendrocytes Promotes Functional Recovery After Spinal Cord Injury ». *Cell Biochemistry and Biophysics* 68 (3): 489-96. <https://doi.org/10.1007/s12013-013-9727-0>.
- Zhang, Jia-Xing, Xue-Qun Chen, Ji-Zeng Du, Qing-Mei Chen, et Chao-Yang Zhu. 2005. « Neonatal Exposure to Intermittent Hypoxia Enhances Mice Performance in Water Maze and 8-Arm Radial Maze Tasks ». *Journal of Neurobiology* 65 (1): 72-84. <https://doi.org/10.1002/neu.20174>.
- Zhang, Kuan, Yanzhao Zhou, Tong Zhao, Liying Wu, Xin Huang, Kuiwu Wu, Lun Xu, et al. 2015. « Reduced Cerebral Oxygen Content in the DG and SVZ In Situ Promotes Neurogenesis in the Adult Rat Brain In Vivo ». Édité par Tiffany Seagroves. *PLOS ONE* 10 (10): e0140035. <https://doi.org/10.1371/journal.pone.0140035>.
- Zhang, Kuan, Lingling Zhu, et Ming Fan. 2011. « Oxygen, a Key Factor Regulating Cell Behavior during Neurogenesis and Cerebral Diseases ». *Frontiers in Molecular Neuroscience* 4. <https://doi.org/10.3389/fnmol.2011.00005>.
- Zhang, Li, Wenquan Kang, Xiaolan Lu, Shiyang Ma, Lei Dong, et Baicang Zou. 2019. « Weighted Gene Co-Expression Network Analysis and Connectivity Map Identifies Lovastatin as a Treatment Option of Gastric Cancer by Inhibiting HDAC2 ». *Gene* 681 (janvier): 15-25. <https://doi.org/10.1016/j.gene.2018.09.040>.
- Zhang, Liguo, Xuelian He, Lei Liu, Minqing Jiang, Chuntao Zhao, Haibo Wang, Danyang He, et al. 2016. « Hdac3 Interaction with P300 Histone Acetyltransferase Regulates the Oligodendrocyte and Astrocyte Lineage Fate Switch ». *Developmental Cell* 36 (3): 316-30. <https://doi.org/10.1016/j.devcel.2016.01.002>.
- Zhang, Ru, et Xin Xie. 2012. « Tools for GPCR Drug Discovery ». *Acta Pharmacologica Sinica* 33 (3): 372-84. <https://doi.org/10.1038/aps.2011.173>.
- Zhang, Y., K. Chen, S. A. Sloan, M. L. Bennett, A. R. Scholze, S. O'Keeffe, H. P. Phatnani, et al. 2014. « An RNA-Sequencing Transcriptome and Splicing Database of Glia, Neurons, and Vascular Cells of the Cerebral Cortex ». *Journal of Neuroscience* 34 (36): 11929-47. <https://doi.org/10.1523/JNEUROSCI.1860-14.2014>.

- Zhao, Jing-Wei, Ruma Raha-Chowdhury, James W. Fawcett, et Colin Watts. 2009. « Astrocytes and Oligodendrocytes Can Be Generated from NG2⁺ Progenitors after Acute Brain Injury: Intracellular Localization of Oligodendrocyte Transcription Factor 2 Is Associated with Their Fate Choice ». *European Journal of Neuroscience* 29 (9): 1853-69. <https://doi.org/10.1111/j.1460-9568.2009.06736.x>.
- Zhao, Xianghui, Xuelian He, Xiaolei Han, Yang Yu, Feng Ye, Ying Chen, ThaoNguyen Hoang, et al. 2010. « MicroRNA-Mediated Control of Oligodendrocyte Differentiation ». *Neuron* 65 (5): 612-26. <https://doi.org/10.1016/j.neuron.2010.02.018>.
- Zhornitsky, Simon, Trina A Johnson, Luanne M Metz, Samuel Weiss, et V Wee Yong. 2015. « Prolactin in Combination with Interferon- β Reduces Disease Severity in an Animal Model of Multiple Sclerosis ». *Journal of Neuroinflammation* 12 (1): 55. <https://doi.org/10.1186/s12974-015-0278-8>.
- Zhou, Qiao, et David J. Anderson. 2002. « The BHLH Transcription Factors OLIG2 and OLIG1 Couple Neuronal and Glial Subtype Specification ». *Cell* 109 (1): 61-73. [https://doi.org/10.1016/S0092-8674\(02\)00677-3](https://doi.org/10.1016/S0092-8674(02)00677-3).
- Zhou, Qiao, Songli Wang, et David J Anderson. 2000. « Identification of a Novel Family of Oligodendrocyte Lineage-Specific Basic Helix-Loop-Helix Transcription Factors ». *Neuron* 25 (2): 331-43. [https://doi.org/10.1016/S0896-6273\(00\)80898-3](https://doi.org/10.1016/S0896-6273(00)80898-3).
- Zhou, Yi, Allison M. Bond, Jamie E. Shade, Yunhua Zhu, Chung-ha O. Davis, Xinyuan Wang, Yijing Su, et al. 2018. « Autocrine Mfge8 Signaling Prevents Developmental Exhaustion of the Adult Neural Stem Cell Pool ». *Cell Stem Cell* 23 (3): 444-452.e4. <https://doi.org/10.1016/j.stem.2018.08.005>.
- Zhou, Yingyao, Bin Zhou, Lars Pache, Max Chang, Alireza Hadj Khodabakhshi, Olga Tanaseichuk, Christopher Benner, et Sumit K. Chanda. 2019. « Metascape Provides a Biologist-Oriented Resource for the Analysis of Systems-Level Datasets ». *Nature Communications* 10 (1): 1523. <https://doi.org/10.1038/s41467-019-09234-6>.
- Zhou, Yiting, Jing Zhang, Lu Wang, Ying Chen, Yushan Wan, Yang He, Lei Jiang, et al. 2017. « Interleukin-1 β Impedes Oligodendrocyte Progenitor Cell Recruitment and White Matter Repair Following Chronic Cerebral Hypoperfusion ». *Brain, Behavior, and Immunity* 60 (février): 93-105. <https://doi.org/10.1016/j.bbi.2016.09.024>.
- Zhu, Xiaoqin, Robert A. Hill, Dirk Dietrich, Mila Komitova, Ryusuke Suzuki, et Akiko Nishiyama. 2011. « Age-Dependent Fate and Lineage Restriction of Single NG2 Cells ». *Development* 138 (4): 745-53. <https://doi.org/10.1242/dev.047951>.
- Zhu, Xiaoqin, Hao Zuo, Brady J. Maher, David R. Serwanski, Joseph J. LoTurco, Q. Richard Lu, et Akiko Nishiyama. 2012. « Olig2-Dependent Developmental Fate Switch of NG2 Cells ». *Development* 139 (13): 2299-2307. <https://doi.org/10.1242/dev.078873>.
- Ziehm, Matthias, Satwant Kaur, Dobril K. Ivanov, Pedro J. Ballester, David Marcus, Linda Partridge, et Janet M. Thornton. 2017. « Drug Repurposing for Aging Research Using Model Organisms ». *Aging Cell* 16 (5): 1006-15. <https://doi.org/10.1111/acer.12626>.
- Zlokovic, Berislav V. 2008. « The Blood-Brain Barrier in Health and Chronic Neurodegenerative Disorders ». *Neuron* 57 (2): 178-201. <https://doi.org/10.1016/j.neuron.2008.01.003>.
- Zoeller, R. T., et J. Rovet. 2004. « Timing of Thyroid Hormone Action in the Developing Brain: Clinical Observations and Experimental Findings ». *Journal of Neuroendocrinology* 16 (10): 809-18. <https://doi.org/10.1111/j.1365-2826.2004.01243.x>.
- Zonouzi, Marzieh, Joseph Scafidi, Peijun Li, Brian McEllin, Jorge Edwards, Jeffrey L Dupree, Lloyd Harvey, et al. 2015. « GABAergic Regulation of Cerebellar NG2 Cell Development Is Altered in Perinatal White Matter Injury ». *Nature Neuroscience* 18 (5): 674-82. <https://doi.org/10.1038/nn.3990>.
- Zuchero, J. Bradley, Meng-meng Fu, Steven A. Sloan, Adiljan Ibrahim, Andrew Olson, Anita Zaremba, Jason C. Dugas, et al. 2015. « CNS Myelin Wrapping Is Driven by Actin Disassembly ». *Developmental Cell* 34 (2): 152-67.

<https://doi.org/10.1016/j.devcel.2015.06.011>.

Zuo, Hao, et Akiko Nishiyama. 2013. « Polydendrocytes in Development and Myelin Repair ». *Neuroscience Bulletin* 29 (2): 165-76. <https://doi.org/10.1007/s12264-013-1320-4>.

Zuo, Hao, William M. Wood, Amin Sherafat, Robert A. Hill, Q. Richard Lu, et Akiko Nishiyama. 2018. « Age-Dependent Decline in Fate Switch from NG2 Cells to Astrocytes After Olig2 Deletion ». *The Journal of Neuroscience* 38 (9): 2359-71. <https://doi.org/10.1523/JNEUROSCI.0712-17.2018>.

Les oligodendrocytes sont les cellules myélinisantes du système nerveux central, jouant un rôle crucial dans la régulation de la conduction saltatoire du potentiel d'action, le support trophique ainsi que dans le processus de plasticité neuronale. La (re)-myélinisation est perturbée chez les enfants prématurés et les patients atteints de sclérose en plaques, entraînant de graves incapacités. À ce jour, aucun médicament présentant une capacité de réparation convaincante chez l'homme n'a été approuvé pour ces pathologies.

Dans ce contexte, nous présentons une stratégie d'identification pharmacogénomique de petites molécules bioactives ayant une large activité pro-oligodendrogénique, sélectionnées grâce à une stratégie d'évaluation de molécules candidates en fonction de leur impact sur les programmes transcriptionnels contrôlant l'oligodendrogenèse et la (re)myélinisation (OligoScore). Nous avons démontré l'activité pro-oligodendrogénique de ces composés *in vitro*, en utilisant des cultures de cellules progénitrices neurales et oligodendrocytaires purifiées, ainsi qu'*ex vivo*, en utilisant des cultures d'explants organotypiques de cervelet.

Les deux molécules les plus prometteuses, l'acide folinique (leucovorine) et la dyclonine hydrochloride, ont été testées pour leur efficacité thérapeutique en utilisant un modèle murin d'hypoxie chronique néonatale, qui reproduit fidèlement certains aspects de la lésion cérébrale des prématurés. Dans ce modèle, les deux composés ont favorisé la prolifération et l'acquisition du destin oligodendrogial à partir des cellules souches/progénitrices neurales, avec la leucovorine promouvant également leur différenciation. Ces résultats ont été étendus à un modèle adulte de démyélinisation/remyélinisation focale de sclérose en plaques, dans lequel les deux composés ont amélioré la réparation des lésions en favorisant la différenciation des précurseurs oligodendrocytaire tout en maintenant le pool de ces cellules, et parallèlement, en accélérant la transition des profils microgliaux du statut pro-inflammatoires à pro-régénératifs et le nettoyage des débris de myéline.

En conclusion, ces travaux ont permis de comprendre davantage les mécanismes fondamentaux du développement des oligodendrocytes à travers l'identification de nouveaux réseaux et de gènes clés, qui constituent de nouveaux candidats pour des études fonctionnelles. D'autre part, le repositionnement *in silico* de la dyclonine hydrochloride et de l'acide folinique (leucovorine), toutes deux approuvées par la FDA et sélectionnées pour leurs propriétés pharmacogénomiques, associé à une validation expérimentale, constitue une stratégie prometteuse et une avancée significative dans la promotion de la réparation cérébrale au sein de diverses pathologies liées à la myéline, telles que la lésion cérébrale des prématurés et la sclérose en plaques.