



HAL
open science

Study of a decision support approach in socio-technical systems management, based on the physical principles of point and solid mechanics

Nafe Moradkhani

► To cite this version:

Nafe Moradkhani. Study of a decision support approach in socio-technical systems management, based on the physical principles of point and solid mechanics. Other [cs.OH]. Ecole des Mines d'Albi-Carmaux, 2023. English. NNT : 2023EMAC0002 . tel-04662727

HAL Id: tel-04662727

<https://theses.hal.science/tel-04662727v1>

Submitted on 26 Jul 2024

HAL is a multi-disciplinary open access archive for the deposit and dissemination of scientific research documents, whether they are published or not. The documents may come from teaching and research institutions in France or abroad, or from public or private research centers.

L'archive ouverte pluridisciplinaire **HAL**, est destinée au dépôt et à la diffusion de documents scientifiques de niveau recherche, publiés ou non, émanant des établissements d'enseignement et de recherche français ou étrangers, des laboratoires publics ou privés.

Université Fédérale



Toulouse Midi-Pyrénées

THÈSE



IMT Mines Albi-Carmaux
École Mines-Télécom

en vue de l'obtention du

DOCTORAT DE L'UNIVERSITÉ DE TOULOUSE

délivré par

IMT – École Nationale Supérieure des Mines d'Albi-Carmaux

présentée et soutenue par

Nafe Moradkhani

le 23 janvier 2023

Study of a decision support approach in
socio-technical systems management, based on the
physical principles of point and solid mechanics

École doctorale et discipline ou spécialité :

EDSYS : Informatique et Génie industriel

Unité de recherche :

Centre Génie Industriel, IMT Mines Albi

Directeurs de thèse :

Frédéric Bénaben, Professeur, IMT Mines Albi, France

Benoit Montreuil, Professeur, Georgia Institute Of Technology, États Unis

Autres membres du jury :

Jacky Montmain, Professeur, IMT Mines Alès, France (*Rapporteur*)

Rameshwar Dubey, Professeur, Liverpool John Moores University, Royaume-Uni (*Rapporteur*)

James Kirchner, Professeur, ETH Zürich, Suisse (*Examineur*)

Chihab Hanachi, Professeur, IRIT, France (*Président*)

Shabnam Mousavi, Maître de Conférences, Max Planck Institute, Allemagne (*Examineur*)

Matthieu Lauras, Professeur, IMT Mines Albi, France (*Encadrant*)

Julien Jeany, Head of R&D LAB, SCALIAN, France (*Invité*)

Abstract

Making sound decisions is an inevitable challenge for managing the performance of socio-technical systems. Uncertainty concerning the outcome of decisions leads to seeking principles that systems might follow. The current study leverages and investigates a framework called, "Physics Of Decisions" as an innovative approach for decision support in the context of instability and uncertainty. The focus is on developing a theoretical and mathematical model to depict risks and opportunities as physical forces pushing and pulling investigated systems as an object within a multidimensional performance framework built on the system's evaluation criteria. The main ambition is to define a method of identifying forces, including their origins, intensity, and interdependence, to inherit principles and law from physics. The principles of classical physics are investigated in the defined framework considering mapping management concepts to the physical notations. This connection allows to (i) examine the system's developments in its performance space through kinematic analysis and (ii) provide reactive and predictive decision support as a result of physical forces analysis and its application to the system through force-related physical laws. Investigating the system's behavior under such laws might disclose its compound relationships, thus leading to proper decisions. The foremost objective of this Ph.D. thesis is to establish a generic perspective for performance management of socio-technical systems that visualizes and integrates the impact of risks and opportunities to control the performance of the examined system. Overall, the main intended contribution of this study is to demonstrate the principles of connecting the system to its performance through an innovative modeling framework using different techniques. In further depth, this approach transforms the investigated system and its internal and contextual potentialities from implicit to explicit connection using sensitivity analysis, differential equations, and optimization functions. The significance of this study has been investigated in various application domains: (i) Polling place management, simulated with an Agent-Based Model (ABM), (ii) an epidemic-affected population, simulation with System Dynamics (SD) simulation model, (iii) road traffic management, performed with Discrete Event Simulation (DES) model, and (iv) a mathematical model to simulate a manufacturing production model.

Keywords: Decision Support System (DSS), Performance Management, Modeling, Risks, Opportunities, Simulation, Physics, Force.

Resumé

Prendre des décisions judicieuses est un défi incontournable pour gérer la performance des systèmes sociotechniques. L'incertitude concernant le résultat des décisions conduit à rechercher des principes que les systèmes pourraient suivre. L'étude actuelle exploite et étudie un cadre appelé "Physics of Decision" en tant qu'approche innovante d'aide à la décision dans un contexte d'instabilité et d'incertitude. L'accent est mis sur le développement d'un modèle théorique et mathématique pour décrire les risques et les opportunités en tant que forces physiques poussant et tirant les systèmes étudiés en tant qu'objet dans un cadre de performance multidimensionnel construit sur les critères d'évaluation du système. L'ambition principale est de définir une méthode d'identification des forces, y compris leurs origines, leur intensité et leur interdépendance, pour hériter des principes et des lois de la physique. Les principes de la physique classique sont étudiés dans le cadre défini en tenant compte des concepts de gestion de mappage aux notations physiques. Cette connexion permet (i) d'examiner les développements du système dans son espace de performance grâce à l'analyse cinématique et (ii) de fournir une aide à la décision réactive et prédictive à la suite de l'analyse des forces physiques et de son application au système par le biais de lois physiques liées aux forces. Enquêter sur le comportement du système en vertu de telles lois pourrait révéler ses relations complexes, conduisant ainsi à des décisions appropriées. L'objectif premier de ce doctorat est d'établir une perspective générique pour la gestion de la performance des systèmes socio-techniques qui visualise et intègre l'impact des risques et des opportunités pour contrôler la performance du système examiné. Dans l'ensemble, la principale contribution prévue de cette étude est de démontrer les principes de connexion du système à ses performances grâce à un cadre de modélisation innovant utilisant différentes techniques. Plus en profondeur, cette approche transforme le système étudié et ses potentialités internes et contextuelles d'une connexion implicite à une connexion explicite en utilisant une analyse de sensibilité, des équations différentielles et des fonctions d'optimisation. L'importance de cette étude a été étudiée dans divers domaines d'application : (i) la gestion des bureaux de vote simulée avec un modèle à base d'agents (ABM), (ii) une simulation de population touchée par une épidémie avec le modèle de simulation system dynamics (SD), (iii) gestion du trafic routier réalisée avec un modèle de simulation d'événements discrets (DES), et (iv) un modèle mathématique pour simuler un modèle de production manufacturière.

Mots clés : Système d'Aide à la Décision (DSS), Gestion de la Performance, Modélisation, Risques, Opportunités, Simulation, Physique, Force.

Acknowledgements

I have set aside this page with great pleasure to express my sincere gratitude to the encouraging and helpful people who have given me the strength, encouragement, and support that have allowed me to overcome challenges during my Ph.D. path. Their kind help and backing have made my thesis a reality.

First and foremost, I am enormously grateful to my director Prof. Frederick Benaben for his invaluable advice and continuous support. His patience, encouragement, never-ending help, and exceptional knowledge made this work feasible. He is the best mentor and advisor I could have imagined, not just for my Ph.D. studies but also for my social life.

My sincere thanks also go to my co-director Prof. Benoit Montreuil for his excellent advice and detailed thoughts on subjects and challenges. He provided me with excessive scientific perspectives and expertise, as well as many insightful discussions.

I wish to thank Prof. Matthieu Lauras for taking the time to share his extensive expertise with me. He provided me with a wealth of excellent scientific advice, exceptionally intriguing discussions, and particular assistance and recommendations in publications.

I'd want to express my gratitude to the jury members for getting to review my work. Special mention should go to Professors Jacky Montmain, James Kirchner, Rameshwar Dubey, Shabnam Mousavi, and Chihab Hanachi. Many thanks to Paul Gaborit for his invaluable assistance in writing this Ph.D. manuscript in L^AT_EX.

I would like to thank Julien Jeany from the Scalian firm for his significant involvement in the POD project from the first place and his valuable recommendations and ideas throughout the contributions and discussions in the [SCAN Laboratory](#), the collaboration between IMT Mines Albi, the Scalian co., and Georgia Institute of Technology. Many thanks to other POD members, Thibaut Cerabona, Louis Faugere, Clara Le Duff, Jiayao Li, and Manon Grest, for their contributions and exchange of ideas and thoughts.

My warmest thanks go to my friends and colleagues at CGI for their assistance with both my everyday life and studies. I would especially like to thank Professors Elyes Lamine, Xavier Lorca, Franck Fontanili, and Sina Namaki, as well as Mustapha Labreche, Marlène Boval, Claude Laffore, Oussema Ben Amara, Ghassen Farikha, Cheik Ouedraogo, Romain Ben Taleb, Rodolphe Barlogis, Sam Ban, Marine Dubillard, and Leah Rifi for their supports.

My parents, my sister, my brothers, and my friends have loved, supported, and encouraged me throughout my whole life, and I will always be grateful to them. It would not have been feasible to finish my studies without their incredible support and understanding during the previous few years. Last but not least, I want to express my sincere gratitude to my wife for her tireless support, inspiration, and patience through all the ups and downs.

Thank you all once again!

To [Jina Amini](#) and all the brave women
who lost their lives fighting for freedom!

Woman, Life, Freedom
Femme, Vie, Libert  
Jin, J  yan, Azada  

Contents

| | |
|--|------|
| <i>Abstract</i> | iii |
| <i>Resumé</i> | v |
| <i>Acknowledgements</i> | vii |
| <i>Contents</i> | ix |
| <i>Abbreviations</i> | xi |
| <i>Preface</i> | xiii |
| <hr/> | |
| 1 Introduction | 1 |
| 1.1 Main overview | 1 |
| 1.2 Performance Space | 5 |
| 1.3 Force Characterization | 6 |
| 1.3.1 Force Identification | 7 |
| 1.3.2 Force Assessment | 8 |
| 1.4 Description Space | 9 |
| 1.5 Force Evaluation | 10 |
| 1.6 Physics of Decision framework | 11 |
| 1.7 Research Problems | 14 |
| 1.8 Thesis Organization | 16 |
| 2 Background and Related Works | 17 |
| 2.1 Principal concepts and motivations | 17 |
| 2.1.1 Physics in decision-making | 18 |
| 2.1.2 Decision Theory | 19 |
| 2.1.3 Performance Management | 20 |
| 2.2 Decision Support System | 21 |
| 2.2.1 General Background | 21 |
| 2.2.2 Bounded Rationality | 25 |
| 2.3 Tools and Technologies in DSS | 28 |
| 2.4 Summary and Conclusion | 33 |
| 3 Thesis Contributions | 35 |
| 3.1 Preliminaries and Notations | 35 |
| 3.2 Thesis Contributions | 38 |
| 3.2.1 System Dynamics Simulation | 38 |
| 3.2.2 Discrete Event Simulation | 51 |
| 3.2.3 Agent-based Simulation | 62 |

| | |
|---|------------|
| 3.2.4 State-space Representation Method | 74 |
| 4 Conclusion and Perspectives | 87 |
| 4.1 Research Summary | 87 |
| 4.2 Research Contributions | 88 |
| 4.3 Future works and perspectives | 89 |
| Résumé étendu en français | 91 |
| Questions de recherche | 93 |
| Etat de l'art | 93 |
| Théorie de la rationalité limitée | 95 |
| Outils et Technologies en DSS | 97 |
| Contributions de la Thèse | 98 |
| Simulation de la dynamique du système (SD) | 99 |
| Simulation d'événements discrets (DES) | 99 |
| Simulation basée sur des agents (ABM) | 100 |
| Méthode de représentation de l'espace d'état (SS) | 101 |
| Travaux futurs et perspectives | 102 |
| <hr/> | |
| <i>List of Figures</i> | <i>105</i> |
| <i>Bibliography</i> | <i>107</i> |

Abbreviations

| | |
|---|---|
| AZ Accessible Zone..... | 5 |
| DS Description Space..... | 8 |
| DSS Decision Support Systems | 2, 3, 5, 16–18, 20–25, 28–30, 33, 34, 88, 90, 91, 94, 95, 97, 99, 105 |
| DZ Danger Zone..... | 5 |
| KPI Key Performance Indicator..... | 5, 6, 9, 11, 13–15, 17, 18, 20, 24, 35, 36, 38, 51, 62, 74, 87–90, 92, 93, 98, 99, 101, 103 |
| POD Physics of Decision..... | 11, 13–21, 23, 24, 27–29, 33–38, 51, 62, 74, 87–89, 92–103, 105 |
| PS Performance Space..... | 5 |
| PT Performance Trajectory..... | 5 |
| STS Socio-technical Systems..... | 2–5, 13, 17, 20, 23, 24, 35, 87, 89–91, 95, 102, 103, 105 |
| STT Socio-technical Theory..... | 3, 91 |
| TZ Target Zone..... | 5 |

Preface

This dissertation presents a physics-based framework to investigate an innovative decision support approach called “**Physics of Decision**,” whose primary idea has been raised by Benaben et al. in the following article. “*A tentative framework for risk and opportunity detection in a collaborative environment based on data interpretation*” (Benaben et al., 2019b). This foundation aimed at conveying classical physics to management science, notably in the risk management field. Later, Benaben et al. developed their initial idea to assume potential perturbations in systems as “**physical forces**” impacting the system’s indicators (Benaben et al., 2019a). In their recent work, Benaben et al. formally defined the physics-based theory to navigate among risks and opportunities, claiming that “**Instability is the norm!**” and decision support systems must provide tools and technologies to deal with that (Benaben et al., 2022). The proposed theory has so far been investigated in a wide range of contexts, including the COVID-19 pandemic crisis, air pollution, traffic management, supply chain management, project management, and polling place management.

This dissertation is an article-based presentation including four primary parts leveraging and investigating the aforementioned physics-based theory. The first part presents the context and problematic formulation. The second part is dedicated to the background of the study and examining research works in the literature. The third part illustrates the applicability of this theory and its corresponding methods through four contributions to four distinguished case studies. Finally, the fourth part concludes this effort and provides potential research places for the future.

Throughout the study, important notes and information are highlighted as follows.

1. The key “**Objectives**” and “**Questions**” are presented in gray-colored frames.
2. The essential “**Requirements**” are presented in green-colored frames.
3. The significant “**Takeaways & Summaries**” are presented in red-colored frames.

Like many researchers in academia, I do believe uncertainty acknowledges undiscovered rules behind human social activities. The current advances, notably in the psychology realm, move toward proofing that behind human decision-making, natural laws from physics, chemistry, biology, etc., lied because there may be a strong connection between nature and social activities. This work is a rudimentary investigation that aims at advancing this ambition.

Nafe Moradkhani.

1

Introduction

| | | |
|-------|---|----|
| 1.1 | Main overview | 1 |
| 1.2 | Performance Space | 5 |
| 1.3 | Force Characterization | 6 |
| 1.3.1 | Force Identification | 7 |
| 1.3.2 | Force Assessment | 8 |
| 1.4 | Description Space | 9 |
| 1.5 | Force Evaluation | 10 |
| 1.6 | Physics of Decision framework | 11 |
| 1.7 | Research Problems | 14 |
| 1.8 | Thesis Organization | 16 |

1.1 Main overview

The world is the whole body of things and phenomena observed or postulated; which comprise a whole and work together to make things happen and are known as a system (Merriam-Webster, 2022). A system is “a regularly interacting or interconnected set of elements creating a cohesive whole,” according to (Merriam-Webster, 2022). Similarly, the Oxford Dictionary describes a system as “a group of things, pieces of equipment, etc., connected or work together” (Oxford, 2022). Most of the world’s systems, such as those in plants, animals, rivers, mountains, sky, clouds, and sun, are “natural,” meaning humans did not design or construct them. Some systems are “engineered,” indicating their development was the result of planning, designs, and construction, much as the production of computers, pencils, cars, or building manufacturing, enterprises, etc. (Webb, 2009). The “abstract” systems, including, for instance, the legal, social, and educational systems, might not be easily observed or touched even if people likewise created them. No matter what kind it is, it might be considered a system if it is composed of components or entities that interact to provide a variety of outcomes. A system’s borders, structure, and purpose—all impacted and surrounded by its environment—are reflected in how it functions (*i.e.*, they affect the system’s behavior). Therefore, whether natural, engineered, or abstract, a system refers to a collection that has been put together for particular purposes. The system, its border, structure, and even its purposes are susceptible to circumstances that might influence it. These events might occur naturally or purposefully through decisions (Backlund, 2000).

Decision support seeks to deliver on system promises (Shim et al., 2002). Many of the current efforts in this area undergo defeat because making decisions is intrinsically challenging due to system complexity and its excessive degrees of uncertainty (Kochenderfer, 2015). It might

be possible to lessen these complexities and uncertainties by developing a framework that can investigate the system by employing tried-and-true principles, such as mathematical and physical laws. In this context, a detailed examination of complex systems and their surroundings might shed light on the breadth of system disturbances and viable control solutions (Sterman, 2010).

Physics touches the whole facet of human life. It enables understanding of the universe and the natural world—and much of today’s and tomorrow’s technology relies on the extracted knowledge from physics. Physics delivers the underlying understanding required for technological advancements that will continue to drive global economic engines, as well as the technical infrastructure and the necessary skills to benefit from scientific advances and discoveries (Simonyi, 2012; L. Phillips, 2014; Teixeira et al., 2012). This research is interested in using physics to understand the behavior of complex systems in response to perturbations and benefit from physical laws to minimize disturbances and maximize opportunities.

Decision-making refers to a process that leads to selecting an action or a course of action among several possible alternative options (Kahneman et al., 1984). This process involves the mental activity or process of obtaining information and understanding through thought, experience, and the senses, which encompasses all elements of intellectual functions and processes such as perception, attention, thought, intelligence, and the formation of knowledge (Edwards, 1954; Simon, 1979).

Decision theory is concerned with decision-making based on assigning probabilities to diverse elements and the imposition of numerical implications on the result. There are three branches of decision theory (Edwards, 1961; Peterson, 2017):

- ▶ **Normative decision theory:** is concerned with identifying the optimal decisions where the best options are continually recognized while considering a hypothetical decision-maker who is comprehensively rational and capable of doing calculations with perfect precision. This theory could be exemplified in how managers strive to identify the best answer to catastrophic problems such as pandemic diseases. For instance, *quarantining the infected individuals must be prior to wearing a mask to decrease the outbreak or vice versa*. Some managers like the delegation model, in which staffs come up with appropriate answers. Other executives prefer the choice technique that delivers the best solution and knowledge,
- ▶ **Descriptive decision theory:** is concerned with identifying and illuminating regularities in the decisions that individuals are disposed to make. It is often set apart from *normative decision theory*, which aims to explain the decisions that individuals ought to make (normative statements are characterized by the modal verbs “should,” “would,” “could” or “must.”). Descriptive decision theory is therefore related to the following instances. *What will happen if the public is forced to wear masks or stay home? Does it decrease mortality? If yes, how much? If not, how much it increases the mortality rate?*,
- ▶ **Prescriptive decision theory:** is interested in describing observable activities and behaviors through conceptual models, assuming that individuals who make the decisions act under standardized rules. Roughly speaking, what should an individual do to make better decisions? What modes of thought, decision aids, and conceptual schemes are helpful? For instance, *developing epidemiological models to demonstrate the connections between various control alternatives (e.g., wearing masks and quarantining infected individuals) and containing an outbreak*.

Decision support system (DSS) is an information system to assist organizations and businesses in their decision-making processes (Keen, 1980). DSSs aid an organization’s management, operations, and planning levels to support making decisions concerning situations where things might change quickly and are challenging to foresee in advance. DSSs might be either automated, operated by individuals, or a combination of the two (Brill et al., 1990).

Socio-technical system (STS) is a system with a complex structure that acknowledges the connection between people and technology in the designs used in executive development (Stranks, 2007; Haula et al., 2020). The “socio-technical” phrase describes the intricate networks of human relationships, technological devices, and cybernetic operations that make up expansive and sophisticated infrastructures (Haula et al., 2020). Social society and its underlying substructures are considered complex STSs. The term “socio-technical” describes how social and technical components of a system are connected (Long, 2018; Stranks, 2007).

Socio-technical theory (STT) concerns joint optimization, with a shared emphasis on excellence achievement in the performance of technical and social elements. A Socio-Technical System (STS) is an elaboration of Socio-Technical Theory (STT). The socio-technical theory is an approach to complex organizational designs that mainly focuses on social and technical systems in a workplace (Walker et al., 2008; Trist, 1981). The following two fundamental principles serve as the foundation for the STT.

- The first is that social and technical elements interact to produce the condition of effective (or poor) system performance. These interactions include (i) “non-linear,” complicated, and even unpredictable interactions and (ii) “linear” or explicit cause-and-effect connections, which often are planned relationships. Whether planned or unintentional, the involvement of social and technological factors leads to both interactions (Trist, 1981; Fox, 1995),
- The implication of the first principle leads to the second principle, emphasizing that focusing solely on the optimization of one aspect—be it socio or technical—tends to increase not only the number of unpredictable, unplanned relationships but also those relationships that are destructive to the system’s performance (Trist, 1981; Fox, 1995).

The STT, therefore, aims at a joint optimization between socio and technical systems, or the coordinated design of the social and technical systems which ensure their compatibility (Cooper et al., 1971; Long, 2018). For a particular socio-technical system (STS), socio-technical theory (STT) proposes numerous potential methods for collaborative optimization. Instead of the all-too-common ways in which new technology fails to meet the expectations of designers and users, socio-technical theory typically focuses on designing various system structures where the interactions between socio and technical elements result in the emergence of productivity (Walker et al., 2008). In light of the noted definitions and explanations, the primary purpose of this study is the following.

*This study introduces a **physics-based** approach to developing a **Decision Support System** emphasizing **Prescriptive** decision theory in support of **Socio-technical Theory for Socio-technical Systems**.*

Figure 1.1 is a brief and to-the-point presentation of the **physics-based** approach that aims at understanding the options available and the associated trigger decisions or uncontrolled events connected with them as essential requirements for system management and decision-making in uncertain situations. Whether controlled or not, these options can be categorized as risks and opportunities. The phrase “physics-based” refers to this study’s approach in which risks and opportunities are viewed as **physical forces** impacting the system’s performance. According to Figure 1.1, this approach considers a socio-technical *System* facing some internal (from the system itself) and external (from its environment) *Potentials*.

The **internal** potentials include (i) *Charges*, or the required costs (regardless of their natures) of the system, and (ii) *Innovations*, or some internal initiatives aimed at improving the system’s structure or behavior. The **external** potentials include (i) *Characteristics* from the

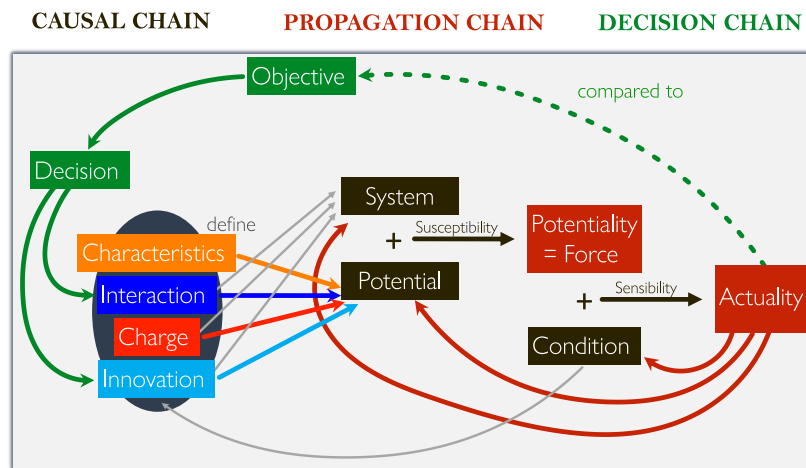

Figure 1.1: Conceptual structure of physics-based DSS for STS (Benaben et al., 2022)

system’s environment, such as contextual changes, and (ii) *Interactions*, the flow of goods, information, or elements from the environment to the system or vice-versa. If the system is susceptible to internal potential (*Charge* and *Innovation*) or external ones (*Characteristic* and *Interaction*), the potentials create forces (risks and opportunities potentially impacting the system). The ability to govern potentials or make decisions about them classifies them into **inflicted** or **managed**. The term “inflicted” refers to potentials that are impossible to be created, eliminated, or controlled; while “managed” potentials can be created, eliminated, and controlled (*i.e.*, potential decisions are made about the managed potential; arrows from *Decision* to *managed* Potentials, *Interaction* and *Innovation*, in Figure 1.1). Figure 1.2 presents the distinction among potentials. These distinctions, however, do not exist in a binary sense in reality; rather, they are on a continuum between being “inflicted” and being “managed.”

In keeping with Figure 1.1, the **Causal Chain** (black chain) explains that the *system* is susceptible to its internal and external *potentials*, which are likely to generate some *Potentialities* (risks and opportunities seen as physical forces). Moreover, these *potentialities* may be sensible to some *Conditions* and thus activated under those specific *conditions*, making them *Actualities* and changing the system’s performance. The **Propagation Chain** (red chain) shows how *actuality* can create, modify or remove the existing *system*, its *potential*, or *conditions* of (other) causal chains. The **Decision Chain** (green chain) compares the system’s *actualities* (performance) to its intended *Objectives*, after which managers can make various *Decisions* (mostly about *Interactions* and *Innovations*, *managed* ones in Figure 1.2) to get the system’s *actualities* closer to its *objectives*. Benaben et al. provide a more detailed explanation of the conceptual structure, presented in Figure 1.1 (Benaben et al., 2022).

| | Inflicted | Managed |
|----------|----------------|-------------|
| Internal | Charge | Innovation |
| External | Characteristic | Interaction |

Figure 1.2: Potential category

The main takeaway of the conceptual structure presented in Figure 1.1 is to establish a generic perspective for performance management of STSs that visualizes and integrates the impact of risks and opportunities on the system performance (indicated as *Actuality* in the figure). Overall, the main expected contribution of this study is to appoint a new modeling paradigm for STSs that may facilitate the handling of complexities of the system and its environment that are implicitly connected. In further depth, the physics-based approach

proposed in this study—based on *prescriptive decision theory* to describe the system changes through a conceptual model with the aim of identifying the optimal decisions—could be found for some use cases by transforming the investigated system and its internal and contextual *potentialities* from implicit to explicit connections.

The management of STSs is primarily concerned with accomplishing its short-term, mid-term, and long-term objectives. These objectives can take numerous forms, but the most common approach to tracking them is through Key Performance Indicators (KPIs) (Parmenter, 2015). Although these indicators may not be able to investigate intangible or qualitative objectives, they are used to assess the vast majority of system objectives. Consequently, the management of the STSs strives to push its performance indicators toward its predetermined short-term, mid-term, and long-term objective values of KPIs. In Figure 1.1, the KPIs are determined with the system *Objective* where the *Actuality* represents their quantitative values while the *Potentiality* influenced them (risk and opportunities viewed as forces). The first of the three requirements for establishing the physics-based approach to develop a DSS for STS, this study's objective, is as follows.

Requirement 1

A multi-criteria space is required to explore the KPIs of socio-technical systems across time—determine them with *objective*, present them with *actuality*, and analyze their variation according to *potentiality*. This space, called **Performance Space**, also allows the pursuit of the overall system performance and a vis-a-vis study between KPIs.

1.2 Performance Space

The “Performance Space” (PS) is built using quantitative system KPIs positioned on axes. Given that indicators might have a specific value at any given time, the system performance can be measured by the created trajectory of the indicators' variations across time in the Performance Space presented in Figure 1.3. The S_t presents the system position or the KPIs vector at the given time t , and its variation over time shapes the system “Performance Trajectory” (PT). Keeping in mind the conceptual layout shown in Figure 1.1, the KPIs evolve

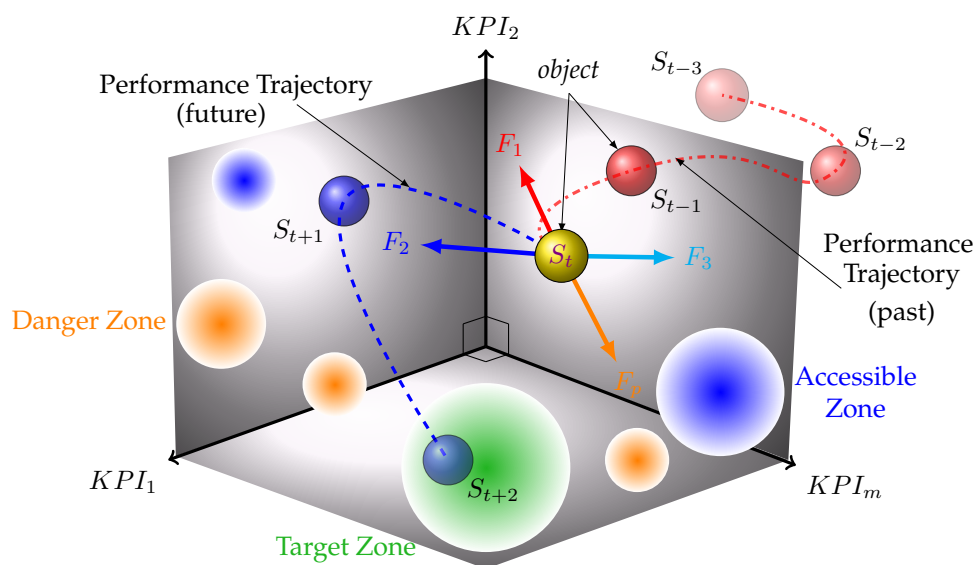

Figure 1.3: Proposed performance space of a socio-technical system

due to changes in the system's "potentialities," indicating that their trigger "conditions" have been satisfied, and consequently, they have become "actualities." Overall, "potentiality" is perceived as an opportunity if the implications are positive in terms of intended KPIs; in other words, a potentiality is an opportunity if it enables the system to move closer to its targets, shown as "Target Zone" (TZ) in Figure 1.3. In a symmetrical sense, "potentiality" is a risk if its consequences shift the system away from the predefined desirable values of KPIs, Target Zone; in other words, this potentiality gets the system closer to undesirable values of its KPIs, indicated as the "Danger Zone" (DZ) in Figure 1.3 (Olsson, 2007; Benaben et al., 2022). As a result of system internal or contextual changes, the preset Target and Danger zones in Figure 1.3 may dynamically change over time. This dynamicity indicates that all the stated zones in Figure 1.3 are current zones rather than permanently fixed zones. For instance, the "Accessible Zones" (AZ) in Figure 1.3 (while not being a Target Zone at time t) may indicate the system's Target Zone at a different time ($t' \neq t$).

The presented red Performance Trajectory depicted with a dot-dashed curve in Figure 1.3 refers to the initial (*past* in the figure) system development until time t (there may have been forces applied to the system that shaped the trajectory in such a presented way; however, the study mainly investigates the applied forces from time t onward). The risks and opportunities seen as forces (F_1, F_2, \dots, F_p) may push and pull the system (considered as an object, depicted with a yellow sphere) in the presented multidimensional Performance Space in Figure 1.3. In other words, the forces resultant deviate the initial Performance Trajectory (the red one) toward (or away from) Target Zone through a new (*future* in the figure) Performance Trajectory depicted in a blue dashed curve.

This study concentrates on developing a theoretical and mathematical model to depict risks and opportunities as physical forces impacting the system viewed as an object in its Performance Space. The primary purposes are the following. **(i)** First, defining a method of identifying forces (their nature and sources), **(ii)** Second, assessing the identified forces (learning their behavior) (section 1.3 addresses these two purposes), **(iii)** Third, evaluating the impact of forces (judging, measuring, and examining what has been learned). Section 1.5 addresses this ambition.

1.3 Force Characterization

The proposed Performance Space in Figure 1.3 focuses on the system mobility (considered as an object), where its movements are studied in this multidimensional space bounded by its KPIs with a potentially very high number of dimensions. Throughout this study, the Performance Trajectory is examined concerning the quantitative values of the KPIs. Although there may be correlations among the KPIs, as the value of each KPI at any given time indicates the system performance associated with that KPI, the KPIs are studied independently (*e.g.*, similar to projecting the movement of a ball on an inclined plane onto the x , y , and z dimensions and assuming their quantitative values as KPIs). Therefore, Performance Space is an orthogonal space—its axes are perpendicular to one another.

The system performance (*Actuality* in Figure 1.1) is examined through the system's Performance Trajectory in the given space on the undesirable or conducive potentialities (risks and opportunities, respectively). Indeed, the potentialities are assumed to as physical forces that veer the system's Performance Trajectory. Therefore, forces are perceived as the fundamental players at the heart of risk and opportunity management and eventually managing the system performance in the context of this study. This section on "characterizing the forces" enables the system manager to comprehensively investigate the potentialities that might deviate the Performance Trajectory in the sequential stages, briefly described below.

- (i) Identifying potential forces emerging from the system and its environment. Section 1.3.1 addresses this aim,

- (ii) Assessing the parameters of the potential forces; once they have been identified in the previous stage. Section 1.3.2 addresses this aim.

1.3.1 Force Identification

The first and foremost step following establishing the Performance Space (Figure 1.3) is determining the system drivers that move it within the space. According to Figure 1.1, forces emerge due to the system's susceptibility to its identified *potentials* shown in Figure 1.2. The following forces, generated by the identified potentials in Figure 1.2, are introduced to support the identification and formalization of risks and opportunities modeled as forces within the Performance Space.

1. **Natural forces** \Rightarrow an *internal, inflicted* force brought on by the system's inertial potential (*charge*). For instance, it could be a company's salary payment and fixed costs, a sports player's aging, the usual mortality rates in society, or the typical wear on a material¹,
2. **Autonomous forces** \Rightarrow an *internal, managed* force resulting from *innovation* potential. For instance, it could be replacing an outdated machine or gadget with a new one for the company, a sports player losing 2 kg weight, developing a new anti-aging therapy to lower mortality rates, or altering the composition of a material,
3. **Contextual forces** \Rightarrow an *external, inflicted* force resulting from environmental potentials (*characteristic*). For instance, the bank's interest rate for the company, the crowd pressure for the sports player, fatality due to a vehicle crash or an unexpected epidemic, or temperature change for a material,
4. **Interface forces** \Rightarrow an *external and managed* force resulting from exchange potentials (*interaction*). For instance, it could be suppliers providing raw materials for a company, nutrition & training for a sports player, immigration policy for a society, or electrolyzer & catalyst for a material.

The transition from potentials to potentialities (susceptibility in the causal chain presented in Figure 1.1) is shown in Figure 1.4 equivalently. The main takeaway from this figure is to identify the origin (internal/external) and the nature (inflicted/managed) of forces that influence (deviate) the Performance Trajectory in the Performance Space (Figure 1.3).

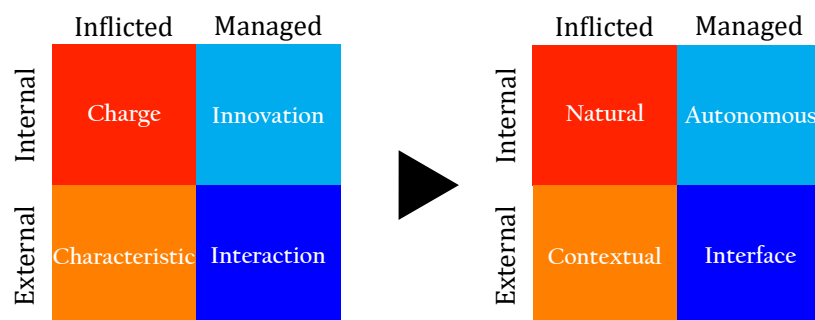

Figure 1.4: System Potentials vs. existing Forces

The Performance Trajectory is subject to force sources whose trigger conditions are satisfied. The Performance Trajectory may reveal more sources of forces as it develops—where unknown forces could drastically change the system's performance. However, if the framework is developed in a way that identifies these forces, it could play a vital role in minimizing potential risks or even turning those risks into opportunities.

¹Similar to how every mass-containing object experiences the unavoidable gravitational force on planets.

1.3.2 Force Assessment

The Force Identification stage (section 1.3.1) classifies the possible forces (Figure 1.4). However, it exclusively identifies their nature and origins and does not explain their properties. The force assessment stage serves to describe the properties of the identified forces. The following are the essential questions that this stage strives to answer. *How much is the force strength? How likely is it to occur? What paradigm would the force have? When and for How Long do the identified forces are applied?*

1. **Force Strength** \Rightarrow The Force Strength examines the *actuality* (Figure 1.1) that follows the force occurrence. The absolute magnitude of a force vector determines the geometrical deviation of the system's trajectory from its expected trajectory (the one without this force). This property, depending on the system's short-term, mid-term and long-term objectives, specifies the severity of risks (Insignificant, Minor, Moderate, Major, and Severe) and symmetrically gives weight to the opportunities, which subsequently determines the safe margins of the system to consider the risks or ignore them and, in the same way, determines the system's distance (how far or close the system is) from opportunities (mainly "Accessible Zones" in Figure 1.3) to seize or relinquish them [answer to **How much**],
2. **Force Likelihood** \Rightarrow The Force Likelihood examines the *conditions* (Figure 1.1) that activate the identified forces which could deviate the Performance Trajectory (Figure 1.3). This property could be characterized (i) qualitatively through expert forums, interviews, best guesses, data collections, data reviews, brainstorming, and a variety of other techniques (Rare, Unlikely, Possible, Likely, Almost Certain), and eventually, quantifying the results to exploit, or (ii) quantitatively through probability distribution calculation of its occurrence (Bernoulli, Uniform, Binomial, Normal, Poisson, Exponential or even Random Distributions) [answer to **How likely**],
3. **Force Pattern** \Rightarrow This property of the identified force—whether inflicted or managed—refers to its application mode. The force pattern (*e.g.*, punching, linear, logarithmic, wave-forms (sine, square, triangular, ramp, saw-tooth), etc.) could be consistent over time or dynamically change across time [answer to **What Paradigm**],
4. **Force Onset time & Duration** \Rightarrow The importance of the Onset time of force application—regardless of its source and nature—depends on the current situation of the system in the Performance Space; for example, instead of the occurrence of the force at time t , if it happens before ($t - i$) or later ($t + j$), it could get the system easier (or more difficult) to its target. This assertion holds for the force duration application. Merely noted, in the Performance Space, time matter [answer to **When and How Long**].

The nature, origin, and properties of forces (characterized through Force Identification and Assessment stages) are equally important; they provide independent perspicuities on forces to be well comprehended. For the system to yield all its promise (short-term, mid-term, and long-term objectives), these stages must be aligned so that decision-makers at any given time may perceive the relationship between the forces and the shape of Performance Trajectory, which may aid them in making cost-effective decisions at the appropriate time and place.



Requirement 2

The necessity of a space dedicated to the forces with the ability to describe and connect the system to its environment is inevitable. This space must (i) dynamically examine (observe, update, and change) the stages of the Force Characterization (identification and assessment) and (ii) adequately describe the observed system, its environment, and the relationships—connections, interactions—between them.

1.4 Description Space

This space presents the system and its environment (parameters, scope of variations, and their relationships) while characterizing the expected forces generated by identified potentials (Figure 1.4). Description Space (DS) generally refers to what is happening **within** and **around** the system and how their changes generate forces in the Performance Space.

The Description Space, similar to Performance Space (which stands on the system's KPIs), is a multidimensional, orthogonal virtual space with dimensions of the system and its environment on its axes². The dimensions of the Description Space that correspond to the "system" are known as "Attributes," whilst the dimensions that pertain to its "environment" are known as "Characteristics." A system with certain attributes might be influenced by several independent events with distinctive characteristics.

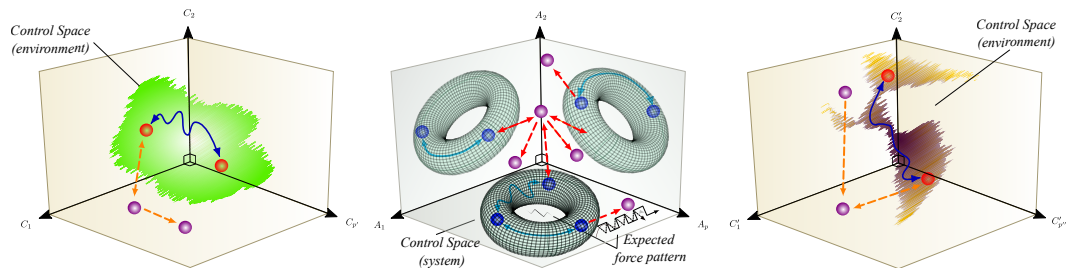

Figure 1.5: Description Space with system's Attributes and its environment's Characteristics

Figure 1.5 presents the Description Space of a system with "Attributes," A_1, A_2, \dots, A_p and its environment including two environmental components with independent "Characteristics," $C_1, C_2, \dots, C_{p'}$ and $C'_1, C'_2, \dots, C'_{p''}$ on axes. The blue and red spheres present the current value of parameters (dimensions) of the system and its environment at a specific time t_i , respectively—whereas the purple ones, or any other place of the Description Space, may present the current value for both the system and its environment, at the same time t_i .

Constraints on the variations of the parameters determine the degree of liberty for intentional or desirable changes in the system and its environment (variations of attributes and characteristics) which are shown with a bounded subspace called "Control Space³." Movements within Control Space present the "managed" potentials (Innovation and Interaction) and subsequently point to the "managed" forces (Autonomous and Interface) in the Performance Space. The other possible movements which do not start and terminate within the Control Spaces (start inside and terminate outside, start outside and terminate inside, start outside and terminate outside), shown in red and orange dashed arrows, indicate the "inflicted" potentials, Charge (for the system) and Characteristic (for the environment)—later their equivalent expected Natural and Contextual forces in the Performance Space.

According to constraints on the attributes and characteristics, Control Spaces could take various forms in the Description Space (Figure 1.5). For instance, the torus-shaped Control Space of the system on the $A_1 - A_p$ plane aggregates a discrete-stochastic control on attribute A_1 , uniform-discrete control on attribute A_2 , and discrete-stochastic control on A_p .

The following statements briefly adjust the Force Characterization stages (sections 1.3.1 and 1.3.2) to the Description Space presented in Figure 1.5.

²KPIs are often a formulation between the system's internal dimensions and its external environment, while a dimension is an atomic property (individual and not breakable to several properties) of the system or its environment.

³Yet more uncertain, unknown, and tough to recognize in the system environment (the two side figures).

- ▶ **Force Identification:** The parameters of the system and its environment (A_1, A_2, \dots, A_p and C_1, C_2, \dots, C_p) on axes present the “internal” and “external” forces’ sources. The intentional or spontaneous variation of these parameters indicates the force’s nature; if it starts and terminates within the Control Spaces, it refers to “managed” forces; whereas the other variations on parameters refer to the “inflicted” ones (it could be a combination of forces, at least one of which is “inflicted”),
- ▶ **Force Assessment:** Movements—whether internal/external/inflicted/managed—in the Description Space holds the following properties. The strength (the scope of its geometric projection on the space’s axes), likelihood (the chance that it will occur), and pattern (the mode of its application to the system).

In summary, the Force Characterization (section 1.3) addresses the origin, nature, and properties of supposed forces. The Description Space built on the dimensions of the system and its environment characterizes the forces that could deviate the Performance Trajectory in the Performance Space (Figure 1.3). However, the Force Characterization section does not address the “impact” of identified and assessed forces. The evaluation of the characterized forces, which depends on how the system responds to them, is discussed in the following section.

1.5 Force Evaluation

The system position (or Performance Trajectory) in the Performance Space (Figure 1.3) is thoroughly contingent upon existing internal and external forces. The evaluation stage seeks to determine the deviations of the Performance Trajectory impacted by “identified” and “assessed” forces in the previous sections. The evaluation refers to the “impact” of the force and not its “origin,” “nature,” and “properties.” In other words, the evaluation stage is thoroughly tied to the structure and properties of the system; how it reacts to the purposely applied (or imposed) forces.

1. **Trajectory Orientation** \Rightarrow Determines whether the applied force is a risk or an opportunity. The force might push the system (the object in the Performance Space) towards its objectives, indicated as Target Zone in Figure 1.3 (could be perceived as an opportunity); symmetrically, it could push the system away from the Target Zone and gets it closer to the Danger Zone (could be perceived as a risk). Merely noted, in the Performance Space, direction matters⁴,
2. **Trajectory Reaction** \Rightarrow Examines the force consequence on the Performance Trajectory according to the system characteristics on the two following issues.
 - (a) **Trajectory Paradigm.** The system responds to the applied forces with or without delay (it might not respond by absorbing the force, see more [here](#)); therefore, the force would emerge in a delayed or an instantaneous manner, respectively (identically, if the considered force is eliminated, its effect may last for a while before deviating the Performance Trajectory or, it may do so right away),
 - (b) **Trajectory Deviation.** or object (so-called system) displacement, examines the force consequence on the Performance Trajectory according to the force magnitude (*Force Strength* in section 1.3.2). The system displacement could be as expected according to the applied force, while it could be less or more depending on the system characteristics (see more [here](#)).

⁴In the proposed Performance Space in Figure 1.3, the center of the mass is consistently subjected to force application; therefore, the angle between a force and the direction of the object (system considered as an object) is not the focus of this study. However, this angle—one of the study’s perspectives—is important.

The Force Evaluation quantifies the force impact on the Performance Trajectory. The sort of the *Trajectory Orientation* and *Trajectory Reaction* might be acquired statically, meaning that a single study can indicate whether (i) a force poses a risk or an opportunity, (ii) the system responds to the applied force with delay or not, and (iii) the movement of the system is consistent with the strength of the applied force or not. This statement is also valid for the Force Identification stage, characterizing the source and the nature of a force; unless fundamental changes happen in the system (its internal and external structure, objectives, etc.) or an unknown force is discovered/identified, then introduced into the system.

In contrast, the quantitative deviations of trajectory require examining the system according to the properties of the applied forces to it (Strength, Likelihood, Pattern, Onset time & Duration presented in 1.3.2). These properties could have various initialization and settings and dynamically change in numerous scenarios. The evaluation stage explores all possible (what-if) scenarios of “**Force Strength**,” “**Force Likelihood**,” “**Force Pattern**,” and “**Force Onset time & Duration**.” These variables operate independently from one another at all times and might interchangeably (or comparable) perform to deviate the Performance Trajectory. For instance, the difference between Performance Trajectory deviations if the force occurs at $t - j$ and not at t (Onset time) could be a similar deviation if the force Strength (resp. Likelihood) is Moderate (resp. Rare) and not Severe (resp. Almost Certain).

Dynamic review of Control Space (restricted parts of the Description Space shown in Figure 1.5) and having far-reaching look at its boundaries is crucial. The flexibility on the Control Space borders could suggest an “inflicted” force according to the present Control Space (*i.e.*, beyond its limits) while critical to deviate the Performance Trajectory toward the Target Zones and worth investing in it. In other words, this flexibility might suggest extending the Control Space to turn the “inflicted” but critical force into a “managed” one.

This study is a force-based paradigm in performance management systems; accordingly, Force Evaluation is centered on the physical forces and the system’s movements stemming from their applications. In practice, the physical notations related to characterized forces are examined to learn the relationship between the forces and the system performance. The Force Evaluation, throughout this study, illustrates the relations between a KPI (and its associated notions, such as its variation, growth, and fluctuation) and physical notations (such as displacement, velocity, and acceleration).

Requirement 3

The rationale for the trajectory deviations is rooted in the forces applied to the system, represented in its Performance Space (section 1.2). On the one hand, the Performance Space displays this trajectory and its back-and-forth movements toward the system’s objectives (shown as Target Zones in Figure 1.3); on the other hand, the Description Space examines the reasons for these deviations and the configuration of the trajectory. A framework that synchronously deals with the Performance Trajectory and the grounds for its deviations, which provides a right-through investigation of the Force Evaluation (1.5), is presented as the last Requirement in the following.

1.6 Physics of Decision framework

The “Physics of Decision” (POD) framework in this section, as a core of this study, links (joins and tunes) the Description Space (Figure 1.5) to the Performance Space (Figure 1.3). This connection presents the relationships between the dimensions of the system and its environment (Description Space) to the considered KPIs (Performance Space) to pave the way to fulfill the Force Evaluation presented in section 1.5. Furthermore, this map between the spaces allows for examining the bidirectional causal effects relations between them. Figure 1.6 illustrates the concatenated spaces (without Zones and Control Spaces).

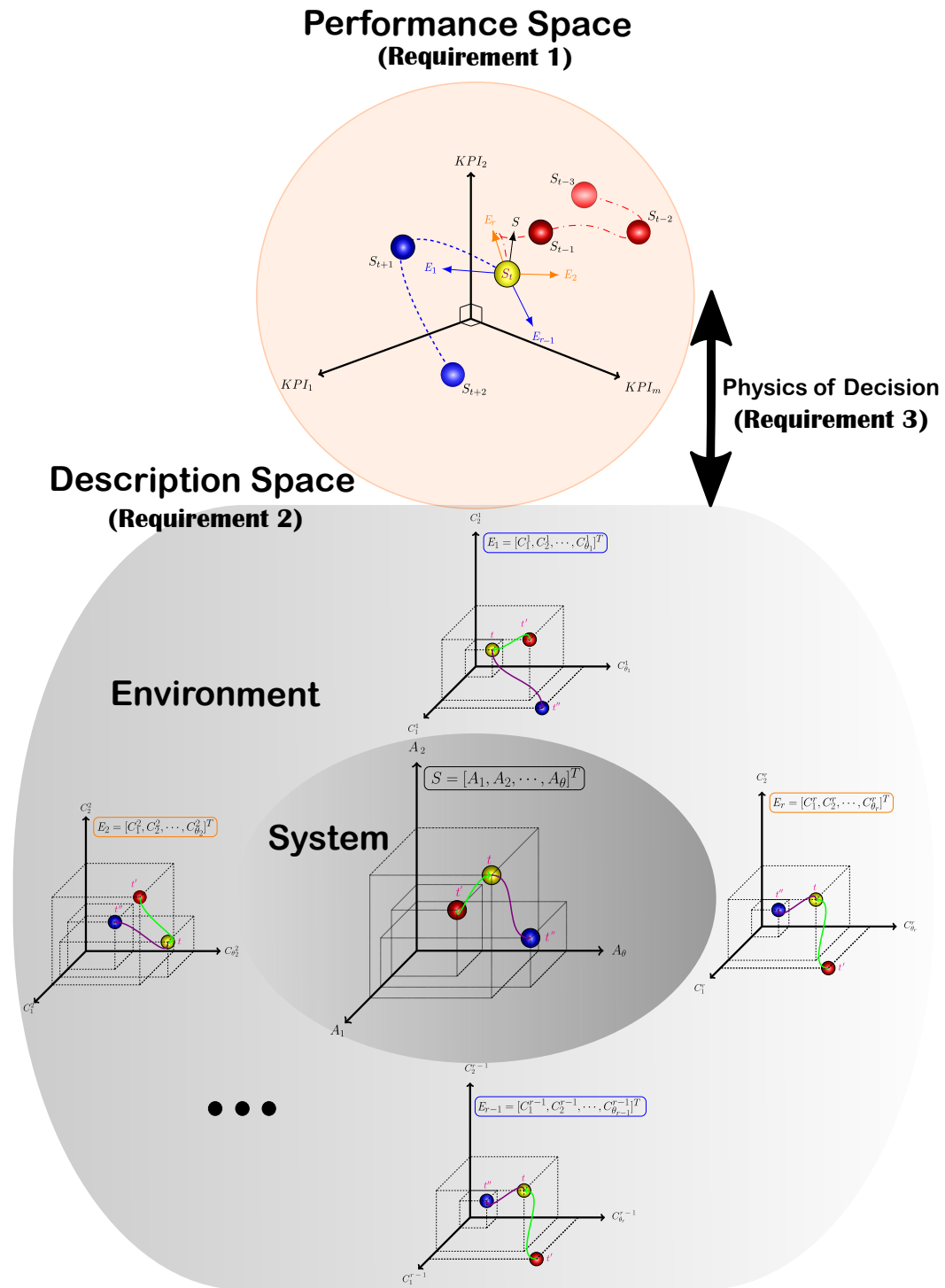

Figure 1.6: Physics of Decision framework

The Description Space, at the bottom of the figure, presents a system with θ “Attribute” ($A_1, A_2, \dots, A_\theta$) and r exclusive contextual elements in its environment ($E_1, E_2, \dots, E_{r-1}, E_r$ with $\theta_1, \theta_2, \dots, \theta_{r-1}, \theta_r$ “Characteristics,” respectively). The system goes on its expected Performance Trajectory until time t , at which moment it is subjected to forces generated by the system (depicted with S force in Performance Space) and the exclusive contextual elements from its environment (depicted with E_1, E_2, E_{r-1}, E_r —either *Contextual* or *Interface* forces). Likewise, this situation holds for later times and possible incoming forces applied to the Performance Trajectory from the system or its environment.



Mapping between the Description Space and the Performance Space through the “Physics of Decision” framework provides the chance to evaluate the forces deviating the Performance Trajectory.



In summary, the Physics of Decision framework aims at evaluating the forces; examining the Performance Trajectory back-and-forth in the Performance Space brought on by the variations of “Force Strength,” “Force Likelihood,” “Force Pattern,” and “Force Onset time & Duration.” The Force Evaluation stage is when the **POD framework** has its most significant upshots and plays a crucial role in simulating STSs. However, this assertion does not stand for the **POD theory** (discussed in section 1.7); see the reason and more detail in section 2.4. This mapping offers the chance to examine the two spaces thoroughly by investigating the internal and external forces (*inflicted* and *managed*) as circumstances that may deviate the Performance Trajectory in the Performance Space.

The presentation of the **POD** framework and the introduction of this study concluded with the following challenge.

What are the properties of the object (the so-called system in the Performance Space) subjected to forces arising from the system and its environment, and how are these properties taken into account in the Physics of Decision framework?

The **POD** framework in Figure 1.6 focuses on the system mobility, considered as an object, inside its Performance Space. The properties of this object may influence the trajectories (expected and deviated ones) and vary their behavior or shape. In other words, some physical properties of the object, such as its mass, stiffness, damping, etc., are factors that might affect the supposed deviations of the Performance Trajectory (*i.e.*, increase or decrease the absolute magnitude of the supposed force).

For instance, the object’s (system’s) mass may prevent it from moving and therefore neutralize the applied forces to it (it absorbs or repels the applied forces); similarly, it may throw the object more than expected (most common) displacements when its mass is light. Moreover, the damping or stiffness may vary the “Force Paradigm” (instantaneous to delayed or vice-versa). In conclusion, these non-conformities may thoroughly influence the Force Evaluation stage (section 1.5). These hypotheses hold for other possible physical properties of the object. The premise behind one of this study’s limits is as follows.



Assumption

The considered object in the Performance Space (Figures 1.3 and 1.6) is assumed as a solid object that consistently stays in a unique shape and does not absorb or repel the applied forces; its displacements on the referential space of its KPIs are always related to KPIs’ quantitative values. In other words, one unit of system movement always corresponds to one unit variation of KPI on its associated axis. **Therefore, this study overlooked the object properties by (i) dealing with the quantitative values of KPIs and (ii) assuming the system is a rigid object.**

1.7 Research Problems

The present work aims at providing a Decision Support System for complex systems in uncertain environments. The Physics of Decision theory aggregates a wide variety of studies in the literature review concerned with risk management, performance management systems, and system modeling. **The Physics of Decision is an open theory to serve in almost any time-dependent system. The primary ambition is to benefit from classical physics to (i) consider a Socio-technical System as physical objects or volumes (rigid or porous solid, liquidy, gaseous, etc.); (ii) equate the system's features to the properties of the object or volume (mass, viscosity, damping, etc.); (iii) connect the system's perturbations to physical phenomena (e.g., forces, pressures, tensions, heat, etc.); (iv) interpret the system's performance through physical notations (e.g., displacement, velocity, acceleration, etc.); and (v) exploit the proven physical laws to figure out the optimum decision (mitigate the risks and strengthen the opportunities) in navigating the system to meet its intended objectives indicated in a multidimensional virtual space built on its criteria (KPIs).** However, the above ambitions are abstract hypotheses and a global vision of the POD theory. The POD theory is not a focus of this study; rather, its framework is the primary pursuit.

The three essential requirements—[Requirement 1](#), [Requirement 2](#), and [Requirement 3](#)—are primary research areas. However, the stated [Assumption](#) is a fundamental physics-oriented aspect of the POD theory to investigate. Given that the present work primarily focuses on [Requirement 3](#), the remainder of this section attempts to define the pertinent research problems concerning the three requirements.

Construction of the Performance Space ([Requirement 1](#)). The introduced Performance Space in section 1.2 and depicted in Figure 1.3 is dedicated to the real-time review of the system's efficiency in fulfilling its determined objectives. The questions regarding the quantitative KPIs are the central pivot of this space, as the first research area. Assuming that some preliminary KPI-oriented investigations are performed and the ones considered are significantly relevant and measurable, the following aspects must be aligned to develop the Performance Space pertinent to system objectives and preferences.

- ▶ **Axes selection:** The identified and considered KPIs on the axes of the Performance Space stand for the aspects of the system that the POD users are seeking to study,
- ▶ **Axes normalization:** The numerical units of the axes must be carefully selected to ensure that they are comparable. Additionally, concerning the visualization, the KPIs unit must be aligned appropriately (scale up to each other),
- ▶ **Zone determination:** The persistent resolution of the unfavorable, neutral⁵, and favorable quantitative values of KPIs determines the Danger, Accessible, and Target zones, respectively. The desired (targeted) or unfavorable (dangerous) values for a particular KPI on its associated axis—minimum, maximum, or specified interval—innumerable zones are determined in the Performance Space. A dynamic review of the considered level for each KPI is crucial in deviating the Performance Trajectory toward intended Target Zones efficiently; This is more true for uncertain systems since agile decisions or trade-offs among system objectives are inevitable aspects in those systems.

Construction of the Description Space ([Requirement 2](#)). Somewhat similar to the construction of the Performance Space, the Description Space (introduced in section 1.4 and depicted in Figure 1.5) aims at identifying the system (Attributes), its environment (Characteristics), and the connections between them. The main interest in the Description Space is characterizing the Attributes and Characteristics rather than system KPIs. Similar to the stated

⁵The KPI values are not the system's objectives and may even be dangerous, but these levels are the points where risky decisions are taken to advance the system toward its Target Zones.

aspect for constructing the Performance Space, the following addresses those aspects for the Description Space. Description Space serves as the background of the POD framework rather than its visualization aspect; therefore, Axes normalization might not be an essential aspect to investigate (unlike the Performance Space). In contrast, the Description Space is where the relationships between axes are paramount, as they present the reasons for the system's behavior (*i.e.*, Performance Trajectory deviations).

- ▶ **Axes determination:** The axes of the Description Space represent a comprehensive examination of all internal potentials and external ones (contextual elements) that the system might face. Identifying all involved Attributes (system) and Characteristics (environment) in the system performance is mandatory and not an option (whereas KPIs are purposefully picked in the Performance Space),
- ▶ **Axes connections:** The formulation (usually mathematical equations) between the system axes with its environment Description Spaces explains their relationships. However, both the Attributes and the Characteristics may be connected (formulated) internally in some way,
- ▶ **Zone determination:** Zone in the Description Space refers to the **Control Space**. The constant resolution of the boundaries of the system's Control Space determines the internal potentials (*Charge* and *Innovation*), identically, the external ones (*Contextual* and *Interaction*) of the system's environment. The dynamic review of the Control Space borders is critical, similar to the Zones in the Performance Space (see the details in section 1.5, more precisely, [here](#)).

Installing the POD framework (Requirement 3). Following the mentioned research problems on constructing the spaces, establishing their connection is the most fundamental step in examining the system (Description Space) and its performance (Performance Space); putting the POD framework into practice meets this purpose. Installing the POD framework completes the proposed physics-based approach to managing the risk and opportunities in socio-technical systems. In other words, the POD framework puts the presented stages (**Force Identification**, **Force Assessment**, and **Force Evaluation**) together intending to examine the system, its environment, the forces (risks and opportunities) that the system might face, and their influence on system performance. The following are the main questions concerning the POD framework installation (section 1.6 and Figure 1.6) as the primary contribution of this study.

- **What are possible approaches to install the POD framework (map the Description Space to Performance space and vice versa)? In other words, what are possible ways to make a precise or approximate formulation between the system and its environment structure versus its performance?**
- **How are the available approaches for the POD framework installation served? In other words, how are the existing approaches for installing the POD framework used in various systems with particular applications?**

These challenging problems are notably essential in supporting the Force Evaluation stage (section 1.5). Discovering potential forces (Internal/External/Inflicted/Managed) and characterizing their properties (Strength, Likelihood, and Pattern) is performed independently of the mapping between the Description and Performance space; Nevertheless, it appears senseless to perform these two stages without exploring how the forces impact the performance trajectory (Force Evaluation stage). Therefore, the primary aim of the POD framework is to pave the way to perform the “**Force Evaluation**” stage (section 1.5).

The current work models several socio-technical systems in distinct ways (compatible with the case studies) and subsequently builds and investigates the **POD** framework for each instance. However, there is some discussion of the research problems related to the spaces' constructions in the presented contributions.

The stated research problems together aim to make the **POD** framework qualified to investigate forces-based principles and laws from classical physics. The ultimate purpose is to pick the best combination of "managed" forces (best balance of risks and opportunities) to lessen the negative impacts of "inflicted" ones. In other words, efficiently deviate the Performance Trajectory toward the stated system objectives (Target Zones) at any particular time (or for a period).

1.8 Thesis Organization

Following is a breakdown of how the remaining portions of this study are organized based on background and related works, thesis contributions, and conclusions and perspectives.

Chapter 2. This chapter, on the literature review, addresses the following topics.

1. The inspiration for this work and related existing physics-based approaches in diverse areas such as social phenomena, economics, psychology, decision-making, etc.,
2. The justification for decision-making, emphasizing the prescriptive decision theory domain, has to do with giving decision-makers tools and conceptual frameworks to assist them in their decision-making processes,
3. Introducing Decision Support Systems (**DSSs**) with a specific discussion on model-oriented types and their diverse application domains,
4. Specific investigations of the existing challenges and shortcomings in human decision-making and suggested remedies, and
5. The comparison between this study's approach and the present tools and technology in the **DSS** field, besides their significance in addressing the limitations in the decision-making.

Chapter 3. This chapter, on the contributions of this study, mainly on the **POD** framework installation, provides the following efforts.

1. A mathematical presentation of the framework,
2. Simulation models for the three distinctive case studies—System Dynamics (SD), Discrete Event Simulation (DES), and Agent-based Model (ABM), and
3. A mathematical model for simulating physical systems using differential equations.

Chapter 4. This chapter summarizes the main objective of this research work, along with the research questions and their answers. In addition, this chapter demonstrates research challenges, limitations, and future works.

2

Background and Related Works

| | | |
|-------|------------------------------------|----|
| 2.1 | Principal concepts and motivations | 17 |
| 2.1.1 | Physics in decision-making | 18 |
| 2.1.2 | Decision Theory | 19 |
| 2.1.3 | Performance Management | 20 |
| 2.2 | Decision Support System | 21 |
| 2.2.1 | General Background | 21 |
| 2.2.2 | Bounded Rationality | 25 |
| 2.3 | Tools and Technologies in DSS | 28 |
| 2.4 | Summary and Conclusion | 33 |

2.1 Principal concepts and motivations

Although “making decisions” concerns forecasting the future, it addresses an assumption of the occurrence of an event (Bennet et al., 2008). Making decisions is naturally challenging; it is complexities pile on complexities. Therefore, decision-makers are obliged to rely more and more on tools and technology to support their intuition and judgment and eventually forecast the future (Mahmud et al., 2022; Bennet et al., 2008). The more effectively these tools and technologies decrease complexities, the more apparent the relationships, the simpler it is to decompose the entangled interactions, the more straightforward decision-making becomes, and ultimately, the more concrete the predictions develop (Mahmud et al., 2022; Le Bris et al., 2019). This chapter initially intends to investigate the existing approaches in the related areas to this study, then leverage them to reduce the complexities in decision-making based on standard and proven rules to examine the socio-technical systems (STSs).

Making decisions is primarily concerned with avoiding risks and seizing opportunities while selecting an action (Benaben et al., 2019b; Bekefi et al., 2008; Hammond et al., 2006). The “Physics of Decision” framework introduced in chapter 1 inherits classical physics to study the system by viewing the risks and opportunities as physical forces pushing and pulling the system as an object in a multidimensional space built on its KPIs (Figure 1.3). The proposed POD framework for decision-making serves as a DSS; therefore, it operates as a prescriptive tool to facilitate the intricacies of the decision-making process.

This chapter discusses (i) the motivation for the presented framework according to the decision theory and performance management (section 2.1), (ii) the main principles of DSSs and contributions from the literature in association with this study (section 2.2), and (iii) a selective comparison of the DSSs in the literature in competition with the features of the POD framework in dealing with complexities of decision-making processes (section 2.3).

2.1.1 Physics in decision-making

Social Physics is a branch of science that studies social phenomena from the same perspective as astronomical, physical, chemical, and physiological phenomena—that is as being governed by natural, unchanging laws—the discovery of which is the specific goal of its study (Comte, 1856). Social physics has recently been applied to analyze the COVID-19 pandemic, demonstrating that the considerable difference in the spread of the virus between countries is due to differences in responses to social stress (Kastalskiy et al., 2021).

Econophysics is an interdisciplinary research field that employs concepts and procedures first developed by physicists to address economic issues, frequently those involving uncertainty, stochastic processes, and nonlinear dynamics (Mantegna et al., 1999).

Psychophysics originated to explain the mathematical relationship between the body and the mind alongside the conscious experience of a sensation induced by an external physical stimulus. Psychophysics had a massive impact on psychology, sensory physiology, and related fields because it provided means of measuring “sensation,” which previously, like all other aspects of the mind, had been considered private and immeasurable (Engen, 1988).

Field Theory is a discipline that studies how individuals interact with their environment as a whole. Kurt Lewin, inspired by force fields in physics, investigates the imposed changes in systems through the vision of “Driving Forces” and the system’s reaction to them as “Restraining Forces,” which lead the system to “Equilibrium Positions” as a result of interactions between Driving and Restraining Forces (Lewin, 1942; Martin, 2003). Lewin’s change model includes unfreezing, change (movement), and refreezing stages. The formula for Lewin’s field theory is $B = f(p, e)$, which states that behavior (B) is a function of the person (p) and their cultural environment (e) (Burnes et al., 2013; Martin, 2003).

Apart from many applications of physics in everyday life aspects, **this study leverages the existing related approaches and aims at establishing a reverse-engineering framework for mechanical analysis and reconstruction of the development of socio-technical systems**, which serves as the inspiration for the POD theory, discussed in section 1.7. In the POD framework, the system development is investigated through the constitution of the Performance Trajectory in the Performance Space, subjected to both generated and already existing risks and opportunities viewed as “physical forces” applied to the system. Hence, the principles of the POD framework are founded on those physical forces and the laws that govern them. Although a DSS could operate by individuals (manual), automatically (automatic), or a combination of both (semi-automatic), its basis is founded on the intuition and judgment of individuals as decision-makers to decide on both social and technical aspects (Brill et al., 1990; Keen, 1980). Without losing generality, technical aspects primarily concern the inanimate realm, while the social aspects concern the animate (living) domain. The following are some omnipresent instances that could serve as the motivation behind employing physics in social activities by illustrating the connection between the animate domain and physical phenomena.

- (i) The periodic gain and loss of weight due to overeating and lack of activity versus healthy diet and exercise, respectively,
- (ii) The sporadic increase and decrease in sales rate stemming from high and low client demand for a seasonal product, respectively,
- (iii) Increment and decrement of virus transmission rate depending on whether a mask is worn or not, quarantine of infected people, population vaccination, workplace closure, etc., in the emergence of epidemic diseases,
- (iv) Increase and drop in inflation brought on by changes in the demand for particular goods, the price of raw materials, devaluations, etc.

In these instances (and tons of similar spontaneous decisions or imposed events in daily life), overeating, dieting, customer demand, wearing masks, population quarantine, high demand for specific goods, etc., might be understood as “**physical forces**” applied on a system assimilated to an inanimate object (e.g., a pendulum). In contrast, the weight, sales rate, virus transmission rate, and inflation might be viewed as the object’s position (an indicator or **KPI**). The motivation for the **POD** framework is laid forth in the assertion that follows.



*The **Physics of Decision** framework is centered on connecting system behavior to physical laws of motion, emphasizing that social aspects (animate domains) behave in a way comparable to technical elements (inanimate realms) in terms of abiding by the physics’ **force-based** principles.*



The stationary-action principle, also known as the *least-action* principle, used to analyze the motion of a mechanical system yields the system’s equations of motion. According to this principle, the trajectories—that is, the results of solving the motion equations—are shaped with stationary points of the action function of the system. To represent diverse phenomena using a single physics principle, Mousavi and Sunder (Mousavi et al., 2021) cover topics and overarching principles for three fundamental scientific disciplines, animate (social sciences), inanimate (physics/chemistry), and animate-inanimate (biology/molecular chem), while considering a shared feature among the three disciplines, “physical existence in all domains is subject to physical laws.” Mousavi and Sunder, based on the *least action* principle, explore how actions (decisions interested in what to do) might be defined by fundamental physical principles before deferring to biological and social science norms. The idea of least action is used by (Mousavi et al., 2020) to structure both animate and inanimate activities from an inverted perspective between physics and decision-making. All inanimate things, animals, and people share the physical corpus, governed by the same physical laws as all other things. For instance, whatever the cause—wind, accident, or suicidal intent—a person or a stone will fall to the ground according to the identical laws of gravity (Mousavi et al., 2019). Out of all possible paths from starting point *A* to ending point *B*, the materially efficient course involves the least amount of action; where the action is a scalar corresponding to the dimension in which value has been preserved (appropriately specified) (Mousavi et al., 2020).



*The **POD** framework, similar to discussed approaches in this section, motivated by laws and principles of classical physics, intends to connect the behavior of the system, depicted as a trajectory in its Performance Space, to classical laws in physics and to drive the system to the most convincing parts of the space possible at hand (Figure 1.3).*



2.1.2 Decision Theory

Decision theory is the theory of rational decision-making to choose an action among a set of alternatives. In a nutshell, the main objective of decision theory is to provide as exact and accurate hypotheses about rational decision-making as possible (Bradley, 2017). Decision theory is an interdisciplinary subject researched by economists, mathematicians, data scientists, psychologists, biologists, politicians, and other social scientists, philosophers, and computer scientists (Peterson, 2017). The following are some primary paramount approaches to the root of decision theory and the rationale behind the behaviors of individuals while making decisions.

Ward Edwards created behavioral decision theory as a new field in psychology with two seminal articles: “The Theory of Decision Making” (Edwards, 1954) and “Behavioral Decision Theory” (Edwards, 1961). “Judgment Under Uncertainty: Heuristics and Biases”

(Kahneman et al., 1982) discussed three heuristics that humans employ to form judgments about uncertainty: representativeness, availability, and anchoring. The “Framing of Decisions and the Psychology of Choice” discusses how decision frames affect decision-maker perception of the decision problem (Tversky et al., 1985). Prospect theory is a descriptive decision-making theory that differs from expected utility theory by using insights from behavioral decision analysis (Kahneman, 1979).

Decision theory characterizes and explains regularities in the choices that individuals are disposed to make (descriptive theory), how rational individuals ought to make decisions (normative theory), and how to assist less-rational individuals who strive for rationality in making better decisions (prescriptive theory) (Bell et al., 1988). Less-rational or non-rational individuals refer to ordinary people who have not thought through their decision-making process or, even if they have, are cognitively incapable of carrying out the desired procedure. Human beings as decision-makers are not perfectly rational; they make mistakes, feel regret, experience anxiety, and finally, struggle to come to a choice. The (Bell et al., 1988) study has considered the third component, the “prescriptive” side, to the usual dichotomy that distinguishes between the normative and descriptive sides (the “ought” and the “is” respectively). This prescriptive study is necessary to respond to the following question. *How can actual people—as opposed to idealized, super-rational, hypothetical beings without psyches—make better decisions in a way that doesn’t violate their profound cognitive concerns?*

In summary, the “prescriptive” decision theory seeks to answer the following questions. How could individuals improve their decision-making? What type of decision-making tools and conceptual frameworks could be helpful?—not for idealized, unconscious machines (*i.e.*, the inanimate automata), but rather for real animate decision-makers (Bell et al., 1988).



*The POD framework presented in chapter 1 focuses on the **prescriptive** aspect of decision theory to provide a DSS with standardized features derived from classical physics (mainly force-based laws of motion). This framework, as a prescriptive tool, seeks to pave the way to provide a multi-criteria performance analysis to STS.*



2.1.3 Performance Management

The process of ensuring that a collection of actions and outputs effectively and efficiently achieves an organization’s objectives is known as performance management. Performance management might concentrate on an organization, a department, an employee, or the processes in place to manage particular tasks (Harzing et al., 2010). The most frequent application of performance management principles is in the workplace; however, these principles are present in any setting where people interact with their environment to achieve desired developments, including schools, community gatherings, sports teams, health settings, governmental agencies, social events, and even political settings (Mettler et al., 2009). Performance management is an approach used by system managers to more closely match the long-term objectives of the system with its short-term and mid-term pursuits to boost effectiveness, productivity, and profitability (Armstrong, 2006).

In general, “system performance” refers to how effectively a system achieves its stated objective and creates value for the stakeholders it aims to reach (Lazowska et al., 1984). Accordingly, “system performance management” focuses on how the management systems, processes, and products translate a system’s stated mission into practice (Schleicher et al., 2018; Lægreid et al., 2006). The system could be social (Xiahou et al., 2018; Abdul Khalid et al., 2019), economical (Băndoi et al., 2021), environmental (Xue et al., 2020), or any other form of a STSs.

In the POD framework context, the notion is that managing a system entails focusing on particular objectives, often expressed by numerical values of KPIs. This study does not

judge the relevancy of the **KPIs** to the system objectives—for example, whether the selected **KPIs** are SMART (Specific, Measurable, Attainable, Relevant, and Time-bound) or not (Ishak et al., 2019). Regardless of the system type and the **KPIs'** relevance to the system objectives, the **POD** framework deals with the quantified criteria (**KPIs**) in the Performance Space.



*In the context of the **POD** framework, system performance management intends to bring its **KPIs** as close as possible to the targeted values, depicted as Target Zones in the Performance Space (Figure 1.3). The measurements are physics-based notations (e.g., displacement, velocity, and acceleration) to make different levels of decisions (operational, tactical, and strategic).*



2.2 Decision Support System

Peter G. W. Keen initially used the phrase “Decision Support Systems” (**DSS**) in the late 1970s. In their 1978 book entitled “Decision Support Systems: An Organizational Perspective,” authors Keen and Morton provided a comprehensive behavioral orientation to **DSS** analysis, design, implementation, evaluation, and development. This study characterized the **DSSs** as computer systems that impact decisions where computer and analytical tools may be sound while the manager’s intent is crucial (Averweg, 2009; Scott-Morton et al., 1978; Keen, 1978). A Decision Support System is an interactive software system that offers information from data and models to assist decision-makers in more successfully solving decision problems.

In light of the above definition, a **DSS** does not necessarily make a decision maker more effective or a decision maker’s replacement (Newman et al., 2014). Decision Support Systems are developed to enable the decision-maker to take into account more aspects of a decision, potentially create better alternatives, analyze more choices, and allow the consideration of multiple scenario analysis and uncertainty (testing options for robustness, minimizing regret, and enhancing the efficiency of complex decision analysis), as well as to possibly support in the exploration of the decision maker’s perceptions and values (H. B. Eom et al., 1990). By incorporating management science and operations research methods, **DSSs** set themselves apart from other computer-based information systems (Newman et al., 2014).

Moreover, **DSS** must offer reliable, fast, and comprehensive information to analyze. A particular **DSS** must present data in a suitable manner that is simple to comprehend and use. **DSSs** may create the information it presents using a decision model, transaction data analysis, or data from external sources. **DSS** may provide managers with information from inside and outside the system, wise judgments, and projections. Managers seek the relevant information at the right moment, in the appropriate format, and for a reasonable cost. Although these system requirements appear straightforward and uncomplicated, fulfilling them is challenging (Shih, 2022; Holsapple et al., 1996; Sprague Jr et al., 1982).

2.2.1 General Background

One of the constantly evolving boundaries in the use of computers in industries is the development of decision support systems. **DSSs** undoubtedly come in a wide variety. Most of **DSSs** put a strong emphasis on data, models, and communications. Moreover, the scope of **DSS** varies—some are developed to serve stand-alone by a single primary user, while others serve a wide range of users inside an organization. **DSS** varies concerning who utilizes each system; for example, some are used by decision-makers directly, while others are used by intermediates like marketing analysts or financial analysts (Power, 2002). Steven Alter had the first attempt to suggest a taxonomy of **DSS** in 1978. This categorization is arranged on

how much the outcome of the **DSS** can influence a decision. A range of generic operations that **DSS** can carry out is related to the taxonomy. From data-oriented to model-oriented, the general processes span this dimension (Alter, 1978). The seven **DSS** types are included in Alter's taxonomy. The following is a quick overview of the **DSS** types that Alter suggests. The highlighted ones, shown in blue, are more tied to the features of **POD** framework.

- **Data-oriented** (data-driven, retrieval-oriented)
 - **File drawer systems** that provide access to data items. Examples include inventory reordering, monitoring systems, and real-time equipment monitoring. This category includes basic online transaction processing (OLTP) query and reporting tools.
 - **Data analysis systems** that enable the processing of data through either more specialized or more generic operators and tools, depending on the task at hand. Examples include the examination of investment prospects and monitoring of variances in budgets. The majority of data warehouse applications fall under this category.
 - **Analysis information systems** that allow users to access several decision-oriented databases and compact models. Examples include competition assessments, product planning and analysis, and sales forecasts based on marketing databases. Systems like online analytical processing (OLAP) fit into this set.

- **Model-oriented** (model-based, quantitative)
 - **Accounting and financial models** that investigate “what-if analysis” and determine the results of various decision-making options. Creating estimates for income statements and balance sheets, goal-seeking analyses of operational strategies, and profitability estimations for new products are a few examples. These models are used in conjunction with “What-if” or sensitivity studies.
 - **Representational models** are simulation models that use causal relationships and accounting concepts to assess the effects of actions. Examples include simulating equipment and industrial processes, risk analysis, and market reaction models.
 - **Optimization models** provide the best outcome while assuming several restrictions and then offering advice for action. Systems for scheduling, allocating resources, and optimizing material use are a few examples.
 - **Suggestion models** carry out the logical processing that results in a particular advised choice for a structured or well-understood task. An optimum bond-bidding model, a **DSS** that uses log-cutting, and credit scoring are a few examples.

Several scholars adapted or expanded Alter's taxonomy (or separately discussed the **DSS** categories from other points of view); For instance, Donovan and Madnick classified **DSS** as either institutional or ad-hoc **DSS** (Donovan et al., 1977); Holsapple and Whinston suggested text-oriented, database-oriented, spreadsheet-oriented, solver-oriented, and rule-oriented **DSSs** (Holsapple et al., 1996); Power extended Alter's categorization in terms of intended users, purpose, and enabling technology (Power, 2002). These categorizations provide features in support of defining a particular **DSS** or decision-support product.

Hackathorn and Keen suggested a **DSS** framework built on the structure of tasks (unstructured, semi-structured, and structured) from Simon Herbert (Simon, 1960) and classification of managerial activities (*i.e.*, operational control, management control, and strategic planning) from Robert N. Anthony (Anthony, 1965), by adding a new dimension, task dependency, in three distinct yet interrelated categories: independent, pooled, and sequential.

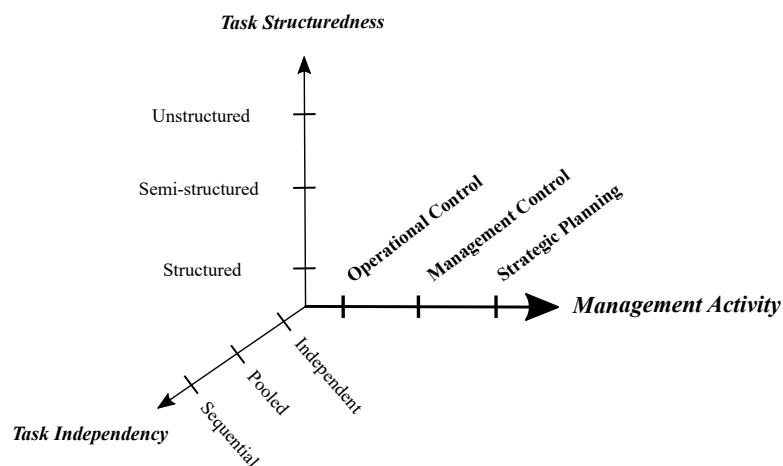

Figure 2.1: DSS framework proposed by Hackathorn and Keen (Hackathorn et al., 1981)

Figure 2.1 presents the suggested **DSS** framework by Hackathorn and Keen (Hackathorn et al., 1981). H. B. Eom and S. M. Lee concentrated on the management level, where **DSSs** might be classified as supporting operational, tactical, or strategic decisions, predominantly (Newman et al., 2014; Borshchev et al., 2004). They placed particular attention on the *Management Activity* aspect of the proposed **DDS** in Figure 2.1 (H. B. Eom et al., 1990). The following briefly explains the decision levels on the **Management Activity** aspect.

- ▶ **Strategic Decision.** Long-term, complex, non-routine decisions often made at a senior management level,
- ▶ **Tactical Decision.** Mid-term, less complex decisions often made to achieve strategic policy at a middle management level,
- ▶ **Operational Decision.** Short-term, simpler, routine, day-to-day decisions, made at a junior management level.

*The presented **POD** framework in chapter 1 serves as a physics-based **DSS** for **STSs**. In terms of the characteristics and types of **DSSs**, the **POD** framework is investigated from predominantly two angles: (i) Modeling the **STSs** and its environment and (ii) Modeling potential internal and external perturbations of the system (risks and opportunities) as physical forces impacting the object, so-called system.*

The following positions the **POD** framework into the **Model-oriented** (notably, Representational and Optimization models) type of **DSS** according to Alter's taxonomy and **Management Activity** aspect of Hackathorn framework (Figure 2.1).

- ▶ Modeling the system (Alter Taxonomy)
 - **Representational model.** The presented **POD** framework (Figure 1.6) performs the causal-effect relationships between the Description and Performance spaces (shown in Figures 1.5 and 1.3, respectively) which provides the chance to examine the impact of the intentional or imposed events from the system and its environment.
 - **Optimization Model.** Moreover, the **POD** framework considering the restriction on the Attributes and Characteristics (Control Spaces of the system and contextual

elements, shown in Figure 1.5), offers the best actions to take through the Force Evaluation stage (section 1.5).

- ▶ Modeling potentials (Hackathorn framework)
 - **Operational Decision.** The object's displacement on the associated axis to a **KPI** in the Performance Space is connected to the immediate variations of that **KPI** (Micro-level). In such a sense, short-term base action must take (generate/eliminate forces) to move the object toward Target Zones.
 - **Tactical Decision.** The object's velocity on the associated axis to a **KPI** in the Performance Space is connected to positive or negative growths of that **KPI** (Meso-level). In such a sense, mid-term base decisions could regulate the system's speed toward Target Zones.
 - **Strategic Decision.** The magnitude and direction of the object's acceleration on the associated axis to a **KPI** are connected to the positive or negative fluctuation of that **KPI** (Macro-level). Therefore, a long-term base action is required to ensure, all around, the object advances toward the Target Zones.

DSS application areas. Eom found many different **DSS** applications had been published in the academic literature (S. B. Eom, 2002; S. B. Eom, 2003). Eom studied **DSS** applications documented in the literature from 1970 to 1992, overlooking conference proceedings articles and Ph.D. dissertations. Further, Eom found more than 1800 papers about **DSS**, many of which concentrated on the model-driven **DSS** described in this article (S. B. Eom, 2003). An additional bibliography of **DSS** applications is provided by Kim and Eom (H. B. Eom et al., 1990). Most subjects of **DSSs** and interfaces include articles illustrating practical applications of **DSS**, and so does this work; Shim et al. have offered a comprehensive conceptual perspective on decision support systems (Shim et al., 2002).

In their most recent study on **DSS** applications, Eom and Kim looked at how **DSS** applications and technologies evolved through time into (i) corporate functional management, which accounted for 73.3% of the study, and (ii) non-corporate domains, which accounted for 26.7%. The **DSS** applications for these two domains are listed below (S. Eom et al., 2006); highlighting that similar to the interest of research studies in the **cooperative functional management** category, the selected case studies in this work are mainly in this category (more specifically, **production/operation** area¹, ~32% out of the total).

- **Corporate functional management.** Inter-Organizational decisions (2%), Strategic Management (4%), Human Resources (4%), Finance (6%), Multi-Functional Applications (8%), Management Information Systems (14%), Marketing/Transportation (18%), *Production/Operation (44%)*.
- **Non-corporate areas.** Agriculture (7%), Urban/Community Planning (7%), Military (11%), Natural Resources (13%), Hospital/Health-Care (13%), Miscellaneous (14%), Education (16%), Government (20%).

There are still discussions and disagreements regarding the categories and the applications of **DSS**; consequently, there is a substantial dose of research related to **DSS** (Power et al., 2007). Given that, the **POD** theory aims at creating a general **DSS** committed to assisting with problems in **STs**—which encompasses a wide range of systems with tremendous diverse challenges. Therefore, regardless of the systems' types and their challenges, the foundation of the theory is observing systems from an abstract point of view, which seeks to find affinities that could be obtained from the perspective of laws founded in physics. This

¹Polling place management (mainly operation), road traffic management (mainly operation), pandemic simulation model (mainly operation), and manufacturing production model (mainly production/operation).

argument implies that addressing the POD theory's functionality and potential challenges in decision-making is considerably more crucial than focusing on its potential areas of contribution. The remainder of this section discusses the primary challenges and how the POD framework addresses them.

2.2.2 Bounded Rationality

The essential bottleneck of DSS models is that, once they are developed and created, they are seldom checked in the future to see whether they still serve as accurate representations of the system, its environment, and potential perturbations they might face. Decision makers (usually managers) provide a model to be built based on their experiences and thoughts, and programmers transform these specifications and expertise into an applicable DSS. Once a model starts producing reliable results, rarely does DSS's user wonder if it still delivers correct results or not. The model definition stands the presumption that the underlying hypotheses are still valid. Consistently questioning the reliability of DSS is a fundamental aspect of DSS since the alternative decision-makers may have depended heavily on the presumptions about the problem situation (Madhavan et al., 2007; Paradice, 2008).

The aforementioned pervasive issue remains concealed in the shadow of the following fact and extends until such a time that the developed DSS is no longer reliable. The fact is that decision-makers inevitably are compelled to consider a variety of realistic options that satisfy them rather than opting for decisions or behaviors to maximize and optimize the outcomes (Paradice, 2008). Simon argued that the most fundamental unit of analysis in decision-making is the premises (*i.e.*, assumptions). The principles that one is most compatible with are those that are most relevant to a particular situation, in Simon's perspective. These assumptions control the alternatives considered and consequently influence the decision-making process and dictate decisions (Simon, 1950; Newell et al., 1972; Simon, 2013).

Bounded rationality is Simon's hypothesis that when individuals make decisions, their rationality is restricted and that, as a result, they will choose a decision that is satisfactory rather than optimum. The complexity of the decision-making problem, the mind's cognitive aptitude, and the amount of time available are some of these constraints. According to this theory, decision-makers operate as satisficers, seeking a satisfactory answer with what they currently have available rather than an ideal one. Thus, humans do not do a thorough cost-benefit analysis to decide the best course of action, instead opting for a solution that satisfies their adequacy requirements. Altogether, the Bounded Rationality hypothesis states that individuals do not make perfectly rational decisions because of both cognitive limits (the difficulty in obtaining and processing all the information needed) and social limits (personal and social ties among individuals) (Simon, 1960; Simon, 1990; Sent, 2018).

According to Herbert Simon's hypothesis of Bounded Rationality, some activities are suggested to minimize the impact of potential issues brought on by Bounded Rationality. The following is an excerpt from his book "Administrative Behavior," addressing those activities and types of decisions that individuals are exposed to make in the organizational sector as an example of the socio-technical systems (Simon, 1950).



Decision-making can be a challenging task sometimes; this especially happens when we are uncertain about the outcome of the decision we make or when we lack knowledge about the particular subject on which we are making the decision. Decision-making skills have become crucial in the present-day workplace with employees' managers and team leaders working towards their organizational goals. The proposed decision-making theory is established by exploring the traits of decision-making by people in administrative posts in organizations. The hypothesis states that there are three steps involved in forming decisions: "Intelligence," "Design," and "Choice" activities.

Intelligence Activity involves identifying issues in organizations and striving to gather data and information for possible solutions to develop. Considering that possible solutions have found a few different ways to overcome a particular problem, now is the time to examine each solution and list its pros and cons; This is performed in the second stage, known as a **Design Activity**. Finally, when the solutions and their pros and cons are examined, the decisions having the most desirable outcome are selected; since each decision comes with consequences, this process is pretty challenging as it requires a variety of skills such as being able to judge between solutions fairly, having a sense of creativity, and of course prior experience in the context of the problem. This stage is known as **Choice Activity**.

Further principles are followed by the three mentioned activities while making decisions. While formulating a decision, there is a **Value** component and a **Fact** to it. **Values** are the ethical component, or more precisely, they are the moral beliefs of the decision-maker. Moral beliefs can be right for one person while being wrong for another, which is why this theory recommends reducing the number of Values used in decision-making but not completely nullifying them. The **Factual** part is verifiable information. It is possible to verify this aspect of the decision, and all parties will likely come to a conclusion—whether it is right or wrong. However, to make a rational decision, a high level of specialization, the use of scientific methods, a comprehensive understanding of the market and political structures, and extensive knowledge of the problem’s context, are all required.

In the administrative sector, there are two different forms of decision-making: **Program** decisions and **Non-program** decisions. Program decisions resemble everyday routines that individuals create on a chart but seldom follow; whereas non-programmed are those that are unique and non-repetitive for every challenge. For instance, establishing a new business to compete with rivals, perhaps enhancing brand image, or even making a personal lifestyle, are some instances of using this theory.

Prior to Simon’s theory, decisions in organizations were exclusively dependent on statistical data, where decision-makers have struggled with the reasons for adverse outcomes of their judgments; Simon drew attention to the limits of human psychology along with other aspects like stress and the environment’s anxiety. The proposed activities, Intelligence (problem discovery), Design (solution discovery), and Choice (choosing solution), to overcome Bounded Rationality are presented in Figure 2.2.



Figure 2.2: Intelligence, Design, and Choice activities and their relationships

According to Figure 2.2, the decision-making process includes (i) the Intelligence-Design-Choice forward chain, shown with blue arrows, and (ii) the Choice-Design-Intelligence backward chain, shown with red arrows. The backward chain is the consequence of the forward chain, where there are deficiencies in the steps of the forward chain, problem discovery, solution discovery, or choosing solutions. The backward chain is briefly detailed in the following though not covered in the excerpt from Simon’s book. The following presents the two chains together and concludes the relationships among the activities.

► Forward Chain

- **Intelligence** ⇒ **Design**. This step transfers the identified problem and the acquired data from Intelligence Activity to generate solutions and alternatives for the problem at hand through the Design Activity.
- **Design** ⇒ **Choice**. This step transfers the discovered solutions and alternatives from the Design Activity to examine and ultimately select the most desirable solutions through the Choice Activity.

► Backward Chain

- **Choice** ⇒ **Design**. This step is performed when none of the discovered solutions from the Design Activity step provide satisfactory results.
- **Design** ⇒ **Intelligence**. This step is taken when the discovered solution or alternative has not been examined well (*i.e.*, there is insufficient knowledge of its benefits and drawbacks).

The intrinsic nature of introduced activities in Simon’s theory is positioned on “Prescriptive Decision Theory” (introduced in sections 1.1 and 2.1.2) aimed at improving the decision-making abilities of non-idealized (less rational) decision-makers². The activities and their relationships must be aligned to make a successful decision.

The fundamental component of the POD framework is modeling the system (and its environment) and its potentials, which are bonded to the Activities and Chains (Forward and Backward), respectively, in Simon’s suggested model.

“Intelligence,” “Design,” and “Choice” activities are what the POD framework based on “Prescriptive Decision Theory” is seeking to cover throughout the Force Characterization and Evaluation stages presented in sections 1.3 and 1.5, respectively. The POD framework’s integration into Simon’s suggested Activities is briefly justified in the following.



In successive steps, (i) building the “Description” and “Performance” spaces and the relationship among them assists in identifying the problem^a and potential solutions to it (**Intelligence Activity**), (ii) constructing the “Mapping” between the two spaces, allows examining the solutions (**Design Activity**), and ultimately, (iii) exploring the “Control Spaces” provides the most desirable obtained action through controlling (creating or eliminating, later, selecting) managed forces (**Choice Activity**). Figure 2.3 summarizes these justifications.

^aPretty much, in the POD context, the stated “problem” is generally translated to minimizing the difference between “Actuality” (system’s current performance) and the intended “Objective” according to the conceptual structure depicted in Figure 1.1.

Two fundamental aspects make up the “Mapping” between two spaces. (i) How the system interacts with its environment; and (ii) How perturbations (risks and opportunities, so-called forces) are examined through mapping. The first aspect mainly pertains to “Intelligence Activity,” whereas the second one primarily pertains to “Design Activity.”

In addition to tuning the POD framework to the proposed activities by Simon, the Force Characterization stage (Identification and Assessment stages presented in section 1.3) and Force Evaluation stage (section 1.5) support the Forward and Backward Chains.

²However, the stated “Fact” and “Value” principles in Simon’s theory are mainly related to the “Normative Decision Theory” (choices that individuals ought to make) and “Descriptive Decision Theory” (choices that individuals are disposed to make), respectively. In addition, the “Programmed” and “Non-programmed” decisions are related to “linear” and “non-linear” interactions, respectively, in the first principle of Socio-Technical Theory, presented in section 1.1.

The axes and arrows depicted in Figure 2.3, along with the following explanations, present this alignment. The following presents the relationships between the transitions among activities and the proposed steps of **Force Identification**, **Force Assessment**, and **Force Evaluation**.

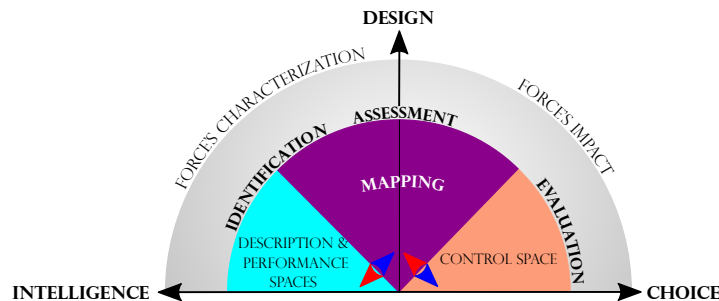

Figure 2.3: The POD framework adjustment into the Activities & Chains (Simon, 1950)

► Forward Chain

- **Intelligence** ⇒ **Design**. The identified forces (Natural, Contextual, Autonomous, Interface) from the **Identification** stage are transferred to the **Assessment** stage to examine their parameters (Strength, Likelihood, and Pattern), then,
- **Design** ⇒ **Choice**. The best force (or combination of the most convincing ones) among the Managed forces (the ones generated/eliminated from Control Spaces), followed by simulating, calculating, and anticipating their impacts, is picked to deviate the Performance Trajectory toward the Target Zones following the **Evaluation** stage.

► Backward Chain

- **Choice** ⇒ **Design**. The dynamic review of Control Spaces and flexibility on its boundaries might suggest an “inflicted” force with the possibility to turn it into a “managed” force, meaning an undiscovered solution could be identified (see the details in section 1.5, more precisely, [here](#)).
- **Design** ⇒ **Intelligence**. Following the Mapping among spaces, it is possible that the forces’ *nature* and *source* are classified inaccurately, or their parameters differ from what was supposed. Thus, re-doing the Assessment or the Identification stage might serve as the second step of the Backward chain.

2.3 Tools and Technologies in DSS

The decision-making tools enable the exploration of all potential choices and alternatives to the decision at hand, appraisal of the costs if chosen, and the probabilities of success or failure. These applications provide the groundwork for ways to make the right choice by simplifying the decision-making process. The wide range of DSS types, discussed in section 2.2.1, has led to the development of tools and technologies that support the specified thoughts, concepts, and strategies that underlie every single type of DSS.

The overall objective of the “Physics of Decision” is to define a unified and generalized theory for performance management and to pave the way to build a decision-support technology based on physical laws. This theory would be independent of a specific application field while equipped with several scientific technologies.

The **POD** theory (section 1.7) focuses on unforeseen perturbations, which leads to risks and opportunities that the systems might face, and so does its framework. According to the section summary of the “Administrative Behavior” book (2.2.2), Simon distinguished between programmed and non-programmed decision types (Simon, 1950). Perturbations, which mainly arise from non-linear interactions in socio-technical systems (section 1.1); dealing with them, are primarily associated with non-programmed decisions (Hassanien et al., 2018).

This section focuses on exploring the existing tools and technologies which assist in making non-programmed decisions in association with **Intelligence, Design, and Choice** activities to reduce the effect of Bounded Rationality drawbacks (*i.e.*, toward making optimum decisions, not just ones that are satisfying). In addition to differentiating the tools and technologies according to the maturity of supporting the mentioned activities, they might be classified as either automated (operated without human intervention), manual (handled by individuals), or semi-automated (a combination of the automated & manual) (Brill et al., 1990; Keen, 1980).

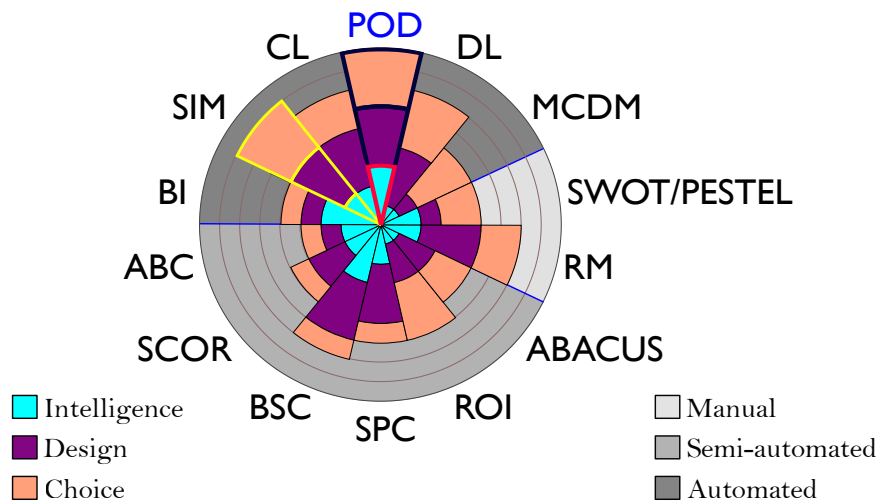

Figure 2.4: DSS Tools and Technologies in support of activities for Bounded Rationality

In Figure 2.4, the primary tools and technologies for performance management and decision-making (*i.e.*, DSSs) are succinctly and qualitatively outlined, along with their significance for the **Intelligence, Design, and Choice** aspects. The circle’s slices are colored to symbolize these aspects and scored on a scale of three for the low, mid, and high levels of maturity. The **POD** framework (highlighted with black color) is envisaged to receive a total score in the three aspects, emphasizing its strength in the **Intelligence** one (indicated with red color). The simulation (**SIM**) approach is acknowledged as being the most advantageous (while the competitive one) to the **POD** framework (indicated with yellow color).

Most of the current tools and technologies exclusively address one or two of the activities, and none significantly support all of the decision-making issues stemming from Bounded Rationality with a high level of maturity. The grading in Figure 2.4 is briefly justified below (clockwise and starting from “Manual” ones), along with some advantages and disadvantages concerning the activities for each tool or technology.

“Manual Decision Support Systems”

SWOT/PESTEL. The Strengths-Weaknesses-Opportunities-Threats (SWOT) analysis manually deals with defining an organization’s strategic action. The power of SWOT is its internal scrutiny of the organization’s capabilities (**Intelligence**), followed by environmental scanning to identify appropriate opportunities and threats (**Intelligence**) and a chance to discover the opposite of the identified opportunities and threats (**Design**), which might help in choosing the most relevant action later on (**Choice**) (GURL, 2017; Benaben et al., 2022).

However, the following are some drawbacks of SWOT which confirm its weaknesses, mainly in the **Design** aspect. (i) No straightforward methodology has been proposed to identify strengths and weaknesses (**Intelligence**), (ii) Most SWOT analyses focus on an excessive number of the organization’s strengths and weaknesses rather than on the main ones, which makes it difficult to translate the findings into actions (**Choice**), (iii) There is no indication of causality among the strengths and weaknesses, nor are they ranked into any hierarchy (**Design**), (iv) The SWOT analysis is typically a one-time event lacking mechanisms for acting upon and monitoring the changes in strengths and weaknesses over the longer term (**Intelligence/Choice**) (Coman et al., 2009).

The Political-Economic-Social-Technological-Environmental-Legal (**PESTEL**) analysis, in terms of the maturity of its impact on Simon’s activities, might be compared to the SWOT analysis as a complementary approach that insists on identifying “external” opportunities and threats (Benaben et al., 2022; Sarsby, 2016).

Risk Management (RM). Risk management involves identifying risks (**Intelligence**), measuring them (**Intelligence**), examining the solutions to those risks (**Design**), and putting those solutions into practice (**Choice**), then using resources in a coordinated and economical way to lessen the likelihood or impact of unfortunate events or to maximize the realization of opportunities (Culp, 2002).

Risk Management is a generic, primitive, often manual, and traditional **DSS** that fully covers Simon’s activity to enrich the proposed activities. However, due to the high level of uncertainty regarding the system, its environment (**Intelligence**), and their interactions, along with a lack of knowledge of them (**Intelligence**), the Risk Management processes became complicated; Consequently, all these weaknesses make the Risk Management approach an unreliable **DSS** for making decisions (Ward et al., 2003).

“Semi-automated Decision Support Systems”

ABACUS. or in general computer-aided software engineering (CASE), is a software suite for finite element analysis and computer-aided engineering. Automotive, aeronautical, and other industrial products employ ABACUS. There are three distinct phases to every whole finite-element investigation. (i) Pre-processing or modeling, this step involves creating an input file including the engineer’s design for a finite-element analyzer (**Intelligence**), (ii) Processing or finite-element analysis, this step generates a visual file as the result of processing or finite-element analysis (**Design**), and (iii) Post-processing, including modifying the output file or producing a report, picture, animation, etc. from it (**Choice**) (Ashby et al., 2013; Fermin et al., 2011).

ABACUS as an instance of CASE primarily address design and choice aspects while neglecting lifecycle because of the significant assumptions and offered models (basic geometry, deterministic) (**Intelligence**) (Ashby et al., 2013; Fermin et al., 2011).

Return on Investment (ROI). ROI is a performance measure used to evaluate the efficiency or profitability of an investment (**Design**) or compare the efficiency of several different investments (**Design**). ROI acts as a comparative analysis that aims to quantify the amount of return on a particular investment concerning the cost of the investment (**Design**). These analyses enable the decision-maker to select an investment that will improve both divisional

and organizational profit performance (**Choice**) while also allowing them to make better use of current investments. As a result of education or skill development, ROI refers to the quantity of knowledge retained and learned (**Intelligence**) (J. J. Phillips, 1998; Hamelmann et al., 2017).

However, ROI (i) might be incomparable with other companies, (ii) encourages management to invest in a short-term project and discourage them from making new investments, and (iii) overlooks the time factor throughout its processes. In summary, ROI cannot be the only indicator used by investors to make decisions because it does not account for risk or time horizon and necessitates a precise measurement of all expenses (**Intelligence**) (P. P. Phillips et al., 2009; Hamelmann et al., 2017).

Statistical Process Control (SPC). is a subfield of statistics that combines exacting time series analysis techniques with graphical data visualization (**Intelligence**), frequently revealing insights into the data more quickly (**Design**) and in a manner more intelligible to ordinary decision-makers (**Intelligence & Design**). Researchers and practitioners might boost their insight from SPC and its central tool—the control chart—to more effectively comprehend and communicate data from the system and its surroundings (**Design**) (Benneyan et al., 2003).

SPC relies on the system's users to provide data about the process using the charts they fill in while monitoring the system. Their reluctance to deliver a sufficient and reliable chart might be a threat (**Intelligence**). Additionally, although a high proportion of undesirable outcomes is a sign of an uncontrolled function, this might be interpreted as a critique of the decision-ability maker's to make a choice. Some decision-makers may feel intimidated and insecure about their decisions (**Choice**) if the system manager hasn't thoroughly described the SPC's function (**Intelligence**) (Hawkins et al., 2003).

Balanced Scorecard (BSC). is a strategic planning framework used by businesses to prioritize their initiatives, goods, and services, coordinate communications around them, and schedule routine tasks and decisions (**Intelligence & Design**). The scorecard allows businesses to track and gauge the effectiveness of their plans to assess how well they have done (**Design**). BSC permits organizations to identify their weaknesses and devise solutions to them (**Intelligence & Design**) (Gomes et al., 2014).

The following weaknesses roughly place the BSC in such a level of maturity concerning Simon's activities. (i) In practice, firms become mired in the task of developing indicators without devoting enough effort to formulating their strategies, resulting in indicators that are out of sync with their strategic objectives (**Intelligence**) (Richardson, 2004), (ii) The BSC does not keep track of industry competitiveness or technical advancements; meaning that BSC does not account for the inherent dangers and ambiguity in the occurrences that might threaten to examine the actions (**Design**) (Gomes et al., 2014), (iii) The effects of this control model can lead to seriously dysfunctional behavior and a loss of control over the choices that the decision-maker opts and how the strategy is applied (**Choice**) (Nørreklit, 2003), and (iv) The strategy's execution issues make it challenging to strike a balance between financial and non-financial indicators (**Choice**) (Anand et al., 2005).

Supply Chain Operations Reference (SCOR). is a management tool that helps companies address, improve, and communicate supply chain management decisions to their suppliers and clients (**Intelligent & Choice**). The model outlines the business procedures necessary to fulfill a customer's requests (**Intelligence**). Additionally, it aids in the explanation of all supply chain operations and offers a framework for how to enhance them (**Design**). SCOR uses appropriate technology to support communication between partners that are part of the supply chain (**Intelligence & Design**) (Huan et al., 2004; Lee et al., 2010; Salazar et al., 2012).

The SCOR model includes five central process workflows: demand and supply planning, warehousing and delivery, sourcing strategies, reverse logistics, and transformation pro-

cesses. These workflows primarily focus on managing the internal system and fall short in evaluating external events—primarily composed of non-programmed decisions. This claims that the absence of the first step in the decision-making process, **Intelligence**, impacts the following steps, the **Design** and **Choice** steps. However, SCOR cannot expound on a what-if perspective since it is constrained to a specific application domain (**Intelligence & Choice**) (Huan et al., 2004; Salazar et al., 2012).

Activity Based Costing (ABC). might be thought of as the contemporary replacement for absorption costing (**Design**), enabling managers to comprehend the net profitability of the product and the client (**Intelligence**). As a result, the company might make successful decisions since they are value-based (**Choice**). ABC has shown to be a practical semi-automated managerial decision-making method that might result in reasonable revenues right away (Cooper et al., 1991; Lombardo, 2015).

However, ABC also faces weaknesses such as complicated implementation (**Design**), pricey, employee opposition, arduous and time-consuming information collection, and questionable information gathering (**Intelligence**) (Lombardo, 2015; Reyhanoglu, 2004).

“Automated Decision Support Systems”

Business Intelligence (BI). refers to the methods and tools that organizations employ to manage and analyze their business information. Reporting (**Choice**), online analytical processing (**Design**), analytics (**Design/Choice**), dashboard development (**Design**), data mining (**Design/Choice**), process mining (**Intelligence/Design**), are examples of typical functions of BI systems (Negash et al., 2008; Chaudhuri et al., 2011).

Information provided by BI tools is outdated. Specifically, decisions often need to make judgments before all the pertinent data is available; This indicates that data gathered from BI reports do not apply to current new challenges (**Intelligence**). Moreover, BI tools frequently fail to identify process problems (**Design**) and consequently fail in predicting (**Choice**) (Lahrman et al., 2011).

Simulation (SIM). is the most convincing imitation of the operation of a real-world process or system over time. Models are an inevitable requirement for simulations; the model reflects the salient traits or behaviors of the chosen system or process (**Intelligence**), whilst the simulation depicts the model’s development through time (**Design**). The use of simplifying approximations and assumptions within the model (**Intelligence**), the commitment and validity of the simulation results, as well as the acquisition of reliable information about the pertinent selection of key characteristics and behaviors used to build the model are all important issues in modeling and simulation (**Choice**) (Banks, 1998).

Simulation techniques such as discrete event simulation, multi-agent simulation, system dynamics are very powerful to manage changes (**Design**) and pick the most affordable decisions (**Choice**) but it is very time-consuming to implement, and often limited to specific systems. Due to the lack of knowledge necessary to create flexible links between the simulated system and recently arrived changes, simulation usually encounters a severe hurdle (**Intelligence**) (Eldabi et al., 2002).

Control Loop (CL). is the fundamental building block of industrial control systems. It has all the physical parts and control capabilities required to automatically change the value of a monitored process variable (**Intelligence**) to match the value of the desired set-points (**Design**). It consists of the process sensor, controller function, and last control element, all of which are necessary for automated control (**Design/Choice**). The analysis and implementation of cause-and-effect interactions (**Design**) are the primary focuses of the CL mechanism (Hägglund, 1995).

The CLs are used for open and closed systems. For instance, the following are some issues for open-loop systems. The non-feedback (open) system in CL does not facilitate the process

of automation, meaning that if the output of CL is affected by some external disturbances, there is no way to correct them automatically (**Intelligence/Design**) (Hägglund, 1995).

Deep Learning (DL). or Deep neural networks (DNN) models have the potential to provide new insights into the study of cognitive processes, such as human decision-making, due to their high capacity and data-driven design. DL is pretty similar to the simulation approach (LeCun et al., 2015). The most important drawback of DL method compared to the simulation technique is the amount of data required to go through layers, extract information about the situation, and then present solutions (**Intelligence**) (Fintz, 2020).

Multi-Criteria-Decision-Making (MCDM). is a research area that involves the analysis of various available options in a situation or research field which spans daily life, social sciences, engineering, medicine, and many other application domains. To assess if each criterion is a good or bad choice for a particular application (**Choice**), MCDM analyzes the measures. It also tries to evaluate this criterion, depending on the chosen criteria, against every other choice to help the decision-maker pick an option with the fewest trade-offs and the most benefits (**Design/Choice**). As a central weakness of MCDM, the first two activities, **Intelligence** and **Design**, are required to meet before moving on to the **Choice** aspect (Ozsahin et al., 2021; Triantaphyllou, 2000).

2.4 Summary and Conclusion

This section discusses the backbone of the proposed physics-based framework to support the **POD** theory standing on the Prescriptive Decision Theory. Prescriptive Decision Theory strives to provide tools and applications to non-idealized decision-makers (section 2.1.2) to make better choices among the possible ones; so does **POD** theory.

The notions of well-established approaches in the literature, including sociophysics, econophysics, psychophysics, and field theory, serve as inspiration for the suggested framework (**POD**). The **POD** theory and its framework are founded on the hypothesis that some social phenomena might be conceived as occurring in inanimate worlds (physical actions, chemical reactions), which allows those events to be studied using well-known classical physics laws and principles (sections 2.1.1 and 2.1.2).

Section 2.2.1 discusses the features of the **POD** framework as a **DSS** on modeling the system and its environment and some potential that it might face on mainly the model-oriented **DSS** type to support the operational, tactical, and strategic decision levels.

In keeping with investigating the **POD** framework as a model-oriented **DSS**, section 2.2.2 discusses the issues in the decision-making processes according to the Bounded Rationality hypothesis and the proposed actions to lessen those issues (section 2.2.2). Moreover, the characteristics of the **POD** framework are discussed and tuned to proposed activities and relationships that go along with them to support Bounded Rationality (Figure 2.3).

Finally, section 2.3 looks at several prominent **DSS** tools and technologies that primarily focus on non-programmed decisions and briefly discusses their significance on Simon's proposed activities (Figure 2.4). The fact is that none of the current approaches fully account for the activities that underpin decision-making processes. This section also examines these drawbacks.

According to the approaches scored in Figure 2.4, the **simulation (SIM)** approach (with a yellow border in Figure 2.4) is well-appropriate to the real-time examination of the system, its environment, and the changes (perturbations, so-called risks & opportunities) that they may undergo. Consequently, simulation is the top-ranked approach among the discussed ones.

However, there is a lot of ambiguity and a high degree of uncertainty due to the nonlinearity of interactions. In conclusion, all approaches, even simulation (see the details [here](#)), face a

significant barrier due to the absence of information about those situations required to build agile connections between the simulated system and newly arriving circumstances. In short, the maturity of **intelligence** activity is critical to overcoming uncertainty, which leads to the discovery of some solutions to investigate (design activity), and hence the selection of the best course of action (choice activity) to make a more accurate prediction of the system's behavior.

The main idea of the **POD** theory is rooted in discovering and revealing some patterns and trends of the system behavior (mainly social aspect) by connecting its evolution (its development as time passes) to proven physical laws of motion. This statement points to the intelligence aspect that **POD** theory might provide as a **DSS** in uncertain systems. In addition, several "sensitivity analysis" and "optimization functions" tools are supplied in the **POD** approach to enhance the Design and Choice aspects, respectively.

To cope with non-programmed decisions, the **POD** framework, based on the **POD** theory and insisting on the "Intelligence" aspect (envisaged to achieve three out of three, bordered with red color in Figure 2.4), aims at connecting non-linear interactions with nature in the yearnings of identifying patterns, behaviors, and inherent laws from physics into the system and interactions. This Ph.D. study on the shoulder of the simulation approach moves toward finding undiscovered laws among systems and their environments. The frequent employment of the simulation approach in the contributions of this thesis aims to draw closer to the desired result in dealing with non-programmed decisions.

3

Thesis Contributions

| | | |
|-------|---|----|
| 3.1 | Preliminaries and Notations | 35 |
| 3.2 | Thesis Contributions | 38 |
| 3.2.1 | System Dynamics Simulation | 38 |
| 3.2.2 | Discrete Event Simulation | 51 |
| 3.2.3 | Agent-based Simulation | 62 |
| 3.2.4 | State-space Representation Method | 74 |

3.1 Preliminaries and Notations

The introduced “Physics of Decision” framework in chapter 1 (section 1.6) strives to link the defined Description Space (section 1.6) to the proposed Performance Space (section 1.2). Managing the performance of socio-technical systems (STS) through making optimum decisions is the target for POD theory investigations and demonstrating its significance in decision-making processes in uncertain contexts. Installing the POD framework with establishing the connection between spaces is the primary contribution of this work—detailed in the primary Research Questions. The first and foremost step in installing the POD framework is simplifying the Description and Performance spaces in such a way as to observe the changes in the system and its environment situation and readily pursue its performance evolutions. The following is an attempt to mathematically present the POD framework and open the door for further investigations.

In a general sense, on the one hand, the **Description Space** is positioned for reviewing the system (and its environment) changes and making decisions to deviate the Performance Trajectory toward its stated Target Zones as the “input” for the POD framework; whereas, on the other hand, the **Performance Space** is positioned to observe system performance as the framework’s “output.” Therefore, the POD framework can be expressed as a function (F) from an input space (U), representing the Description Space of the system, into an output space (Y), representing the Performance Space of the system.

The function F is defined implicitly by the specified input-output pairs. The input points to the vector of “Attributes” and “Characteristics” together in the Description Space, whereas the output points to the vector of “KPIs” in the Performance Space. The method of representing time-dependent systems by vector differential or differential equations is well established in systems theory and applies to a fairly large class of systems (Kumpati et al., 1990).

For example, the differential equation:

$$\begin{aligned} \frac{dx(t)}{dt} &\triangleq \dot{x}(t) = \Phi[x(t), u(t)], & t \in \mathbb{R}^+ \\ y(t) &= \Psi[x(t)]. \end{aligned} \quad (3.1)$$

where:

$$\begin{aligned} u(t) &\triangleq [u_1(t), u_2(t), \dots, u_p(t)]^T \\ x(t) &\triangleq [x_1(t), x_2(t), \dots, x_n(t)]^T \\ y(t) &\triangleq [y_1(t), y_2(t), \dots, y_m(t)]^T \end{aligned}$$

represents a p -input, m -output system of order n . While $u_i(t)$ represents the i -th input vector at time t , $x_i(t)$ represents the i -th state variable of inputs' vectors, $u_1(t), u_2(t), \dots, u_p(t)$, at time t , and $y_i(t)$ represents the i -th output vector at time t . Functions Φ and Ψ are dynamic (or static), nonlinear (or linear) maps defined as $\Phi : \mathbb{R}^n \times \mathbb{R}^p \rightarrow \mathbb{R}^n$ and $\Psi : \mathbb{R}^n \rightarrow \mathbb{R}^m$.

The function Φ presents the states of the system inputs in space \mathcal{U} ; Since the number of inputs is considerably fewer than their possible states ($p \ll n$), the Φ would be a $n \times p \rightarrow n$ dimension function.

The Ψ function is used to depict the relationship between inputs (vector $u(t)$, composed of quantitative values of Attributes and Characteristics) and outputs (vector $y(t)$, composed of the quantitative values of the system's KPIs). The vector $x(t)$ denotes the state of the system at time t and is determined by the state at time $t_0 < t$ and the input $u(t)$ defined over the interval $[t_0, t)$. The output $y(t)$ is determined by the state of the system at time t (Haaser, 1991; Kumpati et al., 1990).

Equation 3.1 is referred to the input-state-output representation of the system. This study is concerned with several time-dependent static (presented in sections 3.2.1 and 3.2.4) and dynamic (presented in sections 3.2.2 and 3.2.3) systems which could be represented by differential equations corresponding to the differential equation given in equation 3.1; yet complicated for some systems (e.g., case studies of 3.2.2 and 3.2.3). These take the form:

$$\begin{aligned} x(k+1) &= \Phi[x(k), u(k)], \\ y(k) &= \Psi[x(k)]. \end{aligned} \quad (3.2)$$

where $u(\cdot)$, $x(\cdot)$, and $y(\cdot)$ are discrete-time sequences. Fig. 1.5 depicts the Physics of Decision framework as a time-dependent technique with the input-states-output vision.

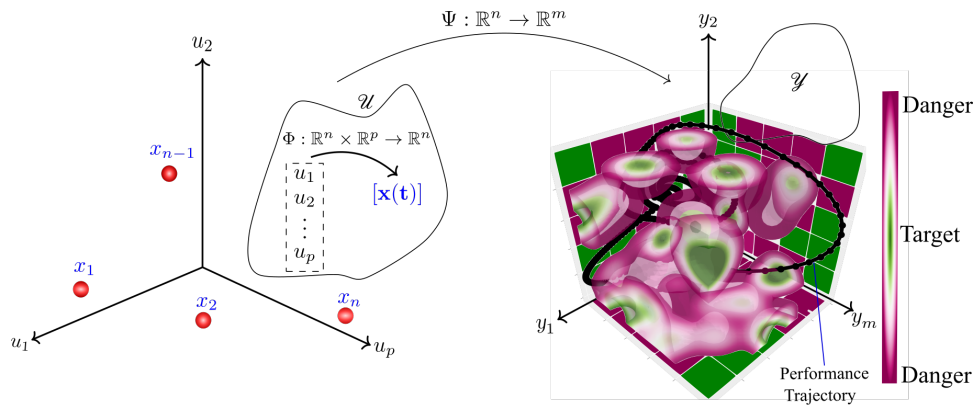

Figure 3.1: Mathematical representation of the Physics of Decision framework

According to equation 3.1, the variations of vector $u(t)$ change the $\dot{x}(t)$ via function Φ . These changes go through function Ψ and consequently deviate Performance Trajectory, shaped with vector $y(t)$ in the Performance Space \mathcal{Y} . This transition from the variation of vector $u(t)$ to the deviation of the Performance Trajectory is assumed as “**physical forces**” in the **POD** framework.

The mathematical representation of the **POD** framework (equation 3.1) is a general vision and serves nearly all time-dependent systems. However, discovering the functions Φ and Ψ is a tremendous challenge and almost impossible for most socio-technical systems because of several unexpected and chaotic behaviors (*e.g.*, actions, movements, decisions, etc.) of individuals in diverse settings. Indeed, the social aspect of the socio-technical systems results in nonlinear, dynamic functions of Φ and Ψ , which frequently change due to individual complex behavior.

In outline, the **POD** framework is obtained by determining the Φ and Ψ functions in equation 3.1. The ambition is to solve this “Differential Equation” (**DE**) among Description and Performance spaces which subsequently provide the chance to discover physical laws of motion. The following three related approaches to this study are proposed based on how complicated the Φ and Ψ functions are to obtain. (i) **Modeling**, (ii) precise **DE**, or (iii) Learning Mechanism (**LM**).

The **DE** is considered the core approach to establishing the **POD** framework. The **Modeling** serves for low abstraction, more detail, in general studying the systems at the micro-level (associated with operational decisions with the more precise approximation of the system presentation). In contrast, the **LM** is employed for high abstraction, fewer details, in general, studying the systems at the macro-level (associated with strategic decisions, with a less precise approximation of the system presentation).

The present work includes four contributions to the **Modeling** (three publications) and **DE** (one publication) approaches while holding the **LM** approach (mainly with Neural Network or **NN**) as a future study. The related contributions to the **Modeling** approach include three distinctive publications dedicated to the **simulation** approach as follows (i) Polling place management simulated with an Agent-Based Model (**ABM**), (ii) an epidemic-affected population simulation with System Dynamics (**SD**) simulation model, and (iii) road traffic management performed with a Discrete Event Simulation (**DES**) model.

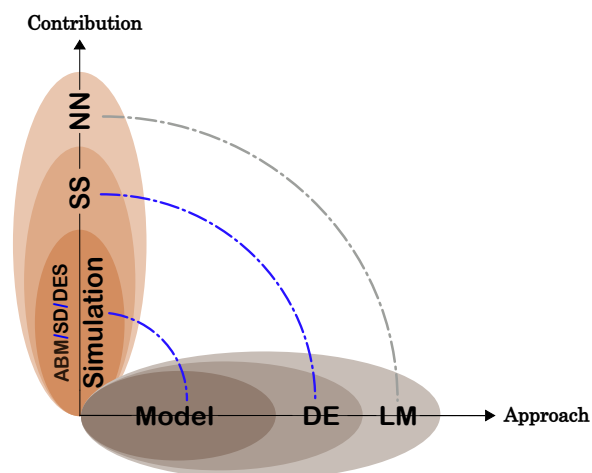

Figure 3.2: Outline of the thesis contributions

The related contribution to the **DE** approach includes a publication dedicated to state-space (**SS**) representation, a mathematical model for physical systems, to simulate a manufacturing

production model. Figure 3.2 presents an overview schematic of the proposed approach versus the thesis contributions (blue arrows indicate present publications, while gray arrows indicate upcoming research). The remainder of this section introduces the simulation and SS contributions for installing the POD framework, along with several investigations associated with potential forces and their effects on the performance trajectory in the system's performance space.

3.2 Thesis Contributions

Referring to the [Research Questions](#), the main focus of this work—an **article-based dissertation**—is the POD framework implementation. The contributions in each subsection are briefly described, along with the author's version and online access to the publisher's version of the articles.

3.2.1 System Dynamics Simulation

The POD framework in this case study is installed through a well-known System Dynamics (SD) model called Susceptible-Exposed-Infected-Recovered (**SEIR**). The SD model includes several differential equations for the transmission of a specific virus among a population in a particular region. The Description Space has constructed on the dimensions of the "region" as the system (Attributes), where the "virus" serves as the contextual element (Characteristics). The Performance Space has constructed on some **KPIs**, for example, the number of infected, hospitalized, and dead, to examine the impact of several forces. The "inflicted" and "managed" forces are generated respectively from the changes in the virus parameters (*e.g.*, latent period) and region parameters through containment measures to control the outbreak (*e.g.*, reducing contact rate through lockdown).

Multi-criteria performance analysis based on Physics of Decision—Application to COVID-19 and future pandemics

Keywords. SEIR, Pandemic, Decision Support System (DSS), Performance Management, Risk management, Optimization

Authors. Nafe Moradkhani, Frederick Benaben, Benoit Montreuil, Matthieu Lauras, Julien Jeany, and Louis Faugere

Publisher. IEEE Transactions on Services Computing (TSC)

Date of Publication. 29 June 2022

Reference. Moradkhani et al., [2022a](#)

Online Access. [Multi-criteria performance analysis based on Physics of Decision — Application to COVID-19 and future pandemics](#)

Multi-criteria performance analysis based on Physics of Decision — Application to COVID-19 and future pandemics

Nafe Moradkhani, Frederick Benaben, Benoit Montreuil, Matthieu Lauras, Julien Jeany, and Louis Faugère

Abstract—The purpose of this study is to present a novel perspective on decision support based on the conventional SEIR pandemic model paradigm considering the risks and opportunities as physical forces deviating the expected performance trajectory of a system. The impact of a pandemic is measured by the deviation of the social system’s performance trajectory within the geometrical framework of its Key Performance Indicators (KPIs). According to the overall premise of utilizing Ordinary Differential Equations to simulate epidemics, the deviations are connected to several alternative interventions. The model is essentially built on two sets of parameters: (i) social system parameters and (ii) pandemic parameters. The ultimate objective is to propose a multi-criteria performance framework to control pandemics that includes a combination of timely measures. On the one hand, the current study optimizes prospective strategies to manage the potential future pandemic, while on the other hand, it explores the COVID-19 epidemic in the state of Georgia (USA).

Index Terms—SEIR, Pandemic, Decision Support System (DSS), Performance Management, Risk management, Optimization

1 INTRODUCTION

TRANSMISSION of infectious diseases has long been a cause of worry and a hazard to public health. It has presented severe risks to the survival of humans and social development. Following pandemic crises such as the Cholera (1817-1923), Spanish Flu (1918-1919), COVID-19 (2019-present), and others [1], [2], implementing pandemic preparedness measures has become a top concern for world-wide public health. Pandemic prevention and containment techniques fall into three major categories: antiviral (chiefly a drug or treatment effective against viruses), vaccination (treatment with a vaccine to produce immunity against disease), and non-pharmaceutical (isolation of the infected cases, quarantine, closure of school and workplaces, and travel restrictions) [3]. A critical step in controlling a “non-pharmaceutical” infectious disease outbreak is attempting to reduce the epidemic peak, which reduces the danger of overburdening healthcare systems and allows for more time for the development of a vaccine and treatment [4]. A thorough assessment of the pandemic-contaminated area and the pandemic itself can provide insight into the scope of the pandemic threat and potential control strategies. The

proposed study considers a pandemic-contaminated region as a system and a pandemic as a potential that may affect system KPIs in a multi-dimensional performance space. The Physics-of-Decision (POD) paradigm proposed in [5] is used in this study. Risks and opportunities, according to the original POD framework, may be viewed as physical forces applied to the system trajectory that could push or pull it in its performance space by varying the system’s KPIs [6].

The primary goal of this study is to present a tentative Decision Support System (DSS) by tuning a well-known Susceptible-Exposed-Infected-Recovered (SEIR) pandemic model to the POD framework through Ordinary Differential Equations (ODEs). To this aim, by putting the POD principles into practice, researchers may be able to study various strategies that might impact the performance of the considered system and assist them in successfully intervening in the control of future pandemics.

The paper is structured as follows. Section 2 focuses on current research efforts and scientific contributions that are related to the topic at hand. Section 3 first introduces the pandemic modeling through ODEs then tunes the presented model into the POD framework. Section 4 provides a specific POD framework process for a Decision Support System. Section 5 shows the value of the POD as a strategies management framework for the COVID-19 pandemic in the State of Georgia (USA) and to control potential future pandemics efficiently. Finally, section 6 provides conclusive remarks and proposes areas for further research.

2 BACKGROUND AND RELATED WORKS

Effective management of emerging pandemic infectious disease issues in the absence of treatment or vaccine is primarily dependent on government preventive strategies [7]. Scientific understanding is scarce regarding these

- N. Moradkhani, Centre Génie Industriel, IMT Mines Albi - University of Toulouse, Albi, France. E-mail: nafe.moradkhani@mines-albi.fr
- F. Benaben, Centre Génie Industriel, IMT Mines Albi - University of Toulouse, Albi, France. E-mail: frederick.benaben@mines-albi.fr
- B. Montreuil, Physical Internet Center, ISyE, Georgia Tech, Atlanta, USA. E-mail: benoit.montreuil@isye.gatech.edu
- M. Lauras, Centre Génie Industriel, IMT Mines Albi - University of Toulouse, Albi, France. E-mail: mathieu.lauras@mines-albi.fr
- J. Jeany, Scalian Lab, Toulouse, France. E-mail: julien.jeany@scalian.com
- L. Faugère, Physical Internet Center, ISyE, Georgia Tech, Atlanta, USA. E-mail: louis.faugere@gatech.edu

strategies in the field of infectious disease control. There is also little information on whether theories and measurements created for risk perception studies on chronic diseases, for example, can be used for infectious diseases [8]. Such information, however, is critical for the successful management of newly developing infectious illnesses, because the capacity to promote health-protective behavioral change is conditional on the understanding of major drivers of such behavior [9]. In recent years, epidemiological models have been the subject of significant research. Compartmental models, such as the SEIR model (see subsection 3.2), have been utilized often for epidemic analysis among the many models. The early dynamics of disease transmission, from initial infected cases through the potential of the intervention to limit disease spread, are the primary focus of epidemic modeling approaches [10].

This study looks at a simplified version of the SEIR pandemics model implemented through ODEs in which no one has preexisting immunity, and every infected one has immunity after recovery. The objective is to characterize the pandemic model to investigate the possible interventions to control the outbreak through finding the most desirable solutions considering the limits of their execution. International travel restrictions [11], contact reduction [12], isolation of sick persons from the outset [13], and the use of masks [14] are some of the most common measures for controlling a non-pharmaceutical pandemic. The current research delves into the SEIR model to distinguish the model's inputs from its outputs, and it looks at the mentioned pandemic control strategies with the assumption that changes in system inputs generate changes in its outputs. Some modified SEIR models such as [15], [16], and [17] attempt to thoroughly assess various intervention techniques. The inputs of the pandemic model are divided into two categories: virus and society. The influence of virus-related elements and the characteristics of the pandemic-affected region as a society on the epidemic, are examined in this study. To investigate a behavioral dynamic epidemic model for multidimensional policy analysis that includes endogenous viral transmission, various simulation-based assessments of outbreak reactions and tactics are established [18]. Understanding the interaction between factors in nonlinear systems attempts to investigate "what-if" possibilities based on the community and region's capabilities. The wearing masks as an example among the non-pharmaceutical intervention measures has been studied in [19] for the COVID-19 epidemic. In the SEIR model, population transmission through dynamic flows has been established using various ODEs. Various pandemics are represented by different input values for the equations, as mentioned in [20].

The foundation of system diagnostics is the characterization of the system and the relationship between its parameters. Controlling the system, necessitates the identification of such linkages and their impact on the system's performance. The varied circumstances of the system across time are defined by system states [21]. Over the last few decades, the field of risk management has produced a number of acknowledged outcomes that are now regarded as reliable contributions [5]. According to [22], risk is defined as a mix of the severity of the system's consequences

on the one hand and the likelihood of occurrence on the other. The Physics of Decision (POD), which is based on physical principles and mathematical equations, is a novel performance management technique in the field of risk management [5]. The POD framework is a multi-criteria, time-dependent approach for performance analysis that quantifies the impact of various pandemic control methods. When compared to earlier researches, the innovation of this approach is the ability to measure the influence of multiple strategies (simultaneously) on system performance in a multi-dimensional framework and then determine the optimum strategies while keeping the execution restrictions in mind.

3 PHYSICS-BASED DECISION SUPPORT SYSTEM

The term "Risk" is used in many ways and is given different definitions depending on the field and context. Common to most definitions of risk is uncertainty and undesirable outcomes. From a reciprocal perspective, those uncertainties that could bring benefits if they were to occur are known as "Opportunities" [23]. The definition of opportunity is: "an uncertainty that could have a positive effect leading to benefits or rewards". The opportunity could be seen as just another form of risk: a risk with negative impacts is a threat, whereas a risk with a positive impact is an opportunity [24].

Decision Support Systems (DSSs) are at the heart of risk/opportunity management projects [25]. The necessity of such systems is critical to deal with the complexities due to massive data and interconnectivity between the system's components and its environment [26].

In this section, the *Physics Of Decisions* (POD) is presented and illustrated as an innovative approach for decision support in context of instability and uncertainty. POD considers that risks and opportunities can be created by spontaneous or intentional changes in the system's parameters or in its environment parameters. These changes may push or pull the system in its *performance space* by varying system's KPIs. **Essentially, these variations' consequences are observed through the deviation of the system "trajectory" within the multidimensional performance space of its KPIs.**

3.1 Preliminaries, Basic Concepts, and Notation

System characterization and identification are fundamental problems in systems theory. The problem of characterization is concerned with the mathematical representation of a system. A model of a system can be expressed as a function F from an input space \mathcal{U} into an output space \mathcal{Y} [27]. The function F is defined implicitly by the specified input-output pairs. The method of representing time-dependent systems by vector differential or differential equations is well established in systems theory and applies to a fairly large class of systems [28]. For example, the differential equation:

$$\begin{aligned} \frac{dx(t)}{dt} &\triangleq \dot{x}(t) = \Phi[x(t), u(t)], & t \in \mathbb{R}^+ \\ y(t) &= \Psi[x(t)]. \end{aligned} \quad (1)$$

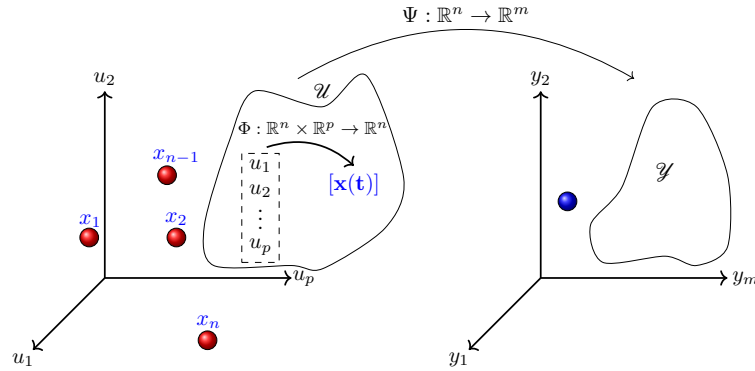

Fig. 1. Mathematical representation of input-state-output of a system

where $u(t) \triangleq [u_1(t), u_2(t), \dots, u_p(t)]^T$, $x(t) = [x_1(t), x_2(t), \dots, x_n(t)]^T$, and $y(t) = [y_1(t), y_2(t), \dots, y_m(t)]^T$, represents a p input, m output system of order n with $u_i(t)$ representing the inputs, $x_i(t)$ the state variables, and $y_i(t)$ the outputs of the system. Φ and Ψ are static nonlinear maps defined as $\Phi : \mathbb{R}^n \times \mathbb{R}^p \rightarrow \mathbb{R}^n$ and $\Psi : \mathbb{R}^n \rightarrow \mathbb{R}^m$. The vector $x(t)$ denotes the state of the system at time t and is determined by the state at time $t_0 < t$ and the input u defined over the interval $[t_0, t)$. The output $y(t)$ is determined by the state of the system at time t . Equation (1) is referred to as the input-state-output representation of the system [27], [28]. This paper is concerned with discrete-time systems which can be represented by differential equations corresponding to the differential equation given in (1). These take the form

$$\begin{aligned} x(k+1) &= \Phi[x(k), u(k)], \\ y(k) &= \Psi[x(k)]. \end{aligned} \quad (2)$$

where $u(\cdot)$, $x(\cdot)$, and $y(\cdot)$ are discrete-time sequences. Fig. 1 illustrates a time-dependent input-states-output system.

3.2 Pandemic modeling through Ordinary Differential Equations

Quantitative studies on mechanisms of disease transmissions provide a foundation for pandemic prevention and control. The Epidemic Dynamics formulates mathematical models based on the occurrence and progressions of diseases to its surroundings to characterizing the infectious agents, describing the transmission processes, analyzing origins of the diseases and factors involved in the transmissions, and predicting the prevalence of the diseases and their patterns [10]. Dynamic models for infectious diseases are mostly based on compartment structures [10]. To formulate a dynamic model for the transmission of an epidemic disease, the population in a given region is often divided into several different groups or compartments. Such models describing the dynamic relations among these compartments are called **compartment models**. The population is assigned to compartments with labels – for example, **S**, **I**, or **R**,

(**S**usceptible, **I**nfectious, or **R**ecovered). The population may progress between compartments. The order of the labels usually shows the flow patterns between the compartments; for example, **SEIS** means Susceptible, Exposed, Infectious, then Susceptible again. The numbers of individuals are presented in the compartments **S**, **E**, **I**, and **R**, at time t , as **S(t)**, **E(t)**, **I(t)**, and **R(t)**, respectively [29]. This section introduces the generic version of pandemics model including Susceptible, Exposed, Hospitalized, Recovered, and Dead as common compartments of different pandemics shown in Fig. 2.

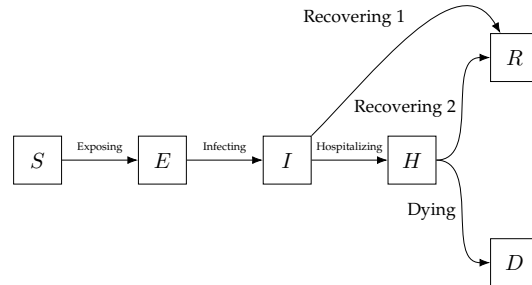

Fig. 2. Flow chart of the SEIR model

This model postulates rules on how populations in each category move to the next categories. Based on Fig. 2, the transitions of the population through the flows from left to right are as follows:

(i) Exposing flow \Rightarrow The individuals move from **S** to **E** through this flow (Fig. 2) at the exposure rate, *i.e.*, the population in category **S** decreases concerning time t and the population in **E** correspondingly increases at the same rate. The exposure rate grows with **I**, the number of infected individuals. A standard hypothesis is that exposure rate is the product of the transmission rate (or *contact rate* (**cr**)) and the probability of infection given that contact occurred

(*infectious rate* (**ir**)) divide by latency due to *infectious duration* (**id**) [30].

$$\text{Exposing flow} = \frac{ir \times cr}{id} S \times I. \quad (3)$$

(ii) *Infecting flow* \Rightarrow The Exposed individuals progress to the Infected category through this flow after the *latent period* (**lp**), the period at which exposed hosts become infected [30].

$$\text{Infecting flow} = \frac{E}{lp}. \quad (4)$$

(iii) *Hospitalizing flow* \Rightarrow The individuals with lower immunity in case of virus infection, called severe infected group, progress to the Hospitalized compartment with the rate of *fraction hospitalized* (**fh**).

$$\text{Hospitalizing flow} = fh \times I. \quad (5)$$

(iv) *Recovering 1 flow* \Rightarrow The lightly Infected individuals (non-severe cases), those who don't need to be Hospitalized, progress to the *Recovery* compartment directly after the *infectious duration* (**id**).

$$\text{Recovery 1 flow} = \frac{1 - fh}{id} I. \quad (6)$$

(v) *Recovering 2 and Dying flows* \Rightarrow The *Hospitalized* individuals, depending on the *fatality rate* (**fr**) of the virus, either recover (*Recovering 2 flow*) or die after *infectious duration* (*Dying flow*). The hospitalized fatality rate (**hfr**) is calculated by dividing the *fatality rate* (**fr**) of the virus by the *fraction hospitalized* (**fh**), $hfr = (fr)/(fh)$.

$$\begin{aligned} \text{Recovery 2 flow} &= \frac{1 - hfr}{id} H, \\ \text{Dying flow} &= \frac{hfr}{id} H. \end{aligned} \quad (7)$$

The basic reproductive number (denoted \mathcal{R}_0), in epidemiological modeling, is the expected number of cases directly caused by one case in a community where everyone is susceptible. In the majority of commonly used epidemic models, a pandemic can spread in a population if $\mathcal{R}_0 > 1$, but not if $\mathcal{R}_0 < 1$. The basic reproductive number for the SEIR model is shown in equation 8, assuming that the latency period is a random variable with exponential distribution with parameter α (i.e., the average latency period is α^{-1} , or lp^{-1}), β , γ , and μ are the rates of infection (the number of contacts per person per time (cr/id), multiplied by the probability of disease transmission in a contact between a susceptible and an infectious subject (**ir**)), recovery, and mortality, respectively [30].

$$\mathcal{R}_0 = \frac{\alpha}{\mu + \alpha} \frac{\beta}{\mu + \gamma} \quad (8)$$

Since the natural mortality rate is not included in the presented SEIR model in Fig. 2 ($\mu = 0$). According to the "Recovery 1" and "Recovery 2" flows in Fig. 2 and equations 6 and 7, the γ is obtained using equation 9.

$$\gamma = \frac{1 - fh}{id} + \frac{1 - hfr}{id} = \frac{2 - (fh + hfr)}{id} \quad (9)$$

Finally, the reproductive number of the presented model is obtained through equation 10.

$$\mathcal{R}_0 = \frac{\beta}{\gamma} = \frac{(cr/id) \times ir}{(2 - (fh + hfr))/id} = \frac{cr \times ir}{2 - (fh + hfr)} \quad (10)$$

Given that the disease spreads in a closed environment; the paper considers there is no emigration nor immigration and neither birth nor death in the population so that the total population remains a constant N for all t , that is:

$$S(t) + E(t) + I(t) + H(t) + R(t) + D(t) = N \quad (11)$$

Instead of establishing the system for a specific total number of the population, the paper simplifies the equation 11 by dividing the sides of the equation by total population N to be efficient for any population size. Therefore, the following proportions are obtained.

$$\begin{aligned} s(t) &= \frac{S(t)}{N}, e(t) = \frac{E(t)}{N}, i(t) = \frac{I(t)}{N}, \\ h(t) &= \frac{H(t)}{N}, r(t) = \frac{R(t)}{N}, d(t) = \frac{D(t)}{N}, \\ s(t) + e(t) + i(t) + h(t) + r(t) + d(t) &= 1 \end{aligned} \quad (12)$$

Based on Fig. 2 and equations (3) - (7), there are six parameters involved in the flows. The vector u presents those parameters as inputs for derived equations.

$$u = [lp, id, fr, ir, cr, fh]^T = [u_1, u_2, u_3, u_4, u_5, u_6]^T \quad (13)$$

The rate of change in the compartments in Fig. 2 from left to right according to the transmission of individuals are represented in equation 14 through Ordinary Differential Equations (ODEs) based on equations and the input vector u (13).

$$\begin{aligned} \frac{ds}{dt} &= -\frac{u_4 u_5}{u_2} si, \\ \frac{de}{dt} &= \frac{u_4 u_5}{u_2} si - \frac{e}{u_1}, \\ \frac{di}{dt} &= \frac{e}{u_1} - \frac{(1 - u_6)}{u_2} i - u_6 i, \\ \frac{dh}{dt} &= u_6 i - \frac{(1 - \frac{u_3}{u_6})}{u_2} h - \frac{h}{u_2} \times \frac{u_3}{u_6}, \\ \frac{dr}{dt} &= \frac{(1 - \frac{u_3}{u_6})}{u_2} h + \frac{(1 - u_6)}{u_2} i, \\ \frac{dd}{dt} &= \frac{h}{u_2} \times \frac{u_3}{u_6}. \end{aligned} \quad (14)$$

The ordinary differential equations (ODEs) system in equation 14, together with some initial conditions (values of the input variables of the model (vector u) at initial starting time $t_0 = 0$), make up an Initial Value Problem, or IVP. IVPs are ubiquitous in modeling systems that evolve in time. They encapsulate how a future state of a system is determined by the present state (the initial data) plus certain rules on how quantities evolve (the ODEs) [31]. As soon as the preliminary infected (or exposed) cases appear

in the region, the pandemic starts to spread. The ODEs in equation 14 are supplemented with some initial conditions. For example, some percentage of the whole population (α) is infected (or exposed) and the rest are susceptible to be infected.

$$\begin{aligned} s(0) &= 1 - \alpha, e(0) = 0, i(0) = \alpha, \\ h(0) &= 0, r(0) = 0, d(0) = 0. \end{aligned} \quad (15)$$

The modeling through ODEs has been completed. The following are some remarks on specific hypotheses.

- (i) The simple version of the presented SEIR model in this section considers that the recovered individuals gain permanent immunity. However, for bacterial diseases, such as encephalitis, and gonorrhoea, the recovered individuals don't gain permanent immunity and can be reinfected [10].
- (ii) The paper considers there is not an emigration or immigration, and neither birth nor death in the population and the population size remains a constant N for all t .
- (iii) The presented model considers all the individuals are susceptible to be infected. It might be a portion of the population is immune to the virus and so not susceptible to it. Besides, depending on the type of the virus, due to the sensitivity of the virus to some parameters such as age category, the health status of the population in the region; some individuals might be more susceptible and some not.
- (iv) The exposed compartment could be distinguished to individuals with and without symptoms and the Infected group, in addition to the light and severe groups, could include infected individuals that don't carry the virus.
- (v) The severely infected individuals could be hospitalized and ICU sections. The model doesn't consider differentiation between these two groups, while it might be the limit capacity for the ICU bed in hospitals.

In addition to the above remarks, there may be other hypotheses for the epidemic model that are not considered in this study. This paper considers one of the simplest cases that is common to most epidemics. It's important to point out that the paper does not cover all the possible versions of epidemics models. This is mostly due to the fact that the study's focus is on the model's application rather than its relevance.

3.3 Physics of Decision theory and its tuning to pandemic performance management

The Physics Of Decision (POD) framework introduced in section 2 is a mathematical representation of a system considering internal system connections and communication of the system with its environment. The next step after characterization and identification of the system is to evaluate the system performance. The three modes are considered to assess the system performance: (i) **Inertia** mode: The performance could change due to its normal behavior and the associated consumption. In this mode, the system is not facing any perturbation. (ii) **Passive** mode: In addition to the performance changes of Inertia, the performance might change because there is (are) perturbation(s) in the system or its environment, (iii) **Active** mode: In addition to the performance changes of Inertia, the performance could change because the system is facing some perturbations

(passive changes) and also because of some taken decisions to manage the consequences of those perturbations. In the case of a pandemic crisis, the change of population size due to migration, or natural birth/death is considered *Inertia*, the sudden change of the population because of the pandemic issues is considered *Passive*, and the change of the population due to some intervention in comparison to the *Passive* mode is considered as *Active* mode. The POD framework defines two spaces in which a system can be positioned.

The *Description Space* describes the parameters of the system and the scope of their variation. The \mathbf{p} -input vector $\mathbf{u}(t)$ represents the input system parameters (subsection 3.1). *Description Space* generally refers to what is happening in and around the monitored system. The parameters of the *Description Space* refer to the "System" and are known as "*Attributes*". A monitored system with particular attributes could be affected by several circumstances. These circumstances are known as "*Potentials*". A potential could have positive or negative impacts on the system (Risks and Opportunities). The parameters of systems' potentials are known as "*Characteristics*". State variable $\mathbf{x}(t)$ is one set of input parameters including *Attributes* (system's parameters) and *Characteristics* (potentials' parameters) that describes the mathematical "*states*" of a system under function Φ (See Fig. 3 and equation 2).

The *Performance Space* under function Ψ describes the system performance with an \mathbf{m} -output vector $\mathbf{y}(t)$. The output vector $\mathbf{y}(t)$ is determined by the system state in the *Description Space* (vector $\mathbf{x}(t)$) at time t .

The relationship between the two spaces is determined by the map function Ψ of the state variables, $\mathbf{x}(t)$ (one set of input parameters including *Attributes* and *Characteristics*) to the outputs, $\mathbf{y}(t)$. This map function could be known (e.g., is formulated with equations from inputs to outputs), or it could be unknown but estimable (e.g., through simulation analysis, approximation function, Neural Network, etc.).

The *Description Space* in Fig. 3 represents a system with a \mathbf{p} -input vector composed by one vector of Attribute (system) and \mathbf{r} vector of potentials (system's environment). The vector of each potential is represented with its characteristics:

- (i) θ_i characteristics for potential P_i (on-axis) and the δ_i possible state variables for each P_i at specific time t shown with colored points in Fig. 3 (oval marked with "Environment"),
- (ii) θ Attributes (on-axis) of the system S and δ possible state variables for these Attributes at specific time t shown with colored points in Fig. 3 (oval marked with "System").

Equation 16 presents the number of inputs p of the input vector \mathbf{u} and the number of possible system states n for the generic version of the POD framework presented in Fig. 3.

$$\begin{aligned} |p| &= \sum_{i=0}^r \theta_i + \theta, \\ |n| &= \prod_{i=1}^r \delta_i \times \delta. \end{aligned} \quad (16)$$

According to the state variables of Attributes and Characteristics, δ and $\prod_{i=1}^r \delta_i$ respectively, n possible initial

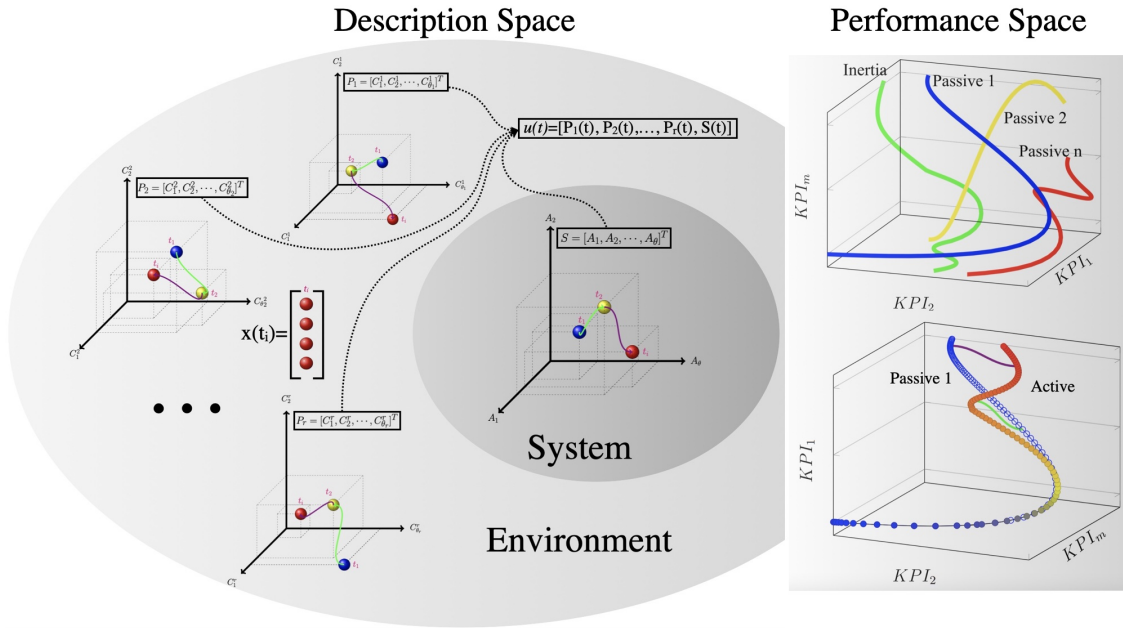

Fig. 3. Description and Performance Spaces of POD framework

system states exist at time t in the *Description Space* ($x(t) = [x_1(t), x_2(t), \dots, x_n(t)]$).

The *Performance Space*, according to Fig. 3, describes:

- (i) on the top, in the case of "no perturbation", the "Inertia" trajectory is shown in green. Besides, the n possible **passive** trajectories have been depicted according to n possible initial system states in the *Description Space*. In this case, the system goes through its own "passive" trajectories in the system's KPIs space according to the δ given colored points for the Attributes of the system S and δ_i given colored point of Characteristics for each potential P_i ,
- (ii) on the bottom, "active" trajectory, in the sense that one movement at specific time t_i from one colored point to another one has been made through green edge in order to deviate the *passive* trajectory (blue trajectory as one of possible n passive trajectories). The same process continues at $t_j (j > i)$ from the new state of the system to another state through another edge (e.g., purple edge).

The system might be destabilized by unforeseen changes. These changes are due to the existence of perturbations that create a passive trajectory. The passive trajectory is determined by the instance in question, with the most likely case being chosen. The changes related to decisions mainly refer to the varying of system parameters including *Attributes* and *Characteristics* (changing the system state by moving the colored points through edges) and consequently, deviation from the system's passive trajectory. Any deviation from that trajectory is considered an active one for the system.

Subsection 3.2 presented the ODEs modeling for the pandemic that disease spread in a closed environment. In the

perspective of the presented POD framework in this section, the system is the "region" contaminated by a "pandemic". The "Attributes" are related to the parameters of the region and there is only one "Potential" which is a pandemic and means, $r = 1$ in equation 15 (at the same period, the potentials except pandemic could be other similar negative potentials (risks) such as hurricanes, earthquakes, etc., or positive potentials (opportunities) such as the development of agriculture and industry, increasing social security, improving the standard of living acts, etc.).

According to Fig. 2 (or equation 13), all the compartments (or left sides of ODEs) could be a KPI in the POD *performance space* ($m = 6$). Besides, the system's inputs, represented in vector u (equation 12), are parameters of the:

- (i) Potential \Rightarrow pandemic, including the following *Characteristics*: latent period, infectious duration, fatality rate, and infectious rate of the virus,

$$P_1 = [C_1^1, C_2^1, C_3^1, C_4^1] = [u_1, u_2, u_3, u_4]. \quad (17)$$

- (ii) System \Rightarrow region, including contact rate and hospitalized fraction as attributes

$$S = [A_1, A_2] = [u_5, u_6] \quad (18)$$

In other words, in the POD framework for the presented ODEs of pandemic, $r = 1$, $\theta_1 = 4$, and $\theta = 2$ (see equation 16).

4 PHYSICS OF DECISION METHODOLOGY

In the perspective of the POD framework, deviations from the system passive trajectory happen due to changes in the

TABLE 1
Physics of Decision process applied on the pandemic model presented in section 3.2

| Input | u | Vector | Variation (Min, Avg, Max) | Movement Type | Consequence Type | Considered Potentiality |
|-----------------------|-------|--------|--------------------------------------|---------------|------------------|-------------------------|
| Latent Period | u_1 | P_1 | (3, 7, 11) [days] [20], [32], [33] | Elusive | Inflicted | Mutation |
| Infectious Duration | u_2 | P_1 | (7, 12, 17) [days] [20], [32], [33] | Elusive | Inflicted | Mutation |
| Fatality Rate | u_3 | P_1 | (1, 5, 9) [percent] [20], [32], [33] | Elusive | Inflicted | Mutation |
| Infectious Rate | u_4 | P_1 | (40, 60, 80) [percent] [32], [33] | Elusive | Managed | Mask/Social Distance |
| Contact Rate | u_5 | S | (5, 10, 15) [person/day] | Driver | Managed | Lockdown/Curfew |
| Fraction Hospitalized | u_6 | S | (5, 10, 15) [percent] [20], [33] | Driver | Managed | Partial Lockdown |

system state in the *Description Space* (moving the colored point in Fig. 3). A movement of a colored point is considered a "strategy". According to the *performance space* in Fig. 3, the passive trajectory is formed by inputs of the pandemic (vector P_1 in equation 17) and inputs of the region (vector S in equation 18).

The key objective of the POD management theory is to use the results of a model-based system on the paradigm of input-states-output to develop a management strategy. The main expected benefit of this vision is to enable decision-makers to manage the performance trajectory of a considered system by visualizing and combining the impact of risks and opportunities. This section develops an original process of the presented approach on a considered system that might face instabilities (Risks and Opportunities). This POD process is applied to the considered problem in the sequential steps presented as follows.

4.1 System Establishment

The first step of the POD process is understanding the observed system and its environment. First, the system which is supposed to be studied is determined; The boundaries of the system in terms of precise study must be clear. The environment of the selected system refers to its potentials (Risks and Opportunities). Once the system and its potentials are determined, the associate parameters of the system to the considered potentials must be appointed (*i.e.*, characterizing the θ inputs of the system). Similarly, the inputs of the system's potentials have to be specified (*i.e.*, characterizing the $C_j^i \{i \in [1, r] \wedge j \in [1, \theta_r]\}$). Subsection 3.2 is dedicated to performing this step for the pandemic (potential) in a closed environment (system).

4.2 System Characterization

The established system includes the inputs of the system (*Attributes*) and its potentials (*Characteristics*). These inputs could be categorized into two groups in terms of their movement in the *Description Space*.

(i) The changes (*i.e.*, movements in the *Description Space*) of inputs more related to the potential are known as "elusive" changes. The elusive changes are considered out of control changes (or at least hard to perform). Table. 1 shows that the inputs u_1 to u_4 are connected to the virus's features (potential), and it is impossible to change them unless the virus itself has a mutation (e.g., fatality rate of the COVID-19 (1%-3.4%) is different from Ebola (50%) [34]). Roughly

speaking, elusive changes look like impossible (or hard) strategies. The consequences resulted from elusive movements could be in two categories, (i) Inflicted consequences that are imposed on the system's outputs and unmanageable, (ii) Managed consequences that might be controlled through some potentialities (e.g., the infectious rate, u_4 , is related to the nature of the virus while the Mask and Social Distance potentialities could reduce it).

(ii) The changes more related to the system are known as "driver" changes. The driver changes (more possible strategies) mainly create deviations in the passive trajectories. In other words, driver changes (and also the elusive changes with "Managed" consequence) make the active trajectories (Fig. 3). The consequences of the driver changes are mainly managed consequences but are essentially related to the limits of the system (see section 4.3).

4.3 System Intending

The consequences of elusive and driver movements in the *Description Space* appear as a deviation in the trajectory of the system in the *Performance Space*. This step is related to (i) Which outputs (KPIs) the system manager is looking for to study (e.g., the number of Hospitalized and Dead cases in the SEIR model), (ii) What constraints might exist for the movement in the *Description Space*; In cases where the system must not be positioned in some states x_i forever or for a specific period in the *Description Space* (e.g., the region allowed to be in confinement only for one month, *i.e.*, the (cr) value can't be close to zero more than one month), (iii) Which movement is preferable to the other if there is any specific priority and/or preference (e.g., wearing mask potentiality to reduce infectious rate is more feasible than confinement potentiality to reduce contact rate), and (iv) The onset of changes and periods that the system stays after the changes until the next change (e.g., the region can't be quarantined until two months after the onset of the pandemic and must return to no-quarantine status after one month).

4.4 Strategy Exploration

When the relationship between inputs in the *Description Space* and outputs in the *Performance Space* is specified (either formulated or estimated), this step would be the final step in the POD process. The last step of the POD process is dedicated to exploring all possible movements in the *Description Space* through experiment analysis to find the most desirable ones to be as close as possible to the

optimum outputs. This is necessarily dependent on clear information about the following elements presented in the previous steps. (i) Inputs (what are they, which type they have, and which type of consequences might they have in terms of movement in the *Description Space*), (ii) Outputs (which ones are considered to study and which one is more important to optimize), and (iii) The constraints (the limits of movements, their preferences, onset and period of the movements).

Table 1 presents the POD process (the first and second steps) for the presented model in subsections 3.2 and 3.3. Table 1 presents an overview of the system and possible potentialities for system management. **The managers of the system identify the "Managed" consequences and adopt strategies that are related to the inputs that their movement in the *Description Space* lead to this group of consequences.** The highlighted rows in Table 1 refer to such inputs with such properties for the pandemic model. The third and fourth steps of the POD process for the presented pandemic model is more investigated in section 5. In the POD approach, the key point is to locate the system (region) and the faced potential (pandemic) within the *Description Space* in order to parametrize and initialize the Decision Support System. The approach addresses the identified system with all of its constraints and the possible strategies to explore when it comes to automated functioning. Finally, following the strategy exploration (4.4), the best-fit strategies to execute will be offered automatically.

5 EXPERIMENTS AND RESULTS

The main experiments are centered on strategy exploration to find the most desirable outcomes to the objectives of the system. The exploration in this context is to study the possible movements in the *Description Space* and finally propose the best ones at any time t that divert the passive trajectory toward the objective of the system in the *Performance Space*.

The input vector for the presented well-known SEIR model in subsection 3.2 includes the "Attribute", the parameters of the system, and "Characteristics", the parameters of the system's potential. The "Attributes" and "Characteristics" refer to region and pandemic respectively.

The *Description Space* \mathcal{U} for the presented SEIR model includes the inputs of the pandemic and the region with vectors $P(t)$ and $S(t)$ respectively.

$$\begin{aligned} u(t) &= \underbrace{[P_1(t), P_2(t), \dots, P_r(t)]}_{\text{Potential}} \underbrace{[S(t)]}_{\text{System}}^T, \\ u(t) &= \underbrace{[u_1, u_2, u_3, u_4]}_{\text{Pandemic}} \underbrace{[u_5, u_6]}_{\text{Region}}^T. \end{aligned} \quad (19)$$

The given vector $u(t)$ illustrates the state $x(t)$ of the system and its potentials in the specific time t through function Φ .

The *Performance Space* \mathcal{Y} for the presented SEIR model indicates by vector $y(t)$ in a given $x(t)$ through function Ψ . This vector includes some notable KPIs.

$$y(t) = [s(t), e(t), i(t), h(t), r(t), d(t)]^T \quad (20)$$

The vector $y(t)$ presents the current position of the system at time t in its multi-dimensional KPI space (*Performance Space*). Different perspectives might be considered for the strategy exploration step of a specific system. Which KPIs are considered to study (it could be all of them at the same time) and which one between selected ones is prior to another one to optimize (they may not have priority): These are two essential questions that must be answered before strategy exploration.

Sensitivity analysis of the inputs and outputs depicted in Fig. 4, (e.g., through simulation campaign) presents the correlation between them. This analysis proposes the priority for the movements in the *Description Space*. The inputs with "Managed" consequences (See Table. 1) are highlighted in blue frame in Fig. 4. The correlation between inputs ($u(t)$) and the outputs (KPIs presented with $y(t)$ vector) are as follows: on average 0.035, 0.012, and 0.0036 for the contact rate (cr), infectious rate (ir), and fraction hospitalized (fh) respectively.

According to these values, the impact of "contact rate" is more than the impact of "infectious rate", which is greater than the impact of "hospitalized fraction". In other words, potentialities are equally important as following commands, according to the "Considered Potentiality" column in Table. 1; Lockdown/Curffew comes first, followed by Mask/Social Distance, and then Partial Lockdown.

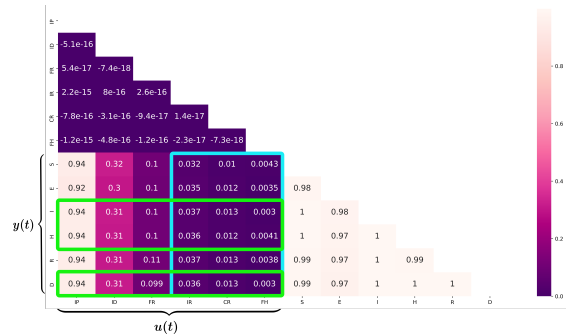

Fig. 4. Input-Output correlations of the presented SEIR model in section 3.2

To examine the POD framework, the three most dominant KPIs in terms of management, including I , H , and D compartments (Infected, Hospitalized, and Dead) are selected to study the possible movements (strategies) through potentialities, considering the onset and period of the strategies in the 3D *performance space*. **The POD perspective for the selected KPIs is to minimize them as much as possible without any preferences between them. The rest of this section is centered on this objective.** According to this objective, the foremost objective is the minimum value for each KPI at any time t . In the 3D *Performance Space*, the reference to study different possible movements (strategies) would be the origin of the space, the $(0, 0, 0)$ coordinates for each axis.

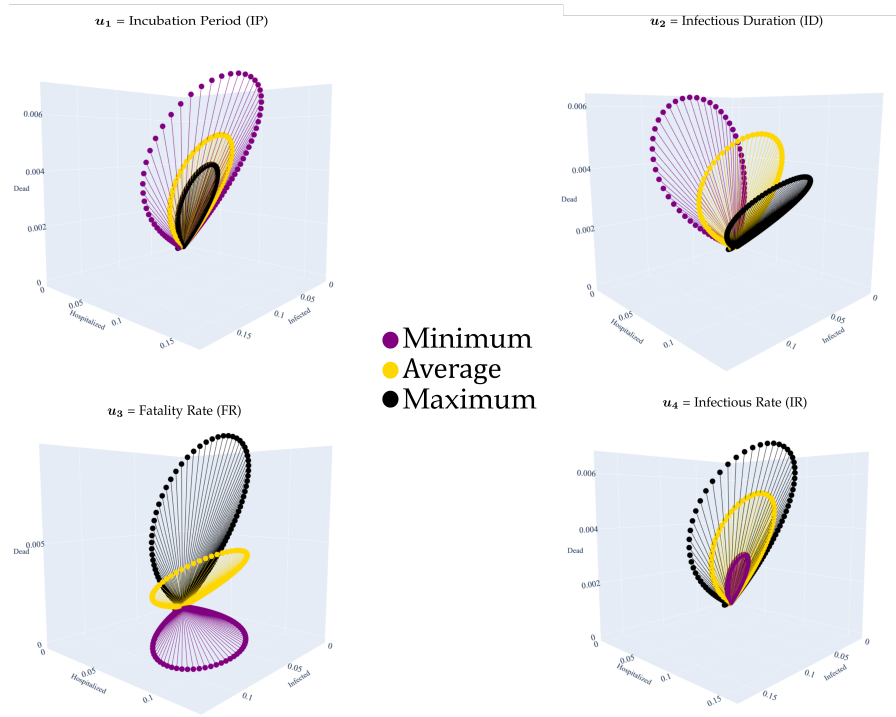

Fig. 5. Pandemic positioning results for its inputs and their distances from the system objective, (0,0,0) coordinates

According to Table. 1, on the one hand, the linked potentiality to vector P 's inputs (pandemic), involves **wearing masks** or keeping a safe distance from other people in the community (**social distance**), both of which might lower the *infectious rate (ir)*. **Lockdown** and/or **Curfew** to minimize *contact rate (cr)* or **Partial lockdown** of the fragile group to receive the virus, to lower the *fraction hospitalized (fh)*, on the other hand, are associated potentialities to the inputs of vector S (region). These strategies are applied to the ODEs of the presented SEIR model which is equivalent to changing the system states in the *Description Space* through the movements (See subsection 5.2).

The POD will be ready to investigate strategies once the possible potentialities and their implementation limits, such as their start time and duration, have been defined.

5.1 Potential positioning

Understanding the possible effects of potential on the system trajectory in the *Performance Space* is the first step in the experiment analysis. Various viruses may have different parameters as inputs in vector u [2], [20]. According to column "Variation" in Table. 1, considering that 1% of the total population is infected at first ($\alpha = 0.01$ in equation 15), the Fig. 5 presents the different trajectories of **Minimum**, **Average**, and **Maximum** values for the $u_1(t)$, $u_2(t)$, $u_3(t)$, and $u_4(t)$ in **purple**, **yellow**, and **black** colors respectively.

The values for non-varying inputs of "Potential" (e.g., in the case of u_1 trajectories in Fig. 5, the u_2 , u_3 , and u_4) as well as the "System" inputs are considered on "Average" in Table. 1.

The inverse impact of u_1 and proportionate impact of u_2 , u_3 , and u_4 on the selected KPIs (I, H, and D) are shown in Fig. 5 (In the proportionate impact, the distance between the points and the origin (0,0,0) grows as the value of input grows, and vice versa for the inverse impact). In addition, Table 2 shows that u_2 and u_4 have bigger fluctuations on the KPIs than u_1 and u_3 .

TABLE 2
Pandemic positioning results for its inputs and the sum of distance from the system objective, (0,0,0) coordinates

| Input | u | Min | Avg | Max |
|---------------------|-------|------|------|-------|
| Latent Period | u_1 | 8.82 | 8.62 | 8.50 |
| Infectious Duration | u_2 | 5.34 | 8.62 | 11.48 |
| Fatality Rate | u_3 | 8.62 | 8.62 | 8.63 |
| Infectious Rate | u_4 | 6.99 | 8.62 | 9.17 |

Table. 2 presents an overview of the potential impacts on the selected KPIs (I, H, and D). Except the "infectious rate" row, the value of other rows would be on average for the system positioning (subsection 5.2). Because this parameter is the only potential parameter that could have "Managed" consequence in terms of movement in the *Description Space*

(i.e., between the "Elusive" inputs, there is only "feasible potentiality" for infectious rate which could be wearing mask and social distance potentialities).

The experiments cover the period from the initial observation of infected cases to 180 days (six months) afterwards. In other words, each point of the given curves in Fig. 5 represents the values for one day of the selected KPIs (daily cases), and the results in Table. 2 are the total sum of the distance between the point (0,0,0) and the 180 points of the curves.

The results presented in Fig. 5 show the system passive trajectories of daily KPIs. In this case, the initial position of the system (region, on the average value) and potential (pandemic) remain constant for the period of study (180 days).

$$x(t_1) = x(t_2) = \dots = x(t_{180}) \quad (21)$$

5.2 System positioning

The impact of potential inputs on KPIs is discussed in the preceding section in the absence of any strategy (no movement on the axis related to the system in the *Description Space* has been taken). This section investigates the active trajectory by examining the results of several possible movements in the *Description Space* of the COVID-19 (potential) for the state of Georgia (region) as alternative strategies that the system manager could take to control the system's trajectory in the *Performance Space* based on the selected system objectives.

The average considered value of the "latent period" and "infectious duration" for the COVID-19 are 6 days and 12 days respectively [19] (these values could vary, for example, the infectious duration is shorter when children or less severe cases are involved [32]). The study uses real data

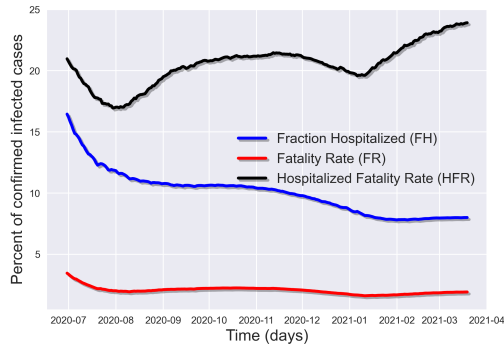

Fig. 6. Fraction Hospitalized and Fatality Rate of the COVID-19 in the State of Georgia

from the COVID-19 virus in the state of Georgia between July 2020 and April 2021 to obtain the values of "fatality rate" and "fraction hospitalized" experimentally [35], [36].

The average value for the *fatality rate* (*fr*) indicated in the red plot in Fig. 6, is 2%. Also indicated in blue is the *fraction*

hospitalized (*fh*), which is 10% on average. In equation 7, the "hospitalized fatality rate" (*hfr*) is calculated by dividing the (*fr*) by (*fh*), as illustrated in the black plot. Based on what has been mentioned so far, the input vector of the Covid-19 potential in the state of Georgia is as follows (see Table. 1 for the units of input vector).

$$u = [u_1, u_2, u_3, u_4, u_5, u_6]^T = [6, 12, 2, u_4, u_5, 10]^T \quad (22)$$

The three highlighted inputs with "Managed" consequences of vector u are presented in Table. 1. The wearing mask potentiality, to reduce "infectious rate" (u_4) and the lockdown potentiality, to reduce "contact rate" (u_5) are considered to study the active trajectories through these two potentialities.

The three related alternatives to these potentialities are being investigated to determine the ideal timing for movements equivalent to the considered potentialities in the *Description Space* of the COVID-19 (Potential) in the state of Georgia (System).

- (i) The two-week lockdown potentiality from week i -th to two weeks after (6 months contains 24 weeks starting at the first day after week-first),
- (ii) The wearing mask obligation starting from week i -th until the end of the study (6 months),
- (iii) The two potentialities (i) and (ii) simultaneously.

The results are presented assuming that the managers can only carry out the potentialities (changing the colored point(s) in the *Description Space*) on the first day of the week for the pandemic-affected region. In other words, the state of the system is altered at the following set.

$$x(t_{7i}) | i \in \{1, 2, \dots, 24\} \quad (23)$$

The passive trajectory of the COVID-19 in the state of Georgia is shown in blue in Fig. 7. This trajectory is the result of the "potential positioning" presented in subsection 5.1 and the reference to examine specified alternatives. The active trajectories in Fig. 7 are related to alternatives (i), (ii), and (iii) of daily KPIs depicted in brown, yellow, and red respectively. It's important to note that these alternatives may have an influence on potential (virus) and system inputs, which isn't reflected in the results (e.g., lockdown and wearing mask potentialities may reduce the fatality rate and fraction hospitalized).

The system positioning related to alternatives of week 2, week 3, week 5, and week 10 after week-first of outset (t_1 to t_7) is presented in Fig. 7. The following are some related observations.

- (i) The active trajectories correspond to the passive trajectory (blue) until the moment of activation, t_{21} , t_{28} , t_{42} , and t_{77} linked to the specified weeks,
- (ii) The deviations of the active trajectories related to the "wearing mask" potentiality from the moment of execution to the end of the path are smooth,
- (iii) In the early weeks, the deviations of the active trajectories associated with the "lockdown" potentiality are

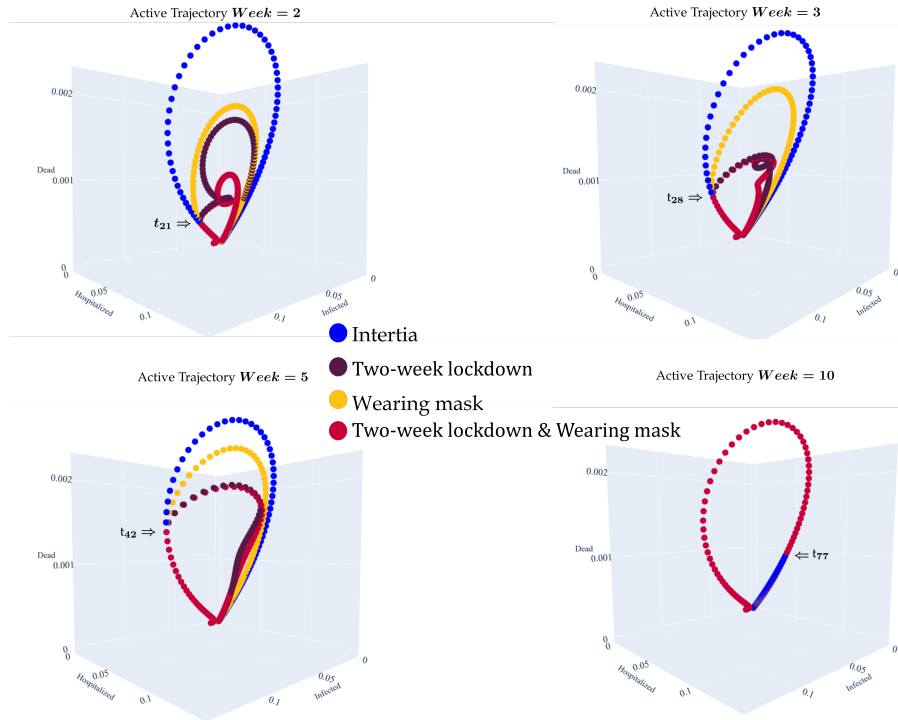

Fig. 7. Region positioning results for its inputs and their distances from the system objective, (0,0,0) coordinates

like a forth and back break (deviation), and as we move away from the early weeks, these deviations become smoother,

- (iv) The later the movement of colored points in the *Description Space* (taking the strategies), the closer the active trajectories are to the passive trajectory.

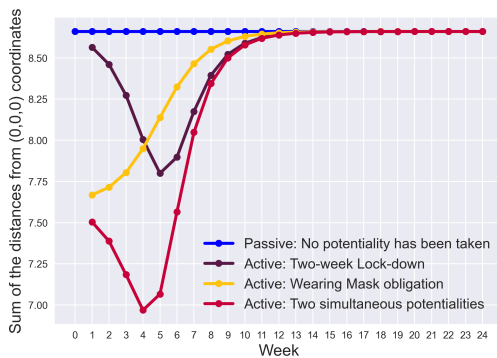

Fig. 8. The considered potentialities for the COVID-19 in the State of Georgia and the sum of the distances from system objective for given potentiality in the 3D framework during 6 months (week 1 to week 24).

Fig. 8 shows the final results of the study for the considered potential strategies for the state of Georgia to containment the COVID-19 in this region. Since the less the sum of the

distances from the origin, the better the movement in the *Description Space*, the following results can be deduced from Fig. 8.

- (i) Week **5th** is the ideal time for movement on the “*cr*” axis, which is the lockdown strategy (starting lockdown after two months),
- (ii) The sooner the “wearing mask obligation” strategy (movement on the “*ir*” axis) is implemented, the better. Over the weeks, the total distance from the target, (0,0,0) has increased,
- (iii) The best time to implement two strategies simultaneously is the **4th** week,
- (iv) From about the **11th** week onwards, the implementation of strategies has very little influence on pandemic control (the sum of the distances is approximately equal to the passive mode).

6 CONCLUSION AND PERSPECTIVES

In this paper, a simplified version of the SEIR model for pandemic spread through Ordinary Differential Equation (ODEs) has been introduced to support a wide range of instances of viruses and populations. The considered parameters allow covering a wide range of scenarios by assessing the consequence of an observed pandemic on the KPIs of a given population. The POD vision has been established to examine the influence of mitigation measures on the evaluation of these KPIs to control COVID-19 in the state of Georgia (USA) and a potential future pandemic.

Within the system KPIs framework, this prediction may be visually displayed as a performance trajectory. Furthermore, decisions may be represented as “what if” scenarios, and their influence, as well as the deviation of the performance trajectory, can be predicted. The next stage in this research is first, to look at the addition vector of the impacts of several simultaneous actions on the performance trajectory in the performance space, and second, to employ this pandemic model as a data supplier for neural network systems. The primary idea is to perform large-scale combinatory simulation campaigns to collect big datasets concerning the general situation of a pandemic-affected social system. Using this data to train neural network systems will allow us to create a formal system capable of simulating any social system affected by a pandemic and implementing any mitigation actions. Optimization algorithms may be used with these tools to determine the best set of actions to do in each given situation (whatever social system is hit by any virus). Finally, the ultimate goal is to develop a modeling system that can characterize the population affected by a specific virus and suggest a combination of timed measures, which can be viewed as physical forces pushing or pulling the observed system’s performance trajectory within the performance framework, to optimize its response to the looming pandemic.

REFERENCES

- [1] D. Arnold, “Pandemic india: Coronavirus and the uses of history,” *The Journal of Asian Studies*, vol. 79, no. 3, pp. 569–577, 2020.
- [2] S. D. Pitlik, “Covid-19 compared to other pandemic diseases,” *Rambam Maimonides medical journal*, vol. 11, no. 3, 2020.
- [3] R. Ullah, G. Zaman, and S. Islam, “Prevention of influenza pandemic by multiple control strategies,” *Journal of Applied Mathematics*, vol. 2012, 2012.
- [4] R. M. Anderson, H. Heesterbeek, D. Klinkenberg, and T. D. Hollingsworth, “How will country-based mitigation measures influence the course of the covid-19 epidemic?” *The lancet*, vol. 395, no. 10228, pp. 931–934, 2020.
- [5] F. Benaben, L. Faugere, B. Montreuil, M. Lauras, N. Moradkhani, T. Cerabona, J. Gou, and W. Mu, “Instability is the norm! a physics-based theory to navigate among risks and opportunities,” *Enterprise Information Systems*, pp. 1–28, 2021.
- [6] N. Moradkhani, L. Faugère, J. Jeany, M. Lauras, B. Montreuil, and F. Benaben, “A physics-based enterprise modeling approach for risks and opportunities management,” in *IFIP Working Conference on The Practice of Enterprise Modeling*. Springer, 2020, pp. 339–348.
- [7] J. Brug, A. R. Aro, and J. H. Richardus, “Risk perceptions and behaviour: towards pandemic control of emerging infectious diseases,” pp. 3–6, 2009.
- [8] J. Brug, A. Oenema, and I. Ferreira, “Theory, evidence and intervention mapping to improve behavior nutrition and physical activity interventions,” *International Journal of Behavioral Nutrition and Physical Activity*, vol. 2, no. 1, pp. 1–7, 2005.
- [9] R. Krumkamp, A. Ahmad, A. Kassen, L. Hjarmoe, A. M. Syed, A. R. Aro, and R. Reintjes, “Evaluation of national pandemic management policies—a hazard analysis of critical control points approach,” *Health policy*, vol. 92, no. 1, pp. 21–26, 2009.
- [10] Z. Ma, *Dynamical modeling and analysis of epidemics*. World Scientific, 2009.
- [11] M. Chinazzi, J. T. Davis, M. Ajelli, C. Gioannini, M. Litvinova, S. Merler, A. P. y Piontti, K. Mu, L. Rossi, K. Sun *et al.*, “The effect of travel restrictions on the spread of the 2019 novel coronavirus (covid-19) outbreak,” *Science*, vol. 368, no. 6489, pp. 395–400, 2020.
- [12] J. Hellewell, S. Abbott, A. Gimma, N. I. Bosse, C. I. Jarvis, T. W. Russell, J. D. Munday, A. J. Kucharski, W. J. Edmunds, S. Funk *et al.*, “Centre for the mathematical modelling of infectious diseases covid-19 working group. feasibility of controlling covid-19 outbreaks by isolation of cases and contacts,” *Lancet Glob Health*, vol. 8, no. 4, pp. e488–e496, 2020.
- [13] N. H. Nam, P. T. M. Tien, L. V. Truong, T. A. El-Ramly, P. G. Anh, N. T. Hien, E. M. Mahmoud, M. M. Eltaras, S. A. E. Khader, M. S. Desokey *et al.*, “Early centralized isolation strategy for all confirmed cases of covid-19 remains a core intervention to disrupt the pandemic spreading significantly,” *PLoS one*, vol. 16, no. 7, p. e0254012, 2021.
- [14] S. E. Eikenberry, M. Mancuso, E. Iboi, T. Phan, K. Eikenberry, Y. Kuang, E. Kostelich, and A. B. Gumel, “To mask or not to mask: Modeling the potential for face mask use by the general public to curtail the covid-19 pandemic,” *Infectious Disease Modelling*, vol. 5, pp. 293–308, 2020.
- [15] Z. Yang, Z. Zeng, K. Wang, S.-S. Wong, W. Liang, M. Zanin, P. Liu, X. Cao, Z. Gao, Z. Mai *et al.*, “Modified seir and ai prediction of the epidemics trend of covid-19 in china under public health interventions,” *Journal of thoracic disease*, vol. 12, no. 3, p. 165, 2020.
- [16] L. López and X. Rodo, “A modified seir model to predict the covid-19 outbreak in spain and italy: simulating control scenarios and multi-scale epidemics,” *Results in Physics*, vol. 21, p. 103746, 2021.
- [17] T. de Camino-Beck, “A modified seir model with confinement and lockdown of covid-19 for costa rica,” *medRxiv*, 2020.
- [18] J. Struben, “The coronavirus disease (covid-19) pandemic: simulation-based assessment of outbreak responses and postpeak strategies,” *System Dynamics Review*, vol. 36, no. 3, pp. 247–293, 2020.
- [19] T. Li, Y. Liu, M. Li, X. Qian, and S. Y. Dai, “Mask or no mask for covid-19: A public health and market study,” *PLoS one*, vol. 15, no. 8, p. e0237691, 2020.
- [20] C. P. Vyasarayani and A. Chatterjee, “New approximations, and policy implications, from a delayed dynamic model of a fast pandemic,” *Physica D: Nonlinear Phenomena*, vol. 414, p. 132701, 2020.
- [21] A. Ferreira and D. Otley, “The design and use of performance management systems: An extended framework for analysis,” *Management accounting research*, vol. 20, no. 4, pp. 263–282, 2009.
- [22] F. Benaben, M. Lauras, B. Montreuil, L. Faugère, G. Juanqiong, and W. Mu, “Physics of organization dynamics: An ai framework for opportunity and risk management,” in *2019 International Conference on Industrial Engineering and Systems Management (IESM)*. IEEE, 2019, pp. 1–6.
- [23] R. Olsson, “In search of opportunity management: Is the risk management process enough?” *International journal of project management*, vol. 25, no. 8, pp. 745–752, 2007.
- [24] D. Hillson, *Exploiting future uncertainty: creating value from risk*. Routledge, 2017.
- [25] C. Fang and F. Marle, “A simulation-based risk network model for decision support in project risk management,” *Decision Support Systems*, vol. 52, no. 3, pp. 635–644, 2012.
- [26] K. Yuthas, “Tamara bekefi, marc j. epstein and,” 2008.
- [27] N. B. Haaser, *Real analysis*. Courier Corporation, 1991.
- [28] S. N. Kumpati, P. Kannan *et al.*, “Identification and control of dynamical systems using neural networks,” *IEEE Transactions on neural networks*, vol. 1, no. 1, pp. 4–27, 1990.
- [29] J. Tolles and T. Luong, “Modeling epidemics with compartmental models,” *Jama*, vol. 323, no. 24, pp. 2515–2516, 2020.
- [30] O. N. Bjornstad, K. Shea, M. Krzywinski, and N. Altman, “The seirs model for infectious disease dynamics,” *Nature Methods*, vol. 17, no. 6, pp. 557–559, 2020.
- [31] A. Bourgois, “Safe & collaborative autonomous underwater docking,” Ph.D. dissertation, ENSTA Bretagne-École nationale supérieure de techniques avancées Bretagne, 2021.
- [32] A. W. Byrne, D. McEvoy, A. B. Collins, K. Hunt, M. Casey, A. Barber, F. Butler, J. Griffin, E. A. Lane, C. McAloon *et al.*, “Inferred duration of infectious period of sars-cov-2: rapid scoping review and analysis of available evidence for asymptomatic and symptomatic covid-19 cases,” *BMJ open*, vol. 10, no. 8, p. e039856, 2020.
- [33] J. Piret and G. Boivin, “Pandemics throughout history,” *Frontiers in microbiology*, p. 3594, 2021.
- [34] A. Abiad, R. M. Arao, and S. Dagli, “The economic impact of the covid-19 outbreak on developing asia,” 2020.
- [35] “Georgia covid-19 data hub,” <https://covid-hub.gio.georgia.gov/>, (Accessed on 11/05/2021).
- [36] “Covid-19 georgia metrics — tableau public,” <https://public.tableau.com/app/profile/dima.nazzal/viz/COVID-19GeorgiaMetrics/GeorgiaCOVID-19Dashboard>, (Accessed on 11/05/2021).

3.2.2 Discrete Event Simulation

The POD framework in this case study has been installed by simulating the Nantes ring road with the vehicles as agents and flooding on a specific part of the ring road as events (named “Disruption Scenarios” in the article). The Description Space has been constructed on the dimensions of the “ring road” (length and capacity and speed limit) and “vehicle” (flow, length) as the system (Attributes), where the “flood” (with its onset time and magnitude as parameters) serves as the contextual element (Characteristics). The Performance Space has constructed on some KPIs, for example, the number of vehicles on the ring road, their average speed, etc., to examine the impact of several forces. The “inflicted” and “managed” forces are generated respectively from both the ring road and flood (*e.g.*, traffic jam, flooding, respectively) and parameters to control the traffic (*e.g.*, opening alternative routes for vehicles in the flooding area and directing them to those routes to reduce traffic).

Persistent physics-based crisis management framework: A case study of traffic in the Nantes city due to flood exposure

Keywords. Disaster Information, Resilience, for Emergency and Crisis Technologies, agent-based, crisis management, evacuation, flood, performance, simulation

Authors. Nafe Moradkhani, H el ene Dolidon, and Frederick Benaben

Publisher. Hawaii International Conference on System Sciences (HICSS)

Date of Publication. 4 January 2022

Reference. Moradkhani et al., 2022c

Online Access. [Persistent physics-based crisis management framework: A case study of traffic in the Nantes city due to flood exposure](#)

Persistent physics-based crisis management framework: A case study of traffic in the Nantes city due to flood exposure

Nafe Moradkhani
IMT Mines Albi, France
nafe.moradkhani@mines-albi.fr

Hélène Dolidon
CEREMA, Nantes, France
helene.dolidon@cerema.fr

Frederick Benaben
IMT Mines Albi, France
frederick.benaben@mines-albi.fr

Abstract

In the context of crisis, the characteristics of the crisis area and the operational measures of the community play key roles in managing the crisis. The Nantes ring road in France is always exposed to flooding and its disruptions. To anticipate the disruptions and timely preventive actions for this frequent phenomenon, the main challenges are (i) forecast of vehicles' flows, (ii) capacity of the ring road to handle the traffic (iii) evaluate the performance of alternate routes during the flooding. The flooded area as a system has components of (i) the flood (e.g. time of onset, magnitude, intensity, etc.), (ii) the area (e.g. geographical features, temporary perimeter barriers, dam, diversion canals), and (iii) the community (e.g. reaction time, emergency strain, evacuation delay). The chosen approach to conduct this anticipative study consists of collecting data about forecasts and using simulation models to work simultaneously on evaluating the performance of the ring road and its alternative routes.

1. Introduction

The city of Nantes is surrounded by the 43 km long Nantes Ring Road (RN 844). The ring road is operated by the Interdepartmental Direction of Western Roads (DIRO), except on a portion to the north that is operated by Cofiroute (see Fig. 1) [1].

With the development of the urban area, the traffic of the ring road has increased significantly and it reaches more than 100,000 vehicles per day in certain sections; therefore, the network congestion is notable at peak hours. Up to 100,000 vehicles circulate on the ring road with the traffic peaks in the morning (8 am-9 am) and evening (5 pm-6 pm) [1, 2, 3]. Significant flows are observed in the south-north (SN) direction in the morning and the opposite direction in the evening. Most of the jobs are located in the northern part of the city and are the main reason for the difference between these flows.

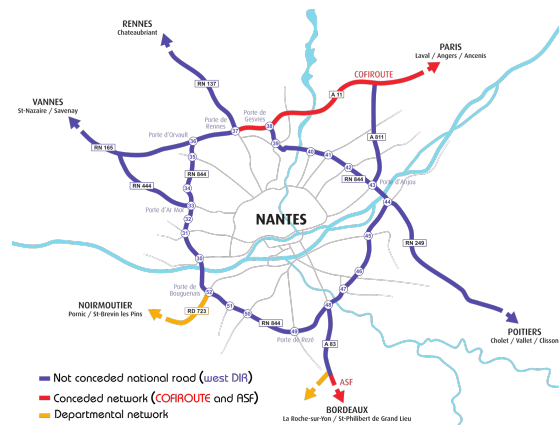

Figure 1: Nantes ring road and its operators.

The northeast part of the Nantes ring road is flooded frequently due to the overflow of the “Gesvres” river. The Gesvres river originates from the Erdre river which is started near Angers city and ends in the city of Nantes. The historical data from the Joneliere station which reports the Gesvres water level shows whenever the Erdre river overflows so does the Gesvres river [3]. This paper focuses on a predictive model of the traffic on the ring road during the flooding to cope with flooding disruptions [3, 4, 5].

Preventive systems with the ability to detect, predict, and make decisions are very useful in the field of crisis management. The necessity of predictor systems to deal with unforeseen events such as flooding is indispensable. These systems are able to detect crises as early as possible and implement appropriate solutions to manage them [6].

This paper relies on an intelligent physics-based framework introduced in [7] to manage crises. This original framework, Physics Of Decision (POD), considers that crisis can be seen as physical forces applied to the system which may push or pull it in its performance space by varying the system’s KPIs (Key

providing simulation tools [16]. There is some software to simulate the traffic considering the capacity of the roads, buffer size, exit rate, etc. (e.g. Aimsun (Transport Simulation Systems (TSS)), CUBE, Dynameq, MITSIMLab, Simtraffic, etc.) [17].

In this paper, quantitative agent-based and stochastic simulation modeling of the ring road is used as it best fits the complexity, context, and essence of the ring road with routes and agents (vehicles). Such simulation modeling is embedded into the physics-based crisis management framework to simulate the traffic process in the ring road and to assess and mitigate the potential crisis related to the ring road.

3. Physic-based crisis management framework

3.1. General Perspective of POD for crisis management

A system might be destabilized by unforeseen changes. These changes mainly refer to the variation of system parameters and consequently, deviation from the system's expected trajectory. The expected trajectory depends on the considered case, but this is often the targeted, planned, or most probable one. Any deviation from that trajectory is considered a crisis for the system. System attributes define the different situations of the system. Identifying these attributes, their relationship, and their level of security is required to design a smart predictor system. The Physics Of Decision (POD) framework introduced in section 1 defines two spaces in which a system can be positioned [9].

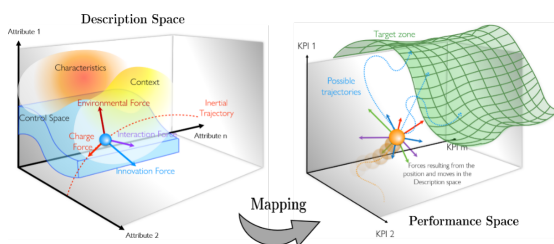

Figure 3: POD-based intelligent crisis management framework.

The Performance Space, depicted on the right side of Fig. 3, describes the performance of the system in a given state by locating it relative to KPIs, with crisis being shown as force vectors in that referential.

The Description Space, depicted on the left side of Fig. 3, represents the system's states by locating it relative to axes defined according to its attributes.

Some attributes are changed at certain times by decision-makers to control the deviation of trajectories. The degree of changes for each attribute is determined by system constraints in the Control Space, which is basically the “easy to access” subpart of the Description Space.

The relationship between the two spaces is determined by a function of Attribute(s) to KPI(s), which maps *Description Space* to *Performance Space*. This function can be straightforward or complex [8]. In cases where equations between the two spaces can be determined, it would be possible to analyze the data and deviations from the normal trajectory caused by the forces. Otherwise, this function should be determined differently, notably through simulation experiments as in this paper, so as to generate the data from which the unknown relationships between attributes and KPIs can be inferred [9].

3.2. Problem statement

The Interdepartmental Direction of Western Roads (DIRO) and Cofiroute operators are responsible for frequent floods on the northeast part of the Nantes ring road [2]. To cope with this crisis, the DIRO must close the ring road, partially or totally (depending on the extent of the submersion of the water to the roadway), between two stations, “Porte de la Chapelle” and “Porte de la Beaujoire” which are two ring road interchanges then they activate other routes (called: “S” alternative routes) which are major alternative adjacent routes in the flooded part [2, 3]. The DIRO decides to close the ring road (totally or partially) between the aforementioned ports based on the Gesvres water level reported by “La Jonelière”, measuring station nearby the river according to the following indicator for the water level [3, 10]:

- 203 cm: water arrives on the right lane of the outer ring road;
- 210 cm: water arrives on the left lane of the outer ring road;
- 228 cm: water arrives on the left lane of the inner ring road;
- 230 cm: water arrives on the right lane of the inner ring road.

The reaction of the ring road operators to the crisis is critical in the flooded part and it gets increasingly more critical if the flood happens during peak hours usage of the ring road. This article mainly focuses on assessing the capability of the ring road to handle the traffic in normal days usage and the flooding days with different

possible times of onset and intensity. The major focus of the case study is ascertaining the bottlenecks and rupture points in the Nantes ring road where issues may emerge from the perspective of the POD-based intelligent crisis management framework.

4. Methodology

4.1. Nantes ring road architect and Gesvres flood

The inner roadway of the Nantes ring road has 23 exits and 24 entrances and the outer roadway has 23 exits and 22 entrances (there is one exit for almost every entrance). Exceptions are located at interchanges 43 (Porte d'Anjou) on its inner roadway and interchange 33 (Porte d'Or Mor) on its outer roadway which have two entrances and two consecutive exits respectively (see Fig. 4).

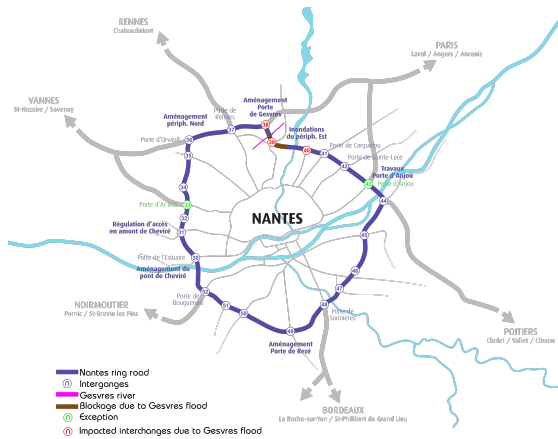

Figure 4: Nantes ring road map.

As soon as the water of the Gesvres river rises and reaches the minimum blockage indicators, the ring road is closed (partially or totally depending on the flood intensity) and the alternative routes are activated to prevent the traffic jam. The alternative route S6 is activated for the vehicles in the south-north (SN) direction (on the outer roadway) and S5 is activated for vehicles in the north-south (NS) direction (on the inner roadway). These two detour routes are indicated for ring road users by specific signs or messages before the blockage part [18].

According to the slope of the ring road in the blockage part, the outer roadway flooded first then based on the intensity of the flood, the water approaches the inner roadway. The two alternative routes S5 and S6

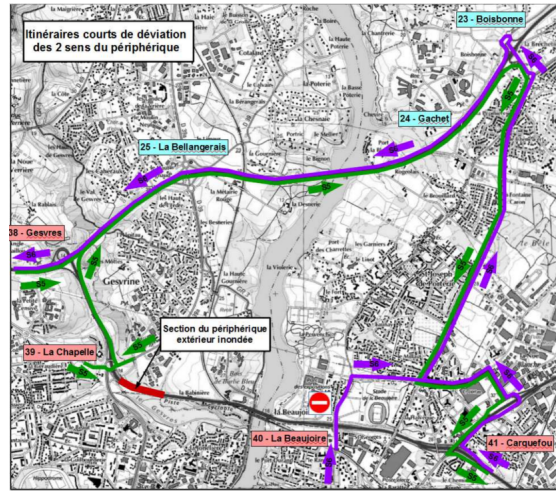

Figure 5: Alternative routes during Gesvres flood on the Nantes ring road (DIRO, 2015).

follow the urban network of Nantes Metropole and the Cofiroute motorway network.

4.2. Traffic jam topology and its process modeling

The traffic jam process is modeled to begin with the entry of a vehicle from one of the 46 entrances (inner and outer) to the Nantes ring road. Once on the ring road, the vehicles circulate on the ring road until they reach their destination. The simulation initializes at 12 midnight so that generally a small number of vehicles are traveling (of course after one full day running the simulation, some vehicles, oncoming vehicles, already travel on the ring road). To reflect the real traffic situation, the whole length of the ring road is segmented into dual segments among each two consecutive exists.

The first segment is from an exit to the first next entrance and the second segment starts from the first observed entrance to the next exit. This process is applied to the whole ring road (inner and outer roadways). This process correctly illustrates the logic of a moving vehicle that has passed an exit on the ring road (the vehicle definitely sees and passes the first next entrance and travels until the next exit and finally decides to exit or keeping continue on the ring road).

The next step is the traffic jam implementation. The vehicles that have passed the first exit, cannot enter segment 1 while there is no space (the minimum required space is at least the vehicle length). The same logic is applied for the vehicles that have passed segment 1 and are trying to enter segment 2. Besides, those

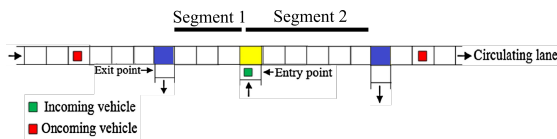

Figure 6: Traffic logic between two exits (including 2 segments) [19]

that are entering the ring road from entrances (Incoming vehicle (green) at yellow cell in Fig. 6) have to stop in the detour route leading to ring road until there is required space at segment 2. The parameters of the implemented traffic process are given in section 4.4. The traffic jam process is applied to the alternative routes (S5 and S6) as well.

Fig. 7 shows the schema of a sample of whole segmented routes on the Nantes ring road for implemented Traffic jam process with the Process Modeling and GIS libraries of the AnyLogic© simulation software used in this study.

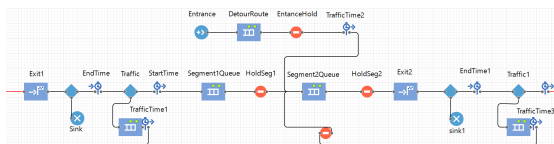

Figure 7: Traffic jam process modeling for the Nantes ring road.

AnyLogic© Process Modeling Library supports discrete-event, or, to be more precise, process-centric modeling paradigm. Process Modeling Library objects can model the real-world systems in terms of agents (transactions, customers, products, parts, vehicles, etc.), processes (sequences of operations typically involving queues, delays, resource utilization), and resources. The processes are specified in the form of flowcharts - a widely adopted graphical representation used in many areas: manufacturing, call centers, business processes, logistics, healthcare, etc.

AnyLogic© flowcharts are hierarchical, scalable, extensible, and object-oriented, which enables the user to model large complex systems at any level of detail. Another important feature of the Process Modeling Library is the ability to create very sophisticated animations of process models. Besides, the GIS library uses the GIS map to implement the routing and navigation from any origin (point/region) to a destination. This library requests the routing from Open Street Map (OSM) server for considered routes with the possibility of shortest or fastest routes for any agent type (car, rail, bike, foot, etc.) [20].

4.3. Safe driving modeling

As long as there is no other vehicle in the sight of a moving vehicle, the vehicle will move at the freeway’s speed limit (the paper considers other possible objects appearing in the path of a moving vehicle as another vehicle). The initial speed considered for the vehicles is a triangular distribution between the minimum and maximum speed limit. The considered initial speed for the ring road is:

Triangular (70 km/h, 90 km/h, 80 km/h)

These values may change when there are other vehicles in the sight of the moving vehicles’ drivers. To simulate the process of decreasing and increasing speed on the ring road, the simulation applies the “Two-second rule”. The two-second rule is a rule of thumb by which a driver may maintain a safe trailing distance at any speed [21, 22]. The rule is that a driver should ideally stay at least two seconds behind any vehicle that is directly in front of his or her vehicle. It is intended for automobiles, although its general principle applies to other types of vehicles. Depending on the distance between the moving vehicle and the newly appeared vehicle, the simulation decreases the speed of the vehicle until the vehicle is within the Two-second rule (likewise, the speed restore gradually as soon as the capacity is back to the allowable range). This process continues until the number of vehicles reaches the maximum capacity of the segment on which the vehicle is moving and as soon as the segment is full, the Hold markup is activated (see Fig. 7).

4.4. Data sources and scenarios

The simulation utilized various parameters as attributes in the Description Space. These parameters include the values of (i) the vehicles as agent (e.g. car, truck) includes their flows, length, origin, speed, and destination (ii) the ring road includes total length, segment’s lengths, speed limit, capacity (one-line or more than one-line roadway), and (iii) the flood includes the time of onset (date and time) and its magnitude.

The Gesvres water level (as the magnitude of the flood) is considered as the origin of applied force to the system (section 3.2). The goal is then to evaluate the probable forces of the modeled crises and their impact on the system trajectory in the Performance Space of the Nantes ring road to reflect a realistic simulation of the traffic jam process.

This section gives more details about the aforementioned parameter considered as Attributes for the Description Space, in the other words, the simulation inputs.

4.4.1. Agent The Description Space related to the parameters of the vehicle, ring road, and the river. This section is related to the parameters of the vehicles considered as agents.

Flow: The simulation only had access to data recorded by some on-road cameras (not all of them) include the flow of the vehicles passing them and their speed (Oncoming vehicles in Fig.6). Lack of access to the flow and speed of the vehicles at entrances and exits was a challenge. To distribute the entire flow of vehicles recorded by on-road cameras between entrances and exits, the two following possibilities are considered concerning the current position of a sample vehicle. (i) Possibility of departure of the intended vehicle while traveling on the road (Oncoming vehicle) at its upcoming exits, (ii) Possibility of departure of a newly arrived vehicle (Incoming vehicle in Fig. 6) on the ring road at the upcoming exits. The first hypothesis is to ensure the exit of an arrived vehicle on the ring road after crossing the maximum halfway of the ring road. Otherwise, the driver should have chosen the opposite direction (this hypothesis is based on heavy traffic data and the almost always optimal time selection of the shortest route). With these hypotheses and trial and error by varying the possible values for the exit probability through the simulation campaigns, the following formula has been obtained for the ring road exits. (U:Uniform, I: Incoming vehicles, O: Oncoming vehicles)

$$Pr(exit_i) = 1 - \frac{U(0.7, 0.95) \times \Sigma I_i + U(0.4, 0.6) \times \Sigma O_i}{\Sigma I_i + \Sigma O_i} \quad (1)$$

According to Fig. 7, the exit probability at the second exit markup in the schema (the distinguisher connected to sink 1) is calculated for the vehicles between ‘StartTime’ and ‘Exit2’ markups and the vehicles between ‘Entrance’ and ‘Exit2’ markups.

The second issue with the vehicle flows was the lack of access to all on-road cameras. The simulation had access to the recorded data of 6 on-road cameras located between exit 40 (Porte de la Beaujoire) and 45 (Porte de Goulaine) (see Fig. 4). To feed the flows of entrances and exits in the simulation on the rest exits, the simulation is duplicated the existing data of exits 40-45 to other similar congestion exits. This simulation feed is implemented according to the vehicle congestion map shown in Fig. 8 concerning the high flow in the south-north direction in the morning and the opposite in the evening.

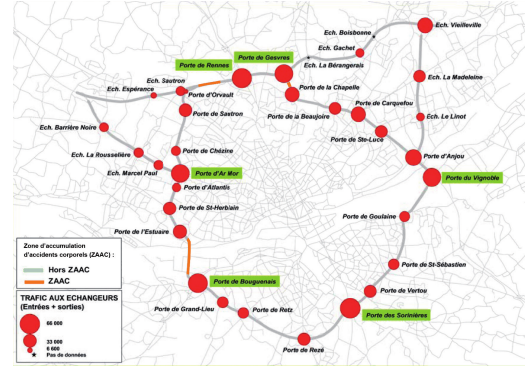

Figure 8: Nantes Agglomeration Traffic Operating System (DREAL - 2010).

Length: The average length of vehicles in terms of type, e.g. car or truck, uniform (4.5, 5.5) meter has been considered [23]. Besides, the minimum considered distance between the agent in heavy traffic is 1 meter.

4.4.2. Ring road Section 4.1 is dedicated to the Nantes ring road architect and its interchanges. In this section, the considered values for the ring road as another attribute in Description Space are explained.

Length and capacity: The Nantes ring road is 43 km long. The total length is segmented into dual segments. The first segment start from an exit to the first next entrance and the second segment starts from the first observed entrance and ends at the next exit (see Fig. 6). To calculate the capacity of each segment, the total length of the segment in meters (automatically is calculated by the OSM server) concerning the minimum distance between two consecutive agents has been divided by the average length of the vehicles.

Speed limit: The permitted speeds were selected to corroborate the rule is used to determine traffic jams in the main cities in France. These rule judges that, for a regulated speed between 70 km/h and 90 km/h and at maximum 60 km/h for the alternative routes. Besides, the following indicator has been considered for the traffic status:

- Traffic is fluid if the speed is greater than 50 km/h,
- Traffic is dense if the speed is between 30 km/h and 50 km/h,
- Traffic is congested if the speed is less than 30 km/h

4.4.3. Flood There are different parameters related to the flooding of the Gesvres river. Some of these parameters are precipitation, rainfall intensity, humidity index, slope, land use, etc. The only parameter considered in this study is the Gesvres water level reported by “La Jonelière” measuring station nearby the river and disrupt the system according to the defined indicator in section 3.2

The attributes’ values can vary in some specific ranges because of the degrees of liberty for the ring road considering, capacity, speed limits. These variations are considered in the control space of Description Space (Fig. 3). Besides, the water level of Gesvres can vary and impacts the ring road performance. The water level is out of control and is considered as “Characteristic” in the POD framework. The water level’s impact on ring road performance (fluid, dense, and congestion traffic) is considered as “Environmental Force” in Fig.3. According to the objectives of the ring road, these variations impact the ring road’s performance. To evaluate the ring road performance, the following Key Performance Indicators (KPIs) are considered:

- The average speed of all exits for each direction (inner and outer roadway of the ring road) and the GIS points on the alternative routes,
- The average flow of vehicles on the ring road and the alternative routes,
- The Average Trip Time (ATT) between interchange 37 and interchange 44 as critical path that could be impacted by the Gesvres flood.

4.5. Disruption Scenarios

Some possible scenarios are considered to implement in the simulation and study their impact on the system’s trajectories in the performance space. These scenarios mainly refer to the flood attributes. Table 1 provides illustrative distinct possible Disruption Scenarios (DS) for the traffic on the Nantes ring road.

Table 1 shows a very limited number of possible disruption scenarios. These scenarios considering the onset of the flood, its intensity, and the interval of the flood (start-end period of the flood) could be different. Table 1 in case of flood, considers the possible disturbances from the beginning of the flood to its end on the same day.

Table 1: Possible Disruption Scenarios (DS) for the Gesvres flood on the Nantes ring road.

| DS | Description | Onset | Magnitude |
|-----|----------------------------|----------|-----------|
| DS1 | Partial flood at peak hour | 08:30 am | 207 cm |
| DS2 | Partial flood at peak hour | 08:30 am | 215 cm |
| DS3 | Total flood at normal hour | 12:00 pm | 240 cm |
| DS4 | Total flood at peak hour | 08:30 am | 240 cm |

5. Experiment and results

The main experiment is centered on the crisis-affected performance of the Nantes ring road. The heavy traffic jam of the ring road due to the Gesvres flood in its northeast part is considered a crisis which is the physical force in the POD framework. In the perspective of the physics-based crisis framework, deviations from the inertia trajectory (i.e. the most probable scenario) are considered as perturbation forces.

According to the POD framework, the first and foremost trajectory is the inertia trajectory which is the reference trajectory to study different possible scenarios. The flow of the vehicles, the capacity of the ring road (i.e. the segments’ capacities), and the limit speed of the ring road are considered to track the inertia trajectory of the ring road. The considered flow for the simulation is for February 5th of 2020 (Wednesday, a typical working day in France).

The result related to the inertia trajectory is for February 5th, 2020. The values for the ring road capacity calculated by the OSM server through AnyLogic© software and the triangular distribution for the limit speed in section 4.3. is considered. The simulation results for the “Inertia” trajectory is shown with magenta color in Fig. 9.

Three disruption scenarios are investigated for the Nantes ring road in terms of flood parameters. Scenarios are related to the onset time and magnitude of the flood at Gesvres river (Table 1). But they could be distinguished scenarios only related to the onset or only related to the magnitude.

The results for the considered scenarios (Table 1) are shown in Fig. 9. The results are for the following interval on 5th of February 2020: (00:00:00-23:59:59). The results for the inertia indicate the high flow from south to north in the outer ring in comparison to the inner

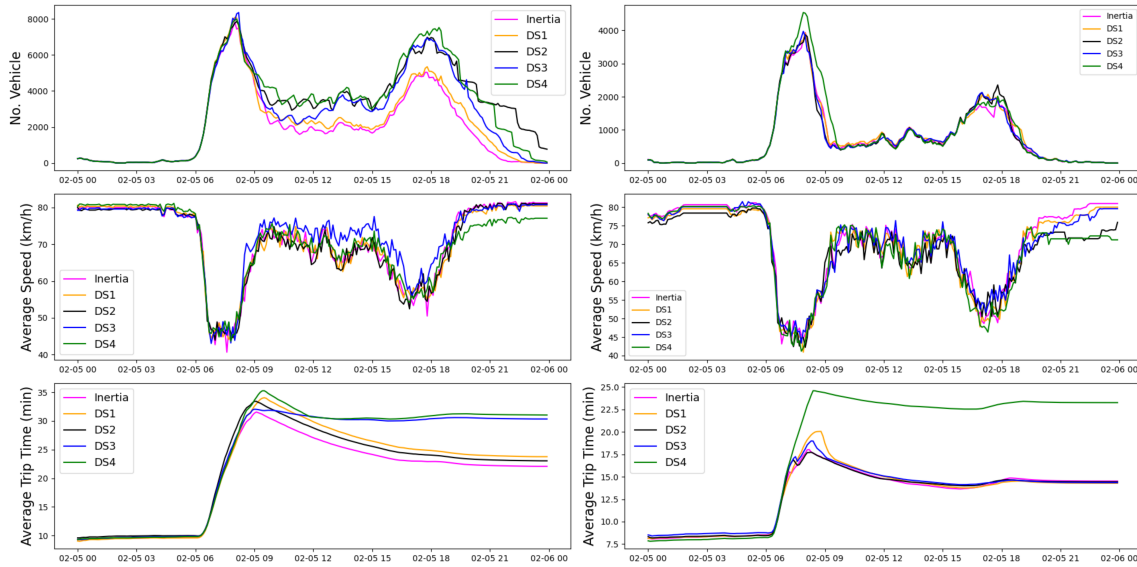

Figure 9: The simulation results for the Nantes ring road and its possible crises.

ring due to the high number of jobs located in the north on the Nantes city. The average speed for the inertia is close to the minimum of the triangular distribution for the limit speed which means the two-line roadway of the Nantes ring road is not quite enough for the vehicle's flow on a normal day. The flow of vehicles on the outer roadway is definitely impacted by DS2, DS3, and DS4. These results show the importance of the onset and magnitude of the flood on the ring road performance. The selected distance between interchanges (37, 44) is about 12.5 km. Considering the limit speed for the ring road, this distance ideally should take 8-9 minutes to travel. The Average Trip Time in "Inertia", "DS3", and "DS4", highlights the following conclusions respectively: (1) lack of road lines for the most probable vehicle flow, (2) the high impact of the Gesvres flood in the outer ring of the ring road and the low capacity of the alternative routes chosen to control the traffic, and (3) besides (1) and (2), the alternative routes (S5 and S6) have a very low capacity to handle the traffic caused by the river flood in the inner roadway.

The performance space gives an overview of the KPIs to the decision-maker while it would be more helpful to have a comparative image of the Nantes ring road traffic-oriented performance. To reach this objective, the KPIs should be examined on the same scale in the performance space. The performance spaces in Fig. 10 are presented for the following KPIs for the inner and outer roadway of the Nantes ring road in two different performance spaces and their comparisons with

non-flooding day (inertia trajectory): (i) Vehicle flow, (ii) Average speed on the roadway, and (iii) Average Trip Time between the two critical interchanges on the ring road.

6. Conclusion and perspectives

This article presented the application of the Physics Of Decision (POD) approach to the crisis situations. The empirical experimentation reported in this paper assesses and quantifies the impact of disruptions on a sensitive highway to heavy traffic jam due to blockage in its specific part. This evaluation is essentially based on an agent-based simulation model, fed on the one hand by vehicle flow forecasts and the structural features of the road and on the other hand by the description of the consequences of disruptions on the system's parameters. The obtained results mainly concern the visualization of performance trajectories and the deviations generated by the anticipated disturbances. The dynamic simulation of the water level in the flooded part of the ring road and connecting it to the current simulation could be the next step for the presented work.

One important takeaway from the presented work in this article concerns the use of forecasts: The next step is to show how real-time data could be used directly to benefit from the presented contributions and provide a live management dashboard to control the traffic jam on a road exposed to blockage. The decision-makers could then visualize or monitor the performance of the

Performance Space of Outer roadway

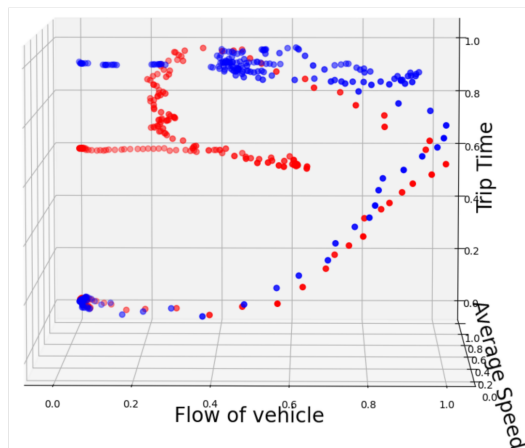

Performance Space of Inner roadway

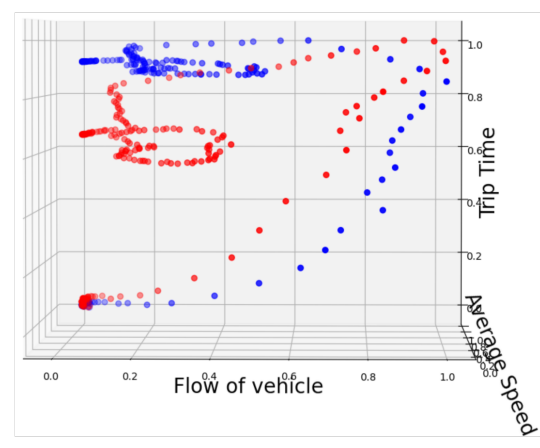

Figure 10: Scaled Inertia trajectories (red trajectories) for outer and inner roadway vs Scaled deviated trajectories (blue trajectories) for the Nantes ring road exposed to Gesvres river.

system live and anticipate the impact of current or future disruption to support their decision-making process.

References

- [1] Wikipedia, “Boulevard périphérique de nantes.” https://fr.wikipedia.org/wiki/Boulevard_p%C3%A9riph%C3%A9rique_de_Nantes, Jun 2021.
- [2] D. i. d. r. Ouest, “Interdepartmental directorate of west roads.” <http://www.dir.ouest.developpement-durable.gouv.fr/>, Jun 2021.
- [3] D. P. d. l. Loire, “Regional directorate for the environment, planning and housing, rn844 périphérique nantais – enjeux et projets.” <http://www.pays-de-la-loire.developpement-durable.gouv.fr/>, Sep 2018.
- [4] Anonym, “The northern ring road again cut by the gesvres flood, the roadway is flooded between the porte de la beaujoire and the porte de la chapelle,” Mar 2020.
- [5] J. KERISEL and H. GONIN, “The crossing the marais de gesvres by the north rocade of the city of nantes,” *REV GEN ROUTES AERODR*, no. 543, 1978.
- [6] G. Macdonald and K. Macdonald, “Safeguarding: A case for intelligent risk management,” *British Journal of Social Work*, vol. 40, no. 4, pp. 1174–1191, 2010.
- [7] F. Benaben, B. Montreuil, L. Faugere, M. Luras, J. Gou, and W. Mu, “A physics-based theory to navigate across risks and opportunities in the performance space: application to crisis management,” in *Proceedings of the 53rd Hawaii International Conference on System Sciences*, 2020.
- [8] N. Moradkhani, L. Faugère, J. Jeany, M. Luras, B. Montreuil, and F. Benaben, “A physics-based enterprise modeling approach for risks and opportunities management,” in *IFIP Working Conference on The Practice of Enterprise Modeling*, pp. 339–348, Springer, 2020.
- [9] F. Benaben, L. Faugere, B. Montreuil, M. Luras, N. Moradkhani, T. Cerabona, J. Gou, and W. Mu, “Instability is the norm! a physics-based theory to navigate among risks and opportunities,” *Enterprise Information Systems*, pp. 1–28, 2021.
- [10] J. Urbach, “Point noir du périph nantais, la porte de gesvres bientôt transformée,” Oct 2020.
- [11] “Jonelière station for the gesvres water level.”
- [12] Anonym, “Traffic difficulties on the nantes ring road, which is partly flooded — tellerreport.com.”
- [13] N.-S. Lee, S. Hirschmeier, S. Müller, and L. J. Luz, “Enablers in crisis information management: a literature review,” in *Proceedings of the 50th Hawaii International Conference on System Sciences*, 2017.
- [14] J. Schanze, “Flood risk management—a basic framework,” in *Flood risk management: Hazards, vulnerability and mitigation measures*, pp. 1–20, Springer, 2006.
- [15] V. Jain, A. Sharma, and L. Subramanian, “Road traffic congestion in the developing world,” in *Proceedings of the 2nd ACM Symposium on Computing for Development*, pp. 1–10, 2012.
- [16] E. Kiesling, M. Günther, C. Stummer, and L. M. Wakolbinger, “Agent-based simulation of innovation diffusion: a review,” *Central European Journal of Operations Research*, vol. 20, no. 2, pp. 183–230, 2012.
- [17] E. B. Lieberman, “Brief history of traffic simulation,” *Traffic and Transportation Simulation*, vol. 17, 2014.
- [18] R. Actu, “Inondations : une partie du périphérique de nantes fermée, la situation ne s’améliore pas,” Mar 2020.
- [19] H. Echab, N. Lakouari, H. Ez-Zahraouy, and A. Benyoussef, “Phase diagram of a single lane roundabout,” *Physics Letters A*, vol. 380, no. 9, pp. 992–997, 2016.

- [20] “Anylogic simulation software, process modeling library.”
- [21] “Two-second driving rule.” https://en.wikipedia.org/wiki/Two-second_rule, Jan 2021.
- [22] D. Uribe, “Multi-agent approach to the two-second driving rule,” *Journal of Computers*, p. 168–175, 2018.
- [23] Magnus.sellen, “Average car length [list of car lengths by car type].” <https://mechanicbase.com/cars/average-car-length/>, Feb 2021.

3.2.3 Agent-based Simulation

The POD framework in this case study has been installed by simulating the polling place in the McCamish Pavilion, located on the Georgia Tech campus in Atlanta, for the 2020 US presidential election. This simulation has been dedicated to examining the overwhelming flow of voters and equipment failure as events (named “Disruption Scenarios” in the article). The Description Space has been constructed on the dimensions of the “polling place” (number of receptors, officers, equipment, etc.) and “voters” (their flow in probable, optimistic, and conservative levels) as the system (Attributes) where the “service times of equipment” (e.g., ballot devices, scanners, etc.) serves as the contextual element (Characteristics). The Performance Space has constructed on some KPIs, for example, the number of voters in the place, number of waiting voters, number of completed votes, etc., to examine the impact of several forces. The “inflicted” and “managed” forces are generated respectively from both the voters and building (e.g., flow and speed of the voters, number of equipment and service providers, respectively) and parameters to accelerate the voting process (e.g., injecting equipment and employing more service providers).

Physics of Decision for Polling Place Management: A Case Study from the 2020 USA Presidential Election

Keywords. Performance, Decision Support, Simulation, Artificial Intelligence, Risk Management, Election, Pandemics, Information System

Authors. Nafe Moradkhani, Frederick Benaben, Benoit Montreuil, Ali Vatankhah Barenji, and Dima Nazzal

Publisher. International Journal of Industrial and Manufacturing Engineering

Date of Publication. 15 June 2021

Reference. Moradkhani et al., 2021

Online Access. [Physics of Decision for Polling Place Management: A Case Study from the 2020 USA Presidential Election](#)

Physics of decision for polling place management: A case study from the 2020 USA presidential election

Nafe Moradkhani, Frederick Benaben, Benoit Montreuil, Ali Vatankhah Barenji, and Dima Nazzal

Abstract—In the context of the global pandemic, the practical management of the 2020 presidential election in the USA was a strong concern. To anticipate and prepare for this election accurately, one of the main challenges was to confront (i) forecasts of voter turnout, (ii) capacities of the facilities and, (iii) potential configuration options of resources. The approach chosen to conduct this anticipative study consists of collecting data about forecasts and using simulation models to work simultaneously on resource allocation and facility configuration of polling places in Fulton County, Georgia’s largest county. A polling place is a dedicated facility, where voters cast their ballots in elections using different devices. This article presents the results of the simulations of such places facing pre-identified potential risks. These results are oriented towards the efficiency of these places according to different criteria (health, trust, comfort). Then a dynamic framework is introduced to describe risks as physical forces perturbing the efficiency of the observed system. Finally, the main benefits and contributions resulting from this simulation campaign are presented.

Keywords—Performance, Decision Support, Simulation, Artificial Intelligence, Risk Management, Election, Pandemics, Information System.

I. INTRODUCTION

POLLING places, where electors cast their votes in person, have long been recognized to be core to the efficiency, convenience, and integrity of election systems all across the world. They are so ubiquitous that they have become taken for granted. Yet they are complex facilities subject to intense scrutiny, huge uncertainty, and severe disruptions. This paper focuses on intelligent risk management for these polling places to support their design, sizing, and operation for high performance from their multiple stakeholders’ perspectives under such uncertainty and disruption.

Intelligent systems with the ability to detect, predict, and make decisions are very useful in the field of management science [1]. In the risk management area, due to dealing with unforeseen events, the necessity of such systems is undeniable. Intelligent Risk Management (IRM) systems are able to identify risks as early as possible and implement appropriate strategies to manage them.

This paper leverages the Physics-of-Decision (POD) intelligent risk management framework introduced in [4]. This

original framework considers that **risks can be seen as physical forces applied to the system which may push or pull it in its performance space by varying the system’s KPIs (Key Performance Indicators) [2].** The framework guides decision-makers in assessing the risks that may happen to a system. Fig. 1 describes the framework, including its components and the relationships between them.

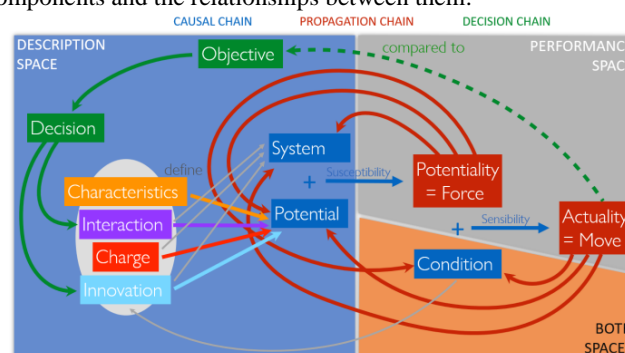

Fig. 1 Intelligent Risk Management framework

In the POD framework, the considered system is facing some potentials. These potentials include (i) Characteristics, i.e. the environmental potentials of the system including contextual changes such as weather or flows of voters, (ii) Interactions, i.e. flows of goods or information between partners, (iii) Charges, i.e. mandatory system costs including allocated resources, time, running costs, etc., and (iv) Innovations, i.e. some initiatives dedicated to modify or improve the structure or the behavior of the system. The susceptibility of the system to the surrounding potential generates some potentialities (i.e. risks or opportunities considered as physical forces). These potentialities might be activated by conditions which trigger the forces and change the system’s performance: the potentialities become actualities and change the performance of the system. By comparing actualities to the actual objectives of the system, managers take some decisions to minimize the difference between the current state of the system and its objectives. A detailed definition of the components and their relationships is given in [3, 4].

Nafe. Moradkhani. Centre Génie Industriel, IMT Mines Albi, Albi, France (e-mail: nafe.moradkhani@mines-albi.fr).

Frederick. Benaben. Centre Génie Industriel, IMT Mines Albi, Albi, France, Physical Internet Center, ISyE School, Georgia Tech, Atlanta, USA (e-mail: frederick.benaben@mines-albi.fr).

Benoit. Montreuil. Physical Internet Center, ISyE School, Georgia Tech, Atlanta, USA (e-mail: benoit.montreuil@isye.gatech.edu).

Ali. Vatankhah Barenji. Physical Internet Center, ISyE School, Georgia Tech, Atlanta, USA (e-mail: abarengi@gatech.edu).

Dima. Nazzal. ISyE School, Georgia Tech, Atlanta, USA (e-mail: dima.nazza@gatech.edu).

The main objective of this article is to introduce a data-driven simulation-model and POD based intelligent risk management system for polling places and to investigate its value using a case study from the largest county in the U.S.A., that is Fulton County in Georgia, in the 2020 presidential election.

The remainder of this paper is organized as follows: Section II highlights related existing research works and scientific contributions. Section III describes the Intelligent Risk Management framework and its principles. Section IV deals with the implementation through the simulation of the case study. Section V examines the results of the simulation-based investigation for the polling place in the McCamish Pavilion, in the Georgia Tech campus in Atlanta. Finally, section VI concludes this research work and provides avenues for further research.

II. BACKGROUND AND RELATED WORKS

The events of 2020 set the stage for one of the most important presidential elections in the history of the United States. In addition to the polarized politics and security concerns, high likelihood of voter participation and public health concerns due to the COVID-19 pandemic made the 2020 presidential elections more important, and yet more complex, than ever. The June 2020 primary elections in Georgia gave a preview of how poorly the election system can perform under these complexities if planning and design were not adjusted to reflect the increased risks. At some polling locations, voters endured 5-hour wait in queue [5]. Judges ordered 20 counties to extend their operating hours to accommodate the higher turnout and the slower processes [6]. Clearly, Georgia was not prepared for a pandemic election with the potential for historic voter turnout. Andrew et al. [7] studied political shifts due to COVID-19 in the 2020 election. Robert et al. [8] show the implications of the 2020 election for the US health policy. This paper deals with the performance of polling places under uncertainty and disruption risks, and the management of the potential forces (Risks and Opportunities) to evaluate the performance of the polling places.

Instability is mainly related to mainstream requirements such as security, privacy, compliance, and capability [9]. Managing risk has always been a challenge in most areas of management. The variety of areas and perspectives have led to different approaches to risk management: Cost-Benefit Analysis and Risk-Benefit Analysis (CBA and RBA) [10], Hertz-type simulation, Hazard and Operational study, Failure Mode and Effects Analysis (FMEA) [9], Fault Tree Analysis, and Event Tree Analysis (FTA and ETA) [11], Monte Carlo and Expert Systems [12, 13]. The new Physics of Decision (POD)

framework leveraged in this paper for application to polling places, inspired by the physical laws, is an innovative approach to cover a large spectrum of risk management techniques and opens the doors to apply the intelligent tools to deal with the complexity of relationships between risk factors and big data [14].

Simulation is an increasingly significant methodological approach to theory development in the literature focused on strategy and organizations [15]. The systematic combination of simulation methods with empirical research is a powerful tool in risk management research. The design of simulation models is strongly linked to the type of system under study. Generally, four important distinctions between types of simulation techniques can be made. These distinguished techniques are (i) Deterministic versus Stochastic, (ii) Static versus Dynamic (iii) Continuous versus Event-Driven, and (iv) Quantitative versus Qualitative [16]. In recent decades, agent-based simulation models have increasingly been utilized, to capitalize on their capability to reproduce the interactions between members of an organization or between different organizations in an artificial environment where “agents” make decisions and communicate one with another [17].

In this paper, quantitative agent-based and event-driven dynamic and stochastic simulation modeling of polling places is used as it best fits the complexity, context and essence of polling places with their various interacting objects (building components, voting machines, scanners, etc.), and agents (voters, volunteers, staff, etc.). Such simulation modeling is embedded into the physics-based risk management framework so as to simulate the voting process in the polling places during election days and to assess and mitigate the potential risks related to the voter flow, equipment failures, and long waiting time for the voters, as notably influenced by the polling place configuration in terms of resources and layout.

III. PHYSICS-BASED INTELLIGENT RISK MANAGEMENT

A. General Perspective of IRM framework

A system can be destabilized by unforeseen changes. These changes mainly refer to the variation of system parameters and consequently, deviation from the system’s expected trajectory. The expected trajectory depends on the considered case, but this is often the targeted, planned or most probable one. Any deviation from that trajectory is considered a risk for the system. System attributes define the different situations of the system. Identifying these attributes, their relationship, and their level of security is required to design a smart system. The **Physics Of Decision** (POD) framework introduced in section I defines two spaces in which a system can be positioned [12].

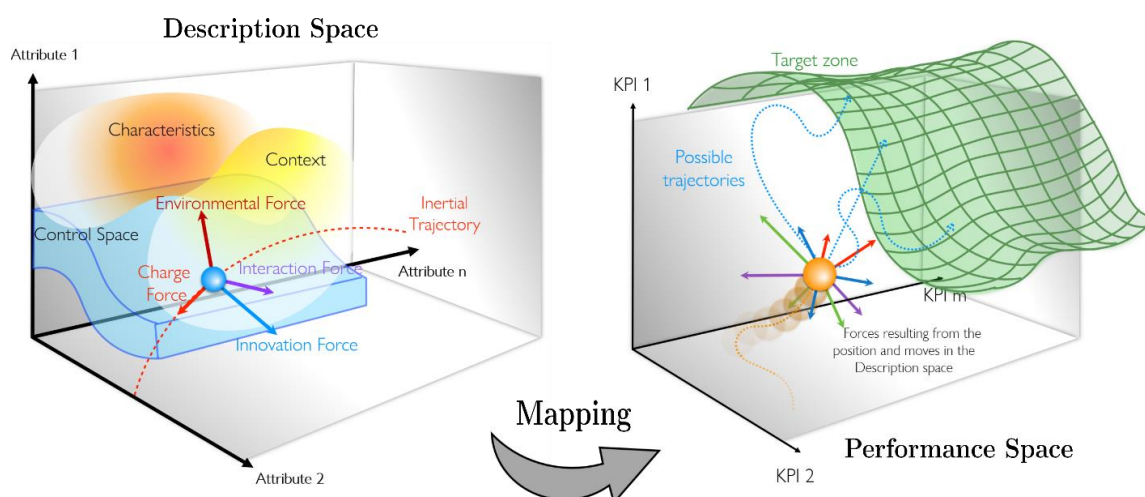

Fig. 2 POD IRM framework spaces

The **Performance Space**, depicted on the right side of Fig. 2, describes the performance of the system in a given state by locating it relative to KPIs, with risks and opportunities being shown as force vectors in that referential. The **Description Space**, depicted on the left side of Fig. 2, represents the system's states by locating it relative to axes defined according to its significant attributes. Some attributes are changed at certain times by decision-makers to control the deviation of trajectories. The degree of changes for each attribute is determined by system constraints in the **Control Space**, which is basically the “easy to access” subpart of the Description Space.

The relationship between the two spaces is determined by a function of Attribute(s) to KPI(s), which maps *Description Space* to *Performance Space*. This function can be straightforward or complex [3, 4]. In cases where equations between the two spaces can be determined, it would be possible to analyze the data and deviations from the normal trajectory caused by the forces. Otherwise, this function should be determined differently, notably through simulation experiments as in this paper, so as to generate the data from which the unknown relationships between attributes and KPIs can be inferred.

B. Problem statement

Polling places can be conceptualized as complex discrete event logistics systems. Their complexity stems from the fact that they are constrained in resources, fraught with variability and uncertainty in voter arrival pattern and resource reliability, and subject to high public scrutiny. Performance is assessed along several criteria such as efficiency, security, voter experience, accessibility, etc. The design and operation of polling places are critical when faced with such multi-criteria performance expectations in modern democracies, and get increasingly more critical when adding such criteria as voting safety in the midst of the COVID-19 pandemic, and voting process trustability, as challenged in 2020 USA Presidential Election.

This article mainly focuses on assessing the capability of polling places to perform in high-risk contexts, as impacted by resource constraints, equipment breakdowns, and COVID-19 safety considerations. The case studied in this research encompasses polling places within Fulton county in the state of Georgia, the largest county in the USA, in the context of the 2020 Presidential Election. In these polling places, voters make their selection on the ballots using Ballot Marking Devices (BMDs), then cast their ballot by scanning it. This article examines one specific polling place among those studied, the McCamish Pavilion which is an indoor arena located on the campus of the Georgia Institute of Technology in Atlanta. The major focus of the case study is ascertaining the bottlenecks and rupture points in the polling place system where issues may emerge from the perspective of the POD-based intelligent risk management framework.

IV. METHODOLOGY

A. McCamish Pavilion layout and Voter flow forecast

The results presented in this article are connected to other contributions from collaborators on this global project: McCamish polling place layout has been designed and optimized by a Facility Capacity and Layout Design Team to decide on the number and location of equipment (BMDs, scanners), helpdesks, registration check-in stations, observers, etc. This physical layout of the place has been defined by allocating the space to the equipment while maintaining social distancing for voters. Similarly, the voter flow between 7:00 and 21:00 each day from early voting to the final day voting has been estimated by the Scenario Forecasting Team based on the historical data and voter surveys conducted throughout 2020. In the article, the focus is on the most probable and high turnout scenarios that were studied. Fig. 3 shows the layout and voter flows for the McCamish polling place. These results are considered as input for the current work.

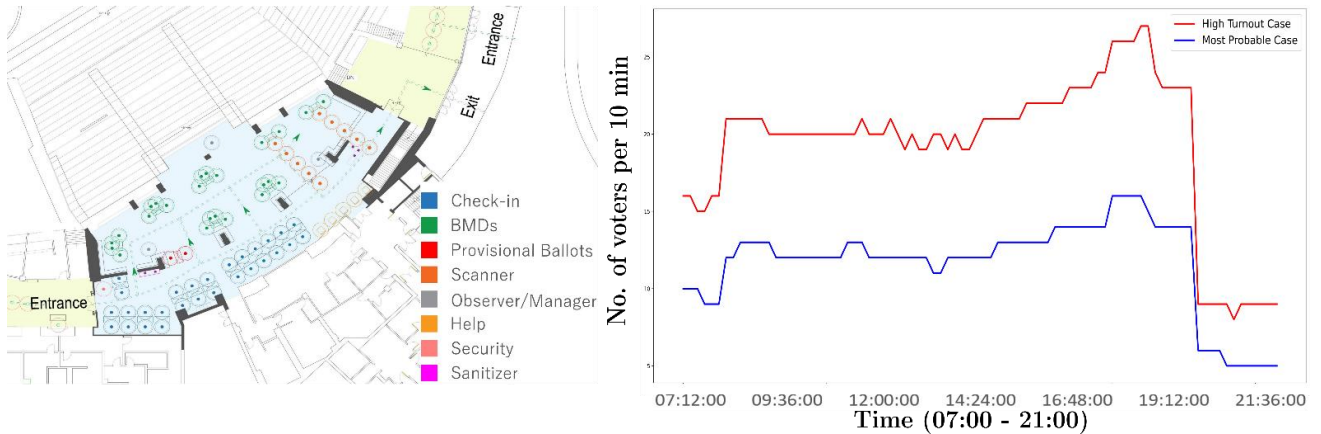

Fig. 3 McCamish Pavilion polling place layout and Voter flow

B. Voting Process

The voting process is modeled to begin with the entry of voters from the entrance on the site of the McCamish polling place. Once in the building, voters move around the McCamish basketball court and then enter the polling place. The check-in process is to validate the eligibility of the voters and to register them with poll pads. A voter needing guidance on the voting process is referred to the helpdesks (estimated 3% of the total voters). Otherwise, the next step is for the voter to mark the

ballot at one of several available BMDs. These BMDs are located in a specific part of the polling place (each collection of 2 or 4 BMDs is considered as one BMD carrier). The final step is for the voter to scan the ballots using a scanner. Each voter's choice is marked on one or more ballots that pass through the scanner, which creates an electronic image of each ballot, interprets it, and tabulates the votes. Fig. 4 shows the schema of the voting process with the Pedestrian library of the AnyLogic© simulation software used in this study.

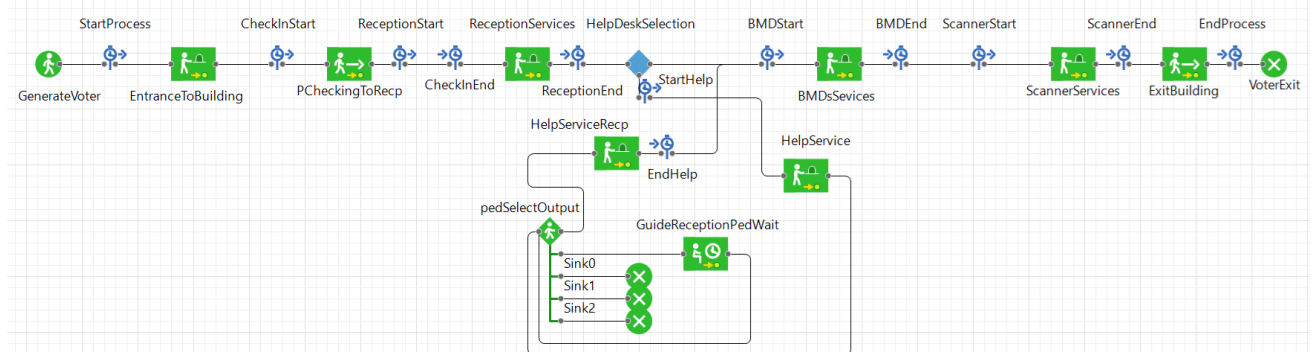

Fig. 4 Voting Process modelled for the McCamish polling place

AnyLogic© Pedestrian Library is dedicated to simulating pedestrian flows in a "physical" environment. The Pedestrian Library allows the creation of flexible models, collects basic and advanced statistics, and effectively visualizes the modeled process to validate and present it. In models created with the Pedestrian Library, pedestrians move in continuous space, reacting to different kinds of obstacles (walls, closed doors, etc.) and other pedestrians.

Besides, this library makes it possible to model voter's behavior (reflecting the real speed of their walking according to their age), physical distance between voters as a precaution against the virus transmission (and present density of voters on a heatmap), cameras at different locations on the layout (for the manager of the place, security, and observers to track the voters and check the density of voters on the place in 2D and 3D). Fig. 5 present these functionalities with the Pedestrian Library.

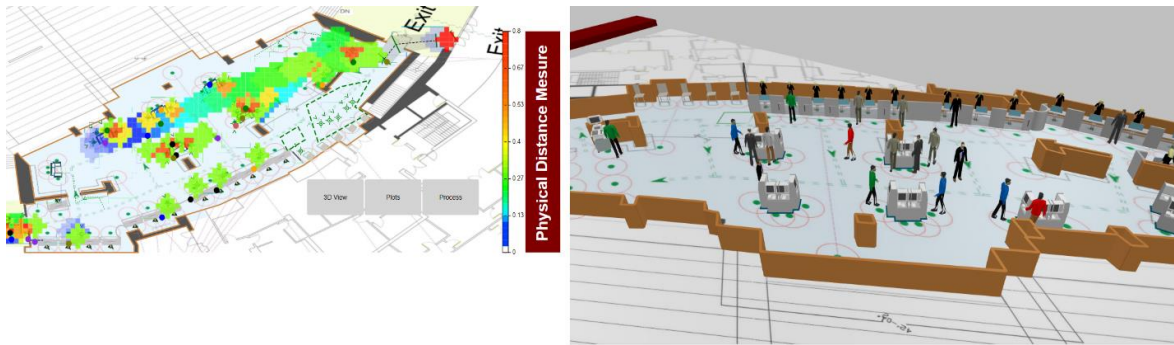

Fig. 5 2D and 3D outputs of McCamish layout for heatmap and cameras

C. Data sources and Scenarios

The simulation utilized various parameters as attributes in the Description Space conceived by the Scenario Forecasting Team. That team has also defined some Disruption Scenarios. The main potential disruptions are related to the voters (agents), and the services (number of operational BMDs for instance). The goal is then to evaluate the probable forces of the modeled risks and their impact on the system trajectory in the Performance Space to reflect a realistic simulation of the election day voting process.

The simulation uses the following mobility and physiology related variables for every single agent. Initial speed (Uniform (0.3, 0.7) m/s), Comfortable speed (Uniform (0.5, 1) m/s), the diameter of agent (Uniform (0.4, 0.5) m), and the physical area around an agent ($1 m^2$).

Services in pedestrian flow models define a group of similar physical service objects (turnstiles, ticket vending machines, security checkpoints, check-in counters, etc.). There are two types of space markup shapes to draw services in the pedestrian model: (i) Service with Lines and (ii) Service with Area. Service with Lines is used for defining service(s) with a queue(s) where pedestrians wait until the service becomes available in a queue line. Service with Area has the same properties as Service with Line but the pedestrians wait chaotically in a specific area instead of queue. The simulation uses the Service with Line to put the voters in queues to respect the physical distance between them. The queue choice policy for all services is the closest queue (the queue that is closest to the service).

The number of resources for the McCamish layout is suggested by the Facility Layout Design Team. In some scenarios, the results show deficiency in resource allocation, which is a force (risk) on the KPIs. In other scenarios, the results show slack in capacity utilization, which is an opportunity to share the resources with other polling places. For such services, the simulation assumed Recovery Delay time (required time for the voters to use them again). Table I summarizes the service parameters reflected in the simulation.

TABLE I
ATTRIBUTES OF SERVICES FOR SIMULATION CAMPAIGN

| Services | | | |
|-------------------|----|--|--------------------|
| Type | No | Service Time | Recovery Delay |
| Primary Checking | 1 | Uniform (10,20) sec | 0 |
| Check-in | 5 | Optimistic: Normal (2, 0.5 ²) min Probable: Normal (3.5, 0.75 ²) min Conservative: Normal (5, 1 ²) min | Uniform (5,15) sec |
| BMDs ¹ | 15 | Optimistic: Normal (7, 1.75 ²) min Probable: Normal (8, 2 ²) min Conservative: Normal (9, 2.25 ²) min | Uniform (0,5) sec |
| Scanners | 2 | Uniform (20, 40) sec | Uniform (0,5) sec |

The attributes' values can vary in some specific ranges because of the degrees of liberty for the polling place considering, space, cost. These variations are considered in the control space of Description Space (Fig. 2). Besides, the voter turnout can vary (Fig.3) and impacts the KPIs. The voter turnout is out of control and is considered as "Characteristic". The voter turnout's impact on KPIs is considered as "Environmental Force" in Fig.2.

According to the objectives of the polling place, these variations impact the polling place's performance. The scenario team considered different possible scenarios to implement in the simulation and study their impact on the system's trajectories in the performance space. Table II provides illustrative distinct possible disruption scenarios for the election day at the McCamish polling place.

TABLE II
SIMULATION DISRUPTION SCENARIOS

| Disruption Scenarios | |
|----------------------|---|
| Type | Description |
| DS1 | 1 BMD carrier outage during peak hours |
| DS2 | 1 BMD machine outage during peak hour |
| DS3 | Three BMD machines outages at varying hours |
| DS4 | Entire IT system failure during peak hour |

¹ The considered BMD carriers include 2 and 4 BMDs

V. EXPERIMENTS AND RESULTS

The main experiments are centered on the risk-affected performance of the McCamish polling place in different aspects such as equipment capacity requirements, health, trust, and comfort. In the perspective of the IRM framework, deviations from the inertia trajectory (*i.e.* the most probable scenario) are considered as forces. Attributes of the voters (agents), the number of services and their significant times (system time and recovery delay) are considered in the Description Space. There are different KPIs to provide to the decision-makers of the McCamish, such as: (i) Number of active voters, (ii) Number of waiting voters, (iii) Number of completed votes, (iv) Total voting time and (v) Utilization of each service (Check-in, BMDs, and scanners). These KPIs are considered as dimensions of the Performance space.

According to the POD framework, the first and foremost trajectory is the inertia trajectory which is the reference trajectory to study different possible scenarios. The voter flows and different service time levels are considered to track the

inertia trajectory of the place. As mentioned earlier, two scenarios are considered for voter flow: most probable and high turnout. Three levels for the service time are: Optimistic, Probable, and Conservative. Combining voter flow scenarios and service time scenarios leads to six possible inertia trajectories (See Fig. 6).

According to the Description space and control subspace, some attributes are “Charge” for the polling place. “Charge” refers to uncontrolled attributes that impact the performance: for example, attributes of voters (speed, diameter, social distance) and services time (system time and recovery delay time). In general, all the running costs are Charge as well. However, some attributes like the number of BMDs, number of scanners, and number of polling pads (Check-in) result from managers’ decision and vary from user-specified minimum to maximum in the control space. In this section, simulation has been run four times based on the values suggested by the forecast team and the average results are as follows.

A. Inertia Trajectory (Baseline)

The results related to the inertia trajectory are for *Most Probable* and *High Voter Turnout* with three different levels for service times. Depicted in Table III, the results show average performance on election day.

TABLE III
RESULTS FOR MOST PROBABLE AND HIGH TURNOUT VOTER FLOW AND PROBABLE / OPTIMISTIC / CONSERVATIVE LEVELS FOR THE SERVICE TIMES

| Attribute | Probable | | Optimistic | | Conservative | |
|----------------------|---------------|--------------|---------------|--------------|---------------|--------------|
| Check-In [n] | 5 | | 5 | | 5 | |
| Help Desk [n] | 5 | | 5 | | 5 | |
| BMD [n] | 15 | | 15 | | 15 | |
| Scanner [n] | 2 | | 2 | | 2 | |
| KPI | Most Probable | High Turnout | Most Probable | High Turnout | Most Probable | High Turnout |
| Voters in Place [n] | 8.92 | 14.28 | 7.82 | 12.78 | 9.88 | 12.34 |
| Waiting Voters [n] | 0.4 | 1.2 | 0.34 | 1.01 | 0.43 | 0.72 |
| Completed Votes [n] | 972 | 1607 | 974 | 1607 | 970 | 1186 |
| Voting Time [min] | 18.88 | 26.05 | 16.99 | 18.2 | 22.39 | 79.47 |
| Check-In Utilization | 22% | 71% | 10% | 28% | 47% | 98% |
| BMD Utilization | 46% | 68% | 39% | 59% | 52% | 64% |
| Scanner Utilization | 31% | 58% | 33% | 60% | 31% | 39% |

The results of the Most Probable voter flow columns show that the place is definitely receptive to the expected values for the McCamish. The service utilization levels are relatively low (in the worst case, Check-In: 47% BMD: 52%, Scanner: 33%). Conservative level of Check-In utilization compared to the probable and optimistic levels negatively increased (10%, 22%, 47%) but still enough to serve the voters. Most of the voters have been served. The worst case is the conservative level for which 970 out of 978 voters (total voters) have voted (99%).

The results of the High turnout level clearly are different from Most Probable level. This conclusion is based on Check-In utilizations in probable and conservative levels (71%, 98%), the Voting time (26 min, 79 min), and the voting rate (e.g. 73% in conservative level, 1186 out of 1618 voters (total voters) have been served).

However, if the service time is optimistic, the results show that McCamish is able to serve the high turnout voter flow (Voting time: 18.2 min, Check-In utilization: 28%, Completed vote: 99%). This result absolutely highlights the force of the efficiency of the BMDs, Scanner as well as the speed of the voter in the voting process.

As a conclusion, if McCamish place could have enough space to receive more than 15 people (on average), considering the social distance between voters and also officers, receptors, etc., McCamish would need more Check-In resources. This result could be deduced from the utilization of the BMDs and scanners (at max 68%).

Fig. 6 shows the inertia trajectories for most probable (First row) and high turnout (Second row) voter flow for the following KPIs: (i) Number of voters in the place (First column), (ii) Number of waiting voters (Second column), and

(iii) Number of completed votes (Third column). More probable values are highlighted in gray parts.

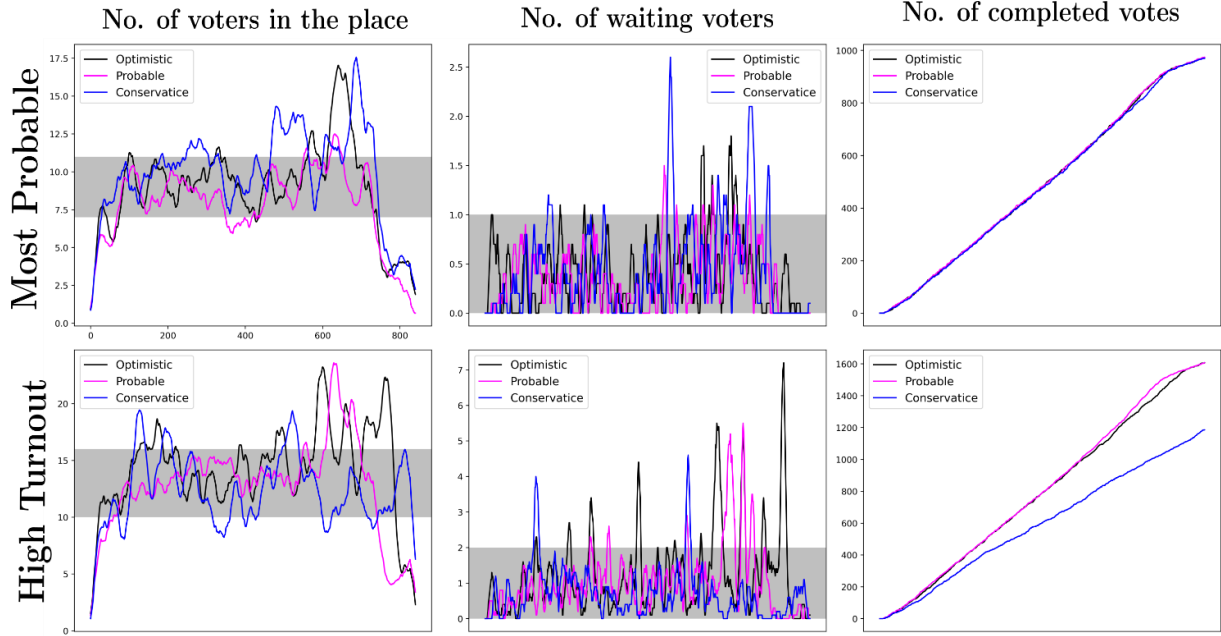

Fig. 6 Inertia Trajectories for McCamish layout

B. Forces of Disruption scenarios

Four Disruption Scenarios are here investigated for the McCamish place (See Table. II). Scenarios DS1, DS2, and DS3 are related to the BMDs break down (scenario DS4 is related to

massive IT failure, see below). According to the results in Table. III, the BMDs utilizations do not affect too much the KPIs. The results for the worst case (DS1: 1 BMD carrier outage during peak hours) are provided in Table IV.

TABLE IV
DS1: 1 BMD CARRIER (4 BMD MACHINES) OUTAGE DURING PEAK HOURS (AVG, 4PM – 5PM AND 5PM-6PM)

| Attribute | Probable | | Optimistic | | Conservative | |
|----------------------|---------------|--------------|---------------|--------------|---------------|--------------|
| Check-In [n] | 5 | | 5 | | 5 | |
| Help Desk [n] | 5 | | 5 | | 5 | |
| BMD [n] | 15 | | 15 | | 15 | |
| Scanner [n] | 2 | | 2 | | 2 | |
| KPI | Most Probable | High Turnout | Most Probable | High Turnout | Most Probable | High Turnout |
| Voters in Place [n] | 9.13 | 16.01 | 7.48 | 13.77 | 10.6 | 14.05 |
| Waiting Voters [n] | 0.53 | 1.93 | 0.42 | 1.4 | 0.79 | 1.14 |
| Completed Votes [n] | 971 | 1606 | 972 | 1607 | 970 | 1284 |
| Voting Time [min] | 19.06 | 24.78 | 16.62 | 18.63 | 22.89 | 81.81 |
| Check-In Utilization | 22% | 70% | 10% | 25% | 50% | 98% |
| BMD Utilization | 45% | 73% | 37% | 63% | 54% | 69% |
| Scanner Utilization | 32% | 58% | 33% | 58% | 32% | 43% |

The comparison of Table III and Table IV shows that the BMDs failure doesn't change the results too much (we obtained almost the same results). This is an obvious result because the

BMDs serve the voters who passed the Check-In, since the Check-In number is low, consequently, the BMDs utilization is almost the same. The last scenario DS4 is the failure of all the IT systems during peak hours. The results are provided in Table IV.

TABLE IV
DS1: 1 DS4: Entire IT system failure during peak hour (Avg, 4pm – 5pm and 5pm-6pm)

| Attribute | Probable | | Optimistic | | Conservative | |
|----------------------|---------------|--------------|---------------|--------------|---------------|--------------|
| Check-In [n] | 5 | | 5 | | 5 | |
| Help Desk [n] | 5 | | 5 | | 5 | |
| BMD [n] | 15 | | 15 | | 15 | |
| Scanner [n] | 2 | | 2 | | 2 | |
| KPI | Most Probable | High Turnout | Most Probable | High Turnout | Most Probable | High Turnout |
| Voters in Place [n] | 9.01 | 15.95 | 7.93 | 14.33 | 10.3 | 13.31 |
| Waiting Voters [n] | 0.72 | 1.75 | 0.64 | 2.45 | 0.53 | 0.85 |
| Completed Votes [n] | 972 | 1566 | 972 | 1605 | 970 | 1171 |
| Voting Time [min] | 26.28 | 38.78 | 22 | 28.6 | 34.71 | 89.67 |
| Check-In Utilization | 33% | 80% | 20% | 39% | 57% | 98% |
| BMD Utilization | 43% | 74% | 37% | 59% | 53% | 68% |
| Scanner Utilization | 34% | 57% | 33% | 58% | 33% | 40% |

DS4 negatively affects the Voting time and the Utilizations of voting devices. These results are quite intuitive because the entire system shuts down. This means the voters need to spend more time to go through. Besides, the influx of the voters after the failure increases the utilization of the services.

Based on the forces of failures, managers can add more resources to bottlenecks or take out the extra resources to share with other polling places. The IRM framework provides this possibility by presenting the Inertia trajectory and its deviations because of forces at some specific time. The framework can also study the deviated trajectories because of different disruptions (BMDs, poll pads, scanners, etc.) and their impact on the performance trajectory. The simulation results provide an overview of the mapping between two spaces (relationships between Attributes and KPIs) (See Fig.2).

To study the possible trajectories, the simulation, considered disruption scenarios for all services (Check-In, BMDs, and Scanners). The high turnout voter flow with probable level for the services are selected as attributes in the description space. Besides, three KPIs have been chosen for the performance space: (i) Number of voters in the place, (ii) Number of waiting voters and (iii) Voting time. The results in Table I, Table II and Table III showed that BMDs and Scanner utilizations were quite low, so we considered more Check-Ins to study the forces due to these two resources. Besides, in this section, the simulation data is from 3 pm to 8 pm, as the most variations and disruptions are for this interval. The results are provided in Fig. 7.

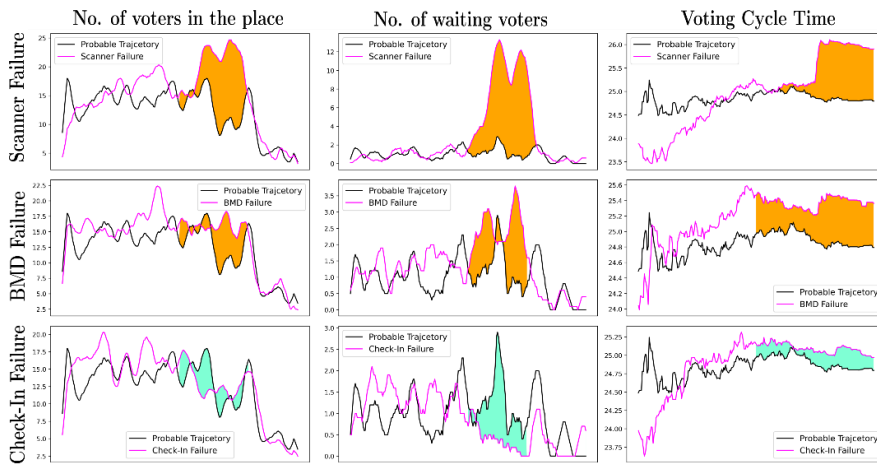

Fig. 7 Inertia trajectories vs Failure trajectories (3-8 pm) for McCamish layout

Note: The plots have been smoothed because of high oscillation and noisy points due to the agent's movement in the place.

The orange parts in Fig. 7 show the forces for BMD and Scanner failure and their impact on the most probable values. The values for the failure trajectories should be negatively more than the Inertia trajectories, while some parts do not follow this rule. The reasons are the impact of the stochastic values (section 3.3.3) for the attributes and the low impact of the failure in these specific parts (First and second rows in Fig. 7). The force of Check-In resources is represented on the third row in Fig. 7. The greater values of Inertia compared to the Check-In failure in some parts indicates that this force does not affect significantly the KPIs and the green parts are the effect of stochastic values for the attributes.

The summary for the presented results for the McCamish layout considering possible disruption scenarios are as follows: (i) McCamish with the suggested values for the number of services (BMDs, Scanners, and Check-In) in the case of most probable voter turnout is sufficient and close to the targets. According to Tables (III, IV, V) the worst performances are: Voting time: 34.71 mins, Completed votes: 99%, BMD utilization: 54%, Check-In utilization: 57% and Scanner utilization: 34%. (ii) In the case of the possibility of more than 16 voters in the McCamish, there is an opportunity to have better performance by injecting more poll pads into the place.

On the other hand, the high voter turnout flow has a huge impact on the KPIs. While the impact of the services' time is not negligible. In the case of the optimistic level, the performance of the McCamish is high, even better than the most probable turnout in some cases. Here are key results: Voting time 29 mins, Completed votes 99%, BMD utilization 63%, Check-In utilization 39%, and Scanner utilization 60%. These interesting results indicate that efficiency of the equipment and adequate knowledge of the voter in the voting process (to keep the services' time on optimistic level), significantly improve the performance of the polling places.

The performance space gives an overview of the KPIs to the decision-maker while it would be more helpful to have a comparative image of the polling place performance. To reach this objective, the KPIs should be examined on the same scale in the performance space. The performance spaces in Fig. 8 are presented for the following KPIs: (i) Number of voters waiting for the scanner, (ii) Number of voters waiting for BMD and (iii) Completed votes, and (v) Voting time (just in the third space). Besides, the disruptions for the performance spaces are as follows: (i) 1 scanner failure at 2 pm (ii) 1 BMD carrier failure at 4 pm, and (i) and (ii) on the same run simultaneously in the third space.

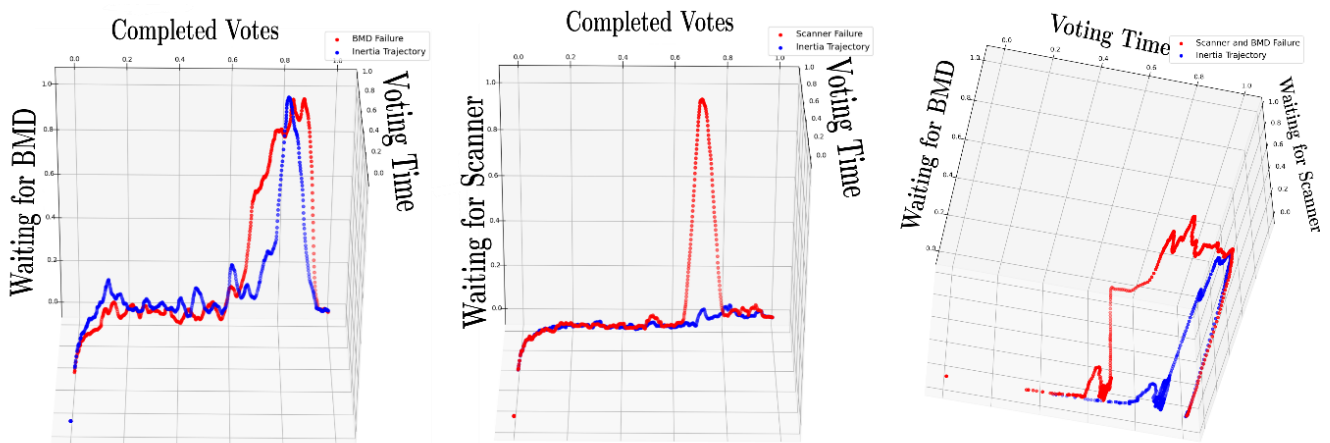

Fig. 8 Scaled Inertia trajectories vs Scaled Failure trajectories for McCamish layout

On the previous Fig. 8, three 3D performance spaces have been presented, each for different events impacting the polling site. The blue curves represent the inertia performance trajectories (*i.e.* without any perturbation) while the red ones represent the performance trajectories impacted by the considered events (from left to right BMD failure, Scanner failure and both devices failure). The scale is also different from one diagram to another. It is interesting to notice that the ratio of BMDs for this precise polling site seems to be over-estimated

as the failure has almost no impact while the scanner failure is clearly critical (difference between first and second diagrams). Besides, even when both devices are facing issues, the waiting time for BMDs is not significantly impacted (with regards to the inertia trajectory). This is a clear warning regarding either the ratio between BMDs and scanners, either the physical arrangement of the polling site. The actual opportunity to see these trajectories and to compare them also with measures that could be taken, and see how it inflict positively the trajectory is one of the benefit of the approach.

VI. CONCLUSIONS AND PERSPECTIVES

The work presented in this article presented the first application of the POD vision to the election system. The empirical experimentation reported in this paper assesses and quantifies the impact of disruptions to a polling location on the KPIs for the election system. This evaluation is essentially based on a pedestrian-level simulation model, fed on the one hand by voter flow forecasts and on the other hand by the description of the consequences of disruptions on the system's variables.

The obtained results mainly concern the visualization of performance trajectories and the deviations generated by the anticipated disturbances. In the studied case, the actual visualization is made possible because the performance is evaluated according to three dimensions, but this performance could be supervised in much higher dimensions, even if it is not easily visualized (which would not penalize the measurement of the deviation of the performance trajectory generated by the events under consideration).

One important takeaway from the work presented in this article concerns the use of forecasts: The very next step is to show how real-time data could be used directly to benefit from the presented contributions and provide a live management dashboard for a voting place. The decision-makers could then visualize or monitor the performance of the system live and anticipate the impact of current or future disruption to support their decision-making process.

Three alternative avenues for further research are hereafter introduced. The first concerns the implementation of simulation campaigns covering a wide range of system parameter values in order to cover more widely the space of possibilities in terms of system variability and associated performance. The objective of these simulation campaigns would be to provide the material likely to discover the event's impact variability and the sensitivity of the system to this event. This could allow the modeling of these impacts in the form of formalized forces. These forces impacting the performance of a polling place could thus be anticipated according to different characteristics of both the sites considered and the events identified.

The second avenue concerns the multi-site (and possibly multi-channel) dimension of the electoral system. In particular, it involves investigating the management of voter flows and resource flows holistically at the county or state level, for example. An electoral system's performance would then be aggregated and studied according to the same principles, but the degrees of freedom offered would be much more significant. The forces exerted on the system would have to be studied with a potentially particulate vision in order to aggregate all the forces at the systemic level.

Finally, the third avenue concerns the optimization aspect of the vision proposed in this article. At this stage, the contributions presented allow to use the "trajectory" vision in order to model, evaluate and potentially visualize the deviation of a polling place's performance due to the occurrence of one (or several) risk(s). However, nothing at this stage allows to use the results of a model based on this paradigm of physical forces to develop a management strategy. This said, the exploration of these performance spaces and the forces exerted within them could make it possible to define strategies for moving within this space, benefiting from certain forces and minimizing certain cost functions.

These three avenues are part of a generic-scope research roadmap on the "Physics Of Decisions" (POD) intelligent risk management framework.

ACKNOWLEDGMENT

The authors would like to thank all the members of the Safe and Secure Election Project, Professors and students, and especially Dr. Richard DeMillo, Principal Investigator of the project for providing us with perspective and guidance.

REFERENCES

- [1] Geraldine Macdonald, Kenneth Macdonald, Safeguarding: A Case for Intelligent Risk Management, *The British Journal of Social Work*, Volume 40, Issue 4, June 2010, Pages 1174–1191, <https://doi.org/10.1093/bjsw/bcq041>.
- [2] Bénaben, Frédéric & Montreuil, Benoit & Faugere, Louis & Luras, Matthieu & Gou, Juanqiong & Mu, Wenxin. (2020). A Physics-Based Theory to Navigate Across Risks and Opportunities in the Performance Space: Application to Crisis Management. 10.24251/HICSS.2020.267.
- [3] Moradkhani N., Faugère L., Jeany J., Luras M., Montreuil B., Benaben F. (2020) A Physics-Based Enterprise Modeling Approach for Risks and Opportunities Management. In: Grabis J., Bork D. (eds) *The Practice of Enterprise Modeling. PoEM 2020. Lecture Notes in Business Information Processing*, vol 400. Springer, Cham. https://doi.org/10.1007/978-3-030-63479-7_23
- [4] Benaben, F., Faugere, L., Montreuil, B., Luras, M., Moradkhani, N., Cerabona, T., ... & Mu, W. (2021). Instability is the norm! A physics-based theory to navigate among risks and opportunities. *Enterprise Information Systems*, 1-28.
- [5] Dustin Chambers Photojournalist. (2020, December 17). Why Do Nonwhite Georgia Voters Have To Wait In Line For Hours? Too Few Polling Places. <https://www.npr.org/2020/10/17/924527679/why-do-nonwhite-georgia-voters-have-to-wait-in-line-for-hours-too-few-polling-pl?t=1612400698730>
- [6] Gardner A., Ye Hee Lee M., Willis H. and M. Glionna J. (2020, June 10). In Georgia, primary day snarled by long lines, problems with voting machines — a potential preview of November. *The Washington Post*. <https://www.washingtonpost.com/politics/voting-june-9->

- primaries/2020/06/09/df6b8aa2-a9e7-11ea-a9d9-a81c1a491c52_story.html
- [7] Johnson, A. F., Pollock, W., & Rauhaus, B. (2020). Mass casualty event scenarios and political shifts: 2020 election outcomes and the US COVID-19 pandemic. *Administrative Theory & Praxis*, 42(2), 249-264.
- [8] Blendon, R. J., & Benson, J. M. (2020). Implications of the 2020 Election for US Health Policy. *New England Journal of Medicine*, 383(18), e105.
- [9] Zoet, M., Welke, R., Versendaal, J., Ravesteyn, P.: Aligning risk management and compliance considerations with business process development. *E-Comm. Web Technol.* 5692, 157 (2009)
- [10] Lave, L. B. 1986. "Approaches to Risk Management: A Critique." *Risk Evaluation and Management*. 1986. New York, NY: Plenum Press.
- [11] Ho, S. S. M., and R. H. Pike. 1992. "The Use of Risk Analysis Techniques in Capital Investment Appraisal." In *Risk: Analysis, Assessment and Management*, edited by J. Ansell and F. Wharton. Chichester: John Wiley & Sons.
- [12] Bell, T. 1989. "Managing Risk in Large Complex Systems – Special Report." In *Spectrum*.
- [13] Covello, V. T., and M. W. Merkhofer. 1993. *Risk Assessment Methods – Approaches for Assessing Health and Environmental Risks*. New York, NY: Plenum Press.
- [14] Kletz, T. A. 1990. *Critical Aspects of Safety and Loss Prevention*. London: Butterworths.
- [15] Davis, J. P., Eisenhardt, K. M., & Bingham, C. B. (2007). Developing theory through simulation methods. *Academy of Management Review*, 32(2), 480-499.
- [16] Müller M., Pfahl D. (2008) Simulation Methods. In: Shull F., Singer J., Sjøberg D.I.K. (eds) *Guide to Advanced Empirical Software Engineering*. Springer, London. https://doi.org/10.1007/978-1-84800-044-5_5
- [17] Fioretti, G. (2013). Agent-based simulation models in organization science. *Organizational Research Methods*, 16(2), 227-242.

3.2.4 State-space Representation Method

The POD framework in this case study has been installed first by simulating some pedagogical physical systems (Mass-Spring-Damper and pendulum) and then management systems (Bass diffusion and inventory-workforce, modeled with system dynamic approach). This simulation has been dedicated to examining combining and aggregating generated forces in non-linear systems. In the main example, the inventory-workforce model, the Description Space has been constructed on the dimensions of the “inventory” (*e.g.*, shipment rate, safety stock coverage, etc.) and “workforce” (*e.g.*, hiring rate, attrition rate) as the system (Attributes) where their setting (*e.g.*, number of workers, number of products, etc.) serves as the contextual element (Characteristics). The Performance Space has constructed on some KPIs, for example, the number of vacant jobs, number of laborers, number of completed products, etc., to examine the impact of several forces. The “inflicted” and “managed” forces have been generated from both the inventory and workforce (*e.g.*, shortage of workers, delay in product delivery, labor productivity, etc.). The main contribution is dealing with non-linearity by leveraging a linearization approach for nonlinear systems (Taylor Series and Jacobian Matrix), consequently, benefiting from control measures established for Linear Time Invariant (LTI) systems.

A force-inspired paradigm for performance-based decision support—Physics of Decision application in nonlinear dynamical systems

This work provides a perspective on performance-based decision support. The chosen approach is based on the principles of “Physics of Decision,” which considers the performance of a system as a physical trajectory within the boundaries of its performance indicators that might be deviated through variation of system parameters. According to the overall premise of employing the state-space method to simulate physical systems, this work presents a decision aggregation method in dynamic systems. The core contribution is to propose a multi-criteria performance framework to manage multi-input-multi-output (MIMO) system performance with a combination of affordable decisions. A nonlinear inventory-workforce management model has been used to demonstrate the proposed approach.

A force-inspired paradigm for performance-based decision support— Physics of Decision application in nonlinear dynamical systems

Nafe Moradkhani^{a,b,*}, Frederick Benaben^{a,b}, Benoit Montreuil^b, Matthieu Laurus^{a,b},
Thibaut Cerabona^{a,b}, Clara LeDuff^{a,b}, Louis Faugere^{b,c} and Julien Jeany^d

^aCentre Génie Industriel, IMT Mines Albi - University of Toulouse, Campus Jarlard, Route De Teillet, Albi, 81000, France

^bPhysical Internet Center, ISyE, Georgia Institute of Technology, 755 Ferst Dr. NW., Atlanta, 30332, GA, USA

^cAmazon.com, 410 Terry Ave N, Seattle, 98109, WA, USA

^dScalian lab, 417 L'Occitane, Labège, Toulouse, 31670, France

ARTICLE INFO

Keywords:

Decision Support System (DSS)
Performance Management
State-space method
Nonlinear systems
System Dynamics
MIMO systems
Information Integration
Linear Time Invariant (LTI) systems

ABSTRACT

This paper provides a perspective on performance-based decision support. The chosen approach is based on the principles of “Physics of Decision,” which considers the performance of a system as a physical trajectory within the boundaries of its performance indicators that might be deviated through variation of system parameters. According to the overall premise of employing the state-space method to simulate physical systems, this work presents a decision aggregation method in dynamic systems. The core contribution is to propose a multi-criteria performance framework to manage multi-input-multi-output (MIMO) system performance with a combination of affordable decisions. A nonlinear inventory-workforce management model has been used to demonstrate the proposed approach.

1. Introduction

Providing a reliable decision support system (DSS) is a long-standing challenge in decision-making. In addition to several fundamental properties that DSS must possess (discussed in section 2), the following defects make implementing DSSs challenging and consequently present an imprecise imitation or simulation of real-world systems: (i) neglecting to consider some components with underlying effects on the system performance, (ii) improper construction of relationships between system parameters, and (iii) **inaccurate system performance predictions due to nonlinear interactions among its parameters** [1, 2, 3].

The third issue is primarily the focus of the present work, which aims to pinpoint how individual decisions in nonlinear circumstances could be combined and consequently estimate their influences on the system’s performance despite complexities due to the system’s nonlinearity. To put it simply, if the studied system is nonlinear, the singular impact of its parameter variations on the system’s performance could not be aggregated; In other words, single parameters’ variations and then the aggregation of their effects on the system performance would not have the same consequence on the system performance when the considered parameters vary concurrently.

In physical systems, the “explicit” method calculates the system status at a future time from the currently known system status, whereas, the “implicit” methods attempt to find a solution to the nonlinear system of equations iteratively

by considering the current state of the system as well as its subsequent (or previous) time state [4]. The implicit method, for example, deals with the nonlinear relationship between applied forces on the system and its physical displacement. Figure 1 illustrates the relationships between the intensity of applied forces to an object connected to a spring (with constant and variable stiffness coefficient, k) and the object displacement ($F = kx$).

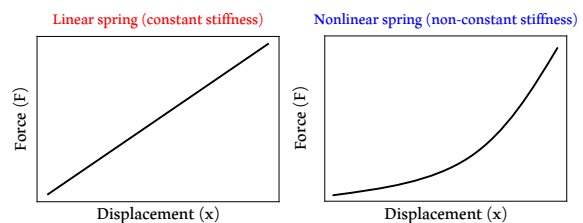

Figure 1: Force vs. Displacement in mass-spring system with linear & non-linear springs

The Physics-of-Decision (POD) is a physics-inspired framework to manage multi-input multi-output (MIMO) systems [5]. According to the original POD framework, opportunities and risks may be viewed as physical forces applied to the system trajectory that could push the system toward or away from its objectives in its performance space. Leveraging the POD framework and a well-known physical system modeling, state-space representation [6, 7], the proposed work attempts to provide an **implicit** method to address decision-related consequences on the system performance in nonlinear dynamical systems. **The overall objective is to provide a solution to a nonlinear system to predict its performance through individual decisions by eliminating imposed consequences that arise from the system’s nonlinearity and assisting the system manager in evaluating several distinctive decisions before taking the best ones.**

*Corresponding author

✉ nafe.moradkhani@mines-albi.fr (N. Moradkhani);
frederick.benaben@mines-albi.fr (F. Benaben);
benoit.montreuil@isye.gatech.edu (B. Montreuil);
matthieu.laurus@mines-albi.fr (M. Laurus);
thibaut.cerabona@mines-albi.fr (T. Cerabona);
clara.le_duff@mines-albi.fr (C. LeDuff); louis.faugere@gatech.edu (L. Faugere); julien.jeany@scalian.com (J. Jeany)

The paper is structured as follows. Section 2 focuses on the Physics-of-Decision fundamentals and current research efforts related to the topic. Section 3 first introduces the state-space modeling, then tunes the POD framework to that. Section 4 provides two nonlinear dynamic models to present the work's significance. Finally, section 5 gives conclusive remarks and proposes areas for further research.

2. Background and related works

As asserted in [8], truth exists, and so does uncertainty. Uncertainty acknowledges the existence of an underlying truth that is a fact in the future. Probability, which is the language of uncertainty, therefore aims at truth. Probability presupposes truth; it is a measure or characterization of truth. Probability is not necessarily the quantification of the uncertainty of truth, because not all uncertainty is quantifiable. Uncertainties are considered potentialities in the decision-making context, whereas potentialities with undesirable outcomes are referred to as "risks" and the ones with conducive consequences as "opportunities" [5]. POD introduces an innovative Decision Support System (DSS) based on physics laws of motion to address those quantified or quantifiable potentialities that arise from incomplete information, lack of knowledge, and experimental data and are reducible in the case of risk and achievable in the case of opportunity.

2.1. Physics-based decision support system

Physics of Decision is concerned with multi-criteria management of systems subject to almost ubiquitous instability and uncertainty, which have to be coped with, and accounted for when managing the systems and their performance [5, 9]. Decision support technologies and performance management allow examining such systems in the three following aspects, as proposed in [10]. (i) **Intelligence**: to comprehend the considered system, its Key Performance Indicators (KPIs), its context, its current and target performance, (ii) **Design**: to comprehend the potential changes that this system and its context may undergo, and (iii) **Choice**: to find a way to choose among changes and their effects on performance to make appropriate decisions.

Through the following methodology, the POD, an innovative approach to decision support, might completely encompass the Intelligence, Design, and Choice aspects of decision support systems in the context of instability and uncertainty [9].

- (i) **Intelligence** through system establishment and characterization: First, the intention of the considered system (objectives considered as KPIs), its specific study limits, the system's associated parameters to the recognized potential, as well as the context parameters themselves, and its internal and external (system's context) potentials are collected and described,
- (ii) **Design** through system vulnerability and sustainability identification: Second, a detailed assessment of the investigated system through sensitivity analysis (*e.g.*,

simulation campaign runs, Artificial Neural Networks (ANN), and clustering) infers the correlation matrix between the system inputs and the intended KPIs,

- (iii) **Choice** through strategy exploration: Finally, regarding the system preferences and limits, using the optimization algorithms, notably the heuristic approach, the most desirable decisions are offered to lead the system toward its objectives in the performance space.

The proposed methodology is included in the POD framework, which has been studied in several contexts. Crisis management context, such as the COVID-19 pandemic crisis [9], the COVID-19 pandemic impact on air pollution [11]. Operational management contexts, such as road traffic management [12], supply chain management [13, 14], and polling place management [15, 16]. Efficiency management context, such as project management [17]. The following section describes the preliminaries and basic concepts of the POD framework.

2.2. Foreword, essential definitions, and notations

System characterization and identification are essential challenges in systems theory. The mathematical representation of a system lies at the heart of the characterization challenge. A simulation method that aims to represent the system functionality through a performance-based approach can be expressed as a function \mathbf{F} from an input space \mathcal{U} , representing the description space of the system, into an output space \mathcal{Y} , representing the performance space of the system [5]. The function \mathbf{F} is defined implicitly by the specified input-output pairs. The method of representing time-dependent systems by differential equations is well established in systems theory and applies to a fairly large class of systems [18]. For example, the differential equation:

$$\begin{aligned} \frac{dx(t)}{dt} &\triangleq \dot{x}(t) = \Phi[x(t), u(t)], & t \in \mathbb{R}^+ \\ y(t) &= \Psi[x(t)]. \end{aligned} \quad (1)$$

where:

$$\begin{aligned} u(t) &\triangleq [u_1(t), u_2(t), \dots, u_p(t)]^T \\ x(t) &\triangleq [x_1(t), x_2(t), \dots, x_n(t)]^T \\ y(t) &\triangleq [y_1(t), y_2(t), \dots, y_m(t)]^T \end{aligned}$$

represents a p -input, m -output system of order n . While $u_i(t)$ represents the i -th input vector at time t , $x_i(t)$ represents the i -th state variable of inputs' vectors, $u_1(t), u_2(t), \dots, u_p(t)$, at time t , and $y_i(t)$ represents the i -th output vector at time t . Functions Φ and Ψ are dynamic¹ "linear" or "nonlinear" maps defined as $\Phi : \mathbb{R}^n \times \mathbb{R}^p \rightarrow \mathbb{R}^n$ and $\Psi : \mathbb{R}^n \rightarrow \mathbb{R}^m$. The function Φ presents the states of the system inputs in space \mathcal{U} ; Since the number of inputs is considerably fewer than their possible states ($p \ll n$), the Φ would be a

¹Although the Φ and Ψ functions could be time-invariant (static) [9], this study concentrates mainly on dynamic (time-variant) functions

POD application in nonlinear dynamical systems - A force-inspired paradigm

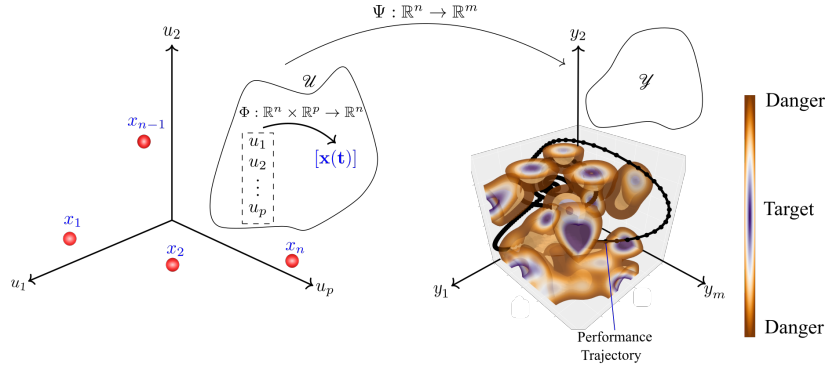

Figure 2: Mathematical representation of the Physics of Decision approach

$n \times p \rightarrow n$ dimension function. The Ψ function is used to depict the relationship between inputs (vector $u(t)$) and outputs (vector $y(t)$). The vector $x(t)$ denotes the state of the system at time t and is determined by the state at time $t_0 < t$ and the input $u(t)$ defined over the interval $[t_0, t)$. The output $y(t)$ is determined by the state of the system at time t [19, 18]. Equation 1 is referred to the input-state-output representation of the system. This paper is concerned with dynamic systems which can be represented by differential equations corresponding to the differential equation given in equation 1. These take the form:

$$\begin{aligned} x(k+1) &= \Phi[x(k), u(k)], \\ y(k) &= \Psi[x(k)]. \end{aligned} \quad (2)$$

where $u(\cdot)$, $x(\cdot)$, and $y(\cdot)$ are discrete-time sequences. Fig. 2 depicts the POD framework as a time-dependent technique with the input-states-output vision.

According to equation 1, the variations of vector $u(t)$ change the $\dot{x}(t)$ via function Φ . These changes go through function Ψ and consequently deviate the system trajectory shaped with vector $y(t)$ in the performance space \mathcal{Y} . This transition from the variation of vector $u(t)$ to the deviation of the system trajectory is assumed as “physical forces” in the POD framework.

3. Force-based paradigm in performance management

The space \mathcal{Y} in Fig. 2 presents the predetermined time-independent Target (objective) and Danger (or could be less targeted) zones concerning the intended level of quantified KPIs (y_1, y_2, \dots, y_m) on the axes. The degree of the system’s liberty to assign values to system inputs (u_1, u_2, \dots, u_p) in the space \mathcal{U} along with the system’s sensitivity to the critical level of the system’s inputs is the main factor in these determinations (system’s susceptibilities) in the performance space \mathcal{Y} . Although these levels may change over time, they provide a forward-thinking view of the systems’ objectives. The most essential takeaway from the presented framework in Fig. 2 is to see the studied system as an object in its multidimensional performance space \mathcal{Y} , which might be pushed

and pulled by produced forces (f_1, f_2, \dots, f_p) resulting from changes in the system’s parameters or in its environment parameters (u_1, u_2, \dots, u_p) at any time t . Essentially, these variations’ consequences are observed through the deviation of the system “trajectory” within the space \mathcal{Y} , the multidimensional performance space of systems’ KPIs.

3.1. Physics of Decision in practice

In the presented POD framework, the emphasis is on the mobility of the investigated system within its performance space \mathcal{Y} , where movements are studied in this multidimensional space defined by the system’s KPIs. These KPIs evolve as a result of changes in the system’s internal and contextual input parameters, vector $u(t)$ in equation 1 [5].

The purpose of the POD theory, which derives from classical physics, is to facilitate the handling of the intricacies of the observed system to assist decision-makers in steering the system (especially in nonlinear circumstances) toward its objectives. The following illustrates the relation between a KPI (and its associated concepts) and physics notations such as displacement, velocity, and acceleration.

- (i) Displacement \Leftrightarrow Variation: The *displacement* (δk_i) of the system on the associated axis to a KPI in the performance space \mathcal{Y} (e.g., y_i) is equivalent to the *variations* of that KPI (δx),
- (ii) Velocity \Leftrightarrow Growth: The derivative of a KPI ($\partial k_i / \partial t$) shows its positive/negative *growth*, which is equalized to the system’s *velocity* ($\partial x / \partial t$) on the KPI’s connected axis,
- (iii) Acceleration \Leftrightarrow Fluctuation: The velocity derivation indicates the system’s *acceleration* ($\partial v / \partial t = \partial^2 x / \partial t^2$) on the connected axis.

The “Displacement” of a KPI shows where the system is falling behind or veering off course to take corrective action quickly, solving the issue before it escalates into a full-blown problem. Displacement mainly gives an intuition or insight of “Operational” decisions that seek to get closer and closer to real time measurement to evaluate the system performance on a short-term basis.

The “Velocity” of a KPI monitors the progress or trend of the system toward a stated destination (system objectives in the performance space \mathcal{Y}) to take “Strategic” decisions over time. This measurement effectively requires observation over a more extended period to provide an accurate picture of system development.

The “Acceleration” magnitude may reflect how strongly or weakly a KPI fluctuates on its connected axis and might help on the “Operational” decisions, while its positive or negative direction may aid in the “Strategic” decision and is always the same as the net force acting on the system produced by inputs’ variations (vector $u(t)$).

The displacement, velocity, and acceleration are equally important; they just provide different information for different purposes. For systems to yield all their promise, strategic and operational decisions must be aligned so that decision-makers at all levels may perceive the relationship between system activity and system performance.

The POD approach focuses on a force-based vision to assess the system’s performance. According to this vision, a system is perceived as an object, and its performance as a trajectory within the performance space \mathcal{Y} may veer off course due to internal or contextual perturbations (interpreted as risks and opportunities) viewed as physical forces acting on the object.

3.2. Physics of Decision installation on state-space representation

State-space representation, a well-established mathematical model in physics, provides a practical and condensed method to describe and analyze systems with multiple inputs and outputs. The most general state-space representation of a linear system with p -inputs, m -outputs, and n -state variables takes the following form:

$$\begin{aligned} \dot{x}(t) &= Ax(t) + Bu(t), \\ y(t) &= Cx(t) + Du(t) \end{aligned} \quad (3)$$

where A is the “state matrix”, B is the “input matrix”, C is the “output matrix”, and D is the “feed-through (or feed-forward) matrix”. The first equation is the *state* equation and the latter is the *output* equation. While all matrices (A , B , C , and D) are allowed to be time-variant (*i.e.*, their elements can depend on time, *e.g.*, $A(t)$); in the common Linear Time Invariant (LTI) systems, matrices will be time invariant (*i.e.*, the functions Φ and Ψ in equation 1 are static). This study focuses on systems whose outputs do not influence inputs; however, this could occur in several systems (*e.g.*, thermostat heater, automatic clothes iron, etc.). In such systems, the state and output equations are influenced by a “feedback” matrix K from the system output². Fig. 3 shows the block diagram for the linear state-space representation, with feedback K (indicated by a dashed line) from the system’s output y to its input u [6, 7]. Using transfer functions (Laplace transfer form) or differential equations to model complex systems becomes laborious; this is even more true if the

²In such systems, the equation 3 becomes: $\dot{x}(t) = Ax(t) + BKy(t)$ and $y(t) = Cx(t) + DKy(t)$ - note that K is the feedback matrix.

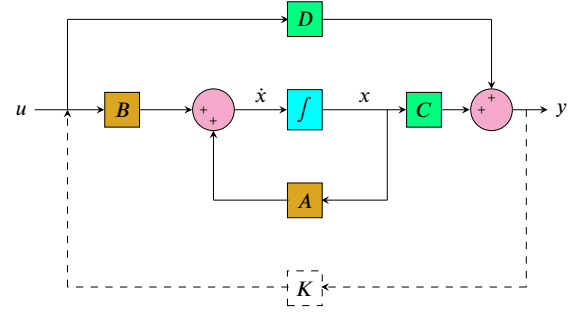

Figure 3: General state-space representation model

system has multiple inputs and outputs [7]. The state space method largely alleviates this complexity. Fig. 4 shows a Mass-Spring-Damper system with its mass, m , spring constant, k , and damping coefficient, b , where the external force acting on the mass, $f(t)$, is considered as input while its position, $p(t)$, is considered as output. According to the free-

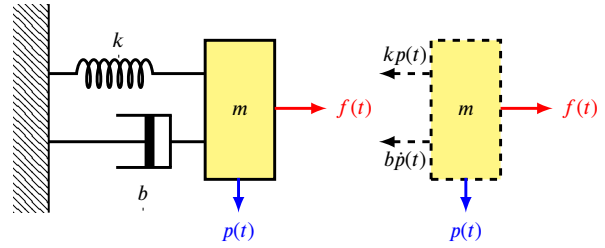

Figure 4: Mass-Spring-Damper System

body diagram shown in dashed lines and Newton’s 2nd law, equation 4 presents the differential equation of this system.

$$f(t) - b \frac{dp}{dt} - k p(t) = m \frac{d^2 p}{dt^2} \quad (4)$$

This system is a straightforward illustration of a “linear” state-space representation. When there is a mass in a system, its position and velocity are commonly chosen as state variables. Also, position, velocity, and force (input) are sufficient to determine this system’s future position (output). For these reasons, position and velocity are chosen as state variables ($x(t)$ in equation 3). The input vector ($u(t)$), state vector ($x(t)$), and output vector ($y(t)$) are shown in equation 5.

$$u(t) = f(t), \quad x(t) = \begin{bmatrix} x_1(t) \\ x_2(t) \end{bmatrix} = \begin{bmatrix} p(t) \\ \dot{p}(t) \end{bmatrix}, \quad y(t) = p(t). \quad (5)$$

Considering the new notation in equation 5, equation 4 becomes equation 6.

$$u(t) - b x_2(t) - k x_1(t) = m \dot{x}_2(t) \quad (6)$$

Through rearranging equations to express $\dot{x}(t)$ and $y(t)$ in terms of $x(t)$ and $u(t)$, equation 7 is obtained.

$$\begin{aligned} \dot{x}_1(t) &= x_2(t), \\ \dot{x}_2(t) &= -\frac{k}{m} x_1(t) - \frac{b}{m} x_2(t) + \frac{1}{m} u(t), \\ y(t) &= x_1(t). \end{aligned} \quad (7)$$

POD application in nonlinear dynamical systems - A force-inspired paradigm

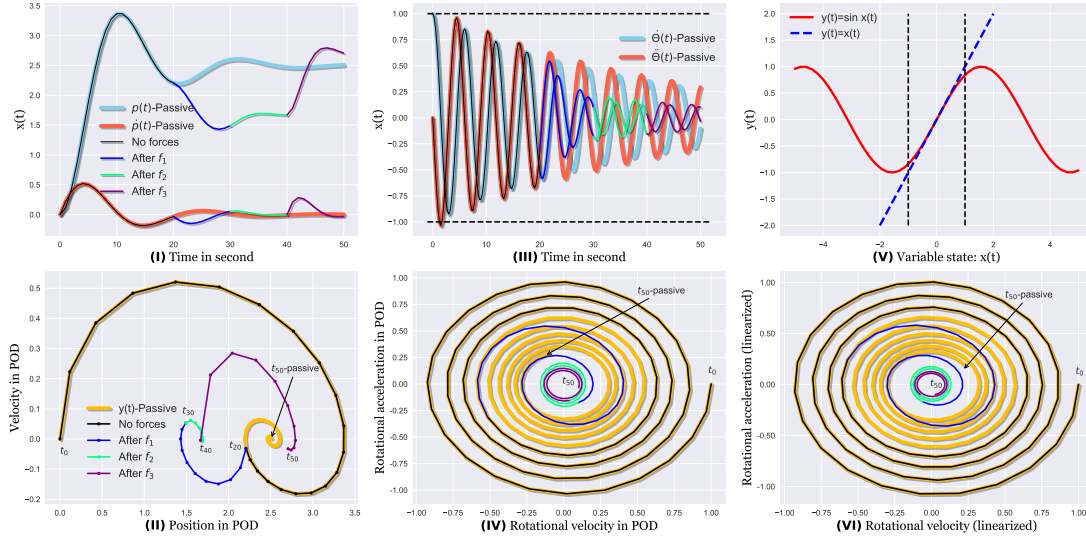

Figure 5: Mass-Spring-Damper and Pendulum systems tuning into the Physics of Decision framework and analyses

Finally, by organizing equation 7 into matrix format, equation 8 shows (the *state* and *output* equations) the state-space model of the Mass-Spring-Damper system presented in Fig. 4.

$$\begin{aligned} \begin{bmatrix} \dot{x}_1(t) \\ \dot{x}_2(t) \end{bmatrix} &= \underbrace{\begin{bmatrix} 0 & 1 \\ -k/m & -b/m \end{bmatrix}}_A \begin{bmatrix} x_1(t) \\ x_2(t) \end{bmatrix} + \underbrace{\begin{bmatrix} 0 \\ 1/m \end{bmatrix}}_B [u(t)], \\ y(t) &= \underbrace{\begin{bmatrix} 1 & 0 \end{bmatrix}}_C \begin{bmatrix} x_1(t) \\ x_2(t) \end{bmatrix}. \end{aligned} \quad (8)$$

The POD framework studies the system's trajectory in the performance space \mathcal{Y} through produced forces stemming from inputs' variations (u_1, u_2, \dots, u_p) at any time t , as opposed to state-space representation in "Time Invariant" systems, which only has $u(t)$ as a time-dependent force. Given this distinction, the state-space representation would be continuous time-variant, as equation 9 shows the matrices and vectors used in the POD framework could be time-variant.

$$\begin{aligned} \dot{x}(t) &= A(t)x(t) + B(t)u(t), \\ y(t) &= C(t)x(t) + D(t)u(t) \end{aligned} \quad (9)$$

Considering the whole Mass-Spring-Damper system as an object in its performance space \mathcal{Y} built on the (i) system position and (ii) system velocity as its KPIs (*i.e.*, output matrix $C = [1 \ 1]$), Fig. 5 (II) presents the tuning of this system to the POD framework along with the results of several discussed investigations in the following. Considering the external force, $f(t)$, the mass, m , the spring constant, k , and damping coefficient, b , the input vector of this system includes $u(t) = [f(t), m(t), k(t), b(t)] = [u_1(t), u_2(t), u_3(t), u_4(t)]$.

To evaluate the system performance, the three following modes are considered to assess the system performance: (i) **Inertia** mode: The performance could change due to its normal behavior and the associated consumption. In this mode, the system is not facing any force, (ii) **Passive** mode: In addition to the performance changes of Inertia, the performance might change because there is (are) force(s) in the system or its environment, and (iii) **Active** mode: In addition to the performance changes of Inertia, the performance could change because the system is facing some forces (passive changes) and also because of some taken decisions to manage the consequences of those forces [9].

It is important to note that the parameter initialization, settings, and applied scenarios in the remaining of this section were chosen to reflect the POD framework, which could be irrational and impossible to implement in real-world circumstances.

The following forces have been picked to investigate the Mass-Spring-Damper system as a "Linear-Time-Variant" system in the POD framework with the initial input vector, $u(t_0) = [5N, 20Kg, 2N/m, 4N\ s/m]$.

- (i) f_1 : replacement of spring at time t_{20} with a higher constant $\rightarrow k(t_{20}) = 3N/m [k(t_0) \text{ to } k(t_{19}) = 2]$,
- (ii) f_2 : concurrent replacement of the following elements at time t_{30} . (i) mass with a lighter mass $\rightarrow m(t_{30}) = 10Kg [m(t_0) \text{ to } m(t_{29}) = 20]$ and (ii) damper with a higher damping coefficient $\rightarrow b(t_{30}) = 6N\ s/m [b(t_0) \text{ to } b(t_{29}) = 2]$,
- (iii) f_3 : applying a greater force at time $t_{40} \rightarrow f(t_{40}) = 8N [f(t_0) \text{ to } f(t_{39}) = 5]$.

According to the tuning of the Mass-Spring-Damper system as a “Linear-Time-Variant” system (equation 9) to the POD framework and applied forces, Fig. 5 (I) displays the system’s variables $x(t)$ (position and velocity) for 50 seconds. The passive trajectory (system variables with initial input vector $u(t_0)$) and deviations (active trajectory) due to f_1 , f_2 , and f_3 have been depicted if the chosen forces are applied together. In Fig. 5 (II), trajectories (passive and active) of the tuned system into the POD framework and built on its KPIs (output $y(t) = x(t)$) have been depicted analogously; with the difference that the whole system viewed as an object in this framework that is being pulled and pushed by generated forces.

The initial passive trajectory is depicted for the period from t_0 until the moment that the first force arrives (f_1 at t_{20}). In linear systems like Mass-Spring-Damper, after f_1 takes effect, a new passive trajectory is formed that takes into account both f_1 and the initial passive impacts with itself starting at time t_{20} (input vector $u(t_0)$ and $u(t_{20})$). Likewise, this rule holds for later times and possible incoming forces applied to the system. The vector sum of applied forces is well established in such systems ($\sum_{i=1}^{i=p} f_i = f_1 + f_2 + \dots + f_i$), making it feasible for applied forces to be aggregated (as in classical physics). The equalized KPI-oriented concepts (variation, growth, and fluctuation) to the Kinematic physical notations (displacement, velocity, and acceleration) in section 3.1 is employed directly for system analyses (taking operational and strategic decisions). If either the state or the output equations-or both-are nonlinear, the vector sum of applied forces is invalid ($\sum_{i=1}^{i=p} f_i \neq f_1 + f_2 + \dots + f_i$).

The following example illustrates such systems and potential solutions to deal with this issue.

The $u(t)$ argument in equation 9 to the functions can be dropped if the system is unforced (i.e., it has no external force). A classic “nonlinear” system is a simple unforced pendulum shown in Fig. 6.

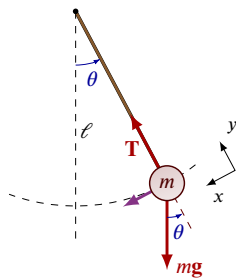

Figure 6: An unforced pendulum system

Equation 10 presents the pendulum motion equation.

$$m\ell^2\ddot{\theta}(t) = -m\ell g \sin \theta(t) - k\ell \dot{\theta}(t) \quad (10)$$

where:

- g is the gravitational acceleration,
- k is coefficient of friction at the pivot point,

- ℓ is the radius of the pendulum (to the center of gravity of the mass m).
- $\theta(t)$ is the angle of the pendulum with respect to the direction of gravity,
- m is the mass of the pendulum (pendulum rod’s mass is assumed to be zero),

Equation 11 shows the state equation of the pendulum.

$$\begin{aligned} \dot{x}_1(t) &= x_2(t), \\ \dot{x}_2(t) &= -\frac{g}{\ell} \sin x_1(t) - \frac{k}{m\ell} x_2(t). \end{aligned} \quad (11)$$

where:

- $x_1(t) = \theta(t)$ is the angle of the pendulum,
- $x_2(t) = \dot{x}_1(t)$ is the pendulum’s rotational velocity,
- $\dot{x}_2(t) = \ddot{x}_1(t)$ is the rotational acceleration.

Finally, equation 12 presents the general form of the pendulum state and output equations (11).

$$\begin{aligned} \dot{x}(t) &= \begin{bmatrix} \dot{x}_1(t) \\ \dot{x}_2(t) \end{bmatrix} = \Phi(x(t)) = \begin{bmatrix} x_2(t) \\ -\frac{g}{\ell} \sin x_1(t) - \frac{k}{m\ell} x_2(t) \end{bmatrix} \\ y(t) &= \begin{bmatrix} 1 & 1 \end{bmatrix} \begin{bmatrix} \dot{x}_1(t) \\ \dot{x}_2(t) \end{bmatrix} \end{aligned} \quad (12)$$

Similar to the Mass-Spring-Damper system example, Fig. 5 (III) and (IV), with the same equivalent legends in (I) and (II) respectively, present the state variables (rotational velocity and rotational acceleration) and output vector $y(t)$ in POD together with the initial input vector $u(t) = [g(t), k(t), \ell(t), \theta(t), m(t)] = [u_1(t), u_2(t), u_3(t), u_4(t), u_5(t)] = [10m/s^2, 2, 8m, 30^\circ, 5Kg]$ at t_0 and the deviations in accordance with the following forces at t_{20} , t_{30} and t_{40} .

- $f_1: k(t_{20}) = 10 [k(t_0) \text{ to } k(t_{19}) = 2]$,
- f_2 : including $f_{21}: \ell(t_{30}) = 6m [\ell(t_0) \text{ to } \ell(t_{29}) = 8]$ and $f_{22}: m(t_{30}) = 30Kg [m(t_0) \text{ to } m(t_{29}) = 5]$,
- $f_3: g(t_{40}) = 8m/s^2 [g(t_0) \text{ to } g(t_{39}) = 10]$.

The presented “continuous time-variant” pendulum system is no longer linear due to the term $\sin x_1(t)$ in equation 11; hence such nonlinear systems don’t obey the forces aggregation rule analogous to linear systems.

Since the $x(t)$ in Fig. 5 (III) alters almost in the $(-1, +1)$ interval (shown in black dashed lines) and the term $\sin x_1(t)$ is almost the same as $x_1(t)$ on this interval, so $\sin x_1(t)$ in the state equation is estimated with $x_1(t)$ (Fig. 4 (V)). **This estimation makes the state equation linear; thus, the forces aggregation works like linear systems.** Fig. 5 (VI) depicts the linearized pendulum system, which almost resembles the original nonlinear trajectory shown in Fig. 5 (IV) (According to Fig. 5 (V), as the pendulum moves away from the point $(0, 0)$, the absolute value of the approximation, $x(t)$, is greater than the actual value, $\sin x(t)$; thus, the

movement of the pendulum is slightly faster than the original movement, and this shift is evident when comparing the Fig. 5 (IV) and Fig. 5 (VI).

The system equilibrium or stationary points are those when the following condition is satisfied. The applied forces are neutralized by each other ($F_{net} = 0$), so that $\dot{x} = 0$ [13]. The equilibrium points of a pendulum are those that satisfy $[x_1(t), x_2(t)] = [n\pi, 0]$ for $n \in \mathbb{Z}$ (same for the Mass-Spring-Damper system when $kp(t) + bp(t) = f(t)$) in Fig. 4.

Real-world systems are almost entirely nonlinear; therefore, applying the state-space model to them is not straightforward as it is for LTI systems (equation 3). It turns out that many nonlinear systems have characteristics that are strikingly comparable to those of their linear counterparts. In addition, various methods make it possible to use linear analysis on nonlinear systems. The linearization of nonlinear systems is a potent method in nonlinear analysis. In dynamics analysis, particularly close to equilibrium points, linearization is used to represent a nonlinear system of ODEs as a linear system [20, 21]. It is possible to employ linearized systems to construct dynamical system controllers that benefit from cutting-edge linear controller approaches to comprehend the local behavior of dynamical systems, notably at equilibrium points [20].

The Taylor series of dynamical ODEs is one of the most widely used linearization methods. The general 1st order structure of the Taylor series is recalled by equation 13 to linearize the function Φ in equation 1 around point (x, u) [21].

$$\dot{x}(t) = \Phi(x, u) \approx \Phi(\bar{x}, \bar{u}) + \left. \frac{\partial \Phi}{\partial x} \right|_{\bar{x}, \bar{u}} (x - \bar{x}) + \left. \frac{\partial \Phi}{\partial u} \right|_{\bar{x}, \bar{u}} (u - \bar{u}) \quad (13)$$

If the values of x and u are chosen in steady state conditions (at equilibrium points) then $\Phi(\bar{x}, \bar{u}) = 0$ because the derivative term $\partial \Phi / \partial u = 0$ in steady states.

The POD framework is supplemented with the linearization method to assess the aggregation of individual decisions (applied forces) in nonlinear case studies to control the system trajectory in the performance space \mathcal{Y} . To state it plainly, *in nonlinear systems, aggregation of taken individual decisions, where the decisions are viewed as forces that move the system in its performance space, will not necessarily be the same as if they were taken together*. This issue mainly arises from cascading effects and subsequently delayed implications in nonlinear systems (see Figure 1). Section 4 goes into further detail about this issue and applies the introduced solution to an extended example.

4. Experiments and results

The main experiments are centered on the significance of the force-based paradigm in the POD framework as a DSS on industrial and strategic simulation models. The presented POD framework in this study constrains the experiments by requiring differential equation models of the systems

being studied in this form so that the equivalent state-space model to the system's ordinary differential equations (ODEs) could form (however, the other POD studies have been implemented through different simulation approaches such as agent based modeling (ABM) [15] and discrete event modeling (DEM) [12] too). The most prevalent form of ODE modeling is the System Dynamics approach (compartmental models), consisting of compartments, flows, causal loop diagrams (CLD), and system parameters. The POD answers the following critical business question in nonlinear systems that the System Dynamics approach, due to nonlinearity, can not address.

“What if the system manager decides to take several individual decisions which cost the system less (easier path or farther from intended danger zones, or both, in the system's performance space (Fig. 2)) if they were taken together and then aggregate them to evaluate the system performance?”

The presented work and supplied procedures assess two well-known *nonlinear* models: a simple illustrative model to apply the linearization and forces aggregation, then an industrial and complicated model, both implemented with the System Dynamics approach to address this issue.

4.1. Bass diffusion system dynamics model

The dynamic model of a basic Bass Diffusion system implemented with ODEs is used to illustrate the state-space method and linearization procedures in nonlinear dynamical systems where the state-space representation in equation 3 cannot be directly applied [22].

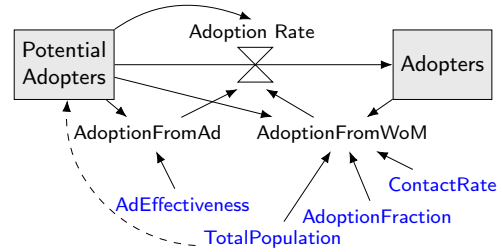

Figure 7: Basic Bass Diffusion system dynamic model

This model consists of a simple differential equation describing how “new products are adopted in a population.” The model presents a rationale for how current and potential adopters of a new product interact. The premise of the strategy is that potential adopters might become new customers through advertisement or word-of-mouth (WoM) mechanism among potential and existing consumers. The Adoption Rate is the accumulation of these two ways of adoption (Advertise and WoM) at any given moment [23]. The potential and current Adopters variations are considered as state variables $x_1(t)$ and $x_2(t)$, respectively. The population individuals are either customers or potential customers, meaning that $x_1 + x_2 = \text{Total population}$ (u_2 latter) and, consequently, $\dot{x}_1 = -\dot{x}_2$. Equation 14 presents the *state* and

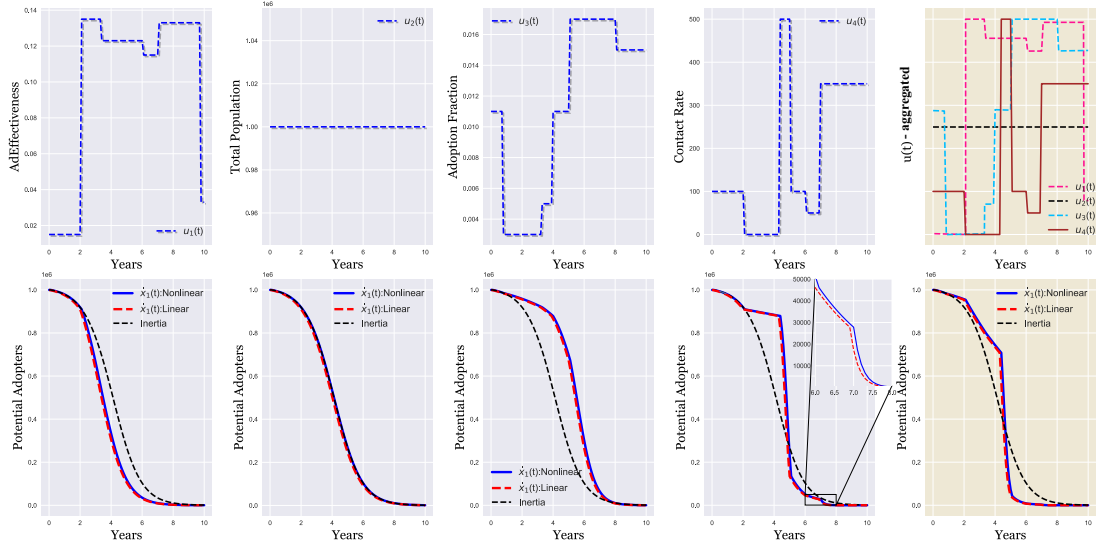

Figure 8: Individual inputs' variations (applied forces) and their aggregations vs. output (potential adopters)

output equations of the Bass Diffusion presented in Fig. 7.

(15)

$$\begin{aligned}
 \dot{x}_1(t) &= -(\text{AdoptionFromAd} + \text{AdoptionFromWoM}) \\
 \dot{x}_1(t) &= \Phi(x(t), u(t)) = -x_1 u_1 - x_1 x_2 u_3 u_4 / u_2 \\
 \dot{x}(t) &= \begin{bmatrix} \dot{x}_1 \\ \dot{x}_2 \end{bmatrix} = \begin{bmatrix} -x_1(u_1 + u_3 u_4) + x_1^2 u_3 u_4 / u_2 \\ x_1(u_1 + u_3 u_4) - x_1^2 u_3 u_4 / u_2 \end{bmatrix} \\
 y(t) &= \begin{bmatrix} 1 & 0 \end{bmatrix} \begin{bmatrix} \dot{x}_1 \\ \dot{x}_2 \end{bmatrix}
 \end{aligned}
 \tag{14}$$

where:

- $u_1(t)$ is AdEffectiveness: Advertisement influence coefficient on Adoption Rate,
- $u_2(t)$ is Total Population: Total adopters and potential adopters,
- $u_3(t)$ is Adoption Fraction: The imitation rate of potential adopters from current adopters,
- $u_4(t)$ is Contact Rate: Contact rate between potential adopters and current adopters,
- $u(t) = [u_1(t), u_2(t), u_3(t), u_4(t)]$.

The state equation of the Bass Diffusion model in equation 14 is nonlinear (due to the term $x_1 x_2$ before arrangement, later x_1^2 that requires linearization. The presented Jacobian Matrix in equation 15 linearizes this state variable concerning input vector $u(t)$ to be in the “continuous time-variant” state-space form (equation 9). Note that $\partial x / \partial x_1 = -u_1 - u_3 u_4 + 2x_1 u_3 u_4 / u_2$.

$$J(\bar{x}) = \begin{bmatrix} \frac{\partial x}{\partial u_1} & \frac{\partial x}{\partial u_2} & \frac{\partial x}{\partial u_3} & \frac{\partial x}{\partial u_4} \end{bmatrix} = [-x_1, -u_3 u_4 x_1^2 / u_2^2, -u_4 x_1 + u_4 x_1^2 / u_2, -u_3 x_1 + u_3 x_1^2 / u_2]$$

Fig. 8 shows the consequences of changing inputs individually (u_1, u_2, u_3 , and u_4 on top) on the Potential Adopters as intended output in linear and nonlinear forms at the bottom. The final plot (the rightmost at the bottom) demonstrates the impact of aggregated input changes (u_1, u_2, u_3 , and u_4) on the output in both linear and nonlinear situations.

According to the zoomed portion of the “Contact Rate” variation plot in Fig. 8, the comparison between linearized and nonlinear versions indicates the following conclusions.

- (i) The 1st order linearization from the Taylor series is sufficient ($x_1^2 \approx 0$) to transform the nonlinear state equation 14 to continuous time-variant form (equations 9) and consequently compute the effects of input variations on the output for the basic Bass Diffusion model, yet; high oscillated models require higher orders.
- (ii) The forces have immediate impacts on the output in the nonlinear form, whereas; there are considerable behind-time impact in the linearized versions. For instance, the variation of Contact Rate from 50 to 350 contacts per person starting at the beginning of year 7th.
- (iii) The forces aggregation in the linear version closely resembles the application of forces together in the nonlinear form (the depicted plots in the rightmost at the bottom of Fig. 8).

4.2. Inventory-workforce system dynamics model

This section presents a more industrial, high oscillated, and continuous time-variant system dynamic approach of an inventory-workforce model, which is entirely nonlinear

POD application in nonlinear dynamical systems - A force-inspired paradigm

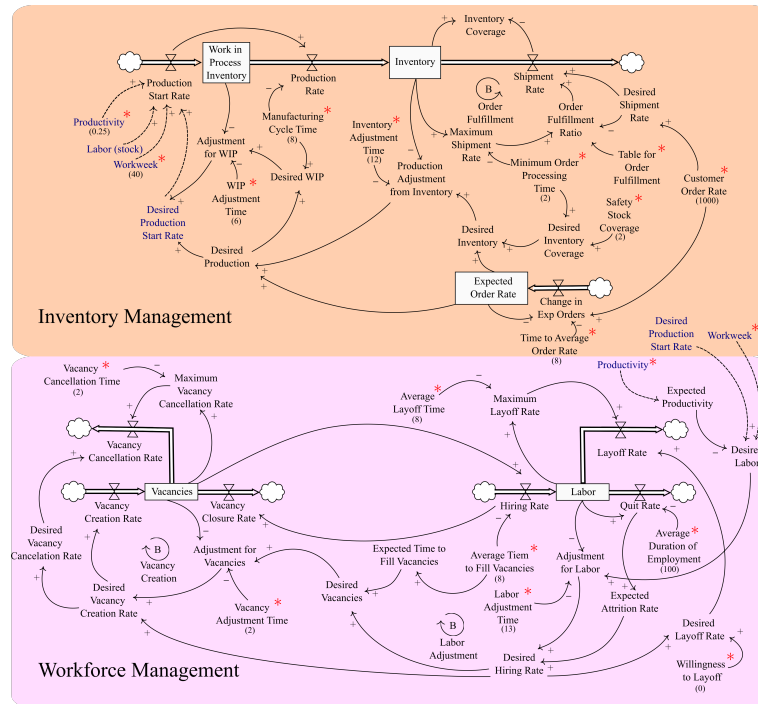

Figure 9: System Dynamic model of inventory-workforce management provided in [24]

in nature. The study employs the linearization approach to compute the linear counterpart of the nonlinear inventory-workforce system at the time of input variations (applied forces), and it calculates the KPIs variation, growth, and fluctuation (section 3.1), which are connected to the physical notations of displacement, velocity, and acceleration, respectively [13].

The inventory-workforce model illustrates how production scheduling and employment regulations interact, potentially causing inconsistency in effectively responding to consumer demand.

The model makes some significant simplifying assumptions. Order backlog is ignored and customer orders are exogenous. The inventory-workforce model emphasizes labor’s importance as a production factor. When the workforce model and the inventory model are combined, production starts to adapt with a delay to the targeted start time. The inventory level with the connected workforce model decreases further after the demand shock (high order from customers) than the inventory model without it.

The inventory model structure and the equations between its parameters, stocks, flows, and causal loop diagrams (CLD) are thoroughly described in chapter 18 of the “Business Dynamics” book [24]. Chapter 19 discusses the workforce model and its link to the inventory model. The behavior of the coupled model, including oscillations and their sources, is also explored [24].

This study avoids repeating how the models work and suffices with the structure of the models and the relationships

between the parameters, stocks, and flows presented in Fig. 9. Dashed arrows represent the shared parameters of the two coupled models. The reason for skipping the inventory-workforce model explanation is that the goal of this research is to apply the presented force-inspired paradigm to the time-dependent nonlinear models (e.g., system dynamic models) rather than the models themselves to propose a decision-making tool.

The inventory-workforce model is tuned to the POD framework presented in section 3 as follows. The POD framework considers the parameters in Fig. 9 with just output arrows (this property is present in 17 parameters) as inputs in the space \mathcal{U} . Fig. 9 depicts the model’s inputs with an asterisk symbol (*). The remaining components, such as flows (e.g., “Shipment Rate”), stocks (e.g., “Labor”), and hybrid variables (e.g., “Desired Vacancies”) are outputs in the space \mathcal{Y} . Input parameters are those that the simulation modeler is able to assign values and alter (*). Hybrid variables, on the other hand, can be utilized as input from a different point of view. The distinction between inputs and outputs is clearly based on the system management’s perspective; it is just a way to separate inputs from outputs inside the POD framework. Following the mapping management concepts onto physical notations, then the linearization approach through the Taylor series and forces aggregation in the inventory-workforce model are explored.

The experiments begin a passive trajectory with the force of 1000 “Customer Order,” which triggers the entire system (other input parameters). The input parameters in Fig. 9

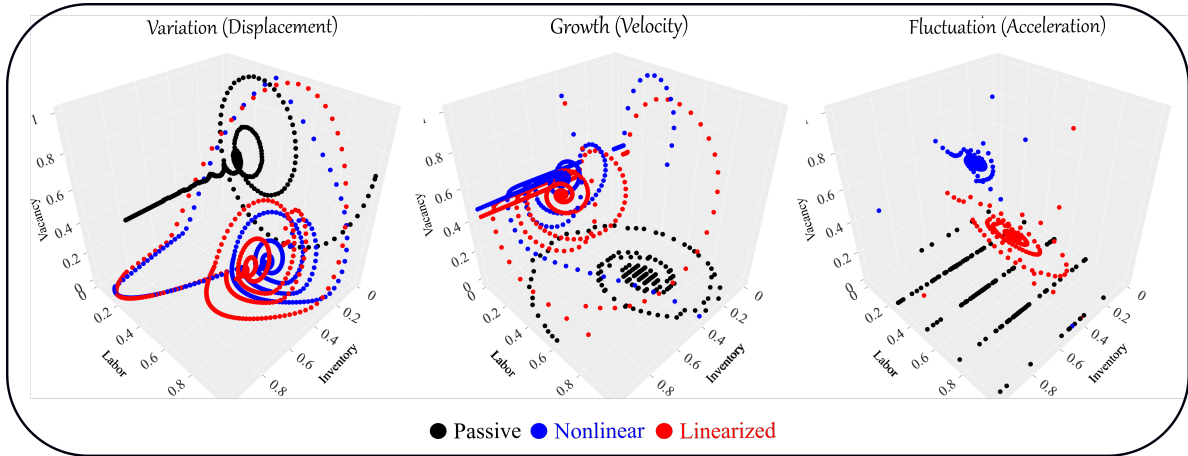

Figure 10: Passive, nonlinear, and linearized trajectories for variation, growth, and fluctuation of the selected KPIs

with the (*) symbol have been initialized to the values in parentheses to form the passive trajectory. The following challenging experiment contrasts individual decisions and their aggregation in linear (or linearized) versus nonlinear circumstances. This evaluation enables mitigating risks brought on by unforeseen outcomes brought on by shifts in system performance by comparing the tentative decision-making that is not the same as definitive decision-making due to the system's nonlinearity. The assertion of the challenging experiment is backed by the forces having the properties listed below. (i) Selected inputs to vary (force creation) belong to both the inventory and workforce sectors; (ii) Forces have indirect impacts on the concerned KPIs (Fig. 9: to be checked through the path from input to the KPIs), and (iii) The applied forces are studied for relatively long periods to take into consideration the simultaneous influence of the interacting forces on the KPIs (not only a brief shock to the system).

- (i) f_1 : The "Safety Stock Coverage" climbed from 2 to 4 product over timeframe (50,70): from inventory sector,
- (ii) f_2 : The "Productivity" descend from 40% to 25% over a (100,150) timeframe: from workforce sector,
- (iii) f_3 : The "Average Time to Fill Vacancies" descend from 10 to 8 over a (120,180) timeframe: from workforce sector.

Fig. 10 depicts the passive, nonlinear, and linearized trajectories for inventory, labor, and vacancies on axes, respectively, for variation, growth, and fluctuation. A pre-process *fit_transform* has been performed on the trajectories to scale the KPIs values to be able to have a vis-a-vis study. This procedure allows simultaneous investigation of trajectories despite different units of indicators (e.g., the Inventory unit is "product" while the Labor unit is "person"). First, the *MinMaxScale* estimator scales and translates each KPI individually such that it is in the given range

(in this experiment, between zero and one instead of the actual values of KPIs); then, the *fit* method calculates the mean and variance of each present feature in the data. The *transform* method transforms all the KPIs through respective mean and variance. Note that in contrast to nonlinear and linearized plots, the supplied passive trajectory plots for Velocity and Acceleration in Fig. 10 depict actual values rather than scaled values due to the significant difference between passive and active trajectories. In addition to this justification, Fig. 10 tries to illustrate the main objective of the study rather than comparisons between passive and active trajectories (actual performance distinctions), which is performance shifts in nonlinear and linearized systems.

Essentially, the coupled inventory-workforce model has been designed in a way that system dynamicity through parameter configuration and tuning fulfills the system demands over time. In other words, through parameter configuration and regularization, the applied forces to the system are neutralized as time passes (e.g., see the tail of the plot for displacement in Fig. 10). Similarly, in physics, the "restoring force" is a force that acts to bring a body to its equilibrium position. The restoring force is always directed back toward the system equilibrium position that depends only on the mass or particle position (the same as the system viewed as an object in this study) [25].

The applied forces, f_1 , f_2 , and f_3 , have been chosen so that the linearization significantly estimates the nonlinear system. In other words, the applied forces are not drastic (e.g., raising the "safety stock coverage" from 2 to 4 units), meaning that the linear system is only an approximation that holds for slight deviations from equilibrium. This keynote highlights the inefficiency of decision aggregation in linearization technique under crisis-like circumstances with drastic variations in system parameters (applied forces to the system). Despite the resemblance between the displacement and velocity plots, the striking difference in the acceleration (fluctuation) plot (i.e., how strongly or weakly the KPIs fluctuate in the system's performance space - section 3.1)

between nonlinear and linearized systems demonstrates the critical role of linearization in the decision aggregation in nonlinear systems.

5. Conclusions and perspectives

This study on top of the "Physics of Decision" principles [5, 9], first tunes the simulation models to well-known physical simulation models called "state-space representation" and then addresses the aggregation of the decisions in nonlinear systems. The decision aggregation importance is that taking numerous decisions at once is cumbersome, overpriced, and unfuturistic; in contrast, taking the same decisions independently and then aggregating them is more advantageous from a financial and futuristic standpoint. This approach assists decision-makers in (i) exploring a variety of strategies and taking the best ones, (ii) allocating resources firmly, and (iii) driving the system toward its objectives through constant avoidance of determined risky zones and proximity to safe areas (targeted objectives) in the system performance space built on systems indicators, that allows them to be more readily in seizing opportunities and avoiding risks. The work's significance has been examined in the experiment section, first with an outdated but illustrative example from the Bass Diffusion model, after with a nonlinear model of an inventory-workforce system developed with the System Dynamic modeling.

Three primary places are listed below to develop the presented work and further research. (i) Model: the presented work deals with System Dynamic models implemented with Ordinary Differential Equations (ODEs); however, including alternative simulation approaches such as agent-based modeling (ABM), discrete event modeling (DEM), and others is an essential development aspect, (ii) Visualization: although the performance space is not limited to three dimensions, examining more than three KPIs concurrently is impossible. Virtual reality (VR) technologies could map and analyze how system inputs affected the performance trajectory for several KPIs at once to look at how they are related, and (iii) Complexity: A comprehensive sensitivity analysis of the system's inputs and outputs could help in determining the impact pattern of inputs and outputs (such as linear, waveforms (sine, square, triangular, ramp), etc.) to examine the performance trajectory of both with and without them as well as to decompose the performance trajectory into multiple trajectories with distinct patterns to have a rigorous linearization.

CRedit authorship contribution statement

Nafe Moradkhani: Conceptualization, Data curation, Formal analysis, Investigation, Methodology, Writing - Original draft preparation. **Frederick Benaben:** Supervision, Conceptualization, Investigation, Writing - review & editing. **Benoit Montreuil:** Supervision, Writing - review & editing. **Matthieu Lauras:** Supervision, Investigation, Writing - review & editing. **Thibaut Cerabona:** Validation, Visualization, Writing - review & editing. **Clara LeDuff:** Validation,

Visualization. **Louis Faugere:** Validation, Writing - review & editing. **Julien Jeany:** Writing - review & editing.

References

- [1] D. Bouyssou, Modelling inaccurate determination, uncertainty, imprecision using multiple criteria, in: A. G. Lockett, G. Islei (Eds.), *Improving Decision Making in Organisations*, Springer Berlin Heidelberg, Berlin, Heidelberg, 1989, pp. 78–87.
- [2] J. N. Gupta, G. A. Forgie, M. Mora, *Intelligent decision-making support systems: foundations, applications and challenges* (2007).
- [3] T. Ilin, L. Varga, The uncertainty of systemic risk, *Risk management* 17 (4) (2015) 240–275.
- [4] J. Reiner, R. Vaziri, Structural analysis of composites with finite element codes: an overview of commonly used computational methods, *Comprehensive composite materials II* (2018) 61–84.
- [5] F. Benaben, L. Faugere, B. Montreuil, M. Lauras, N. Moradkhani, T. Cerabona, J. Gou, W. Mu, Instability is the norm! a physics-based theory to navigate among risks and opportunities, *Enterprise Information Systems* 16 (6) (2022) 1878391.
- [6] D. Rowell, State-space representation of lti systems, URL: <http://web.mit.edu/2.14/www/Handouts/StateSpace.pdf> (2002) 1–18.
- [7] T. Miquel, State space modelling, Master, ENAC, France, < hal-02987750v2 (2021).
- [8] W. Briggs, *Uncertainty: the soul of modeling, probability & statistics*, Springer, 2016.
- [9] N. Moradkhani, F. Benaben, B. Montreuil, M. Lauras, J. Jeany, L. Faugere, Multi-criteria performance analysis based on physics of decision—application to covid-19 and future pandemics, *IEEE Transactions on Services Computing* (2022).
- [10] H. A. Simon, *The new science of management decision*. (1960).
- [11] C. Bellepeau, H. Bergere, C. Thevenet, N. Moradkhani, T. Cerabona, F. Benaben, Use of physics of decision to assess how covid-19 impacted air pollution, in: *ISCRAM 2022-19th International Conference on Information Systems for Crisis Response and Management, ENIT; ISCRAM, 2022*, pp. p–887.
- [12] N. Moradkhani, H. Dolidon, F. Benaben, Persistent physics-based crisis management framework: A case study of traffic in the nantes city due to flood exposure (2022).
- [13] N. Moradkhani, F. Benaben, B. Montreuil, M. Lauras, C. Le Duff, J. Jeany, An intelligent decision support system inspired by newton's laws of motion, in: *Intelligent Decision Technologies*, Springer, 2022, pp. 523–533.
- [14] T. Cerabona, M. Lauras, J.-P. Gitto, B. Montreuil, F. Benaben, Atomic supply chain modelling for risk management based on scor, in: *Working Conference on Virtual Enterprises*, Springer, 2021, pp. 601–610.
- [15] N. Moradkhani, F. Benaben, B. Montreuil, A. V. Barenji, D. Nazzal, Physics of decision for polling place management: a case study from the 2020 usa presidential election, in: *ICMS 2021-15th International Conference on Modeling and Simulation*, Vol. 15, 2021, pp. 440–448.
- [16] T. Cerabona, F. Benaben, B. Montreuil, A. V. Barenji, D. Nazzal, Physics of decision: Application to polling place risk management, in: *2021 Winter Simulation Conference (WSC)*, 2021, pp. 1–12. doi: [10.1109/WSC52266.2021.9715471](https://doi.org/10.1109/WSC52266.2021.9715471).
- [17] C. Le Duff, J.-P. Gitto, J. Jeany, R. Falco, M. Lauras, F. Benaben, A physics-based approach to evaluate crisis impacts on project management, in: *ISCRAM 2022-19th International Conference on Information Systems for Crisis Response and Management, ENIT; ISCRAM, 2022*, pp. p–134.
- [18] S. N. Kumpati, P. Kannan, et al., Identification and control of dynamical systems using neural networks, *IEEE Transactions on neural networks* 1 (1) (1990) 4–27.
- [19] N. B. Haaser, *Real analysis*, Courier Corporation, 1991.
- [20] M. Enqvist, *Linear models of nonlinear systems* (2005).
- [21] M. R. Taylor, P. Bhatwala, Linearization of nonlinear differential equation by taylor's series expansion and use of jacobian linearization process, *International Journal of Theoretical and Applied Science* 4 (1) (2011) 36–38.

- [22] H. M. Youssef, N. A. Alghamdi, M. A. Ezzat, A. A. El-Bary, A. M. Shawky, A new dynamical modeling seir with global analysis applied to the real data of spreading covid-19 in saudi arabia, *Math. Biosci. Eng* 17 (6) (2020) 7018–44.
- [23] M. Baran, Diffusion of innovations in the systems thinking approach, *Management business innovation* (6) (2010) 52.
- [24] J. Sterman, *Business dynamics*, Irwin/McGraw-Hill c2000..., 2010.
- [25] T. J. Rogers, T. Friis, A latent restoring force approach to nonlinear system identification, *Mechanical Systems and Signal Processing* 180 (2022) 109426.

4

Conclusion and Perspectives

| | | |
|-----|---|----|
| 4.1 | Research Summary | 87 |
| 4.2 | Research Contributions | 88 |
| 4.3 | Future works and perspectives | 89 |

4.1 Research Summary

The present work strives to propose a novel attitude to overcome the limits in the decision-making context. The study based on the foundations of the Physics of Decision theory aims at bringing classical physics into the decision-making realm by providing a Decision Support System built on physical laws of motion. The targeted systems to investigate are STSs with entangled connections between people and technology in executive development. The approach is to decompose, as much as feasible, the parameters and conditions involved in the activities (*i.e.*, choices) that decision-makers are disposed (or sometimes obliged) to take. Two virtual orthogonal spaces are defined to separate the system's performance from its parameters (as well as the ones from its environment)—the first space is constructed on its Key Performance Indicators (KPIs), while the second one is on the system attributes (and its environment characteristics). The originality is perceiving risks and opportunities as physical forces that vary the position of an object—considered the equivalent for the system—in back-and-forth movements toward or far from its targeted places. The performance space's targeted places, which the system managers seek to reach, are shaped by the preferred quantitative values of KPIs there. Therefore, the objective is to characterize the forces that the system might undergo and ultimately discover the optimum combinations of existing ones to navigate the system toward its stated targets in the Performance Space.

Two steps in characterizing the forces—force identification and force assessment—are defined to investigate their nature, source, and properties. The last step in evaluating the forces aims to find affordable combinations of those at hand in the system's navigation toward the targeted parts of the performance space. The first two steps are performed in the designated space for system attributes and environmental characteristics, while the third step (evaluation of forces) requires joining the two designated spaces. The present work focuses on creating connections between spaces and leads off to evaluate the potential forces.

Following the introduction of the research study and the scope of this study's contributions, the literature review section addresses the following subjects and subsequently discusses the POD framework for each one.

1. The physics-inspired research works in several areas (social phenomena, economics, psychology, etc.),
2. The rationale of decision-making with a focus on the prescriptive decision theory domain—is related to providing tools and conceptual models to help non-ideal decision-makers, against unconscious machines, improve their decision-making processes,
3. General background of Decision Support Systems (DSSs), including a discussion on the model-oriented types and their application domains,
4. Exclusive discussions on the Bounded Rationality hypothesis on the defects and limits of human-being in decision-making and the proposed activities to lessen them,
5. The existing tools and technologies in the DSS area and their maturity on the suggested activities followed by the Bounded Rationality issues—Intelligence, Design, and Choice.

The contribution section first defines a mathematical representation to represent the POD framework and then discusses the potential approaches to solve the provided model. The POD framework is set on a differential equation (DE) model in which, on the one hand, the system's parameters (and its environment) are the equation's inputs, and their changes over time (*i.e.*, the applied forces to the system) are the equation's state variables; on the other hand, the equation's outputs represents the KPI values as the system's performance indicator. The complexities of the transition functions (i) inputs to state variables and (ii) state variables to outputs are the main challenge of this study. The supplied DE model may be solved using several approaches, which can then be applied using the relevant tools.

4.2 Research Contributions

The research contributions are centered around the proposed DE (equation 3.1) to install the POD framework between the defined spaces. The considered approaches to solving the proposed equation are (i) Modeling, (ii) precise DE, or (iii) Learning Mechanism (LM). The contribution section (section 3.2) supplied three simulation models for the Modeling approach—System Dynamics (SD), Discrete Event Simulation (DES), and Agent-based Model (ABM). Furthermore, a mathematical model for physical systems called state-space (SS) representation supplied the precise DE approach.

1. The chosen SD simulation model is dedicated to modeling the epidemic outbreak—the case study is the COVID-19 epidemic in the state of Georgia in the USA (section 3.2.1).
2. The chosen DES simulation model is dedicated to modeling the impact of disruptions on a sensitive highway to heavy traffic jam due to blockage in its specific part—the case study is the traffic in Nantes city (France) due to flood exposure of the Gesvres river (section 3.2.2).
3. The chosen ABM simulation model is dedicated to modeling the impact of facility configuration disruptions of polling locations during elections—the case study is the 2020 presidential election in the McCamish Pavilion, an indoor arena located on the campus of the Georgia Institute of Technology in Atlanta (section 3.2.3).
4. On the DE approach, the chosen state-space (SS) representation is dedicated to modeling a nonlinear manufacturing production model. Several potential perturbations (*e.g.*, safety stock coverage on inventory management, the productivity of workforces, etc.) and their influences are considered to explore some KPI-oriented concepts—for instance, variation, growth, and fluctuation of KPIs, linked to physical notations, displacement, velocity, and acceleration, respectively (section 3.2.4).

In addition to these contributions, a simulation study using SD modeling is offered, which is more physics-oriented and explores Newton's laws of motion while modeling the same use case as the DE technique (manufacturing production model). The following reference contained this study (Moradkhani et al., 2022b).

4.3 Future works and perspectives

From the vantage point of the [Physics of Decision theory](#), the current study seeks to provide a framework investigating several STSs. The presented work examined the systems as physical objects, and the potential perturbations (risks and opportunities) were viewed as physical forces acting on them. Although the physical notations slightly have been explored, the stated [Assumption](#) has exempted the study from equating the system's features to the properties of the object and subsequently exploiting the proven physical laws. The main drawback of the current study is the assumption that has been made—which envisages fundamental research to discover the relationships between the system's features and object properties. The following are future realms of study on the Learning Mechanism for the [POD](#) framework, along with research concerning the construction of the Performance space (see the details in 1.7).

1. **Construction and exploration of Performance Space.** Learning Mechanism (LM) including unsupervised Machine Learning (ML) approach (*e.g.*, clustering) could be used to identify the stated zones in the Performance Space—Target, Danger, and Accessible—and supervised ML as optimization approach (*e.g.*, classification and regression) to choose the optimum Performance Trajectory among the possible ones. Nevertheless, Reinforcement Learning based on award mechanisms could be sound to find the optimum Performance Trajectory.
2. **Performance Trajectory prediction.** Examining the behavior of Performance Trajectory independent of the [POD](#) framework (*e.g.*, lack of reliable mapping between the spaces) and exclusively from provided raw data of the system could be a research point. The envisaged Learning Mechanism is through back-propagation mechanisms in recurrent neural networks (RNN), notably long short-term memory (LSTM) neural networks—this might allow predicting the future behavior of the Performance Trajectory from the expected and previous ones.
3. **Construction of the [POD](#) framework.** The Learning Mechanism is quite promising in discovering the Φ and Ψ functions in equation 3.1. The purpose is to discover the functions through the trial-and-error mechanism and consequently come to a solution. The most promising approaches are (i) Physics-informed neural networks (PINNs), a universal type of function approximator that can embed the knowledge of any physical laws that govern a given data set in the learning process and described by partial differential equations (PDEs) and (ii) Deep Implicit Layers, known as Neural ODE, based deep equilibrium model using implicit layers—are defined through an equilibrium point of an infinite sequence of computation.

In addition to the [POD](#) framework installation perspectives, the following might be further points to investigate on the diverse subjects.

1. **Target Definition.** From the geometrical perspective, several targets might form to reach a specific value of a [KPI](#); for instance, point (one [KPI](#)), plane (two [KPIs](#)), or volume (for more than two [KPIs](#)) with minimum/maximum values or open/closed interval on axes. A detailed examination of the Performance Space could aid in determining such geometrical forms and, as a result, provide a chance to investigate the vector-based calculations within them to identify the most suitable trajectory from the system's current position toward its objectives.

2. **Object Properties.** The considered object throughout this study was a solid object which moves on the Performance Space regarded to graded axes based on the quantitative values of **KPIs**. Exploring the **POD** framework with actual data through trial-and-error research and comparing the results with reality may provide insights into the object's true qualities over the course of several simulation campaigns runs. This viewpoint offers an opportunity to improve or lessen the effect of applied forces on the system, increasing the trajectory predictions' accuracy and, ultimately, a realistic resemblance of the system and its behavior.
3. **Energy aspect.** Quite comparable to the actual world, **STSs** may hold or release potentials according to their assets (level of their **KPIs**). The system's position or configuration of its attributes within the Performance Space may express its potential energy and could be independent of forces that undergo. In contrast to Potential Energy, Kinetic Energy is related to other resting and moving items in its immediate vicinity (*e.g.*, if the object is placed at a higher height, its kinetic energy will be higher). Therefore, Kinetic Energy could resemble the system's agility in avoiding risks and seizing opportunities due to its level of **KPIs**.
4. **Risk and Opportunity Identification.** The Performance Trajectory is shaped from the system's stationary points in the Performance Space. Examining the previous (from historical data) and inertia trajectories (only impacted by *Charge* and *Contextual* forces) might give intuitions on the system's general behavior. Therefore, predicting the future stationary points through obtained information from past and inertia trajectories could be practical in identifying the forces (risks and opportunities) and ultimately finding their most affordable combination to deviate the Performance Trajectory toward Target Zones.

Finally, the Physics of Decision is an open framework whereby leveraging classical **DSSs**, specific studies might be made. Future works could center on how possible events can be broadly described in more detail, akin to physical phenomena in the real world. For instance, force fields could be sound to employ: Relevant evaluation dimensions of the system and its environment allow identifying different types of force fields. For example, aiming at directing the object (so-called system) to the system's target zones, the investigation could be interested in its critical attributes (*e.g.*, speed, location, radiation, temperature, etc.). Consequently, the related force fields could be regarded (*e.g.*, gravitational fields, magnetic fields, etc.). Then, each distinct contextual element from the system's environment might be seen as a relevant force field with a directional and measurable magnitude at every place. Similarly, the system might be deemed as a force field-sensitive element (*e.g.*, equivalent to the "Lorentz force¹" for a charged particle in an electromagnetic field). However, leaning on the sort of system and potential events that might face, other force-based physical laws such as Newton law² and Colomus³ law could be employed.

¹ $F = q(E + V) \times B$

² $F = ma$

³ $F = q_1 q_2 / r^2$

Résumé étendu en français

La physique touche toutes les facettes de la vie humaine. Elle permet de comprendre l'univers et le monde naturel et une grande partie de la technologie d'aujourd'hui et de demain repose sur les connaissances extraites de la physique. La physique fournit la compréhension fondamentale nécessaire pour les avancées technologiques qui continueront à alimenter les moteurs économiques mondiaux, ainsi que l'infrastructure technique et les compétences nécessaires pour tirer parti des avancées scientifiques et des découvertes. Cette recherche s'intéresse à utiliser la physique pour comprendre le comportement des systèmes complexes en réponse aux perturbations et tirer parti des lois physiques pour minimiser les perturbations et maximiser les opportunités.

La décision est le processus de sélection d'une action parmi plusieurs options en fonction de la pensée, de l'expérience et des sens. La théorie de la décision traite de la prise de décision en attribuant des probabilités aux éléments. Il existe trois branches de la théorie de la décision: normative, descriptive et prescriptive. La théorie normative de la décision se concentre sur l'identification des décisions optimales en supposant un décideur rationnel avec une précision parfaite. La théorie descriptive de la décision examine les régularités dans la prise de décision, tandis que la théorie prescriptive de la décision explique comment prendre de meilleures décisions. Un système d'aide à la décision (**DSS**) est un système d'information utilisé pour aider à la prise de décision dans les organisations et les entreprises, en particulier dans des situations dynamiques et difficiles. Le **DSS** peut être automatisé, exploité par des individus ou une combinaison des deux.

Le système socio-technique (**STS**) est une structure complexe qui reconnaît l'interconnexion entre les personnes et la technologie dans le développement exécutif. Le terme "socio-technique" désigne le réseau complexe de relations humaines, de technologies et d'opérations qui composent des infrastructures sophistiquées. La théorie socio-technique (**STT**) se concentre sur l'optimisation conjointe des éléments techniques et sociaux dans un lieu de travail, dans le but d'améliorer les performances du système. Les deux principes fondamentaux de la **STT** sont : (1) les éléments sociaux et techniques interagissent pour produire une performance efficace ou déficiente et (2) une optimisation conjointe entre les systèmes socio et techniques est nécessaire pour éviter des relations destructives. La **STT** propose des méthodes d'optimisation collaborative et se concentre sur la conception de structures de système qui aboutissent à la productivité. Le but principal de cette étude est basé sur les définitions et explications de la **STT**.



Cette étude présente une approche basée sur la physique pour développer un système de support à la décision mettant l'accent sur la théorie décisionnelle prescriptive en soutien de la théorie socio-technique pour les systèmes socio-techniques.



L'étude présentée dans la Figure 1.1 est une approche basée sur la physique pour comprendre les options disponibles et leurs décisions de déclenchement associées ou les événements incontrôlés pour la gestion et la prise de décision dans des situations incertaines. Ces options sont classées en risques et opportunités et sont considérées comme des forces physiques impactant les performances du système. L'étude considère un système sociotechnique qui fait face à des potentiels internes et externes. Les potentiels internes incluent les charges et les innovations, tandis que les potentiels externes incluent les caractéristiques de l'environnement et les interactions. Les potentiels peuvent créer des forces qui impactent le système et peuvent être de deux types infligées ou gérées. L'étude se base sur la théorie décisionnelle prescriptive pour décrire les changements du système et identifier les décisions optimales. La gestion du système sociotechnique vise à atteindre des objectifs à court, moyen et long terme, qui sont généralement suivis à l'aide d'indicateurs de performance clés (KPIs). Cette gestion vise à faire évoluer les indicateurs de performance vers des valeurs objectives de KPIs.

Cette étude se concentre sur le développement d'un modèle théorique et mathématique pour représenter les risques et les opportunités en tant que forces physiques impactant le système considéré comme un objet dans son Espace de Performance. Les principales finalités sont les suivantes: (i) premièrement, définir une méthode pour identifier les forces (leur nature et leurs sources), (ii) deuxièmement, évaluer les forces identifiées (apprendre leur comportement) (La caractérisation de la force répond à ces deux objectifs), (iii) troisièmement, évaluer l'impact des forces (juger, mesurer et examiner ce qui a été appris). La caractérisation de la force répond à cet objectif. Il y a trois exigences pour construire le cadre basé sur la physique.

- Exigence 1 : Un espace à critères multiples est nécessaire pour explorer les indicateurs clés de performance (KPIs) des systèmes socio-techniques dans le temps - les déterminer avec objectivité, les présenter avec actualité et les analyser en fonction de la potentialité. Cet espace, appelé Espace de Performance, permet également de poursuivre la performance globale du système et une étude entre les KPIs.
- Exigence 2 : La nécessité d'un espace dédié aux forces avec la capacité de décrire et de connecter le système à son environnement est inévitable. Cet espace doit (i) examiner de manière dynamique (observer, mettre à jour et changer) les étapes de la Caractérisation des forces (identification et évaluation) et (ii) décrire adéquatement le système observé, son environnement et les relations - les connexions, les interactions - entre eux.
- Exigence 3 : La raison pour les déviations de trajectoire est enracinée dans les forces appliquées au système, représentées dans son Espace de Performance (section 1.2). D'une part, l'Espace de Performance affiche cette trajectoire et ses mouvements alternatifs en direction des objectifs du système (montrés sous forme de zones cibles dans la Figure 1.3); d'autre part, l'Espace de Description examine les raisons de ces déviations et la configuration de la trajectoire. Un cadre qui traite de manière synchrone la trajectoire de performance et les raisons de ses déviations, qui fournit une enquête approfondie de l'Évaluation des forces (section 1.5), est présenté comme la dernière Exigence dans le paragraphe suivant.

Le cadre “Physique de la décision” (POD), qui est au cœur de cette étude, lie (relie et ajuste) l’Espace de Description (Figure 1.5) à l’Espace de Performance (Figure 1.3). Cette connexion présente les relations entre les dimensions du système et de son environnement (Espace de Description) aux indicateurs de performance considérés (Espace de Performance). De plus, cette carte entre les espaces permet d’examiner les relations causales bidirectionnelles entre eux. La Figure 1.6 illustre les espaces concaténés.

Questions de recherche

Ce travail vise à fournir un système d’assistance à la décision pour les systèmes complexes dans des environnements incertains. La théorie de la physique de la décision regroupe une large variété d’études dans la revue de la littérature concernant la gestion des risques, les systèmes de gestion de la performance et la modélisation des systèmes. La physique de la décision est une théorie ouverte pour servir dans presque tout système dépendant du temps. L’ambition principale est de bénéficier de la physique classique pour (i) considérer un système socio-technique comme des objets ou volumes physiques (solides rigides ou poreux, liquides, gazeux, etc.); (ii) équilibrer les caractéristiques du système aux propriétés de l’objet ou volume (masse, viscosité, amortissement, etc.); (iii) relier les perturbations du système à des phénomènes physiques (par exemple, forces, pressions, tensions, chaleur, etc.); (iv) interpréter les performances du système à travers des notations physiques (par exemple, déplacement, vitesse, accélération, etc.); et (v) exploiter les lois physiques éprouvées pour trouver la décision optimale (réduire les risques et renforcer les opportunités) dans la navigation du système pour atteindre ses objectifs visés dans un espace virtuel multidimensionnel construit sur ses critères (KPIs).

L’installation du cadre POD (Exigence 3) est le principal besoin de l’approche basée sur la physique de cette étude pour gérer les risques et les opportunités dans les systèmes socio-techniques. Autrement dit, le cadre POD rassemble d’examiner le système, son environnement, les forces (risques et opportunités) auxquelles le système peut être confronté et leur influence sur les performances du système. Voici les principales questions concernant l’installation du cadre POD (section 1.6 et Figure 1.6) en tant que contribution principale de cette étude.



- Quelles sont les approches possibles pour concevoir le cadre POD (mapper l’Espace de Description sur l’Espace de Performance et vice versa) ? En d’autres termes, quelles sont les possibilités de formuler avec précision ou approximativement la structure du système et de son environnement par rapport à ses performances ?
- Quelles sont les approches de la littérature existante qui pourrait participer à la conception du cadre POD ? En d’autres termes, qui sont-elles et comment sont-elles utilisées dans différents systèmes avec des applications spécifiques ?



Etat de l’art

Ce chapitre vise à réduire les complexités de la prise de décision en étudiant les approches existantes dans les domaines connexes et en les utilisant en fonction de règles standardisées et éprouvées pour examiner les systèmes socio-techniques. Le cadre “Physique de la Décision” introduit dans le chapitre 1 utilise la physique classique pour étudier le système en considérant les risques et les opportunités comme des forces physiques agissant sur le

système dans un espace multidimensionnel construit sur ses indicateurs clés de performance. Le cadre proposé sert de système d'aide à la décision pour faciliter le processus de prise de décision et fonctionne comme un outil prescriptif. Le chapitre discute de la motivation pour le cadre, des principes fondamentaux des systèmes d'aide à la décision et d'une comparaison des systèmes d'aide à la décision dans la littérature avec les caractéristiques du cadre **POD** pour faire face aux complexités de la prise de décision.

L'étude discute de l'application de différentes branches de la physique dans la prise de décision et les activités sociales. La physique sociale étudie les phénomènes sociaux de la même manière que les phénomènes physiques et a récemment été utilisée pour analyser la pandémie de COVID-19. L'éconophysique utilise des concepts de physique pour aborder les problèmes économiques. La psychophysique a été mise au point pour expliquer la relation entre le corps et l'esprit et a fourni des moyens de mesurer la sensation. La théorie du champ étudie comment les individus interagissent avec leur environnement et le modèle de changement de Lewin comprend les étapes de décongélation, de changement et de reconstitution. Le cadre **POD** vise à établir un cadre d'ingénierie inverse pour l'analyse mécanique du développement des systèmes socio-techniques. Voici le résumé du contexte de cette étude.

1. **Théorie de la Décision.** La section discute du domaine interdisciplinaire de la théorie de la décision, qui vise à comprendre la prise de décision rationnelle et à fournir des hypothèses précises à ce sujet. Le domaine inclut des recherches provenant de différents domaines tels que l'économie, les mathématiques, la psychologie et l'informatique. La théorie de la décision comportementale et la théorie du choix prospectif sont deux approches qui ont été étudiées. La théorie de la décision peut être décrite comme descriptive, normative ou prescriptive. La théorie descriptive de la décision caractérise les choix que font les individus, la théorie normative explique comment les individus devraient prendre des décisions et la théorie prescriptive aide les individus à prendre de meilleures décisions. La théorie de la décision prescriptive cherche à répondre à la question de comment les individus peuvent améliorer leur prise de décision et quels outils et cadres pourraient être utiles pour les décideurs réels.
2. **Gestion des Performances** La gestion de la performance est le processus de veille à ce qu'une collection d'actions et de résultats atteigne efficacement et efficacement les objectifs d'une organisation. Elle peut se concentrer sur une organisation, un département, un employé ou un processus et est utilisée dans divers contextes, y compris le lieu de travail, les écoles, les rassemblements communautaires, les équipes sportives, les centres de santé, les agences gouvernementales et les environnements politiques. L'objectif est de faire correspondre les objectifs à long terme aux poursuites à court et à moyen terme pour améliorer l'efficacité, la productivité et la rentabilité. La gestion de la performance du système se concentre sur la manière dont les systèmes de gestion, les processus et les produits transposent la mission déclarée d'un système en pratique. Dans le cadre du modèle **POD**, le focus est sur des objectifs particuliers, exprimés par des valeurs numériques des indicateurs clés de performance, dans l'Espace des Performances, quelle que soit le type de système ou la pertinence des indicateurs clés de performance pour les objectifs du système.

Un système d'aide à la décision (**DSS**) est un système logiciel interactif qui aide les décideurs à prendre des décisions informées en fournissant des informations, des analyses et des modèles à partir de données. Le **DSS** ne prend pas de décisions pour l'utilisateur, mais offre un soutien pour la prise de décision. Le **DSS** peut utiliser des modèles de décision, l'analyse de données de transaction ou des sources de données externes pour générer des informations et doit fournir des informations rapides, fiables et complètes. Steven Alter

a proposé une taxonomie du **DSS** en 1978 qui comprend 7 types allant du **DSS** orienté données (comme les systèmes de classement et les systèmes d'analyse de données) au **DSS** orienté modèles (comme les modèles comptables et financiers, les modèles de simulation, les modèles d'optimisation et les modèles de suggestion). Le but du **DSS** est d'aider les décideurs à considérer plusieurs scénarios, à analyser plus d'options et à prendre en compte l'incertitude. Un résumé sur la catégorisation est dans le suivant, en insistant sur le fait que le **POD** est principalement dans le **DSS** orienté modèle.

1. **DSS** orienté données incluent :

- (a) Les systèmes de classement pour accéder aux éléments de données (réapprovisionnement d'inventaire, systèmes de surveillance, OLTP)
- (b) Les systèmes d'analyse de données pour le traitement de données à l'aide d'opérateurs et d'outils spécialisés/génériques (applications de data warehouse)
- (c) Les systèmes d'information d'analyse pour accéder à des bases de données orientées décision et des modèles compacts (OLAP)

2. **DSS** orienté modèle incluent :

- (a) Les modèles comptables et financiers pour l'analyse "what-if" et les options de prise de décision (estimations d'états financiers et de bilan)
- (b) Les modèles représentatifs pour la simulation à l'aide de relations causales et de concepts comptables (simulation d'équipements et de processus industriels)
- (c) Les modèles d'optimisation pour trouver les meilleurs résultats en prenant en compte les restrictions (planification, allocation de ressources, optimisation de matériaux) Suggestion models for logical processing leading to advised choice for structured/well-understood tasks (bond bidding, log-cutting, credit scoring).
- (d) Les modèles de suggestion sont des systèmes de calcul qui fournissent des recommandations pour des tâches structurées. Des exemples incluent la mise aux enchères optimale de bons, un système d'aide à la décision utilisant la découpe de journaux et le scoring de crédit.



Le cadre **POD** présenté dans le chapitre 1 sert de système d'aide à la décision basé sur la physique pour les **STS**. En termes de caractéristiques et de types de systèmes d'aide à la décision, le cadre **POD** est étudié à partir de deux angles principaux : (i) la modélisation des **STS** et de son environnement et (ii) la modélisation des perturbations internes et externes du système (risques et opportunités) en tant que forces physiques affectant le système.



Théorie de la rationalité limitée

La théorie de la rationalité limitée (Bounded Rationality Theory), proposée par Herbert Simon, suggère que la rationalité des individus dans la prise de décision est limitée par des contraintes cognitives et sociales, et qu'ils choisissent donc des solutions satisfaisantes plutôt que des solutions optimales. La théorie affirme que la complexité du problème de prise de décision, la capacité cognitive de l'esprit et les contraintes temporelles contribuent toutes à cette rationalité limitée. Dans la perspective de Simon, les décideurs agissent en tant que satisfacteurs, cherchant une solution qui satisfait leurs besoins plutôt que de mener une analyse coûts-avantages approfondie. Dans le contexte des **DSSs**, cette théorie met en lumière la nécessité d'une évaluation continue de la fiabilité des modèles de SDS, car les hypothèses et les prémisses sous-jacentes peuvent changer au fil du temps. Simon suggère

certaines activités pour minimiser l'impact de la rationalité limitée dans la prise de décision organisationnelle. Ce qui suit explique brièvement ces trois activités en se basant sur son livre, "Administrative Behavior" (Simon, 1950).

La prise de décision peut être une tâche difficile, surtout lorsque nous sommes incertains quant à l'issue de la décision que nous prenons ou lorsque nous manquons de connaissances sur le sujet sur lequel nous prenons une décision. Les compétences en matière de prise de décision sont devenues cruciales dans le monde du travail actuel, avec les gestionnaires et les responsables d'équipe travaillant à atteindre leurs objectifs organisationnels. La théorie de la prise de décision proposée est établie en explorant les traits de la prise de décision des personnes occupant des postes administratifs dans les organisations. L'hypothèse affirme qu'il existe trois étapes impliquées dans la formation de décisions: les activités de "Intelligence", de "Design" et de "Choice".

L'activité d'Intelligence consiste à identifier les problèmes dans les organisations et à tenter de rassembler des données et des informations pour développer des solutions possibles. Compte tenu que les solutions possibles ont trouvé plusieurs moyens différents de surmonter un problème particulier, il est maintenant temps d'examiner chaque solution et de dresser la liste de ses avantages et inconvénients; cela se fait dans la deuxième étape, connue sous le nom d'Activité Design. Enfin, lorsque les solutions et leurs avantages et inconvénients sont examinés, les décisions ayant le résultat le plus souhaitable sont sélectionnées; étant donné que chaque décision comporte des conséquences, ce processus est assez difficile car il nécessite une variété de compétences telles que la capacité à juger entre les solutions de manière équitable, un sens de la créativité et bien sûr une expérience antérieure dans le contexte du problème. Cette étape est connue sous le nom d'Activité Choice.

Selon la proposition de Simon, la Figure 2.2 présente la relation entre les activités. Le processus de prise de décision comporte deux chaînes : la chaîne Intelligence-Design-Choix en avant (représentée par des flèches bleues) et la chaîne Choix-Design-Intelligence en arrière (représentée par des flèches rouges). La chaîne arrière est le résultat de déficiences dans la chaîne avant (découverte de problèmes, découverte de solutions ou choix de solutions). Les deux chaînes sont combinées et les relations entre les activités sont conclues.

► Chaîne avant

- **Intelligence** ⇒ **Design**. Cette étape transfère le problème identifié et les données acquises de l'activité Intelligence pour générer des solutions et des alternatives pour le problème en question à travers l'activité Design.
- **Design** ⇒ **Choix**. Cette étape transfère les solutions et alternatives découvertes de l'activité Design pour examiner et finalement sélectionner les solutions les plus souhaitables à travers l'activité Choix.

► Chaîne arrière

- **Choix** ⇒ **Design**. Cette étape est effectuée lorsque aucune des solutions découvertes de l'étape Design ne fournit de résultats satisfaisants.
- **Design** ⇒ **Intelligence**. Cette étape est prise lorsque la solution ou alternative découverte n'a pas été bien examinée (c'est-à-dire qu'il y a une connaissance insuffisante de ses avantages et inconvénients).

Le cadre POD est basé sur la "Théorie prescriptive de la décision" et vise à couvrir les activités "Intelligence", "Design" et "Choice" dans les étapes de Caractérisation de la force

et d'Évaluation. L'intégration du cadre **POD** dans les activités proposées par Simon est brièvement expliquée.

En étapes successives, (i) construire les espaces "Description" et "Performance" et leur relation les aide à identifier le problème et les solutions potentielles (Activité Intelligence), (ii) construire le "Mapping" entre les deux espaces permet d'examiner les solutions (Activité Design), et enfin, (iii) explorer les "Control Spaces" fournit l'action la plus souhaitable obtenue en contrôlant (créant ou éliminant, puis en sélectionnant) les forces gérées (Activité Choice). La Figure 2.3 résume ces justifications.

Outils et Technologies en DSS

Cette section examine l'utilisation d'outils et de technologies de prise de décision pour simplifier le processus de décision et soutenir les décisions non programmées. La Physique de la décision vise à créer une théorie générale pour la gestion des performances et la technologie de prise de décision fondée sur des lois physiques. La théorie se concentre sur les perturbations imprévues qui entraînent des risques et des opportunités, principalement associées à des décisions non programmées. Les outils et les technologies sont classés en automatisés, manuels et semi-automatisés, et ils aident à réduire les effets de la rationalité limitée en améliorant l'intelligence, la conception et les activités de choix.

Dans la Figure 2.4, les principaux outils et technologies pour la gestion des performances et la prise de décision (c'est-à-dire les **DSS**) sont succinctement et qualitativement décrits, ainsi que leur signification pour les aspects Intelligence, Design et Choice. Les tranches du cercle sont colorées pour symboliser ces aspects et évaluées sur une échelle de trois pour les niveaux de maturité bas, moyen et élevé. Le cadre **POD** (mis en évidence en couleur noire) est censé recevoir un score total dans les trois aspects, en mettant l'accent sur sa force dans le domaine de l'Intelligence (indiqué en couleur rouge). L'approche de simulation (SIM) est reconnue comme étant la plus avantageuse (tout en étant la plus concurrentielle) par rapport au cadre **POD** (indiqué en couleur jaune).

En résumé, la section état de l'art discute d'un cadre basé sur la physique qui soutient la Théorie de la Décision Prescriptive. La théorie **POD** est conçue pour aider les décideurs non idéalisés à prendre de meilleures décisions, et est inspirée d'approches bien établies dans la littérature telles que la sociophysique, l'éconophysique, la psychophysique et la théorie des champs. Le cadre **POD** repose sur l'hypothèse que les phénomènes sociaux peuvent être étudiés en utilisant les lois et les principes de la physique classique, et sert de système d'aide à la décision (**DSS**) pour soutenir les décisions opérationnelles, tactiques et stratégiques. Le cadre est conçu pour aborder les problèmes dans les processus de prise de décision liés à la Théorie de la rationalité limitée et est également discuté en termes de ses caractéristiques et de ses relations pour soutenir la Raison Borne. L'article examine également plusieurs outils et technologies **DSS** importants, avec l'approche de simulation considérée comme la plus appropriée pour l'examen du système et de son environnement en raison de sa capacité à gérer les changements en temps réel.

Contributions de la Thèse

La section de contribution définit d’abord une représentation mathématique pour représenter le cadre **POD** (Figure 1.6) et examine ensuite les approches potentielles pour résoudre le modèle fourni (Équation 3.1). Le cadre **POD** est basé sur un modèle d’équation différentielle (ED) dans lequel, d’une part, les paramètres du système (et son environnement) sont les entrées de l’équation et leurs changements au fil du temps (c’est-à-dire les forces appliquées au système) sont les variables d’état de l’équation; d’autre part, les sorties de l’équation représentent les valeurs **KPI** en tant qu’indicateur de performance du système. Les complexités des fonctions de transition (i) entrées à variables d’état et (ii) variables d’état à sorties sont le principal défi de cette étude. Le modèle ED fourni peut être résolu à l’aide de plusieurs approches, qui peuvent ensuite être appliquées à l’aide des outils pertinents.

La représentation mathématique du cadre **POD** (Équation 3.1) est une vision générale et convient à presque tous les systèmes dépendants du temps. Cependant, découvrir les fonctions Φ et Ψ est un défi considérable et presque impossible pour la plupart des systèmes socio-techniques en raison de plusieurs comportements imprévus et chaotiques (par exemple, actions, mouvements, décisions, etc.) des individus dans des environnements divers. En effet, l’aspect social des systèmes socio-techniques entraîne des fonctions non linéaires et dynamiques de Φ et Ψ qui changent fréquemment en raison du comportement complexe des individus.

En résumé, le cadre **POD** est obtenu en déterminant les fonctions Φ et Ψ dans l’équation 3.1. L’ambition est de résoudre cette “équation différentielle” (ED) entre les Espaces Description et Performance qui offrent ensuite la possibilité de découvrir les lois physiques du mouvement. Les trois approches suivantes sont proposées en fonction de la difficulté à obtenir les fonctions Φ et Ψ : (i) modélisation, (ii) ED précise, ou (iii) mécanisme d’apprentissage (LM).

L’ED est considérée comme l’approche centrale pour établir le cadre **POD**. La modélisation sert pour une abstraction faible, plus de détails, en général, en étudiant les systèmes au niveau micro (associé à des décisions opérationnelles avec une approximation plus précise de la présentation du système). À l’inverse, le LM est employé pour une abstraction élevée, moins de détails, en général, en étudiant les systèmes au niveau macro (associé à des décisions stratégiques, avec une approximation moins précise de la présentation du système).

Le travail actuel comprend quatre contributions à l’approche de la modélisation (trois publications) et à l’approche de l’ED (une publication) tout en gardant l’approche LM (principalement avec un réseau neuronal ou NN) comme objet d’étude futur. Les contributions liées à l’approche de la modélisation incluent trois publications distinctes dédiées à l’approche de simulation comme suit : (i) gestion de l’emplacement de vote simulée avec un modèle basé sur les agents (ABM), (ii) simulation de la population affectée par une épidémie avec un modèle de simulation de dynamique système (SD), et (iii) la gestion du trafic routier effectuée avec un modèle de simulation d’événements discrets (DES).

La contribution associée à l’approche DE comprend une publication consacrée à la représentation d’espace d’état (SS), un modèle mathématique pour les systèmes physiques, pour simuler un modèle de production de fabrication. La Figure 3.2 présente un schéma général de l’approche proposée par rapport aux contributions de la thèse (les flèches bleues indiquent les publications actuelles, tandis que les flèches grises indiquent les recherches à venir). Le reste de cette section introduit les contributions de simulation et de SS pour l’installation du cadre **POD**, ainsi que plusieurs enquêtes associées aux forces potentielles et à leurs effets sur la trajectoire de performance dans l’Espace de performance du système.

Le principal objectif de ce travail, une thèse basée sur des articles, est la mise en œuvre du cadre **POD**. Les contributions de chaque sous-section sont brièvement décrites, ainsi qu’un accès en ligne aux articles.

Simulation de la dynamique du système (SD)

Le cadre **POD** dans cette étude de cas est installé à travers un modèle de Dynamique des systèmes (SD) bien connu appelé Susceptible-Exposed-Infected-Recovered (SEIR). Le modèle SD comprend plusieurs équations différentielles pour la transmission d'un virus spécifique parmi une population dans une région particulière. L'Espace de Description est construit sur les dimensions de la "région" en tant que système (attributs), où le "virus" sert d'élément contextuel (caractéristiques). L'Espace de Performance est construit sur certains indicateurs clés de performance, tels que le nombre de personnes infectées, hospitalisées et décédées, pour examiner l'impact de plusieurs forces. Les forces "infligées" et "gérées" sont générées respectivement par les changements des paramètres du virus (par exemple, la période latente) et des paramètres de la région à travers les mesures de confinement pour contrôler l'épidémie (par exemple, en réduisant le taux de contact par le confinement).

Multi-criteria performance analysis based on Physics of Decision—Application to COVID-19 and future pandemics

Résumé. Le but de cette étude est de présenter une perspective nouvelle sur le soutien à la décision fondé sur le paradigme classique du modèle pandémique SEIR, en prenant en compte les risques et les opportunités en tant que forces physiques déviant la trajectoire de performance attendue d'un système. L'impact d'une pandémie est mesuré par l'écart de la trajectoire de performance du système social dans le cadre géométrique de ses indicateurs clés de performance (KPIs). Selon la base générale de l'utilisation d'équations différentielles ordinaires pour simuler les épidémies, les déviations sont liées à plusieurs interventions alternatives. Le modèle repose essentiellement sur deux ensembles de paramètres: (i) les paramètres du système social et (ii) les paramètres de la pandémie. L'objectif ultime est de proposer un cadre de performance multi-critères pour contrôler les pandémies qui inclut une combinaison de mesures opportunes. D'une part, l'étude actuelle optimise les stratégies prospectives pour contrôler la pandémie potentielle à venir, tout en explorant l'épidémie de COVID-19 dans l'état de Géorgie (États-Unis).

Mots clés. SEIR, Pandémie, Système d'aide à la décision (DSS), Gestion de la performance, Gestion des risques, Optimisation

Auteurs. Nafe Moradkhani, Frederick Benaben, Benoit Montreuil, Matthieu Luras, Julien Jeany, and Louis Faugere

Éditeur. IEEE Transactions on Services Computing (TSC)

Date de publication. 29 juin 2022

Référence. Moradkhani et al., 2022a

Accès en ligne. [Multi-criteria performance analysis based on Physics of Decision — Application to COVID-19 and future pandemics](#)

Simulation d'événements discrets (DES)

Le cadre **POD** dans cette étude de cas a été installé en simulant la rocade de Nantes avec les véhicules comme agents et les inondations sur une partie spécifique de la rocade comme événements (nommés "Perturbation Scenarios" dans l'article). L'Espace de Description a été construit sur les dimensions de la "rocade" (longueur et capacité et limite de vitesse) et du "véhicule" (flux, longueur) en tant que système (attributs), où l'"inondation" (avec son temps de début et sa magnitude en tant que paramètres) sert d'élément contextuel (caractéristiques). L'Espace de Performance a été construit à partir de certains KPIs, tels que le nombre de véhicules sur la rocade, leur vitesse moyenne, etc., pour examiner l'impact

de plusieurs forces. Les forces “infligées” et “gérées” sont respectivement générées à la fois de la rocade et de l’inondation (par exemple, les embouteillages, les inondations, respectivement) et des paramètres pour contrôler la circulation (par exemple, en ouvrant des routes alternatives pour les véhicules dans la zone inondée et en les dirigeant vers ces routes pour réduire la circulation).

Persistent physics-based crisis management framework: A case study of traffic in the Nantes city due to flood exposure

Résumé. Dans le contexte de la crise, les caractéristiques de la zone de crise et les mesures opérationnelles de la communauté jouent des rôles clés dans la gestion de la crise. La rocade de Nantes en France est toujours exposée aux inondations et à ses perturbations. Pour anticiper les perturbations et prendre des mesures préventives en temps opportun pour ce phénomène fréquent, les principaux défis sont (i) la prévision des flux de véhicules, (ii) la capacité de la rocade à gérer la circulation (iii) évaluer les performances des routes alternatives pendant les inondations. La zone inondée en tant que système comporte des composants de (i) l’inondation (par exemple, heure de début, magnitude, intensité, etc.), (ii) la zone (par exemple, caractéristiques géographiques, barrières périmétriques temporaires, barrage, canaux de dérivation) et (iii) la communauté (par exemple, temps de réaction, charge d’urgence, délai d’évacuation). L’approche choisie pour mener cette étude prospective consiste à collecter des données sur les prévisions et à utiliser des modèles de simulation pour travailler simultanément sur l’évaluation des performances de la rocade et de ses routes alternatives.

Mots clés. Informations sur les catastrophes, résilience, pour les technologies d’urgence et de crise, basées sur des agents, gestion de crise, évacuation, inondation, performance, simulation

Auteurs. Nafe Moradkhani, Hélène Dolidon, and Frederick Benaben

Éditeur. Hawaii International Conference on System Sciences (HICSS)

Date de publication. 4 janvier 2022

Référence. Moradkhani et al., 2022c

Accès en ligne. [Persistent physics-based crisis management framework: A case study of traffic in the Nantes city due to flood exposure](#)

Simulation basée sur des agents (ABM)

Le cadre POD dans ce cas d’étude a été installé en simulant le lieu de vote au McCamish Pavilion, situé sur le campus de Georgia Tech à Atlanta, pour l’élection présidentielle des États-Unis en 2020. Cette simulation a été consacrée à l’examen du flux débordant des électeurs et de la défaillance des équipements en tant qu’événements (nommés “Perturbation Scenarios” dans l’article). L’Espace de Description a été construit sur les dimensions du “lieu de vote” (nombre de récepteurs, d’officiers, d’équipements, etc.) et des “électeurs” (leur flux à des niveaux probable, optimiste et conservateur) en tant que système (attributs) où les “délais de service des équipements” (par exemple, les dispositifs de bulletin, les numériseurs, etc.) servent d’élément contextuel (caractéristiques). L’Espace de Performance a été construit à partir de certains indicateurs clés de performance, tels que le nombre d’électeurs sur place, le nombre d’électeurs en attente, le nombre de votes terminés, etc., pour examiner l’impact de plusieurs forces. Les forces “infligées” et “gérées” sont générées respectivement des électeurs et du bâtiment (par exemple, le flux et la vitesse des électeurs, le nombre d’équipements et de fournisseurs de services) et les paramètres pour accélérer le

processus de vote (par exemple, l'injection d'équipement et l'emploi de plus de fournisseurs de services).

Physics of Decision for Polling Place Management: A Case Study from the 2020 USA Presidential Election

Résumé. Dans le contexte de la pandémie mondiale, la gestion pratique de l'élection présidentielle 2020 aux États-Unis était un sujet de grande préoccupation. Pour anticiper et préparer cette élection de manière précise, un des principaux défis consistait à faire face à: (i) les prévisions de la participation électorale, (ii) les capacités des installations, et (iii) les options de configuration potentielles des ressources. L'approche choisie pour mener cette étude préventive consiste à collecter des données sur les prévisions et à utiliser des modèles de simulation pour travailler simultanément sur l'allocation de ressources et la configuration des installations de vote dans le comté de Fulton, le plus grand comté de Géorgie. Cet article présente les résultats des simulations de ces lieux confrontés à des risques potentiels pré-identifiés. Ces résultats sont orientés vers l'efficacité de ces lieux selon différents critères (santé, confiance, confort). Ensuite, un cadre dynamique est introduit pour décrire les risques en tant que forces physiques perturbant l'efficacité du système observé. Enfin, les principaux avantages et contributions découlant de cette campagne de simulation sont présentés.

Mots clés. Performance, Aide à la Décision, Simulation, Intelligence Artificielle, Gestion des Risques, Election, Pandémies, Système d'Information

Auteurs. Nafe Moradkhani, Frederick Benaben, Benoit Montreuil, Ali Vatankhah Barenji, and Dima Nazzal

Éditeur. International Journal of Industrial and Manufacturing Engineering

Date de publication. 15 juin 2021

Référence. Moradkhani et al., 2021

Accès en ligne. [Physics of Decision for Polling Place Management: A Case Study from the 2020 USA Presidential Election](#)

Méthode de représentation de l'espace d'état (SS)

Le cadre POD dans cette étude de cas a été installé en premier lieu en simulant des systèmes physiques pédagogiques (Masse-Ressort-Amortisseur et pendule) puis des systèmes de gestion (Diffusion de Bass et inventaire-main-d'œuvre, modélisés avec une approche de système dynamique). Cette simulation a été consacrée à l'examen de la combinaison et de l'agrégation des forces générées dans des systèmes non linéaires. Dans l'exemple principal, le modèle inventaire-main-d'œuvre, l'Espace de Description a été construit sur les dimensions de l'inventaire (par exemple, taux d'expédition, couverture de stock de sécurité, etc.) et de la main-d'œuvre (par exemple, taux d'embauche, taux de départ) en tant que système (attributs) où leur réglage (par exemple, nombre de travailleurs, nombre de produits, etc.) sert d'élément contextuel (caractéristiques). L'Espace de Performance a été construit sur certaines KPIs, par exemple, le nombre de postes vacants, le nombre de travailleurs, le nombre de produits terminés, etc., pour examiner l'impact de plusieurs forces. Les forces "infligées" et "gérées" ont été générées à la fois par l'inventaire et la main-d'œuvre (par exemple, pénurie de travailleurs, délai de livraison de produits, productivité du travail, etc.). La principale contribution consiste à gérer la non-linéarité en utilisant une approche de linéarisation pour les systèmes non linéaires (séries de Taylor et matrice de Jacobien), par conséquent, bénéficiant des mesures de contrôle établies pour les systèmes linéaires et invariants dans le temps (LTI).

A force-inspired paradigm for performance-based decision support—Physics of Decision application in nonlinear dynamical systems

Ce document présente une perspective sur le soutien à la décision basé sur les performances. La méthode choisie repose sur les principes de “Physique de la Décision”, qui considère la performance d’un système comme une trajectoire physique dans les limites de ses indicateurs de performance qui peuvent être déviés par la variation des paramètres du système. Selon la première hypothèse d’utilisation de la méthode de l’espace d’état pour simuler les systèmes physiques, ce travail présente une méthode d’agrégation de décisions dans les systèmes dynamiques. La principale contribution est de proposer un cadre de performance multi-critères pour gérer les performances des systèmes multi-entrées-multi-sorties (MIMO) avec une combinaison de décisions abordables. Un modèle de gestion de l’inventaire-main-d’œuvre non linéaire a été utilisé pour démontrer l’approche proposée.

Travaux futurs et perspectives

Depuis le point de vue de la théorie de la physique de la décision, l’étude actuelle vise à fournir un cadre d’investigation de plusieurs systèmes *STS*. Le travail présenté a examiné les systèmes comme des objets physiques, et les perturbations potentielles (risques et opportunités) ont été considérées comme des forces physiques agissant sur eux. Bien que les notations physiques aient légèrement été explorées, l’hypothèse énoncée a exempté l’étude d’équation des caractéristiques du système aux propriétés de l’objet et, par conséquent, d’exploitation des lois physiques éprouvées. Le principal inconvénient de l’étude actuelle est l’hypothèse qui a été faite, ce qui prévoit une recherche fondamentale pour découvrir les relations entre les caractéristiques du système et les propriétés de l’objet. Les domaines suivants sont des régions futures d’étude sur le mécanisme d’apprentissage pour le cadre *POD*, ainsi que des recherches concernant la construction de l’Espace de Performance (voir les détails à 1,7).

1. **Construction et exploration de l’Espace de Performance.** Le mécanisme d’apprentissage (LM) comprenant une approche d’apprentissage automatique non supervisée (ML) (par exemple, le regroupement) pourrait être utilisé pour identifier les zones indiquées dans l’Espace de Performance - cible, danger et accessible - et une approche d’optimisation supervisée d’apprentissage automatique (par exemple, la classification et la régression) pour choisir la trajectoire de performance optimale parmi les possibles. Cependant, l’apprentissage par renforcement basé sur des mécanismes de récompense pourrait être solide pour trouver la trajectoire de performance optimale.
2. **Prédiction de la trajectoire de performance.** En examinant le comportement de la trajectoire de performance indépendamment du cadre *POD* (par exemple, manque de mappage fiable entre les espaces) et exclusivement à partir des données brutes du système pourrait être un point de recherche. Le mécanisme d’apprentissage prévu est à travers les mécanismes de rétropropagation dans les réseaux neuronaux récurrents (RNN), notamment les réseaux neuronaux à mémoire à long terme (LSTM) - cela pourrait permettre de prédire le comportement futur de la trajectoire de performance à partir de ceux attendus et précédents.
3. **Construction du cadre *POD*.** Le mécanisme d’apprentissage est très prometteur pour découvrir les fonctions Φ et Ψ dans l’équation 3.1. L’objectif est de découvrir les fonctions à travers le mécanisme d’essai-erreur et de parvenir ainsi à une solution.

Les approches les plus prometteuses sont (i) les réseaux de neurones informés de la physique (PINNs), un type universel d'approximateur de fonction qui peut intégrer les connaissances de toutes les lois physiques qui régissent un ensemble de données donné dans le processus d'apprentissage et décrites par des équations différentielles partielles (PDEs) et (ii) les couches implicites profondes, connues sous le nom de ODE de neurones, un modèle d'équilibre profond basé sur des couches implicites - sont définies à travers un point d'équilibre d'une séquence infinie de calcul.

En plus de la construction du cadre **POD**, les points suivants pourraient être des sujets à explorer sur les différents sujets :

1. **Définition de la cible.** Du point de vue géométrique, plusieurs cibles pourraient se former pour atteindre une valeur spécifique d'un **KPI** ; par exemple, un point (un **KPI**), un plan (deux **KPIs**), ou un volume (plus de deux **KPIs**) avec des valeurs minimales / maximales ou un intervalle ouvert / fermé sur les axes. Une étude détaillée de l'Espace de Performance pourrait aider à déterminer ces formes géométriques et, en conséquence, offrir l'occasion d'étudier les calculs basés sur les vecteurs à l'intérieur d'eux pour identifier la trajectoire la plus appropriée à partir de la position actuelle du système vers ses objectifs.
2. **Propriétés des objets.** L'objet considéré dans cette étude était un objet solide qui se déplace dans l'Espace de Performance par rapport à des axes gradués en fonction des valeurs quantitatives des **KPIs**. L'exploration du cadre **POD** avec des données réelles par la recherche par essais et erreurs et la comparaison des résultats avec la réalité peut fournir des informations sur les qualités réelles de l'objet au cours de plusieurs campagnes de simulation. Cette perspective offre l'occasion d'améliorer ou de réduire l'effet des forces appliquées sur le système, d'augmenter la précision des prévisions de trajectoire et, finalement, une ressemblance réaliste du système et de son comportement.
3. **Aspect de l'énergie.** Tout à fait comparable au monde réel, les **STS** peuvent retenir ou libérer des potentiels selon leurs actifs (niveau de leurs **KPIs**). La position ou la configuration des attributs du système dans l'Espace de Performance peut exprimer son énergie potentielle et pourrait être indépendante des forces qui y sont soumises. À l'inverse de l'énergie potentielle, l'énergie cinétique est liée à d'autres éléments en repos et en mouvement dans son environnement immédiat (par exemple, si l'objet est placé à une hauteur plus élevée, son énergie cinétique sera plus élevée). Par conséquent, l'énergie cinétique pourrait ressembler à l'agilité du système dans l'évitement des risques et la saisie des opportunités en raison de son niveau de **KPIs**.
4. **Identification des risques et des opportunités.** La trajectoire de performance est formée à partir des points stationnaires du système dans l'Espace de Performance. L'examen des trajectoires précédentes (à partir des données historiques) et d'inertie (uniquement impactées par les forces de charge et contextuelles) peut donner des intuitions sur le comportement général du système. Par conséquent, la prédiction des points stationnaires futurs à partir des informations obtenues à partir des trajectoires passées et d'inertie pourrait être pratique pour identifier les forces (risques et opportunités) et, finalement, trouver leur combinaison la plus abordable pour dévier la trajectoire de performance vers les zones cibles.

Enfin, la physique de la décision est un cadre ouvert permettant de tirer parti des systèmes de décision classiques, des études spécifiques peuvent être menées. Les travaux futurs pourraient se concentrer sur la façon dont les événements possibles peuvent être largement décrits en plus de détails, similaires à des phénomènes physiques dans le monde réel. Par exemple, les champs de force pourraient être utiles à employer: les dimensions d'évaluation

pertinentes du système et de son environnement permettent d'identifier différents types de champs de force. Par exemple, en visant à diriger l'objet (appelé système) vers les zones cibles du système, l'enquête pourrait être intéressée par ses attributs critiques (tels que la vitesse, l'emplacement, la radiation, la température, etc.). Par conséquent, les champs de force associés pourraient être considérés (tels que les champs gravitationnels, magnétiques, etc.). Ensuite, chaque élément contextuel distinct de l'environnement du système pourrait être considéré comme un champ de force pertinent avec une magnitude directionnelle et mesurable à chaque endroit. De manière similaire, le système pourrait être considéré comme un élément sensible aux champs de force (par exemple, équivalent à la "force de Lorentz"⁴ pour une particule chargée dans un champ électromagnétique). Cependant, en se basant sur le type de système et les événements potentiels qui pourraient survenir, d'autres lois physiques basées sur les forces telles que la loi de Newton⁵ et la loi de Colomus⁶ pourraient être utilisées.

⁴ $F = q(E + V) \times B$

⁵ $F = ma$

⁶ $F = q_1 q_2 / r^2$

List of Figures

| | | |
|-----|--|----|
| 1.1 | Conceptual structure of physics-based DSS for STS (Benaben et al., 2022) . | 4 |
| 1.2 | Potential category | 4 |
| 1.3 | Proposed performance space of a socio-technical system | 5 |
| 1.4 | System Potentials vs. existing Forces | 7 |
| 1.5 | Description Space with system's Attributes and its environment's Characteristics | 9 |
| 1.6 | Physics of Decision framework | 12 |
| 2.1 | DSS framework proposed by Hackathorn and Keen (Hackathorn et al., 1981) | 23 |
| 2.2 | Intelligence, Design, and Choice activities and their relationships | 26 |
| 2.3 | The POD framework adjustment into the Activities & Chains (Simon, 1950) | 28 |
| 2.4 | DSS Tools and Technologies in support of activities for Bounded Rationality | 29 |
| 3.1 | Mathematical representation of the Physics of Decision framework | 36 |
| 3.2 | Outline of the thesis contributions | 37 |

Bibliography

- (Abdul Khalid et al., 2019) S. Abdul Khalid and S. Sheikh Kamaruddin. "A Social Performance Management Framework for Islamic Microfinance Institutions". In: *The Journal of Muamalat and Islamic Finance Research* (2019). DOI: [10.33102/jmifr.v16i1.208](https://doi.org/10.33102/jmifr.v16i1.208) (cit. on p. 20).
- (Alter, 1978) S. Alter. "Development patterns for decision support systems". In: *Mis Quarterly* (1978), pp. 33–42. DOI: [10.2307/249176](https://doi.org/10.2307/249176) (cit. on p. 22).
- (Anand et al., 2005) M. Anand, B. Sahay, and S. Saha. "Balanced scorecard in Indian companies". In: *Vikalpa* 30.2 (2005), pp. 11–26. DOI: [10.1177/0256090920050202](https://doi.org/10.1177/0256090920050202) (cit. on p. 31).
- (Anthony, 1965) R. N. Anthony. *Planning and control systems: a framework for analysis*. Division of Research, Graduate School of Business Administration, Harvard ..., 1965. ISBN: 9780875840475 (cit. on p. 22).
- (Armstrong, 2006) M. Armstrong. *A handbook of human resource management practice*. Kogan Page Publishers, 2006. ISBN: 9780749446314 (cit. on p. 20).
- (Ashby et al., 2013) M. F. Ashby and K. Johnson. *Materials and design: the art and science of material selection in product design*. Butterworth-Heinemann, 2013. ISBN: 9780080982823 (cit. on p. 30).
- (Averweg, 2009) U. R. Averweg. "Historical overview of decision support systems (DSS)". In: *Encyclopedia of Information Science and Technology, Second Edition*. IGI Global, 2009, pp. 1753–1758. DOI: [10.4018/978-1-60566-026-4.ch275](https://doi.org/10.4018/978-1-60566-026-4.ch275) (cit. on p. 21).
- (Backlund, 2000) A. Backlund. "The definition of system". In: *Kybernetes* (2000) (cit. on p. 1).
- (Băndoi et al., 2021) A. Băndoi, C. G. Bocean, M. Del Baldo, L. Mandache, L. G. Mănescu, and C. S. Sitnikov. "Including sustainable reporting practices in corporate management reports: Assessing the impact of transparency on economic performance". In: *Sustainability* 13.2 (2021), p. 940. DOI: [10.3390/su13020940](https://doi.org/10.3390/su13020940) (cit. on p. 20).
- (Banks, 1998) J. Banks. *Handbook of simulation: principles, methodology, advances, applications, and practice*. John Wiley & Sons, 1998. DOI: [10.1002/9780470172445](https://doi.org/10.1002/9780470172445) (cit. on p. 32).
- (Bekefi et al., 2008) T. Bekefi, M. J. Epstein, and K. Yuthas. *Managing opportunities and risks*. CMA Canada, 2008. ISBN: 1-55302-212-2 (cit. on p. 17).
- (Bell et al., 1988) D. E. Bell, H. Raiffa, and A. Tversky. *Decision making: Descriptive, normative, and prescriptive interactions*. Cambridge University Press, 1988. DOI: [10.1017/CBO9780511598951.003](https://doi.org/10.1017/CBO9780511598951.003) (cit. on p. 20).

- (Benaben et al., 2022) F. Benaben, L. Faugere, B. Montreuil, M. Lauras, N. Moradkhani, T. Cerabona, J. Gou, and W. Mu. [“Instability is the norm! A physics-based theory to navigate among risks and opportunities”](#). In: *Enterprise Information Systems* 16.6 (2022), p. 1878391. DOI: [10.1080/17517575.2021.1878391](#) (cit. on pp. xiii, 4, 6, 30).
- (Benaben et al., 2019a) F. Benaben, M. Lauras, B. Montreuil, L. Faugère, G. Juanqiong, and W. Mu. [“Physics of Organization Dynamics: An AI Framework for opportunity and risk management”](#). In: *2019 International Conference on Industrial Engineering and Systems Management (IESM)*. IEEE, 2019, pp. 1–6. DOI: [10.1109/IESM45758.2019.8948167](#) (cit. on p. xiii).
- (Benaben et al., 2019b) F. Benaben, B. Montreuil, J. Gou, J. Li, M. Lauras, I. Koura, and W. Mu. [“A tentative framework for risk and opportunity detection in a collaborative environment based on data interpretation”](#). In: *HICSS 52-52nd Hawaii International Conference on System Sciences*. 2019, 10–p. DOI: [10.24251/HICSS.2019.369](#) (cit. on pp. xiii, 17).
- (Bennet et al., 2008) A. Bennet and D. Bennet. [“The decision-making process in a complex situation”](#). In: *Handbook on Decision Support Systems 1*. Springer, 2008, pp. 3–20. DOI: [10.1007/978-3-540-48713-5_1](#) (cit. on p. 17).
- (Benneyan et al., 2003) J. Benneyan, R. Lloyd, and P. Plsek. [“Statistical process control as a tool for research and healthcare improvement”](#). In: *BMJ Quality & Safety* 12.6 (2003), pp. 458–464. DOI: [10.1136/qhc.12.6.458](#) (cit. on p. 31).
- (Borshchev et al., 2004) A. Borshchev and A. Filippov. [“From system dynamics and discrete event to practical agent based modeling: reasons, techniques, tools”](#). In: *Proceedings of the 22nd international conference of the system dynamics society*. Vol. 22. Citeseer, 2004, pp. 25–29 (cit. on p. 23).
- (Bradley, 2017) R. Bradley. [Decision theory with a human face](#). Cambridge University Press, 2017. ISBN: 978-110700321-7 (cit. on p. 19).
- (Brill et al., 1990) E. D. Brill, J. M. Flach, L. D. Hopkins, and S. Ranjithan. [“MGA: A decision support system for complex, incompletely defined problems”](#). In: *IEEE Transactions on systems, man, and cybernetics* 20.4 (1990), pp. 745–757. DOI: [10.1109/21.105076](#) (cit. on pp. 2, 18, 29).
- (Burnes et al., 2013) B. Burnes and B. Cooke. [“K ur t Lewin’s Field Theory: A Review and Re-evaluation”](#). In: *International journal of management reviews* 15.4 (2013), pp. 408–425. DOI: [10.1111/j.1468-2370.2012.00348.x](#) (cit. on p. 18).
- (Chaudhuri et al., 2011) S. Chaudhuri, U. Dayal, and V. Narasayya. [“An overview of business intelligence technology”](#). In: *Communications of the ACM* 54.8 (2011), pp. 88–98. DOI: [10.1145/1978542.1978562](#) (cit. on p. 32).
- (Coman et al., 2009) A. Coman and B. Ronen. [“Focused SWOT: diagnosing critical strengths and weaknesses”](#). In: *International journal of production Research* 47.20 (2009), pp. 5677–5689. DOI: [10.1080/00207540802146130](#) (cit. on p. 30).
- (Comte, 1856) A. Comte. [Social physics: from the Positive philosophy of Auguste Comte](#). C. Blanchard, 1856. ISBN: 978-1376397789 (cit. on p. 18).
- (Cooper et al., 1971) R. Cooper and M. Foster. [“Sociotechnical systems.”](#) In: *American Psychologist* 26.5 (1971), p. 467. DOI: [10.1037/h0031539](#) (cit. on p. 3).
- (Cooper et al., 1991) R. Cooper and R. S. Kaplan. [“Profit priorities from activity-based costing”](#). In: *Harvard business review* 69.3 (1991), pp. 130–135 (cit. on p. 32).
- (Culp, 2002) C. L. Culp. [The risk management process: business strategy and tactics](#). John Wiley & Sons, 2002. ISBN: 9780471151241 (cit. on p. 30).
- (Donovan et al., 1977) J. J. Donovan and S. E. Madnick. [“Institutional and ad hoc DSS and their effective use”](#). In: *ACM SIGMIS Database: the DATABASE for Advances in Information Systems* 8.3 (1977), pp. 79–88. DOI: [10.1145/1017583.1017599](#) (cit. on p. 22).

-
- (Edwards, 1954) W. Edwards. "The theory of decision making." In: *Psychological bulletin* 51.4 (1954), p. 380. DOI: [10.1037/h0053870](https://doi.org/10.1037/h0053870) (cit. on pp. 2, 19).
- (Edwards, 1961) W. Edwards. "Behavioral decision theory". In: *Annual review of psychology* 12.1 (1961), pp. 473–498 (cit. on pp. 2, 19).
- (Eldabi et al., 2002) T. Eldabi, Z. Irani, R. J. Paul, and P. E. Love. "Quantitative and qualitative decision-making methods in simulation modelling". In: *Management Decision* (2002). DOI: [10.1108/00251740210413370](https://doi.org/10.1108/00251740210413370) (cit. on p. 32).
- (Engen, 1988) T. Engen. "Psychophysics". In: *States of brain and mind*. Springer, 1988, pp. 89–91. DOI: [10.1007/978-1-4899-6771-8_35](https://doi.org/10.1007/978-1-4899-6771-8_35) (cit. on p. 18).
- (H. B. Eom et al., 1990) H. B. Eom and S. M. Lee. "A survey of decision support system applications (1971–April 1988)". In: *Interfaces* 20.3 (1990), pp. 65–79. DOI: [10.1287/inte.20.3.65](https://doi.org/10.1287/inte.20.3.65) (cit. on pp. 21, 23, 24).
- (S. Eom et al., 2006) S. Eom and E. Kim. "A survey of decision support system applications (1995–2001)". In: *Journal of the Operational Research Society* 57.11 (2006), pp. 1264–1278. DOI: [10.1057/palgrave.jors.2602140](https://doi.org/10.1057/palgrave.jors.2602140) (cit. on p. 24).
- (S. B. Eom, 2002) S. B. Eom. *Decision support systems research (1970-1999): A cumulative tradition and reference disciplines*. Edwin Mellen Press, 2002. ISBN: 0773471537 (cit. on p. 24).
- (S. B. Eom, 2003) S. B. Eom. "Decision Support Systems Research and Reference Disciplines, 1970-2001: A Research Guide to the Literature and an Unobtrusive Bibliography with Citation Frequency". In: (2003) (cit. on p. 24).
- (Fermin et al., 2011) D. Fermin, V. Basrur, A. K. Yocum, and A. I. Nesvizhskii. "Abacus: a computational tool for extracting and pre-processing spectral count data for label-free quantitative proteomic analysis". In: *Proteomics* 11.7 (2011), pp. 1340–1345. DOI: [10.1002/pmic.201000650](https://doi.org/10.1002/pmic.201000650) (cit. on p. 30).
- (Fintz, 2020) M. Fintz. "Using Deep Learning to Predict Human Decisions, and Cognitive Models to Explain Deep Learning Models". PhD thesis. University of Haifa (Israel), 2020. DOI: [10.1038/s41598-022-08863-0](https://doi.org/10.1038/s41598-022-08863-0) (cit. on p. 33).
- (Fox, 1995) W. M. Fox. "Sociotechnical system principles and guidelines: past and present". In: *The Journal of applied behavioral science* 31.1 (1995), pp. 91–105. DOI: [10.1177/0021886395311009](https://doi.org/10.1177/0021886395311009) (cit. on p. 3).
- (Gomes et al., 2014) J. Gomes and M. Romão. "Advantages and limitations of performance measurement tools: The balanced scorecard". In: *7th IADIS Information Systems 2014 Conference (IS 2014)*. 2014. ISBN: 978-989-8704-04-7 (cit. on p. 31).
- (GURL, 2017) E. GURL. "SWOT analysis: A theoretical review". In: (2017). DOI: [10.17719/jisr.2017.1832](https://doi.org/10.17719/jisr.2017.1832) (cit. on p. 30).
- (Haaser, 1991) N. B. Haaser. *Real analysis*. Courier Corporation, 1991. ISBN: 9780486665092 (cit. on p. 36).
- (Hackathorn et al., 1981) R. D. Hackathorn and P. G. Keen. "Organizational strategies for personal computing in decision support systems". In: *MIS quarterly* (1981), pp. 21–27. DOI: [10.2307/249288](https://doi.org/10.2307/249288) (cit. on p. 23).
- (Hägglund, 1995) T. Hägglund. "A control-loop performance monitor". In: *Control Engineering Practice* 3.11 (1995), pp. 1543–1551. DOI: [10.1016/0967-0661\(95\)00164-P](https://doi.org/10.1016/0967-0661(95)00164-P) (cit. on pp. 32, 33).
- (Hamelmann et al., 2017) C. Hamelmann, F. Turatto, V. Then, and M. Dyakova. *Social return on investment: accounting for value in the context of implementing Health 2020 and the 2030 Agenda for Sustainable Development (Investment for Health and Development Discussion Paper)*. Tech. rep. World Health Organization. Regional Office for Europe, 2017. URL: <https://apps.who.int/iris/handle/10665/340348> (cit. on p. 31).

- (Hammond et al., 2006) J. S. Hammond, R. L. Keeney, and H. Raiffa. "The hidden traps in decision making". In: *Harvard business review* 84.1 (2006), p. 118 (cit. on p. 17).
- (Harzing et al., 2010) A.-W. Harzing and A. Pinnington. *International human resource management*. Sage, 2010. ISBN: 9781529786347 (cit. on p. 20).
- (Hassanien et al., 2018) S. Hassanien, D. Langer, and M. Abdolrazaghi. "Integrity Risk-Informed Decision Making". In: *International Pipeline Conference*. Vol. 51876. American Society of Mechanical Engineers. 2018, V002T01A016. DOI: [10.1115/IPC2018-78149](https://doi.org/10.1115/IPC2018-78149) (cit. on p. 29).
- (Haula et al., 2020) K. Haula and E. Agbozo. "A systematic review on unmanned aerial vehicles in Sub-Saharan Africa: A socio-technical perspective". In: *Technology in Society* 63 (2020), p. 101357. DOI: [10.1016/j.techsoc.2020.101357](https://doi.org/10.1016/j.techsoc.2020.101357) (cit. on p. 3).
- (Hawkins et al., 2003) D. M. Hawkins, P. Qiu, and C. W. Kang. "The changepoint model for statistical process control". In: *Journal of quality technology* 35.4 (2003), pp. 355–366. DOI: [10.1080/00224065.2003.11980233](https://doi.org/10.1080/00224065.2003.11980233) (cit. on p. 31).
- (Holsapple et al., 1996) C. W. Holsapple, A. B. Whinston, J. H. Benamati, and G. S. Kearns. "Instructor's manual with test bank to accompany decision support systems: a knowledge-based approach." In: (1996) (cit. on pp. 21, 22).
- (Huan et al., 2004) S. H. Huan, S. K. Sheoran, and G. Wang. "A review and analysis of supply chain operations reference (SCOR) model". In: *Supply chain management: An international Journal* (2004). DOI: [10.1108/13598540410517557](https://doi.org/10.1108/13598540410517557) (cit. on pp. 31, 32).
- (Ishak et al., 2019) Z. Ishak, S. L. Fong, and S. C. Shin. "SMART KPI management system framework". In: *2019 IEEE 9th International Conference on System Engineering and Technology (ICSET)*. IEEE. 2019, pp. 172–177. DOI: [10.1109/ICSEngT.2019.8906478](https://doi.org/10.1109/ICSEngT.2019.8906478) (cit. on p. 21).
- (Kahneman, 1979) D. Kahneman. "Prospect theory: An analysis of decisions under risk". In: *Econometrica* 47 (1979), p. 278. DOI: [10.2307/1914185](https://doi.org/10.2307/1914185) (cit. on p. 20).
- (Kahneman et al., 1982) D. Kahneman, S. P. Slovic, P. Slovic, and A. Tversky. *Judgment under uncertainty: Heuristics and biases*. Cambridge university press, 1982. ISBN: 9780521284141 (cit. on p. 20).
- (Kahneman et al., 1984) D. Kahneman and A. Tversky. "Choices, values, and frames." In: *American psychologist* 39.4 (1984), p. 341. DOI: [10.1037/0003-066X.39.4.341](https://doi.org/10.1037/0003-066X.39.4.341) (cit. on p. 2).
- (Kastalskiy et al., 2021) I. A. Kastalskiy, E. V. Pankratova, E. M. Mirkes, V. B. Kazantsev, and A. N. Gorban. "Social stress drives the multi-wave dynamics of COVID-19 outbreaks". In: *Scientific reports* 11.1 (2021), pp. 1–12. DOI: [10.1038/s41598-021-01317-z](https://doi.org/10.1038/s41598-021-01317-z) (cit. on p. 18).
- (Keen, 1978) P. G. Keen. *Decisión support systems; an organizational perspective*. Tech. rep. 1978 (cit. on p. 21).
- (Keen, 1980) P. G. Keen. "Decision support systems: a research perspective". In: *Decision support systems: Issues and challenges: Proceedings of an international task force meeting*. 1980, pp. 23–44. URL: <http://hdl.handle.net/1721.1/47172> (cit. on pp. 2, 18, 29).
- (Kochenderfer, 2015) M. J. Kochenderfer. *Decision making under uncertainty: theory and application*. MIT press, 2015. DOI: [10.7551/mitpress/10187.001.0001](https://doi.org/10.7551/mitpress/10187.001.0001) (cit. on p. 1).
- (Kumpati et al., 1990) S. N. Kumpati, P. Kannan, et al. "Identification and control of dynamical systems using neural networks". In: *IEEE Transactions on neural networks* 1.1 (1990), pp. 4–27. DOI: [10.1109/72.80202](https://doi.org/10.1109/72.80202) (cit. on pp. 35, 36).
- (Lægreid et al., 2006) P. Lægreid, P. G. Roness, and K. Rubecksen. "Performance management in practice: The Norwegian way". In: *Financial Accountability & Management* 22.3 (2006), pp. 251–270. DOI: [10.1111/j.0267-4424.2006.00402.x](https://doi.org/10.1111/j.0267-4424.2006.00402.x) (cit. on p. 20).

-
- (Lahrmann et al., 2011) G. Lahrmann, F. Marx, R. Winter, and F. Wortmann. “Business intelligence maturity: Development and evaluation of a theoretical model”. In: *2011 44th Hawaii International Conference on System Sciences*. IEEE, 2011, pp. 1–10. DOI: [10.1109/HICSS.2011.90](https://doi.org/10.1109/HICSS.2011.90) (cit. on p. 32).
- (Lazowska et al., 1984) E. D. Lazowska, J. Zahorjan, G. S. Graham, and K. C. Sevcik. *Quantitative system performance: computer system analysis using queueing network models*. Prentice-Hall, Inc., 1984. ISBN: 978-0137469758 (cit. on p. 20).
- (Le Bris et al., 2019) S. Le Bris, A. Madrid-Guijarro, and D. P. Martin. “Decision-making in complex environments under time pressure and risk of critical irreversibility: The role of meta rules”. In: *M@n@gement* 22.1 (2019), pp. 1–29. DOI: [10.3917/mana.221.0001](https://doi.org/10.3917/mana.221.0001) (cit. on p. 17).
- (LeCun et al., 2015) Y. LeCun, Y. Bengio, and G. Hinton. “Deep learning”. In: *nature* 521.7553 (2015), pp. 436–444. DOI: [10.1038/nature14539](https://doi.org/10.1038/nature14539) (cit. on p. 33).
- (Lee et al., 2010) M.-C. Lee and T. Chang. “Developing a lean design for Six Sigma through supply chain methodology”. In: *International Journal of Productivity and Quality Management* 6.4 (2010), pp. 407–434. DOI: [10.1504/IJPQM.2010.035891](https://doi.org/10.1504/IJPQM.2010.035891) (cit. on p. 31).
- (Lewin, 1942) K. Lewin. “Field theory and learning.” In: (1942). DOI: [10.1177/016146814204301006](https://doi.org/10.1177/016146814204301006) (cit. on p. 18).
- (Lombardo, 2015) C. Lombardo. “Activity based costing advantage and disadvantages”. In: *TheNext Galaxy.com*, June 17 (2015) (cit. on p. 32).
- (Long, 2018) S. Long. *Socioanalytic methods: discovering the hidden in organisations and social systems*. Routledge, 2018. DOI: [10.4324/9780429480355](https://doi.org/10.4324/9780429480355) (cit. on p. 3).
- (Madhavan et al., 2007) P. Madhavan and D. A. Wiegmann. “Effects of information source, pedigree, and reliability on operator interaction with decision support systems”. In: *Human factors* 49.5 (2007), pp. 773–785. DOI: [10.1518/001872007X230154](https://doi.org/10.1518/001872007X230154) (cit. on p. 25).
- (Mahmud et al., 2022) H. Mahmud, A. N. Islam, S. I. Ahmed, and K. Smolander. “What influences algorithmic decision-making? A systematic literature review on algorithm aversion”. In: *Technological Forecasting and Social Change* 175 (2022), p. 121390. DOI: [10.1016/j.techfore.2021.121390](https://doi.org/10.1016/j.techfore.2021.121390) (cit. on p. 17).
- (Mantegna et al., 1999) R. N. Mantegna and H. E. Stanley. *Introduction to econophysics: correlations and complexity in finance*. Cambridge university press, 1999. ISBN: 9780521620086 (cit. on p. 18).
- (Martin, 2003) J. L. Martin. “What is field theory?” In: *American journal of sociology* 109.1 (2003), pp. 1–49. DOI: [10.1086/375201](https://doi.org/10.1086/375201) (cit. on p. 18).
- (Merriam-Webster, 2022) Merriam-Webster. *Universe*. In: *Merriam-Webster.com dictionary*. URL: <https://www.merriam-webster.com/dictionary/universe> (cit. on p. 1).
- (Mettler et al., 2009) T. Mettler and P. Rohner. “Performance management in health care: the past, the present, and the future”. In: (2009) (cit. on p. 20).
- (Moradkhani et al., 2021) N. Moradkhani, F. Benaben, B. Montreuil, A. V. Barenji, and D. Nazzal. “Physics of decision for polling place management: a case study from the 2020 USA presidential election”. In: *ICMS 2021-15th International Conference on Modeling and Simulation*. Vol. 15. 9. 2021, pp. 440–448. URL: <https://publications.waset.org/10012308/physics-of-decision-for-polling-place-management-a-case-study-from-the-2020-usa-presidential-election> (cit. on pp. 62, 101).
- (Moradkhani et al., 2022a) N. Moradkhani, F. Benaben, B. Montreuil, M. Lauras, J. Jeany, and L. Faugere. “Multi-criteria performance analysis based on Physics of Decision—Application to COVID-19 and future pandemics”. In: *IEEE Transactions on Services Computing* (2022). DOI: [10.1109/TSC.2022.3187214](https://doi.org/10.1109/TSC.2022.3187214) (cit. on pp. 38, 99).

- (Moradkhani et al., 2022b) N. Moradkhani, F. Benaben, B. Montreuil, M. Lauras, C. Le Duff, and J. Jeany. “An Intelligent Decision Support System Inspired by Newton’s Laws of Motion”. In: *Intelligent Decision Technologies*. Springer, 2022, pp. 523–533. DOI: [10.1007/978-981-19-3444-5_45](https://doi.org/10.1007/978-981-19-3444-5_45) (cit. on p. 89).
- (Moradkhani et al., 2022c) N. Moradkhani, H. Dolidon, and F. Benaben. “Persistent physics-based crisis management framework: A case study of traffic in the Nantes city due to flood exposure”. In: *HICSS2022-Hawaii International Conference on System Sciences*. 2022. URL: <http://hdl.handle.net/10125/79642> (cit. on pp. 51, 100).
- (Mousavi et al., 2019) S. Mousavi and S. Sunder. “Physical laws and human behavior: A three-tier framework”. In: (2019). DOI: [10.31219/osf.io/nmpc8](https://doi.org/10.31219/osf.io/nmpc8) (cit. on p. 19).
- (Mousavi et al., 2020) S. Mousavi and S. Sunder. “Physics and decisions: an inverted perspective”. In: *Mind & Society* 19.2 (2020), pp. 293–298. DOI: [10.1007/s11299-020-00244-2](https://doi.org/10.1007/s11299-020-00244-2) (cit. on p. 19).
- (Mousavi et al., 2021) S. Mousavi and S. Sunder. “Framing Human Action in Physics: Valid Reconstruction, Invalid Reduction”. In: *Invalid Reduction (March 14, 2021)* (2021). DOI: [10.2139/ssrn.3859682](https://doi.org/10.2139/ssrn.3859682) (cit. on p. 19).
- (Negash et al., 2008) S. Negash and P. Gray. “Business intelligence”. In: *Handbook on decision support systems 2*. Springer, 2008, pp. 175–193. DOI: [10.1007/978-3-540-48716-6](https://doi.org/10.1007/978-3-540-48716-6) (cit. on p. 32).
- (Newell et al., 1972) A. Newell, H. A. Simon, et al. *Human problem solving*. Vol. 104. 9. Prentice-hall Englewood Cliffs, NJ, 1972. ISBN: 978-1635617924 (cit. on p. 25).
- (Newman et al., 2014) J. P. Newman, H. R. Maier, H. van Delden, A. C. Zecchin, G. C. Dandy, G. Riddell, and C. Newland. “Literature review on decision support systems for optimising long-term natural hazard mitigation policy and project portfolios”. In: *The University of Adelaide, Report 2014.009* (2014). DOI: [10.1016/j.envsoft.2017.06.042](https://doi.org/10.1016/j.envsoft.2017.06.042) (cit. on pp. 21, 23).
- (Nørreklit, 2003) H. Nørreklit. “The balanced scorecard: what is the score? A rhetorical analysis of the balanced scorecard”. In: *Accounting, organizations and society* 28.6 (2003), pp. 591–619. DOI: [10.1016/S0361-3682\(02\)00097-1](https://doi.org/10.1016/S0361-3682(02)00097-1) (cit. on p. 31).
- (Olsson, 2007) R. Olsson. “In search of opportunity management: Is the risk management process enough?” In: *International journal of project management* 25.8 (2007), pp. 745–752. DOI: [10.1016/j.ijproman.2007.03.005](https://doi.org/10.1016/j.ijproman.2007.03.005) (cit. on p. 6).
- (Oxford, 2022) Oxford. *System*. In: *Merriam-Webster.com dictionary*. URL: <https://www.oxfordlearnersdictionaries.com/definition/english/system?q=system> (cit. on p. 1).
- (Ozsahin et al., 2021) I. Ozsahin, D. U. Ozsahin, and B. Uzun. *Applications of Multi-Criteria Decision-Making Theories in Healthcare and Biomedical Engineering*. Academic Press, 2021. ISBN: 9780128240878 (cit. on p. 33).
- (Paradice, 2008) D. Paradice. “Decision support and problem formulation activity”. In: *Encyclopedia of Decision Making and Decision Support Technologies*. IGI Global, 2008, pp. 192–199. DOI: [10.4018/978-1-59904-843-7.ch022](https://doi.org/10.4018/978-1-59904-843-7.ch022) (cit. on p. 25).
- (Parmenter, 2015) D. Parmenter. *Key performance indicators: developing, implementing, and using winning KPIs*. John Wiley & Sons, 2015. ISBN: 978-1-119-62077-8 (cit. on p. 5).
- (Peterson, 2017) M. Peterson. *An introduction to decision theory*. Cambridge University Press, 2017. DOI: [10.1017/CBO9780511800917](https://doi.org/10.1017/CBO9780511800917) (cit. on pp. 2, 19).
- (J. J. Phillips, 1998) J. J. Phillips. “The return-on-investment (ROI) process: Issues and trends”. In: *Educational Technology* 38.4 (1998), pp. 7–14 (cit. on p. 31).
- (L. Phillips, 2014) L. Phillips. “The Never-ending Conundrums of Classical Physics”. In: *Ars Technica* (2014) (cit. on p. 2).

-
- (P. P. Phillips et al., 2009) P. P. Phillips and J. J. Phillips. "Return on investment". In: *Handbook of Improving Performance in the Workplace: Volumes 1-3* (2009), pp. 823–846. DOI: [10.1002/9780470592663.ch53](https://doi.org/10.1002/9780470592663.ch53) (cit. on p. 31).
- (Power, 2002) D. J. Power. *Decision support systems: concepts and resources for managers*. Greenwood Publishing Group, 2002. ISBN: 156720497X (cit. on pp. 21, 22).
- (Power et al., 2007) D. J. Power and R. Sharda. "Model-driven decision support systems: Concepts and research directions". In: *Decision support systems* 43.3 (2007), pp. 1044–1061. DOI: [10.1016/j.dss.2005.05.030](https://doi.org/10.1016/j.dss.2005.05.030) (cit. on p. 24).
- (Reyhanoglu, 2004) M. Reyhanoglu. "Activity-based costing system advantages and disadvantages". In: *Available at SSRN 644561* (2004). DOI: [10.2139/ssrn.644561](https://doi.org/10.2139/ssrn.644561) (cit. on p. 32).
- (Richardson, 2004) S. Richardson. "The key elements of Balanced Scorecard success". In: *Ivey Business Journal* 69.2 (2004), pp. 7–9 (cit. on p. 31).
- (Salazar et al., 2012) F. Salazar, J. Cavazos, and P. Nuño. "Strengths and weaknesses of SCOR model: Supply chain biodiesel castor". In: *IIE Annual Conference. Proceedings*. Institute of Industrial and Systems Engineers (IISE). 2012, p. 1 (cit. on pp. 31, 32).
- (Sarsby, 2016) A. Sarsby. *SWOT analysis*. Lulu. com, 2016. ISBN: 9780993250422 (cit. on p. 30).
- (Schleicher et al., 2018) D. J. Schleicher, H. M. Baumann, D. W. Sullivan, P. E. Levy, D. C. Hargrove, and B. A. Barros-Rivera. "Putting the system into performance management systems: A review and agenda for performance management research". In: *Journal of management* 44.6 (2018), pp. 2209–2245. DOI: [10.1177/0149206318755303](https://doi.org/10.1177/0149206318755303) (cit. on p. 20).
- (Scott-Morton et al., 1978) M. S. Scott-Morton and P. G. Keen. "Decision support systems: an organizational perspective". In: *Reading: Addison-Wesley* (1978) (cit. on p. 21).
- (Sent, 2018) E.-M. Sent. "Rationality and bounded rationality: You can't have one without the other". In: *The European Journal of the History of Economic Thought* 25.6 (2018), pp. 1370–1386. DOI: [10.1080/09672567.2018.1523206](https://doi.org/10.1080/09672567.2018.1523206) (cit. on p. 25).
- (Shih, 2022) H.-S. Shih. "TOPSIS for Decision Support". In: *TOPSIS and its Extensions: A Distance-Based MCDM Approach*. Springer, 2022, pp. 115–142. DOI: [10.1007/978-3-031-09577-1_5](https://doi.org/10.1007/978-3-031-09577-1_5) (cit. on p. 21).
- (Shim et al., 2002) J. P. Shim, M. Warkentin, J. F. Courtney, D. J. Power, R. Sharda, and C. Carlsson. "Past, present, and future of decision support technology". In: *Decision support systems* 33.2 (2002), pp. 111–126. DOI: [10.1016/S0167-9236\(01\)00139-7](https://doi.org/10.1016/S0167-9236(01)00139-7) (cit. on pp. 1, 24).
- (Simon, 1960) H. A. Simon. "The new science of management decision." In: (1960). DOI: [10.1037/13978-000](https://doi.org/10.1037/13978-000) (cit. on pp. 22, 25).
- (Simon, 1979) H. A. Simon. "Rational decision making in business organizations". In: *The American economic review* 69.4 (1979), pp. 493–513 (cit. on p. 2).
- (Simon, 1990) H. A. Simon. "Bounded rationality". In: *Utility and probability*. Springer, 1990, pp. 15–18. DOI: [10.1007/978-1-349-20568-4_5](https://doi.org/10.1007/978-1-349-20568-4_5) (cit. on p. 25).
- (Simon, 2013) H. A. Simon. *Administrative behavior*. Simon and Schuster, 2013 (cit. on p. 25).
- (Simon, 1950) H. A. Simon. *Administrative behavior*. Macmillan New York, 1950. ISBN: 0026109905 (cit. on pp. 25, 28, 29).
- (Simonyi, 2012) K. Simonyi. *A cultural history of physics*. CRC Press, 2012. ISBN: 9781568813295 (cit. on p. 2).
- (Sprague Jr et al., 1982) R. H. Sprague Jr and E. D. Carlson. *Building effective decision support systems*. Prentice Hall Professional Technical Reference, 1982 (cit. on p. 21).
- (Stermann, 2010) J. Sterman. *Business dynamics*. Irwin/McGraw-Hill c2000., 2010. ISBN: 978-0-07-231135-8 (cit. on p. 2).

- (Stranks, 2007) J. W. Stranks. *Human factors and behavioural safety*. Routledge, 2007. ISBN: 9780750681551 (cit. on p. 3).
- (Teixeira et al., 2012) E. S. Teixeira, I. M. Greca, and O. Freire. “The history and philosophy of science in physics teaching: A research synthesis of didactic interventions”. In: *Science & Education* 21.6 (2012), pp. 771–796. DOI: [10.1007/s11191-009-9217-3](https://doi.org/10.1007/s11191-009-9217-3) (cit. on p. 2).
- (Triantaphyllou, 2000) E. Triantaphyllou. “Multi-criteria decision making methods”. In: *Multi-criteria decision making methods: A comparative study*. Springer, 2000, pp. 5–21. DOI: [10.1007/978-1-4757-3157-6](https://doi.org/10.1007/978-1-4757-3157-6) (cit. on p. 33).
- (Trist, 1981) E. L. Trist. *The evolution of socio-technical systems*. Vol. 2. Ontario Quality of Working Life Centre Toronto, 1981. ISBN: 9780774362863 (cit. on p. 3).
- (Tversky et al., 1985) A. Tversky and D. Kahneman. “The framing of decisions and the psychology of choice”. In: *Behavioral decision making*. Springer, 1985, pp. 25–41. DOI: [10.1126/science.7455683](https://doi.org/10.1126/science.7455683) (cit. on p. 20).
- (Walker et al., 2008) G. H. Walker, N. A. Stanton, P. M. Salmon, and D. P. Jenkins. “A review of sociotechnical systems theory: a classic concept for new command and control paradigms”. In: *Theoretical issues in ergonomics science* 9.6 (2008), pp. 479–499. DOI: [10.1080/14639220701635470](https://doi.org/10.1080/14639220701635470) (cit. on p. 3).
- (Ward et al., 2003) S. Ward and C. Chapman. “Transforming project risk management into project uncertainty management”. In: *International journal of project management* 21.2 (2003), pp. 97–105. DOI: [10.1016/S0263-7863\(01\)00080-1](https://doi.org/10.1016/S0263-7863(01)00080-1) (cit. on p. 30).
- (Webb, 2009) B. Webb. “Animals versus animats: Or why not model the real iguana?” In: *Adaptive Behavior* 17.4 (2009), pp. 269–286. DOI: [10.1177/1059712309339867](https://doi.org/10.1177/1059712309339867) (cit. on p. 1).
- (Xiahou et al., 2018) X. Xiahou, Y. Tang, J. Yuan, T. Chang, P. Liu, and Q. Li. “Evaluating social performance of construction projects: An empirical study”. In: *Sustainability* 10.7 (2018), p. 2329. DOI: [10.3390/su10072329](https://doi.org/10.3390/su10072329) (cit. on p. 20).
- (Xue et al., 2020) B. Xue, Z. Zhang, and P. Li. “Corporate environmental performance, environmental management and firm risk”. In: *Business Strategy and the Environment* 29.3 (2020), pp. 1074–1096. DOI: [10.1002/bse.2418](https://doi.org/10.1002/bse.2418) (cit. on p. 20).

RÉSUMÉ

Etude d'une approche d'aide à la décision en gestion de systèmes socio-techniques, basée sur les principes physiques de la mécanique du point et du solide

Prendre des décisions judicieuses est un défi incontournable pour gérer la performance des systèmes sociotechniques. L'incertitude concernant le résultat des décisions conduit à rechercher des principes que les systèmes pourraient suivre. L'étude actuelle exploite et étudie un cadre appelé "Physics of Decision" en tant qu'approche innovante d'aide à la décision dans un contexte d'instabilité et d'incertitude. L'accent est mis sur le développement d'un modèle théorique et mathématique pour décrire les risques et les opportunités en tant que forces physiques poussant et tirant les systèmes étudiés en tant qu'objet dans un cadre de performance multidimensionnel construit sur les critères d'évaluation du système. L'ambition principale est de définir une méthode d'identification des forces, y compris leurs origines, leur intensité et leur interdépendance, pour hériter des principes et des lois de la physique. Les principes de la physique classique sont étudiés dans le cadre défini en tenant compte des concepts de gestion de mappage aux notations physiques. Cette connexion permet (i) d'examiner les développements du système dans son espace de performance grâce à l'analyse cinématique et (ii) de fournir une aide à la décision réactive et prédictive à la suite de l'analyse des forces physiques et de son application au système par le biais de lois physiques liées

aux forces. Enquêter sur le comportement du système en vertu de telles lois pourrait révéler ses relations complexes, conduisant ainsi à des décisions appropriées. L'objectif premier de ce doctorat est d'établir une perspective générique pour la gestion de la performance des systèmes socio-techniques qui visualise et intègre l'impact des risques et des opportunités pour contrôler la performance du système examiné. Dans l'ensemble, la principale contribution prévue de cette étude est de démontrer les principes de connexion du système à ses performances grâce à un cadre de modélisation innovant utilisant différentes techniques. Plus en profondeur, cette approche transforme le système étudié et ses potentialités internes et contextuelles d'une connexion implicite à une connexion explicite en utilisant une analyse de sensibilité, des équations différentielles et des fonctions d'optimisation. L'importance de cette étude a été étudiée dans divers domaines d'application : (i) la gestion des bureaux de vote simulée avec un modèle à base d'agents (ABM), (ii) une simulation de population touchée par une épidémie avec le modèle de simulation system dynamics (SD), (iii) gestion du trafic routier réalisée avec un modèle de simulation d'événements discrets (DES), et (iv) un modèle mathématique pour simuler un modèle de production manufacturière.

MOTS-CLÉS : Système d'Aide à la Décision (DSS), Gestion de la Performance, Modélisation, Risques, Opportunités, Simulation, Physique, Force.

ABSTRACT

Study of a decision support approach in socio-technical systems management, based on the physical principles of point and solid mechanics

Making sound decisions is an inevitable challenge for managing the performance of socio-technical systems. Uncertainty concerning the outcome of decisions leads to seeking principles that systems might follow. The current study leverages and investigates a framework called, "Physics Of Decisions" as an innovative approach for decision support in the context of instability and uncertainty. The focus is on developing a theoretical and mathematical model to depict risks and opportunities as physical forces pushing and pulling investigated systems as an object within a multidimensional performance framework built on the system's evaluation criteria. The main ambition is to define a method of identifying forces, including their origins, intensity, and interdependence, to inherit principles and law from physics. The principles of classical physics are investigated in the defined framework considering mapping management concepts to the physical notations. This connection allows to (i) examine the system's developments in its performance space through kinematic analysis and (ii) provide reactive and predictive decision support as a result of physical forces analysis and its application to the system through force-related physical laws. Investigating

the system's behavior under such laws might disclose its compound relationships, thus leading to proper decisions. The foremost objective of this Ph.D. thesis is to establish a generic perspective for performance management of socio-technical systems that visualizes and integrates the impact of risks and opportunities to control the performance of the examined system. Overall, the main intended contribution of this study is to demonstrate the principles of connecting the system to its performance through an innovative modeling framework using different techniques. In further depth, this approach transforms the investigated system and its internal and contextual potentialities from implicit to explicit connection using sensitivity analysis, differential equations, and optimization functions. The significance of this study has been investigated in various application domains: (i) Polling place management, simulated with an Agent-Based Model (ABM), (ii) an epidemic-affected population, simulation with System Dynamics (SD) simulation model, (iii) road traffic management, performed with Discrete Event Simulation (DES) model, and (iv) a mathematical model to simulate a manufacturing production model.

KEYWORDS: Decision Support System (DSS), Performance Management, Modeling, Risks, Opportunities, Simulation, Physics, Force.