



HAL
open science

Life Cycle Assessment method to support the waste valorisation pathway in French olive oil circular production

Gabriela Espadas-Aldana

► **To cite this version:**

Gabriela Espadas-Aldana. Life Cycle Assessment method to support the waste valorisation pathway in French olive oil circular production. Agricultural sciences. Institut National Polytechnique de Toulouse - INPT, 2022. English. NNT : 2022INPT0046 . tel-04679657

HAL Id: tel-04679657

<https://theses.hal.science/tel-04679657v1>

Submitted on 28 Aug 2024

HAL is a multi-disciplinary open access archive for the deposit and dissemination of scientific research documents, whether they are published or not. The documents may come from teaching and research institutions in France or abroad, or from public or private research centers.

L'archive ouverte pluridisciplinaire **HAL**, est destinée au dépôt et à la diffusion de documents scientifiques de niveau recherche, publiés ou non, émanant des établissements d'enseignement et de recherche français ou étrangers, des laboratoires publics ou privés.



Université
de Toulouse

THÈSE

En vue de l'obtention du

DOCTORAT DE L'UNIVERSITÉ DE TOULOUSE

Délivré par :

Institut National Polytechnique de Toulouse (Toulouse INP)

Discipline ou spécialité :

Sciences des Agroressources

Présentée et soutenue par :

Mme GABRIELA DEL CARMEN ESPADAS ALDANA

le mardi 28 juin 2022

Titre :

Life Cycle Assessment method to support the waste valorisation
pathway in French olive oil circular production

Ecole doctorale :

Sciences de la Matière (SDM)

Unité de recherche :

Laboratoire de Chimie Agro-Industrielle (LCA)

Directeurs de Thèse :

MME CAROLINE SABLAYROLLES

MME CLAIRE VIALLE

Rapporteurs :

M. EULOGIO CASTRO GALIANO, UNIVERSITE DE JAEN

MME TATIANA REYES CARRILLO, UNIVERSITE DE TECHNOLOGIE DE TROYES

Membres du jury :

M. CARLOS VACA-GARCIA, TOULOUSE INP, Président

M. JULIO SACRAMENTO RIVERO, UNIVERSITE AUTONOME DU YUCATAN MEXIQUE, Membre

M. LUDOVIC MONTASTRUC, TOULOUSE INP, Membre

M. JEAN PIERRE BELAUD, TOULOUSE INP, Invité

MME CAROLINE SABLAYROLLES, TOULOUSE INP, Membre

MME CLAIRE VIALLE, TOULOUSE INP, Invitée

***Le plus noble prix de la science
est le plaisir d'éclairer l'ignorance***

- Charles-Irénée Castel de Saint-Pierre



ACKNOWLEDGEMENTS

My journey at the National Polytechnique Institute of Toulouse (Toulouse INP) has been a marathon, it started with my exchange year in chemical engineering in 2014, then the master's degree in green chemistry in 2017 and finally the PhD at the end of 2018. It would not have been possible for me to reach the finish line without the support of many people. The following pages allow me to express my full gratitude to all the people who have helped me along the way.

First of all, I would like to express my gratitude to the Agro-Industrial Chemistry Laboratory for hosting me for the last four years. I would also like to mention the grant provided by the Mexican government, CONACYT (*Consejo Nacional de Ciencia y Tecnología - CONACYT, Mexico*), thanks to which I was able to pursue this PhD.

I reiterate my thanks to the two reviewers (*rapporteurs*), Mr. Eulogio CASTRO GALIANO and Ms. Tatiana REYES CARRILLO, for having accepted to examine my manuscript. I sincerely thank you for the time you devoted to this assignment and for your constructive criticism and advice. The reports that you wrote not only allowed me to put my work into perspective, but also to take a broader view and prepare well for the defence.

During the defence, I had the pleasure to discuss with them as well as with the other members of the jury, namely Mr. Carlos VACA-GARCIA, Mr. Julio SACRAMENTO RIVERO and Mr. Ludovic MONTASTRUC. Thank you for having participated in my thesis jury, as well as for all the previous discussions on this subject.

I was honoured by their presence, particularly that of Mr. VACA-GARCIA: thank you for having accepted to chair my thesis jury, you have been a great source of inspiration since my first arrival in France in 2014. I admire you enormously.

I also address Mr Julio SACRAMENTO RIVERO: 11 years since the first time you were a project supervisor at the Secretariat for Research, Innovation and Higher Education of Yucatán (SIIES) for the youth science education programme. What a wonderful way to close on a high note with the synod of this doctoral thesis. We started with microalgae and ended with olive pomace. I thank you for your academic demands that forced me to always give the best of myself, your advice, but above all, your support at all times and for always pushing me to project myself in a greater direction.

As thesis supervisors, the last three members of my jury are obviously special. Thanks to Caroline and Claire for their trust, for having taken me as a candidate for the CONACYT thesis. And Jean Pierre for joining this adventure since my first day.

Thank you to the three of you for your presence, your responsiveness, your kindness, your sincerity and for your support at all times. I have learned a lot from your complementarity and your experience. Your professional quality is impressive. I have a lot of admiration for your work and, moreover, I have also been able to get to know your human quality and I couldn't be happier. Thank you for always being demanding with me, it pushed me to give my best (even with a broken bone!) as well as giving me scientific confidence. I have never known the famous fear of meetings

between doctoral students and supervisors. Every time we had a meeting, I was looking forward to being with you. I really appreciated having the opportunity to get to know your personal side as well as the academic. I treasure my memories of our congress in Lille and the SMI in Mexico.

Claire, I have always admired your professional side, your tremendous intelligence and your writing skills. Also, on a more personal level, you are a dynamic person, reactive, a good listener and always motivated to find solutions to any problem that may arise. Your way of speaking is energizing and I am very happy to have found a friend in you.

Caroline, you are very resourceful, calm and gentle, steady and a great listener. We reached an invaluable complicity; we knew what the other was thinking just by looking at each other. Thank you for the confidence in all senses, both in my intellectual capacities for the realisation of this manuscript, and in the friendship towards our families.

Jean-Pierre, "the boy of the group", thank you for having always been present throughout these four years of thesis, your reactivity in your emails was of the highest importance for me, always ready to answer any doubt and support me in all that I needed. You were that little voice that always said "of course it's possible, let's try". I really like your technological side, both in your gadgets and in your software and applications. It was always a pleasure to have a coffee with you!

A special thanks to Mr. Phillipe EVON for his help with the latte production part: Your help with the technical development and writing of the article was invaluable. Thank you for your proactivity and for always offering us your support.

I would like to thank my intern, Priscila, with whom we published an article on the valorisation of pomace. Priscila, your work saved me precious time. I thank you for your involvement in the project, your seriousness and your commitment, but what I appreciate most is that you have taught me to become a better "teacher". I cherish our friendship, thank you for taking care of Rocket (and me too!) when we needed it the most.

I don't forget my friends from the LCA: Élise, Alex, Lucero, Christopher, Ale, Victor, Jean François, and especially the 2-A2-27 team: Nico, Margaux, Pauline, Paul and Laurent. Thank you Nico, for your anecdotes and advice which were a great help for the whole office, as well as your patience when I didn't understand something about the lab's manners. Margaux, I learnt a lot of things with you! especially expressions from northern France, thank you for the moral support throughout the thesis and for being my right hand in the lab when I was away in Belgium. Pauline, we didn't spend much time together in the office and yet I feel you close to my heart, thank you for hanging out outside the laboratory and for your friendship, I still think of my post-defence flowers, it was a beautiful gesture. Paul, courage for the thesis, it is not an easy path, but its fruits are sweet at the end. Laurent, I couldn't have had a better PhD teammate and friend, your thesis is also now finished, we spent 8 hours a day for 4 years and even in confinement in videoconference. I will always remember those bike rides to and from the office, thank you for teaching me to get into the habit of using the bike to go everywhere in any situation.

During my thesis, by chance and life circumstances, I found wonderful people in Toulouse: Lysiane and Camille, thank you for your unconditional help, for receiving me with love every time I came back to Toulouse for meetings. Lysiane, I would never have thought that I would find a second mother, and yet this is how I consider you today, my French mother. Cami, all the time spent with you since we met has been -wonderful-, you are a source of peace, fun and joy. You lived with me under the same roof for the last three weeks of the manuscript and two days before

the defence. I can tell you that you lived through "the worst" and I am grateful for your company in this difficult time. Nicole, our friendship was an instant crush, thank you for all the advice, the laughs, the wine evenings, and for being an unconditional emotional support until the last moment of this thesis. The cocktail party was a success thanks to you three.

I think of you too, Kana (Oh no, sorry, Dr. Kunihiro!) my bibu, my sister, for being my support in every moment and situation. I will never forget the first day at ENSIACET when you spoke to me and that was the beginning of this beautiful friendship, what friendship? Sisterhood is the right word! I love you.

By intruding into the personal life of the doctoral student, a thesis is a work that goes beyond the professional framework, specially during the last months of writing. It seems natural to me to acknowledge those who are the foundation of my life: my family. So, I thank my parents, my two brothers, their darlings and my nephews. I know that it was (and still is) not easy to watch me leave to pursue this dream. I am deeply happy that my parents and nephew were present on the day of the rite of passage that is the defence. I thought a lot about them during the thesis and how proud they would be to see me as a doctor.

I have a special thought for my mother, she lived this thesis with me in the distance. She kept me company during the writing of the manuscript, she sat next to me to knit when I was in Mexico on a trip to the SMI or during the long hours of video-calling during those trying times.

To my father. Dad: Thank you for all your support (in every way imaginable). Just as you gave me your medal for 30 years of teaching, I symbolically offer you my doctorate.

I would also like to thank my "chosen" family, my friends I met in Toulouse: Noémie, Jean Fred, Edna, Stéphane, Isabella, Vitor. Thank you for all the lovely evenings and trips we shared which helped me to free my mind outside the academic framework. And to my soul friends in Mexico: Deysi, Steph, Nacho (the English master, thank you for proofreading me every time I asked!), Dani, Camilo, Ceci, Diego, Maricruz... I miss you so much.

And last but not least, my family also turns to my beloved husband, Vincent. Thank you for your patience and support at all times since day 1 of this thesis. We have experienced many changes in parallel with its completion. Finally, we went through several lockdowns, we made the big decision to get a dog -Rocket-, we got engaged and married, and lastly, we moved to another country. None of this would have been possible without your love, support and good humour (even in the face of adversity). There are not enough words to explain how much I love you and to thank you for cheering me up when I needed it most. Thank you for having made the effort to stay by my side for the first three years of my thesis in Toulouse. And now, a new adventure awaits us in our life in Brussels.

Thank you to all those I could not mention, but who know that are important to me.

ABSTRACT

Environmental impacts in the olive oil sector can vary considerably due to the practices and techniques employed in olive cultivation and olive oil production. In this context, the Life Cycle Assessment (LCA) method was selected to assess the environmental aspects and potential impacts associated with this agricultural product throughout its life cycle, from cradle to grave.

This thesis aims to carry out an LCA of olive oil production in French olive orchards and mills in order to evaluate how to valorise waste from a circular point of view. Focusing on the shift from traditional linear production to a circular olive oil production system that recovers materials from organic waste (olive pomace).

The first part of the manuscript covers the olive oil sector, LCA methodology, state-of-the-art of LCA in the olive oil sector, bioeconomy and circular economy.

The second part deals with the agro-industrial case study of French olive growing and the production of virgin olive oil from a business-as-usual perspective. Nowadays, olive oil by-products are discharged on agricultural soil through controlled spreading. Eleven scenarios were created based on three principles: 1) Farming principle (Conventional/Organic), 2) Irrigation system (Irrigated/Dry), and 3) Type of cultivation (Traditional/Intensive). The hotspot turned out to be the agricultural phase due to fertilisation, followed by tillage. The irrigated systems turned out to have a positive environmental impact (*i.e.* less CO₂-eq emissions).

The third part focuses on the valorisation of olive pomace through the creation of an olive pomace-based composite as an alternative ecological material for the construction sector (decking). An LCA of the manufacturing process of this biocomposite was carried out with two thermoplastic matrices: polypropylene and polyethylene. In both cases, the twin-screw compounding operation contributed to the higher burden in most of the midpoint impact categories. This process is mainly concerned by the production of the matrices. New research directions include the use of bio-based polymer matrices, which could reduce the impact of olive pomace compounding. In addition, given the long lifespan of biocomposites, the CO₂ stored in them can mitigate climate change due to the delay of carbon emissions to the technosphere. The reintroduction of olive pomace-based composites (hypothesised to be bio-based and biodegradable) into the olive grove soil was proposed and this result was compared with the carbon dynamics of virgin soil, olive pomace-treated soil and compost-treated soil (made from olive pomace). The proposed end-of-life scenario for olive pomace-based composites produced in France could contribute to mitigating climate change.

The last part addresses the connection of the LCA from a business-as-usual perspective with the LCA of olive pomace valorisation to demonstrate how LCA can support the transition from traditional linear to circular olive production. In the transition to a circular system in which waste is recovered for valorisation, a new product is created that can replace another product with the same function. The results showed that LCA method contributes to objectify the expected environmental benefits of the circular economy approach.

Keywords: circular economy, bioeconomy, environmental assessment, biocomposite, olive pomace

RÉSUMÉ

Les impacts environnementaux dans le secteur de l'huile d'olive peuvent varier considérablement en raison des pratiques et des techniques employées dans la culture des olives et la production d'huile d'olive. Dans ce contexte, la méthode de l'Analyse de Cycle de Vie (ACV) a été choisie pour évaluer les aspects environnementaux et les impacts potentiels associés à ce produit agricole tout au long de son cycle de vie, du berceau à la tombe.

Cette thèse a pour objectif de réaliser une ACV de la production d'huile d'olive dans les vergers et les moulins à huile français afin d'évaluer comment valoriser les déchets d'un point de vue circulaire. Elle se focalise sur le passage d'une production linéaire traditionnelle à un système de production d'huile d'olive circulaire qui récupère les matériaux des déchets organiques (grignons d'olive).

La première partie du manuscrit couvre le secteur de l'huile d'olive, la méthodologie ACV, l'état de l'art de l'ACV dans le secteur de l'huile d'olive, la bioéconomie et l'économie circulaire.

La deuxième partie traite de l'étude de cas agro-industrielle de l'oléiculture française et de la production d'huile d'olive vierge dans une perspective *business-as-usual*. Aujourd'hui, les sous-produits de l'huile d'olive sont rejetés sur les sols agricoles par épandage contrôlé. Onze scénarios ont été créés sur la base de trois principes : 1) production agricole (conventionnel/biologique), 2) système d'irrigation (irrigué/sec) et 3) type de culture (traditionnel/intensif). Le point chaud s'est avéré être la phase agricole en raison de la fertilisation, suivie du travail du sol. Les systèmes irrigués ont un impact environnemental positif (moins d'émissions de CO₂ équivalent).

La troisième partie se concentre sur la valorisation des grignons d'olive à travers la création d'un biocomposite comme matériau biosourcé alternatif pour le secteur de la construction (lattes de terrasse). Une ACV du processus de fabrication de ce biocomposite a été réalisée avec deux matrices thermoplastiques : le polypropylène et le polyéthylène. Dans les deux cas, l'opération de compoundage a contribué à l'impact le plus élevé dans la plupart des catégories d'impact, ce qui est dû à la production des matrices. Les nouvelles orientations de recherche comprennent l'utilisation de matrices polymères biosourcées, qui pourraient réduire l'impact du compoundage des grignons d'olive. En outre, étant donné la durée de vie des biocomposites, le CO₂ stocké dans ces derniers peut atténuer le changement climatique en raison du report des émissions de carbone vers la technosphère. La réintroduction de composites à base de grignons d'olive (supposés biosourcés et biodégradables) dans le sol de l'olivieraie a été proposée et ce résultat a été comparé à la dynamique du carbone du sol vierge, du sol traité aux grignons d'olive et du sol traité au compost (à base de grignons d'olive). Ce scénario proposé pour la fin de vie pourrait contribuer à l'atténuation du changement climatique.

La dernière partie permet de faire le lien entre l'ACV d'un point de vue *business-as-usual* et l'ACV de la valorisation des grignons d'olive pour démontrer comment l'ACV peut soutenir la transition d'une production d'olives traditionnelle linéaire à circulaire. Lors du passage à un système circulaire dans lequel les déchets sont récupérés pour être valorisés, un nouveau produit est créé pouvant ainsi remplacer un autre produit ayant la même fonction. Les résultats ont montré qu'il est intéressant d'utiliser l'ACV comme méthode pour objectiver les avantages environnementaux du concept d'économie circulaire.

Mots clés : économie circulaire, bioéconomie, évaluation environnementale, biocomposite, grignon d'olive.

ABBREVIATIONS

This section lists some of the most commonly used abbreviations throughout this PhD work.

CE	Circular Economy
CTO	<i>Centre Technique de l'Olivier</i>
EF	Environmental Footprint
EOL	End-of-life
EU	European Union
EVOO	Extra virgin olive oil
FU	Functional Unit
ILCD	International Life Cycle Data system
IOC	International Olive Council
LCA	Life Cycle Assessment
LCC	Life Cycle Costing
LCI	Life Cycle Inventory
LCIA	Life Cycle Impact Assessment
LCSA	Life Cycle Sustainability Assessment
OMW	Olive mill wastewater
OP	Olive pomace
OSF	Olive stone fraction
P	Permanent (tree component)
PE	Polyethylene
PET	Polyethylene terephthalate
PP	Polypropylene
SLCA	Social Life Cycle Assessment
VOO	Virgin olive oil
WPC	Wood-plastic composites

Scenarios

CTI	Conventional, Traditional, Irrigated
CTD	Conventional, Traditional, Dry
CII	Conventional, Intensive, Irrigated
CID	Conventional, Intensive, Dry
OTI	Organic, Traditional, Irrigated
OTD	Organic, Traditional, Dry

VOCABULARY

English	Français	Español
Alpechín, amurca	Margines, eaux de végétation	Alpechín, amurca, jamila
Amendments	Amendements	Enmienda
Bird droppings, eces	Fientes	Estiércol, excremento
Core, nucleus, kernel, pit	Noyau	Núcleo, centro, hueso
Crush, grid	Broyage, détritaje	Trituración, molienda
Cutting, mowing	Tonte	Cortar
Deadlock	Impasse	Estancamiento
Droplet, bead, gout	Gouttelette	Gota
Fertiliser, manure, feed	Engrais, fumure	Fertilizante, abono
Foliage	Fronaison	Frondosidad
Fruit set	Nouaison	Cuaja
Harvest, picking	Cueillette, récolte	Cosecha, recolección
Husk	Enveloppe, cosse, coque	Cáscara
Knead	Malaxer	Mezclar
Leaching	Lixiviation	Lixiviación
Liquid manure	Lisier	Purines
Mill	Moulin	Molino, almazara
Obstacle, impediment	Entrave	Impedimento, obstáculo
Pest/ infestation	Ravageurs	Plagas
Plough (GB), Plow (US), noun	Charrue	Arado (máquina)
Pomace, spent olives	Grignon	Orujo
Pressing	Pressurage	Prensado
Pressing mats, scourtins	Scourtins	Capachos
Protected designation of origin	Aoc, Appellation d'origine contrôlée	Denominación de origen controlada
Pruning	Taille	Poda
Pulp, musk, porridge	Bouillie	Papilla
Requirements, specification	Cahier des charges	Especificación de requisitos
Seedling	Plantules	Plántula
Send, forward, route, channel	Acheminer	Canalizar
Slurry	Coulis, purin, bouillie	Lodo, estiércol, purines
Solid manure	Fumier pailleux	Abono, estiércol sólido
Spreading	Epandage, amendement	Dispersión en suelo
Strain	Souche	Cepa
Surface run-off	Ruissellement	Escorrentía
Tilla, ploughing, farming	Labourer	Labrar, arar
Trimmer, strimmer	Débroussailleuse	Desbrozadora

TABLE OF CONTENTS

INTRODUCTION.....	1
CHAPTER I BIBLIOGRAPHIC STUDY.....	5
I.1 PRESENTATION OF THE OLIVE OIL SECTOR.....	7
<i>I.1.1 Olive oil figures</i>	7
I.1.1.1 World olive oil production and consumption.....	7
I.1.1.2 Olive oil production in France.....	7
<i>I.1.2 Regulatory agencies.....</i>	8
I.1.2.1 International Olive Council.....	8
I.1.2.2 Association Française Interprofessionnelle De l'Olive	9
<i>I.1.3 Technical information of olive oil.....</i>	9
<i>I.1.4 Production process</i>	9
I.1.4.1 Olive harvesting and transport.....	10
I.1.4.2 Olive oil extraction.....	10
I.1.4.3 Refining.....	11
I.1.4.4 Purification and packaging process	11
<i>I.1.5 The different types of olive oil.....</i>	12
<i>I.1.6 By-products of olive oil production.....</i>	15
I.1.6.1 By-products disposal (business-as-usual)	16
I.1.6.2 By-products valorisation (new path).....	16
I.2 LIFE CYCLE ASSESSMENT METHODOLOGY.....	17
<i>I.2.1 Introduction to the Life Cycle Assessment methodology.....</i>	17
<i>I.2.2 LCA methodology among other environmental analysis tools.....</i>	18
<i>I.2.3 Definition of the four LCA phases</i>	20
I.2.3.1 Goal & scope definition	20
I.2.3.1.1 Goal definition	20
I.2.3.1.2 Scope definition	20
I.2.3.1.3 System expansion and allocation	21
I.2.3.1.4 Attributional and Consequential LCA.....	21
I.2.3.2 Life cycle inventory analysis.....	23

1.2.3.2.1 Foreground vs background system	23
1.2.3.2.2 Ecoinvent Database.....	24
1.2.3.2.3 Ecoinvent System Models.....	24
1.2.3.3 Life cycle impact assessment.....	25
1.2.3.3.1 Software.....	26
1.2.3.3.2 Impact categories and methods.....	27
1.2.3.4 Life cycle interpretation	27
1.2.3.4.1 Data quality: uncertainty management	27
1.2.3.4.2 Uncertainty calculation in SimaPro with ecoinvent 3.6.....	29
1.2.3.4.3 Sensitivity analysis	29
1.2.3.4.4 Monte Carlo analysis vs. sensitivity analysis.....	30
1.2.3.5 Critical review.....	31
I.3. STATE-OF-THE-ART: OLIVE OIL LIFE CYCLE ASSESSMENT	32
<i>I.3.1 Basis of the study.....</i>	32
<i>I.3.2 Description of LCA studies on olive oil sector.....</i>	38
1.3.2.1 LCA Framework applied to olive oil	38
1.3.2.2 Key features	38
1.3.2.3 International projects.....	38
<i>I.3.3 Goal and scope definition</i>	40
1.3.3.1 Functional Unit (FU).....	41
1.3.3.2 Allocation.....	42
1.3.3.3 Biogenic carbon.....	43
<i>I.3.4 Impact assessment</i>	44
1.3.4.1 Software	44
1.3.4.2 Impact categories and methods	45
<i>I.3.5 Results and interpretation.....</i>	45
1.3.5.1 Variability and difficult quantitative comparison.....	45
1.3.5.2 Climate change category.....	46
1.3.5.3 Hotspots in the olive oil life cycle	47
1.3.5.4 Extraction technologies	47
1.3.5.5 Packaging.....	48
1.3.5.6 Waste management techniques	48
1.3.5.7 Best practices and methodological recommendations.....	49

I.4 CIRCULAR ECONOMY AND BIOECONOMY	51
<i>I.4.1 Circular Economy definition.....</i>	51
<i>I.4.2 Bioeconomy definition.....</i>	53
<i>I.4.3 How the Circular economy relates to the Bioeconomy and vice-versa?</i>	53
<i>I.4.4 Circular Economy and Life Cycle Assessment.....</i>	54
<i>I.4.5 Circular Economy in the olive oil sector.....</i>	55
I.5 CONCLUSIONS.....	56
I.6 REFERENCES.....	57
CHAPTER II LIFE CYCLE INVENTORY AND LIFE CYCLE IMPACT ASSESSMENT OF OLIVE OIL PRODUCTION IN FRANCE	67
II.1 INTRODUCTION.....	69
II.2 METHODOLOGY: LIFE CYCLE ASSESSMENT	70
<i>II.2.1 Goal & scope definition</i>	70
II.2.1.1 Goal definition	70
II.2.1.2 Scope definition	70
<i>II.2.2 Life cycle inventory analysis.....</i>	74
II.2.2.1 Provenance and representativeness.....	74
II.2.2.1.1 Agricultural phase.....	74
II.2.2.1.1 Production phase.....	74
II.2.2.2 Inventory data.....	75
II.2.2.2a Inventory data: agricultural phase.....	79
II.2.2.2a.1 Irrigation.....	79
II.2.2.2a.2 Pruning.....	80
II.2.2.2a.3 Fertilisation	81
II.2.2.2a.4 Phytosanitary treatment (pest control): herbicides, insecticides	83
II.2.2.2a.5 Phytosanitary treatment (disease control): fungicides	85
II.2.2.2a.6 Tillage.....	86
II.2.2.2a.7 Harvesting.....	86
II.2.2.2b Inventory data: production phase.....	87
II.2.2.2c Inventory data: packaging, waste management and packaging end-of-life	88
II.2.2.2c.1 Packaging.....	88
II.2.2.2c.2 Waste management.....	88
II.2.2.2c.3 Packaging end-of-life	89

II.2.2.3 Data quality	90
II.2.3 Life cycle impact assessment.....	91
II.2.3.1 Software, impact categories and impact assessment method.....	91
II.2.3.2 Method robustness.....	93
II.2.3.3 Molecules covered by the method	93
II.2.4 Life cycle interpretation	95
II.2.4.1 Climate change.....	95
II.2.4.2 Overall environmental impact.....	106
II.2.4.2.1 Relative significance of impact category results	106
II.2.4.2.2 Characterisation midpoint results – life cycle	116
II.2.4.2.3 Characterisation endpoint results – life cycle	119
II.2.4.3 Sensitivity analysis of the impact method	120
II.3 CONCLUSIONS	122
II.4 REFERENCES	124
CHAPTER III ENVIRONMENTAL ASSESSMENT OF OLIVE POMACE VALORISATION IN COMPOSITE MATERIALS	129
III.1 INTRODUCTION	131
III.2 STATE-OF-THE-ART: OLIVE POMACE.....	133
III.2.1 Olive pomace definition	133
III.2.1.1 Origin.....	133
III.2.1.2 Chemical characterisation	134
III.2.1.3 Annual production.....	134
III.2.2 Olive pomace disposal and valorisation	134
III.2.2.1 Business as usual.....	134
III.2.2.2 Other methods.....	135
III.2.2.2.1 Anaerobic digestion	135
III.2.2.2.2 Fermentation	135
III.2.2.2.3 Extraction of bioactive compounds.....	136
III.2.2.3 Biocomposite field	136
III.2.3 Lath Market, olive pomace-based composite	137
III.2.4 Carbon dynamics.....	138

III.3 METHODOLOGY: LIFE CYCLE ASSESSMENT.....	139
<i>III.3.1 Goal & scope definition</i>	139
II.3.1.1 Goal definition	139
II.3.1.2 Scope definition	139
<i>III.3.2 Life cycle inventory analysis</i>	141
III.3.2.1 Process tree	141
III.3.2.2 Data collection	142
III.3.2.2.1 Inputs: raw materials	142
III.3.2.2.2 Outputs: By-products of the olive stone composite manufacturing	145
III.3.2.3 Inventory tables	147
<i>III.3.3 Life cycle impact assessment</i>	147
<i>III.3.4 Results</i>	149
<i>III.3.5 Discussion and perspectives.....</i>	156
III.3.5.1 Comparison with a conventional lath	156
III.3.5.2 Biosourcing the matrix.....	157
III.3.5.3 Impact of the diversion of the olive pomace from its original use.....	157
III.3.5.4 Carbon sequestration	158
III.3.5.5 Carbon dynamics	158
III.4 CONCLUSIONS	161
III.5 REFERENCES.....	162
CHAPTER IV DISCUSSION, CONCLUSIONS AND PERSPECTIVES	171
IV.1 INTRODUCTION	173
IV.2 DISCUSSION	174
IV.3 CONCLUSIONS	182
IV.4 PERSPECTIVES	188
IV.5 REFERENCES	189
SCIENTIFIC PRODUCTION	191

RÉSUMÉ EN FRANÇAIS.....	193
CHAPITRE I ÉTUDE BIBLIOGRAPHIQUE.....	198
<i>Présentation du secteur de l'huile d'olive.....</i>	198
Production et consommation mondiales d'huile d'olive.....	198
Les différents types d'huile d'olive.....	199
Sous-produits de la production d'huile d'olive.....	199
<i>Méthodologie d'évaluation de cycle de vie.....</i>	199
Introduction à la méthodologie de l'analyse de cycle de vie.....	199
Définition des quatre phases de l'ACV.....	200
<i>État de l'art : Analyse du cycle de vie de l'huile d'olive.....</i>	200
<i>Économie circulaire et bioéconomie.....</i>	201
Comment l'économie circulaire s'articule-t-elle avec la bioéconomie et vice-versa ?	201
Économie circulaire et analyse de cycle de vie.....	201
CHAPITRE II INVENTAIRE DU CYCLE DE VIE ET ÉVALUATION DE L'IMPACT DU CYCLE DE VIE DE LA PRODUCTION D'HUILE D'OLIVE EN FRANCE	202
<i>Méthodologie : ACV.....</i>	202
Définition de l'objectif et du champ d'application.....	202
Analyse de l'inventaire du cycle de vie	205
Évaluation de l'impact du cycle de vie	206
Interprétation du cycle de vie.....	207
CHAPITRE III ÉVALUATION ENVIRONNEMENTALE DE LA VALORISATION DES GRIGNONS D'OLIVE DANS LES MATÉRIAUX COMPOSITES.....	212
<i>État de l'art : grignons d'olive.....</i>	212
Définition du grignon d'olive	212
Marché des lattes, composites à base de grignons d'olive.....	213
<i>Méthodologie : ACV.....</i>	213
Définition de l'objectif et du champ d'application.....	213
Analyse de l'inventaire du cycle de vie	214
Évaluation de l'impact du cycle de vie	214
Résultats	214

CHAPITRE IV DISCUSSION, CONCLUSIONS ET PERSPECTIVES.....	216
<i>Discussion</i>	216
<i>Conclusions</i>	219
<i>Perspectives</i>	222
RÉFÉRENCES.....	223
APPENDIXES	227
APPENDIX A	229
APPENDIX B	236
APPENDIX C	284
APPENDIX D	297
APPENDIX E	308
APPENDIX F.....	310
APPENDIX G	311
APPENDIX H.....	312
APPENDIX I	315
APPENDIX J	317
APPENDIX K.....	319
APPENDIX L.....	320



INTRODUCTION

INTRODUCTION

Context of the research work

This thesis manuscript describes the work carried out by the author to fulfil the requirements for the degree of Doctor of the University of Toulouse in the speciality in *Sciences des Agroressources*, delivered by *Toulouse INP*. Its realisation was made possible thanks to the financial support of The Mexican National Council for Science and Technology (*Consejo Nacional de Ciencia y Tecnología-CONACYT*, Mexico) scholarship.

The subject of this thesis is part of the "environmental evaluation and ecodesign" research theme of the *Laboratoire de Chimie Agro-industrielle UMR 1010 INRAE – INP Toulouse* (Toulouse, France). Laboratory in which the thesis was carried out. *Laboratoire de Chimie Agro-industrielle* also has an independent department dedicated to the transformation of agricultural by-products into Agro-materials, called *AGROMAT* (Tarbes, France), which was also of great importance for this thesis work.

The present thesis is framed within the context of the continuity of the research work carried out by Dr. Guillaume BUSSET, whose thesis was carried out within the OiLCA project, and the thesis by Dr. Evelien UITTERHAEGEN on the production of thermoplastic biocomposites. The European project OiLCA of the community programme Interreg IV SUDOE aimed to improve the competitiveness of the olive oil sector while reducing the carbon footprint through the optimisation of waste management and the implementation of an eco-label. This project was performed in the south-western Europe region, which includes Spain, Portugal and the South of France, known as SUDOE space.

The supervision of this doctoral work was provided by Dr. Caroline SABLAYROLLES and Dr. Claire VIALLE of the *Laboratoire de Chimie Agro-industrielle UMR 1010 INRAE – INP Toulouse*, and Dr. Jean-Pierre BELAUD of the *Laboratoire de Génie Chimique, UMR 5503 CNRS – INP Toulouse – UPS*. Other important collaboration was made by Dr. Philippe EVON from *AGROMAT* for the olive pomace-based composite valorisation part of this thesis.

Contextualisation of the study

Olive oil is a Mediterranean product that is highly appreciated for its organoleptic properties. Today, olive oil is used as food, medicine and cosmetic applications. Despite its economic importance in many countries, its production is associated with several negative environmental problems such as resource depletion, land degradation, air emissions and waste generation (Salomone et al., 2015a).

Life Cycle Assessment (LCA) method selected for the present work, is used to evaluate the environmental aspects and potential impacts associated with a product throughout its life cycle, from cradle to grave. It is the only multi-criteria, multi-step method that links the environmental impact and the function of a product, service or system (Hauschild et al., 2018).

Environmental impacts in the olive oil sector can vary considerably due to the practices and techniques employed in olive farming and olive oil production. The olive oil supply chain has been widely studied through LCA for more than 10 years. A review of the numerous results and the different scenarios were relevant for future LCA studies on this important agro-economic sector

of the Mediterranean region. This state-of-the-art is based on scientific and technical literature, with the aim of comparing the system, limitations, functional units, life cycle inventories, attribution, impact assessments and interpretations of current LCAs of olive oil.

The agricultural upstream seems to be an environmental hotspot in the literature review. It represents the phase responsible for the most impactful part of the olive oil life cycle, notably due to fertilisation, pesticide treatment and irrigation. Waste management and distribution also represent a crucial problem.

French authorities have developed “the Energy Transition Law for Green Growth” since 2015. This law focuses on waste management as an essential pillar to ensure the transition to a circular economy model. Moreover, the use of the bioeconomy and the circular economy approaches are becoming increasingly important, especially in the field of agriculture, one of the main suppliers of waste. For all these reasons, it is crucial to solving the waste management issues generated by the olive oil production, to explore the alternatives to convert the olive pomace by-product into a co-product.

Scientific challenges

This thesis aims to answer a scientific question and challenges about this agro-industrial process:

How can Life Cycle Assessment support the transition from linear to circular production? Application to French olive oil production.

To answer the scientific question, four challenges were identified:

1. Lack of foreground data for Life Cycle Inventory of olive oil production in France.
2. Lack of referenced Life Cycle Assessment study in France focused on olive oil production.
3. Lack of pathways for olive pomace valorisation and its environmental assessment.
4. Lack of consideration of carbon storage in environmental assessments.

First, the environmental assessment of olive oil production from orchards and mills in the South of France was done from a business-as-usual perspective. A valorisation of olive pomace as a biocomposite was then assessed. Then a discussion on moving from traditional linear production to a circular olive production system that recovers materials from organic residues (olive pomace) was done.

Organisation of the manuscript

This PhD work consists of four main chapters (**Figure 1**):

Chapter I

Bibliographic study

The first chapter presents the bibliographic study, which includes:

- The generalities of the olive oil sector, the main characteristics and the different types of olive oil obtained according to their manufacturing process.
- The LCA methodology and how it is going to be used through the thesis work.
- The review of the previous olive oil's LCA allows us to appreciate the state-of-the-art in the olive oil sector to identify avenues for doctoral research.
- The circular economy and bioeconomy concept.

Chapter II

Life Cycle Inventory and Life Cycle Impact Assessment of olive oil production in France

The second chapter deals with the agro-industrial case study of the French olive growing and the production of virgin olive oil (virgin or extra virgin) from a business-as-usual perspective. The following points can be emphasised:

- Eleven scenarios representative of the agricultural upstream part within the 2-phase extraction technology were elaborated.
- Foreground data on olive cultivation and olive oil extraction were collected in 2014 with the help of the *Centre Technique de l'Olivier* (CTO, France).
- Foreground data on olive cultivation come from eleven different orchards in the south of France for the agricultural part.
- Concerning the processing part, the data are from seven mills located in the same geographical area of olive cultivation.
- The function is to produce virgin or extra virgin olive oil, so the functional unit used is "to produce a litre of virgin olive oil" from cradle to grave.
- Eleven scenarios were created based on three principles: 1) Farming principle (Conventional/Organic), 2) Irrigation system (Irrigated/Dry), and 3) Type of cultivation (Traditional/Intensive).

Chapter III

Environmental assessment of olive pomace valorisation in composite materials

The third chapter is an LCA of olive pomace valorisation in its use as biocomposite material. The following information can be found in this chapter:

- An LCA of the manufacturing process of a biocomposite composed of olive pomace and two different thermoplastic matrices, namely polyethylene and polypropylene.
- The functional unit is the production of 1 m² of olive pomace-based biocomposite lath for building material (decking).
- A study of the carbon dynamics in olive growing for olive oil production in France was performed using the C-TOOL model. The model allows measuring the variation of the amount of carbon in the soil of olive groves and the CO₂ emissions.

- The olive pomace-based composite was compared with the carbon dynamics of the virgin soil, the soil treated with olive pomace and the soil treated with compost (made of olive pomace). This is possible considering that the olive pomace-based panels (the olive pomace-based biocomposite lath mentioned earlier) are ground and put in the agricultural soils after their lifespan.

Chapter IV
Discussion, conclusions and perspectives

The last chapter (Chapter IV) deals with the connection between Chapter II and Chapter III to illustrate how to move from a traditional linear production to a circular olive production system that recovers materials from organic residues. It purposes to discuss about the scientific question of how LCA can support the transition towards a circular economy.

Graphical abstract of the organisation of the manuscript

(EN) Title: **Life Cycle Assessment method to support the waste valorisation pathway in French olive oil circular production**

Keywords: circular economy, bioeconomy, environmental assessment, biocomposite, olive pomace

(FR) *Titre: Analyse de cycle de vie pour la valorisation des déchets dans la production circulaire d'huile d'olive française*

Mots clés : économie circulaire, bioéconomie, évaluation environnementale, biocomposite, grignons d'olive.

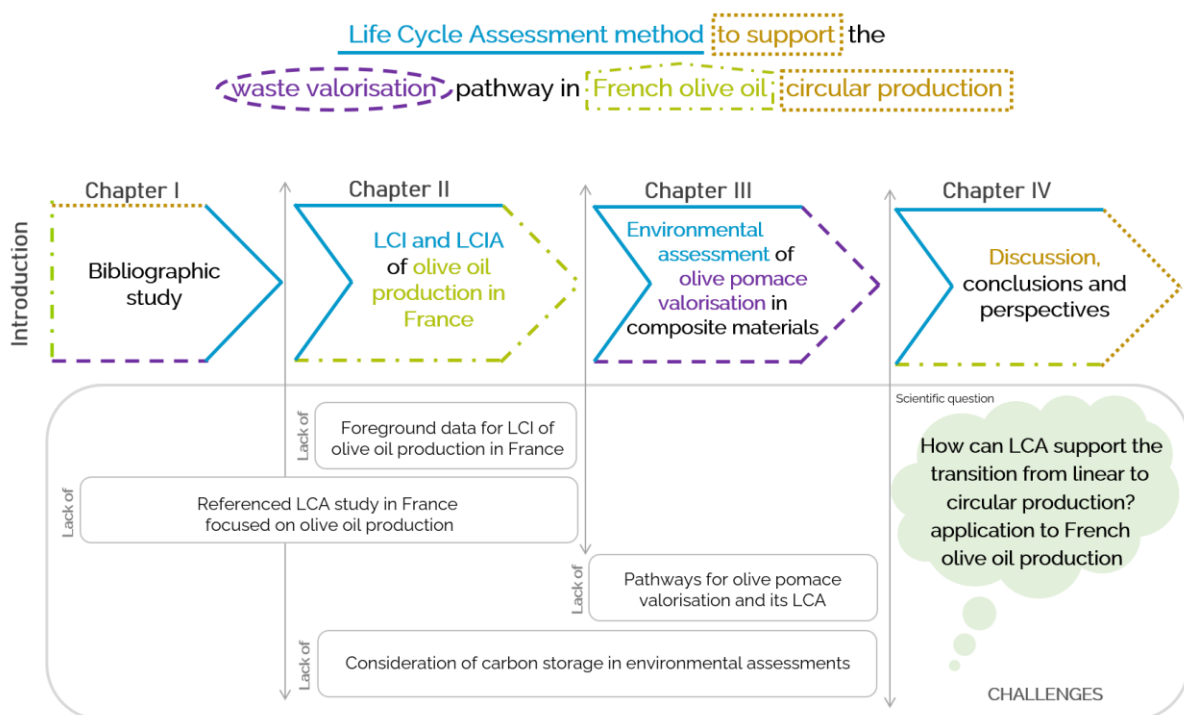

Figure 1. Graphical abstract of the thesis manuscript: title, chapters, scientific question, and challenges addressed.



CHAPTER I

BIBLIOGRAPHIC STUDY

I.1 Presentation of the olive oil sector

The legendary olive tree and the oil obtained from its fruits have accompanied the history of humanity since ancient Greece. Olive oil was indeed closely linked to daily life as it was used as fuel for lighting oil lamps, in cosmetics (manufacture of perfumed ointments and soaps), in religious rites, but especially appreciated for its culinary properties. Moreover, due to the richness and proportion of its components, vitamin A, active E, linoleic acid and alpha linoleic acid, olive oil is very good for human health.

Considered as liquid gold, olive oil is a food, a medicine and a cosmetic.

I.1.1 Olive oil figures

Historically and culturally, olive oil is a product closely linked to the Mediterranean region. Today, only 3% of the world's production takes place outside the Mediterranean area (International Olive Oil Council, 2021a). Spain produces nearly half of the world's olive oil and is followed by Italy and Greece. These three countries are responsible for three-quarters of the world's production.

I.1.1.1 World olive oil production and consumption

Given the organoleptic properties of olive oil, its consumption trends have been increasing worldwide. Consumption went from 2.590×10^6 tons (t) in the 2000/2001 crop year (a period from 1 October to 30 September) to 3.234×10^6 t in 2019/2020, an increase of 25% in the last decade. Over the same period, worldwide production has constantly risen (**Figure I-1**), despite continuous fluctuations from year to year, linked to climatic conditions and the bienniality of the harvest. This world production is also influenced by the olive oil production of Italy and Spain.

Indeed, if averaged over the years 2017 to 2021, Spain produces about 45% of the world's production and Italy produces an equivalent of 12% of the total produced in the world. Then come other producers such as Greece with 8.2%, Portugal with 3.6% and France with 0.2%. This makes Europe the main olive oil producing continent, as it holds about 70% of the world's production.

Performance figures for the 2017/2018 crop year pointed to a worldwide consumption of 3.039×10^6 t, a rise of 11.5% in only one year (IOC, 2018a) and a worldwide production growth of 31.9% (3.379×10^6 t) compared to the previous crop year (International Olive Oil Council, 2021a).

I.1.1.2 Olive oil production in France

In the case of France, the olive-growing heritage is composed of four million olive trees spread over more than 1,500 municipalities and shared between approximately 28,000 owners or producers and 180 oil mills. It is generally the production area that puts on sale the majority of the olive oils produced in France. Currently, France has five olive oil-controlled designations of origin "*Appellation d'Origine Contrôlée*" or AOCs. AOC is an appellation used in France, but throughout Europe, the Protected Designation of Origin or PDO is used instead (Les Moulins de Provence, 2017).

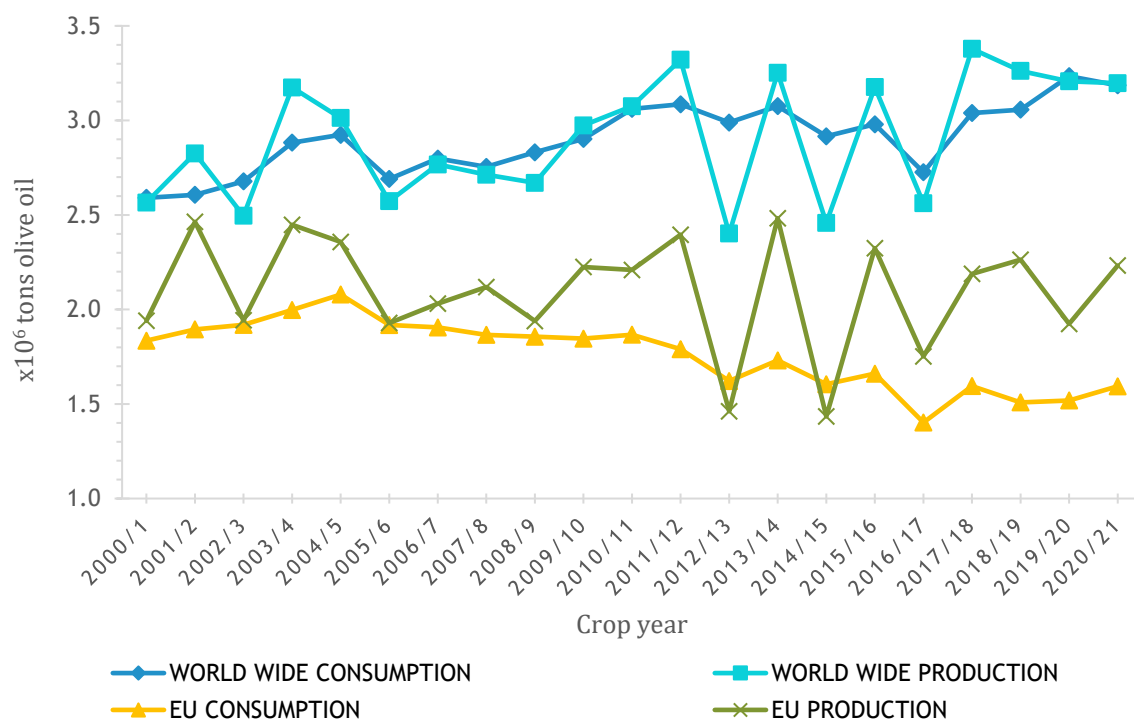

Figure I-1. Olive oil production vs consumption. Adapted from Espadas-Aldana et al. (2019).

France produced in 2017/2018 around 6,200 t of olive oil but it remains highly dependent on other countries because, in fact, French consumption is slightly more than 100,000 t per year (International Olive Oil Council, 2021a).

1.1.2 Regulatory agencies

The main function of a regulatory agency is to monitor and regulate a particular sector of economic activity, including the enforcement of regulations that establish conditions of practice in the affected sector; in the case of olive oil, the two main regulatory agencies are the International Olive Council and the *Association Française Interprofessionnelle De l'OLive*.

1.1.2.1 International Olive Council

The International Olive Council (IOC) (International Olive Oil Council, 2021b) is the only intergovernmental organization in the world dedicated to olive oil and table olives. It was established in Madrid, Spain, in 1959 under the auspices of the United Nations. The Council makes a decisive contribution to the responsible and sustainable development of olive growing and provides a global forum for discussion of all policy issues and present and future challenges. To this end, it seeks to

- Promote international technical cooperation in research and development projects and training and technology transfer activities
- Encourage the expansion of international trade in olive oil and table olives, develop and update trade standards for olive products and improve quality
- To study the impact of olive growing and the olive industry on the environment

- To promote the consumption of olive oil and table olives through action plans and modern promotion campaigns
- To disseminate clear and accurate information and statistics on the world market for olive oil and table olives
- To enable government representatives and experts to meet regularly to discuss the problems of the sector and to set priorities for IOC action
- To work in close collaboration with the private sector.

I.1.2.2 Association Française Interprofessionnelle De l'OLive

L'Association Française Interprofessionnelle De l'OLive (l'AFIDOL) was created in 1999. Now called France Olive since June 2019, it is a private organization, which gathers the partners of the upstream and downstream of the French olive industry. It has an assembly of 48 delegates, designated by the professional families: producers, millers, industrial olive oil packers, table olive confectioners, and nurserymen, who elect a board of directors of 24 members (France Olive, 2020).

As a forum for consultation and decision-making, France Olive is at the service of the profession to enable French olive growing to develop.

I.1.3 Technical information of olive oil

The main technical characteristics of olive oil are presented in **Table I-1**.

Table I-1. Technical characteristics of olive oil (Olivier de Provence, 2021).

Smoke point	210° against 180°C for normal frying temperature
Density	1 litre of olive oil weighs about 920 grams.
Caloric intake	9 calories per gram
Solidification point	2°C
Yield	It takes about 5 to 6 kg of olives to obtain 1 litre of oil
Preservation	Olive oil goes rancid less quickly thanks to its low iodine index; 78/88 against 83/98 for peanut oil and 120/132 for sunflower oil.

I.1.4 Production process

In contrast to fermented beverages such as wine, the production of olive oil does not require chemical transformation, and it is possible to produce oil without complex machinery by using certain techniques, known since ancient times. The four main phases are (**Figure I-2**):



Figure I-2. Olive oil production scheme.

I.1.4.1 Olive harvesting and transport

The process of oil production begins with the harvesting of the olives, which are immediately afterwards taken to the mill to be sorted to eliminate foreign elements and then washed with cold water.

The world olive harvest usually takes place from November until March, but in France, it takes place from September to January. The picking of the olives is a very important process because the changes in the acidity of the olives occur after harvesting: manual harvesting is the best method, but it is very expensive, while mechanical harvesting (if done avoiding the breaking of the fruit skin), can give good results. After harvesting, the olives are sent to the mills and processed within 24 hours, in order to avoid a fermentation phenomenon (Salomone et al., 2015).

I.1.4.2 Olive oil extraction

There are then two different techniques to extract the oil; the batch process by press system and the continuous process by centrifugation.

Traditional pressing (batch process) is still used in some small factories using a hydraulic press, but it is a relatively obsolete technology that has been replaced by centrifugal systems, allowing lower manufacturing costs, and a better quality of oil and olives before processing. This process generates a solid fraction (olive pomace) and an emulsion containing olive oil, which is separated by decantation from the remaining wastewater (Salomone et al., 2015). Here, the crushing of the unstoned olives is done by millstones (2 or 4) in granite which turns in a stone tank. The core contains an antioxidant that is part of the natural preservation of the oil. Then, the paste obtained from the crushing is placed in *scourtins* (fibre discs) at a rate of 2 to 3 kilos well distributed. The *scourtins* retain the solid part, the pomace, made up of the remains of pits and olive pulp and let the liquid composed of oil and water flow out.

On the other hand, for the continuous process, the steps are as follows:

- **Fruit cleaning** entails two operations: leaf removal and washing. Defoliators suck the leaves, twigs and dirt using a powerful air current generated by an extractor fan. The olives are then washed in a stream of water, which is optional, as it is omitted if the olives were harvested by hand.
- **Crushing** of the unstoned olives. It allows the destruction of plant tissues (vacuoles) which releases the oil droplets contained in the cells. The flesh and stone are pulverised to form an olive paste, which is transferred to a tank for mixing.
- **Malaxation**. Also known as beating or kneading. This operation follows the crushing or pressing and aims to break the emulsion between water and oil and make the oil particles agglomerate into larger drops, separating spontaneously from the margins. The margins, (or vegetation water), are effluents from the extraction of olive oil consisting of water contained in the cells of olives, washing water, and those related to the treatment process; because of their very high organic load, and their content of phenols and polyphenols difficult to degrade, these effluents pose significant problems for their disposal. For high-quality oils, blending is carried out cold or by moderately heating the oil paste to a temperature of 27 to 28 °C. EU Regulation 1019 of 2002 only allows the labelling of cold processing (in reference to the extraction process) if all of the operations required for extraction are carried out at a temperature of 27°C or less.

- **Centrifugation.** This is the final operation, which, by a process of rapid rotation in a metal cylinder has the effect of separating the oil, lighter than water, from the water itself.

The centrifugation method covers the need for a continuous extraction process. This method works on the basis of centrifugal force, where the less dense liquid phase forms a concentric inner layer, whereas the denser solid particles are pushed against the wall of the rotating bowl (Boskou, 2006). This extraction process presents two operation alternatives: the three-phase and the two-phase horizontal centrifugation methods.

The difference between the two-phase and three-phase horizontal centrifugation is not whether or not water is added, as it is often mistaken. The difference lies in the number of output streams that the decanter has:

- On the one hand, **the three-phase centrifuge** has as an output for olive oil, vegetable water, also known as olive mill wastewater (OMW) (*alpechin* in Spanish) and pomace (*orujo* in Spanish).

- On the other hand, **the two-phase centrifuge** has as an output for olive oil, and another for wet pomace (*alperujo*, contraction of *alpechin* and *orujo* in Spanish).

It should be noted that the two-phase decanter requires a minimum moisture content of the olive paste (about 50%) to facilitate the separation process. If the olive paste is too dry before being introduced into the decanter, it will be necessary to incorporate a certain amount of water until the moisture level required for a proper operation of the decanter is reached (Vidal, 2019). For this reason, water can be added to the two-phase centrifuge system as well. The three-phase centrifugation device increases water utilization (from 1.25 to 1.75 times more) when compared to the traditional method (Boskou, 2006). Additionally, valuable components, especially natural antioxidants, can be lost in the water phase (OMW), thus reducing the olive oil quality.

1.1.4.3 Refining

Refining allows the treatment of lampante oil, second centrifugation and crude pomace oils so that they can be blended with virgin oils and thus be used for human consumption.

Lampante olive oil is a low-quality olive oil. It has a lot of acidity and a very unpleasant taste and smell that prevents its human consumption. In fact, the traditional name of lampante comes from its use as fuel in oil lamps. According to current legislation, virgin olive oil is lampante when not meeting any of the requirements to be virgin olive oil (International Olive Oil Council, 2021c).

1.1.4.4 Purification and packaging process

In order to purify the extracted oil by separating it from the residual water, decantation is applied with a vertical centrifugal separator. The average yield is about 0.206 kg of extracted oil per kg of olive. The oil is sent to the stainless steel tank for storage before bottling.

Storage and bottling are an important step of the olive oil production because oil quality decreases during this process due to oxidation phenomena, which leads to depletion of its nutritional and sensorial properties. This oxidation depends on oxygen availability and the amount of temperature and light. The packaging acts as a protective layer for these three criteria (Guiso et al., 2016).

Bottling can be made in stainless steel containers, in glass bottles and in bottles made of polyethylene terephthalate (PET) which are 100% recyclable (Salomone et al., 2015).

1.1.5 The different types of olive oil

“Virgin olive oils are oils which are obtained from the fruit of the olive tree (*Olea europaea* L.) solely by mechanical or other physical means under conditions, particularly thermal conditions, that do not lead to alterations in the oil, and which have not undergone any treatment other than washing, decantation, centrifugation and filtration” (International Olive Oil Council, 2021c).

Thus, the most common definition of olive oil refers to oil derived exclusively from the olive, which excludes:

- the oil obtained by treatments with solvents,
- oil obtained by any form of esterification,
- oil obtained by any type of mixture with other oils.

Olive oil comes in different qualities. Depending on the way it is made and handled, olive oil can also have very different tastes from one region to another or from one country to another.

The different qualities of olive oil receive a denomination corresponding to criteria fixed by the regulations. Olive oils suitable for human consumption must not exceed 3.3% (3.3 grams per 100 grams) in free oleic acid content (International Olive Oil Council, 2021c).

Olive oil triglycerides, like all triglycerides that constitute oils and fats, have molecules formed by a glycerol residue and three fatty acid residues of different kinds, whose distribution is characteristic of the olive oil, and at a more detailed level, of the different varieties or place of production. When triglycerides are broken down, the fatty acid residues that made them up can break off and form "free fatty acids". Their percentage in the oil is called "acidity" of the oil, and is expressed in "grams of free oleic acid per 100 grams of oil". This acidity is never perceived as an acidic taste but in the form of this or that degradation, such as a musty taste (Afidol, 2021).

The acidity expressed as a percentage of oleic acid in olive oil is a simple and effective means for the qualitative evaluation and classification by commercial category of olive oils. This parameter is determined according to the ISO 660:2009 reference. The lower the acidity level of the oil, the better the quality. However, it is not the only quality parameter to classify olive oil. There is also the peroxide index, K_{232} , K_{270} , ΔK , median of the defect, median of the fruitiness and fatty acid ethyl ester parameters taken into account for their classification and have limits for each type (Vidal, 2019).

The virgin olive oils (**Figure I-3**) suitable for consumption include (i) extra virgin, (ii) virgin, and (iii) ordinary virgin olive oil.

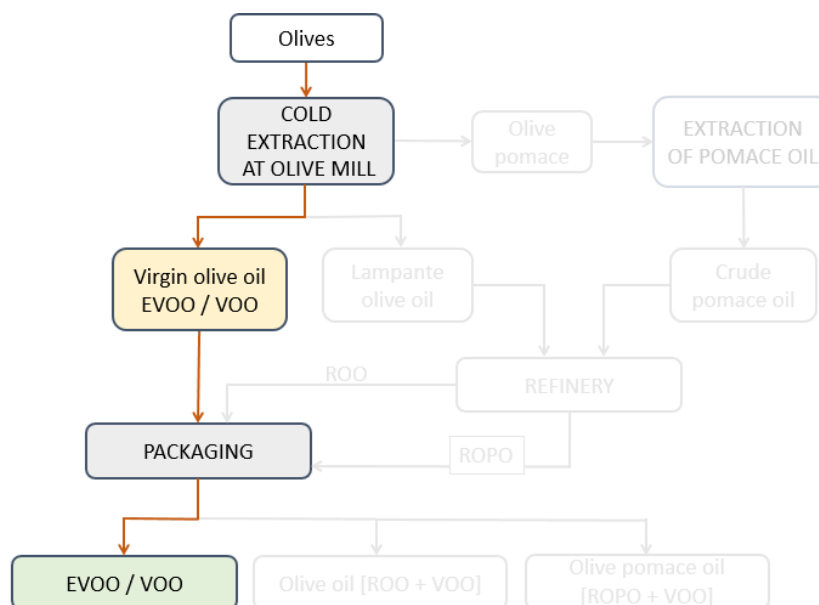

Figure I-3. The processing route for extra virgin/virgin olive oil.

- i. **Extra virgin olive oil (EVOO):** virgin olive oil with a free acidity expressed as oleic acid of no more than 0.80 grams per 100 grams and whose other characteristics correspond to those established for this category by the IOC's Commercial Standard. The lower the acidity level of the oil, the better the quality.
- ii. **Virgin olive oil (VOO):** virgin olive oil with a free acidity expressed as oleic acid of no more than 2.0 grams per 100 grams and whose other characteristics correspond to those set for this category by the IOC's Commercial Standard.
- iii. **Ordinary virgin olive oil:** virgin olive oil with a maximum free acidity expressed as oleic acid of 3.3 grams per 100 grams and whose other characteristics correspond to those laid down for this category in the IOC's Commercial Standard.

Virgin olive oil not fit for consumption as is, known as **(iv) lampante virgin olive oil**, is virgin olive oil whose free acidity expressed as oleic acid is greater than 3.3 grams per 100 grams and/or whose organoleptic and other characteristics correspond to those laid down for this category by the IOC's Commercial Standard. It is intended for the refining industries or technical uses. The different qualities of virgin olive oils expressed in terms of oleic acid content are presented in **Table I-2** below.

Table I-2. Different qualities of virgin olive oils.

Type of virgin olive oil	Oleic Acid per 100 g
Extra virgin olive oil	≤ 1 g
Virgin olive oil	max. at 2 g
Ordinary virgin olive oil	max. at 3.3 g
Lampante virgin olive oil	> 3.3 g

Other classifications are related to the definition of olive oil, distinguishing:

- a. **Refined olive oil (ROO)** is the olive oil obtained by the industrial refining of virgin olive oils that does not involve changes in the initial glyceride structure. Its free acidity expressed as oleic acid is maximum 0.30 grams per 100 grams and its other characteristics correspond to those set for this category by the IOC's Commercial Standard.
- b. **Olive oil [ROO + VOOs]** is a mixture of refined olive oil, which is obtained from the refining of defective oils, which have not reached the quality parameters mentioned above, and virgin olive oil or extra virgin olive oil (**Figure I-4**).
- c. **Olive pomace oil** is the oil obtained by treating olive pomace with solvents or other physical processes, excluding oils obtained by re-esterification processes and any mixture with oils of another nature (**Figure I-5**). It is marketed under the following names and definitions :
 - c.1. **Crude olive-pomace oil** is olive pomace oil whose characteristics correspond to those laid down for this category in the IOC's Commercial Standard. It is intended for refining for use for human consumption or technical purposes.
 - c.2. **Refined olive-pomace oil (ROPO)** is the oil obtained by refining crude olive-pomace oil, whose free acidity expressed as oleic acid may not exceed 0.30 grams per 100 grams and whose other characteristics correspond to those laid down for this category by the IOC Trade Standard.
 - c.3. **Olive-pomace oil [ROPO + VOOs]** is the oil obtained by blending refined olive-pomace oil and virgin olive oils suitable for consumption as is. Its free acidity expressed as oleic acid is a maximum of 1.00 grams per 100 grams and its other characteristics correspond to those established for this category by the IOC's Commercial Standard.

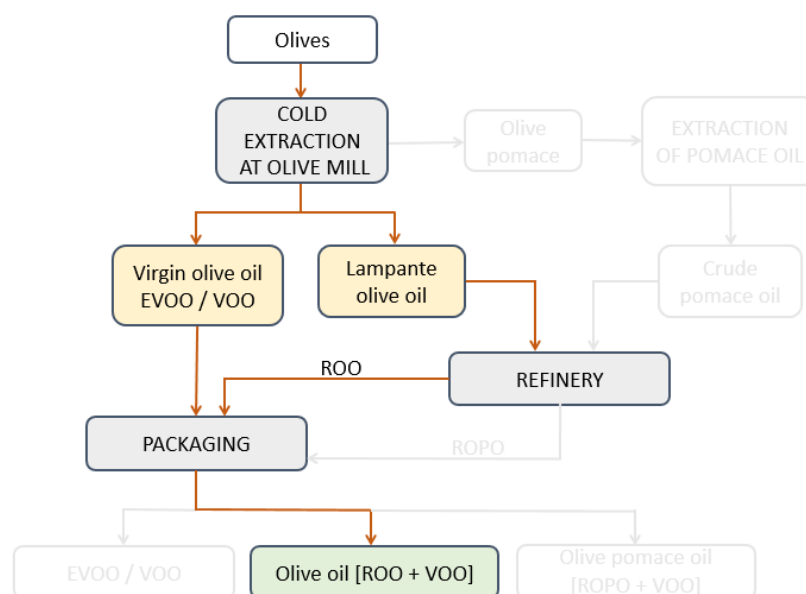

Figure I-4. The processing route for olive oil (ROO + VOO).

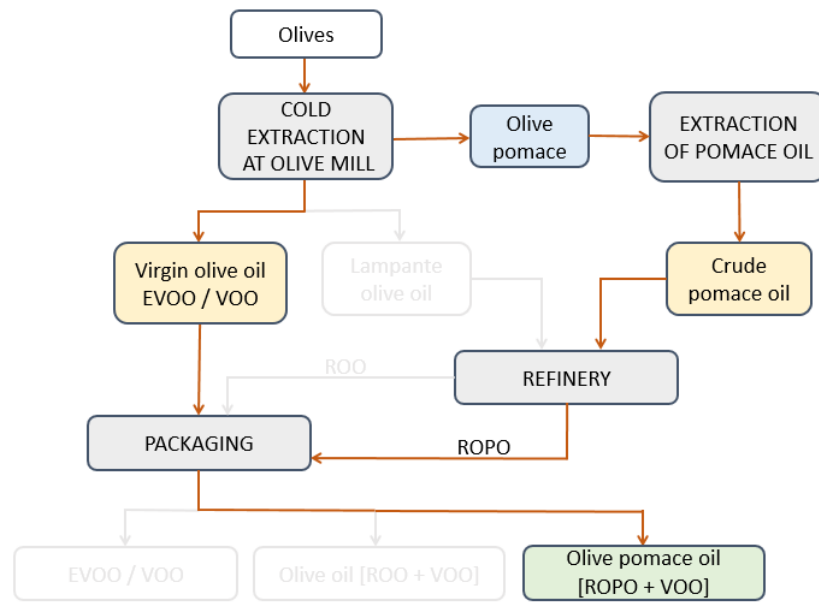

Figure I-5. The processing route for olive pomace oil (ROPO + VOO).

I.1.6 By-products of olive oil production

The rising popularity of olive oil has increased the generation of its by-products:

- the **olive pomace (OP)**, a general term used to refer to the pomace obtained from all the different olive oil extraction processes, and
- an effluent known as **olive mill wastewater (OMW)**, deriving from traditional pressing and the three-phase system, as mentioned before (I.1.4.2 Olive oil extraction) (Dermeche et al., 2013; Salomone et al., 2015).

This OP is a mixture of residual skin, pulp and fragments of the crushed olive stone (Lammi et al., 2018b). The main components of this solid residue are cellulose, hemicelluloses, and lignins. Residual fat and proteins are also present in noteworthy quantities. The moisture content of the solid residues is 22-25% for traditional pressed olive pomace, 65-74% for pomace from a two-phase system, and 40-50% for that from a three-phase one (Contreras et al., 2020; Dermeche et al., 2013). On the other hand, OMW is a red-to-black coloured acidic liquid, with 83-92% content of water, its main components being phenolic compounds, sugars and organic acids. OMW reveals also an important quantity of potassium (Dermeche et al., 2013).

On average, olive fruit contains 20% wt. of oil, and the remaining 80% wt. together with the added water from OP (de la Casa and Castro, 2014). Olive oil processing is considered inefficient due to the high volume of waste generated (Ravindran and Jaiswal, 2016). This particular industry has a seasonable production, which generates a high amount of waste in a short period. The olive oil industry causes many environmental impacts in terms of resource depletion, land degradation, air emissions and waste generation. Moreover, the management of olive oil residues is an economic burden to producers (Azbar et al., 2004; Bhatnagar et al., 2014; Espadas-Aldana et al., 2019; Nunes et al., 2016; Salomone and Ioppolo, 2012). In Europe, the production of OP reaches approximately 6.8 million tons per year (Sauvant, 2011).

I.1.6.1 By-products disposal (business-as-usual)

Currently, olive oil by-products are discharged on agricultural land by controlled spreading (Aparicio-Ruiz and Harwood, 2013; Azbar et al., 2004; Dermeche et al., 2013). Due to its high content in phenolic and lipidic constituents, organic acids, low pH, and salinity, OP should not be used for agricultural spreading (Lammi et al., 2019). Moreover, OP is resistant to bacterial degradation, which makes it a significant source of environmental pollution (Lammi et al., 2019).

Another use of OP has been in animal nutrition. As an example, it is used in Tunisia in a mixture with bran or even cactus to feed dromedaries or sheep. In countries such as Italy and Greece, cows are fed with OP. However, it can cause digestive problems in animals due to its high degree of lignification (Alibes et al., 1983).

Alternatively, OP has also been used for composting, or to produce a non-phytotoxic product through biological conversion (Bioremediation), which can be used as a fertiliser (Dermeche et al., 2013; Haddadin et al., 2009; Morillo et al., 2009).

Over the years, many other methods have been proposed for olive oil waste disposal and valorisation. These techniques include thermo-chemical processes, anaerobic digestion, fermentation, blending, and chemical extraction of bioactive compounds (E. Christoforou and Fokaides, 2016; Contreras et al., 2020; Cossu et al., 2013; Duman et al., 2020). Valorisation routes also include the production of activated carbons, cosmetic applications, the production of polyols, and the improvement of the thermal properties of cement mortar (Barreca and Fichera, 2013; El-Sheikh et al., 2004; Matos et al., 2010).

I.1.6.2 By-products valorisation (new path)

In the most recent years, research has focused on the valorisation of OP in the biocomposite field (Aouat et al., 2021; Banat, 2019; Boufi, 2017; Duman et al., 2020; Kaya et al., 2018; Koutsomitopoulou et al., 2014; Lammi et al., 2019, 2018b, 2018a; Naghmouchi et al., 2015). Due to their natural richness in lignocellulosic fibres, this sector uses agricultural wastes (or by-products) as renewable fillers for polymeric matrices. The obtained results from olive stone flour have confirmed its viability as a cheap reinforcing filler for the polypropylene matrix, thus opening new perspectives for the use of this by-product (Naghmouchi et al., 2015). The developed composites could find applications in buildings, in the automotive industry, and as outdoor products, *e.g.*, deck floors, furniture, park benches, etc. Specific examples of this application are those from the GO-OLIVA project (Spain), which developed Olipast, a new sustainable packaging material from the olive pit (Putinja, 2020), and from the Biolive company, which commercializes the Bio-Pura product, used for the manufacture of television components (Turkey). The Biolive company is also working to produce shrink wrap for beer cans from this material, and other end products for various applications, including consumer electronic casings, automotive interiors, toys, and packaging. Approximately 3.5 tons of bioplastics can be transformed from 5 tons of locally sourced olive seeds ("Biolive Biological and Chemical Technologies," 2020; Material Connexion, 2019).

1.2 Life Cycle Assessment methodology

1.2.1 Introduction to the Life Cycle Assessment methodology

Life Cycle Assessment (LCA) is a method of evaluation of the environmental burdens associated with a product, process, or service by identifying and quantifying energy and materials used and wastes released into the environment; and most importantly, to identify and evaluate opportunities for environmental improvements. LCA is currently the best technique to quantify environmental impacts during the entire lifespan of products or processes, through the inventory of inputs and outputs in a selected system, the assessment of potential impacts and the interpretation of results. It evaluates the entire life cycle “from cradle to grave”, including extraction and processing of raw materials, manufacture, transport/ distribution, use, and end of life. It is important to ensure that all life cycle stages are considered. Nevertheless, often not all life cycle stages are considered, so there are four different approaches to considering the system boundaries (Figure I-6 and Figure I-7):

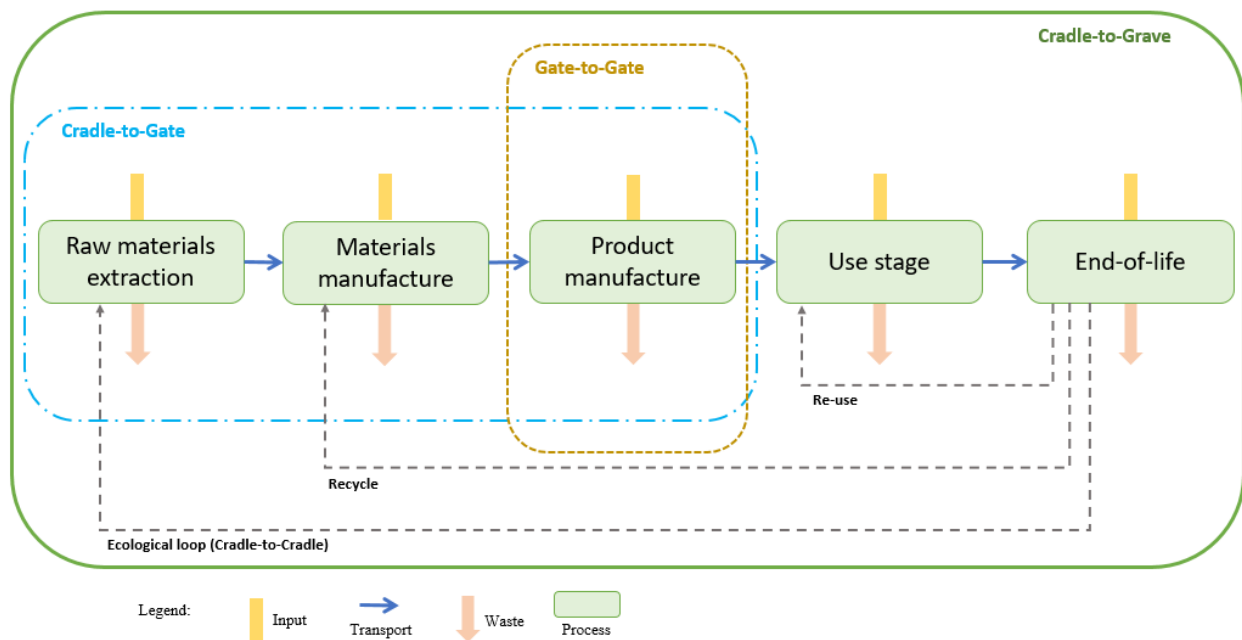

Figure I-6. Different boundaries of the commonly used system.

When governments, companies and consumers need to make an environmental decision, the LCA method can provide them with the necessary information to make this judgment call. Other decision-making tools are available, each one with its specific role, pros and cons.

It is worth saying that LCA is also one of the available tools to evaluate products, packaging and processes and is used, for example, in the preparation of environmental product declarations or environmental footprints/ecolabeling. Ecolabeling is intended to provide a mechanism for informing consumers about which products, within a wide range, meet strict standards for reducing environmental impact, categorized as "environmentally friendly".

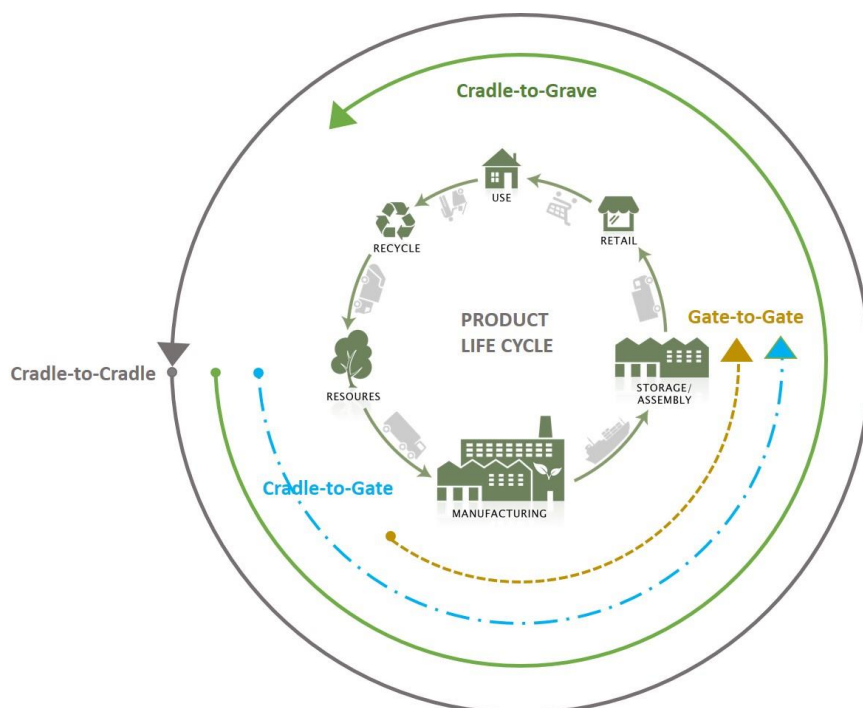

Figure I-7. The four system boundaries of Life Cycle Assessment.

1.2.2 LCA methodology among other environmental analysis tools

LCA has the most in common with the following six environmental analysis tools highlighted in **Table I-3** (Jolliet et al., 2017):

- *Substance flow analysis* (SFA) quantifies the flow and accumulation of a substance (e.g. Hg) or a group of substances (e.g. nitrogen compounds) in the environment.
- *The environmental impact assessment* (EIA) is concerned with individual installations to be built and analyses the environmental impact of a planned project at a specific location. Therefore, it is more of a legal procedure than an analytical tool.
- *Risk assessment* (RA) examines the risk or probability of extreme effects of an installation (e.g. nuclear power plant) or the risks associated with the use of chemical substances.
- *Mass flow analysis* (MFA) accounts for the flow of materials in the economic system of a given region. These materials can be raw materials (glass, paper, concrete, plastics) or technical compounds.
- *The carbon footprint* (CF) determines the direct or indirect greenhouse gas emissions of a product, a human activity or a company.
- *The water footprint* (WF) determines the impacts associated with water as a specific area of focus, and includes water use and environmental exposures related to water quality.

General criteria and life cycle stages from some environmental evaluation methodologies are shown in **Figure I-8**.

Table I-3. Main Characteristics of Environmental Analysis Tools (Joliet et al., 2017).

Tool	Object of study	Scale and Scope	Considered substances and impacts	Basis of comparison	Basic elements
Life cycle assessment (LCA)	Product or service	Global or regional Entire life cycle	Manu substances Multiple impacts on humans and ecosystems	Function of the product or service	Mass balance Multimedia model Effects assessment
Substance flow analysis (SFA)	Polluting substance	Regional or global Substance cycle	Single substance No impact	Given time and region	Mass balance Multimedia model
Risk assessment (RA)	Installation or chemical substance	Local or regional Selected stage	Relevant substances Toxicity	Maximum level of risk	Multimedia model Effects assessment
Material flow analysis (MFA)	Raw material or compound	Regional or national Material life cycle	Single or multiple material No impact	Given time and region	Mass balance Material flow tracking
Carbon footprint (CF)	Product, activity or company	Global Entire life cycle	Greenhouse gases Climate change	Product function, activity, or company	Mass balance Global warming potential
Water footprint (CF)	Product, activity or company	Local or regional Most important life cycle stages	Water consumed and water-related exposure Water quantity and quality	Product function, activity, or company	Water balance Consumption Competition Adaptation
Environmental impact assessment (EIA)	New localised activity	Local scale Local activity	Highly variable	Local carrying capacity	Highly variable

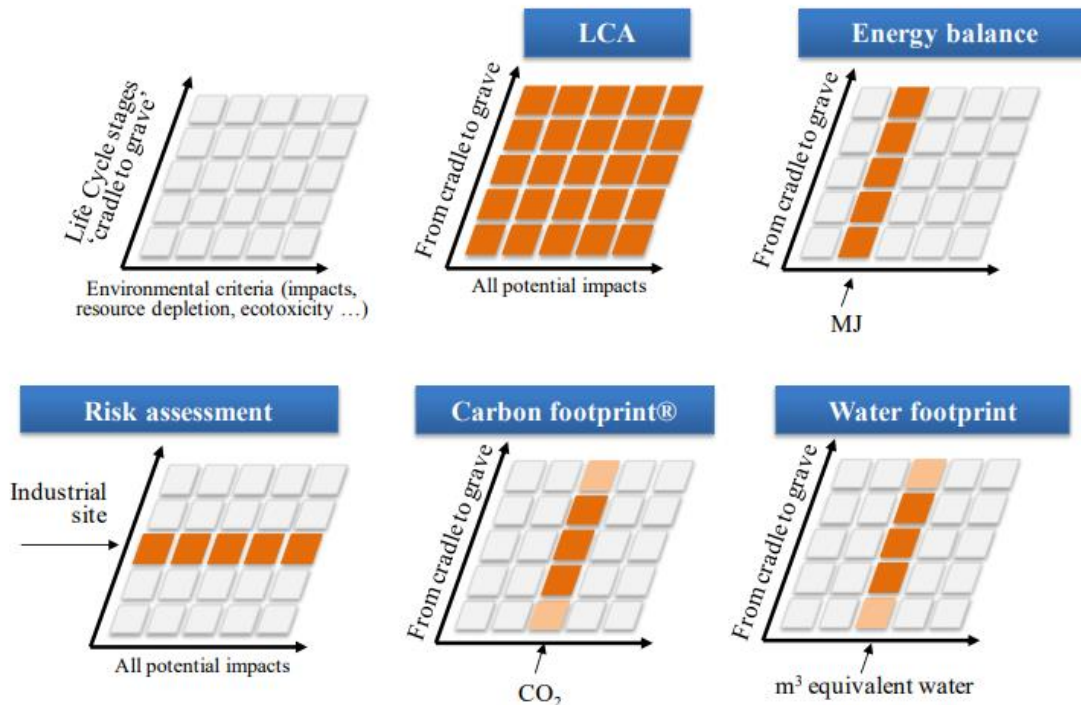

Figure I-8. Presentation of some environmental assessment methods. Adapted from Risch et al. (2012).

In conclusion, only LCA performs a quantified life cycle assessment, covering many different impacts. It is the only multi-criteria, multi-step method that links the multiple environmental impacts and the function of a given product, service, system or process.

1.2.3 Definition of the four LCA phases

According to the ISO standards (ISO, 2006a, 2006b) and SETAC definition; LCA is carried out in four phases (**Figure I-9**): goal and scope definition, inventory analysis, impact assessment and interpretation.

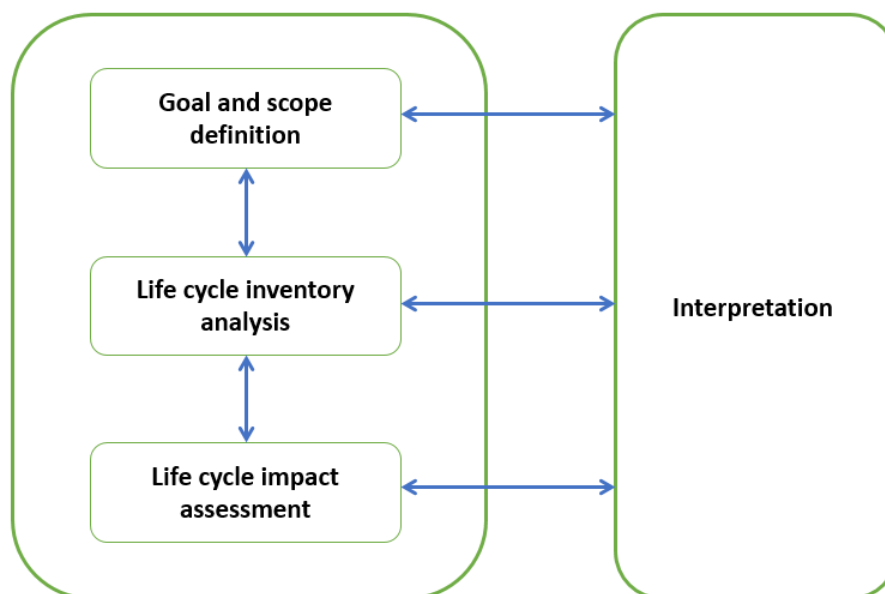

Figure I-9. Phases of Life Cycle Assessment (from ISO 14040)

1.2.3.1 Goal & scope definition

The goal and scope definition is the first phase of LCA and it allows to present the problem, to define the objectives and the field of the study. This phase determines a set of crucial elements: the function of the system and the functional unit to which the emissions and extractions will then be reported. It also defines the limits of the considered system. The basic scenarios and the alternatives to be studied are defined in detail during this phase (Jolliet et al., 2017).

1.2.3.1.1 Goal definition

The goal definition meant to answer, “Which decision(s) is this LCA intended to support?”, “What is the target audience to whom the results will be communicated?” and “Why is this study performed?” It sets the context of the LCA study and is the basis of the scope definition where the assessment is framed and outlined in accordance with the goal definition (Hauschild et al., 2018).

1.2.3.1.2 Scope definition

The scope defines:

- the functional unit (FU): a quantitative description of the function or service for which the assessment is performed. It should include: quantity + quality + duration.
- It is important to define the functional unit right because it significantly influences the way LCA is performed, its results and interpretation, especially in comparative studies (Hauschild et al., 2018).

- the reference flow: the product flow to which all input and output flow for the processes in the product system must be quantitatively related. It scales the data collection in the next LCA phase, the inventory analysis. Reference flows may be different for each scenario.
- the product system, deciding which activities and processes belong to the life cycle of the product that is studied.
- the assessment parameters.
- the geographical and temporal boundaries as well as the level of technology used.
- the relevant perspective to apply in the study: **attributional or consequential approach**.
- and identifies the need to perform a critical review, in particular, if the study is a comparative assertion intended to be disclosed to the public.

The goal definition and the ensuing scope definition are very important to consider when the results of the study are interpreted since these definitions involve choices that determine the collection of data and how the system will be modelled and assessed (Hauschild et al., 2018). Scope definition is probably the most important phase of an LCA.

1.2.3.1.3 System expansion and allocation

In numerous processes, more than one product is produced within the main product, called by-products/co-products.

System expansion and allocation are the two methods to deal with the multi-functionality in LCA. The choice between the two methods is crucial because it can have a big influence on the study results. In system expansion, co-products are considered alternatives to other products on the global market. In allocation, it is necessary to “divide” the environmental impacts of the process between the products. The ISO 14040-series recommend using system expansion whenever possible. If not possible, allocation of environmental impacts between the product and co-products can be performed from an economic or physical point of view. **Figure I-10** shows the ISO hierarchy for solving multifunctionality that can be presented in a decision tree (Hauschild et al., 2018).

1.2.3.1.4 Attributional and Consequential LCA

Understanding the difference between attributional and consequential modelling and when to use them has been (and still is) one of the most difficult aspects of LCA. Some aspects of the terminology are defined in the International Reference Life Cycle Data System (ILCD) guidelines (Joint Research Centre and Institute for Environment and Sustainability, 2010).

First of all, an explanation of the two modelling frameworks is offered, including their handling of multifunctional processes and the use of average or marginal Life Cycle Inventory data (1.2.3.2.1 Foreground vs background system). **Table I-4** summarizes the explanation and discrepancies of attributional and consequential modelling.

Attributional LCI modelling (also known as “traditional LCA”, “LCAs”, or a-LCA) aims to represent a product system in isolation from the rest of the technosphere or economy. The question addressed by attributional LCA can be said to be “what environmental impact is product X responsible for?” As hinted by these questions, there is an element of subjectivity involved in attributing impacts to a product system or deciding the impact responsibility of a product system. Before the ILCD guidelines came into place attributional modelling to solve the issue of

multifunctional processes, provided that subdivision was not possible. By contrast, ILCD in some cases recommends solving multifunctionality by system expansion.

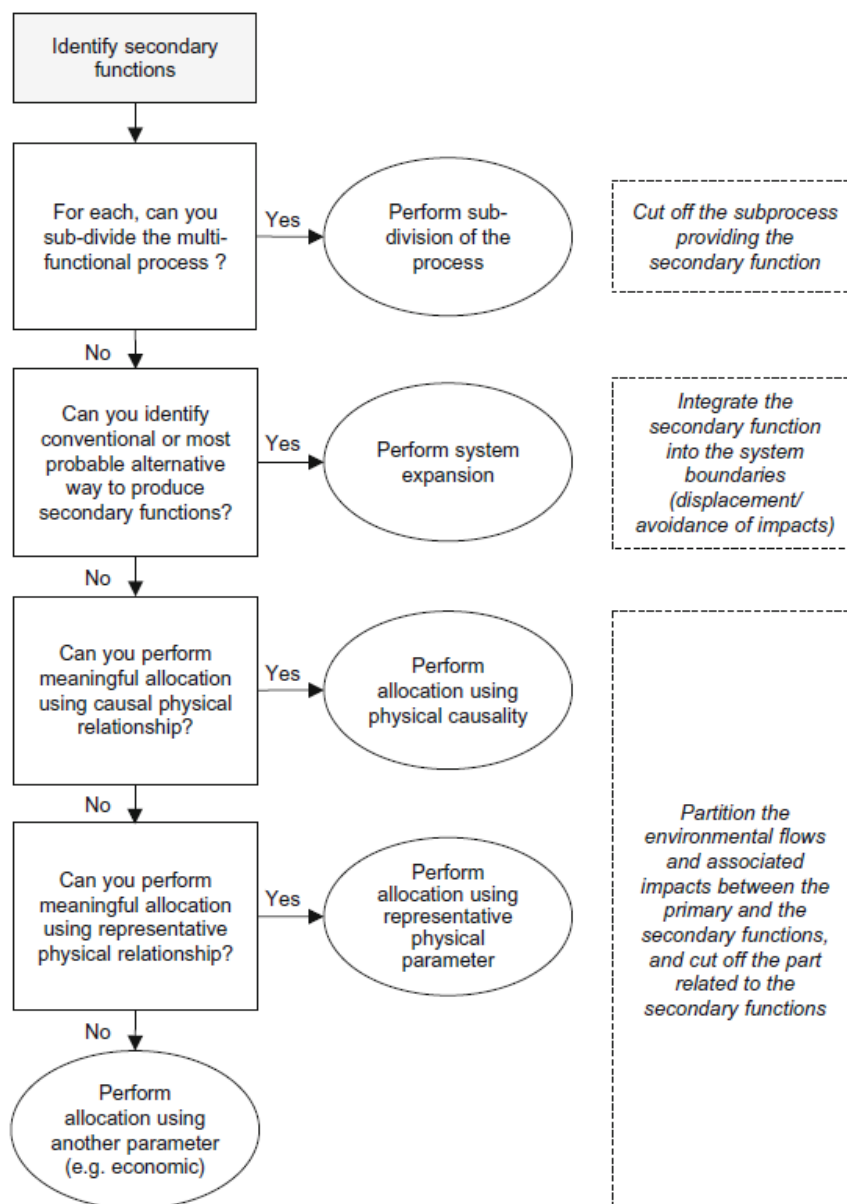

Figure I-10. ISO hierarchy for solving multifunctionality presented in a decision tree (Hauschild et al., 2018).

Consequential LCI modelling (or c-LCA) describe the changes to the economy caused by the introduction of the studied product system. Consequential LCI modelling thus aims to answer the question “What are the environmental consequences of consuming X?” It uses a very different approach than attributional modelling because the change in the economy can look very different from the representation of the isolated product.

Briefly, “*Consequential LCA shall reflect that choosing one alternative over another involves an increasing demand for that alternative. The environmental consequences of this are precisely what the consequential LCA aims to model, and this is done through system expansion and the use of marginal data*” (Hamelin, 2013).

The other main difference between a-LCA and c-LCA is a logical implication of applying system expansion, and regards the type of data included in the LCA model. While a-LCA uses “average data” (e.g. an average of a given national electricity mix), c-LCA includes “marginal data” only, i.e. those from the processes and/or suppliers that are responding to changes in supply/demand (Hamelin, 2013).

Table I-4. The meaning of the attributional and consequential modelling frameworks and their handling of multifunctionality (Hauschild et al., 2018).

LCI modelling framework	Question to be answered	Handling of multifunctional processes when subdivision is not possible		Modelling of background system
		Before ILCD	ILCD	
Attributional	What environmental impact can be attributed to product X?	Allocation	System expansion or allocation	Average processes
Consequential	What environmental consequences of consuming X?	System expansion	System expansion	Marginal processes

1.2.3.2 Life cycle inventory analysis

After the Goal and Scope definition comes the Life Cycle Inventory (LCI).

It aims to collect and compile all data on elementary flows from all processes in the studied product system(s) drawing on a combination of different sources. The output is a compiled inventory of elementary flows that is used as the basis of the subsequent life cycle impact assessment phase (Hauschild et al., 2018).

This phase quantifies pollutant emissions into the air, water, soil and extractions of renewable or non-renewable raw materials. It is a question of quantifying the different flows crossing the system through the inventory (Jolliet et al., 2017).

1.2.3.2.1 Foreground vs background system

Several unit processes are required to accomplish the product studied in an LCA. Thus, it is often useful to distinguish between the unit process belonging to the foreground and background system.

The **foreground system** is defined as the set of processes directly affected by the study delivering a functional unit specified in the Goal and Scope Definition. The **background system** is that which supplies energy and material to the foreground system, usually via a homogeneous market so that individual plants and operations cannot be identified (Clark and Macquarrie, 2002).

In addition, according to Clark and Macquarrie (2002), depending on the source, data can be “**marginal**” or “**average**”. Marginal or process-specific data are sourced directly from the manufacturers and usually are more reliable than average data (or market mix), which can be obtained from different public or commercial LCA databases. Process-specific data should be used for the foreground system; average data are acceptable for the background.

It is important to remind that contrary to attributional LCA, consequential LCA is not associated with the use of average processes for modelling the background system, but instead with the use of marginal processes (Hauschild et al., 2018).

1.2.3.2 Ecoinvent Database

Ecoinvent is recognised as the world's leading supplier of consistent and transparent life cycle inventory data. The database contains more than 3,500 extensively documented industrial processes. Its latest version 3.4 (released in October 2017) includes updates and new data for the electricity sector, natural gas supply chains, chemical products and plastic recycling (Ecoinvent, 2018). Other LCI databases are GaBi, ELCD, Agri-footprint, ESU World Food, among others.

ISO standard for LCA presents some requirements regarding inventory analysis. It is important to remember that:

- All that has significance should be included
- All data should be documented (as well as their uncertainties)
- Treatment of missing data should be documented

1.2.3.3 Ecoinvent System Models

➤ The Allocation, default System Model (Alloc, Def)

Also called “allocation at the point of substitution”. It is based on two methodological decisions:

- It uses the average supply (unconstrained supply) of products, as described in market activity datasets.
- It uses partitioning (allocation) to convert multi-product datasets to single-product datasets.

Average supply means that the model does not use constraints due to markets and technology. In such a model, the product, material or service can be always provided, even if it is scarce. This differs from the *Consequential* model, which uses a constrained supply of products. The model allocates reference products and by-products economically, i.e. according to the market value of the products (SimaPro, 2021).

➤ The Allocation, recycled content System Model (Alloc, Rec)

It is called *Allocation, cut-off by classification* by the ecoinvent Centre since the SimaPro 8.5 release, and uses the same two decisions concerning average supply and allocation as the *Alloc, Def* system model. But *Alloc, Rec* does not take into account any benefit related to the recycling of a material. In this model, recyclable materials are available burden-free to recycling processes, which means that secondary (recycled) materials bear only the impacts of the recycling processes. The model does not give any credit to producers of wastes for the recycling or re-use of products from any waste treatment.

In contrast to the *Alloc, Def* system model that allocates waste (and by-products) at the point of substitution, here, the benefit from recycling materials is attributed to the market processes that provide the secondary materials or by-products (such as heat or electricity from the incineration of waste) (SimaPro, 2021).

➤ The Consequential System Model

It handles the two methodological decisions used in both *Allocation* system models differently:

- It uses a constrained supply of products, based on market activity data and on information about technology level.
- It uses substitution (system expansion) to convert multi-product datasets into single-product datasets.

In a constrained market, a change in demand does not result in a corresponding change in supply but instead in a change in consumption elsewhere. For example, by-product markets are constrained because their production volumes depend on the production volumes of the reference products, and it's the demand for the reference product that drives the production. This system model is intended to reflect the consequences of small-scale, long-term decisions by taking into account the constraints that apply at this scale and time horizon.

Because of the constrained supply of products, the allocation of by-products is avoided by using substitution, and analyses a product that replaces or substitutes the by-product of the reference product. The emissions of that replacing product are then subtracted from the reference product emissions (SimaPro, 2018).

Choosing A System Model: Each model has specific advantages, it depends on the goal and context of the LCA study to make.

1.2.3.3 Life cycle impact assessment

The effects of the environmental burdens identified in the inventory analysis phase are assessed and characterized in the impact assessment phase. It is based on both quantitative and qualitative procedures to characterize and assess the environmental impacts of a system. After the selection of the impact categories, category indicator and characterisation models, this phase can be broken down into the following four steps:

- (1) Classification.
- (2) Characterisation (Midpoint and Endpoint).
- (3) Normalisation.
- (4) Valuation.

(1) Classification is a qualitative step in which the burdens are aggregated into a smaller number of impact categories to indicate the potential impacts on human and ecological health and on resource depletion. The aggregation is done based on potential impacts of the burdens so that one burden can be associated with a number of impacts; e.g. volatile organic compounds (VOCs) contribute to both global warming and ozone depletion (Clark and Macquarrie, 2002).

The most commonly considered impacts in LCA are: resource depletion, global warming, ozone depletion, acidification, eutrophication, photochemical oxidant formation, human toxicity, and aquatic toxicity.

(2) Characterisation is a quantitative step to calculate the total environmental impacts of the burdens estimated in inventory analysis. This is a quantitative phase of LCA and should be based on the scientific findings on the relevant environmental impacts. For instance, CO₂ is a

reference gas for determining the global warming potential of other related gases, such as CH₄, NO₂, and other VOCs (Clark and Macquarrie, 2002).

A characterisation factor represents the contribution per quantity of an elementary flow to a specific environmental impact (category). Its modelling involves the use of different models and parameters and is typically conducted by experts for a particular impact category (Hauschild et al., 2018). *Midpoint characterisation* weights and aggregates the emissions into midpoint impact categories, whereas *Damage or endpoint characterisation* aggregates impact categories into damage categories such as human health, ecosystem quality and resource availability (Jolliet et al., 2016).

Research on LCI assessment methods to calculate impact categories is still ongoing.

(3) Normalisation is an optional step under ISO 14044 (2006). It shows the contribution of the studied product as a fraction of the global impact in a given impact category (Jolliet et al., 2016). It means that indicator scores for all impact categories are expressed in a common metric, typically the annual contributions to the total environmental impacts of an average person. This serves mainly three purposes: 1) for decision-makers to better understand the magnitude of characterised results by relating them to a common familiar and external reference, 2) to check for errors in the assessment resulting in unreasonably low or high normalised results and 3) to pave the road for weighting (Hauschild et al., 2018).

(4) Valuation (or weighting) is the final and most subjective step of impact assessment, in which the relative significance of different impacts is weighted so that they can be compared among themselves. As a result, different environmental impacts are reduced to a single environmental impact function, or *single score*, as a measure of environmental performance. Several techniques have been suggested for use in valuation. They are based mainly on expressing preferences by decision-makers, by 'experts' or by the public (Clark and Macquarrie, 2002).

However, because of some problems and difficulties associated with using these techniques, there is no consensus on the LCA community on how to aggregate the environmental impacts into a single environmental impact function.

1.2.3.3.1 Software

LCA results can be computed without LCA-specific software (e.g. Excel, MatLab) and it can be more educational and rigorous if done well. However, the computation of LCA usually becomes quite elaborated, so the use of specialized software is recommended.

The world's leading LCA software package is SimaPro. It was designed to be a source of science-based information, providing full transparency and avoiding black-box processes (SimaPro, 2018). Other examples of commercial tools for LCA software are GaBi® and Umberto®.

Also, there exist free tools such as OpenLCA and CMLCA. OpenLCA software is produced by GreenDeltaTC GmbH, supported by several sustainability-leading organizations ("OpenLCA.org," 2018). CMLCA is a tool by CML (Centrum voor Milieuwetenschappen: Institute of Environmental Sciences) Leiden University that supports the calculation of LCA, including social life cycle assessment (SLCA) and life cycle sustainability assessment (LCSA) (CMLCA.eu, 2018). However, the import/purchase from ecoinvent or other LCI databases will be necessary.

1.2.3.3.2 Impact categories and methods

Life cycle impact assessment (LCIA) converts all inventoried flows into simpler indicators. In a LCIA, essentially two mainstream ways to derive characterisation factors are followed: mid-point and end-point indicators. The midpoint methods are applied to the characterisation factor to measure the impact, while the endpoint methods are applied to the indicator to express the current damages.

The most famous methods used in SimaPro are ReCiPe 2016 Mid-point/End-point and ILCD 2011 Midpoint (iPoint, 2018). The International Life Cycle Data system (ILCD), developed in 2007, released in 2010 and continuously maintained by JRC, has been adopted in the Environmental Footprint (EF) methodology framework. ILCD format and nomenclature were adopted as requirements for EF (Fazio et al., 2018). Details of each method are available in **Appendix A**.

1.2.3.4 Life cycle interpretation

In the SETAC methodology, this phase is known as Improvement Assessment. It is the final phase of the LCA methodology and aims to identify the possibilities for improving the environmental performance of the system. This phase can be carried out before an LCA study is completed because the opportunities for improvements can be detected at an early stage of carrying out the study. The redesign of the product or a process as a result of the Improvement Assessment phase is not part of the LCA, it is one of its applications (Clark and Macquarrie, 2002).

In the ISO methodology, this phase is known as Interpretation. The Interpretation phase is also aimed at improvements and innovations, but in addition, it covers the following steps: identification of major burdens and impacts, identification of stages in the life-cycle that contribute the most to these impacts, evaluation of these findings, sensitivity analysis (to be explained in 1.2.3.4.3 Sensitivity analysis) and final recommendations (Clark and Macquarrie, 2002).

1.2.3.4.1 Data quality: uncertainty management

Different types of uncertainties can occur in a Life Cycle Assessment (LCA) study, such as uncertainties in input parameters, uncertainties in the model itself, uncertainties in assumptions and choices, and uncertainties in data variability (spatial, temporal, technological).

Until now, few LCA studies have quantitatively estimated the quality of their data. However, it must be seriously considered to ensure the value and credibility of the LCA. In fact, if the total uncertainty of the LCA is greater than the difference between the final impacts of the different scenarios, it could result in a wrong judgment (when comparing scenarios). Due to the many judgments made in an LCA, uncertainty and sensitivity analysis regarding various parameters is essential to understand the robustness of the study results. According to Jolliet et al. (2017), the suitable method to assess parameter uncertainties is Monte Carlo Analysis, when applied correctly, it also determines the significance of a difference between two scenarios.

Monte Carlo analysis first identifies each model input parameter as well as the type of probability distribution (e.g. normal, lognormal, or uniform), using data quality indicators. The model output is then calculated by randomly selecting a value for each input parameter based on its probability distribution.

In the specific context of LCA, the lognormal distribution is often applied by default, as parameter values sometimes vary over several orders of magnitude. The lognormal distribution has the advantage of automatically excluding several impossible scenarios, such as negative emissions or negative process uses (Jolliet et al., 2017).

In ecoinvent, the product life cycle inventory is described by single figures per input or output flow. These numbers contain a level of uncertainty, for instance, because of temporal or spatial approximations. Often the extent of uncertainty cannot be derived directly from the available information. For these cases, a simplified standard procedure was developed to derive uncertainty factors from a qualitative assessment of the data (Pré-Sustainability, 2018).

The procedure is based on a pedigree matrix composed of data quality indicators. Regarding data quality indicators, several have been developed (Weidema et al., 2013; Weidema, 1998; Weidema and Wesnæs, 1996) and they are presented below:

- Data **reliability** is based on the measurement method used and the verification procedures.
- **Completeness** depends on the representativeness of the available data and the number of companies considered over a given period.
- The **temporal, geographical and further technological correlation** indicates whether the location, time and technology of the collected data correspond to the process under study.

Data sources are evaluated on five independent characteristics called "reliability", "completeness", "temporal correlation", "geographical correlation" and "further technological correlation". It used to be six with the "sample size". The **sample size** is no longer used by ecoinvent v3. However, as it was used in SimaPro in the past, it has not been removed in more recent versions but is considered an obsolete indicator, as the sample size should already be taken into account in the basic uncertainty factor. This is a simplification, as generic base uncertainty factors do not account for the large-small sample size differences often encountered in LCAs (Muller et al., 2014).

Each inventory data point receives a qualitative score between 1 (best) and 5 (worst) for each of these indicators. These five indicators with their five quality levels are described using the **Pedigree matrix (Table I-5)**. To transform these qualitative indicator scores into a quantitative score, an uncertainty factor can be assigned to each of the matrix scores (**Table I-6**). Finally, the final uncertainty is calculated using Equation (1) (Jolliet et al., 2017; Citroth et al., 2016; Frischknecht et al., 2007)

$$GSD^2 = \exp \sqrt{\ln(U_R)^2 + \ln(U_C)^2 + \ln(U_G)^2 + \ln(U_T)^2 + \ln(U_L)^2 + \ln(U_S)^2 + \ln(U_B)^2} \quad (1)$$

where U indicates the uncertainty factors based on:

U_R	<i>Reliability</i>
U_C	<i>Completeness</i>
U_G	<i>Geographical correlation</i>
U_T	<i>Temporal correlation</i>
U_L	<i>Technological correlation</i>
U_S	<i>Sample size</i>
U_B	<i>Base uncertainty</i>

1.2.3.4.2 Uncertainty calculation in SimaPro with ecoinvent 3.6

The SimaPro software is capable of performing Monte Carlo analysis using the pedigree matrix (**Table I-5**) described in the ecoinvent Report n°1 (v3) by Weidema et al. (2013). Then, the final uncertainty is calculated using the default uncertainty factors (**Table I-6**) from the pedigree matrix and equation (1) described in the ecoinvent Report n°1 (Frischknecht et al., 2007).

1.2.3.4.3 Sensitivity analysis

A sensitivity analysis evaluates the influence of the most important assumptions have on the LCA results. The principle is simple: change the assumption and recalculate the LCA.

Table I-5. Pedigree matrix used to assess the quality of the data sources described by Weidema et al. (2013) which is used in ecoinvent 3.0 (Ciroth et al., 2016).

Indicator score	1	2	3	4	5 (default)
Reliability	Verified data based on measurements	Verified data partly based on assumptions or non-verified data based on measurements	Non-verified data partly based on qualified estimates	Qualified estimate (e.g. by industrial experts)	Non-qualified estimate
Completeness	Representative data from all sites relevant for the market considered, over an adequate period to even out normal fluctuations	Representative data from >50% of the sites relevant for the market considered, over an adequate period to even out normal fluctuations	Representative data from only some sites (<<50%) relevant for the market considered or >50% of sites but from shorter periods	Representative data from only one site relevant for the market considered or some sites but from shorter periods	Representativeness unknown or data from a small number of sites and shorter periods
Temporal correlation	Less than 3 years of difference to the time period of the dataset	Less than 6 years of difference to the time period of the dataset	Less than 10 years of difference to the time period of the dataset	Less than 15 years of difference to the time period of the dataset	Age of data unknown or more than 15 years of ≠ to the time period of the dataset
Geographical correlation	Data from area under study	Average data from a larger area in which the area under study is included	Data from area with similar production conditions	Data from area with slightly similar production conditions	Data from unknown or distinctly different area (North America instead of Middle East, OECD-Europe instead of Russia)
Further technological correlation	Data from enterprises, processes and materials under study	Data from processes and materials under study (i.e. identical technology) but ≠ enterprises	Data from processes and materials under study but from ≠ technology	Data on related processes or materials	Data on related processes on a laboratory scale or from ≠ technology

Table I-6. Default uncertainty factors (contributing to the square of the geometric standard deviation) applied together with the pedigree matrix. Taken from Frischknecht et al. (2007).

Indicator score	1	2	3	4	5
Reliability	1,00	1,05	1,10	1,20	1,50
Completeness	1,00	1,02	1,05	1,10	1,20
Geographical correlation	1,00	1,03	1,10	1,20	1,50
Temporal correlation	1,00	1,01	1,02	-	1,10
Technological correlation	1,00	-	1,20	1,50	2,00
Sample size	1,00	1,02	1,05	1,10	1,20

As illustrated by the narrowing spiral in **Figure I-11** (Hauschild et al., 2018), the uncertainty of the LCA results is reduced through the repeated iterations, and these are carried on until the strength of the conclusions meets the requirements posed by the goal and scope definition. These arrows indicate that rather than a linearly proceeding process, LCA involves many feedback loops between the different phases of the LCA. Sensitivity and uncertainty analysis are thus not just performed in the interpretation at the end but throughout the study as part of both inventory analysis and impact assessment in order to identify the key figures and assumptions of the study and the data that are associated with the largest uncertainties (Hauschild et al., 2018).

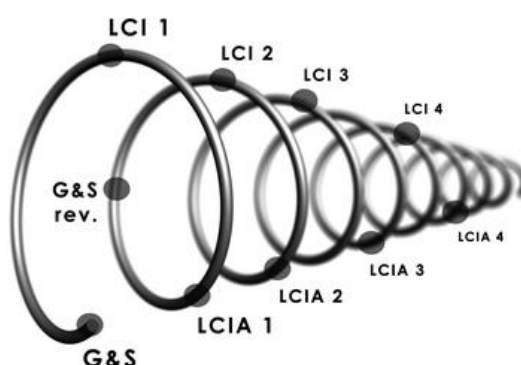

Figure I-11. Narrowing spiral on LCA (Hauschild et al., 2018).

In other words, the sensitivity analysis allows you to assess how sensitive the final results are to these choices. Basically, it consists to perform the LCA again by changing the potentially sensitive parameter by another, and evaluating how this affects the results.

1.2.3.4.4 Monte Carlo analysis vs. sensitivity analysis

Jolliet et al. (2017) point out that the objective of a sensitivity analysis is to test the robustness of the results and their sensitivity to the data, assumptions, and models used. To do this, one must go beyond preconceived notions to identify the key parameters that most influence the outcome.

While Monte Carlo analysis uses a data-intensive method to estimate the uncertainty in the final results by running thousands of simulations based on the possible values of the input parameters. When applied correctly, it also determines the significance of a difference between two scenarios (Jolliet et al., 2017).

I.2.3.5 Critical review

A critical review by experts is a process that seeks to ensure the LCA study is aligned with the requirements of ISO 14044 (2006) (Salomone et al., 2015). These critical reviews –or peer reviews- are known from the international scientific journals, since it is difficult to determine objective criteria for scientific quality, the professional judgement of peers becomes the ultimate quality assurance for scientific work.

- It is a scientifically and technically valid
- It is consistent with the goal and scope of the study, and
- It is transparent and consistent

I.3. State-of-the-art: Olive oil Life Cycle Assessment

Life Cycle Assessment (LCA) has been applied to the olive oil sector for more than 10 years. Numerous results and scenarios have been studied and a review of the existing literature is relevant for future LCA studies on this important agro-economic sector of the Mediterranean region.

The present section proposes a review study on LCA of olive oil, which turned out to be the first publication in the framework of this PhD thesis (Espadas-Aldana et al., 2019). Based on scientific and technical literature, this review aims to compare system boundaries, functional units, life cycle inventories, allocation, impact assessments, and interpretations. Furthermore, an analysis of the assessment of biogenic carbon has been carried out among the reviewed papers.

This publication (Espadas-Aldana et al., 2019) has identified 23 relevant LCA studies of olive oil or olive cultivation for olive oil production. Analysis of the literature converged on an unequivocal environmental hotspot, the agricultural phase, which represents the most impactful phase of the olive oil life cycle, due in particular to fertilisation, pesticide treatment, and irrigation. Waste management and distribution also appear to represent a crucial issue. The comparison work made on climate change impact assessment is on the order of magnitude of 460 kg CO₂-eq/ton of olive and 1.6 kg CO₂-eq/L of olive oil. This study highlights the complexity of carrying out an LCA analysis. At last, best practices and methodological recommendations were matured.

I.3.1 Basis of the study

In this context, LCA has been applied to olive oil for more than ten years in order to identify environmental hotspots and to propose recommendations to limit environmental impacts. An Italian review was published in the 2010 conference proceedings of the “7th International Conference on Life Cycle Assessment in the Agri-Food Sector” (Salomone et al., 2010). A book of the same name was published 5 years later (Salomone et al., 2015). In 2010, the authors found a high number (i.e., 23) of studies with the limitation of its exclusive focus on Italian olive oil production. On the contrary, the recent one is a wider and deeper analysis because it includes international case studies, life cycle thinking tools and “olive industry” case studies instead of only olive oil ones.

Banias et al. (2017) published a systematic literature review of scientific publications about the use of environmental tools in the life cycle of olive oil, taking into account the farming phase, manufacturing, packaging, warehousing, transportation and reverse logistics. Their analysis included 98 papers that were published until the end of 2015. Only 18 are LCA studies. The codification for their reviewed papers consisted of three parts: country of publication, the tools used to estimate the impact, and the serial number of the paper.

The present section proposes an innovative review study about LCA of olive oil based on scientific and technical literature. This review has an added value compared to the existing ones given its emphasis on: (i) taking into account recent environmental LCA studies on olive oil and olives for olive oil; (ii) comparing system boundaries, functional units, life cycle inventories, allocation, impact assessments and interpretations; (iii) the topic inclusion of biogenic carbon on environmental balance of bioproducts; (iv) carrying out a comparison of results on climate change (kg CO₂-eq).

The present work has identified 23 relevant LCA studies of olive oil or of olives for the production of olive oil. **Figure I-12** illustrates the citation interconnections found between these 23 studies and the two reviews mentioned above. We can notice (**Figure I-12**) that Avraamides and Fatta (2008) and Salomone and Ioppolo (2012) are the most cited studies for being one of the first, to the authors' knowledge, in publishing a complete study on LCA on olive oil.

As the main function of the system is the production of olive oil, all the articles dealing with the LCA of olive and olive oil and the LCA of olive oil waste management were taken into account.

To select documents and studies, available online scientific and technical literature was searched. For the source of papers, the Web of Science, Scopus and Science Direct databases were selected. The keywords used were "olive oil" plus "life cycle assessment", "environmental assessment", "environmental impact", "climate change", "carbon footprint", "sustainability", "life cycle costing", "carbon sequestration" and "waste management". The search was conducted on literature that was published up to December 2018.

A compendium of the 23 relevant LCA studies of olive oil or of olives for the production of olive oil with detailed information is presented in **Table I-7**. The information is presented in columns with the following headings:

- CODE. The numerical codes for the publications are the same on **Table I-7** and along all the tables presented in this study.
- TITLE. The original title of the publication and its reference.
- COUNTRY. The country where the study of the cultivation and production of olive oil was carried out. Not the country of origin or establishment of the authors.
- KEYWORDS. Key terms and signal words of the publications (in italics those adapted by our study, in the absence of the originals).
- DATA SOURCES. Origin of data of the publications used for its life cycle inventories.
- SCOPE. System boundaries and topics of study: olives, olive oil or olive mill waste (in italics those adapted by our study, in the absence of the originals).
- FU. Functional unit.
- SOFTWARE. Computer tools used for the LCA studies.
- ENVIRONMENTAL IMPACT CATEGORIES. Impact categories used on the environmental LCA studies.

The acronyms used in **Table I-7** are explained below it.

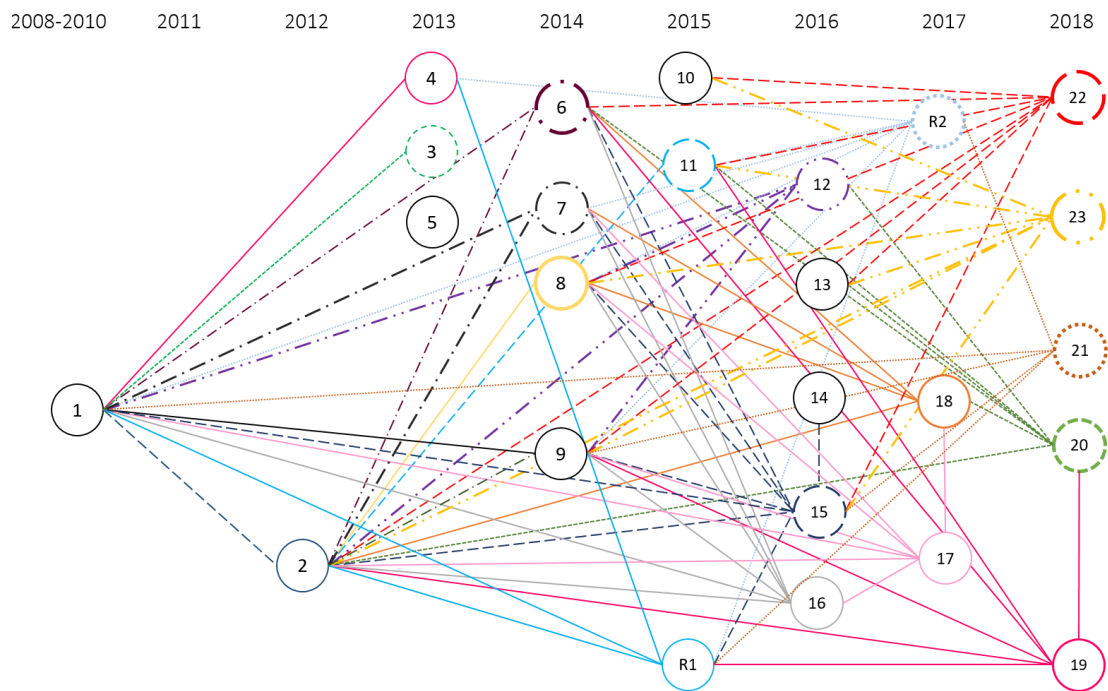

1 (Avraamides and Fatta, 2008), 2 (Salomone and Ioppolo, 2012), 3 (Accorsi et al., 2013), 4 (Chatzisyseon et al., 2013), 5 (Espi et al., 2013) 6 (Mohamad et al., 2014), 7 (Proietti et al., 2014) 8 (Rajaeifar et al., 2014), 9 (Rinaldi et al., 2014) 10 (El Hanandeh, 2015), 11 (Tsarouhas et al., 2015), 12 (El Hanandeh and Gharaibeh, 2016), 13 (Christoforou and Fokaidis, 2016), 14 (Guiso et al., 2016), 15 (Pattara et al., 2016), 16 (Proietti et al., 2016), 17 (Proietti et al., 2017), 18 (Romero-Gómez et al., 2017), 19 (Bernardi et al., 2018), 20 (De Luca et al., 2018), 21 (Navarro et al., 2018), 22 (Parascanu et al., 2018a), 23 (Parascanu et al., 2018b) R1 (Salomone et al., 2015), R2 (Baniyas et al., 2017).

Figure I-12. Citation interconnections found between the 23 studies and the two reviews done on LCA of the olive oil sector (Espadas-Aldana et al., 2019).

Table I-7. Main characteristics of the 23 relevant LCA studies of olive oil or of olive cultivation for olive oil production

CODE	TITLE	COUNTRY	KEYWORDS	DATA SOURCES	SCOPE	FU	SOFTWARE	ENVIRONMENTAL IMPACT CATEGORIES
1	Resource consumption and emissions from olive oil production: a life cycle inventory case study in Cyprus (Avraamides and Fatta, 2008)	Cyprus	LCI, Olive oil, Resource; Emissions	Questionnaires, interviews, on-site measurements, inventory databases.	Cradle-to-gate (Olive oil)	1 L EVOO	SimaPro 7	GHG
2	Environmental impacts of olive oil production: a Life Cycle Assessment case study in the province of Messina (Sicily) (Salomone and Ioppolo, 2012)	Italy	LCA, Olive oil, EI Scenarios analysis	Questionnaires, interviews. International literature, databases.	Cradle-to-gate (Olive oil)	1 ton of olives	SimaPro 7.2	CML v.2 2000
3	Life cycle assessment of an extra-virgin olive oil supply chain (Accorsi et al., 2013)	Italy	FSC, LCA, Food distribution, Food specialties, Sustainability	Questionnaires, interviews, on-site measurements, datasheets, technical reports, manuals Ecoinvent.	Cradle-to-grave (Olive oil)	1 L EVOO	SimaPro 7.1.8	GWP, OD, POF, AA, E, NREC
4	Life cycle assessment of advanced oxidation processes for olive mill wastewater treatment (Chatzisymeon et al., 2013)	Greece	LCA, Olive mill waste Photocatalysis Electrolysis Wet air oxidation	Ecoinvent 2.2	Gate-to-gate (OMW)	1 L Olive mill waste	SimaPro 7.3.3	-IPCC v1.02, 2007 -ReCiPe v1.06, 2008: GWP
5	Report on life cycle and cost analysis according to the requirements established by ISO 14040: Life cycle analysis. Principles and frame of reference (Espí et al., 2013)	France Spain Portugal	LCA, CF, OO	Questionnaires, Ecoinvent 2.2	Cradle-to-grave (Olive oil)	1 L EVOO/VOO/OO	SimaPro 7	IPCC v1.02, 2007. GWP100
6	Optimization of organic and conventional olive agricultural practices from a Life Cycle Assessment and Life Cycle Costing perspectives (Mohamad et al., 2014)	Italy	LCA, LCC, EI, Organic Olive Profitability	Questionnaires Literature review Ecoinvent.	Cradle-to-gate (Olives)	1 ha	SimaPro 7.1	Eco-indicator 99 (H): HH, EQ, RD
7	Carbon footprint of an olive tree grove (Proietti et al., 2014)	Italy	LCA, CF, Olea europaea, Carbon stock CO2 sequestration	On site measurements, Ecoinvent.	Cradle-to-gate (Olives)	1 ha	SimaPro 7.1	-Eco-indicator 99: LU, MD, FD, CC -EPD, 2007: GWP
8	Energy-economic life cycle assessment (LCA) and greenhouse gas emissions analysis of olive oil production in Iran (Rajaeifar et al., 2014)	Iran	CobbeDouglass, Energy-economic analysis, GHG, LCA, Olive oil	Face-to-face questionnaire, Excel spreadsheets.	Cradle-to-gate (Olive oil)	1 ha	Microsoft Excel	GHG

	TITLE	COUNTRY	KEYWORDS	DATA ORIGIN	SCOPE	FU	SOFTWARE	ENVIRONMENTAL IMPACT CATEGORIES
9	Assessment of carbon footprint and energy performance of the extra virgin olive oil chain in Umbria, Italy (Rinaldi et al., 2014)	Italy	LCA, EVOO, GW, Cumulative energy demand	Questionnaires, on-site measurements, Ecoinvent.	Cradle-to-grave (Olive oil)	1 L EVOO	SimaPro 7.3	-IPPC, 2006: CF, EF
10	Energy recovery alternatives for the sustainable management of olive oil industry waste in Australia: life cycle assessment (El Hanandeh, 2015)	Australia	LCA, Energy from waste, WM, Olive husk, Renewable energy	Databases: ELCD, NREL, AusLCI	Manufacturing, transportation, processing of the olive waste	1 Mg of olive solid waste	OpenLCA	-ReCiPe Midpoint (H): OD, GWP100, E, AA, HT, FD, IR, POF
11	Life Cycle Assessment of olive oil production in Greece (Tsarouhas et al., 2015)	Greece	LCA, Olive oil production, EI	Personal contact with growers, literature review.	<i>Cradle-to-gate</i> (Olive oil)	1 L EVOO	-	-Eco-indicator 99, GWP, AA, E, POF
12	Environmental efficiency of olive oil production by small and micro-scale farmers in northern Jordan: Life cycle assessment (El Hanandeh and Gharaibeh, 2016)	Jordan	LCA, Olive oil, EI Micro-scale farming, Uncertainty analysis	Survey of farm management practices.	Cradle-to-gate (Olive oil)	1 kg of olive oil	openLCA v1.4.1, Excel 2010 with Analysis ToolPak	- ReCiPe Midpoint (H): AA, PMF, HT, GWP100, LU
13	Life cycle assessment (LCA) of olive husk torrefaction (E. A. Christoforou and Fokaidis, 2016)	Cyprus	LCA, Torrefaction Biomass, Olive husk	GaBi database	Gate-to-gate (Olive mill waste)	1 ton of torrefied olive husk	GaBi	-CML, 2001: GWP100, AA, E, OD, AD
14	Environmental impact assessment of three packages for high-quality extra-virgin olive oil (Guiso et al., 2016)	Italy	LCA, GWP, shelf life, GHG	Technical sheets, literature review, Ecoinvent 3.	Cradle-to-grave (Olive oil)	1 L of bottling capacity	SimaPro 8.0.2	- IPCC, 2013: GWP, OD, POF, AA, E, NREC
15	Carbon Footprint of extra olive oil: a comparative and driver analysis of different production processes in Centre Italy (Pattara et al., 2016)	Italy	CF, LCA, GHG, CC	Survey of farm management practices.	Cradle-to-gate (Olive oil)	5 L EVOO	SimaPro 8.0.1	- IPCC, 2007: GWP100
16	Assessment of carbon balance in intensive and extensive tree cultivation systems for oak, olive, poplar and walnut plantation (Proietti et al., 2016)	Italy	Tree cultivation systems, Carbon stock, LCA, CO2 sequestration	Datasheets, Ecoinvent.	Gate-to-gate (Olives)	1 ha	SimaPro 8.0.3.14	EPD,2013
17	Extra Virgin Olive oil as carbon negative product: Experimental analysis and validation of results (Proietti et al., 2017)	Italy	Carbon stock GHG, CF, LCA, Olea europaea, Environmental sustainability	Face-to-face questionnaires, Interviews, technical datasheets.	Cradle-to-gate (Olive oil)	1 L EVOO	SimaPro 8	E, GWP100, POF, AA, CF

	TITLE	COUNTRY	KEYWORDS	DATA ORIGIN	SCOPE	FU	SOFTWARE	ENVIRONMENTAL IMPACT CATEGORIES
18	Optimization of olive growing practices in Spain from a life cycle assessment perspective (Romero-Gámez et al., 2017)	Spain	EI, Olive growing systems, Integrated farming, LCA	Experimental data, Ecoinvent.	Cradle-to-gate (Olives)	1 ton of olives	SimaPro 8.0.4.30	ILCD, 2011 V1.05/EU27 2010: CC, AA, FWE, FWET, LU, WRD
19	Harvesting system sustainability in Mediterranean olive cultivation (Bernardi et al., 2018)	Italy	Mechanical harvesting, Olive orchard, Work productivity, Economic sustainability, LCA, EI	Questionnaires, on-site measurements, Ecoinvent 3.3.	Gate-to-gate (Olives)	1 ha, 1 kg	SimaPro 8.1	ReCiPe -midpoint (H) -endpoint (H)
20	Evaluation of sustainable innovations in olive growing systems: A Life Cycle Sustainability Assessment case study in southern Italy (De Luca et al., 2018)	Italy	Agricultural innovations, Olive growing systems LCSA, Multi criteria decision analysis	Specific in-field surveys with semi-structured questionnaires, Background processes: Ecoinvent 3.2.	Cradle-to-gate (Olives)	1 ha	SimaPro	- IPCC, 2013: CC - CML v3.03: HT, FWET, MET, TET - ReCiPe midpoint: LU
21	Tackling the Relevance of Packaging in Life Cycle Assessment of Virgin Olive Oil and the Environmental Consequences of Regulation (Navarro et al., 2018)	Spain	CF, Ecodesign, Policy making, Glass, Tin and polyethylene terephthalate	Questionnaires, personal communication, GaBi professional 2015, Ecoinvent 3.0	Cradle-to-grave (Olive oil)	0.5 L bottle of VOO	GaBi	CML, 2001 (updated 2015)
22	Life cycle assessment of olive pomace valorisation through pyrolysis (Parascanu et al., 2018a)	Spain	LCA, Olive pomace, Pyrolysis, SimaPro	On site measurements, Ecoinvent.	Cradle-to-grave (Olive mill waste)	100 kg olive pomace	SimaPro 8.2	ReCiPe -midpoint (H) -endpoint (H)
23	Environmental assessment of olive pomace valorization through two different thermochemical processes for energy production (Parascanu et al., 2018b)	Spain	LCA, Olive pomace, Gasification, Combustion	On site measurements, Ecoinvent 3.4.	Cradle-to-gate (Olive mill waste)	1MJ of energy production	Simapro 8.2	ReCiPe -midpoint (H) -endpoint (H)

AA= acidification ; AD= abiotic depletion ; ALO= agricultural land occupation ; CC= climate change ; CF= carbon footprint ; E= eutrophication ; EI= environmental impact ; EQ= ecosystem quality ; EVOO= extra virgin olive oil ; FD= fossil depletion ; FSC= food supply chain ; FU= functional unit ; FWD= fresh water depletion ; FWE = freshwater eutrophication ; FWET= fresh water ecotoxicity ; GHG= greenhouse gases ; GWP= global warming potential ; H= hierarchist ; HH= human health ; HT= human toxicity ; IR= ionizing radiation ; LCA= life cycle assessment ; LCC= life cycle costing ; LCI= life cycle inventory ; LCSA= life cycle sustainability assessment ; LU= land use ; MD= minerals depletion ; ME= marine eutrophication ; MET= marine ecotoxicity ; NLT= natural land transformation ; NREC= non-renewable energy consumption ; OD= ozone depletion ; PMF= particulate matter formation ; POF= photochemical oxidant formation ; RD= resource depletion ; TA= terrestrial acidification ; TET= terrestrial ecotoxicity ; ULO= urban land occupation ; WM= waste management ; WRD= water resource depletion

1.3.2 Description of LCA studies on olive oil sector

1.3.2.1 LCA Framework applied to olive oil

LCA of the olive oil production sector is based on ISO 14040 and ISO 14044 standards as a general framework (ISO, 2006a, 2006b). More specifically, a Product Category Rules (PCR) for Environmental Product Declaration (EPD) document was created based on the ISO standards (cited above) and which gives a more specific hypothesis for the olive oil sector (EPD, 2010). An EPD for Crete olive oil producers was created in 2012 (EPD, 2012a). An Italian olive oil company also created its EPD in 2012 (EPD, 2012b).

1.3.2.2 Key features

Studies have been conducted on three different types of documents: review papers, papers, and international scientific conference proceedings. Among the 25 relevant life cycle studies related to the olive oil sector, two are review papers (Baniyas et al., 2017; Salomone et al., 2015), 23 focus on environmental life cycle assessment, five on carbon sequestration (Pattara et al., 2016; Proietti et al., 2014, 2017, 2016; Rinaldi et al., 2014) and four focuses on waste treatment (Chatzisyneon et al., 2013; E. A. Christoforou and Fokaidis, 2016; Parascanu et al., 2018a, 2018b). Among the 23 environmental LCA studies included in this review, only six were already included in the review made by Baniyas et al. (2017).

Only environmental LCA studies on olive oil and on olives for olive oil have been considered. The search was conducted on literature that was published since 2008 and up to December 2018. The study of olive oils and olive groves was carried out from Italy (12), Spain (5), Greece (3), Cyprus (2), Australia (1), Iran (1), Jordan (1), France (1) and Portugal (1). **Figure I-13** illustrates the proportions of publications in different countries. Italy, Spain and Greece were the most active countries in regard to this topic, which coincides with their leadership on worldwide olive oil production. However, Italy is significantly more active than Spain, despite the fact that their production volume is between 2 and 3 times lower than Spanish production (IOC, 2018b). **Figure I-14** evidences the olive oil world production for the year 2017/2018, the IOC (2018a) defines the '*olive crop year*' as the period from 1 October to 30 September.

1.3.2.3 International projects

Six European projects related to olive oil and based on the LCA methodology have been performed: ECOIL, INFOIL, oLIVECLIMA and OLIVE4CLIMATE (by the LIFE programme of the European Commission); OLIVERO and OiLCA.

The ECOIL project (LIFE04 ENV/GR/110) covered the full cycle of olive oil production in Spain, Cyprus and Greece (ECOIL, 2004). It generated 3 main reports (Avraamides and Fatta, 2006; Cortes, 2006; Georgiou et al., 2006) on LCA implementation and one scientific article, which was written on partial results of the project (Avraamides and Fatta, 2008).

The INFOIL project (LIFE08 INF/GR/581) focused on the promotion of sustainable olive oil production and consumption patterns in two major regions of Greece with very high olive oil production, Crete and Peloponnesus (INFOIL, 2010).

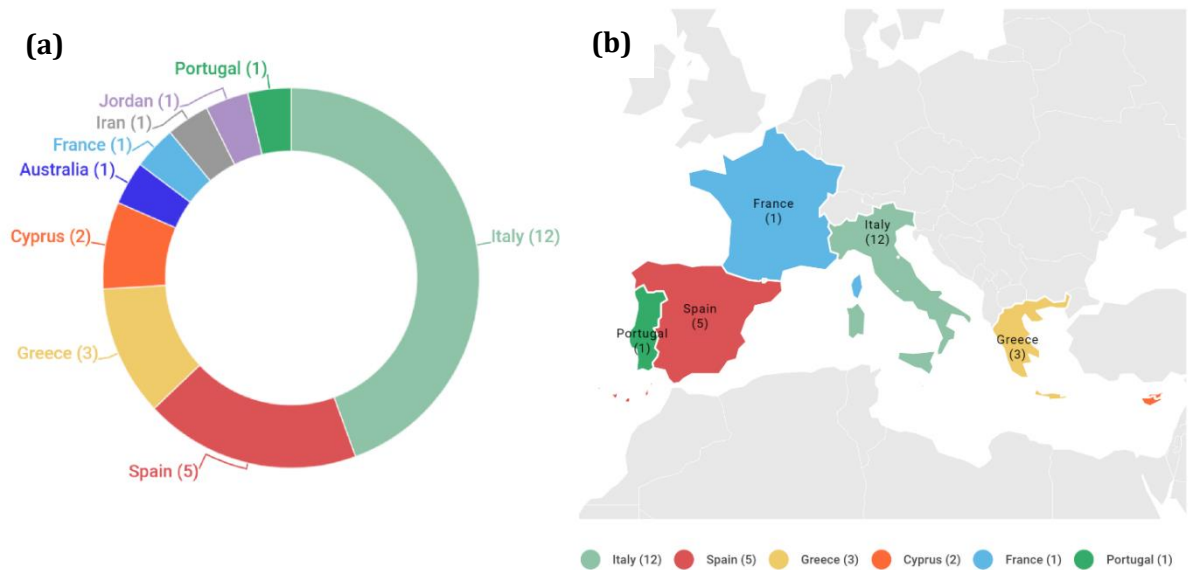

Figure I-13. Proportion and geographic dispersion of studies: (a) Worldwide, (b) Europe (Espadas-Aldana et al., 2019).

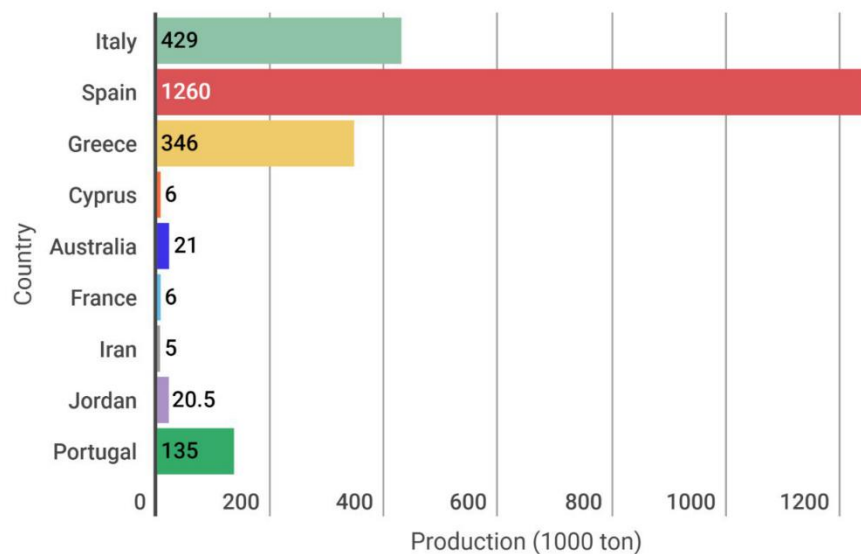

Figure I-14. Olive oil world production in 2017/2018 (Espadas-Aldana et al., 2019).

The oLIVECLIMA project (LIFE11 ENV/GR/942) focused on olive-producing areas in Greece. Its main aim was to introduce new cultivation practices for tree crops in order to find cost-effective means for mitigation and adaptation to climate change. Also, it was designed to boost the uptake of CO₂ by olive trees from the atmosphere and store it in soil as organic matter (oLIVECLIMA, 2012).

The OLIVE4CLIMATE (LIFE15 CCM/IT/141) project conducted an LCA with a holistic vision of the processes and products associated with the production of EVOO, along with a quantification of the carbon sequestration potential in the olive groves. This approach was tested in three Mediterranean countries with heterogeneous environmental conditions: Italy, Greece and Israel (OLIVE4CLIMATE, 2016). One research paper on carbon sequestration (Proietti et al., 2017) studied on the herein presented bibliographical study was partially funded by this project.

The OLIVERO project undertook physical and socio-economic research on Sloping and Mountainous Olive Production Systems (SMOPS) in five target areas in southern Europe (Portugal, Spain, Italy, and Greece). In these target areas 24 different SMOPS were distinguished, with their respective productive, ecological, economic and social functions, and were grouped into five major types: traditional, semi-intensive low input, semi-intensive high input, intensive and organic production systems (Graaff et al., 2010). The main aim of the OLIVERO project was to assess the future of SMOPS in the Mediterranean basin (Stroosnijder et al., 2008).

The OiLCA project was funded by the Interreg IV B SUDOE communitarian initiative. Its aim was to improve the competitiveness of the olive sector in the south-western Europe region, which includes Spain, Portugal and the South of France, known as SUDOE space (OiLCA, 2011). The OiLCA methodology was based on life cycle assessment (LCA) and life cycle costing (LCC) to identify opportunities for the optimisation of olive oil production (Carvalho et al., 2012). One report of Espi et al. (2013) on the LCA of olive oil production and an international conference proceeding (Busset et al., 2015) resulted from the OiLCA project. The OiLCA project generated a computing tool for carbon footprinting and a guideline for eco-labelling (OiLCA, 2013).

1.3.3 Goal and scope definition

Most analyses of the life cycle of olives or olive oil have been done with an environmental and attributional approach. Regarding the herein presented bibliographical study, only one LCA assessment related to olive oil was conducted in accordance with the consequential approach (Accorsi et al., 2015) and one following a Life Cycle Sustainability Assessment (LCSA) methodology (De Luca et al., 2018).

Although Accorsi et al. (2015) worked on the environmental impacts associated with the bottled extra virgin olive oil life cycle, it only followed a consequential approach on the end-of-life treatments of package waste. The environmental impact categories were quantified in accordance with an attributional approach.

De Luca et al. (2018) conceived LCSA as an integrative and holistic methodology that takes into account environmental, economic and social constraints. The object of the analysis was the study of olive orchard management in a specific region of Italy. Three scenarios were chosen: a control scenario, a low-dosage/no-tillage (LDNT) scenario, and a zero chemical weeding scenario. The functional unit (FU) was 1 ha of cultivated surface, and the system boundary consisted of the agricultural production “from cradle to farm gate”. The results showed that LDNT scenario was the best option for environmental and economic perspectives. It caused lower emissions in terms of greenhouse gases (GHG) and achieved the best performance compared to the others for all the examined indicators, causing less overall impact throughout its life cycle; nevertheless, from a social point of view, LDNT scenario was the best one only in terms of psychosocial risk factors. In addition, the results showed that the actors are strongly concerned with toxicity and the social health of workers.

In order to understand the scope (system boundaries) it is necessary to have a general idea of the olive oil life cycle. It includes an agricultural phase, a production phase (at the olive mill), a waste (water and pomace) management phase, the packaging of the olive oil, the product distribution, its consumption and the packaging end of life. A simplified block diagram representing the life cycle of olive oil is represented in **Figure I-15**.

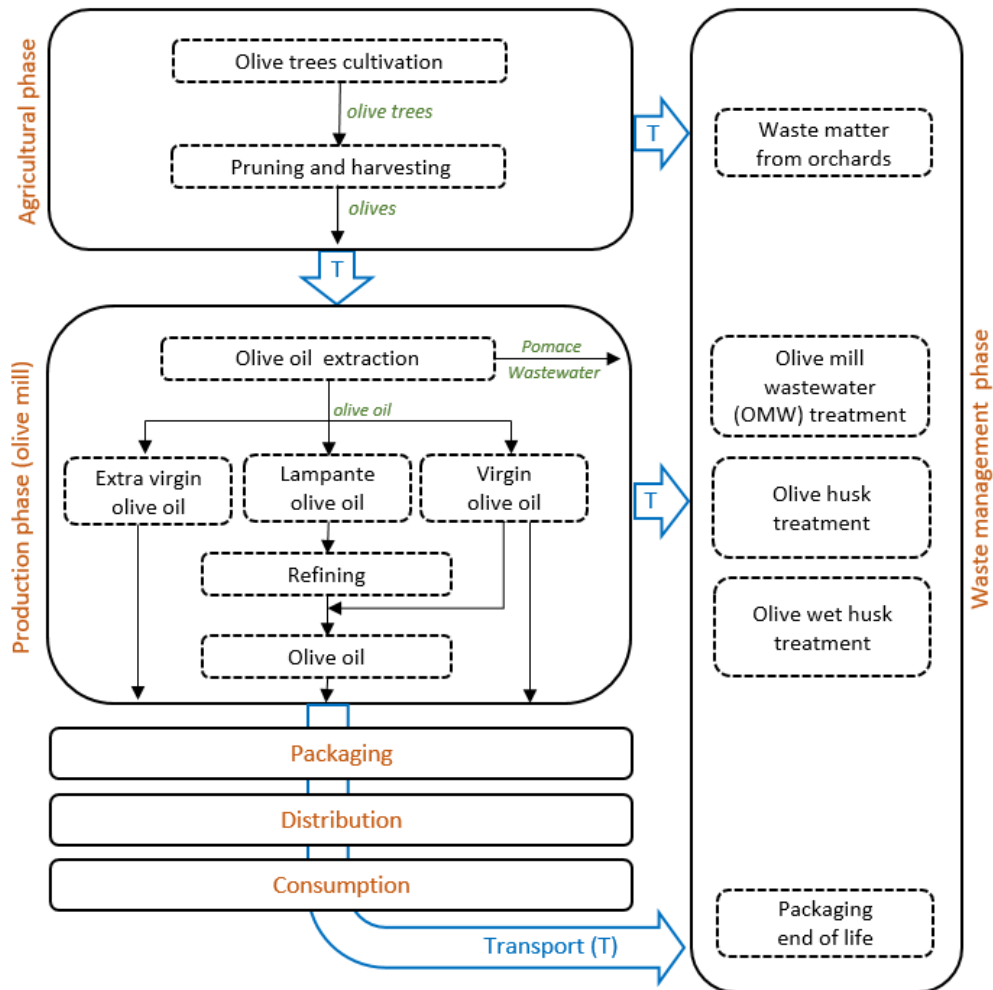

Figure I-15. The life cycle block diagram of olive oil. Adapted from Espadas-Aldana et al (2019).

I.3.3.1 Functional Unit (FU)

Depending on the objectives of each life cycle study, FU might vary at the discretion of the practitioner. According to De Luca et al. (2018) FU strongly depends on the objectives of the assessment, the addressees of the study, and the typology of the investigation. In the selected studies (**Table I-7**), FUs are defined as a quantity of olive (ton or kg), as cultivated surface area (ha), as volume (L) or as energy content (MJ). When the FU is the production of a quantity of olives, the types of olive were unspecified. Olive oil is classified into different categories, depending on quality indicators based on its physical and chemical and organoleptic properties. Olive oil properties are directly related to its extraction method. Studied forms of olive oil were either extra-virgin, virgin, current virgin olive oil, refined, derived from pomace or unspecified. Confusion might occur, for instance, because choosing 1 L of virgin olive oil as the FU is not equivalent to choosing 1 L of olive oil (Salomone and Ioppolo, 2012).

It is important to define the FU in the right way as it significantly influences the way an LCA is performed, as well as its results and their interpretation, especially in comparative studies (Hauschild et al., 2018). The FU according to the PCR for olive oil of the International EPD System is 1 L of olive oil. However, given the high variability of agricultural activities, it is important to be aware of all of the services or functions that are provided by the studied system. Here, a FU can be referred to as 1 ha of olive orchard (Bernardi et al., 2018; De Luca et al., 2018; Mohamad

et al., 2014; Proietti et al., 2016, 2014; Rajaeifar et al., 2014), as mass unit such 1 kg of harvested product (Bernardi et al., 2018) or 1 ton of olives (Romero-Gómez et al., 2017; Salomone and Ioppolo, 2012), since the main objective of agricultural systems is food production (Romero-Gómez et al., 2017). Furthermore, for life cycle assessment focused on the waste treatment of olive mills, mass units were used, such 1 ton of olive solid waste (El Hanandeh, 2015), 1 ton of olive husk (E. A. Christoforou and Fokaides, 2016) and 100 kg of olive pomace (Parascanu et al., 2018a).

According to Hauschild et al. (2018) a well-formulated FU should be capable to respond to the following questions: “what?”, “how much?”, “for how long”/“how many times?”, “where?” and “how well?”; and also, highlights the three types of mistakes when defining the FU: 1) Assuming that same physical quantity of product equals the same function, 2) Being overly restrictive, and 3) Using technical standards or legal requirements incorrectly. Any LCA study on olive oil answers correctly to these questions of FU and most of them made the first mistake.

1.3.3.2 Allocation

In numerous processes, more than one product is produced within the main product, called by-products/co-products. In such cases, it is necessary to “divide” the environmental impacts from the process between the products. Allocation and system expansion are the two methods to deal with the multi-functionality in LCA.

Allocation of environmental impacts between the product and co-products can be performed from an economic or physical point of view. As the allocation method can have a big influence on the study results, the identification of an appropriate allocation method is crucial. The ISO 14040-series recommend using system expansion (disaggregate the given process into different subprocesses) whenever possible. In this review, four articles have been identified making allocation (Avraamides and Fatta, 2008; Parascanu et al., 2018b; Pattara et al., 2016; Rajaeifar et al., 2014) and three used system expansion (El Hanandeh and Gharaibeh, 2016; Rinaldi et al., 2014; Salomone and Ioppolo, 2012). Salomone and Ioppolo (2012) avoided allocation rules by extending system boundaries, including the production of all the by-products obtained in the olive oil industry. The same procedure was used by Rinaldi et al. (2014) and El Hanandeh and Gharaibeh (2016).

An example of physical allocation is found in an energy-economic LCA of the Iranian olive oil industry (Rajaeifar et al., 2014). They adopted a mass-based allocation method, commonly used to allocate by-products energy. This method allocates energy (deducted from the total energy input) to the mentioned by-product by its relative mass, in order to separate the energy used to produce the olive oil from the energy used to produce the olive pomace (Rajaeifar et al., 2014).

Examples of economic allocation can be found in LCA that made special attention in olive pomace, considering that olive oil has a higher unit price (Avraamides and Fatta, 2008; Parascanu et al., 2018b). The economic allocation is used for the olive pomace as a co-product, because it is intended to obtain its energy through a subsequent process and considered to reflect better the value of the products by granting most of the impacts to virgin olive oil (Parascanu et al., 2018b). Although pomace can be potentially used as fuel or for the production of pomace oil through further processing, it was traditionally treated as waste, thus considered of zero value (Avraamides and Fatta, 2008).

1.3.3.3 Biogenic carbon

Biogenic CO₂ emissions are defined as CO₂ emissions related to the natural carbon cycle, as well as those resulting from the combustion, harvest, digestion, fermentation, decomposition, or processing of biologically based materials (US EPA, 2018). Through photosynthesis, plants absorb CO₂ from the atmosphere and release O₂. A portion of the absorbed CO₂ is returned to the atmosphere through respiration, while a part is stored in various organic compounds. This CO₂ component increases, creating a so-called carbon sink, until it reaches the upper limit beyond which the losses, due to respiration and the death of the trees, offset the increase in carbon due to photosynthesis (Proietti et al., 2016). Products and residues of the olive orchard cultivation contain biogenic carbon derived from the uptake of CO₂ by the crop (Rinaldi et al., 2014).

According to the Vegetal-Based Chemistry Association (2015), it is necessary to take into account the CO₂ stock in the plant because it allows a relevant comparison between fossil and bio-based products, between oils annual crops and perennial crops, and particularly, in "cradle-to-gate" but also in "cradle-to-grave" approach when the carbon is not entirely re-emitted (e.g. landfill) or in other forms than CO₂ (e.g. VOC emissions). They recommend disregarding the time lag of CO₂ emissions when calculating the environmental balance of bioproducts. The carbon sequestration is considered influential after ten years. If the life of the product is long, several standards recommend taking carbon sequestration into account, starting from a lifetime of the variable product according to the benchmarks (from 1 to 25 years).

According to ISO/TS 14077, "GHG emissions and removal arising from fossil and biogenic carbon sources and sinks shall be included in the carbon footprint (CF) and shall be documented separately in the CF study report". In addition, the ISO/TS 14067 states that in general when calculating the CF for a product's entire life cycle all the emissions and removals (both biogenic and fossil) must be taken into account, without considering the time period (Rinaldi et al., 2014).

In this review study, five papers mentioned the concept of biogenic carbon (Pattara et al., 2016; Proietti et al., 2014, 2016, 2017; Rinaldi et al., 2014) and three of them expressed having taken it into account (Proietti et al., 2014, 2016, 2017).

Rinaldi et al. (2014) explained that uptake and emissions of stored carbon were not explicitly reported because it was released within a year as a result of the oxidation of the carbon contained in the pruning wastes and in the olives along with the downstream life cycle stages. In addition, they did not take into account the trees' planting and end of life because the region has traditional cultivation with trees over 50 years old and its expected life exceeds 100 years.

Pattara et al. (2016) believe in a lack of uniformity in the application of the accounting methods of biogenic CO₂. In their LCA study, the carbon and related CO₂ were considered as belonging to the short carbon cycle and not in the general CO₂ budget.

Proietti et al. (2014) calculated the CO₂ sources and sinks in order to obtain the net carbon stock of the olive grove and its relation to the impact on climate change. The observations were made along the first 11 years from planting, which includes the crucial period of the life span of the olive grove. The results showed that the greatest impact occurred during the first year of olive grove cultivation with an annual average GWP100 value for the first 11 years of 1.507 t CO₂-eq/ha per year. Furthermore, considering the different years of cultivation, the greatest impact was made by the use of fertilisers and pesticides.

Proietti et al. (2016) contributed with an innovative environmental evaluation in terms of sequestered carbon. Olive trees showed an unexpected capacity to store CO₂-eq considering fruits and prunings in the calculation (28.916 kg CO₂ year⁻¹ plant⁻¹).

Proietti et al. (2017) calculated the carbon and CO₂ stock of the olive grove on a representative number of plants from their LCA study. They applied forest survey methodologies to estimate the biomass and the respective carbon stocked in olive tree permanent (trunk, branches, twigs and root collar, roots) and non-permanent components (prunings and fruits). The analysis showed that the tree's non-permanent components give the major contribution to the amount of carbon stocked by olive trees. Their results are in accordance with Proietti et al. (2016).

According to ISO/TS 14067 (ISO/TS, 2018): "For all products, GHG emissions and removals are included as if released or removed at the beginning of the assessment period". Calculations based on discounting or time-dependent characterisation factors are not part of the carbon footprint but may be reported separately in the study report.

On the other hand, the Publicly Available Specifications (PAS) 2050 builds on the existing ISO 14040 and 14044 standards (ISO, 2006a,b) and further clarify their implementation for the assessment of the GHG emissions of goods and services (BSI, 2011).

According to PAS 2050, both emissions (from biogenic and fossil sources) to the atmosphere and removals shall be accounted in an LCA. Human food and animal feed products are an exception if the biogenic carbon becomes part of the product. Regarding the case study of olive oil production, the biogenic carbon from the agricultural phase (olive tree permanent components, especially taking into account the longevity of olive groves) does not become part of the product (olive oil). Therefore, the assessment of biogenic carbon should be taken into account when performing an LCA that takes into account this phase within its system boundaries.

I.3.4 Impact assessment

I.3.4.1 Software

LCA results can be computed without LCA-specific software (e.g. Excel, MatLab) and that can be more educational and rigorous if done well. However, the computation of LCA usually becomes quite elaborated, so the use of specialised software is recommended. Impact assessment was performed with dedicated software in 20 of the 23 studies. The most popular was SimaPro (versions 7.0 to 8.2), chosen 17 times; especially in Italian studies. OpenLCA was used in Jordan and Australia (El Hanandeh, 2015; El Hanandeh and Gharaibeh, 2016). GaBi software appeared twice (E. A. Christoforou and Fokaides, 2016; Navarro et al., 2018). Lastly, Microsoft Excel was preferred by Rajaeifar et al., (2014). From the OiLCA project, a free software (OiLCATool) was specifically developed for olive oil producers to perform carbon footprinting and life cycle costing based on LCA methodology (OiLCA, 2013).

Moreover, coupling process modelling and LCA methodology have been considered, for example in the chemical industry (Azapagic et al., 2006) and in agro-industry (Gillani et al., 2010). Parascanu et al. (2018a, 2018b) coupled Aspen Plus® 8.8 with SimaPro 8.2 in two studies of olive pomace valorisation. They used the Aspen Plus® 8.8 software to estimate the mass and the energy balances associated with the thermochemical process. The obtained data were subsequently introduced as inputs in the SimaPro 8.2 software for the environmental assessment.

1.3.4.2 Impact categories and methods

Life cycle impact assessment (LCIA) converts all inventoried flows into impacts on the environment indicators. In a LCIA, essentially two mainstream ways to derive characterisation factors are followed: mid-point and end-point indicators. The midpoint methods are applied to the characterisation factor to measure the impact, while the endpoint methods are applied to express the current damages.

In this review study, a large range of different evaluation methods was used for impact characterisation. Depending on the study period, the evaluation methods used were the most famous and recognised European methods: CML-IA, EPD, ReCiPe, IPCC and ILCD. Indeed, more than a third of the reviewed studies used the ReCiPe method (Bernardi et al., 2018; Busset et al., 2012; Chatzisyneon et al., 2013; De Luca et al., 2018; El Hanandeh and Gharaibeh, 2016; Parascanu et al., 2018a; Pattara et al., 2016; Salomone and Ioppolo, 2012). This method is a fusion of two methodologies, it takes the midpoint indicators from CML methodology and the endpoints indicators from Eco-indicator 99. The 18 impact categories at the mid-point method are: ozone depletion (OD), human toxicity (HT), ionizing radiation (IR), photochemical oxidant formation (POF), particulate matter formation (PMF), terrestrial acidification (TA), climate change (CC), terrestrial ecotoxicity (TET), agricultural land occupation (ALO), urban land occupation (ULO), natural land transformation (NLT), marine ecotoxicity (MET), marine eutrophication (ME), freshwater eutrophication (FWE), fresh water ecotoxicity (FWET), fossil depletion (FD), minerals depletion (MD), and fresh water depletion (FWD). The end-point method (ReCiPe end-point) allows to calculate the following impacts: damage to human health (HH), damage to ecosystem diversity (ED) and damage to resource availability (RA) (Huijbregts et al., 2017).

The second preferred method was IPCC single issue method (version 2006, 2007, 2013) (Chatzisyneon et al., 2013; De Luca et al., 2018; Espi et al., 2013; Guiso et al., 2016; Pattara et al., 2016; Rinaldi et al., 2014).

Global warming/climate change is the main evaluated midpoint impact category and is expressed as kg CO₂-eq. However, the other impact categories differ among the studies, thus, making comparisons between them might be difficult. It is important to remember that LCA is a “Multi-criteria” analysis that assesses multiple environmental impacts. Differently, carbon footprint is basically a “Mono-criteria” analysis as it focuses on only one environmental impact, climate change by GHG emission. In this review, three papers with mono-criteria analysis (GHG) were found (Avraamides and Fatta, 2008; Espi et al., 2013; Rajaeifar et al., 2014), which indicates a methodological simplification when called LCA.

1.3.5 Results and interpretation

1.3.5.1 Variability and difficult quantitative comparison

All of the articles have been compared in terms of general characteristics, including methodology, functional unit, system limits, scenarios and different parameters taken into account depending on the study. These comparisons have highlighted the significant variability between the studies. Such variability resulted in difficulties in interpreting and comparing the results. Exhaustive lists of inventory results were missing in many of the studies. Functional units and certain units of similar flows (i.e. the quantity of diesel might be expressed in MJ, kWh, kg or L) were different. Differences in conversion factors might have contributed to increasing errors

in calculation. Another source of divergence is the source of the indirect data. The use of different inventory databases, such as Ecoinvent, GaBi or ELCD, which are based on different methodologies, hypotheses and system boundaries, might have compromised feasible comparison. Furthermore, environmental impact comparison is a big challenge for the following two main reasons: (i) impact indicators are different and based on different hypotheses and (ii) the impact assessment step relays the inventory data.

1.3.5.2 Climate change category

Even if LCA is a multi-criteria analysis (as explained in point I.3.4.2 Impact categories and methods), the impact category preferred by many authors for their publications on LCA is the climate change category.

Two groups for comparison of results were possible. In the climate change impact category, two FU were comparable. **Table I-8** shows the studies with results on kg CO₂-eq/ton of olive and **Table I-9** the studies on kg CO₂-eq/L of olive oil. In order to achieve this, the publications data have been reworked: the column named “climate change” with four sub-columns shows the unit, minimum and maximum data and the size of the sample, where applicable. The last column named “Climate change*” (with an asterisk) exhibits our converted average of the original data on publications with the interest of having comparable results. **Table I-8** makes it possible to compare results among four publications (coded 2, 8, 18 and 20). The scope of all of them is from cradle to gate, specifically for the agricultural phase. It is noticeable that they respect the same order of magnitude, with three of them around 425-489 kg CO₂-eq/ton. The result on publication coded 18 (Romero-Gómez et al., 2017) is 224 kg CO₂-eq/ton, this difference could be explained because 33% of its data came from intensive and super-intensive Spanish agricultural systems, so its yield could be higher than the others. Publication coded 8 (Rajaeifar et al., 2014) is the only one that made mass allocation: 20% of the total energy consumption from agricultural olive production, olive transportation, and oil extraction stages were allocated to the olive oil, the other 80% was allocated to the olive pomace. All the impacts from transportation to the customer centres were allocated to the olive oil because it is the only product transported in that stage (Rajaeifar et al., 2014). This work on mass allocation explains why it has the lowest result of **Table I-8**.

Table I-8. Comparison of results on climate change (kg CO₂-eq/ton of olive) (Espadas-Aldana et al., 2019).

CODE	FU	SCOPE	CLIMATE CHANGE (kg CO ₂ -eq/FU)			CONVERSION FACTOR	CLIMATE CHANGE* kg CO ₂ -eq/ton
			Unit	Min	Max		
2	1 ton of olives	Cradle-to-gate	kg CO ₂ -eq/ton	(n=4)	467	510	489
8	1 ha	Cradle-to-gate	1333 kg CO ₂ -eq/ha mass-alloc: 525 CO ₂ -eq/ha		-	-	1134 kg olives/ha 425 mass-alloc: 168
18	1 ton of olives	Cradle-to-gate	kg CO ₂ -eq/ton	(n=12)	95.4	309	224
20	1 ha	Cradle-to-gate	CO ₂ -eq/ha 50yr	(n=3)	3.6x10 ⁵	3.8x10 ⁵	Data direct on paper per ton 478

On the other hand, **Table I-9** shows the results on kg CO₂-eq/L among five publications (coded 5, 9, 12, 15 and 17). The first two have a scope from cradle to grave but their results are not in the same order of magnitude, this is explainable because the second one took into account freezing and export by truck, ship and plane to USA, Japan, Germany and France from Italy, being

the transportation by plane to USA (~9100km) a big impact on the results (Rinaldi et al., 2014), while the first one took into account transports only by truck at regional, national and European level (~1300 km) (Espino et al., 2013). The last three publications have a scope from cradle to gate, and they respect the same order of magnitude, around 0.6-1.6 kg CO₂-eq/L. Even if the publication coded 15 (Pattara et al., 2016) and 17 (Proietti et al., 2017) have a different number of samples to calculate the average, they both converged at 1.6 kg CO₂-eq/L.

Table I-9. Comparison of results on climate change (kg CO₂-eq/L) (Espadas-Aldana et al., 2019).

CODE	FU	SCOPE	CLIMATE CHANGE (kg CO ₂ -eq/FU)			CONVERSION FACTOR	CLIMATE CHANGE * kg CO ₂ -eq/L
			Average	Min	Max		
5	1 L EVOO/ VOO/OO	Cradle-to-grave	kg CO ₂ -eq/L	(n=3)	2.19	3.47	3
9	1 L EVOO	Cradle-to-grave	17.53 CO ₂ -eq/L				17.5
12	1 kg of OO	Cradle-to-gate	0.57 kg CO ₂ - eq/kg			0.93 kg/L	0.6
15	5 L EVOO	Cradle-to-gate	kg CO ₂ -eq/5L	(n=4)	4.48	10.10	5L --> 1L 1.6 (0.9 to 2)
17	1 L EVOO	Cradle-to-gate	kg CO ₂ -eq/L	(n=7)	0.67	4.48	1.6

I.3.5.3 Hotspots in the olive oil life cycle

All of the studies with minimum cradle-to-mill-gate boundaries (agricultural phase + extraction phase) showed that the impacts of the agriculture phase were the most important (Avraamides and Fatta, 2008; Espino et al., 2013; Pattara et al., 2016; Tsarouhas et al., 2015). This conclusion is consistent with both previous reviews (Baniyas et al., 2017; Salomone et al., 2015). The cause for the predominance of the agricultural phase is fertilisation, irrigation, and phytosanitary treatment. Pruning also generates a large quantity of wood materials, which are generally burnt directly in the orchards without heat recovery or any type of valorisation. The agricultural phase is very complex and impacts numerous linked parameters. It is difficult to identify the influence of certain specific aspects of this phase due to the large range of possible scenarios.

Although distribution represents an important phase, it is only considered in 5 studies (Accorsi et al., 2013; Espino et al., 2013; Guiso et al., 2016; Navarro et al., 2018; Rinaldi et al., 2014). Distribution phase scenarios remain extremely variable because bottles can be directly purchased at the mill or distributed by truck, car, van, boat, train or plane. For these reasons, distribution is often excluded from studies. For similar reasons, the bottling phase (including bottle production and transport to bottling facilities) is rarely considered.

Also, waste treatment is an important hotspot on the olive oil cycle. The impacts are highly variable from one study to another and might be considered as “avoided” impacts due to energy or nutrient recovery (Salomone and Ioppolo, 2012).

I.3.5.4 Extraction technologies

Comparison of extraction technologies appears to be the less variable step of all stages of olive oil production. This notion can be explained by the following two main aspects: (i) the production of “virgin olive oil” is feasible using two types of systems (discontinuous and continuous), which limits the difference in the extraction chain; (ii) The extraction phase remains

a low-impact phase, compared to the agricultural phase which is the most impactful phase. With these aspects, it is not significant to make an improvement that would lead to environmental benefits in the cradle-to-grave scope. Indirect technical consequences due to the type and quality of effluent represent a second relevant difference between extraction techniques (Cinar and Alma, 2008). The main way to reduce the environmental impacts at this stage would be to choose the system that produces waste that is easier to treat, namely, the 2-phase or 2.5-phase system (2-phase modified system). The studies which compared extraction technologies, came to the same conclusion as follows: the 3-phase system is the worst system, followed by the press. The 2-phase or 2.5-phase systems are the best systems (Salomone and Ioppolo, 2012). Oil quality, in terms of nutrients, might differ as a result of the different extraction techniques used. However, this aspect is not included in the LCA methodology, even if the quality of the product remains a key feature for decision-making in agro-industrial systems.

1.3.5.5 Packaging

Olive oil can be obtained nowadays in various presentations and it is very important to take it into account in the inventory analysis. Guiso et al. (2016) provided a comparative impact assessment for tin-plated cans, dimmed glass bottles and stainless steel bottles of EVOO. They outlined that packaging impact decreases for larger sizes. Navarro et al. (2018) studied the contribution of glass polyethylene terephthalate (PET), and tin packages within the whole virgin olive oil life cycle.

In the study made by Espi et al. (2013), the most frequent container was PET (69.41%), followed by glass (24.12%) and tin (5.29%). They demonstrated that although the impact per gramme of smaller material corresponds to glass, the effect of the weight of the container per litre of packed oil made it the container with the greatest impact.

Packaging has an important contribution to finished product environmental impact, and that impact comes not only from the need for extraction of raw materials and subsequent processing for the manufacture of the container but also, from the transport. This includes the transport of packages to the facilities where the oil is packaged and later, its commercial distribution. The impacts are greater when the transport is made by plane. Reducing the weight of the glass bottle could make a great contribution to reducing environmental impacts.

1.3.5.6 Waste management techniques

Waste is divided into the following 4 categories: (i) pruning residues, which are generally burnt (with or without heat recovery); (ii) pomace residues from 2-phase or press systems, which are sent for pomace olive oil extraction or directly burnt or spread into fields or composting; (iii) ashes resulting from incineration processes, which are spread; and (iv), wastewater from 3-phase systems, which is generally dried, spread or filtered. It remains a very complex issue of the sector because it represents a large quantity of organic matter (OiLCA, 2011). In our studies of olive oil production LCA, four focus on waste treatment (Chatzisyneon et al., 2013; E. A. Christoforou and Fokaidis, 2016; Parascanu et al., 2018a, 2018b) and they propose different approaches. Composting is the most impactful option because of the tractor usage for turning the waste matter; Oil husk extraction has lower impacts due to the use as fuels of exhausted pomace and stones (Salomone and Ioppolo, 2012).

1.3.5.7 Best practices and methodological recommendations

In terms of methodological perspectives, data quality improvement and uncertainty analysis remain crucial. Local data are also needed because absolute results are strongly dependent on the studied zones (Espí et al., 2013). Reduction of the data uncertainty induced by the lack of real data and the use of literature models particularly for composting or olive wet pomace emissions appears crucial (Salomone and Ioppolo, 2012). Data quality remains a key issue. Local data and models are needed because climatic conditions are highly variable. Research is needed for improving impact factors, models of fertilisers and pesticides dispersion; impact category models, such as land use, water use, loss of biodiversity and soil function impairment. From the analysis of the literature on LCA, it appears that the positive effects of soil management warrant further study. The impact on soil is the most difficult issue because of the variety, temporality and local properties of soil.

The most important practices concern the agricultural phase and the treatment of waste. Overall, organic cultivation is a way to reduce environmental impacts (EPD, 2012a). The recommended agricultural and waste treatments practices are optimisation of soil management techniques, such as cover cropping and the incorporation of organic material in the soil (i.e., residues from pruning (chopped but not burnt), weed, leaves and residues from the olive oil extraction process) (EPD, 2012a, 2012b). Reduction of the use of mineral fertilisers and pesticides (take into account the fate of pesticides in the fields). The inclusion of the positive contribution of reduced fertiliser and energy use should be studied. The improvement of waste management impacts to soil and groundwater when it is spread (Avraamides and Fatta, 2008). Also, the reduction of the use of diesel and replacing it with biofuel obtained thanks to residues (Romero-Gómez et al., 2017; Tsarouhas et al., 2015). The use of renewable energies (Romero-Gómez et al., 2017) or energy obtained from residues (E. A. Christoforou and Fokaides, 2016).

Additionally, it is important to include the quality aspect of the product (i.e. EVOO, VOO, OO) since it directly affects the functional unit and the used extraction techniques used. Considering the results, perspectives and recommendations offered by the studies, sensitive environmental hotspots, as well as limits, now appear well characterised. Nevertheless, any study includes all of the fields required by the ISO 14040 standard. Framework for communicating information about environmental footprints is available as a Product Category Rule, revealing a certain maturity of the topic and the application of LCA to olive oil production. Most notably, the agricultural practices and waste management approaches (strongly linked to the agriculture phase) evolve important effects in terms of environmental impact assessment. Efforts should be focused on these issues that represent levers for reducing environmental impacts. In future studies, the choice of the FU should be unified and it must respect the rules of a well-defined FU (quantity + quality + duration), and they should have a well-defined goal and scope, along with avoiding allocation.

The inclusion of social aspects has been suggested by (De Luca et al., 2018), and they addressed this issue combined with environmental LCA and life cycle costing in order to develop a complete “Life cycle sustainability assessment” (LCSA).

Despite the uniformity of the methodology used to calculate the biogenic carbon in the olive groves, it is very important to continue with these studies in order to take into account the sequestration of carbon in the plant and apply it to the calculation of its life cycle for the production of olive oil.

Even though LCA is a multi-criteria analysis, climate change was the impact category preferred by many authors. The environmental hotspots were mainly the agriculture, waste treatment and distribution phase. Comparison of extraction technologies appeared to be the less variable step of all stages of olive oil production. Packaging impact decreases for larger sizes of bottles. Some studies focused on waste treatment: composting is the most impactful option and the reuse of pomace and stones permits to reduce of impacts on oil husk extraction.

Finally, it is important to realise a multi-indicator study because the core reason for taking a life cycle perspective is that it allows identifying and preventing the burden-shifting between life cycle stages and between environmental indicators.

I.4 Circular Economy and Bioeconomy

I.4.1 Circular Economy definition

There exist many definitions of the circular economy (CE) (Belaud et al., 2019; EMF, 2021a; Kirchherr et al., 2017; Leipold and Petit-Boix, 2018; Nobre and Tavares, 2021). Nobre and Tavares (2021) published a quest for a CE final definition from a scientific perspective. Their work emphasises how this term has been gaining more prestige in large organisations/industries and attracted the attention of science as well. This growing scientific interest in CE is represented by the evolution of the number of publications in the Scopus® database (**Figure I-16**), where 75% of the publications have been in the last three years prior to their publication (2018, 2019, 2020) out of 17 years (2004-2020) (Nobre and Tavares, 2021).

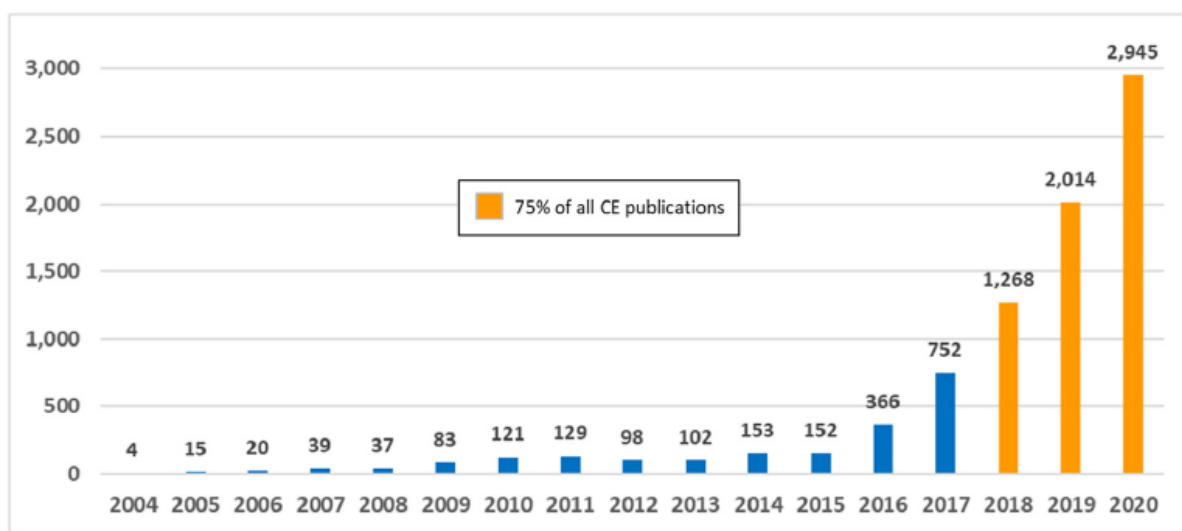

Figure I-16. CE publications in the Scopus® database (Nobre and Tavares, 2021).

The Ellen MacArthur Foundation (EMF) is the reference for all authors since its foundation in 2010 (EMF, 2021b). With strong activism, the foundation has been drawing attention to this subject by putting continuous efforts into inspiring people to rethink, redesign and build a positive future. It also came up with a CE definition:

“In our current economy, we take materials from the Earth, make products from them, and eventually throw them away as waste – the process is linear. In a circular economy, by contrast, we stop waste being produced in the first place.

The circular economy is based on three principles, driven by design:

- 1) *eliminate waste and pollution. Currently, our economy works in a take-make-waste system. We take raw materials from the Earth, we make products from them, and eventually we throw them away as waste. Much of this waste ends up in landfills or incinerators and is lost. This system can not work in the long term because the resources on our planet are finite.*
- 2) *to circulate products and materials (at their highest value). This means keeping materials in use, either as a product or, when that can no longer be used, as components or raw*

materials. This way, nothing becomes waste and the intrinsic value of products and materials are retained.

- 3) regenerate nature. By moving from a take-make-waste linear economy to a circular economy, we support natural processes and leave more room for nature to thrive.

The circular economy is a systems solution framework that tackles global challenges like climate change, biodiversity loss, waste, and pollution” (EMF, 2021a).

The butterfly infographic developed by EMF (EMF, 2021b) is considered one of the most popular and comprehensive CE frameworks (Nobre and Tavares, 2021). It illustrates the continuous flow of materials in the economy (Figure I-17). It presents two main cycles: the technical cycle (in blue - on the right) and the biological cycle (in green - on the left). In the technical cycle, products are kept in circulation in the economy through reuse, repair, remanufacturing and recycling. Thus, materials remain in use and never become waste. In the biological cycle, nutrients from biodegradable materials are returned to the earth, through processes such as composting or anaerobic digestion, allowing the soil to regenerate so that the cycle can continue (EMF, 2021b).

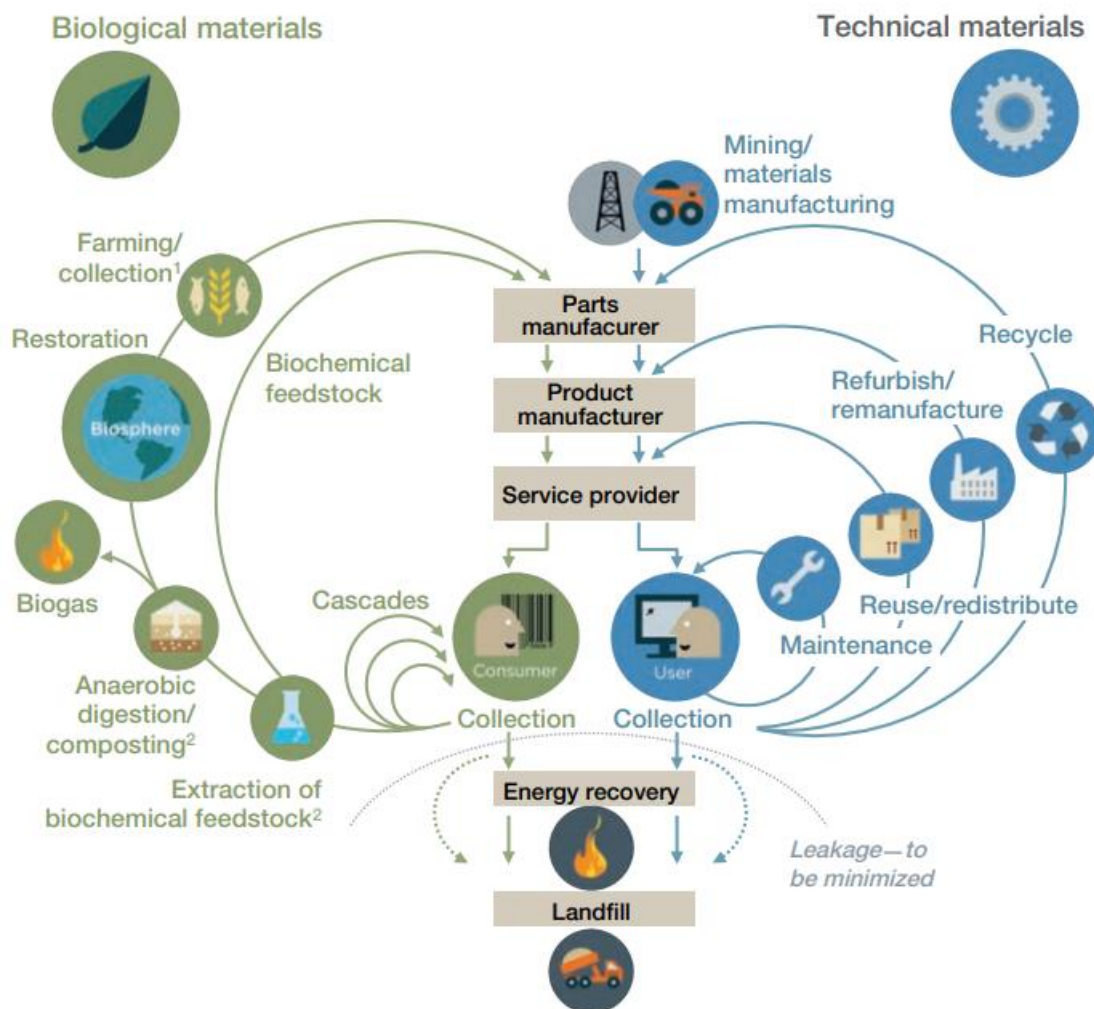

¹ Hunting and fishing

² Can take both postharvest and postconsumer waste as an input

Source: Ellen MacArthur Foundation circular economy team drawing from Braungart & McDonough and Cradle to Cradle (C2C)

Figure I-17. CE system diagram: the butterfly framework (EMF, 2021c).

This graphic (**Figure I-17**) makes a clear separation of the "technosphere" (bleu) and the "biosphere" (green) in the CE. Many scholars and stakeholders using this chart, so far, focus on the technosphere (Leipold and Petit-Boix, 2018).

In summary and going back to the work done by Nobre and Tavares (2021) on the effort to have a comprehensive definition that combines some of the already known and complemented by specialists' input, the closest definition at the moment is:

"Circular Economy is an economic system that targets zero waste and pollution throughout materials lifecycles, from environment extraction to industrial transformation, and to final consumers, applying to all involved ecosystems. Upon its lifetime end, materials return to either an industrial process or, in case of a treated organic residual, safely back to the environment as in a natural regenerating cycle. It operates creating value at the macro, meso and micro levels and exploits to the fullest the sustainability nested concept. Used energy sources are clean and renewable. Resources use and consumption are efficient. Government agencies and responsible consumers play an active role ensuring correct system long-term operation." - (Nobre and Tavares, 2021).

1.4.2 Bioeconomy definition

According to Bugge et al. (2016) there appears to be little consensus on the definition and implications of the bioeconomy. The authors carried out a review of the literature and identified three visions of the bioeconomy: the bio-technology vision, the bio-resource vision, and the bio-economy vision. It was also noted that the perception of a bioeconomy also contains different objectives in terms of a focus on the reduction of waste streams from bio-resources, on the one hand, and the development of new products and economic value chains based on existing waste streams from bio-resources, on the other hand (Bugge et al., 2016).

The bioeconomy refers to any value chain that uses biomaterials and products of agricultural, aquatic or forestry origin as a starting point (EAA, 2018). The European Commission launched a Communication entitled *Innovating for sustainable growth: a bioeconomy for Europe*. This bioeconomy strategy document defines the bioeconomy as:

"[The bioeconomy is] the production of renewable biological resources and their conversion into food, feed, bio-based products and bioenergy. It includes agriculture, forestry, fisheries, food, and pulp and paper production, as well as parts of [the] chemical, biotechnological and energy industries" - (EAA, 2018).

This concept also encompasses the production of renewable biological resources and the conversion of these resources and waste streams into value-added products such as food, feed, bio-based products and bioenergy (Carus, 2017).

1.4.3 How the Circular economy relates to the Bioeconomy and vice-versa?

The European Environment Agency (EAA, 2018) defines these two concepts as partners in sustainability, as the two policies have strong thematic links, with *e.g.* food waste, biomass and bio-based products as areas of intervention. On the one hand, the bioeconomy encompasses any value chain that uses biomaterials as a starting point. On the other hand, the shift from non-renewable resources to biomaterials is an important innovative aspect of the circular economy. Therefore, both are conceptually linked.

Carus (2017) argues that the two approaches are different but complementary, as:

*“the circular economy strengthens the eco-efficiency of processes and the use of recycled carbon to reduce the use of additional fossil carbon. The bioeconomy replaces fossil carbon with biological carbon from biomass from agriculture, forestry and the marine environment [...] The bioeconomy concept goes far beyond the circular economy [see **Figure I-18**], including a lot more aspects such as new chemical building blocks, new processing routes, new functionalities and properties of products” - (Carus, 2017).*

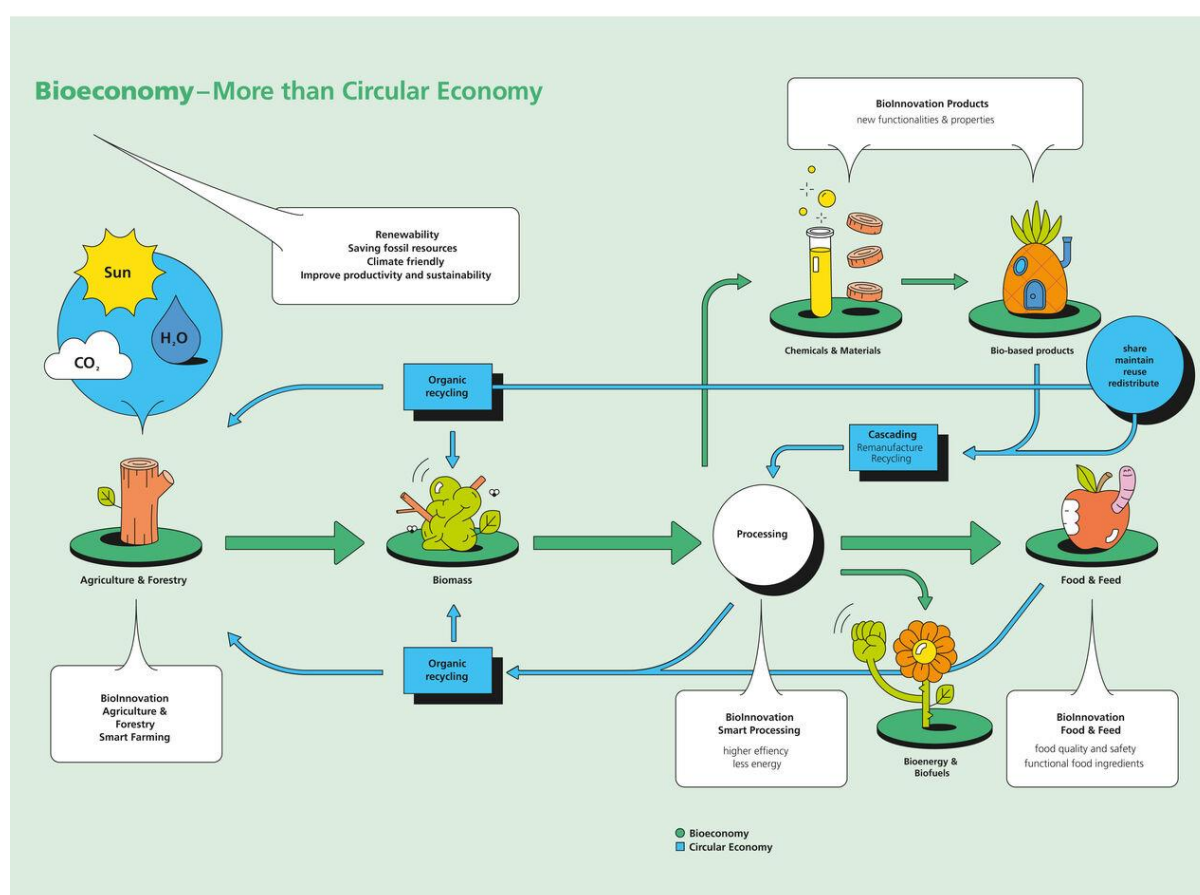

Figure I-18. Bioeconomy: More than Circular Economy: “Agriculture & Forestry” includes all kind of biomass, from agriculture, forestry and marine as well as organic waste streams (Nova 2017) in Carus (2017).

1.4.4 Circular Economy and Life Cycle Assessment

The LCA is considered a CE-related basic principle, as LCA is a science-based technique for assessing the impacts associated with entire product life cycles, standardised in the ISO 14040-series (Nobre and Tavares, 2021; Peña et al., 2021). Nevertheless, LCA is more related to “Manufacturing and Construction” of the Butterfly framework (**Figure I-17**) (Nobre and Tavares, 2021).

CE is often used synonymously with “closing loops” or “cradle-to-cradle” (see **Figure I-7** of I.2.1 Introduction to the Life Cycle Assessment methodology) which is a core element of it. However, the CE implies much more than that. It is about creating value for the economy, society and business while minimizing resource use and environmental and social impacts via system thinking. To evaluate the impacts of the CE, applying a life cycle approach is highly beneficial. LCA

can strengthen the propositions of the circular economy and the other way around (PRé Sustainability, 2015).

LCA can complement the vision of CE for mobilizing businesses and governments with robust measurements, helping to ensure the feasibility of implementation at a product level. Through LCA, it is possible to test the impacts of the circular business models, validate their assumptions and get feedback for improvement (PRé Sustainability, 2015). Closer collaboration between science and practitioners should exist to take into account the needs of end-users in the design of CE assessment efforts (Roos Lindgreen et al., 2020). Moreover, LCA can provide technical support and bring a holistic perspective to CE decision-makers, to assess trade-offs of impacts on a variety of environmental impact indicators, such as water use, energy, climate change, and raw materials (Peña et al., 2021). *“LCA can highlight situations where CE projects may be too narrowly focussed on the ‘circularity’ of a specific resource, and where the specific circular strategy is not the best choice from a broader sustainability perspective”* - (Peña et al., 2021).

I.4.5 Circular Economy in the olive oil sector

The CE in the European Union (EU) has recently been introduced as a high-level strategy to move our societies beyond the limits of growth. In the view of European policymakers, CE will be reached through business innovation or the promotion of existing sustainable business models on the principles of the CE (Leipold and Petit-Boix, 2018). In addition to this, since 2015, French authorities have developed “the Energy Transition Law for Green Growth”. This law has focused on waste management as an essential pillar to ensure the transition to a CE model (Belaud et al., 2019). Moreover, the use of the CE is becoming increasingly important, especially in the field of agriculture, one of the main suppliers of waste. In particular, much research is being carried out to transform agricultural residues by sustainable processes.

There are several EU policies related to bio-based products, one of them is the “Circular Economy Package”. It was created to support businesses and consumers in making the transition to a stronger and more circular economy where resources are used more sustainably. The proposed actions contribute to “closing the loop” of product lifecycles through greater recycling and re-use and bring benefits for both the environment and the economy (European Commission, 2016). As stated by several business stakeholders in the EU (Leipold and Petit-Boix, 2018), the CE is the concept under which products are recycled entirely to minimize waste. The CE is characterised by bio-based materials, renewability, bio-degradability, and compostability. A focus of activities is on biowaste for the production of goods.

According to the European Commission, a “bio-based product” is wholly or partly derived from materials of biological origin, excluding materials embedded in geological formations and/or fossilised. In industrial processes, enzymes can be used by using fermentation and biocatalysis instead of traditional chemical synthesis. It is possible to obtain greater efficiency in the process, which translates into a decrease in energy and water consumption, and a reduction of toxic waste. As they are derived from renewable raw materials such as plants, bio-based products can help reduce CO₂ and offer other advantages such as lower toxicity or innovative product characteristics (*e.g.* biodegradable plastic materials) (European Commission, 2016).

Therefore, the valorisation of OP on the biocomposite field (Chapter III) is important to the CE as biocomposites are composites in which the fibres and/or the polymer matrix are bio-based, but in most cases, the term refers to composite materials reinforced by natural fibres.

I.5 Conclusions

The first section with the presentation of the olive oil sector allows discovering the characteristics of the olive oil, its technical information, the different types and qualities of olive oil, the organisms that regulate it and its manufacturing process that is important to understand the stages of the life cycle that will be assessed with the LCA method. It also addressed how by-products made of biomass are related to the circular economy regulations.

Secondly, the LCA methodology was presented within each of its parts. This part allowed to clarify the following points:

- For the purpose of this PhD work, only attributional LCI modelling is used throughout the following chapters. Yet, Chapter III will touch on attributional analysis with system expansion.
- From this point forward, the acronym “LCA” is used in reference only to the attributional and environmental LCA, unless specified otherwise,
- The ecoinvent 3 database with the Recycled Content Approach (Allocation, cut-off by classification) was used.
- The SimaPro software in its 9.1.1.1 version was used for this PhD thesis work.

Afterwards, in the light of the literature review, crucial environmental issues concerning the life cycle of olive oil and olive cultivation for olive oil production have been extensively studied. The critical analysis was conducted on 23 publications and two review papers between 2008 and 2018, including articles based on six European projects. Italy, Spain, and Greece were the most active publishing countries, which coincides with their leadership in worldwide olive oil production. All the articles have been compared in terms of their general characteristics, methodology, functional unit, system limits, scenarios and further parameters taken into account depending on the study.

Finally, the concept of circular economy was presented, as well as the relationship between life cycle assessment and circular economy and how it is involved in the olive oil sector.

I.6 References

- Accorsi, R., Cascini, A., Ferrari, E., Manzini, R., Pareschi, A., Versari, L., 2013. Life cycle assessment of an extra-virgin olive oil supply chain. Presented at the XVIII Summer School “Francesco Turco” - Industrial Mechanical Plants, Senigallia (AN), Italy.
- Accorsi, R., Versari, L., Manzini, R., 2015. Glass vs. Plastic: Life Cycle Assessment of Extra-Virgin Olive Oil Bottles across Global Supply Chains. *Sustainability* 7. <https://doi.org/10.3390/su7032818>
- Afidol, 2021. . Fr. OLIVE - AFIDOL - Acidité Huile Olive. URL <https://afidol.org/commercant/acidite-de-lhuile-dolive/> (accessed 9.13.21).
- Alibes, X., Berge, Martilotti, F., Nefzaoui, A., Zoïopoulos, P.E., 1983. Utilisation des sous-produits de l'olivier en alimentation animale dans le bassin Méditerranéen. FAO, Rome.
- Aouat, H., Hammiche, D., Boukerrou, A., Djidjelli, H., Grohens, Y., Pillin, I., 2021. Effects of interface modification on composites based on olive husk flour. *Mater. Today Proc., The International Network of Biomaterials and Engineering Science* 36, 94–100. <https://doi.org/10.1016/j.matpr.2020.05.459>
- Aparicio-Ruiz, R., Harwood, J. (Eds.), 2013. *Handbook of Olive Oil: Analysis and Properties*, 2nd ed. Springer US. <https://doi.org/10.1007/978-1-4614-7777-8>
- Avraamides, M., Fatta, D., 2008. Resource consumption and emissions from olive oil production: a life cycle inventory case study in Cyprus. *J. Clean. Prod.* 16, 809–821. <https://doi.org/10.1016/j.jclepro.2007.04.002>
- Avraamides, M., Fatta, D., 2006. TASK 3.2 Implementation of Life Cycle Inventory in Lythrodontas region of Cyprus (No. 3.2). Laboratory of Environmental Eengineering, University of Cyprus, Nicosia, Cyprus.
- Azapagic, A., Millington, A., Collett, A., 2006. A Methodology for Integrating Sustainability Considerations into Process Design. *Chem. Eng. Res. Des.* 84, 439–452. <https://doi.org/10.1205/cherd05007>
- Azbar, N., Bayram, A., Filibeli, A., Muezzinoglu, A., Sengul, F., Ozer, A., 2004. A Review of Waste Management Options in Olive Oil Production. *Crit. Rev. Environ. Sci. Technol.* 34, 209–247. <https://doi.org/10.1080/10643380490279932>
- Banat, R., 2019. Olive Pomace Flour as Potential Organic Filler in Composite Materials: A Brief Review. *Am. J. Polym. Sci.* 9, 10–15.
- Banias, G., Achillas, C., Vlachokostas, C., Moussiopoulos, N., Stefanou, M., 2017. Environmental impacts in the life cycle of olive oil: a literature review. *J. Sci. Food Agric.* 97, 1686–1697. <https://doi.org/10.1002/jsfa.8143>
- Barreca, F., Fichera, C.R., 2013. Use of olive stone as an additive in cement lime mortar to improve thermal insulation. *Energy Build.* 62, 507–513. <https://doi.org/10.1016/j.enbuild.2013.03.040>
- Belaud, J.-P., Adoue, C., Vialle, C., Chorro, A., Sablayrolles, C., 2019. A circular economy and industrial ecology toolbox for developing an eco-industrial park: perspectives from French policy. *Clean Technol. Environ. Policy* 21, 967–985. <https://doi.org/10.1007/s10098-019-01677-1>
- Bernardi, B., Falcone, G., Stillitano, T., Benalia, S., Strano, A., Bacenetti, J., De Luca, A.I., 2018. Harvesting system sustainability in Mediterranean olive cultivation. *Sci. Total Environ.* 625, 1446–1458. <https://doi.org/10.1016/j.scitotenv.2018.01.005>

- Bhatnagar, A., Kaczala, F., Hogland, W., Marques, M., Paraskeva, C.A., Papadakis, V.G., Sillanpää, M., 2014. Valorization of solid waste products from olive oil industry as potential adsorbents for water pollution control—a review. *Environ. Sci. Pollut. Res.* 21, 268–298. <https://doi.org/10.1007/s11356-013-2135-6>
- Biolive Biological and Chemical Technologies [WWW Document], 2020. URL <http://www.biolivearge.com/indexen.html> (accessed 1.27.21).
- Boskou, D., 2006. *Olive Oil: Chemistry and Technology*, Second Edition. AOCs Publishing. <https://doi.org/10.1201/9781439832028>
- Boufi, S., 2017. Biocomposites from olive-stone flour, in: *Lignocellulosic Fibre and Biomass-Based Composite Materials*. Elsevier, pp. 387–408. <https://doi.org/10.1016/B978-0-08-100959-8.00018-4>
- BSI, 2011. PAS 2050:2011 Specification for the assessment of the life cycle greenhouse gas emissions of goods and services. Department for Business Innovation & Skills.
- Bugge, M.M., Hansen, T., Klitkou, A., 2016. What Is the Bioeconomy? A Review of the Literature. *Sustainability* 8, 691. <https://doi.org/10.3390/su8070691>
- Busset, G., Belaud, J.-P., Clarens, F., Espi, J.J., Montréjaud-Vignoles, M., Sablayrolles, C., 2012. Life cycle assessment of treatment processes of solid waste from the olive oil sector.
- Busset, G., Sablayrolles, C., Vignoles, M., Belaud, J.P., 2015. Computer Aided Process Engineering for Sustainability Analysis of Food Production. *Chem. Eng. Trans.* 43, 1339–1344. <http://dx.doi.org/doi:10.3303/CET1543224>
- Carus, M., 2017. The bioeconomy is much more than a circular economy [WWW Document]. BLICKWINKEL. URL <https://www.brain-biotech.com/blickwinkel/circular/the-bioeconomy-is-much-more-than-a-circular-economy/> (accessed 4.20.22).
- Carvalho, J., Ribeiro, A., Araújo, J., Batista, M., Castro, F., Vilarinho, C., 2012. OILCA : enhancing the competitiveness and reducing the carbon footprint of the olive oil sector through waste management optimisation and the establishment of an ecological label. Presented at the 4th International Conference on Engineering for Waste and Biomass Valorisation, Porto, Portugal.
- Chatzisyneon, E., Foteinis, S., Mantzavinos, D., Tsoutsos, T., 2013. Life cycle assessment of advanced oxidation processes for olive mill wastewater treatment. *J. Clean. Prod.* 54, 229–234. <https://doi.org/10.1016/j.jclepro.2013.05.013>
- Christoforou, E., Fokaidis, P.A., 2016. A review of olive mill solid wastes to energy utilization techniques. *Waste Manag.* 49, 346–363. <https://doi.org/10.1016/j.wasman.2016.01.012>
- Christoforou, E.A., Fokaidis, P.A., 2016. Life cycle assessment (LCA) of olive husk torrefaction. *Renew. Energy* 90, 257–266. <https://doi.org/10.1016/j.renene.2016.01.022>
- Cinar, O., Alma, M.H., 2008. Environmental assessment of olive oil production: Olive oil mill wastes and their disposal, in: Ozkaya, M.T., Lavee, S., Ferguson, L. (Eds.), *Proceedings of the Fifth International Symposium on Olive Growing*. Presented at the Fifth International Symposium on Olive Growing, International Society Horticultural Science, Leuven, Belgique, pp. 645–649.
- Ciroth, A., Muller, S., Weidema, B., Lesage, P., 2016. Empirically based uncertainty factors for the pedigree matrix in ecoinvent. *Int. J. Life Cycle Assess.* 21, 1338–1348. <https://doi.org/10.1007/s11367-013-0670-5>
- Clark, J., Macquarrie, D., 2002. Life-cycle Assessment: a Tool for Identification of More Sustainable Products and Processes, in: *Handbook of Green Chemistry and Technology*. Blackwell, pp. 62–80.

- CMLCA: scientific software for LCA [WWW Document], 2018. URL <http://www.cmlca.eu/> (accessed 7.9.18).
- Contreras, M. del M., Romero, I., Moya, M., Castro, E., 2020. Olive-derived biomass as a renewable source of value-added products. *Process Biochem.* 97, 43–56. <https://doi.org/10.1016/j.procbio.2020.06.013>
- Cortes, J.M., 2006. TASK 3.3 Implementation of Life Cycle Inventory in Ribera Baja (Navarra, Spain) (No. 3.3). Fundacion LEIA Environment and energy unit, Cordoba, España.
- Cossu, A., Degl’Innocenti, S., Agnolucci, M., Cristani, C., Bedini, S., Nuti, M., 2013. Assessment of the Life Cycle Environmental Impact of the Olive Oil Extraction Solid Wastes in the European Union. *Open Waste Manag. J.* 6, 12–20. <https://doi.org/10.2174/1876400220131014001>
- de la Casa, J.A., Castro, E., 2014. Recycling of washed olive pomace ash for fired clay brick manufacturing. *Constr. Build. Mater.* 61, 320–326. <https://doi.org/10.1016/j.conbuildmat.2014.03.026>
- De Luca, A.I., Falcone, G., Stillitano, T., Iofrida, N., Strano, A., Gulisano, G., 2018. Evaluation of sustainable innovations in olive growing systems: A Life Cycle Sustainability Assessment case study in southern Italy. *J. Clean. Prod.* 171, 1187–1202. <https://doi.org/10.1016/j.jclepro.2017.10.119>
- Dermeche, S., Nadour, M., Larroche, C., Moulti-Mati, F., Michaud, P., 2013. Olive mill wastes: Biochemical characterizations and valorization strategies. *Process Biochem.* 48, 1532–1552. <https://doi.org/10.1016/j.procbio.2013.07.010>
- Dessane, D., 2003. Energy efficiency and life cycle analysis of organic and conventional olive groves in the Messara Valley, Crete, Greece. Wageningen University, Wageningen, The Netherlands.
- Duman, A.K., Özgen, G.Ö., Üçtuğ, F.G., 2020. Environmental life cycle assessment of olive pomace utilization in Turkey. *Sustain. Prod. Consum.* 22, 126–137. <https://doi.org/10.1016/j.spc.2020.02.008>
- EAA, 2018. The circular economy and the bioeconomy — Partners in sustainability — European Environment Agency (Publication No. 8/2018).
- ECOIL, 2004. ECOIL: Life Cycle Assessment (LCA) as a decision support tool (DST) for the eco-production of olive oil [WWW Document]. URL <http://www.ecoil.tuc.gr/default.html> (accessed 12.11.18).
- Ecoinvent [WWW Document], 2018. URL <https://www.ecoinvent.org/> (accessed 7.8.18).
- El Hanandeh, A., 2015. Energy recovery alternatives for the sustainable management of olive oil industry waste in Australia: life cycle assessment. *J. Clean. Prod.* 91, 78–88. <https://doi.org/10.1016/j.jclepro.2014.12.005>
- El Hanandeh, A., Gharaibeh, M.A., 2016. Environmental efficiency of olive oil production by small and micro-scale farmers in northern Jordan: Life cycle assessment. *Agric. Syst.* 148, 169–177. <https://doi.org/10.1016/j.agsy.2016.08.003>
- El-Sheikh, A.H., Newman, A.P., Al-Daffae, H.K., Phull, S., Cresswell, N., 2004. Characterization of activated carbon prepared from a single cultivar of Jordanian Olive stones by chemical and physicochemical techniques. *J. Anal. Appl. Pyrolysis* 1, 151–164. [https://doi.org/10.1016/S0165-2370\(03\)00061-5](https://doi.org/10.1016/S0165-2370(03)00061-5)
- EMF, 2021a. Circular economy introduction [WWW Document]. URL <https://ellenmacarthurfoundation.org/topics/circular-economy-introduction/overview> (accessed 2.24.22).
- EMF, 2021b. What we do [WWW Document]. URL <https://ellenmacarthurfoundation.org/about-us/what-we-do> (accessed 2.24.22).

- EMF, 2021c. The butterfly diagram: visualising the circular economy [WWW Document]. URL <https://ellenmacarthurfoundation.org/circular-economy-diagram> (accessed 2.23.22).
- EPD, 2012a. Environmental Product Declaration for one pack of 0.75 Litre of extra virgin olive oil (EPD No. 1.0). EPD International.
- EPD, 2012b. Dichiarazione ambientale di prodotto: olio extra vergine di oliva “denociolato” (confezione da 1 litro) (Environmental Product Declaration No. 1.0). EPD International, Orta Nova, Italia.
- EPD, 2010. PCR Virgin Oil and Its Fractions. Product Category Rules 1.0. EPD International.
- Espadas-Aldana, G., Vialle, C., Belaud, J.-P., Vaca-Garcia, C., Sablayrolles, C., 2019. Analysis and trends for Life Cycle Assessment of olive oil production. *Sustain. Prod. Consum.* 19, 216–230. <https://doi.org/10.1016/j.spc.2019.04.003>
- Espi, J.J., Clarens, F., Busset, G., Sablayrolles, C., Montrejaud-Vignoles, M., Carvalho, J., Fonseca, B., Delgado, F., Chacon, L., Capiscol, C., Trillo, R., 2013. Enhancing the competitiveness and reducing the carbon footprint of the olive oil sector through waste management optimisation: OILCA (with critical revision) [in spanish].
- European Commission, 2016. Bio-based products [WWW Document]. Intern. Mark. Ind. Entrep. SMEs - Eur. Comm. URL https://ec.europa.eu/growth/sectors/biotechnology/bio-based-products_en (accessed 10.1.21).
- Fazio, S., Castellani, V., Sala, S., Schau, E., Secchi, M., Zampori, L., Diaconu, E., 2018. Supporting information to the characterisation factors of recommended EF Life Cycle Impact Assessment methods: New methods and differences with ILCD [WWW Document]. JRC Publ. Repos. <https://doi.org/10.2760/671368>
- France Olive, 2020. AOC / AOP. Fr. OLIVE - AFIDOL. URL <https://afidol.org/oleiculteur/aoc/> (accessed 4.7.21).
- Frischknecht, R., Jungbluth, N., Althaus, H.-J., Doka, G., Heck, T., Hellweg, S., Hischier, R., Nemecek, T., Rebitzer, G., Spielmann, M., Wernet, G., 2007. Overview and methodology Data v20 (2007) Ecoinvent report No 1. Swiss Centre for Life Cycle Inventories, Dübendorf.
- Georgiou, K., Mentzis, A., Papadopoulos, A., Vageloglou, V., Papadakis, G.Art., 2006. TASK 3.1 Implementation of Life Cycle Inventory in Voukolies /Polemarchi region of Crete (No. 3.1). Technical University of Crete, Crete, Greece.
- Gillani, S., Belaud, J.-P., Sablayrolles, C., Montréjaud-Vignoles, M., Lann, J., 2010. Review of Life Cycle Assessment in Agro-Chemical Processes. *Chem. Prod. Process Model.* 5. <https://doi.org/10.2202/1934-2659.1496>
- Graaff, J. de, Duarte, F., Fleskens, L., Figueiredo, T. de, 2010. The future of olive groves on sloping land and ex-ante assessment of cross compliance for erosion control. *Land Use Policy* 27, 33–41. <https://doi.org/10.1016/j.landusepol.2008.02.006>
- Guinée, J.B., Heijungs, R., Huppes, G., Zamagni, A., Masoni, P., Buonamici, R., Ekvall, T., Rydberg, T., 2011. Life Cycle Assessment: Past, Present, and Future†. *Environ. Sci. Technol.* 45, 90–96. <https://doi.org/10.1021/es101316v>
- Guiso, A., Parenti, A., Masella, P., Guerrini, L., Baldi, F., Spugnoli, P., 2016. Environmental impact assessment of three packages for high-quality extra-virgin olive oil. *Agric. Eng.* 47. <https://doi.org/10.4081/jae.2016.515>
- Haddadin, M.S.Y., Haddadin, J., Arabiyat, O.I., Hattar, B., 2009. Biological conversion of olive pomace into compost by using *Trichoderma harzianum* and *Phanerochaete chrysosporium*. *Bioresour. Technol.* 100, 4773–4782. <https://doi.org/10.1016/j.biortech.2009.04.047>

- Hamelin, L., 2013. Carbon management and environmental consequences of agricultural biomass in a Danish Renewable Energy strategy. Department of Chemical Engineering, Biotechnology and Environmental Technology, Faculty of Engineering, Denmark.
- Hauschild, M., K. Rosenbaum, R., Irving Olsen, S., 2018. Life Cycle Assessment: Theory and Practice. <https://doi.org/10.1007/978-3-319-56475-3>
- Huijbregts, M.A.J., Steinmann, Z.J.N., Elshout, P.M.F., Stam, G., Verones, F., Vieira, M., Hollander, A., Zijp, M., van Zelm, R., 2017. ReCiPe 2016 v1.1: A harmonized life cycle impact assessment method at midpoint and endpoint level. Report I: Characterization (No. RIVM Report 2016-0104a).
- INFOIL, 2010. INFOIL: Promoting sustainable production and consumption patterns: the example of olive oil [WWW Document]. URL http://ec.europa.eu/environment/life/project/Projects/index.cfm?fuseaction=search.dspPage&n_proj_id=3510#PD (accessed 3.25.19).
- International Olive Oil Council, 2021a. IOC (International Olive Council) [WWW Document]. World Olive Oil Fig. URL <https://www.internationaloliveoil.org/what-we-do/economic-affairs-promotion-unit/#figures> (accessed 9.10.21).
- International Olive Oil Council, 2021b. IOC (International Olive Council) [WWW Document]. IOC Missions. URL <https://www.internationaloliveoil.org/about-ioc/mission-basic-text/> (accessed 9.13.21).
- International Olive Oil Council, 2021c. IOC (International Olive Council) [WWW Document]. Trade Stand. Appl. Olive Oils Olive Pomace Oils. URL <https://www.internationaloliveoil.org/what-we-do/economic-affairs-promotion-unit/#figures> (accessed 9.10.21).
- IOC, 2018a. IOC (International Olive Council) [WWW Document]. World Olive Oil Fig. URL <http://www.internationaloliveoil.org/estaticos/view/131-world-olive-oil-figures> (accessed 12.20.18).
- IOC, 2018b. IOC (International Olive Council) [WWW Document]. IOC Data 201718 Crop Year Show Year--Year Increase Prod. Olive Oil. URL http://www.internationaloliveoil.org/news/view/698-year-2018-news/1049-ioc-data-for-the-2017-18-crop-year-show-a-year-on-year-increase-in-the-production-of-olive-oil?lang=en_US (accessed 12.20.18).
- iPoint, 2018. Life Cycle Impact Assessment – which are the LCIA indicator sets most widely used by practitioners? IPoint Blog. URL <https://www.ipoint-systems.com/blog/lcia-indicator/> (accessed 9.25.20).
- ISO 14040: Environmental Management – Life Cycle Assessment –Principles and framework. International Organization for Standardization (ISO). Geneve, Switzerland., 2006a.
- ISO 14044: Environmental Management – Life Cycle Assessment – Requirements and Guidelines. International Organization for Standardization (ISO). Geneve, Switzerland., 2006b.
- ISO/TS, 2018. ISO/TS 14067: Greenhouse gases - Carbon footprint of products - Requirements and guidelines for quantification and communication. International Organization for Standardization (ISO). Geneve, Switzerland.
- Joint Research Centre, Institute for Environment and Sustainability, 2010. General guide for Life Cycle Assessment: provisions and action steps. Publications Office. <https://doi.org/10.2788/94987>
- Jolliet, O., Saadé-Sbeih, M., Crettaz, P., Jolliet-Gavin, N., Shaked, S., 2017. Analyse du Cycle de vie: Comprendre et réaliser un écobilan (éd. 3), 3e édition. ed. Presses polytechniques et universitaires romandes.

- Jolliet, O., Saadé-Sbeih, M., Shaked, S., Jolliet, A., Crettaz, P., 2016. Environmental Life Cycle Assessment. CRC Press Taylor & Francis Group.
- Kaya, N., Atagur, M., Akyuz, O., Seki, Y., Sarikanat, M., Sutcu, M., Seydibeyoglu, M.O., Sever, K., 2018. Fabrication and characterization of olive pomace filled PP composites. *Compos. Part B Eng.* 150, 277–283. <https://doi.org/10.1016/j.compositesb.2017.08.017>
- Kirchherr, J., Reike, D., Hekkert, M., 2017. Conceptualizing the circular economy: An analysis of 114 definitions. *Resour. Conserv. Recycl.* 127, 221–232. <https://doi.org/10.1016/j.resconrec.2017.09.005>
- Koutsomitopoulou, A.F., Bénézet, J.C., Bergeret, A., Papanicolaou, G.C., 2014. Preparation and characterization of olive pit powder as a filler to PLA-matrix bio-composites. *Powder Technol.* 255, 10–16. <https://doi.org/10.1016/j.powtec.2013.10.047>
- Lammi, S., Barakat, A., Mayer-Laigle, C., Djenane, D., Gontard, N., Angellier-Coussy, H., 2018a. Dry fractionation of olive pomace as a sustainable process to produce fillers for biocomposites. *Powder Technol.* 326, 44–53. <https://doi.org/10.1016/j.powtec.2017.11.060>
- Lammi, S., Gastaldi, E., Gaubiac, F., Angellier-Coussy, H., 2019. How olive pomace can be valorized as fillers to tune the biodegradation of PHBV based composites. *Polym. Degrad. Stab.* 166, 325–333. <https://doi.org/10.1016/j.polymdegradstab.2019.06.010>
- Lammi, S., Le Moigne, N., Djenane, D., Gontard, N., Angellier-Coussy, H., 2018b. Dry fractionation of olive pomace for the development of food packaging biocomposites. *Ind. Crops Prod.* 120, 250–261. <https://doi.org/10.1016/j.indcrop.2018.04.052>
- Leipold, S., Petit-Boix, A., 2018. The circular economy and the bio-based sector - Perspectives of European and German stakeholders. *J. Clean. Prod.* 201, 1125–1137. <https://doi.org/10.1016/j.jclepro.2018.08.019>
- Material Connexion, 2019. Bioplastic Made from Olives [WWW Document]. Mater. Conenexion. URL <https://www.materialconnexion.com/material-insight-bioplastic/> (accessed 1.27.21).
- Matos, M., Barreiro, M.F., Gandini, A., 2010. Olive stone as a renewable source of biopolyols. *Ind. Crops Prod.* 32, 7–12. <https://doi.org/10.1016/j.indcrop.2010.02.010>
- Mohamad, R.S., Verrastro, V., Cardone, G., Bteich, M.R., Favia, M., Moretti, M., Roma, R., 2014. Optimization of organic and conventional olive agricultural practices from a Life Cycle Assessment and Life Cycle Costing perspectives. *J. Clean. Prod.* 70, 78–89. <https://doi.org/10.1016/j.jclepro.2014.02.033>
- Morillo, J.A., Antizar-Ladislao, B., Monteoliva-Sánchez, M., Ramos-Cormenzana, A., Russell, N.J., 2009. Bioremediation and biovalorisation of olive-mill wastes. *Appl. Microbiol. Biotechnol.* 82, 25–39. <https://doi.org/10.1007/s00253-008-1801-y>
- Muller, S., Lesage, P., Citroth, A., Mutel, C., Weidema, B.P., Samson, R., 2014. The application of the pedigree approach to the distributions foreseen in ecoinvent v3. *Int. J. Life Cycle Assess.* 21, 1327–1337. <https://doi.org/10.1007/s11367-014-0759-5>
- Naghmouchi, I., Mutjé, P., Boufi, S., 2015. Olive stones flour as reinforcement in polypropylene composites: A step forward in the valorization of the solid waste from the olive oil industry. *Ind. Crops Prod.* 72, 183–191. <https://doi.org/10.1016/j.indcrop.2014.11.051>
- Navarro, A., Puig, R., Martí, E., Bala, A., Fullana-i-Palmer, P., 2018. Tackling the Relevance of Packaging in Life Cycle Assessment of Virgin Olive Oil and the Environmental Consequences of Regulation. *Environ. Manage.* 62, 277–294. <https://doi.org/10.1007/s00267-018-1021-x>

- Nobre, G.C., Tavares, E., 2021. The quest for a circular economy final definition: A scientific perspective. *J. Clean. Prod.* 314, 127973. <https://doi.org/10.1016/j.jclepro.2021.127973>
- Nunes, M.A., Pimentel, F.B., Costa, A.S.G., Alves, R.C., Oliveira, M.B.P.P., 2016. Olive by-products for functional and food applications: Challenging opportunities to face environmental constraints. *Innov. Food Sci. Emerg. Technol.* 35, 139–148. <https://doi.org/10.1016/j.ifset.2016.04.016>
- OiLCA, 2013. OiLCATool [WWW Document]. URL (accessed 11.8.18).
- OiLCA, 2011. Enhancing the competitiveness and reducing the carbon footprint of the olive oil sector through waste management optimisation and the establishment of an ecological label [WWW Document]. URL (accessed 10.11.18).
- OLIVE4CLIMATE, 2016. OLIVE4CLIMATE – LIFE: a project co-funded by the European Commission that focuses on climate change mitigation through a sustainable supply chain for the olive oil sector [WWW Document]. URL <https://olive4climate.eu/en/> (accessed 3.29.19).
- oLIVECLIMA, 2012. Introduction of new oLIVE crop management practices focused on CLIMATE change mitigation and adaptation [WWW Document]. URL <http://www.oliveclima.eu/en/> (accessed 3.25.19).
- Olivier de Provence, 2021. Les différentes qualités d’huile d’olive [WWW Document]. URL <https://www.olivierdeprovence.com/odpce-fr/huile-olive-classification.php> (accessed 9.15.21).
- Olivieri, G., Falconi, F., Pergreffi, R., Neri, P., Romani, A., 2005. Life cycle assessment for environmental integrated system in the olive oil tuscan company., in: European Meeting of the International Society for Industrial Ecology Conference Proceedings. Presented at the European Meeting of the International Society for Industrial Ecology, Bologna, Italy.
- OpenLCA.org, 2018. URL <http://www.openlca.org> (accessed 7.9.18).
- Parascanu, M.M., Gamero, M.P., Sánchez, P., Soreanu, G., Valverde, J.L., Sanchez-Silva, L., 2018a. Life cycle assessment of olive pomace valorisation through pyrolysis. *Renew. Energy.* <https://doi.org/10.1016/j.renene.2018.02.027>
- Parascanu, M.M., Sánchez, P., Soreanu, G., Valverde, J.L., Sanchez-Silva, L., 2018b. Environmental assessment of olive pomace valorization through two different thermochemical processes for energy production. *J. Clean. Prod.* 186, 771–781. <https://doi.org/10.1016/j.jclepro.2018.03.169>
- Pattara, C., Salomone, R., Cichelli, A., 2016. Carbon footprint of extra virgin olive oil: a comparative and driver analysis of different production processes in Centre Italy. *J. Clean. Prod.* 127, 533–547. <https://doi.org/10.1016/j.jclepro.2016.03.152>
- Peña, C., Civit, B., Gallego-Schmid, A., Druckman, A., Pires, A.C.-, Weidema, B., Mieras, E., Wang, F., Fava, J., Canals, L.M. i, Cordella, M., Arbuckle, P., Valdivia, S., Fallaha, S., Motta, W., 2021. Using life cycle assessment to achieve a circular economy. *Int. J. Life Cycle Assess.* 26, 215–220. <https://doi.org/10.1007/s11367-020-01856-z>
- PRé Sustainability, 2015. Complementing the circular economy with LCA [WWW Document]. PRé Sustain. URL <https://pre-sustainability.com/articles/complementing-the-circular-economy-with-lca/> (accessed 2.24.22).
- PRé-Sustainability, 2018. Improved Pedigree Matrix Approach for ecoinvent | PRé Sustainability [WWW Document]. URL <https://www.pre-sustainability.com/news/improved-pedigree-matrix-approach-for-ecoinvent> (accessed 7.9.18).
- Proietti, P., Sdringola, P., Brunori, A., Ilarioni, L., Nasini, L., Regni, L., Pelleri, F., Desideri, U., Proietti, S., 2016. Assessment of carbon balance in intensive and extensive tree cultivation systems

- for oak, olive, poplar and walnut plantation. *J. Clean. Prod.* 112, 2613–2624. <https://doi.org/10.1016/j.jclepro.2015.10.009>
- Proietti, S., Sdringola, P., Desideri, U., Zepparelli, F., Brunori, A., Ilarioni, L., Nasini, L., Regni, L., Proietti, P., 2014. Carbon footprint of an olive tree grove. *Appl. Energy* 127, 115–124. <https://doi.org/10.1016/j.apenergy.2014.04.019>
- Proietti, S., Sdringola, P., Regni, L., Evangelisti, N., Brunori, A., Ilarioni, L., Nasini, L., Proietti, P., 2017. Extra Virgin Olive oil as carbon negative product: Experimental analysis and validation of results. *J. Clean. Prod.* 166, 550–562. <https://doi.org/10.1016/j.jclepro.2017.07.230>
- Putinja, I., 2020. Researchers Develop Compostable Plastic Packaging From Olive Waste [WWW Document]. *Olive Oil Times*. URL <https://www.oliveoiltimes.com/world/researchers-develop-compostable-plastic-packaging-from-olive-waste/81373> (accessed 1.27.21).
- Rajaeifar, M.A., Akram, A., Ghobadian, B., Rafiee, S., Heidari, M.D., 2014. Energy-economic life cycle assessment (LCA) and greenhouse gas emissions analysis of olive oil production in Iran. *Energy* 66, 139–149. <https://doi.org/10.1016/j.energy.2013.12.059>
- Ravindran, R., Jaiswal, A.K., 2016. Exploitation of Food Industry Waste for High-Value Products. *Trends Biotechnol.* 34, 58–69. <https://doi.org/10.1016/j.tibtech.2015.10.008>
- Rinaldi, S., Barbanera, M., Lascaro, E., 2014. Assessment of carbon footprint and energy performance of the extra virgin olive oil chain in Umbria, Italy. *Sci. Total Environ.* 482–483, 71–79. <https://doi.org/10.1016/j.scitotenv.2014.02.104>
- Risch, E., Roux, P., Boutin, C., Héduit, A., 2012. L'analyse de cycles de vie des systèmes d'assainissement : un outil complémentaire d'aide à la décision. *Sci. Eaux Territ.* 82–90. <https://doi.org/10.14758/SET-REVUE.2012.9.13>
- Romero-Gámez, M., Castro-Rodríguez, J., Suárez-Rey, E.M., 2017. Optimization of olive growing practices in Spain from a life cycle assessment perspective. *J. Clean. Prod.* 149, 25–37. <https://doi.org/10.1016/j.jclepro.2017.02.071>
- Roos Lindgreen, E., Salomone, R., Reyes, T., 2020. A Critical Review of Academic Approaches, Methods and Tools to Assess Circular Economy at the Micro Level. *Sustainability* 12, 4973. <https://doi.org/10.3390/su12124973>
- Salomone, R., Cappelletti, G.M., Ioppolo, G., Mistretta, M., Nicoletti, G.M., Notarnicola, B., Olivieri, G., Pattara, C., Russo, C., Scimia, E., 2010. Italian experiences in life cycle assessment of olive oil: a survey and critical review, in: *Conference Proceedings of the 7th International Conference on Life Cycle Assessment in the Agri-Food Sector*. Presented at the 7th International Conference on Life Cycle Assessment in the Agri-Food Sector, Bari, Italy, pp. 265–270.
- Salomone, R., Cappelletti, G.M., Malandrino, O., Mistretta, M., Neri, E., Nicoletti, G., Notarnicola, B., Pattara, C., Russo, C., Saija, G., 2015. Life Cycle Assessment in the Olive Oil Sector, in: *Life Cycle Assessment in the Agri-Food Sector*. Springer, Cham, pp. 57–121. https://doi.org/10.1007/978-3-319-11940-3_2
- Salomone, R., Ioppolo, G., 2012. Environmental impacts of olive oil production: a Life Cycle Assessment case study in the province of Messina (Sicily). *J. Clean. Prod.* 28, 88–100. <https://doi.org/10.1016/j.jclepro.2011.10.004>
- Sauvant, D., 2011. Les coproduits de l'olivier, déchets ou matières premières d'avenir ? [WWW Document]. *Amis Oliv. Pays Vans*. URL https://www.olivardeche.fr/articles.php?lng=fr&pg=81&fbclid=IwAR27WcF_zf0qqNur869l13AP2zWz8Z9a_E-6F2Dmh14RgcvsAvpOyI3r7I (accessed 1.27.21).

- SimaPro, 2021. The Difference Between the ecoinvent 3.1 System Models [WWW Document]. SimaPro Help Cent. URL <https://support.simapro.com/articles/Article/The-Difference-Between-the-ecoinvent-3-1-System-Models> (accessed 9.15.21).
- SimaPro, 2018a. About SimaPro [WWW Document]. SimaPro. URL <https://simapro.com/about/> (accessed 7.9.18).
- Stroosnijder, L., Mansinho, M.I., Palese, A.M., 2008. OLIVERO: The project analysing the future of olive production systems on sloping land in the Mediterranean basin. *J. Environ. Manage.* 89, 75–85. <https://doi.org/10.1016/j.jenvman.2007.05.025>
- The Difference Between the ecoinvent 3.1 System Models [WWW Document], 2018b. . SimaPro Help Cent. URL <https://support.simapro.com/articles/Article/The-Difference-Between-the-ecoinvent-3-1-System-Models> (accessed 7.8.18).
- Tsarouhas, P., Achillas, C., Aidonis, D., Folinas, D., Maslis, V., 2015. Life Cycle Assessment of olive oil production in Greece. *J. Clean. Prod.* 93, 75–83. <https://doi.org/10.1016/j.jclepro.2015.01.042>
- US EPA, O., 2018. Carbon Dioxide Emissions Associated with Bioenergy and Other Biogenic Sources [WWW Document]. URL [/climatechange/carbon-dioxide-emissions-associated-bioenergy-and-other-biogenic-sources](https://www.epa.gov/climatechange/carbon-dioxide-emissions-associated-bioenergy-and-other-biogenic-sources) (accessed 6.22.18).
- Vegetal-Based Chemistry Association, 2015. Practical Recommendations for the Environmental Assessment of Bio-based Chemicals [in french] [WWW Document]. Assoc. Chim. Végétal. URL <http://www.chimieduvegetal.com/actualites-de-lassociation/recommandations-pratiques-pour-levaluation-environnementale-des-produits-chimiques-dorigine-biosourcee/> (accessed 6.22.18).
- Vidal, A.M., 2019. Mejora de las características organolépticas, funcionales y nutricionales de aceites de oliva vírgenes (PhD Thesis).
- Weidema, B., Bauer, C., Hischer, R., Mutel, C., Nemecek, T., Reinhard, J., Vadenbo, C., Wernet, G., 2013. Overview and methodology. Data quality guideline for the ecoinvent database version 3.
- Weidema, B.P., 1998. Multi-user test of the data quality matrix for product life cycle inventory data. *Int. J. Life Cycle Assess.* 3, 259–265. <https://doi.org/10.1007/BF02979832>
- Weidema, B.P., Wesnæs, M.S., 1996. Data quality management for life cycle inventories—an example of using data quality indicators. *J. Clean. Prod.* 4, 167–174. [https://doi.org/10.1016/S0959-6526\(96\)00043-1](https://doi.org/10.1016/S0959-6526(96)00043-1)



CHAPTER II

LIFE CYCLE INVENTORY AND LIFE CYCLE IMPACT ASSESSMENT OF OLIVE OIL PRODUCTION IN FRANCE

II.1 Introduction

Despite the economic importance of this food product in many countries, the production of olive oil is associated with several negative environmental effects that cause resource depletion, land degradation, air emissions, and waste generation (Salomone et al., 2015). The impacts can vary considerably due to the practices and techniques employed in olive growing and olive oil production.

The olive oil sector, like any economic sector, must now ensure its sustainability.

An article's publication made in the light of the state-of-the-art for this PhD thesis (Espadas-Aldana et al., 2019) has identified 23 relevant LCA studies of olive oil or olive cultivation for olive oil production (see Chapter I, section I.3. State-of-the-art: Olive oil Life Cycle Assessment). Analysis of the literature converged towards an unequivocal environmental hotspot, the agricultural upstream, which represents the phase responsible for the most impactful part of the olive oil life cycle. The management and distribution of waste also represented a crucial problem.

As agriculture has been identified as a hotspot, the objective of this second chapter is to compare the environmental assessment of the production of olive oil from orchards and mills in the South of France, this from a linear perspective, or Business-As-Usual (BAU) scenarios.

- Eleven scenarios of the agricultural upstream part, with the 2-phase extraction technology, were elaborated.
- Data on olive cultivation were collected in 2014 with the help of the Centre Technique de l'Olivier (CTO, France). They come from eleven different orchards in the south of France for the agricultural part.
- Concerning the processing part, the data are from seven mills located in the same geographical area.
- The function is to produce virgin or extra virgin olive oil, so its functional unit (FU) is to "produce a litre of virgin olive oil" from cradle to grave.
- The system scenarios were developed and analysed using SimaPro PhD 9.1.1.1 software and ecoinvent 3.6.

II.2 Methodology: Life Cycle Assessment

As explained in Chapter I.2 Life Cycle Assessment methodology, an LCA is carried out in four phases according to the ISO standards (ISO, 2006a, 2006b) and SETAC definition. These four phases are detailed below.

II.2.1 Goal & scope definition

II.2.1.1 Goal definition

The goal is to study a specific agro-industrial system: the French olive growing and the production of virgin olive oil (virgin or extra virgin) in a linear scenario Business-As-Usual (BAU). In order to compare it to a circular production system (to be seen in Chapter III) that recovers its wastes from a Circular Economy (CE) point of view. All this with the aim of aware the discussion of how LCA can support a transition to a CE.

II.2.1.2 Scope definition

The agro-industrial system studied in this work is French olive growing and the production of virgin/extra virgin olive oil (VOO/EVOO). Its function is to produce VOO or EVOO, so its functional unit (FU) is to "produce one litre of virgin/extra virgin olive oil" from cradle to grave, using the attributional approach.

For this type of system, the analysis of the literature for cradle-to-grave LCAs (see Chapter I.3. State-of-the-art: Olive oil Life Cycle Assessment, section I.3.3.1 Functional Unit (FU)) has shown that a FU based on a quantity of olives intended for oil production makes it possible to free oneself from certain constraints related to the definition of the quality of olive oil (Romero-Gómez et al., 2017; Salomone and Ioppolo, 2012). Moreover, the main interest in choosing a functional unit oriented to olive quantity rather than oil quantity is based on the great organoleptic variability of the different olive oils that can be extracted throughout the life cycle of the system: extra virgin, virgin, lampante, pomace, refined, etc. As a result, unfounded comparisons may lead to erroneous conclusions. However, given that the harvest in France is very short (September to January) and that the function of the system is to produce oil that is sold by the litre. The functional unit of this work is to produce one litre of virgin/extra virgin oil. It should be noted that neither oil quality nor waste quality is included in the environmental assessments analysed.

To understand the scope of the study (system limitations), it is necessary to have a general idea of the olive oil life cycle. The life cycle of the olive oil production system is based on an ancestral process that is generally divided into seven main phases: olive cultivation –or agricultural phase– (in the orchard), oil production (at the mill), packaging, distribution –transport– of the product, use (consumption), end of life (EOL) of the bottles, and management of solid residues (pomace) and liquid effluent (water and wastewater). **Figure II-1** presents the process tree with the mentioned seven main phases.

In addition, there are a significant number of cultural practices and techniques for the production of olives. To begin with, the type of cultivation can be according to the principles of

organic or conventional agriculture; olive growing with or without irrigation; manual or mechanized olive harvesting, or even marginal (in mountainous regions); and the type of farming can be classified as traditional (density between 90 and 100 trees per hectare), intensive (between 300 and 650 trees per hectare) or superintensive (over 1000 trees per hectare) (IOC, 2021a).

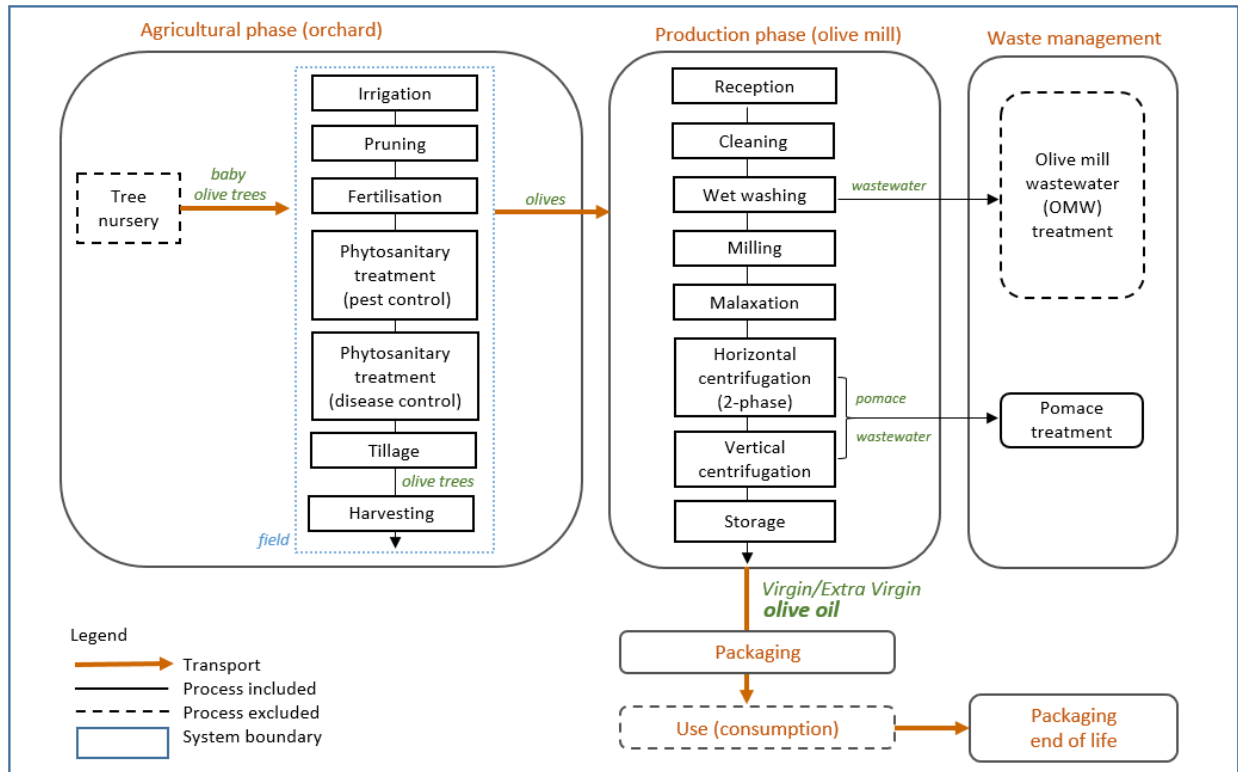

Figure II-1. Process tree (block diagram) of the olive oil production in France.

Concerning the oil extraction phase, there are two different techniques: the discontinuous press system process and the continuous centrifugal process (see Chapter I, I.1 Presentation of the olive oil sector, section I.1.4.2 Olive oil extraction).

The choice of extraction technology induces the production of pomace, margins, and wastewater with different physicochemical and biological properties, which will influence the choice of treatment and, consequently, the related impacts. The "simplest" wastes to be treated are those resulting from the 2-phase system because this system allows the separation of the oil from the olive paste without a big addition of water, which leads to the elimination of the problem of the olive mill wastewater (OMW) (Salomone et al., 2015). OMW is the aqueous residue with a high organic matter content resulting from the extraction by a 3-phase system and remains very difficult to treat.

The system boundaries considered all direct and indirect activities involved in the production of EVOO and include five of the seven phases: agricultural cultivation (at orchard), olive oil production (at the olive mill), packaging, packaging EOL, and mill waste treatment.

Despite the information obtained, there were limitations in the data collection due to the lack of reliable data or its low representativeness (assumed to be negligible). For these reasons, it was considered suitable to make assumptions in the following phases:

- tree nursery (plant breeding and tree planting in the agricultural phase): this process has been omitted (1) due to the lack of reliable data. Also (2), the Mediterranean region of France has traditional cultivation of old trees and most of the trees are centenary. The average life span of olive trees is typically more than 100 years, often reaching several hundreds of years in a productive state (Pattara et al., 2016).
- transportation phase: since distribution remains a complex and extremely variable transport phase from one mill to another and from one year to another. The distribution phase is simplified by considering that the consumer comes directly to the mill to buy the olive oil, as the consumption of French olive oil in France remains local because France does little foreign trade in olive oil (IOC, 2021b). On the other hand, the impacts on a single scenario would be very low given the small distances.
- use phase of olive oil (consumption): because is certainly not significant from a life cycle perspective, considering that the product consumption does not need further preparation or treatments since most of the EVOO is for human consumption in its raw state. The number of people who fry their food with this product is minimal due to its high economic value. So, the use of olive oil in households was assumed to be negligible.

Scenarios:

In order to compare the results of an LCA of olive oil production in the south of France, eleven scenarios (of which there are six different configurations), within the 2-phase system as extraction technology, were developed.

The code for naming the scenarios is "SX-YYY", S for the first letter of the word "scenario" and X the number between 1 and 11 for each of the eleven scenarios. Then, a dash is followed by the first letter for the type of agriculture (Conventional or Organic), the second letter for the type of farming (Traditional or Intensive), and the third letter indicating whether or not it has an irrigation system (Irrigated or Dry). In some Tables, only "SX" will be marked for simplicity. **Table II-1** shows the detailed characteristics of the eleven scenarios studied in this PhD work. Following the naming code, the first five (S1 to S5 CTI) are according to the principle of Conventional agriculture with Traditional intensity of olive growing and Irrigation system. The next two scenarios (S6 and S7 CTD) are for Conventional, Traditional without Irrigation system -hence, a Dry system-. And, the last four scenarios stand for different types: S8-CII for Conventional, Intensive, Irrigated; S9-CID for Conventional, Intensive, Dry; S10-OTI for Organic, Traditional, Irrigated; and S11-OTD stands for Organic, Traditional, Dry.

Table II-1. Detailed characteristics of the eleven scenarios.

Characteristics	Unit	S1-CTI	S2-CTI	S3-CTI	S4-CTI	S5-CTI	S6-CTD	S7-CTD	S8-CII	S9-CID	S10-OTI	S11-OTD
Cultivation surface	ha	2.5	4.5	1.15	20	5	1.71	5	15	0.4	6	15
Number of trees per ha	trees/ha	100	200	285	250	287	285	220	380	330	285	200
Olive yield per ha	t/ha/year	1.30	1.24	2.70	4.00	4.30	2.34	1.78	5.25	1.90	4.50	1.55
Cultivation methods	O or C	C	C	C	C	C	C	C	C	C	O	O
Intensity of production	Trad/Int	Trad	Trad	Trad	Trad	Trad	Trad	Trad	Int	Int	Trad	Trad
Irrigation	I or D	I	I	I	I	I	D	D	I	D	I	D
Productivity	t of olives/year	3.25	5.57	3.11	80.00	21.50	4.00	8.90	78.75	0.76	27.00	23.25
Olive oil yield per olives processed	L/kg	0.22	0.24	0.21	0.21	0.26	0.22	0.18	0.21	0.20	0.20	0.22
Quantity of olive oil	L/ha/year	286.00	300.59	561.60	824.00	1100.80	503.10	325.74	1081.50	378.10	882.00	334.80
Selling price of olive oil	€/L	12.00	12.00	11.00	7.90	7.64	11.00	16.00	7.90	7.90	4.38	21.00
Tractor power	hp ⁽¹⁾	11	50	37	75	60	37	60	75	75	80	60
	kW	8.09	36.77	27.21	55.16	44.13	27.21	44.13	55.16	55.16	58.84	44.13
Tractor consumption (diesel) ⁽²⁾	L/h	1.30	6.00	4.50	9.00	7.20	4.44	7.20	9.00	9.00	9.60	7.20
Year of plantation	years	-	1998	-	1998	1956	-	1996	1995	1997	1986	1995

⁽¹⁾ The metric horsepower (hp metric) is called "*cheval vapeur (CV)*" in French. It is a very old unit of measurement of power that is still widely used today to express the power of a motor. 1 hp metric = 0.735498 kW.

⁽²⁾ The fuel consumption varies according to the power of the tractor. The horsepower is multiplied by 0.12 to determine the hourly consumption. Tractor consumption (diesel) = hp * 0.12 (Seecar, n.d.).

II.2.2 Life cycle inventory analysis

II.2.2.1 Provenance and representativeness

The olive growing system data -foreground data- were collected in 2014 with the help of the Olive Tree Technical Center (CTO, France). It was originally collected for the OiLCA project. The OiLCA project was funded by the Interreg IV B SUDOE communitarian initiative. It aimed to improve the competitiveness of the olive sector in the south-western Europe region, which includes Spain, Portugal, and the South of France, known as SUDOE space (OiLCA, 2011). One report of Espi et al. (2013) on the LCA of olive oil production and an international conference proceeding (Busset et al., 2015) resulted from the OiLCA project.

II.2.2.1.1 Agricultural phase

The data come from eleven different orchards for the agricultural part. Eleven case studies specific to olive growing in the south of France were obtained. The choice of French olive oil producers was guided by the three options chosen to construct the scenarios: Conventional/Organic, Irrigated/Dry, and Traditional/Intensive. In order to assess the representativeness of the data used, **Figure II-2** shows the national statistics (full colour) (Leverge, 2011) of the different options compared to those of the case studies (shaded). The distribution of the cases studied according to the type of agriculture is faithful to the national distribution with a precision of a few percentages (3%). The other two characteristics still respect the majority/minority ratio. The representativeness of the scenarios is therefore confirmed.

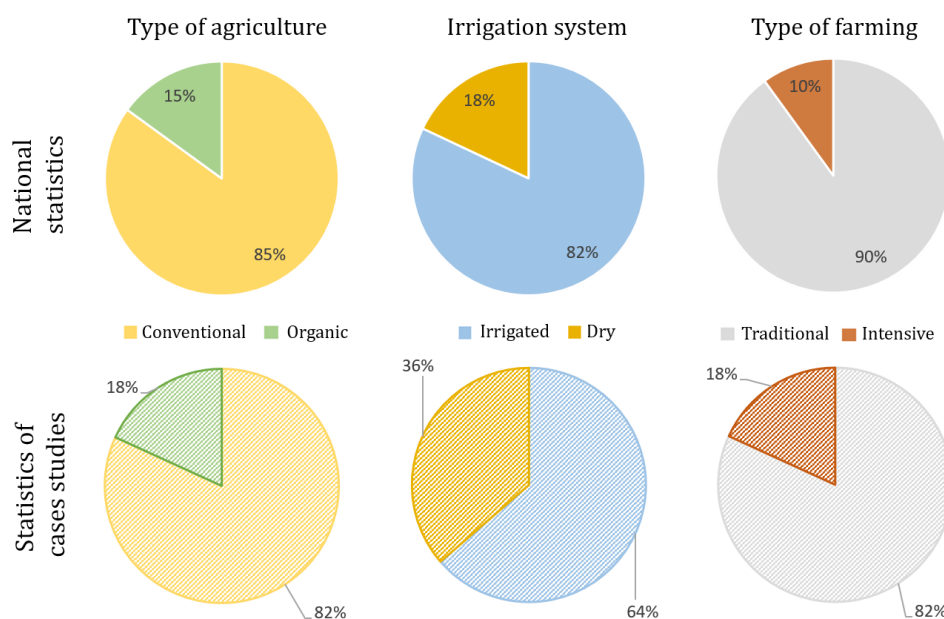

Figure II-2. Statistics on olive growing practices in France.

II.2.2.1.1 Production phase

For the processing part, it comes from seven mills located in the same geographical area within the two-phase system as extraction technology. French national statistics (Leverge, 2011) show that this technique is the most widely used (54%) among the olive oil mills for the extraction

of olive oil (**Figure II-3**). More information of the two-phase extraction can be found in chapter I, section I.1.4.2 Olive oil extraction.

Furthermore, it is worth noting that the two-phase olive oil extraction method is the most widely used in the world today. Almost 95% of the mills in Andalusia (the largest producer in Spain, and therefore, in the world) use this type of extraction (Fernández-Lobato et al., 2021a).

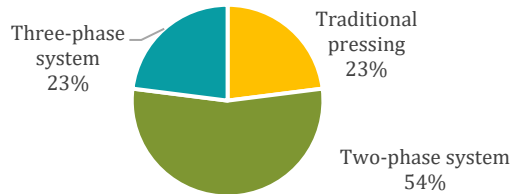

Figure II-3. Statistics on olive oil extraction techniques used in France, national statistics (n=243).

II.2.2.2 Inventory data

The background system was the ecoinvent 3.6 database with the Recycled Content System Model (Allocation, cut-off by classification). The ecoinvent database has the infrastructure and its operation modelled on three levels (**Figure II-4**). Following Nemecek and Kägi (2007) in the ecoinvent report No. 15 Life Cycle Inventories of Agricultural Production Systems, these three levels are convenient due to the various ways of using the infrastructure. This modular representation offers maximum flexibility in the use of these modules.

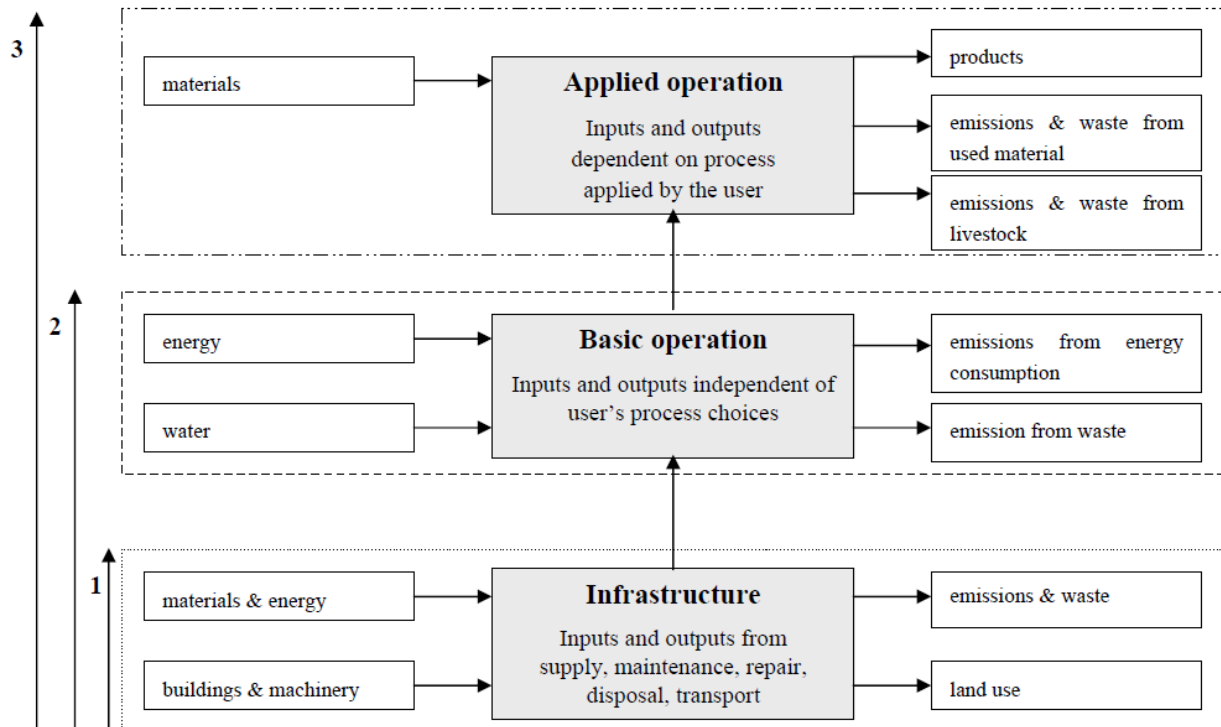

Figure II-4. Modelling of infrastructure and its operation in ecoinvent data (Nemecek and Kägi, 2007).

These three levels of modelling are important to explain and understand because in the same way that ecoinvent is constructed is how the specific processes for this thesis were also developed. Throughout this LCI section, these levels will be mentioned from now on.

Level 1: Infrastructure

The infrastructure modules (buildings and machinery) include the construction and production of the infrastructure unit, as well as transportation (raw materials machinery), maintenance, repair and final disposal.

In the case of the agricultural machinery storage shed, the main assumptions are:

- The total area of the shed: 264 m²
- Lifetime: 50 years
- FU: 1 m²

In the case of agricultural machinery, the FU is 1 kg of the machine throughout its life cycle. The use of this module requires therefore to know the amount of the machine (AM) needed for a specific process or working unit (WU). This was calculated (eq. 1) by multiplying the weight of the machinery by the operation time (how long the machinery is used for the process) and dividing the result by the lifetime of the machinery. For the tractor, diesel consumption and combustion emissions are taken into account in level 2.

$$AM [kg/WU] = Weight [kg] * \frac{Operation\ time [h/WU]}{Lifetime [h]} \quad (eq. 1)$$

For example, in the S2-CTI scenario, a 2500-kg tractor used for 1-hour field work was calculated as follows: 2500 [kg] * 1 [h/WU] / 7200 [h] = 0.35 [kg/WU] of module "tractors, production".

Level 2: Basic operation

The basic operation modules include the inputs and outputs independent of the user's choices, as well as the infrastructure used (level 1). It is a unitary operation performed in the field in order to carry out a crop (ploughing, fertilisation, phytosanitary treatment, ...).

This level of modelling includes:

- mobilisation of infrastructures modelled in level 1
- fuel consumption
- combustion emissions
- heavy metal emissions related to tyre abrasion

On the other hand, it does not contain the consumption of agricultural inputs (fertilisers, pesticides) and the associated emissions, which are highly variable and calculated in a specific way in level 3.

For example, the module "fertilising, by broadcaster", includes the amount of infrastructure used (tractor, fertiliser spreader and shed) as well as the fuel input and emissions related to the use of the tractor (exhaust gases, tyre wear). Since the module can be used for a variety of different fertilisers, the fertiliser itself and all emissions related to spreading the fertiliser on the field (e.g. emissions containing N and P, heavy metals contained in fertilisers) are not included in this module.

➤ **Fuel Consumption.**

Data on mean fuel consumption (mFC) by an agricultural work process was measured on-site for various agricultural work processes (Nemecek and Kägi, 2007). For the specific case of this thesis, mFC was calculated (eq. 2) as explained in **Table II-1**. The fuel consumption varies according to the power of the tractor. The horsepower is multiplied by 0.12 to determine the hourly consumption (Seecar, n.d.).

$$\text{mFC [Tractor consumption (diesel)] [L/h]} = \text{hp} * 0.12 \text{ [L/h]} \quad (\text{eq. 2})$$

By multiplying the values given in litres per hour by the duration per working unit of the fieldwork process (= operation time of the machinery) and the specific weight of diesel (0.84 kg/L), the fuel consumption (FC) for the fieldwork in question was obtained (eq. 3).

$$\text{FC [kg/WU]} = \text{mFC [L/h]} * \text{operation time [h/WU]} * \delta_{\text{Diesel}} \text{ [kg/L]} \quad (\text{eq. 3})$$

➤ **HC-, NO_x- and CO emissions from Combustion**

The amount of exhaust gas produced by a diesel engine depends on engine speed and power. These variables change constantly during the practical application, which is why a specific work process must be characterized by a load spectrum. A load spectrum is a mathematical matrix showing how long the engine works at a determined speed and a given power demand (Rinaldi and Stadler, 2002).

The amount of the three waste gases (WGs) HC²⁰, NO_x, and CO is given in grams per hour, so the amount per working unit was calculated very similarly to the fuel consumption. The value of reference (WG_{reference}) was multiplied by the duration of the fieldwork.

$$\text{WG [g/WU]} = \text{WG}_{\text{reference}} \text{ [g/h]} * \text{operation time [h/WU]} \quad (\text{eq. 4})$$

The values for HC-, NO_x- and CO emissions per hour are reported in **Table B.1** in **Appendix B**.

Substances and emission factors for other air emissions than HC, CO, and NO_x are listed in **Table B.2** in **Appendix B**; the values for petrol are given for the motor mower.

The output of these other waste gases (WG) was calculated by multiplying the fuel consumption (eq. 3 and **Table B.1** in **Appendix B**) of the work process by the emission factor (EF) listed in **Table B.2** in **Appendix B**.

$$\text{WG [g/WU]} = \text{FC [kg}_{\text{fuel}}/\text{WU]} * \text{EF [gWG/ kg}_{\text{fuel}}/\text{l]} \quad (\text{eq. 5})$$

For particulate matter, only those particles with a diameter of less than 2.5 μm (PM_{2.5}) were inventoried. The emission factor for PM_{2.5} was calculated with eq. 6 from SAEFL (2000). For diesel, the values are A = 7.25 and B = 3.62, whereas for petrol the values are A = 2.23 and B = -3.9.

$$\text{EF}_{\text{PM}_{2.5}} \text{ [g/kg}_{\text{fuel}}] = \text{A [g}_{\text{PM}}/\text{kg}_{\text{fuel}}/]} - \text{B [g}_{\text{PM}}/(\text{kg}_{\text{fuel}}/ * \text{kW})] * \text{nominal power}^{0.1} \text{ [kW]} \quad (\text{eq. 6})$$

The output of PM_{2.5} was obtained by multiplying the emission factor from eq. 6 by a correction factor (CF), by the mean power (MP) of the tractor during the fieldwork, by the time taken by the fieldwork.

$$\text{PM}_{2.5} \text{ [g/WU]} = \text{EF}_{\text{PM}_{2.5}} \text{ [g}_{\text{PM}}/\text{kg}_{\text{fuel}}] * \text{CF [kg}_{\text{fuel}}/\text{kWh}] * \text{MP [kW]} * \text{operation time [h/WU]} \quad (\text{eq. 7})$$

The correction factor is needed in order to adapt the data given for the reference year 1990 to the year for which the calculation is made. The value of the correction factor for the year 2002 is 0.854 for diesel and 0.75 for petrol (SAEFL 2000). For operation time and nominal and mean power, see **Table B.1** in **Appendix B**.

➤ **Soil emissions from tyre abrasion**

The heavy-metal emissions (HM) from tyre abrasion were calculated bearing in mind the number of tyre sets used during the lifetime of the machinery. The number of tyre sets needed is obtained by dividing the lifetime of the machinery (LT_m) by the lifetime of one tyre set (LT_t ; **Appendix B, Table B.3**). Multiplying this value by the weight of one set of tyres (per one kilogram of machinery; **Appendix B, Table B.3**), and the amount of tyre rubbed off (RO; **Appendix B, Table B.3**) gives the amount of synthetic rubber from tyre abrasion for one kilogram of agricultural machinery during the machinery's entire lifetime. Hence, to calculate the emission from one field-work process, the amount of synthetic rubber is multiplied by the heavy-metal content ($HM_{content}$) and by the calculated amount of agricultural machinery (AM; eq. 1).

$$HM [g/WU] = (LT_m [h]/LT_t [h]) * Weight [kg_{tyres}/kg_{machinery}] * RO [kg_{rubber}/kg_{tyres}] * HM_{content} [g_{HM}/kg_{rubber}] * AM [kg_{machinery}/WU] \quad (eq. 8)$$

Table II-2 reports all the level 2 basic operations that were prepared in excel and that were necessary for the modelling in SimaPro of the eleven scenarios. Complete dataset details are available in **Appendix B; Table B.4 - Table B.24**.

Table II-2. Datasets created in SimaPro (level 2 basic operation).

Name	Appendix
Application of phytosanitary treatment, by field sprayer {FR} 37CV (1h ha)	B.4
Application of phytosanitary treatment, by field sprayer {FR} 50CV (1h ha)	B.5
Application of phytosanitary treatment, by field sprayer {FR} 60CV (1h ha)	B.6
Application of phytosanitary treatment, by field sprayer {FR} 75CV (1h ha)	B.7
Application of phytosanitary treatment, by field sprayer {FR} 80CV (1h ha)	B.8
Application of plant protection product, by spray wheelbarrow	B.9
Fertilising, by broadcaster {FR} 11CV (1h 1ha)	B.10
Fertilising, by broadcaster {FR} 37CV (1h 1ha)	B.11
Fertilising, by broadcaster {FR} 50CV (1h 1ha)	B.12
Fertilising, by broadcaster {FR} 60CV (1h 1ha)	B.13
Fertilising, by broadcaster {FR} 75CV (1h 1ha)	B.14
Fertilising, by broadcaster {FR} 80CV (1h 1ha)	B.15
Pruning, by chainsaw (1h/ha)	B.16
Pruning, with crusher {FR} 50CV (1h 1ha)	B.17
Pruning, with crusher {FR} 60CV (1h 1ha)	B.18
Pruning, with crusher {FR} 75CV (1h 1ha)	B.19
Pruning, with crusher {FR} 80CV (1h 1ha)	B.20
Tillage by brushcutter (1h/ha)	B.21
Tillage, by tractor and rotary cultivator {FR} 37CV (1h 1ha)	B.22
Tillage, by tractor and rotary cultivator {FR} 60CV (1h 1ha)	B.23
Tillage, by tractor and rotary cultivator {FR} 75CV (1h 1ha)	B.24

Level 3: Applied operation

The applied operation includes all inputs and outputs related to an operation, which are dependent on user choices as well as on the infrastructure used (level 1) and the basic operation (level 2) (Nemecek and Kägi, 2007). The purpose of this level of modelling is to describe an agricultural production cycle.

These data should include:

- the technical itinerary
- the consumption of fertilisers and pesticides
- the occupation/transformation of space
- CO₂ and energy capture
- possible crop processing operations
- emissions in the field

The following is a description of the inventory data collection related to the agricultural phase (II.2.2.2a Inventory data: agricultural phase), the olive oil extraction (II.2.2.2b Inventory data: production phase) and the different phases of the olive oil life cycle (II.2.2.2c Inventory data: packaging, waste management and packaging end-of-life). It also shows how was modelled these data in SimaPro (**Appendix C**).

II.2.2.2a Inventory data: agricultural phase

II.2.2.2a.1 Irrigation

Olive growing can be done with or without irrigation. When we talk about a system without irrigation, we are talking about a dry system, although it receives rainwater. In the case of a scenario with an irrigation system, this is done using water from the French water network and it can follow two types of sub-systems:

- Sprinkler irrigation. A method of applying irrigation water that is intended to simulate natural rainfall. Water is distributed through a system of pipes, which is sprayed into the air by sprinklers so that it breaks into small water droplets that fall to the ground. Scenarios S1-CTI, S4-CTI, S5-CTI, and S8-CII use this type of irrigation system.
- Drip irrigation, also known as drop by drop irrigation, functions as its name implies. Drop by drop, water is distributed directly to the active root zone of olive trees, minimizing evaporation. Scenarios S2-CTI, S3-CTI, and S10-OTI use this type of irrigation system.

The inventory data for both irrigation systems of the eleven scenarios of the French case studies are reported in **Table II-3**.

Table II-4 further shows the background data for both irrigation systems. That is, it lists which datasets were chosen from ecoinvent 3.6.

Table II-3. Life cycle inventory of irrigation systems of cases studied in France.

Sub-Process	Unit	S1	S2	S3	S4	S5	S6	S7	S8	S9	S10	S11
Sprinkler	m ³ /ha/year	600	-	-	1350	800	-	-	1350	-	-	-
Drip	m ³ /ha/year	-	220	800	-	-	-	-	-	-	1200	0

Table II-4. Background data for the irrigation systems of cases studied in France.

Sub-Process	Input from technosphere (ecoinvent 3.6)	Unit
Sprinkler	Irrigation {FR} irrigation, sprinkler Cut-off, U	m ³
Drip	Irrigation {FR} irrigation, drip Cut-off, U	m ³

II.2.2.2a.2 Pruning

The olive tree grows naturally in a ball with very dense foliage. The foliage density leads to disease development. The olive tree is and, the top of the tree is the most lit the olive tree grows naturally upwards.

Pruning the olive tree is necessary because the olive tree grows naturally upwards, as it is very sensitive to light. The objective of pruning is to control the height and size of the tree mainly according to the possibility of harvesting. This technique also allows the light to enter the canopy while avoiding the sunburns on the horns of the carpenters and, it allows the ventilation of the foliage. Pruning is done after the risk of severe cold and until June. It should preferably be done annually. In the case of this study, pruning is done manually every two years with the help of scissors, electric pruning shears, and a shredder. Also in several scenarios, the use of the tractor with a crusher was necessary. The LCI for the pruning operation of the case studies is shown in **Table II-5**.

Table II-5. Life cycle inventory of the pruning operation of cases studied in France.

Input	Unit	S1	S2	S3	S4	S5	S6	S7	S8	S9	S10	S11
Tractor + crusher	h/ha/year	-	2	-	2	2	-	-	2	-	3	6
Diesel	L/ha/year	-	12	-	18	14.4	-	-	18	40.5	28.8	43.2
Chainsaw	h/ha/year	-	-	48	-	-	46	-	-	-	25	-
Shredder	h/ha/year	-	-	-	2	-	-	2	2	-	-	6
Electric pruning shears	h/ha/year	-	-	-	-	77	-	18	-	21	9	-

For the modelling of the basic operation of the use of the tractor with a crusher, four “Pruning, with crusher ...” datasets were created (**Table II-6**) to adapt each scenario in terms of the amount of tractor (Tractor, 4-wheel, agricultural {GLO}| market for | Cut-off, U), fuel consumption (Agricultural machinery, unspecified {GLO}| market for | Cut-off, U) and linked emissions of combustion. These created datasets were adapted from <Tillage, rotary cultivator {CH}| processing | Cut-off, U > following the ecoinvent report No. 15 Life Cycle Inventories of Agricultural Production Systems (Nemecek and Kägi, 2007). For example, the new dataset of “Pruning, with crusher {FR}| 50CV (1h 1ha)” is for France at 1h/ha, tractor (2500 kg, nominal power 50 CV or 36,78 kW) and, fuel consumption (FC) of 6 L/h instead of 1.5h/FU, 3000 kg, 50 kW and 4.2 L/h of FC.

For the modelling of the basic operation of the pruning with a chainsaw, the ecoinvent dataset “Power sawing, without catalytic converter {RER}| processing | Cut-off, U” was adapted to create the new dataset “Pruning, by chainsaw (1h/ha)” (**Table II-6**). The professional power saw from ecoinvent weighs about 7 kg with an FC of 1.6 kg of standard two-stroke petrol blend (0.75 kg/l) for power saws per working hour and with a power output of about 3.1 - 3.2 kW

(Ecoinvent, 2021). The basic operation created was for the STIHL MS 150 TC chainsaw with the characteristics of 1.0 kW at 10000 rpm, the weight of 2.6 kg, FC of 0.3 L/h, and a lifespan of 2500 h.

Complete dataset details are available in **Appendix B; Table B.16 - Table B.20**, as indicated in the level 2 explanation of this main section “II.2.2 Life cycle inventory analysis”.

Table II-6. Created datasets for the pruning operation of cases studied in France.

For scenario	The created dataset used for the pruning operation at level 2
S3-CTI, S6-CTD, S10-OTI	Pruning, by chainsaw (1h/ha)
S2-CTI	Pruning, with crusher {FR} 50CV (1h/ha)
S5-CTI, S11-OTD	Pruning, with crusher {FR} 60CV (1h/ha)
S4-CTI, S8-CII, S9-CID	Pruning, with crusher {FR} 75CV (1h/ha)
S10-OTI	Pruning, with crusher {FR} 80CV (1h/ha)

II.2.2.2a.3 Fertilisation

A large variety of fertilisers are applied by olive growers to improve olive yields. They can be poured directly into the soil by a fertiliser spreader. They are mainly based on phosphorus, nitrogen, and potassium. However, there are some products based on other compounds, such as ammonium sulfate, borax, zinc sulfate, and even compost from agricultural residues such as sheep manure (in S5-CTI) and grape pomace distillation (S11-OTD). They have been quantified in the survey and collected in the agricultural phase-field inventory (**Table II-7**).

Table II-7. Life cycle inventory of the fertilisation operation of cases studied in France.

Input	Unit/ha/year	S1	S2	S3	S4	S5	S6	S7	S8	S9	S10	S11
Ammonium sulfate 21% N	kg	-	100	-	-	-	-	-	-	-	-	-
NPK 1	kg	300	150	200	700	600	200	400	700	700	700	300
Nitrogen (N)	kg	54	18	0	91	66	0	40	91	91	42	24
Phosphorus (P)	kg	138	18	20	56	48	20	12	56	56	14	33
Potassium (K)	kg	0	25.5	50	126	90	50	12	126	126	84	0
NPK 2	kg	150	-	200			200	300	-	-	-	100
Nitrogen (N)	kg	0	-	36	-	-	36	12	-	-	-	0
Phosphorus (P)	kg	0	-	92	-	-	92	48	-	-	-	0
Potassium (K)	kg	45	-	0	-	-	0	48	-	-	-	30
Sodium boron (Solubor 17,5%)	kg	-	-	2.4	3	3	2.4	-	3	3	-	3
Agrocéan boron at 5% B and 5,5% MgO	L	0	2	-	-	-	-	-	-	-	-	-
Zinc Sulfate (Zn)	kg	0.03	-	2.04	-	-	2.04	-	-	-	-	-
Boron (B)	kg	-	-	-	-	-	-	-	-	-	-	0.525
Compost	kg	-	-	-	-	5000	-	-	-	-	-	1100
Nitrogen (N)	kg	-	-	-	-	33.5	-	-	-	-	-	15.4
Phosphorus (P)	kg	-	-	-	-	20	-	-	-	-	-	9.9
Potassium (K)	kg	-	-	-	-	60	-	-	-	-	-	27.5
Tractor (total)	h	3.2	0.7	7	2.5	4.5	7	2.5	2.5	2.5	1	8.5

For the compost made of organic residues for S5-CTI and S11-OTD scenarios, sheep manure and grape pomace distillery were respectively used. **Table II-8** shows the compositional values used to calculate the NPK amounts. Since the sheep manure fertiliser dataset does not exist in the ecoinvent database, the cattle manure dataset was used as a proxy and the NPK amounts were adjusted. All the datasets used for the fertilisation can be found in **Table II-9**.

Table II-8. Compositional values of the two composts used as fertiliser.

Scenario	Type of product	Content/tonne of raw product			Reference
		Total N (kg/t)	P ₂ O ₅ (kg/t)	K ₂ O (kg/t)	
S5-CTI	Sheep manure	6,7	4	12	(Arvalis-Institut du végétal, 2015)
S11-OTD	Grape pomace distillery	14	9	25	(Gazeau, 2012)

Table II-9. Background data for the Fertilisation operation of cases studied in France.

Fertiliser	Input from technosphere (ecoinvent 3.6)	For scenario
Ammonium sulfate 21% N	Ammonium sulfate, as N {RER} ammonium sulfate production Cut-off, U	S2
Nitrogen (N)	Nitrogen fertiliser, as N {GLO} market for Cut-off, U	S1-S6, S8-S10
	Nitrogen fertiliser, as N {GLO} nutrient supply from manure, solid, cattle Cut-off, U	S5, S7
	Nitrogen fertiliser, as N {GLO} nutrient supply from poultry manure, dried Cut-off, U	S11
Phosphorus (P)	Phosphate fertiliser, as P2O5 {GLO} market for Cut-off, U	S1-S6, S8-S10
	Phosphate fertiliser, as P2O5 {GLO} nutrient supply from manure, solid, cattle Cut-off, U	S5, S7
	Phosphate fertiliser, as P2O5 {GLO} nutrient supply from poultry manure, dried Cut-off, U	S11
Potassium (K)	Potassium fertiliser, as K2O {GLO} market for Cut-off, U	S1-S6, S8-S10
	Potassium fertiliser, as K2O {GLO} nutrient supply from manure, solid, cattle Cut-off, U	S5, S7
Sodium borate (Solubor 17,5% B)	Sodium borates {GLO} market for Cut-off, U	S3-S6, S8, S3, S11
	Agrocéan @ at 5% B and 5,5% MgO	Sodium borates {GLO} market for Cut-off, U Magnesium oxide {GLO} market for Cut-off, U
Zinc Sulfate (Zn)	Zinc monosulfate {RER} production Cut-off, U	S1, S3, S6
Boron (B)	Sodium borates {GLO} market for Cut-off, U	S11

However, the application of mineral fertilisers is responsible for emissions of nitrous oxide (N₂O), ammonia (NH₃), and nitrogen oxides (NO_x) to the air, nitrates (NO₃⁻) and phosphates (PO₄³⁻) in water and soil. The molecules NH₃, NO_x, and PO₄³⁻ are particularly emitted during the spraying of mineral fertilisers, while N₂O and CH₄ molecules are generated more during the degradation of nitrogenous elements and organic matter. The calculation of the amount of these molecules emitted is based on different methodologies. For the calculations of the emissions to air (ammonia, dinitrogen monoxide, nitrogen oxides, carbon monoxide, methane, SO₂, NMVOC, and particulate matter) and emission of nitrate to groundwater, the IPCC Tier 1 Emission Factors (IPCC, 2006) was applied.

The ammonium (NH₄⁺) contained in fertilisers can easily be converted into NH₃ and released into the air. Ammonia contributes to acidification and the eutrophication of sensitive ecosystems. Its impact is mainly local and regional (Nemecek and Schenetzler, 2011).

Dinitrogen monoxide -or Nitrous oxide- (N₂O) is produced as an intermediate product in the denitrification process (conversion of NO₃⁻ into N₂) by soil micro-organisms. It can also be produced as a by-product in the nitrification process (conversion of NH₄⁺ into NO₃⁻). Direct and indirect (leaching) N₂O emissions [kg N₂O/ha] from synthetic and organic fertilisers and crop

residues burning were calculated based on the total nitrogen content (N_{tot} [kg N]). The factor of 1.0% N mislaid as N_2O direct was used. Induced emissions from nitrate (NO_3^-) with a factor of 0.75% of N in leached NO_3^- (Nemecek and Schenetzler, 2011). NO_3^- is either supplied to the soil by fertilisers or produced by micro-organisms in the soil via the mineralisation of organic matter. However, nitrate leaching to ground water is explained as “Nitrate in the soil can be absorbed as a nutrient by the plants. In periods of heavy rainfall, however, precipitation exceeds soil evaporation and transpiration of the plants, which leads initially to saturation of the soil with water, and afterwards to percolation to the ground water. As nitrate is easily dissolved in water, the risk of leaching is high” (Nemecek and Schenetzler, 2011). NO_x may also be produced during the denitrification processes in soils. These emissions were estimated from the emissions of N_2O : $NO_x = 0.21 * N_2O$. Carbon monoxide, methane, SO_2 , NMVOC, and particulate matter emissions are mainly associated to crop residue burning. In the case of the study scenarios, there was no burning of the prunings and waste.

A precalculation in Excel was done (**Appendix D**) to calculate the emissions to air and groundwater of each scenario and to be able to insert this information in the created datasets of the fertilisation phase of each scenario at level 3.

For the modelling of the basic operation of the use of the tractor for the fertilising purpose, six “Fertilising, by broadcaster {FR}| XX CV (1h 1ha)...” datasets were created, “XX” being the tractor power for each scenario. Complete dataset details are available in **Appendix B; Table B.10 - Table B.15**, as indicated in the level 2 explanation of this main section “II.2.2 Life cycle inventory analysis”.

II.2.2.2a.4 Phytosanitary treatment (pest control): herbicides, insecticides

A phytosanitary treatment (PT) is an official procedure for the killing, inactivation or removal of pests, or for rendering pests infertile or for devitalization (FAO, 2021). PTs may be single chemical or physical processes or may consist of two or more components (Hennessey et al., 2014). A pesticide is a chemical agent used to destroy or control pests. These chemicals can work by ingestion or by touch and death may occur immediately or over a long period. The generic term pesticides can apply to a wide spectrum of chemicals, including **insecticides** for use against harmful insects, rodenticides for killing rats, mice, etc., **herbicides** for weed control, **fungicides** for control of plant diseases, biocides for destroying harmful living organisms like bacteria, etc. (Horsak et al., 1964; US EPA, 2021). **Table II-10** shows the products used for the phytosanitary treatment of olive trees in the study cases of this thesis. These include herbicides and insecticides for pest control, as well as fungicides for disease control. The life cycle inventory of the phytosanitary treatment for pest control of cases studied in France is available in **Table II-11**. Disease control is treated separately in the next section (II.2.2.2a.5 Phytosanitary treatment (disease control): fungicides).

The insecticides and first fungicide from **Table II-10** cannot be found directly with their product names in the ecoinvent 3.6 database. Nevertheless, the background data to create these datasets could be done by drawing inspiration from the Agribalyse® methodology report version 1.2 (Koch and Salou, 2015).

Table II-10. Products for phytosanitary treatment and their use in olive groves.

Phytosanitary treatment	Product	Applied to treat
Pest control		
Herbicide	Glyphosate	Weeds
Insecticide	Dimethoate	Olive fly (<i>Bactrocera oleae</i>)
	Spinosad ^(OA)	
	Lambda-cyhalothrin (Karate Xpress, 5%) ^(OA)	
	Bacillus thuringiensis ^(OA)	Chenilles phytophages
Disease control		
Fungicide	Kresoxim-methyl (Strobi-DF)	Olive peacock spot (<i>Cyloconium oleaginum</i>)
	Copper oxide (Nordox 75WG, 75%) ^(OA)	
	Copper sulfate (<i>Bouille Bordelaise</i> , 20%) ^(OA)	

^(OA) Product compatible with French organic agriculture (E-Phy, 2021; France Olive, 2020).

Table II-11. Life cycle inventory of the phytosanitary treatment for pest control of cases studied in France.

Input	Unit/ha/year	S1	S2	S3	S4	S5	S6	S7	S8	S9	S10	S11
Glyphosate	L	-	-	25.0	2.60	-	25.0	1.30	2.60	2.60	-	-
Dimethoate	L	3.00	2.25	2.25	1.50	1.50	2.25	-	1.50	1.50	-	-
Spinosad ^(OA)	L	-	-	-	-	-	-	1.20	-	-	3.60	1.20
Lambda-cyhalothrin ^(OA) (Karate Xpress, 5%)	L	-	-	0.60	-	-	0.60	-	-	-	-	-
Bacillus thuringiensis ^(OA)	kg	-	-	-	-	-	-	-	-	-	1.00	-
Tractor (total)	h	10.0	2.10	4.50	2.00	3.00	4.50	0.50	2.00	2.00	6.00	2.00

^(OA) Product compatible with French organic agriculture (E-Phy, 2021; France Olive, 2020).

Agribalyse® is the French LCI database for the agriculture and food sector (Colomb et al., 2014). Most of the datasets used came from the ecoinvent database. However, as the ecoinvent database were not always applicable in France -or inexistent with the same product name-, inputs were modified, when possible, using existing LCI datasets. In this publication of version 1.2 of Agribalyse®, it is explained that the production and application of active substances in pesticides (herbicides, fungicides, insecticides) were considered for agricultural production from cradle to gate. These active substances are listed in Appendix G of their report (Koch and Salou, 2015) showing the assignment factor of its data collection module inputs to LCI datasets in ecoinvent v2.1. The ones relevant to this thesis are listed in **Table II-12**. It gives the assignment of data collection module inputs (first column) to ecoinvent LCI datasets (second column), their relation factor and density to make the adjustments.

All pesticides applied for olive cultivation were assumed to end up as emissions to the soil (100%), following the same hypothesis made in ecoinvent (Nemecek and Schenetzler, 2011). The amounts of pesticides used as inputs were thus calculated as outputs (emissions to soil, agricultural sub-compartment). For many active ingredients, there are no own LCIs, in these cases, the amounts of active ingredients are aggregated and inventoried by their chemical class, for which an LCI exists, as explained above in **Table II-12**. As emissions, though, the active ingredients appear under their specific name: glyphosate, dimethoate, spinosad, lambda-cyhalothrin, bacillus thuringiensis var. kurstaki, kresoxim-methyl, copper oxide, and copper sulfate.

Table II-12. Assignment of active substances as input from technosphere for the phytosanitary treatment of cases studied in France.

Created dataset	Input from technosphere (ecoinvent 3.6)	Relation	Density (g/cm ³)
Glyphosate	Glyphosate {RER} production Cut-off, U	kg to L	1.700
Dimethoate	Organophosphorus-compound, unspecified {RER} production Cut-off, U	kg to L	1.300
Spinosad ^(OA)	Pesticide, unspecified {RER} production Cut-off, U Insecticide, at plant/RER Mass (Agrifootprint as GB)	kg to L	0.512
Lambda-cyhalothrin ^(OA) (Karate Xpress, 5%)	Pyrethroid-compound {RER} production Cut-off, U	kg to L	0.470
Bacillus thuringiensis ^(OA)	Electricity, low voltage {FR} market for Cut-off, U	21 Kwh/kg	-
Kresoxim-methyl (Strobi-DF)	Dinitroaniline-compound {RER} production Cut-off, U	1:1	-
Copper oxide ^(OA) (Nordox 75WG, 75%)	Copper oxide {RER} production Cut-off, U	75%	-
Copper sulfate ^(OA) (Bouille Bordelaise, 20%)	Copper sulfate {GLO} production Cut-off, U	20%	-

^(OA) Product compatible with French organic agriculture (E-Phy, 2021; France Olive, 2020).

II.2.2a.5 Phytosanitary treatment (disease control): fungicides

Fungicides are substances used to kill fungi. They can be of biological or chemical origin and can be broadly classified into two major types: preventive or curative fungicides (Doble and Kumar, 2005).

- Preventive fungicides: substances that prevent fungal infections from occurring in a plant. They include compounds such as sulfur, dichlorocarbamates, organometallics, pthalimides, and benzimidazoles.
- Curative fungicides: substances that move to the place where the infection has occurred and prevent further development of the pathogen. They include compounds such as acetimidazoles, dicarboximidazoles, sterol inhibitors, and many others.

The most serious disease that affects the olive grove is the Olive peacock spot, bird's eyespot, or olive leaf spot (*Cycloconium oleaginum*). It receives this name for the comparison between the bird's eye spot produced on the leaf and the appearance of the peacock's feathers. Its damage and consequences are circular leaf spots, falling leaves, weakening of the tree, and has an important impact on the productivity of the olive tree (France Olive, 2020). This disease is treated with fungicides as kresoxim-methyl and copper oxide or copper sulfate as active ingredients (**Table II-10**).

The life cycle inventory of the phytosanitary treatment for disease control of cases studied in France is presented in **Table II-13**. As mentioned in the previous section, kresoxim-methyl fungicide was not available in the ecoinvent 3.6 database. Therefore, the background data was chosen and adapted following the Agribalyse® methodology (Koch and Salou, 2015) (see **Table II-12**). For the modelling of the basic operation "Application of phytosanitary treatment, by field sprayer {FR}| XX CV (1h ha)", six datasets were created, "XX" being the tractor power for each scenario. Complete dataset details are available in **Appendix B; Table B.4 - Table B.9**, as indicated in the level 2 explanation of this main section "II.2.2 Life cycle inventory analysis".

Table II-13. Life cycle inventory of the phytosanitary treatment for disease control of cases studied in France.

Input	Unit/ha/year	S1	S2	S3	S4	S5	S6	S7	S8	S9	S10	S11
Kresoxim-methyl (Strobi-DF)	kg	-	-	-	-	-	-	0.20	-	-	-	-
Copper oxide ^(OA) (Nordox 75WG, 75%)	kg	3.30	3.30	-	6.60	6.60	-	-	6.60	6.60	6.60	3.30
Copper sulfate ^(OA) (Bouille Bordelaise, 20%)	kg	-	-	37.5	-	-	37.5	12.5	-	-	-	-
Tractor (total)	h	2.40	0.70	4.50	3.00	3.00	4.50	1.50	3.00	3.00	3.00	2.00

^(OA) Product compatible with French organic agriculture (E-Phy, 2021; France Olive, 2020).

II.2.2.2a.6 Tillage

Soil tillage -also called Labor- consists of operations that involve mechanical pulverization of the soil to create favourable conditions for the growth of the crop. It includes the use of tractors and other agricultural machinery with their respective fuel consumption, to perform work in the field once a year. The defined tasks are harrowing and ploughing with a rotary cultivator.

Harrowing is done for breaking up and smoothing out the surface of the soil. In this way, it is distinct in its effect from the plough, which is used for deeper tillage to eliminate directly the weeds and to maintain the soil free of weeds until the harvest. Harrowing is often carried out on fields to follow the rough finish left by ploughing operations. The LCI for this agricultural phase is in the following **Table II-14**.

Table II-14. Life cycle inventory of tillage for the cases studied in France.

Input	Unit/ha/year	S1	S2	S3	S4	S5	S6	S7	S8	S9	S10	S11
Tractor	h	-	1.20	12.00	4.25	4.00	19.00	4.25	4.25	8.00	12	6.33
Diesel	L	-	7.20	54.00	38.25	28.80	85.50	30.60	38.25	72.00	115.2	45.58
Brushcutter	h	4.00	25.00	-	-	-	-	-	-	-	-	10.00
Gasoline	L	8.00	-	-	-	-	-	-	-	-	-	-
Water	m ³	-	-	0.60	-	-	0.60	-	-	-	-	-

It is worth mentioning that the application of the herbicide glyphosate is done at this stage. The LCI for glyphosate is shown in **Table II-11** (see section II.2.2.2a.4 Phytosanitary treatment (pest control): herbicides, insecticides). As well, for the modelling of the basic operation of tillage, four datasets were created. Complete dataset details are available in **Appendix B; Table B.21 - Table B.24**, as indicated in the Level 2 explanation of this main section “II.2.2 Life cycle inventory analysis”.

II.2.2.2a.7 Harvesting

The olive harvest is the culmination of a whole year of work. Harvesting can be carried out mechanically or manually. Most of the scenarios perform the harvesting by hand or with the help of comb pickers. **Table II-15** illustrates the LCI of this section. In the scenarios with mechanical harvesting (S5-CTI, S7-CTD, and S10-OTD), branch vibratos attached to the tractor were used. The electricity in scenarios S4-CTI, S8-CII, and S9-CID stands for the use of a homemade leaf stripper (20h, 20h, 4.5h respectively) with a capacity of 4 kW per hour. The gasoline and lube oil consumption of the branch vibratos and the harvesting infrastructure -HDPE boxes and PET nets- were also included.

Table II-15. Life cycle inventory of the harvesting operation of cases studied in France.

Input	Unit/ha/year	S1	S2	S3	S4	S5	S6	S7	S8	S9	S10	S11
Olives	kg	1300	1237	2700	4000	4300	2340	1780	5250	1900	4500	1550
Branch vibrators	L	-	-	-	-	23	-	23.5	-	-	37.5	-
Electricity	kWh	-	-	-	80	-	-	-	80	18	-	-
Human resource	h	80	80	209	100	93	225	47	100	84.5	150	60

II.2.2.2b Inventory data: production phase

After the agricultural phase, the olives are transported to the mill where the oil will be extracted. This phase is called the production phase and consists of eight parts: reception, cleaning, wet washing, milling, malaxation, horizontal centrifugation (2-phase), vertical centrifugation and storage. These have already been described in chapter I, section I.1.4.2 olive oil extraction.

Table II-16 shows the average used for the life cycle modelling of the eleven scenarios of the France case study. Details of each of the seven mills are available **Appendix E**.

Table II-16 Life cycle inventory of the production phase of cases studied in France (Level 3 applied operation).

Production phase steps	Input	Unit	Average/L olive oil
Reception	Propane	kg	2.80E-04
	Electricity	kWh	2.05E-03
Cleaning	Electricity	kWh	8.80E-03
	Soap	kg	3.58E-06
Wet washing	Electricity	kWh	8.12E-03
	Water	m ³	3.03E-03
	Sodium hydroxide	kg	7.17E-05
	Soap	kg	6.09E-05
	Lubricating oil	kg	7.17E-06
	Electricity	kWh	4.78E-02
Milling	Lubricating oil	kg	3.58E-06
	Electricity	kWh	2.97E-02
Malaxation	Lubricating oil	kg	3.58E-06
	Electricity	kWh	1.14E-01
Horizontal centrifugation (2-phase)	Electricity	kWh	2.50E-02
	Electricity	kWh	5.02E-05
Vertical centrifugation	Sodium hydroxide	kg	7.17E-06
	Lubricating oil	kg	1.19E-03
Storage	Electricity	kWh	2.69E-05
	Cotton	kg	

II.2.2.2c Inventory data: packaging, waste management and packaging end-of-life

II.2.2.2c.1 Packaging

After obtaining the olive oil, the next step is to bottle it. **Table II-17** displays the LCI of the dataset called “Filling bottles” (level 2). **Table II-18** shows the LCI of the packaging phase of cases studied in France (level 3) and contains the “Filling bottles” (level 2) and each of the containers used in proportion to one L of packaged olive oil (“p” stands for amount or “piece” in SimaPro modelling). The containers were modelled at level 1, each with its amount of material (glass, PE, PEHD, can) per piece.

Table II-17. Life cycle inventory of “Filling bottles” dataset for the packaging phase (level 2 basic operation).

Input	Unit/year	Average/L
Electricity	kWh	1.50E-03

Table II-18. Life cycle inventory of the packaging phase of cases studied in France (level 3 applied operation).

Input	p/L
Filling bottles	1
Glass bottle 50 mL	1.55E-02
Glass bottle 200 mL	4.32E-02
Glass bottle 250 mL	1.88E-02
Glass bottle 375 mL	3.58E-03
Glass bottle 500 mL	2.11E-01
Glass bottle 750 mL	1.29E-02
Food plastic bottle 3 L	3.69E-04
Food plastic bottle 5 L	1.16E-03
Food plastic bottle 10 L	9.07E-04
PEHD bottle 2 L	4.74E-03
PEHD bottle 3 L	7.66E-03
PEHD bottle 5 L	8.41E-03
PEHD bottle 220 L	1.43E-05
Can bottle 250 mL	1.38E-03
Can bottle 500 mL	1.29E-02
Can bottle 750 mL	1.43E-03
Can bottle 1 L	2.01E-03
Tetrapack bottle 1.5 L	1.57E-03
Tetrapack bottle 2 L	3.26E-02
Tetrapack bottle 3 L	8.71E-04

II.2.2.2c.2 Waste management

Concerning the waste management phase, there are two important by-products, the OMW and the OP (Chapter I, I.1.6 By-products of olive oil production). The regulation of olive oil by-products is not standardised and varies depending on the olive oil-producing country. In France, OMW and OP aren’t under strict regulations as is the case for Spain and Portugal. These wastes

are only under Regulation (EC) No. 889/2008 as "organic by-products of plant origin for fertiliser" (Mouton, 2012). The pomace and olive mill wastewater co-composted with carbonaceous support correspond, for the RCE n°889/2008, to a "composted or fermented mixture of vegetable matter: product obtained from mixtures of vegetable matter, subjected to composting or anaerobic fermentation with the aim of producing biogas". They are considered products that comply with the NF U 44-051 standard and can be used without a spreading plan (Mouton, 2012).

Different options exist for the treatment processes of OMW and OP. However, as the extraction system of the case studies is a two-phase system, it only deals with "wet OP" as waste. 100% is spread out. The spreading of the pomace is estimated at 4 tons per hour. The production of this waste is estimated at 4.4 kg OP/L olive oil (data from olive mill questionnaires). The dataset "Pomace spreading" was modelled at level 2 with "Agricultural spreading, by tractor (/1 yr)" at level 1. Only the use of the tractor for the agricultural spreading of olive pomace was considered.

II.2.2.2c.3 Packaging end-of-life

For the end-of-life (EOL) of the bottles, an average scenario per type of packaging was constructed (**Table II-19**). Each scenario establishes a proportion between the three possible EOL options: recycling, landfill, and incineration. The proportions are taken from French national statistics. These EOL scenarios were modelled at level 1 for "1p" of each packaging and the "End-of-life_bottles" (**Table II-20**) for 1 L of olive oil was modelled at level 3.

Table II-19. End-of-life scenarios for bottles (ADEME, 2013).

End-of-life scenario (ADEME, 2013)	Recycling	Landfill	Incineration	Total
Glass	68.1 %	31.9 %	0 %	100 %
Metal	63.3 %	36.7 %	0 %	100 %
Plastic	25.0 %	41.9 %	33.1 %	100 %

Table II-20. Life cycle inventory of the packaging end-of-life phase of cases studied in France (level 3 applied operation).

Input	p/L
EOL Glass bottle 50 mL	1.55E-02
EOL Glass bottle 200 mL	4.32E-02
EOL Glass bottle 250 mL	1.88E-02
EOL Glass bottle 375 mL	3.58E-03
EOL Glass bottle 500 mL	2.11E-01
EOL Glass bottle 750 mL	1.29E-02
EOL Food plastic bottle 3 L	3.69E-04
EOL Food plastic bottle 5 L	1.16E-03
EOL Food plastic bottle 10 L	9.07E-04
EOL PEHD bottle 2 L	4.74E-03
EOL PEHD bottle 3 L	7.66E-03
EOL PEHD bottle 5 L	8.41E-03
EOL PEHD bottle 220 L	1.43E-05

Table II-20. Cont.

Input	p/L
EOL Can bottle 250 mL	1.38E-03
EOL Can bottle 500 mL	1.29E-02
EOL Can bottle 750 mL	1.43E-03
EOL Can bottle 1 L	2.01E-03
EOL Tetrapack bottle 1.5 L	1.57E-03
EOL Tetrapack bottle 2 L	3.26E-02
EOL Tetrapack bottle 3 L	8.71E-04

II.2.2.3 Data quality

The assessment of the uncertainty of the inventory data is performed based on a pedigree matrix composed of data quality indicators. Regarding data quality indicators, several have been developed (Weidema et al., 2013; Weidema, 1998; Weidema and Wesnæs, 1996) and they are used for the uncertainty calculations of the European ecoinvent database. An explanation is available in Chapter I, section I.2.3.4 Life cycle interpretation. Subsection “I.2.3.4.1 Data quality: uncertainty management” for the pedigree matrix and “I.2.3.4.2 Uncertainty calculation in SimaPro with ecoinvent 3.6” for how this is managed in the modelisation. Nonetheless, a brief summary is given below:

The analysis of the quality of the data makes it possible to take into account the uncertainty linked to the data used. Indeed, Since the approach is based on a very large quantity of data, its quality must be studied. According to the methodology used for the life cycle inventories carried out and compiled in the ecoinvent database, such an analysis is divided into two successive steps:

- the qualitative assessment of the various parameters that determine the quality of data (reliability, completeness, temporal, geographical and further technological correlation). For each piece of data used in the study, each of the parameters is given a score on a scale parameter of 1 to 5. Thus, a quality score is calculated for each data item by adding the score of each parameter assessed. The higher the score, the lower the quality of the data. This is visible, for example, in **Appendix C** for the S5-CTI_fertilisation dataset.
- the quantitative assessment of the data, which associates an uncertainty factor with the score a parameter may receive in the qualitative assessment. The uncertainty factors are then used to calculate the $V_{95\%}$ variance (with a 95% confidence interval) using the statistical formula of Frischknecht et al. (2007). Determining this variance offers the possibility of performing a Monte Carlo simulation (in SimaPro), which allows for the propagation of uncertainties related to the statistical distribution of the input data.

Monte Carlo analysis uses a data-intensive method to estimate the uncertainty in the final results by running thousands of simulations based on the possible values of the input parameters. When applied correctly, it also determines the significance of a difference between two scenarios (Joliet et al., 2017), as to be presented in the section “II.2.4 Life cycle interpretation”.

II.2.3 Life cycle impact assessment

II.2.3.1 Software, impact categories and impact assessment method

The system scenarios were developed and analyzed with SimaPro PhD 9.1.1.1 software (PRé Sustainability, Amersfoort, The Netherlands). The database used for the modelling was ecoinvent 3.6. The life cycle impact assessment (LCIA) results were assessed by ReCiPe 2016 Midpoint and Endpoint v1.1 (Hierarchist; H) method normalized and weighted based on an average world environmental impact for the year 2010 (World ReCiPe H/A, 2010). The methodology takes into account the Midpoint indicators from CML and the Endpoint indicators from Ecoindicator (Golsteijn, 2012). The midpoint impact categories are global warming (GWP), stratospheric ozone depletion (ODP), ionising radiation (IRP) tropospheric ozone formation - hum- (HOFp), fine particulate matter formation (PMFP), tropospheric ozone formation -eco- (EOFP), terrestrial acidification (TAP), freshwater eutrophication (FEP), marine eutrophication (MEP), terrestrial ecotoxicity (TETP), freshwater ecotoxicity (FETP), marine ecotoxicity (METP), human carcinogenic toxicity (HTPc), human non-carcinogenic toxicity (HTPnc), land use (LOP), mineral resource scarcity (SOP), fossil resource scarcity (FFP), and water consumption (WCP). **Table II-21** summarizes the midpoint impact categories of ReCiPe 2016 within the characterization factors, abbreviation, units and model used.

Table II-21. Overview of the midpoint impact categories and related indicators. Adapted from (Huijbregts et al., 2017, 2016).

Environmental Problem	Midpoint impact category ^(a)	CF _m ^(b)	Abbr.	Unit	Model
Climate change	Global warming	Global warming	GWP	kg CO ₂ eq	IPCC, 2013; Joos et al., 2013
Ozone depletion	Stratospheric ozone depletion	Stratospheric ozone depletion	ODP	kg CFC11 eq	WMO, 2011
Ionising radiation	Ionising radiation	Ionising radiation	IRP	kBq Co-60 eq	Frischknecht et al., 2000
Photochemical ozone formation	Tropospheric ozone formation (hum)	Ozone formation, Human health	HOFp	kg NO _x eq	Van Zelm et al., 2016
Fine particulate matter formation	Particulate matter	Fine particulate matter formation	PMFP	kg PM2.5 eq	Van Zelm et al., 2016
Photochemical ozone formation	Tropospheric ozone formation (eco)	Ozone formation, Terrestrial ecosystems	EOFP	kg NO _x eq	Van Zelm et al., 2016
Terrestrial acidification	Terrestrial acidification	Terrestrial acidification	TAP	kg SO ₂ eq	Roy et al., 2014
Freshwater eutrophication	Freshwater eutrophication	Freshwater eutrophication	FEP	kg P eq	Helmes et al., 2012
	Marine eutrophication	Marine eutrophication	MEP	kg N eq	Cosme et al., 2015
Toxicity	Terrestrial ecotoxicity	Terrestrial ecotoxicity	TETP	kg 1,4-DCB	Van Zelm et al., 2009
	Freshwater ecotoxicity	Freshwater ecotoxicity	FETP	kg 1,4-DCB	Van Zelm et al., 2009
	Marine ecotoxicity	Marine ecotoxicity	METP	kg 1,4-DCB	Van Zelm et al., 2009
	Human toxicity (cancer)	Human carcinogenic toxicity	HTPc	kg 1,4-DCB	Van Zelm et al., 2009
	Human toxicity (non-cancer)	Human non-carcinogenic toxicity	HTPnc	kg 1,4-DCB	Van Zelm et al., 2009
Land use	Land use/transformation	Land use	LOP	m ² a crop eq	De Baan et al., 2013; Curran et al., 2014
Mineral resource scarcity	Mineral resources	Mineral resource scarcity	SOP	kg Cu eq	Vieira et al., 2016
Fossil resource scarcity	Fossil resources	Fossil resource scarcity	FFP	kg oil eq	Jungbluth and Frischknecht 2010
Water use	Water use	Water consumption	WCP	m ³	Döll and Siebert, 2002; Hoekstra and Mekonnen, 2012

^(a) Midpoint impact categories as presented on Figure 1 of (Huijbregts et al., 2017)

^(b) Midpoint characterisation factor name as in SimaPro PhD 9.1.1.1 with ReCiPe 2016

Modelling elements are used to link midpoint indicators to one or more endpoint indicators, which are representative of different topics or “Areas of Protection” (AoP) that “defend” our interests as a society with regards to human health, ecosystems or ecosystem services and resources (Hauschild et al., 2018).

The characterisation factors at the mid-point level are located at some point along the impact pathway, usually at the point from which the environmental mechanism is identical for all environmental flows assigned to that impact category. On the other hand, the characterisation factors at the endpoint level correspond to the three protection areas mentioned above. The two approaches are complementary in the sense that the mid-point characterisation has a stronger relationship to environmental flows and relatively low uncertainty, whereas the end-point characterisation provides better information on the environmental relevance of environmental flows, but with the drawback of being more uncertain than the mid-point characterisation (Huijbregts et al., 2017).

The ReCiPe 2016 methodology includes 18 midpoint impact categories, and three areas of protection or endpoints (Huijbregts et al., 2017). The different midpoint indicators contribute to a small set of endpoint indicators as can be observed in **Figure II-5**.

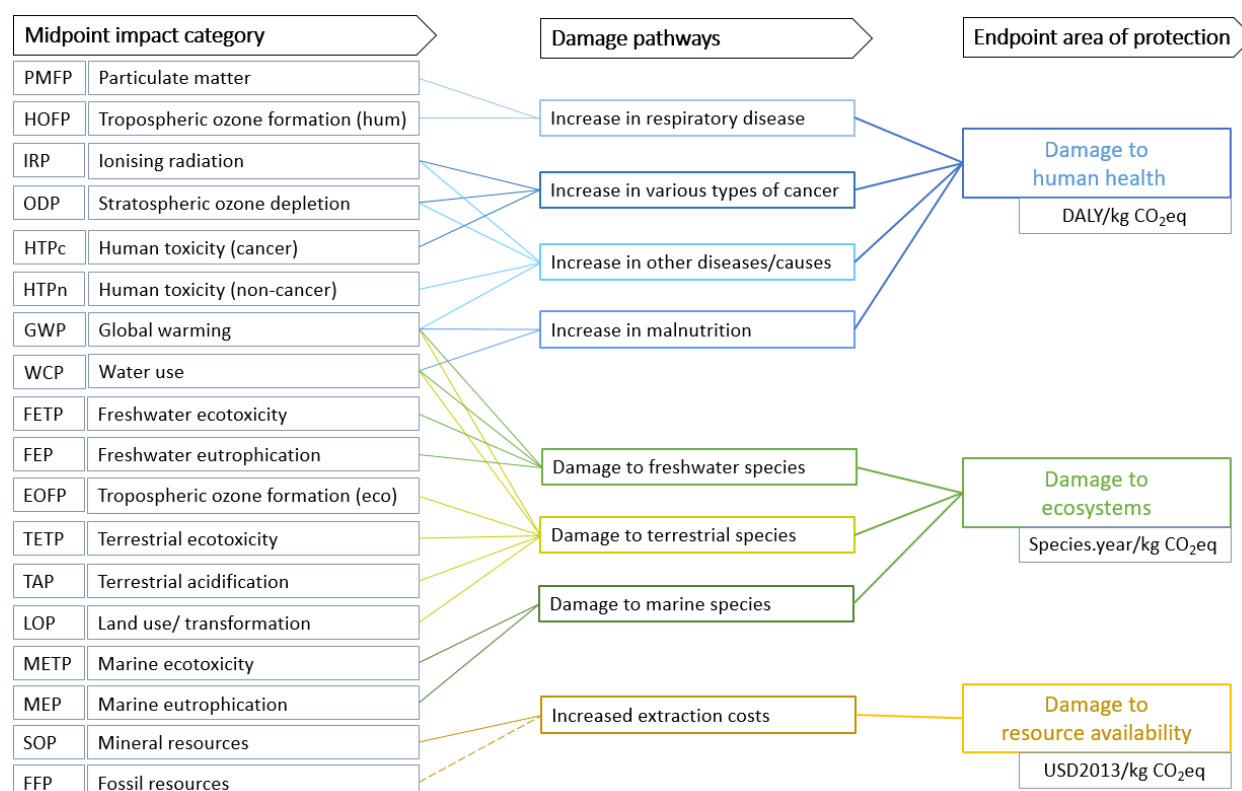

Figure II-5. Summary of the impact categories that are covered in the ReCiPe 2016 method and their relation to the areas of protection (endpoint). The dotted line means that there is no constant mid-to-endpoint factor for fossil resources. Adapted from (Huijbregts et al., 2017).

II.2.3.2 Method robustness

The ReCiPe method was first developed in 2008 through cooperation between RIVM, Radboud University Nijmegen, Leiden University and Pré Consultants (Huijbregts et al., 2017). It is the most widely used impact methodology among LCA practitioners worldwide, followed by IPCC 1013, ILCD 2011, and CML 2012 (iPoint, 2018).

The EF method initiative was introduced by the European Commission and was the one to be used in Product Environmental Footprint Category Rules (PEFCRs) and Organisation Footprint Sector Rules (OEFSRs) of the EF pilot phase (PRéConsultant, 2021).

Impact assessment models are characterized by uncertainties, which influence the robustness of the 18 indicators to different extents. This level of robustness has been exhaustively done for the Environmental Footprint Method (EF) (Sala et al., 2019). Nevertheless, the ReCiPe 2016 models and units are different from the ones used by the EF Method. In the EF method, the first half of the models adopted are classified as level I and level II of robustness. Further information on the robustness of the impact assessment models of the EF Method is available in **Appendix F**. In comparison to the ReCiPe 2016 method, only the Global warming and Stratospheric ozone depletion categories use the same model as in EF, hence it can be assured that the level of robustness is a level I. The Ionising radiation and Photochemical ozone formation categories from EF follows the same models as applied in ReCiPe 2008, whereas ReCiPe 2016 updates its units and models (PRéConsultant, 2021). Finally, for the toxicity categories (freshwater ecotoxicity; human toxicity, non-cancer; human toxicity, cancer) EF applies the USEtox model, and it is worth noting that the USEtox model was not selected for implementation in ReCiPe 2016, as USEtox does not provide characterisation factors for terrestrial and marine toxicity. However, they do use the chemical data from the USEtox database (Huijbregts et al., 2017). For the remaining categories, there is no correlation between both methods, so difficult to discuss robustness levels.

Emissions per FU were first calculated for each phase. Subsequently, the whole life cycle of each of the eleven case studies was compared. Impact assessment results are presented in the next section “II.2.4 Life cycle interpretation”.

II.2.3.3 Molecules covered by the method

In the inventory data part, specifically for the phytosanitary treatments, it was discussed how the fate of pesticides is counted as 100% emission to agricultural soil (Nemecek and Schenetzler, 2011). This is due to the lack of accuracy on the fate of the pesticides used. But the study of the fate of pesticides has been strengthening in recent years as the environmental evaluation of agricultural products in LCA requires a proper estimation of pesticide emissions and associated toxicity impacts. Some characterization models are PestLCI, USEtox, and the OLCA-Pest project.

- PestLCI is a model capable of estimating pesticide emissions to air, surface water and groundwater for use in LCI modelling of field applications (Dijkman et al., 2012).
- The scientific consensus model USEtox is widely applied in LCA for the characterisation of chemical emissions for human toxicity and freshwater ecotoxicity in LCIA (Rosenbaum et al., 2008).

Nevertheless, those models have been primarily developed for temperate conditions, so pesticide-related impacts for crops grown under other conditions (like tropical) has been questioned (Gentil et al., 2020b). To overcome this problem, Gentil et al. (2020a) developed an approach to consistently combine state-of-the-art emission inventory and impact assessment models for assessing human toxicity and freshwater ecotoxicity impacts from pesticide applications for tomato production in tropical conditions. They underline that in many studies, when pesticides are considered, emissions are derived from generic emissions, such as the one done byecoinvent where all pesticides go 100% into the soil. Such generic emission fractions ignore differences across application methods, crops and other important characteristics influencing pesticide emission distributions, such as in tropical conditions with higher temperature enhancing degradation and volatilization of pesticides (Gentil et al., 2020a).

The OLCA-Pest project ("Operationalising Life Cycle Assessment for Pesticides", OLCA-Pest 2017-2020, co-funded by ADEME and all involved partner institutions) underlines that even if pesticides can be evaluated in LCA since the development of advanced indicators like the before mentioned, some limitations were remaining:

- a large number of substances are yet to be characterised in terms of (eco-)toxicity,
- the inability to properly model non-organic substances (metals such as copper-based substances, sulphur, etc.) widely used in agriculture
- and the most important one for the herein study is that there is no consensus agreement on how to estimate the fractions emitted to water, air and soil during field application, and therefore, how to model them in SimaPro.

This project was implemented with nine partner institutions, in order to operationalize recommendations from the consensus-building effort and provide clear guidance for researchers and practitioners. The work conducted under the OLCA-Pest project constitutes a major step forward in the improvement of the scientific foundation for assessing emissions and toxicity impacts of agricultural pesticides in LCA (Fantke et al., 2020).

Having discussed all this, and coming back to the main issue of the molecules covered by the method, even if it is possible to estimate the fractions emitted in water, air and soil (and not to assume 100% in soil), this quantification is useless if the molecule is not taken into account in the impact method, in the case of the actual study, the Recipe 2016 method. Therefore, it was checked whether the active molecules in the pesticides were taken into account (**Table II-22**). Their characterisation factors are available in **Appendix G**.

Table II-22. Active molecules of pesticides taken into account in the ReCiPe 2016 method.

Pesticide	Is the active molecule taken into account in the model?
Glyphosate	Yes
Dimethoate	Yes
Spinosad	No
Lambda-cyhalothrin (Karate Xpress, 5%)	Yes
Bacillus thuringiensis	No
Kresoxim-methyl (Strobi-DF)	Yes
Copper oxide (Nordox 75WG, 75%)	No
Copper sulfate (<i>Bouille Bordelaise</i> , 20%)	No

Furthermore, the OLCA-pest project was developed in the same timeframe (2017-2020) as the thesis project presented herein. The implementation is not yet available for use in LCA software such as SimaPro. What is available online is “PestLCI Consensus V.1.0”, an on-line tool to estimate pesticide emission fractions to different environmental compartments including field crops (Fantke et al., 2020).

II.2.4 Life cycle interpretation

In the ReCiPe 2016 method, only the Global warming and Stratospheric ozone depletion categories use the same model as in EF, hence they have a level I of robustness (most robust model). As explained in Chapter I – I.4.5.2 Climate change category, the impact category preferred by many authors for their publications on LCA is the climate change category, even if LCA is a multi-criteria analysis. In the light of this PhD work, this category is treated in extensive in the herein section.

II.2.4.1 Climate change

Following the example of Proietti et al. (2014), a calculation of the CO₂ sources and sinks to obtain the net carbon stock of the olive grove and its relation to the impact on climate change was done. Their observations were made along the first 11 years from planting, which includes the crucial period of the life span of the olive grove. Their results showed that the greatest impact occurred during the first year of olive grove cultivation with an annual average GWP100 value for the first 11 years of 1.507 t CO₂-eq/ha per year. Furthermore, considering the different years of cultivation, the greatest impact was made by the use of fertilisers and pesticides.

In Proietti et al. (2014) work, to calculate the amount of organic C, the dry matter is multiplied by a value of Carbon Fraction equal to 0.5 (as suggested by IPCC 2003). After that, the amount of CO₂-eq stocked by the average tree in the form of organic substance was obtained by dividing the amount of C by a factor equal to 0.27 (ratio of the moles of carbon and the sum of the moles of carbon and oxygen). The result expressed in tonnes of C per hectare for the above-ground and below-ground biomass in the olive grove was obtained by multiplying the amount of C in the “model tree” by the number of trees per hectare (330).

They considered the weights of the permanent tree components that can be subdivided in “below-ground biomass” (roots, excluding thin roots) and “above-ground biomass” (root collar; trunk; branches; twigs, and leaves) (see **Table II-23**); and the non-permanent tree components (fruit and prunings; leaf abscission) (see **Table II-24**).

The amounts of C, and consequently of CO₂-eq stocked by the olive grove, including prunings and fruit yield, are summarized in **Table II-25**. The observations by Proietti et al. (2014) were made along the first 11 years from planting since this period includes the crucial period of the life span of the olive grove: planting phase; not bearing phase, increasing bearing phase; full cropping phase. In the considered conditions, after 11 years from planting the olive vegetative and productive activities and the cultural practices become almost constant. For this reason, the carbon sequestered chosen for further study is the one from the year 11 (0.18 t C/ha, see **Table II-25**).

Table II-23. Average dry weight of permanent components of three “model tree” (11th year), with calculated C and CO₂-eq stock, measured after pruning and fruit harvesting. Adapted from Proietti et al. (2014).

Permanent tree component (P)	Dry weight (kg/tree)	C (kg/tree)	CO ₂ -eq (kg/tree)	Dry weight (t/ha)*	C (t C/ha)*	CO ₂ -eq (t CO ₂ -eq/ha)*
Roots	8.23	4.12	15.24	2.72	1.36	5.03
Root collar	12.02	6.01	22.26	3.97	1.98	7.35
Trunk	13.94	6.97	25.81	4.60	2.30	8.52
Branches	16.32	8.16	30.22	5.39	2.69	9.97
Twigs	10.00	5.00	18.52	3.30	1.65	6.11
Leaves	6.72	3.36	12.44	2.22	1.11	4.11
Total	67.23	33.62	124.50	20.17	11.09	41.09
Below-ground biomass	8.23	4.12	15.24	2.72	1.36	5.03
Above-ground biomass	59.00	29.50	109.26	19.47	9.74	36.06

* 1 ha = 330 oliviers

Table II-24. Average dry weight of non-permanent components of the model trees, with calculated C and CO₂-eq stock. Adapted from Proietti et al. (2014).

Non-Permanent tree component (NP)	Dry weight (kg/tree)	C (kg/tree)	CO ₂ -eq (kg/tree)	Dry weight (t/ha)*	C (t C/ha)*	CO ₂ -eq (t CO ₂ -eq/ha)*
Fruits	9.28	4.64	17.19	3.06	1.53	5.67
Prunings	12.80	6.40	23.70	4.22	2.11	7.82
Total	22.08	11.04	40.89	7.29	3.64	13.49

* 1 ha = 330 oliviers

Table II-25. Olive grove C and CO₂-eq stock and sequestration during the 11 years. From Proietti et al. (2014).

Year	1	2	3	4	5	6	7	8	9	10	11
C stocked (t C/ha)	0.00	0.20	0.80	1.60	3.00	5.00	7.20	12.35	14.00	14.55	14.73
CO ₂ -eq stocked (t CO ₂ -eq/ha)	0.00	0.74	2.96	5.93	11.11	18.52	26.67	45.74	51.85	53.89	54.55
C sequestered (t C/ha)	0.00	0.20	0.60	0.80	1.40	2.00	2.20	5.15	1.65	0.55	0.18
CO ₂ -eq seq. (t CO ₂ -eq/ha)	0.00	0.74	2.22	2.96	5.19	7.41	8.15	19.07	6.11	2.04	0.67

Nevertheless, as said before, this sequestered carbon also includes prunings and fruit yield. If the description of biogenic carbon (Chapter I, section I.3.3.3 Biogenic carbon) is taken into account, this way of counting is not in concordance with PAS 2050. According to PAS 2050, both emissions (from biogenic and fossil sources) to the atmosphere and removals shall be accounted in an LCA. Yet, human food and animal feed products are an exception if the biogenic carbon becomes part of the product. Regarding the case study of olive oil production, the biogenic carbon from the agricultural phase (olive tree permanent components, especially taking into account the longevity of olive groves) does not become part of the product (olive oil). Therefore, the assessment of biogenic carbon should be taken into account only for the tree permanent components. And also adjusted to an amount of carbon per tree and not per hectare because the hectares of the 11 case studies have different cropping intensities.

For this reason, an adjustment of the 0.18 t C/ha from **Table II-25** was made as follows:

Notation reminder:

P: Permanent tree component
NP: Non-permanent tree component

Calculations :

trees/ha =	330.00	Hypothesis by Proietti et al. (2014)
Ratio (P/P+NP) =	0.75	P=33.62 from Table II-23 and NP=11.04 from Table II-24
C sequestered P (t C/ha) =	0.14	Ratio (0.75) * t C/ha (0.18) =0.14; 0.18 from Table II-25
C sequestered P (t C/tree) =	4.11x10 ⁻⁰⁴	0.14 t C/ha shared among 330 trees

Since the foreground data from the questionnaires on which the eleven case studies are based date from 2014, **Table II-26** shows the year of planting and longevity up to that year. In cases where the year of planting is not available, the average longevity (~20 years) was used. Next, the number of trees per hectare and the olive oil yield (already shown in **Table II-1** but useful for the calculations herein presented). To calculate the carbon stocked (t C/ha) of the permanent tree components at year 11 (the year where cultural practices become almost constant), the total carbon of the permanent tree components (33.62 kg/tree) is multiplied by the number of trees per hectare and adjusted to tonnes. Then, there are three hypotheses to make the accounting for carbon:

- 1) Annually: the carbon sequestered only in the year of olive oil production, in this case, during 2014. And therefore the CO₂-eq sequestered.

$$\text{C sequestered P annually [t C/ha*yr]} = 4.11\text{E-}04 \text{ [t C/tree]} * \text{number of [tree/ha]}$$

CO₂-eq seq. P annually:

$$\text{[t CO}_2\text{-eq/ha*yr]} = \text{C seq. P annually [t C/ha*yr]} / 0.27$$

$$\text{[kg CO}_2\text{-eq/FU]} = \text{CO}_2\text{-eq seq. P annually [t CO}_2\text{-eq/ha*yr]} / \text{olive oil yield [L/ha*yr]} * 1000 \text{ [kg/t]}$$

- 2) Production-yr: the carbon stocked up to the year of olive oil production. In other words, the carbon stocked during the first 11 years plus the carbon sequestered each year from year 11 to the year of production. And therefore the CO₂-eq stocked.

$$\text{C stocked P in production-yr [t C/ha]} = \text{C stocked P at yr 11 [t C/ha]} + ((\text{tree longevity [yr]} - 11) * \text{C sequestered P annually [t C/ha*yr]})$$

CO₂-eq stocked P in production-yr:

$$\text{[t CO}_2\text{-eq/ha]} = \text{C stocked P in production-yr [t C/ha]} / 0.27$$

$$\text{[kg CO}_2\text{-eq/FU]} = \text{CO}_2\text{-eq stocked P in production-yr [t CO}_2\text{-eq/ha]} / \text{olive oil yield [L/ha*yr]} * 1000 \text{ [kg/t]}$$

- 3) Averaged: the carbon (and therefore the CO₂-eq) stocked up to the year of olive oil production (point two) but distributed over the longevity of the tree.

CO₂-eq stocked P averaged:

$$\text{[t CO}_2\text{-eq/ha]} = \text{CO}_2\text{-eq stocked P in production-yr [t CO}_2\text{-eq/ha]} / \text{tree longevity [yr]}$$

$$\text{[kg CO}_2\text{-eq/FU]} = \text{CO}_2\text{-eq stocked P averaged [t CO}_2\text{-eq/ha]} / \text{olive oil yield [L/ha*yr]} * 1000 \text{ [kg/t]}$$

Table II-26. Three hypotheses to make the accounting for carbon stock and carbon sequestration of olive groves.

	Unit	S1-CTI	S2-CTI	S3-CTI	S4-CTI	S5-CTI	S6-CTD	S7-CTD	S8-CII	S9-CID	S10-OTI	S11-OTD
Year of planting	-	-	1998	-	1998	1956	-	1996	1995	1997	1986	1995
Tree longevity (until 2014)	yr	20	16	20	16	58	20	18	19	17	28	19
Number of trees per ha	trees/ha	100	200	285	250	287	285	220	380	330	285	200
Olive oil yield	L/ha*yr	286	301	562	824	1101	503	326	1082	378	882	335
C stocked P at yr 11	t C/ha	3.36	6.72	9.58	8.40	9.65	9.58	7.40	12.77	11.09	9.58	6.72
1) C sequestered P annually	t C/ha*yr	0.04	0.08	0.12	0.10	0.12	0.12	0.09	0.16	0.14	0.12	0.08
CO ₂ -eq seq. P annually	t CO ₂ -eq/ha*yr	0.15	0.30	0.43	0.38	0.44	0.43	0.33	0.58	0.50	0.43	0.30
	kg CO ₂ -eq/FU	0.53	1.01	0.77	0.46	0.40	0.86	1.03	0.53	1.33	0.49	0.91
2) C stocked P in production-yr	t C/ha	3.73	7.13	10.63	8.92	15.19	10.63	8.03	14.02	11.91	11.57	7.38
CO ₂ -eq stocked P in prod.-yr	t CO ₂ -eq/ha	13.82	26.42	39.38	33.03	56.24	39.38	29.73	51.93	44.10	42.85	27.33
	kg CO ₂ -eq/FU	48.32	87.90	70.13	40.08	51.09	78.28	91.28	48.02	116.63	48.58	81.64
3) CO ₂ -eq stocked P averaged over tree longevity	t CO ₂ -eq/ha	0.69	1.65	1.97	2.06	0.97	1.97	1.65	2.73	2.59	1.53	1.44
	kg CO ₂ -eq/FU	2.42	5.49	3.51	2.51	0.88	3.91	5.07	2.53	6.86	1.74	4.30

Table II-27. CO₂-eq emissions generated by producing one litre of French olive oil (FU) throughout its life cycle.

CO ₂ -eq emissions (kg CO ₂ -eq/FU)	S1-CTI	S2-CTI	S3-CTI	S4-CTI	S5-CTI	S6-CTD	S7-CTD	S8-CII	S9-CID	S10-OTI	S11-OTD
Baseline	6.40	3.55	4.49	3.71	2.79	5.14	3.64	3.03	7.06	3.16	4.42
Case 1) Anually	5.87	2.54	3.72	3.25	2.39	4.28	2.61	2.49	5.73	2.67	3.51
Case 2) Production-yr	-41.92	-84.34	-65.64	-36.37	-48.31	-73.14	-87.64	-44.99	-109.57	-45.42	-77.22
Case 3) Averaged	3.98	-1.94	0.98	1.20	1.91	1.23	-1.43	0.50	0.20	1.43	0.12

Application of the LCA methodology:

The annual CO₂-eq emissions in kg CO₂-eq/FU to produce one litre of French olive oil (FU) throughout its life cycle were calculated and are reported in **Table II-27**. The “baseline” CO₂-eq emissions are the ones without taking into account the biogenic carbon with none of the three hypotheses. As a clarification, case 1) corresponds to the first hypothesis; these are the emissions already taking into account the reduction of biogenic carbon sequestered only in the year of olive oil production. Case 2) corresponds to the second hypothesis; these are the emissions with the reduction of the biogenic carbon stocked up to the year of olive oil production. Case 3) shows the emission results of the third hypothesis, with the reduction of the biogenic carbon stocked up to the year of olive oil production (case 2) but distributed -or averaged- over the longevity of the olive tree.

Figure II-6 allows data visualisation of the results presented in **Table II-27**.

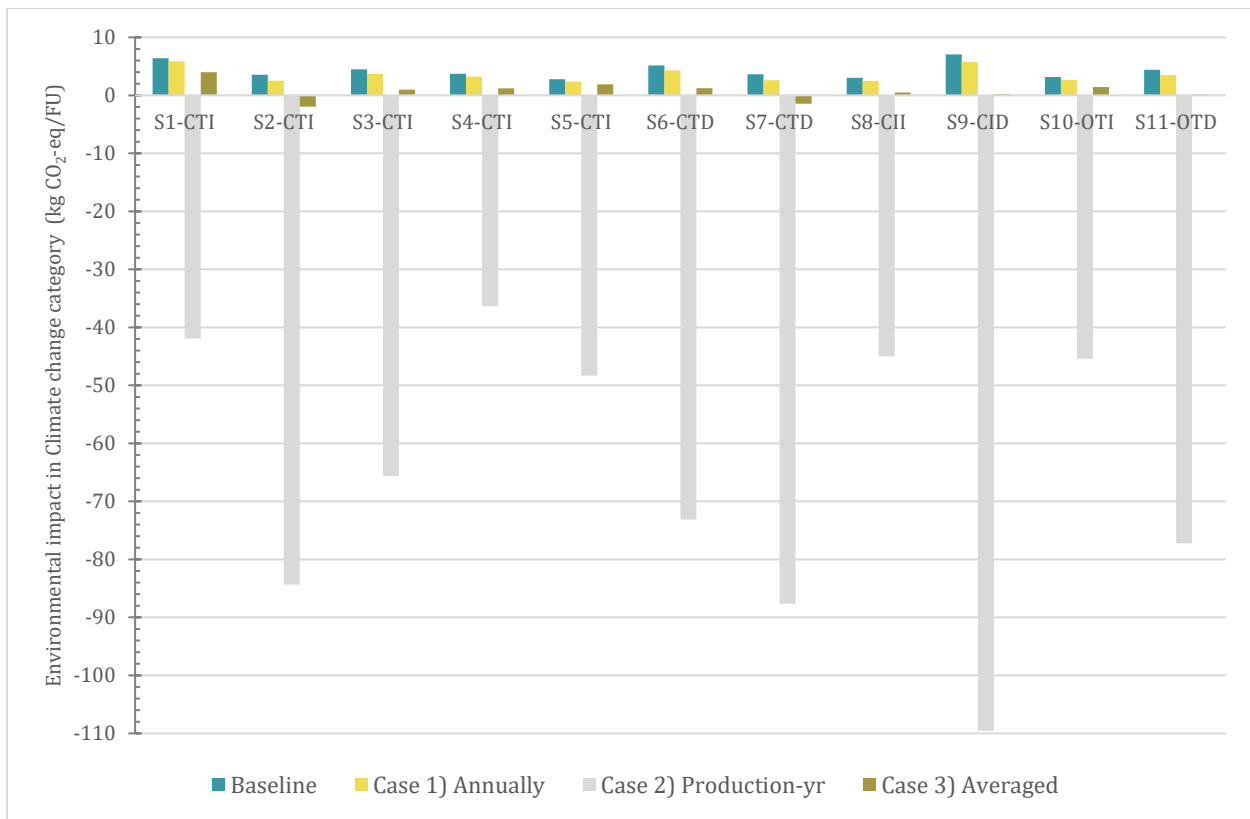

Figure II-6. CO₂-eq emissions generated by producing one litre of French olive oil (FU) throughout its life cycle.

The baseline CO₂-eq emissions obtained are consistent with those obtained by other authors for different case studies (El Hanandeh and Gharaibeh, 2016; Espi et al., 2013; Fernández-Lobato et al., 2021b; Pattara et al., 2016; Proietti et al., 2017; Rinaldi et al., 2014). In **Table II-28**, the present work is compared among six publications. The results of the cases studies in France are compared with case studies in Spain - more specifically, from Jaen, Spain’s largest production area - (Fernández-Lobato et al., 2021b), and Italy, the second-largest producer worldwide after Spain. The first two (Espi et al., 2013; Rinaldi et al., 2014) have a scope from cradle-to-grave but their results are not in the same order of magnitude. This is explainable because the second one took into account freezing

and export by truck, ship and plane to USA, Japan, Germany and France from Italy, being the transportation by plane to USA (~9100 km) a big impact on the results (Rinaldi et al., 2014), while the first one took into account transports only by truck at regional, national and European level (~1300 km) (Espi et al., 2013). They are two publications that have a FU of 1kg of VOO. For the comparison between different FUs, the factor proposed by PEFCE is used: 1 L = 0.92 kg. The last four publications have a scope from cradle to gate, and they respect the same order of magnitude, around 0.6-2.2 kg CO₂-eq/L. Even if the last two (Pattara et al., 2016; Proietti et al., 2017) have a different number of samples to calculate the average, they both converged at ~1.6 kg CO₂-eq/L.

Table II-28. Comparison of climate change results with different authors.

FU	Scope	Climate change				Reference
		(kg CO ₂ -eq/FU)	(kg CO ₂ -eq/L)			
			Min	Max		
1 L EVOO	Cradle-to-grave	(n=11)	2.79	7.06	4.31	Present work
1 L EVOO/ VOO/ OO	Cradle-to-grave	(n=3)	2.19	3.47	2.98	(Espi et al., 2013)
1 L EVOO	Cradle-to-grave				17.53	(Rinaldi et al., 2014)
1 kg of VOO	Cradle-to-gate	(n=5)	1.93	3.00	2.20	(Fernández-Lobato et al., 2021b)
1 kg of OO	Cradle-to-gate				0.62	(El Hanandeh and Gharaibeh, 2016)
5 L EVOO	Cradle-to-gate	(n=4)	4.48	10.10	1.56	(Pattara et al., 2016)
1 L EVOO	Cradle-to-gate	(n=7)	0.67	4.48	1.67	(Proietti et al., 2017)

The results of the three cases taking into account the biogenic carbon are debatable with the results of other publications (Fernández-Lobato et al., 2021a; Proietti et al., 2017, 2014). It is important to note that these authors considered the permanent as well as the non-permanent parts of the olive tree, the latter not being taken into account -as already amply explained- for the purpose of this thesis. In fact, the non-permanent components have a great ability to stock C and give the greatest contribution to the amount of carbon stocked by olive trees (Proietti et al., 2017). This greater quantity is due to the fruits, which have a storage capacity of more than twice than pruning residues. And, even if the carbon stocked by fruits is lost from the olive grove through the harvesting operation, Proietti et al. (2017) work takes into consideration that a significant percentage would return to soil thanks to the soil amendment operation realised with olive pomace. After evaluation, the net balance between removals and emissions is positive with the C sequestered greater than that emitted (**Figure II-7**) (Proietti et al., 2017). Fernández-Lobato et al. (2021a) also reported negative C footprint values and found a significant relationship between olive fruit yield and the magnitude of C footprint: the higher the olive fruit yield, the more negative (*e.g.* more net annual CO₂ fixed by trees) the C footprint was (**Figure II-8**). Even so, Fernández-Lobato's work highlighted that caution should be taken, because most of the CO₂ fixed within the olive fruit will end up as CO₂ in the short-term in other phases. Moreover, the CO₂ fixed in the stable structure of trees (roots, trunk and main branches) throughout the trees' lives, will end up as firewood, and then the accumulated CO₂ in the biomass will be returned to the atmosphere when olive groves are renewed or when there is a change in the type of crop. Their work also shows the relation between carbon sequestration (45.41% for the weighted

average) and the impact produced per 1 kg of VOOs (Figure II-9). This indicates that the olive oil value chain in Jaen and similar regions has an overall negative effect on climate change (Fernández-Lobato et al., 2021b).

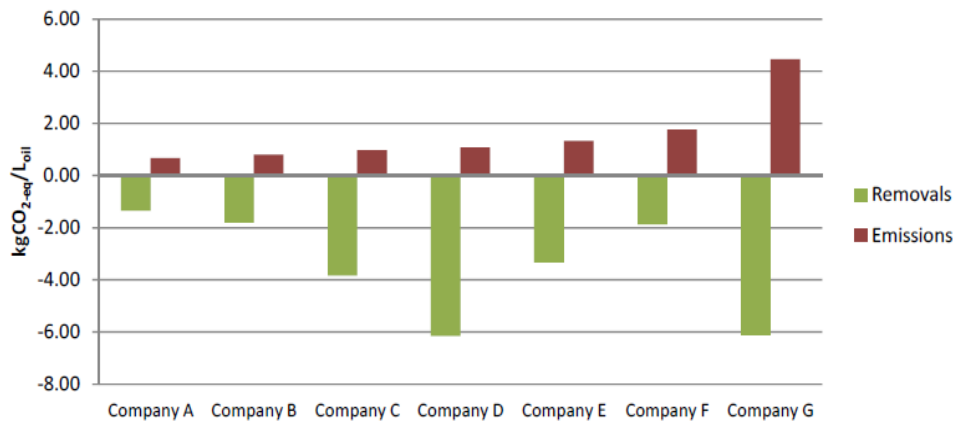

Figure II-7. Comparison between emissions and removals (Proietti et al., 2017).

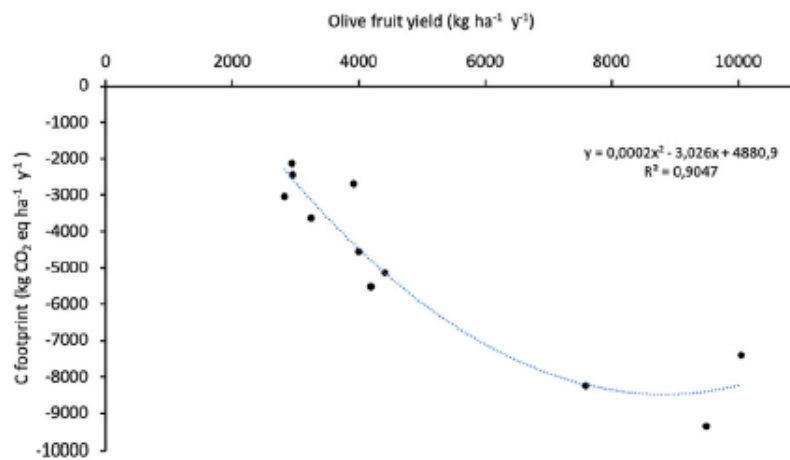

Figure II-8. Relationship between fresh olive fruit yield and C footprint (kg CO₂-eq/ ha) (Fernández-Lobato et al., 2021a).

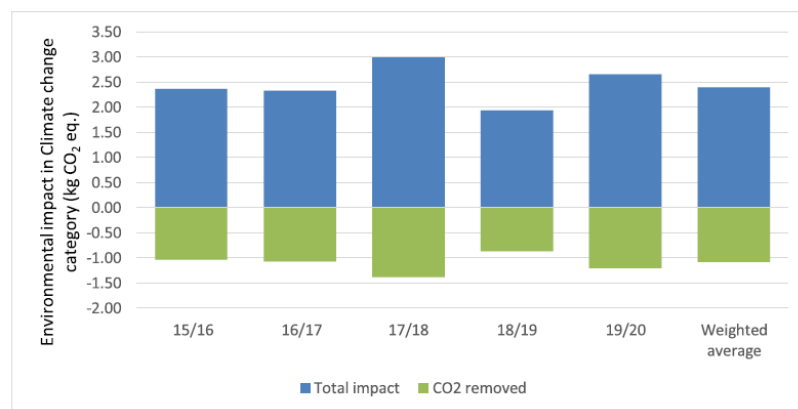

Figure II-9. CO₂ equivalent balance for climate change category based in the long-term carbon sequestration hypothesis for different harvests and weighted average (Fernández-Lobato et al., 2021b).

As shown before in **Figure II-6**, the tree hypothesis affects differently the carbon balance. Case 1) is the closest to temporal reality as the LCA was done on a single year of production and this hypothesis only takes into account the carbon sequestered in the same year. By contrast, case 2) takes into account the biogenic carbon sequestered in each year of the olive tree's life, which in the end provides the stocked carbon up to the year of olive oil production. However, one must be very careful with this hypothesis, since the carbon stored over the years follows a temporality (it is dynamic), and the analysis made in this work is static. It would be interesting to make a comparison over the years, such as Proietti et al. (2014), which demonstrated that after the 4th year, more CO₂-eq was sequestered than emitted during cultivation (see **Figure II-10**). Case 3) is a compromise between the two previous hypotheses, as it takes into account the carbon sequestered during the growth stage of the olive tree until its stabilisation at year 11 of life, simplified with an average of carbon stored over the tree longevity.

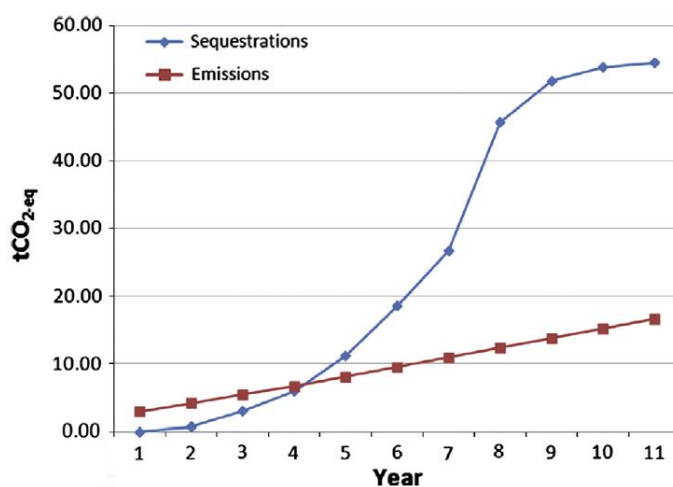

Figure II-10. Comparison between olive grove cumulative CO₂-eq emissions and sequestrations (Proietti et al., 2014).

Now, leaving aside the biogenic carbon hypotheses, the focus will be on the baseline climate change results with a comparative approach to the eleven French case studies. **Figure II-11** shows the distribution of the impact of the life cycle of olive oil production in the Climate change category. All the data is available in **Appendix H; Table H.1**. The highest contribution is from the agricultural phase, as expected from the review analysis (Espadas-Aldana et al., 2019). The olive oil extraction (production phase), packaging, and packaging EOL are common for the eleven scenarios with a contribution of 0.44, 0.32, and 0.09 kg CO₂-eq, respectively. Pomace treatment accounts for 0.007 kg CO₂-eq. in all scenarios as the FU is 1 L of virgin/extra virgin olive oil and the ratio of OP produced is calculated by L of olive oil. OP spreading emissions are due to the use of a tractor for the agricultural spreading of olive pomace.



Figure II-11. Distribution of the impact of the life cycle of olive oil production in the Climate change category.

Once the agricultural phase is identified as a hotspot, the next step is to analyse which process of this phase is the one(s) that triggers it. **Figure II-12** and **Figure II-13** allow visualizing the distribution of the impact of the agricultural phase in the Climate change category. The first one was made in comparison to the highest scenario (S9-CTI) as typically shown in SimaPro for LCA results. This allows a comparison of all processes between the different scenarios, whereas the second one permits seeing the contribution of each process in a specific scenario.

General comparison:

The hotspot in the agricultural phase is fertilisation followed by tillage, which is mainly due to the nitrogen fertiliser employed and to use of the tractor for the spreading of fertilisers and pesticides. It is also important to remind that the application of the herbicide glyphosate is done at the tillage process. The contribution of the irrigation process is also evident in scenarios with this configuration. The harvesting process is the second most important process contributor in scenario S1-CTI after fertilisation, with a large contribution gap against the other scenarios. This is due to the production of polyethylene (PET) nets that S1-CTI uses (10 X 5 m; 2 per tree; 95 g/m²; 10 years), so 200 PET nets/ha; 95 kg PET/ha; 0.33 kg PET/FU. Yet, the other scenarios used only HDPE boxes to help their manual harvesting (20 boxes; life span of 15 years; 2.35 kg HDPE/box) so 3.13 kg of HDPE/ha. They are some scenarios with a bit contribution by the harvesting process: S5-CTI for the use of branch vibrators and PET nets (vs S1-CTI, it only uses 8 PET nets of 8 x 6 m per ha, so 3.65 kg PET/ha or 0.003 kg PET/FU thanks to its high olive yield). Scenarios S7-CTD and S10-OTI also used branch vibrators. The contribution in scenarios S4-CTI, S8-CII, and S9-CID was by the electricity used by a homemade leaf stripper.

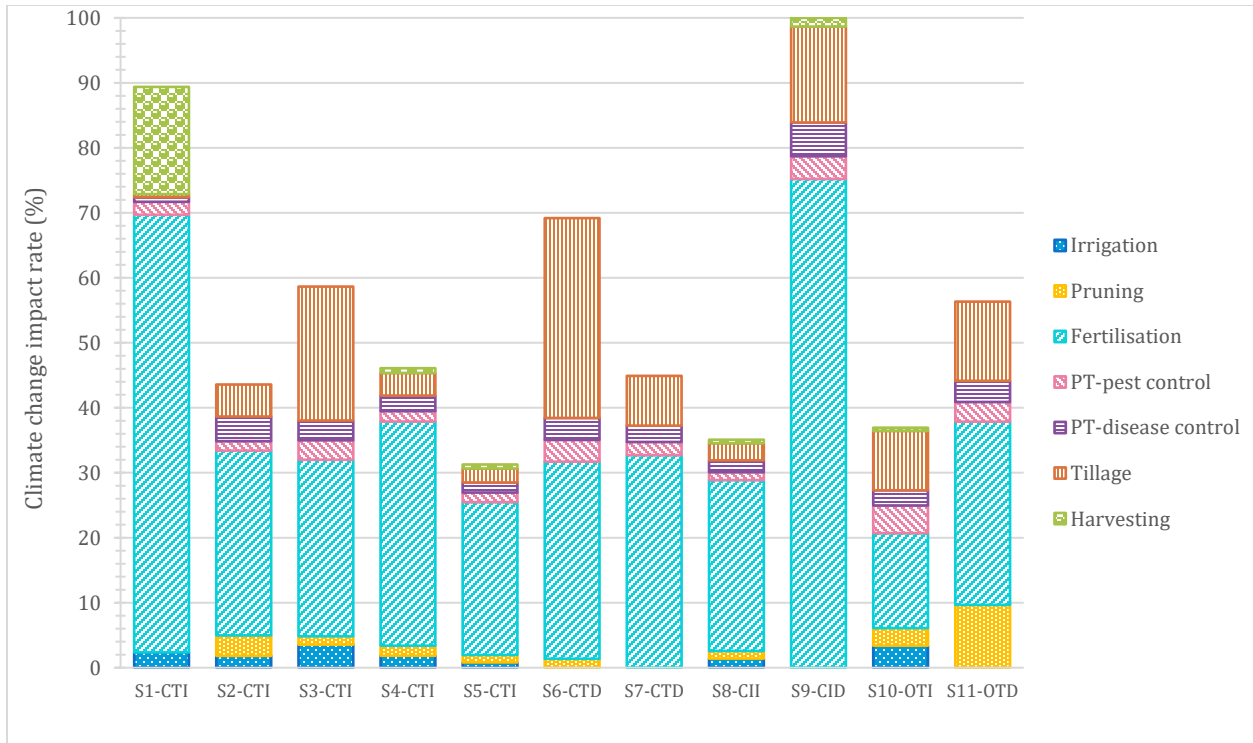

Figure II-12. Distribution of the impact of the agricultural phase in the Climate change category. Graphic made in comparison of the highest scenario (S9-CTI) as typically shown in SimaPro for LCA results.

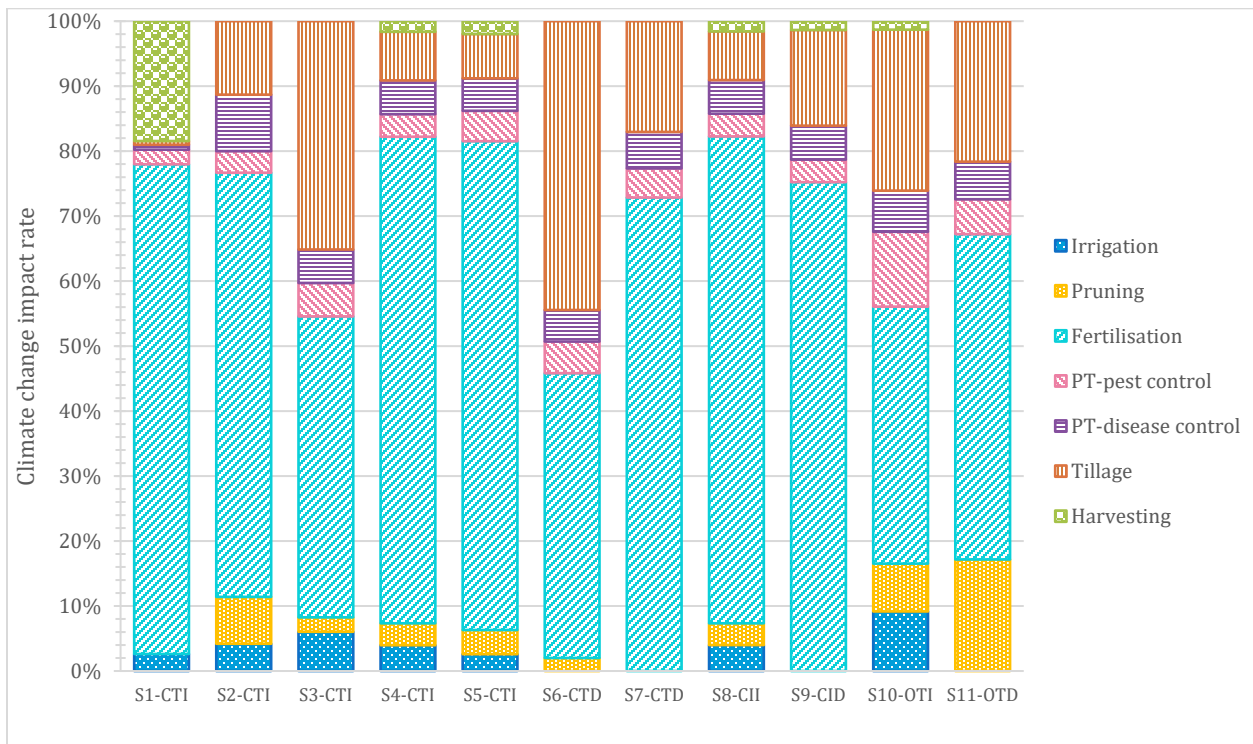

Figure II-13. Distribution of the impact of the agricultural phase in the Climate change category. 100% stacked histogram.

Irrigated vs Dry System:

- S8-CII vs S9-CID

A clear explanation of the significance of the differences of these two graphs which are taken from the same data table (all the data is available in **Appendix H; Table H.2**) is as follows: the scenario with the highest emissions is S9-CID with 7.07 kg CO₂-eq for all its life cycle and 6.21 kg CO₂-eq (88%) for the agricultural phase. Its fertilisation process accounted for 4.67 kg CO₂-eq (66% of the contribution of the life cycle and 75% of the agricultural phase). Whereas S8-CII accounted for 3.03 kg CO₂-eq for all its life cycle and 2.18 kg CO₂-eq (72%) for the agricultural phase. The fertilisation process accounted for 1.63 kg CO₂-eq (54% of the contribution of the life cycle and 75% of the agricultural phase). Both S8-CII and S9-CID fertilisation processes accounted for 75% of their agricultural phase **Figure II-13**, but in comparison to the highest scenario (S9-CID in **Figure II-12**), the agricultural phase of S8-CII seems to be more than half of the fertilisation contribution of the S9 scenario because it is based on its net value.

Both scenarios followed conventional agriculture with an intense type of farming but with a difference in the use of an irrigation system. Both used the same quantities and types of fertilization and PT and yet, scenario S8-CII had a lower environmental impact (57% less than S9-CID). This outcome was possible thanks to the big difference in the olive yield per scenario: S8 with 1081.50 L/ha/year vs S9 with 378.10 L/ha/year.

- S10-OTI vs S11-OTD

Both scenarios followed organic agriculture with a traditional intensity of olive growing but with a difference in the use of an irrigation system. Scenario S10-OTI used twice of fertilisers and PT process and yet, it had a lower environmental impact (28% less than S11-OTD). This outcome was also possible thanks to the big difference in the olive yield per scenario: S10 with 882 L/ha/year vs S11 with 335 L/ha/year.

This suggests that the large difference in olive productivity per hectare is positively influenced mainly by the use of irrigation, the two irrigated systems turned out to have a positive environmental impact (*i.e.* less CO₂-eq emissions) compared to the scenarios with the same type of agriculture and intensity. The impact made by the irrigation process is highly outweighed by the benefits it provides.

Conventional vs Organic system:

As highlighted in the review study about olive oil production (Chapter I.3. State-of-the-art: Olive oil Life Cycle Assessment), FU might vary at the discretion of the practitioner. In the olive oil sector, the FU according to the PCR for olive oil of the International EPD System is 1 L of olive oil, yet, FUs are also defined as a quantity of olive (ton or kg), as cultivated surface area (ha), as volume (L) or as energy content (MJ) (Espadas-Aldana et al., 2019). Nevertheless, it is important to recall that the FU significantly influences the way an LCA is performed, as well as its results and their interpretation, especially in comparative studies (Hauschild et al., 2018). This question has been arisen by several authors about the assessment of organic vs conventional food products (Boone et al., 2019; Roy et al., 2009; van der Werf et al., 2020). Principally because of the complexity of

comparing the performance of conventional and organic farming systems regarding productivity and ecosystem services (Boone et al., 2019).

Conventional agriculture has better yields but uses a greater amount of fertiliser and pesticides compared to organic agriculture, nonetheless organic agriculture requires more arable land (Roy et al., 2009). This can also be found when comparing intensive vs traditional systems. The higher impact of intensive olive farms on climate change is mainly due to higher consumption of fertilisers, especially N based, pesticides, fungicides, herbicides and energy applied together with a higher degree of mechanization compared to traditional systems (Fernández-Lobato et al., 2021a).

It is worth noting the influence of the functional unit on the LCA results between farming practices. Although organic olive cultivation –in general- has lower crop yields per hectare compared to conventional farming systems (Boone et al., 2019; Mohamad et al., 2014), its environmental impact results are better (*i.e.* lower) when expressed per hectare (Mohamad et al., 2014). On the other hand, the conclusions can be reversed when the impacts are expressed per kg of olive or L of oil.

CTI's scenarios (S1 to S5) could be compared with S10-OTI, and CTD's scenarios (S6 and S7) compared to S11-OTD. Both organic scenarios (S10 and S11) had less impact on the fertilisation process than conventional scenarios (**Figure II-13**). Nevertheless, this was not sufficient to give them a higher environmental performance than the conventional ones as more than half of the remaining scenarios (5 out of 9) had lower CO₂-eq emissions (**Figure II-11**). This supports the hypothesis regarding the relationship between the olive fruit yield and the magnitude of C footprint along with the influence of irrigation. This was also highlighted by Fernández-Lobato et al. (2021a).

II.2.4.2 Overall environmental impact

Having discussed the Climate change section, which is only one of the 18 indicators, this part will concern the multi-criteria feature of the LCA. To achieve this, a normalisation of the outcome of the eleven scenarios over their entire life cycle was performed.

II.2.4.2.1 Relative significance of impact category results

The issue of normalisation has already been addressed in chapter I, section I.3.3.3 Life cycle impact assessment. Even if it is an optional step under ISO 14044 (ISO, 2006b), it is helpful because it shows the contribution of the studied product as a fraction of the global impact in a given impact category (Joliet et al., 2016). It means that indicator scores for all impact categories are expressed in a common metric, which makes it easier to compare them. A commonly used reference is the annual contributions to the total environmental impacts of an average person (Hélias and Servien, 2021).

Figure II-14 shows the normalised results of the eleven scenarios over their entire life cycle. It can be observed that the categories that stand out the most are those of toxicity (terrestrial ecotoxicity, freshwater ecotoxicity, marine ecotoxicity, human carcinogenic toxicity, and human non-carcinogenic toxicity). These categories will be discussed below in order to find out which phases of the life cycle of the scenarios are at the origin of these impacts.

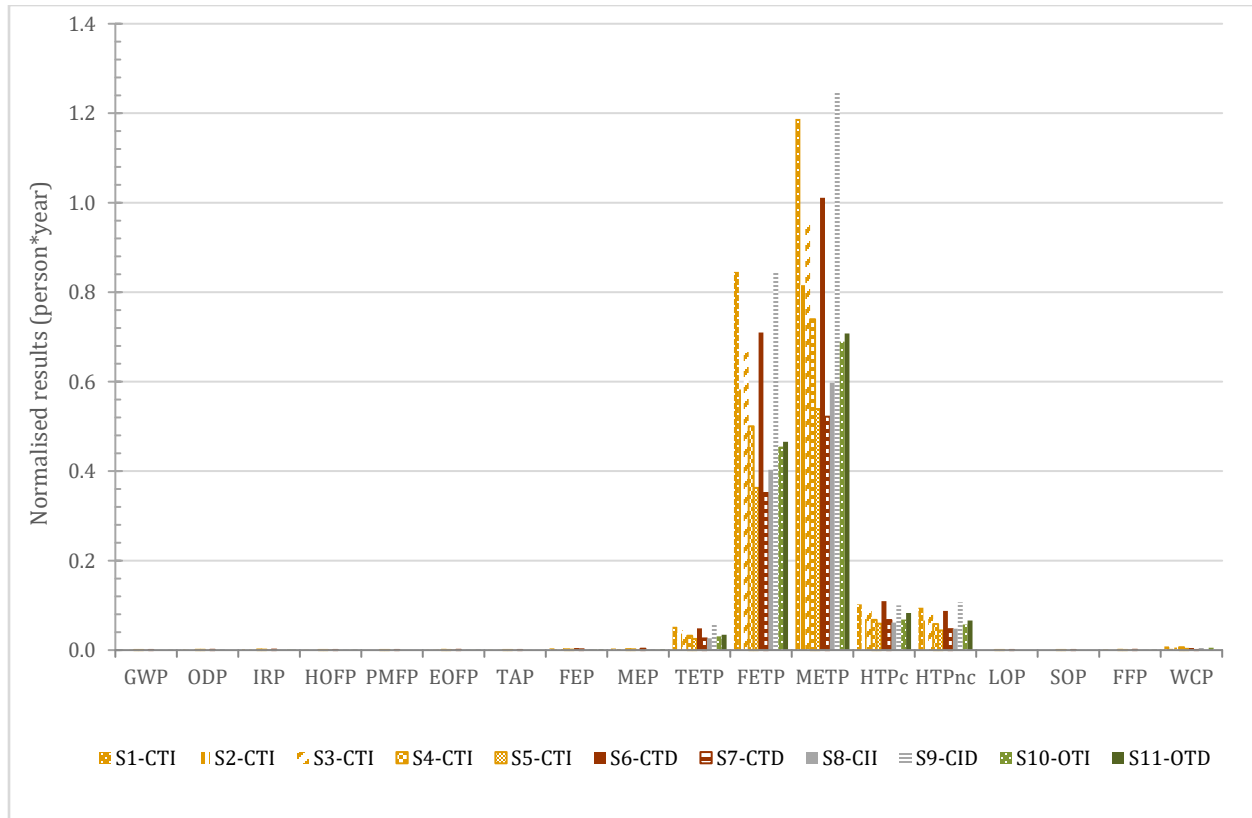

Figure II-14. Normalised results of the 18 midpoint categories for the 11 scenarios over their entire life cycle.

Figure II-15 to Figure II-24 allow visualizing the distribution of the impact of the agricultural phase in the toxicity categories. They are two figures for each category. The first one was made in comparison to the highest scenario as is typically shown in SimaPro for LCA results. This allows a comparison of all processes between the different scenarios, whereas the second one permits to see the contribution of each process in a specific scenario.

- **Figure II-15 and Figure II-16** for the terrestrial ecotoxicity category
- **Figure II-17 and Figure II-18** for the freshwater ecotoxicity
- **Figure II-19 and Figure II-20** for the marine ecotoxicity
- **Figure II-21 and Figure II-22** for the human carcinogenic toxicity
- **Figure II-23 and Figure II-24** for the human non-carcinogenic toxicity

As complementary and necessary information for the analysis of the agricultural toxicity results, **Table II-29** shows the results of the total life cycle. This leads to the following conclusions on the five toxicity impact categories:

➤ **terrestrial ecotoxicity**

In the terrestrial ecotoxicity category, it is the agricultural phase that has the greatest impact on the entire life cycle, namely the PT-disease control. The material most impactful is the (copper production, primary {RAS}) with 47%-56% for the production of copper oxide fungicides. Copper is also used for the building construction of chemical factories.

Terrestrial ecotoxicity

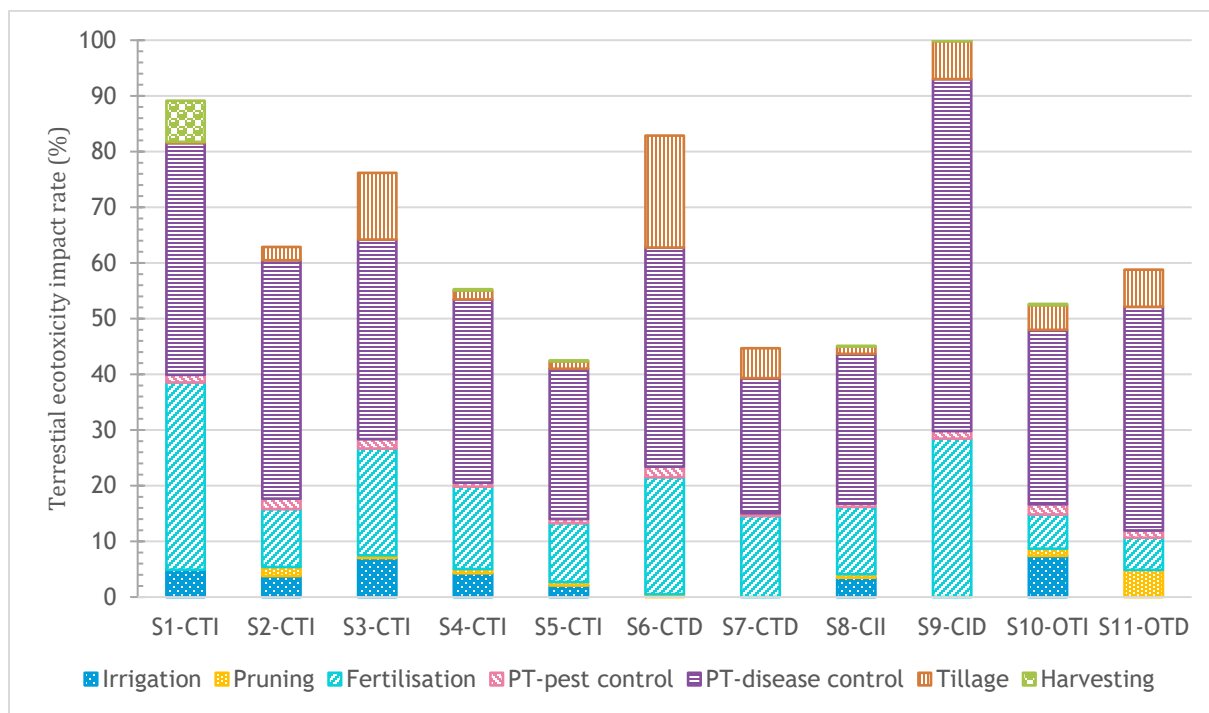

Figure II-15. Distribution of the impact of the agricultural phase in the TETP category. Graphic made in comparison of the highest scenario (S9-CTI) as typically shown in SimaPro for LCA results.

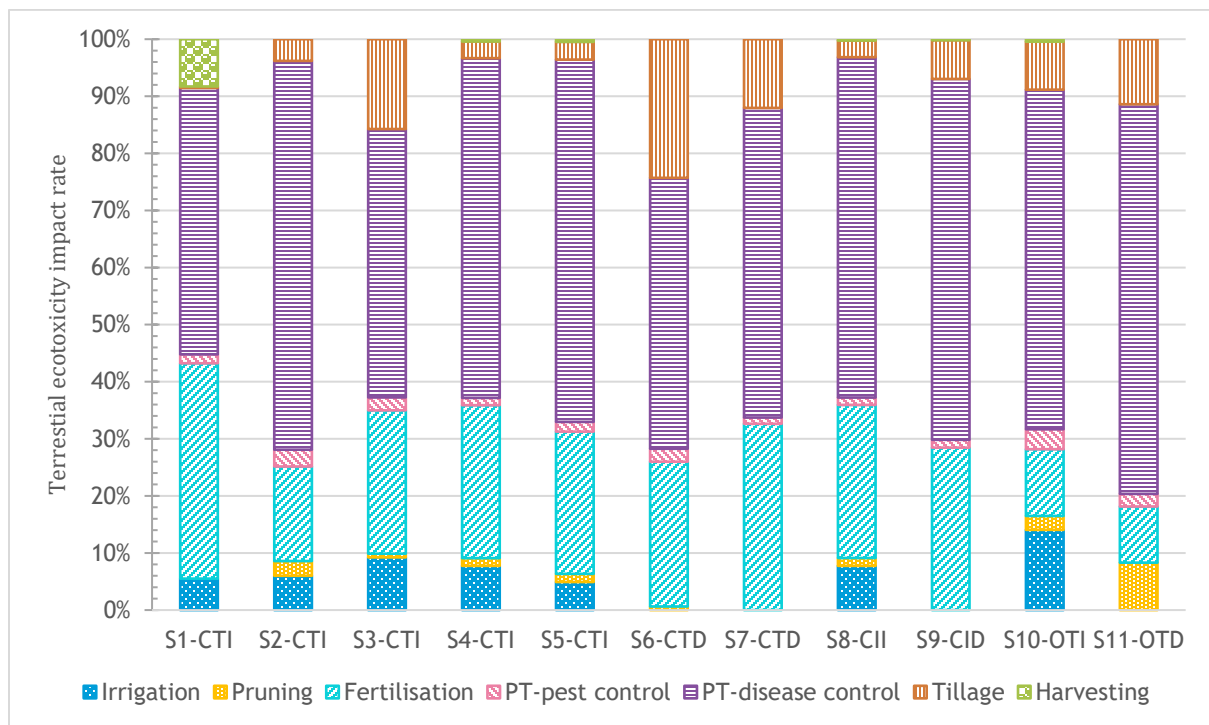

Figure II-16. Distribution of the impact of the agricultural phase in the TETP category. 100% stacked histogram.

Freshwater ecotoxicity

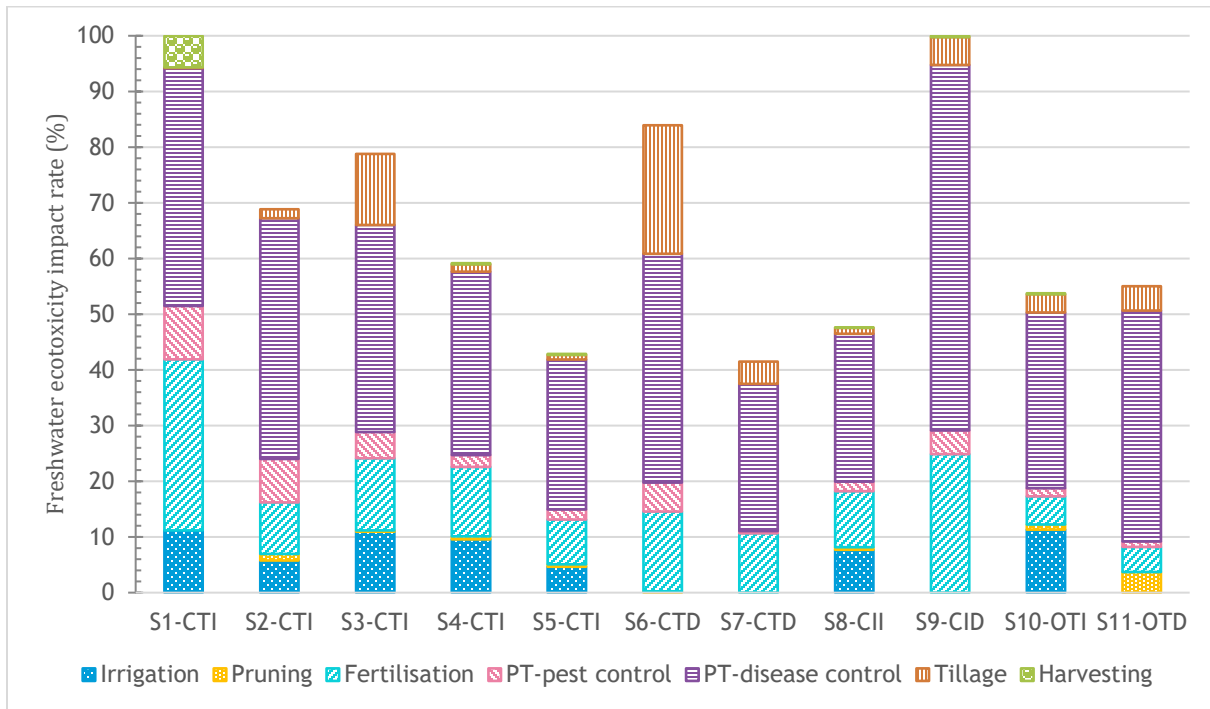

Figure II-17. Distribution of the impact of the agricultural phase in the FETP category. Graphic made in comparison of the higher scenarios (S9-CTI and S2-CTI) as typically shown in SimaPro for LCA results.

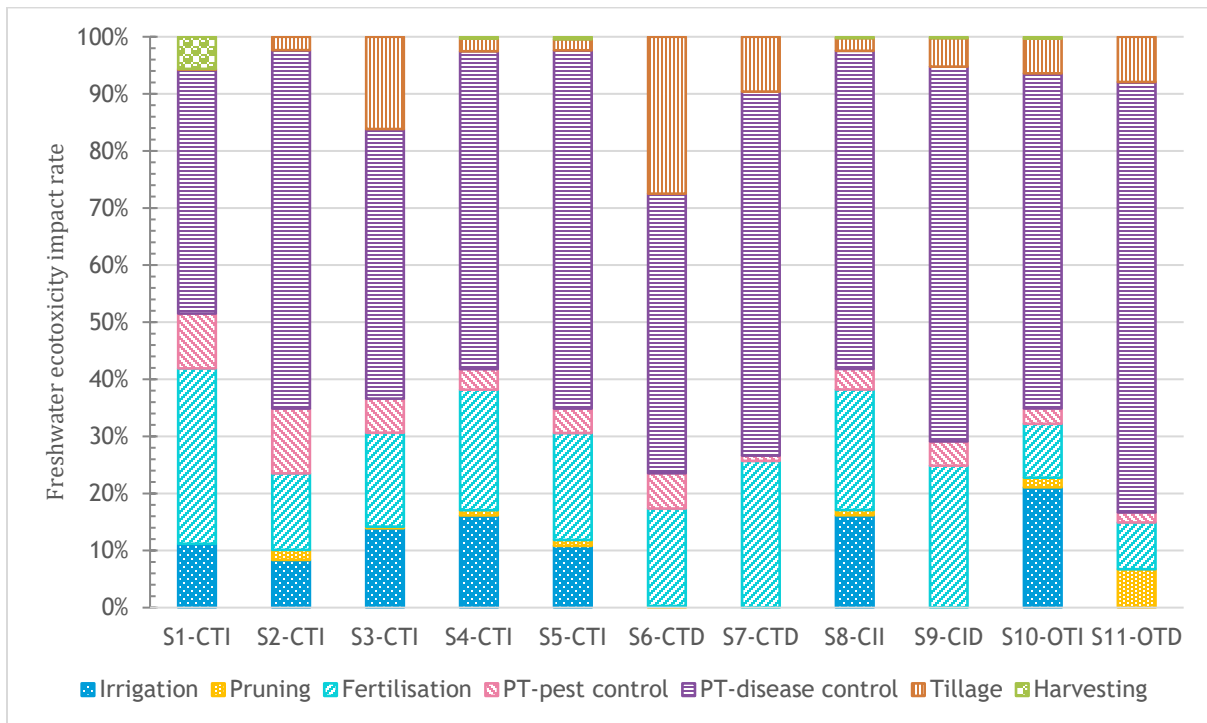

Figure II-18. Distribution of the impact of the agricultural phase in the FETP category. 100% stacked histogram.

Marine ecotoxicity

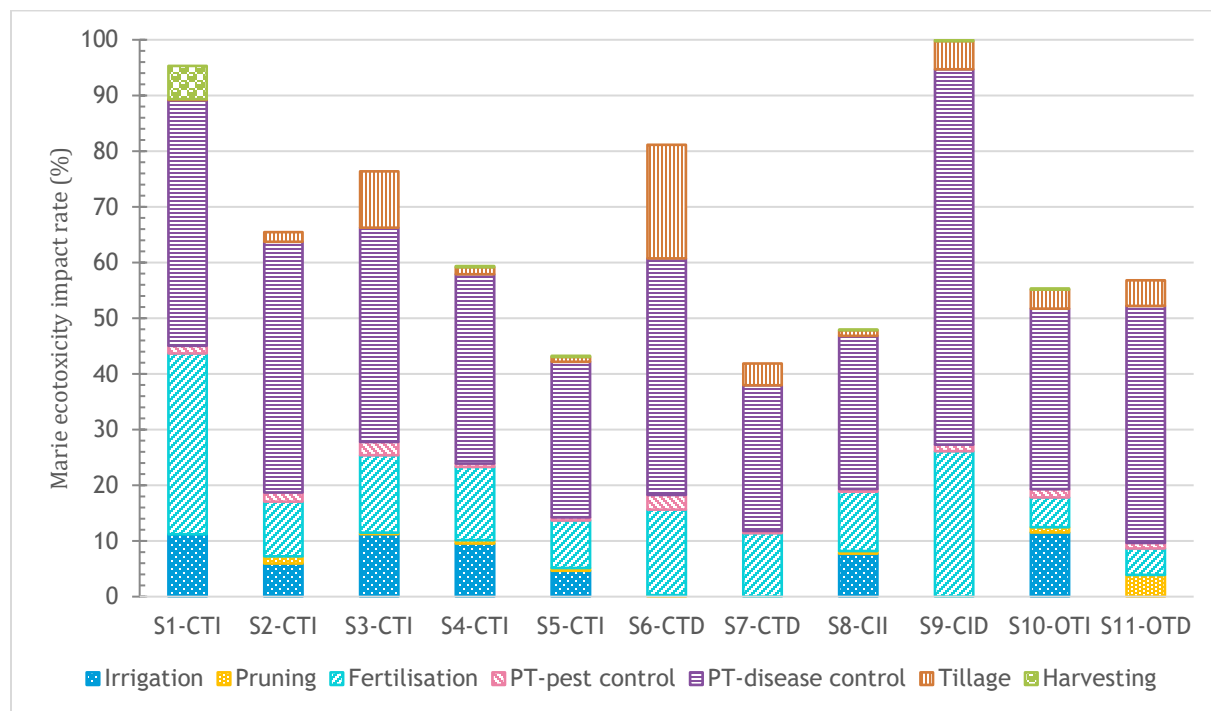

Figure II-19. Distribution of the impact of the agricultural phase in the METP category. Graphic made in comparison of the highest scenario (S9-CTI) as typically shown in SimaPro for LCA results.

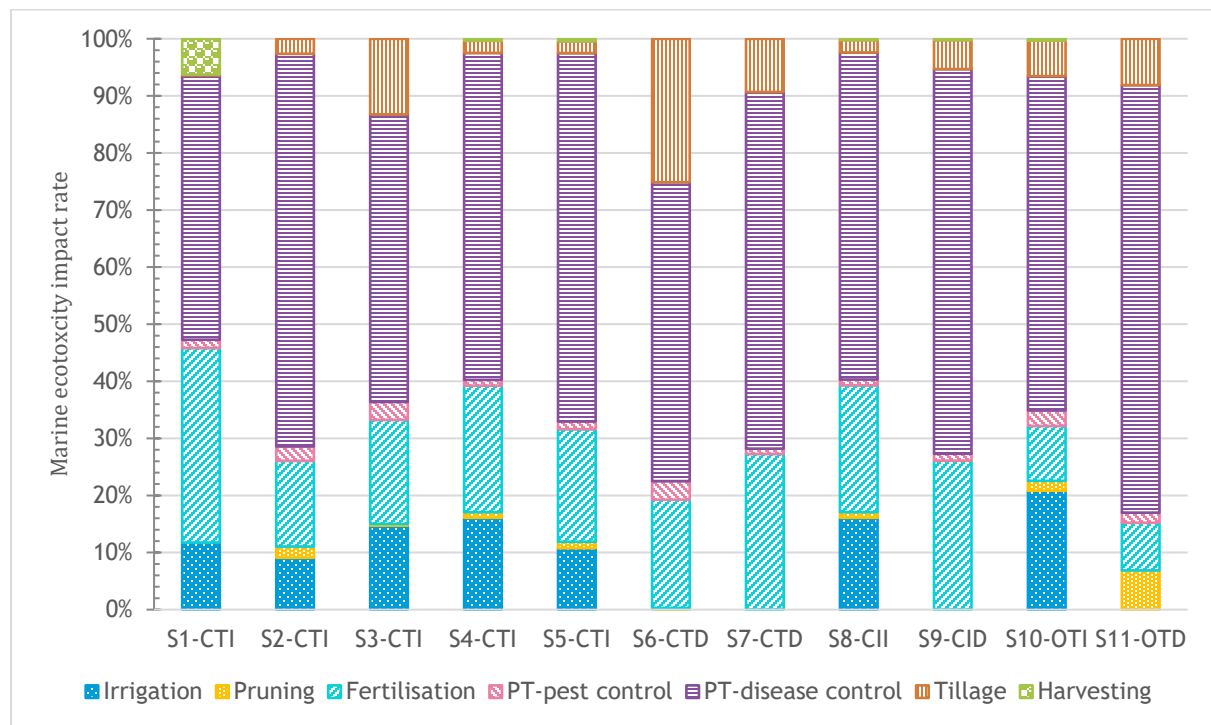

Figure II-20. Distribution of the impact of the agricultural phase in the METP category. 100% stacked histogram.

Human carcinogenic toxicity

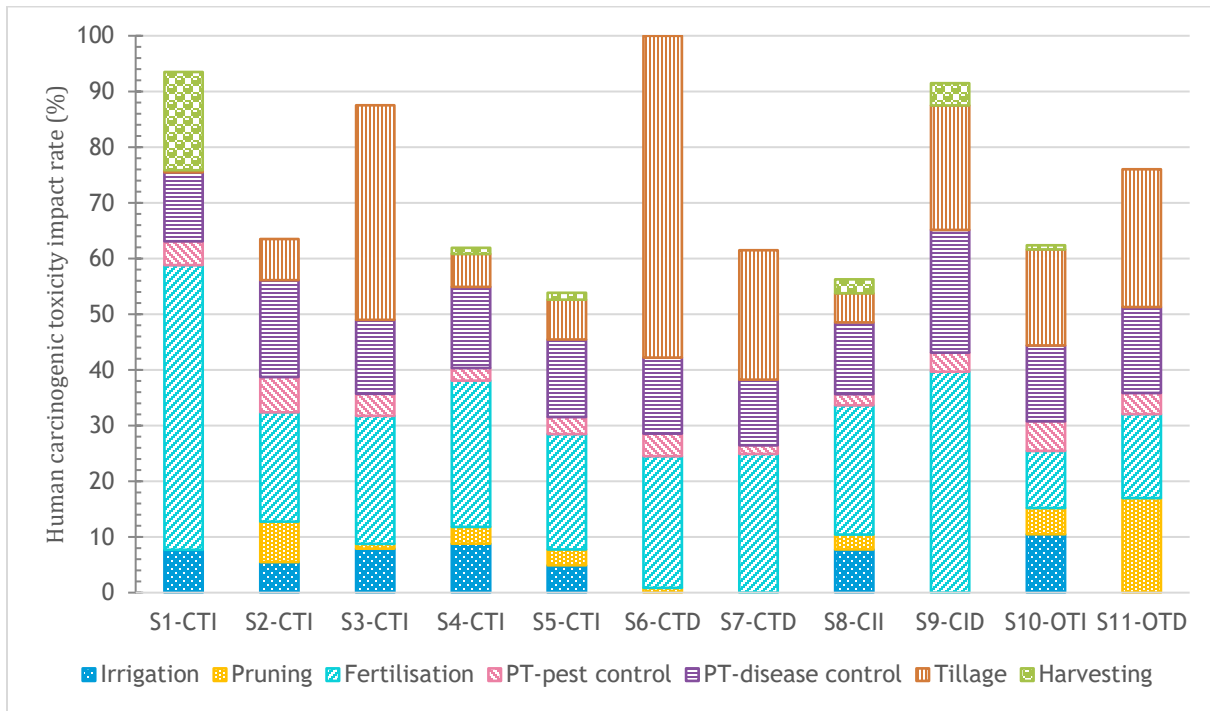

Figure II-21 Distribution of the impact of the agricultural phase in the HTPc category. Graphic made in comparison of the highest scenario (S9-CTI) as typically shown in SimaPro for LCA results

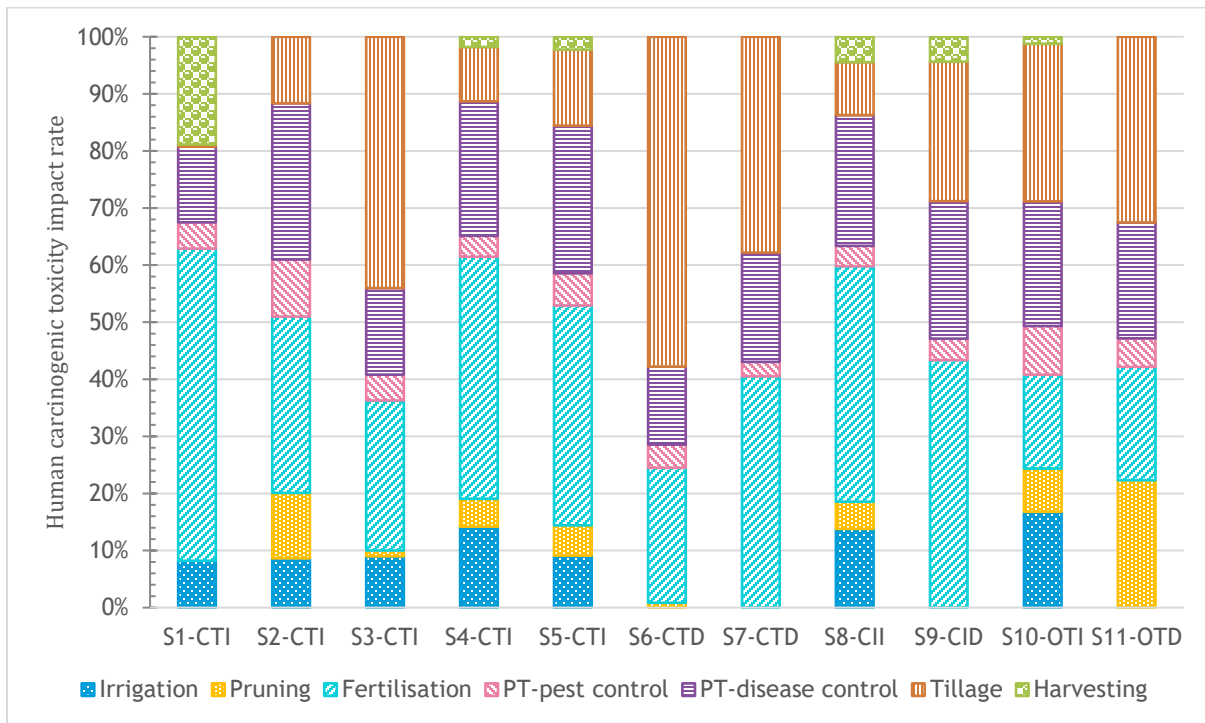

Figure II-22. Distribution of the impact of the agricultural phase in the HTPc category. 100% stacked histogram.

Human non-carcinogenic toxicity

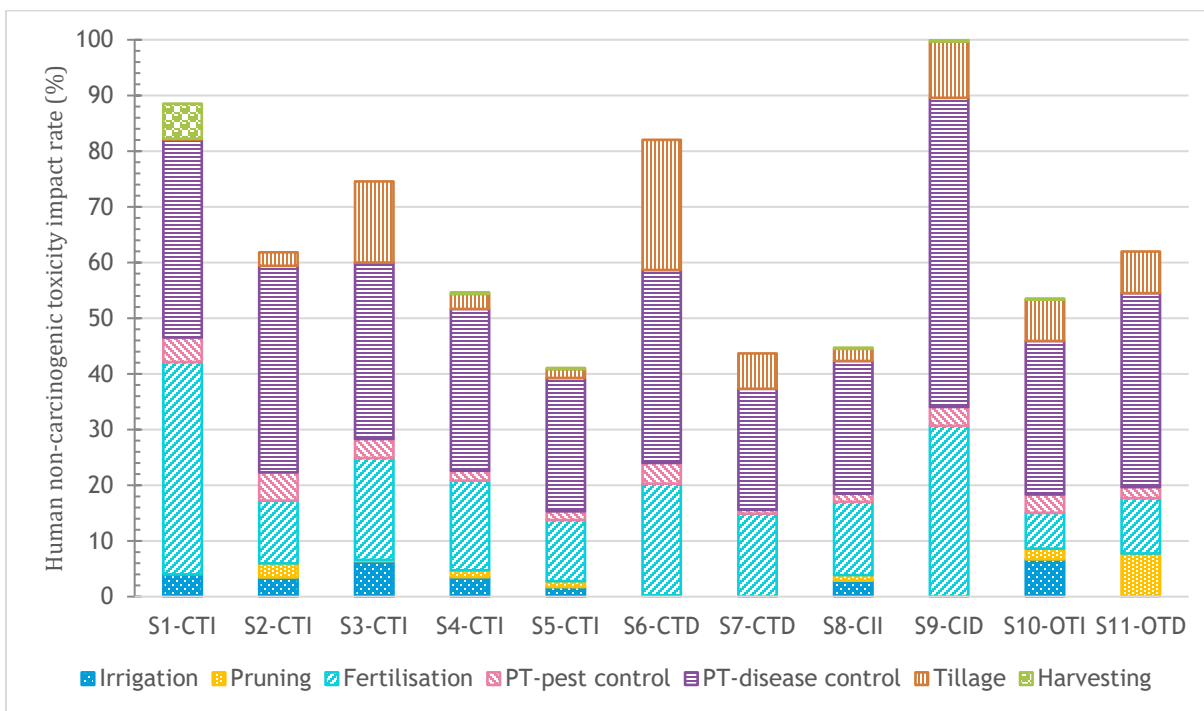

Figure II-23. Distribution of the impact of the agricultural phase in the HTPnc category. Graphic made in comparison of the highest scenario (S9-CTI) as typically shown in SimaPro for LCA results

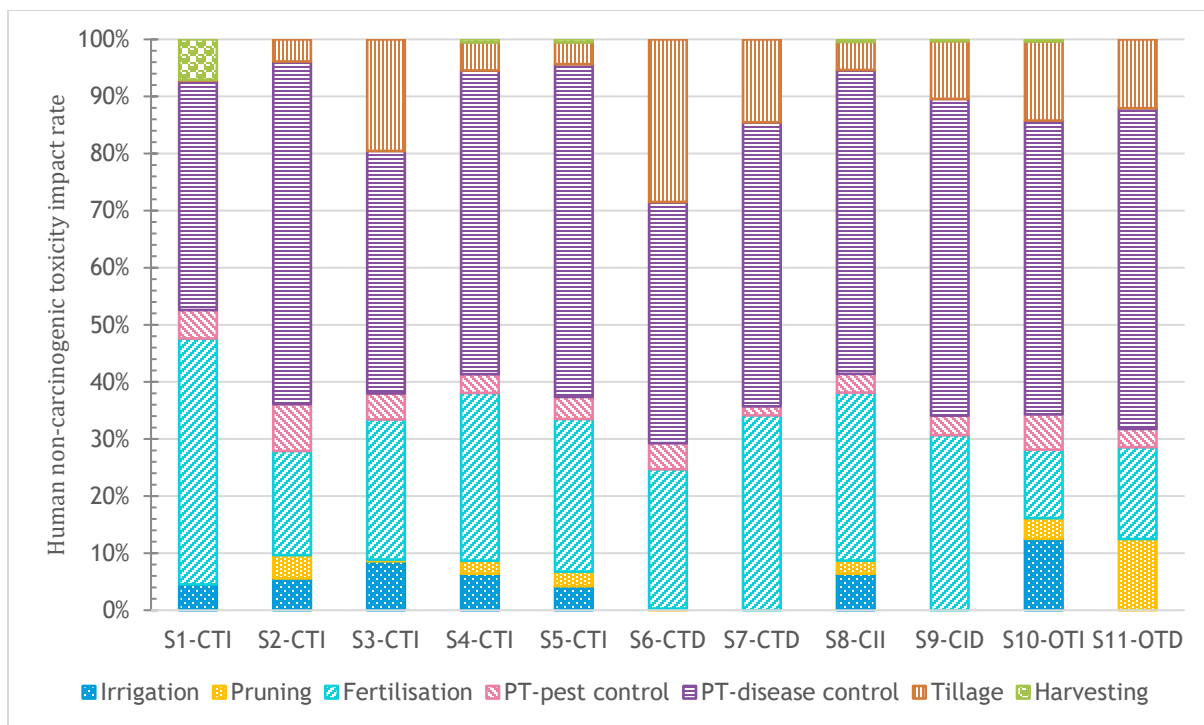

Figure II-24. Distribution of the impact of the agricultural phase in the HTPnc category. 100% stacked histogram.

Table II-29. Toxicity midpoint indicators and their main contributing processes of the analysis of 1 FU over the life cycle of the 11 scenarios with ReCiPe 2016.

Midpoint indicator	S1-CTI	S2-CTI	S3-CTI	S4-CTI	S5-CTI	S6-CTD	S7-CTD	S8-CII	S9-CID	S10-OTI	S11-OTD
Terrestrial ecotoxicity	Agricultural phase; PT-disease control										
	Copper production (52%)	Copper production (55%)	Copper production (48%)	Copper production (51%)	Copper production (47%)	Copper production (48%)	Copper production (43%)	Copper production (48%)	Copper production (56%)	Copper production (51%)	Copper production (51%)
Freshwater ecotoxicity	Agricultural phase; PT-disease control										
	Copper production (34%)	Copper production (37%)	Copper production (34%)	Copper production (35%)	Copper production (34%)	Copper production (34%)	Copper production (34%)	Copper production (33%)	Copper production (41%)	Copper production (36%)	Copper production (40%)
Marine ecotoxicity	Agricultural phase; PT-disease control										
	Copper production (36%)	Copper production (40%)	Copper production (36%)	Copper production (36%)	Copper production (35%)	Copper production (36%)	Copper production (34%)	Copper production (34%)	Copper production (42%)	Copper production (36%)	Copper production (39%)
Human carcinogenic toxicity	Agricultural phase (62%)	Oil extraction (49%)	Agricultural phase (62%)	Oil extraction (50%)	Oil extraction (58%)	Agricultural phase (64%)	Oil extraction (51%)	Oil extraction (55%)	Agricultural phase (61%)	Oil extraction (50%)	Agricultural phase (52%)
	Fertilisation (34%)	Infrastructure (46%)	Tillage (26%)	Infrastructure (47%)	Infrastructure (54%)	Tillage (37%)	Infrastructure (47%)	Infrastructure (52%)	Fertilisation (26%)	Infrastructure (46%)	Tillage (17%)
	Single superphosphate production (14%)	Steel production (30%)	Glyphosate production (14%)	Steel production (32%)	Steel production (35%)	Steel production (15%)	Steel production (33%)	Steel production (34%)	Nutrient supply from calcium nitrate (14%)	Steel production (31%)	Steel production (28%)
Human non-carcinogenic toxicity	Agricultural phase; PT-disease control										
	Copper production (34%)	Copper production (36%)	Copper production (32%)	Copper production (33%)	Copper production (31%)	Copper production (31%)	Copper production (28%)	Copper production (31%)	Copper production (36%)	Copper production (32%)	Copper production (31%)

➤ **freshwater ecotoxicity**

The outcomes are similar to the ones found for terrestrial ecotoxicity. The agricultural phase has the greatest impact on the life cycle, more specifically the PT-disease control with copper production as the main material (with ranges of 34%-41%).

➤ **marine ecotoxicity**

Marine ecotoxicity category joins the two preceding categories (terrestrial and freshwater ecotoxicity) in the analysis of its results the agricultural phase is the most impactful, with PT-disease control being the hotspot of said phase.

➤ **human carcinogenic toxicity**

Unlike the ecotoxicities categories (terrestrial, freshwater and marine ecotoxicity), the human carcinogenic toxicity was affected differently among the eleven case studies. The analysis of each is as follows:

S1-CTI

The hotspot in the life cycle is the agricultural phase (62%), in particular, the fertilisation (34%) with the single superphosphate production used in market of phosphate fertiliser as P₂O₅.

S2-CTI

For the production phase -oil extraction- (49%), it is the oil mill infrastructure (building and containers); steel production converter, chromium steel (16%); steel production electric, chromium steel (14%) that impacts the most. For the agricultural phase (44%): fertilisation (13.5%) is not far from PT-disease control (11.9%).

S3-CTI

Tillage is the hotspot in the agricultural phase with 26%, this is due to the utilisation of glyphosate (Glyphosate production 14%), after that, it is the fertilisation (16%) for the single phosphate production (6%) that impacts the most.

S4-CTI

For the production phase -oil extraction- (50%), it is the oil mill infrastructure (building and containers); steel production converter, chromium steel (17%); steel production electric, chromium steel (15%) that impacts the most. For the agricultural phase (44%): fertilisation is the hotspot with 18%.

S5-CTI

Similar to S2-CTI and S4-CTI, oil extraction is the hotspot (58%) with 54% for infrastructure (building and containers) instead of 46% and 47% in the other mentioned scenarios.

S6-CTD

Hotspot in the life cycle: agricultural phase (64%) with 37% coming from tillage. This is caused by two main datasets:

- tillage by tractor (19%), so the use of the tractor with a rotary cultivator for achieving the tillage. The main material is steel production converter, chromium steel (4%) and steel production electric, chromium steel (10%) for the 'agricultural machinery' dataset,
- and the use of glyphosate (13%)

After that comes the oil extraction (31%) with the oil mill infrastructure (building and containers).

S7-CTD

Hotspot in the life cycle: oil extraction (51%) - oil mill infrastructure (building and containers): steel production converter, chromium steel (17%); steel production electric, chromium steel (15%).

In second place came the agricultural phase (42%): fertilisation being the highest with 17%, followed by tillage (16%).

S8-CII

Hotspot in the life cycle: oil extraction (55%) - oil mill infrastructure (building and containers): steel production converter, chromium steel (18%); steel production electric, chromium steel (16%).

For the agricultural phase (36%): fertilisation is the hotspot with 15%, followed by PT-disease control (8%).

S9-CID

For the agricultural phase (61%): fertilisation is the hotspot with 17%, followed by PT-disease control and tillage, both with 15%. The materials more impactful are nutrient supply from calcium nitrate (14%) in fertilisation for the nitrogen fertiliser as N dataset, and copper oxide production (12%) in PT-disease control. The second most impactful phase of the life cycle is oil extraction with 34%.

S10-OTI

Oil extraction was the hotspot in the life cycle (50%). The oil mill infrastructure (building and containers) with steel production converter, chromium steel (17%), and steel production electric, chromium steel (15%).

For the agricultural phase (42%): tillage is the hotspot with 12% due to the agricultural machinery, followed by PT-disease control (9%) for the use of copper oxide.

S11-OTD

For the agricultural phase (52%): tillage is the hotspot with 17% due to the agricultural machinery production, followed by Pruning (12%), PT-disease control (11%) and fertilisation (10%).

On the life cycle, oil extraction accounted for 41%.

➤ **human non-carcinogenic toxicity**

For the SI-CTI scenario, even if fertilisation (36.7%) is slightly larger than PT-disease control (34.3%), still the material that impacts the most in all life cycle is the copper production (34%).

For the other ten scenarios, it is also the agricultural phase that has the greatest impact on the entire life cycle, but what made the biggest impact was PT-disease control with 28%-36% for the production of copper oxide fungicides.

The copper compounds fungicides used for the disease control phytosanitary treatment showed a significant impact on ecotoxicity indicators. This was also found by Gentil et al. (2020a) for the phytosanitary treatment of open-fields tomatoes: copper sulfate dominates ecotoxicity impacts, especially freshwater ecotoxicity from pesticide field emissions. On the olive growing system, Mohamad et al. (2014) found that mechanical weed control and biological pest control contribute to the mitigation of environmental impact and the reduction of costs, compared to the use of chemical pesticides and herbicides. However, the authors highlighted that much more attention must be given to the application of copper, particularly in the organic system; it should be used in minimum quantities to reduce as much as possible its impact on the ecosystem quality (Mohamad et al., 2014).

II.2.4.2.2 Characterisation midpoint results – life cycle

The environmental impacts results of the life cycle of olive oil production per FU are available in **Appendix H; Table H.3**. In order to make the data more digestible, sub-groups of analysis were carried out.

Figure II-25 illustrates the first configuration (CTI: conventional agriculture, traditional intensity, irrigation system). As already observed in climate change results (section II.2.4.1 Climate change), scenario S1-CTI is the most impactful of the five, and S5-CTI is the most environmentally friendly. Scenario S1-CTI is most affected by the fertilisation stage, as it uses about 4.5 times the tractor time compared to the other scenarios and has the lowest oil yield, contrary to the S5-CTI scenario, which has the highest yield of all the scenarios.

To assess the significance of a difference between two scenarios where the results are not certain, the Monte Carlo analysis can be used. Such is the case for scenarios S1-CTI and S3-CTI with the categories of freshwater eutrophication (FEP), fine particulate matter formation (PMFP), ionising radiation (IRP). **Figure II-26** confirmed that the comparison results of S1-CTI and S3-CTI presented in **Figure II-25** are significant.

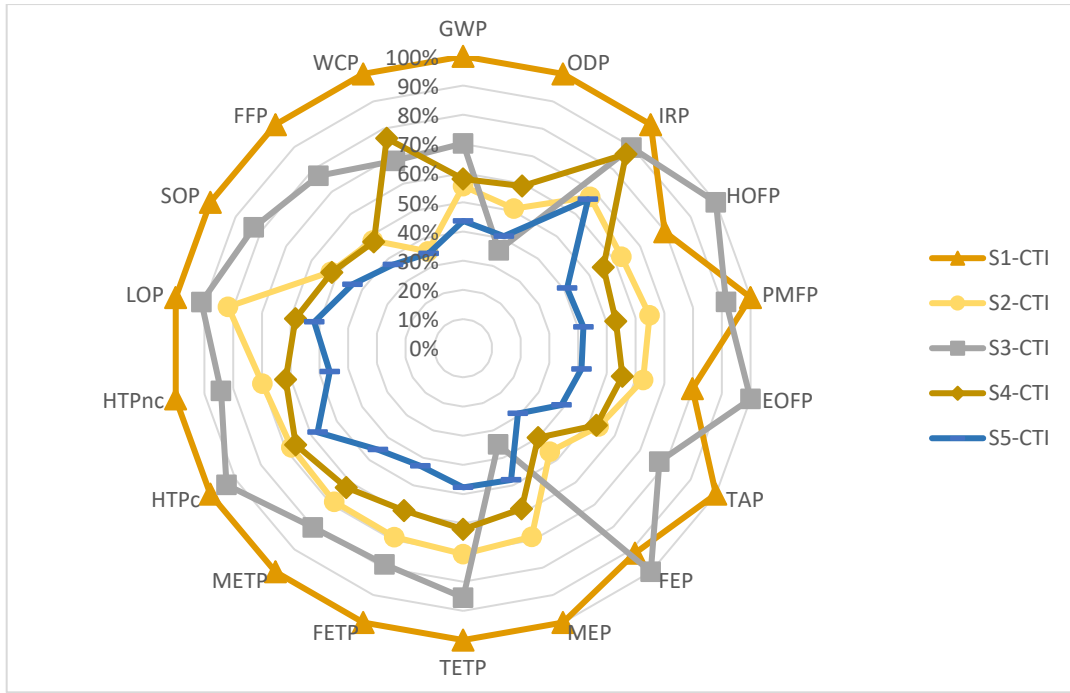

Figure II-25. Midpoint categories results for the life cycle of the CTI's scenarios (S1-CTI to S5-CTI).

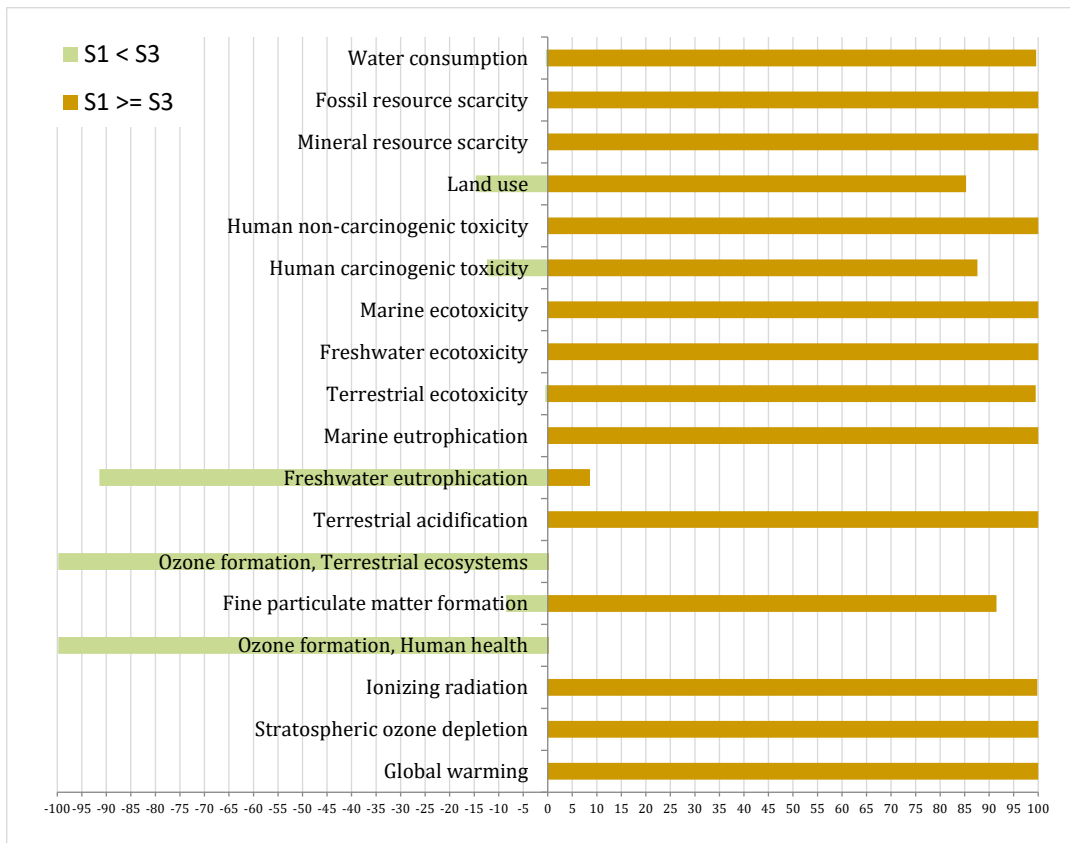

Figure II-26. Uncertainty analysis of scenario S1-CTI vs S3-CTI.

Another interesting feature to be illustrated on the radar graphs is the analysis of the “Irrigated vs Dry System” (Figure II-27) as before done in section II.2.4.1 Climate change. The conclusions are compelling:

- the scenario with the highest emissions is S9-CID
- the irrigated scenarios (S8-CII and S10-OTI) in dotted lines are more environmentally positive (less impact) than dry scenarios (S9-CID and S11-OTD).
- Irrigated scenarios have a bigger olive oil yield, S8 with 1081.50 L/ha/yea and S10 with 882 L/ha/year vs S9 with 378.10 L/ha/year and S11 with 334.80 L/ha/year.

This suggests that the large difference in olive productivity per hectare is positively influenced mainly by the use of irrigation. The only impact category in which the irrigated scenarios are more impactful is evidently in water use (WCP) since for dry systems it is equal to zero. Yet, the impact made by the irrigation process is highly outweighed by the benefits it provides.

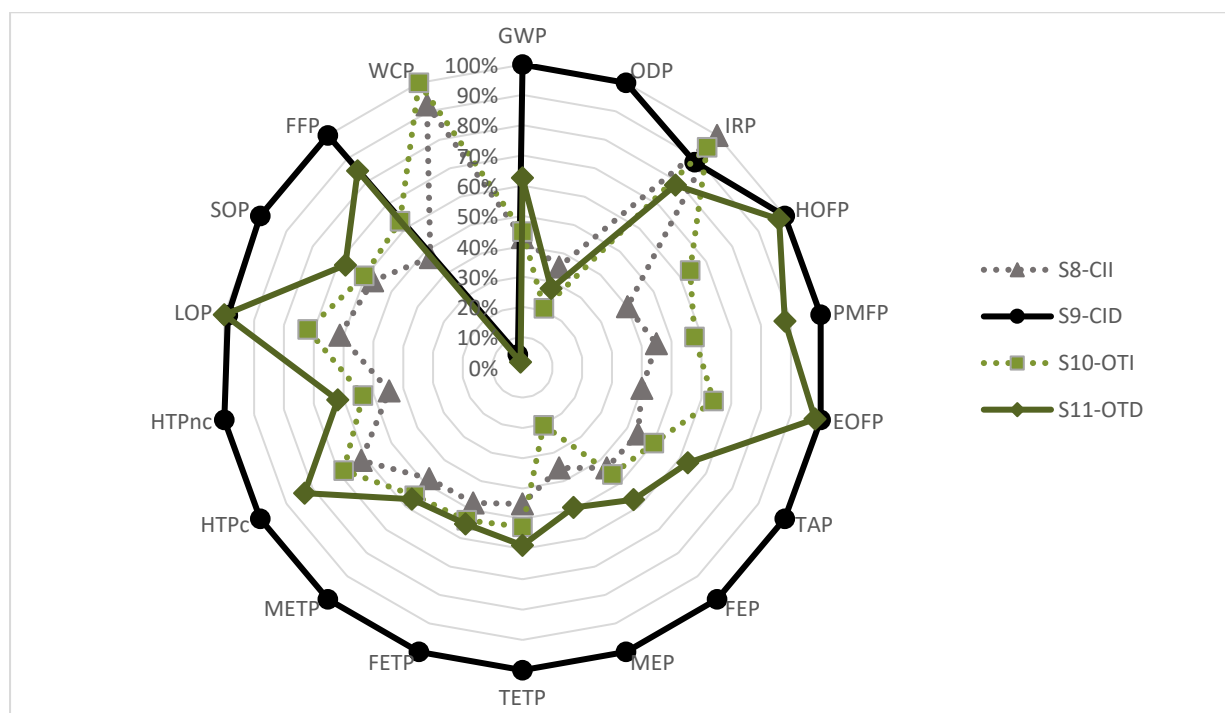

Figure II-27. Characterisation results for the life cycle of irrigated scenarios (S8-CII and S10-OTI) -in dotted lines- vs dry scenarios (S9-CID and S11-OTD) -continuous lines-.

II.2.4.2.3 Characterisation endpoint results – life cycle

The endpoint indicators, or “Areas of Protection” (AoP) depend the societal interests with regards to human health, ecosystems or ecosystem services and resources (Hauschild et al., 2018). **Figure II-28** shows the aggregated impacts for the 11 scenarios cases studied in France, in its agricultural phase, according to the ReCiPe endpoint methodology.



Figure II-28. Endpoint areas of protection for the life cycle of the 11 scenarios.

II.2.4.3 Sensitivity analysis of the impact method

Joliet et al. (2017) stated that the objective of a sensitivity analysis is to test the robustness of the results and their sensitivity to the data, assumptions, and models used. To test the sensitivity to the selected method, the ReCiPe 2016 method (**Appendix H; Table H.3**) was compared against the EF 3.0 method (**Appendix H; Table H.4**) for the environmental impacts of the life cycle of olive oil production per FU. The categories with the same unit are presented in **Table II-30**, namely climate change, stratospheric ozone depletion, freshwater eutrophication, and marine eutrophication. The other categories (with different units on the same category depending on the method) are presented in **Table II-31**.

Between the ReCiPe 2016 method and the EF method the same conclusions can be drawn. This can be explained by some of the models used behind each method (models for the ReCiPe 2016 method are available in **Table II-21**, and the ones adopted as in EF Method are available in **Appendix F**). As discussed in section II.2.3.2 Method robustness; Impact assessment models are characterized by uncertainties, which influence the robustness of the different indicators. The ReCiPe 2016 models and units are different from the ones used by the EF Method. In comparison to the ReCiPe 2016 method, only the Global warming (climate change) and Stratospheric ozone depletion categories use the same model as in EF, hence it can be assured that the level of robustness is a level I.

Through the colour scale in **Table II-30**, it can be seen that the order of impact of the scenarios is the same no matter which of the two models is used, except for the stratospheric ozone depletion category. The colour coding is per impact category (columns), red for the scenario with the highest environmental impact and green for the most environmentally positive (less emissions). The colour scale is going from red (more emissions) - orange - yellow - pale green to deep green (less emissions). For table **Table II-31** the colour coding is the same, just taking attention that now the impact categories are per line.

Table II-30. Sensitivity analysis of selected LCIA methods. Results per FU over the life cycle of olive oil production in France.

Impact category	Climate change		Stratospheric ozone depletion		Freshwater eutrophication		Marine eutrophication	
	kg CO ₂ eq		kg CFC11 eq		kg P eq		kg N eq	
Unit	ReCiPe	EF 3.0	ReCiPe	EF 3.0	ReCiPe	EF 3.0	ReCiPe	EF 3.0
S1-CTI	6.41E+00	6.43E+00	8.84E-05	4.97E-07	2.46E-03	2.46E-03	1.71E-02	6.56E-02
S2-CTI	3.56E+00	3.58E+00	4.50E-05	4.09E-07	1.24E-03	1.24E-03	1.18E-02	4.56E-02
S3-CTI	4.50E+00	4.53E+00	3.16E-05	6.56E-07	2.68E-03	2.68E-03	6.00E-03	2.82E-02
S4-CTI	3.72E+00	3.73E+00	5.23E-05	4.19E-07	1.07E-03	1.07E-03	1.00E-02	3.91E-02
S5-CTI	2.80E+00	2.81E+00	3.61E-05	3.33E-07	7.82E-04	7.82E-04	8.22E-03	3.20E-02
S6-CTD	5.15E+00	5.20E+00	3.53E-05	7.53E-07	3.00E-03	3.00E-03	6.68E-03	3.36E-02
S7-CTD	3.64E+00	3.66E+00	4.89E-05	4.35E-07	1.07E-03	1.07E-03	1.44E-02	5.54E-02
S8-CII	3.03E+00	3.05E+00	4.00E-05	3.62E-07	8.69E-04	8.69E-04	7.67E-03	3.01E-02
S9-CID	7.07E+00	7.10E+00	1.13E-04	6.45E-07	2.00E-03	2.00E-03	2.17E-02	8.41E-02
S10-OTI	3.15E+00	3.17E+00	2.35E-05	4.86E-07	9.25E-04	9.25E-04	4.42E-03	2.06E-02
S11-OTD	4.35E+00	4.40E+00	3.13E-05	6.37E-07	1.14E-03	1.14E-03	1.07E-02	4.64E-02

Table II-31. Sensitivity analysis. Results per FU over the life cycle of olive oil production in France.

<i>a</i>	Impact category	Unit	S1-CTI	S2-CTI	S3-CTI	S4-CTI	S5-CTI	S6-CTD	S7-CTD	S8-CII	S9-CID	S10-OTI	S11-OTD
R	Ionising radiation	kBq Co-60 eq	8.55E-01	5.80E-01	7.68E-01	7.43E-01	5.71E-01	7.81E-01	5.18E-01	6.75E-01	5.97E-01	6.40E-01	5.30E-01
EF	Ionising radiation	kBq U-235 eq	9.24E-01	6.25E-01	8.55E-01	7.80E-01	5.99E-01	8.90E-01	5.72E-01	7.02E-01	7.00E-01	6.92E-01	6.31E-01
R	Ozone formation. Human health	kg NOx eq	1.57E-02	1.24E-02	1.97E-02	1.09E-02	8.13E-03	2.75E-02	1.03E-02	8.91E-03	2.22E-02	1.40E-02	2.12E-02
R	Ozone formation. Terrestrial ecosystems	kg NOx eq	1.60E-02	1.26E-02	2.01E-02	1.11E-02	8.30E-03	2.80E-02	1.05E-02	9.08E-03	2.26E-02	1.43E-02	2.17E-02
EF	Photochemical ozone formation	kg NMVOC eq	2.03E-02	1.55E-02	2.47E-02	1.37E-02	1.03E-02	3.39E-02	1.32E-02	1.12E-02	2.74E-02	1.74E-02	2.67E-02
R	Fine particulate matter formation	kg PM2.5 eq	1.17E-02	7.61E-03	1.07E-02	6.24E-03	4.92E-03	1.35E-02	6.53E-03	5.22E-03	1.16E-02	6.65E-03	1.01E-02
EF	Particulate matter	disease inc.	8.36E-07	5.00E-07	4.12E-07	4.56E-07	4.49E-07	4.66E-07	8.93E-07	3.68E-07	8.95E-07	2.73E-07	7.77E-07
R	Human non-carcinogenic toxicity	kg 1.4-DCB	1.41E+01	9.86E+00	1.19E+01	8.72E+00	6.56E+00	1.31E+01	6.97E+00	7.14E+00	1.59E+01	8.51E+00	9.81E+00
EF	Human toxicity. non-cancer	CTUh	4.20E-07	3.15E-07	3.03E-07	1.57E-07	1.15E-07	3.54E-07	1.02E-07	1.25E-07	3.22E-07	1.30E-07	1.90E-07
R	Human carcinogenic toxicity	kg 1.4-DCB	2.83E-01	1.92E-01	2.65E-01	1.88E-01	1.63E-01	3.03E-01	1.86E-01	1.71E-01	2.77E-01	1.89E-01	2.29E-01
EF	Human toxicity. cancer	CTUh	7.74E-09	5.66E-09	8.84E-09	5.57E-09	4.95E-09	1.01E-08	5.87E-09	5.16E-09	8.08E-09	5.65E-09	6.98E-09
R	Terrestrial acidification	kg SO ₂ eq	3.00E-02	1.61E-02	2.33E-02	1.58E-02	1.17E-02	2.79E-02	1.39E-02	1.31E-02	2.96E-02	1.48E-02	1.84E-02
EF	Acidification	mol H+ eq	6.35E-02	3.79E-02	4.26E-02	3.54E-02	3.02E-02	5.15E-02	5.03E-02	2.85E-02	7.03E-02	2.82E-02	5.42E-02
R	Freshwater ecotoxicity	kg 1.4-DCB	1.04E+00	7.15E-01	8.18E-01	6.14E-01	4.45E-01	8.72E-01	4.31E-01	4.95E-01	1.04E+00	5.58E-01	5.70E-01
EF	Ecotoxicity. freshwater	CTUe	2.15E+02	1.29E+02	2.20E+02	1.17E+02	8.22E+01	2.47E+02	9.83E+01	9.44E+01	2.26E+02	9.35E+01	1.09E+02
R	Land use	m ² a crop eq	2.46E-01	2.01E-01	2.24E-01	1.44E-01	1.28E-01	2.61E-01	1.60E-01	1.30E-01	2.10E-01	1.53E-01	2.12E-01
EF	Land use	Pt	3.65E+01	3.03E+01	3.37E+01	2.09E+01	1.81E+01	4.01E+01	2.37E+01	1.85E+01	3.27E+01	2.29E+01	3.40E+01
R	Water consumption	m ³	2.19E+00	7.74E-01	1.50E+00	1.68E+00	7.57E-01	1.27E+00	3.42E-02	1.28E+00	6.27E-02	1.39E+00	2.56E-02
EF	Water use	m ³ depriv.	1.78E+01	6.28E+00	1.23E+01	1.27E+01	6.07E+00	1.08E+01	1.19E+00	9.84E+00	2.14E+00	1.04E+01	7.46E-01
R	Fossil resource scarcity	kg oil eq	1.42E+00	6.84E-01	1.09E+00	6.76E-01	5.31E-01	1.24E+00	6.67E-01	5.66E-01	1.19E+00	7.44E-01	9.88E-01
EF	Resource use. fossils	MJ	7.68E+01	4.02E+01	6.12E+01	4.30E+01	3.36E+01	6.77E+01	3.83E+01	3.70E+01	6.21E+01	4.40E+01	5.24E+01
R	Mineral resource scarcity	kg Cu eq	1.23E-01	6.46E-02	1.02E-01	6.41E-02	5.40E-02	1.14E-01	7.01E-02	5.69E-02	9.96E-02	6.00E-02	6.69E-02
EF	Resource use. minerals and metals	kg Sb eq	5.14E-04	2.60E-04	3.88E-04	2.56E-04	2.15E-04	4.13E-04	2.84E-04	2.28E-04	3.96E-04	2.56E-04	2.68E-04

^(a) R= ReCiPe 2016 Midpoint Method

EF= EF 3.0 Method

II.3 Conclusions

In this chapter, the environmental assessment of the production of olive oil from orchards and mills in the South of France was done from a Business-As-Usual perspective. The LCA methodology was adopted and explained for each of its four phases (goal and scope definition, life cycle inventory analysis, life cycle impact assessment, and life cycle interpretation). The FU was to "produce one litre of virgin/extra virgin olive oil" from cradle to grave, using the attributional approach. A complete inventory of the life cycle of all types of olive growing systems in France was provided and exhaustively detailed.

Through the state-of-the-art described in Chapter I, several studies attempting the environmental impact of olive oil production focused on hotspot identification to enhance the knowledge on the life cycle of such a system. The literature review converged on an unequivocal environmental hotspot, the agricultural upstream, that was also demonstrated in herein Chapter II. Comparison of extraction technologies appeared to be the less variable step of all stages of the olive oil production. In the present work, eleven scenarios were elaborated. The data came from eleven different orchards for the agricultural part. The choice of French olive oil producers was guided by the three options chosen to construct the scenarios: 1) Principle of agriculture (Conventional/Organic), 2) Irrigation system (Irrigated/Dry), and 3) Type of farming (Traditional/Intensive). The olive oil extraction data came from seven mills located in the same geographical area within the 2-phase system as extraction technology. Therefore, an average of these seven mills was used for the different scenarios, with the same impact on net reference units for all scenarios.

Even though LCA is a multi-criteria analysis, climate change was the impact category preferred by many authors, so an extensive section was dedicated to this analysis. The climate change results went from 2.80 kg CO₂-eq/L (scenario S5-CTI) to 7.07 kg CO₂-eq/L (scenario S9-CID). These results are in concordance with previous studies (El Hanandeh and Gharaibeh, 2016; Espi et al., 2013; Fernández-Lobato et al., 2021b, 2021a; Pattara et al., 2016; Proietti et al., 2017). The hotspot in the agricultural phase is fertilisation followed by tillage, which is mainly due to the nitrogen fertiliser employed and to use of the tractor for the spreading of fertilisers and pesticides.

The biogenic carbon from the permanent tree components was taken into account under three hypotheses. Calculations of the CO₂ sources and sinks to obtain the net carbon stock of the olive grove and its relation to the impact on climate change were done. Fernández-Lobato et al. (2021a) also reported negative C footprint values and found a significant relationship between olive fruit yield and the magnitude of C footprint: the higher the olive fruit yield, the more negative the C footprint was.

The climate change impact results suggested that the large difference in olive productivity per hectare is positively influenced mainly by the use of irrigation, the irrigated systems turned out to have a positive environmental impact (*i.e.* less CO₂-eq emissions) compared to the scenarios with the same type of agriculture and intensity. The impact made by the irrigation process is highly outweighed by the benefits it provides. This was supported through the radar graphs analysis "Irrigated vs Dry System". In fact, the best scenario among the eleven cases was S5-CTI (conventional, traditional, irrigated) which had a productivity of 1100.80 L/ha/year and the least attractive environmentally is S9-CID (conventional, intensive, dry) with 378.10

L/ha/year, almost three times less oil per hectare. This arises the question of how the FU significantly influences the way an LCA is performed, as well as its results and their interpretation. This issue has been largely addressed by several authors in the assessment of organic vs conventional food products (Boone et al., 2019; Roy et al., 2009; van der Werf et al., 2020). Principally because of the complexity of comparing the performance of conventional and organic farming systems not only by regarding productivity but also by taking into account the ecosystem services (Boone et al., 2019).

To discuss the other impact categories a normalisation of the outcome of the eleven scenarios over their entire life cycle was performed. The categories that stand out the most are those of toxicity (terrestrial ecotoxicity, freshwater ecotoxicity, marine ecotoxicity, human carcinogenic toxicity, and human non-carcinogenic toxicity). In the terrestrial, freshwater and marine ecotoxicity categories, the agricultural phase has the greatest impact on the entire life cycle, due to the PT-disease control. The material most impactful is the (copper production, primary {RAS}) for the production of copper oxide fungicides. Unlike the ecotoxicities categories, the human carcinogenic toxicity was affected differently among the eleven case studies, sometimes being the hotspot the agricultural phase, and other the production phase –oil extraction-. The material that stood out the most was steel production for the infrastructure of the olive oil mill.

To assess the significance of a difference between two scenarios where the results are not certain, the Monte Carlo analysis was used to evaluate data quality and uncertainties.

A sensitivity analysis of the impact method was also performed. The ReCiPe 2016 method was compared to the EF 3.0 method for the environmental impacts of the life cycle of olive oil production per FU. The categories within the same unit were climate change, stratospheric ozone depletion, freshwater eutrophication, and marine eutrophication. The remaining categories use different units for the same category in question. Nevertheless, between the ReCiPe 2016 method and the EF method the same conclusions can be drawn.

The Business-As-Usual perspective of olive oil production follows a linear approach in which by-products are not taken into account for re-integration as part of the process or for valorisation in other areas. Another way of looking at this system is "closing the loop" shifting from traditional linear production to a circular olive production system that recovers materials from organic residues, residues like olive pomace. This is the first principle of circular economy: an economic system that targets zero waste and pollution throughout materials lifecycles. Within this framework, the next chapter (Chapter III) aims to assess an innovative pathway from an environmentally perspective for the recovery of olive pomace.

II.4 References

- Arvalis-Institut du végétal, 2015. L'actu d'Arvalis - Plan de fumure Intégrer les valeurs fertilisantes des fumiers et lisiers [WWW Document]. Web-Agri. URL <http://www.web-agri.fr/conduite-elevage/culture-fourrage/article/integrer-les-valeurs-fertilisantes-des-produits-organiques-1178-115410.html> (accessed 5.18.20).
- Boone, L., Roldán-Ruiz, I., Van linden, V., Muylle, H., Dewulf, J., 2019. Environmental sustainability of conventional and organic farming: Accounting for ecosystem services in life cycle assessment. *Sci. Total Environ.* 695, 133841. <https://doi.org/10.1016/j.scitotenv.2019.133841>
- Busset, G., Sablayrolles, C., Vignoles, M., Belaud, J.P., 2015. Computer Aided Process Engineering for Sustainability Analysis of Food Production. *Chem. Eng. Trans.* 43, 1339–1344. <http://dx.doi.org/doi:10.3303/CET1543224>
- Colomb, V., Amar, S., Basset-Mens, C., Gac, A., Gaillard, G., Koch, P., Mousset, J., Salou, T., Tailleur, A., van der Werf, H., 2014. AGRIBALYSE®, the French LCI Database for agricultural products: High quality data for producers and environmental labelling. *OCLE - Ol. Corps Gras Lipides* 22, D104. <https://doi.org/10.1051/ocle/20140047>
- Dijkman, T.J., Birkved, M., Hauschild, M.Z., 2012. PestLCI 2.0: a second generation model for estimating emissions of pesticides from arable land in LCA. *Int. J. Life Cycle Assess.* 17, 973–986. <https://doi.org/10.1007/s11367-012-0439-2>
- Doble, M., Kumar, A., 2005. CHAPTER 8 - Biodegradation of Pesticides, in: Doble, M., Kumar, A. (Eds.), *Biotreatment of Industrial Effluents*. Butterworth-Heinemann, Burlington, pp. 89–100. <https://doi.org/10.1016/B978-075067838-4/50009-9>
- Ecoinvent, 2021. EcoQuery - direct acces to database [WWW Document]. URL <https://v36.ecoquery.ecoinvent.org> (accessed 11.15.21).
- El Hanandeh, A., Gharaibeh, M.A., 2016. Environmental efficiency of olive oil production by small and micro-scale farmers in northern Jordan: Life cycle assessment. *Agric. Syst.* 148, 169–177. <https://doi.org/10.1016/j.agsy.2016.08.003>
- E-Phy, 2021. ephy | [WWW Document]. *Cat. Prod. Phytopharm. Leurs Usages Matières Fertil. Supports Cult. Aut. En Fr.* Fr. Agency Food Environ. Occup. Health Saf. ANSES. URL <https://ephy.anses.fr/> (accessed 11.15.21).
- Espadas-Aldana, G., Vialle, C., Belaud, J.-P., Vaca-Garcia, C., Sablayrolles, C., 2019. Analysis and trends for Life Cycle Assessment of olive oil production. *Sustain. Prod. Consum.* 19, 216–230. <https://doi.org/10.1016/j.spc.2019.04.003>
- Espi, J.J., Clarens, F., Busset, G., Sablayrolles, C., Montrejaud-Vignoles, M., Carvalho, J., Fonseca, B., Delgado, F., Chacon, L., Capiscol, C., Trillo, R., 2013. Enhancing the competitiveness and reducing the carbon footprint of the olive oil sector through waste management optimisation: OILCA (with critical revision) [in spanish].
- Fantke, P., Antón, A., Basset-Mens, C., Nemecek, T., Roux, P., Renad-Gentié, C., Naviaux, P., Gentil, C., Peña, N., Melero, C., 2020. Operationalising Life Cycle Assessment of Pesticides (OLCA-Pest) - Final Project Report (No. ADEME 17-03-C0025). DTU.
- FAO, 2021. PHYTOSANITARY TREATMENTS [WWW Document]. *Food Agric. Organ. U. N. Int. Plant Prot. Conv.* URL <https://www.ippc.int/fr/core-activities/capacity-development/phytosanitary-system/phytosanitary-treatments/> (accessed 1.10.22).
- Fernández-Lobato, L., García-Ruiz, R., Jurado, F., Vera, D., 2021a. Life cycle assessment, C footprint and carbon balance of virgin olive oils production from traditional and intensive olive

- groves in southern Spain. *J. Environ. Manage.* 293, 112951. <https://doi.org/10.1016/j.jenvman.2021.112951>
- Fernández-Lobato, L., López-Sánchez, Y., Blejman, G., Jurado, F., Moyano-Fuentes, J., Vera, D., 2021b. Life cycle assessment of the Spanish virgin olive oil production: A case study for Andalusian region. *J. Clean. Prod.* 290, 125677. <https://doi.org/10.1016/j.jclepro.2020.125677>
- France Olive, 2020. CAHIER DE L'OLÉICULTEUR 2020.
- Frischknecht, R., Jungbluth, N., Althaus, H.-J., Doka, G., Heck, T., Hellweg, S., Hischier, R., Nemecek, T., Rebitzer, G., Spielmann, M., Wernet, G., 2007. Overview and methodology Data v20 (2007) Ecoinvent report No 1. Swiss Centre for Life Cycle Inventories, Dübendorf.
- Gazeau, G., 2012. Agriculture biologique : compost de marc de raisin [WWW Document]. Chamb. Agric. URL <https://paca.chambres-agriculture.fr/nos-publications/la-publication-en-detail/actualites/agriculture-biologique-compost-de-marc-de-raisin/> (accessed 11.15.21).
- Gentil, C., Basset-Mens, C., Manteaux, S., Mottes, C., Maillard, E., Biard, Y., Fantke, P., 2020a. Coupling pesticide emission and toxicity characterization models for LCA: Application to open-field tomato production in Martinique. *J. Clean. Prod.* 277, 124099. <https://doi.org/10.1016/j.jclepro.2020.124099>
- Gentil, C., Fantke, P., Mottes, C., Basset-Mens, C., 2020b. Challenges and ways forward in pesticide emission and toxicity characterization modeling for tropical conditions. *Int. J. Life Cycle Assess.* 25, 1290–1306. <https://doi.org/10.1007/s11367-019-01685-9>
- Golsteijn, L., 2012. ReCiPe. PRé Sustain. URL <https://pre-sustainability.com/articles/recipe/> (accessed 9.14.20).
- Hauschild, M., Rosenbaum, R.K., Olsen, S. (Eds.), 2018. *Life Cycle Assessment: Theory and Practice*. Springer International Publishing. <https://doi.org/10.1007/978-3-319-56475-3>
- Hélias, A., Servien, R., 2021. Normalization in LCA: how to ensure consistency? *Int. J. Life Cycle Assess.* 26, 1117–1122. <https://doi.org/10.1007/s11367-021-01897-y>
- Hennessey, M.K., Jeffers, L., Nendick, D., Glassy, K., Floyd, L., Hansen, J.D., Bailey, W.D., Winborne, I., Bartels, D., Ramsey, C., Devorshak, C., 2014. Phytosanitary Treatments, in: Gordh, G., McKirdy, S. (Eds.), *The Handbook of Plant Biosecurity: Principles and Practices for the Identification, Containment and Control of Organisms That Threaten Agriculture and the Environment Globally*. Springer Netherlands, Dordrecht, pp. 269–308. https://doi.org/10.1007/978-94-007-7365-3_10
- Horsak, R.D., Bedient, P.B., Hamilton, M.C., Thomas, F.B., 1964. 8 - Pesticides, in: Morrison, R.D., Murphy, B.L. (Eds.), *Environmental Forensics*. Academic Press, Burlington, pp. 143–165. <https://doi.org/10.1016/B978-012507751-4/50030-6>
- Huijbregts, M.A.J., Steinmann, Z.J.N., Elshout, P.M.F., Stam, G., Verones, F., Vieira, M., Hollander, A., Zijp, M., van Zelm, R., 2017. ReCiPe 2016 v1.1: A harmonized life cycle impact assessment method at midpoint and endpoint level. Report I: Characterization (No. RIVM Report 2016-0104a).
- Huijbregts, M.A.J., Steinmann, Z.J.N., Elshout, P.M.F., Stam, G., Verones, F., Vieira, M., Zijp, M., Hollander, A., van Zelm, R., 2017. ReCiPe2016: a harmonised life cycle impact assessment method at midpoint and endpoint level. *Int. J. Life Cycle Assess.* 22, 138–147. <https://doi.org/10.1007/s11367-016-1246-y>
- IOC, 2021a. IOC (International Olive Council) [WWW Document]. Glossary. URL http://www.internationaloliveoil.org/glosario_terminos/index?lang=en_US (accessed 10.22.21).

- IOC, 2021b. World Olive Oil - Figures [WWW Document]. Int. Olive Council. URL <https://www.internationaloliveoil.org/what-we-do/economic-affairs-promotion-unit/> (accessed 5.25.21).
- IPCC, 2006. 2006 IPCC Guidelines for National Greenhouse Gas Inventories, Prepared by National Greenhouse Gas Inventories Programme, Eggleston H.S., Buendia L., Miwa K., Ngara T., Tabane K. ed. IGES, Japan.
- iPoint, 2018. Life Cycle Impact Assessment – which are the LCIA indicator sets most widely used by practitioners? IPoint Blog. URL <https://www.ipoint-systems.com/blog/lcia-indicator/> (accessed 9.25.20).
- ISO 14040: Environmental Management – Life Cycle Assessment – Principles and framework. International Organization for Standardization (ISO). Geneva, Switzerland., 2006a.
- ISO 14044: Environmental Management – Life Cycle Assessment – Requirements and Guidelines. International Organization for Standardization (ISO). Geneva, Switzerland., 2006b.
- Jolliet, O., Saadé-Sbeih, M., Crettaz, P., Jolliet-Gavin, N., Shaked, S., 2017. Analyse du Cycle de vie: Comprendre et réaliser un écobilan (éd. 3), 3e édition. ed. Presses polytechniques et universitaires romandes.
- Jolliet, O., Saadé-Sbeih, M., Shaked, S., Jolliet, A., Crettaz, P., 2016. Environmental Life Cycle Assessment. CRC Press Taylor & Francis Group.
- Koch, P., Salou, T., 2015. AGRIBALYSE®: Rapport Méthodologique – Version 1.2. March 2015. Angers. France, p. 385.
- Leverge, S., 2011. Données sur la culture des olives.
- Mohamad, R.S., Verrastro, V., Cardone, G., Bteich, M.R., Favia, M., Moretti, M., Roma, R., 2014. Optimization of organic and conventional olive agricultural practices from a Life Cycle Assessment and Life Cycle Costing perspectives. J. Clean. Prod. 70, 78–89. <https://doi.org/10.1016/j.jclepro.2014.02.033>
- Mouton, R., 2012. Chambre d'agriculture des Bouches du Rhône (13). Agriculture biologique : grignons d'olives et compost [WWW Document]. URL <https://paca.chambres-agriculture.fr/nos-publications/la-publication-en-detail/actualites/agriculture-biologique-grignons-dolives-et-compost/> (accessed 2.8.22).
- Nemecek, T., Kägi, T., 2007. Life Cycle Inventories of Swiss and European Agricultural Production Systems. Final report ecoinvent V2.0 No. 15a. Agroscope Reckenholz-Taenikon Research Station ART, Swiss Centre for Life Cycle Inventories, Zurich and Dübendorf, CH, retrieved from: www.ecoinvent.ch.
- Nemecek, T., Schenutzer, J., 2011. Methods of assessment of direct field emissions for LCIs of agricultural production systems.
- OiLCA, 2011. Enhancing the competitiveness and reducing the carbon footprint of the olive oil sector through waste management optimisation and the establishment of an ecological label [WWW Document]. URL (accessed 10.11.18).
- Pattara, C., Salomone, R., Cichelli, A., 2016. Carbon footprint of extra virgin olive oil: a comparative and driver analysis of different production processes in Centre Italy. J. Clean. Prod. 127, 533–547. <https://doi.org/10.1016/j.jclepro.2016.03.152>
- PRéConsultant, 2021. SimaPro database manual. Methods library.
- Proietti, S., Sdringola, P., Desideri, U., Zepparelli, F., Brunori, A., Ilarioni, L., Nasini, L., Regni, L., Proietti, P., 2014. Carbon footprint of an olive tree grove. Appl. Energy 127, 115–124. <https://doi.org/10.1016/j.apenergy.2014.04.019>
- Proietti, S., Sdringola, P., Regni, L., Evangelisti, N., Brunori, A., Ilarioni, L., Nasini, L., Proietti, P., 2017. Extra Virgin Olive oil as carbon negative product: Experimental analysis and

- validation of results. *J. Clean. Prod.* 166, 550–562. <https://doi.org/10.1016/j.jclepro.2017.07.230>
- Rinaldi, M., Stadler, G., 2002. Trends im Abgasverhalten landwirtschaftlicher Traktoren - Neue Modelle deutlich sauberer, FAT-Bericht Nr. 577. Swiss Federal Research Station for Agricultural Economics and Engineering (FAT). Taenikon, Ettenhausen, Switzerland.
- Rinaldi, S., Barbanera, M., Lascaro, E., 2014. Assessment of carbon footprint and energy performance of the extra virgin olive oil chain in Umbria, Italy. *Sci. Total Environ.* 482–483, 71–79. <https://doi.org/10.1016/j.scitotenv.2014.02.104>
- Romero-Gómez, M., Castro-Rodríguez, J., Suárez-Rey, E.M., 2017. Optimization of olive growing practices in Spain from a life cycle assessment perspective. *J. Clean. Prod.* 149, 25–37. <https://doi.org/10.1016/j.jclepro.2017.02.071>
- Rosenbaum, R.K., Bachmann, T.M., Gold, L.S., Huijbregts, M.A.J., Jolliet, O., Juraske, R., Koehler, A., Larsen, H.F., MacLeod, M., Margni, M., McKone, T.E., Payet, J., Schuhmacher, M., van de Meent, D., Hauschild, M.Z., 2008. USEtox—the UNEP-SETAC toxicity model: recommended characterisation factors for human toxicity and freshwater ecotoxicity in life cycle impact assessment. *Int. J. Life Cycle Assess.* 13, 532. <https://doi.org/10.1007/s11367-008-0038-4>
- Roy, P., Nei, D., Orikasa, T., Xu, Q., Okadome, H., Nakamura, N., Shiina, T., 2009. A review of life cycle assessment (LCA) on some food products. *J. Food Eng.* 90, 1–10. <https://doi.org/10.1016/j.jfoodeng.2008.06.016>
- SAEFL, 2000. Handbuch Offroad-Datenbank, Swiss Agency for the Environment, Forests and Landscape (SAEFL). Bern, Switzerland.
- Sala, S., Beylot, A., Corrado, S., Crenna, E., Sanye Mengual, E., Secchi, M., 2019. Indicators and assessment of the environmental impact of EU consumption (Scientific analysis or review No. KJ-NA-29648-EN-N (online), KJ-NA-29648-EN-C (print)). Publications Office of the European Union, Luxembourg (Luxembourg). <https://doi.org/10.2760/403263> (online), 10.2760/25774 (print)
- Salomone, R., Cappelletti, G.M., Malandrino, O., Mistretta, M., Neri, E., Nicoletti, G., Notarnicola, B., Pattara, C., Russo, C., Saija, G., 2015. Life Cycle Assessment in the Olive Oil Sector, in: *Life Cycle Assessment in the Agri-Food Sector*. Springer, Cham, pp. 57–121. https://doi.org/10.1007/978-3-319-11940-3_2
- Salomone, R., Ioppolo, G., 2012. Environmental impacts of olive oil production: a Life Cycle Assessment case study in the province of Messina (Sicily). *J. Clean. Prod.* 28, 88–100. <https://doi.org/10.1016/j.jclepro.2011.10.004>
- Seecar, n.d. "Mécanisation Agricole", adapté de "Maintenance du Matériel agricole", Centre d'Etudes et d'Expérimentation du Machinisme Agricole Tropical, 1984.
- US EPA, 2021. US EPA Search [WWW Document]. URL https://search.epa.gov/epasearch/?querytext=pesticides&areaname=&areacontacts=&arearesearchurl=&typeofsearch=epa&result_template=2col.ftl#/ (accessed 11.12.21).
- van der Werf, H., Knudsen, M., Cederberg, C., 2020. Towards better representation of organic agriculture in life cycle assessment. *Nat. Sustain.* 3, 419–425. <https://doi.org/10.1038/s41893-020-0489-6>
- Weidema, B., Bauer, C., Hischer, R., Mutel, C., Nemecek, T., Reinhard, J., Vadenbo, C., Wernet, G., 2013. Overview and methodology. Data quality guideline for the ecoinvent database version 3.
- Weidema, B.P., 1998. Multi-user test of the data quality matrix for product life cycle inventory data. *Int. J. Life Cycle Assess.* 3, 259–265. <https://doi.org/10.1007/BF02979832>

Weidema, B.P., Wesnæs, M.S., 1996. Data quality management for life cycle inventories—an example of using data quality indicators. *J. Clean. Prod.* 4, 167-174. [https://doi.org/10.1016/S0959-6526\(96\)00043-1](https://doi.org/10.1016/S0959-6526(96)00043-1)



CHAPTER III

ENVIRONMENTAL ASSESSMENT OF OLIVE POMACE VALORISATION IN COMPOSITE MATERIALS

III.1 Introduction

The estimated production of olive oil in the European Union (EU) is 1 909 110 tonnes for May 2020 (European Commission, 2020a), the EU represents 65% of world exports of olive oil (European Commission, 2020b). Worldwide production is estimated at 3.197×10^6 tonnes for 2020/2021 (IOC, 2021). However, the main concern of this growing sector should be olive oil waste; as the olive oil industry causes many environmental impacts in terms of resource depletion, land degradation, air emissions, and waste generation (Espadas-Aldana et al., 2021, 2019; Salomone and Ioppolo, 2012). Olive pomace is one of the major outputs of olive oil production and it is considered phytotoxic due to its high phenolic content (Antónia Nunes et al., 2018; Malapert et al., 2018).

The production of olive pomace is around 6.8-8.0 million tonnes per year in Europe (Cossu et al., 2013; Sauvant, 2011), of which 9 000 to 16 928 tonnes of pomace are generated in France (Cossu et al., 2013; Mouton, 2012). 80% of the olive's mass consists of olive pulp and stone, therefore, the extraction process yields 4 times more waste than oil (Espadas-Aldana et al., 2019). Moreover, the Mediterranean climate is sunny, warm and dry; its overexploited and fragile organic soil layer may lead to soil erosion. This problem increases with irrigation, the use of pesticides and mineral fertiliser. Besides, waste management is another contributing factor, due to the large quantities of organic waste, that are applied directly to the same soil (Espadas-Aldana et al., 2019).

Currently, olive oil by-products are discharged on agricultural land by controlled spreading (Aparicio-Ruiz and Harwood, 2013; Azbar et al., 2004; Dermeche et al., 2013). The regulation of this waste is not standardised and varies depending on the olive oil-producing country. In Andalusia, one of the principal producer sectors in Spain (leader in olive oil production), the 4/2011 Decree of the Regional Government of Andalusia, establishes that the maximum amount of olive waste released on the soil is $30 \text{ m}^3 \text{ ha/year}$ (Decreto 4/2011, 2011), the same value was established in the Italian regulation ("Legge n. 574," 1996). In Portugal, irrigation of tree and bush crops with olive mill effluents is allowed up to $80 \text{ m}^3/\text{year}$ (Despacho conjunto n° 626/2000). In Greece, the limit value is 5 kg/month of vegetable/animal fats and oils (Law 1180/1981).

On the other hand, in France, pomace and olive mill wastewater are under Regulation (EC) No. 889/2008 as "organic by-products of plant origin for fertiliser". The recovery of these raw organic by-products is done within the framework of a spreading plan to respect the regulations relating to Installations Classified for the Protection of the Environment (mills with a production capacity greater than 200 kg of olives per day). The Rhône-Méditerranée-Corsica Water Agency controls the millers and offers financial incentives for their elimination/recovery (Mouton, 2012). The pomace and olive mill wastewater co-composted with carbonaceous support correspond, for the RCE n°889/2008, to a "composted or fermented mixture of vegetable matter: product obtained from mixtures of vegetable matter, subjected to composting or anaerobic fermentation with the aim of producing biogas". They are considered products that comply with the NF U 44-051 standard and can be used without a spreading plan (Mouton, 2012).

Over the years, many other methods have been proposed for olive oil waste disposal and valorisation. These techniques include thermo-chemical processes, anaerobic digestion, fermentation, blending, and chemical extraction of bioactive compounds (Batuecas et al., 2019;

Christoforou and Fokaidis, 2016; Contreras et al., 2020; Cossu et al., 2013; Dermeche et al., 2013; Duman et al., 2020; El Asli and Qatibi, 2009; Nunes et al., 2016; Oliveira et al., 2016).

The LCA of the manufacturing process of an olive pomace biocomposite was conducted. The aim is to evaluate the environmental performance of a biocomposite composed of olive pomace and two different thermoplastic matrices. Data for the compounding process come from a pilot-scale experiment carried out by the *Laboratoire de Chimie Agro-industrielle (Université de Toulouse, France)* to produce lath for terraces. Two scenarios were investigated which are differentiated by the polymeric matrix used: *i.e.*, one made from polyethylene and the other from polypropylene. The functional unit was the production of 1 m² of olive pomace-based biocomposite lath. The analysis was performed with SimaPro PhD 9.1.1.1 software, and the database used for modelling was ecoinvent 3.6.

Also, the carbon dynamics in olive groves for olive oil production in France was proposed. This was done using the C-TOOL model, which is used to measure the change in the amount of carbon in the soil of olive groves and CO₂ emissions. The olive pomace-based composite (with the hypothesis of being 100% biodegradable) was compared with the carbon dynamics of the virgin soil, the soil treated with olive pomace and the soil treated with compost (made of olive pomace). It was considered that the olive pomace composites are ground and put in the agricultural soils after their lifespan.

This chapter proposes an LCA of olive pomace valorisation in its use as biocomposite material, focusing on shifting from traditional linear production to a circular olive production system that recovers materials from organic residues.

III.2 State-of-the-art: olive pomace

III.2.1 Olive pomace definition

III.2.1.1 Origin

Olive pomace is a by-product of olive oil production. It is generated during the centrifugation phase (as seen in Chapter I, section I.1.4.2 Olive oil extraction). By way of reminder, the centrifugation method covers the need for a continuous extraction process. This method works on the basis of centrifugal force, where the less dense liquid phase forms a concentric inner layer, whereas the denser solid particles are pushed against the wall of the rotating bowl (Boskou, 2006). This extraction process presents two operation alternatives: the three-phase and the two-phase horizontal centrifugation methods (**Figure III-1**).

The difference between them lies in the number of output streams that the decanter has:

- On the one hand, the three-phase centrifuge has as an output for olive oil, vegetable water, also known as olive mill wastewater (OMW) (*alpechin* in Spanish) and pomace (*orujo* in Spanish).
- On the other hand, the two-phase centrifuge has as an output for olive oil, and other for wet pomace (*alperujo*, contraction of *alpechin* and *orujo* in Spanish).

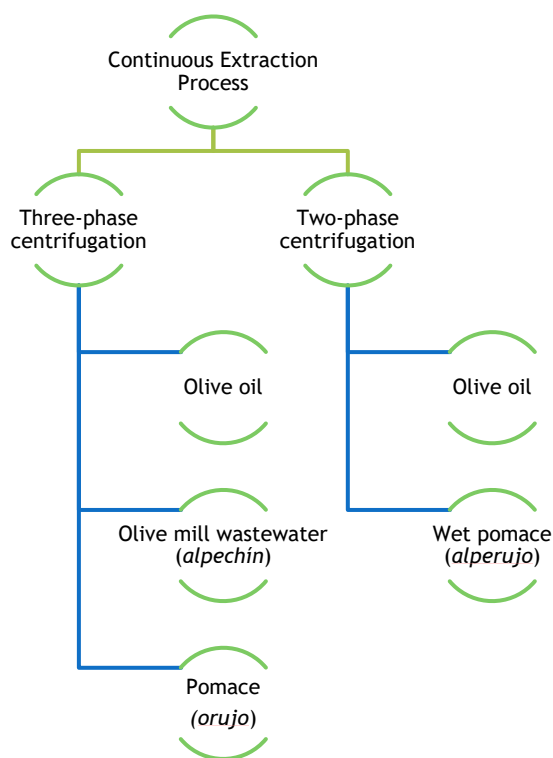

Figure III-1. Outputs of the continuous extraction process of olive oil extraction.

The rising popularity of olive oil has increased the generation of its by-products: the olive pomace (OP), a general term used to refer to the pomace obtained from all the different olive oil extraction processes, and an effluent known as OMW, deriving from traditional pressing and from the three-phase system (Dermeche et al., 2013; Salomone et al., 2015).

III.2.1.2 Chemical characterisation

To further elaborate on the OP seen in Chapter I, section I.1.6 By-products of olive oil production, the following information is noteworthy.

This OP is a mixture of residual skin, pulp and fragments of the crushed olive stone (Lammi et al., 2018b). The main components of this solid residue are cellulose, hemicelluloses, and lignins. Residual fat and proteins are also present in significant quantities. The moisture content of the solid residues is 22-25% for traditional pressed OP, 65-74% for pomace from a two-phase system, and 40-50% for that from a three-phase one (Contreras et al., 2020; Dermeche et al., 2013).

On the other hand, OMW is a red-to-black coloured acidic liquid, with 83-92% content of water, its main components being phenolic compounds, sugars and organic acids. OMW reveals also an important quantity of potassium (Dermeche et al., 2013).

On average, olive fruit contains 20% wt of oil, and the remaining 80% wt together with the added water form OP (de la Casa and Castro, 2014).

III.2.1.3 Annual production

Olive oil processing is considered inefficient due to the high volume of waste generated (Ravindran and Jaiswal, 2016). This particular industry has a seasonable production, which generates a high amount of waste in a short period. The olive oil industry causes many environmental impacts in terms of resource depletion, land degradation, air emissions and waste generation. Moreover, the management of olive oil residues is an economic burden to producers (Azbar et al., 2004; Bhatnagar et al., 2014; Espadas-Aldana et al., 2019; Nunes et al., 2016; Salomone and Ioppolo, 2012). In Europe, the production of OP reaches approximately 6.8-8.06 million tonnes per year (Cossu et al., 2013; Sauvant, 2011), of which 9 000 to 16 928 tonnes of OP are generated in France (Cossu et al., 2013; Mouton, 2012).

III.2.2 Olive pomace disposal and valorisation

III.2.2.1 Business as usual

Currently, olive oil by-products are discharged on agricultural land by controlled spreading (Aparicio-Ruiz and Harwood, 2013; Azbar et al., 2004; Dermeche et al., 2013). Due to its high content in phenolic and lipidic constituents, organic acids, low pH, and salinity, OP should not be used for agricultural spreading (Lammi et al., 2019). Moreover, OP is resistant to bacterial degradation, which makes it a significant source of environmental pollution (Lammi et al., 2019).

Another use of OP has been in animal nutrition. As an example, it is used in Tunisia in a mixture with bran or even cactus to feed dromedaries or sheep. In countries such as Italy and Greece, cows are fed with OP. However, it can cause digestive problems in animals due to its high degree of lignification (Alibes et al., 1983).

OP has also been used for composting, or to produce a non-phytotoxic product through biological conversion (Bioremediation), which can be used as a fertiliser (Dermeche et al., 2013; Haddadin et al., 2009; Morillo et al., 2009).

As mentioned, olive wastes can be applied directly to the soil as an organic amendment, although it is preferable to do so after having been composted. Composted pomace improves the physical-chemical characteristics of the soil to a greater extent than non-composted pomace,

providing greater benefits, such as more stabilized organic matter and plant nutrients, especially potassium, nitrogen and phosphorus (MITECO, 2019). The high concentration of phenolic compounds in non-composted pomace produces a bacteriostatic effect on microorganisms and a phytotoxic effect on crops. In addition, proper management is required due to its high salt content and acidic nature. On the other hand, the high concentration of phosphorus, potassium and organic matter can contribute to the fertilization of crops (MITECO, 2019).

III.2.2.2 Other methods

Over the years, many other methods have been proposed for olive oil waste disposal and valorisation. These techniques include thermo-chemical processes, anaerobic digestion, fermentation, blending, and chemical extraction of bioactive compounds (Batuecas et al., 2019; Christoforou and Fokaidis, 2016; Contreras et al., 2020; Cossu et al., 2013; Dermeche et al., 2013; Duman et al., 2020; El Asli and Qatibi, 2009; Nunes et al., 2016; Oliveira et al., 2016). Valorisation routes also include the production of activated carbons, cosmetic applications, the production of polyols, and the improvement of the thermal properties of cement mortar (Barreca and Fichera, 2013; El-Sheikh et al., 2004; Matos et al., 2010).

III.2.2.2.1 Anaerobic digestion

Batuecas et al. (2019) analyzed the end-of-life disposal solutions, one of their scenarios considered anaerobic digestion as the final step (according to Circular Economy principles), this scenario closed the loop and added value to the olive oil productive chain. This analysis considered the whole olive oil production, thus, in order to focus on waste production and management, the impacts were allocated (Batuecas et al., 2019).

In a more biochemical approach, the life cycle assessment of Batuecas et al. (2019) revealed that anaerobic digestion consumed 80 L of water less than the disposal of olive waste in the soil scenario (considering the functional unit). Waste released on soil leads to the emission of about 57 g of eq. CO₂, whereas, anaerobic digestion delivered 31 g of CO₂ eq, although involving the production of methane and carbon dioxide, with methane having a GWP impact 25 times higher than CO₂, does not involve direct emissions to the atmosphere as the methane is used for the production of electricity (Batuecas et al., 2019).

III.2.2.2.2 Fermentation

Efficient ethanol production processes and inexpensive substrates are the keys to the successful production of bioethanol. OP can be used as an alternative lignocellulosic substrate that could reduce costs and make bioethanol more competitive with fossil fuels. First, an acid and heat pretreatment of OP is done to release the sugars, then, the sugars are fermented to produce ethanol by yeast or bacteria. In their study, El Asli & Qatibi (2009) found that the content of hydrolysates was 18.1 g/L of soluble sugars, which were fermented by a recombinant *Escherichia coli* strain to produce ethanol at a yield of 0.45 g/g of sugar (Dermeche et al., 2013; El Asli and Qatibi, 2009).

Another interesting approach for OP valorisation is the production of enzymes. Oliveira et al. (2016) optimize the production of lipase by *A. ibericus*, *A. niger* and *A. tubingensis* under Solid-state fermentation (SSF), using as a raw material a mixture of OP and wheat bran. SSF is a fermentation process in the absence or near absence of free water, but with enough moisture to support microorganism growth. Lipases cover a wide variety of applications, such as laundry and

household detergents, food, textile, etc. and its global market was estimated to be 2 billion dollars in 2004. Therefore, SSF represents a good alternative for producing industrial enzymes at low cost (Oliveira et al., 2016).

III.2.2.2.3 Extraction of bioactive compounds

There is a rising interest in natural compounds, these compounds can be used in numerous applications in the pharmaceutical, cosmetics, and food industries. OP contains the remaining olive fat, water, and a great number of bioactive compounds. Nunes et al. (2018) found that the total fat content of OP was 2 g/100 g. This remaining oil can be used in cosmetics for formulations or even as an active ingredient. Regarding the vitamin E profile, α -tocopherol is the major vitamin E form found in the OP (2.63 mg/100 g). The phenolic fraction that passes into the oil phase is 2%, while, 98% of phenolics remain in the olive fruit. Researchers have focused their work on the maximization of the extraction yield of such bioactive compounds, low-cost and short time processes, etc. These technologies add economical value to the OP and at the same time reduce its environmental burden, contributing to a sustainable agriculture system (Antónia Nunes et al., 2018; *Olives and Olive Oil as Functional Foods*, 2017).

Phenolic compounds present in olive mill waste have a wide range of molecular weights, which complicates their recovery with high purities that can be achieved by membrane technologies. Several authors have studied the recovery of phenolic compounds by reverse osmosis, microfiltration, nanofiltration, etc. However, it is necessary to apply a pretreatment method to guaranty the recovery of membrane permeability. Fouling reduces the permeate fluxes and determines both efficiency decrease and variation of membrane selectivity; it also makes the process highly expensive due to repeated plant shutdown for cleaning and washing the membranes. Various pretreatment methods have been proposed, such as enzymatic, chemical, and Physico-chemical pretreatments; neutralization; sedimentation; and centrifugation (*Olives and Olive Oil as Functional Foods*, 2017).

Hydroxytyrosol is a phenolic compound present in OP, this molecule presents strong antioxidant activity, anti-inflammatory, and antimicrobial properties. It has a beneficial role in cardio and neurovascular diseases, besides, its proved anti-tumor effect. Cosmetic and pharmaceutical industries have a high interest in this compound. Fernandez-Bolaños et al. (2002) suggest a method for obtaining hydroxytyrosol from *alperujo* by a two-step chromatographic treatment. This new purification system (under patent) makes it possible to obtain large amounts of highly purified hydroxytyrosol. (Antónia Nunes et al., 2018; Fernández-Bolaños et al., 2002; *Olives and Olive Oil as Functional Foods*, 2017).

Nunes et al. (2018) compared a conventional solid-liquid method of extraction with an innovative Multi-frequency Multimode Modulated (MMM) ultrasonic technique to extract antioxidants from OP. The MMM technique allowed a higher recovery of phenolic compounds when compared to the conventional extraction. This process uses water as a solvent and shorter the period of time to 5 min (Antónia Nunes et al., 2018).

III.2.2.3 Biocomposite field

In the most recent years, research has focused on the valorisation of OP on the biocomposite field (Aouat et al., 2021; Banat, 2019; Boufi, 2017; Duman et al., 2020; Kaya et al., 2018; Koutsomitopoulou et al., 2014; Lammi et al., 2019, 2018b, 2018a; Naghmouchi et al., 2015).

Due to their natural richness in lignocellulosic fibres, this sector uses agricultural wastes (or by-products) as renewable fillers for polymeric matrices. The obtained results from olive stone flour have confirmed its viability as a cheap reinforcing filler for the polypropylene matrix, thus opening new perspectives for the use of this by-product (Naghmouchi et al., 2015). The developed composites could find applications in buildings, in the automotive industry, and as outdoor products, *e.g.*, deck floors, furniture, park benches, etc. Specific examples of this application are those from the GO-OLIVA project (Spain), which developed Olipast, a new sustainable packaging material from olive pit (Putinja, 2020), and from the Biolive company, which commercializes the Bio-Pura product, used for the manufacture of television components (Turkey). The Biolive company is also working to produce shrink wrap for beer can from this material, and other end products for various applications, including consumer electronic casings, automotive interiors, toys, and packaging. Approximately 3.5 tons of bioplastics can be transformed from 5 tonnes of locally sourced olive seeds ("Biolive Biological and Chemical Technologies," 2020; Material Connexion, 2019).

Kaya et al. (2018) mixed OP powder with polypropylene (PP) in order to obtain green composites by using melt-mixing techniques. The authors observed that the incorporation of the material decreases the tensile strength of composite (compared to virgin polymer) due to the insufficient wetting of the filler with the matrix, poor dispersion of fillers, presence of agglomerates, and poor adhesion between the filler and the matrix. The dynamic mechanic analysis (DMA) of the biocomposite revealed that the stiffness increased with the addition of the OP particles. Moreover, the thermal stability of PP was improved by filling OP into PP (Kaya et al., 2018).

These positive results are also found in other studies such as the one conducted by Lammi et al. (2019). The biodegradability of a biocomposite was studied, confirming that the incorporation of OP-based fillers in PHBV (poly[3-hydroxybutyrate-co-3-hydroxyvalerate]) accelerated the biodegradation of the composites, which exceeded 100% after 4 months. Fully degradable biopolymers are raising interest, this specific polymer PHBV is used in the production of disposable items and food packaging materials. It is worth noting that food packaging and agriculture sectors represent the largest plastic consumption sectors, with respectively 40% and 5% of the total consumption, and more than 75% of uncollectable and dispersed plastics (Lammi et al., 2019).

III.2.3 Lath Market, olive pomace-based composite

Due to the missing data about OP-based composite market, wood-plastic composite market has been reviewed as a frame of reference for the OP composites.

Stratview Research studied the global market for wood-plastic composites (WPC), which is expected to grow by 10.7% during the period from 2016 to 2021. North America is expected to remain WPC's largest market by region over the next five years, while, Asia-Pacific is expected to experience the fastest growth rate over the same period driven by growing economies, mainly China and India (Wise Guy Reports, 2017).

More than 60% of the world's WPC manufacturers are located in North America and primarily serve the construction and consumer goods industries (Wise Guy Reports, 2017). Depending on the application area, the market is segmented into decking, automotive, sliding & fencing, technical applications, furniture, consumer goods, and others. The decking sector holds

the major market share with 55,55 % of the global market in 2019 and increasing at a fast pace. Composites are used in decking to improve durability and strength (Fortune Business Insights, 2020).

The European WPC market is estimated at 455 216.61 tonnes in 2020, and it is projected to grow around 8% during the forecast period (2021-2026), within a short period the increasing demand for WPC in domestic constructions, due to its characteristics and the numerous construction projects in the region are driving the market's growth (Mordor Intelligence, 2021). Nowadays, Germany owns the WPC market with over 40% of the global European market, the German economy is the biggest manufacturer and consumer of WPC in Europe, and besides more WPC compounders are located in Germany. The segmentation of the market is shared by the following countries Belgium, United Kingdom, France, Sweden, Finland, Denmark, Norway and other European Countries (Mordor Intelligence, 2021).

In France, the major producer of WPC is located in the region of Bretagne with a production capacity of 1 million m² WPC per year (Silvadec, 2020). The French WPC market accounts for over 9% of the European market (Mordor Intelligence, 2021). Then, it is assumed that the French WPC decking sector market is 22 759 t of WPC/year.

If it is assumed that the total production of wood plastic composite used in the decking sector is going to be replaced by the OP-based composite laths. Then, the French market would be 22 759 t of OP-based composite laths per year.

III.2.4 Carbon dynamics

Soil organic carbon (SOC) is the quantity of carbon that remains in the soil after partial decomposition of any material produced by living organisms. SOC is the main component of soil organic matter (SOM) and its contribution is crucial for food production, mitigation and adaptation to climate change, and the achievement of the Sustainable Development Goals (SDGs) (FAO and ITPS, 2020).

SOM is essential for soil structure, retention and release of plant nutrients, it also allows water infiltration and storage in soil. The largest terrestrial organic carbon reservoir is soil and the decrease of SOC shows a certain soil degradation. Soils have different amounts of SOC that depend on local geology, climatic conditions and land use and management, etc. (FAO and ITPS, 2020).

The quantity of organic C stored is on average 2344 Gt in the top three meters of soil, 1500 Gt in the first meter of soil, and around 615 Gt stored in the top 20 cm (Stockmann et al., 2013). Nevertheless, approximately 9 Gt of C is liberated into the atmosphere annually, which comes from fossil C sources (coal, oil and gas) and through ecosystem degradation (Stockmann et al., 2013).

Even a smaller change in organic carbon could create a significant feedback effect on greenhouse gases in the atmosphere. For example, a change of 10% in SOC would be equivalent to all the anthropogenic CO₂ emitted over 30 years (Kirschbaum, 1999). Agricultural activity impacts the global C cycle, thus reliable projections of changes in SOC are needed. This allows to estimate the responses to climate changes and allows farmers and political organizations to promote management options that can decrease CO₂ emissions from agricultural soils and protect the soil resource (Taghizadeh-Toosi et al., 2014).

III.3 Methodology: Life Cycle Assessment

This chapter has been the subject of a publication from which all the figures in this section are taken (Espadas-Aldana et al., 2021).

II.3.1 Goal & scope definition

II.3.1.1 Goal definition

The following LCA focuses on the manufacturing process for a biocomposite made of olive stone fraction (OSF), which is part of olive pomace (OP), and two different polymeric matrices: polypropylene (PP) and polyethylene (PE).

To propose a solution to improve the current valorisation of OP, the objectives of the study are to:

- Analyse and compare the environmental impacts of the different scenarios,
- Identify the unit processes with the strongest environmental impacts,

This study only covers part (waste treatment) of the life cycle of olive oil (Chapter II).

II.3.1.2 Scope definition

In order to build the production inventory and set the scope of the study, the functional unit is defined. Based on similar works (Al-Ma'adeed et al., 2011; Sommerhuber et al., 2017; Vidal et al., 2009) and EN 15804 (European Committee for Standardization, 2013), the functional unit chosen is the production of 1 m² of lath (building material) made of olive pomace-based composite.

Figure III-2a,b show a diagram of the lath to be produced and their dimensions.

In order to focus on the impacts related to the development of a new biocomposite made from OP as filler, and PP or PE as thermoplastic matrix, a “cradle to gate” approach life cycle assessment was carried out. This study is centred on the generation of the raw materials and manufacturing of the biocomposites. In **Figure III-3**, system A shows the completed life cycle of the biocomposite, system B comprehends the generation of the raw materials, and the manufacturing process of the composite, system C1 shows the production of the raw materials used in the process, system C2 shows the manufacturing process of the product and the necessary pre-treatment (*i.e.*, drying, milling, etc.) to prepare the OP fraction. Finally, system C3 includes the use and end of life of the product. It is important to mention that system B comprehends the complete system boundary of the LCA herein done. Namely, the system studied takes into account the production of all the raw materials needed (*i.e.*, OP, PP, PE, and the coupling agents added to the compound to reinforce the matrix/filler interface), and the production of both composites.

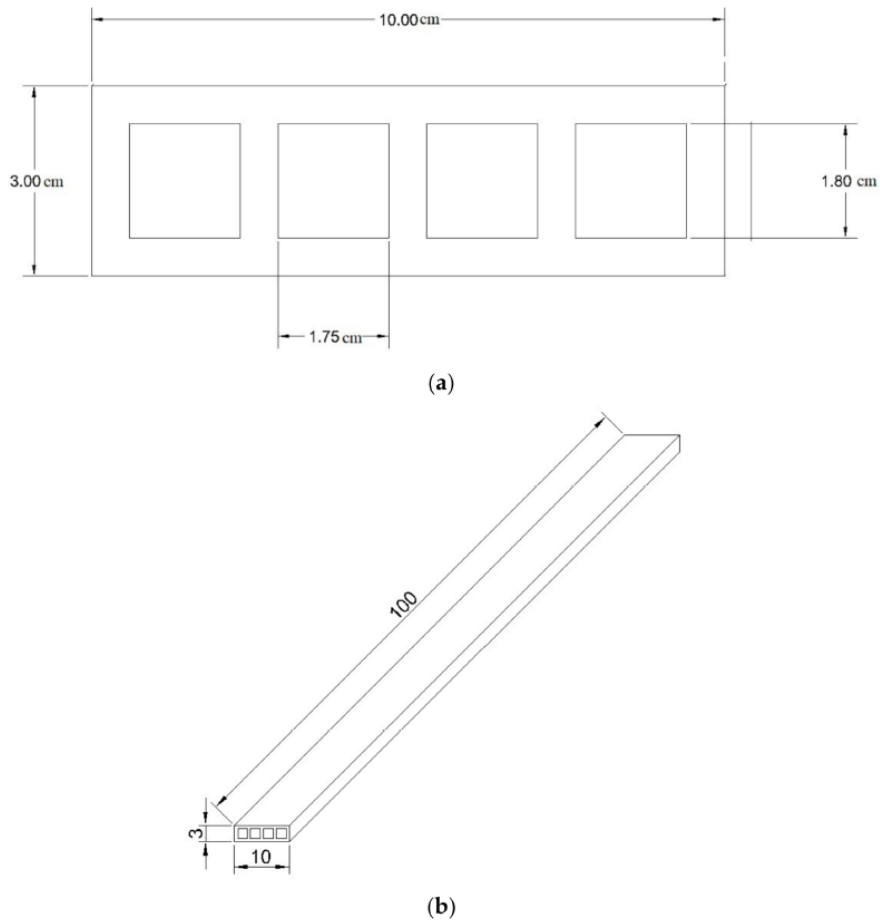

Figure III-2. (a) Profile section of the lath made from the olive pomace-based composite. (b) Overview of the lath made from the olive pomace-based composite (measurements are in centimeters).

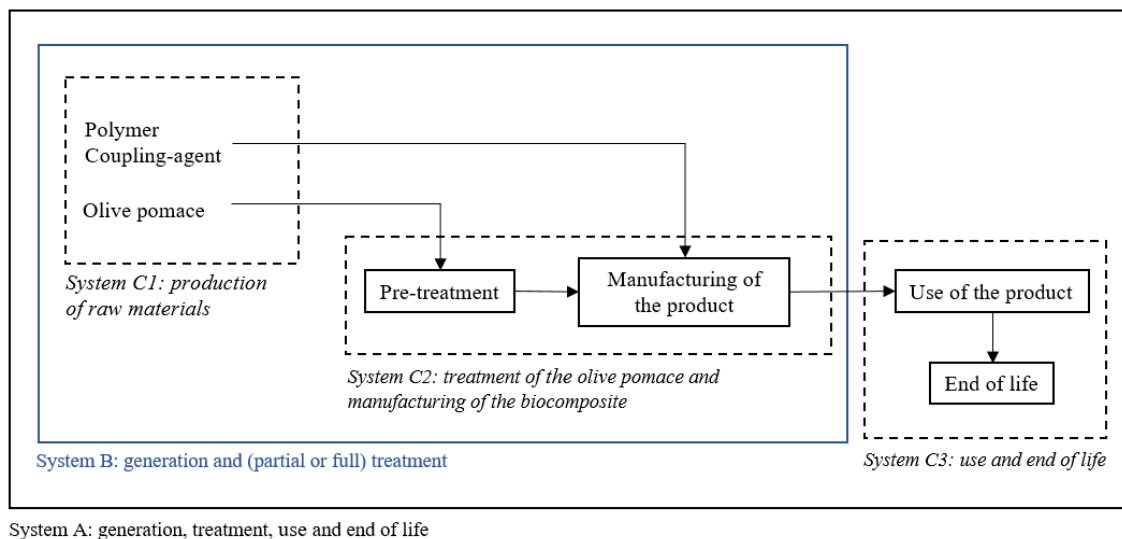

Figure III-3. System boundary of the study.

Several hypotheses must be considered in the actual approach in order to avoid overlapping in the making-decision process:

- The necessary infrastructure is not taken into account, consequently excludes their manufacture as well as their dismantling,
- The electricity is considered to come from the mixed French energy supply,
- The cleaning of the devices used in the process is neglected,
- The transportation of the OP is not taken into account.

The current study presents two different scenarios, which correspond to the mixture of the olive stone and the two different polymeric matrices (**Table III-1**). The polymeric matrices studied are PP and PE. The OSF acts as a filler in the polymeric matrix (Banat, 2019; Boufi, 2017).

Table III-1. Scenarios studied.

Scenario	Filler	Polymeric Matrix
OSF/PP	Olive stone fraction	Polypropylene
OSF/PE	Olive stone fraction	Polyethylene

III.3.2 Life cycle inventory analysis

III.3.2.1 Process tree

Based on the analysis of various publications (Boufi, 2017; Koutsomitopoulou et al., 2014; Lammi et al., 2019, 2018a, 2018b; Naghmouchi et al., 2015, 2014), all the manufacturing processes of olive pomace-based composites presented similar unit operations. First, crude OP is dried in an oven at 60 °C for 24 h. Then, crude OP is milled in a ball mill device at ambient temperature, 86 rpm for 30 min (Lammi et al., 2018b).

The powder passes into an electric sieving machine (RITEC, model 400, France) through a 1.25 mm mesh for 10 min. Two fractions are obtained, the fine fraction corresponds to the pulp-rich fraction (PF) and is recovered at the bottom of the sieve, whereas, the coarse fraction is retained in the sieve (Lammi et al., 2018a).

The coarse fraction is further ground in a knife mill (SM 300, Retch, Germany), with a speed of 1500 rpm and a grid size of 1 mm (Lammi et al., 2018b). Then, the ground powder is sieved through a 0.4 mm mesh to separate the OSF from the intermediate fraction (Lammi et al., 2018b). Polymer granules and the OP-based filler were then blended into a twin-screw extrusion compounding device. The coupling agents used are PE-g-MA (polyethylene-grafted-maleic anhydride) and PP-g-MA (polypropylene-grafted-maleic anhydride) agents, for the PE and PP thermoplastic matrices, respectively.

The presence of dust during the grinding process is very common. The main particle size present is PM10 (particles with the size smaller than 10 µm), nevertheless there are also particles with smaller size, such as PM2.5 (particles with the size smaller than 2.5 µm). Regardless of the milling method, organic dust is always produced when lignocellulosic materials are ground (Sobczak et al., 2019). Dust is harmful to the working environment. Therefore, the particulate matter (*i.e.*, the smallest particles) has to be recovered by a cyclone, and the content conveyed to a dry storage bin (Zhao et al., 2019). The equipment used for grinding includes a cyclone that recovers all the particulates, and collects them directly on a container (RETSCH, 2020).

The development of the biobased lath is part of a confidential work carried out by the *Laboratoire de Chimie Agro-industrielle (Université de Toulouse, France)* on behalf of a bio-sourced plastics industrialist (Uitterhaegen et al., 2018). Composites had been produced by mixing the OP (60% filler) in two polymeric matrices: PE and PP. The addition of a coupling agent has also been carried out to reinforce the matrix/fibre interface. As a result, adding OP to the polymeric matrices showed a mechanical reinforcement of the material, which was illustrated by the increase of the elastic modulus simultaneously with the decrease of the elongation at break, both in tensile and in bending.

Figure III-4 itemizes the process tree of the manufacturing of the olive stone composite, with the different stages of the process and their flows.

III.3.2.2 Data collection

III.3.2.2.1 Inputs: raw materials

➤ Olive pomace

OP is a mixture of different fractions, the pulp-rich fraction (PF), a stone-rich fraction (OSF, as defined above) and an intermediate fraction, which percentage weights are 31.3%, 56.4%, and 11.7%, respectively (Lammi et al., 2018b). The amount of OSF may seem high (56.4%), but this is due to the fact that the olive variety used by Lammi et al. (2018b), the *Chemlal* variety, has a high OSF. It is the most common olive cultivar in Algeria (40% of orchards), where the OP comes from their study (Lammi et al., 2018b). *Aglandau* is the olive variety most used in France for the production of olive oil. This variety represents about 21% of the French olive oil production (and 54% of the production of the 11 case studies in the herein thesis - chapter II). It is the most interesting Provençal variety, with a very good yield of fine, fruity oil with good conservation. The pit is relatively large and quite attached to the pulp (France Olive, 2021).

The moisture of the crude OP considered for the process is 53%, which is close to a three-phase system pomace. The moisture of the material is then decreased to 9% thanks to a drying process (Lammi et al., 2018b). The energy consumption linked to the drying, crushing, and sieving of the OP comes from the technical data of the machinery used and literature data (DECO, 2020; Kylili et al., 2016; RETSCH, 2020; RITEC, 2020). The grinding of the olive husk gave 80% of the weight of the sample (Aslan, 2010). This value was used in the milling of the coarse fraction due to missing data. For the modelling of “Crude olive pomace 53% moisture”, the OP dataset was adapted from the AGRIBALYSE v3.0 database according to Avadí (2020).

The above-mentioned database considers that the impact of olive cultivation is attributed only to olive oil. Nevertheless, a part of the impact of olive oil production is attributed to the virgin OP at an economic allocation of 2.32%. These characteristics belong to the “Olive pomace” file presented in **Table III-2**. Then, this virgin OP follows a new extraction process to obtain pomace oil and de-oiled pomace. There again, a part of the impact is attributed to the de-oiled pomace with an economic allocation of 9.47%, named as “Olive pomace, processed” (**Table III-2**).

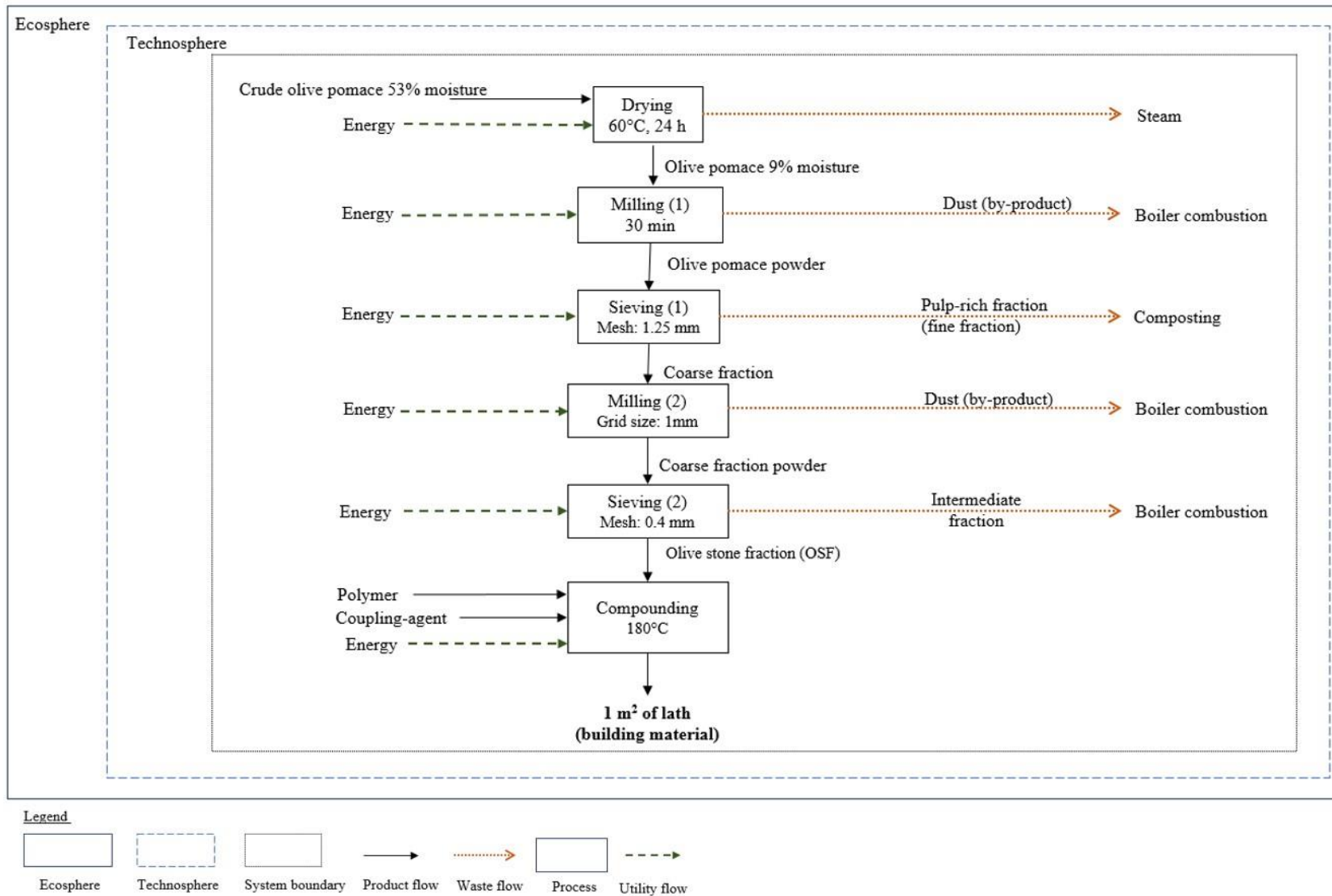

Figure III-4. Process tree of the olive pomace-based composite Adapted from Espadas-Aldana et al. (2021).

Table III-2. Background data for the modelling of olive pomace, processed. Adapted from Avadí (2020).

Process	Input/Output	Amount	Comment
Olive pomace	Input		
	Substrate	4 kg*	No impacts from olive agricultural production were included (empty process)
	Water	0.16 kg	Economic allocation key for wet pomace (70% moisture) by the PEFCR ¹ : 2.32%
	Energy	0.005 kW h*	
	Output		
Olive pomace	1.60 kg	Virgin olive pomace	
Olive pomace, processed	Input		
	Substrate	2.00 kg	"Olive pomace" (previous process)
	Water	0 kg	Economic allocation key for dry pomace by the PEFCR ¹ : 9.47%
	Energy	0.01 kW h	
	Energy	0.70 MJ	
	Output		
Olive pomace, processed	0.93 kg	De-oiled olive pomace	
	Water	1.07 kg	Calculate by mass difference

¹ PEFCR: Product Environmental Footprint Category Rules for olive oil (Schau et al., 2016).

* Modified from Avadí (2020). Original = 1.6 kg substrate, and 0.02 kW h but it was a conversion error.

➤ Polymeric matrices

The word "composite" indicates that two or more separate materials are combined on a macroscopic scale to form a structural unit for various engineering applications. The composite is constituted by the reinforcement (olive stone) and the matrix. Polymers with thermoplastic behaviour are usually used as matrix materials in composites (Qin, 2015).

In the present study, the polymers considered for the matrices are PP and PE, as they are very common thermoplastic polymers used for many applications. Being able to originate from petrol just as from renewable resources, PE is produced through radical polymerization, anionic polymerization, and cationic polymerization, while PP is obtained from high temperature cracking of petroleum hydrocarbons and propane. The properties of PP are almost similar to those of PE. However, PP does not present stress-cracking problems, and it offers electrical and chemical resistance at high temperatures. Besides, it has a little lower density, and its structure is hard and more rigid (Koerner and Koerner, 2018).

The product studied is 1 m² of lath made of olive pomace-based composite. The dimensions of the profile are 10 cm x 3 cm on the outside, 1.72 cm x 1.8 cm for the 4 interior spaces, and 1 m in length, as shown in **Figure III-2a,b**. For a superficial area of 1 m², the total quantity of profiles used is 10. The total area is 0.0174 m², and the volume of 1 m² of lath (building material) is 0.0174 m³. For the latter calculation, the hypothesis of lath contiguous (no space between them) was supposed. **Table III-3** shows the density of each composite and the mass needed for the production of 1 m² of lath. The density of the composites was taken from the extrapolation of the results of Uitterhaegen et al. (Uitterhaegen et al., 2018). Calculations of total area and density are available in **Appendix I**.

Table III-3. Density and mass for the production of 1 m² of lath made of olive pomace-based composite. Adapted from Uitterhaegen et al. (2018).

Composite	Density (kg/m ³)	Mass (kg)
OSF/PP	1060.9	18.459
OSF/PE	1068.0	18.584

➤ Coupling agents

The coupling agent improves the compatibility between the natural fibre and the polymeric matrix. The main incompatibility cause of natural fibres and polymer inside composites is due to the hydrophilic properties of natural fibres and the hydrophobic ones of the thermoplastic matrices. To improve the reinforcement effect of the filler, and especially to ensure efficient load transfer from the matrix to the filler, some authors (Banat, 2019; Boufi, 2017; Naghmouchi et al., 2015) used a polymer-based coupling agent to improve the mechanical properties, especially the maximal strengths, of lignocellulosic-plastic composites.

In the present study, polypropylene-grafted-maleic anhydride (PP-g-MA) and polyethylene-grafted-maleic anhydride (PE-g-MA) were used as coupling agents. The percentage used in the formulation of the composite was 6% wt.

Table III-4 shows the data used in the modelling of the coupling agents. In particular, the percentages of maleic anhydride of each compound were taken from the formulation of the commercial compound.

Table III-4. Data for the modelling of the coupling agents (PP-g-MA, PE-g-MA).

Process	Input/Output	Amount	Comment	Ref.
PP-g-MA	Input			
	Maleic anhydride	0.09 kg	8-10%wt, an average between the two values was taken as reference.	(Sigma-Aldrich, 2020a)
	Polypropylene	0.91 kg		
	Output			
	PP-g-MA	1.00 kg	The data considered for the modelling is the formulation of the commercial compound.	
PE-g-MA	Input			
	Maleic anhydride	0.005 kg	~0.5%wt	(Sigma-Aldrich, 2020b)
	Polyethylene	0.995 kg		
	Output			
	PE-g-MA	1.00 kg	The data considered for the modelling is the formulation of the commercial compound.	

III.3.2.2.2 Outputs: By-products of the olive stone composite manufacturing

The by-products obtained during the processing of the composite (**Figure III-4**), such as olive stone dust and intermediate and fine fractions, can be used as biofuels. The most common waste management approach for the by-products is incineration (Boufi, 2017). As with other fuels, the heating value depends on the moisture content and ranges from around 17 MJ/kg

(moisture 10%) to 20 MJ/kg (moisture 6%) (Pattara et al., 2010). Incineration of natural fibres results in the recovery of energy and carbon credits (Joshi et al., 2004). Another common waste management approach is composting (Duman et al., 2020; El Hanandeh, 2015).

➤ **Boiler combustion of olive stone dust**

Olive mills used combustion to obtain thermal or electric energy, due to the high calorific power of the dried olive husk (4000 kcal/kg) (Intini et al., 2011). However, the energy obtained by combustion is used for dryness of the fresh two-phase olive waste mill, which decreased the total energy recovery (Azbar et al., 2004; Roig et al., 2006).

Wood lower heating value (LHV) ranges between 10.5 MJ/kg for wet wood and 18.6 MJ/kg for dry wood (Morris, 2017).

The properties of the OP present more advantages than other biomass. Indeed, it has a low sulfur content between 0.12% and 0.26%, and an LHV in the range of 16.4-18.6 MJ/kg (Azbar et al., 2004). Moreover, the LHV of olive stone presents similar values in the range of 16.2-19.2 MJ/kg. **Table III-5** shows some LHV of olive stone found in the literature. It is worth mentioning that olive pit is another term used to refer to the olive stone.

Table III-5. Lower heating value of olive stone.

Type of waste	Lower heating value (MJ/kg)	Reference
Olive pit	19.0	(Miranda et al., 2008)
Olive pit	16.2	(Dogru, 2013)
Olive pit	17.3	(Mami et al., 2018)
Olive pit	19.2	(Mata-Sánchez et al., 2014)
Olive stone	16.3	(Iglesias Loredó, 2019)
Olive stone	17.0	(Rodríguez et al., 2008)

For the modelling of the “boiler combustion” on SimaPro, the combustion of natural wood chips from the forest (Heat production, untreated waste wood, at furnace 1000-5000 kW CH) was chosen as a process reference. Included activities start from the delivery of waste wood to the combustion of untreated waste wood chips. It comprises the infrastructure (dust collector, furnace), the wood requirements (LHV), the emissions to air, the electricity needed for its operation, and the disposal of the ashes. The LHV of wood used in the file was 14.0 MJ/kg.

On the other hand, the LHV of olive stone is bigger than that of wood. Therefore, a corrective factor between the olive stone and wood was used in order to adjust the modelling.

The following data were used for comparing the olive stone per kg of wood.

The LHV of wood is 14.0 MJ/kg and the average LHV of the olive pit is 17.5 MJ/kg. After comparing these values, the amount of olive pit that would replace the wood in the boiler is 0.80 kg olive pit per kg of wood.

An example is the milling process, where the quantity of olive pit dust produced is 0.20 kg. This value was replaced by 0.25 kg of wood as a factor of 0.80 kg olive pit/kg wood was used for this calculation.

➤ Composting of pulp rich fraction

The main by-product of the “Sieving 1” process is the olive pulp. For the treatment of this waste, the industrial composting of biowaste process was chosen (Biowaste {CH}|treatment of biowaste, industrial composting| Cut-off, U). The composting treatment is a process of controlled decomposition and humidification of biodegradable materials under managed conditions, which is aerobic and which allows the development of temperatures suitable for mesophilic and thermophilic bacteria as a result of biologically produced heat. The inventory refers to 1 kg of fresh weight of biogenic waste.

The activities of the process include energy demand for operating a compost plant as well as process emissions, the infrastructure of the compost plant and transports related to the collection of the biogenic waste.

III.3.2.3 Inventory tables

Pretreatment data were obtained from the literature. Pre-industrial scale trials carried out in the *Laboratoire de Chimie Agro-Industrielle (Université de Toulouse, France)* have provided the data of the compounding process (Uitterhaegen et al., 2018).

The tables below show the data used for the completed modelling of the process. **Table III-6** shows the Global LCI data corresponding to the foreground system for the production of the olive pomace-based composite. The data of each process are reported per 1 kg of output.

Table III-7 shows the description of the main background processes from Ecoinvent 3.6 considered in this study, and **Table III-8** shows the LCI data corresponding to the production of olive pomace-based composite reported per functional unit.

III.3.3 Life cycle impact assessment

The system scenarios were developed and analyzed with SimaPro PhD 9.1.1.1 software. The life cycle impact assessment (LCIA) results were assessed by ReCiPe 2016 Endpoint v1.04 (Hierarchist; H) method, normalised and weighted based on an average world environmental impact for the year 2000 (World ReCiPe H/A,2000). The methodology takes into account the Midpoint indicators from CML, and the endpoint indicators from Ecoindicator (Golsteijn, 2012). The database used for the modelling was Ecoinvent 3.6.

The ReCiPe 2016 methodology includes 18 midpoint impact categories, and three areas of protection or endpoints (Huijbregts et al., 2017). The different midpoint indicators contribute to a small set of endpoint indicators as can be observed in section II.2.3.1 Software, impact categories and impact assessment method (Chapter II).

Table III-6. Global Life Cycle Inventory data corresponding to the foreground system for the production of the olive-based composite. Data of each process are reported per 1 kg of output.

Process	Flow	Amount	Comments	Ref.
Drying	Input			
	Crude olive pomace (53% moisture)	1.09 kg		
	Energy	0.06 kW h		(Kylili et al., 2016)
	Output			
	Water (steam)	0.09 kg	Emissions to air	
	Olive pomace (9% moisture)	1.00 kg		
Milling (1)	Input			
	Energy	0.11 kW h	Ball mill DECO-PM-2X10L/15L, Electrical detail: 220 VAC, 50 Hz, 1.5 kW	(DECO, 2020)
	Output			
	Olive pomace powder	0.80 kg	Olive husk sample is ground before use, giving 80% of the weight of the sample	(Aslan, 2010)
	Dust (by-product)	0.20 kg		
Sieving (1)	Input			
	Energy	0.04 kW h	Sieving machine RITEC, power: 0.48 kW	(RITEC, 2020)
	Output			
	Coarse fraction	0.687 kg	Fractions of OP: OSF 56.4%, intermediate fraction 11.7%	(Lammi et al., 2018b)
	Pulp-rich fraction	0.313 kg	Fractions of OP: PF 31.3%,	(Lammi et al., 2018b)
Milling (2)	Input			
	Energy	0.1 kW h	Cutting mill SM 300, Retsch. Input: 30 kg/h. Power: 3 kW	(RETSCH, 2020)
	Output			
	Dust (by-product)	0.20 kg	All milling processes are considered 80%	
	Coarse fraction powder	0.80 kg		
Sieving (2)	Input			
	Energy	0.04 kW h	Sieve RITEC, power: 0.48 kW	(RITEC, 2020)
	Output			
	Intermediate fraction	0.17 kg	Fractions of OP: intermediate fraction 11.7%	(Lammi et al., 2018b)
	Olive stone-rich fraction	0.83 kg	Fractions of OP: PF 31.3%, OSF 56.4%	(Lammi et al., 2018b)
Compounding	Input			
	Polymeric matrix	0.34 kg	34 wt.% polymer	
	PE-g-MA / PP-g-MA	0.06 kg	6 wt.% coupling agent	
	Energy (OSF/PP)	0.3566 kW h	The information available was obtained by extrapolating the results of Uitterhaegen et al.	(Uitterhaegen et al., 2018)
	Energy (OSF/PE)	0.2836 kW h	The information available was obtained by extrapolating the results of Uitterhaegen et al.	(Uitterhaegen et al., 2018)
	Output			
	Composite OSF/PP or OSF/PE	1 kg		

Table III-7. Description of the main Ecoinvent 3.6 database processes considered in this study for the background processes.

Input	Ecoinvent database v.3.6
Combustion of dust	Waste wood, untreated {CH} heat production, untreated waste wood, at furnace 1000-5000 kW Cut-off, U
Composting	Biowaste {CH} treatment of biowaste, industrial composting Cut-off, U
Energy	Electricity, medium voltage {FR} market for Cut-off, U
Maleic anhydride	Maleic anhydride {GLO} market for maleic anhydride Cut-off, U
Polyethylene	Polyethylene, high density, granulate {GLO} market for Cut-off, U
Polypropylene	Polypropylene, granulate {GLO} market for Cut-off, U
Steam	Water (Emissions to air)

Table III-8. LCI data corresponding to the production of olive pomace-based composite. Data are reported per functional unit. Adapted from Espadas-Aldana et al. (2021).

Name of the process	Amount (kg) for 1 m ² profile construction of OSF/PP	Amount (kg) for 1 m ² profile construction of OSF/PE
Drying	30.42	30.63
Milling (1)	24.34	24.50
Sieving (1)	16.72	16.83
Milling (2)	13.37	13.47
Sieving (2)	11.07	11.15
Compounding	18.46	18.58

III.3.4 Results

Figure III-5 and **Figure III-6** show the result of the LCA of 1 m² of lath (building material) made of OSF/PE and OSF/PP composites, respectively. As we can observe in both production processes, the main hotspot is the compounding process, which affects all the impact categories, the most affected ones being Global warming (88%), Freshwater eutrophication (87%), and Fossil resource scarcity (95%). Inside the compounding process, the main hotspot is the production of PE and PP. Fossil resource scarcity is the most affected midpoint indicator, due to the production of ethylene and propylene (in the petrochemical industry). Another impact category that is highly affected by compounding is Human carcinogenic toxicity, which reaches values of 86% and 82% for OSF/PE and OSF/PP composites, respectively.

Figure III-7 shows the pie chart of the OSF/PE and OSF/PP compounding processes. Of the three damage categories, the most influenced is Human health, with a value of 88%, follow by Ecosystems and Resources availability, with 6% in both categories. In the Human health category, the main contributor is the polymeric matrix (PE and PP) (83%), whereas the coupling agent (PP-g-MA and PE-g-MA) contributed with 15% impact in the mentioned category of each scenario. The electricity needed for the process has the lowest contribution, *i.e.*, only 2%.

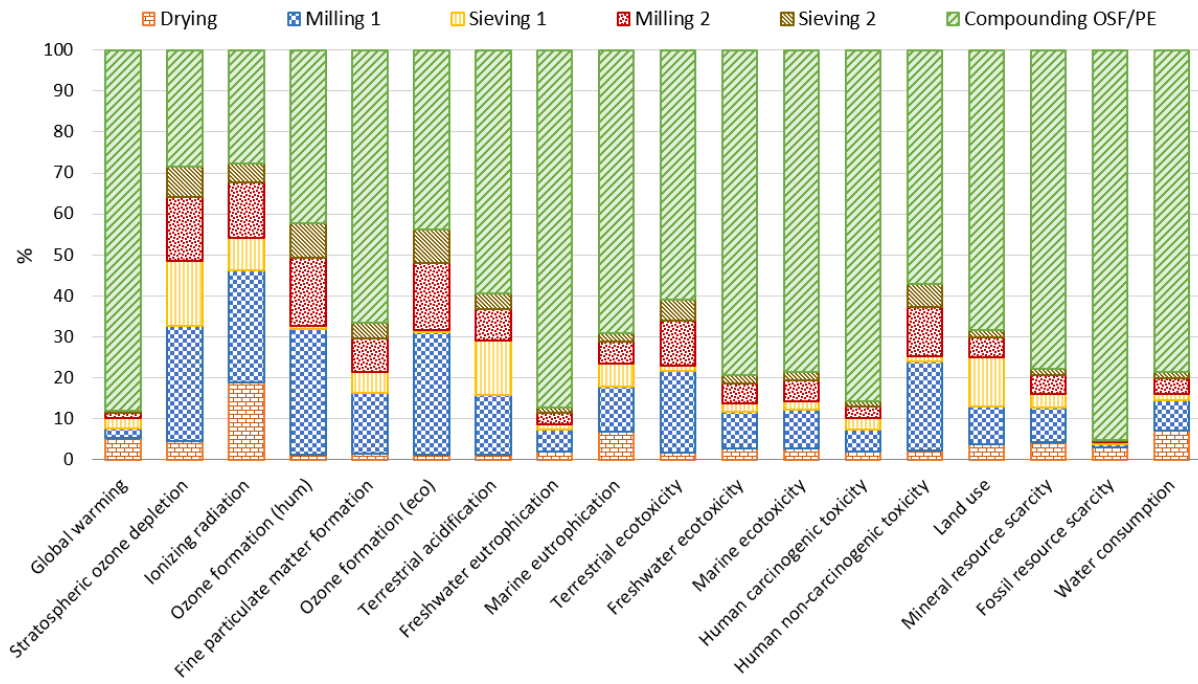

Figure III-5. Contribution of each process to the potential environmental impact of the OSF/PE scenario. Characterization, ReCiPe 2016 Midpoint (H).

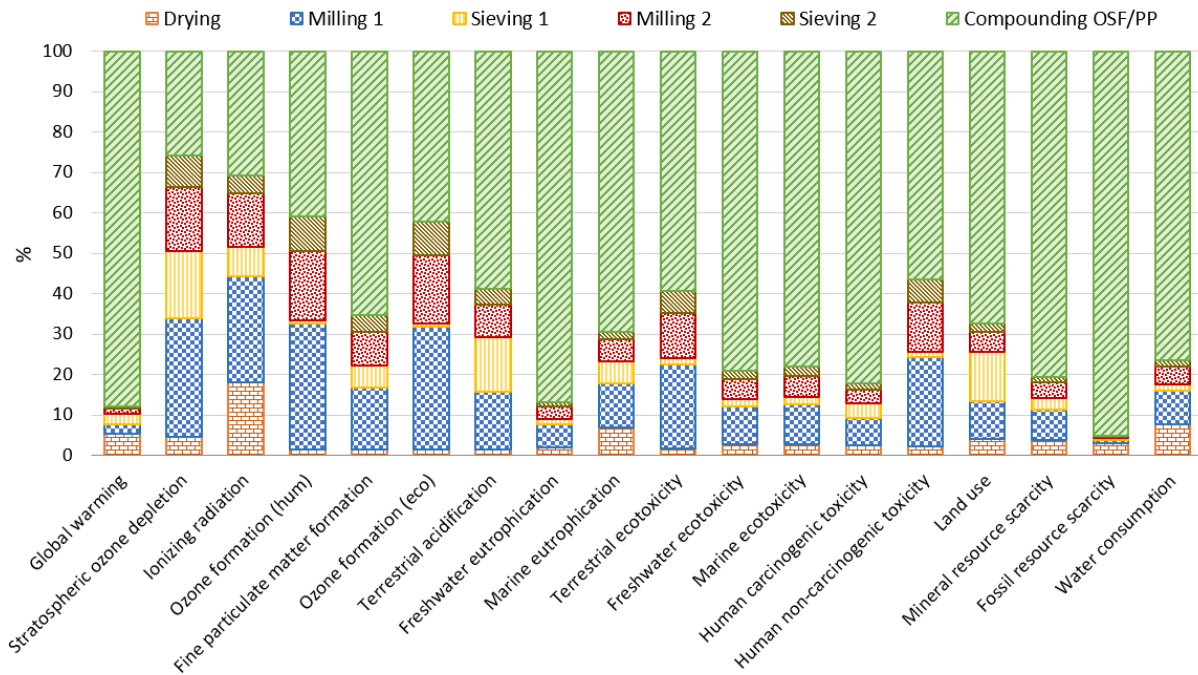

Figure III-6. Contribution of each process to the potential environmental impact of the OSF/PP scenario. Characterization, ReCiPe 2016 Midpoint (H).

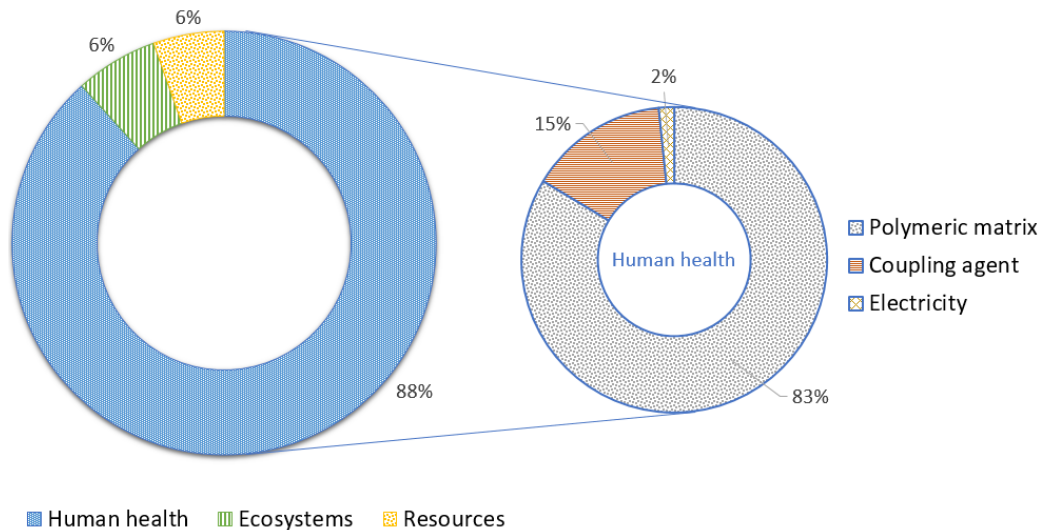

Figure III-7. Contribution of endpoint indicators for the compounding process of OSF/PE and OSF/PP. ReCiPe 2016 Endpoint (H).

From **Table III-9** and **Table III-10**, it is possible to observe the main input and substance that contribute to the pollution of each process. The contribution percentages of each input are expressed based on 100% of each Midpoint indicator. The substance percentages are first calculated from the total of all substances of each process, and the percentage expressed in the table is the percentage that corresponds only to the input mentioned (e.g., in the Drying process, 85% of the Global warming is due to the input of "Olive pomace, processed" and the remaining 15% is due to "Electricity"). 92% of the total substances is from "Carbon dioxide, fossil" and, this breaks down in 79% from "Olive pomace, processed" and 13% from "Electricity". **Table III-9** details the pollutants corresponding to drying, milling and sieving processes, which are similar for both scenarios. For its part, **Table III-10** details the pollutants corresponding to the compounding process in both scenarios.

As mentioned before, Freshwater eutrophication is highly impacted by the compounding process. This indicator shows that along the process the main impacts are produced by the consumption of energy (electricity) from the machines, the combustion and composting process of the waste, and the impacts coming from the polymeric matrices (PP, PE) in both cases. **Table III-9** and **Table III-10** show that the main pollutant in Human carcinogenic toxicity is Chromium VI in water. The values of this midpoint indicator were 721 g 1,4-DCB for the OSF/PE composite, and 574 g 1,4-DCB for the OSF/PP one. Terrestrial ecotoxicity is one of the main contributors to pollution in the case study. The production of 1 FU of the OSF/PE composite released 61.4 kg 1,4-DCB, while the production of the OSF/PP one released 58.8 kg 1,4-DCB. The two main metals emitted during the life cycle of the product were zinc and copper, which generated damages on the ecosystems, especially the soil (Haye et al., 2007). The results show that the Fossil resource scarcity indicator is similar in both cases, with 13.2 kg oil eq for the OSF/PE composite and 13.3 kg oil eq for the OSF/PP one. The Mineral resources scarcity indicator (**Table III-10**) shows that the polymeric matrices (PE and PP) depleted the environment with different substances: the OSF/PE composite mostly drains gold, while the OSF/PP one mainly drains titanium. All the results for each impact category for both biocomposites are presented in **Table III-11**.

Table III-9. Midpoint indicators and their main pollutants of the analysis of 1 FU of the composites production with the ReCiPe 2016 (H) method.

Midpoint indicator	Drying		Milling 1		Sieving 1		Milling 2		Sieving 2	
	Input	Substance	Input	Substance	Input	Substance	Input	Substance	Input	Substance
Global warming	Olive pomace, processed (85%)	Carbon dioxide, fossil (79%)	Electricity (58%)	Carbon dioxide, fossil (52%)	Biowaste, composting (84%)	Methane, biogenic (50.3%)	Electricity (56%)	Carbon dioxide, fossil (50%)	Heat production, waste wood (55%)	Carbon dioxide, fossil (40%)
Stratospheric ozone depletion	Olive pomace, processed (66%)	Dinitrogen monoxide (33%)	Heat production (Waste wood) (90%)	Dinitrogen monoxide (90%)	Biowaste, composting (95%)	Dinitrogen monoxide (94%)	Heat production (Waste wood) (91%)	Dinitrogen monoxide (91%)	Heat production, waste wood (94%)	Dinitrogen monoxide (94%)
Ionizing radiation	Electricity (74%)	Radon-222 (73%)	Electricity (94%)	Radon-222 (92%)	Electricity (96%)	Radon-222 (94%)	Electricity (94%)	Radon-222 (91%)	Electricity (90%)	Radon-222 (88%)
Ozone formation, Human health	Olive pomace, processed (76%)	Nitrogen oxides (73%)	Heat production (Waste wood) (98%)	Nitrogen oxides (97%)	Biowaste, composting (73%)	Nitrogen oxides (70%)	Heat production (Waste wood) (98%)	Nitrogen oxides (98%)	Heat production, waste wood (99%)	Nitrogen oxides (98%)
Fine particulate matter formation	Olive pomace, processed (58%)	Sulfur dioxide (23%)	Heat production (Waste wood) (92%)	Nitrogen oxides (68%)	Biowaste, composting (94%)	Ammonia (83%)	Heat production (Waste wood) (93%)	Nitrogen oxides (69%)	Heat production, waste wood (95%)	Nitrogen oxides (70%)
Ozone formation, Terrestrial ecosystems	Olive pomace, processed (76%)	Nitrogen oxides (71%)	Heat production (Waste wood) (98%)	Nitrogen oxides (97%)	Biowaste, composting (74%)	Nitrogen oxides (68%)	Heat production (Waste wood) (98%)	Nitrogen oxides (97%)	Heat production, waste wood (99%)	Nitrogen oxides (98%)
Terrestrial acidification	Olive pomace (61%)	Sulfur dioxide (31%)	Heat production (Waste wood) (93%)	Nitrogen oxides (83%)	Biowaste, composting (98%)	Ammonia (95%)	Heat production (Waste wood) (94%)	Nitrogen oxides (83%)	Heat production, waste wood (96%)	Nitrogen oxides (85%)
Freshwater eutrophication	Electricity (63%)	Phosphate, water (63%)	Heat production (Waste wood) (58%)	Phosphate, water (42%)	Biowaste, composting (51%)	Phosphate, water (51%)	Heat production, waste wood (61%)	Phosphate, water (43%)	Heat production, waste wood (71%)	Phosphate, water (50%)
Marine eutrophication	Electricity (73%)	Nitrate (70%)	Electricity (85%)	Nitrate (81%)	Biowaste, composting (51%)	Nitrate (47%)	Electricity (83%)	Nitrate (80%)	Electricity (76%)	Nitrate (73%)
Terrestrial ecotoxicity	Electricity (65%)	Copper (44%)	Heat production (Waste wood) (90%)	Zinc (48%)	Biowaste, composting (59%)	Copper (38%)	Heat production (Waste wood) (91%)	Zinc (49%)	Heat production, waste wood (94%)	Zinc (51%)
Freshwater ecotoxicity	Electricity (75%)	Copper (58%)	Heat production (Waste wood) (59%)	Copper (30%)	Electricity (55%)	Copper (43%)	Heat production, waste wood (62%)	Copper (31%)	Heat production, waste wood (71%)	Copper (36%)

Table III-9. Cont.

Midpoint indicator	Drying		Milling 1		Sieving 1		Milling 2		Sieving 2	
	Input	Substance	Input	Substance	Input	Substance	Input	Substance	Input	Substance
Marine ecotoxicity	Electricity (69%)	Copper (51%)	Heat production (Waste wood) (63%)	Copper (25%)	Electricity (54%)	Copper (40%)	Heat production, waste wood (65%)	Copper (26%)	Heat production, waste wood (74%)	Copper (30%)
Human carcinogenic toxicity	Electricity (54%)	Chromium VI, water (38%)	Heat production (Waste wood) (64%)	Chromium VI, water (49%)	Biowaste, composting (81%)	Chromium VI, water (77%)	Heat production (Waste wood) (66%)	Chromium VI, water (51%)	Heat production, waste wood (75%)	Chromium VI, water (58%)
Human non-carcinogenic toxicity	Electricity (62%)	Arsenic, water (29%)	Heat production (Waste wood) (89%)	Zinc, soil (56%)	Electricity (57%)	Zinc (20%)	Heat production (Waste wood) (90%)	Zinc, soil (57%)	Heat production, waste wood (93%)	Zinc, soil (59%)
Land use	Electricity (78%)	Occupation, forest, intensive (65%)	Electricity (60%)	Occupation, forest, intensive (50%)	Biowaste, composting (87%)	Occupation, forest, intensive (68%)	Electricity (58%)	Occupation, forest, intensive (48%)	Heat production, waste wood (53%)	Occupation, forest, intensive (15%)
Mineral resource scarcity	Electricity (63%)	Uranium (42%)	Electricity (59%)	Uranium (39%)	Biowaste, composting (55%)	Iron (30%)	Electricity (56%)	Uranium (38%)	Heat production, waste wood (55%)	Uranium (3%)
Fossil resource scarcity	Olive pomace, processed (89%)	Gas, natural/m ³ (86%)	Electricity (77%)	Gas, natural/m ³ (49%)	Biowaste, composting (64%)	Oil, crude (51%)	Electricity (76%)	Gas, natural/m ³ (48%)	Electricity (67%)	Gas, natural/m ³ (42%)
Water consumption	Olive pomace, processed (63%)	Water, turbine use, unspecified natural origin, FR (25%)	Electricity (64%)	Water, turbine use, unspecified natural origin, FR (80%)	Electricity (88%)	Water, turbine use, unspecified natural origin, FR (88%)	Electricity (62%)	Water, turbine use, unspecified natural origin, FR (78%)	Electricity (51%)	Water, turbine use, unspecified natural origin, FR (70%)

Table III-10. Midpoint indicators and their main pollutants of the analyze of 1 FU on the compounding process of the composites with the ReCiPe 2016 (H) method. Adapted from Espadas-Aldana et al. (2021).

Midpoint indicator	Compounding OSF/PE		Compounding OSF/PP	
	Input	Substance	Input	Substance
Global warning	Polyethylene, high density (84%)	Carbon dioxide, fossil (67%)	Polypropylene (83%)	Carbon dioxide, fossil (66%)
Stratospheric ozone depletion	Polyethylene, high density (78%)	Dinitrogen monoxide (68%)	Polypropylene (74%)	Dinitrogen monoxide (65%)
Ionizing radiation	Electricity (79%)	Radon-222 (77%)	Electricity (85%)	Radon-222 (83%)
Ozone formation, Human health	Polyethylene, high density (84%)	Nitrogen oxides (74%)	Polypropylene (84%)	Nitrogen oxides (75%)
Fine particulate matter formation	Polyethylene, high density (84%)	Sulfur dioxide (44%)	Polypropylene (83%)	Sulfur dioxide (46%)
Ozone formation, Terrestrial ecosystems	Polyethylene, high density (84%)	Nitrogen oxides (69%)	Polypropylene (84%)	Nitrogen oxides (71%)
Terrestrial acidification	Polyethylene, high density (84%)	Sulfur dioxide (62%)	Polypropylene (83%)	Sulfur dioxide (62%)
Freshwater eutrophication	Polyethylene, high density (83%)	Phosphate, water (83%)	Polypropylene (82%)	Phosphate, water (82%)
Marine eutrophication	Polyethylene, high density (75%)	Nitrate (58%)	Polypropylene (73%)	Nitrate (54%)
Terrestrial ecotoxicity	Polyethylene, high density (83%)	Copper (56%)	Polypropylene (82%)	Copper (59%)
Freshwater ecotoxicity	Polyethylene, high density (82%)	Copper (49%)	Polypropylene (81%)	Copper (49%)
Marine ecotoxicity	Polyethylene, high density (82%)	Copper (45%)	Polypropylene (81%)	Copper (45%)
Human carcinogenic toxicity	Polyethylene, high density (83%)	Chromium VI, water (78%)	Polypropylene (82%)	Chromium VI, water (76%)
Human non-carcinogenic toxicity	Polyethylene, high density (82%)	Zinc (50%)	Polypropylene (81%)	Zinc (49%)
Land use	Polyethylene, high density (79%)	Occupation, forest, intensive (37%)	Polypropylene (77%)	Occupation, forest, intensive (35%)
Mineral resource scarcity	Polyethylene, high density (80%)	Gold (24%)	Polypropylene (81%)	Titanium (22%)
Fossil resource scarcity	Polyethylene, high density (85%)	Oil, crude (50%)	Polypropylene (85%)	Oil, crude(50%)
Water consumption	Polyethylene, high density (81%)	Water, turbine use, unspecified natural origin, FR (6%)	Polypropylene (79%)	Water, turbine use, unspecified natural origin, FR (4%)

Table III-11. Results of the environmental impact categories from a cradle-to-grave perspective for the production of 1 m² olive pomace based-composite lath.

Impact category	Unit	OSF/PE	OSF/PP
Global warming	kg CO ₂ eq	20.52	20.25
Stratospheric ozone depletion	kg CFC11 eq	1.46x10 ⁻⁰⁵	1.39x10 ⁻⁰⁵
Ionizing radiation	kBq Co-60 eq	7.38	7.67
Ozone formation, Human health	kg NO _x eq	0.09	0.09
Fine particulate matter formation	kg PM _{2.5} eq	0.03	0.03
Ozone formation, Terrestrial ecosystems	kg NO _x eq	0.09	0.09
Terrestrial acidification	kg SO ₂ eq	0.08	0.08
Freshwater eutrophication	kg P eq	3.87x10 ⁻⁰³	3.72x10 ⁻⁰³
Marine eutrophication	kg N eq	4.30x10 ⁻⁰⁴	4.30x10 ⁻⁰⁴
Terrestrial ecotoxicity	kg 1,4-DCB	61.36	58.76
Freshwater ecotoxicity	kg 1,4-DCB	0.70	0.68
Marine ecotoxicity	kg 1,4-DCB	0.92	0.90
Human carcinogenic toxicity	kg 1,4-DCB	0.72	0.57
Human non-carcinogenic toxicity	kg 1,4-DCB	18.27	17.89
Land use	m ² a crop eq	0.24	0.23
Mineral resource scarcity	kg Cu eq	0.05	0.06
Fossil resource scarcity	kg oil eq	13.18	13.32
Water consumption	m ³	0.24	0.21

Figure III-8 represents the single score result of the LCA production of 1 m² of the OSF/PE and OSF/PP laths, respectively. It is worth mentioning that the score used in the charts is called Eco-points (Pt). One eco-point can be interpreted as one-thousandth of the annual environmental load of one average European inhabitant (Vervaeke, 2012).

In both scenarios, the most impactful process was compounding, where Human health was the more affected area of protection. The results show similar values for the compounding of OSF/PE and OSF/PP composites, 574 mPt and 548 mPt, respectively. The Human health category repeated along with the different processes. Therefore, it can be identified as an area of concern. The contribution for this endpoint category was 89% for both scenarios. Ecosystems and Resources availability had a small impact in comparison with Human health, their total values being 53.7 mPt (6%) and 36.5 mPt (4%), respectively, for the OSF/PE composite, and 52.5 (6%) mPt and 37.1 mPt (5%), respectively, for the OSF/PP composite. As mentioned before, the main contributor to these damage categories was the compounding process. For Ecosystems, the contribution of this process to the total damage category was 76% for both scenarios. While compounding represented 96% on the Resources availability category.

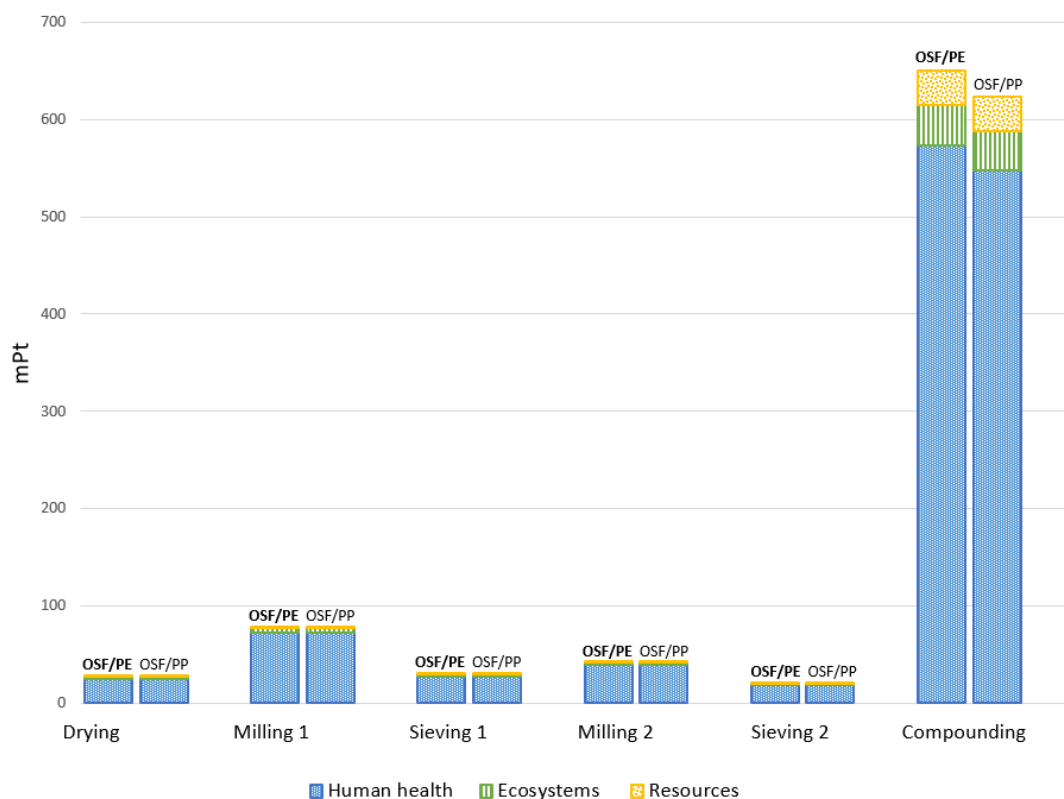

Figure III-8. Single score results of OSF/PE and OSF/PP scenarios. ReCiPe 2016 Endpoint (H).

III.3.5 Discussion and perspectives

III.3.5.1 Comparison with a conventional lath

For comparing the performance of the herein biocomposites made of olive stone flour and its application as a building material, it is important to compare it with a scenario business as usual for this type of application. A common material used for this is “PVC decking”.

This term is used to refer to plastic decking that uses cellular polyvinyl chloride (PVC) as the building material of the lath. Cellular PVC is lighter than standard PVC due to the addition of a foaming agent throughout the manufacturing process (Bergman et al., 2013). The authors reported that the production of 9.3 m² of installed PVC decking in service for 25 years produces 426 kg CO₂-eq. That project considered the full life cycle of the decking product, starting from the raw material extraction to the final disposal in a municipal solid waste landfill (Bergman et al., 2013). The preliminary results (cradle-to-gate) of this project reported the emission of 368 kg CO₂-eq. This translates into 39.6 kg CO₂-eq for 1 m² of PVC decking. In contrast, the herein work results that the production of 1 m² of OSF/PE and OSF/PP lath releases 20.5 kg CO₂-eq and 20.3 kg CO₂-eq, respectively. This may indicate that the pollution caused by PVC decking is almost two times bigger than that caused by the olive pomace-based composites.

What is certain is that PVC is considered carcinogenic, and environmentally hazardous due to the presence of organochlorines. In contrast, PP and PE are chlorine-free plastics (Thorton et al., 2002).

III.3.5.2 Biosourcing the matrix

The most common polymeric matrices used for biocomposites are produced from petrochemicals and are not biodegradable. This type of polymer generates long-term negative impacts on the environment and human health (Lammi et al., 2019). It should nevertheless be noted here that biosourced polyolefins exist on the market, especially BioPE, which is produced from sugar cane waste, and, to a much lesser extent, BioPP.

Biodegradable and bio-sourced polymers are raising great interest, due to the growing environmental concerns and the decline of the fossil resources (Koutsomitopoulou et al., 2014). Among the mentioned polymers, PLA (poly(lactic acid)) and polyhydroxyalkanoates (PHAs) (*e.g.*, PHB (polyhydroxybutyrate), PHV (polyhydroxyvalerate), PHBV (polyhydroxy-butyrates-co-valerate), etc.) are commercially available polymers, produced in large scale and able to compete with more traditional petroleum-based plastics (Gamon et al., 2013; Koutsomitopoulou et al., 2014; Lammi et al., 2019). The environmental assessment of this biodegradable composite reinforced with OP can be the objective for further studies.

III.3.5.3 Impact of the diversion of the olive pomace from its original use

It is important to contemplate the consequences of diverting the OP from its original use.

The conventional uses of olive oil by-products explained earlier (III.2 State-of-the-art: olive pomace) are their controlled spreading, their use as a mixture in animal nutrition, and composting.

Olive wastes are frequently discharged on the soil. For the production of 1 L of EVOO, the associated waste released on soil leads to the emission of around 57 g CO₂-eq. This practice is widespread around the European Community as it is supported by the law in many countries (Batuecas et al., 2019; Salomone et al., 2015).

Duman et al. (2020) studied the composting scenario in Turkey, and found that 2.25 kg of OP in a mixture with 0.34 kg of wheat straw and 0.67 kg of poultry manure can produce 2.09 kg of compost and release into the atmosphere 6.82 kg CO₂-eq, with nitrous oxide as the main emission (Duman et al., 2020).

For the production of the herein functional unit (1 m² of lath (building material) made of olive pomace-based composite), an average of 46.7 kg OP is used (**Appendix J**). Compared with the results of Duman et al. (2020), the composting of the same quantity of OP would liberate to the environment 141.5 kg CO₂-eq, which is almost seven times higher than the pollution caused by the olive pomace-based composites.

The controlled spreading of those 46.7 kg OP would liberate to the environment 0.665 kg CO₂-eq. This is taking into account that, on average, olive fruit contains 20% wt. of oil, and the remaining 80% wt. together with the water added during the olive oil extraction process form OP. The production of 1 L of EVOO generates 4 kg of OP. The controlled spreading of OP is about thirty times less polluting than the production of 1 m² of olive pomace-based composites. Nevertheless, the direct application of this olive oil by-product can cause negative effects on soil due to its high mineral salt content, low pH and presence of polyphenols (Salomone et al., 2015).

III.3.5.4 Carbon sequestration

To deepen the information obtained in this work, the importance of an expected benefit of biocomposites can be discussed, namely long-term carbon sequestration.

The U.S. Environmental Protection Agency defines biogenic CO₂ emissions as CO₂ emissions associated with the natural carbon cycle, together with the emissions resulting from the combustion, harvest, digestion, fermentation, decomposition, or processing of biologically based materials (US EPA, 2018). Products and residues of the olive orchard cultivation contain biogenic carbon derived from the uptake of CO₂ by the crop (Rinaldi et al., 2014).

When talking about olive oil production, the biogenic carbon from the agricultural phase (olive tree permanent components, especially taking into account the longevity of olive groves) does not become part of the product (olive oil). Therefore, in accordance with PAS 2050, the assessment of biogenic carbon should be taken into account when performing an LCA that considers this phase within its system boundaries (Espadas-Aldana et al., 2019). Storing carbon during a long lifespan (composite decking can last between 25 to 30 years) can mitigate climate change because of the delay in the carbon emissions into the technosphere. This advantage, however, could not be quantified with the static LCA approach used in this study. A rough estimation of biogenic carbon, based on the work herein presented, shows that 1 FU of the olive pomace based-composite could contribute to delaying the emission of over 32.5 kg CO₂ (considering a humidity content of OP of 53% and a percentage of total carbon for a three-phase centrifugation of 29%) (*Appendix K*).

III.3.5.5 Carbon dynamics

The current section is focused on carbon dynamics in olive orchards for olive oil production in France. The regions of olive oil production are Provence-Alpes-Côte-d'Azur, Languedoc-Roussillon, Rhône-Alpes, and Corse. The possibility of reintroducing the olive pomace-based composites in the olive orchard's soil is developed here. The hypothesis proposed that the olive pomace-based composites studied were 100% bio-based and biodegradable, these laths are milled and returned to the soil, assuming that the total amount of OP produced in France is used to cover part of the National decking market. The olive pomace-based composite (hypothesis of 100% biodegradable) is compared with the carbon dynamics of the virgin soil, the soil treated with olive pomace and the soil treated with compost (made of olive pomace). This was done using the C-TOOL model, which is used to measure the change in the amount of carbon in the soil of olive groves and CO₂ emissions (C-TOOL modelisation available in *Appendix L*).

For this purpose, 4 scenarios are proposed (*Table III-12*).

Table III-12. Scenarios studied.

Scenario	Description
1	Virgin soil
2	Soil treated with olive pomace spread
3	Soil treated with compost (made of olive pomace)
4	Olive pomace-based composites in the olive orchard's soil

SOC dynamics depend on the exchange between carbon losses due to soil erosion and respiration, and carbon gains by the incorporation of carbon (Abbas et al., 2020). In the herein study, the carbon input is given by the addition of olive pomace to the soil.

Figure III-9 shows the carbon dynamic in the olive orchards in France over a period of 100 years. The results showed that the carbon content in the soil had an increasing tendency for each scenario. In France, the soil treated with compost presented the highest amount of carbon, followed by the soil treated with olive pomace. The scenarios of virgin soil (soil without treatment) (green line) and the crushed olive pomace-based composite (blue line) that returned to soil presented a similar tendency. The trend line of “OP laths return to soil” (blue line) is superimposed on the trend line of “virgin soil” (green line) until 2046, when the OP-based laths returned to the soil, from there the content C of the soil increased rapidly and almost reached the same values that the results of soil treated with olive pomace (orange line).

One hundredth years later, the carbon content of each scenario was 81.46 t/ha for virgin soil, 83.92 t/ha for the OP laths returned to soil, 84.07 t/ha for soil treated with olive pomace, and 85.57 t/ha for soil treated with compost.

After 25 years, the olive pomace based composites completed their lifespan, thus, the crushed laths returned to soil and liberated the carbon sequestered in the decking material. A rough estimation of biogenic carbon, based on the work herein presented, showed that 1 m² of the olive pomace based-composite could contribute to delaying the emission of over 32.5 kg CO₂ (III.3.5.4 Carbon sequestration).

Figure III-10 shows the CO₂ emissions from the olive orchards in France in a period of 100 years. The CO₂ emission had an increasing tendency and showed that soil treated with compost (grey line) produced more CO₂ in the atmosphere due to the also elevated carbon content of the soil. The proposed hypothesis for the end-of-life of the OP-based laths (blue line) showed results close to the olive pomace spreading on soil (orange line), nevertheless, the results present a slight difference, with the spreading being greater. The virgin soil scenario (green line) generated less CO₂ emission than the other scenarios because of the reduced content of carbon in the soil. The proposed end-of-life scenario for the OP laths (blue line) seems a feasible solution to manage the residues of the decking material, as this scenario presented a reduced production of CO₂ compared to traditional methods to treat the olive pomace, namely direct OP spreading or composting.

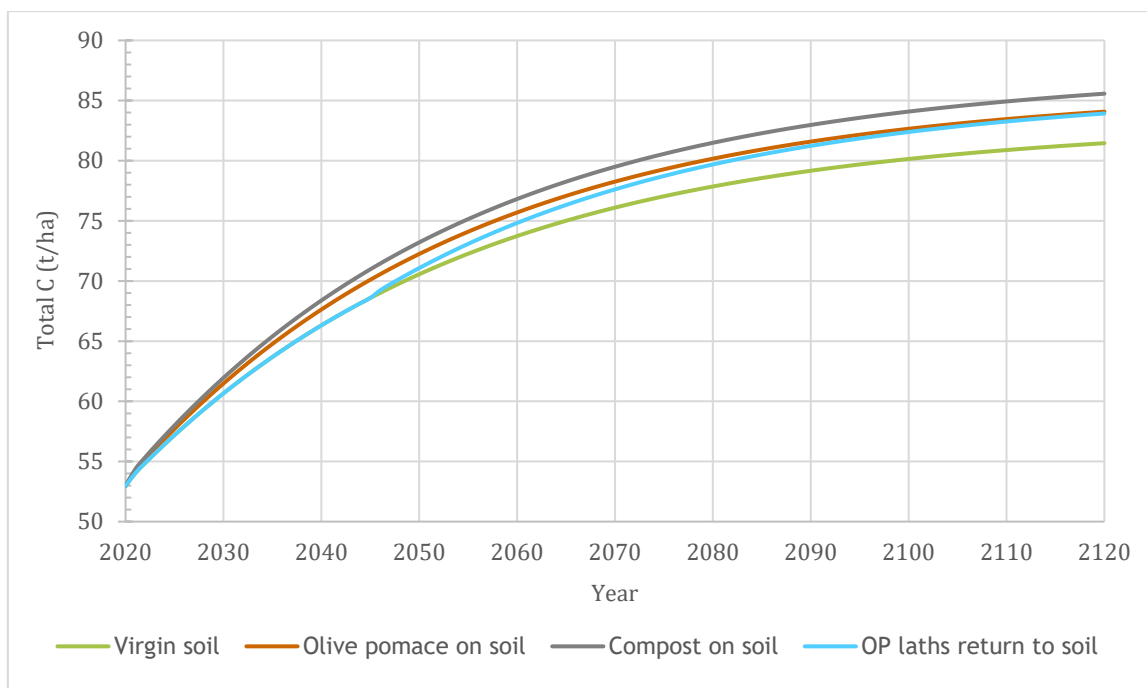

Figure III-9. Carbon dynamics in olive orchards on a 100-year time period in France.

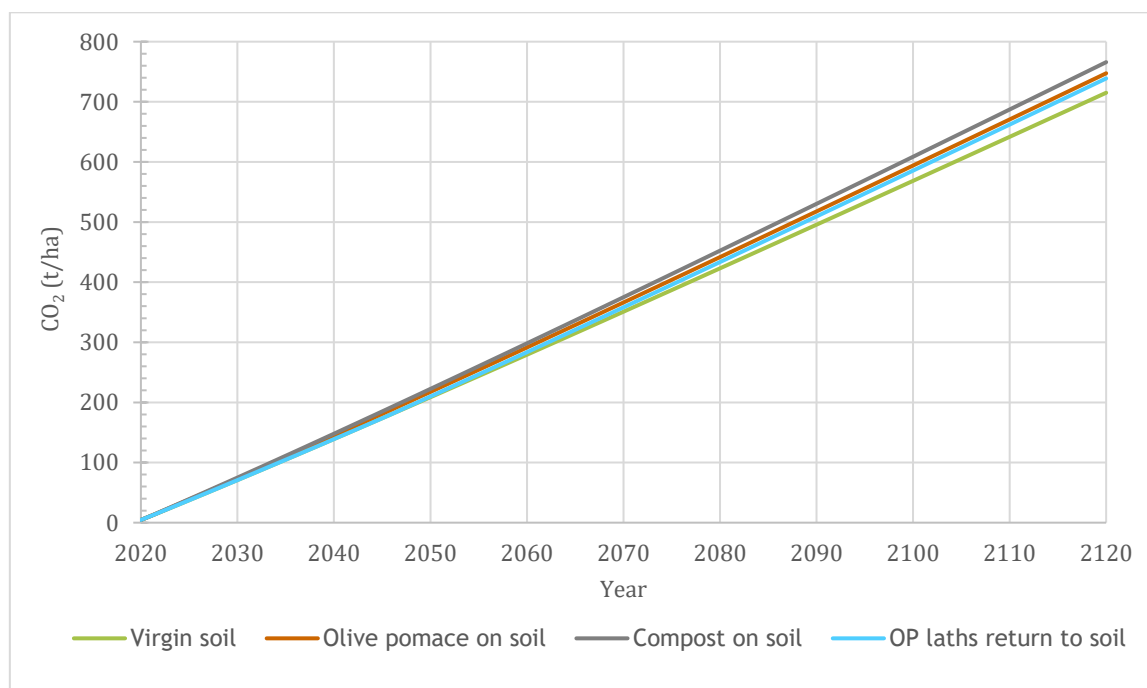

Figure III-10. CO₂ emissions from olive orchards in a 100-year time period in France.

III.4 Conclusions

In this chapter, the valorisation of an olive pomace-based biocomposite is evaluated through the environmental criteria, with the LCA method. The functional unit is the production of 1 m² of a lath (building material) made of an olive pomace-based biocomposite, from cradle-to-gate. Two scenarios with different thermoplastic matrices (PE, PP) are assessed. In both cases, the twin-screw compounding process contributed to the major burden in most of the midpoint impact categories. Compounding is mainly affected by the production of the respective polymers. When comparing the OSF/PE and OSF/PP materials, the impacts are relatively similar. Therefore, a further study at the end of life of the material should be carried out to conclude which of the proposed biocomposites is the less polluting one. The results obtained showed that Human health is the most affected area of protection; it represented 89% for both scenarios, *i.e.*, OSF/PP and OSF/PE. The main contributors to this damage category are energy, carbon dioxide and sulfur dioxide, used and produced in the manufacturing process. Ecosystems and Resources availability represented a lower contribution to the total impact. Scenarios presented values of 6% and 4.5% for ecosystems and resources availability, respectively. New research directions include the use of biobased polymer matrices, which could reduce the impact of manufacturing olive pomace composites.

The comparison of the olive pomace-based composite with the business-as-usual scenario shows that the biocomposite released half of the pollution produced by the PVC decking when considering the same FU. Besides, given the long lifespan of the biocomposites, the CO₂ stored on them can mitigate climate change because of the delay in the carbon emissions into the technosphere.

Furthermore, the carbon dynamics of the olive orchard in the four olive oil-producing regions in France were evaluated through the C-TOOL model. The study proposed the reintroduction of the olive pomace-based composites (after their lifespan) in the olive orchard's soil and compared this result with the carbon dynamics of virgin soil, the soil treated with olive pomace and the soil treated with compost (made of olive pomace). The hypothesis proposed that the olive pomace-based composites were 100% bio-based and biodegradable, and these laths were milled and returned to the soil. The C-TOOL model used as input the temperature of the region, the soil initial conditions, and the biomass left on the field (in terms of carbon).

The results showed that the soil treated with compost had a major carbon content than the one treated with olive pomace, and that both had an increasing tendency. The olive pomace-based composites were reintroduced into the soil in the year 2046 after having completed their lifespan of 25-years, liberating the carbon sequestered. The result showed that compared to virgin soil, the amount of carbon is higher with the reintroduction of the biocomposite, nevertheless, the difference in the carbon content of the soils studied was not significant, it was around 0.2 t/ha.

The CO₂ emissions showed an increasing tendency in 100 years. The soil treated with olive pomace-based composite produced fewer emissions of CO₂ compared with the soil treated with compost and olive pomace spreading. Therefore, the end-of-life scenario proposed to the olive pomace-based composites produced in France could help to mitigate climate change.

This case study evaluates a new path for olive pomace-based composites as an alternative eco-material for the building sector, based on environmental criteria.

III.5 References

- Abbas, F., Hammad, H.M., Ishaq, W., Farooque, A.A., Bakhat, H.F., Zia, Z., Fahad, S., Farhad, W., Cerdà, A., 2020. A review of soil carbon dynamics resulting from agricultural practices. *J. Environ. Manage.* 268, 110319. <https://doi.org/10.1016/j.jenvman.2020.110319>
- Albuquerque, J.A., González, J., García, D., Cegarra, J., 2006. Effects of bulking agent on the composting of “alperujo”, the solid by-product of the two-phase centrifugation method for olive oil extraction. *Process Biochem.* 41, 127–132. <https://doi.org/10.1016/j.procbio.2005.06.006>
- Alibes, X., Berge, Martilotti, F., Nefzaoui, A., Zoïopoulos, P.E., 1983. Utilisation des sous-produits de l'olivier en alimentation animale dans le bassin Méditerranéen. FAO, Rome.
- Al-Ma'adeed, M., Ozerkan, G., Kahraman, R., Rajendran, S., Hodzic, A., 2011. Life Cycle Assessment of Particulate Recycled Low Density Polyethylene and Recycled Polypropylene Reinforced with Talc and Fiberglass [WWW Document]. *Key Eng. Mater.* <https://doi.org/10.4028/www.scientific.net/KEM.471-472.999>
- Antónia Nunes, M., Costa, A.S.G., Bessada, S., Santos, J., Puga, H., Alves, R.C., Freitas, V., Oliveira, M.B.P.P., 2018. Olive pomace as a valuable source of bioactive compounds: A study regarding its lipid- and water-soluble components. *Sci. Total Environ.* 644, 229–236. <https://doi.org/10.1016/j.scitotenv.2018.06.350>
- Aouat, H., Hammiche, D., Boukerrou, A., Djidjelli, H., Grohens, Y., Pillin, I., 2021. Effects of interface modification on composites based on olive husk flour. *Mater. Today Proc., The International Network of Biomaterials and Engineering Science* 36, 94–100. <https://doi.org/10.1016/j.matpr.2020.05.459>
- Aparicio-Ruiz, R., Harwood, J. (Eds.), 2013. *Handbook of Olive Oil: Analysis and Properties*, 2nd ed. Springer US. <https://doi.org/10.1007/978-1-4614-7777-8>
- Aslan, S.S., 2010. Olive Oil Recovery Methods. *Terr. Aquat. Environ. Toxicol.* 2.
- Avadí, A., 2020. Screening LCA of French organic amendments and fertilisers. *Int. J. Life Cycle Assess.* 25, 698–718. <https://doi.org/10.1007/s11367-020-01732-w>
- Azbar, N., Bayram, A., Filibeli, A., Muezzinoglu, A., Sengul, F., Ozer, A., 2004. A Review of Waste Management Options in Olive Oil Production. *Crit. Rev. Environ. Sci. Technol.* 34, 209–247. <https://doi.org/10.1080/10643380490279932>
- Banat, R., 2019. Olive Pomace Flour as Potential Organic Filler in Composite Materials: A Brief Review. *Am. J. Polym. Sci.* 9, 10–15.
- Barreca, F., Fichera, C.R., 2013. Use of olive stone as an additive in cement lime mortar to improve thermal insulation. *Energy Build.* 62, 507–513. <https://doi.org/10.1016/j.enbuild.2013.03.040>
- Batuecas, E., Tommasi, T., Battista, F., Negro, V., Sonetti, G., Viotti, P., Fino, D., Mancini, G., 2019. Life Cycle Assessment of waste disposal from olive oil production: Anaerobic digestion and conventional disposal on soil. *J. Environ. Manage.* 237, 94–102. <https://doi.org/10.1016/j.jenvman.2019.02.021>
- Bergman, R., Suo-Han, H., Oneil, E., Eastin, I., 2013. Life-cycle assessment of redwood decking in the United States with a comparison to three other decking materials. *Consort. Res. Renew. Ind. Mater.* 101.
- Bhatnagar, A., Kaczala, F., Hogland, W., Marques, M., Paraskeva, C.A., Papadakis, V.G., Sillanpää, M., 2014. Valorization of solid waste products from olive oil industry as potential adsorbents

- for water pollution control—a review. *Environ. Sci. Pollut. Res.* 21, 268–298. <https://doi.org/10.1007/s11356-013-2135-6>
- Biolive Biological and Chemical Technologies [WWW Document], 2020. URL <http://www.biolivearge.com/indexen.html> (accessed 1.27.21).
- Boskou, D., 2006. *Olive Oil: Chemistry and Technology*, Second Edition. AOCs Publishing. <https://doi.org/10.1201/9781439832028>
- Boufi, S., 2017. Biocomposites from olive-stone flour, in: *Lignocellulosic Fibre and Biomass-Based Composite Materials*. Elsevier, pp. 387–408. <https://doi.org/10.1016/B978-0-08-100959-8.00018-4>
- Christoforou, E., Fokaides, P.A., 2016. A review of olive mill solid wastes to energy utilization techniques. *Waste Manag.* 49, 346–363. <https://doi.org/10.1016/j.wasman.2016.01.012>
- Contreras, M. del M., Romero, I., Moya, M., Castro, E., 2020. Olive-derived biomass as a renewable source of value-added products. *Process Biochem.* 97, 43–56. <https://doi.org/10.1016/j.procbio.2020.06.013>
- Cossu, A., Degl’Innocenti, S., Agnolucci, M., Cristani, C., Bedini, S., Nuti, M., 2013. Assessment of the Life Cycle Environmental Impact of the Olive Oil Extraction Solid Wastes in the European Union. *Open Waste Manag. J.* 6, 12–20. <https://doi.org/10.2174/1876400220131014001>
- Crop Guide: Growing Olives [WWW Document], 2018. . Haifa Group. URL <https://www.haifa-group.com/olives-fertilizer/crop-guide-growing-olives> (accessed 4.20.21).
- de la Casa, J.A., Castro, E., 2014. Recycling of washed olive pomace ash for fired clay brick manufacturing. *Constr. Build. Mater.* 61, 320–326. <https://doi.org/10.1016/j.conbuildmat.2014.03.026>
- DECO, 2020. 20L Ball Mill Lab Experiment [WWW Document]. Chang. Deco Equip. CoLtd. URL <http://m.deco-ballmill.com/laboratory-ball-mill/lab-roller-ball-mill/20l-ball-mill-lab-experiment.html> (accessed 7.9.20).
- Decreto 4/2011, 2011. Decreto 4/2011, de 11 de enero, por el que se regula el régimen del uso de efluentes de extracción de almazara como fertilizante agrícola. [WWW Document]. URL <https://www.juntadeandalucia.es/boja/2011/14/1> (accessed 6.3.20).
- Dermeche, S., Nadour, M., Larroche, C., Moulti-Mati, F., Michaud, P., 2013. Olive mill wastes: Biochemical characterizations and valorization strategies. *Process Biochem.* 48, 1532–1552. <https://doi.org/10.1016/j.procbio.2013.07.010>
- Dogru, M., 2013. Experimental Results of Olive Pits Gasification in a Fixed Bed Downdraft Gasifier System. *Int. J. Green Energy* 10, 348–361. <https://doi.org/10.1080/15435075.2012.655351>
- Duman, A.K., Özgen, G.Ö., Üçtuğ, F.G., 2020. Environmental life cycle assessment of olive pomace utilization in Turkey. *Sustain. Prod. Consum.* 22, 126–137. <https://doi.org/10.1016/j.spc.2020.02.008>
- El Asli, A., Qatibi, A.-I., 2009. Ethanol production from olive cake biomass substrate. *Biotechnol. Bioprocess Eng.* 14, 118–122. <https://doi.org/10.1007/s12257-008-0071-y>
- El Hanandeh, A., 2015. Energy recovery alternatives for the sustainable management of olive oil industry waste in Australia: life cycle assessment. *J. Clean. Prod.* 91, 78–88. <https://doi.org/10.1016/j.jclepro.2014.12.005>
- El-Sheikh, A.H., Newman, A.P., Al-Daffae, H.K., Phull, S., Cresswell, N., 2004. Characterization of activated carbon prepared from a single cultivar of Jordanian Olive stones by chemical and physicochemical techniques. *J. Anal. Appl. Pyrolysis* 1, 151–164. [https://doi.org/10.1016/S0165-2370\(03\)00061-5](https://doi.org/10.1016/S0165-2370(03)00061-5)

- Espadas-Aldana, G., Guaygua-Amaguaña, P., Vialle, C., Belaud, J.-P., Evon, P., Sablayrolles, C., 2021. Life Cycle Assessment of Olive Pomace as a Reinforcement in Polypropylene and Polyethylene Biocomposite Materials: A New Perspective for the Valorization of This Agricultural By-Product. *Coatings* 11, 525. <https://doi.org/10.3390/coatings11050525>
- Espadas-Aldana, G., Vialle, C., Belaud, J.-P., Vaca-Garcia, C., Sablayrolles, C., 2019. Analysis and trends for Life Cycle Assessment of olive oil production. *Sustain. Prod. Consum.* 19, 216–230. <https://doi.org/10.1016/j.spc.2019.04.003>
- European Commission, 2020a. Monthly EU Olive Oil production (2019-2020) [WWW Document]. Eur. Comm. - Eur. Comm. URL https://ec.europa.eu/info/food-farming-fisheries/farming/facts-and-figures/markets/prices/price-monitoring-sector/plant-products/olive-oil_en (accessed 6.3.20).
- European Commission, 2020b. Olive oil [WWW Document]. Eur. Comm. - Eur. Comm. URL https://ec.europa.eu/info/food-farming-fisheries/plants-and-plant-products/plant-products/olive-oil_en (accessed 6.3.20).
- European Committee for Standardization, 2013. Sustainability of Construction Works – Environmental Product Declarations – Core Rules for the Product Category of Construction Products. European Standard EN15804:2012+A1:2013.
- FAO and ITPS, 2020. Global Soil Organic Carbon Map (GSOCmap) Version 1.5: Technical report. FAO, Rome, Italy. <https://doi.org/10.4060/ca7597en>
- Fernández-Bolaños, J., Rodríguez, G., Rodríguez, R., Heredia, A., Guillén, R., Jiménez, A., 2002. Production in Large Quantities of Highly Purified Hydroxytyrosol from Liquid–Solid Waste of Two-Phase Olive Oil Processing or “Alperujo.” *J. Agric. Food Chem.* 50, 6804–6811. <https://doi.org/10.1021/jf011712r>
- Fortune Business Insights, 2020. Wood Plastic Composite Market Size, Share & Global Report [WWW Document]. Fortune Bus. Insights. URL <https://www.fortunebusinessinsights.com/wood-plastic-composite-market-102821> (accessed 6.21.21).
- France Olive, 2021. Aglandau. Fr. OLIVE - AFIDOL. URL <https://afidol.org/oleiculteur/aglandau/> (accessed 2.7.22).
- Gamon, G., Evon, Ph., Rigal, L., 2013. Twin-screw extrusion impact on natural fibre morphology and material properties in poly(lactic acid) based biocomposites. *Ind. Crops Prod.* 46, 173–185. <https://doi.org/10.1016/j.indcrop.2013.01.026>
- Golsteijn, L., 2012. ReCiPe. PRé Sustain. URL <https://pre-sustainability.com/articles/recipe/> (accessed 9.14.20).
- Haddadin, M.S.Y., Haddadin, J., Arabiyat, O.I., Hattar, B., 2009. Biological conversion of olive pomace into compost by using *Trichoderma harzianum* and *Phanerochaete chrysosporium*. *Bioresour. Technol.* 100, 4773–4782. <https://doi.org/10.1016/j.biortech.2009.04.047>
- Haye, S., Slaveykova, V.I., Payet, J., 2007. Terrestrial ecotoxicity and effect factors of metals in life cycle assessment (LCA). *Chemosphere* 68, 1489–1496. <https://doi.org/10.1016/j.chemosphere.2007.03.019>
- Historique-Météo, 2021. Historique-Météo.net [WWW Document]. Hist. Météo. URL <https://www.historique-meteo.net/> (accessed 4.9.21).
- Huijbregts, M.A.J., Steinmann, Z.J.N., Elshout, P.M.F., Stam, G., Verones, F., Vieira, M., Zijp, M., Hollander, A., van Zelm, R., 2017. ReCiPe2016: a harmonised life cycle impact assessment method at midpoint and endpoint level. *Int. J. Life Cycle Assess.* 22, 138–147. <https://doi.org/10.1007/s11367-016-1246-y>

- Iglesias Loredó, R., 2019. Valorización energética del orujillo de aceituna. Universidad del País Vasco, Bilbao.
- INRAe, 2021. Moyenne Des Teneurs En Argile Pour La Période Début 1990 à Fin 2014, Découpage Par Région - Outil Cartographique Geosol [WWW Document]. URL <https://webapps.gissol.fr/geosol/> (accessed 4.12.21).
- Intini, F., Kühtz, S., Rospi, G., 2011. Energy Recovery of the Solid Waste of the Olive Oil Industries–LCA Analysis and Carbon Footprint Assessment. *J Sustain Energy Env.* 2.
- IOC, 2021. World Olive Oil - Figures [WWW Document]. Int. Olive Counc. URL <https://www.internationaloliveoil.org/what-we-do/economic-affairs-promotion-unit/> (accessed 5.25.21).
- Joshi, S.V., Drzal, L.T., Mohanty, A.K., Arora, S., 2004. Are natural fiber composites environmentally superior to glass fiber reinforced composites? *Compos. Part Appl. Sci. Manuf., AIChE* 2002 35, 371–376. <https://doi.org/10.1016/j.compositesa.2003.09.016>
- Kaya, N., Atagur, M., Akyuz, O., Seki, Y., Sarikanat, M., Sutcu, M., Seydibeyoglu, M.O., Sever, K., 2018. Fabrication and characterization of olive pomace filled PP composites. *Compos. Part B Eng.* 150, 277–283. <https://doi.org/10.1016/j.compositesb.2017.08.017>
- Kirschbaum, M.U.F., 1999. Will changes in soil organic carbon act as a positive or negative feedback on global warming? 32.
- Koerner, G.R., Koerner, R.M., 2018. 7.3 - Polymeric Geomembrane Components in Landfill Liners, in: Cossu, R., Stegmann, R. (Eds.), *Solid Waste Landfilling*. Elsevier, pp. 313–341. <https://doi.org/10.1016/B978-0-12-407721-8.00017-6>
- Koutsomitopoulou, A.F., Bénézet, J.C., Bergeret, A., Papanicolaou, G.C., 2014. Preparation and characterization of olive pit powder as a filler to PLA-matrix bio-composites. *Powder Technol.* 255, 10–16. <https://doi.org/10.1016/j.powtec.2013.10.047>
- Kylili, A., Christoforou, E., Fokaides, P.A., 2016. Environmental evaluation of biomass pelleting using life cycle assessment. *Biomass Bioenergy* 84, 107–117. <https://doi.org/10.1016/j.biombioe.2015.11.018>
- Lammi, S., Barakat, A., Mayer-Laigle, C., Djenane, D., Gontard, N., Angellier-Coussy, H., 2018a. Dry fractionation of olive pomace as a sustainable process to produce fillers for biocomposites. *Powder Technol.* 326, 44–53. <https://doi.org/10.1016/j.powtec.2017.11.060>
- Lammi, S., Gastaldi, E., Gaubiac, F., Angellier-Coussy, H., 2019. How olive pomace can be valorized as fillers to tune the biodegradation of PHBV based composites. *Polym. Degrad. Stab.* 166, 325–333. <https://doi.org/10.1016/j.polymdegradstab.2019.06.010>
- Lammi, S., Le Moigne, N., Djenane, D., Gontard, N., Angellier-Coussy, H., 2018b. Dry fractionation of olive pomace for the development of food packaging biocomposites. *Ind. Crops Prod.* 120, 250–261. <https://doi.org/10.1016/j.indcrop.2018.04.052>
- Legge n. 574 [WWW Document], 1996. URL <https://www.camera.it/parlam/leggi/96574l.htm> (accessed 6.3.20).
- Malapert, A., Reboul, E., Loonis, M., Dangles, O., Tomao, V., 2018. Direct and Rapid Profiling of Biophenols in Olive Pomace by UHPLC-DAD-MS. *Food Anal. Methods* 11, 1001–1010. <https://doi.org/10.1007/s12161-017-1064-2>
- Mami, M.A., Mätzing, H., Gehrman, H.-J., Stapf, D., Bolduan, R., Lajili, M., 2018. Investigation of the Olive Mill Solid Wastes Pellets Combustion in a Counter-Current Fixed Bed Reactor. *Energies* 11, 1965. <https://doi.org/10.3390/en11081965>
- Martin, M., 2019. La carte nationale des stocks de carbone des sols intégrée dans la carte mondiale de la FAO. <https://doi.org/10.15454/JCONRJ>

- Martin, M., Saby, N., Toutain, B., Chenu, J., Ratié, C., Boulonne, L., 2020. Statistiques sur les stocks de carbone (0-30 cm) des sols du réseau RMQS. <https://doi.org/10.15454/RURZXN>
- Mata-Sánchez, J., Pérez-Jiménez, J.A., Díaz-Villanueva, M.J., Serrano, A., Núñez-Sánchez, N., López-Giménez, F.J., 2014. Development of olive stone quality system based on biofuel energetic parameters study. *Renew. Energy* 66, 251–256. <https://doi.org/10.1016/j.renene.2013.12.009>
- Material Connexion, 2019. Bioplastic Made from Olives [WWW Document]. Mater. Conexion. URL <https://www.materialconnexion.com/material-insight-bioplastic/> (accessed 1.27.21).
- Matos, M., Barreiro, M.F., Gandini, A., 2010. Olive stone as a renewable source of biopolyols. *Ind. Crops Prod.* 32, 7–12. <https://doi.org/10.1016/j.indcrop.2010.02.010>
- Miranda, T., Esteban, A., Rojas, S., Montero, I., Ruiz, A., 2008. Combustion Analysis of Different Olive Residues. *Int. J. Mol. Sci.* 9, 512–525.
- MITECO, 2019. Análisis de la consideración como subproducto del orujo graso húmedo procedente de la elaboración de aceite de oliva y destinado a la extracción de aceite de orujo de oliva.
- Mordor Intelligence, 2021. Europe Wood Plastic Composite (WPC) Market [WWW Document]. Mordor Intell. URL <https://www.mordorintelligence.com/industry-reports/europe-wood-plastic-composite-market> (accessed 6.22.21).
- Morillo, J.A., Antizar-Ladislao, B., Monteoliva-Sánchez, M., Ramos-Cormenzana, A., Russell, N.J., 2009. Bioremediation and biovalorisation of olive-mill wastes. *Appl. Microbiol. Biotechnol.* 82, 25–39. <https://doi.org/10.1007/s00253-008-1801-y>
- Morris, J., 2017. Recycle, Bury, or Burn Wood Waste Biomass?: LCA Answer Depends on Carbon Accounting, Emissions Controls, Displaced Fuels, and Impact Costs: Recycle, Bury, or Burn Wood Waste Biomass? *J. Ind. Ecol.* 21, 844–856. <https://doi.org/10.1111/jiec.12469>
- Mouton, R., 2012. Chambre d'agriculture des Bouches du Rhône (13). Agriculture biologique : grignons d'olives et compost [WWW Document]. URL <https://paca.chambres-agriculture.fr/nos-publications/la-publication-en-detail/actualites/agriculture-biologique-grignons-dolives-et-compost/> (accessed 2.8.22).
- Naghmouchi, I., Mutjé, P., Boufi, S., 2015. Olive stones flour as reinforcement in polypropylene composites: A step forward in the valorization of the solid waste from the olive oil industry. *Ind. Crops Prod.* 72, 183–191. <https://doi.org/10.1016/j.indcrop.2014.11.051>
- Naghmouchi, I., Mutjé, P., Boufi, S., 2014. Polyvinyl chloride composites filled with olive stone flour: Mechanical, thermal, and water absorption properties. *J. Appl. Polym. Sci.* 131. <https://doi.org/10.1002/app.41083>
- Nunes, M.A., Pimentel, F.B., Costa, A.S.G., Alves, R.C., Oliveira, M.B.P.P., 2016. Olive by-products for functional and food applications: Challenging opportunities to face environmental constraints. *Innov. Food Sci. Emerg. Technol.* 35, 139–148. <https://doi.org/10.1016/j.ifset.2016.04.016>
- Olive Tree Cultivation [WWW Document], 2010. URL <http://oliveoilsindia.com/Olive-Tree-Cultivation.htm> (accessed 4.22.21).
- Oliveira, F., Moreira, C., Salgado, J.M., Abrunhosa, L., Venâncio, A., Belo, I., 2016. Olive pomace valorization by *Aspergillus* species: lipase production using solid-state fermentation. *J. Sci. Food Agric.* 96, 3583–3589. <https://doi.org/10.1002/jsfa.7544>
- Olives and Olive Oil as Functional Foods, 1st ed, 2017. . John Wiley & Sons, Ltd. <https://doi.org/10.1002/9781119135340>

- Pattara, C., Cappelletti, G.M., Cichelli, A., 2010. Recovery and use of olive stones: Commodity, environmental and economic assessment. *Renew. Sustain. Energy Rev.* 14, 1484–1489. <https://doi.org/10.1016/j.rser.2010.01.018>
- Proietti, S., Sdringola, P., Desideri, U., Zepparelli, F., Brunori, A., Ilarioni, L., Nasini, L., Regni, L., Proietti, P., 2014. Carbon footprint of an olive tree grove. *Appl. Energy* 127, 115–124. <https://doi.org/10.1016/j.apenergy.2014.04.019>
- Putinja, I., 2020. Researchers Develop Compostable Plastic Packaging From Olive Waste [WWW Document]. *Olive Oil Times*. URL <https://www.oliveoiltimes.com/world/researchers-develop-compostable-plastic-packaging-from-olive-waste/81373> (accessed 1.27.21).
- Qin, Q.H., 2015. 1 - Introduction to the composite and its toughening mechanisms, in: Qin, Q., Ye, J. (Eds.), *Toughening Mechanisms in Composite Materials*, Woodhead Publishing Series in Composites Science and Engineering. Woodhead Publishing, pp. 1–32. <https://doi.org/10.1016/B978-1-78242-279-2.00001-9>
- Ravindran, R., Jaiswal, A.K., 2016. Exploitation of Food Industry Waste for High-Value Products. *Trends Biotechnol.* 34, 58–69. <https://doi.org/10.1016/j.tibtech.2015.10.008>
- RETSCH, 2020. Cutting Mill SM 300 - Retsch [WWW Document]. URL <https://www.retsch.com/products/milling/cutting-mills/sm-300/function-features/> (accessed 7.10.20).
- Rinaldi, S., Barbanera, M., Lascaro, E., 2014. Assessment of carbon footprint and energy performance of the extra virgin olive oil chain in Umbria, Italy. *Sci. Total Environ.* 482–483, 71–79. <https://doi.org/10.1016/j.scitotenv.2014.02.104>
- RITEC, 2020. Tamiseurs MC-RITEC [WWW Document]. RITEC. URL <http://ritec.fr/separer/tamiseurs/MC> (accessed 7.10.20).
- Rodríguez, G., Lama, A., Rodríguez, R., Jiménez, A., Guillén, R., Fernández-Bolaños, J., 2008. Olive stone an attractive source of bioactive and valuable compounds. *Bioresour. Technol.* 99, 5261–5269. <https://doi.org/10.1016/j.biortech.2007.11.027>
- Roig, A., Cayuela, M.L., Sánchez-Monedero, M.A., 2006. An overview on olive mill wastes and their valorisation methods. *Waste Manag.* 26, 960–969. <https://doi.org/10.1016/j.wasman.2005.07.024>
- Salomone, R., Cappelletti, G.M., Malandrino, O., Mistretta, M., Neri, E., Nicoletti, G.M., Notarnicola, B., Pattara, C., Russo, C., Saija, G., 2015. Life Cycle Assessment in the Olive Oil Sector, in: Notarnicola, B., Salomone, R., Petti, L., Renzulli, P.A., Roma, R., Cerutti, A.K. (Eds.), *Life Cycle Assessment in the Agri-Food Sector: Case Studies, Methodological Issues and Best Practices*. Springer International Publishing, Cham, pp. 57–121. https://doi.org/10.1007/978-3-319-11940-3_2
- Salomone, R., Ioppolo, G., 2012. Environmental impacts of olive oil production: a Life Cycle Assessment case study in the province of Messina (Sicily). *J. Clean. Prod.* 28, 88–100. <https://doi.org/10.1016/j.jclepro.2011.10.004>
- Sauvant, D., 2011. Les coproduits de l'olivier, déchets ou matières premières d'avenir ? [WWW Document]. *Amis Oliv. Pays Vans*. URL https://www.olivardeche.fr/articles.php?lng=fr&pg=81&fbclid=IwAR27WcF_zf0qqNu-r869l13AP2zWz8Z9a_E-6F2Dmh14RgcvsAvpOyI3r7I (accessed 1.27.21).
- Schau, E.M., Michalopoulos, G., Russo, C., 2016. Product Environmental Footprint Category Rules for Olive Oil.
- Sigma-Aldrich, 2020a. Polypropylene-graft-maleic anhydride [WWW Document]. Sigma-Aldrich. URL <https://www.sigmaaldrich.com/catalog/product/aldrich/427845> (accessed 9.3.20).

- Sigma-Aldrich, 2020b. Polyethylene-graft-maleic anhydride [WWW Document]. Sigma-Aldrich. URL <https://www.sigmaaldrich.com/catalog/product/aldrich/456624> (accessed 9.3.20).
- Silvadec, 2020. Silvadec, le fabricant de bois composite leader en Europe [WWW Document]. Silvadec. URL <https://fr.silvadec.com/silvadec/notre-societe/> (accessed 3.9.21).
- Sobczak, P., Mazur, J., Zawiański, K., Panasiewicz, M., Żukiewicz-Sobczak, W., Królczyk, J., Lechowski, J., 2019. Evaluation of Dust Concentration During Grinding Grain in Sustainable Agriculture. *Sustainability* 11, 1–11.
- Sommerhuber, P.F., Wenker, J.L., Rüter, S., Krause, A., 2017. Life cycle assessment of wood-plastic composites: Analysing alternative materials and identifying an environmental sound end-of-life option. *Resour. Conserv. Recycl.* 117, 235–248. <https://doi.org/10.1016/j.resconrec.2016.10.012>
- Stockmann, U., Adams, M.A., Crawford, J.W., Field, D.J., Henakaarchchi, N., Jenkins, M., Minasny, B., McBratney, A.B., Courcelles, V. de R. de, Singh, K., Wheeler, I., Abbott, L., Angers, D.A., Baldock, J., Bird, M., Brookes, P.C., Chenu, C., Jastrow, J.D., Lal, R., Lehmann, J., O'Donnell, A.G., Parton, W.J., Whitehead, D., Zimmermann, M., 2013. The knowns, known unknowns and unknowns of sequestration of soil organic carbon. *Agric. Ecosyst. Environ.* 164, 80–99. <https://doi.org/10.1016/j.agee.2012.10.001>
- Taghizadeh-Toosi, A., Christensen, B.T., Hutchings, N.J., Vejlin, J., Kätterer, T., Glendining, M., Olesen, J.E., 2014. C-TOOL: A simple model for simulating whole-profile carbon storage in temperate agricultural soils. *Ecol. Model.* 292, 11–25. <https://doi.org/10.1016/j.ecolmodel.2014.08.016>
- Thorton, J., Healthy Building Network, Institute for Local Self-Reliance, 2002. Environmental impacts of polyvinyl chloride building materials. Healthy Building Network, Washington, D.C.
- Toulon, A., Bouhaddi, F., 2020. Statistique agricole annuelle 2018-2019 [WWW Document]. Agreste. URL <https://agreste.agriculture.gouv.fr/agreste-web/disaron/Chd2002/detail/> (accessed 5.11.21).
- Uitterhaegen, E., Parinet, J., Labonne, L., Mérian, T., Ballas, S., Véronèse, T., Merah, O., Talou, T., Stevens, C.V., Chabert, F., Evon, Ph., 2018. Performance, durability and recycling of thermoplastic biocomposites reinforced with coriander straw. *Compos. Part Appl. Sci. Manuf.* 113, 254–263. <https://doi.org/10.1016/j.compositesa.2018.07.038>
- US EPA, O., 2018. Carbon Dioxide Emissions Associated with Bioenergy and Other Biogenic Sources [WWW Document]. URL </climatechange/carbon-dioxide-emissions-associated-bioenergy-and-other-biogenic-sources> (accessed 1.13.21).
- Vera, D., Jurado, F., Margaritis, N.K., Grammelis, P., 2014. Experimental and economic study of a gasification plant fuelled with olive industry wastes. *Energy Sustain. Dev.* 23, 247–257. <https://doi.org/10.1016/j.esd.2014.09.011>
- Vervaeke, M., 2012. Life Cycle Assessment Software for Product and Process Sustainability Analysis. *J. Chem. Educ.* 89, 884–890. <https://doi.org/10.1021/ed200741b>
- Vidal, R., Martínez, P., Garraín, D., 2009. Life cycle assessment of composite materials made of recycled thermoplastics combined with rice husks and cotton linters. *Int. J. Life Cycle Assess.* 14, 73–82. <https://doi.org/10.1007/s11367-008-0043-7>
- Vlyssides, A., M.Loizidou, K.Gimouhopoulos, Zorpas, A., 1998. Olive Oil Processing Wastes Production and Their Characteristics in Relation to Olive Oil Extraction Methods. *Fresenius Environ. Bull.* 7, 308–313.

- Wise Guy Reports, 2017. Marché des composites bois-plastique (WPC) 2017 – Analyse de l'industrie, taille, part, stratégies et prévisions jusqu'en 2025 [WWW Document]. ICrowdNewswire Fr. URL <https://icrowdfr.com> (accessed 3.8.21).
- Zhao, X., Roberts, G., Roberts, E., 2019. US Patent Application for Bio-composite and Bioplastic Materials and Method.



CHAPTER IV

DISCUSSION, CONCLUSIONS AND PERSPECTIVES

IV.1 Introduction

Since 2015, French authorities have developed “the Energy Transition Law for Green Growth”. This law has focused on waste management as an essential pillar to ensure the transition to a circular economy (CE) model (Belaud et al., 2019). Moreover, the use of the CE is becoming increasingly important, especially in the field of agriculture, one of the main suppliers of waste. In particular, much research is being carried out to transform agricultural residues by sustainable processes.

The CE aims to create a closed-loop system; therefore, the utilisation of plant residues and agricultural fibre plays a key role in green composites. Residues that were once treated as waste become the feed for a new process. These by-products can be used in polymer matrices to create much more wealth and eco-friendly materials (Kaya et al., 2018). This vision has allowed the development of new companies and projects that use agricultural waste disposal as filler for polymeric matrices. This valorisation of agricultural residues can decrease the environmental impact of cultivation (“Biolive Biological and Chemical Technologies,” 2020; “Material Insight: Bioplastic Made from Olives,” 2018; Putinja, 2020).

The herein thesis is the first environmental LCA study made on biocomposites from OP (Chapter III) in order to innovate on by-product valorisation from olive oil production. Chapter IV's purpose is to explain the connection of Chapter II (LCI and LCIA of olive oil production in France) with Chapter III (Environmental assessment of olive pomace valorisation in composite materials) and demonstrate how to shift from a traditional linear production (business-as-usual) to a circular olive production system that recovers materials from organic residues. It also aims to point out how LCA is a method to objectify the environmental benefits of the CE concept. Chapter IV also presents the conclusions and perspectives of the thesis.

IV.2 Discussion

Kaya et al. (2018) addressed the concept of the CE in their work, explaining how the residues treated before as waste can become the feed of a new process. These by-products can be used in polymer matrices to create much more wealth and eco-friendly materials. The authors mixed OP powder with polypropylene (PP) in order to obtain green composites by using melt-mixing techniques (Kaya et al., 2018). It was a study on the mechanical and thermal properties of the material and not a life cycle assessment.

Current literature in the sector has shown that a wide range of environmental concerns linked to linear olive oil production have been widely extensively and assessed. Many previous studies have focused on the identification of hotspots within a linear life cycle perspective and the comparison of different alternative systems related to olive cultivation and processing, without offering the now famous and necessary improvements and explorations through the CE approach (Ncube et al., 2022).

Ncube et al. (2022) presented a study to reduce the impacts of the oil supply chain by applying the principles of the CE, that is, to change from linear to circular production, in which by-products are used as raw materials in expanded production processes. The authors address allocation by the exergy value of coproducts and rely on the fact that is an appropriate metric of allocation based on the by-products' ability to drive and support further transformations. As mass allocation would not well estimate the value of co-products and an economic allocation is too dependent on the country of production and olive oil price volatility year to year. Their work highlight that exergy is a time-independent measure that helps for a comparison over time (Ncube et al., 2022). In the last part of their study, Ncube et al. (2022) considered a boundary expansion logic the co-products generated by the proper conversion of "waste materials" will replace the products of other processes, thus generating an "avoided burden".

Batuecas et al. (2019) carried out an LCA of waste disposal from olive oil production: anaerobic digestion and conventional disposal on the soil. Their first scenario was according to CE principles, considering the anaerobic digestion as the final step where the significant organic load of OP and OMW is converted into biogas and therefore its energy content effectively recovered. The authors highlighted that the idea that closing the loop by valorising the olive oil waste through the biogas energy recovery significantly contributes to the reduction of the environmental impacts of the overall production (Batuecas et al., 2019).

Despite all the circular opportunities provided by the by-products of olive oil production, there has not been enough effort to evaluate the sustainability of the potential side production processes and compare the linear and business-as-usual paradigms with circular patterns (Harris et al., 2021; Ncube et al., 2022). Few studies compare circularity indicators (like the Material Circularity Indicator developed by the EMF (EMF, 2015)) with environmental performance or link the circularity indicators between society levels. Adequate tools exist at each level (*e.g.* LCA at the micro-level) to provide the ability to adequately assess and track the CE performance if placed within a suitable framework. The challenge of connecting the micro and macro levels is still ongoing (Harris et al., 2021).

In Chapter II - LCI and LCA of olive oil production in France -, the environmental impacts of the Business-As-Usual (BAU) production pattern were identified for possible improvements. The functional unit was to "produce one litre of virgin/extra virgin olive oil" from cradle to grave.

Mentioned Chapter II proposed a comprehensive environmental assessment of eleven scenarios representing French olive oil production. A comparison of the environmental performance from a life cycle perspective was made among the different scenarios. This analysis was conducted from a BAU perspective. In other words, it was made from a linear production without valorisation of by-products.

On the other hand, **Figure IV-1** shows a simplification of olive oil production to illustrate how waste was managed from the BAU perspective. As the extraction technology of the case studies is the two-phase system, it deals only with "wet OP", and none OMW as waste management. 100% of the olive pomace is spread out in the agricultural field. The production of this waste is estimated at 4.4 kg OP/L olive oil, and the pomace spreading is estimated at 4 tons per hour with the help of a tractor. The modelling for this spreading has already been explained in Chapter II (II.2.2.2c Inventory data: packaging, waste management and packaging end-of-life). Accordingly, 100% of the impacts caused by OP spreading are allocated to olive oil production. Only the impacts linked to the spreading are taken into account. The direct emission of OP in the field was not quantified. No avoided product is considered as the spreading does not replace amendment or fertilising use.

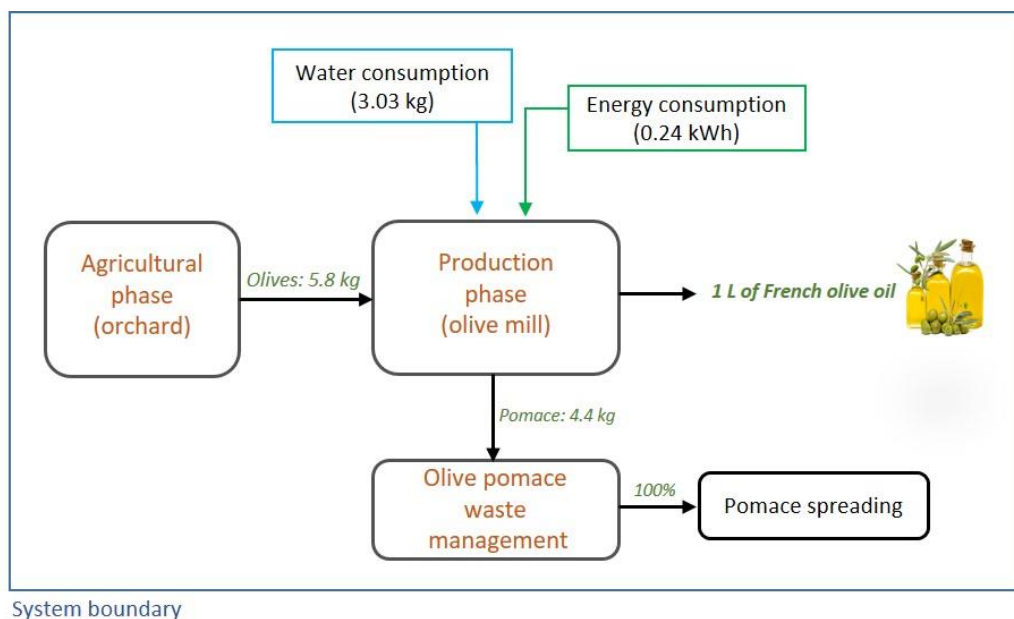

Figure IV-1. Illustration of the system boundary of Chapter II (linear production), focus on waste management.

In addition to the spreading of pomace on agricultural soils, there are other ways to treat pomace for valorisation. These valorisation options have been further elaborated in Chapter III - Olive pomace valorisation in composite materials -. **Figure IV-2** shows which part of the olive oil production system is emphasised in Chapter III. Said Chapter provided an LCA of the manufacturing process of an OP-based composite. The aim was to evaluate the environmental performance of a biocomposite composed of OP and two different thermoplastic matrices. Two scenarios were investigated which are differentiated by the polymeric matrix used: *i.e.*, one made

from polyethylene and the other from polypropylene. The functional unit was the production of 1 m² of OP-based biocomposite lath.

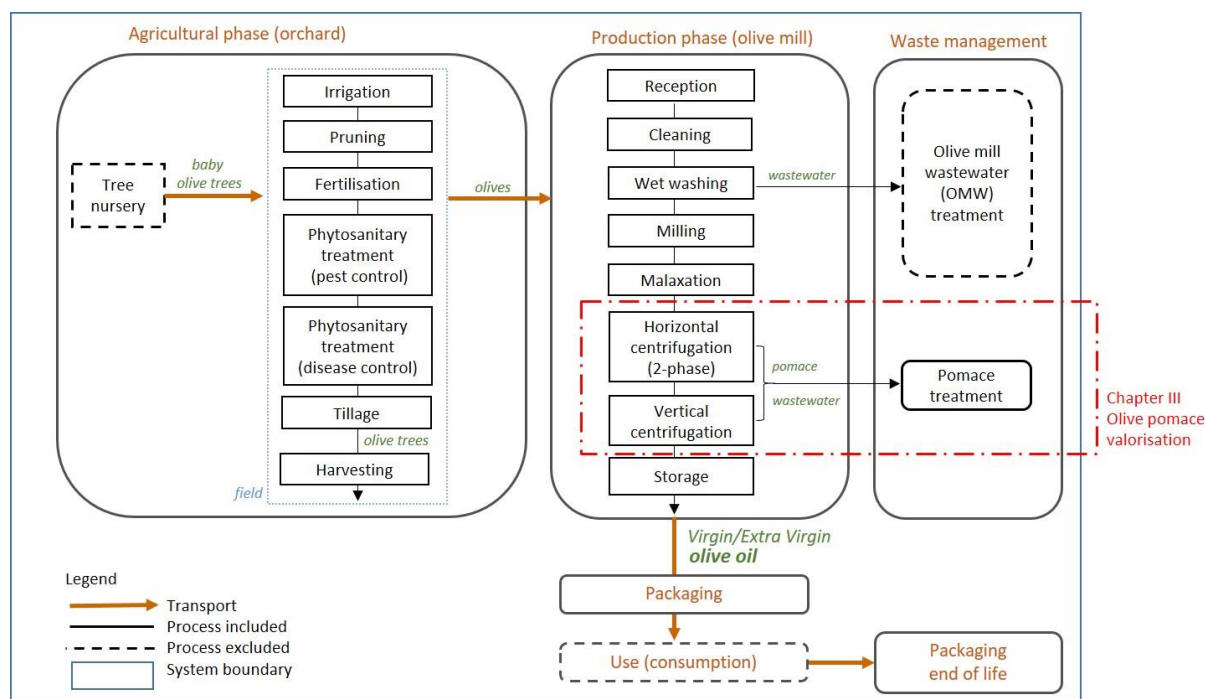

Figure IV-2. Process tree of the olive oil production in France. Adaptation of Figure II-1 to show the emphasis of Chapter III Olive pomace valorisation in composite materials.

For the modelling of these OP-based biocomposite laths, the OP used as raw material was taken from a dataset adapted from the AGRIBALYSE v3.0 database according to Avadí (2020) (see III.3.2.2.1 Inputs: raw materials).

The AGRIBALYSE database considers that the impact of olive cultivation is attributed only to olive oil. On the other hand, a part of the impact of olive oil production is attributed to the virgin OP at an economic allocation of 2.32%. This economic allocation is defined by the PEFCR: Product Environmental Footprint Category Rules for olive oil (Schau et al., 2016). These characteristics belong to the “Olive pomace” file presented in **Table III-2** (in Chapter III). Then, this virgin OP followed a new extraction process to obtain pomace oil and de-oiled pomace. There again, a part of the impact is attributed to the de-oiled pomace with an economic allocation of 9.47%, named “Olive pomace, processed”. The data used by AGRIBALYSE for the inputs/outputs of the olive oil processing was taken from Tsarouhas et al. (2015). The extraction of olive oil, also called olive oil processing, appears to be the less variable step of all stages of olive oil production worldwide (Espadas-Aldana et al., 2019). This is demonstrated in **Table IV-1** with the comparison of the inputs of **Figure IV-1** and **Figure IV-3** used to produce 1 L of extra virgin olive oil.

Table IV-1. Inputs and outputs in the olive oil production subsystem: comparison of AGRYBALYSE dataset with the case study of Chapter II.

Data	Input			Output
	Substrate (kg)	Water (kg)	Electricity (kWh)	Olive pomace (kg)
AGRYBALYSE dataset used in Chapter III Data from Tsarouhas et al. (2015)	4.00 kg	8.00 kg	0.26 kWh	1.60 kg
Data used in the olive oil processing of Chapter II	5.80 kg	3.03 kg	0.24 kWh	4.40 kg

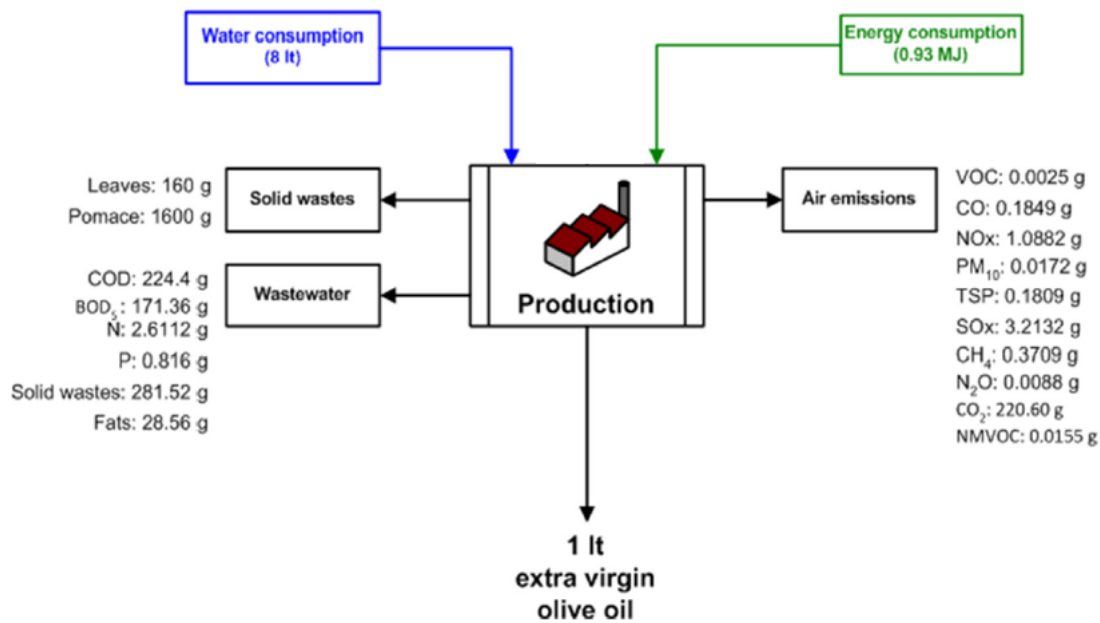

Figure IV-3. Inputs and outputs in the olive oil production subsystem for 1 L of extra virgin olive oil. Adapted from Tsarouhas et al. (2015).

The big difference in the quantity of olive pomace (output) in **Table IV-1** could be explained by the different extraction techniques. Although Tsarouhas et al. (2015) did not specify its extraction technology, it is understood that it is a three-phase system for two reasons: the small amount of olive pomace recovered and the recommendation of the two-stage centrifugation because it is considered the most efficient technology. The LCI and LCA of olive oil production in France (Chapter II) used the two-phase system as extraction technology. In this two-stage centrifugation, high humidity needs to be considered, and consequently, more weight in the “wet” olive pomace output.

For the manufacturing of the olive stone composite, the moisture of the crude OP considered for the process was 53% (Lammi et al., 2018), which is close to a three-phase system pomace (Contreras et al., 2020; Dermeche et al., 2013). The first step is the drying of an olive pomace from 53% to 9% of humidity. The AGRYBALYSE dataset is an olive pomace that comes from a three-phase extraction process and has undergone a new extraction process to obtain de-oiled pomace. However, the data of the last process comes from Intini et al. (2011) where it specifies that virgin pomace comes from a two-phase extraction system. So there is an inconsistency. The moisture content of OP from a two-phase system is 65-74% (Contreras et al., 2020; Dermeche et al., 2013). In the “Olive pomace, processed” dataset of AGRYBALYSE, virgin pomace is transformed into de-oiled pomace after drying and extracting pre-treatments. The drying process reduces the moisture content of the pomace by 10% so that it now has characteristics close to those of a pomace coming from a three-phase system, *i.e.* a “drier” pomace. The pomace production from olive oil production within the two-stage extraction technology is estimated by assuming an average production index equal to 0.75 t_{virgin pomace}/t_{olives} (Intini et al., 2011). This is consistent with the inventory data from the case study of the present thesis and is illustrated in **Figure IV-1**.

The above shows that the AGRYBALYSE dataset can be replaced by the data from the case study of the thesis and thus connect Chapter II with Chapter III.

To be accurate, it is necessary to know the exact moisture content of the OP from the case study of LCA of olive oil production in France (Chapter II) and to adjust the energy requirements of the drying phase of the olive stone composite manufacturing process to arrive at the required 9% moisture content.

Chapter III proposed an LCA of OP valorisation in its use as biocomposite material. **Figure IV-4** shows how the system is bounded if the OP valorisation in composite materials (Chapter III) is included to conduct a circular olive production system that recovers materials from organic residues. This is assuming that 100% of the OP is used for the production of OP-based composite laths for the decking sector. The dotted lines mean that it is an avoided impact, *i.e.* laths avoided to be produced with other materials. These other decking materials that serve an equivalent function include plastic (cellular PVC) and wood-plastic composites (WPCs) with recycled content at 0% and 100% (Bergman et al., 2013).

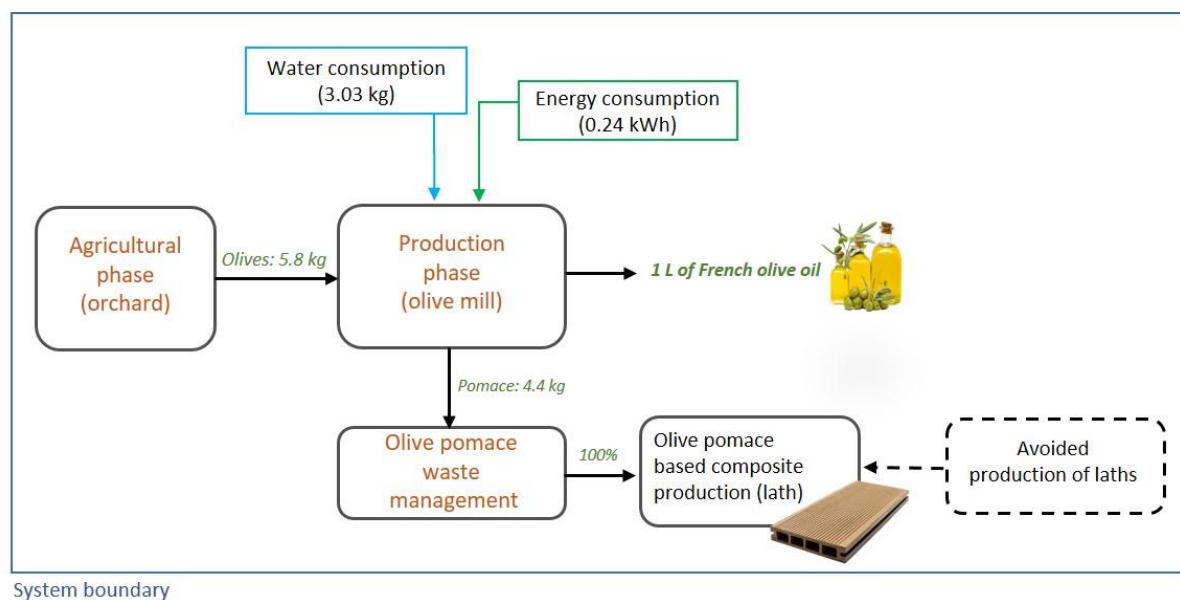

Figure IV-4. Simplification of the system boundary if the olive pomace valorisation (Chapter III) is included to conduct a circular olive production system.

Bergman et al. (2013) reported preliminary results (cradle-to-gate) of the production of 100 ft² (9.29 m²) of installed cellular PVC and WPCs decking. For PVC decking, the primary ingredients were wood flour (50%) and PE. The carbon uptake during tree growth was considered. WPC decking was made from either 100% virgin HDPE or 100% reprocessed LDPE. Only clean and dry plastic LDPE sacks were used (Bergman et al., 2013).

Table IV-2 shows the LCA results of the olive pomace-based composite (Chapter III) and Bergman's three case studies, in their FU and taken to the FU of 1 m² for comparison. The last column shows the results in 0.094 m² as this is the surface area of olive pomace-based composite decking that is produced per litre of olive oil (at a rate of 4.4 kg OP/L olive oil and 46.7 kg OP per m² lath).

Table IV-2. Life cycle impact assessment in cradle-to-gate for four decking products by value per different FU.

From	Decking material (laths)	Global warming (kg CO ₂ -eq) in cradle-to-gate		
		100 ft ²	1 m ²	0.094 m ²
Herein study (Chapter III)	Olive pomace-based composite decking	-	20.4	1.9
	PVC decking	368 ^(a)	39.6	3.7
Bergman et al., 2013	WPC decking (100% virgin HDPE)	242 ^(a)	26.0	2.4
	WPC decking (100% recycled LDPE)	122 ^(a)	13.1	1.2

(a) Values as in the publication (Bergman et al., 2013)

Figure IV-5 illustrates the comparison in climate change (global warming midpoint impact category) of the linear production of 1 L of French olive oil compared to three circular production pathways. This is a simplified approach to illustrate the potential of LCA to assess CE. These three cases were constructed with the following equation:

$$\text{Circular production} = [\text{BAU scenario} - (\text{OP spreading})] + (\text{OP lath production}) - (\text{Avoided lath production})$$

Where

BAU scenario: 4.31 kg CO₂-eq/L (available in **Table II-28**)

OP spreading: 0.007 kg CO₂-eq/L (available in **Appendix H**)

OP lath production: 1.9 kg CO₂-eq/0.094 m² lath (**Table IV-2**)

Avoided lath production: data available per 0.094 m² in **Table IV-2** for each case.

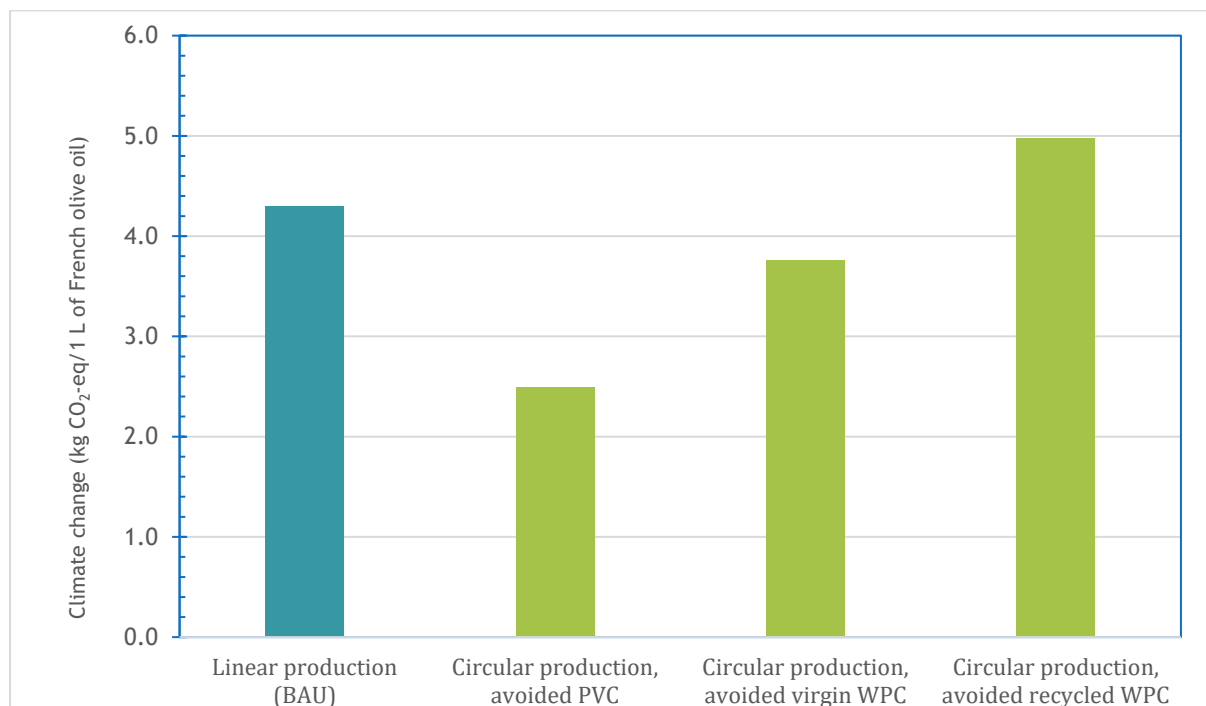

Figure IV-5. Linear production of 1 L of French olive oil compared to three circular production pathways.

Hence, it can be observed that when moving to a circular system in which waste is recovered for valorisation, a new product is created that can replace another product with the same function. In this case, it is possible to avoid the production of decking by another route. Now these avoiding decking can be from three types: cellular PVC, virgin WPC, and recycled WPC.

The results show that it is interesting from an environmental point of view to move to a circular production approach when the objective is to replace the production of cellular PVC and virgin WPC decking, although, this is not the case when compared to recycled WPC decking as the impact is higher.

It is however important to note the following aspects:

- only the climate change category is being discussed and not taking into account the other categories of the LCA methodology.
- care must be taken in the case of WPC composites, as it is important not to misinterpret as the difference is less than 20% in relative percentage (11% for virgin WPC and 14% for recycled WPC).
- carbon uptake during tree growth was considered in the WPC decking. A carbon storage value of 917 kg of CO₂ per product metric ton was calculated by Bergman et al. (2013) and was given a characterization factor of -1 when calculating GWP. The carbon sequestration was not quantified in the LCA of the OP-based composite, however, it was estimated that 1 m² of the OP-based composite could contribute to delaying the emission of over 32.5 kg CO₂ (III.3.5.4 Carbon sequestration), which means a carbon storage of 1754 kg of CO₂ per product metric ton, almost twice as much as the carbon storage capacity of WPC.
- In the LCA of French olive oil (Chapter II), the problem of the innocuity of returning the pomace to the soil was not taken into account. The direct application of this olive oil by-product can cause negative effects on soil due to its high mineral salt content, low pH and presence of polyphenols (Salomone et al., 2015).

This could be further analysed by taking into account the end of life of the laths, with the hypothesis of the OP-based composite being 100% biodegradable. It was considered that the OP composites were ground and put in the agricultural soils after their lifespan. So, the carbon dynamics of this option (circular path) were compared with the carbon dynamics of the virgin soil, the soil treated with OP (BAU scenarios) and the soil treated with compost (made of OP). To find out if there is an interest to remove this pomace that would be originally spread, and create laths instead (Chapter III, section III.3.5.5 Carbon dynamics).

Thanks to the valorisation of waste and residues by expanding the boundaries of the study system, the sustainability of a linear system is ensured through the development of circular models that feedback material residues to previous stages of the same process. In doing so, the overall impact on a larger scale decreases and real benefits are achieved promoting circularity throughout the production chain of this highly valued product in the Mediterranean region. The great advantage of valorising co-products and by-products in the framework of the CE is based on the avoided impacts derived from feeding them to replace some (or all) of the conventional production inflows.

In this case, the first two principles of CE (EMF, 2021) are touched:

- 1) Eliminate waste and pollution: eliminate the olive pomace by-product to convert it into a co-product (olive pomace-based composite laths).
- 2) To circulate products and materials at their highest value keeping the materials in use: with the production of the laths made of olive pomace, this olive pomace remains in use

during the lifespan of the lath and then as spread material on the agricultural soil at the end of life of the lath.

When considering the circular options, the use and end-of-life phase of some by-products is included in a recycling/recovery perspective. Unfortunately, although the circularity of materials is often taken to be synonymous with environmental efficiency, in many cases a properly conducted LCA reveals that this is simply not true.

When considering a circular approach to reduce impacts and optimise the reuse of co-products, some choices have to be made. These choices represent one of the challenges of the bioeconomy/CE: while environmental benefits may be obvious, in some cases, increased circularity may lead to a worse performance in terms of environmental sustainability (Ncube et al., 2022).

For the CE to be effective, there is a need to evaluate and assess the sustainability aspects and its performance before full implementation, especially in the absence of coherent policies at a micro (local, product level), meso (industrial state) and macro level (global level) (Harris et al., 2021). The current understanding of CE strategy modelling lacks a systemic view to link the micro levers and the consequences at the macro scale. A CE assessment tool should account for both scales to drive the transition toward a holistic circularity (Lonca et al., 2018).

IV.3 Conclusions

The next challenge for sustainability is to optimise production processes. The development of green and sustainable technologies is of vital importance in the chemical process industries because of the growing environmental and social concerns faced today. It is a duty and obligation for companies and organisations to improve the quality of the environment, and to seek ways to interact with external factors to contribute not only to satisfying human needs but also to improving our quality of life.

One way of identifying the contribution of transformation processes to overall environmental impacts is through LCA, which is mainly carried out to compare the raw materials and impacts of different transformation routes. The importance of LCA as an environmental decision support method continues to grow rapidly in recent years. In addition, the company could find some interest in the fact that the public expresses a strong interest in ecology and eco-labels.

In the context of environmental engineering science, one of the main scientific challenges today is the development of knowledge, methods and tools for environmental impact assessment. The problems and benefits of biomass-based processes (biorefineries) are intensively debated in the scientific and engineering communities and need to be assessed. In the herein thesis, this approach was applied to a specific biorefinery process: the production of virgin olive oil in France.

Olive oil consumption and production trends have been increasing worldwide due to its organoleptic properties. Despite its economic importance in many countries, its production is associated with several negative environmental effects. LCA is a method adapted to the evaluation of these impacts. The objective was to conduct an LCA of olive oil production from orchards and mills in the South of France. First from a business-as-usual (BAU) perspective, then towards a bioeconomy/circular economy approach. Focusing on shifting from traditional linear production to a circular olive production system that recovers materials from organic residues (olive pomace).

The present section summarises the results of the thesis.

Chapter I

Bibliographic study

Where is the state-of-the-art?

The bibliographic study presented the olive oil sector allowing the discovery of the characteristic of the olive oil, technical information, the existence of different types of this olive oil and its qualities, the organisms that regulate the olive industry and its manufacturing process. This was followed by the LCA methodology which was presented exhaustively in each of its parts.

An article's publication made in the light of the state-of-the-art for this PhD thesis identified 23 relevant LCA studies of olive oil or olive cultivation for olive oil production. The literature review converged on an unequivocal environmental hotspot, the agricultural upstream, which represents the phase responsible for the most impactful part of the olive oil life cycle, notably due

to fertilisation, pesticide treatment and irrigation. Waste management and distribution also represent a crucial issue.

The concept of circular economy and bioeconomy was expressed as well as the relationship between them and how the olive oil sector is concerned.

The scientific question of this thesis was:

**How can Life Cycle Assessment support the transition from linear to circular production?
Application to French olive oil production.**

To answer the scientific question, four challenges were identified:

1. Lack of foreground data for Life Cycle Inventory of olive oil production in France.
2. Lack of referenced Life Cycle Assessment study in France focused on olive oil production.
3. Lack of pathways for olive pomace valorisation and its environmental assessment.
4. Lack of consideration of carbon storage in environmental assessments.

Chapter II

Life Cycle Inventory and Life Cycle Impact Assessment of olive oil production in France

How is the LCA of olive oil production in France from a linear point of view?

In order to compare the results of an LCA of the French olive oil production, eleven scenarios of the agricultural upstream part, with the 2-phase extraction technology, were elaborated. Data on olive cultivation were collected in 2014 with the help of the Centre Technique de l'Olivier (CTO, France). They came from eleven different orchards in the south of France for the agricultural part. For the processing part, the data came from seven mills located in the same geographical area. Therefore, an average of these seven mills was used for the different scenarios, with the same impact on net reference units for all scenarios. The chosen functional unit was to "produce one litre of virgin/extra virgin olive oil" from cradle to grave.

The choice of French olive oil producers was guided by the three options chosen to construct the scenarios: 1) Principle of agriculture (Conventional/Organic), 2) Type of farming (Traditional/Intensive), and 3) Irrigation system (Irrigated/Dry). A complete inventory of the life cycle of all types of olive growing systems in France was provided and exhaustively detailed.

Through the state-of-the-art described in Chapter I, the literature review converged on an unambiguously environmental hotspot, the agricultural upstream, which was also demonstrated in Chapter II. Comparison of extraction technologies appeared to be the less variable step of all stages in olive oil production.

The climate change results showed that the hotspot in the agricultural phase is fertilisation followed by tillage, which is mainly due to the nitrogen fertiliser employed and to use of the tractor for the spreading of fertilisers and pesticides.

The climate change impact results showed that the irrigated systems turned out to have a positive environmental impact (*i.e.* less CO₂-eq emissions) compared to the scenarios with the

same type of agriculture and intensity. This suggested that the large difference in olive productivity per hectare is positively influenced mainly by the use of irrigation. The impact made by the irrigation process is highly outweighed by the benefits it provides. The best scenario among the eleven cases was S5-CTI (conventional, traditional, irrigated) and the least attractive environmentally was S9-CID (conventional, intensive, dry) which had almost three times less oil per hectare. This sparked a discussion on how FU significantly influences the way an LCA is conducted, as well as its results and interpretation.

In order to analyse the other impact categories, the results of the eleven scenarios were then normalised over their life cycle. The most prominent categories were those of toxicity (terrestrial ecotoxicity, freshwater ecotoxicity, marine ecotoxicity, human carcinogenic toxicity, and human non-carcinogenic toxicity). In the terrestrial, freshwater and marine ecotoxicity categories, the agricultural phase has the greatest impact on the entire life cycle, due to the PT-disease control. The most impactful material was copper for the production of copper oxide fungicides. Unlike the ecotoxicities categories, the human carcinogenic toxicity was affected differently among the eleven case studies, sometimes being the hotspot the agricultural phase, and others in the oil extraction phase. The most prominent material was the steel for the infrastructure of the olive oil mill. The results might have been different if the fate of the pesticides had been modelled differently

Furthermore, the ReCiPe 2016 method was compared to the EF 3.0 method for the environmental impacts of the life cycle of olive oil production per FU. The categories within the same unit were climate change, stratospheric ozone depletion, freshwater eutrophication, and marine eutrophication. The remaining categories used different units. Nevertheless, the same conclusions can be drawn between the ReCiPe 2016 method and the EF method.

Chapter III

Environmental assessment of olive pomace valorisation in composite materials

How can olive residues (olive pomace) be valorised? Focusing on shifting from traditional linear production to a circular olive production system that recovers materials from organic residues.

The growing popularity of olive oil has led to an increase in the production of its by-products: olive pomace (OP), a general term used for the pomace obtained from the various olive oil extraction processes, and an effluent known as olive mill wastewater (OMW), from the traditional pressing and three-phase system. Different options exist for the treatment processes of OMW and OP. However, as the extraction system of the case studies in this thesis (Chapter II) was a two-phase system, it only dealt with “wet OP” as waste.

During the olive oil extraction process, the olive stone is crushed and discarded in the olive pomace. However, olive stone flour can be recovered as a filler for polymer composites. An LCA of the valorisation of olive pomace was carried out focusing on the manufacturing process of a biocomposite composed of olive stone fraction (OSF) and two different thermoplastic matrices, namely polyethylene and polypropylene. This was the subject of the second scientific publication achieved during this thesis. The functional unit was the production of 1 m² of olive pomace-based biocomposite lath. The results indicate that the hotspot of the whole process in both scenarios was the twin-screw compounding process in most of the midpoint impact categories. Human

health was the most affected damage category. It accounted for 89% of the two scenarios studied: olive stone fraction/polypropylene (OSF/PP) and olive stone fraction/polyethylene (OSF/PE). Compounding was mainly affected by the production of the respective polymers. When comparing the OSF/PE and OSF/PP materials, the impacts are relatively similar. Therefore, a further study at the end of life of the material should be carried out to conclude which of the proposed biocomposites is the less polluting one.

The comparison of the olive pomace-based composite with the BAU scenario of decking materials indicated that the biocomposite released half of the pollution produced by the PVC decking when considering the same FU. Besides, given the long lifespan of the biocomposites, the CO₂ stored on them can mitigate climate change because of the delay in the carbon emissions into the technosphere.

Furthermore, the carbon dynamics of the olive grove in the olive oil-producing region of France have been assessed using the C-TOOL Model. This model simulates medium and long-term changes in soil organic carbon in temperate mineral soils under agricultural management. The study proposed the reintroduction of the OP-based composites in the olive orchard's soil to compare it with the carbon dynamics of virgin soil, the soil treated with olive pomace and the soil treated with compost (made of OP). The hypothesis proposed that the OP-based composites were 100% bio-based and biodegradable, and these laths were milled and returned to the soil after their lifespan.

The OP-based composites were reintroduced into the soil after they had completed their lifespan of 25-years, releasing the sequestered carbon. The result showed that, compared to virgin soil, the amount of carbon is higher with the reintroduction of the biocomposite, nevertheless, the difference in the carbon content of the soils studied was not significant. The CO₂ emissions showed an increasing tendency in 100 years. The soil treated with OP-based composite produced fewer emissions of CO₂ compared with the soil treated with compost and olive pomace spreading. Therefore, the proposed end-of-life scenario for the OP-based composites produced in France could contribute to mitigating climate change.

Chapter IV

Discussion, conclusions and perspectives

How LCA can support the transition toward a circular economy?

In conclusion, when moving to a circular system in which waste is recovered for valorisation, a new product is created that can replace another product with the same function. In this case, it is possible to avoid the production of three types of decking (cellular PVC, virgin WPC, and recycled WPC). The results showed that it is interesting from an environmental point of view to move to a circular production approach when the objective is to replace the production of cellular PVC.

Challenges achieved

The four challenges of the scientific question were fulfilled:

Challenge 1: Lack of foreground data for LCI of olive oil production in France

Achievement	<ul style="list-style-type: none"> <input type="checkbox"/> Complete LCI of the olive cultivation in France representing the different olive growing systems and based on real orchards. <input type="checkbox"/> LCI of olive oil production in France based on real olive mills.
Results	<ul style="list-style-type: none"> <input type="checkbox"/> Eleven scenarios (of which there are six different configurations), within the 2-phase system as extraction technology, were developed. The choice of French olive oil producers was guided by the three options chosen to construct the scenarios: <ol style="list-style-type: none"> 1) Principle of agriculture (Conventional/Organic), 2) Type of farming (Traditional/Intensive), 3) Irrigation system (Irrigated/Dry). <input type="checkbox"/> The data on the agricultural stream came from eleven different orchards in the south of France. <input type="checkbox"/> The olive oil extraction data came from seven mills located in the same geographical area within the 2-phase system as extraction technology.
Limitations	<ul style="list-style-type: none"> <input type="checkbox"/> Difficult to be generic about the conclusions.

Challenge 2: Lack of referenced LCA study in France focused on olive oil production

Achievement	<ul style="list-style-type: none"> <input type="checkbox"/> Several Life Cycle Impact Assessments (LCIA) from the LCIs, from cradle to grave.
Results	<ul style="list-style-type: none"> <input type="checkbox"/> The climate change results went from 2.80 kg CO₂-eq/L (scenario S5-CTI) to 7.07 kg CO₂-eq/L (scenario S9-CID). <input type="checkbox"/> The climate change impact results suggested that the large difference in olive productivity per hectare is positively influenced mainly by the use of irrigation. <input type="checkbox"/> The categories that stood out the most were those of toxicity (terrestrial ecotoxicity, freshwater ecotoxicity, marine ecotoxicity, human carcinogenic toxicity, and human non-carcinogenic toxicity). <input type="checkbox"/> The question of how the FU significantly influences the way an LCA is performed, as well as its results and their interpretation were discussed.
Limitations	<ul style="list-style-type: none"> <input type="checkbox"/> Difficult to be generic about the conclusions.

Challenge 3: Lack of pathways for olive pomace valorisation and its environmental assessment

Achievement	<ul style="list-style-type: none"> □ Alternative valorisation of olive pomace in laths for decking.
Results	<ul style="list-style-type: none"> □ Production of olive pomace-based biocomposites. Two scenarios with different thermoplastic matrices (PE, PP). □ LCA of the valorisation of olive pomace in composite material based on experimental data acquired in the laboratory (<i>Agromat/Laboratoire de Chimie Agro-industrielle - Université de Toulouse, France</i>) from the <i>Agromat</i> transfer hall (TRL 5-6).
Limitations	<ul style="list-style-type: none"> □ No further assessment of laths' end-of-life.

Challenge 4: Lack of consideration of carbon storage in environmental assessments

Achievement	<ul style="list-style-type: none"> □ Consideration of carbon stocked in the permanent parts of the olive tree. □ Study of the dynamics of carbon returning to the soil.
Results	<ul style="list-style-type: none"> □ The biogenic carbon from the permanent tree components was taken into account under three hypotheses: <ol style="list-style-type: none"> 1) Annually: the carbon sequestered only in the year of olive oil production, in this case, during 2014. And therefore the CO₂-eq sequestered. 2) Production-yr: the carbon stocked up to the year of olive oil production. In other words, the carbon stocked during the first 11 years plus the carbon sequestered each year from year 11 to the year of production. And therefore the CO₂-eq stocked. 3) Averaged: the carbon (and therefore the CO₂-eq) stocked up to the year of olive oil production (point two) but distributed over the longevity of the tree. □ After the olive pomace based composites completed their lifespan, the crushed laths could be returned to the agricultural soil and liberated the carbon sequestered in the decking material. 1 m² of the OP based-composite could contribute to delaying the emission of over 32.5 kg of CO₂. □ Calculations of the CO₂ sources and sinks to obtain the net carbon stock of the olive grove and its relation to the impact on climate change were done.
Limitations	<ul style="list-style-type: none"> □ The dry matter of the olive trees was from a "model tree" in Italy and not from real measurements from a French orchard. □ A rough estimation of biogenic carbon in the OP-based composite laths.

IV.4 Perspectives

When considering the circular options, the use and end-of-life phase of some by-products are included in a recycling/recovery perspective. Unfortunately, although the circularity of materials is often taken to be synonymous with environmental efficiency, LCA can reveal the contrary. Because, in some cases, increased circularity may lead to worse performance in terms of environmental sustainability. For the CE to be effective, there is a need to evaluate and assess the sustainability aspects and its performance before full implementation, especially in the absence of coherent policies.

The herein thesis is the first detailed environmental LCA of different olive growing systems of olive oil production from orchards and mills in the South of France. Furthermore, this thesis evaluated a new path for olive pomace-based composites as an alternative eco-material for the building sector, based on environmental criteria. Future works can include the use of biosourced and biodegradable polymer matrices, which could reduce the impact of the olive pomace-based composites production and could contribute to delaying the emission of CO₂.

Taking into account the limitations mentioned in the previous section and throughout the thesis, the following recommendations can be made for the improvement of the LCA of olive oil in France:

- More accurate modelling of the fate of pesticides in the field using multimedia models (*e.g.* using the PestLCI tool).
- To carry out a dry matter study of the average French trees in order to have an adequate quantification of the carbon sequestered in French olive groves.
- To investigate the different fractions of French olive varieties: the pulp-rich fraction, stone-rich fraction, and the intermediate fraction. The stone-rich fraction is important for the development of OP-based composites.
- To conduct a study to know the exact moisture content of the French OP to be able to adjust the energy requirements of the drying phase of the OP-based composites manufacturing process.
- Coupling/including carbon dynamics in the cradle to grave LCA.

In addition, to illustrate the transition from a traditional linear production to a circular olive production system that recovers material from organic residues, only the valorisation of pomace into biocomposites was carried out. It would be interesting to study all the possible options of valorisation of all the vegetal residues produced throughout the olive oil life cycle (permanent and non-permanent parts of the tree).

Finally, a consequential life cycle assessment on the valorisation of pomace could be carried out, as well as the other sustainability indicators:

- To develop economic criteria to carry out a Life Cycle Costing (LCC).
- To develop the social and sociological aspects of French olive oil production to conduct a Social Life Cycle Assessment (S-LCA).
- To integrate economically (LCC) and social aspects (S-LCA) to become a Life Cycle Sustainability Assessment (LCSA). Drawing on the three-pillar model of sustainability: $LCA + LCC + S-LCA = LCSA$.

IV.5 References

- Avadí, A., 2020. Screening LCA of French organic amendments and fertilisers. *Int. J. Life Cycle Assess.* 25, 698–718. <https://doi.org/10.1007/s11367-020-01732-w>
- Batuecas, E., Tommasi, T., Battista, F., Negro, V., Sonetti, G., Viotti, P., Fino, D., Mancini, G., 2019. Life Cycle Assessment of waste disposal from olive oil production: Anaerobic digestion and conventional disposal on soil. *J. Environ. Manage.* 237, 94–102. <https://doi.org/10.1016/j.jenvman.2019.02.021>
- Belaud, J.-P., Adoue, C., Vialle, C., Chorro, A., Sablayrolles, C., 2019. A circular economy and industrial ecology toolbox for developing an eco-industrial park: perspectives from French policy. *Clean Technol. Environ. Policy* 21, 967–985. <https://doi.org/10.1007/s10098-019-01677-1>
- Bergman, R., Suo-Han, H., Oneil, E., Eastin, I., 2013. Life-cycle assessment of redwood decking in the United States with a comparison to three other decking materials. *Consort. Res. Renew. Ind. Mater.* 101.
- Biolive Biological and Chemical Technologies [WWW Document], 2020. URL <http://www.biolivearge.com/indexen.html> (accessed 1.27.21).
- Contreras, M. del M., Romero, I., Moya, M., Castro, E., 2020. Olive-derived biomass as a renewable source of value-added products. *Process Biochem.* 97, 43–56. <https://doi.org/10.1016/j.procbio.2020.06.013>
- Dermeche, S., Nadour, M., Larroche, C., Moulti-Mati, F., Michaud, P., 2013. Olive mill wastes: Biochemical characterizations and valorization strategies. *Process Biochem.* 48, 1532–1552. <https://doi.org/10.1016/j.procbio.2013.07.010>
- EMF, 2021. Circular economy introduction [WWW Document]. URL <https://ellenmacarthurfoundation.org/topics/circular-economy-introduction/overview> (accessed 2.24.22).
- EMF, 2015. Circularity Indicators: An Approach Measuring Circularity. Methodology [WWW Document]. URL <https://emf.thirdlight.com/link/3jtevhkukz-9of4s4/@/preview/1?o> (accessed 4.17.22).
- Espadas-Aldana, G., Vialle, C., Belaud, J.-P., Vaca-Garcia, C., Sablayrolles, C., 2019. Analysis and trends for Life Cycle Assessment of olive oil production. *Sustain. Prod. Consum.* 19, 216–230. <https://doi.org/10.1016/j.spc.2019.04.003>
- Harris, S., Martin, M., Diener, D., 2021. Circularity for circularity's sake? Scoping review of assessment methods for environmental performance in the circular economy. *Sustain. Prod. Consum.* 26, 172–186. <https://doi.org/10.1016/j.spc.2020.09.018>
- Intini, F., Kühtz, S., Rospi, G., 2011. Energy Recovery of the Solid Waste of the Olive Oil Industries—LCA Analysis and Carbon Footprint Assessment. *J Sustain Energy Env.* 2.
- Kaya, N., Atagur, M., Akyuz, O., Seki, Y., Sarikanat, M., Sutcu, M., Seydibeyoglu, M.O., Sever, K., 2018. Fabrication and characterization of olive pomace filled PP composites. *Compos. Part B Eng.* 150, 277–283. <https://doi.org/10.1016/j.compositesb.2017.08.017>
- Lammi, S., Le Moigne, N., Djenane, D., Gontard, N., Angellier-Coussy, H., 2018. Dry fractionation of olive pomace for the development of food packaging biocomposites. *Ind. Crops Prod.* 120, 250–261. <https://doi.org/10.1016/j.indcrop.2018.04.052>
- Lonca, G., Muggéo, R., Imbeault-Tétreault, H., Bernard, S., Margni, M., 2018. Does material circularity rhyme with environmental efficiency? Case studies on used tires. *J. Clean. Prod.* 183, 424–435. <https://doi.org/10.1016/j.jclepro.2018.02.108>

- Material Insight: Bioplastic Made from Olives [WWW Document], 2018. . Mater. Conenexion. URL <https://www.materialconnexion.com/material-insight-bioplastic/> (accessed 6.19.20).
- Ncube, A., Fiorentino, G., Panfilo, C., De Falco, M., Ulgiati, S., 2022. Circular economy paths in the olive oil industry: a Life Cycle Assessment look into environmental performance and benefits. *Int. J. Life Cycle Assess.* <https://doi.org/10.1007/s11367-022-02031-2>
- Putinja, I., 2020. Researchers Develop Compostable Plastic Packaging From Olive Waste [WWW Document]. *Olive Oil Times*. URL <https://www.oliveoiltimes.com/world/researchers-develop-compostable-plastic-packaging-from-olive-waste/81373> (accessed 6.19.20).
- Salomone, R., Cappelletti, G.M., Malandrino, O., Mistretta, M., Neri, E., Nicoletti, G.M., Notarnicola, B., Pattara, C., Russo, C., Saija, G., 2015. Life Cycle Assessment in the Olive Oil Sector, in: Notarnicola, B., Salomone, R., Petti, L., Renzulli, P.A., Roma, R., Cerutti, A.K. (Eds.), *Life Cycle Assessment in the Agri-Food Sector: Case Studies, Methodological Issues and Best Practices*. Springer International Publishing, Cham, pp. 57–121. https://doi.org/10.1007/978-3-319-11940-3_2
- Schau, E.M., Michalopoulos, G., Russo, C., 2016. Product Environmental Footprint Category Rules for Olive Oil.
- Tsarouhas, P., Achillas, Ch., Aidonis, D., Folinas, D., Maslis, V., 2015. Life Cycle Assessment of olive oil production in Greece. *J. Clean. Prod.* 93, 75–83. <https://doi.org/10.1016/j.jclepro.2015.01.042>

SCIENTIFIC PRODUCTION

This section shows the scientific production during this PhD work.

Articles published in peer-reviewed scientific journals

Espadas-Aldana, G., Guaygua-Amaguaña, P., Vialle, C., Belaud, J.-P., Evon, P., Sablayrolles, C., 2021. *Life Cycle Assessment of Olive Pomace as a Reinforcement in Polypropylene and Polyethylene Biocomposite Materials: A New Perspective for the Valorization of This Agricultural By-Product*. *Coatings* 11, 525. <https://doi.org/10.3390/coatings11050525>

Espadas-Aldana, G., Vialle, C., Belaud, J.-P., Vaca-Garcia, C., Sablayrolles, C., 2019. *Analysis and trends for Life Cycle Assessment of olive oil production*. *Sustainable Production and Consumption*. 19, 216–230. <https://doi.org/10.1016/j.spc.2019.04.003>

Oral presentations at international conferences (speaker highlighted)

Espadas-Aldana, G., Vialle, C., Belaud, J.-P., C., Sablayrolles, C. *Environmental assessment of the French olive oil from organic and conventional farming*. . In the AvniR International Conference, Lille, France, 2019.

Posters at international conferences (speaker highlighted)

Espadas-Aldana, G., Vialle, C., Belaud, J.-P., C., Sablayrolles, C. *Environmental assessment of the olive oil life cycle: a review*. In the 15th International Conference on Renewable Resources & Biorefineries, Toulouse, France, 2019.



RÉSUMÉ EN FRANÇAIS

Analyse du cycle de vie pour la valorisation des déchets dans la production circulaire d'huile d'olive française

Contexte du travail de recherche

Ce manuscrit de thèse décrit le travail réalisé par l'auteur pour répondre aux exigences du diplôme de Docteur de l'Université de Toulouse dans la spécialité Sciences des Agroressources, délivré par Toulouse INP. Sa réalisation a été rendue possible grâce au soutien financier de la bourse du Conseil National de la Science et de la Technologie du Mexique (*Consejo Nacional de Ciencia y Tecnología-CONACYT*, Mexique).

Le sujet de cette thèse s'inscrit dans le thème de recherche "évaluation environnementale et écoconception" du Laboratoire de Chimie Agro-industrielle UMR 1010 INRAE - INP Toulouse (Toulouse, France), laboratoire dans lequel la thèse a été réalisée. Le Laboratoire de Chimie Agro-industrielle possède un département indépendant dédié à la transformation des sous-produits agricoles en Agro-matériaux, appelé AGROMAT (Tarbes, France), qui a également été d'une grande importance pour ce travail de thèse.

La présente thèse s'inscrit dans la continuité des travaux de recherche menés par le Dr. Guillaume BUSSET, dont la thèse a été réalisée dans le cadre du projet OiLCA, et de la thèse du Dr. Evelien UITTERHAEGEN sur la production de biocomposites thermoplastiques. Le projet européen OiLCA du programme communautaire Interreg IV SUDOE visait à améliorer la compétitivité du secteur de l'huile d'olive tout en réduisant l'empreinte carbone par l'optimisation de la gestion des déchets et la mise en place d'un éco-label. Ce projet a été réalisé dans la région du sud-ouest de l'Europe, qui comprend l'Espagne, le Portugal et le sud de la France, connue sous le nom d'espace SUDOE.

L'encadrement de ce travail de doctorat a été assuré par le Dr Caroline SABLAYROLLES et le Dr Claire VIALLE du Laboratoire de Chimie Agro-industrielle UMR 1010 INRAE - INP Toulouse, et le Dr Jean-Pierre BELAUD du Laboratoire de Génie Chimique, UMR 5503 CNRS - INP Toulouse - UPS. Une autre contribution importante a été apportée par le Dr Philippe EVON d'AGROMAT pour la partie valorisation des composites à base de grignons d'olive de cette thèse.

Contextualisation de l'étude

L'huile d'olive est un produit méditerranéen très apprécié pour ses propriétés organoleptiques. Aujourd'hui, l'huile d'olive est utilisée pour des applications alimentaires, médicales et cosmétiques. Malgré son importance économique dans de nombreux pays, sa production est associée à plusieurs problèmes environnementaux négatifs, tels que l'épuisement des ressources, la dégradation des sols, les émissions atmosphériques et la production de déchets (Salomone et al., 2015a).

La méthode d'analyse de cycle de vie (ACV) retenue pour le présent travail permet d'évaluer les aspects environnementaux et les impacts potentiels associés à un produit tout au long de son cycle de vie, du berceau à la tombe. C'est la seule méthode multicritères et multi-étapes qui relie l'impact environnemental et la fonction d'un produit, service ou système (Hauschild et al., 2018).

Les impacts environnementaux dans le secteur de l'huile d'olive peuvent varier considérablement en raison des pratiques et des techniques employées dans la culture des olives

et la production d'huile d'olive. La chaîne d'approvisionnement de l'huile d'olive a été largement étudié par le biais de l'ACV depuis plus de 10 ans. Un examen des nombreux résultats et des différents scénarios s'est révélé pour les futures études ACV sur cet important secteur agro-économique de la région méditerranéenne. L'amont agricole semble être un point sensible de l'environnement dans la revue de la littérature. Il représente la phase responsable du plus d'impacts du cycle de vie de l'huile d'olive, notamment en raison de la fertilisation, du traitement des pesticides et de l'irrigation. La gestion et la distribution des déchets représentent également un problème crucial.

Les autorités françaises ont développé " la loi de transition énergétique pour la croissance verte " depuis 2015. Cette loi met l'accent sur la gestion des déchets comme pilier essentiel pour assurer la transition vers un modèle d'économie circulaire. En outre, le recours à la bioéconomie et aux approches de l'économie circulaire prend de plus en plus d'importance, notamment dans le domaine de l'agriculture, l'un des principaux fournisseurs de déchets. Pour toutes ces raisons, il est crucial de résoudre les problèmes de gestion des déchets générés par la production d'huile d'olive, d'explorer les alternatives pour convertir le sous-produit de grignons d'olive en coproduit.

Verrous scientifiques

Cette thèse vise à répondre à une question et à des défis scientifiques concernant ce produit agro-industriel :

Comment l'analyse du cycle de vie peut-elle soutenir la transition de la production linéaire à la production circulaire ? Application à la production française d'huile d'olive.

Pour répondre à la question scientifique, quatre verrous ont été identifiés :

1. Manque de données de premier plan pour l'inventaire du cycle de vie de la production d'huile d'olive en France.
2. Absence d'étude d'analyse de cycle de vie axée sur la production d'huile d'olive en France.
3. Nouvelle filière pour la valorisation des grignons d'olive et son évaluation environnementale.
4. Difficulté de prise en compte du stockage du carbone dans les évaluations environnementales.

Tout d'abord, l'évaluation environnementale de la production d'huile d'olive à partir de vergers et de moulins dans le sud de la France a été réalisée dans une perspective *business-as-usual*. Une valorisation des grignons d'olive en tant que biocomposite a ensuite été évaluée. Ensuite, une discussion sur le passage d'une production linéaire traditionnelle à un système de production oléicole circulaire qui récupère des matériaux à partir de résidus organiques (grignons d'olive) a été menée.

Résumé graphique de l'organisation du manuscrit

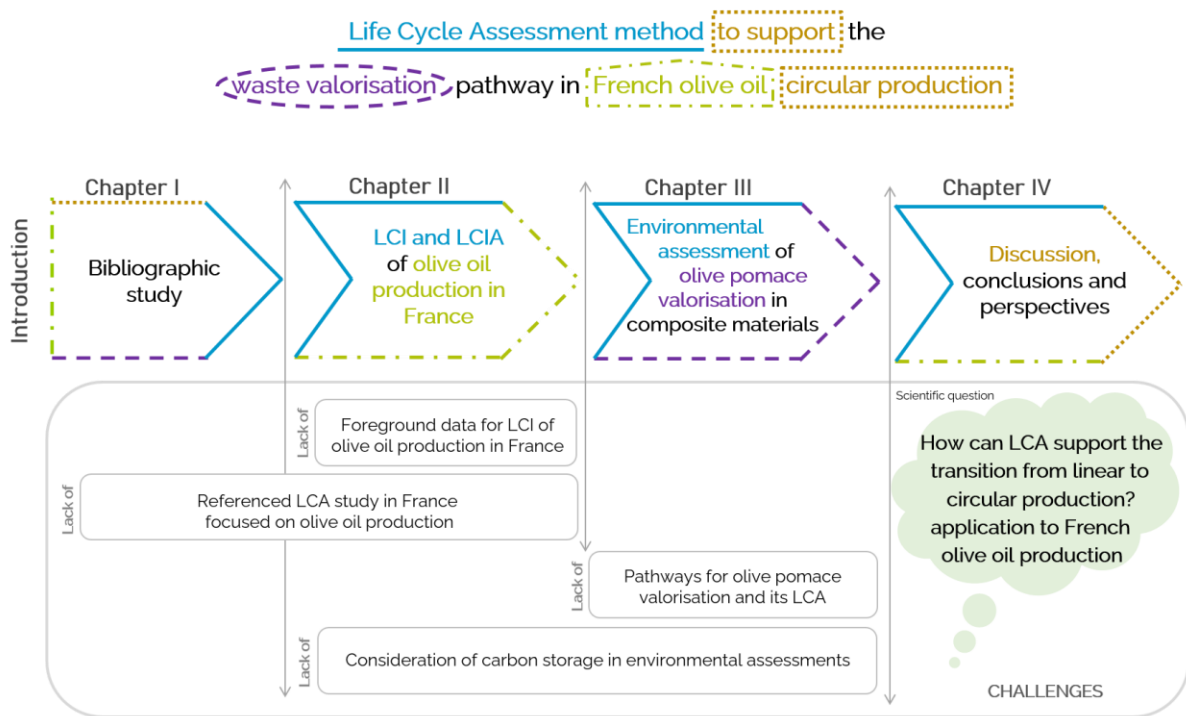

Figure 1. Résumé graphique du manuscrit de la thèse : titre, chapitres, question scientifique et défis abordés.

CHAPITRE I

ÉTUDE BIBLIOGRAPHIQUE

Où en est l'état de l'art ?

Le premier chapitre présente l'étude bibliographique, qui comprend :

- Les généralités du secteur de l'huile d'olive, les principales caractéristiques et les différents types d'huile d'olive obtenus en fonction de leur processus de fabrication.
- La méthodologie de l'ACV et la manière dont elle va être utilisée dans le cadre du travail de thèse.
- L'état de l'art des ACV de l'huile d'olive dans le secteur de l'huile d'olive afin d'identifier des pistes de recherche doctorale.
- Le concept d'économie circulaire et de bioéconomie.

Présentation du secteur de l'huile d'olive

Production et consommation mondiales d'huile d'olive

Compte tenu des propriétés organoleptiques de l'huile d'olive, les tendances de sa consommation sont à la hausse dans le monde entier. La consommation est passée de $2,590 \times 10^6$ tonnes (t) lors de la campagne 2000/2001 (période allant du 1er octobre au 30 septembre) à $3,234 \times 10^6$ t en 2019/2020, soit une augmentation de 25% au cours de la dernière décennie, et la production mondiale n'a cessé d'augmenter (**Figure 2**). L'Espagne produit environ 45% de la production mondiale et l'Italie produit un équivalent de 12% du total. Viennent ensuite d'autres producteurs comme la Grèce avec 8,2%, le Portugal avec 3,6% et la France avec 0,2%. L'Europe est donc le principal continent producteur d'huile d'olive, puisqu'elle détient environ 70 % de la production mondiale.

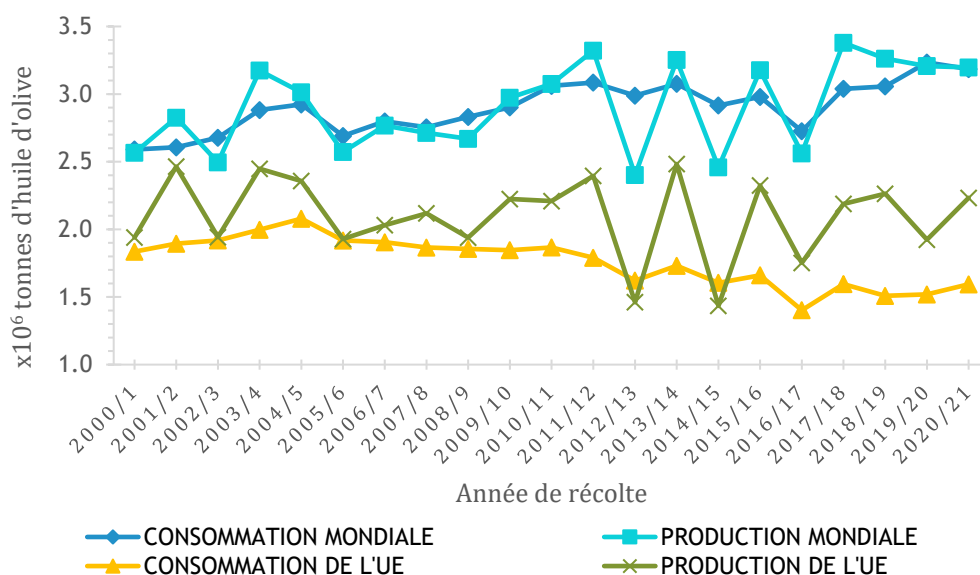

Figure 2. Production d'huile d'olive vs consommation. Adapté de Espadas-Aldana et al. (2019).

La France a produit en 2017/2018 environ 6 200 t d'huile d'olive, mais elle reste très dépendante des autres pays, car la consommation française est légèrement supérieure à 100 000 t par an (International Olive Oil Council, 2021a).

Les différents types d'huile d'olive

Les huiles d'olive vierges sont des huiles obtenues à partir du fruit de l'olivier (*Olea europaea L.*) uniquement par des procédés mécaniques ou d'autres procédés physiques, dans des conditions, notamment thermiques, qui n'entraînent pas d'altération de l'huile, et qui n'ont subi aucun traitement autre que le lavage, la décantation, la centrifugation et la filtration (International Olive Oil Council, 2021b).

Ainsi, la définition la plus courante de l'huile d'olive fait référence à l'huile provenant exclusivement de l'olive, ce qui exclut : l'huile obtenue par des traitements avec des solvants, l'huile obtenue par toute forme d'estérification, et l'huile obtenue par tout type de mélange avec d'autres huiles. L'huile d'olive se présente sous différentes qualités. Selon la façon dont elle est fabriquée et manipulée, l'huile d'olive peut également avoir des goûts très différents d'une région à l'autre ou d'un pays à l'autre. Les différentes qualités d'huile d'olive reçoivent une dénomination correspondant à des critères fixés par la réglementation. Les huiles d'olive aptes à la consommation humaine ne doivent pas dépasser 3,3 % (3,3 grammes pour 100 grammes) en teneur en acide oléique libre (International Olive Oil Council, 2021b).

Sous-produits de la production d'huile d'olive

La popularité croissante de l'huile d'olive a entraîné une augmentation de la production de ses sous-produits :

- les **grignons d'olive** (*Olive Pomace en anglais : OP*), terme général utilisé pour désigner les grignons obtenus à partir de tous les différents processus d'extraction de l'huile d'olive, et
- un effluent connu sous le nom d'**eaux usées du moulin à huile** (*Olive Mill Wastewater en anglais : OMW*), dérivant du pressage traditionnel et du système triphasé (Dermeche et al., 2013; Salomone et al., 2015a).

Ce OP est un mélange de peau résiduelle, de pulpe et de fragments de noyau d'olive broyé (Lammi et al., 2018). Les principaux composants de ce résidu solide sont la cellulose, les hémicelluloses et les lignines. Les graisses et les protéines résiduelles sont également présentes en quantités notables. L'humidité des résidus solides est de 22-25% pour les grignons d'olive pressés de manière traditionnelle, de 65-74% pour les grignons issus d'un système biphasé et de 40-50% pour ceux issus d'un système triphasé (Contreras et al., 2020; Dermeche et al., 2013). D'autre part, l'OMW est un liquide acide de couleur rouge à noire, avec une teneur en eau de 83-92%, ses principaux composants étant des composés phénoliques, des sucres et des acides organiques. L'OMW révèle également une quantité importante de potassium (Dermeche et al., 2013).

Méthodologie d'évaluation de cycle de vie

Introduction à la méthodologie de l'analyse de cycle de vie

L'analyse de cycle de vie (ACV) est une méthode d'évaluation des impacts environnementaux associés à un produit, à un processus ou à un service, qui consiste à identifier et à quantifier

l'énergie et les matériaux utilisés et les déchets rejetés dans l'environnement et, surtout, à identifier et à évaluer les possibilités d'amélioration. L'ACV est actuellement la meilleure technique pour quantifier les impacts environnementaux pendant toute la durée de vie des produits ou des processus, par l'inventaire des entrées et des sorties dans un système sélectionné, l'évaluation des impacts potentiels et l'interprétation des résultats. Elle évalue l'ensemble du cycle de vie "du berceau à la tombe", y compris l'extraction et le traitement des matières premières, la fabrication, le transport/la distribution, l'utilisation et la fin de vie. Il est important de s'assurer que toutes les étapes du cycle de vie sont prises en compte.

Définition des quatre phases de l'ACV

Selon les normes ISO (ISO, 2006a, 2006b) et la définition de la SETAC, l'ACV se déroule en quatre phases (**Figure 3**) : définition de l'objectif et du champ d'application, analyse de l'inventaire du cycle de vie, évaluation de l'impact du cycle de vie et interprétation.

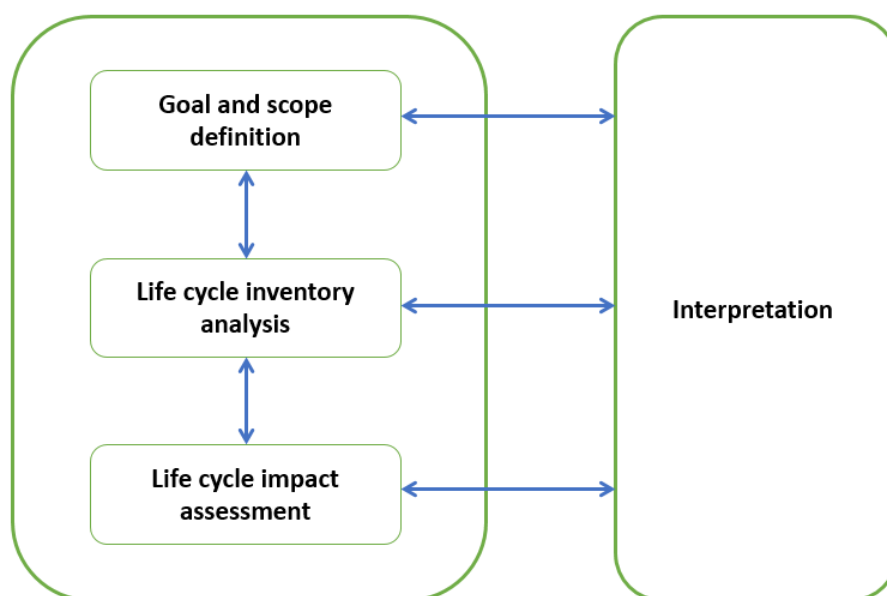

Figure 3. Phases de l'analyse de cycle de vie (d'après ISO 14040)

État de l'art : Analyse du cycle de vie de l'huile d'olive

L'ACV est appliquée au secteur de l'huile d'olive depuis plus de 10 ans. De nombreux résultats et scénarios ont été étudiés et une revue de la littérature existante est pertinente pour les futures études ACV sur cet important secteur agro-économique de la région méditerranéenne.

Une étude de synthèse sur l'ACV de l'huile d'olive s'est avérée être la première publication dans le cadre de cette thèse de doctorat (Espadas-Aldana et al., 2019). Basée sur la littérature scientifique et technique, cette revue vise à comparer les limites du système, les unités fonctionnelles, les inventaires du cycle de vie, l'allocation, les évaluations d'impact et les interprétations. En outre, une analyse de l'évaluation du carbone biogénique a été effectuée parmi les articles examinés.

Cette publication (Espadas-Aldana et al., 2019) a identifié 23 études ACV pertinentes sur l'huile d'olive ou la culture des olives pour la production d'huile d'olive. L'analyse de la littérature

a convergé vers un hotspot environnemental sans équivoque, la phase agricole, qui représente la phase responsable de plus d'impacts du cycle de vie de l'huile d'olive, en raison notamment de la fertilisation, du traitement des pesticides et de l'irrigation. La gestion et la distribution des déchets semblent également représenter un enjeu crucial. Les travaux de comparaison effectués montrent que le score d'impact pour le changement climatique est de l'ordre de 460 kg CO₂-eq/tonne d'olive et de 1,6 kg CO₂-eq/L d'huile d'olive. Cette étude met en évidence la complexité de la réalisation d'une analyse ACV. Enfin, de bonnes pratiques et des recommandations méthodologiques ont été mûries.

Économie circulaire et bioéconomie

Comment l'économie circulaire s'articule-t-elle avec la bioéconomie et vice-versa ?

L'Agence européenne pour l'environnement (AEE, 2018) définit ces deux concepts comme des partenaires de la durabilité, car les deux politiques ont des liens thématiques forts, avec par exemple les déchets alimentaires, la biomasse et les produits biosourcés comme domaines d'intervention. D'une part, la bioéconomie englobe toute chaîne de valeur qui utilise de la biomasse comme point de départ. D'autre part, le passage des ressources non renouvelables aux bioproduits est un aspect innovant important de l'économie circulaire. Par conséquent, les deux sont conceptuellement liés. Carus (2017) affirme que les deux approches sont différentes, mais complémentaires, car : *"l'économie circulaire renforce l'éco-efficacité des processus et l'utilisation du carbone recyclé pour réduire l'utilisation de carbone fossile supplémentaire. La bioéconomie remplace le carbone fossile par du carbone biologique provenant de la biomasse de l'agriculture, de la sylviculture et de l'environnement marin [...] Le concept de bioéconomie va bien au-delà de l'économie circulaire, incluant beaucoup plus d'aspects tels que de nouvelles composantes chimiques, de nouvelles voies de transformation, de nouvelles fonctionnalités et propriétés des produits"* - (Carus, 2017).

Économie circulaire et analyse de cycle de vie

L'ACV est considérée comme un principe de base lié à l'économie circulaire (EC), car il s'agit d'une méthode scientifique d'évaluation des impacts associés au cycle de vie complet des produits, normée dans la série ISO 14040 (Nobre et Tavares, 2021 ; Peña et al., 2021). L'EC est souvent utilisée comme synonyme de "fermeture des boucles" ou "cradle-to-cradle", qui en est un élément central. Cependant, l'EC implique bien plus que cela. Il s'agit de créer de la valeur pour l'économie, la société et les entreprises tout en minimisant l'utilisation des ressources et les incidences environnementales et sociales grâce à une approche systémique. Pour évaluer les impacts de l'EC, il est très utile d'appliquer une approche du cycle de vie. L'ACV peut renforcer les propositions de l'économie circulaire et inversement (PRé Sustainability, 2015).

CHAPITRE II

INVENTAIRE DU CYCLE DE VIE ET ÉVALUATION DE L'IMPACT DU CYCLE DE VIE DE LA PRODUCTION D'HUILE D'OLIVE EN FRANCE

Comment se présente l'ACV de la production d'huile d'olive en France d'un point de vue linéaire ?

Le second chapitre présente l'ACV de l'huile d'olive en France et il comprend les quatre phases de la méthodologie d'ACV :

- La définition de l'objectif et du champ d'application
- L'analyse de l'inventaire du cycle de vie (ICV)
- L'évaluation de l'impact du cycle de vie (EICV)
- L'interprétation du cycle de vie

Méthodologie : ACV

Définition de l'objectif et du champ d'application

Ce chapitre de thèse a pour but d'étudier un système agro-industriel spécifique : l'oléiculture française et la production d'huile d'olive vierge (vierge ou vierge extra) dans un scénario *Business-As-Usual* (BAU).

L'unité fonctionnelle (UF) retenue est de "produire un litre d'huile d'olive vierge/extra vierge" du berceau à la tombe.

Le cycle de vie du système de production de l'huile d'olive est basé sur un processus ancestral qui est généralement divisé en sept phases principales : la culture de l'olive -ou phase agricole- (dans le verger), la production d'huile (au moulin), le conditionnement, la distribution -transport- du produit, l'utilisation (consommation), la fin de vie (EOL) des bouteilles, et la gestion des résidus solides (grignons) et des effluents liquides (eau et eaux usées). La **Figure 4** présente l'arbre des processus avec les sept phases principales mentionnées.

En ce qui concerne la phase d'extraction de l'huile, il existe deux techniques différentes : le procédé à système de pressage discontinu et le procédé centrifuge continu. Le choix de la technologie d'extraction induit la production de grignon, de margines et d'eaux usées ayant des propriétés physico-chimiques et biologiques différentes, qui influenceront le choix du traitement et, par conséquent, les impacts associés.

Afin de comparer les résultats d'une ACV de la production d'huile d'olive dans le sud de la France, onze scénarios (dont six configurations différentes), dans le cadre du système biphasé comme technologie d'extraction, ont été développés.

Le code pour nommer les scénarios est "SX-YYY", S pour la première lettre du mot "scénario" et X le nombre entre 1 et 11 pour chacun des onze scénarios. Ensuite, un tiret est suivi de la première lettre en anglais pour le type d'agriculture : conventionnelle (*Conventional*) ou biologique (*Organic*) ; de la deuxième lettre pour le type d'exploitation : traditionnelle (*Traditional*) ou intensive (*Intensive*) ; et de la troisième lettre indiquant s'il dispose ou non d'un système d'irrigation (*Irrigated or Dry*). Le **Tableau 1** montre les caractéristiques détaillées des onze scénarios étudiés dans ce travail de thèse.

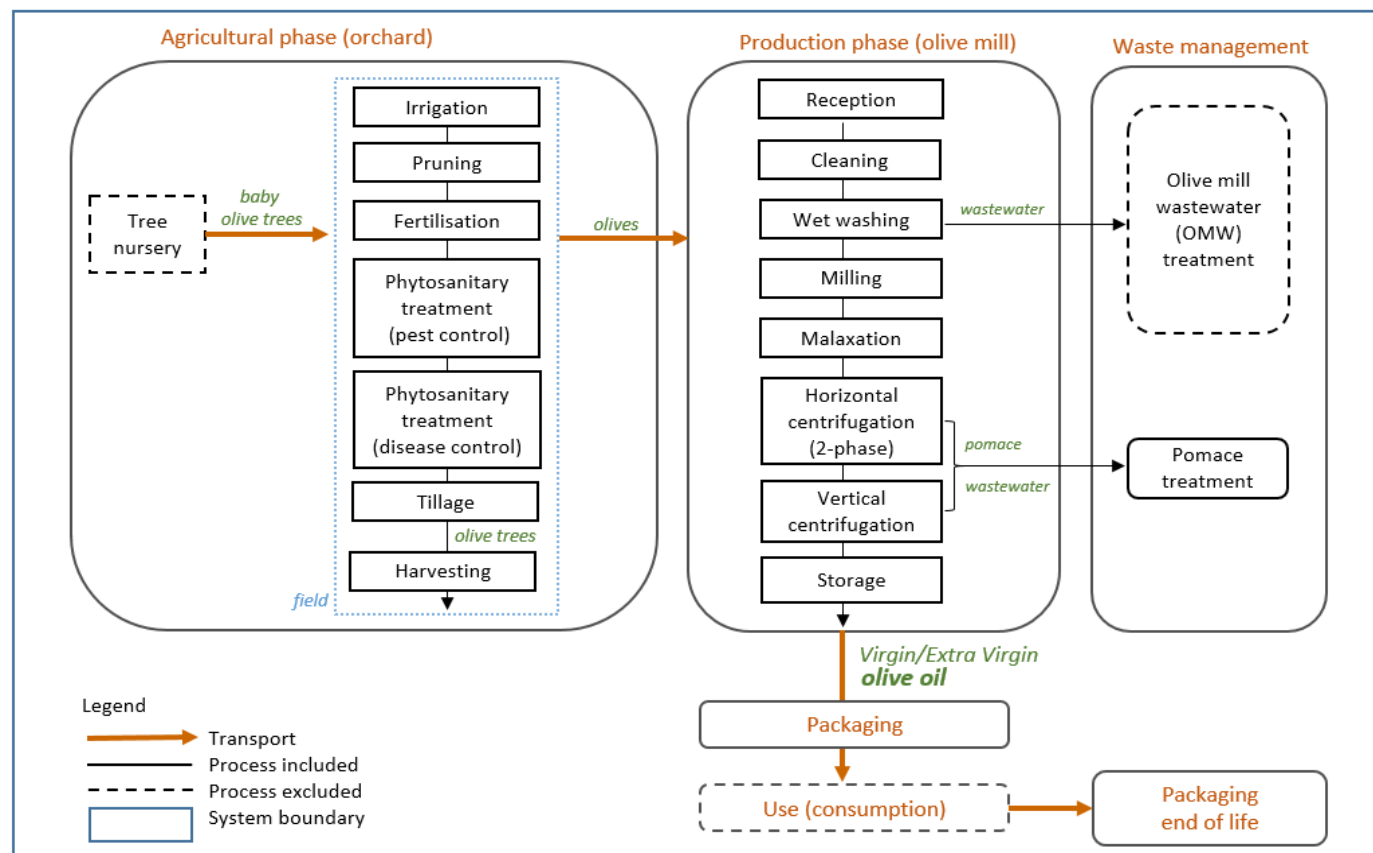

Figure 4. Arbre des processus (schéma fonctionnel) de la production d'huile d'olive en France.

Tableau 1. Caractéristiques détaillées des onze scénarios.

Caractéristiques	Unité	S1-CTI	S2-CTI	S3-CTI	S4-CTI	S5-CTI	S6-CTD	S7-CTD	S8-CII	S9-CID	S10-OTI	S11-OTD
Surface de culture	ha	2,5	4,5	1,15	20	5	1,71	5	15	0,4	6	15
Nombre d'arbres par ha	arbres/ha	100	200	285	250	287	285	220	380	330	285	200
Rendement des olives par ha	t/ha/an	1,30	1,24	2,70	4,00	4,30	2,34	1,78	5,25	1,90	4,50	1,55
Type d'agriculture	O ou C	C	C	C	C	C	C	C	C	C	O	O
Intensité de la production	Trad/Int	Trad	Trad	Trad	Trad	Trad	Trad	Trad	Int	Int	Trad	Trad
Irrigation	I ou D	I	I	I	I	I	D	D	I	D	I	D
Productivité	t d'olives/an	3,25	5,57	3,11	80,00	21,50	4,00	8,90	78,75	0,76	27,00	23,25
Rendement en huile d'olive par olives traitées	L/kg	0,22	0,24	0,21	0,21	0,26	0,22	0,18	0,21	0,20	0,20	0,22
Quantité d'huile d'olive	L/ha/an	286,00	300,59	561,60	824,00	1100,80	503,10	325,74	1081,50	378,10	882,00	334,80
Prix de vente de l'huile d'olive	€/L	12,00	12,00	11,00	7,90	7,64	11,00	16,00	7,90	7,90	4,38	21,00
Puissance du tracteur	hp ⁽¹⁾	11	50	37	75	60	37	60	75	75	80	60
	kW	8,09	36,77	27,21	55,16	44,13	27,21	44,13	55,16	55,16	58,84	44,13
Consommation du tracteur (diesel) ⁽²⁾	L/h	1,30	6,00	4,50	9,00	7,20	4,44	7,20	9,00	9,00	9,60	7,20
Année de plantation	années	-	1998	-	1998	1956	-	1996	1995	1997	1986	1995

⁽¹⁾ Le cheval-vapeur métrique (hp metric) est appelé "*cheval vapeur (CV)*" en français. Il s'agit d'une très ancienne unité de mesure de la puissance qui est encore largement utilisée aujourd'hui pour exprimer la puissance d'un moteur.

1 hp métrique = 0,735498 kW.

⁽²⁾ La consommation de carburant varie en fonction de la puissance du tracteur. La puissance est multipliée par 0,12 pour déterminer la consommation horaire.

Consommation du tracteur (diesel) = ch * 0,12 (Secar, n.d.).

Analyse de l'inventaire du cycle de vie

Les données du système oléicole -données de premier plan- ont été collectées en 2014 avec l'aide du Centre technique de l'olivier (CTO, France). Elles ont été recueillies à l'origine dans le cadre du projet OilCA.

Dans la base de données ecoinvent, l'infrastructure et son fonctionnement sont modélisés sur trois niveaux (**Figure 5**). Suivant Nemecek and Kägi (2007) dans le rapport ecoinvent n° 15 Inventaires du cycle de vie des systèmes de production agricole, ces trois niveaux sont pratiques en raison des différentes manières d'utiliser l'infrastructure. Cette représentation modulaire offre une flexibilité maximale dans l'utilisation de ces modules.

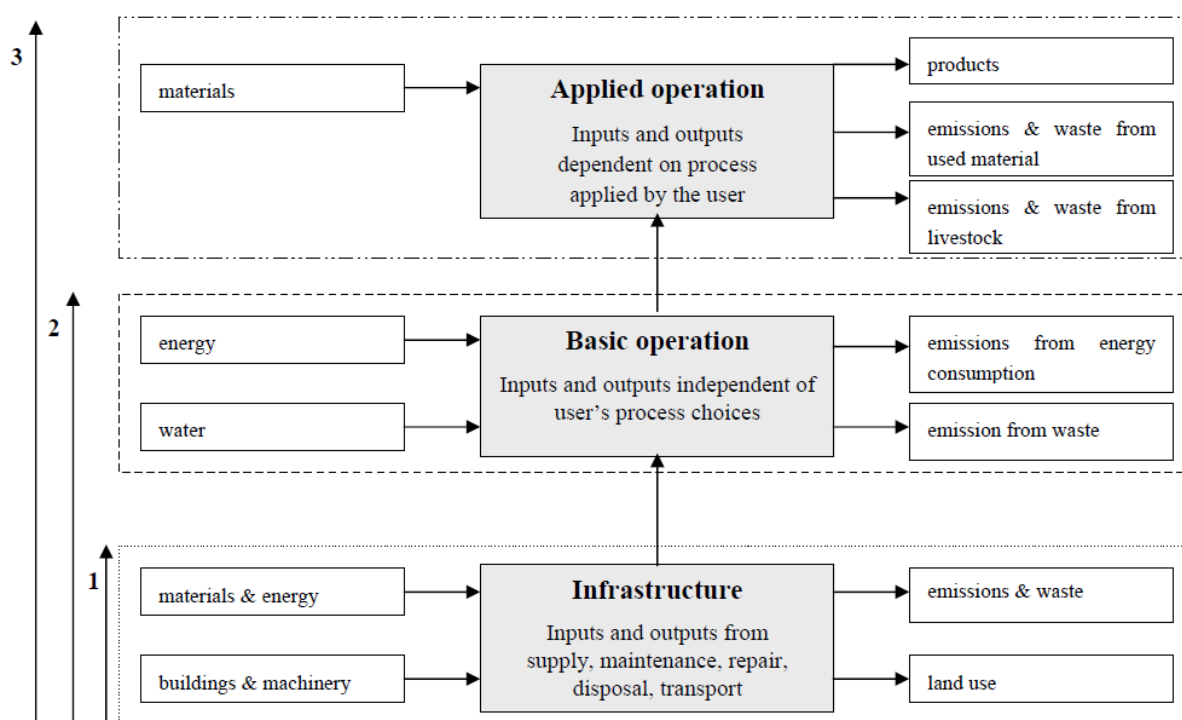

Figure 5. Modélisation de l'infrastructure et de son exploitation dans les données ecoinvent (Nemecek and Kägi, 2007).

Ces trois niveaux de modélisation sont importants à expliquer et à comprendre car de la même manière qu'ecoinvent est construit, c'est ainsi que les processus spécifiques de cette thèse ont également été développés.

Niveau 1 : Infrastructure

Les modules d'infrastructure (bâtiments et machines) comprennent la construction et la production de l'unité d'infrastructure, ainsi que le transport (machines de matières premières), l'entretien, la réparation et l'élimination finale.

Niveau 2 : Fonctionnement de base

Les modules de l'opération de base comprennent les entrées et sorties indépendantes des choix de l'utilisateur, ainsi que l'infrastructure utilisée (niveau 1). Il s'agit d'une opération unitaire réalisée sur le terrain afin de réaliser une culture (labour, fertilisation, traitement phytosanitaire, ...).

Ce niveau de modélisation comprend :

- la mobilisation des infrastructures modélisées au niveau 1
- la consommation de carburant
- les émissions liées à la combustion (HC-, NO_x- et CO)
- les émissions de métaux lourds liées à l'abrasion des pneumatiques

Niveau 3 : Opération appliquée

L'opération appliquée comprend toutes les entrées et sorties liées à une opération, qui dépendent des choix de l'utilisateur ainsi que de l'infrastructure utilisée (niveau 1) et de l'opération de base (niveau 2) (Nemecek et Kägi, 2007). L'objectif de ce niveau de modélisation est de décrire un cycle de production agricole.

Ces données doivent inclure :

- l'itinéraire technique
- la consommation d'engrais et de pesticides
- l'occupation/transformation de l'espace
- le captage du CO₂ et de l'énergie
- les éventuelles opérations de transformation des cultures
- les émissions sur le terrain

Le système d'arrière-plan utilisé est la base de données ecoinvent 3.6 avec le modèle *Recycled Content System Model (Allocation, cut-off by classification)*.

L'application d'engrais minéraux est responsable d'émissions de protoxyde d'azote (N₂O), d'ammoniac (NH₃) et d'oxydes d'azote (NO_x) dans l'air, de nitrates (NO₃⁻) et de phosphates (PO₄³⁻) dans l'eau et le sol. Les molécules NH₃, NO_x et PO₄³⁻ sont particulièrement émises lors de l'épandage des engrais minéraux, tandis que les molécules N₂O et CH₄ sont davantage générées lors de la dégradation des éléments azotés et des matières organiques. Le calcul de la quantité de ces molécules émises est basé sur différentes méthodologies. Pour les calculs des émissions dans l'air (ammoniac, monoxyde de diazote, oxydes d'azote, monoxyde de carbone, méthane, SO₂, COVNM et particules) et des émissions de nitrate dans les eaux souterraines, les facteurs d'émission de niveau 1 du GIEC (IPCC, 2006) ont été appliqués. Un précalcul dans Excel a été effectué pour calculer les émissions dans l'air et dans les eaux souterraines de chaque scénario et pour pouvoir insérer ces informations dans les jeux de données créés de la phase de fertilisation de chaque scénario au niveau 3.

Évaluation de l'impact du cycle de vie

Les scénarios du système ont été développés et analysés avec le logiciel SimaPro PhD 9.1.1.1 (PRé Sustainability, Amersfoort, Pays-Bas). Les résultats de l'évaluation de l'impact du cycle de vie (LCIA) ont été évalués par la méthode ReCiPe 2016 Midpoint and Endpoint v1.1 (Hierarchist ; H) normalisée et pondérée sur la base d'un impact environnemental mondial moyen pour l'année 2010 (World ReCiPe H/A, 2010).

Interprétation du cycle de vie

Changement climatique

En suivant l'exemple de Proietti et al. (2014), un calcul des sources et des puits de CO₂ pour obtenir le stock net de carbone de l'oliveraie et sa relation avec l'impact sur le changement climatique a été effectué. Les auteurs ont considéré les poids des composants permanents de l'arbre qui peuvent être subdivisés en "biomasse souterraine" (racines, à l'exclusion des racines fines) et "biomasse aérienne" (collet des racines ; tronc ; branches ; rameaux et feuilles) ; et les composants non permanents de l'arbre (fruits et tailles ; abscission des feuilles). Les observations de Proietti et al. (2014) ont été faites tout au long des 11 premières années à partir de la plantation puisque cette période comprend la période cruciale de la durée de vie de l'oliveraie. Dans les conditions considérées, après 11 ans de plantation, les activités végétatives et productives de l'olivier et les pratiques culturelles deviennent presque constantes. Pour cette raison, le carbone séquestré choisi pour la suite de l'étude est celui de l'année 11 (0,18 t C/ha).

Néanmoins, ce carbone séquestré comprend également les tailles et le rendement des fruits. Cette façon de comptabiliser le carbone biogénique n'est pas en accord avec le PAS 2050. Selon le PAS 2050, les émissions (de sources biogènes et fossiles) dans l'atmosphère et les absorptions doivent être comptabilisées dans une ACV. Cependant, les produits destinés à l'alimentation humaine et animale constituent une exception si le carbone biogénique fait partie du produit. Dans le cas de la production d'huile d'olive, le carbone biogénique provenant de la phase agricole (composants permanents de l'olivier, compte tenu notamment de la longévité des oliveraies) ne fait pas partie du produit (huile d'olive). Par conséquent, l'évaluation du carbone biogénique doit être prise en compte uniquement pour les composants permanents de l'arbre. Elle doit être ajustée à une quantité de carbone par arbre et non par hectare, car les hectares des 11 études de cas ont des intensités de culture différentes. Pour cette raison, un ajustement de 0,18 t C/ha a été effectué et a donné $4,11 \times 10^{-04}$ t C/arbre (C séquestré P).

Ensuite, il y a trois hypothèses pour faire la comptabilité du carbone :

1. Annuel : le carbone séquestré uniquement l'année de production de l'huile d'olive, dans ce cas, au cours de l'année 2014. Et donc le CO₂-eq séquestré.
2. Production-année : le carbone stocké jusqu'à l'année de production de l'huile d'olive. En d'autres termes, le carbone stocké pendant les 11 premières années plus le carbone séquestré chaque année de la 11e année à l'année de production. Et donc le CO₂-eq stocké.
3. Moyenne : le carbone (et donc le CO₂-eq) stocké jusqu'à l'année de production de l'huile d'olive (point deux), mais réparti sur la longévité de l'exploitation.

Les émissions annuelles de CO₂-eq en kg CO₂-eq/FU pour produire un litre d'huile d'olive française (FU) tout au long de son cycle de vie ont été calculées. Les émissions de CO₂-eq "de base" sont celles qui ne tiennent pas compte du carbone biogénique dans aucune des trois hypothèses (Figure 6).

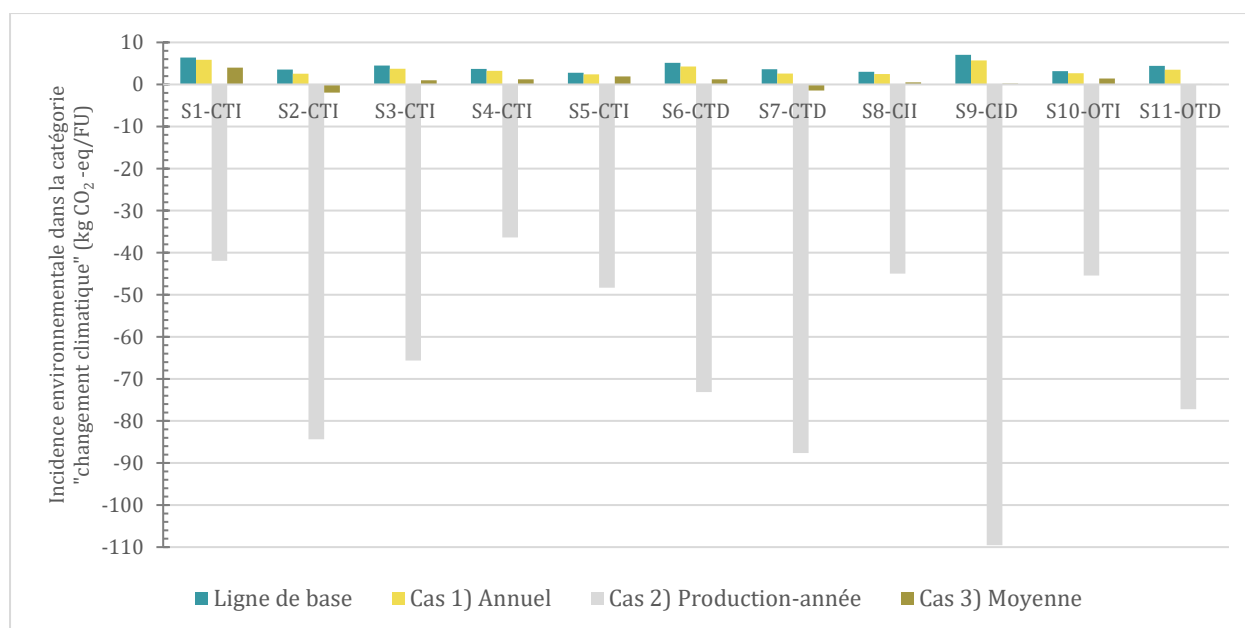

Figure 6. Émissions de CO₂-eq générées par la production d'un litre d'huile d'olive française en tout son cycle de vie.

Dans le **Tableau 2**, le présent travail est comparé à six publications. Les émissions de base de CO₂-eq obtenues sont cohérentes avec celles obtenues par d'autres auteurs (El Hanandeh and Gharaibeh, 2016; Espi et al., 2013; Fernández-Lobato et al., 2021; Pattara et al., 2016; Proietti et al., 2017; Rinaldi et al., 2014).

Tableau 2. Comparaison des résultats du changement climatique avec différents auteurs.

FU	Portée	Changement climatique				Référence
		(kg CO ₂ -eq/FU)		(kg CO ₂ -eq/L)		
		Min	Max			
1 L EVOO	Du berceau à la tombe	(n=11)	2,79	7,06	4,31	Travail actuel
1 L EVOO/ VOO/ OO	Du berceau à la tombe	(n=3)	2,19	3,47	2,98	(Espi et al., 2013)
1 L EVOO	Du berceau à la tombe				17,53	(Rinaldi et al., 2014)
1 kg de VOO	Du berceau à la porte	(n=5)	1,93	3,00	2,20	(Fernández-Lobato et al., 2021)
1 kg d'OO	Du berceau à la porte				0,62	(El Hanandeh and Gharaibeh, 2016)
5 L EVOO	Du berceau à la porte	(n=4)	4,48	10,10	1,56	(Pattara et al., 2016)
1 L EVOO	Du berceau à la porte	(n=7)	0,67	4,48	1,67	(Proietti et al., 2017)

Maintenant, en laissant de côté les hypothèses de carbone biogénique, l'accent est mis sur les résultats de base du changement climatique avec une approche comparative des onze études de cas françaises. La **Figure 7** montre la distribution de l'impact du cycle de vie de la production d'huile d'olive dans la catégorie Changement climatique. La contribution la plus importante est celle de la phase agricole, comme prévu par la revue (Espadas-Aldana et al., 2019). L'extraction de l'huile d'olive (phase de production), l'emballage et la fin de vie de l'emballage sont communs aux onze scénarios avec une contribution de 0,44, 0,32 et 0,09 kg CO₂-eq, respectivement. Le traitement des grignons représente 0,007 kg CO₂-eq. dans tous les scénarios, car l'UF est de 1 L d'huile d'olive vierge/extra vierge et le ratio d'OP produit est calculé par L d'huile d'olive. Les

émissions de l'épandage des OP sont dues à l'utilisation d'un tracteur pour l'épandage agricole des grignons d'olive.

Une fois que la phase agricole est identifiée comme un point chaud, l'étape suivante consiste à réaliser l'étude de contribution par processus.

Le point chaud de la phase agricole est la fertilisation suivie du travail du sol, ce qui est principalement dû à l'emploi d'engrais azotés et à l'utilisation du tracteur pour l'épandage des engrais et des pesticides. Il est également important de rappeler que l'application de l'herbicide glyphosate se fait au moment du labourage. La contribution du processus d'irrigation est également évidente dans les scénarios avec cette configuration. Le processus de récolte est le deuxième contributeur le plus important dans le scénario S1-CTI après la fertilisation, avec un grand écart de contribution par rapport aux autres scénarios.

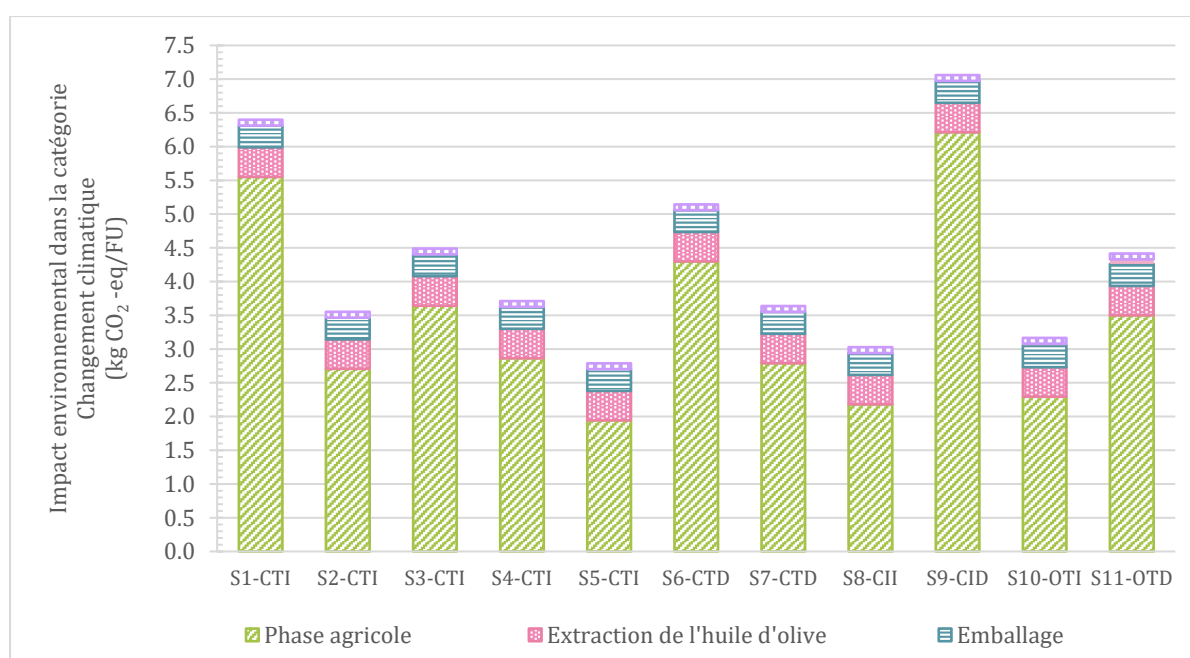

Figure 7. Distribution de l'impact du cycle de vie de la production d'huile d'olive dans la catégorie Changement climatique.

Impact environnemental global

Après avoir examiné la section sur le changement climatique, qui n'est qu'un des 18 indicateurs, il est temps de poursuivre avec la caractéristique multi-indicateur de l'analyse du cycle de vie. Pour ce faire, une normalisation des résultats des onze scénarios sur l'ensemble de leur cycle de vie a été effectuée. La **Figure 8** montre les résultats normalisés des onze scénarios sur l'ensemble de leur cycle de vie. On peut observer que les catégories qui ressortent le plus sont celles de la toxicité et de l'écotoxicité (écotoxicité terrestre, écotoxicité en eau douce, écotoxicité marine, toxicité cancérigène pour l'homme et toxicité non cancérigène pour l'homme).

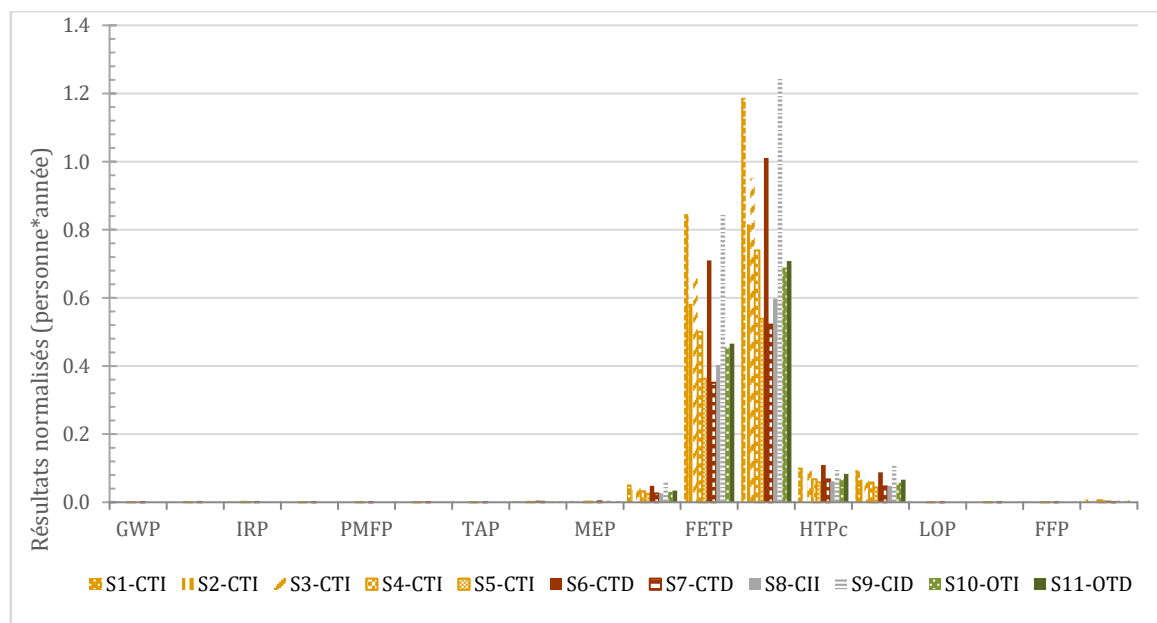

Figure 8. Résultats normalisés des 18 catégories Midpoint pour les 11 scénarios sur l'ensemble de leur cycle de vie.

Les fongicides composés de cuivre utilisés pour le traitement phytosanitaire de lutte contre les maladies ont montré un impact significatif sur les indicateurs d'écotoxicité. Ceci a également été constaté par Gentil et al. (2020a) pour le traitement phytosanitaire des tomates en plein champ : le sulfate de cuivre domine les impacts d'écotoxicité, en particulier l'écotoxicité en eau douce due aux émissions des champs de pesticides. La **Figure 9** met en exergue les impacts de la première configuration (CTI : agriculture conventionnelle, intensité traditionnelle, système d'irrigation). Comme déjà observé dans les résultats du changement climatique, le scénario S1-CTI est le plus impactant des cinq, et le S5-CTI est le plus respectueux de l'environnement. Le scénario S1-CTI est le plus affecté par l'étape de fertilisation, car il utilise environ 4,5 fois le temps de tracteur par rapport aux autres scénarios et a le rendement en huile le plus faible, contrairement au scénario S5-CTI, qui a le rendement le plus élevé de tous les scénarios.

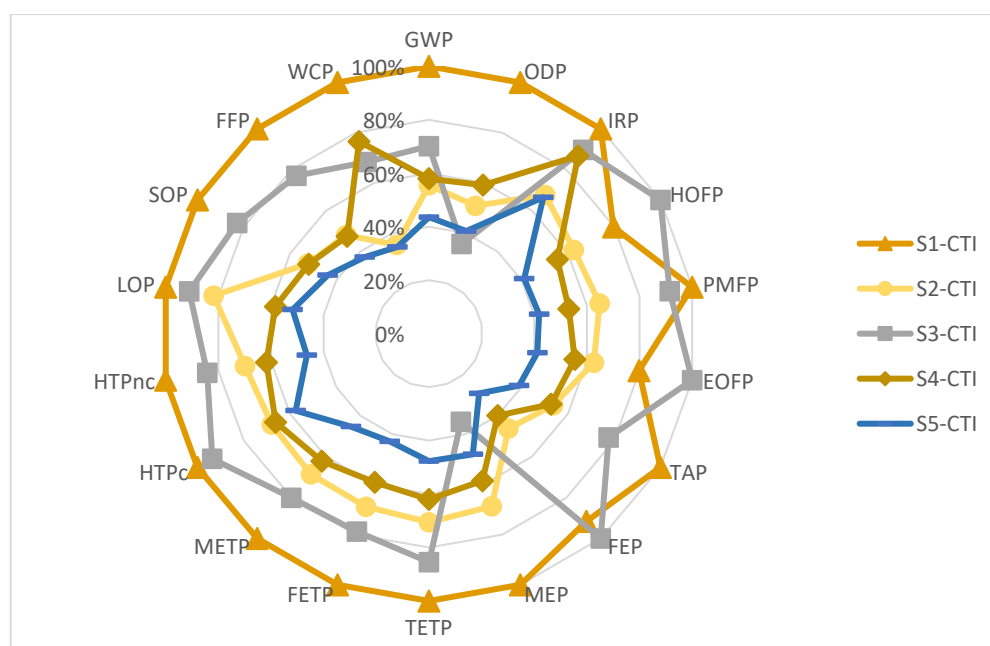

Figure 9. Résultats des catégories intermédiaires pour le cycle de vie des scénarios de la CTI (S1-CTI à S5-CTI).

Une autre caractéristique intéressante à illustrer sur les graphiques radar est l'analyse du "Système irrigué vs sec" (**Figure 10**) comme cela a été fait précédemment dans la section de changement climatique. Le scénario présentant les émissions les plus élevées est S9-CID. Les scénarios irrigués (S8-CII et S10-OTI) en pointillés sont plus positifs sur le plan environnemental (moins d'impact) que les scénarios secs (S9-CID et S11-OTD). En effet, les scénarios irrigués ont un rendement en huile d'olive plus important, S8 avec 1081,50 L/ha/an et S10 avec 882 L/ha/an contre S9 avec 378,10 L/ha/an et S11 avec 334,80 L/ha/an.

Cela suggère que la grande différence dans la productivité des olives par hectare est influencée positivement principalement par l'utilisation de l'irrigation. La seule catégorie d'impact dans laquelle les scénarios irrigués ont plus d'impact est évidemment l'utilisation de l'eau (WCP) puisque pour les systèmes secs, elle est égale à zéro. Pourtant, l'impact du processus d'irrigation est largement compensé par les avantages qu'il procure.

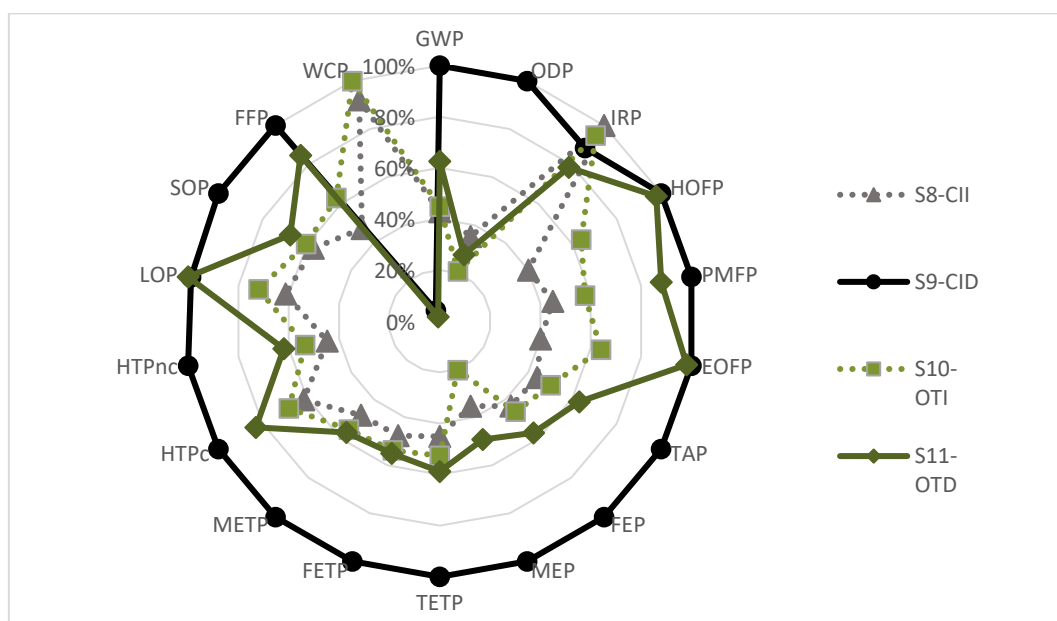

Figure 10. Résultats de la caractérisation du cycle de vie des scénarios irrigués (S8-CII et S10-OTI) -en lignes pointillées- par rapport aux scénarios secs (S9-CID et S11-OTD) -en lignes continues-.

CHAPITRE III

ÉVALUATION ENVIRONNEMENTALE DE LA VALORISATION DES GRIGNONS D'OLIVE DANS LES MATÉRIAUX COMPOSITES

Comment valoriser les résidus d'olives (grignons d'olives) ? En se concentrant sur le passage d'une production linéaire traditionnelle à un système de production d'olives circulaire qui récupère les matériaux des résidus organiques.

Ce chapitre propose une analyse du cycle de vie de la valorisation des grignons d'olive dans son utilisation comme matériau biocomposite, en passant d'une production linéaire traditionnelle à un système de production d'olives circulaire qui récupère les matériaux à partir des résidus organiques.

Ce chapitre comprend :

- L'état de l'art du devenir du grignon d'olive
- L'analyse de cycle de vie du processus de fabrication d'un biocomposite à base de grignons d'olive

État de l'art : grignons d'olive

Définition du grignon d'olive

Les grignons d'olive sont un sous-produit de la production d'huile d'olive. Ils sont générés lors de la phase de centrifugation (Boskou, 2006). Ce procédé d'extraction présente deux alternatives de fonctionnement : les méthodes de centrifugation horizontale à trois phases et à deux phases.

La différence entre eux réside dans le nombre de flux de sortie dont dispose le décanteur :

- D'une part, la centrifugeuse triphasée a pour sortie l'huile d'olive, l'eau végétale, également connue sous le nom d'eaux usées du moulin à huile (OMW) (*alpechin* en espagnol) et les grignons (*orujo* en espagnol).
- D'autre part, la centrifugeuse biphasée a comme sortie l'huile d'olive, et l'autre les grignons humides (*alperujo*, contraction d'*alpechin* et *orujo* en espagnol).

La popularité croissante de l'huile d'olive a augmenté la génération de ses sous-produits : les grignons d'olive (OP), terme général utilisé pour se référer aux grignons obtenus à partir de tous les différents processus d'extraction de l'huile d'olive, et un effluent connu sous le nom de OMW, dérivant du pressage traditionnel et du système triphasé (Dermeche et al., 2013; Salomone et al., 2015b).

Ce OP est un mélange de peau résiduelle, de pulpe et de fragments du noyau d'olive broyé (Lammi et al., 2018). Les principaux composants de ce résidu solide sont la cellulose, les hémicelluloses et les lignines. Les graisses et les protéines résiduelles sont également présentes en quantités significatives. L'humidité des résidus solides est de 22-25% pour les OP pressées traditionnelles, de 65-74% pour les grignons issus d'un système biphasé et de 40-50% pour ceux issus d'un système triphasé (Contreras et al., 2020; Dermeche et al., 2013).

En moyenne, le fruit de l'olivier contient 20 % en poids d'huile, et les 80 % en poids restants, avec l'eau ajoutée, forment l'OP (de la Casa and Castro, 2014).

Marché des lattes, composites à base de grignons d'olive

En raison du manque de données sur le marché des composites à base de grignons d'olive, le marché des composites bois-plastique (WPC) a été examiné comme cadre de référence.

Le marché européen du WPC est estimé à 4,55 kilo-tonnes en 2020, et il devrait croître d'environ 8% au cours de la période de prévision (2021-2026), dans une courte période la demande croissante de WPC dans les constructions domestiques, en raison de ses caractéristiques et les nombreux projets de construction dans la région sont le moteur de la croissance du marché (Mordor Intelligence, 2021).

En France, le principal producteur de WPC est situé dans la région de Bretagne avec une capacité de production de 1 million de m² WPC par an (Silvadec, 2020). Le marché français des WPC représente plus de 9% du marché européen (Mordor Intelligence, 2021). Le marché français du secteur des terrasses en WPC peut donc être estimé à 22 759 t de WPC/an.

Si l'on suppose que la production totale de bois plastique composite utilisée dans le secteur des terrasses va être remplacée par les lattes composites à base de marc d'olivier. Le marché français serait alors de 22 759 t de lattes composites à base de marc d'olivier par an.

Méthodologie : ACV

Cette section a fait l'objet d'une publication (Espadas-Aldana et al., 2021).

Définition de l'objectif et du champ d'application

L'ACV suivante se concentre sur le processus de fabrication d'un biocomposite composé de fraction de noyau d'olive (OSF), qui fait partie des grignons d'olive (OP), et de deux matrices polymères différentes : le polypropylène (PP) et le polyéthylène (PE), dans une vision du "berceau à la porte".

Les objectifs de l'étude sont d'analyser et de comparer les impacts environnementaux des différents scénarios, ainsi que d'identifier les processus unitaires ayant les impacts environnementaux les plus forts.

Basé sur des travaux similaires (Al-Ma'adeed et al., 2011; Sommerhuber et al., 2017; Vidal et al., 2009) et de la norme EN 15804 (European Committee for Standardization, 2013) l'unité fonctionnelle choisie est la production de 1 m² de lattes (matériau de construction) en composite à base de grignon d'olive.

Deux scénarios différents ont été élaborés (**Tableau 3**).

Tableau 3. Scénarios étudiés.

Scénario	Remplissage	Matrice polymérique
OSF/PP	Fraction de noyau d'olive	Polypropylène
OSF/PE	Fraction de noyau d'olive	Polyéthylène

Analyse de l'inventaire du cycle de vie

La mise au point de la latte biosourcée s'inscrit dans le cadre d'un travail réalisé par le *Laboratoire de Chimie Agro-industrielle (Université de Toulouse, France)* pour le compte d'un industriel de la plasturgie biosourcée (Uitterhaegen et al., 2018). Des composites avaient été produits en mélangeant l'OP (60% de charge) dans deux matrices polymériques : PE et PP. L'ajout d'un agent de couplage a également été réalisé pour renforcer l'interface matrice/fibre. En conséquence, l'ajout d'OP aux matrices polymères a montré un renforcement mécanique du matériau, qui a été illustré par l'augmentation du module élastique simultanément avec la diminution de l'allongement à la rupture, à la fois en traction et en flexion. La **Figure 11** détaille l'arbre du processus de fabrication du composite de noyau d'olive, avec les différentes étapes du processus et leurs flux.

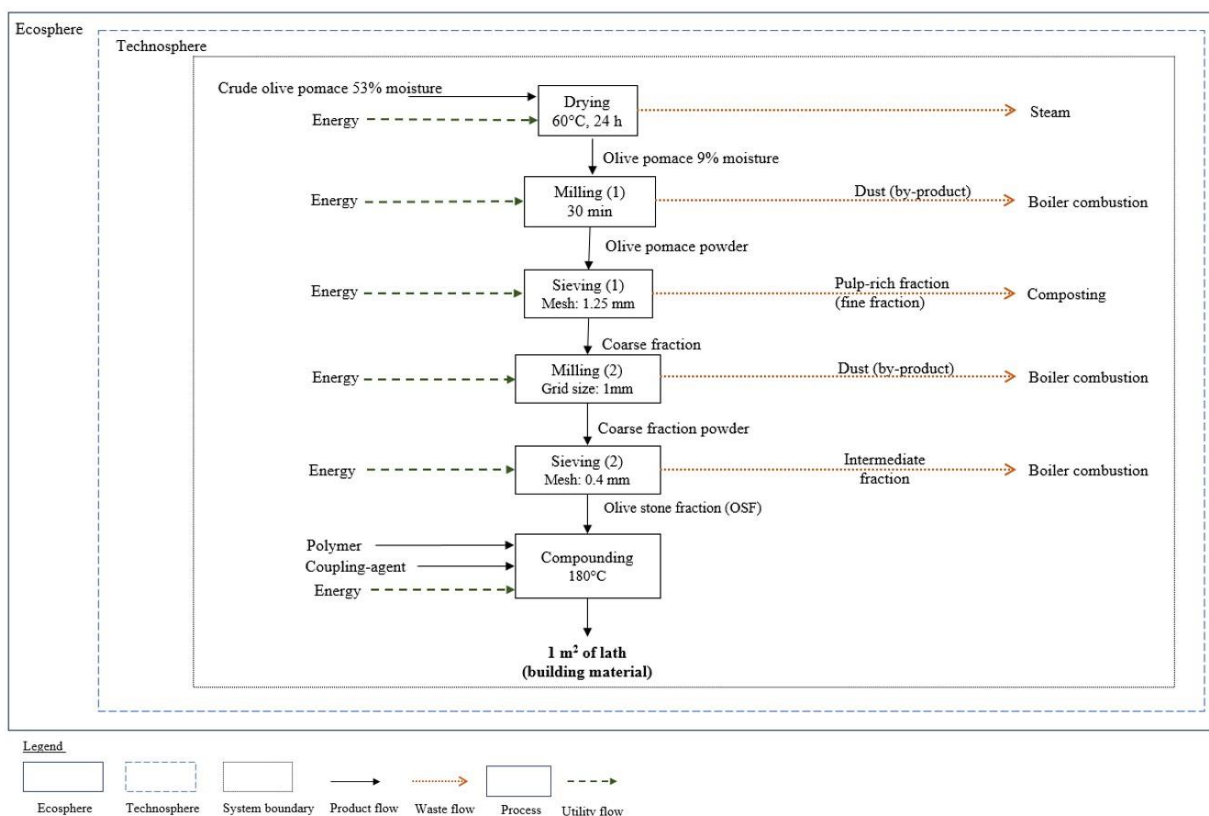

Figure 11. Arbre de procédé du composite à base de grignon d'olive. Adapté de Espadas-Aldana et al. (2021).

Les données de première plan relatives au prétraitement ont été obtenues dans la littérature. Les essais à l'échelle pré-industrielle ont été réalisés au *Laboratoire de Chimie Agro-Industrielle*. Ils ont fourni les données du processus de compoundage (Uitterhaegen et al., 2018).

Évaluation de l'impact du cycle de vie

Les scénarios du système ont été développés et analysés avec le logiciel SimaPro PhD 9.1.1.1. Les résultats de l'analyse d'impact du cycle de vie ont été évalués par ReCiPe 2016 Endpoint v1.04.

Résultats

Dans les deux processus de production, le principal point chaud est le processus de compoundage, qui affecte toutes les catégories d'impact, les plus touchées étant le réchauffement

climatique (88%), l'eutrophisation de l'eau douce (87%) et la raréfaction des ressources fossiles (95%). Dans le processus de compoundage, le principal point chaud est la production de PE et de PP. La raréfaction des ressources fossiles est l'indicateur intermédiaire le plus touché, en raison de la production d'éthylène et de propylène (dans l'industrie pétrochimique). Une autre catégorie d'impact fortement affectée par le compoundage est la toxicité cancérigène pour l'homme, qui atteint des valeurs de 86% et 82% pour les composites OSF/PE et OSF/PP, respectivement.

La possibilité de réintroduire les composites à base de grignon d'olive dans le sol de l'olivieraie a également été développée. L'hypothèse proposée est que les composites à base de grignon d'olive étudiés sont 100% biosourcés et biodégradables (*e.g.*, PLA (poly(lactic acid)) and polyhydroxyalkanoates (PHAs)). Ces lattes sont broyées et retournées au sol, en supposant que la quantité totale d'OP produite en France est utilisée pour couvrir une partie du marché national des terrasses. La dynamique carbone du sol du retour au sol du composite à base de grignons d'olive a été comparée à celle du sol vierge, du sol traité avec OP et du sol traité avec du compost (à base d'OP). Cette comparaison a été réalisée à l'aide du modèle C-TOOL (Taghizadeh-Toosi et al., 2014), qui permet de mesurer la variation de la quantité de carbone dans le sol des oliveraies et les émissions de CO₂.

Les résultats ont montré que le sol traité avec du compost avait un contenu en carbone plus important que celui traité avec des grignons d'olive, et que les deux avaient une tendance à l'augmentation. Les composites à base de grignons d'olive ont été réintroduits dans le sol en 2046 après avoir terminé leur durée de vie de 25 ans, libérant le carbone séquestré. Le résultat a montré que par rapport à un sol vierge, la quantité de carbone est plus élevée avec la réintroduction du biocomposite, néanmoins, la différence dans le contenu en carbone des sols étudiés n'était pas significative, elle était d'environ 0,2 t/ha.

Les émissions de CO₂ ont montré une tendance à l'augmentation en 100 ans. Le sol traité avec le composite à base d'OP a produit moins d'émissions de CO₂ par rapport au sol traité avec le compost et l'épandage d'OP. Par conséquent, le scénario de fin de vie proposé aux composites à base d'OP produits en France pourrait contribuer à atténuer le changement climatique.

CHAPITRE IV

DISCUSSION, CONCLUSIONS ET PERSPECTIVES

Comment l'ACV peut-elle soutenir la transition vers une économie circulaire ?

Depuis 2015, les autorités françaises ont développé " la loi de transition énergétique pour la croissance verte ". Cette loi a mis l'accent sur la gestion des déchets comme pilier essentiel pour assurer la transition vers un modèle d'économie circulaire (EC) (Belaud et al., 2019). De plus, l'utilisation de l'EC devient de plus en plus importante, notamment dans le domaine de l'agriculture, l'un des principaux fournisseurs de déchets. En particulier, de nombreuses recherches sont menées pour transformer les résidus agricoles par des procédés durables.

L'EC vise à créer un système en boucle fermée ; par conséquent, l'utilisation de résidus végétaux et de fibres agricoles joue un rôle clé dans les composites verts. Les résidus qui étaient autrefois traités comme des déchets deviennent l'alimentation d'un nouveau processus. Cette vision a permis le développement de nouvelles entreprises et de nouveaux projets qui utilisent les déchets agricoles comme charge pour les matrices polymères. Cette valorisation des résidus agricoles peut diminuer l'impact environnemental de la culture ("Biolive Biological and Chemical Technologies," 2020; "Material Insight: Bioplastic Made from Olives," 2018; Putinja, 2020).

L'objectif du chapitre IV est d'expliquer le lien entre le chapitre II (ICV et EICV de la production d'huile d'olive en France) et le chapitre III (Évaluation environnementale de la valorisation des grignons d'olive dans les matériaux composites) et d'illustrer le passage d'une production linéaire traditionnelle à un système de production oléicole circulaire qui récupère la matière des résidus organiques. Il vise également à souligner comment l'ACV est une méthode permettant d'objectiver les avantages environnementaux du concept d'EC. Le chapitre IV présente également les conclusions et les perspectives de la thèse.

Discussion

Malgré toutes les opportunités circulaires offertes par les sous-produits de la production d'huile d'olive, il n'y a pas eu suffisamment d'efforts pour évaluer la durabilité des processus de production secondaires potentiels et pour comparer les paradigmes linéaires et de maintien du statu quo avec les modèles circulaires (Harris et al., 2021; Ncube et al., 2022).

Dans le chapitre II - ICV et EICV de la production d'huile d'olive en France -, les impacts environnementaux du modèle de production *Business-As-Usual* (BAU) ont été identifiés en vue d'améliorations possibles. L'unité fonctionnelle était de "produire un litre d'huile d'olive vierge/extra vierge" du berceau à la tombe.

La **Figure 12** présente les limites du système de production d'huile d'olive afin d'illustrer la manière dont les déchets ont été gérés dans une perspective BAU. Comme la technologie d'extraction des études de cas est le système biphasé, elle ne traite que l'"OP humide", et aucun OMW comme gestion des déchets. 100% des grignons d'olive sont répandus dans les champs agricoles. La production de ce déchet est estimée à 4,4 kg OP/L d'huile d'olive, et l'épandage des grignons est estimé à 4 tonnes par heure à l'aide d'un tracteur. Par conséquent, 100% des impacts causés par l'épandage des OP sont alloués à la production d'huile d'olive. Seuls les impacts liés à l'épandage sont pris en compte. L'émission directe d'OP dans le champ n'a pas été quantifiée.

Aucun produit évité n'est considéré, car l'épandage ne remplace pas l'utilisation d'amendement ou de fertilisant.

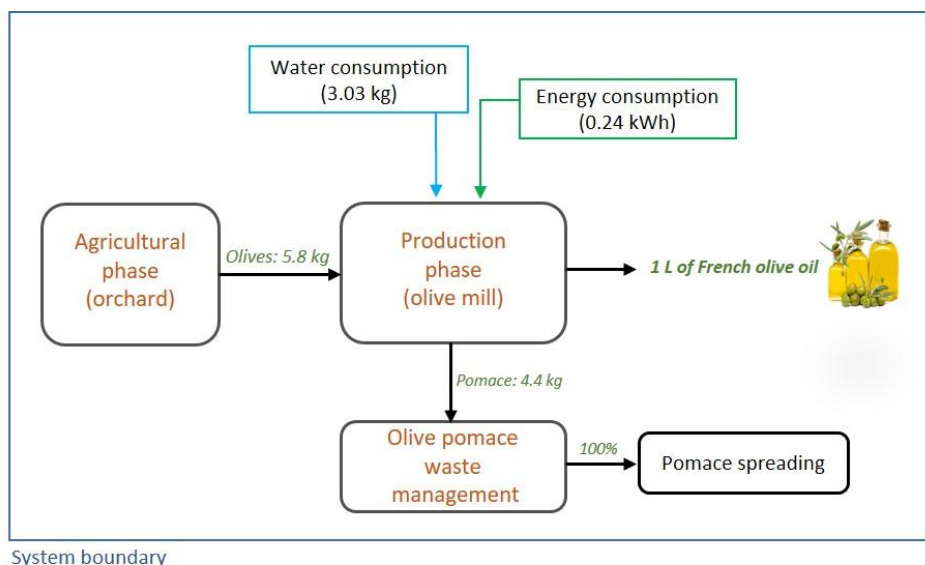

Figure 12. Illustration de la frontière du système du chapitre II (production linéaire), axée sur la gestion des déchets.

En plus de l'épandage des grignons sur les sols agricoles, il existe d'autres moyens de traiter les grignons pour les valoriser. L'objectif du chapitre III était d'évaluer la performance environnementale d'un biocomposite composé d'OP et de deux matrices thermoplastiques différentes. Deux scénarios ont été étudiés, qui se différencient par la matrice polymérique utilisée : l'un à base de polyéthylène et l'autre de polypropylène. L'unité fonctionnelle était la production de 1 m² de latte biocomposite à base d'OP.

Pour la modélisation de ces lattes biocomposites à base d'OP, l'OP utilisé comme matière première a été tiré d'un ensemble de données adapté de la base de données AGRIBALYSE v3.0 selon Avadí (2020). Néanmoins, le jeu de données AGRYBALYSE peut être remplacé par les données de l'étude de cas de la thèse et ainsi relier le Chapitre II au Chapitre III.

Pour être précis, il est nécessaire de connaître le taux d'humidité exact de l'OP à partir de l'étude de cas de l'ACV de la production d'huile d'olive en France (Chapitre II) et d'ajuster les besoins énergétiques de la phase de séchage du processus de fabrication du composite de noyau d'olive pour arriver au taux d'humidité requis de 9%. La **Figure 13** montre comment le système est borné si la valorisation du PO dans les matériaux composites (Chapitre III) est incluse pour mener un système de production d'olives circulaire qui récupère les matériaux des résidus organiques. Ceci en supposant que 100% du PO est utilisé pour la production de lattes composites à base de PO pour le secteur des terrasses. Les lignes en pointillés signifient qu'il s'agit d'un impact évité, c'est-à-dire que l'on évite que les lattes soient produites avec d'autres matériaux.

La **Figure 14** illustre la comparaison en matière de Changement climatique (catégorie d'impact intermédiaire) de la production linéaire d'un litre d'huile d'olive française par rapport à trois voies de production circulaire. Il s'agit d'une approche simplifiée pour illustrer le potentiel de l'ACV pour évaluer la circularité des matières.

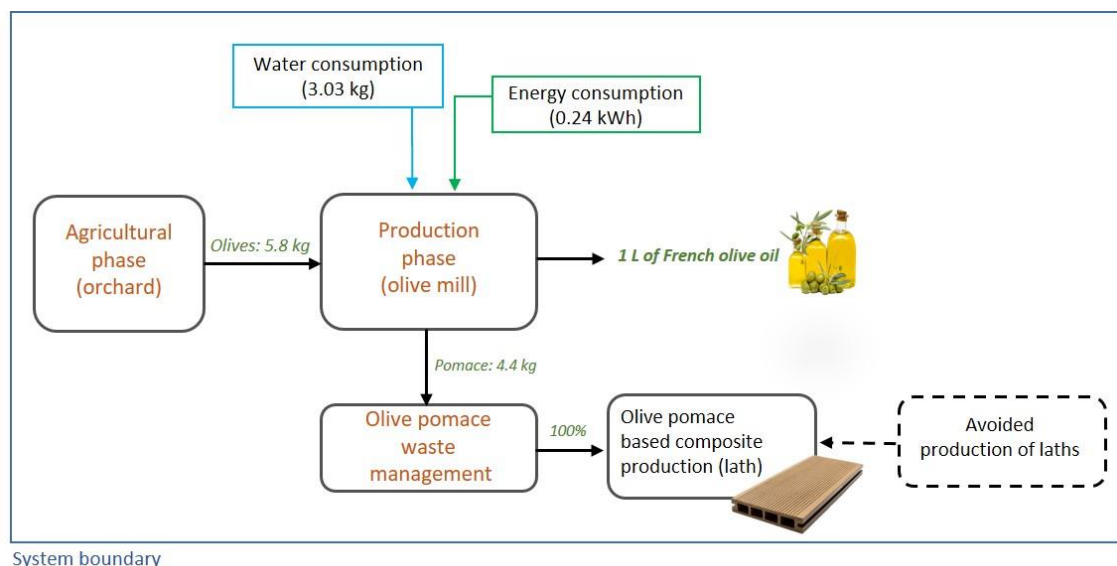

Figure 13. Simplification des limites du système si la valorisation des grignons d'olive (chapitre III) est incluse pour conduire un système de production d'olives circulaire.

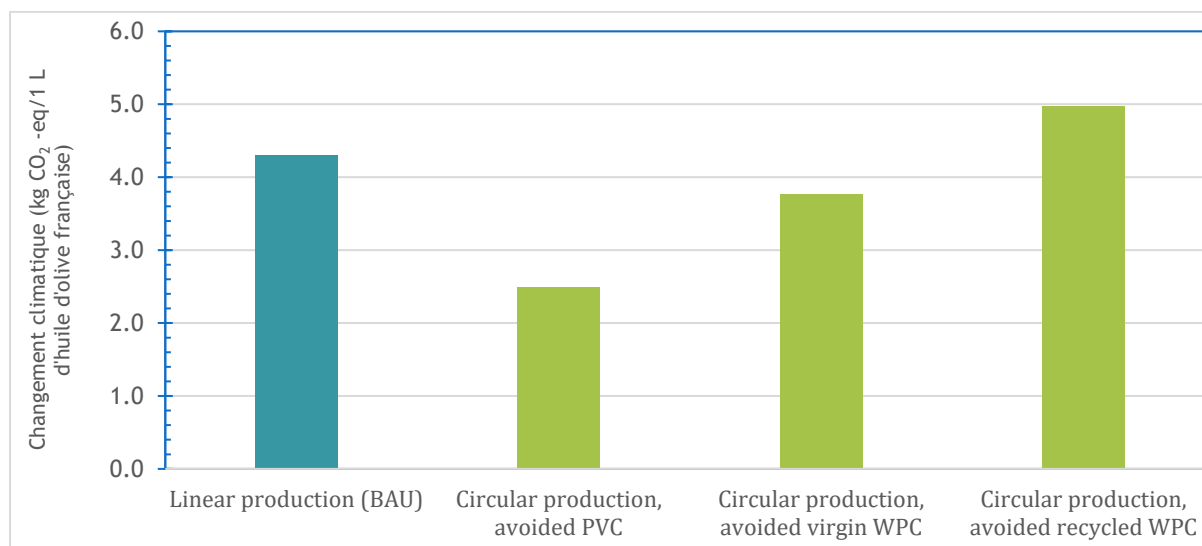

Figure 14. Production linéaire de 1 L d'huile d'olive française comparée à trois filières de production circulaire.

On peut donc observer qu'en passant à un système circulaire dans lequel les déchets sont récupérés pour être valorisés, un nouveau produit est créé qui peut remplacer un autre produit ayant la même fonction. Dans ce cas, il est possible d'éviter la production de lattes de terrasse par une autre voie. Or, ces lattes de terrasse évitées peuvent être de trois types : PVC cellulaire, WPC vierge et WPC recyclé (Bergman et al., 2013).

Les résultats montrent qu'il est intéressant d'un point de vue environnemental de passer à une approche de production circulaire lorsque l'objectif est de remplacer la production de terrasses en PVC cellulaire et en WPC vierge, bien que ce ne soit pas le cas lorsque l'on compare les terrasses en WPC recyclé, car l'impact est plus élevé.

Ceci pourrait être analysé plus en détail en prenant en compte la fin de vie des lattes, avec l'hypothèse que le composite à base d'OP soit 100% biodégradable. Il a été considéré que les composites OP étaient broyés et mis dans les sols agricoles après leur durée de vie. Ainsi, la

dynamique du carbone de cette option (trajectoire circulaire) a été comparée à la dynamique du carbone du sol vierge, du sol traité avec des OP (scénarios BAU) et du sol traité avec du compost (composé d'OP). Pour savoir s'il y a un intérêt à retirer ce grignon qui serait initialement épandu, et créer des lattes à la place.

Grâce à la valorisation des déchets et des résidus en élargissant les limites du système étudié, la durabilité d'un système linéaire est assurée par le développement de modèles circulaires qui renvoient les résidus de matériaux aux étapes précédentes du même processus. Ce faisant, l'impact global à plus grande échelle diminue et des avantages réels sont obtenus en promouvant la circularité tout au long de la chaîne de production de ce produit très apprécié dans la région méditerranéenne. Le grand avantage de la valorisation des coproduits et des sous-produits dans le cadre de l'EC est basé sur les impacts évités dérivés de leur utilisation pour remplacer une partie (ou la totalité) des flux entrants de la production conventionnelle.

Dans ce cas, les deux premiers principes de l'EC (EMF, 2021) sont touchés :

- 1) Éliminer les déchets et la pollution : éliminer le sous-produit des grignons d'olive pour le transformer en coproduit (lattes composites à base de grignons d'olive).
- 2) Faire circuler les produits et les matériaux à leur valeur maximale en gardant les matériaux en usage : avec la production des lattes en grignon d'olive, ce grignon d'olive reste en usage pendant la durée de vie de la latte et ensuite comme matériau d'épandage sur le sol agricole à la fin de la vie de la latte.

Conclusions

Le prochain défi pour la durabilité consiste à optimiser les processus de production. Le développement de technologies vertes et durables est d'une importance vitale dans les industries des procédés chimiques en raison des préoccupations environnementales et sociales croissantes auxquelles nous sommes confrontés aujourd'hui. C'est un devoir et une obligation pour les entreprises et les organisations d'améliorer la qualité de l'environnement et de chercher des moyens d'interagir avec les facteurs externes pour contribuer non seulement à satisfaire les besoins humains, mais aussi à améliorer notre qualité de vie.

L'analyse du cycle de vie (ACV) est l'un des moyens d'identifier la contribution des processus de transformation aux impacts environnementaux globaux. Elle est principalement réalisée pour comparer les matières premières et les impacts de différentes voies de transformation. L'importance de l'ACV en tant que méthode d'aide à la décision environnementale continue de croître rapidement ces dernières années. En outre, l'entreprise pourrait trouver un certain intérêt dans le fait que le public exprime un fort intérêt pour l'écologie et les écolabels.

Dans le contexte de la science de l'ingénierie environnementale, l'un des principaux défis scientifiques actuels est le développement de connaissances, de méthodes et d'outils pour l'évaluation de l'impact environnemental. Les problèmes et les avantages des processus basés sur la biomasse (bioraffineries) font l'objet de débats intenses dans les communautés scientifiques et d'ingénieurs et doivent être évalués. Dans la présente thèse, cette approche a été appliquée à un processus de bioraffinage spécifique : la production d'huile d'olive vierge en France.

La consommation et la production d'huile d'olive ont augmenté dans le monde entier en raison de ses propriétés organoleptiques. Malgré son importance économique dans de nombreux

pays, sa production est associée à plusieurs effets négatifs sur l'environnement. L'ACV est une méthode adaptée à l'évaluation de ces impacts. L'objectif était de réaliser une ACV de la production d'huile d'olive à partir de vergers et de moulins dans le sud de la France. D'abord dans une perspective de maintien du statu quo (BAU), puis vers une approche d'économie circulaire du cycle de vie. L'accent est mis sur le passage d'une production linéaire traditionnelle à un système de production d'olives circulaire qui récupère des matériaux à partir de résidus organiques (grignons d'olive).

Défis relevés

Il est important de noter que les quatre verrous de la question scientifique ont été relevés.

Verrou 1:

Manque de données de première plan pour l'inventaire du cycle de vie de la production d'huile d'olive en France

Réalisation	<ul style="list-style-type: none"> <input type="checkbox"/> ICV complet de l'oléiculture en France représentant les différents systèmes oléicoles et basé sur des vergers réels. <input type="checkbox"/> ICV de la production d'huile d'olive en France basé sur des moulins à huile réels.
Résultats	<ul style="list-style-type: none"> <input type="checkbox"/> Onze scénarios (dont six configurations différentes), dans le cadre du système biphasé comme technologie d'extraction ont été développés. Le choix des producteurs d'huile d'olive français a été guidé par les trois options retenues pour construire les scénarios : <ol style="list-style-type: none"> 1) Principe d'agriculture (Conventionnel/Biologique –<i>Organic</i>–), 2) Type d'exploitation (Traditionnel/Intensif), 3) Système d'irrigation (Irrigué/Sec –<i>Dry</i>–). <input type="checkbox"/> Les données sur l'amont agricole provenaient de onze vergers différents dans le sud de la France. <input type="checkbox"/> Les données sur l'extraction de l'huile d'olive provenaient de sept moulins situés dans la même zone géographique et utilisant le système biphasé comme technologie d'extraction.
Limites	<ul style="list-style-type: none"> <input type="checkbox"/> Difficile d'être générique quant aux conclusions.

Verrou 2:

Absence d'étude d'analyse de cycle de vie axée sur la production d'huile d'olive en France.

Réalisation	<ul style="list-style-type: none"> <input type="checkbox"/> Plusieurs EICV à partir des ICV, du berceau à la tombe.
Résultats	<ul style="list-style-type: none"> <input type="checkbox"/> Les résultats relatifs au changement climatique sont compris entre 2,80 kg CO₂-eq/L (S5-CTI) et 7,07 kg CO₂-eq/L (S9-CID). <input type="checkbox"/> Les résultats de l'impact du changement climatique suggèrent que la grande différence dans la productivité des olives par hectare est influencée positivement principalement par l'utilisation de l'irrigation. <input type="checkbox"/> Les catégories qui se démarquent le plus sont celles de la toxicité (écotoxicité terrestre, écotoxicité en eau douce, écotoxicité marine,

	<p>toxicité cancérigène pour l'homme et toxicité non cancérigène pour l'homme).</p> <ul style="list-style-type: none"> <input type="checkbox"/> La question de la façon dont le FU influence significativement la manière dont une ACV est réalisée, ainsi que ses résultats et leur interprétation ont été discutés.
Limites	<ul style="list-style-type: none"> <input type="checkbox"/> Difficile d'être générique quant aux conclusions.

Verrou 3:

Nouvelle filière pour la valorisation des grignons d'olive et son évaluation environnementale.

Réalisation	<ul style="list-style-type: none"> <input type="checkbox"/> Valorisation alternative des grignons d'olive en lattes pour terrasses.
Résultats	<ul style="list-style-type: none"> <input type="checkbox"/> Production de biocomposites à base de grignons d'olive. Deux scénarios avec différentes matrices thermoplastiques (PE, PP). <input type="checkbox"/> ACV de la valorisation des grignons d'olive en matériau composite basée sur les données expérimentales acquises dans le laboratoire (Agromat/Laboratoire de Chimie Agro-industrielle - Université de Toulouse, France) du hall de transfert Agromat (TRL 5-6).
Limites	<ul style="list-style-type: none"> <input type="checkbox"/> Aucune autre évaluation de la fin de vie des lattes.

Verrou 4:

Difficulté de prise en compte du stockage du carbone dans les évaluations environnementales

Réalisation	<ul style="list-style-type: none"> <input type="checkbox"/> Prise en compte du carbone stocké dans les parties permanentes de l'olivier. <input type="checkbox"/> Étude de la dynamique du carbone retournant au sol.
Résultats	<ul style="list-style-type: none"> <input type="checkbox"/> Le carbone biogénique des parties permanentes de l'arbre a été pris en compte selon trois hypothèses : <ol style="list-style-type: none"> 1) Annuellement : le carbone séquestré uniquement l'année de production de l'huile d'olive, dans ce cas, au cours de l'année 2014. Et donc le CO₂-eq séquestré. 2) Production-année : le carbone stocké jusqu'à l'année de production de l'huile d'olive. En d'autres termes, le carbone stocké pendant les 11 premières années plus le carbone séquestré chaque année de la 11ème année à l'année de production. Et donc le CO₂-eq stocké. 3) Moyenné : le carbone (et donc le CO₂-eq) stocké jusqu'à l'année de production de l'huile d'olive (point deux) mais réparti sur la longévité de l'arbre. <input type="checkbox"/> Après que les composites à base de grignons d'olive aient achevé leur durée de vie, les lattes broyées pourraient être retournées au sol agricole et libérer le carbone séquestré dans le matériau de la terrasse. 1 m² du composite à base d'OP pourrait contribuer à retarder l'émission de plus de 32,5 kg de CO₂.

Limites

- Des calculs des sources et des puits de CO₂ ont été effectués pour obtenir le stock net de carbone de l'oliveraie et sa relation avec l'impact sur le changement climatique.
- La matière sèche des oliviers provenait d'un "arbre modèle" en Italie et non de mesures réelles d'un verger français.
- Une estimation approximative du carbone biogénique dans les lattes composites à base d'OP.

Perspectives

Les travaux futurs peuvent inclure l'utilisation de matrices polymères biosourcées et biodégradables, ce qui pourrait réduire l'impact de la production de composites à base de grignons d'olive et pourrait contribuer à retarder l'émission de CO₂.

En tenant compte des limitations mentionnées dans la section précédente et tout au long de la thèse, les recommandations suivantes peuvent être faites pour l'amélioration de l'ACV d'huile d'olive en France:

- Modéliser plus précisément le devenir des pesticides au champ en utilisant des modèles multimédias (par exemple en utilisant l'outil PestLCI).
- Quantifier les impacts de l'application des OP au champ, en prenant en compte les émissions directes.
- Réaliser une étude de la matière sèche des arbres français moyens afin d'avoir une quantification adéquate du carbone séquestré dans les oliveraies françaises.
- Étudier les différentes fractions des variétés d'olives françaises : la fraction riche en pulpe, la fraction riche en noyaux et la fraction intermédiaire. La fraction riche en noyaux est importante pour le développement de composites à base d'OP.
- Mener une étude pour connaître le taux d'humidité exact de l'OP française afin de pouvoir ajuster les besoins énergétiques de la phase de séchage du processus de fabrication des composites à base d'OP.
- Coupler/inclure la dynamique du carbone dans l'ACV du berceau à la tombe.

De plus, pour illustrer la transition d'une production linéaire traditionnelle vers un système de production oléicole circulaire qui récupère la matière des déchets organiques, seule la valorisation des grignons en biocomposites a été réalisée. Il serait intéressant d'étudier toutes les options possibles pour la valorisation de tous les résidus végétaux produits tout au long du cycle de vie de l'huile d'olive (parties permanentes et non permanentes de l'arbre).

Finalement, une analyse du cycle de vie conséquentielle sur la valorisation du grignon pourrait être réalisée. Tout comme les autres indicateurs de durabilité.

- Développer les critères économiques pour réaliser une analyse du coût du cycle de vie (CCV).
- Développer les aspects sociaux et sociologiques de la production française d'huile d'olive pour réaliser une analyse du cycle de vie sociale (AsCV).
- Intégrer les aspects économiques (CCV) et sociaux (AsCV) pour réaliser une analyse de durabilité du cycle de vie (ADCV). S'inspirer du modèle de durabilité à trois piliers : ACV + CCV + AsCV = ADCV.

Références

- Al-Ma'adeed, M., Ozerkan, G., Kahraman, R., Rajendran, S., Hodzic, A., 2011. Life Cycle Assessment of Particulate Recycled Low Density Polyethylene and Recycled Polypropylene Reinforced with Talc and Fiberglass [WWW Document]. Key Eng. Mater. <https://doi.org/10.4028/www.scientific.net/KEM.471-472.999>
- Avadí, A., 2020. Screening LCA of French organic amendments and fertilisers. Int. J. Life Cycle Assess. 25, 698–718. <https://doi.org/10.1007/s11367-020-01732-w>
- Belaud, J.-P., Adoue, C., Vialle, C., Chorro, A., Sablayrolles, C., 2019. A circular economy and industrial ecology toolbox for developing an eco-industrial park: perspectives from French policy. Clean Technol. Environ. Policy 21, 967–985. <https://doi.org/10.1007/s10098-019-01677-1>
- Bergman, R., Suo-Han, H., Oneil, E., Eastin, I., 2013. Life-cycle assessment of redwood decking in the United States with a comparison to three other decking materials. Consort. Res. Renew. Ind. Mater. 101.
- Biolive Biological and Chemical Technologies [WWW Document], 2020. URL <http://www.biolivearge.com/indexen.html> (accessed 1.27.21).
- Boskou, D., 2006. Olive Oil: Chemistry and Technology, Second Edition. AOCS Publishing. <https://doi.org/10.1201/9781439832028>
- Contreras, M. del M., Romero, I., Moya, M., Castro, E., 2020. Olive-derived biomass as a renewable source of value-added products. Process Biochem. 97, 43–56. <https://doi.org/10.1016/j.procbio.2020.06.013>
- de la Casa, J.A., Castro, E., 2014. Recycling of washed olive pomace ash for fired clay brick manufacturing. Constr. Build. Mater. 61, 320–326. <https://doi.org/10.1016/j.conbuildmat.2014.03.026>
- Dermeche, S., Nadour, M., Larroche, C., Moulti-Mati, F., Michaud, P., 2013. Olive mill wastes: Biochemical characterizations and valorization strategies. Process Biochem. 48, 1532–1552. <https://doi.org/10.1016/j.procbio.2013.07.010>
- El Hanandeh, A., Gharaibeh, M.A., 2016. Environmental efficiency of olive oil production by small and micro-scale farmers in northern Jordan: Life cycle assessment. Agric. Syst. 148, 169–177. <https://doi.org/10.1016/j.agsy.2016.08.003>
- EMF, 2021. Circular economy introduction [WWW Document]. URL <https://ellenmacarthurfoundation.org/topics/circular-economy-introduction/overview> (accessed 2.24.22).
- Espadas-Aldana, G., Guaygua-Amaguaña, P., Vialle, C., Belaud, J.-P., Evon, P., Sablayrolles, C., 2021. Life Cycle Assessment of Olive Pomace as a Reinforcement in Polypropylene and Polyethylene Biocomposite Materials: A New Perspective for the Valorization of This Agricultural By-Product. Coatings 11, 525. <https://doi.org/10.3390/coatings11050525>
- Espadas-Aldana, G., Vialle, C., Belaud, J.-P., Vaca-Garcia, C., Sablayrolles, C., 2019. Analysis and trends for Life Cycle Assessment of olive oil production. Sustain. Prod. Consum. 19, 216–230. <https://doi.org/10.1016/j.spc.2019.04.003>
- Espi, J.J., Clarens, F., Busset, G., Sablayrolles, C., Montrejaud-Vignoles, M., Carvalho, J., Fonseca, B., Delgado, F., Chacon, L., Capiscol, C., Trillo, R., 2013. Enhancing the competitiveness and reducing the carbon footprint of the olive oil sector through waste management optimisation: OILCA (with critical revision) [in spanish].

- European Committee for Standardization, 2013. Sustainability of Construction Works – Environmental Product Declarations – Core Rules for the Product Category of Construction Products. European Standard EN15804:2012+A1:2013.
- Fernández-Lobato, L., López-Sánchez, Y., Blejman, G., Jurado, F., Moyano-Fuentes, J., Vera, D., 2021. Life cycle assessment of the Spanish virgin olive oil production: A case study for Andalusian region. *J. Clean. Prod.* 290, 125677. <https://doi.org/10.1016/j.jclepro.2020.125677>
- Gentil, C., Basset-Mens, C., Manteaux, S., Mottes, C., Maillard, E., Biard, Y., Fantke, P., 2020. Coupling pesticide emission and toxicity characterization models for LCA: Application to open-field tomato production in Martinique. *J. Clean. Prod.* 277, 124099. <https://doi.org/10.1016/j.jclepro.2020.124099>
- Harris, S., Martin, M., Diener, D., 2021. Circularity for circularity's sake? Scoping review of assessment methods for environmental performance in the circular economy. *Sustain. Prod. Consum.* 26, 172–186. <https://doi.org/10.1016/j.spc.2020.09.018>
- Hauschild, M., K. Rosenbaum, R., Irving Olsen, S., 2018. Life Cycle Assessment: Theory and Practice. <https://doi.org/10.1007/978-3-319-56475-3>
- International Olive Oil Council, 2021a. IOC (International Olive Council) [WWW Document]. World Olive Oil Fig. URL <https://www.internationaloliveoil.org/what-we-do/economic-affairs-promotion-unit/#figures> (accessed 9.10.21).
- International Olive Oil Council, 2021b. IOC (International Olive Council) [WWW Document]. Trade Stand. Appl. Olive Oils Olive Pomace Oils. URL <https://www.internationaloliveoil.org/what-we-do/economic-affairs-promotion-unit/#figures> (accessed 9.10.21).
- IPCC, 2006. 2006 IPCC Guidelines for National Greenhouse Gas Inventories, Prepared by National Greenhouse Gas Inventories Programme, Eggleston H.S., Buendia L., Miwa K., Ngara T., Tabane K. ed. IGES, Japan.
- ISO 14040: Environmental Management – Life Cycle Assessment – Principles and framework. International Organization for Standardization (ISO). Geneva, Switzerland., 2006a.
- ISO 14044: Environmental Management – Life Cycle Assessment – Requirements and Guidelines. International Organization for Standardization (ISO). Geneva, Switzerland., 2006b.
- Kaya, N., Atagur, M., Akyuz, O., Seki, Y., Sarikanat, M., Sutcu, M., Seydibeyoglu, M.O., Sever, K., 2018. Fabrication and characterization of olive pomace filled PP composites. *Compos. Part B Eng.* 150, 277–283. <https://doi.org/10.1016/j.compositesb.2017.08.017>
- Lammi, S., Le Moigne, N., Djenane, D., Gontard, N., Angellier-Coussy, H., 2018. Dry fractionation of olive pomace for the development of food packaging biocomposites. *Ind. Crops Prod.* 120, 250–261. <https://doi.org/10.1016/j.indcrop.2018.04.052>
- Material Insight: Bioplastic Made from Olives [WWW Document], 2018. . Mater. Conenexion. URL <https://www.materialconnexion.com/material-insight-bioplastic/> (accessed 6.19.20).
- Mordor Intelligence, 2021. Europe Wood Plastic Composite (WPC) Market [WWW Document]. Mordor Intell. URL <https://www.mordorintelligence.com/industry-reports/europe-wood-plastic-composite-market> (accessed 6.22.21).
- Ncube, A., Fiorentino, G., Panfilo, C., De Falco, M., Ulgiati, S., 2022. Circular economy paths in the olive oil industry: a Life Cycle Assessment look into environmental performance and benefits. *Int. J. Life Cycle Assess.* <https://doi.org/10.1007/s11367-022-02031-2>
- OiLCA, 2011. Enhancing the competitiveness and reducing the carbon footprint of the olive oil sector through waste management optimisation and the establishment of an ecological label [WWW Document]. URL (accessed 10.11.18).

- Pattara, C., Salomone, R., Cichelli, A., 2016. Carbon footprint of extra virgin olive oil: a comparative and driver analysis of different production processes in Centre Italy. *J. Clean. Prod.* 127, 533–547. <https://doi.org/10.1016/j.jclepro.2016.03.152>
- Proietti, S., Sdringola, P., Desideri, U., Zepparelli, F., Brunori, A., Ilarioni, L., Nasini, L., Regni, L., Proietti, P., 2014. Carbon footprint of an olive tree grove. *Appl. Energy* 127, 115–124. <https://doi.org/10.1016/j.apenergy.2014.04.019>
- Proietti, S., Sdringola, P., Regni, L., Evangelisti, N., Brunori, A., Ilarioni, L., Nasini, L., Proietti, P., 2017. Extra Virgin Olive oil as carbon negative product: Experimental analysis and validation of results. *J. Clean. Prod.* 166, 550–562. <https://doi.org/10.1016/j.jclepro.2017.07.230>
- Putinja, I., 2020. Researchers Develop Compostable Plastic Packaging From Olive Waste [WWW Document]. *Olive Oil Times*. URL <https://www.oliveoiltimes.com/world/researchers-develop-compostable-plastic-packaging-from-olive-waste/81373> (accessed 6.19.20).
- Rinaldi, S., Barbanera, M., Lascaro, E., 2014. Assessment of carbon footprint and energy performance of the extra virgin olive oil chain in Umbria, Italy. *Sci. Total Environ.* 482–483, 71–79. <https://doi.org/10.1016/j.scitotenv.2014.02.104>
- Salomone, R., Cappelletti, G.M., Malandrino, O., Mistretta, M., Neri, E., Nicoletti, G., Notarnicola, B., Pattara, C., Russo, C., Saija, G., 2015a. Life Cycle Assessment in the Olive Oil Sector, in: *Life Cycle Assessment in the Agri-Food Sector*. Springer, Cham, pp. 57–121. https://doi.org/10.1007/978-3-319-11940-3_2
- Salomone, R., Cappelletti, G.M., Malandrino, O., Mistretta, M., Neri, E., Nicoletti, G.M., Notarnicola, B., Pattara, C., Russo, C., Saija, G., 2015b. Life Cycle Assessment in the Olive Oil Sector, in: Notarnicola, B., Salomone, R., Petti, L., Renzulli, P.A., Roma, R., Cerutti, A.K. (Eds.), *Life Cycle Assessment in the Agri-Food Sector: Case Studies, Methodological Issues and Best Practices*. Springer International Publishing, Cham, pp. 57–121. https://doi.org/10.1007/978-3-319-11940-3_2
- Seecar, n.d. "Mécanisation Agricole", adapté de "Maintenance du Matériel agricole", Centre d'Etudes et d'Expérimentation du Machinisme Agricole Tropical, 1984.
- Silvadec, 2020. Silvadec, le fabricant de bois composite leader en Europe [WWW Document]. Silvadec. URL <https://fr.silvadec.com/silvadec/notre-societe/> (accessed 3.9.21).
- Sommerhuber, P.F., Wenker, J.L., Rüter, S., Krause, A., 2017. Life cycle assessment of wood-plastic composites: Analysing alternative materials and identifying an environmental sound end-of-life option. *Resour. Conserv. Recycl.* 117, 235–248. <https://doi.org/10.1016/j.resconrec.2016.10.012>
- Uitterhaegen, E., Parinet, J., Labonne, L., Mérian, T., Ballas, S., Véronèse, T., Merah, O., Talou, T., Stevens, C.V., Chabert, F., Evon, Ph., 2018. Performance, durability and recycling of thermoplastic biocomposites reinforced with coriander straw. *Compos. Part Appl. Sci. Manuf.* 113, 254–263. <https://doi.org/10.1016/j.compositesa.2018.07.038>
- Vidal, R., Martínez, P., Garraín, D., 2009. Life cycle assessment of composite materials made of recycled thermoplastics combined with rice husks and cotton linters. *Int. J. Life Cycle Assess.* 14, 73–82. <https://doi.org/10.1007/s11367-008-0043-7>



APPENDIXES

Appendix A

Method: ReCiPe 2016

● Description

ReCiPe is the most recent and harmonized indicator approach available in life cycle impact assessment.

The ReCiPe LCA methodology was created by RIVM, CML , PRé Consultants, Radboud Universiteit Nijmegen and CE Delft. The group of authors include the developers of the CML 2001 and Ecoindicator 99 methodologies.

ReCiPe can be seen as a fusion of the two methodologies, taking the midpoint indicators from CML and the endpoint indicators from Ecoindicator.

ReCiPe 2016 is an updated and extended version of ReCiPe 2008. Like the predecessor, ReCiPe 2016 includes both midpoint (problem oriented) and endpoint (damage oriented) impact categories, available for three different perspectives (individualist (I), hierarchist (H), and egalitarian (E)). The characterization factors are representative for the global scale, instead of the European scale as it was done in ReCiPe 2008. Because of that the method was moved from the European category to Global.

● Cultural Perspective

All mid- and endpoint indicators are available in three versions taking into account three different cultural perspectives:

→ **Individualist (I)** is based on the short-term interest, impact types that are undisputed, technological optimism as regards to human adaptation. Uses the shortest time frame e.g. a 20 year timeframe for global warming, GWP20

→ **Hierarchist (H)** is based on the most common policy principles with regards to time-frame and other issues. Uses the medium time frame e.g. a 100 year timeframe for global warming, GWP100

→ **Egalitarian (E)** is the most precautionary perspective, taking into account the longest time-frame, impact types that are not yet fully established but for which some indication is available, etc. Uses the longest time frame e.g. a 1000 year timeframe for global warming, (GWP1000) and infinite time for ozone depletion (ODPInf)

● Characterisation

ReCiPe comprises two sets of impact categories with associated sets of characterization factors. At the midpoint level, 18 impact categories are addressed:

→ **Eighteen midpoint indicators**; low uncertainty but difficult to interpret. The midpoint indicators are similar to what is used in the CML methodology: climate change, acidification, eutrophication etc.

1. Climate change
2. Stratospheric ozone depletion
3. Ionizing radiation

4. Ozone formation, human health
5. Fine particulate matter formation
6. Ozone formation, terrestrial ecosystems
7. Terrestrial acidification
8. Freshwater eutrophication
9. Marine eutrophication
10. Terrestrial ecotoxicity
11. Freshwater ecotoxicity
12. Marine ecotoxicity
13. Human carcinogenic toxicity
14. Human non-carcinogenic toxicity
15. Land use
16. Mineral resource scarcity
17. Fossil resource scarcity
18. Water use

1. Climate change

The characterization factor of climate change is the global warming potential, based on IPCC 2013 report. For the Individualist perspective 20 year time horizon was used, for Hierarchist 100 years and for Egalitarian 1000 years. Climate-carbon feedbacks are included for non-CO₂ GHGs in the Hierarchist perspective. The unit is **yr/kg CO₂ equivalents**.

2. Ozone depletion

The characterisation factor for ozone layer depletion accounts for the destruction of the stratospheric ozone layer by anthropogenic emissions of ozone depleting substances (ODS). The unit is **yr/kg CFC-11 equivalents**.

3. Ionizing radiation

The characterization factor of ionizing radiation accounts for the level of exposure for the global population. The unit is **yr/kBq Cobalt-60 equivalents to air**.

4. Photochemical ozone formation, human health

The characterization factor is determined from the change in intake rate of ozone due to change in emission of precursors (NO_x and NMVOC). The unit of human health ozone formation potential is **yr/kg NO_x equivalents**.

5. Fine particulate matter formation

The characterization factor of particulate matter formation is the intake fraction of PM_{2.5}. The unit is **yr/kg PM_{2.5} equivalents**.

6. Photochemical ozone formation, terrestrial ecosystems

The characterization factor is determined from the change in intake rate of ozone due to change in emission of precursors (NO_x and NMVOC). The unit of ecosystem ozone formation potential is **yr/kg NO_x equivalents**.

7. Terrestrial acidification

The characterization factor for terrestrial acidification is Acidification Potential (AP) derived using the emission weighted world average fate factor of SO₂. The unit is **yr/kg SO₂ equivalents**.

8. Freshwater eutrophication

The characterization factor of freshwater eutrophication accounts for the environmental persistence (fate) of the emission of P containing nutrients. The unit is **yr/kg P to freshwater equivalents**.

9. Marine eutrophication

The characterization factor of marine eutrophication accounts for the environmental persistence (fate) of the emission of N containing nutrients. The unit is **yr/kg N to marine equivalents**.

10-14. Human toxicity and ecotoxicity

The characterisation factor of human toxicity and ecotoxicity accounts for the environmental persistence (fate) and accumulation in the human food chain (exposure), and toxicity (effect) of a chemical. The unit is **yr/kg 1,4-dichlorobenzene (1,4-DCB)**.

15. Land use

The amount of natural land transformed and occupied for a certain time. The unit is **m²*yr**.

16. Mineral resource scarcity

The characterization factor for mineral resource scarcity is the surplus ore potential. The unit is **kg Copper (Cu) equivalents**.

17. Fossil resource scarcity

The characterization factor of fossil resource scarcity is the fossil fuel potential, based on the higher heating value. The unit is **kg oil equivalents**.

18. Water use

The factor for the water use is the amount of fresh water consumption. The unit is **m³ water consumed**. Current implementation includes regionalized characterization factors in the endpoint version of the method.

→ **Three endpoint indicators**; easy to understand but more uncertain. The endpoint indicators are similar to what is used in the Ecoindicator 99 methodology: Damage to Human health, ecosystems, and resource availability

1. Human Health, expressed as the number of year life lost and the number of years lived disabled. These are combined as Disability Adjusted Life Years (DALYs), an index that is also used by the World Bank and WHO. The unit is years.

2. Ecosystems, expressed as the loss of species over a certain area, during a certain time. The unit is years.

3. Resource scarcity, expressed as the surplus costs of future resource production over an infinitive timeframe (assuming constant annual production), considering a 3% discount rate. The unit is USD2013. Mind that fossil resource scarcity does not have constant mid-to-endpoint factor but individual factors for each substance.

Damage category	Indicator - unit	
Human health	HH	DALY
Ecosystem quality	EQ	PDF*m ² *years
Ecosystem services & resources	ER	\$

- **DALY** or "disability adjusted life years": the total amount of healthy life lost, to all causes, whether from premature mortality or from some degree of disability.
- **PDF*m²*years** or "potentially disappeared fraction": the percentage of species disappeared over a certain area and during a certain time.
- **\$**: the additional costs for future generations to extract or use resources

● Normalisation

Normalisation is developed both for the midpoint and endpoint indicators. Global normalisation factors for the reference year 2010 are included since version 1.03 of ReCiPe 2016. However, the reference report has not been published yet and the global reference inventory is still to be implemented in SimaPro.

● Weighting

Weighting is not developed for the mid-point indicators by the ReCiPe authors. The midpoint values can be weighted using the thinkstep LCIA Survey 2012. Using this only makes sense combined with a normalisation hereby bringing the impacts to the same unit of person-equivalents. The endpoint indicators can be weighted using the ReCiPe weighting factors developed by the authors or using the weighting factors developed in the thinkstep LCIA Survey 2012

Unlike other approaches (Eco-Indicator 99, EPS Method, LIME, and Impact 2002+) it does not include potential impacts from future extractions in the impact assessment, but assumes such impacts have been included in the inventory analysis.

Therefore, weighting sets from the previous version of ReCiPe are reused here. Those are based on panel weighting performed at damage category (endpoint) level. A specific weighting set is available for each perspective. Additionally, the average result of the panel assessment is available as weighting set.

The hierarchist version of ReCiPe with average weighting is chosen as default. In general, value choices made in the hierarchist version are scientifically and politically accepted.

Relationship between LCI parameters (left), midpoint indicator (middle) and endpoint indicator (right) in ReCiPe 2016.

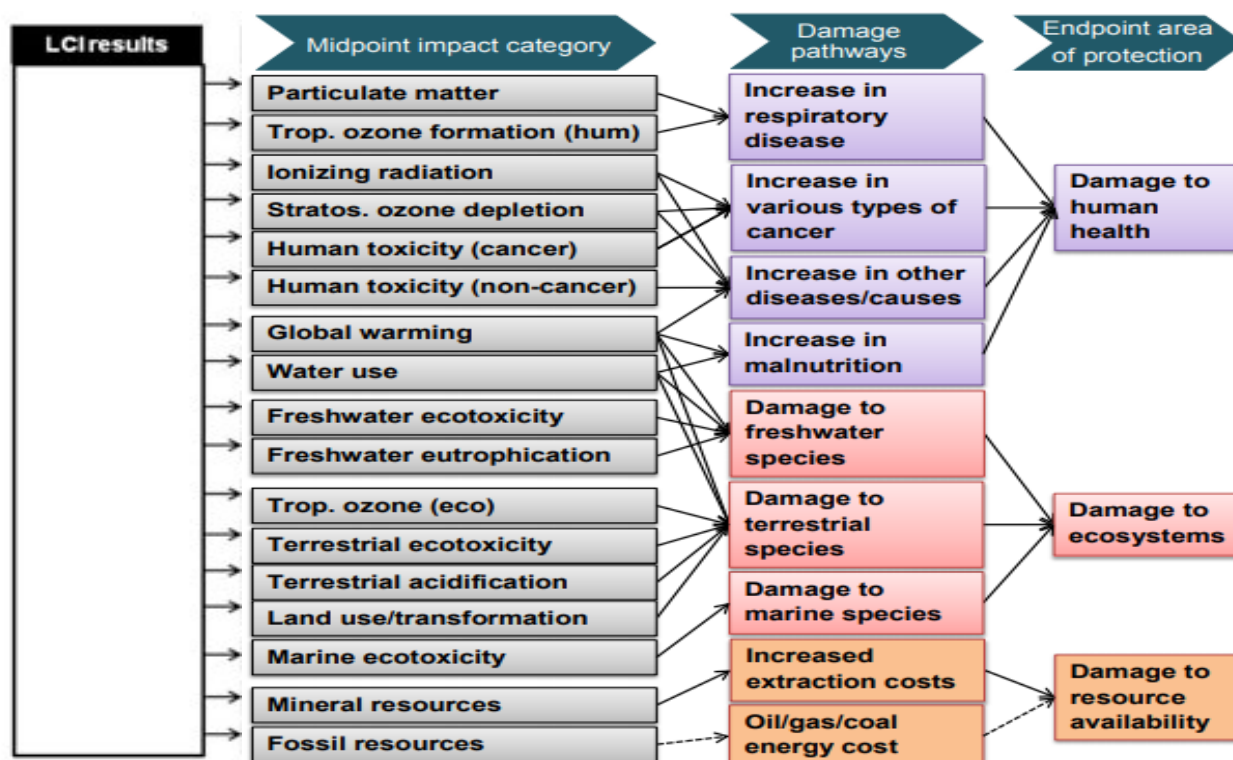

REFERENCES

Huijbregts M.A.J., Steinmann Z.J.N., Elshout P.M.F., Stam G, Verones F., Vieira M.D.M., Hollander A, Zijp M, van Zelm R. 2016. *ReCiPe 2016: A harmonised life cycle impact assessment method at midpoint and endpoint level; Report I: Characterisation*. 15 December 2016.

Sleeswijk, A.W.; van Oers, L.F.; Guinée, J.B.; Huijbregts, M.A.J. 2007. *Normalization in product life cycle assessment: An LCA of the global and European economic systems in the year 2000*. *Sci Total Environ* 390 (1):227-240.

Pre-Sustainability, 2018. <https://www.pre-sustainability.com/recipe>

PRéConsultant, 2018. SimaPro Database Manual Methods Library. www.pre-sustainability.com
https://www.rivm.nl/en/Topics/L/Life_Cycle_Assessment_LCA/ReCiPe

PRéConsultant, 2021. SimaPro Database Manual Methods Library.

Method: ILCD 2011 Midpoint + International Reference Life Cycle Data System

- The International Reference Life Cycle Data System (ILCD) provides a common basis for consistent, robust and quality assured life cycle data, methods and assessments.
- The ILCD 2011 Midpoint+ method is the current PEF method (The European Product Environmental Footprint or EUPEF).
- This LCIA method includes 16 midpoint impact categories:

1 - Climate change: Global Warming Potential calculating the radiative forcing over a time horizon of 100 years. | **IPCC 2007.**

2 - Ozone depletion: Ozone Depletion Potential (ODP) calculating the destructive effects on the stratospheric ozone layer over a time horizon of 100 years. | **World Meteorological Organization (WMO) 1999.**

3 - Human toxicity, cancer effects: Comparative Toxic Unit for humans (CTUh) expressing the estimated increase in morbidity in the total human population per unit mass of a chemical emitted (cases per kilogramme). | **USEtox.**

4 - Human toxicity, non-cancer effects: Comparative Toxic Unit for humans (CTUh) expressing the estimated increase in morbidity in the total human population per unit mass of a chemical emitted (cases per kilogramme). | **USEtox.**

5 - Particulate matter: Quantification of the impact of premature death or disability that particulates/respiratory inorganics have on the population, in comparison to PM2.5. | **Rabl and Spadaro 2004.**

6 - Ionizing radiation HH (human health): Quantification of the impact of ionizing radiation on the population, in comparison to Uranium 235. | **Frischknecht et al. 2000.**

7 - Ionizing radiation E (ecosystems): Comparative Toxic Unit for ecosystems (CTUe) expressing an estimate of the potentially affected fraction of species (PAF) integrated over time and volume per unit mass of a radionuclide emitted (PAF m³ year/kg). Relevant for freshwater ecosystems. | **Garnier-Laplace et al. 2008.**

8 - Photochemical ozone formation: Expression of the potential contribution to photochemical ozone formation. Only for Europe. It includes spatial differentiation | **van Zelm et al. 2008.**

9 - Acidification: Accumulated Exceedance (AE) characterizing the change in critical load exceedance of the sensitive area in terrestrial and main freshwater ecosystems, to which acidifying substances deposit. European-country dependent. | **Seppälä et al. 2006 and Posch et al. 2008.**

10 - Terrestrial eutrophication: Accumulated Exceedance (AE) characterizing the change in critical load exceedance of the sensitive area, to which eutrophying substances deposit. European-country dependent. | **Seppälä et al. 2006 and Posch et al. 2008.**

11 - Freshwater eutrophication: Expression of the degree to which the emitted nutrients reaches the freshwater end compartment (phosphorus considered as limiting factor in

freshwater). European validity, country dependent characterisation factors. | **ReCiPe version 1.05.**

12 - Marine eutrophication: Expression of the degree to which the emitted nutrients reaches the marine end compartment (nitrogen considered as limiting factor in marine water). European validity, country dependent characterisation factors. | **ReCiPe version 1.05.**

13 - Freshwater ecotoxicity: Comparative Toxic Unit for ecosystems (CTUe) expressing an estimate of the potentially affected fraction of species (PAF) integrated over time and volume per unit mass of a chemical emitted (PAF m³ year/kg). Specific groups of chemicals requires further works. | **USEtox.**

14 - Land use: Soil Organic Matter (SOM) based on changes in SOM, measured in (kg C/m²/a). Biodiversity impacts not covered by the data set. | **Mila i Canals et al. 2007.**

15 - Water resource depletion: Freshwater scarcity: Scarcity-adjusted amount of water used. | **Swiss Ecoscarcity 2006.**

16 - Mineral, fossil & renewable resource depletion: Scarcity of mineral resource with the scarcity calculated as 'Reserve base'. It refers to identified resources that meets specified minimum physical and chemical criteria related to current mining practice. The reserve base may encompass those parts of the resources that have a reasonable potential for becoming economically available within planning horizons beyond those that assume proven technology and current economics. | **van Oers et al. 2002.**

REFERENCES

European Commission, Joint Research Centre, Institute for Environment and Sustainability. Characterisation factors of the ILCD Recommended Life Cycle Impact Assessment methods. Database and Supporting Information; 2012

SIMAPRO 8.0, Ecoinvent 3.0

Appendix B

Table B.1 Characteristics of the employed agricultural machinery, fuel consumption, and emission for the work processes (Nemecek and Kägi, 2007).
Table from Nemecek and Kägi (2007) in the ecoinvent report No. 15 Life Cycle Inventories of Agricultural Production Systems: Appendix A7, Tab. A. 10

Module-name ^a	Vehicles						Machines					Fuel consumption ^c		Emission per hour ^{c,d}		
	Class	Weight ^b [kg]	Space requirement ^b [m ²]	Annual employment ^b [h/a]	Nominal power ^c [kW]	Mean power ^c [kW]	Class	Weight ^b [kg]	Space requirement ^b [m ²]	Annual employment ^b [h/a]	per hour [l/h]	per FU ^a [kg/FU]	HC [g/h]	NO _x [g/h]	CO [g/h]	
→ application of plant protection products, by field sprayer	Tractor	3300	15.2	600	50	4.1	AM - general	477	6.1	75	3	1.76	10	113	14	
baling	Tractor	3700	15.8	600	62	17.9	AM - general	2286	13.4	60	6.8	0.74	14	237	30	
irrigating (per ha)	Tractor	3300	15.2	600	50	9.7	AM - general	1300	14.6	200	4.5	3.78	17	193	36	
combine harvesting	Combine harvester	9445	53.6	125	150	105.0	–	–	–	114	30.5	33.31	4.5	51	9.6	
→ fertilising, by broadcaster	Tractor	3300	15.2	600	50	8.6	AM - general	193	3.8	80	4.2	5.29	10	154	14	
hoeing	Tractor	3300	15.2	600	50	7.3	AM - tillage	559	12.2	29	3.9	3.28	12	144	17	
harvesting, by complete harvester, potatoes	Tractor	3300	15.2	600	50	2.6	AM - general	3198	24.4	143	2.5	28.14	13	121	24	
slurry spreading, by vacuum tanker	Tractor	3300	15.2	600	50	8.9	Slurry tankers	1690	19.9	167	4.3	0.22	12	156	26	
potato planting	Tractor	3300	15.2	600	50	0.6	AM - general	447	7.9	60	2	8.90	7	76	10	
→ mowing, by motor mower	Tractor	370	7.8	70	8	0.8	–	–	–	70	2	3.40	35	30	950	
chopping, maize	Tractor	11100	47.4	600	3 × 62	34 + 2 × 20	AM - general	9515	102.6	53 + 2 × 80	–	52.75	46	836	139	
solid manure loading and spreading, by hydraulic loader and spreader	Tractor	7000	31	600	50 + 62	2 + 18	AM - general	3848	29.7	115 + 100	–	5.31E-04	28	367	53	
mulching	Tractor	3300	15.2	600	50	7.3	AM - tillage	664	8.1	63	3.8	3.51	11	143	15	
sowing	Tractor	3300	15.2	600	50	6.1	AM - general	507	8.4	29	3.5	3.82	10	131	11	
planting	Tractor	3300	15.2	600	50	0.6	AM - general	175	5	143	2	16.80	7	76	10	
tillage, harrowing, by spring tine harrow	Tractor	3700	15.8	600	62	17.2	AM - tillage	538	12.2	28	6.6	4.44	15	247	33	

Module-name ^a	Vehicles						Machines				Fuel consumption ^c		Emission per hour ^{c,d}		
	Class	Weight ^b [kg]	Space requirement ^b [m ²]	Annual employment ^b [h/a]	Nominal power ^c [kW]	Mean power ^c [kW]	Class	Weight ^b [kg]	Space requirement ^b [m ²]	Annual employment ^b [h/a]	per hour [l/h]	per FU ^a [kg/FU]	HC [g/h]	NO _x [g/h]	CO [g/h]
tillage, rotary cultivator	Tractor	3300	15.2	600	50	34.4	AM - tillage	902	6.8	31	11.2	14.11	25	387	126
tillage, cultivating, chiselling	Tractor	5300	19.4	600	78	48.9	AM - tillage	709	9.9	44	15.4	15.52	27	507	108
tillage, ploughing	Tractor	5300	19.4	600	78	46.5	AM - tillage	1039	13.3	73	14.8	26.11	26	490	99
tillage, rolling	Tractor	3300	15.2	600	50	8.6	AM - tillage	910	6.1	21	4.2	3.18	10	154	14
transport, tractor and trailer	Tractor	3700	15.8	600	62	19.8	Trailers	4084	43.6	80	7.3	0.04	14	239	36
harvesting, by complete harvester, beets	Tractor	5300	19.4	600	78	48.9	AM - general	2660	22	200	15.4	103.49	27	507	108
potato haulm cutting	Tractor	3300	15.2	600	50	7.3	AM - general	540	7	24	3.8	4.79	11	143	15
mowing, by rotary mower	Tractor	3300	15.2	600	50	14.1	AM - general	643	6.1	28	5.7	4.31	12	186	19
haying, by rotary tedder	Tractor	3300	15.2	600	50	7.3	AM - general	552	12.6	60	3.8	1.92	11	143	15
swath, by rotary windrower	Tractor	3300	15.2	600	50	6.1	AM - general	315	12.2	54	3.5	2.94	11	133	16
fodder loading, by self-loading trailer	Tractor	3700	15.8	600	62	16.3	AM - general	3035	27.3	100	6.3	0.11	13	214	23
loading bales	Tractor	3300	15.2	600	50	8.6	AM - general	450	13.4	112	4.2	0.08	12	142	18
tillage, hoeing and earthing-up, potatoes	Tractor	3300	15.2	600	50	7.3	AM - tillage	495	10.2	44	3.9	3.60	12	144	17
tillage, currying, by weeder	Tractor	3300	15.2	600	50	7.3	AM - tillage	475	8.1	25	3.8	1.60	11	143	15
tillage, harrowing, by rotary harrow	Tractor	3700	15.8	600	62	34.4	AM - tillage	1183	7	32	11.4	11.49	17	389	77
potato grading	-	-	-	-	-	-	AM - general	962	20.2	200	- ^e	- ^e	-	-	-

a See Tab. A. 9 for corresponding module description

b Ammann (2001), Ammann (2002) and personal communication in September 2002 from H. Ammann. FAT, Ettenhausen, Switzerland.

c Personal communication in July 2002 from M. Rinaldi. FAT, Ettenhausen, Switzerland.

d For calculation of other air emissions see chapter 7.2.6.

e Electricity usage: 2 kWh/hour, 1 kWh/ton of ungraded potatoes.

Table B.2 Emission factors for air emissions from fuel combustion (SAEFL, 2000).

Table from Nemecek and Kägi (2007) in the ecoinvent report No. 15 Life Cycle Inventories of Agricultural Production Systems: Tab. 7.1.

Substance	Formula	Emission factor [g / kg fuel consumption]		Significance / remarks
		Diesel	Petrol	
Carbon dioxide	CO ₂	3.12E+03	3.00E+03	Global warming
Sulphur dioxide	SO ₂	1.01E+00	7.20E-02	Photochemical oxidation, acidification
Lead	Pb	0	1.46E-01	Terrestrial ecotoxicity
Methane	CH ₄	1.29E-01	2.92E+00	Global warming
Benzene	C ₆ H ₆	7.30E-03	9.48E+00	Human toxicity
Particulate Matter	PM _{2.5}	EF _{PM2.5}	EF _{PM2.5}	See formula 7.8
Cadmium	Cd	1.00E-05	1.00E-05	Terrestrial ecotoxicity
Chromium	Cr	5.00E-05	5.00E-05	Terrestrial ecotoxicity
Copper	Cu	1.70E-03	1.70E-03	Human toxicity, freshwater aquatic ecotoxicity, terrestrial ecotoxicity
Dinitrogen monoxide	N ₂ O	1.20E-01	1.30E-01	Global warming
Nickel	Ni	7.00E-05	7.00E-05	Human toxicity, freshwater aquatic ecotoxicity, terrestrial ecotoxicity
Zinc	Zn	1.00E-03	1.00E-03	Terrestrial ecotoxicity
Benzo(a)pyrene	C ₂₀ H ₁₂	3.00E-05	4.00E-05	ecoinvent quality guidelines requires to separate B(a)p from other PAHs
Ammonia	NH ₃	2.00E-02	4.00E-02	Acidification, eutrophication
Selenium	Se	1.00E-05	1.00E-05	Human toxicity, freshwater aquatic ecotoxicity, terrestrial ecotoxicity
Polycyclic aromatic hydrocarbons		Sum of different PAHs listed below		Human toxicity, freshwater aquatic ecotoxicity, terrestrial ecotoxicity
Benz(a)-Anthracene		8.00E-05	7.50E-05	
Benzo(b)-Fluor-anthracene		5.00E-05	4.00E-05	
Chrysene		2.00E-04	1.00E-05	
Dibenzo(a,h)-Anthracene		1.00E-05	1.50E-04	
Fluoranthene		4.50E-04	4.50E-04	
Phenanthrene		2.50E-03	1.20E-03	

Table B.3 Basic values for the calculation of heavy-metal emission from tyre abrasion (Nemecek and Kägi, 2007).

Table from Nemecek and Kägi (2007) in the ecoinvent report No. 15 Life Cycle Inventories of Agricultural Production Systems: Tab. 7.2.

	Tractors	Harvesters	Trailers	Agricultural machinery, general	Slurry tankers
Lifetime of tyres [h]	2,500	1,080	750	2,500	2,500
Weight of one set of tyres [kg _{tyres} /kg _{machinery}]	0.0975	0.0675	0.0475	0.0275	0.0475
Synthetic rubber, rubbed off [kg _{rubber} /kg _{tyres}]	0.29	0.29	0.56	0.56	0.56

The class "agricultural machinery, tillage" has no tyres.

Table B.4 Calculations in Excel sheet for basic operations (level 2) as “Application of phytosanitary treatment, by field sprayer {FR} 37CV (1h ha)”.

Description de l'opération agricole		Proxy: application of plant protection products, by fieldsprayer	
Nom de l'opération	Application_by-field-sprayer_37CV_1h1ha		
Données d'entrée	Valeur	Unité	
Durée de l'opération	1.00	h	
Chevaux vapeur metric (CV)	37.00	CV	
Puissance nominale	27.21	kW	
Consommation de carburant	4.44	l/h	
Puissance moyenne du tracteur pendant l'opération	4.1	kW	
Type de tracteur	Tracteur (-29 kW)		Rapport 15 ecoinvent: Tab. A.10, page 197/360
Machine agricole (hors travail du sol)	Field sprayer		
Machine agricole de travail du sol	-		
Résultats			
Infrastructure	Valeur	Unité	
Tractor production	0.308333333	kg	
Agricultural machinery, tillage, production	0.00	kg	
Agricultural machinery, general, production	0.48	kg	
Diesel, at regional storage	3.73	kg	
Shed for tractor	4.40E-04	m ²	
Shed for machinery tillage	1.63E-03	m ²	
Shed for machinery general	0.00E+00	m ²	
Soil emission from tractor tyre abrasion	Valeur	Unité	
Zn	3.35E-01	g/(ha.a)	
Pb	5.44E-02	g/(ha.a)	
Cd	1.26E-02	g/(ha.a)	
Soil emission from machinery tyre abrasion	Valeur	Unité	
Zn	4.70E-02	g/(ha.a)	
Pb	7.64E-03	g/(ha.a)	
Cd	1.76E-03	g/(ha.a)	

Paramètres

(Ils sont récupérés de la boîte violette "Base de données")

Paramètres tracteur

Poids	1850	kg
Durée de vie	6000	h
Puissance nominale	27.213426	kW
Espace de stockage	11	m ²
Utilisation annuelle	500	h/an
Part des pneus dans le tracteur	0.0975	kg pneus/kg tracteur

hyp > donnée de fiche

Paramètres pneus tracteur

Durée de vie	2500	h
Part de caoutchouc perdu sur la durée de vie	0.29	kg caoutchouc/kg pneus
Teneur en zinc	16	g/kg de pneus
Teneur en plomb	2.6	g/kg de pneus
Teneur en cadmium	0.6	g/kg de pneus

Paramètres outils agricoles (hors travail du sol)

Poids	477	kg
Espace de stockage	6.1	m ²
Utilisation annuelle	75	h/an
Durée de vie	1000	h
Part des pneus dans la machine	0.0275	kg pneus/kg machine

Paramètres pneus outils agricoles

Durée de vie	2500	h
Part de caoutchouc perdu sur la durée de vie	0.56	kg caoutchouc/kg pneus
Teneur en zinc	16	g/kg de pneus
Teneur en plomb	2.6	g/kg de pneus
Teneur en cadmium	0.6	g/kg de pneus

Paramètres hangar de stockage

Durée de vie hangar	50	ans
---------------------	----	-----

Base de données

Tracteur	Tracteur (-29 kW)	Tracteur (30-64 kW)	Tracteur (65-94 kW)
Poids	1900	3300	5300
Durée de vie	6000	7200	7200
Puissance nominale	27.95	50	78
Espace de stockage	11.0	15.2	19.4
Utilisation annuelle	500	600	600

SPREADER= fertiliser, lime
SPRAYER= fertiliser, herbicides

Machine agricole de travail du sol	-	Plough, 4 furrow	Spring tooth harrow	Rotary harrow	Roller, 2,5-3 m	Field cultivator
Poids		1039	538	1183	910	902
Espace de stockage		13.3	12.2	7	6.1	6.8
Utilisation annuelle		73	28	32	21	31
Durée de vie		480	540	360	500	480

Machine agricole (hors travail du sol)	-	Seeder	Hoe	Fertiliser spreader	Field sprayer	Rotary mower
Poids		507	559	193	477	643
Espace de stockage		8.4	12.2	3.8	6.1	6.1
Utilisation annuelle		35	29	80	75	28
Durée de vie		525	525	1000	1000	600

Emissions de combustion			
Molécule	Facteur d'émission (g/kg diesel)	Facteur d'émission (g/h tracteur)*	Emission to air (g/(ha.a))
HC		10	1.00E+01
NOx		113	1.13E+02
CO		14	1.40E+01
CO2	3.12E+03		1.16E+04
SO2	1.01E+00		3.77E+00
CH4	1.29E-01		4.81E-01
C6H6	7.30E-03		2.72E-02
PM2,5	2.21E+00		7.75E+00
Cd	1.00E-05		3.73E-05
Cr	5.00E-05		1.86E-04
Cu	1.70E-03		6.34E-03
N2O	1.20E-01		4.48E-01
Ni	7.00E-05		2.61E-04
Zn	1.00E-03		3.73E-03
Benzo(a)pyrene	3.00E-05		1.12E-04
NH3	2.00E-02		7.46E-02
Se	1.00E-05		3.73E-05
PAH	3.29E-03		1.23E-02
Benzo(a)-Anthracene	8.00E-05		2.98E-04
Benzo(b)-Fluoranthracene	5.00E-05		1.86E-04
Chrysene	2.00E-04		7.46E-04
Dibenzo(a,h)-Anthracene	1.00E-05		3.73E-05
Fluoranthene	4.50E-04		1.68E-03
Phenanthrene	2.50E-03		9.32E-03

Rapport 15: Tab. A.10,
page 197/360
FIELD SPRAYER

* Emissions variables en fonction des conditions de vitesse et de puissance effective du tracteur pendant l'opération

Fiche SimaPro opération agricole

Output	Amount	Unit
Application_by-field-sprayer_37CV_1h1ha		1 ha

Inputs	Amount	Unit
Tractor, 4-wheel, agricultural {GLO} market for	0.3083	kg
Agricultural machinery, tillage {GLO} market for	0.00E+00	kg
Agricultural machinery, unspecified {GLO} market for	0.4770	kg
Diesel, at regional storageDiesel {Europe without Switzerland} market fo	3.7296	kg
Shed {GLO} market for	0.00207	m²

Emissions to air	Amount	Unit	Location
NM VOC, non-methane volatile organic compounds, unspecified origin	1.00E-02	kg	air/low population density
Nitrogen oxides	1.13E-01	kg	air/low population density
Carbon monoxide, fossil	1.40E-02	kg	air/low population density
Carbon dioxide, fossil	1.16E+01	kg	air/low population density
Sulfur dioxide	3.77E-03	kg	air/low population density
Methane, fossil	4.81E-04	kg	air/low population density
Benzene	2.72E-05	kg	air/low population density
Particulates, < 2,5 um	7.75E-03	kg	air/low population density
Cadmium	3.73E-08	kg	air/low population density
Chromium	1.86E-07	kg	air/low population density
Copper	6.34E-06	kg	air/low population density
Dinitrogen monoxide	4.48E-04	kg	air/low population density
Nickel	2.61E-07	kg	air/low population density
Zinc	3.73E-06	kg	air/low population density
Benzo(a)pyrene	1.12E-07	kg	air/low population density
Ammonia	7.46E-05	kg	air/low population density
Selenium	3.73E-08	kg	air/low population density
PAH, Polycyclic aromatic hydrocarbons	1.23E-05	kg	air/low population density
Benzo(a)-Anthracene	2.98E-07	kg	air/low population density
Benzo(b)-Fluoranthracene	1.86E-07	kg	air/low population density
Chrysene	7.46E-07	kg	air/low population density
Dibenzo(a,h)-Anthracene	3.73E-08	kg	air/low population density
Fluoranthene	1.68E-06	kg	air/low population density
Phenanthrene	9.32E-06	kg	air/low population density

Emission to soil	Amount	Unit	Location
Zinc	3.82E-04	kg	soil/agricultural
Lead	6.20E-05	kg	soil/agricultural
Cadmium	1.43E-05	kg	soil/agricultural

Table B.5 Calculations in Excel sheet for basic operations (level 2) as "Application of phytosanitary treatment, by field sprayer {FR} 50CV (1h ha)".

Description de l'opération agricole		Proxy: application of plant protection products, by fieldsprayer
Nom de l'opération	Application_by-field-sprayer_50CV_1h1ha	
Données d'entrée	Valeur	Unité
Durée de l'opération	1.00	h
Chevaux vapeur metric (CV)	50.00	CV
Puissance nominale	36.77	kW
Consommation de carburant	6	l/h
Puissance moyenne du tracteur pendant l'opération	4.1	kW
Type de tracteur	Tracteur (30-64 kW)	
Machine agricole (hors travail du sol)	Field sprayer	
Machine agricole de travail du sol	-	

Rapport 15 ecoinvent:
Tab. A.10, page 197/360

Résultats		
Infrastructure	Valeur	Unité
Tractor production	0.347222222	kg
Agricultural machinery, tillage, production	0.00	kg
Agricultural machinery, general, production	0.48	kg
Diesel, at regional storage	5.04	kg
Shed for tractor	5.07E-04	m ²
Shed for machinery tillage	1.63E-03	m ²
Shed for machinery general	0.00E+00	m ²
Soil emission from tractor tyre abrasion	Valeur	Unité
Zn	4.52E-01	g/(ha.a)
Pb	7.35E-02	g/(ha.a)
Cd	1.70E-02	g/(ha.a)
Soil emission from machinery tyre abrasion	Valeur	Unité
Zn	4.70E-02	g/(ha.a)
Pb	7.64E-03	g/(ha.a)
Cd	1.76E-03	g/(ha.a)

Paramètres		(Ils sont récupérés du boîte violette "Base de données")
Paramètres tracteur		
Poids	2500	kg
Durée de vie	7200	h
Puissance nominale	36.7749	kW
Espace de stockage	15.2	m ²
Utilisation annuelle	600	h/an
Part des pneus dans le tracteur	0.0975	kg pneus/kg tracteur
Paramètres pneus tracteur		
Durée de vie	2500	h
Part de caoutchouc perdu sur la durée de vie	0.29	kg caoutchouc/kg pneus
Teneur en zinc	16	g/kg de pneus
Teneur en plomb	2.6	g/kg de pneus
Teneur en cadmium	0.6	g/kg de pneus
Paramètres outils agricoles (hors travail du sol)		
Poids	477	kg
Espace de stockage	6.1	m ²
Utilisation annuelle	75	h/an
Durée de vie	1000	h
Part des pneus dans la machine	0.0275	kg pneus/kg machine
Paramètres pneus outils agricoles		
Durée de vie	2500	h
Part de caoutchouc perdu sur la durée de vie	0.56	kg caoutchouc/kg pneus
Teneur en zinc	16	g/kg de pneus
Teneur en plomb	2.6	g/kg de pneus
Teneur en cadmium	0.6	g/kg de pneus
Paramètres hangar de stockage		
Durée de vie hangar	50	ans

hyp > donnée de fiche
hyp > donnée de fiche

Fiche Simapro opération agricole

Output	Amount	Unit
Application_by-field-sprayer_50CV_1h1ha		1 ha

Inputs	Amount	Unit
Tractor, 4-wheel, agricultural {GLO} market for	0.3472	kg
Agricultural machinery, tillage {GLO} market for	0.00E+00	kg
Agricultural machinery, unspecified {GLO} market for	0.4770	kg
Diesel, at regional storageDiesel {Europe without Switzerland} market fo	5.0400	kg
Shed {GLO} market for	0.00213	m ²

Dans les cellules colorées, c'est les données qui changent entre la fiche de Simapro de fertilising et application of phytosanitary treatment

Emissions to air	Amount	Unit	Location
NMVOG, non-methane volatile organic compounds, unspecified origin	1.00E-02	kg	air/low population density
Nitrogen oxides	1.13E-01	kg	air/low population density
Carbon monoxide, fossil	1.40E-02	kg	air/low population density
Carbon dioxide, fossil	1.57E+01	kg	air/low population density
Sulfur dioxide	5.09E-03	kg	air/low population density
Methane, fossil	6.50E-04	kg	air/low population density
Benzene	3.68E-05	kg	air/low population density
Particulates, < 2,5 um	7.21E-03	kg	air/low population density
Cadmium	5.04E-08	kg	air/low population density
Chromium	2.52E-07	kg	air/low population density
Copper	8.57E-06	kg	air/low population density
Dinitrogen monoxide	6.05E-04	kg	air/low population density
Nickel	3.53E-07	kg	air/low population density
Zinc	5.04E-06	kg	air/low population density
Benzo(a)pyrene	1.51E-07	kg	air/low population density
Ammonia	1.01E-04	kg	air/low population density
Selenium	5.04E-08	kg	air/low population density
PAH, Polycyclic aromatic hydrocarbons	1.66E-05	kg	air/low population density
Benz(a)-Anthracene	4.03E-07	kg	air/low population density
Benzo(b)-Fluoranthracene	2.52E-07	kg	air/low population density
Chrysene	1.01E-06	kg	air/low population density
Dibenz(a,h)-Anthracene	5.04E-08	kg	air/low population density
Fluoranthene	2.27E-06	kg	air/low population density
Phenanthrene	1.26E-05	kg	air/low population density

Emission to soil	Amount	Unit	Location
Zinc	4.99E-04	kg	soil/agricultural
Lead	8.12E-05	kg	soil/agricultural
Cadmium	1.87E-05	kg	soil/agricultural

Table B.6 Calculations in Excel sheet for basic operations (level 2) as "Application of phytosanitary treatment, by field sprayer {FR} 60CV (1h ha)".

Description de l'opération agricole		Proxy: application of plant protection products, by fieldsprayer
Nom de l'opération	Application_by-field-sprayer_37CV_1h1ha	
Données d'entrée	Valeur	Unité
Durée de l'opération	1.00	h
Chevaux vapeur metric (CV)	60.00	CV
Puissance nominale	44.13	kW
Consommation de carburant	7.2	l/h
Puissance moyenne du tracteur pendant l'opération	4.1	kW
Type de tracteur	Tracteur (-29 kW)	
Machine agricole (hors travail du sol)	Field sprayer	
Machine agricole de travail du sol	-	

Rapport 15 ecoinvent:
Tab. A.10, page 197/360

Résultats		
Infrastructure	Valeur	Unité
Tractor production	0.334714286	kg
Agricultural machinery, tillage, production	0.00	kg
Agricultural machinery, general, production	0.48	kg
Diesel, at regional storage	6.05	kg
Shed for tractor	4.40E-04	m ²
Shed for machinery tillage	1.63E-03	m ²
Shed for machinery general	0.00E+00	m ²
Soil emission from tractor tyre abrasion	Valeur	Unité
Zn	4.24E-01	g/(ha.a)
Pb	6.89E-02	g/(ha.a)
Cd	1.59E-02	g/(ha.a)
Soil emission from machinery tyre abrasion	Valeur	Unité
Zn	4.70E-02	g/(ha.a)
Pb	7.64E-03	g/(ha.a)
Cd	1.76E-03	g/(ha.a)

Paramètres		(Ils sont récupérés de la boîte violette "Base de données")
Paramètres tracteur		
Poids	2343	kg
Durée de vie	7000	h
Puissance nominale	44.12988	kW
Espace de stockage	11	m ²
Utilisation annuelle	500	h/an
Part des pneus dans le tracteur	0.0975	kg pneus/kg tracteur
Paramètres pneus tracteur		
Durée de vie	2500	h
Part de caoutchouc perdu sur la durée de vie	0.29	kg caoutchouc/kg pneus
Teneur en zinc	16	g/kg de pneus
Teneur en plomb	2.6	g/kg de pneus
Teneur en cadmium	0.6	g/kg de pneus
Paramètres outils agricoles (hors travail du sol)		
Poids	477	kg
Espace de stockage	6.1	m ²
Utilisation annuelle	75	h/an
Durée de vie	1000	h
Part des pneus dans la machine	0.0275	kg pneus/kg machine
Paramètres pneus outils agricoles		
Durée de vie	2500	h
Part de caoutchouc perdu sur la durée de vie	0.56	kg caoutchouc/kg pneus
Teneur en zinc	16	g/kg de pneus
Teneur en plomb	2.6	g/kg de pneus
Teneur en cadmium	0.6	g/kg de pneus
Paramètres hangar de stockage		
Durée de vie hangar	50	ans

hyp > donnée de fiche

Fiche SimaPro opération agricole

Output	Amount	Unit
Application_by-field-sprayer_37CV_1h1ha	1	ha

Inputs	Amount	Unit
Tractor, 4-wheel, agricultural {GLO} market for	0.3347	kg
Agricultural machinery, tillage {GLO} market for	0.00E+00	kg
Agricultural machinery, unspecified {GLO} market for	0.4770	kg
Diesel, at regional storageDiesel {Europe without Switzerland} market fo	6.0480	kg
Shed {GLO} market for	0.00207	m ²

Emissions to air	Amount	Unit	Location
NM VOC, non-methane volatile organic compounds, unspecified origin	1.00E-02	kg	air/low population density
Nitrogen oxides	1.13E-01	kg	air/low population density
Carbon monoxide, fossil	1.40E-02	kg	air/low population density
Carbon dioxide, fossil	1.88E+01	kg	air/low population density
Sulfur dioxide	6.11E-03	kg	air/low population density
Methane, fossil	7.80E-04	kg	air/low population density
Benzene	4.42E-05	kg	air/low population density
Particulates, < 2,5 um	6.87E-03	kg	air/low population density
Cadmium	6.05E-08	kg	air/low population density
Chromium	3.02E-07	kg	air/low population density
Copper	1.03E-05	kg	air/low population density
Dinitrogen monoxide	7.26E-04	kg	air/low population density
Nickel	4.23E-07	kg	air/low population density
Zinc	6.05E-06	kg	air/low population density
Benzo(a)pyrene	1.81E-07	kg	air/low population density
Ammonia	1.21E-04	kg	air/low population density
Selenium	6.05E-08	kg	air/low population density
PAH, Polycyclic aromatic hydrocarbons	1.99E-05	kg	air/low population density
Benz(a)-Anthracene	4.84E-07	kg	air/low population density
Benzo(b)-Fluoranthracene	3.02E-07	kg	air/low population density
Chrysene	1.21E-06	kg	air/low population density
Dibenz(a,h)-Anthracene	6.05E-08	kg	air/low population density
Fluoranthene	2.72E-06	kg	air/low population density
Phenanthrene	1.51E-05	kg	air/low population density

Emission to soil	Amount	Unit	Location
Zinc	4.71E-04	kg	soil/agricultural
Lead	7.65E-05	kg	soil/agricultural
Cadmium	1.77E-05	kg	soil/agricultural

Table B.7 Calculations in Excel sheet for basic operations (level 2) as "Application of phytosanitary treatment, by field sprayer {FR} 75CV (1h ha)".

Description de l'opération agricole		Proxy: application of plant protection products, by fieldsprayer
Nom de l'opération	Application_by-field-sprayer_75CV_1h1ha	
Données d'entrée	Valeur	Unité
Durée de l'opération	1.00	h
Chevaux vapeur metric (CV)	75.00	CV
Puissance nominale	55.16	kW
Consommation de carburant	9	l/h
Puissance moyenne du tracteur pendant l'opération	4.1	kW
Type de tracteur	Tracteur (30-64 kW)	
Machine agricole (hors travail du sol)	Field sprayer	
Machine agricole de travail du sol	-	

Rapport 15 ecoinvent:
Tab. A.10, page 197/360

Résultats		
Infrastructure	Valeur	Unité
Tractor production	0.520833333	kg
Agricultural machinery, tillage, production	0.00	kg
Agricultural machinery, general, production	0.48	kg
Diesel, at regional storage	7.56	kg
Shed for tractor	5.07E-04	m ²
Shed for machinery tillage	1.63E-03	m ²
Shed for machinery general	0.00E+00	m ²
Soil emission from tractor tyre abrasion	Valeur	Unité
Zn	6.79E-01	g/(ha.a)
Pb	1.10E-01	g/(ha.a)
Cd	2.54E-02	g/(ha.a)
Soil emission from machinery tyre abrasion	Valeur	Unité
Zn	4.70E-02	g/(ha.a)
Pb	7.64E-03	g/(ha.a)
Cd	1.76E-03	g/(ha.a)

Paramètres		(Ils sont récupérés de la boîte violette "Base de données")
Paramètres tracteur		
Poids	3750	kg hyp > donnée de fiche
Durée de vie	7200	h
Puissance nominale	55.16235	kW
Espace de stockage	15.2	m ²
Utilisation annuelle	600	h/an
Part des pneus dans le tracteur	0.0975	kg pneus/kg tracteur
Paramètres pneus tracteur		
Durée de vie	2500	h
Part de caoutchouc perdu sur la durée de vie	0.29	kg caoutchouc/kg pneus
Teneur en zinc	16	g/kg de pneus
Teneur en plomb	2.6	g/kg de pneus
Teneur en cadmium	0.6	g/kg de pneus
Paramètres outils agricoles (hors travail du sol)		
Poids	477	kg
Espace de stockage	6.1	m ²
Utilisation annuelle	75	h/an
Durée de vie	1000	h
Part des pneus dans la machine	0.0275	kg pneus/kg machine
Paramètres pneus outils agricoles		
Durée de vie	2500	h
Part de caoutchouc perdu sur la durée de vie	0.56	kg caoutchouc/kg pneus
Teneur en zinc	16	g/kg de pneus
Teneur en plomb	2.6	g/kg de pneus
Teneur en cadmium	0.6	g/kg de pneus
Paramètres hangar de stockage		
Durée de vie hangar	50	ans

Fiche SimaPro opération agricole

Output	Amount	Unit
Application_by-field-sprayer_75CV_1h1ha	1	ha

Inputs	Amount	Unit	
Tractor, 4-wheel, agricultural {GLO} market for	0.5208	kg	Dans les cellules colorées, c'est les données qui changent entre la fiche de Simapro de fertilising et application of phytosanitary treatment
Agricultural machinery, tillage {GLO} market for	0.00E+00	kg	
Agricultural machinery, unspecified {GLO} market for	0.4770	kg	
Diesel, at regional storageDiesel {Europe without Switzerland} market fo	7.5600	kg	
Shed {GLO} market for	0.00213	m²	

Emissions to air	Amount	Unit	Location
NM VOC, non-methane volatile organic compounds, unspecified origin	1.00E-02	kg	air/low population density
Nitrogen oxides	1.13E-01	kg	air/low population density
Carbon monoxide, fossil	1.40E-02	kg	air/low population density
Carbon dioxide, fossil	2.36E+01	kg	air/low population density
Sulfur dioxide	7.64E-03	kg	air/low population density
Methane, fossil	9.75E-04	kg	air/low population density
Benzene	5.52E-05	kg	air/low population density
Particulates, < 2,5 um	6.46E-03	kg	air/low population density
Cadmium	7.56E-08	kg	air/low population density
Chromium	3.78E-07	kg	air/low population density
Copper	1.29E-05	kg	air/low population density
Dinitrogen monoxide	9.07E-04	kg	air/low population density
Nickel	5.29E-07	kg	air/low population density
Zinc	7.56E-06	kg	air/low population density
Benzo(a)pyrene	2.27E-07	kg	air/low population density
Ammonia	1.51E-04	kg	air/low population density
Selenium	7.56E-08	kg	air/low population density
PAH, Polycyclic aromatic hydrocarbons	2.49E-05	kg	air/low population density
Benz(a)-Anthracene	6.05E-07	kg	air/low population density
Benzo(b)-Fluoranthracene	3.78E-07	kg	air/low population density
Chrysene	1.51E-06	kg	air/low population density
Dibenz(a,h)-Anthracene	7.56E-08	kg	air/low population density
Fluoranthene	3.40E-06	kg	air/low population density
Phenanthrene	1.89E-05	kg	air/low population density

Emission to soil	Amount	Unit	Location
Zinc	7.26E-04	kg	soil/agricultural
Lead	1.18E-04	kg	soil/agricultural
Cadmium	2.72E-05	kg	soil/agricultural

Table B.8 Calculations in Excel sheet for basic operations (level 2) as "Application of phytosanitary treatment, by field sprayer {FR} 80CV (1h ha)".

Description de l'opération agricole		Proxy: application of plant protection products, by fieldsprayer
Nom de l'opération	Application_by-field-sprayer_80CV_1h1ha	
Données d'entrée	Valeur	Unité
Durée de l'opération	1.00	h
Chevaux vapeur metric (CV)	80.00	CV
Puissance nominale	58.84	kW
Consommation de carburant	9.6	l/h
Puissance moyenne du tracteur pendant l'opération	4.1	kW
Type de tracteur	Tracteur (30-64 kW)	
Machine agricole (hors travail du sol)	Field sprayer	
Machine agricole de travail du sol	-	

Rapport 15 ecoinvent:
Tab. A.10, page 197/360

Résultats		
Infrastructure	Valeur	Unité
Tractor production	0.555555556	kg
Agricultural machinery, tillage, production	0.00	kg
Agricultural machinery, general, production	0.48	kg
Diesel, at regional storage	8.06	kg
Shed for tractor	5.07E-04	m ²
Shed for machinery tillage	1.63E-03	m ²
Shed for machinery general	0.00E+00	m ²
Soil emission from tractor tyre abrasion	Valeur	Unité
Zn	7.24E-01	g/(ha.a)
Pb	1.18E-01	g/(ha.a)
Cd	2.71E-02	g/(ha.a)
Soil emission from machinery tyre abrasion	Valeur	Unité
Zn	4.70E-02	g/(ha.a)
Pb	7.64E-03	g/(ha.a)
Cd	1.76E-03	g/(ha.a)

Paramètres		(Ils sont récupérés de la boîte violette "Base de données")
Paramètres tracteur		
Poids	4000	kg
Durée de vie	7200	h
Puissance nominale	58.83984	kW
Espace de stockage	15.2	m ²
Utilisation annuelle	600	h/an
Part des pneus dans le tracteur	0.0975	kg pneus/kg tracteur
Paramètres pneus tracteur		
Durée de vie	2500	h
Part de caoutchouc perdu sur la durée de vie	0.29	kg caoutchouc/kg pneus
Teneur en zinc	16	g/kg de pneus
Teneur en plomb	2.6	g/kg de pneus
Teneur en cadmium	0.6	g/kg de pneus
Paramètres outils agricoles (hors travail du sol)		
Poids	477	kg
Espace de stockage	6.1	m ²
Utilisation annuelle	75	h/an
Durée de vie	1000	h
Part des pneus dans la machine	0.0275	kg pneus/kg machine
Paramètres pneus outils agricoles		
Durée de vie	2500	h
Part de caoutchouc perdu sur la durée de vie	0.56	kg caoutchouc/kg pneus
Teneur en zinc	16	g/kg de pneus
Teneur en plomb	2.6	g/kg de pneus
Teneur en cadmium	0.6	g/kg de pneus
Paramètres hangar de stockage		
Durée de vie hangar	50	ans

hyp > donnée de fiche

Fiche SimaPro opération agricole

Output	Amount	Unit
Application_by-field-sprayer_80CV_1h1ha	1	ha

Inputs	Amount	Unit
Tractor, 4-wheel, agricultural {GLO} market for	0.5556	kg
Agricultural machinery, tillage {GLO} market for	0.00E+00	kg
Agricultural machinery, unspecified {GLO} market for	0.4770	kg
Diesel, at regional storageDiesel {Europe without Switzerland} market fo	8.0640	kg
Shed {GLO} market for	0.00213	m ²

Dans les cellules colorées, c'est les données qui changent entre la fiche de Simapro de fertilising et application of phytosanitary treatment

Emissions to air	Amount	Unit	Location
NMVOOC, non-methane volatile organic compounds, unspecified origin	1.00E-02	kg	air/low population density
Nitrogen oxides	1.13E-01	kg	air/low population density
Carbon monoxide, fossil	1.40E-02	kg	air/low population density
Carbon dioxide, fossil	2.51E+01	kg	air/low population density
Sulfur dioxide	8.14E-03	kg	air/low population density
Methane, fossil	1.04E-03	kg	air/low population density
Benzene	5.89E-05	kg	air/low population density
Particulates, < 2,5 um	6.33E-03	kg	air/low population density
Cadmium	8.06E-08	kg	air/low population density
Chromium	4.03E-07	kg	air/low population density
Copper	1.37E-05	kg	air/low population density
Dinitrogen monoxide	9.68E-04	kg	air/low population density
Nickel	5.64E-07	kg	air/low population density
Zinc	8.06E-06	kg	air/low population density
Benzo(a)pyrene	2.42E-07	kg	air/low population density
Ammonia	1.61E-04	kg	air/low population density
Selenium	8.06E-08	kg	air/low population density
PAH, Polycyclic aromatic hydrocarbons	2.65E-05	kg	air/low population density
Benz(a)-Anthracene	6.45E-07	kg	air/low population density
Benzo(b)-Fluoranthracene	4.03E-07	kg	air/low population density
Chrysene	1.61E-06	kg	air/low population density
Dibenz(a,h)-Anthracene	8.06E-08	kg	air/low population density
Fluoranthene	3.63E-06	kg	air/low population density
Phenanthrene	2.02E-05	kg	air/low population density

Emission to soil	Amount	Unit	Location
Zinc	7.71E-04	kg	soil/agricultural
Lead	1.25E-04	kg	soil/agricultural
Cadmium	2.89E-05	kg	soil/agricultural

Table B.9 Calculations in Excel sheet for basic operations (level 2) as "Application of plant protection product, by spray wheelbarrow".

Description de l'opération agricole		Proxy: application of plant protection products, by field sprayer ROW Processing	
Nom de l'opération	Application_by-spray-wheelbarrow_1h1ha		
Données d'entrée	Valeur	Unité	
Durée de l'opération	1.00	h	
Chevaux vapeur metric (CV)	0.00	CV	
Puissance nominale	0.00	kW	
Consommation de carburant	0	l/h	
Puissance moyenne du tracteur pendant l'opération	0	kW	
Type de tracteur			
Machine agricole (hors travail du sol)	Spray wheelbarrow		
Machine agricole de travail du sol	-		

Rapport 15 ecoinvent:
Tab. A.10, page 197/360

Résultats		
Infrastructure	Valeur	Unité
Tractor production	#N/A	kg
Agricultural machinery, tillage, production	0.00	kg
Agricultural machinery, general, production	0.09	kg
Diesel, at regional storage	0.00	kg
Shed for tractor		m ²
Shed for machinery general	9.50E-04	m ²
Shed for machinery tillage	0.00E+00	m ²
Soil emission from tractor tyre abrasion	Valeur	Unité
Zn	0.00E+00	g/(ha.a)
Pb	0.00E+00	g/(ha.a)
Cd	0.00E+00	g/(ha.a)
Soil emission from machinery tyre abrasion	Valeur	Unité
Zn	8.38E-03	g/(ha.a)
Pb	1.36E-03	g/(ha.a)
Cd	3.14E-04	g/(ha.a)

Paramètres		(Ils sont récupérés de la boîte violette "Base de données")	
Paramètres tracteur			
Poids	0	kg	hyp > donnée de fiche
Durée de vie	#N/A	h	
Puissance nominale	0	kW	
Espace de stockage	#N/A	m ²	
Utilisation annuelle	#N/A	h/an	
Part des pneus dans le tracteur	0.0975	kg pneus/kg tracteur	
Paramètres pneus tracteur			
Durée de vie		h	
Part de caoutchouc perdu sur la durée de vie		kg caoutchouc/kg pneus	
Teneur en zinc		g/kg de pneus	
Teneur en plomb		g/kg de pneus	
Teneur en cadmium		g/kg de pneus	
Paramètres outils agricoles (hors travail du sol)			
Poids	85	kg	
Espace de stockage	3.8	m ²	
Utilisation annuelle	80	h/an	
Durée de vie	1000	h	
Part des pneus dans la machine	0.0275	kg pneus/kg machine	
Paramètres pneus outils agricoles			
Durée de vie	2500	h	
Part de caoutchouc perdu sur la durée de vie	0.56	kg caoutchouc/kg pneus	
Teneur en zinc	16	g/kg de pneus	
Teneur en plomb	2.6	g/kg de pneus	
Teneur en cadmium	0.6	g/kg de pneus	
Paramètres hangar de stockage			
Durée de vie hangar	50	ans	

Base de données			
Tracteur	Tracteur (-29 kW)	Tracteur (30-64 kW)	Tracteur (65-94 kW)
Poids	1900	3300	5300
Durée de vie	6000	7200	7200
Puissance nominale	27.95	50	78
Espace de stockage	11.0	15.2	19.4
Utilisation annuelle	500	600	600

Données de rapport
15 - Tab. A. 10,
page 197/360

Machine agricole de travail du sol	-	Plough, 4 furrow	Spring tooth harrow	Rotary harrow	Roller, 2.5-3 m	Field cultivator
Poids		1039	538	1183	910	902
Espace de stockage		13.3	12.2	7	6.1	6.8
Utilisation annuelle		73	28	32	21	31
Durée de vie		480	540	360	500	480

Machine agricole (hors travail du sol)	-	Seeder	Hoe	Fertiliser spreader	Field sprayer	Rotary mower	Spray wheelbarrow
Poids		507	559	193	477	643	85
Espace de stockage		8.4	12.2	3.8	6.1	6.1	3.8
Utilisation annuelle		35	29	80	75	28	80
Durée de vie		525	525	1000	1000	600	1000

SPREADER= fertilis SPRAYER= fertiliser, herbicides
Spray wheelbarrow proxy de fertiliser spreader

Fiche SimaPro opération agricole

Output	Amount	Unit
Application_by-spray-wheelbarrow_1h1ha		1 ha

Inputs	Amount	Unit
Tractor, 4-wheel, agricultural {GLO} market for	#N/A	kg
Agricultural machinery, tillage {GLO} market for	0.00E+00	kg
Agricultural machinery, unspecified {GLO} market for	0.0850	kg
Diesel, at regional storageDiesel {Europe without Switzerland} market fo	0.0000	kg
Shed {GLO} market for	0.00095	m ²

Emissions to air	Amount	Unit	Location
NM VOC, non-methane volatile organic compounds, unspecified origin	0.00E+00	kg	air/low population density
Nitrogen oxides	0.00E+00	kg	air/low population density
Carbon monoxide, fossil	0.00E+00	kg	air/low population density
Carbon dioxide, fossil	0.00E+00	kg	air/low population density
Sulfur dioxide	0.00E+00	kg	air/low population density
Methane, fossil	0.00E+00	kg	air/low population density
Benzene	0.00E+00	kg	air/low population density
Particulates, < 2,5 um	0.00E+00	kg	air/low population density
Cadmium	0.00E+00	kg	air/low population density
Chromium	0.00E+00	kg	air/low population density
Copper	0.00E+00	kg	air/low population density
Dinitrogen monoxide	0.00E+00	kg	air/low population density
Nickel	0.00E+00	kg	air/low population density
Zinc	0.00E+00	kg	air/low population density
Benzo(a)pyrene	0.00E+00	kg	air/low population density
Ammonia	0.00E+00	kg	air/low population density
Selenium	0.00E+00	kg	air/low population density
PAH, Polycyclic aromatic hydrocarbons	0.00E+00	kg	air/low population density
Benz(a)-Anthracene	0.00E+00	kg	air/low population density
Benzo(b)-Fluoranthracene	0.00E+00	kg	air/low population density
Chrysene	0.00E+00	kg	air/low population density
Dibenz(a,h)-Anthracene	0.00E+00	kg	air/low population density
Fluoranthene	0.00E+00	kg	air/low population density
Phenanthrene	0.00E+00	kg	air/low population density

Emission to soil	Amount	Unit	Location
Zinc	8.38E-06	kg	soil/agricultural
Lead	1.36E-06	kg	soil/agricultural
Cadmium	3.14E-07	kg	soil/agricultural

Table B.10 Calculations in Excel sheet for basic operations (level 2) as “ Fertilising, by broadcaster {FR} 11CV (1h 1ha)”.

Description de l'opération agricole		
Nom de l'opération	Fertilising_by-broadcaster_11CV_1h1ha	
Données d'entrée	Valeur	Unité
Durée de l'opération	1.00	h
Chevaux vapeur métric (CV)	11.00	CV
Puissance nominale	8.09	KW
Consommation de carburant	1.32	l/h
Puissance moyenne du tracteur pendant l'opération	8	KW
Type de tracteur	Tracteur (-29 kW)	
Machine agricole (hors travail du sol)	Fertiliser spreader	
Machine agricole de travail du sol	-	

Rapport 15 ecoinvent.
Tab. A.10, page 197/360

Résultats		
Infrastructure	Valeur	Unité
Tractor production	0.091666667	kg
Agricultural machinery, tillage, production	0.00	kg
Agricultural machinery, general, production	0.19	kg
Diesel, at regional storage	1.11	kg
Shed for tractor	4.40E-04	m ²
Shed for machinery tillage	9.50E-04	m ²
Shed for machinery general	0.00E+00	m ²
Soil emission from tractor tyre abrasion	Valeur	Unité
Zn	9.95E-02	g/(ha.a)
Pb	1.62E-02	g/(ha.a)
Cd	3.73E-03	g/(ha.a)
Soil emission from machinery tyre abrasion	Valeur	Unité
Zn	1.90E-02	g/(ha.a)
Pb	3.09E-03	g/(ha.a)
Cd	7.13E-04	g/(ha.a)

Paramètres		(Ils sont récupérés de la boîte violette "Base de données")
Paramètres tracteur		
Poids	550	kg
Durée de vie	6000	h
Puissance nominale	8.090478	kW
Espace de stockage	11	m ²
Utilisation annuelle	500	h/an
Part des pneus dans le tracteur	0.0975	kg pneus/kg tracteur
Paramètres pneus tracteur		
Durée de vie	2500	h
Part de caoutchouc perdu sur la durée de vie	0.29	kg caoutchouc/kg pneus
Teneur en zinc	16	g/kg de pneus
Teneur en plomb	2.6	g/kg de pneus
Teneur en cadmium	0.6	g/kg de pneus
Paramètres outils agricoles (hors travail du sol)		
Poids	193	kg
Espace de stockage	3.8	m ²
Utilisation annuelle	80	h/an
Durée de vie	1000	h
Part des pneus dans la machine	0.0275	kg pneus/kg machine
Paramètres pneus outils agricoles		
Durée de vie	2500	h
Part de caoutchouc perdu sur la durée de vie	0.56	kg caoutchouc/kg pneus
Teneur en zinc	16	g/kg de pneus
Teneur en plomb	2.6	g/kg de pneus
Teneur en cadmium	0.6	g/kg de pneus
Paramètres hangar de stockage		
Durée de vie hangar	50	ans
Paramètres outils de travail du sol		
Poids	0	kg
Espace de stockage	0	m ²
Utilisation annuelle	0	h/an
Durée de vie	0	h

Base de données			
Tracteur	Tracteur (-29 kW)	Tracteur (30-64 kW)	Tracteur (65-94 kW)
Poids	1900	3300	5300
Durée de vie	6000	7200	7200
Puissance nominale	27.95	50	78
Espace de stockage	11.0	15.2	19.4
Utilisation annuelle	500	600	600
Machine agricole de travail du sol	-	Plough, 4 furrow	Spring tooth harrow
Poids		1039	538
Espace de stockage		13.3	12.2
Utilisation annuelle		73	28
Durée de vie		480	540
			Rotary harrow
			1183
			7
			32
			360
			Roller, 2.5-3 m
			910
			6.1
			21
			500
			Field cultivator
			902
			6.8
			31
			480
Machine agricole (hors travail du sol)	-	Seeder	Hoe
Poids		507	559
Espace de stockage		8.4	12.2
Utilisation annuelle		35	29
Durée de vie		525	525
			Fertiliser spreader
			193
			3.8
			80
			1000
			Rotary mower
			643
			6.1
			28
			600

Données de rapport 15 : weight
page 59/360, Tab. A. 10 , page
197/360

Emissions de combustion			
Molécule	Facteur d'émission (g/kg diesel)	Facteur d'émission (g/h tracteur)*	Emission to air (g/(ha.a))
HC		10	1.00E+01
NOx		154	1.54E+02
CO		14	1.40E+01
CO2	3.12E+03		3.44E+03
SO2	1.01E+00		1.12E+00
CH4	1.29E-01		1.43E-01
C6H6	7.30E-03		8.09E-03
PM2.5	2.79E+00		1.90E+01
Cd	1.00E-05		1.11E-05
Cr	5.00E-05		5.54E-05
Cu	1.70E-03		1.88E-03
N2O	1.20E-01		1.33E-01
Ni	7.00E-05		7.76E-05
Zn	1.00E-03		1.11E-03
Benzo(a)pyrene	3.00E-05		3.33E-05
NH3	2.00E-02		2.22E-02
Se	1.00E-05		1.11E-05
PAH	3.29E-03		3.65E-03
Benz(a)-Anthracene	8.00E-05		8.87E-05
Benzo(b)-Fluoranthracene	5.00E-05		5.54E-05
Chrysene	2.00E-04		2.22E-04
Dibenzo(a,h)-Anthracene	1.00E-05		1.11E-05
Fluoranthene	4.50E-04		4.99E-04
Phenanthene	2.50E-03		2.77E-03

Rapport 15: Tab. A.10 , page
197/360 FERTILISING BY
BROADCASTER

* Emissions variables en fonction des conditions de vitesse et de puissance effective du tracteur pendant l'opération

Fiche SimaPro opération agricole

Output	Amount	Unit
Fertilising_by-broadcaster_11CV_1h1ha		1 ha

Inputs	Amount	Unit
Tractor, 4-wheel, agricultural {GLO} market for	0.0917	kg
Agricultural machinery, tillage {GLO} market for	0.00E+00	kg
Agricultural machinery, unspecified {GLO} market for	0.1930	kg
Diesel, at regional storageDiesel {Europe without Switzerland} market fo	1.1088	kg
Shed {GLO} market for	0.00139	m ²

Emissions to air	Amount	Unit	Location
NMVOC, non-methane volatile organic compounds, unspecified origin	1.00E-02	kg	air/low population density
Nitrogen oxides	1.54E-01	kg	air/low population density
Carbon monoxide, fossil	1.40E-02	kg	air/low population density
Carbon dioxide, fossil	3.44E+00	kg	air/low population density
Sulfur dioxide	1.12E-03	kg	air/low population density
Methane, fossil	1.43E-04	kg	air/low population density
Benzene	8.09E-06	kg	air/low population density
Particulates, < 2,5 um	1.90E-02	kg	air/low population density
Cadmium	1.11E-08	kg	air/low population density
Chromium	5.54E-08	kg	air/low population density
Copper	1.88E-06	kg	air/low population density
Dinitrogen monoxide	1.33E-04	kg	air/low population density
Nickel	7.76E-08	kg	air/low population density
Zinc	1.11E-06	kg	air/low population density
Benzo(a)pyrene	3.33E-08	kg	air/low population density
Ammonia	2.22E-05	kg	air/low population density
Selenium	1.11E-08	kg	air/low population density
PAH, Polycyclic aromatic hydrocarbons	3.65E-06	kg	air/low population density
Benz(a)-Anthracene	8.87E-08	kg	air/low population density
Benzo(b)-Fluoranthracene	5.54E-08	kg	air/low population density
Chrysene	2.22E-07	kg	air/low population density
Dibenz(a,h)-Anthracene	1.11E-08	kg	air/low population density
Fluoranthene	4.99E-07	kg	air/low population density
Phenanthene	2.77E-06	kg	air/low population density

Emission to soil	Amount	Unit	Location
Zinc	1.19E-04	kg	soil/agricultural
Lead	1.93E-05	kg	soil/agricultural
Cadmium	4.45E-06	kg	soil/agricultural

Table B.11 Calculations in Excel sheet for basic operations (level 2) as "Fertilising, by broadcaster {FR} 37CV (1h 1ha)".

Description de l'opération agricole		
Nom de l'opération	Fertilising by-broadcaster 37CV 1h1ha	
Données d'entrée	Valeur	Unité
Durée de l'opération	1.00	h
Chevaux vapeur metric (CV)	37.00	CV
Puissance nominale	27.21	kW
Consommation de carburant	4.44	l/h
Puissance moyenne du tracteur pendant l'opération	8.6	kW
Type de tracteur	Tracteur (-29 kW)	
Machine agricole (hors travail du sol)	Fertiliser spreader	
Machine agricole de travail du sol	-	

Rapport 15 ecoinvent
Tab. A.10, page 197/30

Résultats		
Infrastructure	Valeur	Unité
Tractor production	0.308333333	kg
Agricultural machinery, tillage, production	0.00	kg
Agricultural machinery, general, production	0.19	kg
Diesel, at regional storage	3.73	kg
Shed for tractor	4.40E-04	m²
Shed for machinery tillage	9.50E-04	m²
Shed for machinery general	0.00E+00	m²
Soil emission from tractor tyre abrasion	Valeur	Unité
Zn	3.35E-01	g/(ha.a)
Pb	5.44E-02	g/(ha.a)
Cd	1.26E-02	g/(ha.a)
Soil emission from machinery tyre abrasion	Valeur	Unité
Zn	1.90E-02	g/(ha.a)
Pb	3.09E-03	g/(ha.a)
Cd	7.13E-04	g/(ha.a)

Paramètres			(Ils sont récupérés de la boîte violette "Base de données")
Paramètres tracteur			
Poids	1850	kg	hyp > donnée d'Ecoinvent
Durée de vie	6000	h	
Puissance nominale	27.213426	kW	hyp > donnée d'Ecoinvent
Espace de stockage	11	m²	
Utilisation annuelle	500	h/an	
Part des pneus dans le tracteur	0.0975	kg pneus/kg tracteur	
Paramètres pneus tracteur			
Durée de vie	2500	h	
Part de caoutchouc perdu sur la durée de vie	0.29	kg caoutchouc/kg pneus	
Teneur en zinc	16	g/kg de pneus	
Teneur en plomb	2.6	g/kg de pneus	
Teneur en cadmium	0.6	g/kg de pneus	
Paramètres outils agricoles (hors travail du sol)			
Poids	193	kg	
Espace de stockage	3.8	m²	
Utilisation annuelle	80	h/an	
Durée de vie	1000	h	
Part des pneus dans la machine	0.0275	kg pneus/kg machine	
Paramètres pneus outils agricoles			
Durée de vie	2500	h	
Part de caoutchouc perdu sur la durée de vie	0.56	kg caoutchouc/kg pneus	
Teneur en zinc	16	g/kg de pneus	
Teneur en plomb	2.6	g/kg de pneus	
Teneur en cadmium	0.6	g/kg de pneus	
Paramètres hangar de stockage			
Durée de vie hangar	50	ans	
Paramètres outils de travail du sol			
Poids	0	kg	
Espace de stockage	0	m²	
Utilisation annuelle	0	h/an	
Durée de vie	0	h	

Base de données			
Tracteur	Tracteur (-29 kW)	Tracteur (30-64 kW)	Tracteur (65-94 kW)
Poids	1900	3300	5300
Durée de vie	6000	7200	7200
Puissance nominale	27.95	50	78
Espace de stockage	11.0	15.2	19.4
Utilisation annuelle	500	600	600

Données de rapport 15 : weight
page 59/360, Tab. A. 10 , page
197/360

Machine agricole de travail du sol	-	Plough, 4 furrow	Spring tooth harrow	Rotary harrow	Roller, 2.5-3 m	Field cultivator
Poids	-	1039	538	1183	910	902
Espace de stockage	-	13.3	12.2	7	6.1	6.8
Utilisation annuelle	-	73	28	32	21	31
Durée de vie	-	480	540	360	500	480

Machine agricole (hors travail du sol)	-	Seeder	Hoe	Fertiliser spreader	Rotary mower
Poids	-	507	559	193	643
Espace de stockage	-	8.4	12.2	3.8	6.1
Utilisation annuelle	-	35	29	80	28
Durée de vie	-	525	525	1000	600

Fiche SimaPro opération agricole

Output	Amount	Unit
Fertilising_by-broadcaster_37CV_1h1ha	1	ha

Inputs	Amount	Unit
Tractor, 4-wheel, agricultural {GLO} market for	0.3083	kg
Agricultural machinery, tillage {GLO} market for	0.00E+00	kg
Agricultural machinery, unspecified {GLO} market for	0.1930	kg
Diesel, at regional storageDiesel {Europe without Switzerland} market fo	3.7296	kg
Shed {GLO} market for	0.00139	m ²

Emissions to air	Amount	Unit	Location
NM VOC, non-methane volatile organic compounds, unspecified origin	1.00E-02	kg	air/low population density
Nitrogen oxides	1.54E-01	kg	air/low population density
Carbon monoxide, fossil	1.40E-02	kg	air/low population density
Carbon dioxide, fossil	1.16E+01	kg	air/low population density
Sulfur dioxide	3.77E-03	kg	air/low population density
Methane, fossil	4.81E-04	kg	air/low population density
Benzene	2.72E-05	kg	air/low population density
Particulates, < 2,5 um	1.63E-02	kg	air/low population density
Cadmium	3.73E-08	kg	air/low population density
Chromium	1.86E-07	kg	air/low population density
Copper	6.34E-06	kg	air/low population density
Dinitrogen monoxide	4.48E-04	kg	air/low population density
Nickel	2.61E-07	kg	air/low population density
Zinc	3.73E-06	kg	air/low population density
Benzo(a)pyrene	1.12E-07	kg	air/low population density
Ammonia	7.46E-05	kg	air/low population density
Selenium	3.73E-08	kg	air/low population density
PAH, Polycyclic aromatic hydrocarbons	1.23E-05	kg	air/low population density
Benz(a)-Anthracene	2.98E-07	kg	air/low population density
Benzo(b)-Fluoranthracene	1.86E-07	kg	air/low population density
Chrysene	7.46E-07	kg	air/low population density
Dibenz(a,h)-Anthracene	3.73E-08	kg	air/low population density
Fluoranthene	1.68E-06	kg	air/low population density
Phenanthrene	9.32E-06	kg	air/low population density

Emission to soil	Amount	Unit	Location
Zinc	3.54E-04	kg	soil/agricultural
Lead	5.75E-05	kg	soil/agricultural
Cadmium	1.33E-05	kg	soil/agricultural

Table B.12 Calculations in Excel sheet for basic operations (level 2) as “Fertilising, by broadcaster {FR} 50CV (1h 1ha)”.

Description de l'opération agricole		
Nom de l'opération	Fertilising by-broadcaster 50CV 1h1ha	
Données d'entrée	Valeur	Unité
Durée de l'opération	1.00	h
Chevaux vapeur metric (CV)	50.00	CV
Puissance nominale	36.77	kW
Consommation de carburant	6	l/h
Puissance moyenne du tracteur pendant l'opération	8.6	kW
Type de tracteur	Tracteur (30-64 kW)	
Machine agricole (hors travail du sol)	Fertiliser spreader	
Machine agricole de travail du sol	-	

Rapport 15 ecoinvent: Tab. A.10, page 197/360

Résultats		
Infrastructure	Valeur	Unité
Tractor production	0.347222222	kg
Agricultural machinery, tillage, production	0.00	kg
Agricultural machinery, general, production	0.19	kg
Diesel, at regional storage	5.04	kg
Shed for tractor	5.07E-04	m²
Shed for machinery tillage	9.50E-04	m²
Shed for machinery general	0.00E+00	m²
Soil emission from tractor tyre abrasion	Valeur	Unité
Zn	4.52E-01	g/(ha.a)
Pb	7.35E-02	g/(ha.a)
Cd	1.70E-02	g/(ha.a)
Soil emission from machinery tyre abrasion	Valeur	Unité
Zn	1.90E-02	g/(ha.a)
Pb	3.09E-03	g/(ha.a)
Cd	7.13E-04	g/(ha.a)

Paramètres		(Ils sont récupérés de la boîte violette "Base de données")
Paramètres tracteur		
Poids	2500 kg	hyp > donnée d'Ecoinvent
Durée de vie	7200 h	
Puissance nominale	36.7749 kW	hyp > donnée d'Ecoinvent
Espace de stockage	15.2 m²	
Utilisation annuelle	600 h/an	
Part des pneus dans le tracteur	0.0975 kg pneus/kg tracteur	
Paramètres pneus tracteur		
Durée de vie	2500 h	
Part de caoutchouc perdu sur la durée de vie	0.29 kg caoutchouc/kg pneus	
Teneur en zinc	16 g/kg de pneus	
Teneur en plomb	2.6 g/kg de pneus	
Teneur en cadmium	0.6 g/kg de pneus	
Paramètres outils agricoles (hors travail du sol)		
Poids	193 kg	
Espace de stockage	3.8 m²	
Utilisation annuelle	80 h/an	
Durée de vie	1000 h	
Part des pneus dans la machine	0.0275 kg pneus/kg machine	
Paramètres pneus outils agricoles		
Durée de vie	2500 h	
Part de caoutchouc perdu sur la durée de vie	0.56 kg caoutchouc/kg pneus	
Teneur en zinc	16 g/kg de pneus	
Teneur en plomb	2.6 g/kg de pneus	
Teneur en cadmium	0.6 g/kg de pneus	
Paramètres hangar de stockage		
Durée de vie hangar	50 ans	
Paramètres outils de travail du sol		
Poids	0 kg	
Espace de stockage	0 m²	
Utilisation annuelle	0 h/an	
Durée de vie	0 h	

Base de données			
Tracteur	Tracteur (-29 kW)	Tracteur (30-64 kW)	Tracteur (65-94 kW)
Poids	1900	3300	5300
Durée de vie	6000	7200	7200
Puissance nominale	27.95	50	78
Espace de stockage	11.0	15.2	19.4
Utilisation annuelle	500	600	600
Machine agricole de travail du sol	-	Plough, 4 furrow	Spring tooth harrow
Poids		1039	538
Espace de stockage		13.3	12.2
Utilisation annuelle		73	28
Durée de vie		480	540
			Rotary harrow
			1183
			7
			32
			21
			500
			480
			Roller, 2,5-3 m
			910
			6.1
			6.1
			31
			480
Machine agricole (hors travail du sol)	-	Seeder	Hoe
Poids		507	559
Espace de stockage		8.4	12.2
Utilisation annuelle		35	29
Durée de vie		525	525
			Fertiliser spreader
			193
			3.8
			80
			28
			600
			Rotary mower
			643
			6.1
			28
			600

Données de rapport 15 : weight page 59/360, Tab. A. 10 , page 197/360

Fiche SimaPro opération agricole

Output	Amount	Unit
Fertilising_by-broadcaster_50CV_1h1ha		1 ha

Inputs	Amount	Unit
Tractor, 4-wheel, agricultural {GLO} market for	0.3472	kg
Agricultural machinery, tillage {GLO} market for	0.00E+00	kg
Agricultural machinery, unspecified {GLO} market for	0.1930	kg
Diesel, at regional storageDiesel {Europe without Switzerland} market fo	5.0400	kg
Shed {GLO} market for	0.00146	m ²

Emissions to air	Amount	Unit	Location
NM VOC, non-methane volatile organic compounds, unspecified origin	1.00E-02	kg	air/low population density
Nitrogen oxides	1.54E-01	kg	air/low population density
Carbon monoxide, fossil	1.40E-02	kg	air/low population density
Carbon dioxide, fossil	1.57E+01	kg	air/low population density
Sulfur dioxide	5.09E-03	kg	air/low population density
Methane, fossil	6.50E-04	kg	air/low population density
Benzene	3.68E-05	kg	air/low population density
Particulates, < 2,5 um	1.51E-02	kg	air/low population density
Cadmium	5.04E-08	kg	air/low population density
Chromium	2.52E-07	kg	air/low population density
Copper	8.57E-06	kg	air/low population density
Dinitrogen monoxide	6.05E-04	kg	air/low population density
Nickel	3.53E-07	kg	air/low population density
Zinc	5.04E-06	kg	air/low population density
Benzo(a)pyrene	1.51E-07	kg	air/low population density
Ammonia	1.01E-04	kg	air/low population density
Selenium	5.04E-08	kg	air/low population density
PAH, Polycyclic aromatic hydrocarbons	1.66E-05	kg	air/low population density
Benzo(a)-Anthracene	4.03E-07	kg	air/low population density
Benzo(b)-Fluoranthracene	2.52E-07	kg	air/low population density
Chrysene	1.01E-06	kg	air/low population density
Dibenz(a,h)-Anthracene	5.04E-08	kg	air/low population density
Fluoranthene	2.27E-06	kg	air/low population density
Phenanthrene	1.26E-05	kg	air/low population density

Emission to soil	Amount	Unit	Location
Zinc	4.71E-04	kg	soil/agricultural
Lead	7.66E-05	kg	soil/agricultural
Cadmium	1.77E-05	kg	soil/agricultural

Table B.13 Calculations in Excel sheet for basic operations (level 2) as “Fertilising, by broadcaster {FR} 60CV (1h 1ha)”.

Description de l'opération agricole		
Nom de l'opération	Fertilising by-broadcaster 60CV 1h1ha	
Données d'entrée	Valeur	Unité
Durée de l'opération	1.00	h
Chevaux vapeur metric (CV)	60.00	CV
Puissance nominale	44.13	kW
Consommation de carburant	7.2	l/h
Puissance moyenne du tracteur pendant l'opération	8.6	kW
Type de tracteur	Tracteur (30-64 kW)	
Machine agricole (hors travail du sol)	Fertiliser spreader	
Machine agricole de travail du sol	-	

Rapport 15 ecoinvent:
Tab. A.10, page 197/360

Résultats		
Infrastructure	Valeur	Unité
Tractor production	0.41666667	kg
Agricultural machinery, tillage, production	0.00	kg
Agricultural machinery, general, production	0.19	kg
Diesel, at regional storage	6.05	kg
Shed for tractor	5.07E-04	m²
Shed for machinery tillage	9.50E-04	m²
Shed for machinery general	0.00E+00	m²
Soil emission from tractor tyre abrasion	Valeur	Unité
Zn	5.43E-01	g/(ha.a)
Pb	8.82E-02	g/(ha.a)
Cd	2.04E-02	g/(ha.a)
Soil emission from machinery tyre abrasion	Valeur	Unité
Zn	1.90E-02	g/(ha.a)
Pb	3.09E-03	g/(ha.a)
Cd	7.13E-04	g/(ha.a)

Paramètres		
(Ils sont récupérés de la boîte violette "Base de données")		
Paramètres tracteur		
Poids	3000	kg
Durée de vie	7200	h
Puissance nominale	44.12988	kW
Espace de stockage	15.2	m²
Utilisation annuelle	600	h/an
Part des pneus dans le tracteur	0.0975	kg pneus/kg tracteur
Paramètres pneus tracteur		
Durée de vie	2500	h
Part de caoutchouc perdu sur la durée de vie	0.29	kg caoutchouc/kg pneus
Teneur en zinc	16	g/kg de pneus
Teneur en plomb	2.6	g/kg de pneus
Teneur en cadmium	0.6	g/kg de pneus
Paramètres outils agricoles (hors travail du sol)		
Poids	193	kg
Espace de stockage	3.8	m²
Utilisation annuelle	80	h/an
Durée de vie	1000	h
Part des pneus dans la machine	0.0275	kg pneus/kg machine
Paramètres pneus outils agricoles		
Durée de vie	2500	h
Part de caoutchouc perdu sur la durée de vie	0.56	kg caoutchouc/kg pneus
Teneur en zinc	16	g/kg de pneus
Teneur en plomb	2.6	g/kg de pneus
Teneur en cadmium	0.6	g/kg de pneus
Paramètres hangar de stockage		
Durée de vie hangar	50	ans
Paramètres outils de travail du sol		
Poids	0	kg
Espace de stockage	0	m²
Utilisation annuelle	0	h/an
Durée de vie	0	h

Base de données			
Tracteur	Tracteur (-29 kW)	Tracteur (30-64 kW)	Tracteur (65-94 kW)
Poids	1900	3300	5300
Durée de vie	6000	7200	7200
Puissance nominale	27.95	50	78
Espace de stockage	11.0	15.2	19.4
Utilisation annuelle	500	600	600
Machine agricole de travail du sol	-	Plough, 4 furrow	Spring tooth harrow
Poids		1039	538
Espace de stockage		13.3	12.2
Utilisation annuelle		73	28
Durée de vie		480	540
			Rotary harrow
			1183
			7
			32
			360
			910
			6.1
			21
			500
			902
			6.8
			31
			480
Machine agricole (hors travail du sol)	-	Seeder	Hoe
Poids		507	559
Espace de stockage		8.4	12.2
Utilisation annuelle		35	29
Durée de vie		525	525
			Fertiliser spreader
			193
			3.8
			80
			1000
			643
			6.1
			28
			600

Données de rapport 15 : weight
page 59/360, Tab. A. 10 , page
197/360

Fiche SimaPro opération agricole

Output	Amount	Unit
Fertilising_by-broadcaster_60CV_1h1ha	1	ha

Inputs	Amount	Unit
Tractor, 4-wheel, agricultural {GLO} market for	0.4167	kg
Agricultural machinery, tillage {GLO} market for	0.00E+00	kg
Agricultural machinery, unspecified {GLO} market for	0.1930	kg
Diesel, at regional storageDiesel {Europe without Switzerland} market fo	6.0480	kg
Shed {GLO} market for	0.00146	m ²

Emissions to air	Amount	Unit	Location
NM VOC, non-methane volatile organic compounds, unspecified origin	1.00E-02	kg	air/low population density
Nitrogen oxides	1.54E-01	kg	air/low population density
Carbon monoxide, fossil	1.40E-02	kg	air/low population density
Carbon dioxide, fossil	1.88E+01	kg	air/low population density
Sulfur dioxide	6.11E-03	kg	air/low population density
Methane, fossil	7.80E-04	kg	air/low population density
Benzene	4.42E-05	kg	air/low population density
Particulates, < 2.5 um	1.44E-02	kg	air/low population density
Cadmium	6.05E-08	kg	air/low population density
Chromium	3.02E-07	kg	air/low population density
Copper	1.03E-05	kg	air/low population density
Dinitrogen monoxide	7.26E-04	kg	air/low population density
Nickel	4.23E-07	kg	air/low population density
Zinc	6.05E-06	kg	air/low population density
Benzo(a)pyrene	1.81E-07	kg	air/low population density
Ammonia	1.21E-04	kg	air/low population density
Selenium	6.05E-08	kg	air/low population density
PAH, Polycyclic aromatic hydrocarbons	1.99E-05	kg	air/low population density
Benzo(a)-Anthracene	4.84E-07	kg	air/low population density
Benzo(b)-Fluoranthracene	3.02E-07	kg	air/low population density
Chrysene	1.21E-06	kg	air/low population density
Dibenz(a,h)-Anthracene	6.05E-08	kg	air/low population density
Fluoranthene	2.72E-06	kg	air/low population density
Phenanthrene	1.51E-05	kg	air/low population density

Emission to soil	Amount	Unit	Location
Zinc	5.62E-04	kg	soil/agricultural
Lead	9.13E-05	kg	soil/agricultural
Cadmium	2.11E-05	kg	soil/agricultural

Table B.14 Calculations in Excel sheet for basic operations (level 2) as "Fertilising, by broadcaster {FR}| 75CV (1h 1ha)".

Description de l'opération agricole			
Nom de l'opération		Fertilising_by-broadcaster_75CV_1h1ha	
Données d'entrée		Valeur	Unité
Durée de l'opération		1.00	h
Chevaux vapeur metric (CV)		75.00	CV
Puissance nominale		55.16	kW
Consommation de carburant		9	l/h
Puissance moyenne du tracteur pendant l'opération		8.6	kW
Type de tracteur		Tracteur (30-64 kW)	
Machine agricole (hors travail du sol)		Fertiliser spreader	
Machine agricole de travail du sol		-	

Rapport 15 ecoinvent:
Tab. A.10, page 197/36

Résultats		
Infrastructure		
Tractor production	0.520833333	kg
Agricultural machinery, tillage, production	0.00	kg
Agricultural machinery, general, production	0.19	kg
Diesel, at regional storage	7.56	kg
Shed for tractor	5.07E-04	m²
Shed for machinery tillage	9.50E-04	m²
Shed for machinery general	0.00E+00	m²
Soil emission from tractor tyre abrasion		
Zn	6.79E-01	g/(ha.a)
Pb	1.10E-01	g/(ha.a)
Cd	2.54E-02	g/(ha.a)
Soil emission from machinery tyre abrasion		
Zn	1.90E-02	g/(ha.a)
Pb	3.09E-03	g/(ha.a)
Cd	7.13E-04	g/(ha.a)

Paramètres		(ils sont récupérés de la boîte violette "Base de données")	
Paramètres tracteur			
Poids	3750	kg	hyp > donnée d'Ecoinvent
Durée de vie	7200	h	
Puissance nominale	55.16235	kW	hyp > donnée d'Ecoinvent
Espace de stockage	15.2	m²	
Utilisation annuelle	600	h/an	
Part des pneus dans le tracteur	0.0975	kg pneus/kg tracteur	
Paramètres pneus tracteur			
Durée de vie	2500	h	
Part de caoutchouc perdu sur la durée de vie	0.29	kg caoutchouc/kg pneus	
Teneur en zinc	16	g/kg de pneus	
Teneur en plomb	2.6	g/kg de pneus	
Teneur en cadmium	0.6	g/kg de pneus	
Paramètres outils agricoles (hors travail du sol)			
Poids	193	kg	
Espace de stockage	3.8	m²	
Utilisation annuelle	80	h/an	
Durée de vie	1000	h	
Part des pneus dans la machine	0.0275	kg pneus/kg machine	
Paramètres pneus outils agricoles			
Durée de vie	2500	h	
Part de caoutchouc perdu sur la durée de vie	0.56	kg caoutchouc/kg pneus	
Teneur en zinc	16	g/kg de pneus	
Teneur en plomb	2.6	g/kg de pneus	
Teneur en cadmium	0.6	g/kg de pneus	
Paramètres hangar de stockage			
Durée de vie hangar	50	ans	
Paramètres outils de travail du sol			
Poids	0	kg	
Espace de stockage	0	m²	
Utilisation annuelle	0	h/an	
Durée de vie	0	h	

Base de données			
Tracteur			
	Tracteur (-29 kW)	Tracteur (30-64 kW)	Tracteur (65-94 kW)
Poids	1900	3300	5300
Durée de vie	6000	7200	7200
Puissance nominale	27.95	50	78
Espace de stockage	11.0	15.2	19.4
Utilisation annuelle	500	600	600
Machine agricole de travail du sol			
	-	Plough, 4 furrow	Spring tooth harrow
Poids		1039	538
Espace de stockage		13.3	12.2
Utilisation annuelle		73	28
Durée de vie		480	540
		Rotary harrow	Roller, 2.5-3 m
		1183	910
		7	6.1
		32	21
		360	500
		Field cultivator	902
			6.8
			31
			480
Machine agricole (hors travail du sol)			
	-	Seeder	Hoe
Poids		507	559
Espace de stockage		8.4	12.2
Utilisation annuelle		35	29
Durée de vie		525	525
		Fertiliser spreader	Rotary mower
		193	643
		3.8	6.1
		80	28
		1000	600

Données de rapport 15 : weight
page 59/360, Tab. A. 10 , page
197/360

Fiche SimaPro opération agricole

Output	Amount	Unit
Fertilising_by-broadcaster_75CV_1h1ha	1	ha

Inputs	Amount	Unit
Tractor, 4-wheel, agricultural {GLO} market for	0.5208	kg
Agricultural machinery, tillage {GLO} market for	0.00E+00	kg
Agricultural machinery, unspecified {GLO} market for	0.1930	kg
Diesel, at regional storageDiesel {Europe without Switzerland} market fo	7.5600	kg
Shed {GLO} market for	0.00146	m ²

Emissions to air	Amount	Unit	Location
NM VOC, non-methane volatile organic compounds, unspecified origin	1.00E-02	kg	air/low population density
Nitrogen oxides	1.54E-01	kg	air/low population density
Carbon monoxide, fossil	1.40E-02	kg	air/low population density
Carbon dioxide, fossil	2.36E+01	kg	air/low population density
Sulfur dioxide	7.64E-03	kg	air/low population density
Methane, fossil	9.75E-04	kg	air/low population density
Benzene	5.52E-05	kg	air/low population density
Particulates, < 2,5 um	1.35E-02	kg	air/low population density
Cadmium	7.56E-08	kg	air/low population density
Chromium	3.78E-07	kg	air/low population density
Copper	1.29E-05	kg	air/low population density
Dinitrogen monoxide	9.07E-04	kg	air/low population density
Nickel	5.29E-07	kg	air/low population density
Zinc	7.56E-06	kg	air/low population density
Benzo(a)pyrene	2.27E-07	kg	air/low population density
Ammonia	1.51E-04	kg	air/low population density
Selenium	7.56E-08	kg	air/low population density
PAH, Polycyclic aromatic hydrocarbons	2.49E-05	kg	air/low population density
Benz(a)-Anthracene	6.05E-07	kg	air/low population density
Benzo(b)-Fluoranthracene	3.78E-07	kg	air/low population density
Chrysene	1.51E-06	kg	air/low population density
Dibenz(a,h)-Anthracene	7.56E-08	kg	air/low population density
Fluoranthene	3.40E-06	kg	air/low population density
Phenanthrene	1.89E-05	kg	air/low population density

Emission to soil	Amount	Unit	Location
Zinc	6.98E-04	kg	soil/agricultural
Lead	1.13E-04	kg	soil/agricultural
Cadmium	2.62E-05	kg	soil/agricultural

Table B.15 Calculations in Excel sheet for basic operations (level 2) as "Fertilising, by broadcaster {FR}| 80CV (1h 1ha)".

Description de l'opération agricole		
Nom de l'opération	Fertilising_by-broadcaster_80CV_1h1ha	
Données d'entrée	Valeur	Unité
Durée de l'opération	1.00	h
Chevaux vapeur metric (CV)	80.00	CV
Puissance nominale	58.84	kW
Consommation de carburant	9.6	l/h
Puissance moyenne du tracteur pendant l'opération	8.6	kW
Type de tracteur	Tracteur (30-64 kW)	
Machine agricole (hors travail du sol)	Fertiliser spreader	
Machine agricole de travail du sol	-	

Rapport 15 ecoinvent:
Tab. A.10, page 197/360

Résultats		
Infrastructure	Valeur	Unité
Tractor production	0.55555556	kg
Agricultural machinery, tillage, production	0.00	kg
Agricultural machinery, general, production	0.19	kg
Diesel, at regional storage	8.06	kg
Shed for tractor	5.07E-04	m²
Shed for machinery tillage	9.50E-04	m²
Shed for machinery general	0.00E+00	m²
Soil emission from tractor tyre abrasion	Valeur	Unité
Zn	7.24E-01	g/(ha.a)
Pb	1.18E-01	g/(ha.a)
Cd	2.71E-02	g/(ha.a)
Soil emission from machinery tyre abrasion	Valeur	Unité
Zn	1.90E-02	g/(ha.a)
Pb	3.09E-03	g/(ha.a)
Cd	7.13E-04	g/(ha.a)

Paramètres		
(Ils sont récupérés de la boîte violette "Base de données")		
Paramètres tracteur		
Poids	4000	kg
Durée de vie	7200	h
Puissance nominale	58.83984	kW
Espace de stockage	15.2	m²
Utilisation annuelle	600	h/an
Part des pneus dans le tracteur	0.0975	kg pneus/kg tracteur
Paramètres pneus tracteur		
Durée de vie	2500	h
Part de caoutchouc perdu sur la durée de vie	0.29	kg caoutchouc/kg pneus
Teneur en zinc	16	g/kg de pneus
Teneur en plomb	2.6	g/kg de pneus
Teneur en cadmium	0.6	g/kg de pneus
Paramètres outils agricoles (hors travail du sol)		
Poids	193	kg
Espace de stockage	3.8	m²
Utilisation annuelle	80	h/an
Durée de vie	1000	h
Part des pneus dans la machine	0.0275	kg pneus/kg machine
Paramètres pneus outils agricoles		
Durée de vie	2500	h
Part de caoutchouc perdu sur la durée de vie	0.56	kg caoutchouc/kg pneus
Teneur en zinc	16	g/kg de pneus
Teneur en plomb	2.6	g/kg de pneus
Teneur en cadmium	0.6	g/kg de pneus
Paramètres hangar de stockage		
Durée de vie hangar	50	ans

hyp > donnée d'Ecoinvent
hyp > donnée d'Ecoinvent

Paramètres outils de travail du sol	
Poids	0 kg
Espace de stockage	0 m²
Utilisation annuelle	0 h/an
Durée de vie	0 h

Base de données			
Tracteur	Tracteur (-29 kW)	Tracteur (30-64 kW)	Tracteur (65-94 kW)
Poids	1900	3300	5300
Durée de vie	6000	7200	7200
Puissance nominale	27.95	50	78
Espace de stockage	11.0	15.2	19.4
Utilisation annuelle	500	600	600
Machine agricole de travail du sol	-	Plough, 4 furrow	Spring tooth harrow
Poids		1039	538
Espace de stockage		13.3	12.2
Utilisation annuelle		73	28
Durée de vie		480	540
			Rotary harrow
			1183
			7
			32
			360
			Roller, 2.5-3 m
			910
			6.1
			21
			500
			Field cultivator
			902
			6.8
			31
			480
Machine agricole (hors travail du sol)	-	Seeder	Hoe
Poids		507	559
Espace de stockage		8.4	12.2
Utilisation annuelle		35	29
Durée de vie		525	525
			Fertiliser spreader
			193
			643
			3.8
			28
			1000
			Rotary mower
			600

Données de rapport 15 : weight
page 59/360, Tab. A. 10 , page
197/360

Fiche SimaPro opération agricole

Output	Amount	Unit
Fertilising_by-broadcaster_80CV_1h1ha	1	ha

Inputs	Amount	Unit
Tractor, 4-wheel, agricultural {GLO} market for	0.5556	kg
Agricultural machinery, tillage {GLO} market for	0.00E+00	kg
Agricultural machinery, unspecified {GLO} market for	0.1930	kg
Diesel, at regional storageDiesel {Europe without Switzerland} market fo	8.0640	kg
Shed {GLO} market for	0.00146	m ²

Emissions to air	Amount	Unit	Location
NM VOC, non-methane volatile organic compounds, unspecified origin	1.00E-02	kg	air/low population density
Nitrogen oxides	1.54E-01	kg	air/low population density
Carbon monoxide, fossil	1.40E-02	kg	air/low population density
Carbon dioxide, fossil	2.51E+01	kg	air/low population density
Sulfur dioxide	8.14E-03	kg	air/low population density
Methane, fossil	1.04E-03	kg	air/low population density
Benzene	5.89E-05	kg	air/low population density
Particulates, < 2.5 um	1.33E-02	kg	air/low population density
Cadmium	8.06E-08	kg	air/low population density
Chromium	4.03E-07	kg	air/low population density
Copper	1.37E-05	kg	air/low population density
Dinitrogen monoxide	9.68E-04	kg	air/low population density
Nickel	5.64E-07	kg	air/low population density
Zinc	8.06E-06	kg	air/low population density
Benzo(a)pyrene	2.42E-07	kg	air/low population density
Ammonia	1.61E-04	kg	air/low population density
Selenium	8.06E-08	kg	air/low population density
PAH, Polycyclic aromatic hydrocarbons	2.65E-05	kg	air/low population density
Benzo(a)-Anthracene	6.45E-07	kg	air/low population density
Benzo(b)-Fluoranthracene	4.03E-07	kg	air/low population density
Chrysene	1.61E-06	kg	air/low population density
Dibenz(a,h)-Anthracene	8.06E-08	kg	air/low population density
Fluoranthene	3.63E-06	kg	air/low population density
Phenanthrene	2.02E-05	kg	air/low population density

Emission to soil	Amount	Unit	Location
Zinc	7.43E-04	kg	soil/agricultural
Lead	1.21E-04	kg	soil/agricultural
Cadmium	2.79E-05	kg	soil/agricultural

Table B.16 Calculations in Excel sheet for basic operations (level 2) as “Pruning, by chainsaw (1h/ha)”.

Description de l'opération agricole		Proxy: Tillage_brushcutter, Fiche technique Stihl MS 150 TC
Nom de l'opération	Pruning_chainsaw	Tronçonneuse/sierra eléctrica
Données d'entrée	Valeur	Unité
Durée de l'opération	1.00	h
Consommation de carburant	0.3	l/h
Puissance moyenne du tracteur pendant l'opération	1	kW
Type de tracteur		
Machine agricole (hors travail du sol)	-	
Machine agricole de travail du sol	-	

Résultats		
Infrastructure	Valeur	Unité
Tractor production	#DIV/0!	kg
Agricultural machinery, tillage, production	0.00	kg
Agricultural machinery, general, production	0.00	kg
Petrol, at regional storage	0.23	kg
Shed for tractor	0.00E+00	m ²
Shed for machinery tillage	4.35E-04	m ²
Shed for machinery general	0.00E+00	m ²
Soil emission from tractor tyre abrasion	Valeur	Unité
Zn	#DIV/0!	g/(ha.a)
Pb	#DIV/0!	g/(ha.a)
Cd	#DIV/0!	g/(ha.a)
Soil emission from machinery tyre abrasion	Valeur	Unité
Zn	#DIV/0!	g/(ha.a)
Pb	#DIV/0!	g/(ha.a)
Cd	#DIV/0!	g/(ha.a)

Paramètres		(Ils sont récupérés de la boîte violette "Base de données")
Paramètres tracteur		
Poids		kg hyp > donnée de fiche
Durée de vie		h
Puissance nominale		kW
Espace de stockage		m ²
Utilisation annuelle		h/an
Part des pneus dans le tracteur		kg pneus/kg tracteur
Paramètres pneus tracteur		
Durée de vie		h
Part de caoutchouc perdu sur la durée de vie		kg caoutchouc/kg pneus
Teneur en zinc		g/kg de pneus
Teneur en plomb		g/kg de pneus
Teneur en cadmium		g/kg de pneus
Paramètres outils agricoles (hors travail du sol)		
Poids	2.6	kg
Espace de stockage	1	m ²
Utilisation annuelle	46	h/an
Durée de vie	2500	h
Part des pneus dans la machine	0	kg pneus/kg machine
Paramètres pneus outils agricoles		
Durée de vie		h
Part de caoutchouc perdu sur la durée de vie		kg caoutchouc/kg pneus
Teneur en zinc		g/kg de pneus
Teneur en plomb		g/kg de pneus
Teneur en cadmium		g/kg de pneus
Paramètres hangar de stockage		
Durée de vie hangar	50	ans

Emissions de combustion			
Molécule	Facteur d'émission (g/kg essence)	Facteur d'émission (g/h tracteur)*	Emission to air (g/(ha.a))
HC			0.00E+00
NOx			0.00E+00
CO			0.00E+00
CO2	3.00E+03		6.75E+02
SO2	7.20E-02		1.62E-02
Pb	1.46E-01		0.03285
CH4	2.92E+00		0.657
C6H6	9.48E+00		2.133
PM2,5	2.23E+00		1.67E+00
Cd	1.00E-05		2.25E-06
Cr	5.00E-05		1.13E-05
Cu	1.70E-03		3.83E-04
N2O	1.30E-01		2.93E-02
Ni	7.00E-05		1.58E-05
Zn	1.00E-03		2.25E-04
Benzo(a)pyrene	4.00E-05		9.00E-06
NH3	4.00E-02		9.00E-03
Se	1.00E-05		2.25E-06
PAH	3.29E-03		7.40E-04
Benz(a)-Anthracene	7.50E-05		1.69E-05
Benzo(b)-Fluoranthracene	4.00E-05		9.00E-06
Chrysene	1.00E-04		2.25E-05
Dibenzo(a,h)-Anthracene	1.50E-05		3.38E-06
Fluoranthene	4.50E-04		1.01E-04
Phenanthrene	1.20E-03		2.70E-04

* Emissions variables en fonction des conditions de vitesse et de puissance effective du tracteur pendant l'opération

Fiche SimaPro opération agricole

Output	Amount	Unit
Pruning_chainsaw		1 ha

Inputs	Amount	Unit
Tractor, 4-wheel, agricultural {GLO} market for	#DIV/0!	kg
Agricultural machinery, tillage {GLO} market for	0.00E+00	kg
Agricultural machinery, unspecified {GLO} market for	0.0010	kg
Petrol, two-stroke blend {CH} petrol blending for two-stroke engines Cut	0.2250	kg
Shed {GLO} market for	0.00043	m²

1,428571429E-4 p ; Depuis la fiche

*Power saw, without catalytic converter RER Processing 0,0004 p = 0,0028 kg machinery

Emissions to air	Amount	Unit	Location
NMVOC, non-methane volatile organic compounds, unspecified origin	0.00E+00	kg	air/low population density
Nitrogen oxides	0.00E+00	kg	air/low population density
Carbon monoxide, fossil	0.00E+00	kg	air/low population density
Carbon dioxide, fossil	6.75E-01	kg	air/low population density
Sulfur dioxide	1.62E-05	kg	air/low population density
Methane, fossil	6.57E-04	kg	air/low population density
Benzene	2.13E-03	kg	air/low population density
Particulates, < 2,5 um	1.67E-03	kg	air/low population density
Cadmium	2.25E-09	kg	air/low population density
Chromium	1.13E-08	kg	air/low population density
Copper	3.83E-07	kg	air/low population density
Dinitrogen monoxide	2.93E-05	kg	air/low population density
Nickel	1.58E-08	kg	air/low population density
Zinc	2.25E-07	kg	air/low population density
Benzo(a)pyrene	9.00E-09	kg	air/low population density
Ammonia	9.00E-06	kg	air/low population density
Selenium	2.25E-09	kg	air/low population density
PAH, Polycyclic aromatic hydrocarbons	7.40E-07	kg	air/low population density
Benz(a)-Anthracene	1.69E-08	kg	air/low population density
Benzo(b)-Fluoranthracene	9.00E-09	kg	air/low population density
Chrysene	2.25E-08	kg	air/low population density
Dibenz(a,h)-Anthracene	3.38E-09	kg	air/low population density
Fluoranthene	1.01E-07	kg	air/low population density
Phenanthrene	2.70E-07	kg	air/low population density

Emission to soil	Amount	Unit	Location
Zinc	#DIV/0!	kg	soil/agricultural
Lead	#DIV/0!	kg	soil/agricultural
Cadmium	#DIV/0!	kg	soil/agricultural

Table B.17 Calculations in Excel sheet for basic operations (level 2) as "Pruning, with crusher {FR} 50CV (1h 1ha)".

Description de l'opération agricole		
Nom de l'opération	Pruning-crusher 50CV 1h1ha	
Données d'entrée	Valeur	Unité
Durée de l'opération	1.00	h
Chevaux vapeur metric (CV)	50.00	CV
Puissance nominale	36.77	kW
Consommation de carburant	6	l/h
Puissance moyenne du tracteur pendant l'opération	34	kW
Type de tracteur	Tracteur (30-64 kW)	
Machine agricole (hors travail du sol)	Rotary cultivator with hammer-mil, PROXY:Tillage, rotary cultivator	
Machine agricole de travail du sol	-	

Rapport 15 ecoinvent:
Tab. A.10, p. 198/360

Résultats		
Infrastructure	Valeur	Unité
Tractor production	0.347222222	kg
Agricultural machinery, tillage, production	0.00	kg
Agricultural machinery, general, production	1.50	kg
Diesel, at regional storage	5.04	kg
Shed for tractor	5.07E-04	m ²
Shed for machinery tillage	4.86E-03	m ²
Shed for machinery general	0.00E+00	m ²
Soil emission from tractor tyre abrasion	Valeur	Unité
Zn	4.52E-01	g/(ha.a)
Pb	7.35E-02	g/(ha.a)
Cd	1.70E-02	g/(ha.a)
Soil emission from machinery tyre abrasion	Valeur	Unité
Zn	8.89E-02	g/(ha.a)
Pb	1.44E-02	g/(ha.a)
Cd	3.33E-03	g/(ha.a)

Paramètres			(Ils sont récupérés de la boîte violette "Base de données")
Paramètres tracteur			
Poids	2500	kg	hyp > donnée d'Ecoinvent
Durée de vie	7200	h	
Puissance nominale	36.7749	kW	hyp > donnée d'Ecoinvent
Espace de stockage	15.2	m ²	
Utilisation annuelle	600	h/an	
Part des pneus dans le tracteur	0.0975	kg pneus/kg tracteur	
Paramètres pneus tracteur			
Durée de vie	2500	h	
Part de caoutchouc perdu sur la durée de vie	0.29	kg caoutchouc/kg pneus	
Teneur en zinc	16	g/kg de pneus	
Teneur en plomb	2.6	g/kg de pneus	
Teneur en cadmium	0.6	g/kg de pneus	
Paramètres outils agricoles (hors travail du sol)			
Poids	902	kg	
Espace de stockage	6.8	m ²	
Utilisation annuelle	28	h/an	
Durée de vie	600	h	
Part des pneus dans la machine	0.0275	kg pneus/kg machine	
Paramètres pneus outils agricoles			
Durée de vie	2500	h	
Part de caoutchouc perdu sur la durée de vie	0.56	kg caoutchouc/kg pneus	
Teneur en zinc	16	g/kg de pneus	
Teneur en plomb	2.6	g/kg de pneus	
Teneur en cadmium	0.6	g/kg de pneus	
Paramètres hangar de stockage			
Durée de vie hangar	50	ans	

Base de données		Données de rapport 15 : weight page 59/360, Tab. A. 10 , page 197/360				
Tracteur	Tracteur (-29 kW)	Tracteur (30-64 kW)	Tracteur (65-94 kW)			
Poids	1900	3300	5300			
Durée de vie	6000	7200	7200			
Puissance nominale	27.95	50	78			
Espace de stockage	11.0	15.2	19.4			
Utilisation annuelle	500	600	600			
Machine agricole de travail du sol	-	Plough, 4 furrow	Spring tooth harrow	Rotary harrow	Roller, 2,5-3 m	Field cultivator
Poids		1039	538	1183	910	902
Espace de stockage		13.3	12.2	7	6.1	6.8
Utilisation annuelle		73	28	32	21	31
Durée de vie		480	540	360	500	480
Machine agricole (hors travail du sol)	-	Seeder	Hoe	Fertiliser spreader	Rotary mower	Rotary cultivator
Poids		507	559	193	643	902
Espace de stockage		8.4	12.2	3.8	6.1	6.8
Utilisation annuelle		35	29	80	28	28
Durée de vie		525	525	1000	600	600

Emissions de combustion			
Molécule	Facteur d'émission (g/kg diesel)	Facteur d'émission (g/h tracteur)*	Emission to air (g/(ha.a))
HC		25	2.50E+01
NOx		387	3.87E+02
CO		126	1.26E+02
CO2	3.12E+03		1.56E+04
SO2	1.01E+00		5.09E+00
CH4	1.29E-01		6.50E-01
C6H6	7.30E-03		3.68E-02
PM2,5	2.06E+00		5.98E+01
Cd	1.00E-05		5.04E-05
Cr	5.00E-05		2.52E-04
Cu	1.70E-03		8.57E-03
N2O	1.20E-01		6.05E-01
Ni	7.00E-05		3.53E-04
Zn	1.00E-03		5.04E-03
Benzo(a)pyrene	3.00E-05		1.51E-04
NH3	2.00E-02		1.01E-01
Se	1.00E-05		5.04E-05
PAH	3.29E-03		1.66E-02
Benz(a)-Anthracene	8.00E-05		4.03E-04
Benzo(b)-Fluoranthracene	5.00E-05		2.52E-04
Chrysene	2.00E-04		1.01E-03
Dibenzo(a,h)-Anthracene	1.00E-05		5.04E-05
Fluoranthene	4.50E-04		2.27E-03
Phenanthrene	2.50E-03		1.26E-02

Rapport 15: Tab. A.10, page 198/360 PROXY: Tillage, rotary cultivator

Fiche SimaPro opération agricole

Output	Amount	Unit
Pruning-crusher_50CV_1h1ha		1 ha

Inputs	Amount	Unit
Tractor, 4-wheel, agricultural {GLO} market for	0.3472	kg
Agricultural machinery, tillage {GLO} market for	0.00E+00	kg
Agricultural machinery, unspecified {GLO} market for	1.5033	kg
Diesel, at regional storageDiesel {Europe without Switzerland} market fo	5.0400	kg
Shed {GLO} market for	0.00536	m²

Emissions to air	Amount	Unit	Location
NM VOC, non-methane volatile organic compounds, unspecified origin	2.50E-02	kg	air/low population density
Nitrogen oxides	3.87E-01	kg	air/low population density
Carbon monoxide, fossil	1.26E-01	kg	air/low population density
Carbon dioxide, fossil	1.55E+01	kg	air/low population density
Sulfur dioxide	5.09E-03	kg	air/low population density
Methane, fossil	6.50E-04	kg	air/low population density
Benzene	3.68E-05	kg	air/low population density
Particulates, < 2,5 um	5.98E-02	kg	air/low population density
Cadmium	5.04E-08	kg	air/low population density
Chromium	2.52E-07	kg	air/low population density
Copper	8.57E-06	kg	air/low population density
Dinitrogen monoxide	6.05E-04	kg	air/low population density
Nickel	3.53E-07	kg	air/low population density
Zinc	5.04E-06	kg	air/low population density
Benzo(a)pyrene	1.51E-07	kg	air/low population density
Ammonia	1.01E-04	kg	air/low population density
Selenium	5.04E-08	kg	air/low population density
PAH, Polycyclic aromatic hydrocarbons	1.66E-05	kg	air/low population density
Benz(a)-Anthracene	4.03E-07	kg	air/low population density
Benzo(b)-Fluoranthracene	2.52E-07	kg	air/low population density
Chrysene	1.01E-06	kg	air/low population density
Dibenzo(a,h)-Anthracene	5.04E-08	kg	air/low population density
Fluoranthene	2.27E-06	kg	air/low population density
Phenanthrene	1.26E-05	kg	air/low population density

Emission to soil	Amount	Unit	Location
Zinc	5.41E-04	kg	soil/agricultural
Lead	8.80E-05	kg	soil/agricultural
Cadmium	2.03E-05	kg	soil/agricultural

Table B.18 Calculations in Excel sheet for basic operations (level 2) as “Pruning, with crusher {FR} 60CV (1h 1ha)”.

Description de l'opération agricole		
Nom de l'opération	Pruning-crusher_60CV_1h1ha	
Données d'entrée	Valeur	Unité
Durée de l'opération	1.00	h
Chevaux vapeur metric (CV)	60.00	CV
Puissance nominale	44.13	kW
Consommation de carburant	7.2	l/h
Puissance moyenne du tracteur pendant l'opération	34	kW
Type de tracteur	Tracteur (30-64 kW)	
Machine agricole (hors travail du sol)	Rotary cultivator	
Machine agricole de travail du sol	-	

Rapport 15 ecoinvent:
Tab. A.10, p. 198/360
with hammer-mil, PROXY:Tillage, rotary cultivator

Résultats		
Infrastructure	Valeur	Unité
Tractor production	0.416666667	kg
Agricultural machinery, tillage, production	0.00	kg
Agricultural machinery, general, production	1.50	kg
Diesel, at regional storage	6.05	kg
Shed for tractor	5.07E-04	m ²
Shed for machinery tillage	4.86E-03	m ²
Shed for machinery general	0.00E+00	m ²
Soil emission from tractor tyre abrasion	Valeur	Unité
Zn	5.43E-01	g/(ha.a)
Pb	8.82E-02	g/(ha.a)
Cd	2.04E-02	g/(ha.a)
Soil emission from machinery tyre abrasion	Valeur	Unité
Zn	8.89E-02	g/(ha.a)
Pb	1.44E-02	g/(ha.a)
Cd	3.33E-03	g/(ha.a)

Paramètres		
(Ils sont récupérés de la boîte violette "Base de données")		
Paramètres tracteur		
Poids	3000	kg
Durée de vie	7200	h
Puissance nominale	44.12988	kW
Espace de stockage	15.2	m ²
Utilisation annuelle	600	h/an
Part des pneus dans le tracteur	0.0975	kg pneus/kg tracteur
Paramètres pneus tracteur		
Durée de vie	2500	h
Part de caoutchouc perdu sur la durée de vie	0.29	kg caoutchouc/kg pneus
Teneur en zinc	16	g/kg de pneus
Teneur en plomb	2.6	g/kg de pneus
Teneur en cadmium	0.6	g/kg de pneus
Paramètres outils agricoles (hors travail du sol)		
Poids	902	kg
Espace de stockage	6.8	m ²
Utilisation annuelle	28	h/an
Durée de vie	600	h
Part des pneus dans la machine	0.0275	kg pneus/kg machine
Paramètres pneus outils agricoles		
Durée de vie	2500	h
Part de caoutchouc perdu sur la durée de vie	0.56	kg caoutchouc/kg pneus
Teneur en zinc	16	g/kg de pneus
Teneur en plomb	2.6	g/kg de pneus
Teneur en cadmium	0.6	g/kg de pneus
Paramètres hangar de stockage		
Durée de vie hangar	50	ans

Fiche SimaPro opération agricole

Output	Amount	Unit
Pruning-crusher_60CV_1h1ha	1	ha

Inputs	Amount	Unit
Tractor, 4-wheel, agricultural {GLO} market for	0.4167	kg
Agricultural machinery, tillage {GLO} market for	0.00E+00	kg
Agricultural machinery, unspecified {GLO} market for	1.5033	kg
Diesel, at regional storageDiesel {Europe without Switzerland} market fo	6.0480	kg
Shed {GLO} market for	0.00536	m ²

Emissions to air	Amount	Unit	Location
NM VOC, non-methane volatile organic compounds, unspecified origin	2.50E-02	kg	air/low population density
Nitrogen oxides	3.87E-01	kg	air/low population density
Carbon monoxide, fossil	1.26E-01	kg	air/low population density
Carbon dioxide, fossil	1.87E+01	kg	air/low population density
Sulfur dioxide	6.11E-03	kg	air/low population density
Methane, fossil	7.80E-04	kg	air/low population density
Benzene	4.42E-05	kg	air/low population density
Particulates, < 2,5 um	5.70E-02	kg	air/low population density
Cadmium	6.05E-08	kg	air/low population density
Chromium	3.02E-07	kg	air/low population density
Copper	1.03E-05	kg	air/low population density
Dinitrogen monoxide	7.26E-04	kg	air/low population density
Nickel	4.23E-07	kg	air/low population density
Zinc	6.05E-06	kg	air/low population density
Benzo(a)pyrene	1.81E-07	kg	air/low population density
Ammonia	1.21E-04	kg	air/low population density
Selenium	6.05E-08	kg	air/low population density
PAH, Polycyclic aromatic hydrocarbons	1.99E-05	kg	air/low population density
Benz(a)-Anthracene	4.84E-07	kg	air/low population density
Benzo(b)-Fluoranthracene	3.02E-07	kg	air/low population density
Chrysene	1.21E-06	kg	air/low population density
Dibenz(a,h)-Anthracene	6.05E-08	kg	air/low population density
Fluoranthene	2.72E-06	kg	air/low population density
Phenanthrene	1.51E-05	kg	air/low population density

Emission to soil	Amount	Unit	Location
Zinc	6.32E-04	kg	soil/agricultural
Lead	1.03E-04	kg	soil/agricultural
Cadmium	2.37E-05	kg	soil/agricultural

Table B.19 Calculations in Excel sheet for basic operations (level 2) as “Pruning, with crusher {FR} 75CV (1h 1ha)”.

Description de l'opération agricole		
Nom de l'opération	Pruning-crusher_75CV_1h1ha	
Données d'entrée	Valeur	Unité
Durée de l'opération	1.00	h
Chevaux vapeur metric (CV)	75.00	CV
Puissance nominale	55.16	kW
Consommation de carburant	9	l/h
Puissance moyenne du tracteur pendant l'opération	34.4	kW
Type de tracteur	Tracteur (30-64 kW)	
Machine agricole (hors travail du sol)	Rotary cultivator	
Machine agricole de travail du sol	-	

Rapport 15 ecoinvent:
Tab. A.10, p. 198/360
with hammer-mil, PROXY:Tillage, rotary cultivator

Résultats		
Infrastructure	Valeur	Unité
Tractor production	0.520833333	kg
Agricultural machinery, tillage, production	0.00	kg
Agricultural machinery, general, production	1.50	kg
Diesel, at regional storage	7.56	kg
Shed for tractor	5.07E-04	m²
Shed for machinery tillage	4.86E-03	m²
Shed for machinery general	0.00E+00	m²
Soil emission from tractor tyre abrasion	Valeur	Unité
Zn	6.79E-01	g/(ha.a)
Pb	1.10E-01	g/(ha.a)
Cd	2.54E-02	g/(ha.a)
Soil emission from machinery tyre abrasion	Valeur	Unité
Zn	8.89E-02	g/(ha.a)
Pb	1.44E-02	g/(ha.a)
Cd	3.33E-03	g/(ha.a)

Paramètres			(Ils sont récupérés de la boîte violette "Base de données")
Paramètres tracteur			
Poids	3750	kg	hyp > donnée d'Ecoinvent
Durée de vie	7200	h	hyp > donnée d'Ecoinvent
Puissance nominale	55.16235	kW	hyp > donnée d'Ecoinvent
Espace de stockage	15.2	m²	
Utilisation annuelle	600	h/an	
Part des pneus dans le tracteur	0.0975	kg pneus/kg tracteur	
Paramètres pneus tracteur			
Durée de vie	2500	h	
Part de caoutchouc perdu sur la durée de vie	0.29	kg caoutchouc/kg pneus	
Teneur en zinc	16	g/kg de pneus	
Teneur en plomb	2.6	g/kg de pneus	
Teneur en cadmium	0.6	g/kg de pneus	
Paramètres outils agricoles (hors travail du sol)			
Poids	902	kg	
Espace de stockage	6.8	m²	
Utilisation annuelle	28	h/an	
Durée de vie	600	h	
Part des pneus dans la machine	0.0275	kg pneus/kg machine	
Paramètres pneus outils agricoles			
Durée de vie	2500	h	
Part de caoutchouc perdu sur la durée de vie	0.56	kg caoutchouc/kg pneus	
Teneur en zinc	16	g/kg de pneus	
Teneur en plomb	2.6	g/kg de pneus	
Teneur en cadmium	0.6	g/kg de pneus	
Paramètres hangar de stockage			
Durée de vie hangar	50	ans	

Fiche SimaPro opération agricole

Output	Amount	Unit
Pruning-crusher_75CV_1h1ha		1 ha

Inputs	Amount	Unit
Tractor, 4-wheel, agricultural {GLO} market for	0.5208	kg
Agricultural machinery, tillage {GLO} market for	0.00E+00	kg
Agricultural machinery, unspecified {GLO} market for	1.5033	kg
Diesel, at regional storageDiesel {Europe without Switzerland} market fo	7.5600	kg
Shed {GLO} market for	0.00536	m ²

Emissions to air	Amount	Unit	Location
NMVOC, non-methane volatile organic compounds, unspecified origin	2.50E-02	kg	air/low population density
Nitrogen oxides	3.87E-01	kg	air/low population density
Carbon monoxide, fossil	1.26E-01	kg	air/low population density
Carbon dioxide, fossil	2.34E+01	kg	air/low population density
Sulfur dioxide	7.64E-03	kg	air/low population density
Methane, fossil	9.75E-04	kg	air/low population density
Benzene	5.52E-05	kg	air/low population density
Particulates, < 2,5 um	5.42E-02	kg	air/low population density
Cadmium	7.56E-08	kg	air/low population density
Chromium	3.78E-07	kg	air/low population density
Copper	1.29E-05	kg	air/low population density
Dinitrogen monoxide	9.07E-04	kg	air/low population density
Nickel	5.29E-07	kg	air/low population density
Zinc	7.56E-06	kg	air/low population density
Benzo(a)pyrene	2.27E-07	kg	air/low population density
Ammonia	1.51E-04	kg	air/low population density
Selenium	7.56E-08	kg	air/low population density
PAH, Polycyclic aromatic hydrocarbons	2.49E-05	kg	air/low population density
Benz(a)-Anthracene	6.05E-07	kg	air/low population density
Benzo(b)-Fluoranthracene	3.78E-07	kg	air/low population density
Chrysene	1.51E-06	kg	air/low population density
Dibenz(a,h)-Anthracene	7.56E-08	kg	air/low population density
Fluoranthene	3.40E-06	kg	air/low population density
Phenanthrene	1.89E-05	kg	air/low population density

Emission to soil	Amount	Unit	Location
Zinc	7.68E-04	kg	soil/agricultural
Lead	1.25E-04	kg	soil/agricultural
Cadmium	2.88E-05	kg	soil/agricultural

Table B.20 Calculations in Excel sheet for basic operations (level 2) as "Pruning, with crusher {FR} 80CV (1h 1ha)".

Description de l'opération agricole		
Nom de l'opération	Pruning-crusher 80CV 1h1ha	
Données d'entrée	Valeur	Unité
Durée de l'opération	1.00	h
Chevaux vapeur metric (CV)	80.00	CV
Puissance nominale	58.84	kW
Consommation de carburant	9.6	l/h
Puissance moyenne du tracteur pendant l'opération	34.4	kW
Type de tracteur	Tracteur (30-64 kW)	
Machine agricole (hors travail du sol)	Rotary cultivator with hammer-mil, PROXY:Tillage, rotary cultivator	
Machine agricole de travail du sol	-	

Rapport 15 ecoinvent:
Tab. A.10, p. 198/360

Résultats		
Infrastructure	Valeur	Unité
Tractor production	0.55555556	kg
Agricultural machinery, tillage, production	0.00	kg
Agricultural machinery, general, production	1.50	kg
Diesel, at regional storage	8.06	kg
Shed for tractor	5.07E-04	m ²
Shed for machinery tillage	4.86E-03	m ²
Shed for machinery general	0.00E+00	m ²
Soil emission from tractor tyre abrasion	Valeur	Unité
Zn	7.24E-01	g/(ha.a)
Pb	1.18E-01	g/(ha.a)
Cd	2.71E-02	g/(ha.a)
Soil emission from machinery tyre abrasion	Valeur	Unité
Zn	8.89E-02	g/(ha.a)
Pb	1.44E-02	g/(ha.a)
Cd	3.33E-03	g/(ha.a)

Paramètres			(Ils sont récupérés de la boîte violette "Base de données")
Paramètres tracteur			
Poids	4000	kg	hyp > donnée d'Ecoinvent
Durée de vie	7200	h	hyp > donnée d'Ecoinvent
Puissance nominale	58.83984	kW	hyp > donnée d'Ecoinvent
Espace de stockage	15.2	m ²	
Utilisation annuelle	600	h/an	
Part des pneus dans le tracteur	0.0975	kg pneus/kg tracteur	
Paramètres pneus tracteur			
Durée de vie	2500	h	
Part de caoutchouc perdu sur la durée de vie	0.29	kg caoutchouc/kg pneus	
Teneur en zinc	16	g/kg de pneus	
Teneur en plomb	2.6	g/kg de pneus	
Teneur en cadmium	0.6	g/kg de pneus	
Paramètres outils agricoles (hors travail du sol)			
Poids	902	kg	
Espace de stockage	6.8	m ²	
Utilisation annuelle	28	h/an	
Durée de vie	600	h	
Part des pneus dans la machine	0.0275	kg pneus/kg machine	
Paramètres pneus outils agricoles			
Durée de vie	2500	h	
Part de caoutchouc perdu sur la durée de vie	0.56	kg caoutchouc/kg pneus	
Teneur en zinc	16	g/kg de pneus	
Teneur en plomb	2.6	g/kg de pneus	
Teneur en cadmium	0.6	g/kg de pneus	
Paramètres hangar de stockage			
Durée de vie hangar	50	ans	

Fiche SimaPro opération agricole

Output	Amount	Unit
Pruning-crusher_80CV_1h1ha		1 ha

Inputs	Amount	Unit
Tractor, 4-wheel, agricultural {GLO} market for	0.5556	kg
Agricultural machinery, tillage {GLO} market for	0.00E+00	kg
Agricultural machinery, unspecified {GLO} market for	1.5033	kg
Diesel, at regional storageDiesel {Europe without Switzerland} market fo	8.0640	kg
Shed {GLO} market for	0.00536	m ²

Emissions to air	Amount	Unit	Location
NMVOOC, non-methane volatile organic compounds, unspecified origin	2.50E-02	kg	air/low population density
Nitrogen oxides	3.87E-01	kg	air/low population density
Carbon monoxide, fossil	1.26E-01	kg	air/low population density
Carbon dioxide, fossil	2.50E+01	kg	air/low population density
Sulfur dioxide	8.14E-03	kg	air/low population density
Methane, fossil	1.04E-03	kg	air/low population density
Benzene	5.89E-05	kg	air/low population density
Particulates, < 2.5 um	5.31E-02	kg	air/low population density
Cadmium	8.06E-08	kg	air/low population density
Chromium	4.03E-07	kg	air/low population density
Copper	1.37E-05	kg	air/low population density
Dinitrogen monoxide	9.68E-04	kg	air/low population density
Nickel	5.64E-07	kg	air/low population density
Zinc	8.06E-06	kg	air/low population density
Benzo(a)pyrene	2.42E-07	kg	air/low population density
Ammonia	1.61E-04	kg	air/low population density
Selenium	8.06E-08	kg	air/low population density
PAH, Polycyclic aromatic hydrocarbons	2.65E-05	kg	air/low population density
Benzo(a)-Anthracene	6.45E-07	kg	air/low population density
Benzo(b)-Fluoranthracene	4.03E-07	kg	air/low population density
Chrysene	1.61E-06	kg	air/low population density
Dibenz(a,h)-Anthracene	8.06E-08	kg	air/low population density
Fluoranthene	3.63E-06	kg	air/low population density
Phenanthrene	2.02E-05	kg	air/low population density

Emission to soil	Amount	Unit	Location
Zinc	8.13E-04	kg	soil/agricultural
Lead	1.32E-04	kg	soil/agricultural
Cadmium	3.05E-05	kg	soil/agricultural

Table B.21 Calculations in Excel sheet for basic operations (level 2) as "Tillage by brushcutter (1h/ha)".

Description de l'opération agricole		Proxy: tillage, rotary cultivator
Nom de l'opération	Tillage_brushcutter	Débroussailleuse / desbrozadora
Données d'entrée	Valeur	Unité
Durée de l'opération	1.00	h
Consommation de carburant	2	l/h
Puissance moyenne du tracteur pendant l'opération	2	kW
Type de tracteur		
Machine agricole (hors travail du sol)	-	
Machine agricole de travail du sol	-	Rotary cultivator

Résultats		
Infrastructure	Valeur	Unité
Tractor production	#DIV/0!	kg
Agricultural machinery, tillage, production	0.00	kg
Agricultural machinery, general, production	0.00	kg
Petrol, at regional storage	1.36	kg
Shed for tractor	0.00E+00	m ²
Shed for machinery tillage	2.00E-03	m ²
Shed for machinery general	0.00E+00	m ²
Soil emission from tractor tyre abrasion	Valeur	Unité
Zn	#DIV/0!	g/(ha.a)
Pb	#DIV/0!	g/(ha.a)
Cd	#DIV/0!	g/(ha.a)
Soil emission from machinery tyre abrasion	Valeur	Unité
Zn	#DIV/0!	g/(ha.a)
Pb	#DIV/0!	g/(ha.a)
Cd	#DIV/0!	g/(ha.a)

Paramètres		(Ils sont récupérés de la boîte violette "Base de données")
Paramètres tracteur		
Poids		kg
Durée de vie		h
Puissance nominale	2	kW
Espace de stockage		m ²
Utilisation annuelle		h/an
Part des pneus dans le tracteur		kg pneus/kg tracteur
Paramètres pneus tracteur		
Durée de vie		h
Part de caoutchouc perdu sur la durée de vie		kg caoutchouc/kg pneus
Teneur en zinc		g/kg de pneus
Teneur en plomb		g/kg de pneus
Teneur en cadmium		g/kg de pneus
Paramètres outils agricoles (hors travail du sol)		
Poids	8.4	kg
Espace de stockage	1	m ²
Utilisation annuelle	10	h/an
Durée de vie	4680	h
Part des pneus dans la machine	0	kg pneus/kg machine
Paramètres pneus outils agricoles		
Durée de vie		h
Part de caoutchouc perdu sur la durée de vie		kg caoutchouc/kg pneus
Teneur en zinc		g/kg de pneus
Teneur en plomb		g/kg de pneus
Teneur en cadmium		g/kg de pneus
Paramètres hangar de stockage		
Durée de vie hangar	50	ans

Base de données

Tracteur	Tracteur (30-64 kW)	Tracteur (65-94 kW)
Poids	3300	5300
Durée de vie	7200	7200
Puissance nominale	50	78
Espace de stockage	15.2	19.4
Utilisation annuelle	600	600

Machine agricole de travail du sol	-	Plough, 4 furrow	Spring tooth harrow	Rotary harrow	Roller, 2,5-3 m	Field cultivator
Poids		1039	538	1183	910	902
Espace de stockage		13.3	12.2	7	6.1	6.8
Utilisation annuelle		73	28	32	21	31
Durée de vie		480	540	360	500	480

Machine agricole (hors travail du sol)	-	Seeder	Hoe	Fertiliser spreader	Rotary mower	Rotary mower original
Poids		507	559	193	477	643
Espace de stockage		8.4	12.2	3.8	6.1	6.1
Utilisation annuelle		35	29	80	75	28
Durée de vie		525	525	1000	600	600

Emissions de combustion

Molécule	Facteur d'émission (g/kg essence)	Facteur d'émission (g/h tracteur)*	Emission to air (g/(ha.a))
HC			0.00E+00
NOx			0.00E+00
CO			0.00E+00
CO2	3.00E+03		6.75E+02
SO2	7.20E-02		1.62E-02
Pb	1.46E-01		0.03285
CH4	2.92E+00		0.657
C6H6	9.48E+00		2.133
PM2,5	2.23E+00		1.67E+00
Cd	1.00E-05		2.25E-06
Cr	5.00E-05		1.13E-05
Cu	1.70E-03		3.83E-04
N2O	1.30E-01		2.93E-02
Ni	7.00E-05		1.58E-05
Zn	1.00E-03		2.25E-04
Benzo(a)pyrene	4.00E-05		9.00E-06
NH3	4.00E-02		9.00E-03
Se	1.00E-05		2.25E-06
PAH	3.29E-03		7.40E-04
Benz(a)-Anthracene	7.50E-05		1.69E-05
Benzo(b)-Fluoranthracene	4.00E-05		9.00E-06
Chrysene	1.00E-04		2.25E-05
Dibenzo(a,h)-Anthracene	1.50E-05		3.38E-06
Fluoranthene	4.50E-04		1.01E-04
Phenanthrene	1.20E-03		2.70E-04

* Emissions variables en fonction des conditions de vitesse et de puissance effective du tracteur pendant l'opération

Fiche SimaPro opération agricole

Output	Amount	Unit
Tillage_brushcutter	1	ha

Inputs	Amount	Unit
Tractor, 4-wheel, agricultural {GLO} market for	#DIV/0!	kg
Agricultural machinery, tillage {GLO} market for	0.00E+00	kg
Agricultural machinery, unspecified {GLO} market for	0.0018	kg
Petrol, two-stroke blend {CH} petrol blending for two-stroke engines Cu	1.3600	kg
Shed {GLO} market for	0.00200	m ²

Emissions to air	Amount	Unit	Location
NM VOC, non-methane volatile organic compounds, unspecified origin	0.00E+00	kg	air/low population density
Nitrogen oxides	0.00E+00	kg	air/low population density
Carbon monoxide, fossil	0.00E+00	kg	air/low population density
Carbon dioxide, fossil	4.08E+00	kg	air/low population density
Sulfur dioxide	9.79E-05	kg	air/low population density
Methane, fossil	3.97E-03	kg	air/low population density
Benzene	1.29E-02	kg	air/low population density
Particulates, < 2,5 um	9.61E-03	kg	air/low population density
Cadmium	1.36E-08	kg	air/low population density
Chromium	6.80E-08	kg	air/low population density
Copper	2.31E-06	kg	air/low population density
Dinitrogen monoxide	1.77E-04	kg	air/low population density
Nickel	9.52E-08	kg	air/low population density
Zinc	1.36E-06	kg	air/low population density
Benzo(a)pyrene	5.44E-08	kg	air/low population density
Ammonia	5.44E-05	kg	air/low population density
Selenium	1.36E-08	kg	air/low population density
PAH, Polycyclic aromatic hydrocarbons	4.47E-06	kg	air/low population density
Benzo(a)-Anthracene	1.02E-07	kg	air/low population density
Benzo(b)-Fluoranthracene	5.44E-08	kg	air/low population density
Chrysene	1.36E-07	kg	air/low population density
Dibenz(a,h)-Anthracene	2.04E-08	kg	air/low population density
Fluoranthene	6.12E-07	kg	air/low population density
Phenanthrene	1.63E-06	kg	air/low population density

Emission to soil	Amount	Unit	Location
Zinc	#DIV/0!	kg	soil/agricultural
Lead	#DIV/0!	kg	soil/agricultural
Cadmium	#DIV/0!	kg	soil/agricultural

Table B.22 Calculations in Excel sheet for basic operations (level 2) as "Tillage, by tractor and rotary cultivator {FR} 37CV (1h 1ha)".

Description de l'opération agricole		Proxy: tillage, rotary cultivator	
Nom de l'opération	Tillage_37CV_1h1ha		
Données d'entrée	Valeur	Unité	
Durée de l'opération	1.00	h	
Chevaux vapeur metric (CV)	37.00	CV	
Puissance nominale	27.21	kW	
Consommation de carburant	4.44	l/h	
Puissance moyenne du tracteur pendant l'opération	34.4	kW	
Type de tracteur	Tracteur (-29 kW)		
Machine agricole (hors travail du sol)	-		
Machine agricole de travail du sol	Field/rotary cultivator	Rotary cultivator	(griffon en français)

Rapport 15 ecoinvent:
Tab. A.10, p. 198/360

Résultats		
Infrastructure	Valeur	Unité
Tractor production	0.308333333	kg
Agricultural machinery, tillage, production	1.88	kg
Agricultural machinery, general, production	0.00	kg
Diesel, at regional storage	3.73	kg
Shed for tractor	4.40E-04	m ²
Shed for machinery tillage	0.00E+00	m ²
Shed for machinery general	4.39E-03	m ²
Soil emission from tractor tyre abrasion	Valeur	Unité
Zn	3.35E-01	g/(ha.a)
Pb	5.44E-02	g/(ha.a)
Cd	1.26E-02	g/(ha.a)
Soil emission from machinery tyre abrasion	Valeur	Unité
Zn	8.89E-02	g/(ha.a)
Pb	1.44E-02	g/(ha.a)
Cd	3.33E-03	g/(ha.a)

Field cultivator

Paramètres

(Ils sont récupérés de la boîte violette "Base de données")

Paramètres tracteur

Poids	1850	kg	hyp > donnée d'Ecoinvent
Durée de vie	6000	h	
Puissance nominale	27.213426	kW	hyp > donnée d'Ecoinvent
Espace de stockage	11	m ²	
Utilisation annuelle	500	h/an	
Part des pneus dans le tracteur	0.0975	kg pneus/kg tracteur	

Paramètres pneus tracteur

Durée de vie	2500	h
Part de caoutchouc perdu sur la durée	0.29	kg caoutchouc/kg pneus
Teneur en zinc	16	g/kg de pneus
Teneur en plomb	2.6	g/kg de pneus
Teneur en cadmium	0.6	g/kg de pneus

Paramètres outils agricoles (hors travail du sol)

Poids	0	kg
Espace de stockage	0	m ²
Utilisation annuelle	0	h/an
Durée de vie	0	h
Part des pneus dans la machine	0.0275	kg pneus/kg machine

Paramètres outils de travail du sol

Poids	902	kg
Espace de stockage	6.8	m ²
Utilisation annuelle	31	h/an
Durée de vie	480	h

Paramètres pneus outils agricoles

Durée de vie	2500	h
Part de caoutchouc perdu sur la durée	0.56	kg caoutchouc/kg pneus
Teneur en zinc	16	g/kg de pneus
Teneur en plomb	2.6	g/kg de pneus
Teneur en cadmium	0.6	g/kg de pneus

Paramètres hangar de stockage

Durée de vie hangar	50	ans
---------------------	----	-----

Base de donnéesDonnées de rapport 15 :
weight page 59/360, Tab. A. 10 , page 197/360

Tracteur	Tracteur (-29 kW)	Tracteur (30-64 kW)	Tracteur (65-94 kW)
Poids	1900	3300	5300
Durée de vie	6000	7200	7200
Puissance nominale	27.95	50	78
Espace de stockage	11.0	15.2	19.4
Utilisation annuelle	500	600	600

Machine agricole de travail du sol	-	Plough, 4 furrow	Spring tooth harrow	Rotary harrow	Roller, 2,5-3 m	Field/rotary cultivator
Poids		1039	538	1183	910	902
Espace de stockage		13.3	12.2	7	6.1	6.8
Utilisation annuelle		73	28	32	21	31
Durée de vie		480	540	360	500	480

Machine agricole (hors travail du sol)	-	Seeder	Hoe	Fertiliser spreader	Rotary mower	Rotary cultivator
Poids		507	559	193	643	902
Espace de stockage		8.4	12.2	3.8	6.1	6.8
Utilisation annuelle		35	29	80	28	28
Durée de vie		525	525	1000	600	600

Emissions de combustion			
Molécule	Facteur d'émission (g/kg diesel)	Facteur d'émission (g/h tracteur)*	Emission to air (g/(ha.a))
HC		25	2.50E+01
NOx		387	3.87E+02
CO		126	1.26E+02
CO2	3.12E+03		1.14E+04
SO2	1.01E+00		3.77E+00
CH4	1.29E-01		4.81E-01
C6H6	7.30E-03		2.72E-02
PM2,5	2.21E+00		6.50E+01
Cd	1.00E-05		3.73E-05
Cr	5.00E-05		1.86E-04
Cu	1.70E-03		6.34E-03
N2O	1.20E-01		4.48E-01
Ni	7.00E-05		2.61E-04
Zn	1.00E-03		3.73E-03
Benzo(a)pyrene	3.00E-05		1.12E-04
NH3	2.00E-02		7.46E-02
Se	1.00E-05		3.73E-05
PAH	3.29E-03		1.23E-02
Benzo(a)-Anthracene	8.00E-05		2.98E-04
Benzo(b)-Fluoranthracene	5.00E-05		1.86E-04
Chrysene	2.00E-04		7.46E-04
Dibenz(a,h)-Anthracene	1.00E-05		3.73E-05
Fluoranthene	4.50E-04		1.68E-03
Phenanthene	2.50E-03		9.32E-03

Rapport 15: Tab. A.10 , page
198/360 TILLAGE, ROTARY
CULTIVATOR

* Emissions variables en fonction des conditions de vitesse et de puissance effective du tracteur pendant l'opération

Fiche SimaPro opération agricole

Output	Amount	Unit
Tillage_37CV_1h1ha		1 ha

Inputs	Amount	Unit
Tractor, 4-wheel, agricultural {GLO} market for	0.3083	kg
Agricultural machinery, tillage {GLO} market for	1.88E+00	kg
Agricultural machinery, unspecified {GLO} market for	0.0000	kg
Diesel, at regional storage Diesel {Europe without Switzerland} market fo	3.7296	kg
Shed {GLO} market for	0.00483	m ²

Emissions to air	Amount	Unit	Location
NMVOC, non-methane volatile organic compounds, unspecified origin	2.50E-02	kg	air/low population density
Nitrogen oxides	3.87E-01	kg	air/low population density
Carbon monoxide, fossil	1.26E-01	kg	air/low population density
Carbon dioxide, fossil	1.14E+01	kg	air/low population density
Sulfur dioxide	3.77E-03	kg	air/low population density
Methane, fossil	4.81E-04	kg	air/low population density
Benzene	2.72E-05	kg	air/low population density
Particulates, < 2,5 um	6.50E-02	kg	air/low population density
Cadmium	3.73E-08	kg	air/low population density
Chromium	1.86E-07	kg	air/low population density
Copper	6.34E-06	kg	air/low population density
Dinitrogen monoxide	4.48E-04	kg	air/low population density
Nickel	2.61E-07	kg	air/low population density
Zinc	3.73E-06	kg	air/low population density
Benzo(a)pyrene	1.12E-07	kg	air/low population density
Ammonia	7.46E-05	kg	air/low population density
Selenium	3.73E-08	kg	air/low population density
PAH, Polycyclic aromatic hydrocarbons	1.23E-05	kg	air/low population density
Benzo(a)-Anthracene	2.98E-07	kg	air/low population density
Benzo(b)-Fluoranthracene	1.86E-07	kg	air/low population density
Chrysene	7.46E-07	kg	air/low population density
Dibenz(a,h)-Anthracene	3.73E-08	kg	air/low population density
Fluoranthene	1.68E-06	kg	air/low population density
Phenanthene	9.32E-06	kg	air/low population density

Emission to soil	Amount	Unit	Location
Zinc	4.24E-04	kg	soil/agricultural
Lead	6.88E-05	kg	soil/agricultural
Cadmium	1.59E-05	kg	soil/agricultural

Table B.23 Calculations in Excel sheet for basic operations (level 2) as "Tillage, by tractor and rotary cultivator {FR} 60CV (1h 1ha)".

Description de l'opération agricole			Proxy: tillage, rotary cultivator
Nom de l'opération		Tillage 60CV 1h1ha	
Données d'entrée	Valeur	Unité	
Durée de l'opération	1.00	h	
Chevaux vapeur metric (CV)	60.00	CV	
Puissance nominale	44.13	kW	
Consommation de carburant	7.2	l/h	
Puissance moyenne du tracteur pendant l'opération	34.4	kW	
Type de tracteur	Tracteur (30-64 kW)	Rotary cultivator (griffon en français)	
Machine agricole (hors travail du sol)	-		
Machine agricole de travail du sol	Field cultivator		

Rapport 15 ecoinvent:
Tab. A.10, p. 198/360

Résultats		
Infrastructure	Valeur	Unité
Tractor production	0.334714286	kg
Agricultural machinery, tillage, production	1.88	kg
Agricultural machinery, general, production	0.00	kg
Diesel, at regional storage	6.05	kg
Shed for tractor	5.07E-04	m ²
Shed for machinery tillage	0.00E+00	m ²
Shed for machinery general	4.39E-03	m ²
Soil emission from tractor tyre abrasion	Valeur	Unité
Zn	4.24E-01	g/(ha.a)
Pb	6.89E-02	g/(ha.a)
Cd	1.59E-02	g/(ha.a)
Soil emission from machinery tyre abrasion	Valeur	Unité
Zn	0.00E+00	g/(ha.a)
Pb	0.00E+00	g/(ha.a)
Cd	0.00E+00	g/(ha.a)

Paramètres			(Ils sont récupérés de la boîte violette "Base de données")
Paramètres tracteur			hyp > donnée de fiche
Poids	2343	kg	
Durée de vie	7000	h	
Puissance nominale	44.16	kW	
Espace de stockage	15.2	m ²	
Utilisation annuelle	600	h/an	
Part des pneus dans le tracteur	0.0975	kg pneus/kg tracteur	
Paramètres pneus tracteur			
Durée de vie	2500	h	
Part de caoutchouc perdu sur la durée de vie	0.29	kg caoutchouc/kg pneus	
Teneur en zinc	16	g/kg de pneus	
Teneur en plomb	2.6	g/kg de pneus	
Teneur en cadmium	0.6	g/kg de pneus	
Paramètres outils agricoles (hors travail du sol)			
Poids	0	kg	
Espace de stockage	0	m ²	
Utilisation annuelle	0	h/an	
Durée de vie	0	h	
Part des pneus dans la machine	0.0275	kg pneus/kg machine	
Paramètres outils de travail du sol			
Poids	902	kg	
Espace de stockage	6.8	m ²	
Utilisation annuelle	31	h/an	
Durée de vie	480	h	
Paramètres pneus outils agricoles			
Durée de vie	2500	h	
Part de caoutchouc perdu sur la durée de vie	0.56	kg caoutchouc/kg pneus	
Teneur en zinc	16	g/kg de pneus	
Teneur en plomb	2.6	g/kg de pneus	
Teneur en cadmium	0.6	g/kg de pneus	
Paramètres hangar de stockage			
Durée de vie hangar	50	ans	

Fiche SimaPro opération agricole

Output	Amount	Unit
Tillage_60CV_1h1ha	1	ha

Inputs	Amount	Unit
Tractor, 4-wheel, agricultural {GLO} market for	0.3347	kg
Agricultural machinery, tillage {GLO} market for	1.88E+00	kg
Agricultural machinery, unspecified {GLO} market for	0.0000	kg
Diesel, at regional storageDiesel {Europe without Switzerland} market fo	6.0480	kg
Shed {GLO} market for	0.00489	m ²

Emissions to air	Amount	Unit	Location
NMVOOC, non-methane volatile organic compounds, unspecified origin	1.00E-02	kg	air/low population density
Nitrogen oxides	1.13E-01	kg	air/low population density
Carbon monoxide, fossil	1.40E-02	kg	air/low population density
Carbon dioxide, fossil	1.88E+01	kg	air/low population density
Sulfur dioxide	6.11E-03	kg	air/low population density
Methane, fossil	7.80E-04	kg	air/low population density
Benzene	4.42E-05	kg	air/low population density
Particulates, < 2,5 um	5.77E-02	kg	air/low population density
Cadmium	6.05E-08	kg	air/low population density
Chromium	3.02E-07	kg	air/low population density
Copper	1.03E-05	kg	air/low population density
Dinitrogen monoxide	7.26E-04	kg	air/low population density
Nickel	4.23E-07	kg	air/low population density
Zinc	6.05E-06	kg	air/low population density
Benzo(a)pyrene	1.81E-07	kg	air/low population density
Ammonia	1.21E-04	kg	air/low population density
Selenium	6.05E-08	kg	air/low population density
PAH, Polycyclic aromatic hydrocarbons	1.99E-05	kg	air/low population density
Benz(a)-Anthracene	4.84E-07	kg	air/low population density
Benzo(b)-Fluoranthracene	3.02E-07	kg	air/low population density
Chrysene	1.21E-06	kg	air/low population density
Dibenz(a,h)-Anthracene	6.05E-08	kg	air/low population density
Fluoranthene	2.72E-06	kg	air/low population density
Phenanthrene	1.51E-05	kg	air/low population density

Emission to soil	Amount	Unit	Location
Zinc	4.24E-04	kg	soil/agricultural
Lead	6.89E-05	kg	soil/agricultural
Cadmium	1.59E-05	kg	soil/agricultural

Table B.24 Calculations in Excel sheet for basic operations (level 2) as "Tillage, by tractor and rotary cultivator {FR}| 75CV (1h 1ha)".

Description de l'opération agricole			Proxy: tillage, rotary cultivator
Nom de l'opération		Tillage 75CV 1h1ha	
Données d'entrée		Valeur	Unité
Durée de l'opération		1.00	h
Chevaux vapeur metric (CV)		75.00	CV
Puissance nominale		55.16	kW
Consommation de carburant		9	l/h
Puissance moyenne du tracteur pendant l'opération		34.4	kW
Type de tracteur		Tracteur (30-64 kW)	
Machine agricole (hors travail du sol)		-	
Machine agricole de travail du sol		Field/rotary cultivator	Rotary cultivator (griffon en français)

Rapport 15 ecoinvent:
Tab. A.10, p. 198/360

Résultats			
Infrastructure		Valeur	Unité
Tractor production		0.520833333	kg
Agricultural machinery, tillage, production		1.88	kg
Agricultural machinery, general, production		0.00	kg
Diesel, at regional storage		7.56	kg
Shed for tractor		5.07E-04	m ²
Shed for machinery tillage		0.00E+00	m ²
Shed for machinery general		4.39E-03	m ²
Soil emission from tractor tyre abrasion		Valeur	Unité
Zn		6.79E-01	g/(ha.a)
Pb		1.10E-01	g/(ha.a)
Cd		2.54E-02	g/(ha.a)
Soil emission from machinery tyre abrasion		Valeur	Unité
Zn		8.89E-02	g/(ha.a)
Pb		1.44E-02	g/(ha.a)
Cd		3.33E-03	g/(ha.a)

Field cultivator

Paramètres			(Ils sont récupérés de la boîte violette "Base de données")
Paramètres tracteur			
Poids	3750	kg	hyp > donnée d'Ecoinvent
Durée de vie	7200	h	
Puissance nominale	55.16235	kW	hyp > donnée d'Ecoinvent
Espace de stockage	15.2	m ²	
Utilisation annuelle	600	h/an	
Part des pneus dans le tracteur	0.0975	kg pneus/kg tracteur	
Paramètres pneus tracteur			
Durée de vie	2500	h	
Part de caoutchouc perdu sur la durée de vie	0.29	kg caoutchouc/kg pneus	
Teneur en zinc	16	g/kg de pneus	
Teneur en plomb	2.6	g/kg de pneus	
Teneur en cadmium	0.6	g/kg de pneus	
Paramètres outils agricoles (hors travail du sol)			
Poids	0	kg	
Espace de stockage	0	m ²	
Utilisation annuelle	0	h/an	
Durée de vie	0	h	
Part des pneus dans la machine	0.0275	kg pneus/kg machine	
Paramètres outils de travail du sol			
Poids	902	kg	
Espace de stockage	6.8	m ²	
Utilisation annuelle	31	h/an	
Durée de vie	480	h	
Paramètres pneus outils agricoles			
Durée de vie	2500	h	
Part de caoutchouc perdu sur la durée de vie	0.56	kg caoutchouc/kg pneus	
Teneur en zinc	16	g/kg de pneus	
Teneur en plomb	2.6	g/kg de pneus	
Teneur en cadmium	0.6	g/kg de pneus	
Paramètres hangar de stockage			
Durée de vie hangar	50	ans	

Fiche SimaPro opération agricole

Output	Amount	Unit
Tillage_75CV_1h1ha		1 ha

Inputs	Amount	Unit
Tractor, 4-wheel, agricultural {GLO} market for	0.5208	kg
Agricultural machinery, tillage {GLO} market for	1.8792	kg
Agricultural machinery, unspecified {GLO} market for	0.0000	kg
Diesel, at regional storageDiesel {Europe without Switzerland} market for	7.5600	kg
Shed {GLO} market for	0.00489	m ²

Emissions to air	Amount	Unit	Location
NMVOOC, non-methane volatile organic compounds, unspecified origin	2.50E-02	kg	air/low population density
Nitrogen oxides	3.87E-01	kg	air/low population density
Carbon monoxide, fossil	1.26E-01	kg	air/low population density
Carbon dioxide, fossil	2.34E+01	kg	air/low population density
Sulfur dioxide	7.64E-03	kg	air/low population density
Methane, fossil	9.75E-04	kg	air/low population density
Benzene	5.52E-05	kg	air/low population density
Particulates, < 2,5 um	5.42E-02	kg	air/low population density
Cadmium	7.56E-08	kg	air/low population density
Chromium	3.78E-07	kg	air/low population density
Copper	1.29E-05	kg	air/low population density
Dinitrogen monoxide	9.07E-04	kg	air/low population density
Nickel	5.29E-07	kg	air/low population density
Zinc	7.56E-06	kg	air/low population density
Benzo(a)pyrene	2.27E-07	kg	air/low population density
Ammonia	1.51E-04	kg	air/low population density
Selenium	7.56E-08	kg	air/low population density
PAH, Polycyclic aromatic hydrocarbons	2.49E-05	kg	air/low population density
Benz(a)-Anthracene	6.05E-07	kg	air/low population density
Benzo(b)-Fluoranthracene	3.78E-07	kg	air/low population density
Chrysene	1.51E-06	kg	air/low population density
Dibenz(a,h)-Anthracene	7.56E-08	kg	air/low population density
Fluoranthene	3.40E-06	kg	air/low population density
Phenanthrene	1.89E-05	kg	air/low population density

Emission to soil	Amount	Unit	Location
Zinc	7.68E-04	kg	soil/agricultural
Lead	1.25E-04	kg	soil/agricultural
Cadmium	2.88E-05	kg	soil/agricultural

Appendix C

How the olive oil life cycle system was modelled in SimaPro respecting the three levels of theecoinvent database modelisation (Nemecek and Kägi, 2007).

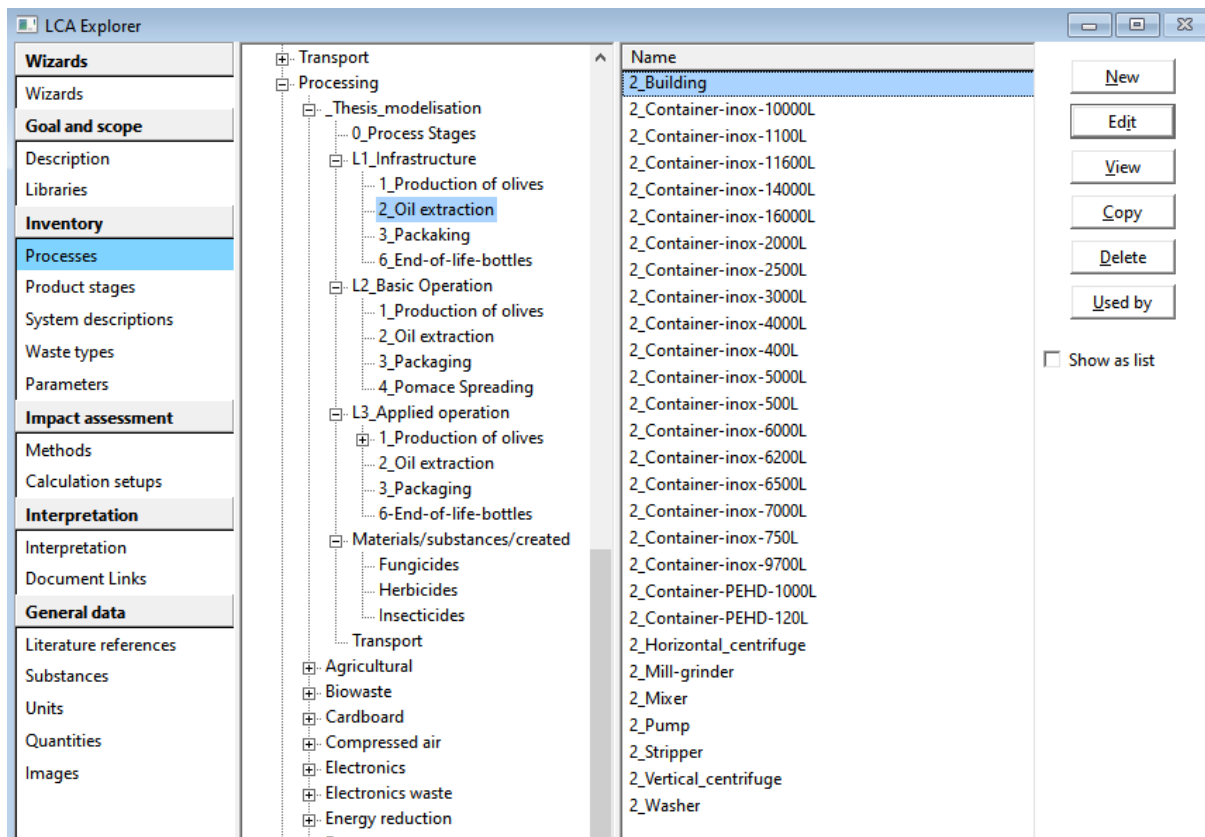
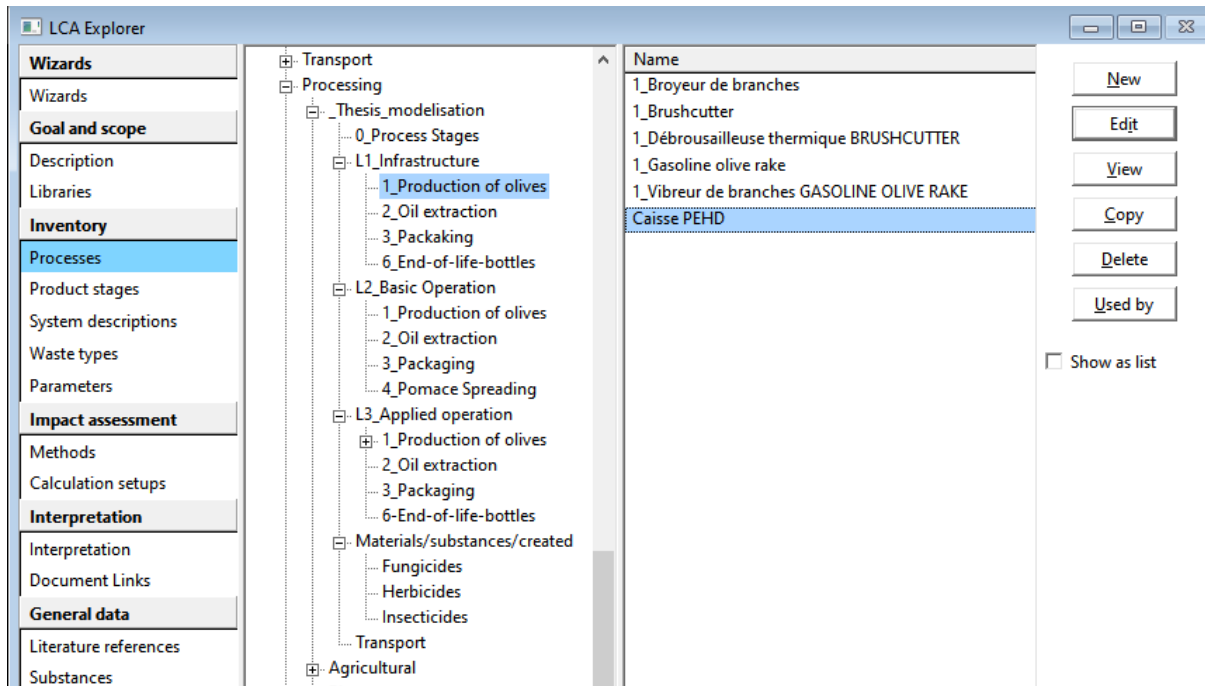

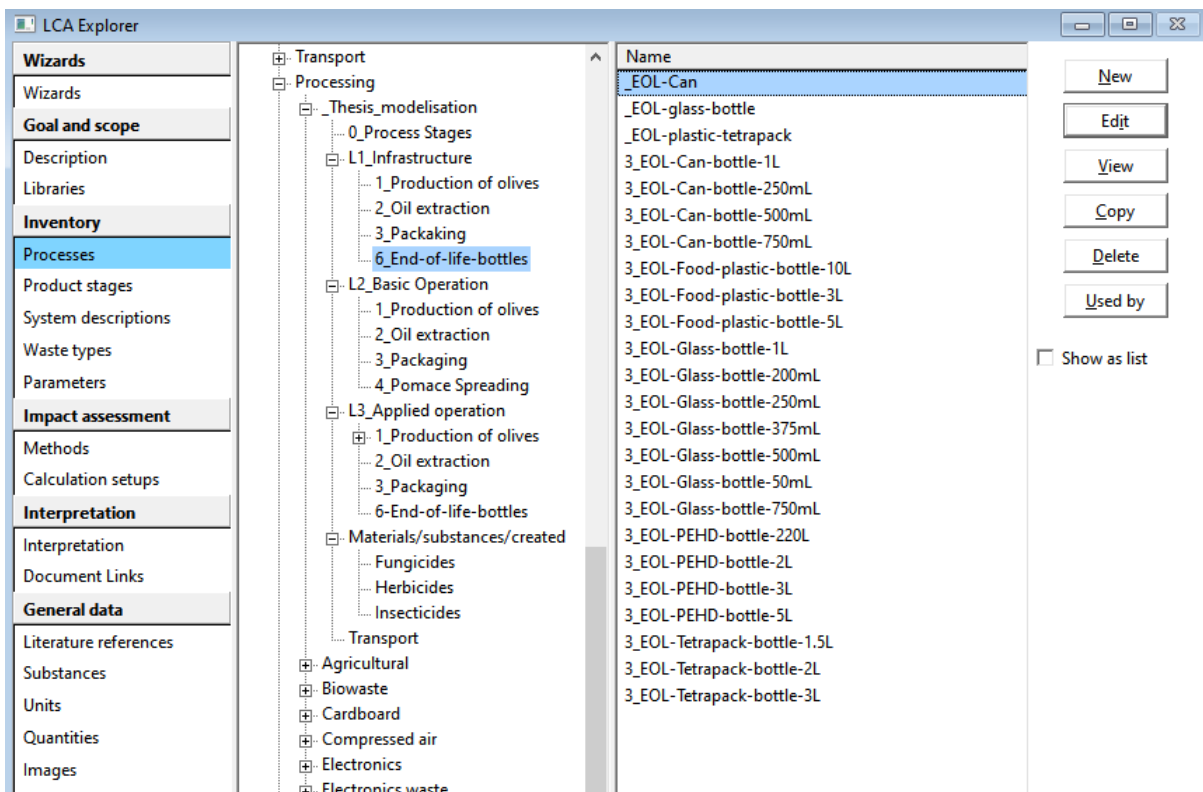
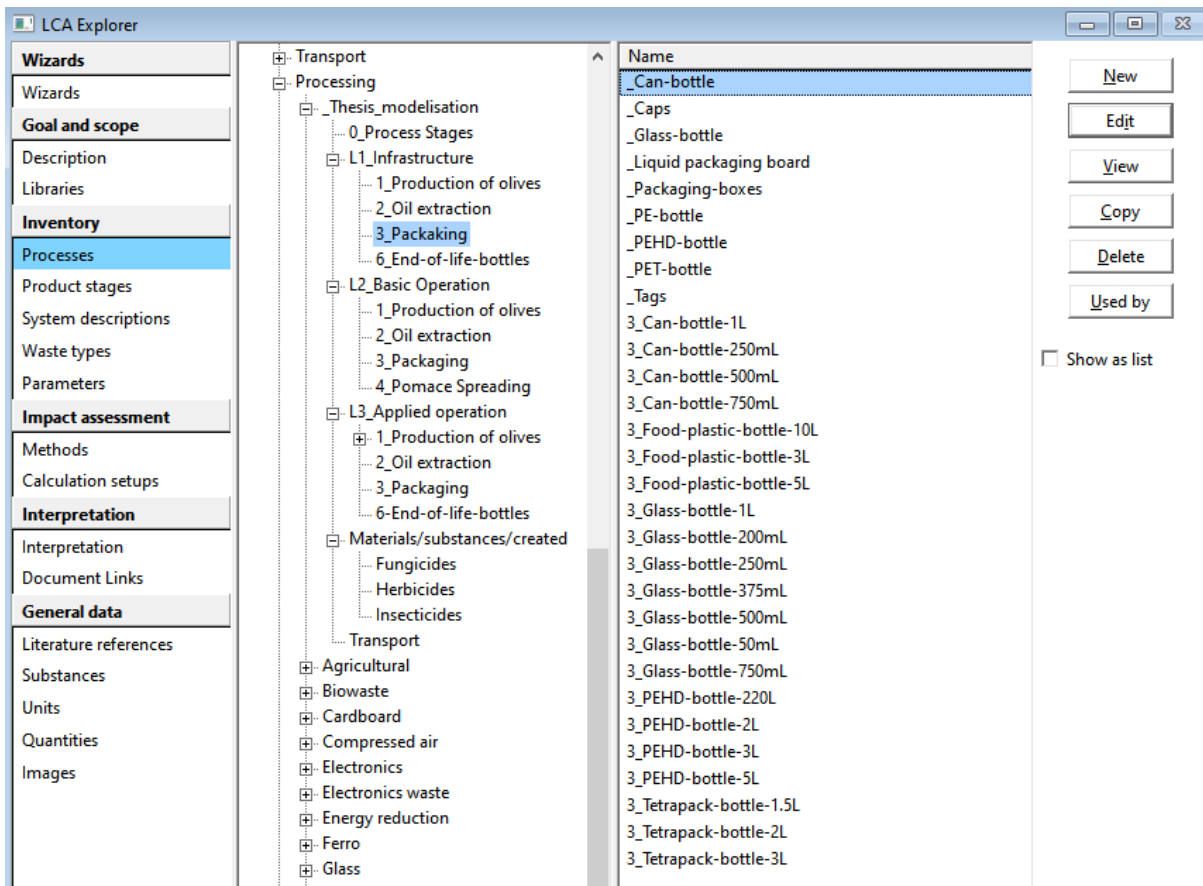

The screenshot shows the LCA Explorer interface with the 'Processes' tab selected. The left sidebar contains a navigation menu with categories like 'Wizards', 'Goal and scope', 'Inventory', 'Impact assessment', and 'Interpretation'. The main area is divided into a tree view on the left and a list view on the right. The tree view shows a hierarchy: Transport > Processing > Thesis_modelisation > 0_Process Stages > L1_Infrastructure > 1_Production of olives. The list view displays a table of processes with columns for Name and various parameters. The first process is 'Application of phytosanitary treatment, by field sprayer {FR} 37CV (/1h ha)'. Other processes include fertilising, pruning, and tillage.

Name
Application of phytosanitary treatment, by field sprayer {FR} 37CV (/1h ha)
Application of phytosanitary treatment, by field sprayer {FR} 50CV (/1h ha)
Application of phytosanitary treatment, by field sprayer {FR} 60CV (/1h ha)
Application of phytosanitary treatment, by field sprayer {FR} 75CV (/1h ha)
Application of phytosanitary treatment, by field sprayer {FR} 80CV (/1h ha)
Application of plant protection product, by spray wheelbarrow
Fertilising, by broadcaster {CH} processing Cut-off, U (EXCEL)
Fertilising, by broadcaster {FR} 11CV (1h 1ha)
Fertilising, by broadcaster {FR} 37CV (1h 1ha) 1850kg
Fertilising, by broadcaster {FR} 37CV (1h 1ha) 2343kg NOT TO USE
Fertilising, by broadcaster {FR} 50CV (1h 1ha)
Fertilising, by broadcaster {FR} 60CV (1h 1ha)
Fertilising, by broadcaster {FR} 60CV (1h 1ha) 2343 kg
Fertilising, by broadcaster {FR} 75CV (1h 1ha)
Fertilising, by broadcaster {FR} 80CV (1h 1ha)
Power sawing, without catalytic converter {RER} processing Cut-off, U COM
Pruning, by chainsaw (1h/ha)
Pruning, with crusher {FR} 50CV (1h 1ha)
Pruning, with crusher {FR} 60CV (1h 1ha)
Pruning, with crusher {FR} 75CV (1h 1ha)
Pruning, with crusher {FR} 80CV (1h 1ha)
Tillage by brushcutter (1h ha)
Tillage, by tractor and rotary cultivator {FR} 37CV (1h 1ha)
Tillage, by tractor and rotary cultivator {FR} 60CV (1h 1ha)
Tillage, by tractor and rotary cultivator {FR} 75CV (1h 1ha)

The screenshot shows the LCA Explorer interface with the 'Processes' tab selected. The tree view shows the hierarchy: Transport > Processing > Thesis_modelisation > 0_Process Stages > L1_Infrastructure > 2_Oil extraction. The list view is currently empty, indicating that the selected process is not yet fully defined or is a placeholder.

The screenshot shows the LCA Explorer interface with the 'Processes' tab selected. The tree view shows the hierarchy: Transport > Processing > Thesis_modelisation > 0_Process Stages > L1_Infrastructure > 3_Packaging. The list view is currently empty.

The screenshot shows the LCA Explorer interface with the 'Processes' tab selected. The tree view shows the hierarchy: Transport > Processing > Thesis_modelisation > 0_Process Stages > L2_Basic Operation > 4_Pomace Spreading. The list view shows a process named 'Agricultural Spreading, by tractor (/year)'. Below the name, there is a detailed description: 'Gabriela ESPADAS Update: Modification of <Fertilising, by broadcaster {FR} processing | Cut-off, U >, now for France at 1h 1ha, tractor (2343 kg, nominal power 60CV or 44,16 kW), fuel consumption FC of 7,2 l/h instead of 1.5h ha, 3000kg, 50kW and 4,2 l/h of FC.'

The screenshot shows the LCA Explorer interface. On the left is a sidebar with various menu items like 'Wizards', 'Goal and scope', 'Processes', etc. The main area displays a tree structure of processes under 'Transport' > 'Processing' > 'Thesis_modelisation'. The 'S1-CTI' process is selected. On the right, a list of processes is shown, including 'CTI-1_fertilisation', 'CTI-1_harvesting', 'CTI-1_irrigation', etc. Below the list, the details for 'S1-CTI' are displayed, including fertiliser types and their quantities.

The screenshot shows the 'Edit processing process' window for 'S5-CTI_fertilisation'. It has tabs for 'Documentation', 'Input/output', 'Parameters', and 'System description'. The 'Input/output' tab is active, showing a table of products, inputs, and outputs.

Products									
Outputs to technosphere: Products and co-products									
Output	Amount	Unit	Quantity						
S5-CTI_fertilisation	1	ha	Area						
Inputs									
Inputs from technosphere: materials/fuels									
Input	Amount	Unit	Distrib	SD2 or 2	Comment				
Fertilising, by broadcaster {FR} 60CV (1h 1ha)	4,5	ha	Logn	1,07	(1,1,1,2,na)1,5+3h, Niveau 2 Opération agricole Basic operation				
Nitrogen fertiliser, as N {GLO} nutrient supply from manure, solid, cattle Cut-off, U	33,5	kg	Logn	1,21	(1,1,1,2,na)5ton Fumier de brebis, ovine = manure of ewe, ovine / cattle = bétail, bovin http://www.web-agri.fr/conduite-elevage/culture-fourrage/article/i				
Phosphate fertiliser, as P2O5 {GLO} nutrient supply from manure, solid, cattle Cut-off, U	20	kg	Logn	1,21	(na,na,na,na,na)5ton Fumier de brebis, 5*4=20				
Potassium fertiliser, as K2O {GLO} nutrient supply from manure, solid, cattle Cut-off, U	60	kg	Logn	1,21	(1,1,1,2,3,na)5ton Fumier de brebis, 5*12=60				
Nitrogen fertiliser, as N {GLO} market for Cut-off, U	66	kg	Logn	1,07	(1,1,1,2,2,na)600 kg NPK Phoskali (11-8-15), 600*0,11=66				
Phosphate fertiliser, as P2O5 {GLO} market for Cut-off, U	48	kg	Logn	1,07	(1,1,1,2,2,na)600 kg NPK Phoskali (11-8-15), 600*0,08=48				
Potassium fertiliser, as K2O {GLO} market for Cut-off, U	90	kg	Logn	1,07	(1,1,1,2,2,na)600 kg NPK Phoskali (11-8-15), 600*0,15=90				
Sodium borates {GLO} market for Cut-off, U	0,6	kg	Logn	1,07	(1,1,1,2,2,na)3kg Solubor à 20%, 3*0,20=0,6				
Outputs									
Emissions to air									
Sub-compartment	Amount	Unit	Distribution	SD2 or 2SD	Min	Max			
Ammonia, FR	15,95042056	kg	Undefined						
Dinitrogen monoxide	2,124375	kg	Undefined						
Nitrogen oxides	0,44611875	kg	Undefined						
Emissions to water									
Nitrate	132,19	kg	Undefined						
Emissions to soil									

Edit processing process 'CTI-1_harvesting'

Documentation | **Input/output** | Parameters | System description

Products

Outputs to technosphere: Products and co-products	Amount	Unit	Quantity	Allocation %	Category	Comment
CTI-1_harvesting	1	ha	Area	100 %	._Thesis_modelisa...S1-CTI	Récolte: 1300 kg/ha/an

Add

Outputs to technosphere: Avoided products

Amount	Unit	Distribution	SD2 or 2SD	Min
Add				

Inputs

Inputs from nature

Sub-compartment	Amount	Unit	Distribution	SD2 or 2SD	Min
Add					

Inputs from technosphere: materials/fuels

Amour	Unit	Comment
Caisse PEHD	20/15 p	15 ans/20 caisses
Polyethylene terephthalate, granulate, amorphous (RER) production Cut-	(200*5 kg	Filets PET Polyéthylène : F 1031 95 g/m2, 10 ans, 10X5m (2 par arbre) (chez diatex); 100 arbres donc 200 fillets

Add

Edit processing process 'CTI-3_Irrigation'

Documentation | **Input/output** | Parameters | System description

Products

Outputs to technosphere: Products and co-pr	Amount	Unit	Quantity	Allocation %	Comment
CTI-3_Irrigation	1	ha	Area	100	Quantité d'eau utilisé pour irriguer 1ha ES: - FR: Origine de l'eau dans un canal qui livre l'eau sous pression, 0,12 €/ m3

Add

Outputs to technosphere: Avoided products

Amount	Unit	Distribution	SD2 or 2SD	Min
Add				

Inputs

Inputs from nature

Sub-compartment	Amount	Unit	Distribution	SD2 or 2SD	Min
Add					

Inputs from technosphere: materials/fuels

Amour	Unit	Comment
Irrigation (FR) irrigation, drip Cut-off, U	800 m3	Inventory refers to the production and supply of 1 m3 of fresh water for irrigation. This dataset is created as a child of the global dataset, i.e. some of the values are inherited from the global dataset and some are country-specific. Following values are edited, because they are country specific: amount of water withdrawn from the ground, amount of water withdrawn from the surface waters and the annual production volume.

Edit processing process 'CTI-4_Irrigation'

Documentation | **Input/output** | Parameters | System description

Outputs to technosphere: Products and co-pr

Amount	Unit	Quantity	Allocation %	Comment	
CTI-4_Irrigation	1	ha	Area	100 %	Quantité d'eau utilisé pour irriguer 1ha Irrigation par micro aspersion 2h par ha par an = 1350m3 = sprinkler Tubes à changer tous les 10 ans

Add

Outputs to technosphere: Avoided products

Amount	Unit	Distribution	SD2 or 2SD	Min
Add				

Inputs

Inputs from nature

Sub-compartment	Amount	Unit	Distribution	SD2 or 2SD	Min
Add					

Inputs from technosphere: materials/fuels

Amour	Unit	Comment
Irrigation (FR) irrigation, sprinkler Cut-off, U	1350 m3	Inventory refers to the production and supply of 1 m3 of fresh water for irrigation. This dataset is created as a child of the global dataset, i.e. some of the values are inherited from the global dataset and some are country-specific. Following values are edited, because they are country specific: amount of water withdrawn from the ground, amount of water withdrawn from the surface waters and the annual production volume.

Documentation							Input/output		Parameters		System description		
Outputs to technosphere: Products and co-products							Amount	Unit	Quantity	Allocation %	Comment		
S2-CTD_phytosanitary treatment (Contrôle de maladies)							1	ha	Area	100 %	Niveau 3, herbicide et insecticide		
Add													
Outputs to technosphere: Avoided products							Amount	Unit	Distribution	SD2 or 2SD	Min		
Add													
Inputs													
Inputs from nature							Sub-compartment	Amount	Unit	Distribution	SD2 or 2SD	Min	
Add													
Inputs from technosphere: materials/fuels							Amount	Unit	Comment				
Application of phytosanitary treatment, by field sprayer {FR} 60CV (/1h)							1,5	ha	Niveau 2				
Krésoxim-méthyl (strobi-DF)							0,2	kg	Created by GE				
Copper (sulfate) Bouille Bordelaise							12,5	kg	Created by GE Bouille Bordelaise (Sulfate de cuivre) 1 traitements par an 20% cuivre ; 12,5 kg/ha/application 12,5kg*0,20= 2,5kg de sulfate de cuivre				
Add													
Inputs from technosphere: electricity/heat							Amount	Unit	Distribution	SD2 or 2SD	Min		
Add													
Outputs													
Emissions to air							Sub-compartment	Amount	Unit	Distribution	SD2 or 2SD	Min	
Add													
Emissions to water							Sub-compartment	Amount	Unit	Distribution	SD2 or 2SD	Min	
Add													
Emissions to soil							Sub-compartment	Amount	Unit	Comment			
Copper sulfate							agricultural	2,5	kg	100% sol			
Kresoxim-methyl							agricultural	0,2*0,5 = 0,1	kg	100% sol Strobi-DF, Krésoxim-méthyl 500g/kg			

Edit processing process 'CTI-3_phytosanitary treatment (Contrôle de parasites)'

Documentation	Input/output	Parameters	System description			
Outputs to technosphere: Products and co-products						
CTI-3_phytosanitary treatment (Contrôle de parasites)	1	ha	Area	100 %	_Thesis_modelisa...S3-CTI	Niveau 3
Add						
Outputs to technosphere: Avoided products						
Add						
Inputs						
Inputs from nature						
Add						
Inputs from technosphere: materials/fuels						
Application of phytosanitary treatment, by field sprayer (FR) 37CV (/1h ha)	4,5	ha				Niveau 2
Dimethoate	2,25	l				Created by GE 3 traitements à 750 ml par application mélangée à 1000 L d'eau
Lambda-cyhalothrin (Karate Xpress) /L	0,6	l				Created by GE 2 traitements à 0,3L/ha/app, dilué dans 1000L eau
Irrigation (FR) market for Cut-off, U	5	m3				3000 L pour le Dimethoate et 2000L pour le Lambda-cyhalothrine
Add						
Inputs from technosphere: electricity/heat						
Add						
Outputs						
Emissions to air						
Add						
Emissions to water						
Add						
Emissions to soil						
Dimethoate	agricultural	1,3*2,25 = 2,93	kg			densité 1,3 kg par litre
Lambda-cyhalothrin	agricultural	0,6*(0,05*0,47) = 0,0141	kg			Masse volumique apparente de Karate Xpress : 0,47 g/mL @ fiche technique de fournisseur Masse volumique apparente de Lambda-cyhalothrine : 1,33 g/cm3 = 1,33 kg/L Sur E-phy : Karate Xpress = 5% Lambda-cyhalothrine d'où : 0,05 * 0,47 g/mL de Karate Xpress = 0,0235 g de Lamba-cyhalothrine dans 1 mL de Karate Xpress = 0,0235 kg de Lamba-cyhalothrine dans 1 L de Karate Xpress masse volumique de lambda : 1,33 g/cm3 0,6 L de Karate Xpress avec 5% de Lambda

Edit processing process 'BTI_pruning'

Documentation	Input/output	Parameters	System description			
Outputs to technosphere: Products and co-products						
S10-OTI_pruning	1	ha	Area	100 %		Info dans documentation
Add						
Outputs to technosphere: Avoided products						
Add						
Inputs						
Inputs from nature						
Add						
Inputs from technosphere: materials/fuels						
Pruning, with crusher (FR) 80CV (1h 1ha)	3	ha				
Pruning, by chainsaw (1h/ha)	25	hr				
Add						

Edit processing process 'CTI-3_tillage'

Documentation		Input/output		Parameters		System description	
Outputs to technosphere: Products and co-pr							
CTI-3_tillage	1	ha	Area	100 %	Niveau 3		
Add							
Outputs to technosphere: Avoided products							
Add							
Inputs							
Inputs from nature							
Add							
Inputs from technosphere: materials/fuels							
Tillage, by tractor and rotary cultivator {FR}	37CV (1h 1ha)	8	ha		Niveau 2 : 8 h ha (griffons)		
Application of phytosanitary treatment, by field sprayer {FR}	37CV (/1h)	4	ha		Niveau 2: 4 h ha pour application de glyphosate		
Glyphosate		25	l		Created by GE car original en kg		
Irrigation {FR} market for Cut-off, U		0,6	m3		25L Glyphosate dans 600L eau		
Add							
Inputs from technosphere: electricity/heat							
Add							
Outputs							
Emissions to air							
Add							
Emissions to water							
Add							
Emissions to soil							
Glyphosate	agricultural	25*1,7 = 42,5	kg		Densité de 1,7 g/cm ³		
Add							
Final waste flows							
Add							

LCA Explorer

- Wizards
 - Wizards
 - Goal and scope
 - Description
 - Libraries
 - Inventory
 - Processes**
 - Product stages
 - System descriptions
 - Waste types
 - Parameters
 - Impact assessment
 - Methods
 - Calculation setups
 - Interpretation

Transport

Processing

- _Thesis_modelisation
 - _0_Process Stages
 - L1_Infrastructure
 - 1_Production of olives
 - 2_Oil extraction
 - 3_Packaging
 - 6_End-of-life-bottles
 - L2_Basic Operation
 - 1_Production of olives
 - 2_Oil extraction
 - 3_Packaging
 - 4_Pomace Spreading
 - L3_Applied operation
 - 1_Production of olives
 - 2_Oil extraction**
 - 3_Packaging
 - 6-End-of-life-bottles

Name

- 2_1_Reception
- 2_2_Cleaning
- 2_3_Wet_Washing
- 2_4_Crushing(Milling)
- 2_5_Malaxation
- 2_6_Centrifugation-horizontal-2phase
- 2_7_Centrifugation-vertical
- 2_8_Pomace-stock
- 2_9_Oil-stock

Buttons: New, Edit, View, Copy, Delete, Used by, Show as list

LCA Explorer

- Wizards
 - Wizards
 - Goal and scope
 - Description
 - Libraries
 - Inventory
 - Processes**
 - Product stages
 - System descriptions
 - Waste types
 - Parameters
 - Impact assessment
 - Methods
 - Calculation setups
 - Interpretation

Processing

- _Thesis_modelisation
 - _0_Process Stages
 - L1_Infrastructure
 - 1_Production of olives
 - 2_Oil extraction
 - 3_Packaging
 - 6_End-of-life-bottles
 - L2_Basic Operation
 - 1_Production of olives
 - 2_Oil extraction
 - 3_Packaging
 - 4_Pomace Spreading
 - L3_Applied operation
 - 1_Production of olives
 - 2_Oil extraction
 - 3_Packaging**
 - 6-End-of-life-bottles

Name

- Bottling**

Buttons: New, Edit, View, Copy, Delete, Used by, Show as list

Edit processing process 'Bottling'

Documentation		Input/output		Parameters		System description	
Outputs to technosphere: Products and co-products		Amount	Unit	Quantity	Allocation %	Comment	
Bottling		1	l	Volume	100 %		
Add							
Outputs to technosphere: Avoided products		Amount	Unit	Distribution	SD2 or 2SD	Min	
Add							
Inputs							
Inputs from nature		Sub-compartment	Amount	Unit	Distribution	SD2 or 2SD	Min
Add							
Inputs from technosphere: materials/fuels		Amount	Unit	Comment			
3_Filling-bottles		1	l				
3_Glass-bottle-50mL		1,55E-2	p				
3_Glass-bottle-200mL		4,32E-2	p				
3_Glass-bottle-250mL		1,88E-2	p				
3_Glass-bottle-375mL		3,58E-3	p				
3_Glass-bottle-500mL		2,11E-1	p				
3_Glass-bottle-750mL		1,29E-2	p				
3_Glass-bottle-1L		0	p	Presse (pas 2-phases)			
3_Food-plastic-bottle-3L		3,69E-4	p				
3_Food-plastic-bottle-5L		1,16E-3	p				
3_Food-plastic-bottle-10L		9,07E-4	p				
3_PEHD-bottle-2L		4,74E-3	p				
3_PEHD-bottle-3L		7,66E-3	p				
3_PEHD-bottle-5L		8,41E-3	p				
3_PEHD-bottle-220L		1,43E-5	p				
3_Can-bottle-250mL		1,38E-3	p				
3_Can-bottle-500mL		1,29E-2	p				
3_Can-bottle-750mL		1,43E-3	p				
3_Can-bottle-1L		2,01E-3	p				
3_Tetrapack-bottle-1.5L		1,57E-3	p				
3_Tetrapack-bottle-2L		3,26E-2	p				
3_Tetrapack-bottle-3L		8,71E-4	p				
Add							

LCA Explorer

Wizards

Wizards

Goal and scope

Description

Libraries

Inventory

Processes

Product stages

System descriptions

Waste types

Parameters

- [-] L2_Basic Operation
 - 1_Production of olives
 - 2_Oil extraction
 - 3_Packaging
 - 4_Pomace Spreading
- [-] L3_Applied operation
 - 1_Production of olives
 - 2_Oil extraction
 - 3_Packaging
 - 6-End-of-life-bottles
- [-] Materials/substances/creat
 - Fungicides
 - Herbicides
 - Insecticides

Name

End-of-life_Bottles

New

Edit

View

Copy

Delete

Used by

Show as list

LCA Explorer

Wizards

Wizards

Goal and scope

Description

Libraries

Inventory

Processes

Product stages

System descriptions

Waste types

Parameters

Impact assessment

- [-] L2_Basic Operation
 - 1_Production of olives
 - 2_Oil extraction
 - 3_Packaging
 - 4_Pomace Spreading
- [-] L3_Applied operation
 - 1_Production of olives
 - 2_Oil extraction
 - 3_Packaging
 - 6-End-of-life-bottles
- [-] Materials/substances/creat
 - Fungicides
 - Herbicides
 - Insecticides
- Transport

Name

Copper (oxide) Nordox 75 WG

Copper (oxide) Nordox 75 WG GLO MARKET

Copper (sulfate) Bouille Bordelaise

Krésoxim-méthyl (strobi-DF)

Copper oxide (RER)| production | Cut-off, U 75%

New

Edit

View

Copy

Delete

Used by

Show as list

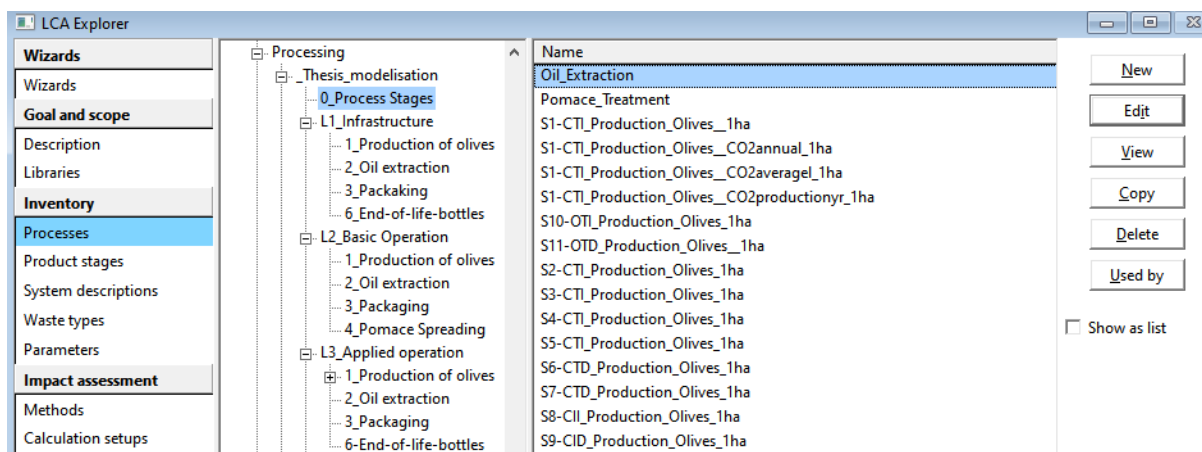
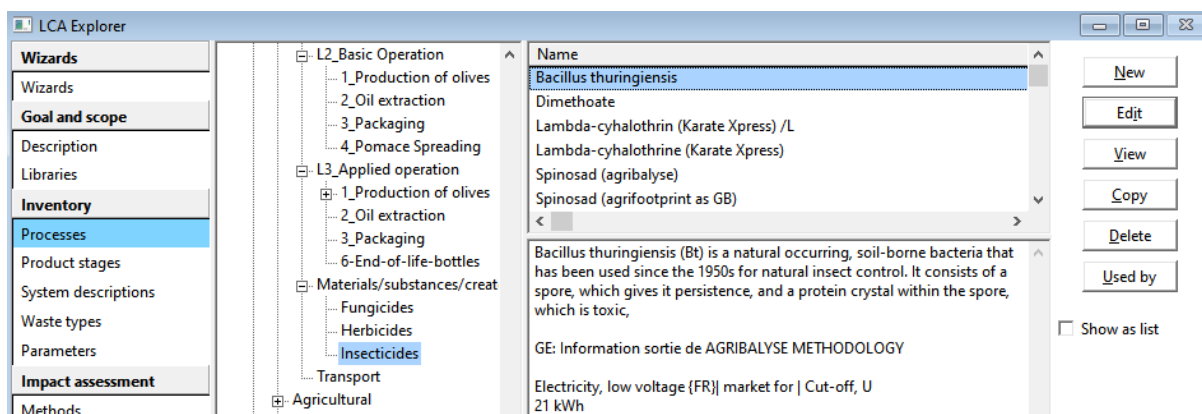
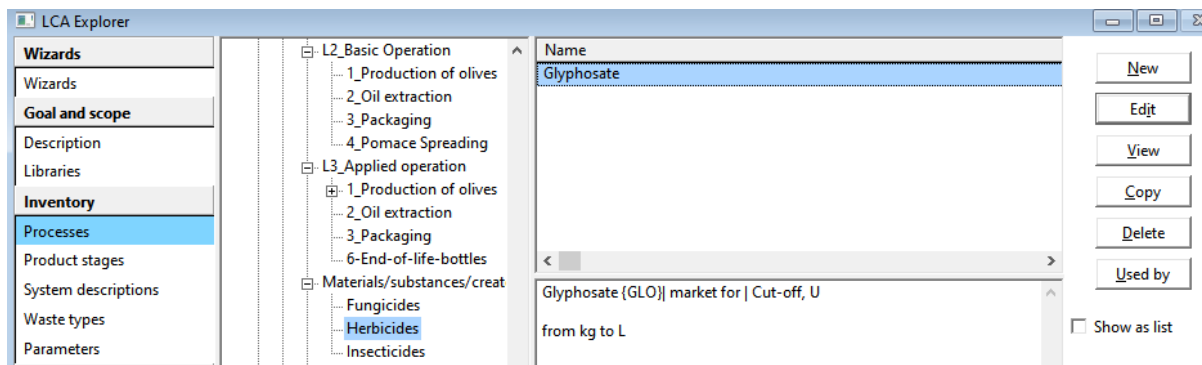

Edit processing process 'S1-CTI_Production_Olives_CO2annual_1ha'

Documentation	Input/output	Parameters	System description		
Outputs to technosphere: Products and co-products					
Amount	Unit	Quantity	Allocation %	Comment	
1	ha	Area	100 %		
Add					
Outputs to technosphere: Avoided products					
Amount	Unit	Distribution	SD2 or 2SD	Min	
Add					
Inputs					
Inputs from nature					
Sub-compartment	Amount	Unit	Distribution	SD2 or 2SD	Min
Add					
Inputs from technosphere: materials/fuels					
Amour	Unit	Comment			
CTI-1_Irrigation	1 ha				
CTI-1_pruning	1 ha				
CTI-1_fertilisation	1 ha				
CTI-1_phytosanitary treatment (Contrôle de maladies)	1 ha				
CTI-1_phytosanitary treatment (Contrôle de parasites)	1 ha				
CTI-1_tillage	1 ha				
CTI-1_harvesting	1 ha				
S1-CTI_CO2-stocked_annual	1 ha				
Add					

Edit processing process 'Oil_Extraction'

Documentation	Input/output	Parameters	System description		
Outputs to technosphere: Products and co-products					
Amount	Unit	Quantity	Allocation %	Comment	
1	l	Volume	100 %		
Add					
Outputs to technosphere: Avoided products					
Amount	Unit	Distribution	SD2 or 2SD	Min	
Add					
Inputs					
Inputs from nature					
Sub-compartment	Amount	Unit	Distribution	SD2 or 2SD	Min
Add					
Inputs from technosphere: materials/fuels					
Amour	Unit	Comment			
2_1_Reception	1 l				
2_2_Cleaning	1 l				
2_3_Wet_Washing	1 l				
2_4_Crushing(Milling)	1 l				
2_5_Malaxation	1 l				
2_6_Centrifugation-horizontal-2phase	1 l				
2_7_Centrifugation-vertical	1 l				
2_8_Pomace-stock	1 l				
2_9_Oil-stock	1 l				
2_Infrastructure_mill	1 l	Level II			
Add					

Edit processing process 'Pomace_Treatment'

Documentation	Input/output	Parameters	System description		
Products					
Outputs to technosphere: Products and co-products					
Amount	Unit	Quantity	Allocation %	Comment	
4000	kg	Mass	100 %	épandeurs à 4 tonnes OP / 1 heure	
Add					
Outputs to technosphere: Avoided products					
Amount	Unit	Distribution	SD2 or 2SD	Min	
Add					
Inputs					
Inputs from nature					
Sub-compartment	Amount	Unit	Distribution	SD2 or 2SD	Min
Add					
Inputs from technosphere: materials/fuels					
Amount	Unit	Comment			
Agricultural Spreading, by tractor (/year)	1/37,87 = 0,0264	year	Agricultural spreading 37.87 h/year		
Add					

Edit life cycle 'S1-CTI'							
Input/output		Parameters					
Name	Status	Comment					
S1-CTI	None						
Assembly	Amount	Unit	Distribution	SD2 or 2SD	Min	Max	Comment
	0		Undefined				
Processes	Amount	Unit	Distribution	SI	Comment		
S1-CTI_Production_Olives_1ha	1/286 = 0,0035	ha			286 L olive oil per ha		
Oil_Extraction	1*2,95 = 2,95	l			correction factor L/yr bottled vs L/yr received		
Bottling	1*2,95 = 2,95	l			correction factor L/yr bottled vs L/yr received		
Pomace_Treatment	4,39	kg	Undefined		4,3952 kg OP/L olive oil, 100% spreaded		
End-of-life_Bottles	1*2,95 = 2,95	l			correction factor L/yr bottled vs L/yr received		
Add							

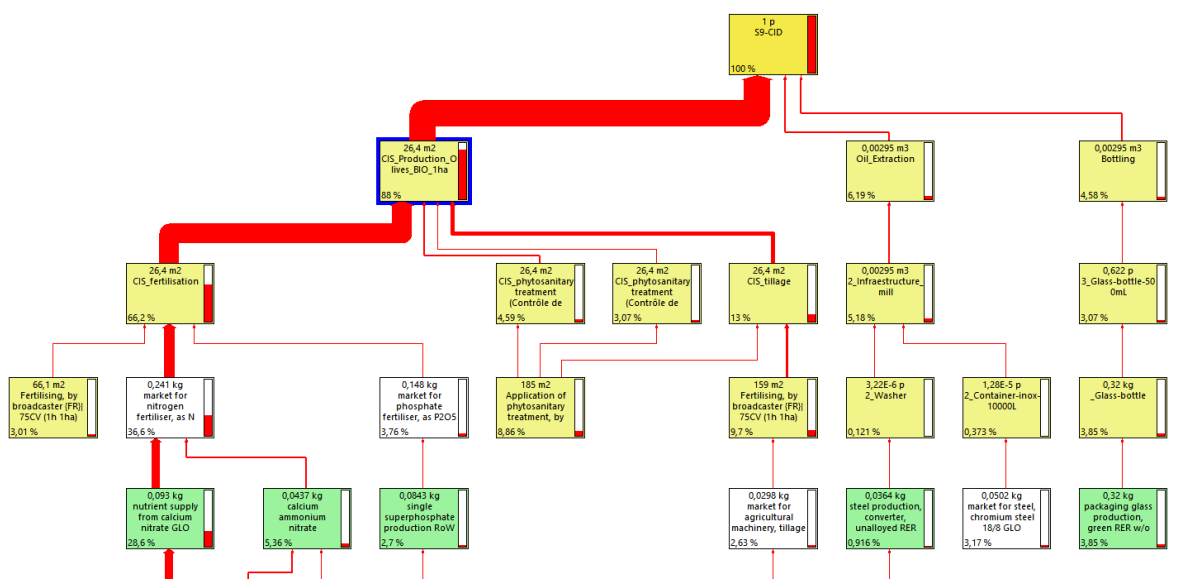
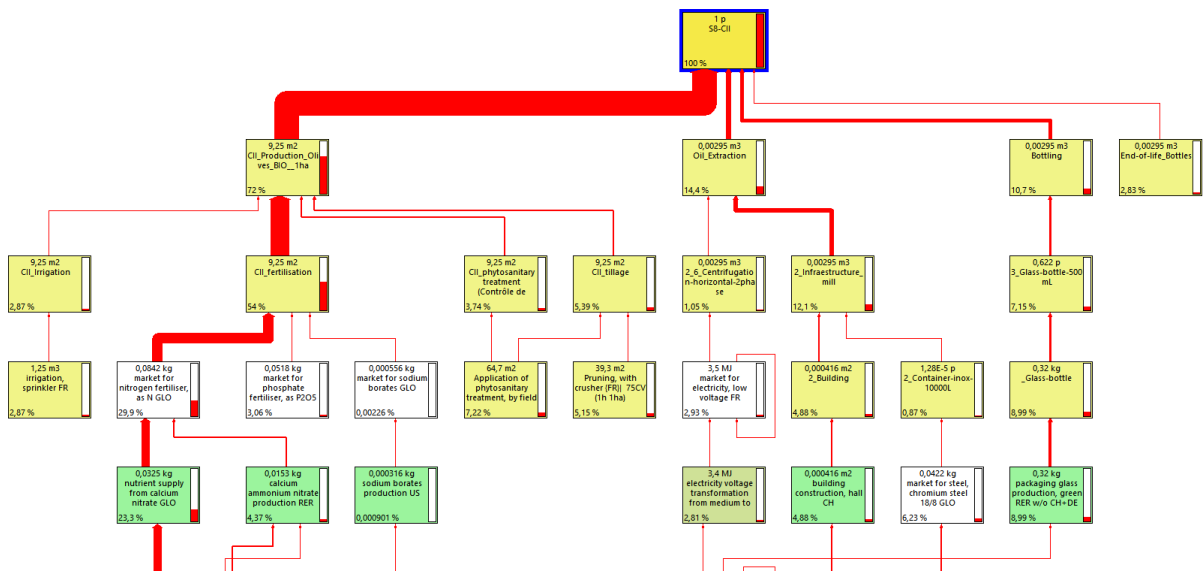

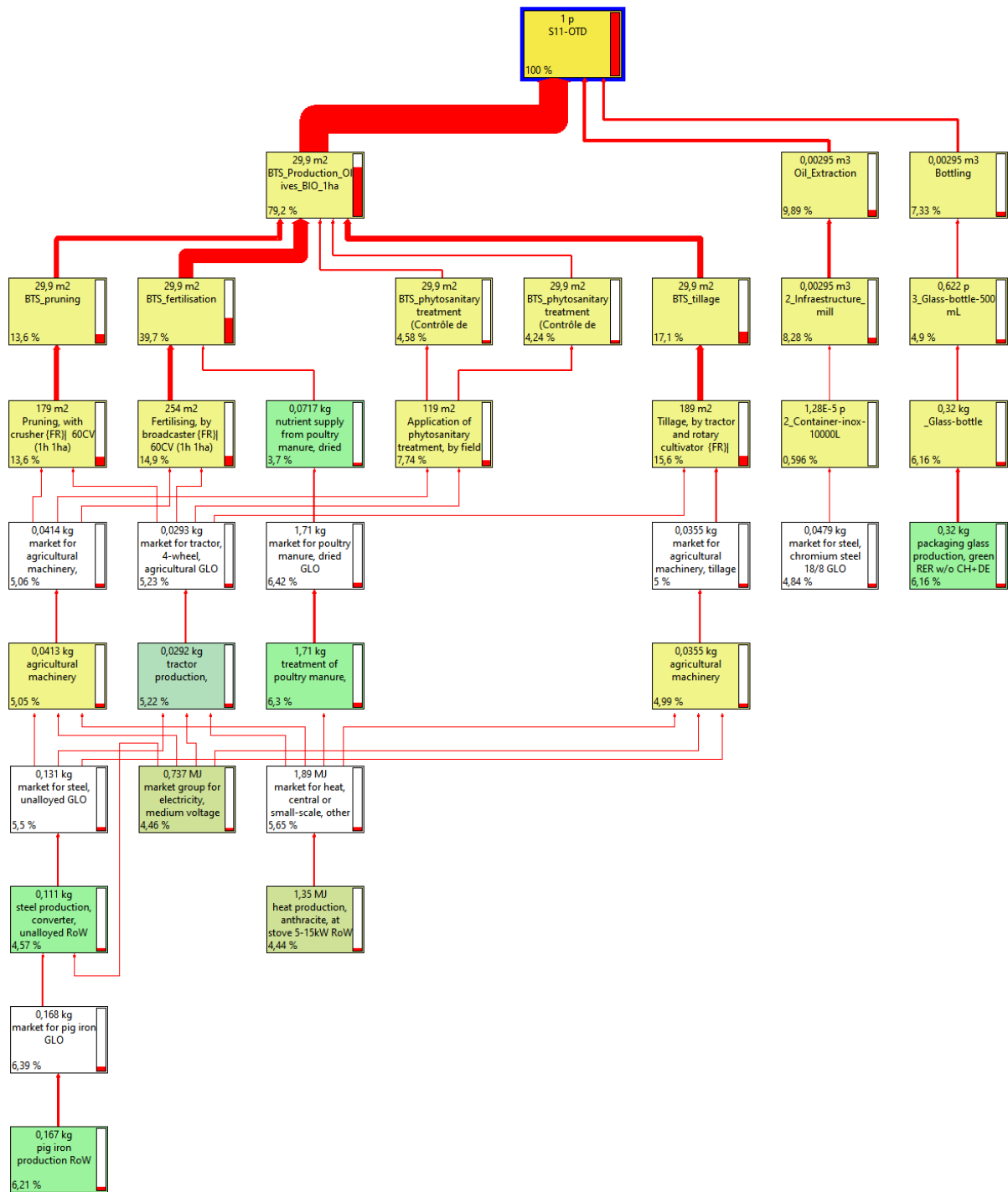

Appendix D

Calculations in Excel (level 3) of the emissions to air (ammonia, dinitrogen monoxide, nitrogen oxides, carbon monoxide, methane, SO₂, NMVOC, and particulate matter) and emission of nitrate to groundwater. IPCC Tier 1 Emission Factors.

S1-CTI

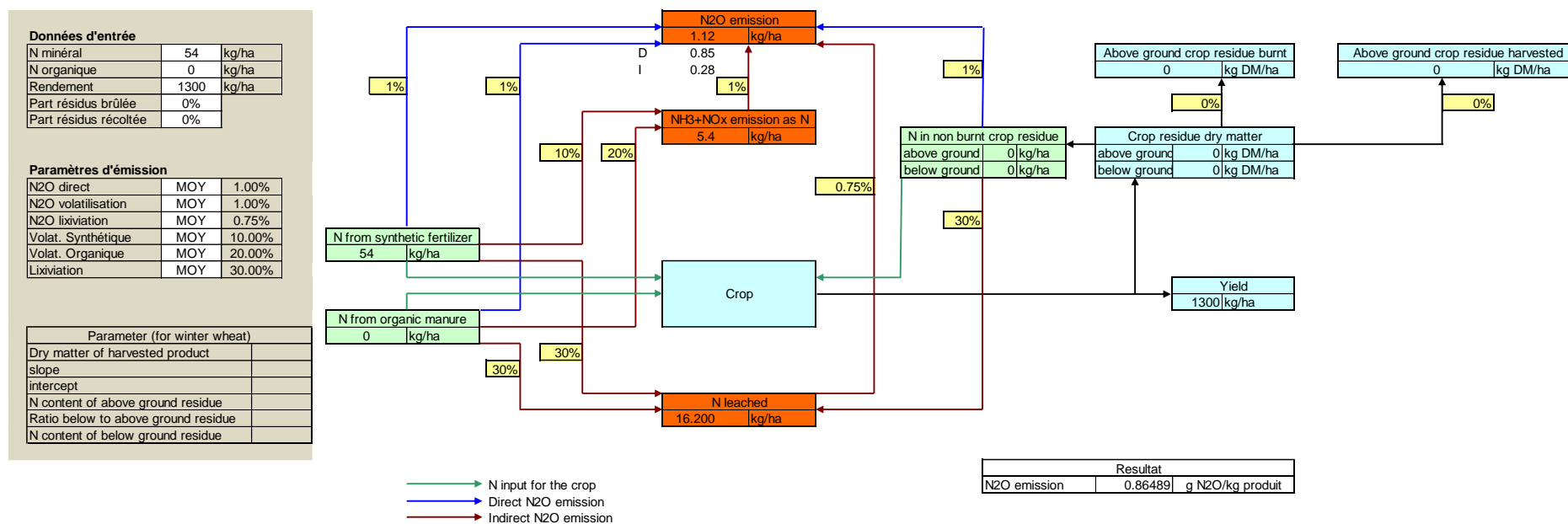

Appendix D

Emissions à renseigner dans Simapro			
output	Amount	Unit	
Produit	1300	kg	
Co-produit	0	kg	
Emission to air	Amount	Unit	Location
Ammonia	6.45151246	kg	air/low population density
Dinitrogen monoxide	1.12435714	kg	air/low population density
Nitrogen oxides	0.236115	kg	air/low population density
Carbon monoxide	0.00E+00	kg	air/low population density
Methane	0.00E+00	kg	air/low population density
SO2	0.00E+00	g	air/low population density
NMVOC	0.00E+00	kg	air/low population density
Particulate matter	0.00E+00	kg	air/low population density
Emission to ground water			
Nitrate	71.74	kg	water/ground

S2-CTI

Données d'entrée		
N minéral	39	kg/ha
N organique	0	kg/ha
Rendement	1237	kg/ha
Part résidus brûlée	0%	
Part résidus récoltée	0%	

Paramètres d'émission		
N2O direct	MOY	1.00%
N2O volatilisation	MOY	1.00%
N2O lixiviation	MOY	0.75%
Volat. Synthétique	MOY	10.00%
Volat. Organique	MOY	20.00%
Lixiviation	MOY	30.00%

Parameter (for winter wheat)	
Dry matter of harvested product	
slope	
intercept	
N content of above ground residue	
Ratio below to above ground residue	
N content of below ground residue	

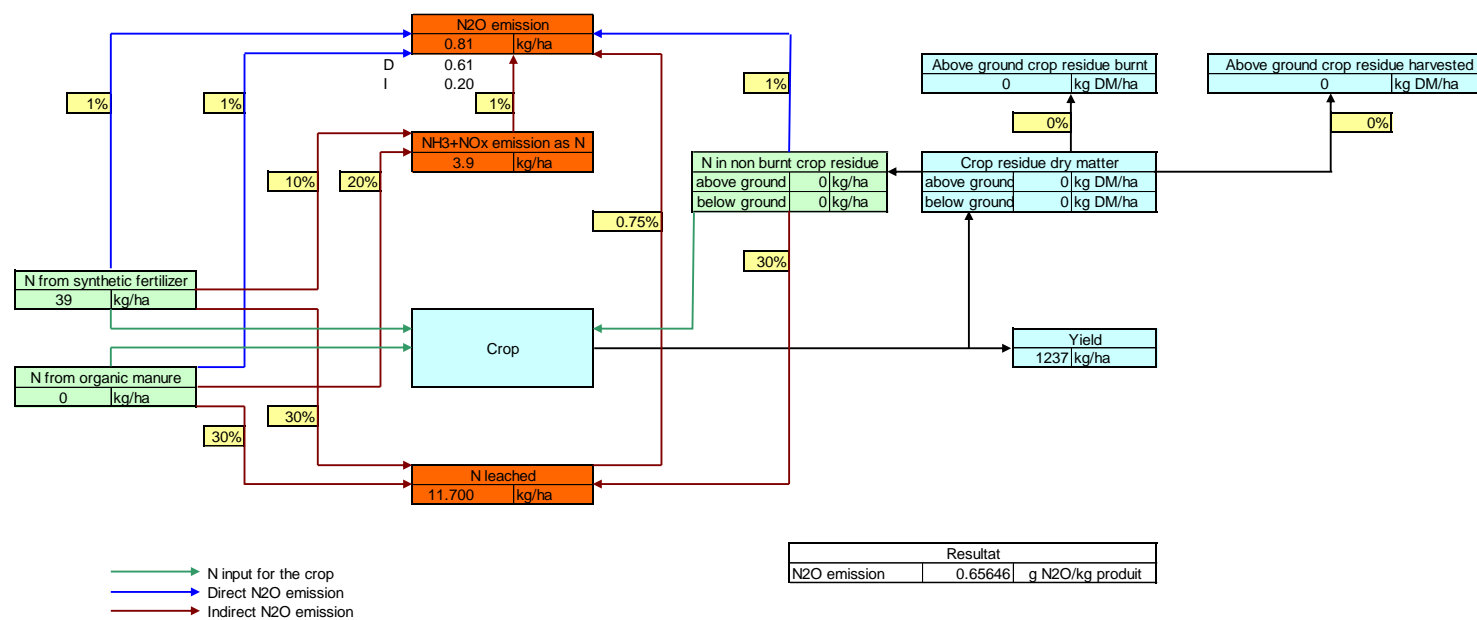

Resultat	
N2O emission	0.65646 g N2O/kg produit

Emissions à renseigner dans Simapro			
output	Amount	Unit	
Produit	1237	kg	
Co-produit	0	kg	
Emission to air			
	Amount	Unit	Location
Ammonia	4.65942567	kg	air/low population density
Dinitrogen monoxide	0.81203571	kg	air/low population density
Nitrogen oxides	0.1705275	kg	air/low population density
Carbon monoxide	0.00E+00	kg	air/low population density
Methane	0.00E+00	kg	air/low population density
SO2	0.00E+00	g	air/low population density
NMVOC	0.00E+00	kg	air/low population density
Particulate matter	0.00E+00	kg	air/low population density
Emission to ground water			
Nitrate	51.81	kg	water/ground

S3-CTI

Données d'entrée		
N minéral	36	kg/ha
N organique	0	kg/ha
Rendement	2700	kg/ha
Part résidus brûlée	0%	
Part résidus récoltée	0%	

Paramètres d'émission		
N2O direct	MOY	1.00%
N2O volatilisation	MOY	1.00%
N2O lixiviation	MOY	0.75%
Volat. Synthétique	MOY	10.00%
Volat. Organique	MOY	20.00%
Lixiviation	MOY	30.00%

Parameter (for winter wheat)	
Dry matter of harvested product	
slope	
intercept	
N content of above ground residue	
Ratio below to above ground residue	
N content of below ground residue	

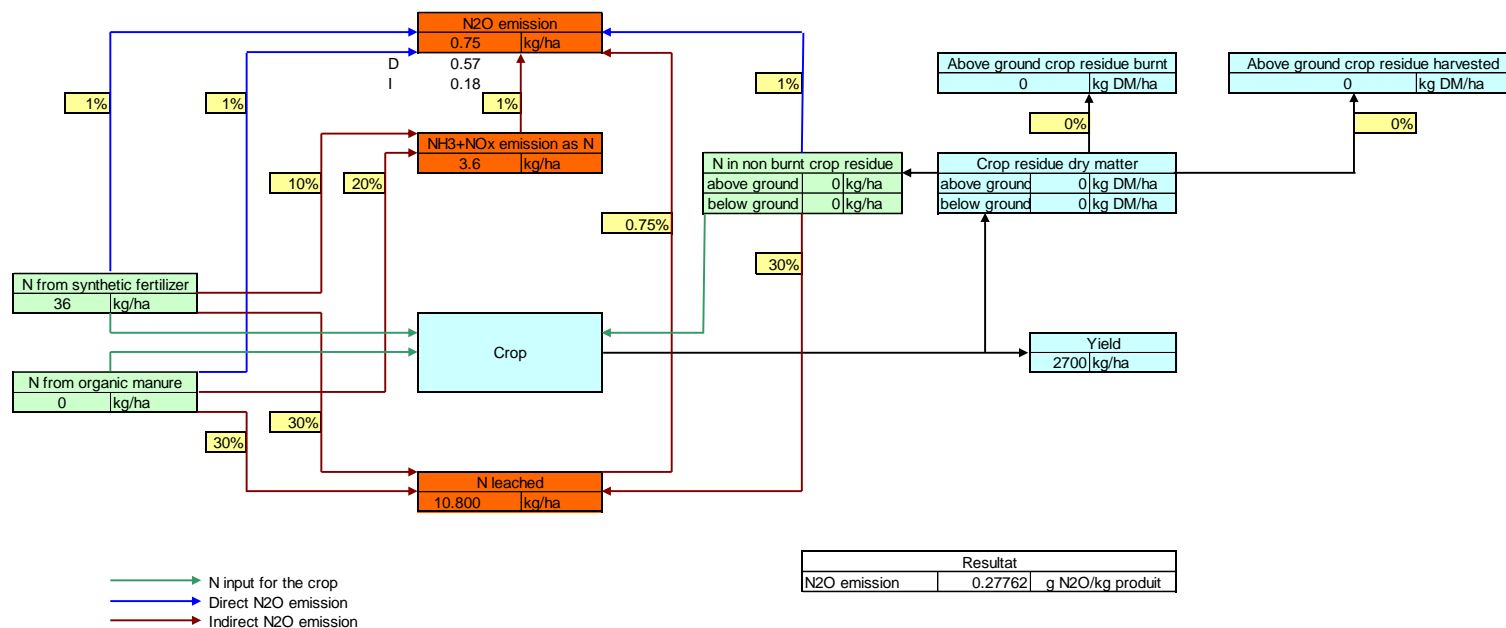

Emissions à renseigner dans Simapro			
output	Amount	Unit	
Produit	2700	kg	
Co-produit	0	kg	
Emission to air	Amount	Unit	Location
Ammonia	4.30100831	kg	air/low population density
Dinitrogen monoxide	0.74957143	kg	air/low population density
Nitrogen oxides	0.15741	kg	air/low population density
Carbon monoxide	0.00E+00	kg	air/low population density
Methane	0.00E+00	kg	air/low population density
SO2	0.00E+00	g	air/low population density
NMVOC	0.00E+00	kg	air/low population density
Particulate matter	0.00E+00	kg	air/low population density
Emission to ground water			
Nitrate	47.83	kg	water/ground

S4-CTI, S8-CII, S9-CID

Données d'entrée		
N minéral	91	kg/ha
N organique	0	kg/ha
Rendement	4000	kg/ha
Part résidus brûlée	0%	
Part résidus récoltée	0%	

Paramètres d'émission		
N2O direct	MOY	1.00%
N2O volatilisation	MOY	1.00%
N2O lixiviation	MOY	0.75%
Volat. Synthétique	MOY	10.00%
Volat. Organique	MOY	20.00%
Lixiviation	MOY	30.00%

Parameter (for winter wheat)	
Dry matter of harvested product	
slope	
intercept	
N content of above ground residue	
Ratio below to above ground residue	
N content of below ground residue	

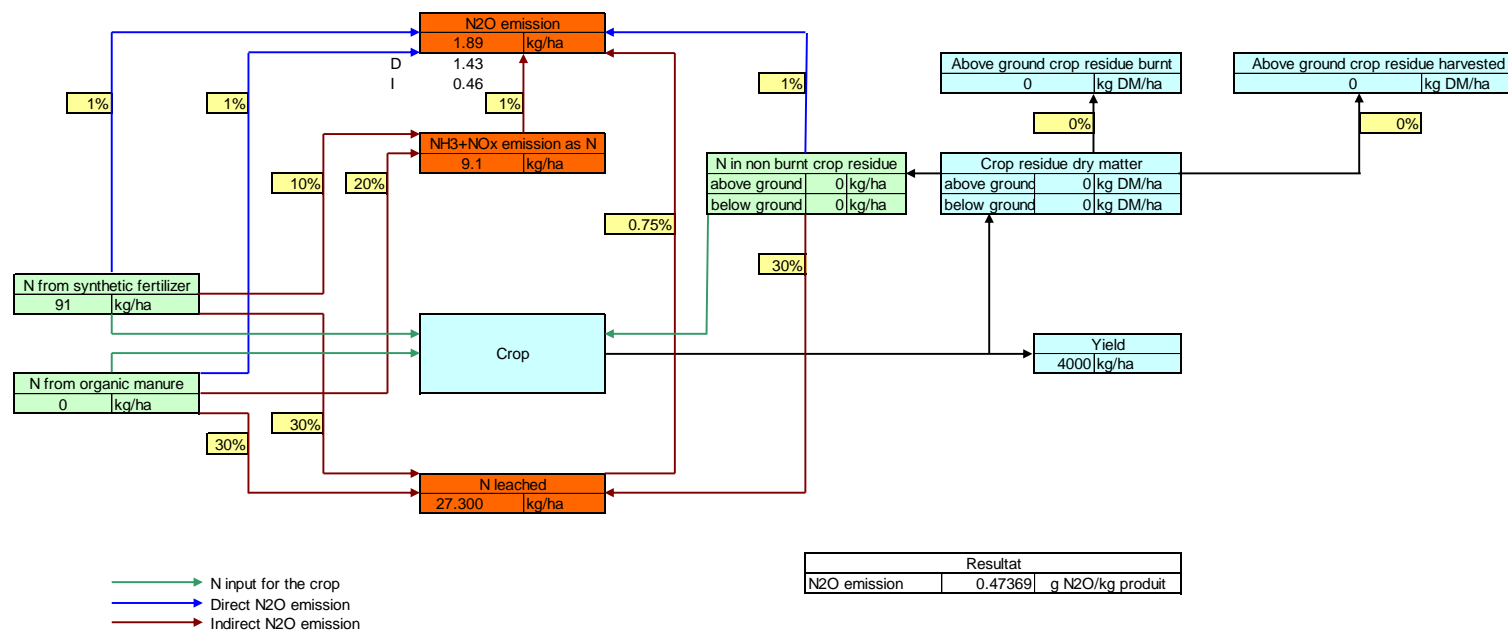

Emissions à renseigner dans Simapro			
output	Amount	Unit	
Produit	4000	kg	
Co-produit	0	kg	
Emission to air	Amount	Unit	Location
Ammonia	10.8719932	kg	air/low population density
Dinitrogen monoxide	1.89475	kg	air/low population density
Nitrogen oxides	0.3978975	kg	air/low population density
Carbon monoxide	0.00E+00	kg	air/low population density
Methane	0.00E+00	kg	air/low population density
SO2	0.00E+00	g	air/low population density
NMVOC	0.00E+00	kg	air/low population density
Particulate matter	0.00E+00	kg	air/low population density
Emission to ground water			
Nitrate	120.90	kg	water/ground

S5-CTI

Données d'entrée		
N minéral	66	kg/ha
N organique	33.5	kg/ha
Rendement	4300	kg/ha
Part résidus brûlée	0%	
Part résidus récoltée	0%	

Paramètres d'émission		
N2O direct	MOY	1.00%
N2O volatilisation	MOY	1.00%
N2O lixiviation	MOY	0.75%
Volat. Synthétique	MOY	10.00%
Volat. Organique	MOY	20.00%
Lixiviation	MOY	30.00%

Parameter (for winter wheat)	
Dry matter of harvested product	
slope	
intercept	
N content of above ground residue	
Ratio below to above ground residue	
N content of below ground residue	

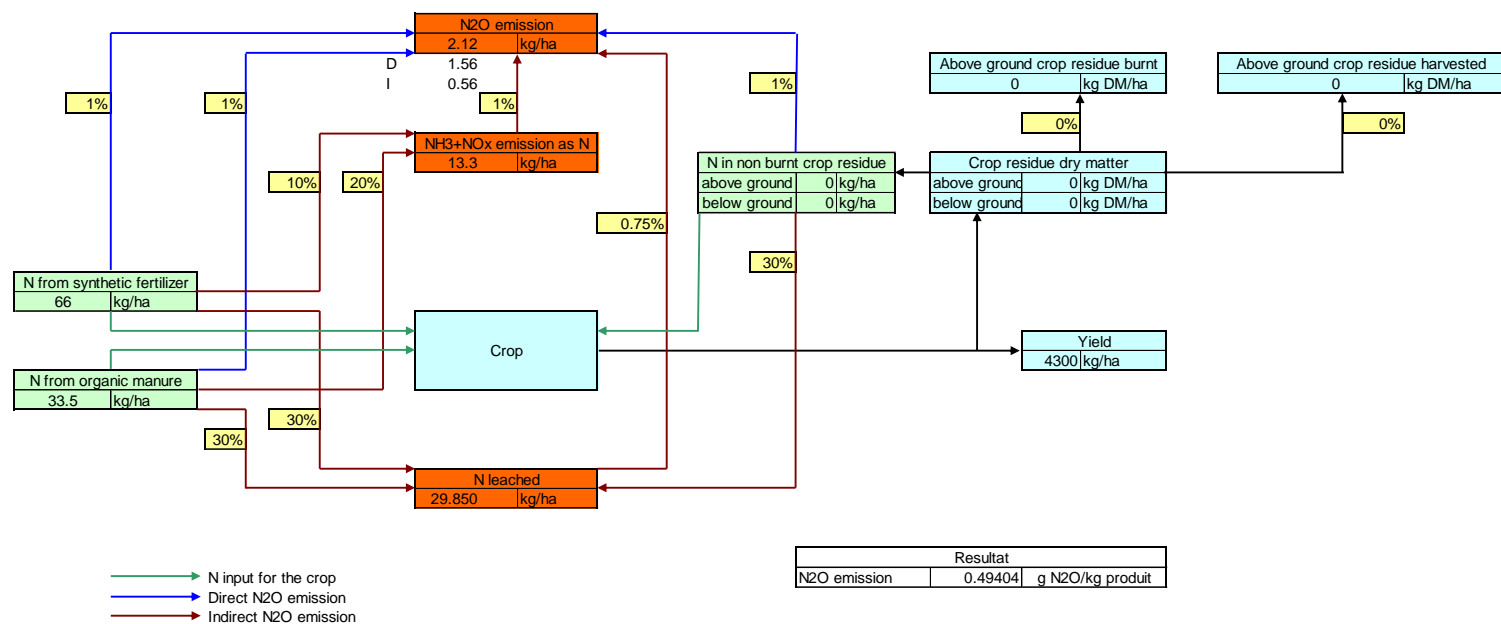

Emissions à renseigner dans Simapro			
output	Amount	Unit	
Produit	4300	kg	
Co-produit	0	kg	
Emission to air	Amount	Unit	Location
Ammonia	15.9504206	kg	air/low population density
Dinitrogen monoxide	2.124375	kg	air/low population density
Nitrogen oxides	0.44611875	kg	air/low population density
Carbon monoxide	0.00E+00	kg	air/low population density
Methane	0.00E+00	kg	air/low population density
SO2	0.00E+00	g	air/low population density
NMVOC	0.00E+00	kg	air/low population density
Particulate matter	0.00E+00	kg	air/low population density
Emission to ground water			
Nitrate	132.19	kg	water/ground

S6-CTD

Données d'entrée		
N minéral	36	kg/ha
N organique	0	kg/ha
Rendement	2340	kg/ha
Part résidus brûlée	0%	
Part résidus récoltée	0%	

Paramètres d'émission		
N2O direct	MOY	1.00%
N2O volatilisation	MOY	1.00%
N2O lixiviation	MOY	0.75%
Volat. Synthétique	MOY	10.00%
Volat. Organique	MOY	20.00%
Lixiviation	MOY	30.00%

Parameter (for winter wheat)	
Dry matter of harvested product	
slope	
intercept	
N content of above ground residue	
Ratio below to above ground residue	
N content of below ground residue	

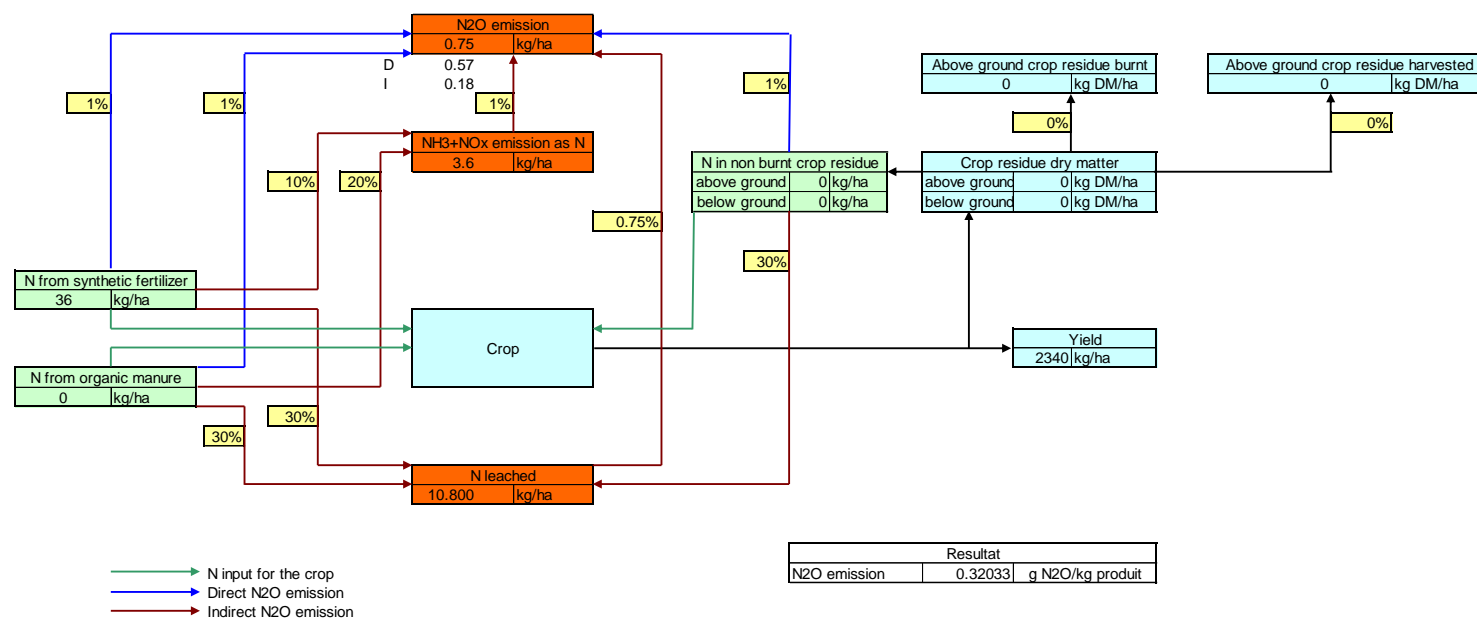

Emissions à renseigner dans Simapro			
output	Amount	Unit	
Produit	2340	kg	
Co-produit	0	kg	
Emission to air	Amount	Unit	Location
Ammonia	4.30100831	kg	air/low population density
Dinitrogen monoxide	0.74957143	kg	air/low population density
Nitrogen oxides	0.15741	kg	air/low population density
Carbon monoxide	0.00E+00	kg	air/low population density
Methane	0.00E+00	kg	air/low population density
SO2	0.00E+00	g	air/low population density
NMVOC	0.00E+00	kg	air/low population density
Particulate matter	0.00E+00	kg	air/low population density
Emission to ground water			
Nitrate	47.83	kg	water/ground

S7-CTD

Données d'entrée		
N minéral	12	kg/ha
N organique	40	kg/ha
Rendement	1780	kg/ha
Part résidus brûlée	0%	
Part résidus récoltée	0%	

Paramètres d'émission		
N2O direct	MOY	1.00%
N2O volatilisation	MOY	1.00%
N2O lixiviation	MOY	0.75%
Volat. Synthétique	MOY	10.00%
Volat. Organique	MOY	20.00%
Lixiviation	MOY	30.00%

Parameter (for winter wheat)	
Dry matter of harvested product	
slope	
intercept	
N content of above ground residue	
Ratio below to above ground residue	
N content of below ground residue	

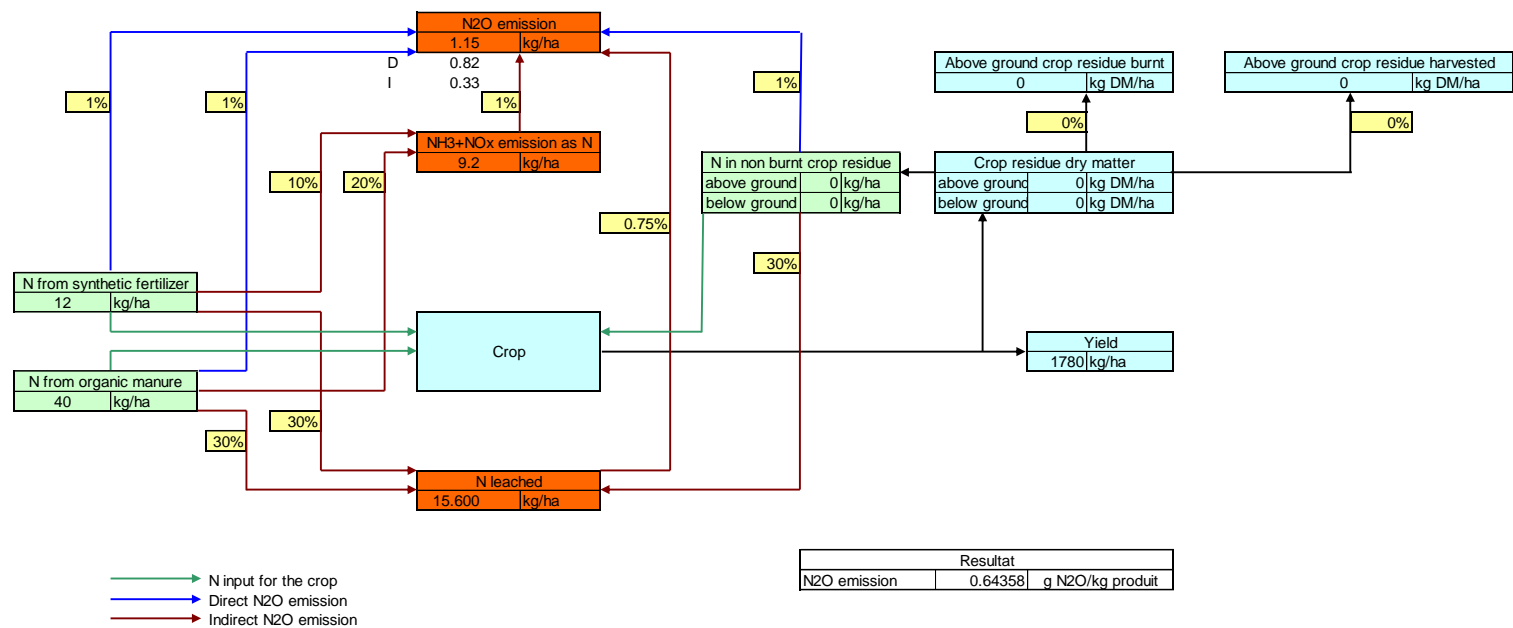

Emissions à renseigner dans Simapro			
output	Amount	Unit	
Produit	1780	kg	
Co-produit	0	kg	
Emission to air	Amount	Unit	Location
Ammonia	11.0638052	kg	air/low population density
Dinitrogen monoxide	1.14557143	kg	air/low population density
Nitrogen oxides	0.24057	kg	air/low population density
Carbon monoxide	0.00E+00	kg	air/low population density
Methane	0.00E+00	kg	air/low population density
SO2	0.00E+00	g	air/low population density
NMVOC	0.00E+00	kg	air/low population density
Particulate matter	0.00E+00	kg	air/low population density
Emission to ground water			
Nitrate	69.09	kg	water/ground

S10-OTI

Données d'entrée		
N minéral	42	kg/ha
N organique	0	kg/ha
Rendement	4500	kg/ha
Part résidus brûlée	0%	
Part résidus récoltée	0%	

Paramètres d'émission		
N2O direct	MOY	1.00%
N2O volatilisation	MOY	1.00%
N2O lixiviation	MOY	0.75%
Volat. Synthétique	MOY	10.00%
Volat. Organique	MOY	20.00%
Lixiviation	MOY	30.00%

Parameter (for winter wheat)	
Dry matter of harvested product	
slope	
intercept	
N content of above ground residue	
Ratio below to above ground residue	
N content of below ground residue	

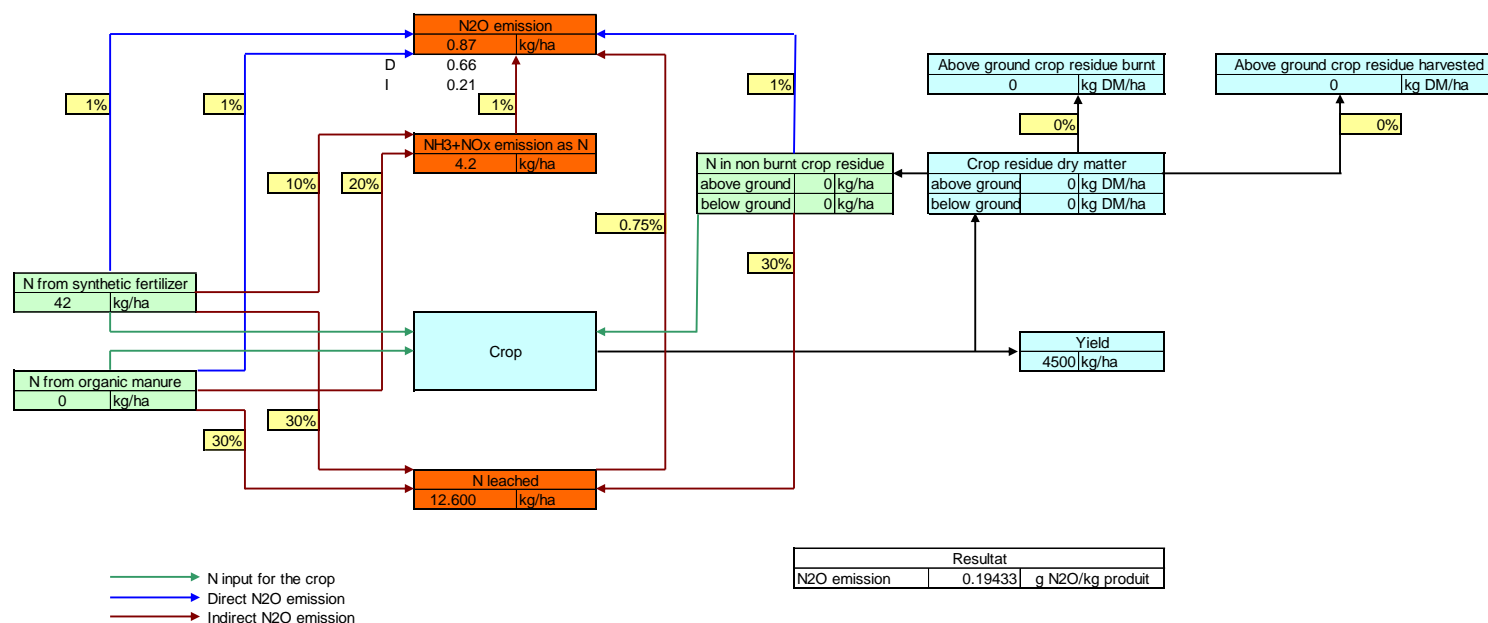

Emissions à renseigner dans Simapro			
output	Amount	Unit	
Produit	4500	kg	
Co-produit	0	kg	
Emission to air	Amount	Unit	Location
Ammonia	5.01784303	kg	air/low population density
Dinitrogen monoxide	0.8745	kg	air/low population density
Nitrogen oxides	0.183645	kg	air/low population density
Carbon monoxide	0.00E+00	kg	air/low population density
Methane	0.00E+00	kg	air/low population density
SO2	0.00E+00	g	air/low population density
NMVOC	0.00E+00	kg	air/low population density
Particulate matter	0.00E+00	kg	air/low population density
Emission to ground water			
Nitrate	55.80	kg	water/ground

S11-OTD (grape pomace)

Données d'entrée		
N minéral	0	kg/ha
N organique	39.4	kg/ha
Rendement	1550	kg/ha
Part résidus brûlée	0%	
Part résidus récoltée	0%	

Paramètres d'émission		
N2O direct	MOY	1.00%
N2O volatilisation	MOY	1.00%
N2O lixiviation	MOY	0.75%
Volat. Synthétique	MOY	10.00%
Volat. Organique	MOY	20.00%
Lixiviation	MOY	30.00%

Parameter (for winter wheat)		
Dry matter of harvested product		
slope		
intercept		
N content of above ground residue		
Ratio below to above ground residue		
N content of below ground residue		

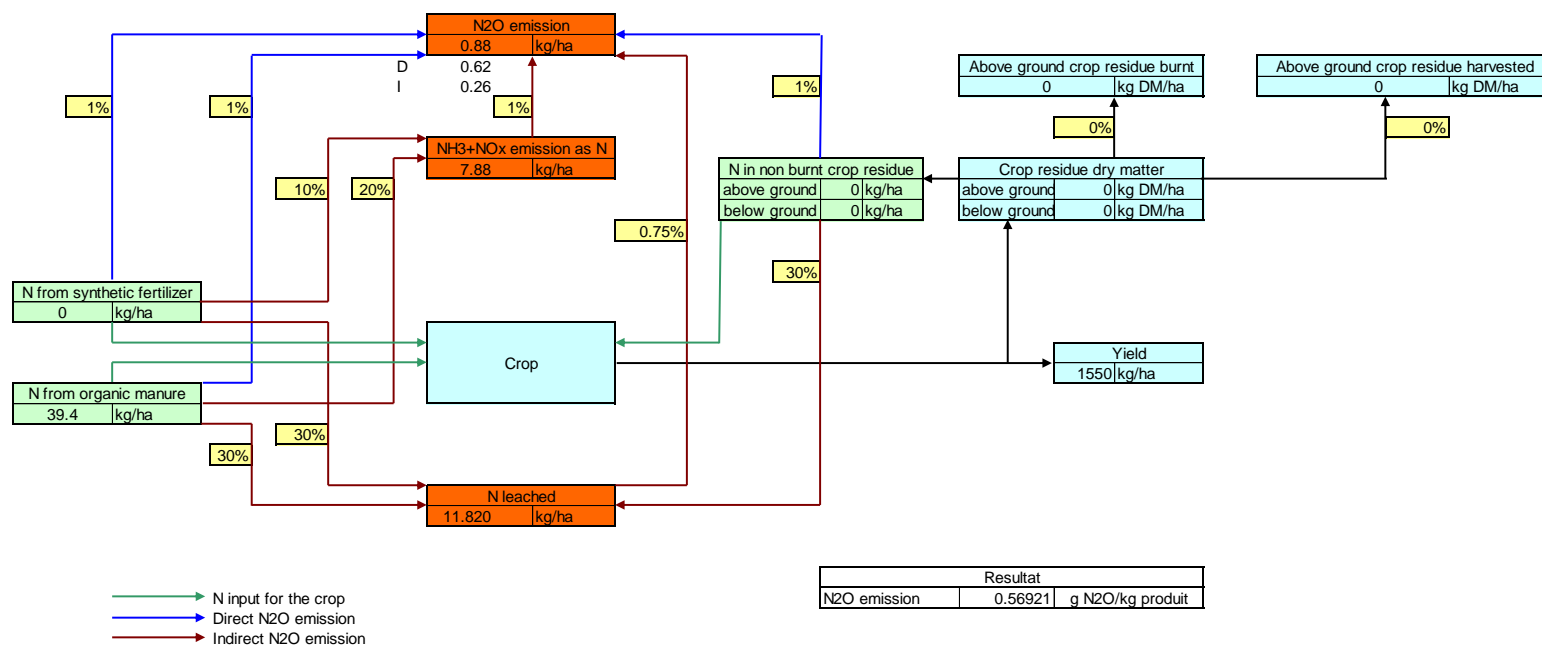

Emissions à renseigner dans Simapro			
output	Amount	Unit	
Produit	1550	kg	
Co-produit	0	kg	
Emission to air	Amount	Unit	Location
Ammonia	9.48568368	kg	air/low population density
Dinitrogen monoxide	0.88227857	kg	air/low population density
Nitrogen oxides	0.1852785	kg	air/low population density
Carbon monoxide	0.00E+00	kg	air/low population density
Methane	0.00E+00	kg	air/low population density
SO2	0.00E+00	g	air/low population density
NM VOC	0.00E+00	kg	air/low population density
Particulate matter	0.00E+00	kg	air/low population density
Emission to ground water			
Nitrate	52.35	kg	water/ground

S11-OTD (mineral)

Données d'entrée		
N minéral	0	kg/ha
N organique	60.3	kg/ha
Rendement	1550	kg/ha
Part résidus brûlée	0%	
Part résidus récoltée	0%	

Paramètres d'émission		
N2O direct	MOY	1.00%
N2O volatilisation	MOY	1.00%
N2O lixiviation	MOY	0.75%
Volat. Synthétique	MOY	10.00%
Volat. Organique	MOY	20.00%
Lixiviation	MOY	30.00%

Parameter (for winter wheat)	
Dry matter of harvested product	
slope	
intercept	
N content of above ground residue	
Ratio below to above ground residue	
N content of below ground residue	

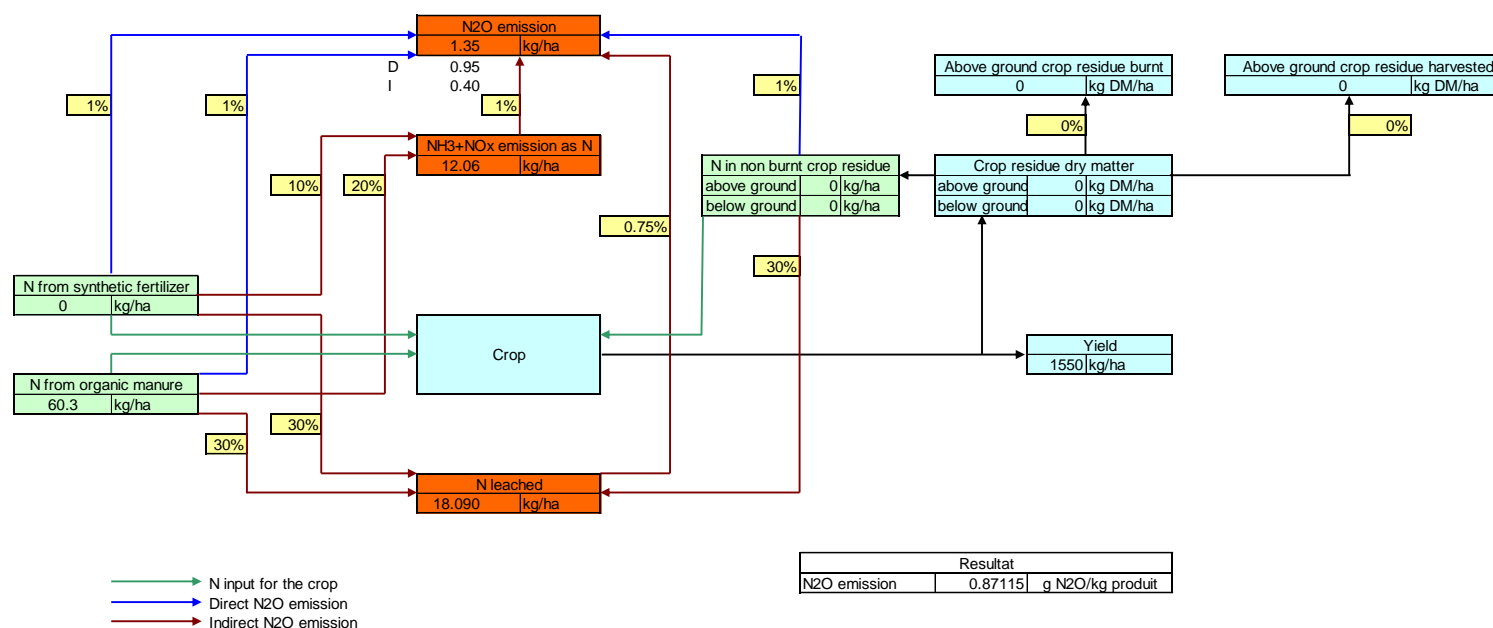

Emissions à renseigner dans Simapro			
output	Amount	Unit	
Produit	1550	kg	
Co-produit	0	kg	
Emission to air			
	Amount	Unit	Location
Ammonia	14.5174296	kg	air/low population density
Dinitrogen monoxide	1.35028929	kg	air/low population density
Nitrogen oxides	0.28356075	kg	air/low population density
Carbon monoxide	0.00E+00	kg	air/low population density
Methane	0.00E+00	kg	air/low population density
SO2	0.00E+00	g	air/low population density
NMVOC	0.00E+00	kg	air/low population density
Particulate matter	0.00E+00	kg	air/low population density
Emission to ground water			
Nitrate	80.11	kg	water/ground

Appendix E

Inventory data: production phase

For the modelisation of the eleven scenarios of the France case study, an average of seven mills with the 2-phase horizontal centrifugation was used

The code for naming the olive mills is “MX”, M meaning “mill” and X the number between 1 and 7 for each of the seven olive mills. Table E.1 shows the annual olive oil production in L olive oil/year and the average. This is useful to understand the following Tables (reception, cleaning, wet washing, milling, malaxation, horizontal centrifugation (2-phase), vertical centrifugation and storage) because they are expressed in unit/year, It is therefore necessary to average the seven mills in unit/year and then divide it by the average [L olive oil/year] from Table E.1 to get the result in average/L. The latter data are summarised in **Table II-16** appearing in the body of this thesis.

Table E.1 Annual olive oil production [L olive oil/year] per olive mill

M1	M2	M3	M4	M5	M6	M7	Average (L/yr)
1.69E+05	1.07E+04	4.20E+04	1.26E+04	1.65E+04	2.84E+04	3.00E+02	39861.85

II.2.2.2b.1 Reception

Input	Unit/year	M1	M2	M3	M4	M5	M6	M7	Average/L
Propane	kg	-	78	-	-	-	-	-	2.80E-04
Electricity	kWh	50.40	42.00	252.35	72.00	19.50	135.00	-	2.05E-03

II.2.2.2b.2 Cleaning

Input	Unit/year	M1	M2	M3	M4	M5	M6	M7	Average/L
Electricity	kWh	1382.91	166.32	366.52	5.40	116.22	396.00	20.99	8.80E-03
Soap	kg	-	-	-	-	-	-	1-	3.58E-06

II.2.2.2b.3 Wet washing

Input	Unit/year	M1	M2	M3	M4	M5	M6	M7	Average/L
Electricity	kWh	1029.06	367.60	400.40	132.00	35.36	302.40	-	8.12E-03
Water	m ³	746.00	50.00	20.00	3.38	5.07	20.00	0.43	3.03E-03
Sodium hydroxide	kg	-	-	-	-	-	20.00	-	7.17E-05
Soap	kg	-	-	-	17	-	-	-	6.09E-05
Lubricating oil	kg	-	-	-	-	-	2.00	-	7.17E-06

II.2.2.2b.4 Milling

Input	Unit/year	M1	M2	M3	M4	M5	M6	M7	Average/L
Electricity	kWh	6040.44	729.12	1155.00	1544.40	2018.64	1705.50	146.89	4.78E-02
Lubricating oil	kg	-	1.00	-	-	-	-	-	3.58E-06

II.2.2.2b.5 Malaxation

Input	Unit/year	M1	M2	M3	M4	M5	M6	M7	Average/L
Electricity	kWh	2973.60	405.72	1093.40	2088.00	633.36	1102.50	-	2.97E-02
Lubricating oil	kg	-	1.00	-	-	-	-	-	3.58E-06

II.2.2.2b.6 Horizontal centrifugation (2-phase)

Input	Unit/year	M1	M2	M3	M4	M5	M6	M7	Average/L
Electricity	kWh	18794.16	2698.50	3622.08	3232.80	1471.08	1999.80	-	1.14E-01

II.2.2.2b.7 Vertical centrifugation

Input	Unit/year	M1	M2	M3	M4	M5	M6	M7	Average/L
Electricity	kWh	2772.00	333.00	1694.00	666.00	290.16	1210.00	-	2.50E-02
Sodium hydroxide	kg	-	-	-	14	-	-	-	5.02E-05
Lubricating oil	kg	-	33	-	-	-	-	-	7.17E-06

II.2.2.2b.8 Storage

Input	Unit/year	M1	M2	M3	M4	M5	M6	M7	Average/L
Electricity	kWh	-	17.00	169.40	8.44	-	137.50	0.98	1.19E-03
Cotton	kg	-	-	-	14	-	-	7.50	2.69E-05

Appendix F

Table F.1 Impact categories, underpinning models, and robustness of the impact assessment models (Sala et al., 2019).

Impact category	Unit	Model adopted as in EF	Model robustness ^a
Climate change	kg CO ₂ eq.	IPCC, 2013	I
Ozone depletion	kg CFC-11 eq.	World Meteorological Organisation (WMO), 2014	I
Particulate matter	Disease incidence	Fantke et al., 2016	I
Ionising radiation	kBq U-235 eq.	Frischknecht et al., 2000	II
Photochemical ozone formation	kg NMVOC eq.	Van Zelm et al., 2008, as applied in ReCiPe 2008	II
Acidification	mol H ⁺ eq.	Posch et al., 2008	II
Eutrophication, terrestrial	mol N eq.	Posch et al., 2008	II
Eutrophication, freshwater	kg P eq.	Struijs et al., 2009	II
Eutrophication, marine	kg N eq.	Struijs et al., 2009	II
Freshwater ecotoxicity	CTUe	USEtox (Rosenbaum et al., 2008)	II/III
Human toxicity, non-cancer	CTUh	USEtox (Rosenbaum et al., 2008)	II/III
Human toxicity, cancer	CTUh	USEtox (Rosenbaum et al., 2008)	USEtox (Rosenbaum et al., 2008) (II/III)
Land use	Pt	Bos et al., 2016 (based on)	III
Water use	m ³ water eq.	AWARE 100 (based on) (UNEP 2016; Boulay et al. 2018)	III
Resource use, fossils	MJ	ADP fossils (van Oers et al., 2002)	III
Resource use, minerals and metals	kg Sb eq.	ADP ultimate reserve (van Oers et al., 2002)	III

^aEuropean Commission, *PEFCR Guidance document*, - Guidance for the development of Product Environmental Footprint Category Rules (PEFCRs), version 6.3, December 2017.

Appendix G

Table G.1 Characterisation factors for active molecules of pesticides taken into account in the ReCiPe 2016 method.

		Active substances			
Ecotoxicity (kg 1,4-DCB)		Glyphosate	Diméthoate	Lambda- cyhalothrin	Krésoxim- méthyl
Terrestrial					
Air		1.24E+03	2.35E+03	2.48E+05	1.97E+04
Air	Low. Pop.	1.51E+03	1.01E+04	3.12E+05	3.20E+04
Water		3.27E-11	2.32E-01	1.87E+04	1.80E+01
Water	Ocean	1.77E-13	1.24E-02	9.83E+03	1.17E+00
Soil		1.27E-10	4.20E+00	5.64E+03	1.96E+01
Soil	Agricultural	6.13E-05	7.52E+00	5.51E+03	2.02E+01
Freshwater					
Air		4.26E-01	3.37E+00	5.59E+02	6.15E+01
Air	Low. Pop.	1.70E-01	6.13E-01	5.98E+02	1.75E+01
Water		2.39E+00	3.87E+01	4.81E+04	7.05E+02
Water	Ocean	1.99E-17	7.51E-07	1.88E+01	6.41E-04
Soil		1.62E+00	2.97E+01	4.23E+02	2.28E+02
Soil	Agricultural	3.51E-01	5.71E+00	6.89E+01	3.20E+01
Marine					
Air		8.28E-02	1.66E-01	2.08E+04	1.87E+01
Air	Low. Pop.	9.23E-02	3.84E-01	2.63E+04	2.58E+01
Water		5.69E-02	9.22E-01	1.07E+04	3.90E+01
Water	Ocean	2.56E-01	4.15E+00	6.39E+04	9.58E+01
Soil		3.86E-02	7.07E-01	5.53E+02	1.26E+01
Soil	Agricultural	8.35E-03	1.36E-01	4.74E+02	1.79E+00
Human non-carcinogenic					
Air		1.01E+01	2.03E+01	-	1.60E+00
Air	Low. Pop.	1.12E+01	5.62E+01	-	1.45E+00
Water		2.00E-01	7.70E+00	-	1.81E+00
Water	Ocean	3.41E-05	1.65E-03	-	5.90E-03
Soil		1.35E-01	5.92E+00	-	5.83E-01
Soil	Agricultural	7.68E-01	2.97E+01	-	1.13E-01

Appendix H

Table H.1 Impact of the life cycle of olive oil production on climate change (global warming category). Unit = kg CO₂-eq/L.

Scenario	Σ	Agricultural phase	Olive oil extraction	Packaging	Pomace treatment	Packaging EOL
S1-CTI	6.41	5.5524	0.4382	0.3236	0.0069	0.0855
S2-CTI	3.56	2.7067	0.4382	0.3236	0.0069	0.0855
S3-CTI	4.50	3.6430	0.4382	0.3236	0.0069	0.0855
S4-CTI	3.72	2.8637	0.4382	0.3236	0.0069	0.0855
S5-CTI	2.80	1.9426	0.4382	0.3236	0.0069	0.0855
S6-CTD	5.15	4.2980	0.4382	0.3236	0.0069	0.0855
S7-CTD	3.64	2.7900	0.4382	0.3236	0.0069	0.0855
S8-CII	3.03	2.1803	0.4382	0.3236	0.0069	0.0855
S9-CID	7.07	6.2128	0.4382	0.3236	0.0069	0.0855
S10-OTI	3.15	2.2948	0.4382	0.3236	0.0069	0.0855
S11-OTD	4.35	3.4997	0.4382	0.3236	0.0069	0.0855

Table H.2 Impact of the agricultural phase on climate change (global warming category). Unit = kg CO₂-eq/L.

Scenario	Σ	Irrigation	Pruning	Fertilisation	Phytosanitary treatment		Tillage	Harvesting
					(pest control)	(disease control)		
S1-CTI	5.55	0.1460	0.0000	4.1840	0.1239	0.0424	0.0317	1.0242
S2-CTI	2.71	0.1132	0.1953	1.7671	0.0897	0.2356	0.3058	0.0000
S3-CTI	3.64	0.2204	0.0804	1.6875	0.1873	0.1876	1.2797	0.0000
S4-CTI	2.86	0.1140	0.0963	2.1443	0.0994	0.1485	0.2143	0.0469
S5-CTI	1.94	0.0506	0.0721	1.4610	0.0910	0.0971	0.1325	0.0384
S6-CTD	4.30	-	0.0860	1.8838	0.2090	0.2094	1.9097	0.0000
S7-CTD	2.79	-	0.0000	2.0328	0.1252	0.1563	0.4757	0.0000
S8-CII	2.18	0.0869	0.0734	1.6337	0.0757	0.1132	0.1632	0.0341
S9-CID	6.21	-	0.0000	4.6730	0.2167	0.3237	0.9157	0.0837
S10-OTI	2.29	0.2105	0.1687	0.9075	0.2643	0.1455	0.5681	0.0303
S11-OTD	3.50	-	0.6007	1.7524	0.1872	0.2023	0.7570	0.0000

Table H.3 Environmental Impacts of the life cycle of olive oil production per FU, ReCiPe 2016 Midpoint.

Impact category	Unit	S1-CTI	S2-CTI	S3-CTI	S4-CTI	S5-CTI	S6-CTD	S7-CTD	S8-CII	S9-CID	S10-OTI	S11-OTD
Global warming	kg CO ₂ eq	6.41E+00	3.56E+00	4.50E+00	3.72E+00	2.80E+00	5.15E+00	3.64E+00	3.03E+00	7.07E+00	3.15E+00	4.35E+00
Stratospheric ozone depletion	kg CFC11 eq	8.84E-05	4.50E-05	3.16E-05	5.23E-05	3.61E-05	3.53E-05	4.89E-05	4.00E-05	1.13E-04	2.35E-05	3.13E-05
Ionizing radiation	kBq Co-60 eq	8.55E-01	5.80E-01	7.68E-01	7.43E-01	5.71E-01	7.81E-01	5.18E-01	6.75E-01	5.97E-01	6.40E-01	5.30E-01
Ozone formation. Human health	kg NO _x eq	1.57E-02	1.24E-02	1.97E-02	1.09E-02	8.13E-03	2.75E-02	1.03E-02	8.91E-03	2.22E-02	1.40E-02	2.12E-02
Fine particulate matter formation	kg PM _{2.5} eq	1.17E-02	7.61E-03	1.07E-02	6.24E-03	4.92E-03	1.35E-02	6.53E-03	5.22E-03	1.16E-02	6.65E-03	1.01E-02
Ozone formation. Terrestrial ecosystems	kg NO _x eq	1.60E-02	1.26E-02	2.01E-02	1.11E-02	8.30E-03	2.80E-02	1.05E-02	9.08E-03	2.26E-02	1.43E-02	2.17E-02
Terrestrial acidification	kg SO ₂ eq	3.00E-02	1.61E-02	2.33E-02	1.58E-02	1.17E-02	2.79E-02	1.39E-02	1.31E-02	2.96E-02	1.48E-02	1.84E-02
Freshwater eutrophication	kg P eq	2.46E-03	1.24E-03	2.68E-03	1.07E-03	7.82E-04	3.00E-03	1.07E-03	8.69E-04	2.00E-03	9.25E-04	1.14E-03
Marine eutrophication	kg N eq	1.71E-02	1.18E-02	6.00E-03	1.00E-02	8.22E-03	6.68E-03	1.44E-02	7.67E-03	2.17E-02	4.42E-03	1.07E-02
Terrestrial ecotoxicity	kg 1.4-DCB	5.41E+01	3.81E+01	4.62E+01	3.35E+01	2.58E+01	5.03E+01	2.71E+01	2.74E+01	6.06E+01	3.19E+01	3.55E+01
Freshwater ecotoxicity	kg 1.4-DCB	1.04E+00	7.15E-01	8.18E-01	6.14E-01	4.45E-01	8.72E-01	4.31E-01	4.95E-01	1.04E+00	5.58E-01	5.70E-01
Marine ecotoxicity	kg 1.4-DCB	1.23E+00	8.42E-01	9.82E-01	7.64E-01	5.57E-01	1.04E+00	5.39E-01	6.17E-01	1.29E+00	7.11E-01	7.29E-01
Human carcinogenic toxicity	kg 1.4-DCB	2.83E-01	1.92E-01	2.65E-01	1.88E-01	1.63E-01	3.03E-01	1.86E-01	1.71E-01	2.77E-01	1.89E-01	2.29E-01
Human non-carcinogenic toxicity	kg 1.4-DCB	1.41E+01	9.86E+00	1.19E+01	8.72E+00	6.56E+00	1.31E+01	6.97E+00	7.14E+00	1.59E+01	8.51E+00	9.81E+00
Land use	m ² a crop eq	2.46E-01	2.01E-01	2.24E-01	1.44E-01	1.28E-01	2.61E-01	1.60E-01	1.30E-01	2.10E-01	1.53E-01	2.12E-01
Mineral resource scarcity	kg Cu eq	1.23E-01	6.46E-02	1.02E-01	6.41E-02	5.40E-02	1.14E-01	7.01E-02	5.69E-02	9.96E-02	6.00E-02	6.69E-02
Fossil resource scarcity	kg oil eq	1.42E+00	6.84E-01	1.09E+00	6.76E-01	5.31E-01	1.24E+00	6.67E-01	5.66E-01	1.19E+00	7.44E-01	9.88E-01
Water consumption	m ³	2.19E+00	7.74E-01	1.50E+00	1.68E+00	7.57E-01	1.27E+00	3.42E-02	1.28E+00	6.27E-02	1.39E+00	2.56E-02

Table H.4 Environmental Impacts of the life cycle of olive oil production per FU, EF 3.0 Method (adapted).

Impact category	Unit	S1-CTI	S2-CTI	S3-CTI	S4-CTI	S5-CTI	S6-CTD	S7-CTD	S8-CII	S9-CID	S10-OTI	S11-OTD
Climate change	kg CO ₂ eq	6.43E+00	3.58E+00	4.53E+00	3.73E+00	2.81E+00	5.20E+00	3.66E+00	3.05E+00	7.10E+00	3.17E+00	4.40E+00
Ozone depletion	kg CFC11 eq	4.97E-07	4.09E-07	6.56E-07	4.19E-07	3.33E-07	7.53E-07	4.35E-07	3.62E-07	6.45E-07	4.86E-07	6.37E-07
Ionising radiation	kBq U-235 eq	9.24E-01	6.25E-01	8.55E-01	7.80E-01	5.99E-01	8.90E-01	5.72E-01	7.02E-01	7.00E-01	6.92E-01	6.31E-01
Photochemical ozone formation	kg NMVOC eq	2.03E-02	1.55E-02	2.47E-02	1.37E-02	1.03E-02	3.39E-02	1.32E-02	1.12E-02	2.74E-02	1.74E-02	2.67E-02
Particulate matter	disease inc.	8.36E-07	5.00E-07	4.12E-07	4.56E-07	4.49E-07	4.66E-07	8.93E-07	3.68E-07	8.95E-07	2.73E-07	7.77E-07
Human toxicity. non-cancer	CTUh	4.20E-07	3.15E-07	3.03E-07	1.57E-07	1.15E-07	3.54E-07	1.02E-07	1.25E-07	3.22E-07	1.30E-07	1.90E-07
Human toxicity. cancer	CTUh	7.74E-09	5.66E-09	8.84E-09	5.57E-09	4.95E-09	1.01E-08	5.87E-09	5.16E-09	8.08E-09	5.65E-09	6.98E-09
Acidification	mol H+ eq	6.35E-02	3.79E-02	4.26E-02	3.54E-02	3.02E-02	5.15E-02	5.03E-02	2.85E-02	7.03E-02	2.82E-02	5.42E-02
Eutrophication. freshwater	kg P eq	2.46E-03	1.24E-03	2.68E-03	1.07E-03	7.82E-04	3.00E-03	1.07E-03	8.69E-04	2.00E-03	9.25E-04	1.14E-03
Eutrophication. marine	kg N eq	6.56E-02	4.56E-02	2.82E-02	3.91E-02	3.20E-02	3.36E-02	5.54E-02	3.01E-02	8.41E-02	2.06E-02	4.64E-02
Eutrophication. terrestrial	mol N eq	3.33E-01	2.30E-01	1.77E-01	2.04E-01	2.00E-01	2.20E-01	4.17E-01	1.59E-01	4.32E-01	1.29E-01	4.01E-01
Ecotoxicity. freshwater	CTUe	2.15E+02	1.29E+02	2.20E+02	1.17E+02	8.22E+01	2.47E+02	9.83E+01	9.44E+01	2.26E+02	9.35E+01	1.09E+02
Land use	Pt	3.65E+01	3.03E+01	3.37E+01	2.09E+01	1.81E+01	4.01E+01	2.37E+01	1.85E+01	3.27E+01	2.29E+01	3.40E+01
Water use	m ³ depriv.	1.78E+01	6.28E+00	1.23E+01	1.27E+01	6.07E+00	1.08E+01	1.19E+00	9.84E+00	2.14E+00	1.04E+01	7.46E-01
Resource use. fossils	MJ	7.68E+01	4.02E+01	6.12E+01	4.30E+01	3.36E+01	6.77E+01	3.83E+01	3.70E+01	6.21E+01	4.40E+01	5.24E+01
Resource use. minerals and metals	kg Sb eq	5.14E-04	2.60E-04	3.88E-04	2.56E-04	2.15E-04	4.13E-04	2.84E-04	2.28E-04	3.96E-04	2.56E-04	2.68E-04
Climate change - Fossil	kg CO ₂ eq	6.34E+00	3.49E+00	4.44E+00	3.65E+00	2.73E+00	5.11E+00	3.58E+00	2.96E+00	7.01E+00	3.09E+00	4.32E+00
Climate change - Biogenic	kg CO ₂ eq	8.80E-02	8.33E-02	8.64E-02	8.32E-02	8.25E-02	8.71E-02	8.33E-02	8.27E-02	8.51E-02	8.31E-02	8.38E-02
Climate change - Land use and LU change	kg CO ₂ eq	6.42E-03	2.45E-03	5.91E-03	2.41E-03	1.89E-03	6.76E-03	3.06E-03	2.06E-03	4.11E-03	2.15E-03	2.86E-03

Appendix I

Calculation of the quantity of composite needs for the production of 1 m² profile (lath) construction of OSF/PP.

Figure I.1 shows a section used for house terrace slats, the dimensions are 10 cm x 3 cm outside and 1.75 cm x 1.8 cm for the 4 interior spaces.

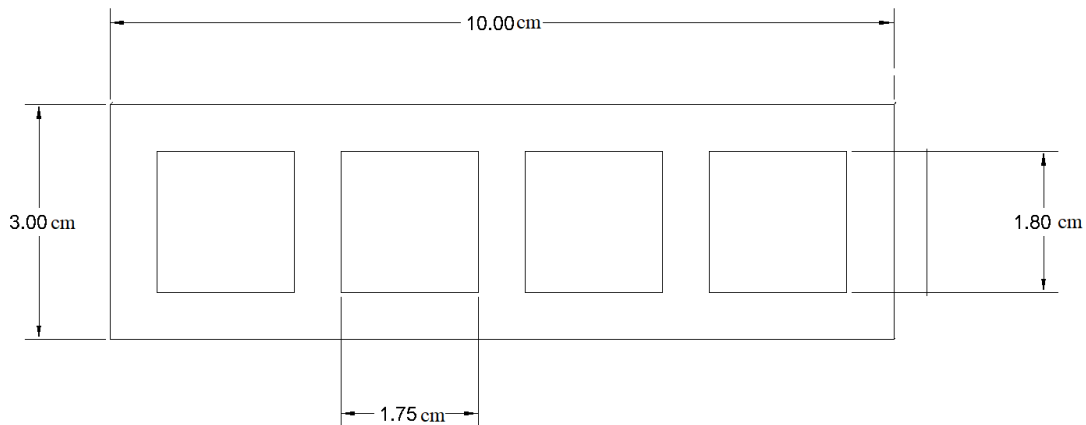

Figure I.1. Section used for house outdoor terrace.

Area of the section

$$A_1 = 3.00 \text{ cm} * 10.00 \text{ cm} = 30.00 \text{ cm}^2$$

Area of the empty squares

$$A_2 = 1.80 \text{ cm} * 1.75 \text{ cm} * 4 = 12.60 \text{ cm}^2$$

Surface area of the section

$$A = A_1 - A_2 = (30.00 - 12.60) \text{ cm}^2 = 17.40 \text{ cm}^2 = 0.00174 \text{ m}^2$$

Figure I.2 show a profile (lath) of the outdoor terrace of the composite, the dimension shown are measured in centimeters.

For a superficial area of 1 m², the total quantity of profiles used are 10. The total area is 0.0174 m² and the volume of 1 m² of lath (building material) is 0.0174 m³. For the latter calculation, the hypothesis of lath contiguous (no space between them) was supposed.

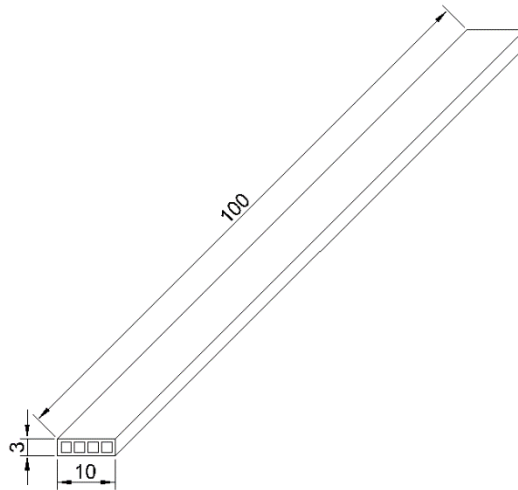

Figure I.2. Profile of an outdoor terrace (measurements are in centimetres).

The formula of density was used in the calculation of the olive-based composite mass. The following section shows an example of the calculation, the mass composite calculated was OSF/PP. **Table III-3** shows the density and the calculated mass of the composites. The density of the composites was taken from the extrapolation of the results of Uitterhaegen et al. (2018).

$$\rho = \frac{m}{V}$$

$$m = \rho * V$$

$$m_{OSF/PP} = 1060.9 \text{ kg/m}^3 * 0.0174\text{m}^3$$

$$m_{OSF/PP} = 18.459 \text{ kg}$$

$$m_{OSF/PE} = 1068.0 \text{ kg/m}^3 * 0.0174\text{m}^3$$

$$m_{OSF/PE} = 18.583 \text{ kg}$$

Appendix J

The Figures J.1 to J.4 shown the flowchart of the production of different quantities of the biocomposite.

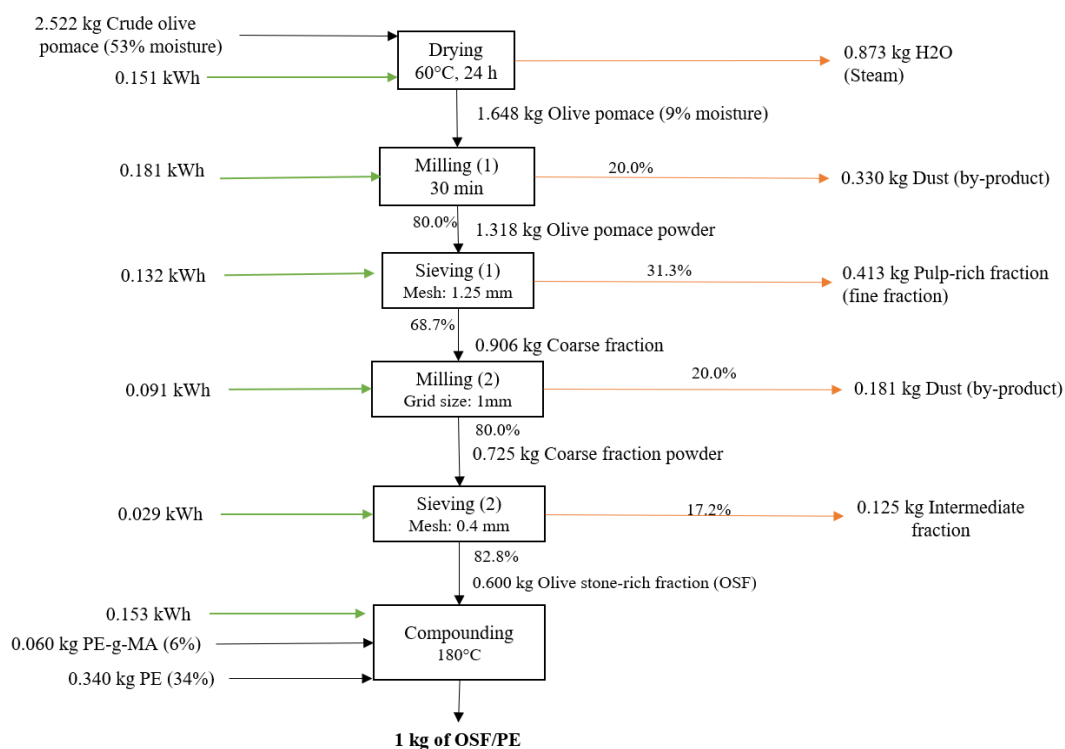

Figure J.1. Flow diagram of the production of 1 kg OSF/PE.

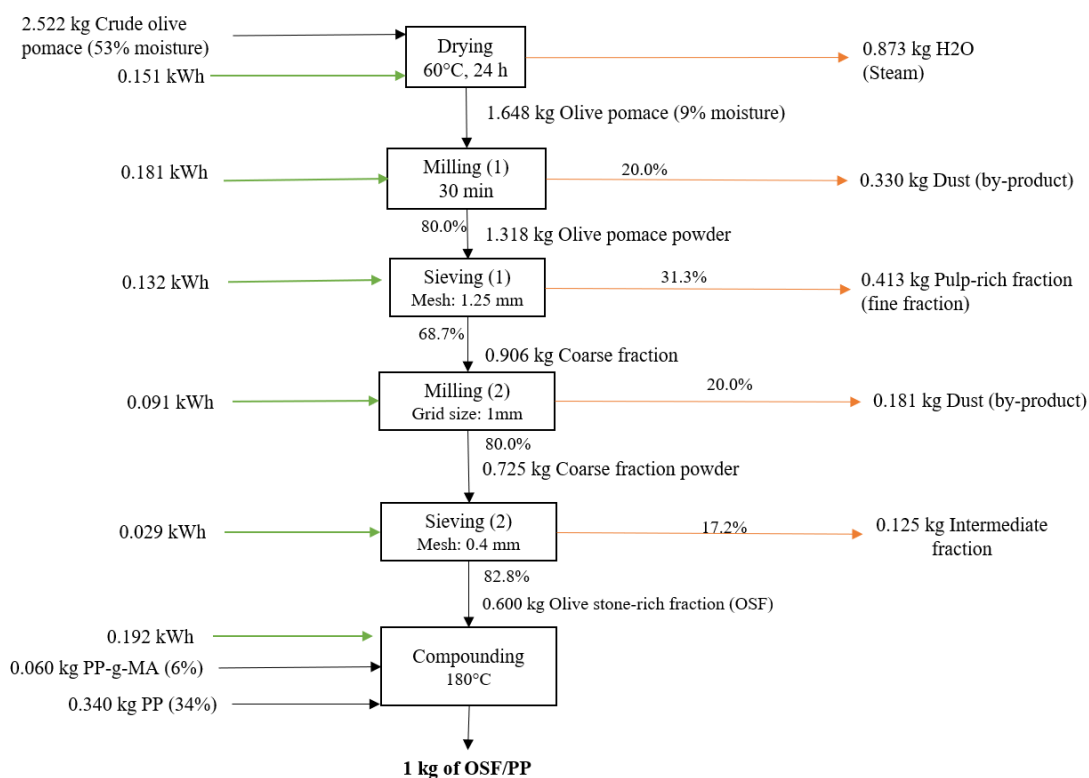

Figure J.2. Flow diagram of the production of 1 kg OSF/PP.

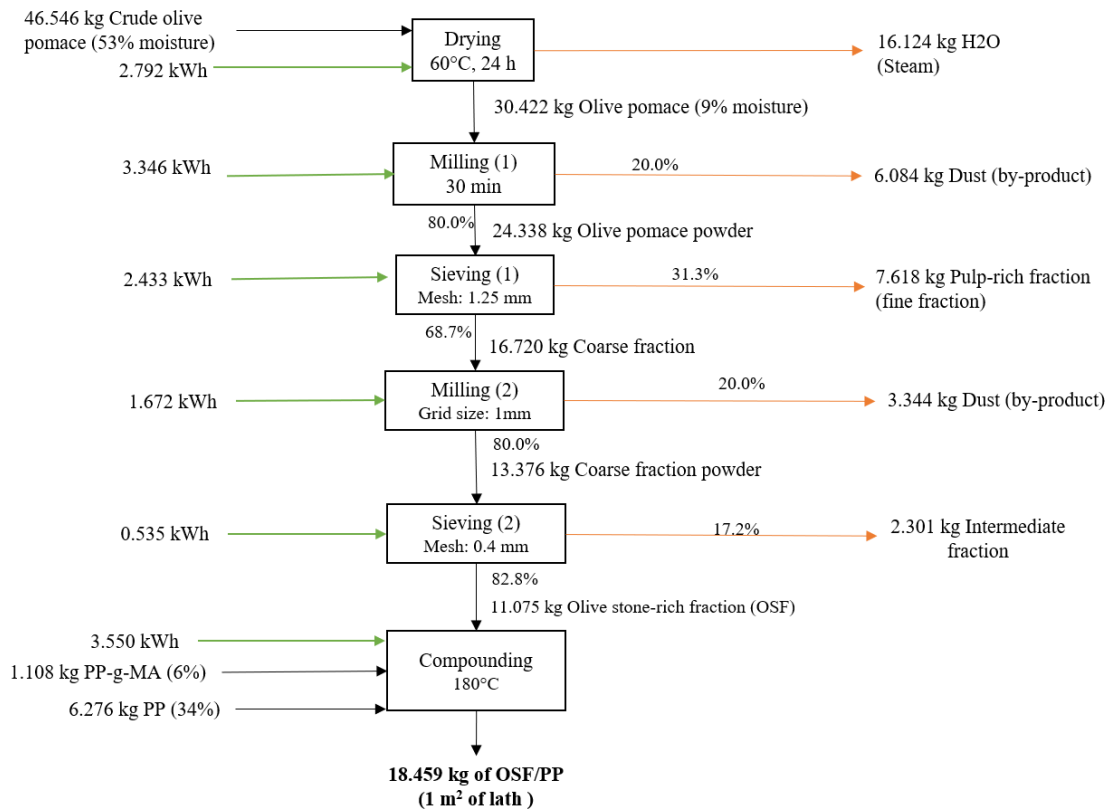

Figure J.3. Flow diagram of the production of 18.459 kg OSF/PP (1 m² of lath).

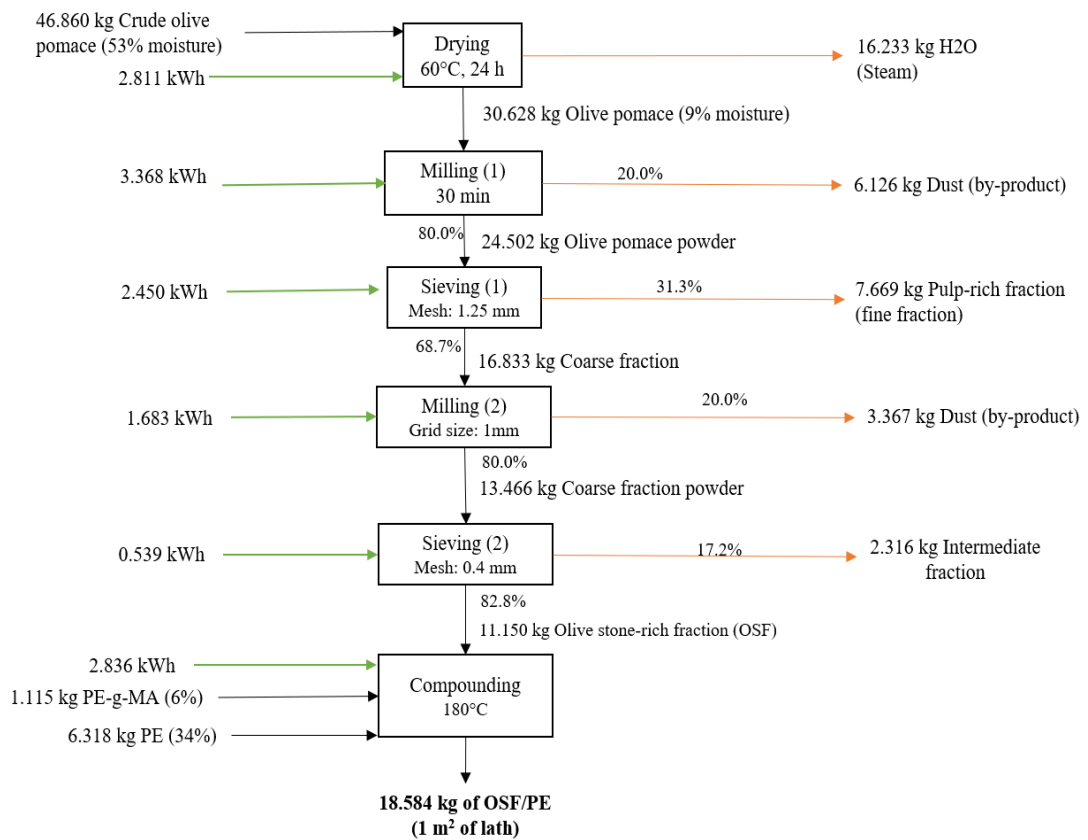
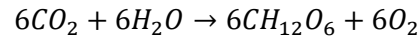

Figure J.4. Flow diagram of the production of 18.584 kg OSF/PE (1 m² of lath).

Appendix K

Carbon sequestration calculation

The development of any plant is linked to the phenomenon of photosynthesis. Photosynthesis is characterised by the following equation:



According to the chemical equation of photosynthesis, in order to sequester 1 mole (fixed number of atoms) of carbon, the plant will need to use 1 mole of CO₂. Carbon and carbon dioxide do not have the same molar mass (M_{CO₂}) and (M_C). Therefore, it is necessary to take this difference into account in the calculations.

In fact, the mass of carbon present in the plant species is thus what will determine the mass of carbon dioxide sequestered.

In order to know the mass of carbon, the total dry matter is used (M_{Dry}), as well as the carbon content in this dry matter, in percentage, P_C.

The mass of sequestered CO₂ is expressed as follows:

$$M_{CO_2} = M_{Dry} * \frac{P_C}{100} * \frac{M_{CO_2}}{M_C}$$

However, the plant species used as raw material will always have a moisture content, H, expressed in %. Thus, it is important to express the dry mass as a function of the wet mass, M_{humide}, expressed as follow:

$$M_{CO_2} = \frac{M_{humide}}{1 + \frac{H}{100}} * \frac{P_C}{100} * \frac{M_{CO_2}}{M_C}$$

The quantity of OP used for the manufacturing of 1 m² of lath is 46.7 kg of OP (average) with initial moisture of 53%. The percentage of total carbon for a three-phase centrifugation olive pomace is 29.03 % (Dermeche et al., 2013; Vlyssides et al., 1998).

$$M_{CO_2} = \frac{46.7 \text{ kg}}{1 + \frac{53}{100}} * \frac{29.03}{100} * \frac{44 \frac{\text{kg}}{\text{kmol}}}{12 \frac{\text{kg}}{\text{kmol}}}$$

$$M_{CO_2} = 32.49 \text{ kg}$$

Appendix L

The C-TOOL Model

Dynamic process-oriented simulation models are useful to project the effects of management on SOC and able to simulate C turnover in agricultural soils (Taghizadeh-Toosi et al., 2014). This case study used the C-TOOL model for their carbon simulation, nevertheless, the model structure is inspired by other models such as CENTURY, CN-SIM, Daisy, ICBM and RothC.

The C-TOOL model allows simulations of the medium to long-term changes in SOC in temperate mineral soils under agriculture management. The model structure is described in detail in the work of Taghizadeh-Toosi et al. (2014).

C-TOOL contemplates the inputs and turnover of C related to three SOC pools, which are located in the topsoil (0-25 cm) and the subsoil (25-100 cm), the transport of SOC from topsoil to subsoil, and emissions of CO₂, besides simulation of ¹⁴C natural abundance is also possible (Taghizadeh-Toosi et al., 2014).

The three conceptual pools are:

- C in Fresh Organic Matter (FOM; carbon above ground in the form of plant residues, roots, animal manure),
- C in Humified Organic Matter (HUM; organic matter that has gone through a microbial transformation and is physically and/or chemically stable in the soil), and
- C in Resistant Organic Matter (ROM; biologically resistant organic matter with a very slow turnover).

It is important to mention that C-TOOL is parameterized with data that covers different crops and soil management in United Kingdom, Sweden and Denmark (Taghizadeh-Toosi et al., 2014).

Figure L.1 shows the C-TOOL model structure. In the first pool, the addition of FOM (plant aboveground and belowground tissues, and animal manure) to the soil causes the organic matter decomposition. In the second pool, this organic matter goes through a transformation due to catabolism. The organic matter present in the animal manure suffers decomposition in the animal gut or manure storage, thus a percentage of the manure C contribute to the HUM pool, contrary to plant residues that contribute to FOM. The degree of humification is modelled through the f_{HUM} factor, which is > 0 for manure and 0 for plant residues (Taghizadeh-Toosi et al., 2014).

After simulating the turnover of FOM, two steps are assumed in C-TOOL:

1. A proportion of the resulting SOM (t_F) is transported to the deeper layer, and
2. The remaining of SOM is going through a humidification process (**Figure L.1**).

After the decomposition process, C-TOOL calculus simultaneously the amount of SOC that is removed by transport to the subsoil or released as CO₂ from the HUM pool. In the ROM pool, the same procedure is applied (Taghizadeh-Toosi et al., 2014).

In C-TOOL, the transport of C goes from topsoil pools (0-25 cm depth) to subsoil pool (25-100 cm). The fraction of C transported from each pool is shown in **Figure L.1**.

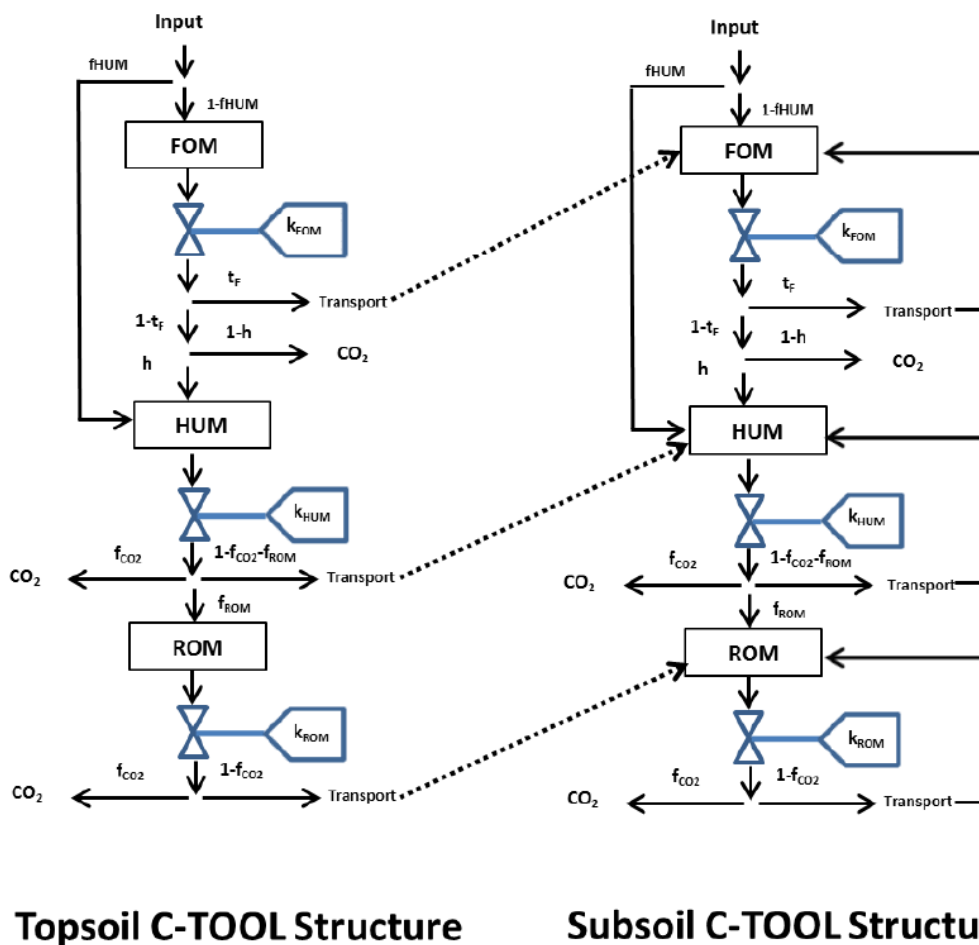

Figure L.1 C-TOOL model structure for top and subsoil; FOM: fresh organic matter, HUM: humified organic matter, ROM: resistant organic matter, f_{HUM} : fraction of input going to HUM, k_{FOM} : decomposition rate of FOM, k_{HUM} : decomposition rate of HUM, f_{ROM} : fraction of FOM going to ROM, k_{ROM} : decomposition rate of ROM, t_F : fraction going to downward transport, h : humification coefficient, f_{CO_2} : fraction of released CO_2 . (Taghizadeh-Toosi et al., 2014)

Table **Table L.1** shows the C-TOOL model parameters and their default and optimized values.

Table L.1. C-TOOL parameters and values from Taghizadeh-Toosi et al. (2014)

C-TOOL parameter	Value
Initial C content (Mg ha ⁻¹)	Optimized for each treatment
Initial f_{HUM} (top and sub soil)	0.595
Initial f_{ROM} (top and sub soil)	0.405
f_{HUM} (Crop)	0
f_{ROM}	0.012
k_{FOM} (yr ⁻¹)	1.44
k_{HUM} (yr ⁻¹)	0.0192 ± 0.008 ^a
k_{ROM} (yr ⁻¹)	4.63x10 ⁻⁴
t_F	0.03
f_{CO_2}	0.628

^a Standard error

Data collection

- **Mean monthly temperatures of the region**

From the website *Historique-météo.net* (Historique-Météo, 2021), the information of the maximal and minimal monthly temperatures was collected. The collection data focused on the four regions of olive oil production in France from 2015 to 2020.

- **Soil initial conditions (total carbon and clay content)**

The website *Gis Sol* has a lot of data on the soils of France available, such as geographical inventory of soils, monitoring of their properties and the evolution of their qualities. From the « *Carte nationale des stocks de carbone des sols intégrée dans la carte mondiale de la FAO (0-30 cm)* » available in the mentioned website, the quantity of total initial carbon on the soil was obtained. This chart shows the carbon content of soils in France.

Figure L.2 shows the soil carbon stock in French territory. The black circle on the chart shows the region of Provence-Alpes-Côte d'Azur; here an estimation of the average stock of carbon has been made. The carbon stock of the metropolitan France olive oil production regions is shown in **Table L.2**.

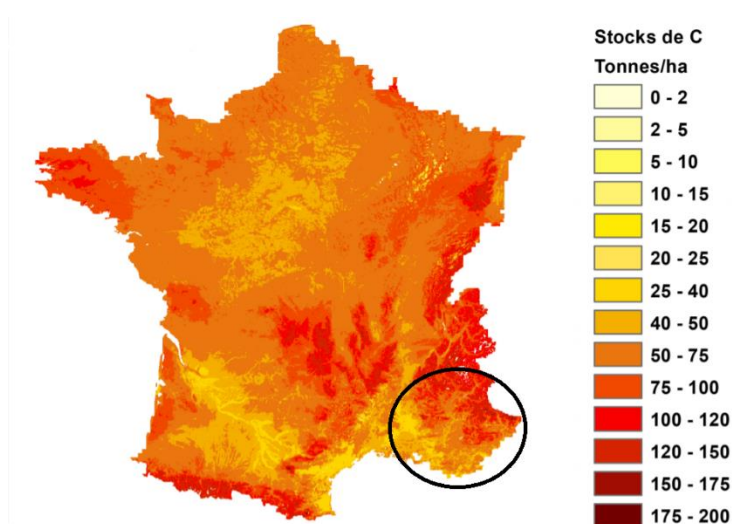

Figure L.2. Map of the carbon content of the soil in France (Martin, 2019).

Table L.2. Average carbon content in metropolitan France.

Carbon content (t/ha)	Average C content (t/ha)			
	Region	<i>Provence-Alpes-Côte d'Azur</i>	<i>Languedoc-Roussillon</i>	<i>Rhône-Alpes</i>
15-20		17.5	17.5	32.5
25-40		32.5	32.5	62.5
40-50		45.0	45.0	87.5
50-75		62.5	60.0	110.0
100-120		110.0	-	73.1
Initial Carbon (t/ha)		53.5	38.8	32.5

The quantity of carbon stock in the soil of Corse was obtained from «*Statistiques sur les stocks de carbone (0-30 cm) des sols du réseau RMQS*» available in *Gis Sol*. The mean value of the C stock in the soil of Corse is 35 t/ha (Martin et al., 2020).

Figure L.3 shows the interface of the program used to obtain the clay content of the olive oil-producing regions. Said information was obtained from the *Gis Sol* website. Figure 5 shows the information corresponding to the Provence-Alpes-Côte d'Azur region. The average clay content of the olive oil productive regions is reported in **Table L.3**.

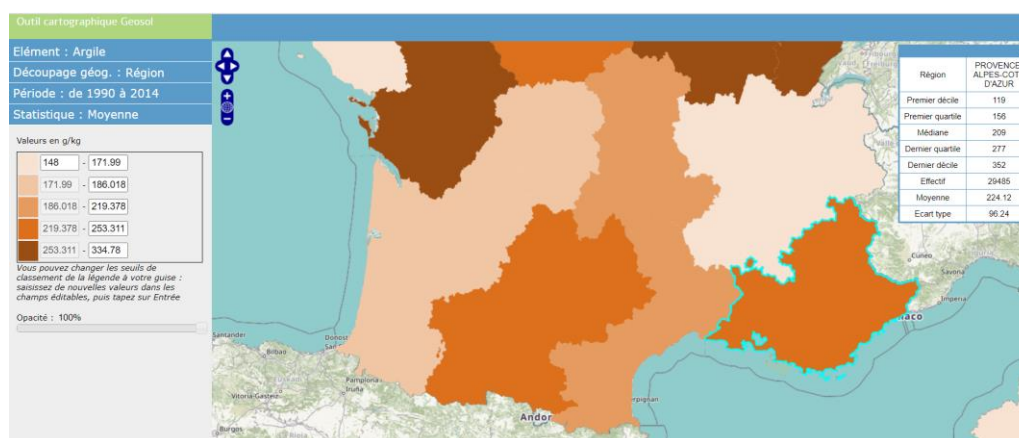

Figure L.3. Clay content in the Provence-Alpes-Côte d'Azur region (INRAe, 2021) . Values are expressed in g/kg.

Table L.3. Clay content in the olive grove soil.

Region	Clay content (g/kg)	Clay content (%)
Provence-Alpes-Côte d'Azur	224.12	22
Languedoc-Roussillon	210.62	21
Rhône-Alpes	173.17	17
Corse	154.04	15

- **Biomass left on the field in terms of carbon**

It is important to identify the biomass left at the ground as Above Ground (AG) and Below Ground (BG), with that propose the following paragraphs describe some aspects of the cultivation of the olives.

The cultivation of the olives includes irrigation, pruning, fertilisation, pest treatment, soil management and harvesting. The steps that generate large quantities of biomass are pruning and harvesting, which are done manually or mechanically (Salomone et al., 2015).

Proper pruning can increase the productivity of the plantation and is necessary to adjust the trees to the climatic conditions ("Olive Tree Cultivation," 2010).

The aims of the pruning are:

- Balance vegetation with fruit yield,
- Minimize the non-productive period,
- Prolong the productivity of the trees,
- Delay senescence, and

- Save soil water.

There are three main types of pruning:

1. Regulated pruning, which develops the tree's frame (important in the first years of the tree's life).
2. Pruning for fruiting, which induces productive branches to form fruits, leaving the structural branches unaffected.
3. Renovating pruning, which stimulates sprouting to rejuvenate senescent trees.

Once a year, pruning and treatment of pruning residues are carried out. Vera et al. (2014) estimated that one hectare of olive groves generates from 2,5 to 3 tonnes of pruning wastes per year.

The acidity level of the olive changes after harvesting, and other changes may occur depending on the harvest methods. Hand harvesting is the most appropriate method, but it is very expensive, whereas mechanical harvesting can give good results if it is properly conducted (the breaking of the fruit skin should be avoided) (Salomone et al., 2015).

The dimensions of the olive tree can vary depending on the variety and age of the tree. As a result, the "model tree" method is used to calculate the C content in the AG and BG, this popular method is used in the forestry sector. Proietti et al., (2014) selected three representative olive trees of the olive grove, having at 80 cm of diameter above the ground level and height of the trunk equal to the average diameter and height, the trees selected had 11-year-old in the olive grove. After the mentioned age, the olive vegetative, productive activities and cultural practices are considered to remain constant (Proietti et al., 2014). **Figure L.4** shows the part of the olive tree.

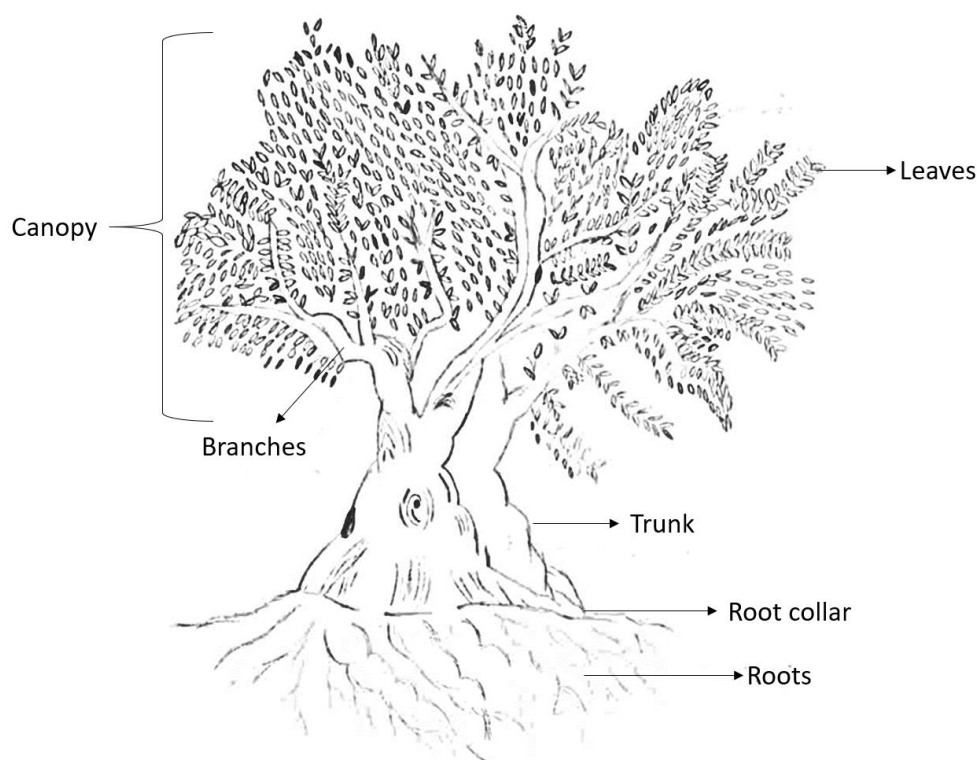

Figure L.4. Parts of the olive tree.

Table L.4 shows the average dry weight and C content of the “model tree”. The individual component of the olive tree, i.e. the trunk, branches, twigs and root collar (above ground) and roots (below ground) were weight. Proietti et al. (2014) placed samples into a ventilated oven at 105 °C until they reached constant weight. To determine the amount of C in the samples, the dry matter is multiplied by 0.5 (Carbon fraction), as explained in Chapter II, section II.2.4.1 Climate change.

Table L.4. Average dry weight and C content of the three “model tree” (11-year-old), measured after pruning and fruit harvesting. Adapted from Proietti et al. (2014).

Biomass	Permanent tree component (P)	Dry weight (kg/tree)	C (kg/tree)
Below-ground biomass	Roots	8.23	4.12
	Root collar	12.02	6.01
	Trunk	13.94	6.97
Above-ground biomass	Branches	16.32	8.16
	Twigs	10.00	5.00
	Leaves	6.72	3.36
	Total	67.23	33.62

The organic carbon contained in the permanent tree components by the “model tree” method was 33.62 kg, distributed in 29.50 kg C per tree in the AG and 4.12 kg per tree in the BG (Proietti et al., 2014). In order to estimate the quantity of C for the herein study, it was assumed that the tree density of France is 220 trees per hectare, which is between a traditional and intensive production system (“Crop Guide,” 2018). Thus, the amount of C in the “model tree” was multiplied by the number of trees per hectare (220) to obtain the results in tonnes of C per hectare for the AG and BG biomass.

Table L.5 summarized the carbon content of the permanent tree components in the 11 year-old “model tree” for the French olive grove (220 trees/ha), the total C of the permanent tree components was 7.39 t C/ha, subdivided into AG biomass with 6.49 t C/ha, and the BG biomass with 0.90 t C/ha.

Table L.5. Carbon content in the biomass left on the French olive grove field.

Biomass	C content (t/ha*year)
Above ground (AG)	6.49
Below ground (BG)	0.90
Total (AG+BG)	7.39

To estimate the quantity of OP that can return to the soil. It is important to determine the quantity of OP needed for the national production of laths. Accordingly, it is assumed that the total production of wood plastic composite used in the decking sector is going to be replaced by the olive pomace-based composite laths.

As mentioned (III.2.3 Lath Market, olive pomace-based composite) the European market of WPC is 455 216.61 t/year, while the French market accounts for over 9% of this market. The decking sector holds the major market share with 55.55 % of the global market in 2019 and increasing at a fast pace. Composites are used in decking to improve durability and strength

(Fortune Business Insights, 2020). Then, the assumed French market is 22 758.6 t of WPC/year. This value is assumed as the quantity of olive pomace-based composite laths produce in France.

Table L.6 shows the quantity of OP used in the manufacturing of 1 m² of olive pomace-based composites (details in **Appendix J**). This information was used to estimate the quantity of OP needed to cover the total demand for the French decking market if the olive pomace-based composites replaced the WPC. The total OP needed to cover the manufacturing of the proposed laths was 57 389 t/year.

Table L.6. Crude Olive pomace used in the manufacture of 1 m² of lath made of olive pomace-based composites. Adapted from Espadas-Aldana et al. (2021).

Composite	Weight of the lath (kg)	Needed crude olive pomace (kg)
OSF/PP	18.458	46.546
OSF/PE	18.584	46.860
Average weight	18.521	46.703

The French national production of OP depends on the method used for the extraction of olive oil. The three-phase decanter process generated annually 9 361 t, the two-phase decanter process generated 5 742 t and the traditional method generated 1 825 t (Cossu et al., 2013). In total, France produces 16 928 t of OP per year, which could be used to cover a fraction of the OP demand for the French decking market. The OP would cover 30% of the total lath market demand. Therefore, the direct spreading of the OP in the ground could be avoided, and the OP capture in the laths would return to the soil after 25 years (life span of the laths).

To determine the carbon content that will return to the soil after 25 years, the following information was taken into consideration. In 2019, the total production of olive oil in France was harvested from a surface of 17 717 ha (Toulon and Bouhaddi, 2020). The percentage of carbon present in the olive cake varies from 29.03 to 42.9 (Dermeche et al., 2013), the average value is 36%, this value is used for the calculation.

$$\frac{16\,928\text{ t/year}}{17\,717\text{ ha}} * 0.36 = 0.35 \frac{\text{t C}}{\text{ha} * \text{year}}$$

The C content in the annual production of OP in France is 0.35 t C/ha*year.

The following paragraphs are dedicated to estimating the quantity of C present in the compost made of olive pomace because in one of the comparing scenarios the soil is treated with compost.

To improve composting, it is necessary the addition of a bulking agent. OP is a scarcely porous material, plastic and vulnerable to compaction. The addition of the bulking agents allows adequate gas exchange and prevent excessive compaction of the composting substrate (Alburquerque et al., 2006). Alburquerque et al. (2006) proposed olive leaves as bulking agent, the authors prepared a pile of composting of approximately 2 m wide, 3 m long and 1.5 m high. The pile had a mixture of OP, olive leaves and urea in the following proportions (dry weight basis):

- 87 % Olive Pomace
- 12% Olive leaf
- 1% Urea

Urea was added as an additional nitrogen source to decrease the initial C/N ratio of the composting mixture. The characterization of the compost reported that the carbon content was about 50% (Alburquerque et al., 2006).

Considering that the production of OP is 16 928 t/year, the total production of compost would be 19 457.5 tons per year (with the data available).

$$16928 \frac{t \text{ OP}}{\text{year}} * \frac{100 t \text{ compost}}{87 t \text{ OP}} = 19457.47 t \text{ compost/year}$$

To determine the C content in the compost that would return to the soil, the surface considered is 17717 ha.

$$\frac{19\,457.47 t \text{ compost/year}}{17\,717 ha} * 0.5 = 0.55 \frac{t C}{ha * year}$$

The C content in the annual production of compost made of OP in France is 0.55 t C/ha*year.