



HAL
open science

Contributions to green Internet of Things

Sana Benhamaid

► **To cite this version:**

Sana Benhamaid. Contributions to green Internet of Things. Computer Science [cs]. Université de Technologie de Compiègne, 2023. English. NNT : 2023COMP2727 . tel-04684033

HAL Id: tel-04684033

<https://theses.hal.science/tel-04684033v1>

Submitted on 2 Sep 2024

HAL is a multi-disciplinary open access archive for the deposit and dissemination of scientific research documents, whether they are published or not. The documents may come from teaching and research institutions in France or abroad, or from public or private research centers.

L'archive ouverte pluridisciplinaire **HAL**, est destinée au dépôt et à la diffusion de documents scientifiques de niveau recherche, publiés ou non, émanant des établissements d'enseignement et de recherche français ou étrangers, des laboratoires publics ou privés.

Par Sana BENHAMAID

Contributions to green Internet of Things

Thèse présentée
pour l'obtention du grade
de Docteur de l'UTC



Soutenue le 14 mars 2023

Spécialité : Informatique et Sciences et Technologies de l'Information et des Systèmes : Unité de recherche Heudyasic (UMR-7253)

D2727



UNIVERSITÉ DE TECHNOLOGIE DE COMPIÈGNE

THÈSE DE DOCTORAT

Contributions to green Internet of Things

Auteure :

Sana BENHAMAID

Composition du jury :

Lyes KHOUKHI,	Professeur des universités, Université de Normandie ,	Rapporteur
Valeria LOSCRI,	Chargée de recherche HDR, INRIA - Lille Europe	Rapporteuse
Marcelo DIAS DE AMORIM,	Directeur de Recherche, Sorbonne Université	Examineur
Aziz MOUKRIM,	Professeur des universités, Université de Technologie de Compiègne ,	Examineur
Abdelamadjid BOUABDALLAH,	Professeur des universités, Université de Technologie de Compiègne ,	Directeur de Thèse
Hicham LAKHLEF,	Maître de conférences HDR, Université de Technologie de Compiègne ,	Co-Directeur de Thèse

Thèse présentée pour l'obtention du grade de Docteur

Spécialité : Informatique et Sciences et Technologies de l'Information et des Systèmes

Soutenue le 14 Mars 2023

Pour mes parents

Pour mes frères et ma soeur

Le One Piece existe

Remerciements

C'est avec une grande émotion que je m'apprête à écrire les dernières lignes de ce manuscrit de thèse. Un chapitre de ma vie s'achève et un nouveau commence. Je voudrais donc clore celui-ci en remerciant toutes les personnes qui ont, de près ou de loin, contribué d'une façon ou d'une autre à cet aboutissement.

Abdelmadjid et Hicham, si vous avez l'occasion de lire ces lignes, je vous exprime ma gratitude d'avoir pu bénéficier de votre confiance et de votre expertise pendant la thèse et j'espère avoir été à la hauteur. Je n'oublierai jamais vos conseils. Vous avez toujours été à l'écoute, très réactifs face à mes questions et vous m'avez donné la liberté de poursuivre toutes les directions de recherche que j'envisageais.

Je remercie également les membres de mon jury de thèse pour leur lecture attentive et leurs remarques pertinentes et judicieuses qui aboutiront indéniablement à de nouveaux travaux scientifiques. Ce fut pour moi un immense honneur d'avoir mon travail évalué par des chercheurs et chercheuses de grande renommée. Merci également pour votre présence à ma soutenance, même si la plupart d'entre vous étaient en visioconférence (pour cela, je ne remercie pas la SNCF).

Je tiens à remercier très chaleureusement mes collègues permanents et non-permanents du laboratoire Heudiasyc avec qui j'ai pu partager des discussions scientifiques (et non-scientifiques) si intéressantes et enrichissantes ainsi que tous le personnel administratif notamment, Bérengère Guermonprez et Nathalie Alexandre qui ont toujours été à l'écoute et qui ont été d'une grande aide tout au long de la thèse. Je souhaite également remercier les doctorants qui ont passé ces 3 années de thèse avec moi et avec qui j'ai partagé de nombreux "midis jeux" qui ont parfois mis en péril notre bonne entente.

Je tiens à remercier les personnes sans qui tout cela n'aurait jamais été possible, c'est-à-dire, ma famille. Merci à maman (Nora Bardi) et papa (Saddek Benhamaid) pour tous les sacrifices que vous avez fait pour nous offrir la meilleure éducation possible. Merci de m'avoir soutenu tout au long de ces années et j'espère vous avoir rendu fiers. Merci à mes frères Lyes et Reda et à ma sœur Hanane d'avoir été d'un soutien indéfectible que ce soit pour les bus à 5 h du mat, les situations de stress (très souvent injustifiées) ou les 2 années de COVID. Merci de m'avoir rassuré et d'avoir fait en sorte que je passe ma thèse dans les meilleures conditions possibles.

Maintenant, je souhaite remercier mes amis ou devrais-je dire ma deuxième famille. Tout d'abord, Amina Djaibet, ma meilleure amie qui réalise l'exploit de me supporter depuis 14 ans. Merci pour ton soutien et ton sens de l'humour durant toutes ces années. Merci à Cilia Khemici, Sakina Meftah, Zineb El Moukadem qui ont été présentes dans des moments difficiles et joyeux qui m'ont soutenu avec douceur et clarté. Je tiens à remercier les "imposteurs". Merci à Maxime Noizet d'être la formidable personne qu'il est et merci à Soundouss Messoudi aka "la voix

de la raison”.

La liste de personnes à remercier est si longue qu’il faudrait que je fasse deux ou trois thèses de plus pour citer tout le monde. Voici, néanmoins une liste des personnes avec qui j’ai partagé d’excellents moments : Lahcene Mezouari, Loic Adam, Mohamed Ali Kandi, Mohamed Amine Ouberkouk, Yonatan Carlos Carranza Alarcon, Youcef Amarouche, ... Et je tiens à m’excuser si j’en ai oublié quelques-uns!

Abstract

The Internet of Things (IoT) is a rapidly growing field that has the potential to revolutionize the way we live and work. However, each evolution is accompanied by its share of challenges. One of the primary challenges facing the IoT is the critical energy consumption of IoT networks. Therefore, it is of paramount importance to minimize the energy consumption within IoT networks in order to extend the lifetime and reduce their environmental impact.

Green IoT involves the development and deployment of software and hardware solutions that are designed to minimize the environmental impact and promote the sustainability of IoT. This area has received increasing attention in recent years from both the industry and academia. In the first part of this thesis, we present our first contribution to the Green IoT. We provide a deep study and analysis of the most recent approaches in this field as well as discussions and recommendations on the combination of these approaches with the major IoT applications. In the second part of this thesis, we present our contributions to Green IoT through mobility-based data collection. Mobility-based data collection refers to employing moving platforms, such as cars, buses, and drones, to collect data from IoT devices. While most of the related works usually rely on static trajectory planning approaches and assume that the mobile platform has complete knowledge of the environment. In this thesis, we focused on achieving an intelligent, energy-efficient, and adaptive trajectory planning for a the mobile platform in a dynamic environment where little prior information is available (no previous data set). The environment is also subject to changes (cluster mobility, etc). To achieve this goal, we propose novel trajectory planning approaches based on deep reinforcement learning where the mobile platform learns from experience without the need for a previous data set and adapts its trajectory to the changes in the environment in order to maximize the amount of collected data and minimize its energy consumption.

Keywords: Internet-of-Things, Green IoT, energy efficiency, mobile data collection, deep reinforcement learning, adaptive trajectory planning

Résumé

L'Internet des objets (IoT) est un domaine en pleine expansion qui a le potentiel de révolutionner notre façon de vivre et de travailler. Cependant, chaque évolution s'accompagne de son lot de défis. Pour l'IoT, le principal défi est l'énergie et la manière de minimiser sa consommation d'énergie afin d'étendre la durée de vie et de réduire l'impact environnemental des réseaux IoT.

Dans la première partie de cette thèse, nous étudions un domaine de l'IoT qui a reçu une attention croissante ces dernières années, à savoir le Green IoT. Ce domaine implique le développement et le déploiement de solutions logicielles et matérielles conçues pour minimiser l'impact environnemental et promouvoir la durabilité de l'IoT. Dans la deuxième partie de cette thèse, nous présentons une façon de réaliser le Green IoT qui est la collecte de données basée sur la mobilité. Notre contribution est une solution basée des stations mobiles, telles que des voitures, des bus et des drones, pour collecter des données à partir de dispositifs IoT. Afin de réduire la consommation énergétique globale de ces réseaux, la collecte de données basée sur la mobilité utilise généralement des approches de planification de trajectoire statiques pour la plateforme mobile et ce, dans un environnement bien défini. Cependant, dans cette thèse, nous nous sommes concentrés sur la réalisation d'une planification de trajectoire intelligente, économe en énergie et adaptative pour une plateforme mobile en utilisant l'approche d'apprentissage par renforcement profond. En effet, la plateforme mobile devra apprendre et construire sa trajectoire à partir de son expérience sans avoir besoin d'un ensemble de données précédemment collecté et adapter cette trajectoire aux changements de l'environnement.

Mots-clés: Internet des objets, Green IoT, efficacité énergétique, collecte de données mobiles, apprentissage par renforcement profond, planification adaptative de la trajectoire.

CONTENTS

List of Publications	xv
List of Figures	xvii
List of Tables	xvii
List of Abbreviations	xxii
1 Introduction	1
2 Green Internet of Things	5
2.1 The Internet of Things and its challenges	5
2.2 Application of IoT	6
2.3 Definition of Green IoT	9
2.4 Green IoT enabling technologies	10
2.5 Conclusion	13
3 Study and Analysis of Energy Management Techniques In Green Internet of Things	15
3.1 Problem statement and challenges	16
3.2 Energy management Techniques	18
3.3 Recent Advances in IoT ecosystem Energy Management	38
3.4 Research Perspectives in IoT Energy Management	43
3.5 Discussion	53
3.6 Conclusion	57
4 Energy-efficient Trajectory Planning for Mobile Data Collection using deep Q-learning	59
4.1 Problem statement	60
4.2 Related Works	61
4.3 Background on Reinforcement Learning	62
4.4 System Model and Problem Formulation	65
4.5 Trajectory planning of a mobile node for data collection using Deep Q-learning	66
4.6 Conclusion	74
5 Energy-efficient Trajectory Planning for Mobile Data Collection using Deep SARSA	77
5.1 Background on SARSA learning	77
5.2 The proposed algorithm	78
5.3 Simulation and performance analysis	79

5.4	Results Comparison with Q-learning and discussion	83
5.5	Conclusion	85
6	Conclusion	87
	Bibliography	91

List of Publications

- **Journal papers**

- **Sana Benhamaid**, Abdelmadjid Bouabdallah, and Hicham Lakhlef. "Recent advances in energy management for Green-IoT: An up-to-date and comprehensive survey". In: Journal of Network and Computer Applications 198 (2022): 103257.

- **International Conferences**

- **Sana Benhamaid**, Hicham Lakhlef, and Abdelmadjid Bouabdallah. "Energy-Efficient and Context-aware Trajectory Planning for Mobile Data Collection in IoT using Deep Reinforcement Learning". In: the 30th International Conference on Software, Telecommunications and Computer Networks (SoftCOM). IEEE, 2022.

- **International Workshops**

- **Sana Benhamaid**, Hicham Lakhlef, and Abdelmadjid Bouabdallah. "Towards Energy Efficient Mobile Data Collection In Cluster-based IoT Networks". In the 19th International Conference on Pervasive Computing and Communications Workshops and other Affiliated Events (PerCom Workshops). IEEE, 2021.

- **Other**

- Chafia Bouanaka, Nadira Benlahrache, **Sana Benhamaid**, Emira Bouhamed. "A Review of IoT Systems Engineering: Application to the Smart traffic lights system". In: The International Conference on Advanced Aspects of Software Engineering (ICAASE). IEEE, 2020.

LIST OF FIGURES

2.1	Smart city application domains	7
2.2	Life cycle of green IoT	9
2.3	LPWAN positioning compared to radio communication technologies [Mekki et al., 2019].	12
3.1	Taxonomy of Energy Management Techniques	16
3.2	Backscatter Communication paradigms	20
3.3	Architecture designs for SWIPT. (a) Time switching architecture: based on a pre-defined time factor, connected antennas will be allocated a time to harvest energy and to decode information. (b) Power splitting (PS) architecture: the PS receiver divides the received signal into two power streams based on a certain PS ratio. (c) Antenna switching receiver: antenna switching between harvest energy and information decoding based on an optimization algorithm. (d) separate receiver architecture with separate receivers for energy and information decoding	24
3.4	Mobile Energy Transfer RBC scenario	25
3.5	Concept of Wake-Up Radio	31
3.6	Hierarchical organization between edge, fog, and cloud computing	39
3.7	Research Perspectives in energy management for IoT	44
3.8	The relation between artificial intelligence, machine learning and deep learning	50
4.1	AlphaGo playing against Lee Sedol the Go game world champion	63
4.2	Reinforcement learning standard architecture	64
4.3	The backup diagram indicating the update rule behind Q-learning	68
4.4	The training curves of the mobile node's energy consumption for DQN	71
4.5	The training curves of the mobile node's collected data for DQN	71
4.6	The training curves of the mobile node's minimum reward for DQN	71
4.7	The training curves of the mobile node's maximum reward for DQN	72
5.1	The backup diagrams indicating the update rule behind SARSA	78
5.2	The training curves of the mobile node's energy consumption for DS	81
5.3	The training curves of the mobile node's collected data for DS	82
5.4	The training curves of the mobile node's minimum reward for DS	82
5.5	The training curves of the mobile node's maximum reward for DS	82
5.6	The training curves of the mobile node's energy consumption for DS and DQN	84
5.7	The training curves of the mobile node's energy consumption for DS and DQN	84

LIST OF TABLES

3.1	The State-Of-The-Art of Energy Harvesting In The literature	17
3.2	The Energy Harvesting Techniques and their challenges	19
3.3	The Utility Of Energy Harvesting Techniques In Major IoT Applications	29
3.4	The State-Of-The-Art of Energy Saving In The literature	29
3.5	The Pros And Cons Of The Energy Saving Techniques	37
3.6	The state-of-the-art of the energy saving in the IoT ecosystem	40
3.7	The State-Of-The-Art of Recent Energy Management Approaches For IoT	44
3.8	The Pros And Cons Of Intelligent Energy Saving Techniques	49
3.9	Recommendations On How To Use The Energy Management Techniques to meet IoT applications requirements	54
4.1	Rewards definition	67
4.2	Algorithm parameters	72
4.3	Reward function parameters	73

LIST OF ABBREVIATIONS

ABC	AMBIENT BACKSCATTER COMMUNICATION
AI	ARTIFICIAL INTELLIGENCE
ARBC	ADAPTIVE RESONANT BEAM CHARGING
BAC	BUILDING AUTOMATION CONTROL
BBC	BISTATIC BACKSCATTER COMMUNICATION
BLE	BLUETOOTH LOW ENERGY
CMOS	COMPLEMENTARY METAL OXIDE SEMICONDUCTOR
CR	COGNITIVE RADIO
CPZ	CELLULAR PARTITION ZOOMING
DQN	DEEP Q-NETWORK
DS	DEEP SARSA
EH	ENERGY HARVESTING
ES	ENERGY SAVING
IoT	INTERNET OF THINGS
IIoT	INDUSTRIAL INTERNET OF THINGS
LPWAN	LOW POWER WIDE AREA NETWORK
MDP	MARKOV DECISION PROCESS
MBC	MONOSTATIC BACKSCATTER COMMUNICATION
MIMO	MULTIPLE INPUT MULTIPLE OUTPUT
MN	MOBILE NODE
MPPT	MAXIMUM POWER POINT TRACKING
MQTT	MESSAGE QUEUING TELEMETRY TRANSPORT
NB	NARROW BAND
NOMA	NON ORTHOGONAL MULTIPLE ACCESS
NFV	NETWORK FUNCTION VIRTUALIZATION

QoS	QUALITY OF SERVICE
RF	RADIO FREQUENCY
RFID	RADIO FREQUENCY IDENTIFICATION
RL	REINFORCEMENT LEARNING
SDN	SOFTWARE DEFINED NETWORKING
SS	SAFE SPOT
SWIPT	SIMULTANEOUS WIRELESS INFORMATION AND POWER TRANSFER
UAV	UNMANNED AERIAL VEHICLE
WSN	WIRELESS SENSOR NETWORK

INTRODUCTION

The Internet of Things (IoT) is a paradigm that envisions to connect everyday objects and integrate them to the internet using microcontrollers, transceivers, and protocol stacks. This paradigm attracts the attention of both academia and industries and aims at the digitization of a plethora of applications with high societal relevance. The IoT applications in our daily life activities are manifold, from smart transportation that offers ground breaking progress in the transportation and logistic industry to smart home that facilitates its in-habitants activities. IoT covers several fields such as smart traffic, healthcare, agriculture, industry 4.0 and can even be found in our everyday objects such as pens, clothes, etc. As a result, the world has known an explosive growth in the number of these devices. According to IHS Markit, 125 billions of IoT devices are expected to be connected with each other by 2030. This has brought about many benefits to our daily lives by improving convenience, efficiency, and productivity.

The exponential evolution of IoT comes with its challenges. As the number of connected devices continues to grow, the worry about their environmental impact increases proportionally. The demand of IoT networks for energy is in constant increase, putting a strain on the power grid and contributing to greenhouse gas emissions. The second energy challenge for IoT comes with the nature of IoT devices. These devices are often small sized and battery-limited but are used to perform monitoring and control tasks in IoT applications over long periods of time and without interruption. They can also be placed in areas which are difficult to access (e.g. under water systems, military systems, unsafe environments, etc.) and can quickly run out of energy. Consequently, IoT devices not only have a limited lifetime but also replacing their batteries frequently becomes an arduous and costly task. In response to these challenges, the concept of the Green Internet of Things has emerged.

In this thesis, we delve into the field of Green Internet of Things (IoT) in an effort to fully comprehend the capability of this technology to tackle the obstacles presented by traditional IoT systems. The Green IoT approach aims to address these issues by incorporating sustainable

practices and technologies into the design and operation of IoT systems. To gain a thorough understanding of the topic, in this thesis, we propose a comprehensive review and analysis of existing literature and case studies of the novel energy management techniques for IoT. The objective is to gain insights into the current state of Green IoT and its potential to support a more sustainable future. We also provide interesting discussions and recommendations on the use of these techniques in the major IoT applications. The findings of this research can provide valuable information for organizations, researchers and policy-makers who are interested in promoting sustainable development through the implementation of Green IoT.

Another green IoT development approach that we considered in our contribution consists in improving the efficiency and effectiveness of data collection in IoT. More specifically, we concentrate on enhancing the energy efficiency of mobile data collection. Mobile data collection in IoT refers to the process of gathering data from sensors or other devices using a mobile platform, such as a robot or drone. The traditional solutions that are proposed usually rely on static trajectory planning approaches and assume that the mobile platform has complete knowledge of the environment. However, in real-world scenarios, the environment is subject to changes, which makes it difficult for mobile platforms to collect data using traditional methods. In this thesis, first, we propose a formal definition as well as a Markov decision process representation of our dynamic environment. Then, we proposed novel trajectory planning approaches for data collection based on deep reinforcement learning. Our approaches allow the mobile platform to learn from experience and adapt its trajectory to changing conditions in real-time, without the need for a previous data set. The goal of the trajectory planning methods we propose is to maximize the amount of collected data while minimizing energy consumption. Our approaches have the potential to open new perspectives for data collection in dynamic environments and make it more efficient and cost-effective.

The rest of this thesis is organized as follows. Chapter 2 serves as an introduction to the topic of Green IoT, providing a background on the Internet-of-Things (IoT) and its various applications. Additionally, it defines the concept of Green IoT and the technologies that enable it. In Chapter 3, we present our study and analysis of the energy management and Green techniques in IoT along with the most recent advances in this direction. We also set out the most recent trends in this area and provide discussions and recommendations on the combination of these techniques with the main IoT applications. In Chapter 4, we provide a background on reinforcement learning to explain the underlying concepts and principles

that form the basis of our proposed algorithms. Additionally, we expose our proposed environment system through a formal description and a Markov decision process and present our adaptive and energy-efficient trajectory planning algorithm for mobile data collection based on deep Q-learning. In Chapter 5, we propose another algorithm for an energy efficient trajectory planning for mobile data collection based on deep SARSA and provide a comparison of the results we obtained for our two algorithms discussed in Chapter 4 and 5. Finally, we summarize the main findings of the research in Chapter 6 and discuss the future work directions and open issues that need to be addressed.

GREEN INTERNET OF THINGS

CONTENTS

2.1	The Internet of Things and its challenges	5
2.2	Application of IoT	6
2.3	Definition of Green IoT	9
2.4	Green IoT enabling technologies	10
2.5	Conclusion	13

IoT has evolved from effervescence to reality. It has become an essential part of human day-to-day life. In fact, its evolution is so important that the world has known an explosive growth in the number of IoT devices and lead to the emergence of energy consumption concerns. In order to tackle the energy challenges of IoT, green IoT has emerged as an attractive area of research for both academia and industry. In this chapter, we present an overview on the IoT and its major applications. Then, we provide a complete definition of Green IoT based on our literature study. Finally, we will describe the main enabling technologies for Green IoT.

2.1 THE INTERNET OF THINGS AND ITS CHALLENGES

The Internet of Things (IoT) is a paradigm that envisions to connect everyday objects and integrate them to the internet using microcontrollers, transceivers, and protocol stacks. This paradigm attracts the attention of both academia and industries and aims at the digitization of a plethora of applications with high societal relevance. The IoT applications in our daily life activities are manifold, from smart transportation that offers ground breaking progress in the transportation and logistic industry to smart home that facilitates its in-habitants activities. IoT covers several fields such as smart traffic, healthcare, agriculture, industry 4.0 and can even be found in our everyday objects such as pens, clothes, etc. According to IHS Markit, 125 billions of IoT devices are expected to be connected

with each other by 2030 [Howell, 2017]. This number is highly influenced by the emergence of 5G networks and the exploitation of new spectrum frequencies [Li et al., 2018]. Moreover, IoT devices are usually small and battery limited and the exchange of massive information between these devices gives rise to enormous energy requirements. These requirements are often not supported by IoT devices and can quickly lead to battery depletion and the network's death.

So, how can we develop energy-efficient solutions that will not only reduce the energy consumption in IoT networks and their carbon footprints but also increase the networks lifetime? Accordingly, we witness the emergence of the Green Internet of Things which focuses on saving and managing energy in IoT networks in order to optimize and reduce the energy consumption and prolong the IoT networks lifetime. In the next few years, Green IoT will make significant changes in our daily life and will help realize the vision of "green ambient intelligence" [Al-Turjman et al., 2019].

2.2 APPLICATION OF IOT

With the rapid evolution of IoT, a plethora of IoT applications emerged covering practically all areas of our daily lives. We divide these applications into six categories : industrial automation, healthcare, habitat monitoring, smart cities, smart energy and transportation.

2.2.1 *Industrial Automation*

In the recent years, the industry has been revolutionized by the use of artificial intelligence which lead to an increase in productivity and efficiency. Moreover, with the development of internet technologies and cloud computing, the industry is entering a new era called the fourth industrial evolution or industry 4.0, which includes Industrial Internet of Things (IIoT). IIoT focuses on the connections of machines and devices in industries and manufacturing. IIoT consists in connecting industrial components such as machines and control systems with information systems and business processes. Consequently, a large amount of data is collected and transmitted to be processed analytically to produce optimal industrial operations. IIoT also includes smart manufacturing, which centers on elaborating an efficient product life cycle, with the aim of quickly and dynamically adapt to the changes in demands.

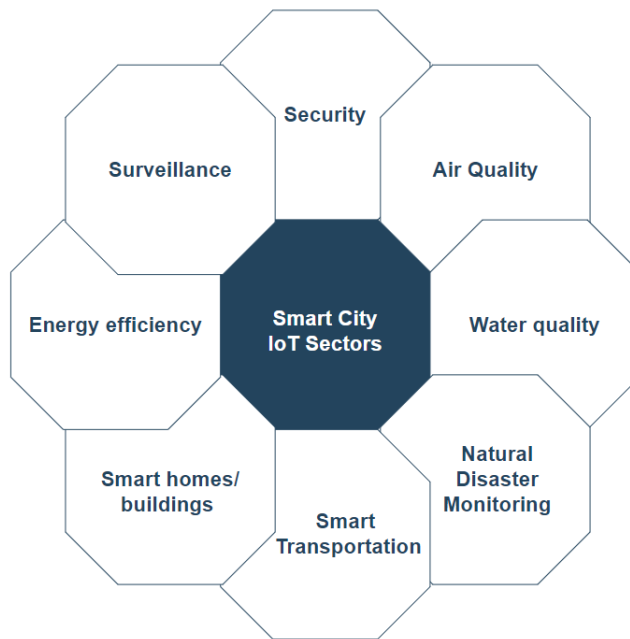

Figure 2.1: Smart city application domains

2.2.2 Healthcare

The domains of healthcare and technology have been closely linked. However, the recent years have witnessed a quick growth of IoT in healthcare. It has opened the possibility to add to the hospital-centric care, the patient-centric care, which has provided evidence of its success on smaller scales. IoT can be adapted to meet the challenges of modern healthcare. Healthcare system can be categorized into three main areas: large healthcare institutions (i.e., hospitals), small clinics and pharmacies, and non-clinical environments (i.e., patient homes, communities, rural areas lacking healthcare) [Farahani et al., 2020].

2.2.3 Habitat Monitoring

IoT has been broadly used in habitat monitoring. It refers to a supervised habitat equipped with devices such as sensors or other appliances. For example, these appliances can be laundry machines, LEDs and heaters that are connected to the Internet in order to manage homes' and buildings' features (lighting, temperature). Using IoT for monitoring habitats can even be extended to improve the well-being of animals in their environment. In [Daud et al., 2020], the authors propose a smart aquarium solution that automatically feeds the fish and monitors the pH value of the aquarium water in order to alert the owners in case of a need for a water change. This solution not only enhances the well-being of the fish but also helps the owner take good care of their animals.

2.2.4 *Smart Energy*

Electricity is at the center of modern social, economic, and industrial development. However, new challenges have emerged as to how to efficiently manage the demand and distribution of electricity. Since IoT offers numerous cutting-edge solutions in critical domains and infrastructures, it was natural to consider using IoT to transform traditional power system networks into efficient and smart energy grids. IoT can address the reliability, efficiency, and flexibility challenges of conventional grid systems. Smart grids should provide personalized energy distribution depending on the users' actions. This is why, it offers large-scale integration of renewable energy resources, establishment of real-time data communication between consumers and service providers regarding tariff information and energy consumption. It also offer facility to collect and transfer statistics of system parameters for analysis, and infrastructure to implement necessary actions based on those analyses [[Abir et al., 2021](#)].

2.2.5 *Transportation*

Since IoT is playing a massive part in coping with most of society's technical challenges, the idea of making the sector of transportation smart becomes achievable. In fact, problems such as traffic congestion, road safety, accident detection, automatic fare collection, and limited car parking facilities can be solved by IoT. Apart from cars, IoT also holds the promise of achieving modern, interoperable, safe, and secure railways infrastructures. As for aviation, studies of IoT in the aviation industry are able to provide benefits such as achieving customer satisfaction growth with higher comfort, enhancing the productivity on supply chain activities while reducing the cost with decreasing of human related accidents, developing security and decreasing travel time [[Karakuş et al., 2018](#)].

2.2.6 *Smart cities*

With the ever growing population and the constant need for better services and infrastructures in the cities, it has become a priority for governments and businesses to tackle these challenges. Therefore, IoT emerged as the most appropriate approach to serve this necessity as all the devices are connected and can communicate with each other. A smart city is composed of a large and diverse number of IoT devices that can be involved different smart city applications that range all the way from air quality sensors, water quality sensors, security, and more application domains as shown in [Figure 2.1](#). The association of multiple IoT devices data assures more

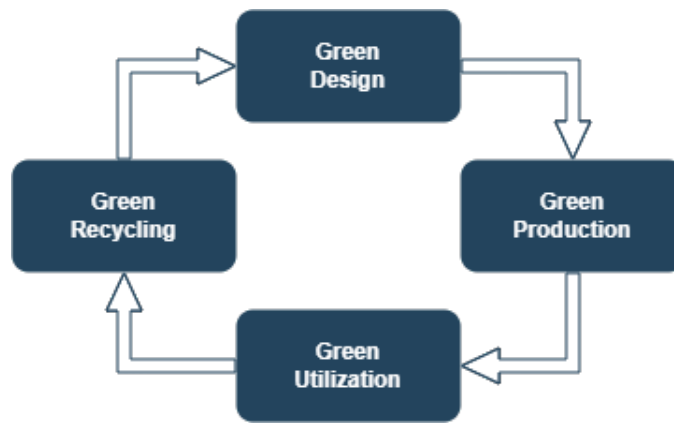

Figure 2.2: Life cycle of green IoT

knowledge and insights about the city. For example, transportation sensors and air quality sensors are related to one another. Basically, a smart city encompasses all the previous applications we described previously.

2.3 DEFINITION OF GREEN IOT

Green IoT is a term that has emerged in the recent years to describe the strategies and techniques used to achieve energy efficiency in IoT systems and increase their lifetime. Green IoT also includes the IoT applications that aim to reduce the wastage of resources and the carbon footprint of every area of the daily life: health, transportation, agriculture, etc. However, although IoT helps the sustainability of the planet, it also results in augmentation of energy consumption in other sectors thus increasing the greenhouse gas emission. This augmentation is due to the massive manufacturing of IoT devices and their shipment as well as the over exploitation of data centers to ensure the availability of services. Consequently, Green IoT also encompasses the life cycle of IoT systems which takes into consideration green design, green production, green utilization and green disposal and recycling to have minimal or no impact on the environment [Albreem et al., 2017]. We summarize the lifecycle of green IoT in Figure 2.2.

Considering green designs, the IoT industry should consider creating sustainable and energy efficient devices at design level. For example, energy efficient system on chips are designed in order to reduce the energy consumption at circuit level. The systems are now drastically smaller and can manage power dynamically while assuring secure communications. Another evolution is to use battery-less devices that harvest energy from their surroundings. This approach is getting a lot of traction from both the academia and the industry. Besides green designs, we should also consider the green production aspects of IoT. The production of IoT devices should reduce its greenhouse gas emissions as well as use renewable and clean

energies harvested from ambient sources. The third aspect is green utilization and it consists on using energy efficient techniques in the deployment and utilization of IoT systems as well as using recyclable materials for the production of devices which links the production to the recycling aspect of green IoT. In fact, millions of devices are present but no longer used. Their materials should be then, recycled and re-used in order to reduce their greenhouse gas emission.

2.4 GREEN IOT ENABLING TECHNOLOGIES

Reducing greenhouse gas emissions in IoT implies greening IoT system at different levels. In this section, we present the main enabling technologies to accomplish green IoT systems.

2.4.1 *Green devices*

IoT devices are evolving at a fast pace along with the variety of services they offer. Therefore, IoT devices should not only be able to achieve the tasks for a long period of time but also meet the users' expectations. Green IoT devices help to reduce the environmental impact of IoT networks. They also often use less materials and are designed for easy recycling, making them more sustainable. Adopting green IoT devices can lower operating costs and reduce carbon footprint. In the following section, we present the main green devices approaches for IoT.

2.4.1.1 *Radio Frequency Identifiers (RFID)*

RFID play a central role in IoT. It is an automatic technology that helps machines to identify objects and information through radio waves. RFID is widely used in many sectors due to the contact-less, low power and rapid feature target recognition. An RFID system is composed of RFID tag, reader and terminal. When an object equipped with an RFID tag, which is a carrier of identification information, is in the range of the RFID reader, the tag sends information to the reader. This information is sent by the energy harvested from the reader's signal. Although, energy efficiency in Active RFID (i.e., RFID with a battery and a dual antenna) is discussed in the literature, exploring passive RFID (i.e., RFID with no battery and one antenna) and Wireless Identification and Sensing Platform can result in a more energy efficient and low power computation in IoT.

2.4.1.2 *Green Sensor on Chips*

The design of integrated circuits in IoT networks is vital in energy saving. With the deployment of a high number of IoT devices, such electronic systems may trigger sustainability concerns as the electricity consumption of

ICT infrastructure such as network components and data centers is exponentially increasing. Integrated circuits should employ a sustainable design approach to lessen these effects in the Design-for-the-environment approach. Hence, low-power system-on-a-chip approach have emerged in order to minimize the embodied energy and carbon footprint of IoT devices, the toxicity of e-waste, and the internet traffic caused by the generated data. Systems-on-a-chip in nanometer CMOS technologies can contribute to these objectives by allowing compact batteryless WSNs with on-node data processing [Bol et al., 2013].

2.4.1.3 *Time Reversal*

With their omnipresence and diversity, IoT devices often operate on diverse bandwidth and thus need standardization in terms of communication means. For this purpose, various middlewares have been developed. However, middlewares are often complex and are not suitable for resource-constrained systems. Time Reversal is a technique that proposes a unified approach to deal with the challenge of heterogeneous bandwidths of IoT devices communications. It is a technique that focuses on signal waves in both time and space domains. This technique focuses on harvesting energy from the surrounding environment by using the multi-paths propagation to recollect all the signal energy. A Time Reversal system is able to reduce the energy consumption and interference and thereby can support multiple concurrent active users [Chen et al., 2014].

2.4.2 *Green Communications*

Communication in IoT is highly energy consuming due to the large number of connected IoT devices. These devices can not only communicate between themselves but also dispatch their data to the network components and datacenters in order to delegate the computational operations. Consequently, reducing the energy consumption of IoT communications implies proposing energy efficient solution at three levels : networks, transmission protocols and data centers. In this section, we're going to present the efforts made by both academia and industry to reduce the power consumption at those three levels.

2.4.2.1 *Low Power Wide Area Networks(LPWANs)*

LPWANs constitute a novel communication paradigm, which is developed in complement to the traditional cellular and short-range wireless technologies (such as Bluetooth, ZigBee, Z-wave, Wi-Fi, etc.) to address the requirements of IoT applications. This technology provides low cost, low power, and extended range connectivity for robust IoT networks. These features come at the expense of a low data rate (in orders of tens of kilobits

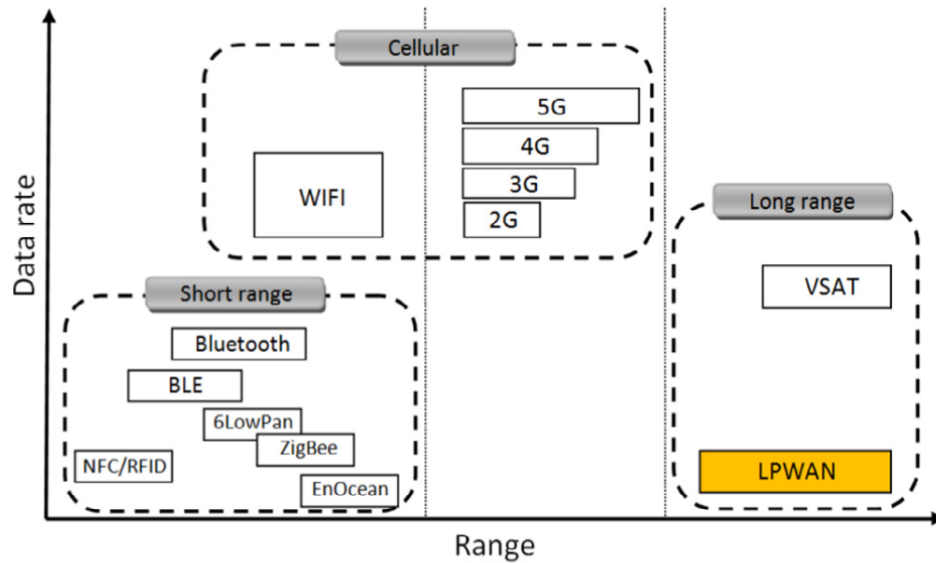

Figure 2.3: LPWAN positioning compared to radio communication technologies [Mekki et al., 2019].

per second) and higher latency (in orders of seconds or minutes). Therefore, it was designed for applications that require transmitting few and small messages per day in long range. Figure 2.3 presents the positioning of LPWAN compared to other radio communications schemes. It is expected to connect to the Internet one fourth of the overall IoT/M2M devices in the industry and to cover a wide range of business sectors. These business sectors include but are not limited to smart city, smart grid, smart metering, logistics, industrial monitoring, agriculture, etc. [Raza et al., 2017].

The most famous LPWANs technologies are: Sigfox, LoRaWAN, and NB-IoT [Mekki et al., 2018]. Sigfox and LoRaWAN both excel in terms of network capacity, device lifetime, and cost, and both of them were developed in France by the start-ups Sigfox and Cycleo respectively. NB-IoT is an LPWAN technology based on narrowband technology. The 3rd Generation Partnership Project (3GPP) is at the origin of NB-IoT standardization. The strongest assets of this technology are that it offers low latency and good quality of service.

2.4.2.2 Green routing protocols

IoT networks and especially wireless sensor networks are resource-constrained and thereby have limited computational and communication capabilities. A good amount of the IoT nodes' power is used in the transmission of data in comparison to receiving and idle states. It is also essential to note that the network lifetime is tightly tied to the IoT nodes' power requirement. Therefore, various routing protocols and algorithms were proposed in the literature in order to reduce the power consumption

of data transmission in IoT networks. The network lifetime can be defined as the number of packet transmissions for a source and a destination node before the first node dies. Therefore, energy balance is a very challenging problem in order to maximize the network lifetime. In [Kumar et al., 2016], proposed a routing protocol that ensures a fairly balanced traffic load inside the network. Instead of always using the same path to transmit data, the protocol sends the data through different paths using tangents from the source to the destination. Therefore, a balanced distribution of transmission load is achieved within the network extending its lifetime.

2.4.3 Green Data Centers

The ever-growing rise of IoT applications and their services is driving an exponential growth of data centers. Enterprises are installing servers or expanding their capacity in order to store or compute the enormous amount of IoT network and sensor data. These data centers will get overburdened by the data produced by billions of IoT applications and will inevitably increase their energy consumption. The energy consumption of data centers alone will rise from 200 TWh in 2016 to 2967 TWh in 2030 [Katal et al., 2022]. Most of the energy consumption in data centers comes from the servers, cooling infrastructures, network components, and even by the location of the data center. This energy consumption is determined by the amount of data managed and their residence time in the data center. Basically, the more time data stays in the data center, the more energy is consumed. Various factors can influence this energy consumption such as computation time, queuing time, execution time, and response time. Thus, it becomes necessary to develop energy-efficient techniques for the effective utilization of data in data centers. Therefore, The efficiency of data centers can be improved by using energy-efficient equipment, improving airflow to reduce the power consumption of the cooling operations, and developing software solutions to reduce, as much as possible, the data remaining time in the data center. New approaches such as Software Defined Networking (SDN) and Network Function Virtualization (NFV) are also used to reduce the energy consumption of IoT networks and will be discussed in the next chapters.

2.5 CONCLUSION

Throughout this chapter, we can see that the Internet of Things (IoT) has the potential to revolutionize our lives, but it also presents new challenges in terms of energy consumption and environmental impact. Green IoT is an emerging field that aims to address these challenges by designing and implementing IoT systems that are more energy-efficient and sustainable. In this chapter, we have presented a background on the Internet

of things, its main applications, and the energy challenges this technology faces. Then, we have discussed the Green IoT which emerged as a solution to create sustainable IoT. Finally, we have presented the main enabling technologies of Green IoT.

CHAPTER 3

STUDY AND ANALYSIS OF ENERGY MANAGEMENT TECHNIQUES IN GREEN INTERNET OF THINGS

CONTENTS

3.1	Problem statement and challenges	16
3.2	Energy management Techniques	18
3.3	Recent Advances in IoT ecosystem Energy Management	38
3.4	Research Perspectives in IoT Energy Management	43
3.5	Discussion	53
3.6	Conclusion	57

The Internet of Things (IoT) relies on a large number of connected devices that are often powered by batteries. These devices are expected to last for long periods of time, sometimes for several years, with minimal maintenance. However, the energy requirements of these devices can pose a significant challenge. The constant communication, processing, and storage required by these devices can consume a lot of energy, which can lead to short battery life and frequent replacement. Energy management is a critical aspect of IoT networks as it can help to extend the life of connected devices and minimize the need for maintenance.

This area has received increasing attention in recent years from both the industry and academia. In this chapter, we present our study of the literature and expose and analyze the recent energy-saving and harvesting solutions proposed. We also set out the recent research trends for Green IoT such as green 5G IoT, green social IoT, green networks

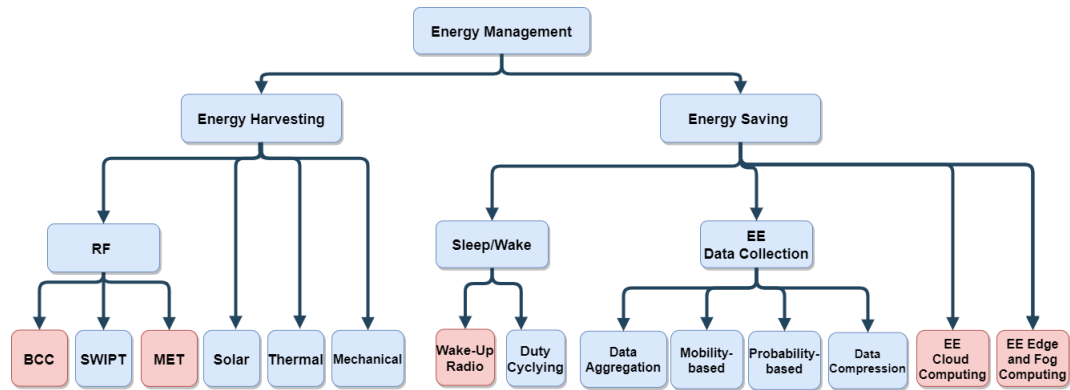

Figure 3.1: Taxonomy of Energy Management Techniques

softwarization, backscatter communications, etc. Finally, we will provide recommendations on how to use these energy-efficient solutions in the most famous IoT applications. This deep dive and analysis of the most recent energy-efficient solutions resulted in a journal article published in the Journal of Network and Computer Applications [Benhamaid et al., 2022].

3.1 PROBLEM STATEMENT AND CHALLENGES

Since IoT applications and services are reaching almost every corner of our life, the carbon footprint of these applications is increasing proportionately with the number of IoT devices. IoT networks are composed of devices that can be rich or limited in energy resources and the aim of Green IoT is to reduce the energy consumption of both types of devices while still being able to effectively perform their tasks and services. Key and widespread IoT technologies such as wireless sensor networks are composed of small and battery-limited sensor devices that gather information and build efficient and reliable information and communication systems. However, these devices are typically used to perform monitoring and control tasks in IoT applications over long periods and without interruption. Sensors can also be placed in areas that are difficult to access (e.g. under water systems, military systems, unsafe environments, etc.) and can quickly run out of energy. Consequently, replacing their batteries frequently becomes an arduous and costly task. Energy storage and power management should also ensure the constant availability and operability of IoT devices given that, neither cable power nor battery replacement are feasible options in harsh conditions. Many energy-saving software and hardware solutions have been developed in order to reduce IoT networks' energy consumption and maintenance costs.

Currently, the world experiences a scarcity of energy sources in addition to the important emission of CO₂ resulting from human activity.

Table 3.1: The State-Of-The-Art of Energy Harvesting In The literature

Energy Harvesting Technologies		References
RF Source EH	Backscatter Communications	[Hoang et al., 2020], [Zhang et al., 2019b], [Yang et al., 2018], [Ji et al., 2020], [Timoudas et al., 2020], [Feng et al., 2018], [Ma et al., 2018], [Cao et al., 2019]
	SWIPT	[Perera et al., 2017c], [Perera et al., 2017b], [Liu et al., 2019a], [Lu et al., 2017], [Ji et al., 2019], [Luo et al., 2019], [Park et al., 2020a], [Lee et al., 2018], [Liu et al., 2017]
	MET	[Almasoud et al., 2017], [Madhja et al., 2016], [Zhang et al., 2019a], [Liu et al., 2018]
Solar EH		[Luo et al., 2018], [Li et al., 2015], [Nguyen et al., 2017], [Wu et al., 2016], [Wu et al., 2018a]
Thermal EH		[Abdal-Kadhim et al., 2018], [Yun et al., 2016], [Priya et al., 2018], [Teply et al., 2019]
Mechanical EH		[Jushi et al., 2016], [Kamenar et al., 2016], [Magno et al., 2016]

Greening information and communication technologies become an imperious need considering the damage caused to our environment. Consequently, energy harvesting solutions have been studied in order to power IoT devices with green and renewable energies such as solar energy, wind energy, mechanical energy, etc. Since Green IoT is a newly studied research field, one essential domain that is not widely discussed is energy measurement. In fact, with the battery-limited nature of IoT devices and their high number and energy consumption, measuring and analyzing the energy consumption of IoT devices is key to achieving applications' QoS requirements. Due to the high cost and large size of the existing commercial energy measurement solutions, researchers proposed various alternatives. However, these alternatives are often limited by their complexity, measurement range, and accuracy [Dezfouli et al., 2018]. IoT energy measurement tools should also be standardized to be able to support all types of devices with their different complexities at a low cost. As we can see, although the revolution of IoT changing our lives has started, many challenges still need to be overcome in terms of energy consumption and environmental issues. Accordingly, numerous potential solutions in different disciplines are being explored to achieve this goal which requires a lot of effort.

3.2 ENERGY MANAGEMENT TECHNIQUES

In order to tackle the energy issues in IoT networks, two approaches are usually employed: energy harvesting and energy saving. Energy harvesting can be described as the mechanisms employed to produce energy from a network ambient environment to provide an uninterrupted power supply for the network devices. On the other hand, energy-saving schemes focus on developing algorithms, protocols, and even hardware solutions to minimize the network energy consumption and maximize its lifetime. Based on these two categories, we propose a technique-based taxonomy (Fig. 3.1) which represents the recent energy management solutions studied in the literature in order to extend IoT networks' lifetime and reduce the carbon footprint of those networks. Our taxonomy includes recent energy management techniques that can be found in the literature.

As shown in Fig. 3.1, we divide the energy harvesting category in the taxonomy depending on the energy sources into four sections: RF energy harvesting in which we include Backscatter Communications (BCC) [Hoang et al., 2020], a novel energy harvesting technology, Mobile Energy Transfer (MET) and Simultaneous Wireless Information and Power Transfer (SWIPT) technology. We also discuss the most recent research in energy harvesting techniques with green sources such as solar, thermal, and mechanical energy. We will present these techniques more deeply later in this section. The second category of energy management solutions we represent in the taxonomy includes energy-saving solutions. As shown in Fig. 3.1, we classified energy-saving solutions depending on the technology they employ. We introduce recent intelligent energy-saving techniques that use Machine Learning (ML) and Deep Learning (DL) to reduce the energy consumption in IoT networks. We present energy-efficient data collection techniques used in IoT networks as well as, sleep/wake-up schemes such as Duty Cycling and the recent low-power Wake-Up Radio technology.

In what follows, we will discuss the energy management techniques for IoT networks. First, we start by presenting the energy-harvesting techniques followed by the energy-saving techniques discussed in the literature. It is worth mentioning that we will present and focus more deeply on the emerging energy management techniques.

3.2.1 *Energy Harvesting Techniques*

We will discuss the energy harvesting techniques existing in the literature. We focus our review on the recent solutions proposed for each one of

Table 3.2: The Energy Harvesting Techniques and their challenges

Energy Harvesting Techniques	Concept	Challenges
Backscatter communication	<ul style="list-style-type: none"> -Batteryless devices -Use RF signal to code information and send it to the receiver 	<ul style="list-style-type: none"> -Short range -Efficient information coding -Security -High deployment cost
SWIPT	<ul style="list-style-type: none"> -Battery less or battery powered devices -The information and power for the device are sent through the same signal 	<ul style="list-style-type: none"> -Efficient information decoding -Interference -Short range -Security
MET	<ul style="list-style-type: none"> -Use a mobile node to power IoT devices 	<ul style="list-style-type: none"> -The energy consumption of the mobile node -Interference
Solar EH	<ul style="list-style-type: none"> -Use solar energy to power devices 	<ul style="list-style-type: none"> -Light availability -Energy transport
Thermal EH	<ul style="list-style-type: none"> -Generate electric power from the difference in temperature 	<ul style="list-style-type: none"> -Efficient power generation
Wind/Water Energy	<ul style="list-style-type: none"> -Generate electric power from water and wind movement 	<ul style="list-style-type: none"> -Difficult to deploy -Unpredictable
Humain Motion	<ul style="list-style-type: none"> -Generate electric power from human movement 	<ul style="list-style-type: none"> -Low energy -Differs from one person to another

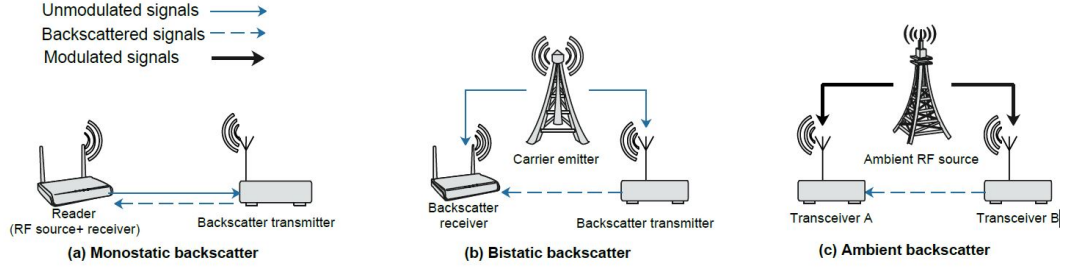

Figure 3.2: Backscatter Communication paradigms

these techniques. In Table 3.2, we present the concept and challenges of the energy harvesting techniques and Table 3.1 summarizes the energy harvesting works organized by the nature of the harvested energy: *RF, solar, thermal, and mechanical energy*.

3.2.1.1 RF energy harvesting (Wireless Power Transfer Techniques)

In what follows, we will present RF energy harvesting techniques focusing deeply on backscatter technology since it is an emerging technique in energy harvesting.

1. Backscatter Communications

One of the major issues that IoT networks face is the limited network lifetime due to the battery dependency of IoT devices. Having these devices complete tasks over a long period could easily lead to battery depletion and induce a replacement cost. In some cases, sensors do not need to be kept active consistently and will wear out their batteries unnecessarily. Backscatter communications allow battery-less devices to transform wireless signals and use them as a source of power and a communication medium. Having battery-less devices is a major advantage of backscatter communications as it helps reduce energy consumption, removes the constraint of frequent battery replacement, and averts undesired performances due to energy shortage.

According to [Hoang et al., 2020], there are three different paradigms of Backscatter Communications (Fig. 3.2): *Monostatic Backscatter Communication (MBC)*, *Bistatic Backscatter Communication (BBC)* and *Ambient Backscatter Communication (ABC)*.

- *Monostatic Backscatter Communication*: as shown in Fig. 3.2(a) MBC system is composed of two components: a reader and a backscatter transmitter (e.g. RFID tag). The specificity of MBC is that the receiver and the RF source are located in the reader. The RF source sends a signal that activates the tag which modulates the signal and reflects it to the backscatter

receiver. Since the RF source and the receiver are located in the same device, the modulated signals may suffer from a round trip path loss which makes it more suited for short-range RFID applications.

- *Bistatic Backscatter Communication*: the main difference between BBC and MBC systems lies in the separation of the RF source (re-named the carrier emitter in BBC) and the backscatter receiver in different components which significantly reduces the round-trip path-loss problem (as represented in Fig. 3.2(b)). Moreover, by optimally placing carrier emitters, the overall communication range can be extended and the system performance is greatly improved. Although the deployment and maintenance of the carrier emitters in BBCs are costly, their design remains simple which makes their manufacturing cost lower than MBCs.
- *Ambient Backscatter Communication*: in Ambient backscatter communication systems (Fig. 3.2(c)) and similarly to BBC systems, ABC systems carrier emitter is separated from the backscatter receiver. However, the carrier emitter, in this case, can be an already available ambient RF source in the environment such as a Wi-Fi access point or a cellular base station. In [Zhang et al., 2019b], an ABS system is presented as a batteryless device (tag or sensor) which can harvest wireless energy from an RF source and then transmit "0" or "1" bit to a sink node through reflecting or non-reflecting states. In addition to having virtually no cost of deployment, the manufacturing costs and power consumption of ABCs can be reduced by the use of low-cost and low-power components.

Various works studied backscatter communications and their impact on the energy consumption of IoT networks and proposed solutions to further improve the energy efficiency of these systems. In [Yang et al., 2018], the authors proposed a cooperative ambient backscatter communication system that allows a device to recover information from both the ambient backscatter devices and the RF source. The proposed solution enhances the maximum likelihood detection performance if the backscatter device symbol period is longer than the RF source symbol period. This solution can be upgraded to be exploited in smart home and wearable applications. In order to further enhance the energy efficiency of backscatter communications, various works studied the optimization of the communication

parameters. The authors in [Ji et al., 2020] proposed a joint optimization based on the source antenna number and power splitting factor under the condition that the minimum energy required by the destination node is met while in [Timoudas et al., 2020], the authors proposed a solution to optimize the needed power to transmit for a base station and the radio of backscattered signal of the IoT devices in the context of massive IoT. For complex IoT systems, other parameters (such as the number of base stations, the number of backscatter devices, and their positions) need to be optimized in order to be energy efficient and to adapt to the IoT application needs. The authors in [Feng et al., 2018], focused on the link layer of backscatter communication systems using centralized MAC protocols, while other solutions used distributed MAC protocol [Ma et al., 2018],[Cao et al., 2019]. Distributed MAC protocols are more suitable than the centralized protocols for large-scale IoT networks with unstable network topologies and high topology maintenance costs.

Although backscatter communications seem ideal to achieve green IoT, it still has to overcome some challenges such as the risk of interference when there is a high number of nodes as well as, the bit rate limitations as it is not simple to implement very complex modulations on a backscatter tag due to its limited capability in manipulating the RF signal and performing baseband processing. In addition to that, backscatter communications networks need to overcome the short-range limitation and the high deployment cost they may generate.

2. *Simultaneous Wireless Information and Power Transfer (SWIPT)*

SWIPT is one of the most attractive and challenging technologies in energy management. It is a technique that enables the simultaneous transfer of information and power wirelessly [Perera et al., 2017c]. Theoretically, SWIPT allows an IoT device to harvest energy and receive RF information from the same RF signal that carries both energy and information. Therefore, an IoT device can be self-powered by receiving data. However, in most cases, it is not possible to perform energy harvesting and information decoding simultaneously from the same signal. The information could be altered or lost by the energy harvesting operation. Thus, different receiver architectures were designed to achieve SWIPT: *Separate Receiver*, *Time Switching (TS)*, *Power Splitting(PS)*, and *Antenna Switching* [Perera et al., 2017c]. These architectures are presented in Figure 3.3

In SWIPT, the power and information needed for an IoT node

are sent at the same time which keeps the node alive and extends the lifetime of IoT networks. Various solutions have been proposed to adapt and achieve SWIPT. For example, in [Perera et al., 2017b], the authors provide a comprehensive study related to SWIPT in different types of wireless communication setups. In [Liu et al., 2019a], the authors proposed a dual-battery green energy harvesting architecture that achieves SWIPT. It consists in using one battery to power the device while the other one is harvesting energy in order to reduce energy shortage probability. However, this solution is limited to small IoT networks with devices that can support a dual battery. The proposed solution also adds complexity to sensor devices and is expensive for massive IoT networks with a high number of devices. In [Lu et al., 2017], the authors proposed a collaborative energy and information transfer protocol for WSN that does not require the power and information splitter component which is convenient for IoT networks and reduces the complexity and cost of the sensors. In [Huang et al., 2018], the authors studied the optimization of the energy efficiency in a SWIPT-based distributed antenna system by coordinating the energy harvesting and information decoding for IoT devices. The proposed solutions take into consideration the number of IoT devices in the network.

SWIPT was also associated with deep learning to further enhance the energy saving potential of this technology. In [Luo et al., 2019], the authors proposed a solution based on deep learning to minimize the total transmit power of a multi-carrier NOMA SWIPT system while satisfying the Quality-of-Service (QoS) requirements of each user. Deep learning was also used with SWIPT in [Park et al., 2020a]. The authors proposed a dual-mode SWIPT system that uses an adaptive mode switching based on deep learning to exploit both single-tone and multi-tone SWIPT. Although deep learning proves to be efficient for SWIPT-based systems, it also requires an important amount of resources that should be considered to build green and sustainable IoT networks. In [Lee et al., 2018], the authors proposed a hybrid resource and task algorithm in a SWIPT system that enables the devices to do their required tasks in a distributed manner. However, this solution should be improved to take into consideration delay-sensitive tasks for it to satisfy the real-time requirement of IoT applications. Finally, in [Liu et al., 2017], the authors proposed a cooperative SWIPT scheme that consists of a conflict-free schedule initialization algorithm, a cooperative resource allocation algorithm, and a heuristic algorithm to obtain maximum energy efficiency in the transmission schedule with the appropriate resource allocation policy.

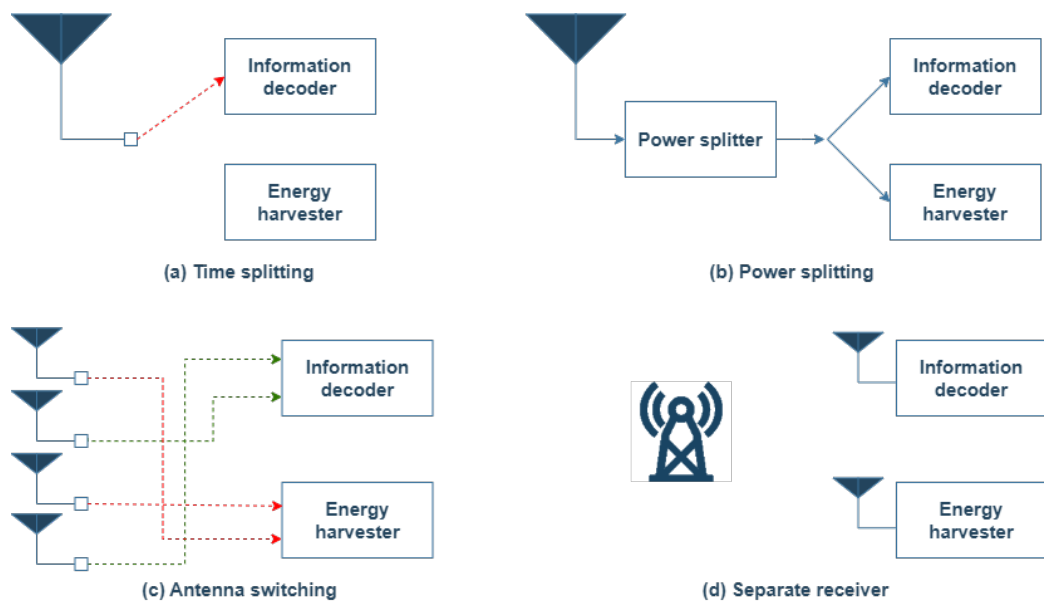

Figure 3.3: Architecture designs for SWIPT. (a) Time switching architecture: based on a pre-defined time factor, connected antennas will be allocated a time to harvest energy and to decode information. (b) Power splitting (PS) architecture: the PS receiver divides the received signal into two power streams based on a certain PS ratio. (c) Antenna switching receiver: antenna switching between harvest energy and information decoding based on an optimization algorithm. (d) separate receiver architecture with separate receivers for energy and information decoding

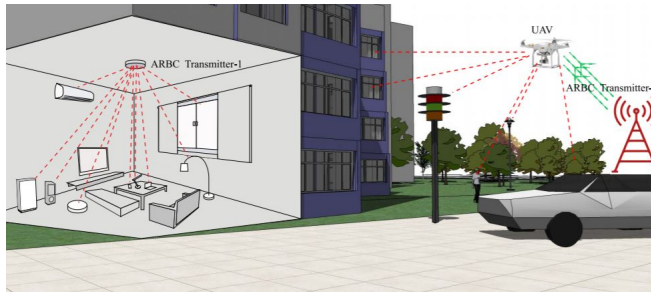

Figure 3.4: Mobile Energy Transfer RBC scenario

SWIPT is theoretically a very efficient energy harvesting technique. However, this technique offers several challenges. In SWIPT, the information and energy are sent through the same signal. This signal needs to be efficiently decoded in order to recover the correct information. The signal can also be altered by the energy harvesting mechanisms or by interference. SWIPT is limited in range since the signals can weaken when crossing long distances. Finally, signals that are sent to the devices can be hijacked by hackers. Therefore, a level of security should be added in order to protect potential private and personal data.

3. *Mobile Energy Transfer*

Mobile energy transfer is an ambitious energy-efficient technique for IoT networks. It extends wireless power transfer technologies since the use of classical wireless power transfer technologies is not suitable if the node is isolated, placed in areas that are difficult to access, and does not support free charging. Mobile energy transfer consists in giving a mobile node (such as a car, a bus, etc), the ability to transfer energy to the devices within its transmission range.

Various works have studied the use of mobile energy transfer technology for IoT networks' energy management. The energy consumption of the mobile node is a key challenge of mobile energy transfer-enabled IoT networks. In [Almasoud et al., 2017], the authors proposed a solution to minimize the total energy consumption of a mobile base station while supporting the data and energy demands of IoT devices to guarantee QoS. This study shows that various parameters can impact the energy consumption of MET-based IoT networks such as the mobile base station locations and its movement speed, the number of devices and their tolerable time for delivering data and energy as well as the transmission powers (the power needed for energy and data transmission). In [Madhja et al., 2016], the authors proposed a hierarchical and wireless energy transfer using mobile chargers in Wireless Rechargeable Sensor Networks while in [Zhang et al., 2019a], the authors presented one

of the mobile energy transfer technologies called Adaptive Resonant Beam Charging (ARBC). As shown in Fig. 3.4, it consists of two specially separated components: a transmitter and a receiver (car, TV, etc.) and in some cases, a relay (UAV in Fig. 3.4) which is used to relay the energy between the transmitter and the receiver. In [Liu et al., 2018], the authors proposed a mobile power network based on long-range and short-range wireless power transfer technologies and discussed the challenges of MET such as interference, efficiency, range, and topology.

3.2.1.2 *Solar energy harvesting*

Given its abundance in the environment, solar energy is considered as an affordable and clean energy source that could eliminate the energy shortage problem in IoT networks. This technique directly converts sunlight into usable electricity which is convenient for locations with high light availability. However, the solar energy harvesting technique flaws arise in locations where light availability cannot always be guaranteed. Additionally, transporting solar energy from one location to another when needed may cause considerable energy waste which shows that there is still room for research and improvement in this area.

In the literature, various authors studied solar energy harvesting for IoT networks. In [Luo et al., 2018], the authors presented a review on solar energy harvesting for IoT applications and discussed the use of artificial intelligence and more specifically artificial neural networks to enhance and rapidly design energy harvesting systems for IoT applications. Numerous authors proposed solutions on solar energy harvesting for WSNs in [Li et al., 2015], [Shin et al., 2016] and [Nguyen et al., 2017]. In [Li et al., 2015], the authors proposed an intelligent solar energy harvesting system based on maximum power point tracking for wireless sensor nodes used in IoT, which prefers to use solar power and takes the lithium battery as a supplementary under the condition of inadequate illumination. This solution offers IoT systems more reliability in case of scarcity of solar energy in the area. In [Shin et al., 2016], the authors proposed an energy prediction algorithm that uses the light intensity of fluorescent lamps in an indoor environment for wireless sensor nodes for IoT. This solution can be particularly helpful to achieve green and sustainable smart homes since lamps can be used to power the sensors used in the smart home. In [Nguyen et al., 2017], the authors proposed a new routing algorithm that aims to improve the lifetime of sensor nodes as well as the QoS under variable traffic load and solar and RF energy availability. The proposed algorithm significantly improves the energy efficiency of the IoT network even if the number of nodes increases drastically which constitutes a

suitable solution for massive, complex, and scalable IoT networks. In [Wu et al., 2016] and [Wu et al., 2018a], the authors proposed a solution to improve solar energy harvesting in wearable IoT applications. In [Wu et al., 2016], the authors proposed an MPPT (Maximum Power Point Tracking) algorithm based on the output current to extract the maximum power from a flexible solar panel to power wearable pulse sensors. Finally, in [Wu et al., 2018a], the authors presented a self-powered wearable IoT sensor network that uses solar energy and is designed for safety environmental monitoring.

3.2.1.3 *Thermal Energy Harvesting*

Thermal energy is the energy that comes from heat and variations in temperature. The human body and the environment can be a source of thermal energy. For example, a temperature difference can be created by the human body and the environment depending on the health condition, the location of a person, or body motion. Two techniques are used in thermal energy harvesting: thermometric, a technique that directly converts temperature difference into usable energy, and pyroelectric, a technique that generates electrical energy when there is a temperature change. It is important to efficiently generate electric energy from a thermal generator in order to extract maximum electric energy to power devices and exploit the maximum potential of this approach.

In the literature, various authors tackled the subject of thermal energy harvesting for IoT. In [Abdal-Kadhim et al., 2018], the authors discussed the use of a thermal energy harvesting approach to power up a wireless sensor node for IoT applications. This study shows the efficiency of using thermal energy to power IoT nodes and the importance of using thermal energy harvesting in long-term IoT applications. Thermal energy harvesting proves to be efficient for various IoT applications. For example, in [Yun et al., 2016], the authors studied the use of energy thermal harvesting for self-powered smart home sensors. For healthcare, in [Priya et al., 2018], the authors studied a human body heat-based solution for wearable biomedical IoT nodes. Finally, in [Teplý et al., 2019], the authors proposed a solution to optimize the energy consumption of thermal energy in IoT nodes by proposing an intelligent control of the individual parts of an IoT node. Unlike in [Abdal-Kadhim et al., 2018], This solution uses a battery to store the harvested energy and then uses the nodes' battery to power the application.

3.2.1.4 *Mechanical Energy Harvesting*

Mechanical energy harvesting consists in harvesting the energy that results from movement, pressure, human activity, or any type of motion from an object. It is considered as a very efficient energy-harvesting solution since the more and faster the object moves the more energy is produced to do more tasks. Mechanical energy comes from various sources such as wind and water flow or human motion and can be converted into electrical energy and exploited to supply IoT devices. For example, it can be interesting to use the energy produced from human motion to power a human temperature monitoring device that the user wears or power neighbouring houses using energy produced by wind and water flow. Mechanical energy harvesting offers a wide range of possibilities which makes it an ideal solution for creating green and sustainable applications.

In the literature, mechanical energy harvesting has been thoroughly discussed. Several authors focused on wind flow and hydro in [Jushi et al., 2016] and [Kamenar et al., 2016] respectively. In [Jushi et al., 2016], the authors discussed the use of wind energy in autonomous WSNs and weather forecast to improve the prediction of wind conditions in the near future. In this solution, the authors used a one and two hours weather forecast window in case of zero wind energy which shows that the unpredictable nature of wind energy makes it unsuitable for IoT applications that require constant availability and real-time performances. In [Magno et al., 2016], the authors studied kinetic energy harvesting for wearables resulting from human motion. This study shows that human motion can produce an impressive amount of energy per day. However, since the energy produced can vary from one person to another it can be difficult to develop a solution that is destined for a large population. In [Kamenar et al., 2016], the authors described the conception, modeling, calculation, design, manufacturing, and validation of the performances of energy harvesting devices deployed in river streams to be employed as a power source for pollution monitoring wireless sensor clusters.

3.2.1.5 *Discussion*

The energy harvesting techniques presented in the previous sections are employed to produce energy from their surrounding environment and to power IoT networks. In Table 3.2, we summarize the energy harvesting techniques presented previously and the ability to use them in, what we consider, the major IoT applications (smart home, healthcare, agriculture and industrial IoT). For RF source harvested energy, SWIPT and MET can be applied to the use cases listed previously. In the case of backscatter communications, the technology is suitable for smart homes,

Table 3.3: The Utility Of Energy Harvesting Techniques In Major IoT Applications

EH Technologies		Smart Building	Healthcare	Agriculture	Industrial IoT
RF Source EH	Backscatter Communications	+++	+	+++	+
	SWIPT	+++	+++	+++	+++
	MET	+++	+++	+++	+++
Solar EH		+++	+++	+++	+
Thermal EH		+++	+++	+++	+++
Mechanical EH	Human motion	+	+++	+	+
	Wind/Water Flow	+++	++	+++	++

Table 3.4: The State-Of-The-Art of Energy Saving In The literature

Energy Saving Technologies		References
Sleep Scheduling	Wake-Up Radio	[Froytlog et al., 2019], [Piyare et al., 2017], [Deng et al., 2019], [Basagni et al., 2017], [Giovannelli et al., 2017],[Frøytlog et al., 2019], [Rakovic et al., 2020],[Bello et al., 2019]
	Duty Cycling	[Passos et al., 2019], [Munir et al., 2018],[Dhall et al., 2018]
Data Collection	Data Aggregation	[Pourghebleh et al., 2017], [Pourghebleh et al., 2017],[John et al., 2018], [Song et al., 2017], [Ko et al., 2019]
	Probability based	[Razafimandimby et al., 2018]
	Compressive Sensing	[Chandnani et al., 2020], [Uthayakumar et al., 2018], [Wang et al., 2019a], [Hsieh et al., 2020]
	Mobility based	[Wang et al., 2019b], [Zhan et al., 2017], [Chen et al., 2019], [Chang et al., 2019],[Wang et al., 2018]

agriculture applications, and indoor medical applications. Backscatter communications are still at a development stage, therefore, it faces limited range, security, and interference problems which makes it not suitable for applications that handle critical data and require a high level of reliability such as industrial and outdoor medical applications. Solar energy harvesting is largely used in smart homes and buildings, healthcare, and agriculture. However, while solar energy can be used in industrial IoT, the network designers should take into consideration the uncontrollable nature of solar energy and how it can affect the performance of the high-reliability requirements of industrial IoT applications.

As shown in Table 3.3, thermal energy can be employed in different IoT applications as it can be frequently produced and stored to supply IoT devices. In the case of mechanical energy harvesting, human motion is considered suitable for healthcare applications. However, it does not produce enough energy to be helpful in other applications. Wind and water flow can produce enough energy for various applications, however, the uncontrollable nature of those energies is unsuitable for industrial or healthcare IoT applications which require high availability and no energy shortage.

3.2.2 Energy Saving techniques

In this section, we discuss the existing energy-saving techniques in the literature by presenting and focusing on the most recent solutions proposed for each one of these techniques. In Table 3.4, we summarize the energy-saving works studied.

3.2.2.1 Sleep/Wake-Up Techniques

1. *Wake-Up Radios*: Wake-Up Radio is a novel hardware solution that has been developed to reduce the energy consumption of devices and extend the network lifetime. It consists in having a low-power radio attached to the device's main radio in charge of waking it up when an incoming signal is sensed. In IoT systems, a Wake-up Radio-enabled IoT device has been defined in [Froytlog et al., 2019]. It is a microcontroller unit associated with a main radio and a wake-up receiver. The microcontroller and the main radio are in deep sleep most of the time. As shown in Fig. 3.5, when the receiver receives a request by means of a wake-up signal transmitted by an external node, it generates an interrupt signal to wake up the microcontroller to perform certain tasks and transmit data back via its main radio.

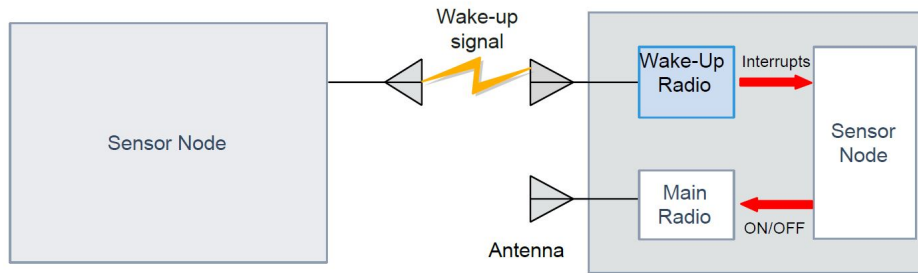

Figure 3.5: Concept of Wake-Up Radio

Based on power usage, three types of wake-up radios have been identified [Piyare et al., 2017]: active, passive, and semi-active wake-up radios. Active wake-up radios require continuous external power supply such as batteries. Passive wake-up radios do not need energy from power supplies. They harvest energy from the transmitted signal instead. In semi-active wake-up radios, some components of the receiver require continuous power from an external source while the RF front-end remains passive. Wake-up radios can be particularly useful in a smart home/office scenario, or in an industrial context like warehouses and can be enhanced further to be used in smart cities [Deng et al., 2019]. However, due to the sleep and wake-up nature of wake-up radio, we can expect an increase in data reception latency.

According to [Piyare et al., 2017], designing wake-up radio in a larger environment requires considering different design aspects such as:

- *Power consumption*: the node's power consumption should not exceed the main radio's sleep power to keep the balance between the energy saved and used by the device.
- *Time to wake-up*: the time needed to wake up the device radio should be minimum in order to reduce the latency and thus enlarge the spectrum of applications Wake-up Radios can be used for.
- *False wake-ups and interference*: due to interference and wrongly receiving signals intended for other devices, a node or several nodes could be unnecessarily activated causing huge energy waste. Thus, designers should find the right compromise and find solutions to those challenges without increasing the energy consumption.
- *Sensitivity*: in Wake-up Radio environment, the sensitivity of the receiving node has a considerable impact on the power demand as having high sensitivity requires high power demand at the

receiving side and having low sensitivity means needing high radiated power at the transmitter side.

- *Communication range*: the range of a Wake-up Radio has an impact on the type of application it is used in, as well as on the system's power consumption. For example, having short-range communication would require a multi-hop communication which will increase the nodes' density and power consumption.
- *Data rate*: having a higher data rate in a Wake-up Radio context is a way to improve energy efficiency and wake-up latency. Similarly, having a longer bit duration also increases the communication range and the reliability of the wake-up signal.
- *Cost and size*: the Wake-up Radio should be cost-effective in order to be integrated into the IoT context and existing sensor nodes. The cost should not exceed 5-10 per cent of the complete sensor node cost.
- *Frequency regulation*: the design of Wake-up Radios should adhere to frequency regulations in industrial, scientific, and medical (ISM) bands. It should also be adapted to communication standards such as the maximum allowed effective radiated power (ERP) used to transmit the Wake-up signal (WuS).

In the literature, various studies proved the efficiency of low-power wake-up radios energy saving. In [Bello et al., 2019], the authors studied the design (from physical to media access control) and utilization of passive wake-up radios in IoT applications. This review also discusses the limitation of wake-up radios such as the short communication range, the high latency, lack of standardization, mobility as well as contention, and channel access. In [Basagni et al., 2017], the authors proposed GREENROUTES, an energy-aware cross-layer routing protocol for wake-up radio-based green networks. This protocol selects the relay nodes based on their distance in hops from the sink and uses semantic addressing to enhance capabilities. Since wake-up radios are sensible to the distance between nodes, it would be interesting to see if this protocol is efficient in case the nodes are distantly distributed. The authors in [Giovanelli et al., 2017] analyzed Bluetooth Low Energy (BLE) beacons scenarios in IoT applications and discussed the benefits of integrating wake-up radios in the BLE protocol stack which can help both reduce the time to contact all the beacons and also reduce the current consumption. Low-power wake-up radios networks still suffer from the limited range of their components. This is why, in [Frøytlog et al., 2019], the authors tackled the wake-up radios limited range issue and proposed a design and implementation of long-range low-power

wake-up radio for IoT devices that increases the lifetime of the devices and reduces the power consumption and overall cost in a large scale deployment. Another approach was proposed in [Rakovic et al., 2020] to improve the energy efficiency and communication range of wake-up radios in IoT systems. The proposed approach consists in applying error correction codes on wake-up signals. Since wake-up radios suffer from short-range capability and low signal sensibility, wake-up radios commonly misinterpret the wake-up signal which leads to performance degradation of the system. Code correction on wake-up signals constitutes an efficient solution to improve the robustness and sensitivity of wake-up devices.

2. *Duty-cycling:*

Duty-cycling, also known as 'sleep schedule', is considered one of the most effective ways of saving energy and extending networks' lifetime. Duty-cycling algorithms are used to reduce the node's battery consumption by alternating between sleep and wake-up modes. The node is usually set in a low power mode and only wakes up when needed (e.g. data reception, radio transmission). Those algorithms usually fall under 3 categories: topology control protocols, sleep/wake-up protocols, and MAC protocols with low duty-cycles.

Duty-cycling has been studied broadly and due to its constant relevance, several recent works on duty cycling and its impact on the energy consumption of IoT networks have been proposed. In [Passos et al., 2019], the authors provided a qualitative and quantitative comparison between the families of asynchronous duty-cycling methods, their characteristics, and the most suited Green IoT applications for each of them. Asynchronous duty-cycling methods undergo excessive transmission energy consumption while waiting for the receiver to wake up in addition to the multiple unicast transmissions that not only consume energy but can also lead to a network congestion. In [Munir et al., 2018], the authors proposed an algorithm to optimize the duty-cycle duration of low-power IoT devices equipped with energy-harvesting circuits in Wi-Fi-based IoT networks. This solution uses an optimal weighting moving-average filter to predict the harvested energy and find the optimal weighting factor to estimate the duration of the off period for IoT devices. The devices will exploit the off periods to harvest enough energy for data acquisition. Finally, in [Dhall et al., 2018], the authors proposed a modified duty cycling efficient path planning algorithm for an IoT-based precision agriculture system. The proposed duty-cycling algorithm is performed on the data transmission phase and the path

planning algorithm studies all the paths and chose the shorted path. This solution proves to be effective even with a high number of devices. However, since the solution's performance depends on the clusters, it would be interesting to optimize the cluster organization in order to reduce the overall energy consumption.

3.2.2.2 *Energy Efficient Data Collection*

Millions of IoT devices are deployed in intelligent applications like smart homes, smart transportation, and so forth. These devices generate huge amounts of data. In order to communicate its data to the base station or to its neighbors, an IoT device will consume large amounts of energy. Moreover, IoT networks are usually constituted of a large number of devices that have limited batteries. Once emptied or depleted, those batteries are often difficult to replace especially if the devices are placed in an isolated or difficult-to-access position. One promising solution is to collect the generated data and communicate it in an efficient way to reduce the transmission energy cost. Several data collection approaches have emerged in order to reduce the energy consumption, delay, and maximize the network lifetime [Chandnani et al., 2020].

1. *Data Aggregation approach:* This approach consists in reducing the number of transmissions in a network and removing redundant and duplicated transmission of data. Data aggregation is a procedure of one or a number of nodes that gather data from other nodes for a period of time, aggregate them and transmit the aggregated result. In [Chandnani et al., 2020], the authors divided the data aggregation techniques into three classes: tree-based, cluster-based, and centralized-based. In [Pourghebleh et al., 2017], the authors presented a systematic review of the data aggregation mechanisms for IoT and presented a detailed comparison of the techniques used in each class. The authors found out that tree-based techniques offer low energy consumption, high network lifetime, and great scalability compared to the other techniques while cluster-based techniques offer low traffic and high fault tolerance. On the other hand, centralized techniques focus mainly on security aspects. The latency, network lifetime, as well as device heterogeneity, should also be considered in data aggregation techniques. In [John et al., 2018], the authors did a review on tree-based data aggregation techniques. The tree architecture is composed of nodes structured in the form of a tree. A tree contains leaf nodes and forwarding nodes. The authors found that tree-based aggregation consumes less energy than clustering and grid-based aggregation. However, in a tree-based approach, the failure of an intermediate node affects the whole topology and disturbs the network activity. In [Song

et al., 2017], the authors proposed a cluster-based data collection technique that uses a sensor-based cluster formation algorithm to elect the controllers and handle the different types of sensors. This algorithm is used alongside a multi-tier aggregation function. This solution allows us to extend the network lifetime, maximize the coverage and eliminate redundant data at the controller. However, using these structures can have major drawbacks. For example, tree and cluster structures increase the vulnerability of the network and make it less secure. They also do not take into consideration sleep and transmission latency. In [Ko et al., 2019], the authors proposed a centralized-based data aggregation for IoT which gathers data and sends it to a centralized IoT gateway. This method also proposes an efficient sleep scheduling method along with data aggregation in order to ensure data consistency in the network. Compared to the tree and cluster structures, the centralized structure is more secure. However, it has low fault tolerance.

2. *Probability based approach:* The probability-based approach allows us to save energy by using approximation models to find correlations between data. The goal of probability-based solutions is to predict the value of the sensed data. In [Razafimandimby et al., 2018], the authors proposed a Bayesian inference approach that allows us to avoid the transmission of highly correlated sensor data and reduce IoT networks' energy consumption. This approach was applied to a hierarchical architecture with smart devices and data centers and proved to reduce the number of transmitted data with good information accuracy in three different scenarios. In general, it is difficult to implement since the devices that help achieve the probability-based approach can be increasingly complex and the models are not optimal considering the high correlation between the devices' data.
3. *Compressive sensing based approach:* Compressive sensing consists in compressing the collected data and reducing the quantity of data sent throughout the network. Compressive sensing helps reduce the size of the sensory information matrix as possible to reduce information and communication redundancy. According to [Chandnani et al., 2020], compressive sensing approaches can be divided into three categories: Conventional compression, Distributed source coding, and Distributed compressive sensing. In [Uthayakumar et al., 2018], the authors presented a review of data compression techniques from different perspectives such as data quality, coding schemes, data type, and applications. Data compressing techniques

are described by their compatibility, representation efficiency, computational complexity, and memory management. Data compressing solutions should optimize these characteristics in order to enhance the efficiency of IoT networks and reduce the devices' complexity. In [Wang et al., 2019a], the authors proposed a clustering routing protocol based on energy-efficient compressive sensing that finds the optimal size of a cluster, and the optimal distribution of cluster heads and also alleviates the "hot spot problem". This solution reduces efficiently the overall energy consumption of the network and extends its lifetime. In this case, there is a temporal correlation between data which means it would be interesting to use a predictive approach in order to reduce the energy consumption resulting from the spatial-temporal correlation. In [Hsieh et al., 2020], the authors employed distributed source coding between two nodes in a NOMA (Non-Orthogonal Multiple Access) pair to optimize the performance and minimize the energy consumption in resource-constrained cellular IoT networks. This solution focuses only on mobile broadband applications, where transmissions typically occur in the downlink with full-buffered traffic.

4. *Mobility based Data Collection:* Recently, mobile data collection approaches have been widely used as a mean to develop energy-efficient IoT networks and extend their lifetime. Mobile data collection allows battery-limited devices to save their transmission energy and thus extend their lifetime. Mobile data collection can be achieved by three methods. The first method consists in using static sensor nodes and a mobile sink that will collect data from these nodes when they are sufficiently close to it. The second method consists in having a static sink and mobile nodes. Since the nodes can move, they improve the network coverage and decrease the number of nodes needed (e.g. we can have fewer sensors in the network since one sensor can move and cover other areas of the network). This strategy has been studied widely in recent years the number of mobiles is increasing. The third method consists in having mobile sensor nodes and a mobile sink.

There have been various studies that focused on energy-efficient mobility-based data collection in the literature. In [Wang et al., 2019b], [Zhan et al., 2017] and [Chen et al., 2019], the authors studied the use of a mobile sink (UAV) with fixed nodes and proposed a solution that optimizes the UAV trajectory in order to ensure an energy-efficient data collection. In [Chang et al., 2019], the authors proposed an algorithm for a distributed bus-based data collection to maximize the lifetime and throughput of WSNs. On the other hand.

Table 3.5: The Pros And Cons Of The Energy Saving Techniques

Energy Saving Technologies		Pros	Cons
Sleep/Wake-Up	Wake-Up Radio	<ul style="list-style-type: none"> • Reduce the power consumption of battery powered networks • On demand sleep / wake-up • Reduce idle listening and overhearing 	<ul style="list-style-type: none"> • Short communication range • High deployment cost • High interference
	Duty-Cycling	<ul style="list-style-type: none"> • Reduce the power consumption of IoT devices • On demand / asynchronous / schedule rendez-vous 	<ul style="list-style-type: none"> • High sleep latency • Data transmission latency • Idle listening, over-emitting and overhearing
Data Collection	Data aggregation	<ul style="list-style-type: none"> • Reduces energy consumption • Reduces traffic load 	<ul style="list-style-type: none"> • Risks of high latency • Less secure for the non-centralized approaches
	Probability based	<ul style="list-style-type: none"> • Predict sensing data • Save transmission energy 	<ul style="list-style-type: none"> • Not accurate • Add communication costs
	Compressive Sensing	<ul style="list-style-type: none"> • Reduce information redundancy • Save communication energy 	<ul style="list-style-type: none"> • Restricted to non-complex sensor data • Not always feasible
	Mobility based	<ul style="list-style-type: none"> • Reduce routing distance and transmission costs • High network flexibility and coverage 	<ul style="list-style-type: none"> • High energy consumption to recover dysfunctional mobile nodes • Optimal Path for the mobile node is difficult to find

Researchers also studied the use of mobile nodes with a static sink. In [Wang et al., 2018], the authors proposed a solution based on the Internet of Vehicles that allows traffic data gathering architecture with an efficient sink node selection. This solution shows only certain vehicles and paths should be selected to reduce the network energy consumption. As shown in the latter works, mobility-based data collection is a very promising energy-saving technology if the mobile sink has a low carbon footprint and is provided with an optimized trajectory which constitutes a challenging research area.

3.2.2.3 Discussion

The energy-saving techniques presented in the previous section are used to reduce the energy consumption of IoT devices as much as possible. In Table 3.5, we summarize the energy-saving techniques presented

previously and highlight the pros and cons of using these techniques in IoT networks.

In the case of sleep/wake-up schemes, both duty-cycling and wake-up radios considerably reduce the nodes' energy consumption. While wake-up radios is an on-demand sleep and wake-up scheme, duty cycling schemes can be divided into three categories: on-demand, asynchronous, and schedule rendez-vous. Accordingly, wake-up radio schemes are able to reduce the idle listening and overhearing that duty-cycling may suffer from. However, it has a limited communication range, a high deployment cost, and can suffer from high interference. Duty-cycling, on the other hand, in addition to idle listening, overhearing, and over-emitting can also struggle with high sleep latency (e.g. sending data to a node that is not ready to receive data) and data transmission latency (e.g. waiting for the next wake-up phase to send data). Choosing either wake-up radios or duty-cycling depends essentially on the network needs and requirements.

Energy efficient data collection approaches are efficient schemes to reduce the energy consumption of IoT. However, they still have challenges and issues to overcome such as security and latency issues for cluster-based and tree-based data aggregation or the hardly achievable sensory data sparsity in data compression. Mobility-based approaches can also be subject to data loss and energy starvation if the system policy used is not well defined.

3.3 RECENT ADVANCES IN IOT ECOSYSTEM ENERGY MANAGEMENT

In order to achieve Green-IoT, several new approaches for energy management have been explored by researchers to reduce the energy consumption of the different components of the IoT infrastructures from data centers to the IoT nodes. These developments emerged with the exploitation of new communication paradigms like 5G and the rapid growth of technologies such as artificial intelligence, cloud, etc. In this section, we will present the recent advances in energy management for IoT networks ecosystem. In Figure 3.6, we present the architecture in which Edge, Fog, and Cloud devices are organized while in Table 3.6, we summarize the energy management solutions studied for cloud, fog, and edge-enabled IoT networks.

3.3.1 *Energy management in IoT-Cloud Computing*

With the start of the IoT revolution, the number of IoT devices has exploded and with it, the amount of data collected by those devices. Since IoT devices do not possess the computational power to process all of the collected data, combining IoT with cloud computing provides

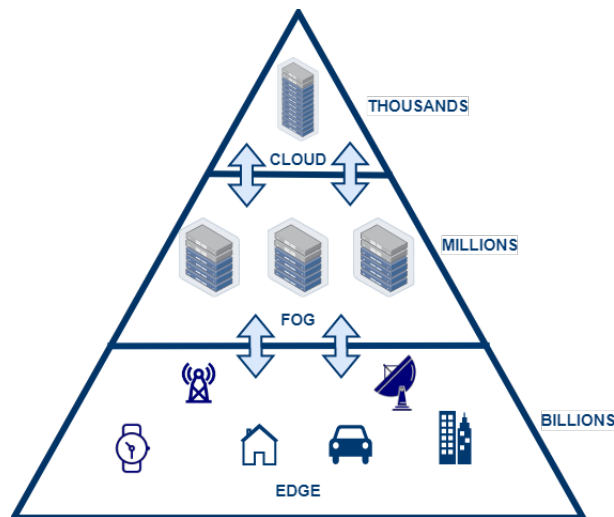

Figure 3.6: Hierarchical organization between edge, fog, and cloud computing

high-performance computing capability and high-capacity storage to support the ubiquitous need for data collection and processing in IoT networks. Cloud computing allows battery-dependant IoT devices to offload various tasks to the cloud (e.g. data cleaning) and conserve their energy. Cloud computing also allows the scalability of IoT systems as well as adding security and reliability to the services. Although cloud computing seems to only bring benefits to IoT, it is well-known that the cloud servers that host cloud applications are highly energy-consuming. Therefore, it is also necessary to reduce the cloud's energy consumption by using its resources efficiently. Reducing energy consumption in Cloud computing can also be achieved by the use of low-power devices and the virtualization of services.

In the literature, a large scope of energy-saving solutions in cloud computing-enabled IoT networks have been studied. In [Kaur et al., 2015], the authors proposed an energy-efficient architecture for IoT that allows the system to predict the sleep interval of sensors-based IoT networks upon their remaining battery level and reduce the energy consumption of sensor nodes and cloud resources. However, this solution is not recommended for applications with strict real-time requirements since it is specific to systems with a sleep/wake-up strategy. Various solutions proposed energy saving in cloud computing by using service composition optimization. In [Baker et al., 2017], the authors proposed a multi-cloud IoT service composition algorithm (E2C2). The composition of services is energy-aware and integrates the minimum number of IoT services to meet a user's requirements. This solution outperforms similar algorithms that have been previously proposed: All Cloud, Base Cloud, Smart Cloud [Zou et al., 2010] and COM2 [Kurdi et al., 2015]. To further improve service composition solutions, we should take into account not only

Table 3.6: The state-of-the-art of the energy saving in the IoT ecosystem

Energy Management Approach	References
Cloud Computing	[Kaur et al., 2015], [Baker et al., 2017], [Zou et al., 2010], [Kurdi et al., 2015], [Kumari et al., 2017], [Gharehpasha et al., 2020], [Alharbi et al., 2019]
Fog Computing	[Sarkar et al., 2015], [Perera et al., 2017a], [Mebrek et al., 2017], [Nayeri et al., 2021], [Peralta et al., 2017], [Oma et al., 2018b], [Oma et al., 2018a], [Lavassani et al., 2018]
Edge Computing	[Sun et al., 2016], [Min et al., 2019] [Liu et al., 2019b], [Azar et al., 2019]

the cloud providers' aggregate energy, but also the energy needed for the service execution. In [Kumari et al., 2017], the authors presented a partitioning method of an application into offloadable and non-offloadable components to reduce the energy consumption and the execution time. This solution offloads components to the cloud however, it requires high network reliability in order to ensure the application well functioning and availability.

Other solutions focused on energy saving using power-aware virtual machine placement in cloud providers. In [Gharehpasha et al., 2020], the authors also proposed a virtual machine placement algorithm in order to reduce the number of active physical machines and reduce their energy consumption while also load balancing between the active physical machines. However, in this solution, a static virtual machine placement is done which means once a virtual machine is a placement it can not be migrated to another physical machine. In [Alharbi et al., 2019], the authors proposed an ant system for dynamic virtual machine placement that reduces the number of active physical machines and reduces the overall energy consumption of the data center. In dynamic virtual machine placement, virtual machines can be migrated from one physical machine to another. Therefore, security strategies should be applied during migration in order to protect private data from hackers' attacks.

3.3.2 *Energy management in Fog Computing*

Fog computing is a decentralized computing paradigm that brings computation and data storage closer to the devices that generate or collect data. It is meant to address the issue of sending data over long distances to the cloud, which can be slow and expensive. By bringing computation closer to the edge of the network, fog computing constitutes an extension of cloud computing rather than a replacement for it. Fog is a highly virtualized platform that can reduce the amount of data that needs to be transmitted and processed in the cloud, and can also enable real-time decision-making and actions. Fog Computing platforms are designed to support mobility, and geo-distribution in addition to the low latency required in various IoT applications (e.g. industrial-IoT). These characteristics make the Fog platforms suitable to support the energy constraints of IoT applications.

Various works have discussed using fog computing to reduce the energy consumption in IoT systems. In [Sarkar et al., 2015], the authors studied the sustainability of Fog Computing and its performances compared to traditional Cloud in terms of power consumption, CO₂ emissions, and cost in IoT networks. Fog computing enhances the performance of latency-sensitive applications in terms of QoS and eco-friendliness. In [Perera et al., 2017a], the authors identified major features (such as dynamic discovery, configuration, management of devices, multi-protocol support at different layers of the network architecture, mobility, etc.) that fog computing platforms need to support toward building sustainable sensing infrastructure for a smart city. Fog computing platforms should be built in a manner that different applications can use. They should also offer built-in support for different types of communication and data analytics frameworks in order to implement the different features of fog-IoT platforms. In [Mebrek et al., 2017], the authors proposed a solution that allows a number of IoT devices to select a fog instance that will receive their data considering the energy consumption (e.g energy consumed by the transport network, energy to process and store the data, energy to forward the data to the cloud if needed) and the latency (transmission latency, processing latency, forwarding to cloud latency). In [Nayeri et al., 2021], the authors reviewed the AI-based application placement solutions that address latency, resource utilization and energy consumption issues in fog-enabled IoT networks. Fog application placement solutions focus mostly on achieving efficient load-balancing methods. Machine learning and more specifically, reinforcement learning algorithms, are widely used and combined with evolutionary algorithms in order to solve the fog application placement problem. Algorithms can be combined to cover each others' weaknesses and achieve challenges such as security,

privacy, availability, etc. In [Peralta et al., 2017], the authors proposed an energy efficient fog-based IoT scheme that reduces end-devices energy consumption for industrial IoT by reducing their transmission. This scheme uses a Message Queuing Telemetry Transport (MQTT) broker to predict future data measurements, operate as gateway and offload expensive data processing from the Cloud to the Fog.

In order to reduce the energy consumption in fog-based IoT networks, various fog computing models were proposed. In [Oma et al., 2018b], the authors proposed a linear fog computing model to reduce the total energy consumption. Although linear models are simple and useful they are only suitable for IoT networks with few number of sensor nodes. Consequently, in [Oma et al., 2018a], the authors proposed a tree-based fog computing model that supports a large number of IoT devices and reduces the total electric consumption compared to the Cloud Computing model. Finally in [Lavassani et al., 2018], the authors proposed a distributed (online) learning model on the sensor device. The model is created by mining the collected data that approximate the data stream behavior and then transmitting only the updated model parameters to a fog computing system. This solution saves energy in IoT devices by preventing unnecessary uplink transmission.

3.3.3 *Energy management in Edge Computing*

With the increasing number of IoT devices, the data produced by those devices is also escalating explosively. Processing efficiently those data then becomes a necessity in Green-IoT. Therefore, edge computing technologies emerge as a very attractive solution for energy management in IoT as they bridge the gap between the limited capability of low-powered devices and their computational demands. Edge computing allows the workload to be offloaded from the cloud to a location closer to the source of data that need to be processed. It offers the possibility to downstream data on behalf of cloud services and upstream data on behalf of IoT services. It consequently has the potential to extend the lifetime of battery constrained IoT devices, reduce the network traffic, increase the bandwidth, improve the privacy and achieve a considerable energy and communication delay saving.

Different approaches have been proposed to achieve energy saving in Edge computing based IoT networks. Energy efficiency using edge computing can be achieved through different schemes : from offloading strategies to data reduction schemes as well as the efficient management of IoT devices and applications. In [Sun et al., 2016], the authors tackled the scalability and energy consumption challenges that IoT faces by proposing

a novel architecture including the cloud, mobile edge computing and IoT. It includes a framework which develops a selective offloading scheme to reduce the energy consumption of IoT devices and the overhead of edge devices. However, this architecture needs to overcome many challenges related to nodes identification by the virtual machines (e.g., if the nodes change their location) as well as the migration of nodes and virtual machines. In fact, if a mobile node changes its location, the system should find an efficient strategy that can either migrates the virtual machine or not based on the QoS requirements of the application. In [Min et al., 2019], the authors proposes a reinforcement learning based offloading scheme for IoT devices with energy harvesting. IoT devices select an edge device and their offloading rate according to their current battery level, the previous radio transmission rate to each edge device, and the predicted amount of harvested energy. This solution also includes a deep reinforcement-based offloading scheme to further accelerate the learning speed. In [Liu et al., 2019b], the authors also combined Edge Computing with deep reinforcement learning in an IoT-based energy management system to reduce the energy consumption in a smart home context. The proposed solution consists of an offline and an online phase. During the offline phase, a deep neural network is trained and a deep reinforcement learning model based on Q-learning is built and exploited during the online phase. The proposed solution proves to reduce the energy cost. Such solutions can be proposed to reduce the energy consumption of smart homes in a smart city context. In [Azar et al., 2019], the authors focused on compressing the data collected by the edge device before their transmission. The proposed solution is based on an error-bounded lossy compressor designed for high-performance applications with high data production. The proposed compression algorithm proved that the extracted data produced similar classification accuracy as the compressed data.

3.4 RESEARCH PERSPECTIVES IN IOT ENERGY MANAGEMENT

In this section, we will discuss the use of approaches like social IoT, 5G-IoT, and network softwarization as well as artificial intelligence and Cognitive Radio IoT to reduce the global energy consumption of IoT networks. We will also present the most recent solutions proposed for this purpose. In Table 3.7, we summarize the papers studied for each approach.

3.4.1 *Energy management techniques in 5G IoT*

With the emergence of 5G technology, it is expected to significantly enhance the capabilities of the IoT. In fact, 5G offers higher speed, greater capacity, lower latency and enhanced reliability to IoT networks in order

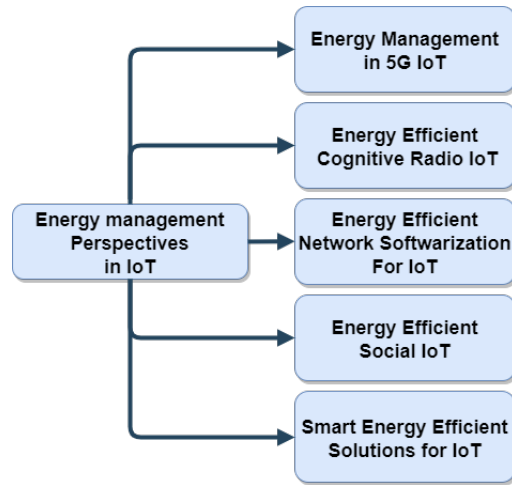

Figure 3.7: Research Perspectives in energy management for IoT

Table 3.7: The State-Of-The-Art of Recent Energy Management Approaches For IoT

Energy Management Approach		References
5G-IoT		[Buzzi et al., 2016], [Gandotra et al., 2017], [Costanzo et al., 2017], [Dao et al., 2020], [Zhang et al., 2016]
Cognitive Radio IoT		[Haykin, 2005],[Qureshi et al., 2017], [Xu et al., 2017], [Liu et al., 2020], [Hao et al., 2016]
Network softwarization		[Krishnan et al., 2015], [Liao et al., 2018], [Naeem et al., 2020], [Huin et al., 2018], [Yazdinejad et al., 2020],[Eghbali et al., 2021],[Zemrane et al., 2018]
Social IoT		[Atzori et al., 2012], [Jiang et al., 2016], [Meng et al., 2017], [Zhou et al., 2018], [Lee et al., 2016], [Al-Turjman, 2019], [Yang et al., 2020]
AI-based	Machine learning	[Lavassani et al., 2018],[Machorro-Cano et al., 2020], [Zhao et al., 2018], [Thomas et al., 2016], [O'Dwyer et al., 2019], [Sheikhi et al., 2015], [Mounce et al., 2015], [Paris et al., 2019]
	Deep learning	[Liu et al., 2019b], [Hu et al., 2018], [Liessner et al., 2018], [Wu et al., 2018b]
Application-based		[Shyam et al., 2017], [Kazmi et al., 2020], [Chen et al., 2016], [Franzitta et al., 2017], [Şengör et al., 2017], [Kampeerawat et al., 2017], [Esther et al., 2016], [Rahim et al., 2018], [Ożadowicz, 2017]

to meet the intense user demands. The devices will not be limited to smart phones but also home appliances, cars, and other devices and will contribute to build a smart society. 5G IoT also claims a data rate increase up to 10 Gb/s and uses multiple technologies (e.g. massive multi-input multi-output (MIMO), small cells, beamforming, etc.) in order to support the tremendous number of users. However, since 5G technology needs more installation infrastructures and supports a large number of users, this technology suffers not only from a lack of spectrum efficiency but also from energy efficiency problems that are causing negative effects on the environment and human health. This exponential growth has raised the energy consumption and carbon footprint of those networks to alarming rates which led both the industry and academia to turn towards a greener and more sustainable 5G technology.

In the literature, various studies discussed the importance of energy efficiency in 5G networks. In [Buzzi et al., 2016], the authors presented an overview of energy-efficient techniques for 5G networks covering resource allocation, network planning, network deployment, hardware solutions, etc. In [Gandotra et al., 2017], the authors presented a detailed survey on energy-efficient cellular networks and proposed a spectrum-sharing solution for prolonged battery life in IoT networks. In [Costanzo et al., 2017], the authors provided an overview of several recent solutions for the wireless powering of devices exploiting either near-field or far-field techniques. These techniques are expected to have a leading role in the realization of 5G-IoT networks. In [Dao et al., 2020], the authors proposed a probabilistic decay feature-based solution which focused on the energy consumption of spectrum sensing for IoT devices in 5G networks. In [Zhang et al., 2016], the authors proposed an integrating and energy-efficient system model for 5G-IoT that uses a massive MIMO array to replace the single remote antenna and cellular partition zooming (CPZ) mechanism as a select-and-sleep mechanism, shortening consequently the distance between the components and reducing the number of routers.

3.4.2 *Energy Efficient Cognitive Radio IoT*

With the high number of IoT devices connected to the internet, the frequency spectrum used by those devices to communicate is getting crowded. Cognitive radio is an approach that aims to improve the usage efficiency of the radio electromagnetic spectrum by using all available frequencies. It is an intelligent wireless communication system that can be programmed and configured dynamically. Cognitive radio technology is built on a software-defined radio which is aware of its environment and uses the understanding-by-building methodology to learn from the environment [Haykin, 2005]. It automatically detects the available

channels in the wireless spectrum and accordingly adapts its transmission and reception parameters in order to ensure communication reliability and efficient utilization of the radio spectrum.

Recently, the integration of cognitive radio and IoT have been widely studied as a potential solution for bandwidth scarcity and devices' high demand of uninterrupted connectivity. Compared to traditional IoT, spectrum sensing may consume a lot of energy and reduce the transmission power of the network. Thus, reducing energy consumption in cognitive radio networks remains one of the most important challenges in IoT networks' energy management. In [Qureshi et al., 2017], the authors proposed an energy-efficient protocol for cognitive radio IoT that reduces the number of handshakes, avoids re-transmission for reliable data communication, and thus reduces communication time and enables energy transmission with high throughput. The reduction in communication time reduces considerably the energy consumption of the network. Other solutions focus on reducing the energy consumption using optimization algorithms. In [Xu et al., 2017], the authors proposed an algorithm for joint time and power allocation optimization while in [Liu et al., 2020], the authors focused on optimizing resources and sensing time in green cognitive IoT. The solution consists in having two groups of IoT nodes alternate between spectrum sensing and energy harvesting in order to compensate for sensing energy consumption. The authors in [Hao et al., 2016], proposed an algorithm to optimize the power allocation and sensing time during imperfect sensing in cooperative cognitive radio networks. These works show that Cognitive radios resolve the problem of high spectrum requirements, reduce waiting time and thus allow devices to consume less energy. However, they may also face interference issues between secondary and primary users and struggle to compromise between good QoS and energy efficiency.

3.4.3 *Energy efficient network softwarezation for IoT*

IoT connects billions of devices to provide a variety of services (smart homes, smart agriculture, industry 4.0, etc). In order to achieve these services, IoT devices employ various protocols, communication ways, and formats of data. The diversity and heterogeneity of IoT data and devices compared to traditional networks in addition to the need for security, privacy, storage and processing means that IoT networks require dynamic solutions for management, configuration, and flow scheduling solutions. Network softwarezation in the form of Software Defined Networks and Network Function Virtualization have emerged in order to overcome the previously discussed challenges. Network softwarezation consists in transforming telecommunication processing into a software-based environment. It is based on SDN which separates the control plane of

the network and the data plane and thus separates the control from the forwarding in the network. The IoT network devices are employed for forwarding the data while the network controllers define the forwarding policies for the devices. These controllers can be organized in a centralized manner or a hierarchical manner in order to prevent the controller from becoming a single point of failure and enhance the system's fault tolerance [Eghbali et al., 2021]. SDN-integrated IoT can offer smart routing and load balancing as well as intelligent network traffic management and analysis. SDN can also provide a global view of IoT networks and improve the scalability and security of the networks. Network softwarization is also based on NFV which decouples the functions of a network from the network hardware and runs it as virtual machines on containers. Network softwarization schemes such as NFV aim to replace energy-consuming network hardware and improve the performances and capabilities of IoT systems. However, it is important to mention that these network functions are often run on servers which are the predominant energy consumers. Then, how does network softwarization impact the overall energy consumption of IoT networks and how can we reduce and optimize its energy consumption?

To this end, various works studied the energy consumption in the network softwarization field. In [Zemrane et al., 2018], the authors surveyed SDN-based solutions to improve IoT networks and describes SDN as a solution to IoT challenges focusing on energy saving, network management and mobility. In [Naeem et al., 2020], the authors proposed an SDN-enabled routing protocol that not only efficiently utilizes the limited bandwidth cost to reduce the energy consumption but also achieves the QoS requirements for an industrial IoT network while in [Yazdinejad et al., 2020], the authors proposed a cluster architecture using blockchain-based SDN controllers with distributed network management for IoT devices that provide a secure and energy-efficient mechanism for IoT devices in an SDN domain using a routing protocol. Numerous authors focused on reducing the energy consumption of SDN and NFV enabled data centers and thus, reducing the energy consumption of the whole IoT system. In [Krishnan et al., 2015], the authors proposed an open stack based solution to enable policies that enforce constraints in the system with periodic event monitoring and dynamic resource management to minimize energy consumption in NFV data centers. In [Liao et al., 2018], the authors proposed an energy consumption control solution in SDN-based cloud data centers using the integration of virtual machine migration based on mixed single-parent genetic algorithm. It is also important to note that SDN solutions can also achieve energy efficiency through energy-efficient routing protocols.

3.4.4 *Social IoT for energy management*

IoT is a paradigm that resulted from the integration of social networking concepts into the Internet. Social networks are able to connect a large number of individuals and this characteristic has previously inspired researchers in internet-related works [Atzori et al., 2012]. Similarly to social networks, IoT networks use a variety of technologies to connect a large number of things which made the idea of combining these two concepts not only possible but also advisable. The concept of Social IoT was motivated by popular social networks over the Internet such as Facebook and Twitter. The term "social IoT" refers to the use of IoT in social networking and communication. It also refers to the use of IoT technology to gather data on social interactions and behavior, which can be used for various purposes such as market research or urban planning. Therefore, it has attracted scientists and researchers in E-business, E-learning, sociology, psychology, and networking. It has also caught the eyes of researchers in energy management as they consider it a promising solution in green networking.

Since Device-to-Device communication and social network are two essential components of IoT, various authors studied energy management using Social IoT and proposed solutions to enhance the energy and spectrum efficiency in this context. For example, in [Yang et al., 2020], the authors proposed a social interaction-assisted resource-sharing scheme for Device-to-Device communication, to improve the utilization of spectrum resources and thus, reduce the energy consumption in Green-IoT networks. The interconnection of IoT devices can also be used to efficiently harvest energy. For example, in [Jiang et al., 2016], the authors proposed a social-aware energy harvesting Device-to-Device communications architecture that integrates energy harvesting technologies and social networking characteristics into Device-to-Device communication to improve the spectrum and energy efficiency for local data dissemination in 5G cellular networks. In [Meng et al., 2017], the authors also worked on using social interaction in Device-to-Device communication but in this case to improve the efficiency of data exchange, sharing, and delivery reducing thus, the energy consumption in the network. In [Zhou et al., 2018], the authors proposed an energy efficient Cyber-Physical-Social system powered by IoT, where wireless network virtualization over SDN was adopted to enhance the service operation and the system management. In [Lee et al., 2016], the authors propose an efficient pervasive interconnection technique to process and share information in an IoT environment based on the human's social network and the device's sociality. In [Al-Turjman, 2019], the authors studied the use of smartphone sensors to contribute to smart social spaces as well as the energy consumption of femtocell, a potential communication technology for the realization of 5G-IoT.

Table 3.8: The Pros And Cons Of Intelligent Energy Saving Techniques

Intelligent Energy Saving Techniques	Pros	Cons
Machine Learning	<ul style="list-style-type: none"> -Help identify trends and patterns -Performances improve over time 	<ul style="list-style-type: none"> -Consumes energy while running the algorithms -Algorithms become obsolete when the data grows -Irrelevant and invaluable data can cause bad results
Deep Learning	<ul style="list-style-type: none"> -Ideal for complex tasks -Supports large amounts of data 	<ul style="list-style-type: none"> -Bad quality data leads to bad results -Opacity of neural networks -More data security

3.4.5 Intelligent energy management techniques for IoT

IoT networks are composed of physical devices such as vehicles, houses, and any other items enhanced with sensors and software that enable data collection, distribution, and analysis. However, due to the high number of IoT devices and their small sizes, they do not possess the computational power to process all the data collected hence, machine learning and big data technologies are efficient approaches to develop intelligent solutions to the collected data management. Big data technologies allow the collection and analysis of large amounts of data while machine learning studies algorithms and statistical models based on patterns and inferences that systems use to meet their goals [Machorro-Cano et al., 2020]. Likewise, machine learning is a very reliable and robust approach, therefore, it is largely used in real-time applications. It is considered ideal for learning-based problems and is capable of identifying the background and characteristics of such problems to learn from them and execute actions based on the knowledge acquired thus increasing system performances. Due to the high number of IoT devices, the energy consumed by IoT devices is huge. In addition, the world we live in faces a huge environmental crisis with climate change and high rates of air pollution, water pollution, etc. Reducing energy consumption in IoT networks is, then, one of the greatest challenges we might face. Researchers can exploit machine learning and intelligent solutions in order to predict energy consumption in IoT networks and applications.

Various solutions have been proposed in order to reduce the energy consumption of IoT devices. However, those solutions are usually static, limited to a certain context, and do not include taking smart and intelligent

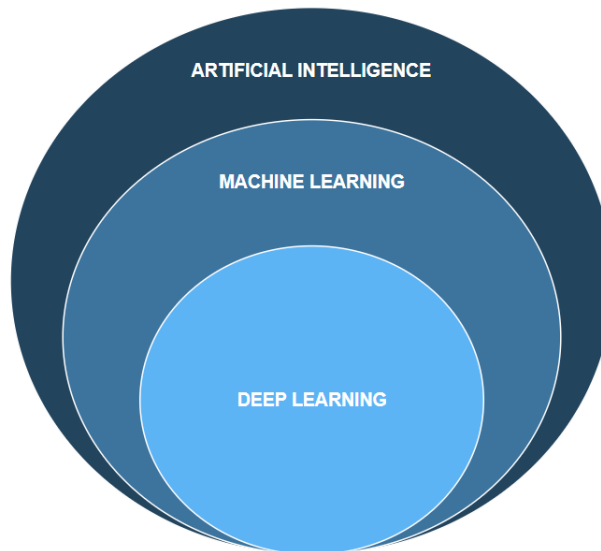

Figure 3.8: The relation between artificial intelligence, machine learning and deep learning

decisions. For example: in the case of energy management of home appliances consumption, various optimization solutions have been proposed. However, those solutions are depending on a certain context and do not consider a change of habit for the in-habitant. This is why, machine learning has emerged as a promising approach to develop intelligent solutions for energy efficiency in smart homes as they are able, using smart meters data, to not only reduce the energy consumption but also adapt the decision-making depending on the inhabitants' habits. In fact, it would be interesting to exploit machine learning in order to adjust transport scheduling depending on air pollution or action depollution mechanisms if sensors detect a high pollution rate in water, etc. Hence, many researchers turned towards achieving Green-IoT at different network layers using intelligent solutions like machine learning and deep learning that proved their efficiency in other fields.

3.4.5.1 Background on machine and deep learning

Machine learning and deep learning are two Artificial Intelligence (AI) approaches. These approaches are often confused as deep learning is considered a part of machine learning (as shown in Figure 3.8). However, in this context, we believe is important to differentiate them as they are two concepts used in different contexts and application fields.

Machine learning can be defined as algorithms that provide a system the ability to automatically learn and improve its performances. Machine learning algorithms learn from data or experiences and apply what they have learned to make informed decisions. They usually involve

human intervention to give feedback to the algorithm. Machine learning algorithms are often categorized as supervised or unsupervised learning. Supervised learning uses the experiences learned from past data and apply it to new data using labeled examples to predict future actions or events, while unsupervised learning uses unlabeled and unclassified data and helps the system find all kinds of unknown patterns in data. Another category of machine learning is semi-supervised machine learning which uses both supervised and unsupervised learning. Typically, those algorithms use a small amount of labeled data and the rest is usually unlabeled data. Semi-supervised algorithms decrease the labeling effort and increase the learning accuracy of the system. Finally, reinforcement learning is an approach in which the learning methods consist in interacting with the environment by taking actions and receiving rewards or errors. Within a specific context, this method maximizes the system's performances and automatically determines its ideal behavior.

Deep learning algorithms are an evolution of machine learning algorithms as they use a programmable layered structure of algorithms called an artificial neural network. These artificial neural networks enable systems to make accurate decisions without human intervention. Deep learning differs from the other machine learning algorithms as it is able to accomplish complex tasks using unstructured data, process a large amount of data and learn efficiently without human intervention. In what follows, we will present machine learning and deep learning based solutions employed to reduce the energy consumption of IoT networks.

3.4.5.2 *Machine Learning-based Energy Saving techniques*

With the emergence of IoT and the exploding number of IoT devices, the volume of the data generated by IoT systems also increases considerably. Consequently, machine learning techniques have emerged to use the data generated by IoT devices and make IoT applications more intelligent. However, due to the high number of IoT devices, the energy consumed by those devices has also increased considerably, thus, energy saving has become a priority for IoT systems designers and end-users. This motivated researchers to study the use of machine learning in order to create green smart and sustainable IoT network applications.

The amount of works concerning the use of machine learning to achieve energy saving is large. To help reduce the energy consumption, machine learning can be used in energy-saving IoT applications such as Smart Buildings [Zhao et al., 2018], [Thomas et al., 2016], Smart Energy [O'Dwyer et al., 2019],[Sheikhi et al., 2015], Smart Water [Mounce et al., 2015]. Other works focus on saving energy by efficiently transmitting data and reducing the number of transmitted packets [Lavassani et al.,

2018]. While in [Paris et al., 2019], the authors focused on energy-efficient mobility prediction using machine learning. This shows if the data features are known and with the available datasets, machine learning algorithms prove to be an interesting solution that can be used and adapted to different aspects of energy saving in IoT networks.

3.4.5.3 *Deep Learning-based Energy Saving techniques*

Deep Learning is a promising approach for energy management in IoT networks. As shown in Table 3.8, it differs from machine learning as it provides better performances with large-scale data. Deep learning algorithms are self-directed in data-analysis and can automatically extract new features for problems in contrast to machine learning algorithms which depend on the extracted and already identified features.

Deep learning has been used in several works related to energy saving. In [Liu et al., 2019b], a deep reinforcement learning-based energy scheduling was proposed to deal with the uncertainty and intermittence of energy supplies. In [Hu et al., 2018] and [Liessner et al., 2018] a deep reinforcement learning approach was proposed to obtain an energy management strategy for a hybrid electric vehicle. On the other hand, in [Wu et al., 2018b], a deep Q-learning-based energy management strategy for power-split Hybrid Electric Buses is proposed. As shown in the works presented previously, deep learning can be used in numerous energy saving applications. However, it is more suitable for large-scale applications that require constant learning and that need to adapt to the state of their environment.

3.4.6 *Application-based energy management*

IoT has revolutionized the way we live. However, IoT technologies face several challenges such as the increase in energy consumption and carbon footprint of IoT nodes. Therefore, IoT applications must be smart, eco-friendly, and sustainable, and with the recent development of Green IoT, it has become a tool towards achieving green and sustainable societies. Various IoT solutions have been proposed where IoT is an enabler for greening several fields of our society such as waste management, retail and logistics, smart streets, etc. For smart waste management, the authors in [Shyam et al., 2017] proposed a smart waste management system where the waste level in waste bins is communicated and an optimized and energy efficient route is proposed to the workers. In [Kazmi et al., 2020], the authors proposed a smart street framework where streetlights are powered by solar panels and are efficiently monitored and maneuvered by IoT. The

streetlights operate at different intensities depending on the traffic flow rate and the absence or presence of sunlight and vehicles. In the proposed solution, streetlights are also equipped with sensors to help monitor air quality.

Throughout the years, it has also been proven that traditional infrastructures that help simplify human beings daily lives (e.g. public transportation systems, home appliances, cars, factories, etc.) waste a tremendous amount of energy. Therefore, in order to continue using these vehicles and infrastructures without draining our planet's energy resources, greening using IoT becomes a top priority and constitutes a step towards achieving green and sustainable societies. Consequently, various solutions have been proposed as alternatives to traditional and polluting applications. In [Chen et al., 2016] the authors discussed the use of Intelligent Transportation Systems to achieve energy saving and what changes both consumers and decision-makers should take in order to reduce the energy consumption of public transport systems. In [Franzitta et al., 2017], the authors studied the use of renewable energies to power public transport (buses) and reduce the energetic dependence on fossil fuels by replacing diesel vehicles with hydrogen-powered vehicles. Numerous works specialized in energy management for trains and railways station such as [Şengör et al., 2017] and [Kampeerawat et al., 2017]. Personal vehicles are also concerned with energy management. In [Giliberto et al., 2019], the authors proposed a solution based on fuzzy logic aimed at prolonging the battery life of electric bikes. The use of electric bikes (e-bikes) is particularly interesting in IoT networks as they can be used as mobile node for energy or data transmission. Reducing energy consumption in buildings also caught the eye of researchers [Esther et al., 2016]. For example, in [Rahim et al., 2018] and [Ożadowicz, 2017], the authors proposed solutions to minimize the energy consumption of homes and building appliances while causing the minimum discomfort to the user. In [Rahim et al., 2018], the authors proposed a hybrid solution based on three heuristic algorithms for home energy management in a smart building while in [Ożadowicz, 2017], the authors proposed an approach to both physical and logical organization of an active demand side management system for building-integrated prosumer microgrids based on IoT and standard building automation and control systems (BACS).

3.5 DISCUSSION

In this section, we will present recommendations and indications to IoT system designers on which techniques can help achieve the requirements of an IoT application in an energy-efficient way. The application fields of IoT in a single domain are diverse thus, the requirements can differ from one application to another in the same field. However, a number

Table 3.9: Recommendations On How To Use The Energy Management Techniques to meet IoT applications requirements

IoT application	Requirements	Techniques	Recommendations
Smart Home	Availability, low latency, EE data communication, data reduction, context-aware, security	Task offloading, data aggregation, social IoT, intelligent smart home solutions	Reduce data transmissions through data aggregation, reduce response time and latency, adapt to the context, use task offloading to enhance fault tolerance
Agriculture	IoT nodes reliability, sensor data management, flexibility	mobile energy transfer, intelligent data collection, data reduction	Exploit moving vehicles to power devices, use intelligent mobile data collection to reduce data transmission, reduce and compress sensor data
Healthcare	Low response time, fault tolerance, node mobility, security	Mechanical EH, mobile energy transfer, social IoT	Use RF wireless charging and mobile energy transfer for the mobile node, achieve self-powered IoT devices through mechanical energy harvesting, achieve security and reduce time to response and latency with network softwarization, enhance availability and fault tolerance with social IoT
Industrial IoT	Low response time, availability, security, fault tolerance, flexibility, mobility, devices heterogeneity and scalability	Intelligent sleep/wake-up techniques, intelligent mobile data collection, RF energy harvesting, intelligent mobile energy transfer, CR-IoT, task offloading, network softwarization	Reduce data transmissions through machine learning based data collection and data reduction, reduce response time and latency, optimize spectrum efficiency, employ RF wireless charging and intelligent mobile energy transfer

of these techniques can be used for different applications. For example, using battery-less devices with backscatter communications, simultaneously transmitting power and information with SWIPT, in addition to periodically alternating between sleep and wake-up states for IoT devices with duty-cycling and wake-up radios that can be combined with machine learning techniques to optimize the sleep and wake-up time. These techniques are very promising and are used in scenarios where the device does not need to be constantly active. 5G technology is integrated with IoT networks in order to boost the communication and response time as well as the capacity of IoT networks. Security is also crucial for IoT applications that use private and critical data such as smart homes, healthcare, and industrial IoT. IoT system designers should consider security at different layers of the network with security protocols as well as network softwarization that not only allows to save energy by replacing physical security devices but also to have powerful security mechanisms. Green energy sources also need to be exploited for various applications in order to power the devices and ensure the availability of the devices and real-time data.

3.5.1 *Smart Home*

IoT is drastically transforming how households are managed. Devices and home appliances are equipped with communication interfaces and are remotely and automatically controlled in order to offer a comfortable experience for the inhabitants. In this regard, smart homes services need to be available at any time and with low latency. Therefore, processing data at edge, fog and cloud level allows having a quick response [Mao et al., 2018]. Task offloading at different levels of the platform also enhances the availability of the service and allows a quick recovery in case one of the components stops working [Chowdhury et al., 2020]. If smart home sensor data are communicated to the edge, fog, or cloud for processing and since communication costs more energy than local computation, energy-efficient data communication schemes need to be developed for smart home through lightweight protocols, data reduction, data aggregation schemes [Pattamaset et al., 2021] and social IoT [Kim et al., 2015] to exploit the interconnection between the devices to find energy efficient communication routes. Smart homes solutions should also be context-aware and flexible thus, these applications can use machine and deep learning techniques in order to adapt to the user's needs and reduce the energy consumption [Jo et al., 2018].

3.5.2 *Agriculture*

IoT was introduced in agriculture to improve agricultural yield and quality for the increasing world population. IoT is used to collect real-time information about temperature, humidity, and soil and transmit them to a platform where they will be used to monitor the production. IoT devices in smart agriculture applications need to be reliable through weather conditions and available for years without the need for battery replacement. In addition to green energy sources and intelligent sleep/wake-up techniques, energy efficiency in agriculture IoT devices can also be achieved through using mobile vehicles such as tractors as power relays and data sinks to ensure the availability of the application data. A combination of sleep/wake-up techniques and UAV-based mobile energy harvesting is proposed in [Jawad et al., 2019] for a smart agriculture system. Agricultural applications are in constant expansion. Therefore, sensor data management is a key challenge that needs to be taken into consideration through different device organization schemes as well as data reduction and flexible data collection strategies.

3.5.3 *Healthcare*

IoT is progressively integrated into healthcare in order to improve the access and enhance the quality of care. IoT healthcare applications aim to achieve excellent healthcare services at affordable costs. IoT in healthcare can be used to monitor a patient's behavior and extract information that will improve well-being, healthcare, and patient support. Patients' medical information are critical, this is why healthcare application should protect data with secure transmission protocols. Healthcare IoT applications should also offer real-time information about the patient's health condition with low response time which will be possible with the democratization of 5G networks. In order to ensure efficient patient support and services, IoT healthcare services should be available even if one of the components stops working and devices should be able to function through arduous conditions for a long period (e.g. wearable heart rate monitor). One of the most suitable approaches presented in this chapter to meet those requirements is social IoT. IoT devices in healthcare are often mobile, the connection and relationships between these devices can be exploited in order to ensure the availability of critical information and the system's fault tolerance. In [Al-Turjman, 2019], the authors used 5G and exploited Social IoT to ensure service availability for smart devices. The social aspect of IoT devices can also be exploited for power transmission between devices [Pei et al., 2020]. For healthcare IoT applications that use wearable devices, human motion and mechanical energy harvesting can constitute the perfect

solution to further increase the devices' and network's lifetime [Wu et al., 2021].

3.5.4 *Industrial IoT*

IoT has recently made its way to the industry. It refers to the interconnection of all the industrial assets and aims to collect the maximum data from these assets to achieve optimal industrial operations. Industrial applications that are safety-critical and used for control and decision-making need to be available and reliable at any time. In order to achieve industrial IoT applications requirements of real-time performance, 5G communication technologies [Slalmi et al., 2021] that offer low latency can be combined with CR-IoT [Abbas et al., 2020] to satisfy end-to-end deadlines of the tasks and optimize the frequency spectrum utilization and thus, reduce the waiting time. Edge and Fog computing can be used to perform energy-hungry computation at the edge of the network (as in [Hsu et al., 2019]) with low latency instead of handling them on the cloud which induces a longer transmission time and a higher energy consumption. With the large amounts of data generated in industrial IoT applications, a compromise must be made between the high availability of industrial IoT and the high energy consumption of data transmission. Therefore, IoT devices data should be organized and reduced through data aggregation and reduction techniques presented to reduce the transmission data energy consumption and latency in industrial IoT applications. Similarly to smart homes, industrial IoT applications should use artificial intelligence in order to offer a flexible and context-aware experience and exploit mobile devices in order to power other devices through intelligent mobile energy transfer strategies [Park et al., 2020b].

3.6 CONCLUSION

With the constant need of human beings to have a safe, comfortable and stable environment, Green IoT emerged as a key and hot technology. It guarantees a decrease in the energy consumption of IoT. In the coming years, the number of IoT devices will be even higher as big companies (e.g. Google, Amazon, etc) are investing in the sector. Thus, companies and organizations should develop IoT solutions from an eco-friendly and energy-efficient standpoint. Re-usability and recycling of IoT devices should also be a focal point of the research of Green IoT to avoid the energy resulting from the process of producing new smart devices. Therefore, in order to achieve Green and sustainable IoT, there is a crucial need for new IoT policies and standardization that include the principles of Green IoT.

In this chapter, we focused on gathering a large range of energy management technologies that will help achieve Green IoT systems. We have also discussed recent trends and new perspectives in IoT networks energy management. Finally, we provide discussions and recommendations on the combination of the techniques presented with the major IoT application. It is important to mention that other factors like QoS and security can further increase the energy consumption of Green IoT networks. For the longest time, in order to offer the best experience to the user, energy-consuming solutions that achieve a good QoS were often privileged to a green solution that could lack an aspect of QoS. Security is also another energy-consuming factor of Green IoT. With the high expansion of IoT networks and high IoT nodes connectivity, the cybersecurity risks increase accordingly. Personal and private data will also circulate through IoT networks. Therefore, it is important to address cybersecurity issues.

ENERGY-EFFICIENT TRAJECTORY PLANNING FOR MOBILE DATA COL- LECTION USING DEEP Q-LEARNING

CONTENTS

4.1	Problem statement	60
4.2	Related Works	61
4.3	Background on Reinforcement Learning	62
4.4	System Model and Problem Formulation	65
4.5	Trajectory planning of a mobile node for data collection using Deep Q-learning	66
4.6	Conclusion	74

In this chapter, we undertake an in-depth examination of the trajectory planning of mobile platforms for mobile data collection in IoT networks. To begin with, we provide an overview of the motivations that have driven our interest in this particular area of research. Second, we provide a comprehensive background on the semi-supervised machine learning approach known as reinforcement learning to provide a solid understanding of the underlying concepts and principles that form the basis of our proposed system. Third, we present a formal description of our proposed system model and a Markov decision process representation of our system to provide the underlying mathematical models that we employed in our proposed system. Fourth, we will present the Q-learning and our proposed deep Q-learning algorithm for trajectory planning of a mobile node for data collection in IoT networks to provide a detailed understanding of the algorithms and methods we proposed and employed in our system. We also describe the simulations that we carried out to evaluate the performance of our proposed solution. Finally, we provide a description and analysis of the results we obtained to provide a clear

understanding of the performance of our proposed algorithm, as well as the key insights and observations that we gained from our research. Additionally, we discuss the implications of our results and their significance in the broader context of trajectory planning for mobile data collection in IoT networks.

4.1 PROBLEM STATEMENT

In the era of pervasive IoT, millions of IoT devices are deployed in intelligent applications. These devices generate huge amounts of data and consume large amounts of energy to communicate their data to the base stations or their neighbors. Since IoT devices usually have limited batteries, once emptied or depleted, those batteries are often difficult to replace especially if the devices are placed in an isolated or a difficult to access position. In the literature, various authors studied how to reduce the energy consumption of spatially distributed IoT nodes [Abbasian Dehkordi et al., 2020]. Researchers have studied cluster-based energy efficient solutions which consist of regrouping IoT devices into clusters and electing a node depending on its energy capability. This node will serve as a relay node between the cluster devices and the gateways or receivers. The relay node will be responsible for sending data and will allow IoT devices to save their energy by only sending their data through the relay node [Song et al., 2017]. In order to enhance the energy efficiency of cluster-based solutions, authors proposed energy-efficient routing protocols applied to these contexts. For example, in [Toor et al., 2019], the authors proposed an energy-efficient cluster-based routing protocol for wireless sensor networks that uses different parameters in order to balance the energy load and decrease the energy consumption of the network. However, using a routing protocol to reduce the energy consumption in an IoT network implies that these devices must be connected which is not always realistically possible if the nodes are placed in isolated or harsh conditions.

One of the solutions proposed to tackle the limitation of routing-based energy efficient solutions are the mobile data collection approaches [Wala et al., 2020]. However, the most challenging part of mobile sink-based solutions is to determine and plan the trajectory of the mobile sink in order to efficiently gather data from the IoT nodes. Indeed, mobile data collection allows us to reduce the transmission energy of IoT nodes. However, to reduce the overall energy consumption of the network, it is essential to have an energy-efficient trajectory for the mobile node during the data collection.

In order to reduce the energy consumption of mobile data collection for IoT networks, it is important to provide energy-efficient trajectory

planning for the mobile node. After a deep study of the literature, we have noticed that most of the existing approaches to mobile data collection rely on pre-defined rules or schedules to determine when and where to collect data. These methods can be inflexible and may not be well-suited to dynamic environments. These solutions suppose that the mobile node has a great knowledge of its environment and do not consider a change of context in the system such as a change in the clusters' data generated or position. Recently, artificial intelligence techniques such as machine learning or deep learning are used in order to propose intelligent solutions that allow devices to learn and take intelligent decisions.

Our approach involves planning an intelligent, adaptive and energy-efficient trajectory for a mobile node in an environment in which the mobile node has little to no prior information about. The mobile node will visit clusters and collect data from a cluster with the goal of maximizing the amount of collected data while minimizing its energy consumption. Additionally, we want to adapt the trajectory of the mobile node to the changes in the environment such as the number of clusters, etc.

4.2 RELATED WORKS

In the literature, most of the existing data collection and trajectory planning solutions in the data collection context use non-learning-based approaches. For example, in [Mozaffari et al., 2017], the authors proposed a framework that optimizes the deployment and mobility of multiple unmanned aerial vehicles (UAV) in order to collect data in the uplink from ground IoT devices and minimize the energy consumption of the mobile nodes. In [Ghorbel et al., 2019], the authors proposed an algorithm that optimizes the UAV stops for data collection from neighboring sensors and the itinerary followed by the UAV in order to ensure the efficient collection of all data with minimum energy consumption. However, in IoT networks, devices do not constantly collect and transmit data, their activity depends on the environment around them or the period the node is visited in. In the previous solutions, a change in the activity of the IoT network is not considered. Consequently, having a mobile sink periodically collecting data, following a static trajectory may cause energy waste and does not constitute an optimal solution to achieve energy efficiency.

In recent years, researchers have considered learning-based solutions and especially reinforcement learning as a very promising trend in this field. In [Hsu et al., 2020], the authors proposed a distributed reinforcement learning approach for path planning and collision avoidance of UAVs. In this study, the mobile nodes are given a visiting order and the algorithm designs an optimal path for data collection in IoT

networks with devices having different communication radios. Compared to this study, our solution uses deep reinforcement learning which is more suitable for complex environments and the mobile node is able to explore the environment and establish its visiting order depending on its experience. In [Zhang et al., 2020], the authors proposed a deep reinforcement learning scheme that plans the trajectory of a mobile node that is used as a data collector and charger in wireless-powered IoT networks. The solution minimizes the average data buffer length, the residual battery level of the system and avoids devices' data overflow. In [Bayerlein et al., 2021], the authors proposed a multi-agent reinforcement learning approach that allows the control the trajectory of a team of cooperative UAVs in order to maximize the collected data under flying time and collision constraints. In [Bayerlein et al., 2020], the authors proposed a double deep Q network to plan the trajectory of a UAV on an IoT data harvesting mission. The solution proposed aims to maximize the collected data under flying time and navigation constraints and allows the UAV to adapt to variations in the number of IoT devices. Contrary to our solution, the previously discussed solutions do not take into consideration the inconsistencies in the IoT device's activity (e.g., a device can collect more data on a certain period of the day than another).

Our solution consists of planning an adaptive and energy-efficient trajectory for the mobile node using a deep reinforcement learning algorithm. The mobile node will visit clusters and collect data from an elected node in the cluster called the relay node. The relay node is responsible for collecting the data from the IoT nodes in the cluster and transmitting it to the mobile node. The objective of our solution is to maximize the collected data while minimizing the energy consumption of the mobile node and IoT devices. In our solution, the mobile node will build an energy-efficient data collection trajectory depending on the context of the network (e.g., the clusters' activity). Fundamentally, The mobile node will adapt its trajectory and save energy by not visiting a cluster with no data to transmit. The learning algorithm used to plan the trajectory is also computed on the mobile node. Other solutions proposed reinforcement learning solutions to plan the trajectory of mobile nodes in order to either optimize data collection or minimize the energy consumption and need to perform expensive computations in order to adapt to a change in the context. This solution doesn't require a previously recorded data set. The mobile node will build its knowledge by exploring the environment.

4.3 BACKGROUND ON REINFORCEMENT LEARNING

In order to achieve the best performances, most of machine learning algorithms require previously recorded datasets. However, finding an

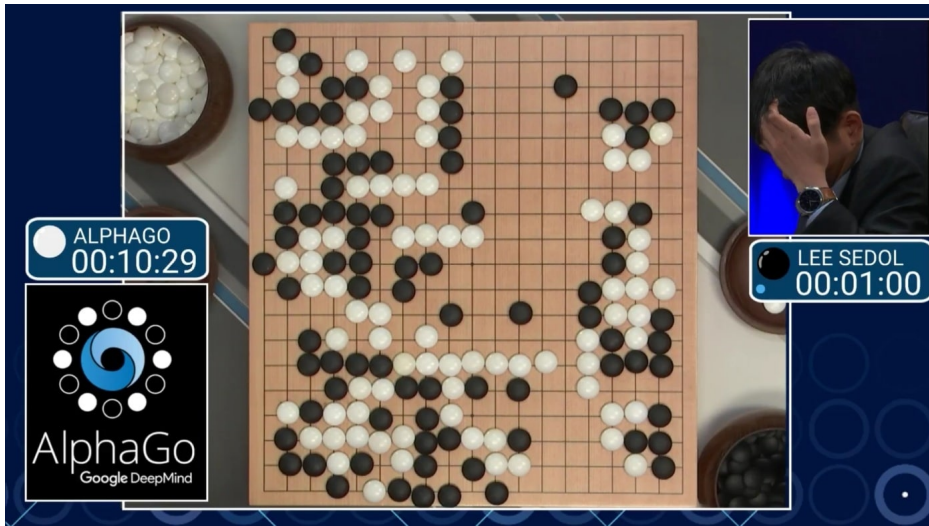

Figure 4.1: AlphaGo playing against Lee Sedol the Go game world champion

available dataset or building one that responds exactly to our needs is an arduous task. Reinforcement learning is a type of machine learning where an agent learns to make decisions by interacting with its environment [Ray, 2019][Wiering et al., 2012]. The agent receives rewards or penalties for its actions, and uses this feedback to adjust its behavior in order to maximize the total reward it receives over time. This process of learning through trial and error is similar to how animals learn to perform tasks in the real world. It is based on the idea of a “reinforcement signal” that indicates whether the agent’s actions are good or bad. The agent’s goal is to learn a policy that will maximize the rewards over time. The agent is not given the right actions to take but instead explores the environment and tries which actions lead to the most reward. reinforcement learning problems are often described with Markov decision processes [Van Otterlo et al., 2012] and its standard architecture is given Figure 4.2.

One of the most reinforcement learning examples is AlphaGo. It is a computer program that plays the board game Go, which is considered to be much more complex than games like chess. The program was developed by Google DeepMind and it was able to beat the world champion at the time, Lee Sedol, in a best-of-five match in 2016 (Figure 4.1). AlphaGo used a combination of reinforcement learning and deep neural networks to learn how to play the game. In the first place, the program was trained on a dataset of thousands of professional Go games. Then, the program improved its play by playing against itself. This way, the program was able to learn the best strategies for playing the game Go, and it was able to adapt its playstyle depending on the opponent.

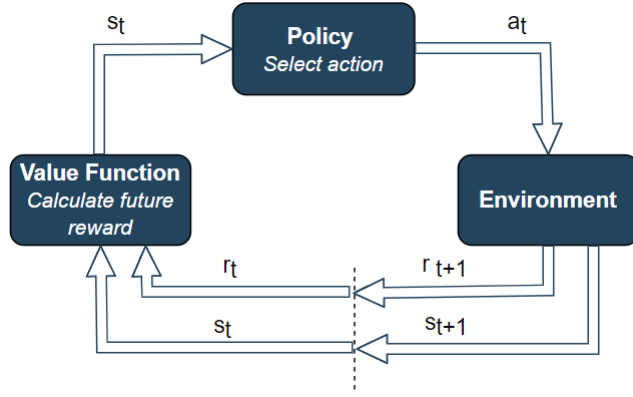

Figure 4.2: Reinforcement learning standard architecture

Formally, for an autonomous agent (i.e., the mobile node, in our case) observing a state s of its environment at time step t $s_t \in S$ where S is the set of states. The mobile node executes an action $a_t \in A$, where A is the set of possible actions and interacts with its environment. This action changes the state of the environment to a new state s_{t+1} and the agent will receive a reward $r_t \in R$ accordingly. The agent's goal is to find a policy π that maps a state s_t to a probability of choosing action a_t . This policy is represented as follows

$$\pi : S \rightarrow P(A)$$

The reward is the sum of discounted future rewards. To calculate the reward we use γ , where $\gamma \in [0, 1]$ is a discount factor that determines the effect of the future rewards on the current one and T is the time when the process terminates. The future reward is defined as follows

$$R_t = \sum_{i=0}^T \gamma^k r_{t+k+1},$$

We also define the state-action value function which represents an agent at state s taking action a under policy π

$$Q^\pi(s, a) = E_\pi[R(t)|s_t = s, a_t = a]$$

where $E_\pi[R(t)|s_t = s, a_t = a]$ is the expected return. The learning goal is to find the optimal state-action function which is based on the Bellman equation. It is described by the following

$$Q^{\pi^*}(s, a) = \mathbb{E}[R_{t+1} + \gamma \max_{a_*} Q_*(s_{t+1}, a_{t+1})]$$

Reinforcement learning is a semi-supervised machine learning algorithm. It is different from supervised learning which consists of learning from a set of labeled data provided by a knowledgeable external supervisor [Sutton et al., 2018]. The goal of supervised learning is to find the right answer while for reinforcement learning it is to find how to carry out a certain task and when a data set is not available, the learner uses their previous

experience. reinforcement learning is also different from unsupervised learning. Unsupervised learning is a learning paradigm that aims to find correlations in sets of unlabeled data. This type of learning is not based on correct examples. Finding structure in a reinforcement learning agent experience might be interesting. However, in our solution, the most important objective is to maximize the reward (e.g. maximize the collected data and minimize the energy consumption) in an environment the agent needs to explore and adapt the trajectory to the context's changes. covered by unsupervised learning. Consequently, reinforcement learning is the most suitable technique for our problem.

4.4 SYSTEM MODEL AND PROBLEM FORMULATION

In this section, we will formally describe the environment, present our system model and formulate our problem as a Markov decision process.

4.4.1 System Model

We consider an IoT network composed of a number of clusters randomly distributed in a square grid world of size $M \times M \in \mathbb{N}^2$ with a mobile node collecting data through a relay node from a number K of clusters of IoT devices. We suppose that the relay node is already chosen depending on its energy capability. The k -th relay node is permanently located at $[x_k(t), y_k(t)]$ in the grid world with $k \in [1, K]$ and $t = 1, 2, \dots, T$, represents the number of time slots. We consider the velocity $v(t)$ of the mobile node constant and enough for the mobile node to move from one square of the grid to the one next to it. We consider the velocity as constant since we want our energy-efficient solution to be adapted to any type of mobile node. At time step t , the mobile node has an energy capacity $u(t)$ and $w_c(t)$ the amount of energy needed to visit the next cluster at time step n . We also consider $w_f(t)$ the minimum level of energy needed for the mobile node to move to a safe stop spot z with $z \in [1, Z]$. A safe spot is an area in the square grid where the mobile node will go when its energy level is not sufficient to visit another cluster in order to recharge its energy. After a node is discovered, we calculate the minimum energy needed for the mobile node to reach a cluster or a safe spot by the following

$$w_{m,z}(n) = |x_m(t) - x_z(t)| + |y_m(t) - y_z(t)|$$

Where $[x_m(t), y_m(t)]$ corresponds to the coordinates of the mobile node and $[x_z(t), y_z(t)]$ are the coordinates of a cluster or a safe spot on the grid. We also suppose that the only information possessed by the mobile node is the initial position of the safe spot.

4.4.2 Markov Decision Process

In order to find an optimal data collection policy that maximizes the data collection and minimizes the energy consumption of our mobile node. We will formulate our problem as a Markov decision process problem. In this section, we define the state space, action space, and reward function. We solve this MDP problem using reinforcement learning. The MDP is defined by the tuple (S, A, R, P) with state-space S , action-space A , and reward function R .

The state in time t , is given by $s_t = p_t, e_t, C$ where:

- $p_t \in \mathbb{R}^2$ is the mobile node position on the grid;
- $e_t \in \mathbb{N}$ is the remaining energy of the mobile node in time t ;
- $C \in \mathbb{R}^{2 \times K}$ represents the coordinates of the K cluster heads.

The mobile node is limited to flying to one of the four adjacent grids from its current grid in each time slot. The action space is defined as

$$A = \text{north, east, south, west}$$

The movement of our mobile node from a position p_t is expressed as

$$p_{t+1} = \begin{cases} p_t + (-X, 0) & \text{if } a_t = \text{west} \\ p_t + (X, 0) & \text{if } a_t = \text{east} \\ p_t + (0, X) & \text{if } a_t = \text{north} \\ p_t + (0, -X) & \text{otherwise} \end{cases}$$

where X is the length of a square in the grid. The reward function is a function that maps state-action pairs to a real-valued reward, i.e., $R : S \times A \rightarrow \mathbb{R}$. It consists of the rewards : $r_{ed}, r_{sd}, r_{ee}, r_{ne}, r_{ss}, r_{move}$ and r_{finish} . the positive rewards and negative rewards (penalties) summarized in Table 4.1. With cd_k , the amount of collected data from relay node k of cluster c . $w_{c,i}$ is the minimum energy needed to move from cluster c to position i while $e_{m,i}$ represents the actual energy spent by the mobile node from position i to cluster c .

4.5 TRAJECTORY PLANNING OF A MOBILE NODE FOR DATA COLLECTION USING DEEP Q-LEARNING

The main aim of our solution is to plan an adaptive and energy-efficient trajectory that maximizes the quantity of collected data and minimizes the energy consumption of the mobile node. For that, we want our mobile node to explore the environment, find an optimal trajectory and modify it in case a cluster stops its activity or in case a new cluster appears. In

Reward	Type	Environment Conditions
r_{ed}	Positive	if $cd_k > 0$ and $w_{c,i} = e_{m,i}$
r_{sd}	Positive	if $cd_k > 0$ and $w_{c,i} > e_{m,i}$
r_{ee}	Positive	if $cd_k = 0$ and $w_{c,i} = e_{m,i}$
r_{ne}	Negative	if $cd_k = 0$ and $w_{c,i} > e_{m,i}$
r_{move}	Negative	if the mobile node moves without collecting data
r_{ss}	Positive	if the mobile node collects data from the clusters and ends the episode on a safe spot
r_{finish}	Negative	if the mobile node energy reaches 0 without being in a safe spot

Table 4.1: Rewards definition

order to achieve this goal, first, we chose to use Q-learning.

In a complex and sophisticated environment with large state and action spaces like our environment problem, computing and updating table values for each state-action pair is not efficient. In this case, it is more interesting to find an approximation of the Q-value rather than directly computing it. In order to do that, we will use deep learning combined with Q-Learning to approximate the optimal Q-function $Q_{\pi}(s, a)$. Deep Learning is a machine learning technique based on neural networks with a powerful generalizing ability. This approach can retrieve highly abstract structures or features from the real environment and then precisely depict the complicated dependencies between raw data. However, it can not directly select a policy for decision-making problems. Consequently, allying Q-learning with deep learning constitutes the most appropriate solution for our problem.

4.5.1 Background on Q-learning

Q-learning is a type of reinforcement learning algorithm that is used to find the optimal action-selection policy for an agent. It works by creating a table (called a Q-table) that contains the agent's estimated "quality" (or "Q-value") of taking each possible action in each possible state of the environment. The agent uses this table to decide which action to take at any given time, with the goal of maximizing the total future reward it will receive. As the agent interacts with the environment, it updates the Q-table based on the rewards it receives, in order to improve its action-selection policy over time.

Q-learning is an off-policy algorithm which means the agent will sometimes apply a policy even if it is sub-optimal in order to improve the policy. In order to update and estimate the current state-action value function we use the next state-action value. It is important to note that even if the

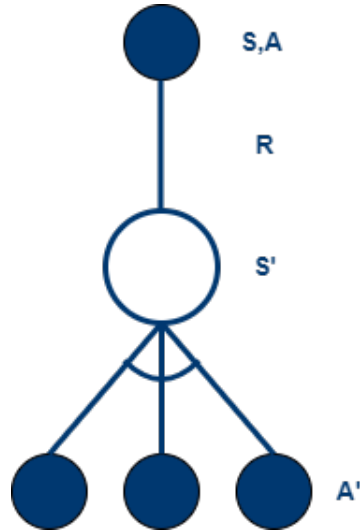

Figure 4.3: The backup diagram indicating the update rule behind Q-learning

next state s_{t+1} is given, the next action a_{t+1} is still unknown. The update equation of the state-action value function in Q-learning is

$$Q(s, a) \leftarrow Q(s, a) + \alpha[r + \gamma \max_{a'} Q(s', a') - Q(s, a)]$$

As we can see, in Q-learning the next action is chosen greedily to maximize the next state-action value $Q(s_{t+1}, a_{t+1})$. Here, $Q(s, a)$ is the current estimate of the Q-value for state s and action a , r is the reward obtained after taking action a in state s , γ is the discount factor (a value between 0 and 1 that determines the importance of future rewards), and α is the learning rate (a value between 0 and 1 that determines how much the new information should be incorporated). s' is the next state and a' is the action taken in the next state. The term $\max(Q(s', a'))$ represents the maximum estimated Q-value for the next state.

The update rule (shown in Figure 4.3) adjusts the current estimate of the Q-value towards the observed reward and the estimated future reward. If the observed reward is high, the Q-value is increased more. If the estimated future reward is high, the Q-value is also increased more. The learning rate determines how much the new information should be incorporated, while the discount factor determines the importance of future rewards.

4.5.2 The proposed algorithm

We propose a DQN algorithm (specified in Algorithm 1) in order to plan the trajectory of a mobile node. The trajectory will maximize the quantity of collected data and minimize the energy consumed by the mobile node.

Algorithm 1: DQN-based Energy Efficient Mobile Data Collection

```

1 initialize action-value with random weights  $\theta$  and  $\theta'$ , replay
   memory size  $H$ , number of episodes  $F$ 
2 initialize  $\epsilon$  for exploration and  $\epsilon_{\text{expt}}$ 
3 for episode :1, ...,  $F$  do
4   Initialize the environment and receive initial state  $s_t$ ;
5   Set  $t = 0$ ;
6   while  $u > 0$  do
7     if  $\epsilon > \epsilon_{\text{expt}}$  then
8       | Choose  $a_t$  randomly from action space;
9     else
10      | Select  $a_t = \text{argmax}Q(s_t, a_t, \theta)$ ;
11    end
12    Execute action  $a_t$ , compute  $r_t$  and observe the next state
        $s_{t+1}$ ;
13    Store experience  $(s_t, a_t, r_t, s_{t+1})$  in the replay memory with a
       random placement policy;
14    Sample a random mini-batch of  $G$  experiences
        $(s_t, a_t, r_t, s_{t+1})$  from replay memory;
15    Calculate the target value;
16    Update the weights  $\theta' = \theta$  every  $J$  time step;
17    Set  $u = u - i$ ;
18    Set  $t = t + 1$ ;
19  end
20  Decrease  $\epsilon$ ;
21 end

```

The proposed algorithm will also adapt the mobile node trajectory depending on the clusters' activity. Deep Q-Learning is a variant of Q-Learning that utilizes a neural network as a function approximator to approximate the Q-value function. The neural network takes the current state of the environment as input, and outputs a vector of Q-values for all possible actions. The Q-value for a given action is then obtained by selecting the appropriate element from this vector. In addition to previously described specifications, our DQN algorithm will also use experience replay which is a technique that allows us to store the agent's experiences at each time step in a dataset called replay memory [Fan et al., 2020]. At each time step, the agent samples a random minibatch of experiences from this memory and uses them to update the parameters of the neural network. At time step t , the agent's experience is defined as follows

$$e_t = (s_t, a_t, r_{t+1}, s_{t+1})$$

The main reason for using experience replay is to break the correlation of consecutive samples [De Bruin et al., 2015]. In our solution, we use two neural networks. The policy network θ approximates the optimal policy by finding the optimal Q-function. It accepts the current state s_n and finds the evaluation of the value $Q(s_n, a_n, \theta)$. We also use a second network called target network θ' to improve the stability of learning. The target network weights are frozen with the original policy network and are updated periodically. It accepts the next state s_{n+1} and outputs the Q-value $Q(s_{n+1}, a_{n+1}, \theta')$. These values are optimized to minimize the loss function defined by

$$L(\theta) = \mathbb{E}[(T_t - Q(s_t, a_t))^2]$$

where T_n is the target value in the DQN algorithm. It is defined as following

$$T_t = r_t + \gamma^{t-1} \max Q(s_{t+1}, a_{t+1}, \theta')$$

where the Q-value for the next state s_{t+1} is passed to the target neural network θ' for more stability in learning. ϵ is the exploration rate which represents the probability that our mobile node will explore the environment and ϵ_{expt} is the threshold from which our mobile node will stop exploring the environment and will exploit the experience acquired through the policy network.

4.5.3 Simulation and performance analysis

In this section, we will present the simulations carried out in order to assess the learning performance of using DQN. Our algorithm is trained for a total of 8000 episodes. We assume that four clusters are randomly distributed in 10 x 10 units area. The battery capacity of the

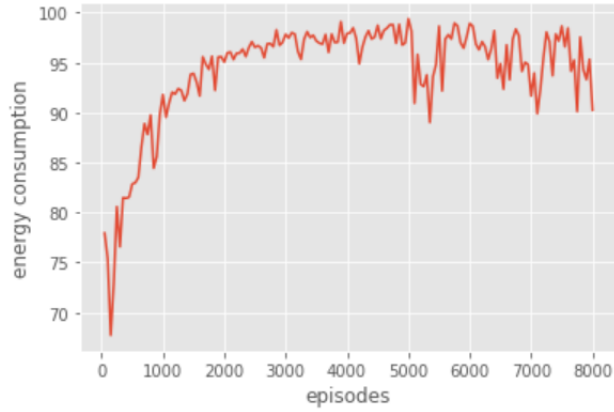

Figure 4.4: The training curves of the mobile node's energy consumption for DQN



Figure 4.5: The training curves of the mobile node's collected data for DQN

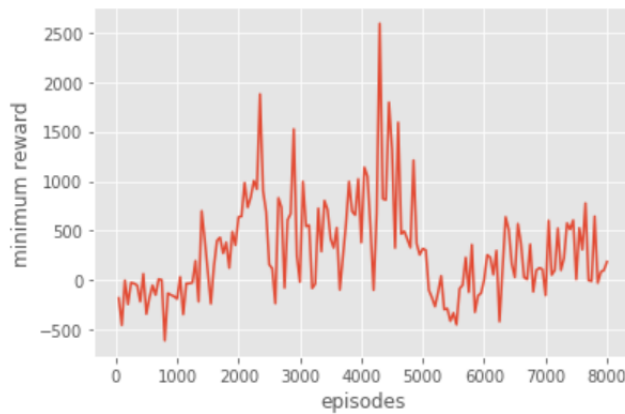

Figure 4.6: The training curves of the mobile node's minimum reward for DQN



Figure 4.7: The training curves of the mobile node's maximum reward for DQN

mobile node is set to 100 units. The mobile node consumes i unit of energy to move from one area to another. The mobile node consumes i unit of energy to collect data when the relay node is in its range. The cluster head is considered in the range of the mobile node if they are both in the same position $[x_t, y_t]$ at time step t . The maximum of possible data to collect for the mobile node for each episode is between 600 and 799 units. Our simulation were performed with Tensorflow and Python. The configuration of the neural network is given in Table 4.2.

Table 4.2: Algorithm parameters

Parameters	Values
Number of training episodes F	8000
Learning rate α	0,01
Reward discount γ	0,99
Exploration probability ϵ	1 (will be decayed)
Exploitation probability ϵ_{expt}	0,001
Current mobile node energy u	100
Replay memory size H	50000
Minibatch size G	64
Network structure	[256,256]

We carried out this simulation with the goal of maximizing the amount of collected data while minimizing the energy consumption as well as adapting the mobile node's trajectory to the clusters' activity. It is important to note, that using learning approaches to plan a trajectory is more appropriate for networks with no critical data that need to be collected during a single training episode (e.g., all the clusters' data should be collected during the maximum time where the mobile node can move). In

order to observe the behavior of our algorithms in an environment where the context could change, we programmed a decrease in activity for two clusters between episode 5000 and episode 6000 (e.g., no data to transmit). The clusters resume their activity after episode 6000. The rewards for this policy are resumed in Table 4.3. From the results we obtained we can notice that:

Table 4.3: Reward function parameters

Reward	Value
r_{ed}	500
r_{sd}	50
r_{ss}	1000
r_{ee}	10
r_{nc}	-100
r_{ne}	-300
r_{finish}	-500
r_{move}	-1

4.5.4 Results description

- From 0 to 5000 episode: The data collected by the mobile device showed a significant increase, reaching 570 units as depicted in Figure 4.5. Concurrently, the energy consumption rapidly rose to 95 units and remained within a range of 95 to 99 units, as illustrated in Figure 4.4. Additionally, we observe that the maximum reward increases along with the amount of collected data as seen in Figure 4.7. Furthermore, the minimum reward also showed positive results, peaking at 2500, contrasting the initially negative values at the start of the training period, as depicted in Figure 4.6.
- From episode 5000 to episode 6000: when the clusters stop their activity, we observe a marked decline in the quantity of data gathered and the energy consumption of the mobile node. This indicates that the mobile node terminates the data collection sooner and saves more energy than before the change of activity. We also notice that the mobile node discovers the remaining clusters in the environment. Simultaneously, we note a significant decline in minimum reward after episode 5000, leveling off to the initial training values. slight dip in maximum reward, but it quickly rebounds as the mobile node discovers new clusters.

- From episode 6000 to episode 8000: When the clusters resume their activity, we can notice that the amount of collected data increases while the overall energy consumption decreases. At the end of the training, the mobile node is able to collect the maximum possible data while consuming less energy. Additionally, we see an improvement in rewards, with both the maximum and minimum values rising and returning to positive figures.

4.5.5 *Results analysis*

Before episode 5000, the mobile node gradually collects more data while spending between 95 and 99 units of energy which means our agent learns to collect more data while spending the same amount of energy. This is also shown through the increase in the maximum reward. We can also notice that the mobile node never spends all of its 100 units of energy which means that the mobile node stops the data collection at a safe spot before getting depleted of all its energy. Between episodes 5000 and 6000, one of the clusters stops its activity. Accordingly, the amount of collected data, the amount of energy consumed, the maximum reward as well as the minimum reward all drop. After episode 6000, the mobile node discovers all the clusters and collects all the available data in the network while consuming less energy. Finally, we can conclude that our deep Q-learning algorithm trains the mobile node to find an energy-efficient strategy for data collection. The results also show that the mobile node quickly adapts to the changes in the environment and is finally able to collect all the data while consuming less energy.

4.6 CONCLUSION

In this chapter, we have presented a novel approach to trajectory planning for a mobile node in mobile data collection within IoT networks. Specifically, we have introduced an energy-efficient deep Q-learning algorithm, which is combined with experience replay, to optimize the mobile node's trajectory. The results of our experiments demonstrate that the mobile node is able to use information about the environment to learn and find an energy-efficient data collection trajectory with the deep Q-learning algorithm. This is achieved by using the experience replay mechanism, which allows the mobile node to learn from past experiences and improve its decision making. Furthermore, our results also indicate that the DQN algorithm is able to adapt the mobile node trajectory to changes in the context scenario, such as variations in the amount of collectible data, without the need for expensive retraining or data recollection. This allows the mobile node to collect the maximum possible data while minimizing energy consumption. Overall, our results demonstrate that the energy-efficient deep

Q-learning algorithm combined with experience replay is an effective approach for trajectory planning of a mobile node in mobile data collection for IoT networks.

CHAPTER 5

ENERGY-EFFICIENT TRAJECTORY PLANNING FOR MOBILE DATA COLLECTION USING DEEP SARSA

CONTENTS

5.1	Background on SARSA learning	77
5.2	The proposed algorithm	78
5.3	Simulation and performance analysis	79
5.4	Results Comparison with Q-learning and discussion	83
5.5	Conclusion	85

Since deep Q-learning proved to be able to provide an efficient and adaptive trajectory for the mobile node(MN), we have decided to compare its results with another reinforcement learning algorithm called SARSA (State-Action-Reward-State-Action). In this chapter, we present the SARSA learning algorithm and the proposed deep SARSA algorithm for the trajectory planning of a mobile node for mobility-based data collection. Then, we describe the simulations we carried out and present an analysis of the results we obtained. Finally, we will present a comparison between the deep Q-learning algorithm results and the deep SARSA algorithm results and discuss the benefits and drawbacks of each algorithm. It is important to note that the system model and Markov decision process applied to the deep SARSA learning is identical to the one applied to the deep Q-learning algorithm.

5.1 BACKGROUND ON SARSA LEARNING

SARSA is a type of reinforcement learning algorithm that is similar to Q-learning, but with a variation on the update rule. Like Q-learning, SARSA uses a Q-table to store the estimated quality of taking each action in each



Figure 5.1: The backup diagrams indicating the update rule behind SARSA

state, and uses this table to guide its decision-making. The main difference between SARSA and Q-learning is the way the Q-table is updated. In Q-learning, the agent updates the Q-value for a given state-action pair based on the maximum expected future reward for the next state, whereas in SARSA the agent updates the Q-value based on the expected future reward for the next state-action pair that it would take. This means that in SARSA the agent takes into account the action it will take in the next step, not only the next state. SARSA uses the estimated Q-value for the next action chosen according to the current policy of the current state. The learning process of SARSA can be formalized as follows: At each time step, the agent observes the current state, selects an action based on its current policy, receives a reward, and observes the next state. The update rule for SARSA (shown in Figure 5.1) is given by:

$$Q(s, a) \leftarrow Q(s, a) + \alpha[r + \gamma Q(s', a') - Q(s, a)]$$

Here, $Q(s, a)$ is the current estimate of the Q-value for state s and action a , r is the reward obtained after taking action a in state s , γ is the discount factor (a value between 0 and 1 that determines the importance of future rewards), and α is the learning rate (a value between 0 and 1 that determines how much the new information should be incorporated). s' is the next state and a' is the action taken in the next state according to the current policy. As its name suggests, in SARSA the training quintuple is (s, a, r, a', s') which means in every update, the quintuple will be derived while a' in Q-learning is just for estimation.

5.2 THE PROPOSED ALGORITHM

Since our mobile node will operate in a complex and sophisticated environment with large state and action spaces, computing and updating

table values for each state-action pair is not efficient. Similarly to the Q-learning algorithm, in our context, it is more interesting to find an approximation of the Q-value rather than directly computing it. This is why we propose a deep SARSA algorithm in order to plan the trajectory of a mobile node. The aim is to maximize the quantity of collected data and minimize the energy consumed by the mobile node during the data collection.

Deep Sarsa is a reinforcement learning algorithm that combines the ideas of Sarsa, a temporal-difference learning algorithm, with neural networks. Like Sarsa, it estimates the value of each state-action pair, but instead of using a table to store these values, it uses a neural network to estimate the Q-value. This allows the algorithm to learn from high-dimensional inputs, such as images. The proposed algorithm is made with the objective to adapt the mobile node trajectory depending on the clusters' activity. Deep SARSA also uses experience replay to break the correlation of consecutive samples and improve the stability and sample efficiency of the algorithm. Similarly to the DQN algorithm, we use two neural networks for training the deep SARSA algorithm: The policy network and the target network. The policy network to approximate the optimal policy by finding the optimal Q-function and the target network to improve the stability of learning. The target network weights are frozen with the original policy network and are updated periodically. It accepts the next state s_{n+1} and outputs the Q-value $Q(s_{n+1}, a_{n+1}, \theta')$. These values are optimized to minimize the loss function defined by

$$L(\theta) = \mathbb{E}[(T_t - Q(s_t, a_t))^2]$$

where T_n is the target value in the deep SARSA algorithm. It is defined as following

$$T_t = r_t + \gamma^{t-1} Q(s_{t+1}, a_{t+1}, \theta')$$

similarly to the deep Q-learning algorithm, the Q-value for the next state s_{t+1} is passed to the target neural network θ' for more stability in learning. ϵ is the exploration rate which represents the probability that our mobile node will explore the environment and ϵ_{expt} is the threshold from which our mobile node will stop exploring the environment and will exploit the experience acquired through the policy network.

5.3 SIMULATION AND PERFORMANCE ANALYSIS

In this section, we will present the simulations carried out in order to assess the learning performance of using deep SARSA. The algorithm is trained for 8000 episodes. As for the DQN algorithm, we assume that four clusters are randomly distributed in 10×10 units area. The

Algorithm 2: DS Energy-Efficient Mobile Data Collection

```

1 initialize action-value with random weights  $\theta$  and  $\theta'$ , replay
   memory size  $H$ , number of episodes  $F$ 
2 initialize  $\epsilon$  for exploration and  $\epsilon_{\text{expt}}$ 
3 for episode : 1, ...,  $F$  do
4   if  $\epsilon > \epsilon_{\text{expt}}$  then
5     | Choose  $a_t$  randomly from action space;
6   else
7     | Select  $a_t = \text{argmax}Q(s_t, a_t, \theta)$ ;
8   end
9   Set  $t = 0$ ;
10  while  $u > 0$  do
11    | Execute action  $a_t$ , compute  $r_t$  and observe the next state
12    |  $s_{t+1}$ ;
13    | Store experience  $(s_t, a_t, r_t, s_{t+1})$  in the replay memory with a
14    | random placement policy;
15    | Sample a random mini-batch of  $G$  experiences
16    |  $(s_t, a_t, r_t, s_{t+1})$  from replay memory;
17    | Set  $s_t = s_{t+1}$ 
18    | if  $\epsilon > \epsilon_{\text{expt}}$  then
19    | | Choose  $a_t$  randomly from action space;
20    | | else
21    | | | Select  $a_t = \text{argmax}Q(s_t, a_t, \theta)$ ;
22    | | end
23    | | Calculate the target value;
24    | | Update the weights  $\theta' = \theta$  every  $J$  time step;
25    | | Set  $u = u - i$ ;
26    | | Set  $t = t + 1$ ;
27  end
28  Decrease  $\epsilon$ ;
29 end

```

battery capacity of the mobile node is set to 100 units. The mobile node consumes i unit of energy to move from an area to another. The mobile node consumes i_1 unit of energy to collect data when the relay node is in its range. The configuration of the neural network is given in Table 4.2. The deep SARSA was trained in the exact same conditions as the DQN in order to determine which approach is more suitable for our problem.

In order to observe the behavior of our deep SARSA algorithm in an environment where the context could change, we programmed a decrease of activity for two clusters between episode 5000 and episode 6000 (e.g., no data to transmit). The clusters resume their activity after episode 6000. The rewards for this policy are resumed in Table 4.3.

5.3.1 Results description

- From 0 to 5000 episode: The mobile node's data collection begins within a range of 260 to 370 units and gradually increases to reach 540 units, as illustrated in Figure 5.3. Meanwhile, energy consumption remains stable at a range of 70 to 90 units, as shown in Figure 5.2. It is notable that the mobile node does not fully deplete its energy reserves, indicating that the data collection stops at a safe point (SS) before all energy is consumed. The maximum reward, illustrated in Figure 5.5, starts off high and shows a slight increase, while the minimum reward, shown in Figure 5.4, remains globally negative.
- From episode 5000 to episode 6000: when the clusters stop their activity, we observe a significant reduction in the quantity of data collected as depicted in Figure 5.3. However, the mobile node's global energy consumption remains unchanged to before the change in activity as shown in Figure 5.2. Simultaneously, we can see that the

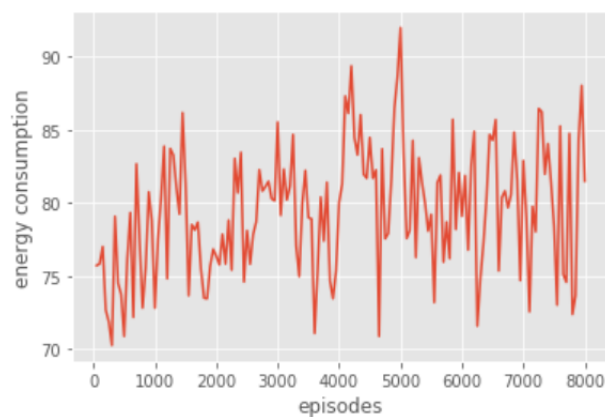

Figure 5.2: The training curves of the mobile node's energy consumption for DS

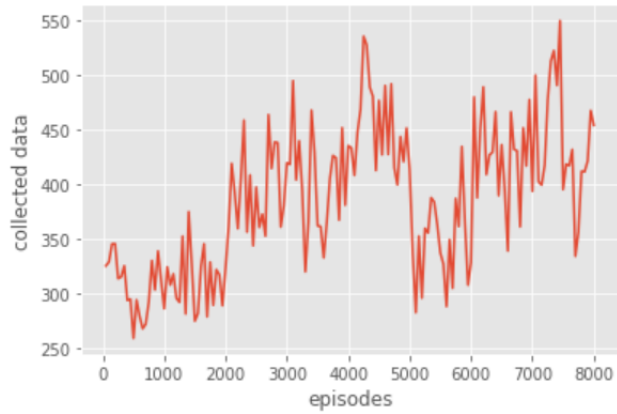

Figure 5.3: The training curves of the mobile node's collected data for DS

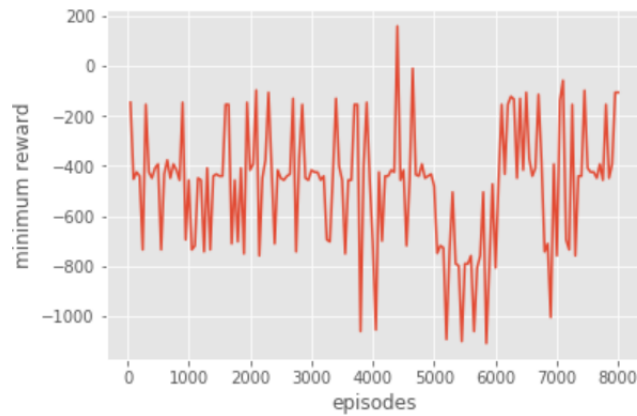

Figure 5.4: The training curves of the mobile node's minimum reward for DS

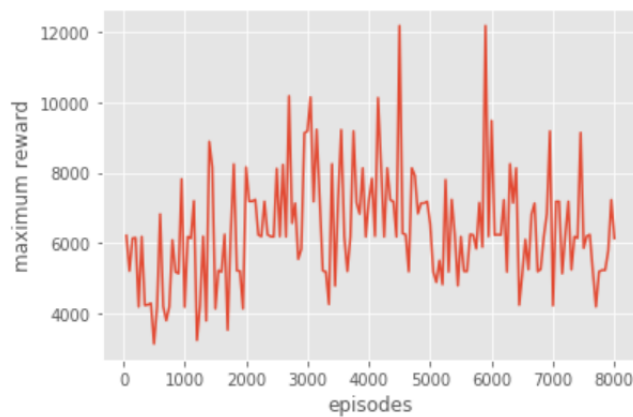

Figure 5.5: The training curves of the mobile node's maximum reward for DS

minimum reward experiences a drastic decline after episode 5000 (Figure 5.4), while the maximum reward experiences a slight decrease (Figure 5.5).

- From episode 6000 to episode 8000: When the clusters resume their activity, we observe a significant increase in the amount of data collected as illustrated in Figure 5.3. Meanwhile, the mobile node's overall energy consumption remains under 89 units as shown in Figure 5.2. The mobile node is able to collect the same quantity of data as before the activity change, while maintaining consistent energy consumption. Additionally, the minimum reward experiences a marked improvement (Figure 5.4), while the maximum reward remains stable throughout the entire training period (Figure 5.5).

5.3.2 Results analysis

From the beginning of the training the mobile node collects a significant amount of data (starts with 325 units) and even reaches 500 units of data before episode 5000. We can also observe that, before episode 5000, the mobile node spends energy in the range of 70 to 90 units which means that the mobile node stops the data collection at a safe spot before the depletion of its energy. Between episodes 5000 and 6000, one of the clusters stops its activity. Accordingly, the amount of collected data, the maximum reward as well as the minimum reward all drop. However, the amount of energy spent remains unchanged. After episode 6000, the mobile node collects the same amount of data while consuming nearly the same amount of energy as before episode 5000. Finally, we can conclude that our deep SARSA algorithm trains the mobile node to find an energy efficient strategy for data collection. However, the results also show that the mobile node never collects all the data available in the network (the maximum reached is 550) and does not adapt to the changes in the environment.

5.4 RESULTS COMPARISON WITH Q-LEARNING AND DISCUSSION

In this section, we discuss and compare the results we obtained in Figures 4.4, 4.5, 5.2, 5.3 and summarize them in Figures 5.6 and 5.7. First of all, we observed that deep SARSA quickly finds a good policy that collects data while consuming minimum energy. On the other hand, DQN makes a slow start where the mobile node collects a low amount of data while consuming nearly all of the mobile node's energy at each episode. However, at the end of the training, we can observe that DQN allows the mobile node to collect the maximum amount of data possible while consuming less energy. For deep SARSA, during all the training, the mobile node was never able to collect the maximum amount of data.

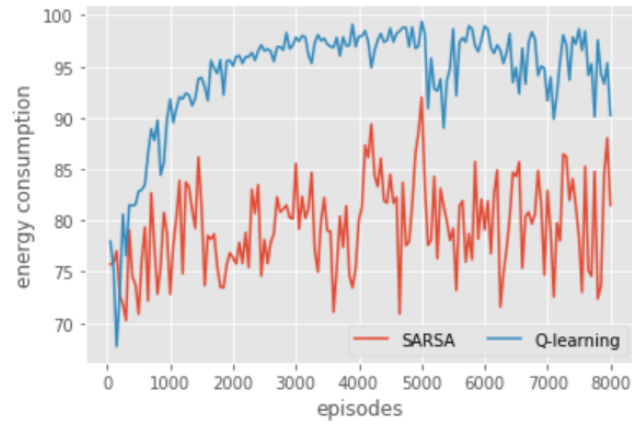

Figure 5.6: The training curves of the mobile node’s energy consumption for DS and DQN

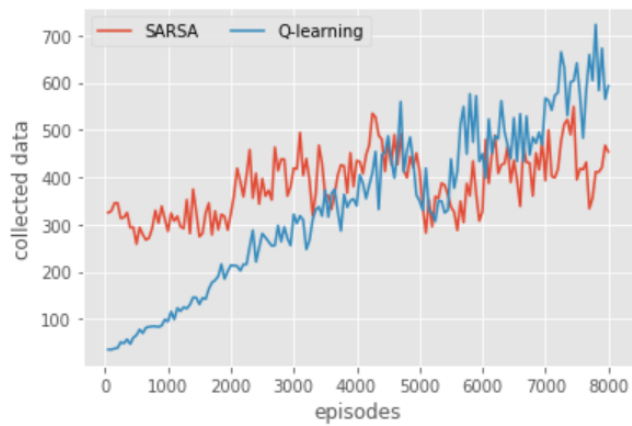

Figure 5.7: The training curves of the mobile node’s energy consumption for DS and DQN

Our results indicate that the decision of whether to use DQN or deep SARSA for an energy efficient data collection depends on the specific needs of the system. If the system prioritizes energy efficiency and adaptability for the trajectory, DQN would be the more appropriate choice. The DQN algorithm tries to learn the best trajectory to collect data from all clusters while consuming the minimum energy possible. Our results also showed that the DQN algorithm demonstrated great adaptability between episodes 5000 and 6000, quickly re-learning the trajectory after episode 6000 without doing expensive re-computations and learning, thus enhancing its performance. However, it should be noted that DQN took longer to achieve the same level of performance as deep SARSA.

On the other hand, deep SARSA was able to quickly discover and collect data, but it was never able to collect the maximum amount of

data. Additionally, it can be concluded that the deep SARSA algorithm took safer decisions and is more appropriate for systems that require less risk-taking for the mobile node. By considering the next action, the deep SARSA algorithm was able to better handle the uncertainty of the environment. However, these results also reveal one of the drawbacks of SARSA as the algorithm is easily stuck at a local optimum. In conclusion, both DQN and deep SARSA have their own strengths and weaknesses, and the choice of which algorithm to use will depend on the specific needs and requirements of the system.

5.5 CONCLUSION

In this chapter, we have presented a new approach to trajectory planning for a mobile node in mobile data collection within IoT networks. Specifically, we have introduced an energy-efficient deep SARSA algorithm, which is combined with experience replay, to optimize the mobile node's trajectory. The results of our experiments demonstrate that both the deep SARSA and DQN algorithms are able to use information about the environment to learn and find energy-efficient data collection trajectories. However, when comparing the two algorithms under the same parameters, we found that the DQN algorithm exhibits greater adaptability to significant changes in the context scenario, such as variations in the amount of collectible data, without the need for expensive retraining or data recollection. On the other hand, the deep SARSA algorithm tends to produce a less risky and safer trajectory. This makes the DQN algorithm more suitable for scenarios where the environment is highly dynamic and the amount of data to be collected is uncertain, while the deep SARSA algorithm is more appropriate for scenarios where safety and risk management for the mobile node are the primary concerns.

CONCLUSION

The IoT is revolutionizing various aspects of our lives. Everyday objects, such as appliances and vehicles, are now embedded with sensors, chips, and antennas which allow them to gather data from their surroundings and share it with other connected devices. From shopping, transportation, education, and even leisure activities, IoT is changing the way we experience them. However, IoT comes with its limitations, particularly in terms of energy consumption. IoT devices require significant amounts of energy to operate and transmit data, which can lead to challenges in terms of battery life and overall energy consumption. Additionally, the constant data transmission and large-scale deployment of IoT devices also have an impact on the environment as IoT devices often rely on non-renewable energy sources and the production of these devices also generates e-waste and pollution.

To address these limitations, the concept of "Green IoT" has emerged, which focuses on developing energy-efficient IoT devices and networks. This includes using low-power communication protocols, designing devices with energy-harvesting capabilities, and optimizing the overall energy consumption of the network. Additionally, Green IoT also includes the use of renewable energy sources to power the devices. Through these approaches, the aim is to create a more sustainable and eco-friendly version of the IoT, that can help to reduce energy consumption and minimize the environmental impact of IoT deployment.

To contribute to the Green IoT, in this thesis, we have provided a deep examination and analysis of the energy management techniques within the frame of Green IoT. We proposed a topology that combines energy conservation and energy harvesting techniques in IoT and presented the most relevant and recent research work in those fields. We also provided insight into the energy-efficient techniques in the IoT network ecosystem including edge, fog, and cloud platforms. Furthermore, we presented the novel approaches used for IoT energy efficiency and provided recommendations on how to use the energy-efficient techniques presented in the main IoT applications.

One area of Green IoT that caught our interest is mobility-based data collection. Data collection using a mobile platform in IoT refers to the process of gathering data from devices and objects using a mobile device as the primary means of data collection. This data can then be analyzed and used for various applications. The mobile platform can also be used to connect devices and allow resource-constrained IoT devices to reduce their transmission energy. Additionally, data collected using a mobile platform can also be used to improve energy efficiency, reduce carbon emissions, and monitor the health of ecosystems.

To further enhance the energy efficiency of these systems, it is imperative to provide an energy-efficient trajectory planning for the mobile platform. However, we have noticed that most of the current solutions use static trajectory planning for the mobile platform in well-defined environments. This is why, in this thesis, we focused on finding intelligent, energy-efficient, and adaptive trajectories in an environment where the mobile platform has little to no knowledge about. Deep reinforcement learning emerged to us as the most appropriate solution for our needs. In fact, we applied two reinforcement learning algorithms to the environment we defined and arrived to different conclusions, and extracted different use cases where they can be used. The contributions of this thesis are very encouraging and open up multiple research perspectives.

To further enhance the capabilities of our deep reinforcement learning algorithms for energy-efficient and adaptive trajectory planning for mobile platforms, we have identified several key areas of focus for future research. One of the major areas we are interested in is fine-tuning the parameters of our Q-learning algorithm to achieve faster learning times. Through our results, the Q-learning algorithm proved its ability to learn from experience and adapt to changing environments, however, fine-tuning the parameters can optimize the algorithm to learn faster and more efficiently. By experimenting with different parameter settings, we aim to find the optimal configuration for our specific use case. The faster learning times can potentially lead to more efficient and effective trajectory planning for the mobile platform, allowing it to quickly adapt to changing environments and gather data more effectively.

Another area of focus is the deep SARSA algorithm. During the simulation, the SARSA algorithm showed a conservative approach, which prioritizes safety over exploration, we believe that by fine-tuning the algorithm's parameters, we may be able to find a balance between the safety of the mobile platform and its ability to learn an energy-efficient policy that allows it to gather all the collectible data. This could lead to a

more versatile and dynamic algorithm that can adapt to a wider range of environments and scenarios. By investigating the deep SARSA algorithm, we aim to find an algorithm that can be applied in a broader range of situations and environments.

We are also interested in the potential of combining the Q-learning and deep SARSA algorithms through the use of a technique known as backward learning. This approach is currently being researched in our lab, and we are excited to see how it could be applied to our specific context. The combination of the two algorithms could potentially lead to an algorithm that combines the best aspects of both Q-learning and SARSA, resulting in a more robust and effective trajectory planning strategy for mobile platforms. By investigating this combination, we aim to find an algorithm that can provide a balance between exploration and safety, leading to a more efficient and adaptable algorithm.

Finally, we are also investigating the potential of incorporating other machine learning techniques, such as new neural networks, to enhance the capabilities of our proposition. This could potentially lead to even more efficient and effective trajectory planning for mobile platforms, allowing them to gather data more effectively and adapt to changing environments more quickly. Overall, we believe that by further investigating these areas, we can significantly improve the capabilities of our deep reinforcement algorithms and take a step forward in achieving energy-efficient and adaptive trajectory planning for mobile platforms.

BIBLIOGRAPHY

- Abbas, Ghulam, Ziaul Haq Abbas, Muhammad Waqas, Ahmad Kamal Hassan, et al. (2020). "Spectrum utilization efficiency in the cognitive radio enabled 5G-based IoT". In: *Journal of Network and Computer Applications* 164, p. 102686 (cited on p. 57).
- Abbasian Dehkordi, Soroush, Kamran Farajzadeh, Javad Rezazadeh, Reza Farahbakhsh, Kumbesan Sandrasegaran, and Masih Abbasian Dehkordi (2020). "A survey on data aggregation techniques in IoT sensor networks". In: *Wireless Networks* 26.2, pp. 1243–1263 (cited on p. 60).
- Abdal-Kadhim, Ali M and KOKS LEONG (2018). "Application of thermal energy harvesting in powering wsn node with event-priority-driven dissemination algorithm for IoT applications". In: *Journal of Engineering Science and Technology* 13.8, pp. 2569–2586 (cited on pp. 17, 27).
- Abir, SM Abu Adnan, Adnan Anwar, Jinho Choi, and ASM Kayes (2021). "Iot-enabled smart energy grid: Applications and challenges". In: *IEEE access* 9, pp. 50961–50981 (cited on p. 8).
- Al-Turjman, Fadi (2019). "5G-enabled devices and smart-spaces in social-IoT: an overview". In: *Future Generation Computer Systems* 92, pp. 732–744 (cited on pp. 44, 48, 56).
- Al-Turjman, Fadi, Ahmed Kamal, Mubashir Husain Rehmani, Ayman Radwan, and Al-Sakib Khan Pathan (2019). *The Green Internet of Things (G-IoT)* (cited on p. 6).
- Albreem, Mahmoud AM, Ayman A El-Saleh, Muzamir Isa, Wael Salah, M Jusoh, MM Azizan, and A Ali (2017). "Green internet of things (IoT): An overview". In: *2017 IEEE 4th Int. Conf. on Smart Instrumentation, Measurement and Application (ICSIMA)*. IEEE, pp. 1–6 (cited on p. 9).
- Alharbi, Fares, Yu-Chu Tian, Maolin Tang, Wei-Zhe Zhang, Chen Peng, and Minrui Fei (2019). "An ant colony system for energy-efficient dynamic virtual machine placement in data centers". In: *Expert Systems with Applications* 120, pp. 228–238 (cited on p. 40).
- Almasoud, Abdullah M and Ahmed E Kamal (2017). "Efficient data and energy transfer in IoT with a mobile cognitive base station". In: *2017 IEEE 28th Annual Int. Symposium on Personal, Indoor, and Mobile Radio Communications (PIMRC)*. IEEE, pp. 1–5 (cited on pp. 17, 25).
- Atzori, Luigi, Antonio Iera, Giacomo Morabito, and Michele Nitti (2012). "The social internet of things (siot)–when social networks meet the internet of things: Concept, architecture and network characterization". In: *Computer networks* 56.16, pp. 3594–3608 (cited on pp. 44, 48).

- Azar, Joseph, Abdallah Makhoul, Mahmoud Barhamgi, and Raphaël Couturier (2019). "An energy efficient IoT data compression approach for edge machine learning". In: *Future Generation Computer Systems* 96, pp. 168–175 (cited on pp. 40, 43).
- Baker, Thar, Muhammad Asim, Hissam Tawfik, Bandar Aldawsari, and Rajkumar Buyya (2017). "An energy-aware service composition algorithm for multiple cloud-based IoT applications". In: *Journal of Network and Computer Applications* 89, pp. 96–108 (cited on pp. 39, 40).
- Basagni, Stefano, Valerio Di Valerio, Georgia Koutsandria, and Chiara Petrioli (2017). "Wake-up radio-enabled routing for green wireless sensor networks". In: *2017 IEEE 86th Vehicular Technology Conf. (VTC-Fall)*. IEEE, pp. 1–6 (cited on pp. 29, 32).
- Bayerlein, Harald, Mirco Theile, Marco Caccamo, and David Gesbert (2020). "UAV path planning for wireless data harvesting: A deep reinforcement learning approach". In: *GLOBECOM 2020-2020 IEEE Global Communications Conference*. IEEE, pp. 1–6 (cited on p. 62).
- (2021). "Multi-UAV path planning for wireless data harvesting with deep reinforcement learning". In: *IEEE Open Journal of the Communications Society* 2, pp. 1171–1187 (cited on p. 62).
- Bello, Hilal, Zeng Xiaoping, Rosdiadee Nordin, and Jian Xin (2019). "Advances and Opportunities in Passive Wake-Up Radios with Wireless Energy Harvesting for the Internet of Things Applications". In: *Sensors* 19.14, p. 3078 (cited on pp. 29, 32).
- Benhamaid, Sana, Abdelmadjid Bouabdallah, and Hicham Lakhlef (2022). *Recent advances in energy management for Green-IoT: An up-to-date and comprehensive survey*. Vol. 198. Elsevier, p. 103257 (cited on p. 16).
- Bol, David, Julien De Vos, François Botman, Gueric de Streel, Sébastien Bernard, Denis Flandre, and Jean-Didier Legat (2013). "Green SoCs for a sustainable Internet-of-Things". In: *2013 IEEE Faible Tension Faible Consommation*. IEEE, pp. 1–4 (cited on p. 11).
- Buzzi, Stefano, I Chih-Lin, Thierry E Klein, H Vincent Poor, Chenyang Yang, and Alessio Zappone (2016). "A survey of energy-efficient techniques for 5G networks and challenges ahead". In: *IEEE Journal on Selected Areas in Communications* 34.4, pp. 697–709 (cited on pp. 44, 45).
- Cao, Xuelin, Zuxun Song, Bo Yang, Mohamed El Mossallamy, Lijun Qian, and Zhu Han (2019). "A Distributed Ambient Backscatter MAC Protocol for Internet-of-Things Networks". In: *IEEE Internet of Things Journal* (cited on pp. 17, 22).
- Chandnani, Neeraj and Chandrakant N Khairnar (2020). "A comprehensive review and performance evaluation of recent trends for data aggregation and routing techniques in IoT networks". In: *Social Networking and Computational Intelligence*, pp. 467–484 (cited on pp. 29, 34, 35).
- Chang, Chih-Yung, Chung-Chih Lin, Cuijuan Shang, I-Hsiung Chang, and Diptendu Sinha Roy (2019). "DBDC: A Distributed Bus-Based Data

- Collection Mechanism for Maximizing Throughput and Lifetime in WSNs". In: *IEEE Access* 7, pp. 160506–160522 (cited on pp. 29, 36).
- Chen, Jiahui, Feng Yan, Shenshen Mao, Fei Shen, Weiwei Xia, Yi Wu, and Lianfeng Shen (2019). "Efficient Data Collection in Large-Scale UAV-aided Wireless Sensor Networks". In: *2019 11th Int. Conf. on Wireless Communications and Signal Processing (WCSP)*. IEEE, pp. 1–5 (cited on pp. 29, 36).
- Chen, Yan, Feng Han, Yu-Han Yang, Hang Ma, Yi Han, Chunxiao Jiang, Hung-Quoc Lai, David Claffey, Zoltan Safar, and KJ Ray Liu (2014). "Time-reversal wireless paradigm for green internet of things: An overview". In: *IEEE Internet of Things Journal* 1.1, pp. 81–98 (cited on p. 11).
- Chen, Yang, Arturo Ardila-Gomez, and Gladys Frame (2016). *Achieving energy savings by intelligent transportation systems investments in the context of smart cities*. World Bank (cited on pp. 44, 53).
- Chowdhury, Chandreyee, Sarbani Roy, Arpita Ray, and Sumanta Kumar Deb (2020). "A Fault-Tolerant Approach to Alleviate Failures in Offloading Systems". In: *Wireless Personal Communications* 110.2, pp. 1033–1055 (cited on p. 55).
- Costanzo, Alessandra and Diego Masotti (2017). "Energizing 5G: Near-and far-field wireless energy and data transfer as an enabling technology for the 5G IoT". In: *IEEE Microwave Magazine* 18.3, pp. 125–136 (cited on pp. 44, 45).
- Dao, Nhu-Ngoc, Woongsoo Na, Anh-Tien Tran, Diep N Nguyen, and Sungrae Cho (2020). "Energy-Efficient Spectrum Sensing for IoT Devices". In: *IEEE Systems Journal* (cited on pp. 44, 45).
- Daud, Ahmad Kamal Pasha Mohd, Norakmar Arbain Sulaiman, Yuslinda Wati Mohamad Yusof, and Murizah Kassim (2020). "An IoT-Based Smart Aquarium Monitoring System". In: *2020 IEEE 10th Symposium on Computer Applications & Industrial Electronics (ISCAIE)*. IEEE, pp. 277–282 (cited on p. 7).
- De Bruin, Tim, Jens Kober, Karl Tuyls, and Robert Babuška (2015). "The importance of experience replay database composition in deep reinforcement learning". In: *Deep reinforcement learning workshop, NIPS* (cited on p. 70).
- Deng, Der-Jiunn, Ming Gan, Yu-Chen Guo, Jian Yu, Ying-Pei Lin, Shao-Yu Lien, and Kwang-Cheng Chen (2019). "Ieee 802.11 ba: Low-power wake-up radio for green iot". In: *IEEE Communications Magazine* 57.7, pp. 106–112 (cited on pp. 29, 31).
- Dezfouli, Behnam, Immanuel Amirtharaj, and Chia-Chi Chelsey Li (2018). "EMPIOT: An energy measurement platform for wireless IoT devices". In: *Journal of Network and Computer Applications* 121, pp. 135–148 (cited on p. 17).

- Dhall, Ruchi and Himanshu Agrawal (2018). "An Improved Energy Efficient Duty Cycling Algorithm for IoT based Precision Agriculture". In: *Procedia Computer Science* 141, pp. 135–142 (cited on pp. 29, 33).
- Eghbali, Zahra and Mina Zolfy Lighvan (2021). "A hierarchical approach for accelerating IoT data management process based on SDN principles". In: *Journal of Network and Computer Applications* 181, p. 103027 (cited on pp. 44, 47).
- Esther, B Priya and K Sathish Kumar (2016). "A survey on residential demand side management architecture, approaches, optimization models and methods". In: *Renewable and Sustainable Energy Reviews* 59, pp. 342–351 (cited on pp. 44, 53).
- Fan, Jianqing, Zhaoran Wang, Yuchen Xie, and Zhuoran Yang (2020). "A theoretical analysis of deep Q-learning". In: *Learning for Dynamics and Control*. PMLR, pp. 486–489 (cited on p. 70).
- Farahani, Bahar, Farshad Firouzi, and Krishnendu Chakrabarty (2020). "Healthcare iot". In: *Intelligent internet of things*. Springer, pp. 515–545 (cited on p. 7).
- Feng, Lilei, Yang Shen, Guojun Chen, Xieyang Xu, Purui Wang, and Chenren Xu (2018). "A Visible Light Backscatter Communication Solution for Low-cost Parking Space Detection". In: *Proceedings of the 2018 ACM Int. Joint Conf. and 2018 Int. Symposium on Pervasive and Ubiquitous Computing and Wearable Computers*, pp. 343–344 (cited on pp. 17, 22).
- Franzitta, Vincenzo, Domenico Curto, Daniele Milone, and Marco Trapanese (2017). "Energy saving in public transport using renewable energy". In: *Sustainability* 9.1, p. 106 (cited on pp. 44, 53).
- Frøytlog, Anders, Magne Arild Haglund, Linga Reddy Cenkeramaddi, Thomas Jordbru, Rolf Arne Kjellby, and Baltasar Beferull-Lozano (2019). "Design and implementation of a long-range low-power wake-up radio for IoT devices". In: *2019 IEEE 5th World Forum on Internet of Things (WF-IoT)*. IEEE, pp. 247–250 (cited on pp. 29, 32).
- Froytlog, Anders, Thomas Foss, Ole Bakker, Geir Jevne, M Arild Haglund, Frank Y Li, Joaquim Oller, and Geoffrey Ye Li (2019). "Ultra-low power wake-up radio for 5G IoT". In: *IEEE Communications Magazine* 57.3, pp. 111–117 (cited on pp. 29, 30).
- Gandotra, Pimmy, Rakesh Kumar Jha, and Sanjeev Jain (2017). "Green communication in next generation cellular networks: A survey". In: *IEEE Access* 5, pp. 11727–11758 (cited on pp. 44, 45).
- Gharehpasha, Sasan, Mohammad Masdari, and Ahmad Jafarian (2020). "Virtual machine placement in cloud data centers using a hybrid multi-verse optimization algorithm". In: *Artificial Intelligence Review*, pp. 1–37 (cited on p. 40).
- Ghorbel, Mahdi Ben, David Rodríguez-Duarte, Hakim Ghazzai, Md Jahangir Hossain, and Hamid Menouar (2019). "Joint position and travel

- path optimization for energy efficient wireless data gathering using unmanned aerial vehicles". In: *IEEE Transactions on Vehicular Technology* 68.3, pp. 2165–2175 (cited on p. 61).
- Giliberto, Mario, Fabio Arena, and Giovanni Pau (2019). "A fuzzy-based Solution for Optimized Management of Energy Consumption in e-bikes." In: *J. Wirel. Mob. Networks Ubiquitous Comput. Dependable Appl.* 10.3, pp. 45–64 (cited on p. 53).
- Giovanelli, Davide, Bojan Milosevic, Davide Brunelli, and Elisabetta Farella (2017). "Enhancing Bluetooth Low Energy with wake-up radios for IoT applications". In: *2017 13th Int. Wireless Communications and Mobile Computing Conf. (IWCMC)*. IEEE, pp. 1622–1627 (cited on pp. 29, 32).
- Hao, Wanming, Osamu Muta, Haris Gacanin, and Hiroshi Furukawa (2016). "Energy-Efficient Resource Allocation for Cooperative Cognitive Radio Networks with Imperfect Spectrum Sensing". In: *Proceedings of the Fifth Int. Conf. on Network, Communication and Computing*, pp. 257–261 (cited on pp. 44, 46).
- Haykin, Simon (2005). "Cognitive radio: brain-empowered wireless communications". In: *IEEE journal on selected areas in communications* 23.2, pp. 201–220 (cited on pp. 44, 45).
- Hoang, Dinh Thai, Dusit Niyato, Dong In Kim, Nguyen Van Huynh, and Shimin Gong (2020). *Ambient Backscatter Communication Networks*. Cambridge University Press (cited on pp. 17, 18, 20).
- Howell, Jenalea (2017). "Number of connected iot devices will surge to 125 billion by 2030, IHS markit says". In: *IHS Markit Technology*, Oct 24 (cited on p. 6).
- Hsieh, Hung-Yun, En-Yu Lin, and Shao-Chun Wu (2020). "Minimizing NOMA Resource Usage for Cellular IoT Networks through Distributed Source Coding". In: *GLOBECOM 2020-2020 IEEE Global Communications Conference*. IEEE, pp. 1–6 (cited on pp. 29, 36).
- Hsu, Che-Wei, Yung-Lin Hsu, and Hung-Yu Wei (2019). "Energy-efficient and reliable MEC offloading for heterogeneous industrial IoT networks". In: *2019 European Conference on Networks and Communications (EuCNC)*. IEEE, pp. 384–388 (cited on p. 57).
- Hsu, Yu-Hsin and Rung-Hung Gau (2020). "Reinforcement learning-based collision avoidance and optimal trajectory planning in UAV communication networks". In: *IEEE Transactions on Mobile Computing* 21.1, pp. 306–320 (cited on p. 61).
- Hu, Yue, Weimin Li, Kun Xu, Taimoor Zahid, Feiyan Qin, and Chenming Li (2018). "Energy management strategy for a hybrid electric vehicle based on deep reinforcement learning". In: *Applied Sciences* 8.2, p. 187 (cited on pp. 44, 52).
- Huang, Yuwen, Mengyu Liu, and Yuan Liu (2018). "Energy-Efficient SWIPT in IoT Distributed Antenna Systems". In: *IEEE Internet of Things*

- Journal* 5.4, pp. 2646–2656. DOI: [10.1109/JIOT.2018.2796124](https://doi.org/10.1109/JIOT.2018.2796124) (cited on p. 23).
- Huin, Nicolas, Myriana Rifai, Frédéric Giroire, Dino Lopez Pacheco, Guillaume Urvoy-Keller, and Joanna Moulhierac (2018). “Bringing energy aware routing closer to reality with SDN hybrid networks”. In: *IEEE Trans. on Green Communications and Networking* 2.4, pp. 1128–1139 (cited on p. 44).
- Jawad, Aqeel Mahmood, Haider Mahmood Jawad, Rosdiadee Nordin, Sadik Kamel Gharghan, Nor Fadzilah Abdullah, and Mahmood Jawad Abu-Alshaeer (2019). “Wireless power transfer with magnetic resonator coupling and sleep/active strategy for a drone charging station in smart agriculture”. In: *IEEE Access* 7, pp. 139839–139851 (cited on p. 56).
- Ji, Baofeng, Bingbing Xing, Kang Song, Chunguo Li, Hong Wen, and Luxi Yang (2019). “The efficient BackFi transmission design in ambient backscatter communication systems for IoT”. In: *IEEE Access* 7, pp. 31397–31408 (cited on p. 17).
- Ji, Baofeng, Zhenzhen Chen, Sudan Chen, Benchuan Zhou, Chunguo Li, and Hong Wen (2020). “Joint optimization for ambient backscatter communication system with energy harvesting for IoT”. In: *Mechanical Systems and Signal Processing* 135, p. 106412 (cited on pp. 17, 22).
- Jiang, Li, Hui Tian, Zi Xing, Kun Wang, Ke Zhang, Sabita Maharjan, Stein Gjessing, and Yan Zhang (2016). “Social-aware energy harvesting device-to-device communications in 5G networks”. In: *IEEE Wireless Communications* 23.4, pp. 20–27 (cited on pp. 44, 48).
- Jo, Hana and Yong Ik Yoon (2018). “Intelligent smart home energy efficiency model using artificial TensorFlow engine”. In: *Human-centric Computing and Information Sciences* 8.1, pp. 1–18 (cited on p. 55).
- John, NituElza and A Jyotsna (2018). “A survey on energy efficient tree-based data aggregation techniques in wireless sensor networks”. In: *2018 International Conference on Inventive Research in Computing Applications (ICIRCA)*. IEEE, pp. 461–465 (cited on pp. 29, 34).
- Jushi, Adnant, Alain Pegatoquet, and Trong Nhan Le (2016). “Wind energy harvesting for autonomous wireless sensor networks”. In: *2016 Euro-micro Conf. on Digital System Design (DSD)*. IEEE, pp. 301–308 (cited on pp. 17, 28).
- Kamenar, Ervin, Saša Zelenika, David Blažević, Senka Maćešić, Goran Gregov, Kristina Marković, and Vladimir Glažar (2016). “Harvesting of river flow energy for wireless sensor network technology”. In: *Microsystem Technologies* 22.7, pp. 1557–1574 (cited on pp. 17, 28).
- Kampeerawat, Warayut and Takafumi Koseki (2017). “A strategy for utilization of regenerative energy in urban railway system by application of smart train scheduling and wayside energy storage system”. In: *Energy Procedia* 138, pp. 795–800 (cited on pp. 44, 53).

- Karakuş, Güzide, Emre Karşıgil, and Leyla Polat (2018). "The role of IoT on production of services: A Research on aviation industry". In: *The International Symposium for Production Research*. Springer, pp. 503–511 (cited on p. 8).
- Katal, Avita, Susheela Dahiya, and Tanupriya Choudhury (2022). "Energy efficiency in cloud computing data centers: a survey on software technologies". In: *Cluster Computing*, pp. 1–31 (cited on p. 13).
- Kaur, Navroop and Sandeep K Sood (2015). "An energy-efficient architecture for the Internet of Things (IoT)". In: *IEEE Systems Journal* 11.2, pp. 796–805 (cited on pp. 39, 40).
- Kazmi, Syed Najeeb Ali, Abasin Ulasyar, and Muhammad Faisal Nadeem Khan (2020). "IoT based Energy Efficient Smart Street Lighting Technique with Air Quality Monitoring". In: *2020 14th International Conference on Open Source Systems and Technologies (ICOSST)*. IEEE, pp. 1–6 (cited on pp. 44, 52).
- Kim, Younggi and Younghee Lee (2015). "Automatic generation of social relationships between Internet of Things in smart home using SDN-based home cloud". In: *2015 IEEE 29th International conference on advanced information networking and applications workshops*. IEEE, pp. 662–667 (cited on p. 55).
- Ko, Haneul, Jaewook Lee, and Sangheon Pack (2019). "CG-E2S2: Consistency-guaranteed and energy-efficient sleep scheduling algorithm with data aggregation for IoT". In: *Future Generation Computer Systems* 92, pp. 1093–1102 (cited on pp. 29, 35).
- Krishnan, Ram, Tim Hinrichs, Dilip Krishnawamy, and Ruby Krishnaswamy (2015). "Policy-based monitoring and energy management for NFV data centers". In: *2015 Int. Conf. on Computing and Network Communications (CoCoNet)*. IEEE, pp. 10–17 (cited on pp. 44, 47).
- Kumar, Vipin and Sushil Kumar (2016). "Energy balanced position-based routing for lifetime maximization of wireless sensor networks". In: *Ad Hoc Networks* 52, pp. 117–129 (cited on p. 13).
- Kumari, Raj and Sakshi Kaushal (2017). "Energy efficient approach for application execution in mobile cloud IoT environment". In: *Proceedings of the Second Int. Conf. on Internet of things, Data and Cloud Computing*, pp. 1–8 (cited on p. 40).
- Kurdi, Heba, Abeer Al-Anazi, Carlene Campbell, and Auhood Al Faries (2015). "A combinatorial optimization algorithm for multiple cloud service composition". In: *Computers & Electrical Engineering* 42, pp. 107–113 (cited on pp. 39, 40).
- Lavassani, Mehrzad, Stefan Forsström, Ulf Jennehag, and Tingting Zhang (2018). "Combining fog computing with sensor mote machine learning for industrial IoT". In: *Sensors* 18.5, p. 1532 (cited on pp. 40, 42, 44, 51).
- Lee, Haesung, Kwangyoung Kim, and Joonhee Kwon (2016). "A pervasive interconnection technique for efficient information sharing in social iot

- environment". In: *Int. journal of smart home* 10.1, pp. 9–22 (cited on pp. 44, 48).
- Lee, Hyun-Suk and Jang-Won Lee (2018). "Resource and task scheduling for SWIPT IoT systems with renewable energy sources". In: *IEEE Internet of Things Journal* 6.2, pp. 2729–2748 (cited on pp. 17, 23).
- Li, Shancang, Li Da Xu, and Shanshan Zhao (2018). "5G Internet of Things: A survey". In: *Journal of Industrial Information Integration* 10, pp. 1–9 (cited on p. 6).
- Li, Yin and Ronghua Shi (2015). "An intelligent solar energy-harvesting system for wireless sensor networks". In: *EURASIP Journal on Wireless Communications and Networking* 2015.1, p. 179 (cited on pp. 17, 26).
- Liao, Qing and Zun Wang (2018). "Energy consumption optimization scheme of cloud data center based on SDN". In: *Procedia computer science* 131, pp. 1318–1327 (cited on pp. 44, 47).
- Liessner, Roman, Christian Schroer, Ansgar Malte Dietermann, and Bernard Bäker (2018). "Deep Reinforcement Learning for Advanced Energy Management of Hybrid Electric Vehicles." In: *ICAART* (2), pp. 61–72 (cited on pp. 44, 52).
- Liu, Mingqing, Mingliang Xiong, Hao Deng, Qingwen Liu, Jun Wu, and Pengfei Xia (2018). "Mobile Energy Internet". In: *arXiv preprint arXiv:1802.01570* (cited on pp. 17, 26).
- Liu, Tao, Xiaodong Wang, and Le Zheng (2017). "A cooperative SWIPT scheme for wirelessly powered sensor networks". In: *IEEE Trans. on Communications* 65.6, pp. 2740–2752 (cited on pp. 17, 23).
- Liu, Xilong and Nirwan Ansari (2019a). "Toward green IoT: Energy solutions and key challenges". In: *IEEE Communications Magazine* 57.3, pp. 104–110 (cited on pp. 17, 23).
- Liu, Xin, Ying Li, Xueyan Zhang, Weidang Lu, and Mudi Xiong (2020). "Energy-Efficient Resource Optimization in Green Cognitive Internet of Things". In: *Mobile Networks and Applications*, pp. 1–9 (cited on pp. 44, 46).
- Liu, Yi, Chao Yang, Li Jiang, Shengli Xie, and Yan Zhang (2019b). "Intelligent edge computing for IoT-based energy management in smart cities". In: *IEEE Network* 33.2, pp. 111–117 (cited on pp. 40, 43, 44, 52).
- Lu, Weidang, Yi Gong, Xin Liu, Jiaying Wu, and Hong Peng (2017). "Collaborative energy and information transfer in green wireless sensor networks for smart cities". In: *IEEE Trans. on Industrial Informatics* 14.4, pp. 1585–1593 (cited on pp. 17, 23).
- Luo, Jingci, Jie Tang, Daniel KC So, Gaojie Chen, Kanapathippillai Cumanan, and Jonathon A Chambers (2019). "A deep learning-based approach to power minimization in multi-carrier NOMA with SWIPT". In: *IEEE Access* 7, pp. 17450–17460 (cited on pp. 17, 23).
- Luo, Ping, Dingming Peng, Yuanfei Wang, and Xinyi Zheng (2018). "Review of Solar Energy Harvesting for IoT Applications". In: *2018 IEEE*

- Asia Pacific Conf. on Circuits and Systems (APCCAS)*. IEEE, pp. 512–515 (cited on pp. 17, 26).
- Ma, Zhijie, Li Feng, and Fangxin Xu (2018). “Design and analysis of a distributed and demand-based backscatter MAC protocol for internet of things networks”. In: *IEEE Internet of Things Journal* 6.1, pp. 1246–1256 (cited on pp. 17, 22).
- Machorro-Cano, Isaac, Giner Alor-Hernández, Mario Andrés Paredes-Valverde, Lisbeth Rodríguez-Mazahua, José Luis Sánchez-Cervantes, and José Oscar Olmedo-Aguirre (2020). “HEMS-IoT: A Big Data and Machine Learning-Based Smart Home System for Energy Saving”. In: *Energies* 13.5, p. 1097 (cited on pp. 44, 49).
- Madhja, Adelina, Sotiris Nikolettseas, and Theofanis P Raptis (2016). “Hierarchical, collaborative wireless energy transfer in sensor networks with multiple mobile chargers”. In: *Computer Networks* 97, pp. 98–112 (cited on pp. 17, 25).
- Magno, Michele, Lorenzo Spadaro, Jaskirat Singh, and Luca Benini (2016). “Kinetic energy harvesting: Toward autonomous wearable sensing for Internet of Things”. In: *2016 Int. Symposium on Power Electronics, Electrical Drives, Automation and Motion (SPEEDAM)*. IEEE, pp. 248–254 (cited on pp. 17, 28).
- Mao, Jian, Qixiao Lin, and Jingdong Bian (2018). “Application of learning algorithms in smart home IoT system security”. In: *Mathematical foundations of computing* 1.1, p. 63 (cited on p. 55).
- Mebrek, Adila, Leila Merghem-Boulaia, and Moez Esseghir (2017). “Efficient green solution for a balanced energy consumption and delay in the IoT-Fog-Cloud computing”. In: *2017 IEEE 16th Int. Symposium on Network Computing and Applications (NCA)*. IEEE, pp. 1–4 (cited on pp. 40, 41).
- Mekki, Kais, Eddy Bajic, Frederic Chaxel, and Fernand Meyer (2018). “Overview of cellular LPWAN technologies for IoT deployment: Sigfox, LoRaWAN, and NB-IoT”. In: *2018 IEEE International Conference on Pervasive Computing and Communications Workshops (PerCom Workshops)*. IEEE, pp. 197–202 (cited on p. 12).
- (2019). “A comparative study of LPWAN technologies for large-scale IoT deployment”. In: *ICT express* 5.1, pp. 1–7 (cited on p. 12).
- Meng, Yue, Chunxiao Jiang, Hsiao-Hwa Chen, and Yong Ren (2017). “Cooperative device-to-device communications: Social networking perspectives”. In: *IEEE Network* 31.3, pp. 38–44 (cited on pp. 44, 48).
- Min, Minghui, Liang Xiao, Ye Chen, Peng Cheng, Di Wu, and Weihua Zhuang (2019). “Learning-based computation offloading for IoT devices with energy harvesting”. In: *IEEE Trans. on Vehicular Technology* 68.2, pp. 1930–1941 (cited on pp. 40, 43).

- Mounce, SR, C Pedraza, T Jackson, P Linford, and JB Boxall (2015). "Cloud based machine learning approaches for leakage assessment and management in smart water networks". In: *Procedia engineering*. Vol. 119. 1. Elsevier, pp. 43–52 (cited on pp. 44, 51).
- Mozaffari, Mohammad, Walid Saad, Mehdi Bennis, and Mérouane Debbah (2017). "Mobile unmanned aerial vehicles (UAVs) for energy-efficient Internet of Things communications". In: *IEEE Transactions on Wireless Communications* 16.11, pp. 7574–7589 (cited on p. 61).
- Munir, Daniyal, Syed Tariq Shah, Danish Mehmood Mughal, Kwang Hyun Park, and Min Young Chung (2018). "Duty Cycle Optimizing for WiFi-based IoT Networks with Energy Harvesting". In: *Proceedings of the 12th Int. Conf. on Ubiquitous Information Management and Communication*, pp. 1–6 (cited on pp. 29, 33).
- Naeem, Faisal, Muhammad Tariq, and H Vincent Poor (2020). "SDN-enabled Energy-Efficient Routing Optimization Framework for Industrial Internet of Things". In: *IEEE Trans. on Industrial Informatics* (cited on pp. 44, 47).
- Nayeri, Zahra Makki, Toktam Ghafarian, and Bahman Javadi (2021). "Application placement in Fog computing with AI approach: Taxonomy and a state of the art survey". In: *Journal of Network and Computer Applications*, p. 103078 (cited on pp. 40, 41).
- Nguyen, Thien D, Jamil Y Khan, and Duy T Ngo (2017). "An effective energy-harvesting-aware routing algorithm for WSN-based IoT applications". In: *2017 IEEE Int. Conf. on Communications (ICC)*. IEEE, pp. 1–6 (cited on pp. 17, 26).
- Oma, Ryuji, Shigenari Nakamura, Tomoya Enokido, and Makoto Takizawa (2018a). "A tree-based model of energy-efficient fog computing systems in IoT". In: *Conf. on Complex, Intelligent, and Software Intensive Systems*. Springer, pp. 991–1001 (cited on pp. 40, 42).
- (2018b). "An energy-efficient model of fog and device nodes in IoT". In: *2018 32nd Int. Conf. on Advanced Information Networking and Applications Workshops (WAINA)*. IEEE, pp. 301–306 (cited on pp. 40, 42).
- Ożadowicz, Andrzej (2017). "A new concept of active demand side management for energy efficient prosumer microgrids with smart building technologies". In: *Energies* 10.11, p. 1771 (cited on pp. 44, 53).
- O'Dwyer, Edward, Indranil Pan, Salvador Acha, and Nilay Shah (2019). "Smart energy systems for sustainable smart cities: Current developments, trends and future directions". In: *Applied energy* 237, pp. 581–597 (cited on pp. 44, 51).
- Paris, Lorenzo and Mohammad Hossein Anisi (2019). "An Energy-efficient Predictive Model for Object Tracking Sensor Networks". In: *2019 IEEE 5th World Forum on Internet of Things (WF-IoT)*. IEEE, pp. 263–268 (cited on pp. 44, 52).

- Park, Jong Jin, Jong Ho Moon, Kang-Yoon Lee, and Dong In Kim (2020a). "Transmitter-Oriented Dual Mode SWIPT with Deep Learning Based Adaptive Mode Switching for IoT Sensor Networks". In: *IEEE Internet of Things Journal* (cited on pp. 17, 23).
- Park, Seong-Taek, Guozhong Li, and Jae-Chang Hong (2020b). "A study on smart factory-based ambient intelligence context-aware intrusion detection system using machine learning". In: *Journal of Ambient Intelligence and Humanized Computing* 11.4, pp. 1405–1412 (cited on p. 57).
- Passos, Diego, Helga Balbi, Ricardo Carrano, and Celio Albuquerque (2019). "Asynchronous Radio Duty Cycling for Green IoT: State of the Art and Future Perspectives". In: *IEEE Communications Magazine* 57.9, pp. 106–111 (cited on pp. 29, 33).
- Pattamaset, Siriporn and Jae Sung Choi (2021). "Efficient Data Aggregation for Human Activity Detection with Smart Home Sensor Network Using K-Means Clustering Algorithm". In: *Advances in Computer Science and Ubiquitous Computing*. Springer, pp. 9–15 (cited on p. 55).
- Pei, Xinyue, Wei Duan, Miaowen Wen, Yik-Chung Wu, Hua Yu, and Valdemar Monteiro (2020). "Socially Aware Joint Resource Allocation and Computation Offloading in NOMA-Aided Energy-Harvesting Massive IoT". In: *IEEE Internet of Things Journal* 8.7, pp. 5240–5249 (cited on p. 56).
- Peralta, Goiuri, Markel Iglesias-Urkia, Marc Barcelo, Raul Gomez, Adrian Moran, and Josu Bilbao (2017). "Fog computing based efficient IoT scheme for the Industry 4.0". In: *2017 IEEE Int. workshop of electronics, control, measurement, signals and their application to mechatronics (ECMSM)*. IEEE, pp. 1–6 (cited on pp. 40, 42).
- Perera, Charith, Yongrui Qin, Julio C Estrella, Stephan Reiff-Marganiec, and Athanasios V Vasilakos (2017a). "Fog computing for sustainable smart cities: A survey". In: *ACM Computing Surveys (CSUR)* 50.3, pp. 1–43 (cited on pp. 40, 41).
- Perera, TDP, DNK Jayakody, S De, and Maksim Anatoljevich Ivanov (2017b). "A survey on simultaneous wireless information and power transfer". In: *Journal of Physics: Conf. Series*. Vol. 803. 1. IOP Publishing, p. 012113 (cited on pp. 17, 23).
- Perera, Tharindu D Ponnimbaduge, Dushantha Nalin K Jayakody, Shree Krishna Sharma, Symeon Chatzinotas, and Jun Li (2017c). "Simultaneous wireless information and power transfer (SWIPT): Recent advances and future challenges". In: *IEEE Communications Surveys & Tutorials* 20.1, pp. 264–302 (cited on pp. 17, 22).
- Piyare, Rajeev, Amy L Murphy, Csaba Kiraly, Pietro Tosato, and Davide Brunelli (2017). "Ultra low power wake-up radios: A hardware and networking survey". In: *IEEE Communications Surveys & Tutorials* 19.4, pp. 2117–2157 (cited on pp. 29, 31).

- Pourghebleh, Behrouz and Nima Jafari Navimipour (2017). "Data aggregation mechanisms in the Internet of things: A systematic review of the literature and recommendations for future research". In: *Journal of Network and Computer Applications* 97, pp. 23–34 (cited on pp. 29, 34).
- Priya, V, Murali K Rajendran, Shourya Kansal, Gajendranath Chowdary, and Ashudeb Dutta (2018). "A human body heat driven high throughput thermal energy harvesting single stage regulator for wearable biomedical IoT nodes". In: *IEEE Internet of Things Journal* 5.6, pp. 4989–5001 (cited on pp. 17, 27).
- Qureshi, Faisal Fayyaz, Rahat Iqbal, and Muhammad Nabeel Asghar (2017). "Energy efficient wireless communication technique based on cognitive radio for internet of things". In: *Journal of Network and Computer Applications* 89, pp. 14–25 (cited on pp. 44, 46).
- Rahim, Muhammad Hassan, Adia Khalid, Nadeem Javaid, Musaed Alhussein, Khursheed Aurangzeb, and Zahoor Ali Khan (2018). "Energy efficient smart buildings using coordination among appliances generating large data". In: *IEEE access* 6, pp. 34670–34690 (cited on pp. 44, 53).
- Rakovic, Valentin, Robert Adamovski, Aleksandar Risteski, and Liljana Gavrilovska (2020). "Improving Energy Efficiency and Reliability in WuR-Based IoT Systems: An Error Correction Approach". In: *Wireless Personal Communications*, pp. 1–12 (cited on pp. 29, 33).
- Ray, Susmita (2019). "A quick review of machine learning algorithms". In: *2019 International conference on machine learning, big data, cloud and parallel computing (COMITCon)*. IEEE, pp. 35–39 (cited on p. 63).
- Raza, Usman, Parag Kulkarni, and Mahesh Sooriyabandara (2017). "Low power wide area networks: An overview". In: *IEEE communications surveys & tutorials* 19.2, pp. 855–873 (cited on p. 12).
- Razafimandimby, Cristanel, Valeria Loscrí, Anna Maria Vegni, Driss Aourir, and Alessandro Neri (2018). "A Bayesian Approach for an Efficient Data Reduction in IoT". In: *Interoperability, Safety and Security in IoT*. Ed. by Giancarlo Fortino, Carlos E. Palau, Antonio Guerrieri, Nora Cuppens, Frédéric Cuppens, Hakima Chaouchi, and Alban Gabillon. Cham: Springer International Publishing, pp. 3–10. ISBN: 978-3-319-93797-7 (cited on pp. 29, 35).
- Sarkar, Subhadeep, Subarna Chatterjee, and Sudip Misra (2015). "Assessment of the Suitability of Fog Computing in the Context of Internet of Things". In: *IEEE Trans. on Cloud Computing* 6.1, pp. 46–59 (cited on pp. 40, 41).
- Şengör, İbrahim, Hasan Can Kılıçkiran, Hüseyin Akdemir, Bedri Kekezoğlu, Ozan Erdinc, and Joao PS Catalao (2017). "Energy management of a smart railway station considering regenerative braking and stochastic behaviour of ESS and PV generation". In: *IEEE Trans. on Sustainable Energy* 9.3, pp. 1041–1050 (cited on pp. 44, 53).

- Sheikhi, Aras, Mohammad Rayati, and Ali Mohammad Ranjbar (2015). "Energy Hub optimal sizing in the smart grid; machine learning approach". In: *2015 IEEE Power & Energy Society Innovative Smart Grid Technologies Conf. (ISGT)*. IEEE, pp. 1–5 (cited on pp. 44, 51).
- Shin, Minchul and Inwhee Joe (2016). "Energy management algorithm for solar-powered energy harvesting wireless sensor node for Internet of Things". In: *Iet Communications* 10.12, pp. 1508–1521 (cited on p. 26).
- Shyam, Gopal Kirshna, Sunilkumar S Manvi, and Priyanka Bharti (2017). "Smart waste management using Internet-of-Things (IoT)". In: *2017 2nd international conference on computing and communications technologies (IC-CCT)*. IEEE, pp. 199–203 (cited on pp. 44, 52).
- Slalmi, Ahmed, Rachid Saadane, Abdellah Chehri, and Hatim Kharraz (2021). "How will 5G transform industrial IoT: latency and reliability analysis". In: *Human Centred Intelligent Systems*. Springer, pp. 335–345 (cited on p. 57).
- Song, Liumeng, Kok Keong Chai, Yue Chen, John Schormans, Jonathan Loo, and Alexey Vinel (2017). "QoS-aware energy-efficient cooperative scheme for cluster-based IoT systems". In: *IEEE Systems Journal* 11.3, pp. 1447–1455 (cited on pp. 29, 34, 60).
- Sun, Xiang and Nirwan Ansari (2016). "EdgeIoT: Mobile edge computing for the Internet of Things". In: *IEEE Communications Magazine* 54.12, pp. 22–29 (cited on pp. 40, 42).
- Sutton, Richard S and Andrew G Barto (2018). *Reinforcement learning: An introduction*. MIT press (cited on p. 64).
- Teplý, T, V Janíček, A Bouřa, J Novák, and M Husák (2019). "Energy consumption optimization for thermal energy harvester applications". In: (cited on pp. 17, 27).
- Thomas, Brian L and Diane J Cook (2016). "Activity-aware energy-efficient automation of smart buildings". In: *Energies* 9.8, p. 624 (cited on pp. 44, 51).
- Timoudas, Thomas Ohlson, Rong Du, and Carlo Fischione (2020). "Enabling Massive IoT in Ambient Backscatter Communication Systems". In: *ICC 2020-2020 IEEE Int. Conf. on Communications (ICC)*. IEEE, pp. 1–6 (cited on pp. 17, 22).
- Toor, Amanjot Singh and AK Jain (2019). "Energy aware cluster based multi-hop energy efficient routing protocol using multiple mobile nodes (MEACBM) in wireless sensor networks". In: *AEU-International Journal of Electronics and Communications* 102, pp. 41–53 (cited on p. 60).
- Uthayakumar, J, T Vengattaraman, and P Dhavachelvan (2018). "A survey on data compression techniques: From the perspective of data quality, coding schemes, data type and applications". In: *Journal of King Saud University-Computer and Information Sciences* (cited on pp. 29, 35).

- Van Otterlo, Martijn and Marco Wiering (2012). "Reinforcement learning and markov decision processes". In: *Reinforcement learning*. Springer, pp. 3–42 (cited on p. 63).
- Wala, Tanuj, Narottam Chand, and Ajay K Sharma (2020). "Energy efficient data collection in smart cities using iot". In: *Handbook of Wireless Sensor Networks: Issues and Challenges in Current Scenario's*. Springer, pp. 632–654 (cited on p. 60).
- Wang, Jingjing, Chunxiao Jiang, Zhu Han, Yong Ren, and Lajos Hanzo (2018). "Internet of vehicles: Sensing-aided transportation information collection and diffusion". In: *IEEE Transactions on Vehicular Technology* 67.5, pp. 3813–3825 (cited on pp. 29, 37).
- Wang, Quan, Deyu Lin, Pengfei Yang, and Zhiqiang Zhang (2019a). "An energy-efficient compressive sensing-based clustering routing protocol for WSNs". In: *IEEE Sensors Journal* 19.10, pp. 3950–3960 (cited on pp. 29, 36).
- Wang, Zijie, Rongke Liu, Qirui Liu, John S Thompson, and Michel Kadoch (2019b). "Energy Efficient Data Collection and Device Positioning in UAV-Assisted IoT". In: *IEEE Internet of Things Journal* (cited on pp. 29, 36).
- Wiering, Marco A and Martijn Van Otterlo (2012). "Reinforcement learning". In: *Adaptation, learning, and optimization* 12.3, p. 729 (cited on p. 63).
- Wu, Fan, Jean-Michel Redouté, and Mehmet Rasit Yuce (2018a). "We-safe: A self-powered wearable IoT sensor network for safety applications based on LoRa". In: *IEEE Access* 6, pp. 40846–40853 (cited on pp. 17, 27).
- Wu, Jingda, Hongwen He, Jiankun Peng, Yuecheng Li, and Zhanjiang Li (2018b). "Continuous reinforcement learning of energy management with deep Q network for a power split hybrid electric bus". In: *Applied energy* 222, pp. 799–811 (cited on pp. 44, 52).
- Wu, Mengge, Kuanming Yao, Dengfeng Li, Xingcan Huang, Yiming Liu, Lidai Wang, Enming Song, Junsheng Yu, and Xinge Yu (2021). "Self-Powered Skin Electronics for Energy Harvesting and Healthcare Monitoring". In: *Materials Today Energy*, p. 100786 (cited on p. 57).
- Wu, Taiyang, Md Shamsul Arefin, Jean-Michel Redouté, and Mehmet Rasit Yuce (2016). "A solar energy harvester with an improved MPPT circuit for wearable IoT applications". In: *Proceedings of the 11th EAI Int. Conf. on Body Area Networks*, pp. 166–170 (cited on pp. 17, 27).
- Xu, Chi, Wei Liang, and Haibin Yu (2017). "Green-energy-powered cognitive radio networks: Joint time and power allocation". In: *ACM Trans. on Embedded Computing Systems (TECS)* 17.1, pp. 1–18 (cited on pp. 44, 46).
- Yang, Gang, Qianqian Zhang, and Ying-Chang Liang (2018). "Cooperative ambient backscatter communications for green Internet-of-Things". In: *IEEE Internet of Things Journal* 5.2, pp. 1116–1130 (cited on pp. 17, 21).

- Yang, Wei, Hai Huang, Xiaojun Jing, Zhannan Li, and Chunsheng Zhu (2020). "Social Interaction Assisted Resource Sharing Scheme for Device-to-Device Communication Towards Green Internet of Things". In: *IEEE Access* 8, pp. 71652–71661 (cited on pp. 44, 48).
- Yazdinejad, Abbas, Reza M Parizi, Ali Dehghantanha, Qi Zhang, and Kim-Kwang Raymond Choo (2020). "An energy-efficient SDN controller architecture for IoT networks with blockchain-based security". In: *IEEE Trans. on Services Computing* (cited on pp. 44, 47).
- Yun, Maxwell, Ecenur Ustun, Phillip Nadeau, and Anantha Chandrakasan (2016). "Thermal energy harvesting for self-powered smart home sensors". In: *2016 IEEE MIT Undergraduate Research Technology Conf. (URTC)*. IEEE, pp. 1–4 (cited on pp. 17, 27).
- Zemrane, Hamza, Youssef Baddi, and Abderrahim Hasbi (2018). "SDN-based solutions to improve IoT: survey". In: *2018 IEEE 5th International Congress on Information Science and Technology (CiSt)*. IEEE, pp. 588–593 (cited on pp. 44, 47).
- Zhan, Cheng, Yong Zeng, and Rui Zhang (2017). "Energy-efficient data collection in UAV enabled wireless sensor network". In: *IEEE Wireless Communications Letters* 7.3, pp. 328–331 (cited on pp. 29, 36).
- Zhang, Di, Zhenyu Zhou, Shahid Mumtaz, Jonathan Rodriguez, and Takuro Sato (2016). "One integrated energy efficiency proposal for 5G IoT communications". In: *IEEE Internet of Things Journal* 3.6, pp. 1346–1354 (cited on pp. 44, 45).
- Zhang, Jidong, Yu Yu, Zhigang Wang, Shaopeng Ao, Jie Tang, Xiuyin Zhang, and Kai-Kit Wong (2020). "Trajectory planning of UAV in wireless powered IoT system based on deep reinforcement learning". In: *2020 IEEE/CIC International Conference on Communications in China (ICCC)*. IEEE, pp. 645–650 (cited on p. 62).
- Zhang, Qingqing, Gang Wang, Jie Chen, Georgios B Giannakis, and Qingwen Liu (2019a). "Mobile energy transfer in internet of things". In: *IEEE Internet of Things Journal* 6.5, pp. 9012–9019 (cited on pp. 17, 25).
- Zhang, Wei, Yao Qin, Wenjing Zhao, Minzheng Jia, Qiang Liu, Ruisi He, and Bo Ai (2019b). "A green paradigm for Internet of Things: Ambient backscatter communications". In: *China Communications* 16.7, pp. 109–119 (cited on pp. 17, 21).
- Zhao, Hengyang, Qi Hua, Hai-Bao Chen, Yaoyao Ye, Hai Wang, Sheldon X-D Tan, and Esteban Tlelo-Cuautle (2018). "Thermal-sensor-based occupancy detection for smart buildings using machine-learning methods". In: *ACM Trans. on Design Automation of Electronic Systems (TODAES)* 23.4, pp. 1–21 (cited on pp. 44, 51).
- Zhou, Yuchen, Fei Richard Yu, Jian Chen, and Yonghong Kuo (2018). "Robust energy-efficient resource allocation for IoT-powered cyber-physical-social smart systems with virtualization". In: *IEEE Internet of Things Journal* 6.2, pp. 2413–2426 (cited on pp. 44, 48).

Zou, Guobing, Yixin Chen, Y Yang, Ruoyun Huang, and You Xu (2010). “AI planning and combinatorial optimization for web service composition in cloud computing”. In: *Proc Int. Conf. on cloud computing and virtualization*, pp. 1–8 ([cited on pp. 39, 40](#)).