



HAL
open science

Efficacy and persistence of promising plant-based mosquito repellents towards green vector control strategies

Jirod Nararak

► **To cite this version:**

Jirod Nararak. Efficacy and persistence of promising plant-based mosquito repellents towards green vector control strategies. Parasitology. Université Montpellier; Mahāwitthayālai Kasētsāt (Thaïlande), 2020. English. NNT : 2020MONTT074 . tel-04692804

HAL Id: tel-04692804

<https://theses.hal.science/tel-04692804>

Submitted on 10 Sep 2024

HAL is a multi-disciplinary open access archive for the deposit and dissemination of scientific research documents, whether they are published or not. The documents may come from teaching and research institutions in France or abroad, or from public or private research centers.

L'archive ouverte pluridisciplinaire **HAL**, est destinée au dépôt et à la diffusion de documents scientifiques de niveau recherche, publiés ou non, émanant des établissements d'enseignement et de recherche français ou étrangers, des laboratoires publics ou privés.

THÈSE POUR OBTENIR LE GRADE DE DOCTEUR DE L'UNIVERSITÉ DE MONTPELLIER

En Biologie Santé

École doctorale Sciences Chimiques et Biologiques pour la Santé (CBS2)

Unité de recherche HSM-HydroSciences Montpellier (UMR 5569 IRD-CNRS-UM)

En partenariat international avec le Department of Entomology, Faculty of Agriculture, Kasetsart University, Thaïlande

**EFFICACITE ET PERSISTANCE DE REPULSIFS A BASE DE PLANTES POUR
DES STRATEGIES VERTES DE LUTTE ANTIVECTORIELLE**

**EFFICACY AND PERSISTENCE OF PROMISING PLANT-BASED
MOSQUITO REPELLENTS TOWARDS GREEN VECTOR CONTROL
STRATEGIES**

Présentée par M. Jirod NARARAK

Le 15/12/2020

Sous la direction de Mme Sylvie Manguin
et M. Theeraphap Chareonviriyaphap

Devant le jury composé de

Mme Anne Bousquet-Melou, Maître de Conférences à l'Université Aix-Marseille

M. Padet Siriyasatien, Professeur à l'Université Chulalongkorn

Mme Unchalee Sanguanpong, Associate Professeur à l'Université Maejo-Kasetsart

M. Fabrice Chandre, Directeur de Recherche à l'IRD

Mme Evelyne Ollivier, Professeur à l'Université Aix-Marseille

Mme Sylvie Manguin, Directrice de Recherche à l'IRD

M. Theeraphap Chareonviriyaphap, Professeur à l'Université Kasetsart

Rapporteur

Rapporteur

Examineur

Examineur

Examineur

Directrice de Thèse

Directeur de Thèse



UNIVERSITÉ
DE MONTPELLIER

Contents	
Acknowledgements	5
List of abbreviations	6
List of tables	9
List of figures	10
Résumé	12
Summary	21
General Introduction	29
Conceptual Framework	34
Chapter 1. Literature review	35
1. Mosquitoes	35
1.1 The medically important mosquito species in Thailand	36
1.2 Mosquito-borne diseases	39
1.3 Type of Pathogen Responsible for the Disease	40
1.3.1 Virus	40
1.3.1.1 Dengue	40
1.3.1.2 Chikungunya	41
1.3.1.3 Japanese encephalitis (JE)	42
1.3.1.4 Zika fever	44
1.3.2 Protozao	45
1.3.2.1 Malaria	45
1.3.3 Helminth	47
1.3.3.1 Lymphatic filariasis (LF)	47
2. Vector control strategies	48
2.1 Malaria vector control	50
2.2 Dengue vector control	51
2.3 Synthetic insecticide resistance in mosquito control	52
3. Stimuli that attract mosquitoes	54
3.1 Chemoreceptors in mosquitoes	56
3.2 Olfactory receptor neurons	57
3.3 Gustatory receptor neurons (GRNs)	58

4. Insect repellents	59
4.1 Mode of action of mosquito repellents	59
4.2 Mosquito insecticide interaction concept	60
4.3 Evolution of topical repellents	61
4.4 Recommendation for insect repellents	62
4.5 How repellents contribute to disease prevention and vectorial capacity	66
5. Natural repellent against mosquitoes	68
5.1 Essential oil for mosquito repellency	76
5.1.1 Citronella	76
5.1.2 Catnip	77
5.1.3 Lemon eucalyptus oil	77
5.1.4 Vetiver	77
5.2 Insect repellent of natural based origin	78
5.2.1 Para-menthane-3,8-diol (PMD)	79
5.2.2 IR3535	79
5.2.3 Picaridin (KBR 30231)	80
5.2.4 β -Caryophyllene oxide	81
6. Testing method for insect repellents	83
6.1 Excito-repellency assay	83
6.2 High-throughput repellency apparatus	84
6.3 A noncontact repellent assay system (NCRAS)	85
7. Conclusion	87
Chapter 2 Excito-repellency screening and biological safety of β-caryophyllene oxide (plant-based repellents) on <i>Aedes aegypti</i>, <i>Aedes albopictus</i>, <i>Anopheles minimus</i>, <i>Anopheles dirus</i> (Diptera: Culicidae)	
1. Introduction	88
2. Articles displayed in Chapter 2	89
3. Conclusion	108

Chapter 3 Behavioral avoidance and biological safety of vetiver oil and its constituents against *Aedes aegypti* (L.), *Aedes albopictus* (Skuse) and *Culex quinquefasciatus* (Say)

1. Abstract	110
2. Introduction	111
3. Materials and Methods	113
4. Result	120
5. Discussion	132

Chapter 4. Synergistic repellent and irritant effect of binary mixture of β -caryophyllene oxide and vetiver oil against mosquito vectors

1. Abstract	137
2. Introduction	138
3. Material and Methods	140
4. Result	143
5. Discussion	155

Chapter 5. Formulations and tests of natural mosquito repellent compounds using a non-contact repellency assay system (NCRAS).

1. Abstract	158
2. Introduction	159
3. Material and Methods	162
4. Result	168
5. Discussion	169

Chapter 6. Semi-field study of β -caryophyllene oxide and vetiver oil based topical repellent against *Aedes aegypti* (L.)

1. Abstract	175
2. Introduction	176
3. Material and Methods	178
4. Result	182
5. Discussion	187

Chapter 7. Conclusion and perspective

1. Conclusion 190

2. Perspective 198

Literature cited 200

Acknowledgements

I would like to express my special gratitude and appreciation to my thesis advisors, Prof. Dr. Sylvie Manguin and Prof. Dr. Theeraphap Chareonviriyaphap for their generous encouragement, valuable advice, and financial support.

My deepest appreciation is extended to Prof. Dr Evelyne Ollivier and Dr. Valérie Mahiou, for their constant encouragement and critical comments on thesis improvement. I would like to thank the Assoc. Prof. Unchalee Sanguanpong, for her kind advices and guidance on formulation technique. It was my honor to spend times learning and working in your laboratory. I extend my sincere thanks to Dr. Michael J. Bangs for his valuable guidance, patiently correcting the manuscripts and thesis.

I wish to thank Dr. Sunaiyana Sathantriphop from MOPH for her kind advice and guidance on my thesis. Special thank are also due to all the staff of Mosquito-laboratory and the graduate students at the Department of Entomology, Kasetsart University, Bangkok, Thailand for the warmest welcome, kind help, friendships, experiences, and most importantly for all the knowledge that I acquired.

I gratefully acknowledge the financial support provided for this study by the International Research Network (IRN), Thailand Research Fund Organization (Grant No. IRN58W0003-IRN5803PHDW04). I also thank the PHC SIAM BIOVECTHAI project (French Ministry of Foreign Affairs) and the Center of Agricultural Biotechnology (CAB).

Finally, I am deeply grateful to my family for their love, kindness, support, encouraging me with their best wishes and being once again the source of motivation throughout this study.

Jirod NARARAK

List of abbreviations

AM	=	Ante Meridiem (before midday)
BCO	=	β -Caryophyllene oxide
BOE	=	Bureau of Epidemiology
BVBD	=	Bureau of Vector Borne Disease
°C	=	Degree of Celsius
CC	=	Contact Control
CHIKV	=	Chikungunya virus
CIA	=	Contact irritancy assay
cm	=	Centimeter
cm ²	=	Square Centimeter
CT	=	Contact Treatment
DDC	=	Department of Disease Control
DDT	=	Dichlorodiphenyltrichloroethan
DEET	=	Diethyltoluamide
DF	=	Dengue fever
DHF	=	Dengue haemorrhagic fever
DMSc	=	Department of Medical Science
DVBD	=	Department of Vector Borne Disease
EFSA	=	European Food Safety Authority
EO	=	Essential oil
EPA	=	United States Environmental Protection Agency
ER	=	Excito-repellency system
Esp	=	Escaped mosquitoes
ET	=	Escape Time
<i>et al.</i>	=	<i>et. alii</i> (and others)
FDA	=	Food and Drug Administration
FEAO	=	Foreign Workers Administration
g	=	Gram
GC/MS	=	Gas chromatography / mass spectroscopy
GMS	=	Greater Mekong Subregion

GR	=	Gustatory receptor
GRN	=	Gustatory receptor neurons
HITSS	=	High Throughput Screening System
HLC	=	Human landing collection
hr	=	Hour
HSC	=	Hazardous Substance Committee
HSCA	=	Hazardous Substance Control Act
IR	=	Ionotropic receptors
IR3535	=	Ethyl butylacetylaminopropionate
IRS	=	Indoor residual spraying
ITNs	=	Insecticides treated nets
JE	=	Japanese encephalitis
KD	=	Knock Down
LD ₅₀	=	Median lethal dose
LF	=	Lymphatic filariasis
LI	=	Landing inhibition
LLINs	=	Long lasting insecticide net
m ²	=	Square Meter
min	=	Minute (S)
ml	=	Milliliter
MoAC	=	Ministry of Agriculture and Cooperatives
MOI	=	Ministry of Industry
MoPH	=	Ministry of Public Health
NC	=	Noncontact Control
NCRAS	=	A noncontact repellency assay system
NE	=	Not Escaped mosquitoes
NIH	=	National Institutes of Health
NMR	=	Nuclear Magnetic Resonant
NRU	=	Natural rad uptake
NT	=	Noncontact Treatment
OR	=	Olfactory receptor

ORN	=	Olfactory receptor neuron
O/W	=	Oil in water
<i>P</i>	=	Probability Value
PM	=	Post Meridiem (after midday)
PMD	=	Para-menthane-3,8-diol
ppm	=	Part per Million
RH	=	Relative Humidity
SE	=	Standard error
SFS	=	Semi-field study
SFSH	=	Semi-field screen house
SRA	=	Spatial repellency assay
syn.	=	Synonyms
TLC	=	Thin Layer Chromatography
TOX	=	Toxicity assay
ULV	=	Ultra low volume
U.S.	=	United States of America
USD	=	The United States dollar
USDA	=	United States Department of Agriculture
UV	=	Ultraviolet
VC	=	Vectorial capacity
VO	=	Vetiver oil
v/v	=	Volume/volume
WHO	=	World Health Organization
w/v	=	Weigh/volume
WWII	=	World War II
ZIKV	=	Zika virus

List of Tables

Table 1 Summary of reported case counts of notifiable mosquito-borne diseases in Thailand...	39
Table 2 Insect repellents registered by the Environmental Protection Agency (EPA)	64
Table 3 The Environmental Protection Agency, U.S. and The Food and Drug Administration, Thailand Guide for the safe and effective use of repellents.....	66
Table 4 An overview of repellent plant efficacy against mosquitoes in Thailand	70
Table 5 Physical and chemical properties.	81
Table 6 Escape response of <i>Aedes aegypti</i> in the contact irritancy assay to vetiver oil and vetiver components.	121
Table 7 Escape response of <i>Aedes albopictus</i> in the contact irritancy assay to vetiver oil and vetiver components	122
Table 8 Escape response of <i>Culex quinquefasciatus</i> in the contact irritancy assay to vetiver oil and vetiver components	123
Table 9 In vitro cytotoxic and phototoxic activity of vetiver components oxide against mouse normal fibroblast (BALB/c 3T3) cell lines.	129
Table 10 In vitro genotoxicity activity of vetiver components oxide on CHO-K1 cells.	131
Table 11 Treatment and combinations of β -caryophyllene oxide and Vetiver oil.....	141
Table 12 Percent escape responses of mosquitoes exposed to one compound or a combination of β -caryophyllene oxide (BCO) and vetiver oil (VO)	144
Table 13 Percent knockdown per mosquito species exposed to one compound or a combination of β -caryophyllene oxide (BCO) and vetiver oil (VO).....	149
Table 14 Comparisons of mosquito escape responses between contact and non-contact chambers for mosquito species exposed to BCO and VO	151
Table 15 Log-rank comparisons of escape responses between combinations of BCO and VO to four mosquito species	152
Table 16 Comparisons of mosquito escape responses between contact and non-contact chambers for <i>Ae. aegypti</i> , <i>Ae. albopictus</i> , <i>An. minimus</i> and <i>Cx. quinquefasciatus</i> exposed to BCO and VO	153
Table 17 Estimation of the escape time in minutes for 25% (ET ₂₅), 50% (ET ₅₀) and 75% (ET ₇₅) of mosquito exposed to serial concentrations of BCO and VO in contact and non-contact chambers.	154
Table 18 Formulations of a skin lotion based on plant-based repellent.....	162
Table 19 Mean \pm SE landing <i>Ae. aegypti</i> mosquitoes in minute over 30-min intervals until 8 hrs after exposure to screened forearms treated with a repellent product.....	172
Table 20 Mean \pm SE landing <i>Cx. quinquefasciatus</i> mosquitoes in minute over 30-min intervals until 8 hrs after exposure to screened forearms treated with a repellent product	173
Table 21 Landing inhibition (LI) and spatial activity index (SAI) of <i>Aedes aegypti</i> against BCO-VO repellent released in semi-field screened house.	183
Table 22 Statistic analysis of BCO-VO repellent product against <i>Aedes aegypti</i> in semi-field screen house.	184

List of Figures

Figure 1 World map of areas at risk for dengue transmission	40
Figure 2 Geographical distribution of the Japanese encephalitis risk.....	43
Figure 3 Map of malaria case incidence rate (cases per 1,000 people at risk) by country in 2018	46
Figure 4 The global distribution and transmission limits of lymphatic filariasis	47
Figure 5 Stimuli attracting mosquitoes to humans.....	55
Figure 6 Combination of cues used by mosquitoes to detect humans	55
Figure 7 (A) Insect chemosensory organs: antennae, maxillary palps, labellum, tarsi and wing margin covered by sensilla. (B) An olfactory sensillum housing support cells and an olfactory receptor neuron (ORN in blue); odorants bind to receptors in the ORN dendrite across sensillum lymph after penetration through cuticular pores.	57
Figure 8 (A) Locations of gustatory sensilla in female mosquitoes, on tarsi (1), labella (2), labrum (3), and cibarium (4), used for locating and landing on a potential host. (B) Gustatory receptor neurons (GRNs) and a single mechanosensory neuron (mech.) in a single sensillum ...	58
Figure 9 Structure of six insect repellents.....	62
Figure 10 (A) Spatial insect repellent exhibits its effect at distance. (B) Sensory receptors (odorant receptor, gustatory receptor, and ionotropic receptor, distributed on various arthropod appendages).....	67
Figure 11 Structure of some plant-based insect repellent.....	80
Figure 12 Molecular scheme of β -caryophyllene oxide.....	82
Figure 13 Excito-repellency test chamber	83
Figure 14 High throughput screening assay system (HITSS), 1=treatment (metal cylinder), 2=clear (Plexiglas) cylinder, 3=end cap, 4=linking section, 5=treatment drum, 6=treatment net; A=contact irritancy assay, B=spatial repellency assay, C=toxicity.....	85
Figure 15 The noncontact repellent assay system (NCRAS) component with blow-up (top) and assembled set-up (bottom). (A) Plexiglas barrier that separates assay into 2 equal-sized matched chambers, (B) exposure chamber (subdivided into 2 chambers), (C) section fitted with an outer screen mesh barrier.	86
Figure 16 High throughput screening assay system (HITSS).....	115
Figure 17 Spatial repellent responses of <i>Aedes aegypti</i> , <i>Aedes albopictus</i> and <i>Culex quinquefasciatus</i> exposed to six components of vetiver oil.	126
Figure 18 Percentage 1-hour Knock-down rates (TOX) with standard error (SE) in <i>Aedes aegypti</i> , <i>Aedes albopictus</i> , <i>Culex quinquefasciatus</i> laboratory strains exposed to three concentrations of vetiver oil, terpinen-4-ol, α -terpineol, valencene, vetiverol and vetivone	127
Figure 19 Percentage 24-hour mortality rates (TOX) with standard error (SE) in <i>Aedes aegypti</i> , <i>Aedes albopictus</i> and <i>Culex quinquefasciatus</i> laboratory strains exposed to three concentrations of vetiver oil, terpinen-4-ol, -terpineol, valencene, vetiverol and vetivone.....	128
Figure 20 A) Excito-repellency (ER) test system in which the four chambers were ranged in sequence for each trial, one pair as non-contact and matched control, the other set as contact and control chamber. B) Treated and control papers were placed behind each screened portion of the inner chamber for non-contact repellency trials. C) Treated and control papers were attached to the inside portion of the screened inner chamber for contact irritancy trials.....	142
Figure 21 Survival curves for <i>Ae. aegypti</i> in treated non-contact and contact excito-repellency assays. Escape responses were recorded at 1-min intervals for 30-min exposure to various	

combinations percent concentrations of BCO and VO. Paired control escape responses not shown.	145
Figure 22 Survival curves for <i>Ae. albopictus</i> in treated non-contact and contact excito-repellency assays. Escape responses were recorded at 1-min intervals for 30-min exposure to various combinations percent concentrations of BCO and VO. Paired control escape responses not shown.	146
Figure 23 Survival curves for <i>An. minimus</i> in treated non-contact and contact excito-repellency assays. Escape responses were recorded at 1-min intervals for 30-min exposure to various combinations percent of BCO and VO. Paired control escape responses not shown.	147
Figure 24 Survival curves for <i>Cx. quinquefasciatus</i> in treated non-contact and contact excito-repellency assays. Escape responses were recorded at 1-min intervals for 30-min exposure to various combinations percent of BCO and VO. Paired control escape responses not shown.	148
Figure 25 A non-contact repellency assay system (NCRAS)	165
Figure 26 A non-contact repellency assay system (NCRAS) set-up (top view) with volunteer subject sitting in the testing position.....	166
Figure 27 Mean± SE landing mosquito in minute over 30-min intervals until 8 hrs. after exposure to screened forearms untreated and treated with repellent to <i>Ae. aegypti</i> and <i>Cx. quinquefasciatus</i>	174
Figure 28 A semi-field screen house (SFSH) measuring 4x3.5x40 m.....	179
Figure 29 Scheme of a semi-field screen house (SFSH) for spatial repellent evaluation in two separate compartments.....	180
Figure 30 Mean± SE of <i>Aedes aegypti</i> landing in semi-field study between treatment and control trials from 0600-1800 hrs.....	185
Figure 31 The spatial activity index (SAI) for semi-field trial during 15 consecutive replicates (nights). The SAI ranges from -1 to +1, with zero, negative, and positive values representing no preference to either control or treated collectors, preference to active treated collectors, and preference to untreated collectors, respectively.....	186
Figure 32 Outcome of thesis	187

Résumé

Un grand nombre de parasites, bactéries et virus sont transmis à l'homme par des invertébrés, notamment des moustiques, phlébotomes, punaises, simuliés, mouche tsé-tsé, tiques, acariens, escargots, puces et poux. Les maladies à transmission vectorielle représentent un problème majeur de santé publique à l'échelle mondiale, en particulier dans les zones tropicales et subtropicales. Les moustiques sont les animaux les plus dangereux de la planète du fait du nombre et de la variété des agents pathogènes qu'ils sont capables de transmettre. Leur capacité à transporter et diffuser des agents pathogènes à l'homme est responsable de millions de décès chaque année. Les maladies transmises par les moustiques comprennent le paludisme, la filariose lymphatique, la dengue, l'encéphalite japonaise, le chikungunya, le Zika, pour n'en citer que quelques-unes. Le lourd fardeau que représentent le paludisme, la dengue et bien d'autres arboviroses à l'échelle mondiale, avec les limites des moyens de contrôle actuellement disponibles, en particulier dans de nombreux pays à revenu faible ou intermédiaire, exige une plus grande attention. Des millions de personnes de pays sous-développés et en développement vivent dans des zones présentant un risque particulièrement élevé de contracter ces maladies transmises par des arthropodes.

Les outils pour réduire la transmission des maladies à vecteurs reposent principalement sur le vaccin, la prophylaxie et la lutte antivectorielle. Cependant, rares sont les vaccins efficaces contre les maladies à transmission vectorielle. En outre, peu de traitement contre les arboviroses sont disponibles et la résistance des parasites aux médicaments est de plus en plus répandue, en particulier pour le paludisme. Par conséquent, la lutte antivectorielle constitue la principale approche pour prévenir et contrôler les épidémies de la plupart des maladies à transmission vectorielle. Diverses méthodes de lutte ont été proposées pour lutter contre les moustiques vecteurs, telles que la lutte chimique (insecticide), la lutte biologique (poissons) et la lutte mécanique (éliminer les habitats larvaires). Cependant, le contrôle des moustiques, grâce à l'utilisation d'insecticides chimiques, reste la technique la plus utilisée et la plus efficace dans la lutte contre les maladies à transmission vectorielle. Toutefois, plusieurs espèces de moustiques ont développé une tolérance ou une résistance à de nombreux insecticides chimiques. En outre, il y a un réel manque d'approches de lutte antivectorielle contre les moustiques qui piquent à l'extérieur des maisons, donc les répulsifs apportent un réel avantage dans le sens où ils offrent la possibilité de protéger les gens, lorsqu'ils sont en milieu extérieur, contre les moustiques diurnes (*Aedes*) et

les espèces qui piquent tôt dans la soirée pour les moustiques nocturnes (*Anopheles*, *Culex*). Ainsi l'un des outils alternatifs et prouvés efficaces pour lutter contre les insectes hématophages est l'utilisation de répulsifs.

Les répulsifs contre les moustiques jouent un rôle important dans le contrôle de la transmission des maladies en réduisant le contact humain-vecteur. En général, les répulsifs sont relativement peu coûteux et abordables par les utilisateurs locaux et les voyageurs des pays développés et en développement. L'un des principes actifs synthétiques les plus couramment utilisés dans les produits anti-moustiques à application topique (sur la peau) trouvés dans le commerce est le DEET (*N,N*-diéthyl-meta-toluamide). Le DEET demeure l'insectifuge le plus courant, c'est un composé efficace contre la plupart des insectes piqueurs et autres arthropodes (moustiques, mouches piqueuses, tiques, puces et acariens). Bien que DEET soit considéré comme présentant une sécurité remarquable après 40 ans d'utilisation dans le monde entier, malgré les fortes concentrations utilisées dans les produits commercialisés (30-50%), des réactions toxiques peuvent se produire chez les personnes très sensibles et il présente l'inconvénient de fondre tous les supports en plastique.

Les produits phytochimiques, provenant du processus d'extraction de diverses espèces végétales, peuvent produire de nombreux effets contre les insectes, y compris insecticide et répulsif. Les insectifuges à base de plantes sont une alternative aux composés synthétiques parce que la matière première peut être facilement accessible, acceptable localement et abordable pour les communautés à faible revenu, tout en étant très efficace contre les piqûres de moustiques.

L'objectif principal de cette étude était de développer et de tester l'efficacité de nouveaux répulsifs à base de plantes provoquant une forte action excito-répulsive chez plusieurs espèces de moustiques tout en montrant une totale innocuité chez l'homme. Cette thèse contient sept parties, une introduction générale sur l'état des connaissances concernant le sujet, présenté dans le premier chapitre, puis les diverses études décrites dans les Chapitres 2 à 6, et enfin une conclusion générale et des perspectives d'étude dans le Chapitre 7.

Chapitre 1

Le Chapitre 1 fournit des informations générales sur les maladies transmises par les moustiques en Thaïlande, surtout celles dont le fardeau a été le plus lourd sur la santé humaine au cours des dernières années. Le paludisme et la dengue sont les deux maladies transmissibles par

les moustiques les plus courantes et qui causent une morbidité et une mortalité élevées. En Thaïlande, la première épidémie de dengue a été reconnue en 1958. Depuis lors, la maladie est devenue largement répandue et elle est considérée comme l'un des principaux problèmes de santé publique en Thaïlande. La plus grande épidémie de dengue hémorragique (DHF) en Thaïlande s'est produite en 1987 avec 174 825 cas et 1 007 décès signalés. Les dernières données du Département de contrôle des maladies ont recensé plus de 87 037 cas de dengue de janvier à décembre 2019. Le paludisme, une autre maladie transmise par les moustiques, comprenant cinq espèces de parasites du genre *Plasmodium*, peut être grave, voire fatale. En Thaïlande, le nombre de cas de paludisme a été considérablement réduit depuis 1996. La situation actuelle fait état de cas de paludisme le long des frontières internationales thaïlandaises avec le Myanmar à l'ouest et au nord (35,4 %), le Laos au nord et à l'est (2,2 %), le Cambodge à l'est (7,8 %) et la Malaisie au sud (49,8 %). En 2019, un total de 3 204 807 travailleurs migrants vivait en Thaïlande. Ces mouvements de populations compliquent fortement le contrôle de ces maladies à transmission vectorielle.

Ce chapitre présente également les données sur les répulsifs à base de plantes en Asie du Sud-Est, comme les nombreuses huiles essentielles extraites de plantes sauvages et domestiques qui ont été étudiées pour leur activité insectifuge. Dans notre étude, nous avons identifié 29 espèces végétales au sein de 13 familles de plantes qui ont montré certaines propriétés anti-moustiques. Ces dernières années, la chimie botanique a joué un rôle de plus en plus important dans la recherche de composés biologiquement actifs. Les produits chimiques à effet répulsif, trouvés dans différentes parties des plantes, ont été identifiés dans certains extraits de plantes. Sur les moustiques, ces constituants agissent non seulement comme répulsifs, mais aussi comme dissuasifs nutritionnels, substances toxiques, régulateurs de croissance, etc. L'Agence pour la Protection Environnementale (EPA) caractérise les répulsifs biopesticides, tels que para-menthane-3,8-diol (PMD), 3-[N-butyl-N-acetyl]-aminopropionique acide, ethyl ester (IR3535), 2-undecanone, comme dérivant de, ou étant les versions synthétiques de produits naturels. Dans notre étude, les deux composés végétaux, l'oxyde de β -caryophyllène (dérivé synthétique) et l'huile essentielle de vétiver (produit naturel), ont attiré notre attention après une importante recherche scientifique.

En conclusion, d'énormes efforts ont été faits pour développer des répulsifs efficaces contre les moustiques, ce qui a permis d'augmenter le nombre de répulsifs synthétiques qui sont largement utilisés. Cependant, l'utilisation de répulsifs synthétiques contre les moustiques a soulevé certaines questions sur les risques pour la sécurité et la santé des humains et l'environnement. Par conséquent, les répulsifs à base de plantes devraient être plus largement étudiés pour servir d'alternatives plus sûres que les répulsifs synthétiques. À l'heure actuelle, le développement de répulsifs naturels à base de plantes, ayant une efficacité plus importante et une protection plus longue, est nécessaire. Les composés à base de plantes dans les produits répulsifs deviennent de plus en plus populaires. L'objectif de ce projet était d'étudier des composés préalablement sélectionnés et de tester leur efficacité sur plusieurs espèces de moustiques vecteurs afin de développer et d'améliorer l'efficacité des produits répulsifs. Une meilleure compréhension du fonctionnement des répulsifs doit également être étudiée, car les composés très actifs peuvent mener à des méthodes entièrement nouvelles sur les insectifuges. L'urgente nécessité d'éviter les infections dues aux agents pathogènes transmis par les moustiques a eu un impact à l'échelle mondiale sur les études faites sur les répulsifs avec une augmentation de l'évaluation d'un grand nombre de molécules et de composés actifs prometteurs. Le développement de nouvelles formulations de principes actifs naturels pourrait amener sur le marché de nouveaux produits non seulement plus efficaces, mais aussi mieux acceptés par les utilisateurs. Ainsi, le développement de ces répulsifs pourrait conduire à l'avenir à de nouvelles et plus efficaces façons d'utilisation permettant une meilleure protection contre les piqûres de moustiques.

Chapitre 2

Ce chapitre vise à étudier les réponses comportementales d'*Aedes aegypti*, *Aedes albopictus*, *Anopheles minimus* et *Anopheles dirus* à diverses concentrations d'oxyde de β -caryophyllène (BCO) (0,1, 0,25, 0,5 et 1%) grâce à un système de chambre de test excito-répulsif (ER). Ce système ER a été précédemment mis au point et décrit par Chareonviriyaphap (2002). Il permet l'étude du comportement d'évitement des insecticides par les moustiques femelles sous forme d'irritation par contact et de répulsion sans contact. En outre, les effets phototoxiques et génotoxiques de BCO ont été étudiés respectivement sur les fibroblastes de souris Balb/c 3T3 (3T3-L1) et sur la ligne de cellules d'ovaires de hamster chinois (CHO-K1).

Selon les résultats obtenus dans ce chapitre, BCO montre un effet répulsif et irritant plus fort que celui du DEET à la même concentration. *Anopheles minimus* s'est avéré encore plus sensible au BCO qu'*Aedes aegypti*, *Aedes albopictus* et *Anopheles dirus*. Pour les tests de toxicité, BCO n'a montré aucune activité phototoxique, ni génotoxique. BCO peut ainsi être considéré comme un répulsif sûr et efficace contre les moustiques.

A côté du BCO, un autre composé, l'huile essentielle de vétiver (VO), déjà signalée comme répulsif de plusieurs insectes, tels que les termites, les moustiques, les charançons, les coléoptères, a aussi été testée pour évaluer ses capacités répulsives.

Chapitre 3

De nombreuses huiles essentielles à effet répulsif sont largement utilisés pour la protection personnelle contre les moustiques. L'huile essentielle de vétiver (VO) et ses constituants ont démontré diverses activités anti-moustiques. Dans cette étude, trois actions chimiques de l'huile de vétiver et cinq de ses constituants (terpinen-4-ol, α -terpineol, valence, vetiverol et vetivone) ont été caractérisées sur trois vecteurs, *Aedes aegypti*, *Aedes albopictus* et *Culex quinquefasciatus* par le système de test de dépistage à haut débit (HITSS). Ce système HITSS a été développé et utilisé pour décrire quantitativement les réponses des moustiques à différentes actions provoquées par les produits chimiques que sont l'irritabilité de contact, l'effet répulsif spatial, et la toxicité pour les moustiques. De plus, les effets phototoxiques et génotoxiques de VO et de ses constituants ont été étudiés. Des réponses significatives d'évitement d'*Ae. aegypti* et *Ae. albopictus* à tous les composés testés, à des concentrations entre 2,5 et 5%, ont été observées. L'effet répulsif spatial a également été noté sur différentes populations de moustiques de laboratoire à diverses concentrations. La réponse toxique la plus importante sur les moustiques testés a été trouvée à la concentration la plus élevée, à l'exception de la vetivone, qui n'a eu aucun effet toxique sur *Ae. aegypti*, ni *Ae. albopictus*. Les résultats des tests de toxicité ont indiqué que VO et ses constituants ne présentent aucun effet phototoxique, ni génotoxique.

En termes d'efficacité et d'innocuité, les Chapitres 2 et 3 ont identifié BCO et VO comme pouvant être utilisés en tant que répulsifs naturels sûrs. Bien que BCO et VO ont déjà montré une activité répulsive significative contre les moustiques, paradoxalement aucun travail n'a été fait pour identifier le degré d'action insectifuge provoqué par le mélange de ces deux composés. L'étude suivante a été de combiner BCO et VO à différentes concentrations pour évaluer l'efficacité de l'effet répulsif de ce mélange sur les moustiques de laboratoire.

Chapitre 4

Le déploiement de combinaisons synergiques vise à réduire à la fois la dose de substances utilisée et le risque de développer une résistance physiologique dans toute population d'insectes. Pour évaluer ce concept, deux composés avec des activités anti-moustiques confirmées ont été mélangés pour potentiellement augmenter l'efficacité répulsive, grâce à trois formes binaires combinant BCO (1%) et VO (2,5%) qui ont été préparés afin de tester l'activité excito-répulsive sur *Ae. aegypti*, *Ae. albopictus*, *An. minimus* et *Cx. quinquefasciatus* à l'aide d'un système de test ER. L'activité répulsive de chaque espèce de moustiques a été étudiée à partir de BCO 1%, VO 2.5%, et leurs mélanges binaires [BCO+VO (1:1), BCO+VO (2:1), BCO+VO (1:2)]. En général, le mélange de composés produit une réponse beaucoup plus forte sur les moustiques que celle du composé utilisé seul, indépendamment des conditions d'essai et des espèces. La combinaison de BCO:VO a montré son efficacité sur les quatre espèces de moustiques vecteurs, en particulier *Cx. quinquefasciatus* et *An. minimus*, mais certains mélanges ont produit un effet répulsif plus faible sur *Ae. aegypti* et *Ae. albopictus*. Cependant, le mélange BCO:VO a permis de fournir un meilleur effet répulsif contre les 4 espèces de moustiques que le même répulsif utilisé seul. En termes de toxicité, BCO+VO (2:1) a montré une activité knockdown chez *Ae. albopictus*, *An. minimus* et *Cx. quinquefasciatus*.

En résumé, la combinaison binaire de BCO et VO produit des activités additives d'irritabilité de contact, de répulsif sans contact et de knock-down à de faibles concentrations, suggérant que les combinaisons de ces deux composés répulsifs peuvent servir à développer un répulsif contre les moustiques plus efficaces qu'avec un seul composé. L'activité répulsive synergique apportée par des huiles essentielles, comme celle utilisée dans la présente étude, pourrait être utile pour des alternatives aux répulsifs synthétiques pour la protection personnelle contre les moustiques. Une telle pratique réduirait le poids chimique sur l'environnement et favoriserait l'utilisation durable des bio-ressources disponibles localement par les communautés rurales. D'un point de vue pratique, les deux composés doivent être formulés comme des produits à base de plantes et des essais préliminaires doivent être faits en laboratoire. Le chapitre suivant vise à formuler des combinaisons de BCO:VO et à tester leurs efficacités et la durée du temps de protection dans des conditions de laboratoire.

Chapitre 5

L'utilisation croissante d'insectifuges naturels comme produits sûrs pour la prévention des maladies transmissibles par les moustiques a suscité une acceptation grandissante par les populations locales touchées par ces maladies. BCO et VO ont démontré qu'ils étaient efficaces en tant que répulsifs de moustiques vecteurs, tout en étant sûrs. L'objectif de ce chapitre était de développer un nouveau répulsif de type émulsion huile dans eau (O/W) contenant BCO et VO. Les gouttelettes d'huile de VO ont été dispersées dans la phase aqueuse et des émulsifiants appropriés ont été utilisés pour empêcher toute séparation de phase macroscopique. Un système d'analyse de répulsion sans contact (NCRAS) a été utilisé comme méthode alternative possible pour tester le temps de protection des produits à base de plantes contre *Aedes aegypti* et *Culex quinquefasciatus*. Ce nouveau système utilise une barrière d'écran physique qui ne permet pas aux moustiques de se poser directement sur les surfaces traitées (avant-bras) d'un volontaire humain. Le résultat a montré que le produit à base de plantes est efficace sur les deux espèces de moustiques pendant un long temps de protection évalué à 240 min (4 heures). Avec une amélioration supplémentaire des caractéristiques physiques et chimiques de la formulation, le temps de protection pourrait même être augmenté, définissant ce mélange des 2 composés comme ayant des potentiels substantiels en tant que nouveau répulsif pour la protection personnelle contre les piqûres de moustiques. En raison du risque humain et des questions éthiques, le NCRAS a été développé comme un test alternatif au système de tests sur bras-en-cage, un outil courant pour étudier l'efficacité des formulations insectifuges. Cependant, le NCRAS, présenté dans cette étude, a besoin d'une normalisation complète de son protocole physique et technique conçu pour être comparable au système commun de bras-en-cage.

De nombreux répulsifs commerciaux contiennent un certain nombre de composés à base de plantes, y compris d'extrait de plantes naturels ou synthétiques, d'huile essentielle et de parfum. La présente étude a indiqué que la nouvelle lotion répulsive (émulsion O/W) contenant du BCO et VO est très prometteuse en tant que nouveau répulsif à base de plantes. En outre, les vecteurs du paludisme les plus efficaces en Asie du Sud-Est sont des moustiques qui piquent tôt dans la soirée et en dehors des habitations, ils échappent donc aux méthodes de lutte antivectorielle traditionnelles basées sur l'IRN et l'ITN. Par conséquent, de nouvelles stratégies pour contrôler les moustiques piqueurs précocement et en milieu extérieur doivent être trouvées afin de réduire

la transmission du paludisme. Cela pourrait ouvrir de nouvelles possibilités de développement futur de répulsifs anti-moustiques plus efficaces et plus écologiques, répondant aux besoins des consommateurs d'aujourd'hui.

Afin de mieux étudier les produits répulsifs développés durant ces études, des essais sur le terrain doivent également être effectués pour évaluer l'efficacité des composés en milieux naturels, car les facteurs humains et environnementaux pourraient potentiellement affecter l'activité répulsive.

Chapitre 6

Depuis des décennies, certains dérivés à base de plantes sont réputés pour leurs valeurs thérapeutiques et pharmaceutiques. Les répulsifs topiques dérivés de plantes ont prouvé leurs capacités à réduire l'incidence de la transmission des maladies vectorielles. Dans ce chapitre, BCO:VO a été testé contre le vecteur de la dengue, *Aedes aegypti*, dans une serre protégée en conditions semi-naturelles (SFSH). Cette étude a été réalisée dans une grande enceinte construite dans les conditions ambiantes permettant aux moustiques d'agir avec des réactions comportementales similaires à celles de conditions naturelles. L'autre avantage de cette étude en conditions semi-naturelles (SFS) est que les produits peuvent être testés sur des moustiques collectés sur le terrain dans des conditions contrôlées de laboratoire. Les spécimens d'*Aedes aegypti* ont été marqués avec une poudre de couleur fluorescente et libérés dans le SFSH. Environ 3 mL du produit BCO-VO ont été appliqués sur la zone testée localisée sur les deux jambes d'un volontaire. Le contrôle était de l'autre côté du SFSH et avait de l'éthanol à la place du produit à tester. Deux collecteurs, positionnés aux extrémités opposées de la SFSH, effectuaient les captures de moustiques sur les 2 volontaires (test et contrôle). Les résultats ont montré que les produits BCO-VO ont fourni une protection 87,27 % plus élevée ($P < 0,001$) pendant une longue période de 12 heures par rapport au contrôle non protégé. La conclusion de cette étude confirme la haute efficacité du produit BCO-VO qui vient compléter et confirmer les essais faits en laboratoire. En outre, la SFS peut estimer la dose efficace et la persistance du produit BCO-VO contre *Ae. aegypti* en conditions semi-naturelles.

Chapitre 7

Les études décrites dans les chapitres 2 à 6 représentent les efforts fournis au cours ma thèse de Doctorat pour identifier des potentiels insectifuges naturels, respectueux de l'environnement et sûrs pour un usage public. Les 2 composés issus de plantes, l'oxyde de β -caryophyllène et l'huile essentielle de vétiver, sont venus à notre attention après une importante recherche scientifique.

En conclusion, une étude approfondie sur l'activité répulsive de BCO et VO a été réalisée allant d'un nouveau processus de synthèse verte au développement de formulations permettant une longue protection contre les moustiques. L'inhibition de l'attraction du moustique à la peau traitée avec le répulsif BCO-VO était significativement beaucoup plus élevée que pour le contrôle en conditions de laboratoire et semi-naturelles sur une longue période de protection de 12 heures. Un autre résultat important présenté dans cette thèse est que ces deux molécules, BCO et VO, fournissent une action de protection significativement plus élevée, à des concentrations de 0,5% et 1%, contre les piqûres de moustiques comparativement au DEET, la molécule la plus couramment utilisée dans les produits répulsifs commerciaux à des concentrations de 30-50%. Le développement de tels répulsifs topicaux offre une protection personnelle efficace pour être potentiellement utilisés comme complément d'autres méthodes de lutte antivectorielle dans le cadre d'une stratégie intégrée de gestion de la lutte antivectorielle dans les régions tropicales et subtropicales du monde, ainsi que dans les pays tempérés où *Ae. albopictus* représente non seulement une nuisance, mais aussi un risque de propagation d'épidémies d'arbovirus.

Summary

A wide assortment of parasites, bacteria and viruses are transmitted to humans by invertebrates, most notably mosquitoes, sandflies, triatomine bugs, black flies, tsetse flies, ticks, mites, snails, fleas and lice. Vector-borne diseases are a primary public health concern globally, especially in the tropical/sub-tropical areas. Mosquitoes, in fact, are the deadliest animals on the planet given the number and variety of pathogens they are capable of transmitting. Their ability to carry and spread pathogens to humans are responsible for millions of deaths every year. Mosquito-borne diseases include malaria, lymphatic filariasis, dengue, Japanese encephalitis, chikungunya, Zika and many others. The burden that malaria, dengue and other arboviral diseases poses globally, with limitations on effective tools for controlling them, particularly in many lower- and middle-income countries, demands greater attention. Millions of people in underdeveloped and developing countries live in areas of unacceptably high risk for contracting diseases transmitted by arthropods.

Tools to reduce disease transmission rely mostly on vaccine, prophylaxis drug, and vector control. However, effective vaccines for most vector-borne diseases are not yet available. Also, very few drugs against arboviral diseases are available and the resistance of parasites to drugs has been increasingly reported, especially for malaria. Therefore, vector control constitutes to be the main approach to prevent and control outbreaks of most vector-borne diseases. Various control methods have been proposed to combat mosquito vectors such as chemical control (insecticide), biological control (fish) and mechanical control (eliminate larval habitats). However, mosquito control, through the use of chemical insecticides, is still the most feasible and efficient technique in the control of vector-borne diseases. Unfortunately, several species of mosquitoes have developed tolerance or resistance to many chemical insecticides. In addition, there is a real lack of vector control approaches against outdoor biting mosquitoes, thus repellents bring a real advantage in the sense that they offer the possibility to protect people when outside against diurnal mosquitoes (*Aedes*) and early biting species of nocturnal mosquitoes (*Anopheles* and *Culex*). To facilitate this, one of the alternate and proven effective tools to fight against blood-sucking insects is the use of insect repellents.

Mosquito repellents play a significant role in disrupting disease transmission by reducing human-vector contact. In general, mosquito repellents are comparatively inexpensive and affordable by local users and travelers from developed and developing countries. One of the most common synthetic active ingredients used in commercial topical (i.e., applied to skin) mosquito

repellent products is the DEET (*N,N*-diethyl-meta-toluamide). DEET remains the "gold standard" insect repellent, a compound that is effective against most biting insects and other arthropods (e.g., mosquitoes, other biting flies, ticks, fleas, and chigger mites). Although, DEET has a remarkable safety profile after 40 years of worldwide use, despite high concentrations in commercial products (30-50%), toxic reactions can occur in highly sensitive people and it presents the inconvenient to melt all plastic supports.

Phytochemicals derived from extractions of various plant species can produce numerous effects against insects, including killing and repellency. Plant-based mosquito repellents are an alternative to synthetic compounds because the raw material can be readily accessible, locally accepted, and affordable to low income communities, while quite efficient to prevent mosquito bites.

The main objective of this study was to develop and test the efficacy of new plant-based repellents on mosquito species that provide high excito-repellency action as well as human safety. This thesis contains seven parts, the state of knowledge on the subject presented in the first chapter, the main content of the study in Chapters 2 to 6, and finally a general conclusion and study perspectives in Chapter 7.

Chapter 1

In the Chapter 1, the general information on mosquito-borne diseases in Thailand is provided, in particular those having caused the highest burden in the previous years. Malaria and Dengue are the two most common mosquitoes-borne disease that cause high morbidity and mortality. In Thailand, a dengue outbreak was first recognized in 1958. Since then, the disease has become widely distributed as one of the major public health problems in Thailand. The biggest outbreak of dengue hemorrhagic fever (DHF) in Thailand occurred in 1987 with 174,825 cases and 1,007 deaths reported. The latest data by the Department of Disease Control recorded over 87,037 cases of dengue from January to December 2019. Malaria, another mosquito-borne disease due to five species of *Plasmodium* parasites, can be severe and even fatal. In Thailand, the number of malaria cases has been significantly reduced since 1996. The current situation is reporting malaria cases along the Thai international borders with Myanmar on the west and north (35.4%), Laos on the north and east (2.2%), Cambodia on the east (7.8%), and Malaysia on the south

(49.8%). In 2019, a total of 3,204,807 migrant workers lived in Thailand. These population movements greatly complicate the control of these vector-borne diseases.

This chapter also reviewed the information on plant-based repellents in Southeast Asia, as numerous essential oils extracted from wild and domestic plants have been investigated for mosquito repellent activity. In our investigation, we identified 29 plant species within 13 plant families that showed some mosquito repellent properties. In recent years, botanical chemistry plays a more and more important role in finding biologically active compounds. The repellent chemicals found in different parts of the plants have been identified in some plant extracts. These constituents not only act as repellents but also as feeding deterrents, toxicants, growth regulators, etc. The Environmental Protection Agency (EPA) characterizes biopesticide repellents— para-menthane-3,8-diol (PMD), 3-[N-butyl-N-acetyl]-aminopropionic acid, ethyl ester (IR3535), 2-undecanone—are derived from, or synthetic versions of, natural materials. In our study, the two plant-based compounds reported here, β -caryophyllene oxide (Synthetic natural derived) and vetiver oil (natural product), came to our attention *via* large scientific research.

In conclusion, enormous efforts have been made to develop effective repellents against mosquitoes, as a consequence synthetic repellent have been widely developed and used. However, the use of synthetic repellents against mosquitoes has raised some issues on safety and health risks to humans and the environment. Therefore, plants-based repellents should be increasingly studied to serve as safer alternatives to synthetic repellents. At present, the development of natural product-based repellents with more effective and long-lasting protection is needed. Plant-based compounds become more popular as active ingredients in repellent products. The aim of this project was to investigate few previously selected compounds and test their efficacy on several mosquito vectors in order to develop and improve the efficacy of repellent products. A better understanding on how repellents work is also important to investigate as highly active compounds may lead to entirely new ways in insect repellent. The urgent need to prevent the infection due to vector-borne pathogens has impacted repellent studies globally with an increase in the evaluation of a large number of promising active molecules and compounds. The development of new formulations could guide to products that are not only more effective but also more acceptable to users. Taken together these elements, development of repellents may lead to entirely new and more effective ways to use repellents in the future and to better protect ourselves against mosquito bites.

Chapter 2

This chapter is aiming at investigating the behavioral responses of *Aedes aegypti*, *Aedes albopictus*, *Anopheles minimus* and *Anopheles dirus* to various concentrations of β -caryophyllene oxide (BCO) (0.1, 0.25, 0.5 and 1%) using an excito-repellency (ER) test chamber system. The ER test boxes were earlier described by Chareonviriyaphap (2002). These boxes have been applied for insecticide avoidance behavior study of female mosquitoes in the forms of contact irritant and non-contact repellent. In addition, the phototoxic and genotoxic effects of BCO were investigated on Balb/c 3T3 mouse fibroblasts (3T3-L1) and Chinese hamster ovary cell line (CHO-K1), respectively.

According to results reported in this chapter, BCO had stronger repellent and irritant effects than DEET at the same concentration. *Anopheles minimus* was found to be more sensitive to BCO than that of *Aedes aegypti*, *Aedes albopictus* and *Anopheles dirus*. For the toxicity tests, BCO did not show any phototoxic and genotoxic activities. BCO could be considered as a safe repellent, effective against mosquitoes.

Besides the BCO compound, another compound, vetiver oil (VO), which was reported to repel several insects such as termites, mosquitoes, weevils, beetles, was tested for its repellent characteristic.

Chapter 3

Numerous essential oils with repellent action are widely used for personal protection against host-seeking mosquitoes. Vetiver oil (VO) and its constituents have demonstrated various mosquito repellent activities. In this study, three chemical actions of vetiver oil and five of its constituents (terpinen-4-ol, α -terpineol, valencene, vetiverol and vetivone) were characterized against *Aedes aegypti*, *Aedes albopictus* and *Culex quinquefasciatus* by the high-throughput screening assay system (HITSS). The HITSS was developed and used to quantitatively describe responses of mosquitoes to different actions of chemicals, which are contact irritancy, spatial repellency, and toxicity to mosquitoes. Moreover, the phototoxic and genotoxic effects of VO and its constituents were investigated. Significant contact escape responses in *Ae. aegypti* and *Ae. albopictus* to all test compounds at concentrations between 2.5 and 5% were observed. Spatial repellency responses were also observed on different laboratory mosquito populations under various concentrations. The most significant toxic response on mosquitoes was found at the

highest concentration, except for vetivone, which had no toxic effect on *Ae. aegypti* and *Ae. albopictus*. Results on phototoxic and genotoxic hazard revealed that VO and their constituents present no phototoxic potential or any significant genotoxic response.

In term of efficacy and safety, Chapters 2 and 3 have identified BCO and VO for being used as green plant-based repellent. Although, BCO and VO have exhibited significant repellent activity against mosquito, comparatively no work has been done to identify the degree of behavioral responses using the mixtures of these two plant-based repellents. The next study was to combine BCO and VO at different concentrations to evaluate the efficacy of the repellency effect on laboratory mosquitoes.

Chapter 4

Deploying synergistic combinations is aimed to decrease the dose substances and help reducing the risk of developing physiological resistance in any insect population. To support this phenomenon, two compounds with confirmed mosquito repellent activities were mixed to potentially increase the repellent efficacy, i.e. three binary mixture forms of BCO (1%) and VO (2.5%) were prepared to test the excito-repellency activity on *Ae. aegypti*, *Ae. albopictus*, *An. minimus* and *Cx. quinquefasciatus* using an ER repellency test system. We evaluated the mosquito-repellent activity of BCO 1%, VO 2.5%, and their binary mixtures [BCO+VO (1:1), BCO+VO (2:1), BCO+VO (1:2)]. In general, mixture compounds produced a much stronger response on mosquitoes than that of the single, regardless of the test conditions and species. The combination of BCO:VO were effective against four mosquito vector species, especially *Cx. quinquefasciatus* and *An. minimus*, but some of them were weaker than when tested against *Ae. aegypti* and *Ae. albopictus*. However, the BCO:VO mixture was found to provide better repellency effect against mosquitoes than the same repellent alone. In terms of toxicity, BCO+VO (2:1) showed knockdown activity with *Ae. albopictus*, *An. minimus* and *Cx. quinquefasciatus*.

In summary, the binary combination of BCO and VO produces additive contact irritancy, non-contact repellency, and knockdown activities at low concentrations, suggesting that combinations of these two repellent compounds may serve for developing a more effective mosquito repellent than with one compound only. The synergistic repellent activity of the essential oils used in the present study might be useful for alternatives to synthetic repellents for personal protection against mosquitoes. Such practice would reduce the chemical burden on the

environment and promote sustainable use of locally available bioresource by rural communities. For practicality, both compounds need to be formulated as plant-based products and preliminary tested in the laboratory. The next chapter is aiming to formulate combinations of BCO:VO and test their efficacy and length of protection time under laboratory conditions.

Chapter 5

Increasing use of natural mosquito repellents as safe products for the prevention of mosquito-borne diseases has created a growing acceptance by the local populations affected by these diseases. BCO and VO demonstrated to be effective to repel mosquito, as well as being safe. The aim of this chapter was to develop a new repellent oil in water (O/W) emulsion containing BCO and VO. The oil droplets of VO were dispersed in the aqueous phase and suitable emulsifiers were used to prevent any macroscopic phase separation. A non-contact repellency assay system (NCRAS) was used as a possible alternative method for testing the protection time of plant-based products against *Aedes aegypti* and *Culex quinquefasciatus*. This new system uses a physical screen barrier that does not allow mosquitoes to land directly on the treated surface areas (forearms) of a human volunteer. The result showed that the plant-based product provided the great effective protection time against both mosquito species of 240 min (4 hrs). With additional improvement in physical and chemical characteristics of the formulation, the protection time could even be increased, which define these compounds as having substantial potentials to be used in novel plant-based repellents for personal protection against mosquito bites. Due to the human risk and ethical issues, the NCRAS was developed as an alternative assay to the arm-in-cage system, a common tool to investigate the efficacy of mosquito repellent formulations. However, the NCRAS presented in this study needs complete standardization of its physical and technical designed protocol to be comparable to the common arm-in-cage system.

Numerous commercial repellents contain a number of plant-based compounds including plant extract, essential oil, plant based-synthetic and fragrance. The present study indicated that the new repellent lotion (O/W emulsion) containing BCO and VO is very promising as a new novel plant-based repellent. Moreover, the most efficient malaria vectors in Southeast Asia are outdoor biting mosquitoes with early feeding activity that escape from the traditional vector control methods based on IRN and ITN coverage. Therefore, new strategies to prevent these outdoor and early biting mosquitoes must be found in order to reduce malaria transmission. This might open

up new opportunities for future development of more efficient, and eco-sourced mosquito repellents, which meets the needs of today's consumers.

To better investigate the repellent products obtained from these studies, field testing must also be done to further support the effectiveness of the test compounds in natural settings because human host and environmental factors could potentially affect a repellent activity.

Chapter 6

For decades, some plant-based derivatives have been renowned for their therapeutic and pharmaceutical values. Topical repellents derived from plant have proven to reduce the incidence of vector borne disease transmission. In this chapter, BCO:VO was tested against dengue vector, *Aedes aegypti*, in the semi-field screen house (SFSH). The semi-field study (SFS) was performed in the large constructed enclosure under ambient conditions allowing mosquitoes to act with similar behavior responses as under natural conditions. The other benefit of SFS is that the products can be tested with the field collected mosquitoes under laboratory controlled-conditions. *Aedes aegypti* specimens were marked with fluorescent color powder and released in the SFSH. Approximately 3 mL of the BCO-VO product was applied to the test area of both legs of each volunteer. The control was on the other side of the SFSH (ethanol for control). Two collectors conducting human-landing collections on both volunteers (test and control) were positioned at opposite ends of the SFSH. Results showed that BCO-VO products provided 87.27% greater protection ($P < 0.001$) for a long period of 12 hrs compared to the unprotected control. The finding of this study confirmed the efficacy of BCO-VO product that comes as a necessary complement as well as a confirmation of laboratory testing. Moreover, the SFS can estimate the effective dose and persistence of the BCO-VO product against *Ae. aegypti* in near-natural conditions.

Chapter 7

The studies described in Chapters 2 to 6 represent the efforts made during my PhD thesis to identify potential naturally insect repellents that are environment-friendly and safe for public use. The two plants-based compounds reported here, β -caryophyllene oxide and vetiver oil, came to our attention *via* a wide scientific research.

In conclusion, an extensive study on the repellent activity of BCO and VO has been performed ranging from a novel green synthesis process to the development of formulation systems to reach long-lasting protection against mosquitoes. The landing inhibition of BCO-VO

repellent was significantly higher than for the control in laboratory and semi-field conditions with a long protecting period of 12 hrs. Another important result presented in this thesis is that these two molecules, BCO and VO, provided a significantly higher protection action at 0.5% and 1% concentrations, against mosquito bites compared to DEET, the most common molecule currently used in commercial repellent products at concentrations pf 30-50%. The development of such topical repellents would offer efficient personal protection to be potentially used as a complement to other vector control methods under an integrated vector control management strategy in the tropical and subtropical regions of the world, as well as temperate countries where *Ae. albopictus* is representing not only a nuisance, but also a risk of propagation of arboviral outbreaks.

General Introduction

Several vector-borne diseases cause serious problems in human society. Important vectors of disease pathogens include mosquitoes, sandflies, triatomine bugs, black flies, ticks, tsetse flies, mites, snails, and lice. Diseases remain a concern in many parts of the world, especially in the tropical and subtropical zones. Mosquitoes as vectors are known as the deadliest animals in the world. They are able to carry and spread disease agents to humans that cause millions of deaths every year. In 2018, approximately 700,000 people were killed by infected mosquitoes with malaria being the major cause of deaths with 57% (400,000) of the total fatalities due to mosquito-borne diseases (WHO, 2019b). In addition to malaria, there is a large number of disease agents transmitted by mosquitoes including dengue, filariasis, Japanese encephalitis, chikungunya and more recently reported Zika (Benelli, 2016).

The burden from malaria, dengue and several other arboviruses creates a key concern in human society since no effective tool (e.g. vaccines) is available for controlling most of them, especially in endemic countries. Millions of humans in undeveloped and developing countries appear at risk for this burden. In 2017, an estimated 219 million cases of malaria were reported worldwide and there were an estimated 435,000 deaths from malaria globally (WHO, 2018). In 2018, more cases were estimated with 228 million cases of malaria worldwide and 405,000 deaths (WHO, 2019c). Children aged under 5 years are the most vulnerable group affected by malaria, they accounted for 67% (272,000) of all malaria deaths worldwide (WHO, 2019c). Malaria prevention and treatment are known as the most cost-effective public health interventions. They provide a consistently high return on investment, beyond the direct benefit of improved health (Purdy *et al.*, 2013). In 2017, global financing for malaria control and elimination fell short of the estimated US\$ 4.4 billion needed (WHO, 2018). Besides, the incidence of dengue has recently grown dramatically around the world. A vast majority of dengue cases are asymptomatic and hence the actual number of dengue cases are underestimated and many cases are misclassified (Endy *et al.*, 2002). One estimate indicates 390 million dengue infections per year (95% credible interval 284–528 million), of which 96 million (67–136 million) manifest clinical symptoms (with any severity of disease) (Bhatt *et al.*, 2013).

Thailand is located in a tropical region, where environmental conditions are favorable for the spread of many mosquito-borne diseases, especially malaria and dengue (Loyd and Kaewpitoon, 2015; Morin *et al.*, 2013). Tools to reduce disease transmission rely mostly on vaccine, prophylaxis drug, or vector control. However, effective vaccines for most vector-borne diseases are not yet available. Also, resistance of parasites to drugs has been increasingly reported, especially for malaria (Phyo and Nosten, 2018). Therefore, vector control seems to be the main approach to prevent or control outbreaks of most vector-borne diseases. Various control methods to combat mosquito vectors such as chemical control (insecticide), biological control (fish) and mechanical control (eliminate larval habitats) have been proposed (Rozendaal, 1997). However, mosquito control through the use of chemical insecticides is still the most feasible and efficient technique in the control of vector-borne diseases. Unfortunately, several species of mosquitoes have developed tolerance or resistance to many chemical insecticides, especially *Ae. aegypti* which has been found resistant to pyrethroids across Thailand (Chareonviriyaphap *et al.*, 2013; Jirakanjanakit *et al.*, 2014). To facilitate this, one of the alternate and proven effective tools to fight against blood-sucking insects is the use of insect repellents (Debboun and Strickman, 2013; Katz *et al.*, 2008).

Mosquito repellents play a key role in disrupting the disease transmission by reducing human-vector contact. As a whole, mosquito repellent products are comparatively cheap and affordable by local people or travelers from developed and developing countries (Fradin, 1998). One of the most commercialized mosquito repellent products, being used to protect human from insect bites, is DEET (*N,N*-diethyl-meta-toluamide) (Nentwig, 2003). DEET remains the "gold standard" insect repellent, which is used against most biting insects i.e. mosquitoes, ticks, fleas, biting flies and chigger mites. Researchers found that a formulation containing 23.8% DEET completely protected study participants for upwards of 300 minutes (5 hrs), while a soybean-oil-based product only worked for 95 minutes, three times less than DEET (Scientific American, 2008) (Fradin, 1998). Although, DEET is very effective as an insect repellent, some people have irritation or an allergic reaction to DEET (Katz *et al.*, 2008). As reviewed by Brown and Hebert (1997), research has shown that DEET has significant adverse or toxic effects to humans, especially when misapplied at high concentrations (Roberts *et al.*, 1997). In addition, DEET has demonstrated to mitigate odor-evoked currents mediated by the insect odorant receptor complex (Odalo *et al.*,

2005). Researchers found that a formulation containing 30% DEET completely protected study participants for 6 hrs (Tavares *et al.*, 2018). This substance has a remarkable safety profile after 40 years of worldwide use, but a review of the literature revealed 17 reports of DEET-induced encephalopathy in children (Briassoulis *et al.*, 2001). One alternate tool to protect from mosquito bites, which is safe, easily available and highly effective, is using natural plant-based repellents (Novak and Gerberg, 2005).

Plant-based mosquito repellents are an alternative to synthetic repellents because the raw material is easily accessible, and they are locally acceptable and affordable to low income communities (Maia and Moore, 2011). Investigations of essential oils and plant extracts using an excito-repellency test system with female mosquitoes was first studied in 2008 by Polsomboon *et al.* (2008). Subsequently, the excito-repellency action has been evaluated with extracts from several native plants including; *Melaleuca leucadendron* leaf, *Litsea cubeba* fruit, *Litsea salicifolia* fruit and oils from catnip, orange peel (*Citrus aurantium*), cinnamon leaf (*Cinnamomum verum*), citronella grass, clove flower (*Syzygium aromaticum*), hairy basil leaf (*Ocimum americanum*), vetiver grass (*Vetiveria zizanoides*), and kaffir lime (*Citrus hystrix*) against various female mosquito species (Boonyuan *et al.*, 2014; Nararak *et al.*, 2016b; Nararak *et al.*, 2017; Noosidum *et al.*, 2008; Sathantriphop *et al.*, 2006; Sathantriphop *et al.*, 2014). Citronella is the one of the most widely used natural repellents on the market. Beside citronella, Tisgratog *et al.* (2016b) reviewed that clove, hairy basil, catnip, and vetiver essential oils could serve as potential mosquito repellent products against *Ae. aegypti*, *An. minimus*, *Cx. quinquefasciatus* in a laboratory setting. In another field study, the extracts of citronella oil (10-13%) were tested for 4 hrs to protect from night biting mosquitoes (*Culex* species and *Mansonia* species) (Thavara *et al.*, 2002). However, none of these test repellent compounds have been further formulated and developed for public use (except for vetiver currently on the process of public registration).

Vetiver oil is one of the plants that have been reported to repel several insects such as termites, mosquitoes, weevils, beetles (Nararak *et al.*, 2016a; Sujatha, 2010; Zhu *et al.*, 2001). Zhu *et al.* (2001) reported vetiver oil as the most effective repellent because of its long-lasting activity. Furthermore, β -caryophyllene oxide is a bicyclic sesquiterpene molecule, occurring naturally in essential oils from various medicinal and edible plants and used as a food flavouring agent and a

fragrance and cosmetic ingredient. β -caryophyllene oxide is found in plant-based essential oils that have the ability to repel mosquitoes; for example, the study of Suleiman et al. (2014) found the leaves of *Artabotrys hexapetalus* containing large amounts of β -caryophyllene oxide with high mosquito repellent activity against *Anopheles gambiae* s.s. mosquitoes. These two plant-based compounds reported here, β -caryophyllene oxide and vetiver oil, came to our attention via pharmacognosy scientific and literature research.

In general, chemicals can protect humans from mosquito bites or nuisance in two forms, either by killing the mosquito or by modifying mosquito behavior to inhibit blood feeding. The second, behavior avoidance, includes two types of responses, which are irritability and repellency. The outcome of these two different forms of behavioral avoidance can be quantified using either a special designed excito-repellency test system or high-throughput screening system (HITSS) to determine the repellency, irritancy and toxicity. Field experiment using a hut equipped with entrance and exit traps successfully differentiated the two forms of behavioral responses in mosquito populations (Suwannachote *et al.*, 2009).

In the past, repellent assays using a human bait model was developed to study the protection times of chemicals on mosquitoes called the “Arm-in cage” technique (Logan *et al.*, 2010). This system may provide a potential risk for human volunteers to be bitten by mosquitoes during the exposure period. Recently, a novel non-contact repellency assay system (NCRAS) was designed and evaluated as a possible alternative method for testing chemicals that repel or inhibit mosquitoes from blood feeding without using a human volunteer (Tisgratog *et al.*, 2016a). This system provides a physical screen barrier that prevents mosquitoes from making physical contact with a human volunteer. Tisgratog *et al.* (2016a) reported that NCRAS serves as a promising tool but requires further evaluation and possible modification in design and testing protocol to achieve more desirable operational attributes in comparison with direct skin-non contact repellency mosquito assays. Also, most scientists in research on repellents for humans accept that field tests should be conducted with human subjects (Schreck, 1977). A specialized testing system described by several senior scientists (Bar-Zeev and Gothilf, 1974; Potapov and Vladimirova, 1965) understandably require animal test subjects or traps, but the field test appears a closer to the actual use test and should duplicate as closely as possible the intended use of the repellent.

In recent years, the food and cosmetic business companies along with both national and international health and food safety authorities have extensively debated the safety of novel plant and plant-derived ingredients for their use in foods. These issues consistently produced a consensus that adequate specifications of plant identity and composition are key factors in the safety assessment of plant-derived ingredients (Antignac *et al.*, 2011). Although a plant-based compound may generate an excellent mosquito repellent, this compound may produce toxic and adverse effects in humans or animals, or both. Consequently, potential cytotoxic effects of hazardous substances must be studied prior to product development. The required purposes of this study were to determine the safety of plant-based repellents using an *in vitro* phototoxicity test and an *in vitro* micronucleus assay.

In this study, we employed a range of different research approaches and activities which were organized into seven different tasks. β -Caryophyllene oxide and vetiver are plant-based candidates preselected based on our previous studies (Nararak *et al.*, 2016b; Nararak *et al.*, 2019). The entire processes of this study was carried out under the following steps: 1) identifying a plant species potentially used as a source of mosquito repellents; 2) systematically screening excito-repellency and insecticidal properties of β -caryophyllene oxide and vetiver essential oil (EO), and a combination of both compounds against several species of mosquito vectors; 3) identifying primary active ingredient(s) in vetiver EO; 4) evaluating the efficacy of potential active ingredient(s) using a High-throughput screening system (HITSS) on three species of mosquitoes; 5) investigating the phototoxicity and genotoxicity activities of plant-based repellents; 6) evaluating the efficacy of natural mosquito repellent formulations using a non-contact mosquito repellent assay system (NCRAS); 7) and performing a semi-field experiment to test the efficacy and persistence of bioactive ingredients on three mosquitoes species.

Conceptual Framework

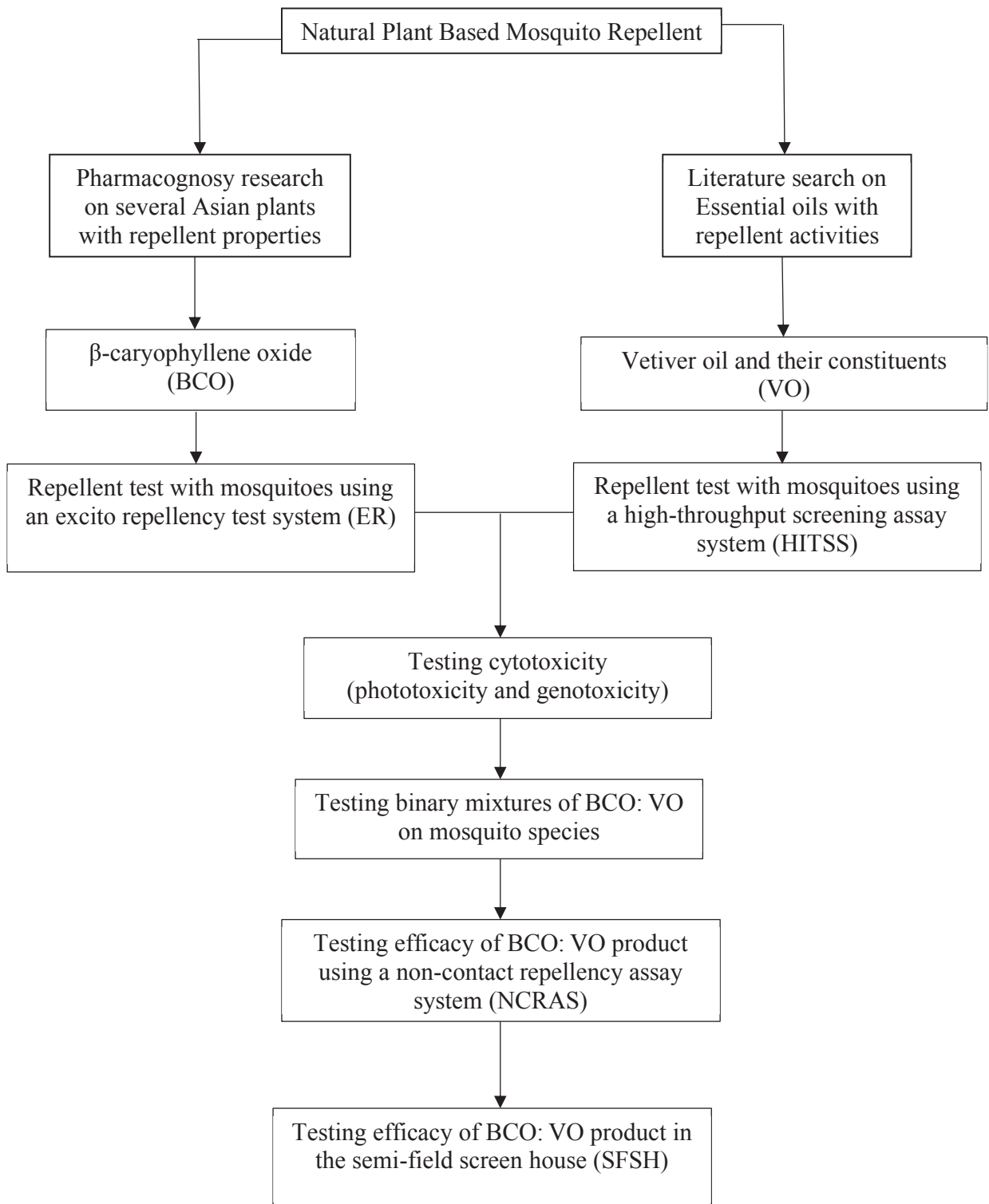

Chapter 1. Literature review

1. Mosquitoes

Mosquitoes are regarded as the most important group of two-winged biting flies that belong to the Order Diptera. Mosquitoes differ from other flies in which their wings are covered by tiny scales. Mosquitoes undergo complete metamorphosis with four different stages of development, including egg, larva, pupa and adult. All mosquito species need an aquatic habitat for egg, larval and pupal development stages. After egg hatching, there are four larval instars before molting into the pupal stage and then molting again to become an adult. Adult female mosquitoes have long tube-like mouthparts which are called a proboscis. This part can pierce the skin of a vertebrate host in order to extract blood, which contains some amino acids and iron for the egg development. Some mosquito species bite during the day and some at night. Only females of *Toxorhynchites* spp. can produce egg batch without blood feeding (Schiller *et al.*, 2019).

Mosquitoes are distributed on all continents in the world. There are over 4,000 different species of mosquitoes throughout the world (Meigen, 1871). Mosquitoes are classified as follow:

Phylum:	Arthropoda
Class:	Insecta
Order:	Diptera
Suborder:	Nematocera
Family :	Culicidae
Subfamily:	Anophelinae
Subfamily:	Culicinae

1.1 The medically important mosquito species in Thailand

Among the approximately 4,000 known mosquito species in the world, a few (<10%) are regarded as efficient vectors of pathogenic agents of infectious diseases, which have a high impact on human welfare and health (Manguin *et al.*, 2010). These vectors can transmit disease agents which cause illness in human population. Such diseases include malaria, filariases, and several mosquito-borne-viral diseases such as, dengue, zika, chikungunya, Japanese encephalitis (JE) and yellow fever. Mosquito-borne diseases are referred to those human diseases that are transmitted to people through bites of infected mosquitoes. The pathogen must go through a maturation phase into the mosquito and the human host. More than half of the human population, mainly in undeveloped and developing countries, are now at risk for serious infectious diseases (Balogun *et al.*, 2016). Currently, it is estimated that the disease burdens from malaria and dengue will likely become more serious in the near future, without any solutions near at hand. This is especially worrisome in African, Central and South American and Asian countries (WHO, 2019b).

Thailand has a tropical climate, where environmental and climatic conditions are favorable for the spread of many mosquito-borne diseases such as dengue, zika, chikungunya, malaria, Japanese encephalitis and filariasis. These diseases remain serious public health problems, which are related to four genera of mosquitoes, *Aedes*, *Culex*, *Anopheles* and *Mansonia*. At present, there are 480 mosquito species found in Thailand (Gaffigan Thomas V. *et al.*, 2015). Mosquitoes in Thailand were morphologically identified to four medically important genera. These four genera are listed in nine subgenera, 11 groups or subgroups, and 38 individual species considered to be of medical importance (Rattarithikul and Panthusiri, 1994).

Aedes aegypti (Linnaeus) is considered as the main vector of at least three important viral diseases, namely dengue, zika, and yellow fever. This mosquito is comparatively small in size with white lyre shaped markings on the thorax and black and white banded legs. It is a domesticated tropical species that prefers to breed in clean, clear and quiet water. It is found primarily in artificial water storage containers inside homes and is highly anthropophilic. This species originates from Egypt, northern Africa but it is now widespread in tropical and subtropical regions around the globe (Mattingly, 1957; Powell *et al.*, 2018). Global redistribution of this

mosquito species was facilitated by the mass movement of human populations, first, the flow of humans to the New World associated with the slave trade between the 15th to 19th centuries, and then travel to Asia as a consequence of trades between the 18th and 19th centuries. Worldwide redistribution occurred after World War II following troop movements (Powell *et al.*, 2018).

Aedes albopictus (Skuse) or the Asian tiger mosquito transmits dengue and zika viruses and it also plays an important role in transmitting chikungunya virus (CHIKV). The *Ae. albopictus* female is easily recognized by the bold black shiny scales and distinct silver white scales on the palpus and tarsi (Hawley, 1988). The black scutum contains a distinguishing white stripe which begins from the mid of dorsal surface of the head and goes toward the thorax. It is a medium-sized mosquito (approximately 2.0 to 10.0 mm, males are on average 20% smaller than females). This species is usually found in natural containers and commonly in rubber and palm oil plantations (Ponlawat and Harrington, 2005). *Aedes albopictus* is currently considered a serious biting nuisance for humans in some European countries, especially Italy (Scholte and Schaffner, 2007), France (Vazeille *et al.*, 2008), and Spain where the quality of life in infested areas is being reduced as a result (Aranda *et al.*, 2006). Adult females bite aggressively, usually during the day and preferably outdoors. However, there are reports showing that *Ae. albopictus* is becoming partially endophilic (Genchi *et al.*, 2009), and is found to be biting indoors in Thailand (Thavara *et al.*, 2001a).

Culex mosquitoes are distributed worldwide. Several species prefer to bite humans and can be efficient vectors. Some *Culex* species preferentially bite avians or mammals (Farajollahi *et al.*, 2011). *Culex quinquefasciatus*, the southern house mosquito, is considered one of the most common and widespread species within the *Culex* group (Niebylski and Meek, 1992). Even though this species is not the main disease vector in Thailand, it is considered a common vector of lymphatic filariasis (LF) worm in cities of neighboring countries of Myanmar, Lao and Cambodia. Several cases of LF have also been reported from international borders, especially the Thai-Myanmar and Thai-Cambodia borders (Dickson *et al.*, 2017). *Culex* adults are usually drab, unicolorous mosquitoes, but some species of the subgenus *Culex* have markings on the legs and pale spots on the wings similar to *Anopheles*. *Culex* are characterized by the presence of distinct pulvilli and the absence of prespiracular setae and postspiracular setae.

Anopheles mosquitoes are represented by at least 79 species in Thailand (Tananchai *et al.*, 2019). All important malaria vectors in Thailand are members of complexes with closely related sibling species, morphologically undistinguishable, that sometimes differ significantly in their biology, behavior, and epidemiological characteristics related to disease transmission, including susceptibility to malaria parasites and to insecticides used in vector control programs. The body of the adult *Anopheles* mosquito appears dark brown to black. The head has an elongated, forward-projecting proboscis used for feeding, and two maxillary palps of the same length than the proboscis. During resting, the abdomen of the malaria mosquito species points upward, rather than being parallel with the substrate surface like most mosquitoes. The most important malaria vectors belong to the subgenus *Cellia* and include members in the Leucosphyrus Group (Neomyzomyia Series), Maculatus Group (Neocellia Series), and the Minimus Subgroup (Myzomyia Series). Only seven species are incriminated as malaria vectors in Thailand such as *Anopheles baimaii* Sallum & Peyton, *Anopheles dirus* Peyton & Harrison, *An. minimus* Theobald, *Anopheles aconitus* Dönitz, *Anopheles maculatus* Theobald, *Anopheles pseudowillmori* (Theobald) and *An. sawadwongporni* Rattanaarithikul & Green. Main malaria vectors in Thailand occupy deep and foothill forests (Dirus Complex) or forest fringe habitats and secondary forested areas (Maculatus Group and Minimus Complex), especially along the international borders (Tainchum *et al.*, 2015; Tananchai *et al.*, 2019).

Mansonia mosquitoes are relatively large mosquitoes and are characterized by the presence of broad, asymmetrical scales on the veins of both wings. There is often a mixture of dark and pale scales that imparts a speckled appearance to the wings. *Mansonia* is similar to some species of *Culex*, *Aedini* and *Coquillettidia*, but the tarsal claws are simple, the abdomen is truncate in females (distinctions from aedine genera), pulvilli are not evident (distinction from *Culex*) and postspiracular setae are present (distinction from old world species of *Coquillettidia*). *Mansonia Indiana*, *Mansonia uniformis*, *Mansonia bonneae* and *Mansonia annulata* are the main vectors of *Brugia malayi*, a human lymphatic filariasis (Harinasuta *et al.*, 1970). Additionally, *Wuchereria bancrofti* agent of the Bancroftian filariasis, occurs on the southwest to northwest Thai-Myanmar border and this pathogen is transmitted by a large number of mosquito species belonging to six genera (Manguin *et al.*, 2010; (Nuchprayoon *et al.*, 2003).

1.2 Mosquito-borne diseases

In the tropical and subtropical areas of the world, vector-borne infectious diseases are still one of the major public health problems. Thailand is located in the tropical zone and several vector-borne diseases are endemic (Table 1). High numbers of cases of vector-borne diseases are prevalent throughout the country. Mosquitoes, black flies, sandflies, tsetse flies, biting midges, ticks, chiggers, houseflies and cockroaches are considered to be disease vectors or pests of humans. Insect disease vectors have been reported to transmit several pathogens to humans by biological or mechanical transmission. Among these, mosquitoes are the most important vectors that transmit disease pathogens to humans.

Table 1 Summary of reported case counts of notifiable mosquito-borne diseases in Thailand

Mosquito-borne diseases	2019	2018	2017	2016	2015	2014
Chikungunya	11,721	3,580	10	17	25	190
Dengue fever	87,037	55,076	31,843	38,466	86,653	23,170
Filariasis	4	20	4	4	6	17
Japanese B encephalitis	8	18	N/A	722	622	565
Malaria	1,995	2,114	2,969	5,273	5,933	11,352
Zika virus	274	601	544	N/A	N/A	N/A

Source: National Disease Surveillance (Report 506), Bureau of Epidemiology (BOE), Department of Disease Control (DDC), Ministry of Public Health (MOPH), Thailand

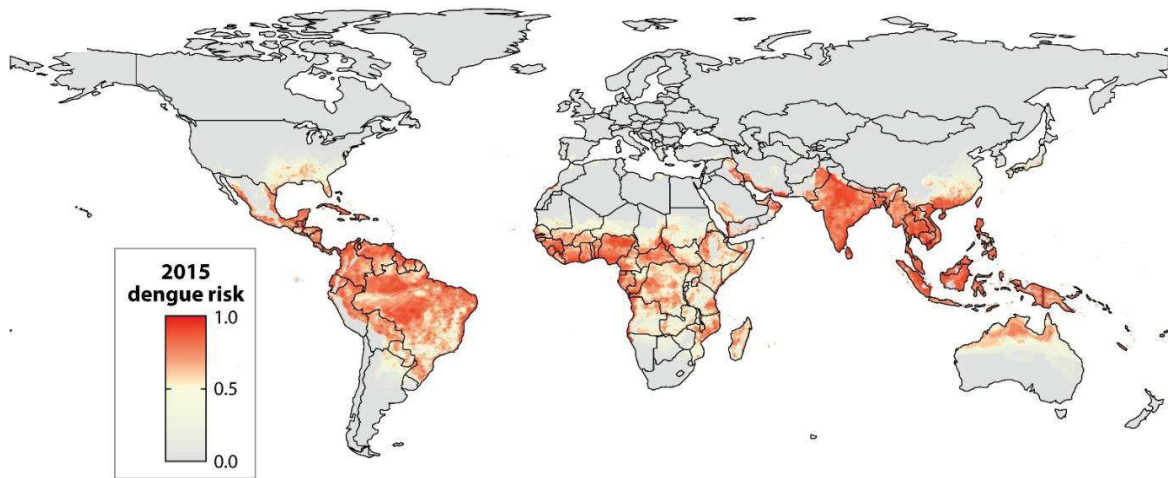

AR Brady OJ, Hay SI. 2020.
Annu. Rev. Entomol. 65:191–208

Figure 1 World map of areas at risk for dengue transmission

Source: (Brady and Hay, 2020)

1.3 Type of pathogens responsible for diseases

1.3.1 Virus

1.3.1.1 Dengue

People in many areas of the world are at risk for a wide variety of vector-borne diseases including, dengue fever (DF) and dengue hemorrhagic fever (DHF). Dengue was first recognized as an arthropod-borne virus (arbovirus) early in the 19th century. Several early epidemics of dengue in Asia, the Americas and Europe are thought to have been associated to severe hemorrhagic manifestations, but the relationship between DHF and DF was not identified until 1956, after an outbreak in the Philippines. Since then, the hemorrhagic or shock syndrome has spread to many areas of Southeast Asia, the Pacific and the Americas (Gubler 1997). This mosquito-borne disease causes high levels of morbidity and mortality to humans each year. Approximately 100-400 million people are estimated to be infected with dengue viruses worldwide (Brady and Hay, 2020).

There are at least four antigenically distinct forms of the virus (DENV-1, 2, 3, 4), which are transmitted primarily by *Ae. aegypti*, an efficient mosquito vector that often resides in and near human dwellings. There are four symptomatic appearances of dengue, which include classic dengue, DF, DHF and DSS (dengue shock syndrome). Classic, uncomplicated dengue begins with a high fever two to seven days after a person is bitten by an infected mosquito. Fever due to DF may reach 40°C during the next five days and is accompanied by bone and joint pain and an intense headache. Within four days after the onset of fever, skin rashes usually appear and sometimes small points of hemorrhage can be seen under the skin. DHF begins much like dengue, with rapid onset of fever, headache, vomiting and coughing but is followed by deterioration and physical collapse within two to five days. The cause of death is due to leakage of blood serum from capillaries, which results from a sudden drop in blood pressure, symptomatic of DHF.

Geographical distribution of DF and DHF cover almost all tropical and subtropical countries (Figure 1). In Thailand, a dengue outbreak was first recognized in 1958. Since then, the disease has become widely distributed as one of the major public health problems in Thailand (Kantachuvesiri, 2002). The biggest outbreak of DHF in Thailand occurred in 1987 with 174,825 cases and 1,007 deaths reported (Kittayapong *et al.*, 2006). The incidence rate in 2018 was 129.96 cases/100,000 population with 117 deaths. The latest data by the Department of Disease Control recorded over 87,037 cases of dengue from January to December 2019 (Table 1).

1.3.1.2 Chikungunya

Chikungunya (CHIK) is an arboviral disease transmitted through the bite of infected *Aedes* mosquitoes. The word “chikungunya” means “to walk bent over” in the African local dialect Makonde, and is referring to the effects of the incapacitating arthralgia of the infected patients. Chikungunya virus (CHIKV) is the etiological agent, member of the *Alphavirus* genus in the *Togaviridae* family (Galán-Huerta *et al.*, 2015). In Asia, the first CHIKV fever outbreak took place in Thailand in 1958 (Rianthavorn *et al.*, 2010). The symptoms of CHIKV infection are fever and severe joint pain. Patients may experience headache, muscle pain, joint swelling, or rash. Compared to dengue, CHIK is an uncommonly reported viral disease and probably misdiagnosed

as a classic dengue infection where they co-exist (Chareonviriyaphap *et al.*, 2013). Periodic outbreaks occur throughout the areas of Africa, Indian Ocean, and Asia, they are typically self-limiting infections and rarely result in severe disease. Although, in some cases, major epidemics can occur such as the one in 2005-2006 on the Reunion Island (France) where 255,000 cases were reported among a population of about 770,000 people causing 213 deaths (Josseran *et al.*, 2006). The vector was *Aedes albopictus* that invaded the island only a year prior to this epidemic (Latreille *et al.*, 2019).

The Thai Ministry of Public Health also reported a major increase in the number of chikungunya cases, especially in the southern part of Thailand between 2008-2009 (Rianthavorn *et al.*, 2010). In 2019, 11,721 CHIKV cases were reported in the country as compared to the 3,580 cases found in 2018 (Table 1). Most cases were reported from the southern provinces including Phuket, Pattani, Songkhla, Narathiwat and Phang Nga where the ecological situation favors the proliferation of *Ae. albopictus* mosquito (Javelle *et al.*, 2019).

1.3.1.3 Japanese encephalitis (JE)

Japanese encephalitis virus (JEV) was recognized before 1935, and JEV was first isolated in Japan in 1935 (Solomon *et al.*, 2000). Japanese encephalitis (JE) remains an important viral-borne disease in Asia, including Bangladesh, Brunei Darussalam, Cambodia, China, Taiwan, India, Indonesia, Japan, Democratic People's Republic of Korea (North Korea), Republic of Korea (South Korea), Lao People's Democratic Republic (Laos), Malaysia, Myanmar, Nepal, Pakistan, Papua New Guinea, Philippines, Russian Federation (Russia), Singapore, Sri Lanka, Vietnam, Thailand and Democratic Republic of Timor-Leste (Timor-Leste) (Figure 2). Over 3 billion people live in the 24 countries affected by JE (Sakamoto *et al.*, 2019). The JEV is a single RNA virus belonging to the family *Flaviviridae*. The virus is transmitted to humans by the bite of infected *Culex* mosquitoes. These mosquitoes feed on viraemic vertebrate hosts such as domestic pigs, resulting in frequent epidemics of JE. The virus is known to spread and is active over a vast geographic area covering India, China, and most of Southeast Asia (Figure 2). Around 30,000-50,000 cases were reported in Asian countries annually, with case fatality rates between

0.3% and 60%, depending on the age at time of infection and severity of symptoms (Ghosh and Basu, 2009).



Figure 2 Geographical distribution of the Japanese encephalitis risk

Source: (Hills *et al.*, 2019)

JE has been found in Thailand since the 1950s (Chunsuttiwat, 1989). Typical JE takes place as an epidemic in the widespread paddy field areas associated with *Culex tritaeniorhynchus*, *Culex gelidus*, and *Culex vishnui* group mosquitoes (Nitapattana *et al.*, 2008). Between 1969-1987, 600 to 2,500 cases of JE were reported annually and the highest number of patients was recorded in 1980 (2,413 cases) in Thailand. The Ministry of Public Health (MOPH) launched a JE control program in 1973 with the major emphasis being on the control of mosquito vectors. Since 1990, the JE vaccine has been introduced into the Thai National Immunization Program (NIP) and has been used to immunize children and adults in the highest risk areas (Muangchana *et al.*, 2012). Since then, the prevention strategies for JE disease rely on vaccination and vector control. Thailand has a successful JE immunization program that has drastically reduced disease incidence. However, JEV remains an important cause of encephalitis when there

are gaps in protection (Olsen *et al.*, 2010). Since 2010, the number of reported cases of viral encephalitis has decreased from a peak of 722 cases in 2016 to 8 cases in 2019 (Table 1).

1.3.1.4 Zika fever

Like other arboviruses, the Zika virus (ZIKV) is a mosquito-borne flavivirus that was first identified in Uganda in 1947. Zika (ZIK) is an emerging public health threat that already affected more than 30 countries in Asia, Africa, and Americas (Sikka *et al.*, 2016). ZIKV was found to circulate in African and Southeast Asian countries in the 20th century (Faye *et al.*, 2014). Further global migration events led to the spread to other regions including Oceania in 2007, French Polynesia in 2013, and Americas in 2015 (Sharma *et al.*, 2017).

The most common symptoms of ZIK are fever, rash, red eyes, and joint pain. ZIK has spread into developed, developing and undeveloped countries. In 1952, the first human cases were detected in Uganda and the United Republic of Tanzania. As a result, infants with microcephaly due to ZIKV began to be reported. The United States Centers for Disease Control and Prevention (CDC) announced that ZIKV infection during pregnancy is a cause of microcephaly, producing severe fetal brain defects and fetal death (CDC, 2016). In 2016, WHO announced that the outbreak of the ZIKV is an international public health emergency that was causing a pandemic outbreak, especially in areas where prevention and control of the disease was lacking (Heymann *et al.*, 2016). (Shinohara *et al.*, 2016) reported that Japanese travelers were infected with ZIKV after returning from southern Thailand. Soon after, a Thai patient with ZIKV traveling to Taiwan was detected at the Taipei airport by using RT-PCR and ELISA (Huang *et al.*, 2016). The Thai Department of Disease Control (DDC) has reported cases of this disease since 2017. The number of ZIKV cases in Thailand was 544 in 2017, 601 in 2018, and 274 in 2019 (Table 1).

1.3.2 Protozao

1.3.2.1 Malaria

Malaria is a parasitic disease causing a tremendous amount of deaths in most tropical regions of the world, especially sub-Saharan Africa (Figure 3). An estimated 156 and 158 million malaria cases occurred worldwide in 2017 and 2018 respectively, compared with 115 million cases in 2010 (WHO, 2019c). In 2018, the mortality due to malaria reached 405,000 deaths worldwide. The largest burden occurs in the WHO African Region with 93% of all malaria cases (213 million) and 94% of fatalities (380,000), followed by the Southeast Asian region (3.4%) and the Eastern Mediterranean region (2.1%) (Organization, 2019). At least four species of *Plasmodium* have been recognized to commonly infect humans and cause malaria disease, including *Plasmodium falciparum*, *Plasmodium vivax*, *Plasmodium malariae* and *Plasmodium ovale* (Wernsdorfer and Mac Gregor, 1988). Recently, *P. knowlesi*, a simian malaria parasite, has been found to infect humans in the Southeast Asian region with increasing frequency (Hii *et al.*, 2018). This species is currently the most common cause of human malaria in Malaysia (Karunajeewa and Berman, 2019). For example, in 2016, Malaysia reported a total of 428 malaria cases and 340 (82.9%) cases were derived from *P. knowlesi* (Ramdzan *et al.*, 2020). In the state of Sabah, suspected *P. knowlesi* reports increased from 2% (59/2,741) of total malaria notifications in 2004 to 62% (996/1,606) in 2013 (Fornace *et al.*, 2016). With the addition of this fifth *Plasmodium* species, *P. falciparum* and *P. vivax* are the most predominant malaria species in Southeast Asia.

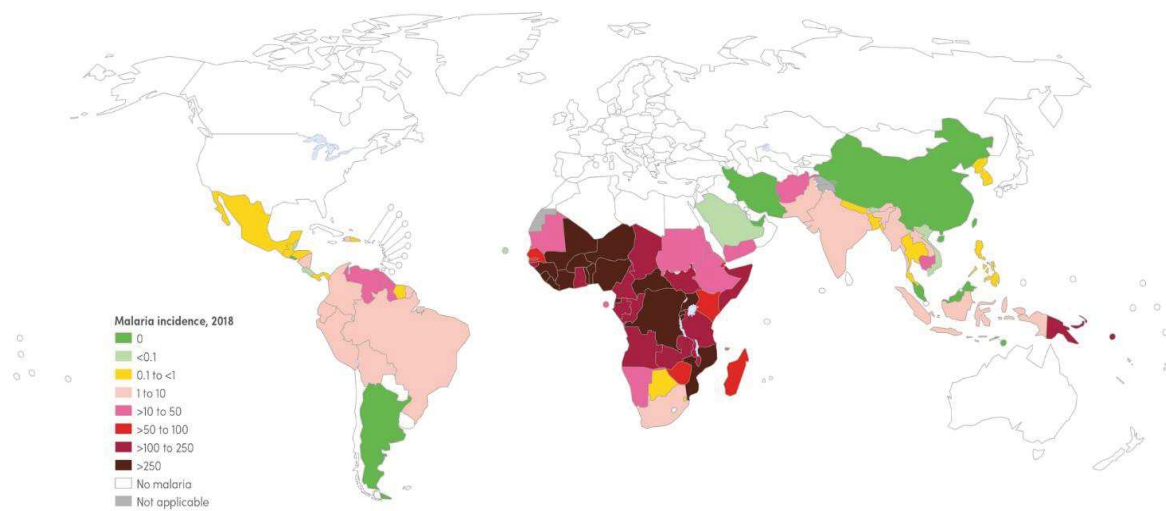

WHO: World Health Organization.

Figure 3 Map of malaria case incidence rate (cases per 1,000 people at risk) by country in 2018

Source: WHO database (2019)

In Thailand, the number of malaria cases has been significantly reduced since 1996 (Chareonviriyaphap *et al.*, 2000; Tananchai *et al.*, 2019). The current situation of malaria cases were reported along the Thai international borders with Myanmar on the west and north (35.4%), Laos on the north and east (2.2%), Cambodia on the east (7.8%), and Malaysia on the south (49.8%) (DVBD, 2109). In 2019, a total of 3,204,807 migrant workers lived in Thailand. These workers are mostly from neighboring countries, especially Myanmar (58%), Cambodia (23%), and Lao (9%) (FEAO, Foreign Workers Administration Office. 2019). The cross-border movement of the population includes many illegal crossings that can lead to malaria transmission and making the control of the spread of this disease very difficult (Kaehler *et al.*, 2019).

The Department of Disease Control (DDC), Ministry of Public Health (MOPH) is the main governmental institute that compiles all malaria data in the country. Table 1 shows malaria cases documented by the Bureau of Epidemiology (BOE), DDC, MOPH. Most malaria cases have been reported from the undeveloped and poor margin sites along the Thai-Myanmar, Thai-Malaysia, Thai-Cambodia and Thai-Lao borders. For this reason, malaria remains

a focus in some locations with low economic conditions, uncontrolled population movements and an unstable political climate (DVBD 2018).

1.3.3 Helminth

1.3.3.1 Lymphatic filariasis (LF)

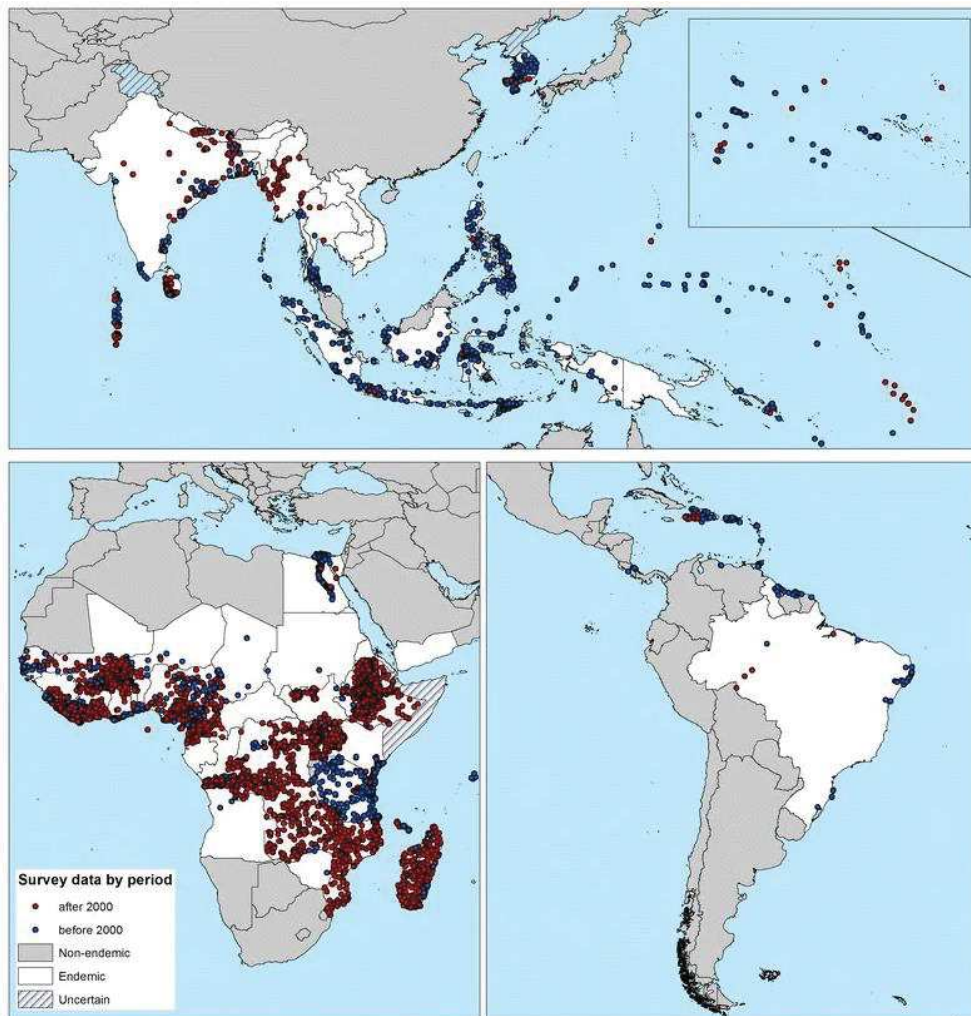

Figure 4 The global distribution and transmission limits of lymphatic filariasis

Source: Cano *et al.* (2014)

Lymphatic filariasis (LF) is one of the oldest known and most debilitating neglected tropical disease. The clinical manifestations include painful and incapacitating lymphoedema called elephantiasis (Ramaiah and Ottesen, 2014). More than 1.4 billion people in 50 countries throughout the tropics and sub-tropics are faced by LF (Figure 4) (Joshi, 2018). LF is caused by infection with nematodes of the Filarioididae family that includes three species of human-parasitic worms, *Wuchereria bancrofti*, *Brugia malayi* and *Brugia timori*. They are transmitted to humans by different genera of mosquitoes (Manguin *et al.*, 2010). This disease is caused by macroscopic nematode pathogens, of which *W. bancrofti* is responsible for 90% of all human LF infections. The remaining 10% of infections are due to the other two species of the genus *Brugia* that occur only in Asia. There are three variants of *W. bancrofti* recognized based on periodicity patterns of circulating microfilaria (mf) found in peripheral blood of humans; namely, the nocturnally periodic (NP), nocturnal subperiodic (NSP) and diurnal subperiodic (DSP) forms (Manguin *et al.*, 2010).

An estimated 120 million people in 81 countries are infected with at least one of these parasite species, and an estimated 1.34 billion live in areas where filariasis is endemic and are therefore at risk of infection (WHO, 2010). The Southeast Asian region has been reported to have the highest burden. The region also accounts for approximately 57% of the total global burden of 5.1 million disability-adjusted-life-years lost due to LF (WHO, 2010). Thus, achieving the goal of eliminating LF in Southeast Asia will have a significant impact on reducing the global burden of this disease. In Thailand, the endemic areas are located along the western border of the country and in the South. *Brugia malayi*, transmitted by the *Culex quinquefasciatus*, is endemic in the southern part of the country, while *W. bancrofti*, transmitted by mosquitoes belonging to the *Anopheles* genus in rural areas and the *Culex* genus in urban ones, is endemic in the western border provinces (Sudomo *et al.*, 2010). A total of 4 to 20 cases of LF were reported in Thailand between 2014-2019 (Table 1).

2. Vector control strategies

Due to frequent outbreaks of mosquito-borne diseases, vector control is one of the most important strategies to interrupt the disease transmission cycle between humans and mosquito

vectors. Vector control in Thailand has one mission with a single purpose, which is to prevent vector-borne diseases from affecting the citizens of Thailand. The Division of Vector Borne Disease, Ministry of Public Health, is in charge of vector control programs. Since effective vaccines or drugs are not always available for the prevention or treatment of diseases, control of disease transmission often relies mainly on the control of the disease vectors. Several different methods such as chemical, biological and physical techniques are being used for mosquito control. The three main methods of vector control that have been used in Thailand are as follows:

Chemical control: The use of pesticides in Thailand began during the Second World War with the importation of DDT (dichlorodiphenyltrichloroethane) to launch an anti-malaria campaign (Thongdara *et al.*, 2009). In Thailand, DDT was first used in 1950 as an insecticide of choice in agricultural practices and in public health to control malaria vectors (Kumblad *et al.*, 2001). The use of DDT in vector control had resulted in tremendous success to interrupt malaria transmission (Chareonviriyaphap *et al.*, 2000). In 1983, DDT was banned from Thailand because of the adverse effect on animal species such as fish and mammals, and its long persistence in the environment (Volta *et al.*, 2009). Subsequent types of synthetic compounds were introduced to Thailand, including organophosphates, carbamates and pyrethroids. These compounds have been extensively used in Thailand for the control of both agricultural pests and human/animal disease vectors (Chareonviriyaphap *et al.*, 2013). In recent years, pyrethroids have been the most widely used family of insecticides in mosquito control programs because they are safe to animals and cause relatively low environment harm (Chrustek *et al.*, 2018). Synthetic pyrethroids have commonly been used to kill adult mosquitoes, especially during outbreak events, particularly permethrin and deltamethrin, which were introduced to Thailand in the early 1990s for the control of malaria (mainly impregnated in bednets) and dengue (mainly thermal fogging and ULV sprays) (Plernsub *et al.*, 2016). Temephos, which is an organophosphate insecticide, is mainly used as a larvicide to control *Aedes* larvae.

Physical control: The simple principle of this method consists in environmental management to eliminate mosquito breeding sites for controlling mosquito larvae (Rafatjah, 1976). For example, urban development in many parts of the world occurs without the consultation

of entomologists, epidemiologists, and health-care specialists to address issues such as storm water management, urban refugia, and vector control (Norris, 2004).

Biological control: This method is used to reduce densities of larval and adult stages of mosquitoes. Some biological agents include viruses, bacteria, protozoa, fungi, plants, parasitic worms, predatory mosquitoes, copepods, and fish. For instance, the fish (*Gambusia affinis*) has been introduced to mosquito breeding sites for controlling mosquito larvae in 1944 (Chandra *et al.*, 2008; Wongsiri and Andre, 1984).

2.1 Malaria vector control

Up to now, the significant successful eradication of malaria in various parts of the world has been achieved mainly based on vector control strategies (Harrison, 1978) and this control remains on the forefront in the fight against malaria in endemic areas, having relied principally on long-lasting insecticidal nets (LLINs) (Hoel *et al.*, 2007) and indoor residual spraying (IRS) (Javelle *et al.*, 2019). Thailand has had great success in the national malaria control program, based on vector control and the application of IRS with DDT to control transmission from 1949-1951 (Chareonviriyaphap *et al.*, 2000). Based on highly successful field trials, DDT became the insecticide of choice for mosquito vector control in the country until DDT importation for public health use was stopped in 1995. The DDT termination was due partly to the perceived adverse environmental and human health issues and reports of poor community compliance and acceptance. In 1994, DDT was replaced by other insecticide families to control malaria, such as organophosphates, carbamates and synthetic pyrethroids. Currently, synthetic pyrethroids are the most widely used insecticide family in mosquito control in Thailand, and more globally around the world, which contains insecticides such as deltamethrin, cypermethrin, and permethrin. Alternatively, temephos, an organophosphate, is mainly used to control mosquito larvae (Chareonviriyaphap *et al.*, 2013; Kongmee *et al.*, 2019).

LLINs and IRS have significantly decreased malaria transmission by reducing indoor mosquito biting. However, reaching the malaria transmission reduction goal with LLINs has not been achieved because behavioral resistance occurs in mosquitoes i.e., their behaviors change to

avoid exposure to insecticides by feeding outdoors instead (Roberts and Andre, 1994). Tananchai *et al.* (2019) has recently published a review showing that residual malaria transmission can persist despite comprehensive, population-wide coverage of LLINs and IRS with chemical molecules to which local vector populations are fully susceptible. Topical repellents could offer a good personal protection (Debboun and Strickman, 2013) to be potentially used as complement to LLINs and IRS for additional protection from residual transmission (Alonso *et al.*, 2011). Numerous investigations have demonstrated that topical repellents could offer great protection from malaria transmission either when used alone, or in combination with LLINs or IRS, in areas with highly exophagic mosquito vectors to better control outdoor malaria transmission (Hill *et al.*, 2007; Rowland *et al.*, 2004). Personal protection using insect repellents is considered to be one of the most efficient means to reduce the outdoor transmission of mosquito-borne diseases (Durnez and Coosemans, 2013).

2.2 Dengue vector control

Aedes aegypti is highly anthropophilic, often resides in and near human houses. This species is highly adapted to all man-made and natural environments and is the main vector of dengue virus in tropical and sub-tropical regions (Powell and Tabachnick, 2013). The key to preventing dengue transmission is to reduce human-vector contact using synthetic chemicals. Several synthetic insecticides have been used in dengue control programs, including organochlorines, organophosphates, carbamates, and synthetic pyrethroids. Deltamethrin is currently the most commonly used insecticide in public health programs and has been the mainstay for the emergency control of *Ae. aegypti* adults in Thailand since 1994. Temephos is also commonly used in water containers for the control of *Aedes* larvae, as well as *Bacillus thuringiensis israelensis (bti)* used as a biocontrol agent to control *Ae. aegypti* larvae (Loke *et al.*, 2010). Additionally, several synthetic pyrethroids are commonly used by home owners to control household mosquitoes (Chuaycharoensuk *et al.*, 2011; Garelli *et al.*, 2011). Decades of routine contact with insecticides have led to high levels of resistance in mosquitoes, especially *Ae. aegypti* (Chareonviriyaphap *et al.*, 2013). The development of resistance by *Ae. aegypti* is a key concern for disease control programs.

2.3 Synthetic insecticide resistance in mosquito control

Resistance is defined as when the “*insect can tolerate doses of insecticide that demonstrate lethal to greater number of individuals in a population of the same species*” (WHO, 1975). Nowadays, mosquitoes have been found that have developed a resistance to all main families of insecticides including organochlorines, organophosphates, and carbamates (Chareonviriyaphap *et al.*, 2013). Insecticide resistance has appeared in every major groups of insects and is a key obstacle in vector control programs. Resistance has been observed in more than 500 insect species worldwide (Hemingway and Ranson, 2000). Generally, response to insecticides can be categorized into two major types: physiological and behavioral resistances (Chareonviriyaphap *et al.*, 1997). “Physiological” resistance refers to the ability of a mosquito population to survive exposure to a concentration of insecticide that would normally result in a complete kill. The development of physiological resistance, which corresponds to metabolic and/or target site modifications to insecticides, has been well documented in many insect groups and disease vectors around the world. One or more mechanisms may be involved in physiological resistance, including alteration of target site nerve receptors (e.g., *kdr*, *Rdl* and *Ace.1R*) and detoxification *via* increased enzyme activity of non-specific esterases, glutathione S-transferases and P-450 mediated monooxygenases (mixed function oxidases). In contrast, “behavioral” avoidance is defined as the ability of an insect to move away from an insecticide-treated area, often without lethal consequence. This type of response can be further divided into direct contact excitation, known as ‘irritancy’, and non-contact spatial ‘repellency’. The term ‘contact irritancy’ involves an insect leaving an insecticide treated area after making direct physical contact with the treated chemical, whereas ‘spatial repellency’ is when insects escape from the insecticide-treated area without making direct contact (Chareonviriyaphap *et al.*, 2013).

Close to 80% of the active ingredients being used in homes are pyrethroids. Thermal fogging and ultra-low volume (ULV) sprays are commonly used against adult dengue mosquitoes but they are becoming increasingly less effective due to resistance developing in vector populations (Chareonviriyaphap *et al.*, 2013). The development of insecticide resistance in mosquitoes is a serious public health issue everywhere including Southeast Asian countries. In Thailand, *Ae. aegypti* has been reported to be resistant to all major groups of insecticides, such as

organochlorines (DDT), organophosphates (fenitrothion, malathion, and temephos), carbamates (proprhex) and synthetic pyrethroids (deltamethrin, permethrin, lambda-cyhalothrin and etofenprox) (Chareonviriyaphap *et al.*, 1999; Chareonviriyaphap *et al.*, 2013; Paeporn *et al.*, 2005; Somboon *et al.*, 2003). Resistance of *Ae. aegypti* to insecticides has been reported across different parts of Thailand (Thanispong *et al.*, 2013; Thanispong *et al.*, 2008). Furthermore, Jirakanjanakit *et al.* (2014) reported that *Ae. aegypti* populations, from different provinces of Thailand, were incipient resistant or resistant to deltamethrin and permethrin, except those from some areas of Songkhla Province (southern) and Phan District of Chiang Rai Province (northern). From the same study, susceptibility to fenitrothion was also found in *Ae. aegypti* populations from Bangkok (central), Chonburi (eastern), Chiang Rai, Kanchanaburi (western), and Songkhla, whereas, resistance was found in almost all areas of Nakhon Sawan (north central) and Nakhon Ratchasima (northeastern) Provinces.

For *Anopheles* mosquitoes, the use of pyrethroids in nets and the long use of other chemical classes such as organochlorine compounds (e.g. dichlorodiphenyltrichloroethane, DDT) and organophosphate compounds for IRS have all led to the development of resistance against the pyrethroids. Resistance to one class of insecticides has been reported in at least one malaria vector species in 60 of the 96 malaria-endemic countries that conducted monitoring since 2010. Forty-nine malaria endemic countries documented resistance to at least two classes of insecticides (WHO, 2016). In addition, resistance to all four available classes of synthetic insecticide has been reported (Mnzava *et al.*, 2015).

In Thailand, insecticides have been used for IRS combined with LLINs to control malaria. Four groups of insecticides, organochlorines, organophosphates, carbamates, and pyrethroids, are recommended by WHO (Organization, 1998). Chareonviriyaphap *et al.* (2013) reported that *An. minimus* and *An. annularis* from the northwestern part of Thailand were resistant to DDT, even though this insecticide was banned in Thailand 20 years ago (Kumblad *et al.*, 2001). DDT was replaced by the organophosphates, carbamates, and synthetic pyrethroids, sequentially. Currently, the synthetic pyrethroid group is the only one that plays a major role for IRS and LLINs in Thailand due to its low human toxicity (Khan, 1983). Fortunately, very few reports of insecticide resistance in *Anopheles* mosquitoes have been reported in Thailand. For instance, Sumarnrote *et*

al. (2017) reported that *Anopheles* spp. from Ubon Ratchathani Province, *An. dirus* s.l., *An. maculatus* s.l., *An. barbirostris*, *An. nivipes* and *An. philippinensis* were susceptible to pyrethroid insecticides (deltamethrin and permethrin), only *An. peditaeniatus* of the Hyrcanus group, was resistant to DDT, deltamethrin and permethrin along the Thailand-Lao (Sumarnrote *et al.*, 2020; Sumarnrote *et al.*, 2017). Resistance or suspected resistance to DDT, deltamethrin and permethrin was also detected in *An. barbirostris* s.l., *An. hyrcanus* s.l. , *An. jamesii*, *An. maculatus* s.l. and *An. vagus* collected along the Thailand-Myanmar border (Chaumeau *et al.*, 2017).

3. Stimuli that attract mosquitoes

Mosquitoes use visual, thermal, and olfactory stimuli to locate their hosts (Raji and DeGennaro, 2017). Olfaction is probably the most important one because it enables mosquitoes to detect carbon dioxide (CO₂) exhaled from human breath from a distance by using sensory organs in their antenna and maxillary palps (Figure 5) (Lu *et al.*, 2007). Mosquitoes use visual receptors to enable more accurate location of their vertebrate hosts and when mosquitoes get closer, they can detect the host body heat and skin volatiles to help them identify a landing site (Eiras and Jepson, 1994).

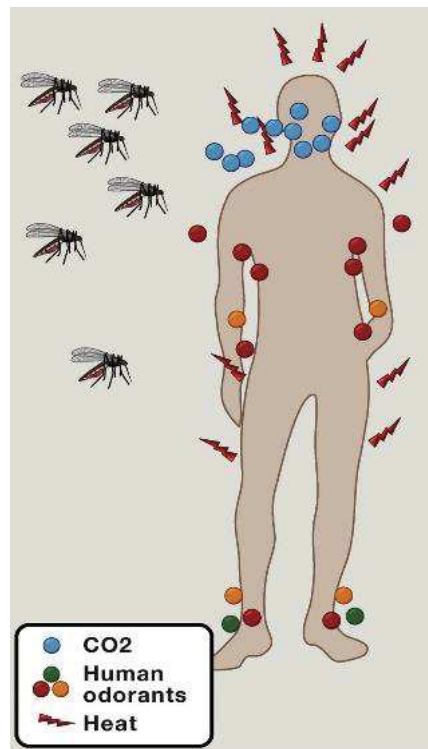

Figure 5 Stimuli attracting mosquitoes to humans

Source: Potter (2014)

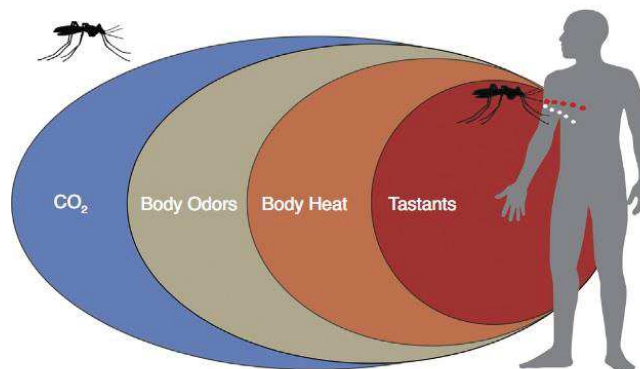

Figure 6 Combination of cues used by mosquitoes to detect humans

Source: Raji and DeGennaro (2017)

Many compounds are released from humans as products of metabolism and over 100 volatile compounds in human breath and body emanations have been identified (Bock and Cardew, 2008). Among these compounds, only a few of them have been isolated and fully characterized.

The CO₂ and lactic acid from human skin are the two major factors influencing mosquito-human attraction. The more carbon dioxide is released into the air from human breath, the better as it serves as a long-range airborne attractant that can be detected by mosquitoes from a distance (Figure 6). Human odorants mainly contain ammonia, L-lactic acid and 1-octen-3-ol. Lactic acid, in combination with carbon dioxide, is also attractive to mosquitoes (Njiru *et al.*, 2006). The blend of host odors are found more attractive than carbon dioxide or lactic acid alone (Gillies, 1980; Gillies and Wilkes, 1972; Njiru *et al.*, 2006). Skin temperature and moisture play a key role in attracting mosquitoes when they get closer to the host (Khan, 1977). Different species of mosquitoes may display strong biting preferences for different parts of the human body (such as the head, hand or feet), which may be related to local skin temperature and eccrine sweat gland output (Figure 6) (Takken and Verhulst, 2013). Control of these mosquitoes is largely limited to use of repellents and insecticides. Recently, steps have been taken to study the attraction of these insects to their hosts and thereby attempt to cut off the lethal action of these pests at the source itself (Keswani and Bellare, 2010).

3.1 Chemoreceptors in mosquitoes

Chemoreceptors are the first to detect chemical messages from the environment and translate it into a message that can be processed in the organism (Meinwald and Eisner, 1995). They are usually located at the interface between organism and environment. Multicellular organisms have developed specialized sensory organs, these receptors are specifically localized in dendrites of the chemosensory neurons (Wicher and Marion-Poll, 2018). Mosquitoes largely use their olfactory sense to smell and find blood hosts, nectar sources, resting places, oviposition sites, and to avoid some repellents (Ray, 2015). Chemoreception has received less attention among the chemical senses of mosquitoes, while there is more effort to understand the sensory physiology of feeding in mosquitoes. Studies have also been concerned with discovery of the stimuli that attract mosquitoes to their host. The contact chemoreceptor organs of mosquitoes are known to be located on the tarsi, labella, and ligula (Owen, 1963).

Chemoreceptors of smell (olfaction) and taste (gustation) are proteins or protein complexes (Sparks *et al.*, 2018). Mosquitoes can detect odor chemicals from hosts at distance through their olfactory receptors located on their antenna and on the maxillary palps, whereas mosquitoes detect taste chemicals using gustatory receptors or taste receptors located on the mosquito tarsi and labellum, which play major roles in pre-biting and biting (Sparks *et al.*, 2013). These receptors were first identified in *Drosophila* using bioinformatic and molecular approaches, a total of 60 olfactory receptor (OR) and 60 gustatory receptor (GR) genes were identified in *D. melanogaster* (Robertson *et al.*, 2003). Subsequently, other insects including mosquitoes have been studied, three chemosensory receptors were found in the *Anopheles gambiae* genome: 79 ORs (Pitts *et al.*, 2004), 46 ionotropic receptors (Javelle *et al.*) (Liu *et al.*, 2010), and 60 GRs (Lu *et al.*, 2007).

3.2 Olfactory receptor neurons

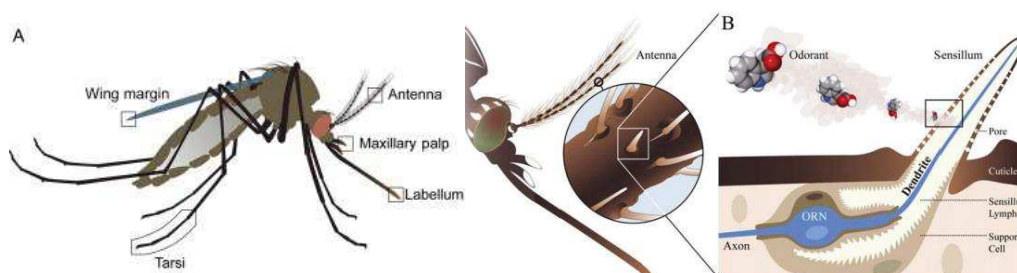

Figure 7 (A) Insect chemosensory organs: antennae, maxillary palps, labellum, tarsi and wing margin covered by sensilla. (B) An olfactory sensillum housing support cells and an olfactory receptor neuron (ORN in blue); odorants bind to receptors in the ORN dendrite across sensillum lymph after penetration through cuticular pores.

Source: Suh *et al.* (2014) receptors to detect both carbon dioxide as well as skin odors

Chemosensory neurons are present in specialized sensory hairs called sensilla. In mosquitoes, olfactory sensilla are present on two pairs of olfactory organs on the head, antenna and maxillary palps. Several pores found in the cuticular walls of the sensilla allow passage of odorant molecules from the environment to the dendrites of ORNs (Figure 7) (Potter, 2014).

Mosquitoes use these receptors to detect their host cues, including carbon dioxide (CO₂) and host odor at a distance. In 1962, the first single-cell recording of an olfactory receptor neuron (ORN) was recorded in the Necrophorous carrion beetle (Boeckh, 1962). In 1976, Lacher (1967) reported the ORNs in *Aedes aegypti* using electrophysiological recordings.

3.3 Gustatory receptor neurons (GRNs)

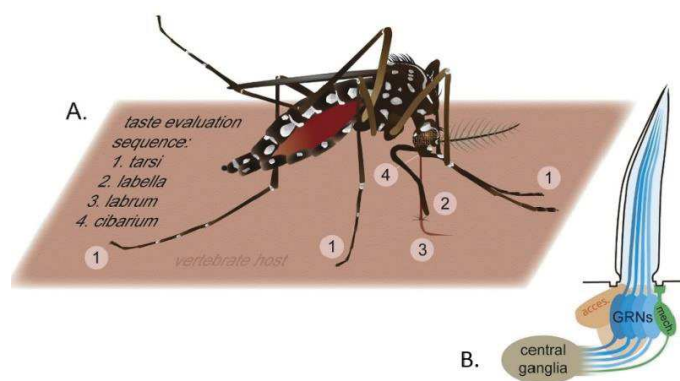

Figure 8 (A) Locations of gustatory sensilla in female mosquitoes, on tarsi (1), labella (2), labrum (3), and cibarium (4), used for locating and landing on a potential host. (B) Gustatory receptor neurons (GRNs) and a single mechanosensory neuron (mech.) in a single sensillum

Source: Sparks and Dickens (2017)

Gustatory (taste) sensilla have an uniparous opening at the tip of cuticle taking the form of hairs or pegs containing lumen-filled spaces that serve as the interface between the aqueous chemical environment and the nervous system (GRNs), typically four, and a mechanosensory neuron (Figure 8). Physiological and behavioral analysis has shown that mosquito GRNs are tuned to four classes of compounds: sugars (attractants), bitter compounds (repellents), salts and water. Techniques for electrophysiological recording from gustatory receptors neurons (GRNs) in insect were first rescripted by Hodgson *et al.* (1955), and recently the recording of GRNs in mosquitoes responding to insect repellents was made by Sparks *et al.* (2018).

3.2 Insect repellent

4.1 Modes of action of mosquito repellents

Mosquito repellents are substances designed to make people unattractive to mosquitoes and keep mosquitoes away from people (Patel *et al.*, 2012). Most repellent substances work by interfering with the mosquito's ability to detect attractant chemicals that humans produce or they may prevent biting mosquitoes from landing and biting (Bernier *et al.*, 2006). The mosquitoes have the ability to follow human emanations such as CO₂, lactic acid or carboxylic acid, allowing them to locate their hosts (Bernier *et al.*, 2000). For example, repellents containing DEET (diethyltoluamide), as an active ingredient, will evaporate when applied to the skin (Santhanam *et al.*, 2005). DEET will inhibit the binding of the human host stimuli to mosquito chemical receptors. This essentially "hides" the protected person from the mosquito. Since the active ingredient must evaporate from the surface to start working, the repellent activity lasts for a limited time, usually few hours (Karr *et al.*, 2012).

Discovery and characterization of behaviorally active odor compounds are important because they can assist us in developing new repellent active ingredients against mosquitoes (Maia and Moore, 2011). Mosquitoes have complicated olfactory systems with hundreds of receptor proteins from three different families: olfactory receptors (ORs) or odorant receptors, ionotropic receptors (IR) and gustatory receptors (GR), or taste receptors families (Ray, 2015).

Olfactory and gustatory systems play a key role for insects to survive, reproduce, mate, and find hosts or oviposition sites (Hansson and Stensmyr, 2011). Insects are extremely sensitive to chemosensory systems that can detect and discriminate blood host types based on chemical cues (Ben-Shaul, 2015). The ability to respond to various chemical compounds is conferred by odor and taste receptors, which in both insects and mammals have seven transmembrane domain receptors encoded by highly diverse gene families (Gross, 2006). Recent progress in determining the chemical specificities and functional properties of these receptors has provided insight into the mechanisms underlying odor and taste coding in insects.

4.2 Mosquito-insecticide interaction concept

The terminology and definition of repellents target to create a unique and useful vocabulary allowing to describe mosquito chemical interactions are defined in this section. Acceptable terms accurately pass on information about behavioral response (effects), as well as accurately delineate their mediating mechanisms (causes). The terms of mosquito-insecticide interaction have been expanded in an attempt to convey the interactions between mosquitoes and chemicals (Dethier *et al.*, 1960; Haynes, 1988; Miller *et al.*, 2009).

For sublethal effects of insecticides, these terms were applied to agents that interfere with the normal physiological processes of growth, reproduction and their behaviors without necessarily leading to mortality (Levinson, 1975). Dethier *et al.* (1960) redefined repellent as “*a chemical causing a responder to make movements oriented away from the stimulus source*”. Repellent required “action-at-distance”; thus, a repellent must act in the vapor phase, as an odor and can activate tastes as well as olfactory receptor (Christophers, 1947). Although this is the term of repellent given by Dethier *et al.* (1960), this definition may mislead to determine the sensory-behavioral mechanisms associated with host attraction and repulsion. Davis (1985) proposed that repellent may interfere with the perception of host-attractant signals by: (1) exciting a receptor for a competing behavior, (2) switching a sensory message from attraction to repulsion, (3) activating several different receptor systems and so jam the meaningful sensory information, and/or (4) exciting a repellent (i.e., noxious substance) receptor. U.S. Environmental Protection Agency (EPA) test guidelines describe a repellent as “*a product intended to disrupt the host-seeking behavior of insect or other arthropods, driving or keeping them away from treated human skin*” (King, 1951). In 1993, Roberts *et al.* (1997) used the term of excito-repellency to encompass all chemical-interaction inducing irritant and repellent behaviors. They further demonstrated the actions between activities of avoidance resulting from physical contact and noncontact action by classifying chemicals as irritant when tarsal contact is required and as repellent when avoidance is provoked by the volatile.

Then, Chareonviriyaphap *et al.* (2013) reported that the mosquito behavior in responses to chemical appears to evolve after a certain time of exposure. The term of behavioral

avoidance was suggested, e.g. modified behavior whereby indoor biting (endophilic) mosquitoes sometime adapt to biting outdoor (exophilic) in response to the pressure of IRS. Resistance describes the ability of insect population to withstand a toxicant to a greater extent than a normal population and this ability of insects could be passed onto the next generation.

4.3 Evolution of topical mosquito repellents

Mosquito repellents prevent humans from the bite of female mosquitoes and help avoid the possible transmission of vector-borne pathogens, if any. Historically, the strategies for reducing the incidence of mosquito-borne diseases have been two pronged, centering on habitat control using chemical and biological means, and applying personal protection in the form of insect repellents. The insect repellent compounds such as various plant oils, smokes, tars, etc., were used to displace or kill insects. Beyond history, human observed several groups of animals anoint themselves with leave, fruit, and even millipedes that contain chemical that are proven deterrents of mosquitoes (Weldon *et al.*, 2003; Weldon *et al.*, 2011). This observation showed that personal protection by applying repellents could reduce the contact with arthropod-vectors (Weldon, 2004). Before the World War II (WWII), there were only four principal repellents: (1) Citronella used as a hair dressing for head lice, (2) dimethyl phthalate discovered in 1929, (3) Indalone® , which was patented in 1937, and (4) Rutgers 612, which became available in 1939 (Peterson and Coats, 2001).

During the WWII, the first development of new repellent technologies was triggered, as the tropical areas posed significant vector-borne disease threats to allied military personal. More of less 20,000 chemicals were evaluated but less than 10% showed a respectable repellency activities (Dethier, 1956). One of the most effective and widely used insect repellents is *N, N*-diethyl-meta-toluamide (DEET) (Figure 9). Until now, other synthesized topical repellent compounds have been heavily relied on previous investigations, which identified amide and imide compounds as highly successful contact repellents. Among these are picaridin, a piperidine carboxylate ester, and IR3535 (Figure 9), which are currently considered to rival DEET in some repellency bioassays (Norris and Coats, 2017).

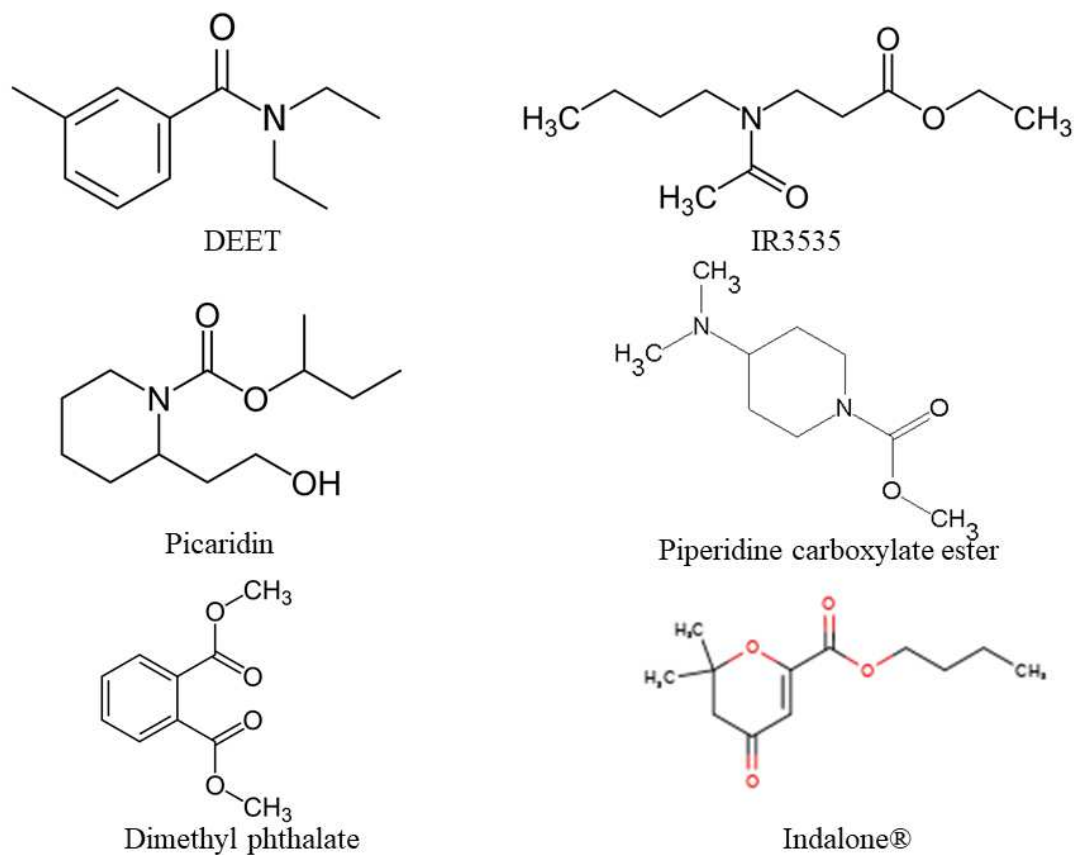

Figure 9 Structure of six insect repellents.

4.4 Recommendation for insect repellents

In USA, Centers for Disease Control and Prevention (CDC) recommends that consumer uses repellent products that have been registered by the Environmental Protection Agency (EPA). EPA registration approved for both efficacy, toxicity and human safety when applied accordingly to the instructions on the label. Under the regulation, EPA is required to review scientific studies and data on the market before registering a repellent. EPA characterizes the active ingredients, DEET and picaridin, as “conventional repellents” (Zielinski-Gutierrez *et al.*, 2012). The EPA estimates that over 38% of U.S. citizen uses a DEET-based insect repellent each year, accounting for more than 20 million people annually (EPA, U.S. Environmental Protection Agency 1980). Despite assurance from the US agency regarding the safety of DEET, users frequently

express concern over the use of conventional repellents and may prefer to apply plant-based repellent alternatives (CDC, 2008). Reasons may include concerns of encephalopathy and neurotoxic effects, particularly in children from using the synthetic repellent such as DEET (Briassoulis *et al.*, 2001; Hidayatulfathi *et al.*, 2017). Thus, patients are referred to use natural components, which could be safer, eco-friendly, and just as effective as conventional repellents (Ashwini *et al.*, 2013; Chen-Hussey *et al.*, 2014).

In conclusion, the EPA and CDC strongly recommend products containing EPA registered active ingredients for personal use on skin and/or clothing that include *N,N* diethylmetatoluamide (DEET), picaridin (also known as KBR 3023, Bayrepel and icaridin), IR3535 (Ethyl butylacetylaminopropionate), oil of lemon eucalyptus (p-menthane-3,8-diol), catnip oil, 2-undecanone, citronella, and permethrin (applied on clothing only) as shown in Table 2.

Table 2 Insect repellents registered by the Environmental Protection Agency (EPA)

Insect repellents	Structure or Major components	CAS Number
DEET	<i>N,N</i> -diethyl- <i>m</i> -toluamide	134-62-3
Picaridin	1-piperidinecarboxylic acid 2-(2-hydroxyethyl)-1-methylpropylester	119515-38-7
Permethrin	3-phenoxybenzyl (1 <i>RS</i> ,3 <i>RS</i> ;1 <i>RS</i> ,3 <i>SR</i>)-3-(2,2-dichlorovinyl)-2,2-dimethyl-cyclopropanecarboxylate	52645-53-1
IR 3535	Ethyl <i>N</i> -acetyl- <i>N</i> -butyl- β -alaninate	52304-36-6
PMD	<i>p</i> -Menthane-3,8-diol	42822-86-6
Methyl nonyl ketone (MNK)	2-undecanone	112-12-9
Lemon Eucalyptus oil	1,8-Cineole	-
Catnip oil	Nepetalactone	-
Citronella oil	3,7-dimethyl-octenal	-

In Thailand, there are two major governmental agencies such as the Ministry of Public Health (MoPH) responsible for public health household products, including the Bureau of Cosmetic and Hazardous Substance Control, Food and Drug Administration (FDA), and the National Institute of Health (Agnihotri *et al.*), and the Department of Medical Science (DMSc). Registration and licensing on pesticides for public usage are regulated by FDA with supporting

test results from the DMSc, Ministry of Public Health. There are several legal instruments established to control the use of public health pesticides and to reduce their risk to human health and the environment. Among these laws and regulations, the Hazardous Substance Control Act (HSCA) B.E. 2535 (1992) is considered the most important chemical control law in Thailand. The purpose of the HSCA is to regulate the importation, production, marketing, and possession of all hazardous chemicals (including industrial chemicals, pesticides and biocides) used in Thailand. Under this Act, the Hazardous Substance Committee (HSC) was set up as the governing body, which assigned various aspects of governance to three main Thai ministries: Ministry of Industry (MOI), Ministry of Public Health (MoPH), and Ministry of Agriculture and Cooperatives (MoAC). Registration of insect repellents and household insecticides are carried out by different authorities, all insect repellents used in the public health programs are subjected to registration at the FDA. This mandatory process is to assure human safety and quality or efficacy of the products. The registration process of hazardous substances used in household and public health is approved by the Hazardous Substances Control Division. In Thailand, DEET, icaridin, and ethyl butylacetyl amino propionate (IR3535) are used as active ingredients in FDA-registered-skin applied insect repellents, whereas citronella oil does not require registration because it is defined as a natural ingredient. The US EPA and Thai FDA issued guidelines to consumers about proper application of insect repellents (Table 3).

Table 3 The Environmental Protection Agency, U.S. and The Food and Drug Administration, Thailand Guide for the safe and effective use of repellents.

Applying the Product	Other Safety Tips
Read and follow the label directions to ensure proper use; be sure you understand how much to apply	Check the label to see if there are warnings about flammability. If so, do not use around open flames or lit cigarettes
Apply repellents only to exposed skin and/or clothing. Do not use under clothing	After returning indoors, wash treated skin and clothes with soap and water
Do not apply near eyes and mouth, and apply sparingly around ears	Do not use any product on pets or other animals unless the label clearly states it is for animals
When using sprays, do not spray directly into face; spray on hands first and then apply to face	Most insect repellents do not work against lice or fleas
Never use repellents over cuts, wounds, or irritated skin	Store insect repellents safely out of the reach of children, in a locked utility cabinet or garden shed
Do not spray in enclosed areas	Use other preventive actions to avoid getting bitten by mosquito
Avoid breathing a spray product	
Do not use it near food	

Table adapted from information presented by the United States Environmental Protection Agency, a government agency and factsheet of The Food and Drug Administration in Thailand.

4.5 How repellents contribute to disease prevention and vectorial capacity (?)

Insect repellents usually work by providing a vapor barrier deterring the insects from coming into direct contact with human skin (Nerio *et al.*, 2010). Area-applied repellents can provide protection from insect bites at distance that can exceed several meters (Bohbot *et al.*, 2014) (Figure 10).

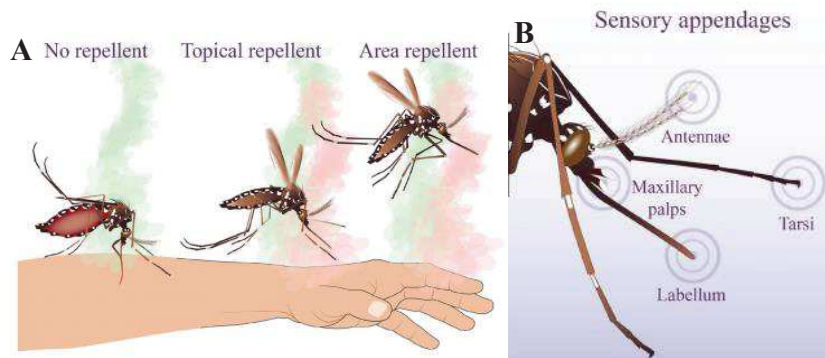

Figure 10 (A) Spatial insect repellent exhibits its effect at distance. (B) Sensory receptors (odorant receptor, gustatory receptor, and ionotropic receptor, distributed on various arthropod appendages).

Source: (Bohbot *et al.*, 2014)

The mosquito vectors success to transmitting pathogens to a human depends on their ability to find the host and blood feed. Among factors that influence the rate at which new human disease infections are disseminated per day by a mosquito i.e. vectorial capacity (Ogoma *et al.*, 2014).

Vectorial capacity

$$c = \frac{ma^2bp^n}{-ln^p}$$

Equation describing the vectorial capacity of a particular vector population.

C = new infections disseminated / person / day by each mosquito

m = number of mosquitoes / person

a = probability a vector feeds on host / day

ma = the number of bites/ man / days

p = probability of daily vector survival

$1/-ln^p$ = duration of the vector's life in days once it has survived the intrinsic incubation period

n = duration of the extrinsic incubation period in days

b = proportion of sporozoite positive mosquitoes that are infectious

Vectorial capacity (VC) is a measure of the effectiveness of a given vector species to transmit disease pathogens. VC is defined as “*the average number of inoculations with a specific parasite, originating from one case of malaria unit time, that the population would distribute to man if all the vector females biting the case became infected*”. The majority of work involving the VC equation has considered insecticides that reduce both number and life expectancy of mosquito to have an excellent impact on reducing vector-borne diseases intensity. The interruption of host-seeking is the keystone for all arthropod-disease vector control programs. This metric is reliant on a number of factors that either increase or decrease the likelihood of an arthropod vector to successfully disseminate biologically viable disease agents to their target host species. VC is extremely sensitive to changes in the biting rate because a vector needs to bite twice to obtain and then transmit a pathogen, hence, human biting is squared the equation (Ma^2). Thus, the use of repellent will have strong effect on overall VC by reducing the probability of infecting or being infected by a vector, as described by Ma^2 . Numerous studies have attempted to characterize the effect of repellent on the decrease of arthropod disease transmission (Kroeger *et al.*, 1997; Naowarat *et al.*, 2012; Philip *et al.*, 1944). Naowarat *et al.* (2012) demonstrated that when the numbers of humans, which used the mosquito repellents, is increasing, it is decreasing the numbers of the susceptible human to receive CHIKV.

5. Natural repellents against mosquitoes

Since a long time before the dawn of synthetic chemicals, people have been using plants and plant-based substances to repel or kill mosquitoes and other domestic pest insects. Botanical repellents have been touted as attractive alternatives to synthetic chemical insecticides for vector controls because botanical reputedly pose little threat to the environment or health. Some of them are effective protection against insect bites including mosquitoes (Fallatah and Khater, 2010; Sutthanont *et al.*, 2010; Tawatsin *et al.*, 2001; Trongtokit *et al.*, 2005a). Plants and their extracts have been used for millennia to protect against or repel arthropods. Some of the earliest recorded uses of repellents are noted in the writings of Herodotus (484 BCE– ca 425 BCE) detailing the use of a plant oil by an Egyptian fisherman to repel mosquitoes (Paluch *et al.*, 2010). Some historical evidence of natural repellents showed that for example: The Ainu people of Hokkaido, Japan, and the Micmac Indians of Newfoundland (island), Canada, both wore leggings of sedge, bark, or cloth

to reduce insect which tends to be concentrated around the lower legs (Curtis *et al.*, 1990). Likewise, the ancient Chinese literature comprises many prescriptions for repellents against mosquitoes and other bloodsucking-insects (Dhang, 2014). Plant-based repellents are still extensively used in this traditional way throughout rural communities in the tropics because for many of the poorest communities, this is the only means of protection from mosquito bites that are available (Maia and Moore, 2011) and indeed for some of these communities, as in developed countries, “natural” smelling repellents are preferred because plants are perceived as safe and reliable for mosquito bite protection.

Traditional plants have been obtainable for use as medicinal plants to control mosquitoes and other arthropod pests. Selection by plants to produce repellents can be readily explained by their protective role against phytophagous insects (Maia and Moore, 2011). A location with high concentrations of botanical-based insect repellents is in tropical Asia and Southeast Asia, where numerous essential oils extracted from wild and domestic plants have been investigated for mosquito repellent activity (Table 4).

Table 4 An overview of repellent plant efficacy against mosquitoes in Thailand

Family	Common name	Plant	Used parts	Protection time (% Repellency)*	Mosquito Species	Sources
Annonaceae	Ylang ylang	<i>Cananga odorata</i>	Flower, Leave	8.4 min	<i>Ae. aegypti</i>	(Phasomkusolsil and Soonwera, 2011)
				24 min	<i>An. dirus</i>	
				60 min	<i>Cx. quinquefasciatus</i>	
Apiaceae	Sawtooth coriander	<i>Eryngium fortidum</i>		5 h	<i>Ae. albopictus</i>	(Bansidhi <i>et al.</i> , 2005)
				7.8 h	<i>Cx. quinquefasciatus</i>	
				8 h	<i>An. dirus</i>	
	Celery	<i>Apium graveolens</i>	-	3 h	<i>Ae. aegypti</i>	(Choochote <i>et al.</i> , 2004)
Araliaceae	Phakpaem	<i>Eleutherococcus trifoliatus</i>	-	8 h	<i>An. dirus</i>	(Tawatsin <i>et al.</i> , 2006)
				8 h	<i>Ae. albopictus</i>	

Table 4 (Continued)

Family	Common name	Plant	Used parts	Protection time (% Repellency)*	Mosquito Species	Sources
Gramineae	Citronella grass	<i>Cymbopogon nardus</i>	Stem	2 h	<i>Ae. aegypti</i>	(Trongtokit <i>et al.</i> , 2005b)
				100 min	<i>Cx. quinquefasciatus</i>	
				130 min	<i>An. minimus</i>	(Phasomkusolsil and Soonwera, 2010)
				140 min	<i>Cx. quinquefasciatus</i>	
				115 min	<i>Ae. aegypti</i>	
	Lemon grass	<i>Cymbopogon citratus</i>	Stem		Mosquito	(Trongtokit <i>et al.</i> , 2005b)
	Sweet basil	<i>Ocimum basilicum</i>	Leaves	30 min	<i>Ae. aegypti</i>	(Phasomkusolsil and Soonwera, 2010)
				30 min	<i>An. dirus</i>	
				42 min	<i>Cx. quinquefasciatus</i>	

Table 4 (Continued)

Family	Common name	Plant	Used parts	Protection time (% Repellency)	Species	Sources
Lauraceae	Litsea tree	<i>Litsea petiolata</i>	-		Mosquitoes	(Phukerd and Soonwera, 2014)
	Ta khri ton	<i>Litsea cubeba</i>	-	8 h	<i>An. dirus</i>	(Tawatsin <i>et al.</i> , 2006)
Lythraceae	Prayong	<i>Aglaia odorata</i>	-	8 h	<i>An. dirus</i>	(Tawatsin <i>et al.</i> , 2006)
				7.8 h	<i>Ae. albopictus</i>	
Myristicaceae	Nutmeg tree	<i>Myriaticum fragrans</i>	-	8 h	<i>An. dirus</i>	(Tawatsin <i>et al.</i> , 2006)
Myrtaceae	Clove	<i>Syzygium aromaticum</i>	Flower	(32.4%)	<i>Ae. aegypti</i>	(Trongtokit <i>et al.</i> , 2004)
				(89.0%)	<i>Cx. triaenorrhynchus</i> and <i>Cx. gelidus</i>	
				2 h	<i>Ae. aegypti</i>	
	Eucalyptus	<i>Eucalyptus globulus</i>	Leaves		Mosquitoes	(Sritabutra <i>et al.</i> , 2011)

Table 4 (Continued)

Family	Common name	Plant	Used parts	Protection time (% Repellency)	Species	Sources
	Guava	<i>Psidium guajava</i>	Leaves	8 h	<i>An. dirus</i>	(Tawatsin <i>et al.</i> , 2006)
Rutaceae	Orange calamondin	<i>Citrofortunella microcarpa</i>	Fruit	61 min (98.4%)	<i>Ae. aegypti</i>	(Soonwera, 2015)
	Key lime	<i>Citrus aurantifolia</i>	Fruit	65 min (98.5%)	<i>Ae. aegypti</i>	(Soonwera, 2015)
	Pomelo	<i>Citrus maxima</i>	Fruit	45 min (97.7%)	<i>Ae. aegypti</i>	(Soonwera, 2015)
	Citron	<i>Citrus medica</i>	Fruit	11 min (98.5%)	<i>Ae. aegypti</i>	(Soonwera, 2015)
	Mandarin orange	<i>Citrus reticulata</i>	Fruit	21 min (98.7%)	<i>Ae. aegypti</i>	(Soonwera, 2015)
Saururaceae	Fishwort	<i>Houttuynia cordata</i>	-	8 h	<i>An. dirus</i>	(Tawatsin <i>et al.</i> , 2006)
Schisandraceae	Chiness star anise	<i>Illicium verum</i>	Fruit		<i>Ae. aegypti</i>	(Chaiyasit <i>et al.</i> , 2006)

Table 4 (Continued)

Family	Common name	Plant	Used parts	Protection time (%Repellency)	Species	Sources
Zingiberaceae	Cassumunar ginger	<i>Zingiber cassumunar</i>	Rhizomes		Mosquitoes	(Phukerd and Soonwera, 2014)
	Aromatic turmeric	<i>Curcuma aromatica</i>	Rhizomes	0.5 h	<i>Ae. aegypti</i>	(Choochote <i>et al.</i> , 2005)
				240 min	<i>Cx. quinquefasciatus</i>	
				210 min	<i>An. dirus</i>	
	Tumeric	<i>Curcuma longa</i>	Rhizomes	7.7 h	<i>Ae. albopictus</i>	
				8 h	<i>Cx. quinquefasciatus</i>	
Zingiberaceae	Galanga	<i>Alpinia galanga</i>	Rhizomes		Mosquitoes	(Phukerd and Soonwera, 2014)
	Ginger	<i>Zingiber officinale</i>	Rhizomes	8 h	<i>An. dirus</i>	(Tawatsin <i>et al.</i> , 2006)
	Finger root	<i>Boesenbergia rotunda</i>	Rhizomes		Mosquitoes	(Phukerd and Soonwera, 2014)

Family	Common name	Plant	Used parts	Protection time (%Repellency)	Species	Sources
Family	Common name	Plant	Used parts	Protection time (%Repellency)	Species	Sources
Zingiberaceae	White ginger	<i>Hedychium coronarium</i>	Rhizomes	7.5 h	<i>Ae. albopictus</i>	(Tawatsin <i>et al.</i> , 2006)
				7.7 h	<i>Ae. dirus</i>	
	Wild ginger	<i>Zingiber zerumbet</i>	Rhizomes		Mosquitoes	(Phukerd and Soonwera, 2014)

* Min, minutes; h, hours

5.1 Essential oils for mosquito repellency

Mosquito repellents derived from plant extracts are mostly essential oils (EOs). Numerous EOs have been found to possess properties against various biting insects (Nerio *et al.*, 2010). EOs are mostly distilled from members of the Lamiaceae (mint family), Poaceae (aromatic grasses), and Pinaceae (pine and cedar families). They are classified as secondary metabolite chemicals because their functions are often not directly linked to growth, photosynthesis, or reproductive function of the plant, but rather they have been hypothesized to be primarily protective and allow plants to survive and compete better. The chemical constituents of EOs are primarily terpenes and related compounds (terpenoids). Almost all of the botanical repellents are also used for food flavoring or in the perfume industry, indicating that they are safer than DEET. Therefore, the commercialization of a number of plant-EOs as “natural” mosquito repellents and prefers to use these alternatives to DEET (Fradin, 1998).

5.1.1 Citronella

The essential oil of citronella has been widely used for decades, as this natural insect repellent is commercially available. The citronella group of grasses originating from India has a widespread distribution. These plants have varying amounts of repellent chemicals (mostly terpenoids), but the most abundant ones are citronella, citronellol, and geraniol. The grass *Citronella nardus* is the most common species used in commercial blending of repellent products. Several other species of *Cymbopogon* are used in commercially available plant products. Citronella oil usually comes from *C. nardus* and *C. winterianus*; they are usually defined as Ceylon and Java types, respectively (Weiss, 1997). However, citronella oil extracted from *C. nardus* (formerly *Andropogon nardus*) has been broadly recognized as a mosquito repellent since 1882 (Dethier, 1948).

In Thailand, all citronella oils formulated as topical mosquito repellents have been distilled from *C. nardus*. Traditional uses include treatment of fever, intestinal parasites, digestive and menstrual problems. In Chinese medicine, it is used for rheumatic pain. In Thailand, it is called Ta Krai hom (Oyen and Dung, 1999).

5.1.2 Catnip

Catnip (*Nepeta cataria* L.) is best known as cat attractant, although its insect repellent properties have been under study for many years. This oil contains 2 stereoisomers of nepetalactone E,Z (trans, cis) and Z,E (cis, trans). The 2 stereoisomers have been reported to function as insect repellents against 13 families of insects (Eisner, 1964). It deterred flea beetles and fresh catnip also repelled black ants (Riotte, 1998). The interesting results obtained by Bohbot *et al.* (2011), using deorphanized olfactory receptor genes expressed in *Xenopus oocytes*, demonstrated that nepetalactone inhibits the response of *Ae. aegypti* odor receptor AaOR8 plus AaOR7 to (R)-(-)-1-octen-3-ol (Bohbot *et al.*, 2011).

5.1.3 Lemon eucalyptus oil

Corymbia citriodora (old nomenclature includes *Eucalyptus citriodora* and *Eucalyptus maculate* var. *citriodora*), also known as lemon eucalyptus plant, has been reported for many centuries as having insect repellent properties. The lemon-eucalyptus is originating from China. Chemical analysis of *C. citriodora* showed that it contained citronella, citronellol, geraniol, isopulegol, and sesquiterpenes (Moore *et al.*, 2014). Lemon eucalyptus essential oil with 85% citronellal is by far more effective at repelling mosquitoes for several minutes than the essential oil itself. Thirty percent of eucalyptus oil can prevent mosquito bites for 2 hrs; however, the oil must have at least 70% cineole content (Batish *et al.*, 2008). On the other hand, eucalyptus oil alone showed insufficient protection against *Culex*, *Aedes*, *Anopheles*, the three main mosquito genera (Lupi *et al.*, 2013).

5.1.4 Vetiver

Vetiver synonym names are *Phalaris zizanioides* L. (1771), *Andropogon muricatus* Retzius (1783), *A. zizanioides* Urban (1903). Vernacular names in Thai are faek, ya-faekhom, ya-faeklum. Vetiver oil is distilled from rhizome and roots, which is used in perfumes, deodorants, soaps and other cosmetic articles. Its sent is quite strong and woody. Dried roots or sachets of powdered roots are stored between clothes to give them a pleasant smell and to repel

insect pests. Vetiver oils and roots have insecticidal and insect-repellent properties that are poorly known. Furthermore, *V. zizanioides* can be planted in Southeast Asia in strips as permanent field boundaries and occasionally in contour strips to control erosion. Strips of densely packed, stiff and tough grass stems break the speed of run-off water and divide it evenly. The very thick root system has a physically powerful tendency to grow downward and effectively anchors strips of plants deep into the soil that retain it.

Vetiver oil consists of a complex mixture of more than 300 compounds. The major components of *V. zizanioides* comprise vetiverol, vetivene, alpha- and beta-vetivone, khusimol, elemol, vetiselinol, beta-eudesmol, terpenes, zizanoic acid, vanillin, hydrocarbons, sesquiterpenes, alcohols, ketones (Jain *et al.*, 1982). Vetiver oil has been used for its insect repellent properties against termites, mosquitoes, weevils, beetles. (Jain *et al.*, 1982; Trongtokit *et al.*, 2005a; Zhu *et al.*, 2001). In addition, vetiver oil was used as larvicide against *Cx. quinquefasciatus* (Murty and Jamil, 1986), and as an insecticide to kill red flour beetles (Sujatha, 2010). This oil and its constituents were shown to also repel and kill termites (Zhu *et al.*, 2001).

5.2 Insect repellent of natural based origin

In recent years, botanical chemistry is playing a more and more important role in finding biologically active compounds. The repellent chemicals found in different parts of plants have been identified in some plant-extracts. These constituents not only act as repellents but also as feeding deterrents, toxicants, growth regulators, etc. The major groups of chemical substances identified are categorized as alkaloids, phenols, terpenoids, and others. Chemical repellents have been synthesized to satisfy people needs to disrupt the mosquitoes and to provide safe personal protection against mosquito bites for people of all ages. They have been evaluated for repellency against various mosquito vectors, but few compounds are commercially found. The EPA added PMD, IR3535, Picaridin derived from or synthetic versions of natural materials (Figure 11).

5.2.1 Para-menthane-3,8-diol (PMD)

One promising natural product-based repellent is para-menthane-3,8-diol (PMD). PMD comes from the waste distillate of lemon eucalyptus (*C. citriodora*) oil extract. CDC recommended PMD as a plant-based repellent for vector-borne disease prevention (Carroll and Loye, 2006). It is commercially available in several countries in EU, Africa, Asia, and U.S. It has low acute toxicity levels (oral LD₅₀ = 2,480 mg/kg and dermal LD₅₀ > 2,000 mg/kg in rat) (Trigg, 1996). PMD has undergone several trials in different parts of the world. Laboratory studies by Trongtokit et al. showed 20% and 30% PMD for 11-12 hours at dosage of 1.7 mg/cm² against *An. stephensi* (Trongtokit et al., 2005a). Field studies in China showed that the protection from *Ae. vexans* and *Ae. albopictus* was 2 and 5.5 hours, respectively, when PMD was used in 20%-30% glycerol alcohol formulation (Li et al., 1974).

5.2.2 IR3535

Insect repellent 3535 (IR 3535), [3-(N-acetyl-N-butyl) aminopropionic acid ethyl ester], was developed in 1975 by Merck Company. It became available in U.S. in 1999 after registered in EPA. They classified this compound as biopesticide, as it is a substituted B-amino acid, structure similar to naturally occurring B-alanine, which is an amino acid in the amino group (Moore and Debboun, 2007).

Thavara et al. (2001b) reported that both IR3535 (20%) and DEET (20%) demonstrated equal repellency against several mosquito species from 94 to 100% during the test periods. This study clearly documents the potential of IR3535 use as a topical treatment against a wide range of mosquitoes. Boonyuan et al. (2017) reported that IR3535 required 15 min for 90% of *An. minimus* to exit in contact trials using excito-repellency test.

5.2.3 Picaridin (KBR 3023)

The compound named 1-piperidine carboxylic acid-2(2-hydroxyethyl)-1-methylpropylester was explored by Bayer in 1980 (Kruger and Sasse, 1988). This compound derived from piperidine-based compounds. The piperidine compound is found in piperine, the main active ingredient agent in pepper (*Piper sp.*) (Moore and Debboun, 2007). It has several synonyms: Picaridin is its common name used by Bayer, while Icaridin is used by WHO. This compound is registered in several countries. It demonstrates very low toxicity. It shows neither dermal, nor eye irritation, nor skin sensitization.

The effectiveness of picaridin provides 2-5 hrs of protection from mosquitoes when using 10% formulation and 6-10 hrs of protection when using 20% formulation (Strickman *et al.*, 2009). In the other hand, picaridin performed poorly as an irritant or repellent against *Cx. quinquefasciatus* and *An. minimus* using excito-repellency tests (Boonyuan *et al.*, 2017).

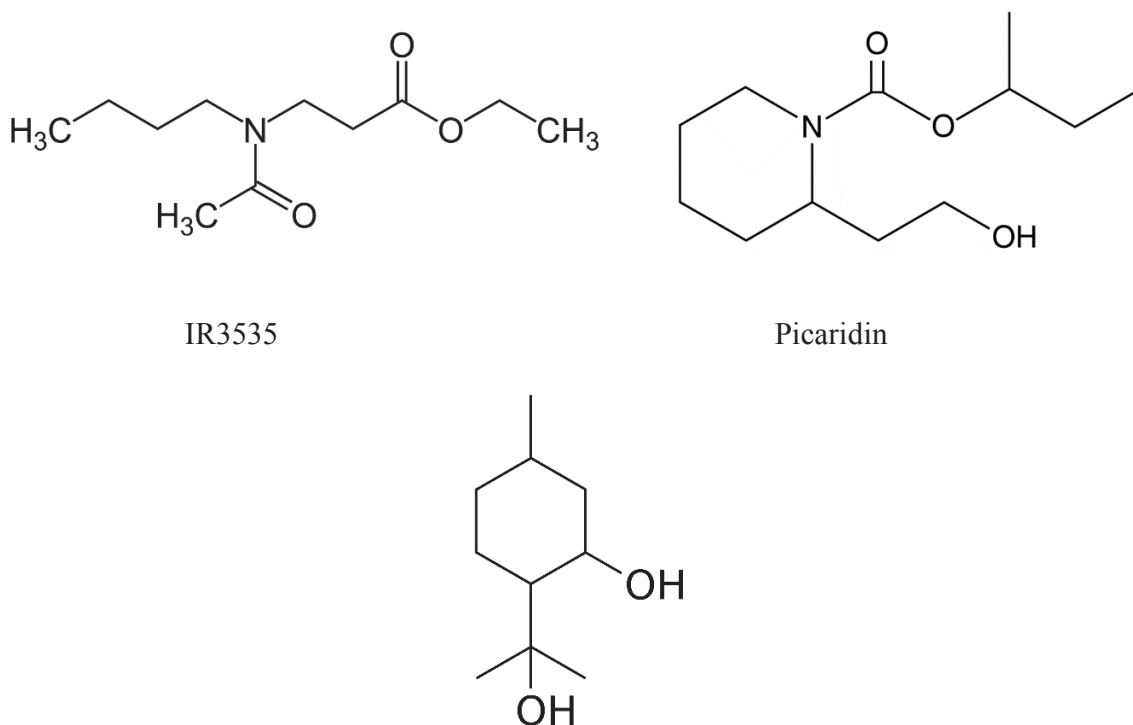

Figure 11 Structure of some plant-based insect repellent

5.2.4 β -caryophyllene oxide

The following is a summary of the most important chemical and physical properties of β -caryophyllene oxide (Table 5).

Table 5 Physical and chemical properties.

Property	Description
IUPAC Name	4,12,12-trimethyl-9-methylidene-5-oxatricyclo[8.2.0.0 ^{4,6}]dodecane
Synonym	β -Caryophyllene epoxide, (-)-Epoxy-caryophyllene, (-)-Epoxydihydrocaryophyllene, trans-Caryophyllene oxide
CAS Registry number	1139-30-6
Molecular formula	C ₁₅ H ₂₄ O
Molecular weight	220.35
Color	Opaque white
Physical State	Solid
Biological source	Synthetic
Flammability	Flash point 110 °C

β -caryophyllene oxide is a bicyclic sesquiterpene molecule (Figure 12), occurring naturally in essential oils from various medicinal and edible plants. This compound is used as a food flavoring agent, as well as a fragrance and cosmetic ingredient. Di Sotto *et al.* (2013) reported that β -caryophyllene oxide could pass through the cell membrane without inducing genotoxic effects at molecular level by using a biomembrane model, suggesting that it may be safe to human for use in repellent formulations. Moreover, β -caryophyllene oxide has been approved as a flavoring agent by FDA and the European Food Safety Authority (EFSA) (Fidy *et al.*, 2016). β -Caryophyllene oxide is found in plant-based essential oils that have the ability to repel mosquitoes. The study of Suleiman *et al.* (2014) found that leaves of *Artabotrys hexapetalus* contained large amounts of β -caryophyllene oxide with high mosquito repellent activity against *An. gambiae*, the main malaria vector species in sub-Saharan Africa. β -Caryophyllene oxide is a

common sesquiterpene obtained from the oxidation of β -caryophyllene, and found in various plant essential oils (Fidyt *et al.*, 2016; Suleiman *et al.*, 2014). Various biological activities for β -caryophyllene oxide were investigated such as a flavoring/fragrance ingredient having a strong woody odor and as cosmetic and food additive (Di Sotto *et al.*, 2013; Fidyt *et al.*, 2016). This compound can provide significant chemo-protective action against cancer cell growth (Fidyt *et al.*, 2016). Zheng *et al.* (1992) found that five active compounds, β -caryophyllene, β -caryophyllene oxide, α -humulene, α -humulene epoxide I, and eugenol, derived from clove (*Eugenia caryophyllata* Thunb.), have potential anticarcinogenic properties. On the other hand, β -caryophyllene oxide is widely found in plant-based essential oils that have the ability to repel mosquitoes (Jaenson *et al.*, 2006; Trongtokit *et al.*, 2005b). Odalo *et al.* (2005) found that a blend of linalool, β -caryophyllene oxide, γ -terpinene, and 1-methylpyrrole (45:39:8:8), and an essential oil of *Croton pseudopulchellus* Pax had strong repellent properties against adults of *An. gambiae*. In addition, Tabanca *et al.* (2015) found that the major chemical constituents of essential oil extracted from the leaves of *Perilla frutescens* (Nararak *et al.*) (Lamiaceae), were (-)-caryophyllene oxide and (-)-limonene, providing a good biting deterrent activity.

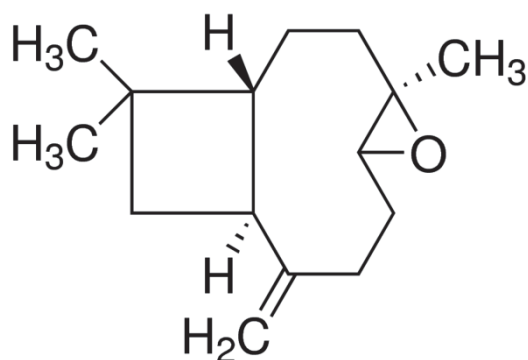

Figure 12 Molecular scheme of β -caryophyllene oxide.

6. Testing methods for insect repellents

6.1 Excito-repellency Assay

A larger scale apparatus was designed earlier than the high-throughput screening system. The excito-repellency test boxes were previously described (Chareonviriyaphap *et al.*, 1997; Rachou *et al.*, 1963; Roberts *et al.*, 1984a). These boxes have been applied for insecticide avoidance behavior study of female mosquitoes in the forms of contact irritant and non-contact repellent by Chareonviriyaphap *et al.* (1997). Contact irritability refers to direct tarsal contact with an insecticide that can cause a mosquito to escape from the test chamber. On the other hand, non-contact repellency results on insect detecting chemicals from a distance, and escaping out of the treated area without making physical contact with the insecticide. Later, the test boxes were modified by Chareonviriyaphap *et al.* (2002) to improve the efficacy of the excito-repellency test boxes and reduce their size for an easier use in field conditions (Figure 13). Many investigators are working on natural repellents, and new ideas and data are being published progressively. Currently they are ongoing tests to determine its utility for natural repellent, specifically plant essential oils.

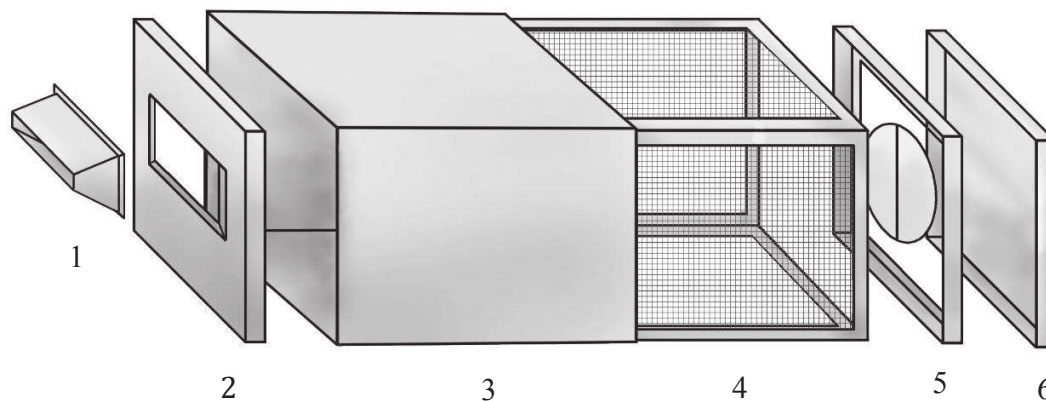
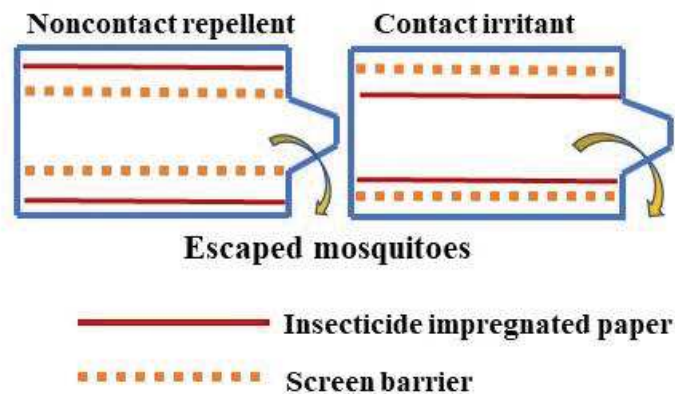

Figure 13 Excito-repellency test chamber

Source: Kongmee *et al.* (2012)

1. Exit window
2. Front door
3. Outer chamber
4. Screened inner chamber
5. Plexiglas panel with rubber latex door
6. Rear door cover



6.2 High-Throughput Repellency Apparatus

A novel apparatus was designed and tested by Grieco *et al.* (2005a), which is used to determine the three chemical actions, comprising irritant (A), spatial repellent (B), and toxic (C) actions of insecticide (Figure 14). Grieco *et al.* (2005a) used the HITSS to determine contact irritancy and spatial repellency activities of *Ae. aegypti* to DEET, Bayrepel and SS220, and found that DEET had low contact irritant response and showed no spatial repellent activity at any of the doses tested. SS220 was more toxic than DEET and Bayrepel. Deletre *et al.* (2013) reported the use of the HITSS on contact irritant and spatial repellent behavioral responses of *An. gambiae* to 20 plant extracts in laboratory testing conditions. The data revealed that most plants had irritant and repellent effects on *An. gambiae* females. Tisgratog *et al.* (2018) reported the response of *An. minimus* to four constituents of vetiver oil (valencene, terpinen-4-ol, isolongifolene, vetiverol) by using HITSS. The data proved that valencene is the most promising compound of the four to repel *An. minimus*.

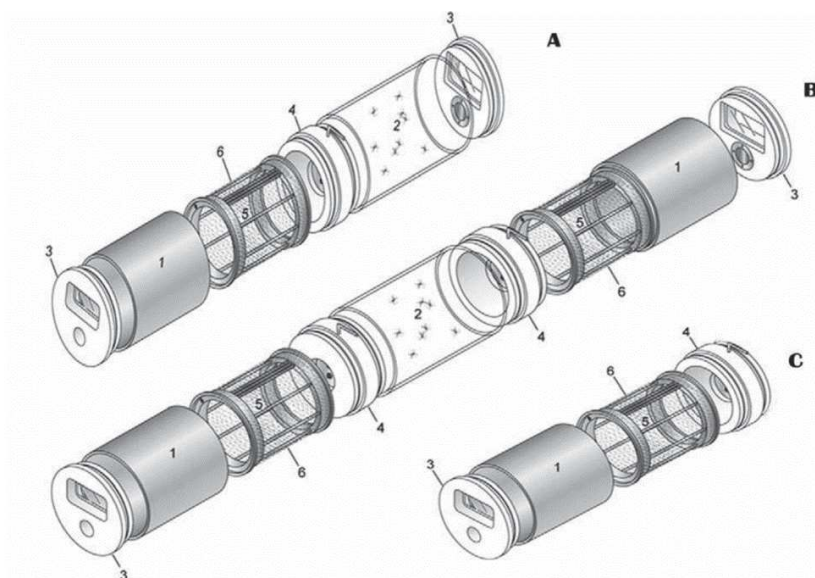

Figure 14 High throughput screening assay system (HITSS), 1= treatment (metal cylinder), 2=clear (Plexiglas) cylinder, 3=end cap, 4=linking section, 5=treatment drum, 6=treatment net; A=contact irritancy assay, B=spatial repellency assay, C=toxicity.

Source: Grieco *et al.* (2005a)

6.3 A Noncontact repellent assay system (NCRAS)

Mosquito repellents are commonly evaluated on human in laboratory conditions (Barnard and Xue, 2004; Frances *et al.*, 2005; Tawatsin *et al.*, 2006; Tawatsin *et al.*, 2001). Application of repellents to the skin is a common personal protection practice. The effectiveness of this technique depends on environmental factors and mosquito species (Khan *et al.*, 1975). The arm-in cage technique, a human-bait repellency technique, has been evaluated in the laboratory. These methods are designed with human volunteers as “bait” and applying a test chemical directly on the human skin and exposing these skin areas directly to biting female mosquitoes. This evaluation technique potentially carries elements of health risk, albeit largely minimal, for the volunteer having direct contact with biting mosquitoes.

Recently, a novel noncontact repellency assay system (NCRAS) was designed and evaluated as a possible alternative method for testing compounds that repel or inhibit mosquitoes

from blood feeding on the host (Figure 15). Designing an alternative repellency test system that does not allow a mosquito direct contact to exposed skin, whether treated with a candidate compound or not, would present an advantage over current exposure assays. This new NCRAS system provides equivalent findings in comparison with standard testing methods (Tisgratog *et al.*, 2016a).

The NCRAS shows good promise but requires further evaluation and possible modification in its design and testing protocol to achieve more desirable operational attributes in comparison with direct skin-contact repellency mosquito assays (Tisgratog *et al.*, 2016a).

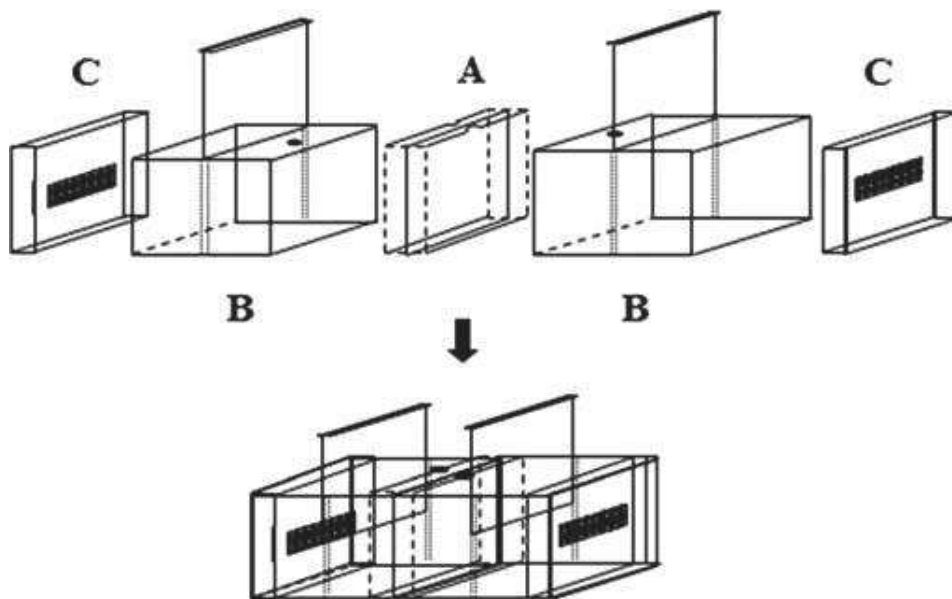

Figure 15 The noncontact repellent assay system (NCRAS) component with blow-up (top) and assembled set-up (bottom). (A) Plexiglas barrier that separates assay into 2 equal-sized matched chambers, (B) exposure chamber (subdivided into 2 chambers), (C) section fitted with an outer screen mesh barrier.

Source: Tisgratog *et al.* (2016a)

7. Conclusion

Enormous efforts have been made to develop effective repellents active against mosquitoes, and as a consequence synthetic repellents have been widely developed and used. However, the use of synthetic repellents against mosquitoes has raised some issues on safety and health risks to humans and the environment. Therefore, plants-based repellents should be increasingly studied to serve as alternatives to synthetic repellents. At present, the development of natural product-based repellents with more effective and long-lasting protection is needed and there is a real demand for such natural repellent products as they become more and more popular. The aim of this project was to investigate and improve repellent products based on plant-compounds known as having repellent activities against mosquitoes. A better understanding on how repellents work was also important to investigate as highly active compounds may lead to entirely new ways of using insect repellents. The urgent need to prevent the infection due to vector-borne pathogens has impacted repellent studies globally with an increase in the evaluation of a large number of promising active ingredients. The development of new formulations could guide to products that are not only more effective but also more acceptable to the user. Taken together, development of repellents may lead to entirely new and more effective ways to use repellents in the future.

Chapter 2 Excito-repellency screening and biological safety of β -caryophyllene oxide (plant-based repellents) on *Aedes aegypti*, *Aedes albopictus*, *Anopheles minimus*, *Anopheles dirus* (Diptera: Culicidae)

Introduction

Mosquito-borne diseases, such as dengue haemorrhagic fever, arbovirus encephalitis, malaria and lymphatic filariasis, remain a major source of illness and death worldwide, particularly in tropical and subtropical climates. Many strategies have been used to reduce or eliminate vectors for preventing the spread of diseases. Personal protection using insect repellents is considered as one of the most efficient measures, which has been widely used to reduce the transmission of mosquito-borne diseases. Topical application of insect repellents, as part of personal protection measures, reduces human contact with mosquitoes.

DEET (*N,N*-diethyl-3-methylbenzamide) has long been used as an insect repellent against blood-sucking insects and other arthropod pests. Several studies indicating its excito-repellent effect is a result of avoidance of DEET in the vapor phase by mosquitoes and arthropod pests. DEET concentrations in insect repellents range from 5 to 100%. In human studies, up to 50% of a topically applied dose can be absorbed into the circulatory system. Thus, using DEET as topical insect repellent has raised some critical concerns (Briassoulis *et al.*, 2001).

Plant-derived compounds, or phytochemicals can serve as possible alternatives or biorational chemistries for developing synthetic chemical repellents or insecticides. Many plant-based ingredients are included in current formulations of insect repellents such as citronella, Neem, PMD (para-menthane-3,8-diol) and eucalyptus oils. These plant-based repellents need to be used up to 5-10% in order to be compared to DEET.

β -caryophyllene oxide is a bicyclic sesquiterpene molecule, occurring naturally in essential oils from various medicinal and edible plants. It has been used as a food flavoring agent, fragrance and cosmetic ingredient. Additionally, β -caryophyllene oxide has been found in plant-based essential oils that could repel mosquitoes.

It is also commonly stated that plant-based compounds are safer for humans than synthetic compounds. However, this compound may produce toxic and adverse effects on humans. Consequently, potential cytotoxic effects of hazardous substances must be evaluated before product development.

Thus, this chapter is aiming at investigating the behavioral responses of *Aedes aegypti*, *Aedes albopictus*, *Anopheles minimus* and *Anopheles dirus* to various concentrations of β -caryophyllene oxide (0.1, 0.25, 0.5 and 1%) using an excito-repellency test chamber system. In addition, the phototoxic and genotoxic effects of β -caryophyllene oxide were investigated on Balb/c 3T3 mouse fibroblasts (3T3-L1) and Chinese hamster ovary cell line (CHO-K1), respectively.

Articles displayed in Chapter 2

Article 1. Jirod Nararak, Sunaiyana Sathantriphop, Monthathip Kongmee, Valerie Mahiou-Leddet, Evelyne Ollivier, Sylvie Manguin, Theeraphap Chareonviriyaphap, 2019. Excito-repellent activity of β -caryophyllene oxide against *Aedes aegypti* and *Anopheles minimus*, *Acta Tropica*, Volume 197, 105030, ISSN 0001-706X, <https://doi.org/10.1016/j.actatropica.2019.05.021>.

Article 2. Jirod Nararak, Carole Di Giorgio, Chutipong Sukkanon, Valerie Mahiou-Leddet, Evelyne Ollivier, Sylvie Manguin and Theeraphap Chareonviriyaphap. Excito-repellency and biological safety of β -caryophyllene oxide against *Anopheles dirus* and *Aedes albopictus* (Diptera: Culicidae). *Acta Tropica*, Volume 210, October 2020, 105556
<https://doi.org/10.1016/j.actatropica.2020.105556>



Excito-repellent activity of β -caryophyllene oxide against *Aedes aegypti* and *Anopheles minimus*



Jirod Nararak^a, Sunaiyana Sathantriphop^b, Monthathip Kongmee^c, Valerie Mahiou-Leddet^d, Evelyne Ollivier^d, Sylvie Manguin^e, Theeraphap Chareonviriyaphap^{a,*}

^a Department of Entomology, Faculty of Agriculture, Kasetsart University, Bangkok, 10900, Thailand

^b National Institute of Health, Department of Medical Sciences, Ministry of Public Health, Nonthaburi, 11000, Thailand

^c Department of Entomology, Faculty of Agriculture at Kamphaeng Saen, Kamphaeng Saen Campus, Kasetsart University, Nakhon Pathom, 73140, Thailand

^d Aix Marseille Université, Avignon Université, CNRS, IRD, IMBE, FAC PHARM, Marseille, France

^e HydroSciences Montpellier (HSM), Institut de Recherche pour le Développement (IRD), CNRS, Université Montpellier, Montpellier, France

ARTICLE INFO

Keywords:

Aedes aegypti
Anopheles minimus
 β -Caryophyllene oxide
 Contact irritancy
 Non-contact repellency

ABSTRACT

Contact irritant and non-contact repellent activities of β -caryophyllene oxide were evaluated against laboratory strains of female *Aedes aegypti* (USDA strain), a major arbovirus vector and *Anopheles minimus* (KU strain), a major malaria parasite vector, compared with the synthetic repellent DEET, using an excito-repellency test system. β -caryophyllene oxide and DEET were tested at concentrations of 0.1, 0.25, 0.5 and 1.0% (v/v). *Anopheles minimus* was found to be more sensitive to β -caryophyllene oxide than that of *Ae. aegypti* and exhibited high avoidance response rates (86–96% escape) at 0.5% and 1.0% concentrations in contact and non-contact trials compared with *Ae. aegypti* (22–59% escape). However, at the same concentrations, DEET displayed lower irritancy and repellency capacities against these two mosquito species (range 0–54% escape) compared to β -caryophyllene oxide. The analysis of escape responses showed significant differences between mosquito species at all concentrations ($P < 0.05$) except for 0.1%. For both species, there were significant differences in irritant and repellent responses between β -caryophyllene oxide and DEET at higher concentrations (0.5 and 1.0%).

1. Introduction

Thailand is located in the tropical region, where the environmental conditions are suitable for the spread of many vector-borne diseases. Dengue fever, due to a virus belonging to the family Flaviviridae, is considered one of the most dangerous mosquito-borne diseases because it can lead to serious health complications and deaths. *Aedes* (*Stegomyia*) *aegypti* (Skuse) is the primary vector of dengue virus in Thailand, while *Aedes* (*Stegomyia*) *albopictus* (Skuse) is considered as a secondary vector (Hutamaï et al., 2007). *Aedes aegypti* is commonly found to live and breed in artificial containers near human dwellings and has a high tendency to blood-feed on humans (Baak-Baak et al. (2013)). Besides dengue, both mosquito species can also be vectors of yellow fever, chikungunya, and Zika viruses (Grard et al., 2014). Malaria is another mosquito-borne disease that can be severe and fatal, due to five species of *Plasmodium* parasites including *Plasmodium falciparum*, *P. vivax*, *P. ovale*, *P. malariae*, and *P. knowlesi* (Wilson et al., 2011). The

high majority of reported malaria cases in Thailand are caused by *P. falciparum* and *P. vivax* and occur along the international borders, especially the Thai-Myanmar and Thai-Cambodia borders (Parker et al., 2015). These border areas are also epicenters for malaria drug resistance, especially Artemisinin Combination Therapy (ACT) resistance (Bhumiratana et al., 2013; Phyto and Nosten, 2018).

Many strategies have been used to reduce or eliminate vectors of dengue and malaria for preventing the spread of diseases. For decades, chemical control has been the most effective means because it provides the fastest and most efficient way to control vectors, especially important in dengue or malaria risk areas (Chareonviriyaphap et al., 2013; Silva et al., 2014). However, the use of repellents for personal protection is also an important strategy that is acclaimed by the local population such as forest-goers in Vietnam who declared willing to use mosquito repellent for 89% of them (Ohrt et al., 2018). The personal protection products against mosquitoes is commonly found in Thailand (Mulla et al., 2001). Mosquito repellents are used sparingly and can

* Corresponding author at: Department of Entomology, Faculty of Agriculture, Kasetsart University, Bangkok, 10900, Thailand.

E-mail addresses: rgt532@gmail.com (J. Nararak), sunaiyana@yahoo.com (S. Sathantriphop), fagrmk@ku.ac.th (M. Kongmee), valerie.mahiou@univ-amu.fr (V. Mahiou-Leddet), evelyne.ollivier@univ-amu.fr (E. Ollivier), sylvie.manguin@ird.fr (S. Manguin), faasthc@ku.ac.th (T. Chareonviriyaphap).

<https://doi.org/10.1016/j.actatropica.2019.05.021>

Received 25 November 2018; Received in revised form 26 February 2019; Accepted 17 May 2019

Available online 20 May 2019

0001-706X/ © 2019 Elsevier B.V. All rights reserved.

provide protection and reduce discomfort due to the biting pressure of mosquitoes when staying in high-density mosquito areas or having outdoor activities during the active time for vectors. Mosquito repellents derived from plant-based essential oils are becoming more widely accepted and as used as an alternative to synthetic repellents like DEET (Soonwera and Phasomkusolsil, 2015).

Globally, the primary methods for malaria vector control remain indoor residual spraying (IRS) and long-lasting insecticide-treated nets (LLINs), methods also widely used in Thailand (Satitvipawee et al., 2012; World Health Organization (WHO), 2012; Chareonviriyaphap et al., 2013). However, many countries, especially in sub-Saharan Africa, have reported widespread resistance of *Anopheles* mosquitoes to pyrethroid insecticides, active ingredients commonly used for IRS and virtually all LLINs (Protopopoff et al., 2013; Baffour-Awuah et al., 2016; Ali Khan et al. (2018); Riveron et al., 2016). Additionally, resistance to the other classes of insecticides by malaria vectors, namely organochlorines (DDT), organophosphates (malathion and others), and carbamates (proprhexur and bendiocarb) have been reported in *Anopheles* (Aizoun et al., 2013; Cisse et al., 2015; Mohammed et al., 2015). Therefore, personal protection against mosquito bites, including the use of effective mosquito repellents, remains a useful, easy and relatively inexpensive method of transmission control.

β -caryophyllene oxide is a bicyclic sesquiterpene molecule, occurring naturally in essential oils from various medicinal and edible plants and used as a food flavouring agent and a fragrance and cosmetic ingredient. Di Sotto et al. (2013) reported that β -caryophyllene oxide could pass through the cell membrane without inducing genotoxic effects at gene or chromosomal level by using a biomembrane model, suggesting that it may be safe for use in repellent formulations. Moreover, β -caryophyllene oxide is approved as a flavoring agent by the Food and Drug Administration (FDA) and by the European Food Safety Authority (EFSA) (Fidyt et al., 2016). β -caryophyllene oxide is found in plant-based essential oils that have the ability to repel mosquitoes; for example, the study of Suleiman et al. (2014) found the leaves of *Artemisia hexapetalus* containing large amounts of β -caryophyllene oxide with high mosquito repellent activity against *Anopheles gambiae* s.s. mosquitoes. The aim of this study was to measure contact irritant and non-contact repellent activities of β -caryophyllene oxide against laboratory strains of *Ae. aegypti* and *An. minimus* using an excito-repellency test system and to explore the escape response patterns of these two species to different concentrations of β -caryophyllene oxide as compared with DEET.

2. Materials and methods

2.1. Mosquitoes

Laboratory strains of *Ae. aegypti* and *An. minimus* were used to assess irritant and repellent properties of β -caryophyllene oxide compared to the standard active ingredient in insect repellent like DEET. *Aedes aegypti* eggs (USDA strain) were obtained from the U.S. Department of Agriculture, Gainesville, FL and the colony has been continuously maintained under laboratory condition for over 50 years and is completely susceptible to all insecticides. Specimens of *An. minimus* (KU strain) were originally obtained from the Malaria Division, Department of Communicable Disease Control (CDC), Ministry of Public Health, Nonthaburi, Thailand in 1998. Specimens of both species were reared in the insectary of the Department of Entomology, Faculty of Agriculture, Kasetsart University under the conditions of $25 \pm 5^\circ\text{C}$ and $80 \pm 10\%$ relative humidity with a 12:12 light:dark photoperiod. Larvae were fed with powdered Tetramin[®] tropical fish food daily. Pupae were collected and transferred into a screened cage ($30 \times 30 \times 30$ cm) then emerged into adults. Adults were provided 10% sugar solution as an energy source. All mosquito cages were covered with damp towels to retain moisture. Non-blood fed female mosquitoes (3–5 days old) were starved (provided only water) for 24 h prior

to testing.

2.2. Test compounds

DEET (*N, N*-diethyl-3-methylbenzamide) with 97% purity was used as the gold standard synthetic repellent, obtained from the Sigma-Aldrich Company Ltd. (Lot No: MKBH0428 V). β -caryophyllene oxide was purchased from the Acros Organics Company Ltd. (95% purity, Lot No: A0356135).

2.3. Filter paper treatment

β -caryophyllene oxide and DEET were diluted with absolute ethanol to provide concentrations of 0.1, 0.25, 0.5 and 1.0% (v/v). The 2.8 ml test solution was spread evenly over the surface of the filter paper (14.7×17.5 cm) by using a 5 ml pipette and pipette controller following the method of Sathantriphop et al. (2014). Treated papers for four replicates were prepared for each concentration and control papers were treated with absolute ethanol only. All treated papers were air dried in a horizontal position at room temperature for 1 h prior to starting the test. All solutions and treated papers were ex-emporaneously prepared prior to testing.

2.4. Contact irritancy and non-contact repellency tests

Contact irritant and non-contact repellent actions were performed to evaluate the escape responses of *Ae. aegypti* and *An. minimus* exposed to serial concentrations of β -caryophyllene oxide and DEET using the excito-repellency (ER) test system (Chareonviriyaphap et al., 2004; Tainchum et al., 2014). The ER test system consists of four chambers that are divided into 2 treatments and 2 controls for contact and non-contact chambers. In the former chambers (contact), the four treated papers were placed in front of four inner screens where mosquitoes made direct physical contact on the treated areas, whereas for the latter chambers (non-contact), all treated papers were placed behind the inner screens where mosquitoes could not touch the treated surface. Fifteen starved female mosquitoes were introduced into each test chamber and allowed them to adjust environmental conditions inside the chamber for 3 min. The exit door of each test chamber was then opened to allow mosquitoes to escape from the test chamber to a receiving paper box that connected to the chamber. Escaped mosquitoes were recorded at 1-min intervals up until 30 min. After the exposure time, escaping and remaining mosquitoes were separately kept in clean plastic cups, provided cotton pads soaked with 10% sugar solution for 24 h. Knockdown after the 30-min exposure time and the mortality at 24 h were noted. Four replicates were required for each concentration treatment and control. All the tests were performed between 0800 to 1600 h.

2.5. Data analysis

Abbott's formula (Abbott, 1925) was used to correct mortality and escape rates for control responses. Multiple log-rank tests were used to compare two Kaplan-Meier survival curves for escape response data of test mosquitoes exposed to contact and non-contact chambers, control and treatment, concentrations, substances and species using SAS version 9 (SAS Institute, Carv. NC) (Robert et al. (1997)). Survival curves were considered to be significantly different when $P < 0.05$. The time in minutes for 50% (ET₅₀) and 80% (ET₈₀) of test mosquitoes escaped from the test chamber were estimated from the Kaplan-Meier survival curves.

3. Results

Behavioral tests measure the escape responses of laboratory-bred females of *Ae. aegypti* (USDA strain) and *An. minimus* (KU strain) to

Table 1

Percent escape, knockdown (KD), and mortality of *Aedes aegypti* exposed to serial concentrations of β -caryophyllene oxide and DEET in contact and non-contact chambers.

Essential oil	Test	Concentrations (%)	Treatment		Control		% KD at 30 min exposure				% Mortality at 24 hr				
							Treatment		Control		Treatment		Control		
			N	% Esp ^{a(b)}	N	% Esp	Esp	NE	Esp	NE	Esp	NE	Esp	NE	
β -caryophyllene oxide	C	0.1	60	3.5	60	3.3	0	0	0	0	0	0	0	0	0
		0.25	60	16.7	58	0	0	0	0	0	0	0	0	0	0
		0.5	60	56.9	61	3.3	0	0	0	0	0	0	0	0	0
	NC	1.0	60	59.3	60	1.7	0	0	0	0	0	0	0	0	0
		0.1	60	0	60	3.3	0	0	0	0	0	0	0	0	0
		0.25	60	3.4	60	1.7	0	0	0	0	0	0	0	0	0
DEET	C	0.5	60	29.9	61	4.9	0	0	0	0	0	0	0	0	0
		1.0	60	22.0	60	1.7	0	0	0	0	0	0	0	0	0
		0.1	60	0	60	8.3	0	0	0	0	0	0	0	0	0
	NC	0.25	60	5.3	60	5.0	0	0	0	0	0	0	0	0	0
		0.5	60	39.0	60	1.7	0	0	0	0	0	0	0	0	0
		1.0	60	37.1	61	9.8	0	0	0	0	0	0	0	0	0
DEET	C	0.1	60	0	60	8.3	0	0	0	0	0	0	0	0	0
		0.25	60	5.3	60	5.0	0	0	0	0	0	0	0	0	0
	NC	0.1	60	6.7	60	0	0	0	0	0	0	0	0	0	0
		0.25	60	0	58	6.9	0	0	0	0	0	0	0	0	0
DEET	C	0.5	60	8.9	60	6.7	0	0	0	0	0	0	0	0	0
		1.0	60	1.9	60	8.3	0	0	0	0	0	0	0	0	0

C = contact; NC = non-contact; Esp = escaped mosquitoes; NE = Non-escaped mosquitoes; ^a Escape rates adjusted with paired controls using Abbott's formula.

Table 2

Percent escape, knockdown (KD), and mortality of *Anopheles minimus* exposed to serial concentrations of β -caryophyllene oxide and DEET in contact and non-contact chambers.

Compound	Test	Concentrations (%)	Treatment		Control		% KD at 30 min exposure				% Mortality at 24 hr				
							Treatment		Control		Treatment		Control		
			N	% Esp ^a	N	% Esp	Esp	NE	Esp	NE	Esp	NE	Esp	NE	
β -caryophyllene oxide	C	0.1	60	25.0	60	0	0	0	0	0	0	0	0	0	0
		0.25	60	63.9	58	12.1	0	0	0	0	0	0	0	0	0
		0.5	62	95.8	61	16.4	0	0	0	0	2	1	0	1.67	
	NC	1.0	62	92.2	60	16.7	3.33	0	0	0	2	0	1.67	0	
		0.1	60	7.1	60	5.0	0	0	0	0	0	0	0	0	
		0.25	60	22.5	60	18.3	0	0	0	0	0	0	0	0	
DEET	C	0.5	60	85.7	61	18.0	0	0	0	0	1	0	1.67	1.67	
		1.0	60	86.9	60	11.7	0	0	0	0	2	0	0	0	
		0.1	60	50.9	60	15.0	0	0	0	0	0	0	0	0	
	NC	0.25	61	54.2	60	3.3	0	0	0	0	0	0	0	0	
		0.5	60	46.8	59	18.6	0	0	0	0	0	0	0	0	
		1.0	60	28.0	60	16.7	0	0	0	0	0	0	0	0	
DEET	C	0.1	60	5.5	60	8.3	0	0	0	0	0	0	0	0	
		0.25	60	12.3	60	5.0	0	0	0	0	0	0	0	0	
	NC	0.5	59	26.1	60	8.3	0	0	0	0	0	0	0	0	
		1.0	60	9.7	60	13.3	0	0	0	0	0	0	0	0	

C = contact; NC = non-contact; Esp = escaped mosquitoes; NE = Non-escaped mosquitoes; ^a Escape rates adjusted with paired controls using Abbott's formula.

evaluate contact irritant and non-contact repellent actions of β -caryophyllene oxide compared to DEET, the gold standard synthetic mosquito repellent, β -caryophyllene oxide or DEET was tested at 4 concentrations, 0.1, 0.25, 0.5, and 1.0% (v/v). The results showed that *An. minimus* had a much higher escape response to β -caryophyllene oxide than *Ae. aegypti* for both contact and non-contact trials (Tables 1 and 2). At 0.5% concentration, the escape rate of *An. minimus* was of 95.8% for contact and 85.7% for non-contact versus 56.9% and 29.9% respectively for *Ae. aegypti*, and at 1.0% concentration, 92.2% escape for contact and 86.9% escape for non-contact for *An. minimus* versus 59.3% and 22.0% for *Ae. aegypti* respectively. Except at 0.1% concentration, DEET exhibited lower irritant and repellent effects in the range of 0–39% escape rate for *Ae. aegypti* and 5.5–54.2% for *An. minimus* compared to β -caryophyllene oxide (Tables 1 and 2). Interestingly, at 0.25, 0.5 and 1% concentrations β -caryophyllene oxide shows a stronger irritant and repellent effects than DEET. After a 30 min exposure, very few mosquitoes were knocked down (3.3%) in 1.0% β -

caryophyllene oxide contact chamber and only 1–2% were killed in these tests (Tables 1 and 2). Mosquitoes were neither knocked down nor killed among the controls.

Calculating the escape time in minutes (ET values) for 50% and 80% of mosquitoes that escaped from the treatment chambers (contact and non-contact chambers) given in Table 3, only β -caryophyllene oxide 0.5% and 1.0% provided both ET₅₀ and ET₈₀ values when tested on *An. minimus*. The ET₅₀ for the 0.5% β -caryophyllene oxide was at 3–6 min and ET₈₀ at 10–13 min. For 1.0% concentration, ET₅₀ ranged from 4 to 14 min and the ET₈₀ from 4 to 28 min (Table 3).

The three paired comparisons of escape responses of *Ae. aegypti* and *An. minimus* with various conditions were conducted using the log rank test as shown in Tables 4–6. Table 4 shows that differences in escape responses of mosquitoes between contact and non-contact trials were highly significant, in particular when *Ae. aegypti* was exposed to β -caryophyllene oxide at 1.0% and *An. minimus* exposed to β -caryophyllene oxide at 0.25% (P < 0.0001). The log rank test also showed

Table 3

Estimation of the escape time in minutes for 50% (ET₅₀) and 80% (ET₈₀) of *Ae. aegypti* and *An. minimus* exposed to serial concentrations of β-caryophyllene oxide and DEET in contact and non-contact chambers.

Mosquito	Compound	Test	0.1%		0.25%		0.5%		1.0%	
			ET ₅₀	ET ₈₀	ET ₅₀	ET ₈₀	ET ₅₀	ET ₈₀	ET ₅₀	ET ₈₀
<i>Ae. aegypti</i>	β-caryophyllene oxide	C	*	–	–	–	5	–	6	–
		NC	–	–	–	–	–	–	–	–
	DEET	C	–	–	–	–	–	–	–	–
		NC	–	–	–	–	–	–	–	–
<i>An. minimus</i>	β-caryophyllene oxide	C	–	–	13	–	3	10	4	4
		NC	–	–	–	–	6	13	14	28
	DEET	C	–	–	24	–	20	–	–	–
		NC	–	–	–	–	–	–	–	–

C = contact; NC = noncontact.

* Few mosquitoes escaped from the test chambers, the ET values could not be calculated.

Table 4

Log rank comparisons of mosquito escape responses between in contact and in non-contact chambers for *Ae. aegypti* and *An. minimus* exposed to β-caryophyllene oxide and DEET.

Compound	Concentrations (%)	P-value	
		<i>Ae. aegypti</i>	<i>An. minimus</i>
β-caryophyllene oxide	0.1	0.4057	0.0530
	0.25	0.0384*	< 0.0001*
	0.5	0.0026*	0.0704
	1.0	< 0.0001*	0.0005*
DEET	0.1	0.9902	< 0.0001*
	0.25	0.4858	< 0.0001*
	0.5	0.0027*	0.0024*
	1.0	< 0.0001*	0.0331*

* Indicates significant difference (P < 0.05) between contact and non-contact.

Table 5

Log rank comparisons of irritant and repellent actions between β-caryophyllene oxide and DEET against *Ae. aegypti* and *An. minimus* in contact and non-contact chambers.

Mosquito	Concentrations (% v/v)	P-value	
		Contact	Non-contact
<i>Ae. aegypti</i>	0.1	0.9900	0.3937
	0.25	0.2850	0.6954
	0.5	0.0109*	0.0193*
	1.0	0.0142*	0.0443*
<i>An. minimus</i>	0.1	0.0002*	0.7106
	0.25	0.1062	0.0190*
	0.5	< 0.0001*	< 0.0001*
	1.0	< 0.0001*	< 0.0001*

* Indicates significant difference (P < 0.05) between β-caryophyllene oxide and DEET.

significant differences between β-caryophyllene oxide and DEET at the higher concentration levels (0.5 and 1.0%) in both contact and non-contact trials (P < 0.05) (Table 5). Strong differences were detected for almost all paired comparisons between two mosquito species when exposed to four concentrations of β-caryophyllene oxide, except at 0.1% in non-contact trial (P = 0.0903) (Table 6).

Kaplan-Meier survival curves of *Ae. aegypti* and *An. minimus* mosquitoes that left the chambers with β-caryophyllene oxide or DEET for contact and non-contact trials are shown in Fig. 1. *An. minimus* exhibited very high escape rates from both contact and non-contact chambers treated with 0.5 and 1.0% β-caryophyllene oxide, whereas only moderate escape response was found in *Ae. aegypti* when exposed to contact chamber. Relationships among percent escape responses,

Table 6

Log rank comparisons of escape responses between *Ae. aegypti* and *An. minimus* in contact and non-contact chambers treated with β-caryophyllene oxide and DEET.

Compound	Concentrations (%)	P-value	
		Contact	Non-contact
β-caryophyllene oxide	0.1	0.0064*	0.0903
	0.25	< 0.0001*	< 0.0001*
	0.5	< 0.0001*	< 0.0001*
	1.0	< 0.0001*	< 0.0001*
DEET	0.1	< 0.0001*	0.2331
	0.25	< 0.0001*	0.0900
	0.5	0.1009	0.0403*
	1.0	0.5701	0.0875

* Indicates significant difference (P < 0.05) between *Ae. aegypti* and *An. minimus*.

knockdown and mortality of mosquitoes exposed to β-caryophyllene oxide and DEET are also presented in Figs. 2 and 3. β-caryophyllene oxide at higher concentrations of 0.5 and 1.0% had strong irritant and repellent effects on *An. minimus*, but insecticidal effect was very low with knockdown and mortality rates lower than 4%. However, no knockdown and mortality occurred for escape and non-escaped specimens with β-caryophyllene oxide and DEET on *Ae. aegypti*.

4. Discussion

The irritant and repellent effects of β-caryophyllene oxide and DEET, at four different concentrations (0.1, 0.25, 0.5 and 1.0% v/v) with matched controls, were evaluated against laboratory strains of *Ae. aegypti* and *An. minimus* using the ER test chamber. The study showed that at higher concentrations (0.5 and 1%), β-caryophyllene oxide had a significantly greater repellent and irritant effects compared to DEET. Moreover, *An. minimus* exhibited much stronger escape responses against β-caryophyllene oxide than *Ae. aegypti* on both contact and non-contact assays. A previous study reported *An. minimus* with strong escape responses (> 70%) to DEET at a concentration of 2.5% v/v using the same test methods (Sathantriphop et al., 2014). Examples of other interspecies comparisons found *An. minimus* more sensitive to several types of essential oils compared to *Ae. aegypti* (Phasomkusolsil and Soonwera, 2010). Nararak et al. (2017) found that *An. minimus* had a higher avoidance response to Kaffir lime essential oil, *Citrus hystrix* DC. than *Ae. aegypti*.

β-caryophyllene oxide is a common sesquiterpene generated from the oxidation of β-caryophyllene, and found in various plant essential oils (Di Sotto et al., 2013; Fidy et al., 2016). In the past, various biological activities were observed for β-caryophyllene oxide, also used as a flavouring/fragrance ingredient having a strong woody odor and as

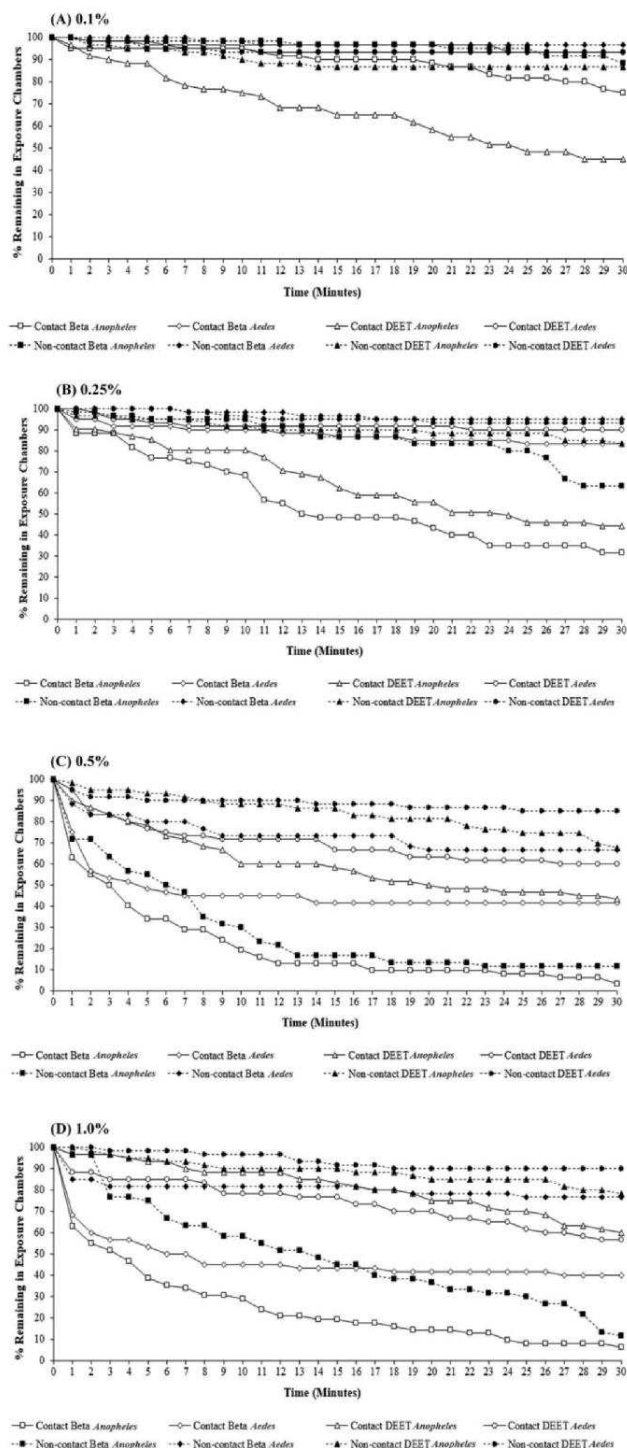

Fig. 1. Kaplan-Meier survival curves for *Ae. aegypti* and *An. minimus* in contact and non-contact chambers at 1-min intervals during 30 min exposure to β -caryophyllene oxide or DEET at (A) 0.1%, (B) 0.25%, (C) 0.5% or (D) 1.0%.

cosmetic and food additive (Di Sotto et al., 2013; Fidyt et al., 2016). This compound can provide significant chemo-protective action against cancer cell growth (Fidyt et al., 2016). Zheng et al. (1992) found that five active compounds, β -caryophyllene, β -caryophyllene oxide, α -humulene, α -humulene epoxide I, and eugenol, derived from clove (*Eugenia caryophyllata* Thunb.), have potential anticarcinogenic properties. On the other hand, β -caryophyllene oxide is widely found in plant-based essential oils that have the ability to repel mosquitoes (Trongtokit

et al., 2005; Jaenson et al., 2006). β -caryophyllene oxide is one of the major constituents of *Artabotrys hexapetalus* (L.f.) Bhandari oil obtained from leaves, which was found to exhibit strong repellent activity against females of *Anopheles gambiae* s.s., the main malaria vector species in sub-Saharan Africa (Suleiman et al., 2014). Odalo et al. (2005) found that a blend of linalool, β -caryophyllene oxide, γ -terpinene, and 1-methylpyrrole (45:39:8:8), and an essential oil of *Croton pseudopulchellus* Pax had strong repellent properties against adults of *An. gambiae*. In addition, Tabanca et al. (2015) found that the major chemical constituents of essential oil extracted from the leaves of *Perilla frutescens* (L.) (Lamiaceae), were (-)-caryophyllene oxide and (-)-limonene, providing a good biting deterrent activity. One study examining the repellent effect on the olfactory system of *Culex* mosquito antennal sensilla neurons showed that β -caryophyllene and (-)-caryophyllene oxide produced a strong response on short, blunt-tipped type I (SBT-I-B) neurons (Liu et al., 2013). While, the current study used synthetic β -caryophyllene oxide on *An. minimus* and *Ae. aegypti*, the results clearly showed that the synthetic compound also possesses excellent repellent and irritant properties, specifically against *An. minimus*, and can be used as an alternative repellent compound. Therefore, β -caryophyllene oxide should be considered for further evaluation and possibly for the development of a new mosquito repellent formulation.

Mosquito repellents are particularly beneficial for people who live and work beyond areas treated with residual insecticides or lacking LLINs and some studies showed that local people are willing to use the plant-based repellent (Ohr et al., 2018). Although thousands of plants have been screened as potential sources of viable insect repellents (Trongtokit et al., 2005; Phasomkusolsil and Soonwera, 2010; Maia and Moore, 2011), only a few plant-derived chemicals tested to date have demonstrated a broad effectiveness and durable action comparable to DEET. For the current study, β -caryophyllene oxide produced much stronger irritant and repellent properties against *An. minimus* and *Ae. aegypti* compared to the standard reference repellent (DEET), thus this compound has high potential for further development as an alternative active ingredient in mosquito repellent formulations. Although *Ae. aegypti* had a lower avoidance response to the concentrations tested compared to *An. minimus*, higher concentrations of β -caryophyllene oxide should be explored. Additionally, other mosquito vector and pest species should be screened for excito-repellency responses against this bioactive compound. Further work is required for evaluating the persistence of this repellent compound in various formulations when applied to skin and safety consideration such as toxicity for short and long-term use by humans.

Conflict of interest

The authors declare no conflict of interest.

Author contributions

TC conceived and designed the experiments. JN performed the experiments. MK and SS analyzed the data. SS, MK and JN wrote the manuscript. SM, VML and EO consulted and edited the manuscript. All authors read and approved the manuscript.

Acknowledgments

We gratefully acknowledge the financial support provided for this study by the International Research Network (IRN), Thailand Research Fund Organization (Grant No. IRN58W0003-IRN5803PHDW04). We also thank the PHC SIAM BIOVECTHAI project (French Ministry of Foreign Affairs) and the Center of Agricultural Biotechnology (CAB). We are grateful to Michael J. Bangs for his constructive comments and revision of this manuscript.

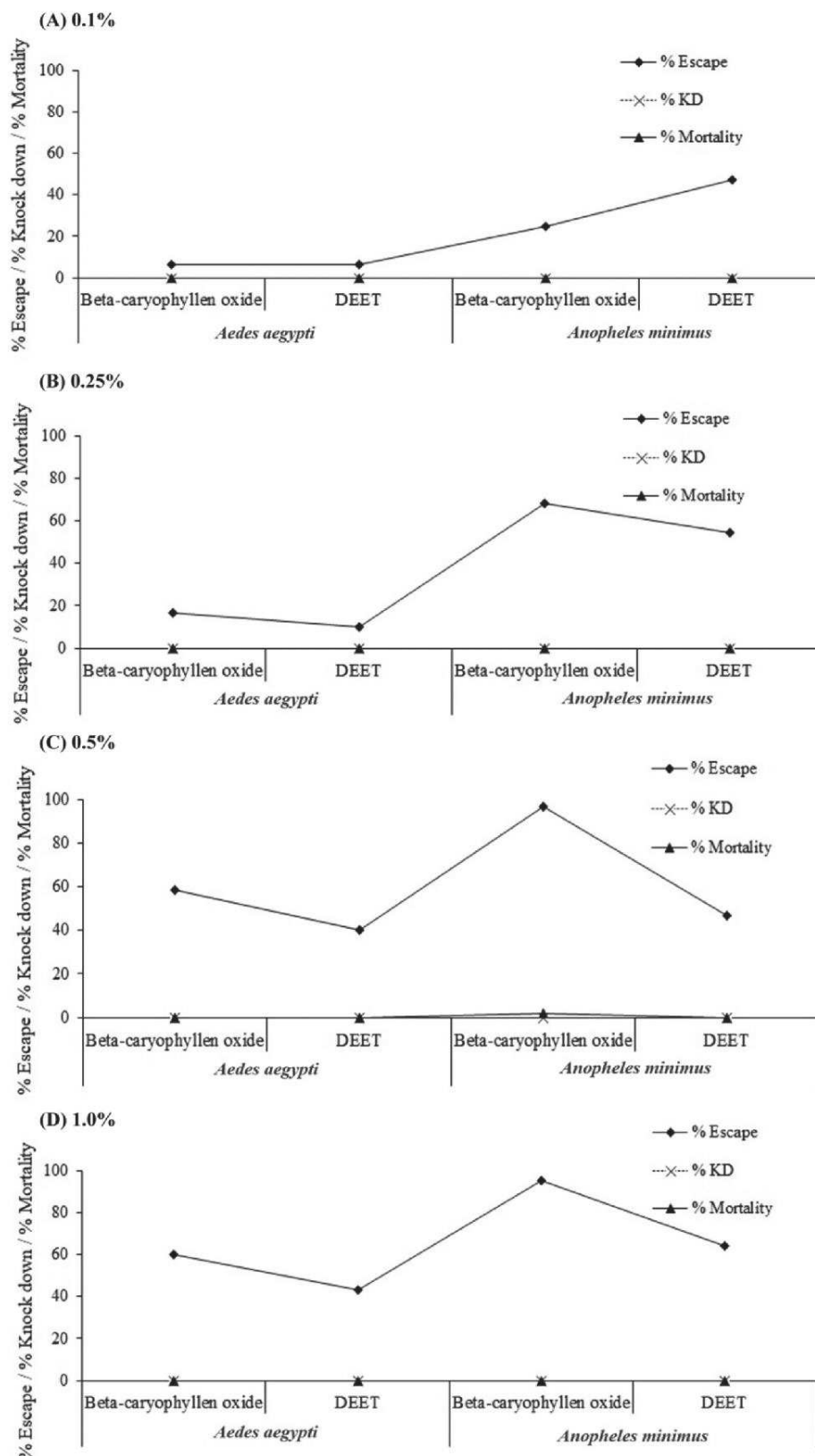

Fig. 2. Relationships among % escape response, % knock down for non-escaped mosquitoes at 30 min exposure and % mortality at 24 h for non-escaping *Ae. aegypti* and *An. minimus* exposed to β -caryophyllene oxide and DEET at (A) 0.1%, (B) 0.25%, (C) 0.5% and (D) 1.0% in contact chambers. (A) 0.1%.

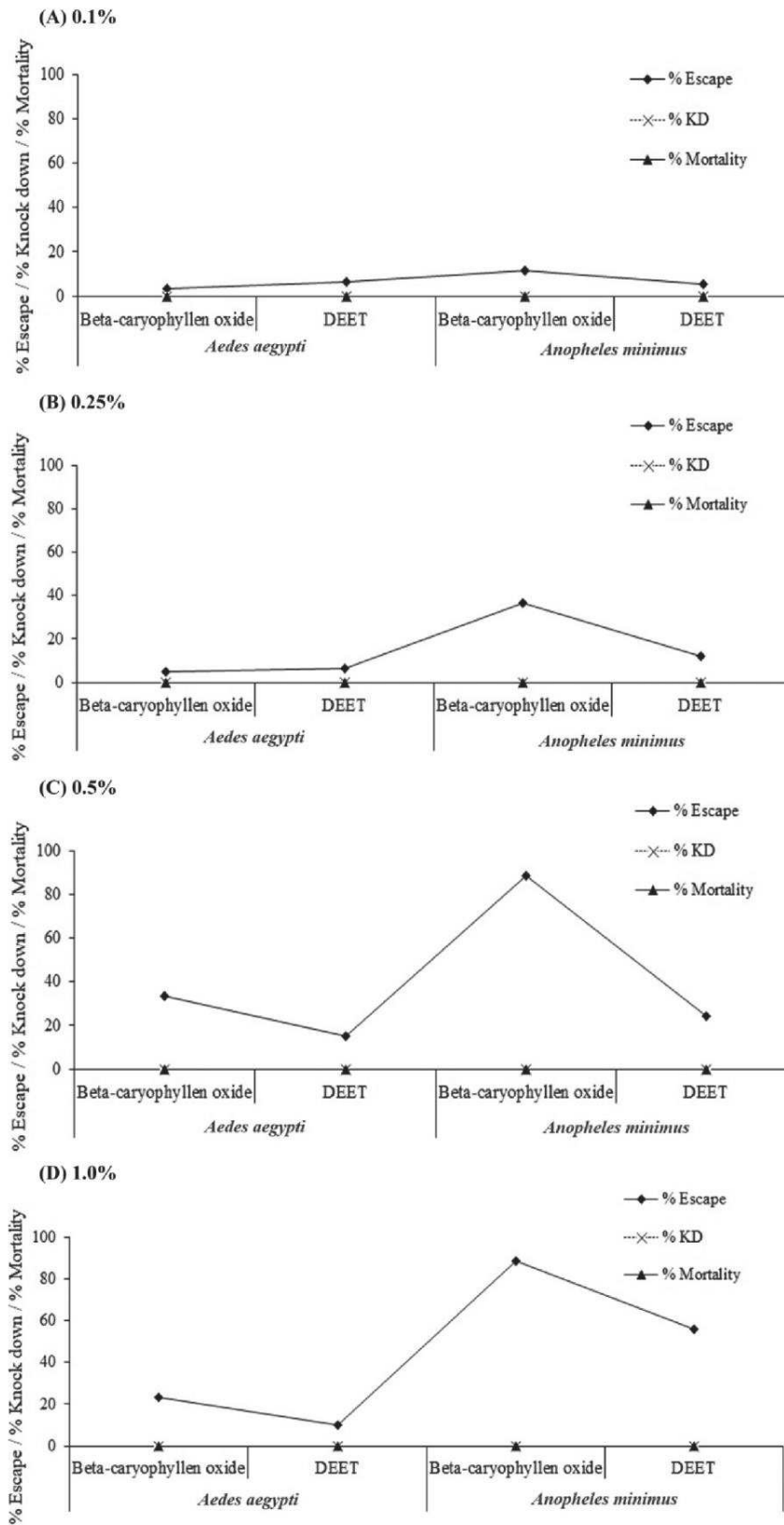
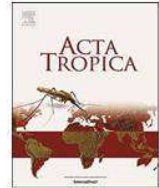
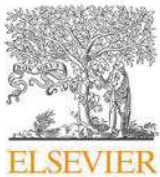

Fig. 3. Relationships among % escape response, % knock down for non-escaped mosquitoes at 30 min exposure and % mortality at 24 h for non-escaping *Ae. aegypti* and *An. minimus* exposed to β -caryophyllene oxide and DEET at (A) 0.1%, (B) 0.25%, (C) 0.5% and (D) 1.0% in non-contact chambers.

References

- Abbott, W.S., 1925. A method of computing the effectiveness of an insecticide. *J. Econ. Entomol.* 18, 265–267.
- Aizoun, N., Aikpon, R., Gnanguenon, V., Oussou, O., Agossa, F., Padonou, G., Akogbéto, M., 2013. Status of organophosphate and carbamate resistance in *Anopheles gambiae* sensu lato from the south and north Benin, West Africa. *Parasit. Vectors.* 6, 274. <https://doi.org/10.1186/1756-3305-6-274>.
- Ali Khan, H.A., Akram, W., Lee, S., 2018. Resistance to Selected Pyrethroid Insecticides in the Malaria Mosquito, *Anopheles stephensi* (Diptera: Muscidae), From Punjab, Pakistan. *J. Med. Entomol.* <https://doi.org/10.1093/jme/tjx247>.
- Baak-Baak, C.M., Rodríguez-Ramírez, A.D., García-Rejón, J.E., Ríos-Delgado, S., Torres-Estrada, J.L., 2013. Development and laboratory evaluation of chemically-based baited ovitrap for the monitoring of *Aedes aegypti*. *J. Vector Ecol.* 38, 175–181.
- Baffour-Awuah, S., Augustina, A.A., Maiga-Ascofare, O., Dieudonné, S.D., Adjei-Kusi, P., Owusu-Dabo, E., Obiri-Danso, K., 2016. Insecticide resistance in malaria vectors in Kumasi, Ghana. *Parasites Vectors.* 9, 633. <https://doi.org/10.1186/s13071-016-1923-5>.
- Bhumiratana, A., Intarapuk, A., Sorosjinda-Nunthawarasilp, P., Maneekan, P., Koyadun, S., 2013. Border malaria associated with multidrug resistance on Thailand-Myanmar and Thailand-Cambodia borders: transmission dynamic, vulnerability, and surveillance. *Biomed. Res. Int.*, 363417. <https://doi.org/10.1155/2013/363417>.
- Chareonviriyaphap, T., Prabaripai, A., Bangs, M.J., 2004. Excito-repellency of deltamethrin on the malaria vectors, *Anopheles minimus*, *Anopheles dirus*, *Anopheles sawadwongporni* and *Anopheles maculatus*, in Thailand. *J. Am. Mosq. Control Assoc. Suppl.* 20, 45–54.
- Chareonviriyaphap, T., Bangs, M.J., Suwonkerd, W., Kongmee, M., Corbel, V., Ngoen-Klan, R., 2013. Review of insecticide resistance and behavioral avoidance of vectors of human diseases in Thailand. *Parasite Vector.* 6, 280. <https://doi.org/10.1186/1756-3305-6-280>.
- Cisse, M.B., Keita, C., Dicko, A., Dengela, D., Coleman, J., Lucas, B., Mihigo, J., Sadou, A., Belemvire, A., George, K., Fornadel, C., Beach, R., 2015. Characterizing the insecticide resistance of *Anopheles gambiae* in Mali. *Malar. J.* 14, 327. <https://doi.org/10.1186/s12936-015-0847-4>.
- Di Sotto, A., Maffei, F., Hrelia, P., Castelli, F., Sarpietro, M.G., Mazzanti, G., 2013. Genotoxicity assessment of β -caryophyllene oxide. *Regul. Toxicol. Pharmacol.* 66, 264–268. <https://doi.org/10.1016/j.yrtph.2013.04.006>.
- Fidy, K., Fiedorowicz, A., Strzadala, L., Szumny, A., 2016. β -caryophyllene and β -caryophyllene oxide-natural compounds of anticancer and analgesic properties. *Cancer Med.* 5, 3007–3017. <https://doi.org/10.1002/cam4.816>.
- Grard, G., Caron, M., Mombo, I.M., Nkoghe, D., Mboui Ondo, S., Jielle, D., Fontenille, D., Paupy, C., Leroy, E.M., 2014. Zika Virus in Gabon (Central Africa) - 2007: a new threat from *Aedes albopictus*? *PLoS Negl. Trop. Dis.* 8, 1–6. <https://doi.org/10.1371/journal.pntd.0002681>.
- Hutamai, S., Suwonkerd, W., Suwannchote, N., Somboon, P., Prapanthadara, L., 2007. A survey of dengue viral infection in *Aedes aegypti* and *Aedes albopictus* from re-epidemic area in the north of Thailand using nucleic acid sequence based amplification assay. *Southeast Asian J. Trop. Med. Publ. Hlth.* 38, 448–454.
- Jaenson, T.G., Palsson, K., Borg-Karlson, A.K., 2006. Evaluation of extracts and oils of mosquito (Diptera: culicidae) repellent plants from Sweden and Guinea-Bissau. *J. Med. Entomol.* 43, 113–119.
- Liu, F., Chen, L., Appel, A.G., Liu, N., 2013. Olfactory responses of the antennal trichoid sensilla to chemical repellents in the mosquito, *Culex quinquefasciatus*. *J. Insect Physiol.* 59, 1169–1177. <https://doi.org/10.1016/j.jinsphys.2013.08.016>.
- Mai, M.F., Moore, S.J., 2011. Plant-based insect repellents: a review of their efficacy, development and testing. *Malar. J.* 10 (Suppl 1), S11. <https://doi.org/10.1186/1475-2875-10-S1-S11>.
- Mohammed, B.R., Abdulsalam, Y.M., Deeni, Y.Y., 2015. Insecticide resistance to *Anopheles* spp. mosquitoes (Diptera: Culicidae) in Nigeria: A. *Int. J. Mosq. Res.* 3, 56–63.
- Mulla, M.S., Thavara, U., Tawatsin, A., Kong-Ngamsuk, W., Chompoosti, J., 2001. Mosquito burden and impact on the poor: measures and costs for personal protection in some communities in Thailand. *J. Am. Mosq. Control Assoc.* 17, 153–159.
- Nararak, J., Sathantriphop, S., Kongmee, M., Bangs, M.J., Chareonviriyaphap, T., 2017. Excito-repellency of *Citrus hystrix* DC leaf and peel essential oils against *Aedes aegypti* and *Anopheles minimus* (Diptera: culicidae), vectors of human pathogens. *J. Med. Entomol.* 54, 178–186. <https://doi.org/10.1093/jme/tjw143>.
- Odalo, J.O., Omolo, M.O., Malebo, H., Angira, J., Njeru, P.M., Ndiege, I.O., Hassanali, A., 2005. Repellency of essential oils of some plants from the Kenyan coast against *Anopheles gambiae*. *Acta Trop.* 95, 210–218.
- Ohrt, C., Ngo, T.D., Nguyen, T.Q., 2018. Preparing for the next global threat: a call for targeted, immediate decisive action in Southeast Asia to prevent the next pandemic in Africa. In: Manguin, S. (Ed.), *Towards-Malaria Elimination-A Leap Forward*. IntechOpen.
- Parker, D.M., Carrara, V.L., Pukrittayakamee, S., McGready, R., Nosten, F.H., 2015. Malaria ecology along the Thailand-Myanmar border. *Malar. J.* 14, 388. <https://doi.org/10.1186/s12936-015-0921-y>.
- Phasomkusolsil, S., Soonwera, M., 2010. Insect repellent activity of medicinal plant oils against *Aedes aegypti* (Linn.), *Anopheles minimus* (Theobald) and *Culex quinquefasciatus* say based on protection time and biting rate. *Southeast Asian J. Trop. Med. Publ. Hlth* 41, 831840.
- Phyo, A.P., Nosten, F., 2018. The artemisinin resistance in Southeast Asia: an imminent global treat to malaria elimination. In: Manguin, S. (Ed.), *Toward Malaria Elimination-A Leap Forward*. IntechOpen.
- Protopopoff, N., Matowo, J., Malima, R., Kavishe, R., Kaaya, R., Wright, A., West, P.A., Kleinschmidt, L., Mosha, F.W., Rowland, M., 2013. High level of resistance in the mosquito *Anopheles gambiae* to pyrethroid insecticides and reduced susceptibility to bendiocarb in north-western Tanzania. *Malar. J.* 12, 149. <https://doi.org/10.1186/1475-2875-12-149>.
- Riveron, J.M., Osaé, M., Egyir-Yawson, A., Irving, H., Ibrahim, S.S., Wondji, C.S., 2016. Multiple insecticide resistance in the major malaria vector *Anopheles funestus* in southern Ghana: implications for malaria control. *Parasit. Vectors* 9, 504. <https://doi.org/10.1186/s13071-016-1787-8>.
- Robert, D.R., Chareonviriyaphap, T., Harlan, H.H., Hshieh, P., 1997. Methods for testing and analyzing excito-repellency responses of malaria vectors to insecticides. *J. Am. Mosq. Control Assoc. Suppl.* 13, 13–17.
- Sathantriphop, S., White, S.A., Achee, N.L., Sanguanpong, U., Chareonviriyaphap, T., 2014. Behavioral responses of *Aedes aegypti*, *Aedes albopictus*, *Culex quinquefasciatus*, and *Anopheles minimus* against various synthetic and natural repellent compounds. *J. Vector Ecol.* 39, 328–339.
- Satitwipawee, P., Wongkhang, W., Pattanasin, S., Hoithong, P., Bhumiratana, A., 2012. Predictors of malaria-association with rubber plantations in Thailand. *BMC Public Health* 12, 1115. <https://doi.org/10.1186/1471-2458-12-1115>.
- Silva, A.P., Santos, J.M., Martins, A.J., 2014. Mutations in the voltage-gated sodium channel gene of anophelines and their association with resistance to pyrethroids—a review. *Parasit. Vectors* 7, 450.
- Soonwera, M., Phasomkusolsil, S., 2015. Efficacy of Thai herbal essential oils as green repellent against mosquito vectors. *Acta Trop.* 142, 127–130. <https://doi.org/10.1016/j.actatropica.2014.11.010>.
- Suleiman, R.A., Mgani, Q.A., Nyandoro, S.S., 2014. Chemical compositions and mosquito repellency of essential oils from *Artemisia hexapetalus* and *Artemisia rupestris*. *Int. J. Biol. Chem. Sci.* 8, 2804–2812.
- Tabanca, N., Demirci, B., Ali, A., Ali, Z., Blythe, E.K., Khan, I.A., 2015. Essential oils of green and red *Perilla frutescens* as potential sources of compounds for mosquito management. *Ind. Crops Prod.* 65, 36–44.
- Tainchum, K., Ritthison, W., Sathantriphop, S., Tanasilchayakul, S., Manguin, S., Bangs, M.J., Chareonviriyaphap, T., 2014. Influence of time of assay on behavioral responses of laboratory and field populations *Aedes aegypti* and *Culex quinquefasciatus* (Diptera: culicidae) to DEET. *J. Med. Entomol.* 51, 1227–1236. <https://doi.org/10.1603/ME14004>.
- Trongtokit, Y., Rongsriyam, Y., Komalamisra, N., Apiwathnasorn, C., 2005. Comparative repellency of 38 essential oils against mosquito bites. *Phytother. Res.* 19, 303–309.
- World Health Organization (WHO), 2012. *Global Plan for Insecticide Resistance Management in Malaria Vectors* (GPIRM). Geneva, Switzerland.
- Wilson, W.E., Kantele, A., Jokiranta, T.S., 2011. Review of cases with the emerging fifth human malaria parasite, *Plasmodium knowlesi*. *Clin. Infect. Dis.* 52, 1356–1362.
- Zheng, G.Q., Kenney, P.M., Lam, L.K.T., 1992. Sesquiterpenes from clove (*Eugenia caryophyllata*) as potential anticarcinogenic agents. *J. Nat. Prod.* 55, 999–1003.



Excito-repellency and biological safety of β -caryophyllene oxide against *Aedes albopictus* and *Anopheles dirus* (Diptera: Culicidae)

Jirod Nararak^{a,b}, Carole Di Giorgio^c, Chutipong Sukkanon^a, Valerie Mahiou-Leddet^c, Evelyne Ollivier^c, Sylvie Manguin^b, Theeraphap Chareonviriyaphap^{a,*}

^a Department of Entomology, Faculty of Agriculture, Kasetsart University, Bangkok 10900, Thailand

^b HydroSciences Montpellier (HSM), Institut de Recherche pour le Développement (IRD), CNRS, Université Montpellier, Montpellier, France

^c Aix Marseille Univ, Avignon Université, CNRS, IRD, IMBE, FAC PHARM, Marseille, France

ARTICLE INFO

Keywords:

Excito-repellency test system
 β -Caryophyllene oxide
 Phototoxic
 Genotoxic
 Mosquitoes

ABSTRACT

The activity of β -caryophyllene oxide as either a contact or noncontact repellent was evaluated against two laboratory strains (*Aedes albopictus* and *Anopheles dirus*) using an excito-repellency test system. *N*, *N*-Diethyl-3-methylbenzamide (DEET) was used as a standard reference baseline for comparative purposes. β -Caryophyllene oxide and DEET were tested at concentrations of 0.1, 0.25, 0.5 and 1.0% (v/v). In addition, the phototoxic and genotoxic effects of β -caryophyllene oxide were investigated on Balb/c 3T3 mouse fibroblasts (3T3-L1) and Chinese hamster ovary cell line (CHO-K1). The results demonstrated that the higher concentrations of test compounds (0.5 and 1.0%) produced greater behavioral responses. *Aedes albopictus* was more sensitive to β -caryophyllene oxide than *An. dirus*. Moderate avoidance response rates (25–56% escape) of *Ae. albopictus* at 0.5% and 1.0% β -caryophyllene oxide were observed in contact and noncontact trials compared with low response rates from *An. dirus* (26–31% escape). DEET at \leq 1% displayed lower irritancy and repellency (1–38%) than β -caryophyllene oxide when tested against the two mosquito species. Knockdown responses (37%) were only observed in *An. dirus* exposed to 1% β -caryophyllene oxide in the contact trial. β -Caryophyllene oxide did not show any phototoxic potential (PIF = 0.38) nor was there any significant genotoxic response as indicated by no increase in micro-nucleated cells with or without metabolic activation. β -Caryophyllene oxide could be considered as a safe repellent, effective against mosquitoes.

1. Introduction

Mosquito-borne diseases represent a key hazard for millions of people worldwide. Mosquitoes serve as vectors of pathogens for devastating human scourge, including malaria, filariasis, yellow fever, dengue, West Nile virus and chikungunya (Benelli and Mehlhorn, 2018). Malaria and dengue are the two most common mosquito-borne diseases that cause high morbidity and mortality (Wiwanitkit, 2011). Millions of humans in the least developed and developing countries are mainly at risk from these diseases. To a lower extent, now developed countries are too at risk of dengue outbreaks due to the invasion of *Aedes albopictus* (Skuse) into temperate regions and population movement from dengue-endemic areas (Vairo et al., 2018). In 2017, an estimated 219 million cases of malaria occurred worldwide, with an estimated 435,000 deaths from malaria globally (WHO, 2018).

Anopheles dirus Peyton & Harrison is the most important malaria vector in Southeast Asia (Tainchum et al., 2015). This species inhabits forest and forest fringes and exhibits mostly exophagic behavior (Baimai et al., 1984; Tananchai et al., 2012, 2019). In contrast, dengue and chikungunya are arboviral infections transmitted by two species of *Aedes* mosquitoes—*Aedes aegypti* L. and *Ae. albopictus*. The latter, known as the Asian tiger mosquito, is native from Southeast Asian countries (Smith, 1956). The distribution of *Ae. albopictus* has been extended recently by invasion into more northerly latitudes as well as into higher altitudes such as the United States of America and Europe (Chouin-Carneiro et al., 2016; Martinet et al., 2019). These two mosquito species have been found highly refractory to common control tools due to their highly exophagic behavior and are regarded as great potential vectors even though they are present in low population densities. Therefore, the prevention and control of most vector-borne

* Corresponding author : Department of Entomology, Faculty of Agriculture, Kasetsart University, Bangkok, Thailand, 10900

E-mail addresses: rgt532@gmail.com (J. Nararak), carole.di-giorgio@univ-amu.fr (C.D. Giorgio), c.sukkanon@gmail.com (C. Sukkanon), valerie.mahiou@univ-amu.fr (V. Mahiou-Leddet), evelyne.ollivier@univ-amu.fr (E. Ollivier), sylvie.manguin@ird.fr (S. Manguin), faasthc@ku.ac.th (T. Chareonviriyaphap).

<https://doi.org/10.1016/j.actatropica.2020.105556>

Received 30 October 2019; Received in revised form 17 May 2020; Accepted 22 May 2020

Available online 30 May 2020

0001-706X/ © 2020 Elsevier B.V. All rights reserved.

diseases remain dependent on various vector control strategies to decrease the transmission risk, which is a major challenge for outdoor-biting mosquitoes such as these two *Aedes* species.

Among the available vector control tools, chemical method remains the most used and effective in combatting mosquito vectors. A number of chemical compounds can protect humans from blood-feeding pests by one or more of three identified actions: contact irritancy, noncontact spatial repellency, or toxicity (Grieco et al., 2007). The first two properties are potential outcome behavioral responses of mosquitoes after or before they make tarsi contact with treated surfaces (Chareonviriyaphap et al., 1997; Roberts et al., 1997). Most studies have focused primarily on the insecticidal action of chemicals to control mosquitoes, whereas few investigations have paid attention to the non-toxic properties, including irritancy and repellency (Chareonviriyaphap et al., 1997, 2004, 2013; Grieco et al., 2007). Moreover, much of the previous work has focused on potent synthetic compounds (Mongkalagoon et al., 2009; Thanispong et al., 2009). The extensive use of these synthetic compounds has raised key concerns over the selection pressure induced by insecticides on resistance gene mechanism (Chareonviriyaphap et al., 2003). For example, the commonly used pyrethroids are applied to control malaria mosquitoes but have become increasingly less effective due to the development of physiological resistance in mosquito populations (Chareonviriyaphap et al., 2000, 2013). Consequently, alternative plant-based repellents have been used to protect people, particularly children, during outdoor activities. In addition, such alternative repellents cause no harm to various nontarget organisms (with additional benefits as a potential source of bioactive chemicals, fragrances and flavoring agents) and are recommended as an alternative source of materials for insect control (Isman, 2002; Yang et al., 2005).

Personal protection using insect repellents is considered as one of the most efficient measures, which has been widely used to reduce the outdoor transmission of mosquito-borne diseases (Debboun and Strickman, 2013). Commercial mosquito repellents containing *N,N*-Diethyl-3-methylbenzamide (DEET) have been used by people worldwide. Research has suggested that DEET is not safe when applied to children's skin or if improperly used (Briassoulis et al., 2001). Several side effects have been reported from DEET including rash, skin irritation and eye irritation (Amichai et al., 1994; Patel et al., 2012).

The compound tested in this study is β -caryophyllene oxide, generally found in essential oils of various plant species such as *Artemisia anomala* S. Moore, *Salvia miltiorrhiza* Bunge, *Chloroxylon swietenia* DC., *Psidium guajava* L., *Origanum vulgare* L., *Cinnamomum* spp., *Syzygium aromaticum* (L.) Merr. & L.M. Perry, *Piper nigrum* L. and *Serjania yucatanensis* Standl. (Garneau et al., 2013; Gertsch et al., 2008; Jun et al., 2011; Liang et al., 2009; Polanco-Hernández et al., 2012; Shell, 1997; Telang et al., 2003; Zhao et al., 2013). The interest of β -caryophyllene oxide is that it has been reported to repel mosquitoes. Suleiman et al. (2014) reported that leaves of *Artabotrys hexapetalus* (L. f.) Bhandari contained large amounts of β -caryophyllene oxide with high mosquito repellent activity against *Anopheles gambiae* s.s. in Africa. A more recent study reported that *Ae. aegypti* and *Anopheles minimus* exhibited high avoidance response rates at 0.5% and 1% concentrations of β -caryophyllene oxide compared to DEET (Nararak et al., 2019), showing the high repellent potential of this molecule.

In recent years, the food and cosmetic industries and both national and international health and food safety authorities have extensively debated the safety of novel plants and plant-derived ingredients for their use in foods. These discussions consistently produced a consensus that adequate specifications of plant identity and composition are key issues in the safety assessment of plant-derived ingredients (Antignac et al., 2011). Although β -caryophyllene oxide is beneficial as a mosquito repellent, this compound may produce toxic and adverse effects on humans or animals or both. Consequently, potential cytotoxic effects of hazardous substances must be assessed prior to product development. Little scientific data is available on the possible adverse

effects or the biological safety of β -caryophyllene oxide in experimental administration to animals. What has been reported is that based on a biomembrane model, β -caryophyllene oxide could pass through the cell membrane without inducing genotoxic effects at the gene or chromosomal level (Di Sotto et al., 2013).

In the current study, following the repellent study already done on *Ae. aegypti* and *An. minimus* (Nararak et al., 2019), we investigated the active excito-repellent properties of β -caryophyllene oxide against *Ae. albopictus* and *An. dirus*, using an excito-repellency (ER) test system. The ER test system is the gold standard to quantitatively determine the two distinct forms of behavioral responses in mosquito population in response to test chemicals (Sathantriphop et al., 2006). A test chamber system and protocol that can easily differentiate these two types of behavioral responses has been described (Chareonviriyaphap et al., 1997; Roberts et al., 1997). Moreover, in the current study, we evaluated the safety of β -caryophyllene oxide using an *in vitro* phototoxicity test and an *in vitro* micronucleus assay.

2. Materials and Methods

2.1. Mosquitoes used

Samples of *Ae. albopictus* were originally captured in 1996 in Chanthaburi province, eastern Thailand by staff from the Ministry of Public Health, Thailand. Representatives of this population have been maintained in the entomological laboratory at Kasetsart University since 2013 and females only were used in the current study. Samples of *An. dirus* were based on individuals originally collected in 1981 in Khao Mai Kao sub-district, Bang Lamung District, Chonburi Province, eastern Thailand. These two mosquito species were reared in separate insectaries of the Department of Entomology, Faculty of Agriculture, Kasetsart University, Bangkok, Thailand. All larvae and adults were held under laboratory-controlled conditions of $25 \pm 5^\circ\text{C}$ and $80 \pm 10\%$ relative humidity with a 12:12 (L:D) photoperiod. Larvae were fed with fish food twice daily. Adults were reared in a screened cage and provided with 10% sugar solution as food. Three-to-five day-old female mosquitoes were starved for 24 h before testing.

2.2. Test compounds

DEET (*N,N*-Diethyl-3-methylbenzamide) with 97% purity obtained from the Sigma-Aldrich Company Ltd. (Lot No: MKBH0428V) was used as the gold standard insect repellent. β -Caryophyllene oxide was purchased from the Acros Organics Company Ltd. (95% purity, Lot No: A0356135).

2.3. Filter paper treatment

β -Caryophyllene oxide and DEET were diluted with absolute ethanol to provide respective concentrations of 0.1, 0.25, 0.5 and 1.0% (v/v). The 2.8 mL test solution was spread evenly over the fine surface of filter paper (14.7 × 17.5 cm) using a 5 mL serological pipette and pipette controller. Similar treated papers for four replicates were prepared for each concentration and the control papers were treated with absolute ethanol only. All treated papers were air-dried in a horizontal position at room temperature for 1 h prior to starting the test. All solutions and treated papers were freshly prepared on the day required.

2.4. Excito-repellency test system

Experiments were conducted to compare the behavioral responses of mosquitoes using an ER test system described by Chareonviriyaphap et al. (2002). The test system consisted of two pairs each for contact and noncontact exposure chambers. For a pair of contact chambers, the treated papers were placed on the inside of a screened inner chamber so that female mosquitoes could rest directly

Table 1
Percentage escape of *Ae. albopictus* and *An. dirus* exposed to serial doses of β -caryophyllene oxide and DEET in contact and noncontact chambers.

Compound	Test	Dose (%)	<i>Aedes albopictus</i>						<i>Anopheles dirus</i>									
			Treatment		Control		% Knockdown after 30 min exposure		Treatment		Control		% Knockdown after 30 min exposure					
			N	% Esp ^(a)	N	% Esp	Esp	NE	Esp	NE	N	% Esp ^(a)	N	% Esp	Esp	NE	Esp	NE
β -Caryophyllene oxide	C	0.1	60	3.51	60	5.00	0	0	0	0	60	0	60	8.33	0	0	0	0
		0.25	60	3.85	58	10.34	0	0	0	0	60	0	58	10.34	0	0	0	0
		0.5	60	46.43	61	8.20	0	0	0	0	62	26.32	61	6.56	0	0	0	0
	NC	1.0	60	56.36	60	8.33	0	0	0	0	62	32.73	60	8.33	0	37	0	0
		0.1	60	1.75	60	5.00	0	0	0	0	60	3.51	60	5	0	0	0	0
		0.25	60	1.79	60	6.67	0	0	0	0	60	1.79	60	6.67	0	0	0	0
DEET	C	0.5	60	31.03	61	4.92	0	0	0	0	60	31.03	61	4.92	0	0	0	0
		1.0	60	25.45	60	8.33	0	0	0	0	60	31.67	60	0	0	0	0	0
		0.1	60	0	60	8.33	0	0	0	0	60	3.57	60	5.08	0	0	0	0
	NC	0.25	60	5.26	60	5	0	0	0	0	61	3.51	60	5.00	0	0	0	0
		0.5	60	38.98	60	1.67	0	0	0	0	60	16.98	59	11.67	0	0	0	0
		1.0	60	38.18	61	9.84	0	0	0	0	60	26.42	60	13.11	0	0	0	0
NC	0.1	60	6.7	60	0	0	0	0	0	60	3.57	60	5.08	0	0	0	0	
	0.25	60	0	58	6.9	0	0	0	0	60	1.79	58	6.90	0	0	0	0	
	0.5	60	8.93	60	6.7	0	0	0	0	59	8.93	60	6.67	0	0	0	0	
1.0	60	10	60	0	0	0	0	0	60	1.82	60	8.33	0	0	0	0		

C = contact; NC = noncontact; Esp = escaped mosquitoes; NE = Non escape mosquitoes

^a Escape rates adjusted with paired controls using Abbott's formula.

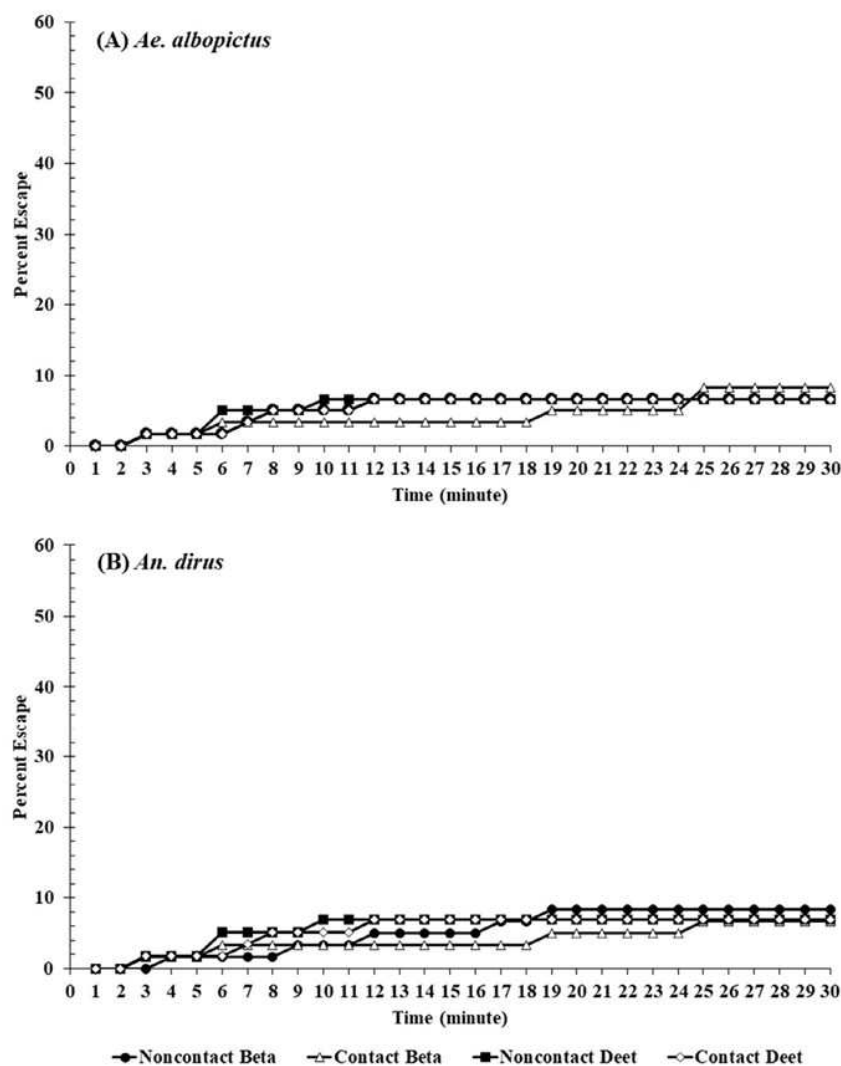

Fig. 1. Patterns of escape percentage from ER chambers for contact and noncontact assay designs during 30 min exposure to β -caryophyllene oxide and DEET at 0.1%: (A) *Ae. albopictus*, (B) *An. dirus*.

on the treated papers. Alternatively, a pair of noncontact trials had treated papers outside the screened inner chamber, which prevented the female mosquitoes from resting directly on the treated papers. After starvation for 24h, fifteen healthy, non-bloodfed female mosquitoes were introduced into four chambers simultaneously using a mouth aspirator and allowed 3 min to adjust to the chambers. Subsequently, the escape funnels were opened to begin the observation period. The number of mosquitoes escaping from the chamber into the receiving cage was recorded at 1 min intervals for a total of 30 min. After the 30 min exposure period, the numbers of knockdown and dead mosquitoes were recorded separately. All mosquitoes that either escaped to the receiving box or remained inside the chamber were kept in clean plastic cups and provided with cotton pads soaked with 10% sugar solution for 24h. The numbers of both knockdown and mortality were respectively recorded after 30 min exposure and after 24h.

The mean percentage of escaped mosquitoes was calculated per test chamber. Abbott's formula was applied to adjust escape responses based on paired control escape responses (Abbott, 1987). A log-rank test was used to analyze paired comparisons of the escape patterns based on the compound, species and concentrations (Mantel and Haenszel, 1959). Statistical significance was accepted for all tests at $P < 0.05$.

2.5. Safety evaluation procedures for β -caryophyllene oxide

In accordance with OECD (2004) guideline for the identification of efficacy of β -caryophyllene oxide, the safety evaluation showed no prohibited or restricted components. For safety reasons, the *in vitro* 3T3 NRU phototoxicity test (OECD N°432) was first conducted to identify the toxicity of the test substance induced by chemicals after exposure to light. The 3T3 NRU phototoxicity test is based on the comparison of a chemical when tested in the presence and in the absence of a non-cytotoxic dose of simulated solar light. Cytotoxicity is expressed as a concentration-dependent reduction of the uptake of the vital dye Neutral Red when measured 24 h after chemical treatment and irradiation.

Balb/c 3T3 mouse fibroblasts (3T3-L1) (ATCC, USA, ATCC® CL-173™, N° P6110401, Lot. 09I006), low passage number (<50), maintained into DMEM (Dulbecco's Minimum Essential Medium, PAN BIOTECH, lot 1874561) supplemented with penicillin 100 IU/mL, streptomycin 100 µg/mL (PAN BIOTECH, Lot 945514) and 10% inactivated calf serum (PAN BIOTECH, Lot P56314), were seeded into two 96-well tissue culture plates (0.1 mL per well) at concentration of 1×10^5 cells/mL, and incubated at 37°C (5% CO₂) for 24 h until semi-confluent. At the end of the incubation period, the culture medium was decanted and replaced by 100 µL of Hank's balanced salt solution (HBSS) containing the appropriate concentrations of the test substance (0, 0.0005, 0.001, 0.005, 0.01, 0.05, 0.1, and 0.5 µM). Subsequently, cells were incubated at 37°C (5% CO₂) in the dark for 60 min. From the two plates prepared for each series of test substance concentrations and the controls, one was randomly selected for the determination of cytotoxicity without irradiation (-Irr), and the other for the determination of photo-cytotoxicity with irradiation (+Irr). The irradiation procedure was performed using a solar simulator Suntest CPS+ apparatus (Atlas Material Testing Technology BV, Moussy le Neuf, France) equipped with a xenon arc lamp (1,100 W), a special glass filter restricting transmission of light below 290 nm and a near IR-blocking filter. For the +Irr, the irradiance was fixed at 750 W/m² throughout the experiments and the combined light dose was 5 J/cm²/min based on UVA irradiation (0.41 J/cm²) or visible irradiation (4.06 J/cm²). The test solution was removed, cells were rinsed twice with 150 µL HBSS and incubated for 18-22h in 0.1 mL of culture medium at 37°C (5% CO₂). Cells were washed, placed into Neutral Red medium (50 µg/mL Neutral Red in complete medium) and incubated for 3 h at 37°C, 5% CO₂. Then the medium was removed and cells were washed three times with 0.2 mL of HBSS to remove any excess dye. The Neutral Red medium was removed and destaining solution (50% ethanol, 1% acetic acid, 49% distilled water; 50 µL per well) was added into each well. Then, the

plates were shaken for 15-20 min at room temperature in the dark. All the test samples and controls were run in triplicate in three independent experiments. A positive control (chlorpromazine (SIGMA), final concentrations 1-100 µg/mL without irradiation and 0.01 to 1 µg/mL with irradiation) and a negative control (HBSS) were included in each set of experiments. Cell viability (increase Neutral Red uptake) was measured using a fluorescence-luminescence reader (Infinite M200 Pro, TECAN). The optical density (OD) of each well was read at 540 nm. The results obtained for wells treated with the test material were compared to those of untreated control wells (HBSS, 100% viability) and converted to percentage values. The concentrations were calculated for the test material causing a 50% release of the preloaded Neutral Red without irradiation (IC₅₀ -Irr) and with irradiation (IC₅₀ +Irr) compared to the control culture using the Phototox Version 2.0 software (Federal Institute for Risk Assessment, zebet@bfr.bund.d). The mean OD value of blank wells (containing only Neutral Red desorbed solution) was subtracted from the mean OD value of three treated wells (dilutions of the test material, positive control or HBSS). The percentages of cell viability were calculated as:

$$\text{Viability (\%)} = \frac{\text{Mean OD of test wells} - \text{mean OD of blanks}}{\text{Mean OD of negative control} - \text{mean OD of blanks}}$$

The photo-irritation-factor (PIF) was calculated using the following formula:

$$\text{PIF} = \frac{\text{IC}_{50} (-\text{Irr})}{\text{IC}_{50} (+\text{Irr})}$$

Based on validation studies, a test substance with a PIF < 2 predicts no phototoxicity, a PIF between 2 and 5 predicts a probable phototoxicity and a PIF > 5 predicts phototoxicity.

Then, the *in vitro* micronucleus assay (MNvit) was used to detect the long-term toxicity of each treatment chemical. The micronucleus assay is a mutagenicity assay which is based on the detection of micronuclei (MNC) in the cytoplasm of interphase cells and allows the detection of the cytogenetic activity of clastogenic and/or aneugenic compounds in the cell culture (Johnson et al., 2010). The micronucleus assay was performed on a Chinese hamster ovary cell line (CHO-K1; ATCC, USA) maintained in McCoy's 5A medium supplemented with 1 mM glutamine, 100 units/mL and 10 µg/mL of a mixture of penicillin and streptomycin, respectively, and 10% of inactivated calf serum. The CHO-K1 cells were transferred into Labteck wells at a concentration of 100,000 cells/mL, and incubated for 24 h at 37°C in CO₂ (5%). The test without metabolic activation was performed where, the test substance was added into cell cultures at the concentrations previously defined. A negative control containing culture medium, a solvent control containing 1% DMSO and a positive control containing 0.6 µg/mL of mitomycin C were also run.

When the assay was performed in the presence of metabolic activation, S9 mix metabolizing mixture was added to cell cultures at a concentration of 10%. The metabolic activation system (S9) was a 9,000 g centrifuged supernatant of a liver homogenate (S9) and was prepared from male Sprague-Dawley rats treated with a single injection of Aroclor 1254 (500 mg/kg body weight). The protein concentration in the S9 homogenate was 26 mg/mL as determined by the method of Lowry. The S9 mix contained 10% S9, 5 mM G6P, 4 mM NADP, 33 mM KCl, and 8 mM MgCl₂ diluted in saline phosphate buffer. Then, the test substance was added to the cell cultures at the concentrations previously defined. A negative control containing culture medium, a solvent control containing 1% DMSO and a positive control containing 5 µg/mL of benzo[a]pyrene were added.

After 3 h of incubation at 37°C in CO₂ (5%), the culture medium of both with (S9) and without (-S9) metabolic activation assays were removed, the cells were rinsed with phosphate buffered saline (PBS), and then returned to culture in McCoy's 5A medium containing 3 µg/mL of cytochalasin B. After incubation for 21 h at 37°C, the cells were rinsed with PBS, fixed with methanol and stained with 10% Giemsa for 20

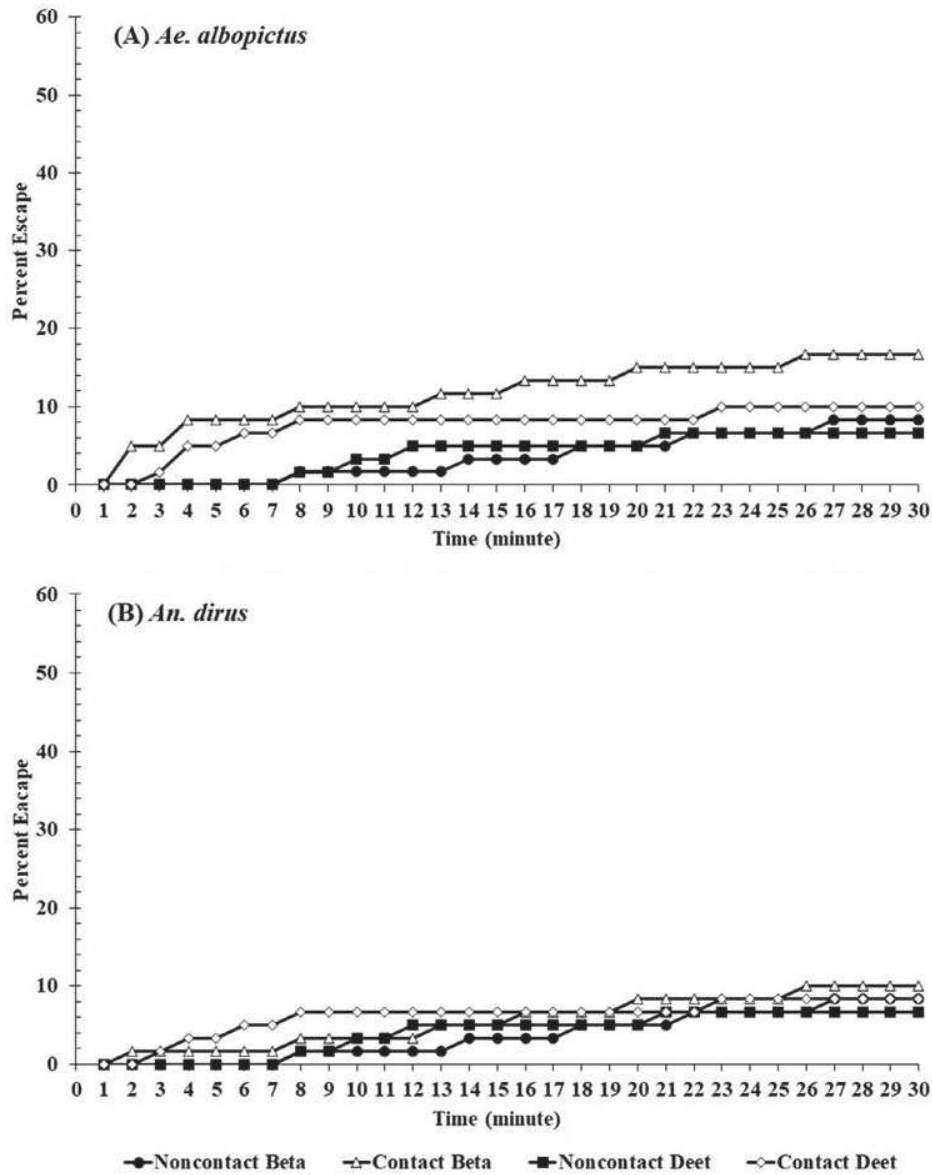

Fig. 2. Patterns of escape percentage from ER chambers for contact and noncontact assay designs during 30 min exposure to β -caryophyllene oxide and DEET at 0.25%: (A) *Ae. albopictus*, (B) *An. dirus*.

min.

The results were analyzed under a microscope at $\times 1,000$ magnification. The antiproliferative activity of test substances was estimated by counting the number of binucleated cells relative to the number of mononucleated cells for 500 cells for each dose (250 cells counted per well). The cytokinesis blocked proliferative index (CBPI) was calculated using the following formula:

$$CBPI = \frac{2 \times (BI + MONO)}{500}$$

BI is the number of binucleated cells and MONO is the number of mononucleated cells

The cytostasis index (CI%) is the percentage of cell replication inhibition and was calculated using the following formula:

$$CI\% = 100 - \left(\frac{100 \times (CBPI_{test\ material} - 1)}{CBPI_{solvent\ control} - 1} \right)$$

After this step, only the doses inducing a decrease of less than 55 ± 5 CI% compared to the negative control were considered for

counting micronuclei. The rates of micronuclei were evaluated for the presence of independent nuclear core entities in 1,000 binucleated cells per well, which corresponded to 2,000 cells examined per test substance dose. Micronuclei were stained in the same manner and identified as small nuclei well-differentiated from the cell nucleus, having a diameter less than one-third of that of the cell nucleus. The micronuclei rates obtained for different doses of test substances were compared to the negative control using a χ^2 test. The assay was considered positive if a dose-response relationship was obtained between the rate of micronuclei and the doses tested, where at least one of these doses induced a statistically significant increase ($P < 0.05$) in the number of micronucleated cells compared to the negative control.

3. Results

Excito-repency responses of *Ae. albopictus* and *An. dirus* exposed to 0.1, 0.25, 0.5, 1.0% v/v of DEET and β -caryophyllene oxide were evaluated for contact irritancy and noncontact repency responses using an excito-repency system. DEET was used as a standard

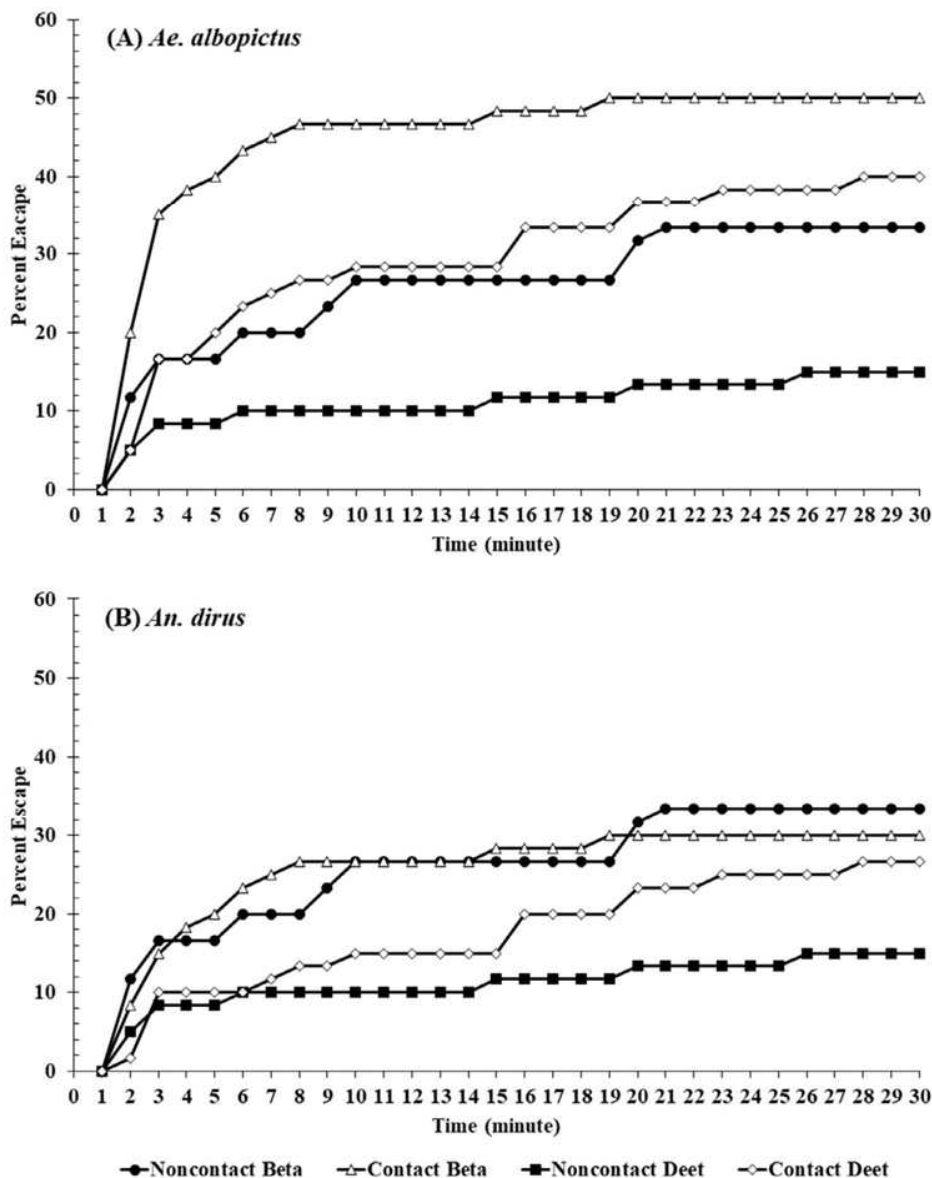

Fig. 3. Patterns of escape percentage from ER chambers under contact and noncontact assay designs during 30 min exposure to β -caryophyllene oxide and DEET at 0.5%: (A) *Ae. albopictus*, (B) *An. dirus*.

repellent for comparison purposes. The results showed that *Ae. albopictus* (3.51-56.36%) had a much higher escape response to β -caryophyllene oxide than *An. dirus* (0-32.73%) in both the contact and noncontact trials (Table 1).

The escape responses of *Ae. albopictus* to β -caryophyllene oxide were characterized in contact and noncontact exposure chambers by comparison to DEET (Table 1). β -Caryophyllene oxide at 0.5 and 1.0% elicited stronger escape responses than DEET in the contact and noncontact treatments. No knockdown and mortality were observed from treatments and control chambers at all concentrations. The greater escape response percentages of *Ae. albopictus* were observed at 0.5 and 1.0% in the contact trial with β -caryophyllene oxide (46.43 and 56.36%, respectively) and DEET (38.98 and 38.18% respectively). In noncontact trial, however, the low percentage responses were 31.03 and 25.45% for β -caryophyllene oxide and were 8.93 and 10% for DEET at 0.5 and 1.0%, respectively. For *An. dirus*, the stronger escape responses were found at 0.5 and 1.0%, in both contact (26.32 and 32.73% respectively) and noncontact trial (31.03 and 31.67%,

respectively) as shown in Table 1. A knockdown response (37%) was observed in *An. dirus* exposed to 1% β -caryophyllene oxide in the contact trial.

The escape patterns from the chambers using survival curves at 1 min intervals in the contact and noncontact designs with paired controls under different concentrations of β -caryophyllene oxide and DEET against *Ae. albopictus* and *An. dirus* are shown in Figures 1-4. The rates represent probabilities for escaping from a chamber with a particular compound and concentration. Overall, β -caryophyllene oxide exhibited a strong escape response in both contact and noncontact trials at all concentrations. Delayed escape responses were observed for 0.1 and 0.25% with all compounds in the contact and noncontact trials (Figures 1-2). With *Ae. albopictus*, strong contact escape patterns were evident for 0.5 and 1.0% β -caryophyllene oxide (Figures 3-4).

The multiple log-rank comparisons of *Ae. albopictus* and *An. dirus* in the paired contact and noncontact treatment trials for β -caryophyllene oxide and DEET are shown in Table 2. Interestingly, there were no significant differences in escape patterns for all contact versus

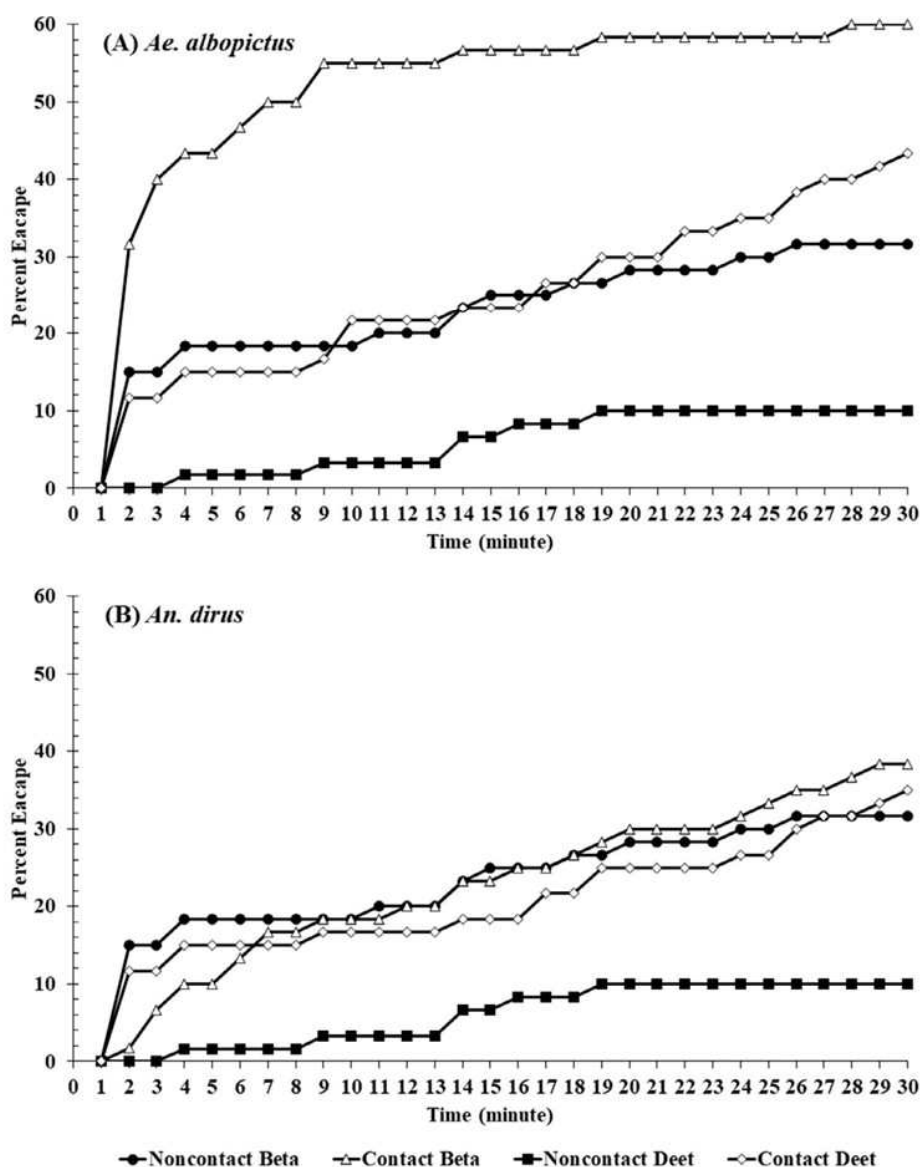

Fig. 4. Patterns of escape percentage from ER chambers under contact and noncontact assay designs during 30 min exposure to β -caryophyllene oxide and DEET at 1%: (A) *Ae. albopictus*, (B) *An. dirus*.

Table 2

Comparisons of mosquito escape responses between contact and noncontact chambers for *Ae. albopictus* and *An. dirus* exposed to β -caryophyllene oxide and DEET.

Compound	Dose (%)	P-value	
		<i>Ae. albopictus</i>	<i>An. dirus</i>
β -Caryophyllene oxide	0.1	0.7430	0.7274
	0.25	0.1510	0.7348
	0.5	0.0394*	0.7644
	1.0	0.0009*	0.5754
DEET	0.1	0.9902	0.9898
	0.25	0.4858	0.7063
	0.5	0.3908	0.1368
	1.0	<0.0001*	0.0011*

* Indicates significant difference ($P < 0.05$) between contact and noncontact.

Table 3

Comparisons of irritant and repellent actions between β -caryophyllene oxide and DEET against *Ae. albopictus* and *An. dirus* in contact and noncontact chambers.

Compound	Dose (%)	P-value	
		Contact	Noncontact
<i>Ae. albopictus</i>	0.1	0.7473	0.9828
	0.25	0.2850	0.7496
	0.5	0.1272	0.1994
	1.0	0.0142*	0.0030*
<i>An. dirus</i>	0.1	0.9529	0.7945
	0.25	0.7748	0.7496
	0.5	0.5365	0.0193*
	1.0	0.7112	0.0030*

* Indicates significant difference ($P < 0.05$) between β -caryophyllene oxide and DEET.

Table 4
Comparisons of escape responses between *Ae. albopictus* and *An. dirus* in contact and noncontact chambers treated with β -caryophyllene oxide and DEET.

Compound	Dose (%)	P-value	
		Contact	Noncontact
β -Caryophyllene oxide	0.1	0.7374	0.7334
	0.25	0.2681	1.0000
	0.5	0.0184*	1.0000
	1.0	0.0024*	1.0000
DEET	0.1	0.9606	0.9606
	0.25	0.7495	1.0000
	0.5	0.0995*	0.0013*
	1.0	0.3584	1.0000

* Indicates significant difference ($P < 0.05$) between *Ae. albopictus* and *An. dirus*.

Table 5
In vitro cytotoxic and phototoxic activity of β -caryophyllene oxide against mouse normal fibroblast (BALB/c 3T3) cell lines.

Compound	IC ₅₀ without irradiation	IC ₅₀ with irradiation	PIF	Phototoxicity
β -Caryophyllene oxide	13.23 \pm 1.37	34.79 \pm 5.49	0.38	Non-phototoxic
Chlorpromazine	48.9 \pm 3.26	1.05 \pm 0.29	54.71	Phototoxic

Results are expressed as mean \pm SD

noncontact trials, except at the concentrations of 0.5% and 1.0%, which were statistically significant in escape patterns for contact versus noncontact trials for *Ae. albopictus* (Table 2).

The statistical comparison of the escape responses for mosquitoes exposed to β -caryophyllene oxide compared to DEET, at different concentrations, are presented in Table 3. In both the contact and noncontact trials using *Ae. albopictus*, the escape responses were significantly higher with β -caryophyllene oxide than DEET at 1.0% concentration. For *An. dirus*, the escape responses were significantly higher with β -caryophyllene oxide than DEET in the noncontact trials at 0.5 and 1%. The statistical comparisons between the two species exposed to β -caryophyllene oxide and DEET in either the contact or noncontact trials are shown in Table 4. For β -caryophyllene oxide, *Ae. albopictus* showed significantly higher escape responses compared to *An. dirus* in the contact trials at 0.5% and 1.0% ($P = 0.0184$ and 0.0024 , respectively), while significance differences in the escape responses were found at 0.5% in both contact and noncontact trials using DEET.

Overall, a higher percent escape reaction was observed when *Ae. albopictus* and *An. dirus* were tested on β -caryophyllene oxide when compared to DEET at 0.5–1%. A greater escape response was seen from the contact chamber than that from the noncontact chamber and control, regardless of test compounds and concentrations.

The cytotoxic potential of β -caryophyllene oxide was evaluated in murine fibroblasts (3 T3) incubated with the compound (0.1–10 mg/

Table 6
In vitro genotoxicity activity of β -caryophyllene oxide on CHO-K1 cells.

Compound (% or $\mu\text{g}\cdot\text{mL}^{-1}$)	Assay performed without S9 mix			Assay performed with S9 mix		
	Proliferative Index (%)	MNC (per 1,000)	P	Proliferative Index (%)	MNC (per 1,000)	P
Negative control	100	10.5 \pm 0.7	-	100	10.5 \pm 2.1	-
Positive control [§]	98.2	31.5 \pm 2.1	< 0.001	97.6	24.0 \pm 1.4	< 0.001
Solvent control	98.6	9.5 \pm 0.7	NS ^a	98.4	10.0 \pm 1.4	NS
β -caryophyllene oxide	0.5	99.7	10.5 \pm 2.1	NS	98.8	9.5 \pm 0.7
	1	98.4	11.0 \pm 1.4	NS	97.4	13.0 \pm 2.8
	5	65.1	9.5 \pm 2.1	NS	73.2	11.0 \pm 1.4
	10	TOX	-	-	TOX	-

[§] Positive controls: mitomycin C (0.05 $\mu\text{g}\cdot\text{mL}^{-1}$) without S9 mix and benzo-[a]-pyrene (5 $\mu\text{g}\cdot\text{mL}^{-1}$) with S9 mix; MNC: Micronucleated cells per 1,000; P: Probability of the comparison between the negative control and the tested dose using the Chi-squared test; TOX: Toxic.

^a NS: non-significant activity; Results are expressed as mean \pm SD

mL). The compound exhibited negligible cytotoxicity (IC₅₀ = 13.23 \pm 1.37 $\mu\text{g}\cdot\text{mL}^{-1}$) as shown in Table 5. PIF values were used to classify the phototoxicity potential (Table 5). The phototoxicity assay considered dark (IC₅₀ = 13.23 \pm 1.37 $\mu\text{g}\cdot\text{mL}^{-1}$) and irradiated (IC₅₀ = 34.79 \pm 5.49 $\mu\text{g}\cdot\text{mL}^{-1}$) conditions. According to the analyses, β -caryophyllene oxide did not exhibit phototoxic potential (PIF = 0.368) for the dose levels tested.

Genotoxicity was assayed starting from the highest concentration at which neither necrosis nor cytotoxic or cytostatic effects was observed. When tested on the Chinese hamster ovary (CHO)-K1 cell line, β -caryophyllene oxide did not produce any cytotoxic effects up to a concentration of 5 $\mu\text{g}\cdot\text{mL}^{-1}$. At concentrations of 0.5, 1.0 and 5.0 $\mu\text{g}\cdot\text{mL}^{-1}$, β -caryophyllene oxide did not increase the MNC (micronucleated cells) frequency with respect to the control (Table 6). No concentration of β -caryophyllene oxide induced an increase in MNC with or without metabolic activation. These results indicated that the compound was not derived from clastogenic/aneugenic activity and did not produce clastogenic/aneugenic metabolites (Table 6).

4. Discussion

Several plant-based essential oils have been evaluated for mosquito repellent activity as protection against mosquitoes and other arthropod pests in Thailand. These have included *Ocimum americanum* L. (Hairy basil), *Cymbopogon nardus* (L.) Rendle (Citronella), *Vetiveria zizanioides* (L.) Nash (Vetiver), *Citrus hystrix* DC. (Kaffir lime), *Cinnamomum verum* J. Presl (Cinnamon leaf), *Syzygium aromaticum* (L.) Merr. & L.M. Perry (Clove flower), and *Zingiber officinale* Roscoe (Ginger) (Boonyuan et al., 2014; Nararak et al., 2016, 2017; Suwansirisilp et al., 2013). These essential oils have shown great promise as insect repellents and have been effective against several species of mosquitoes due to the presence of a variety of bioactive constituents that interfere with insect behavior and growth (Tisgratog et al., 2016, 2018). The plant products have been effective as insect repellents or insecticidal agents and one of the potential repellent compounds is β -caryophyllene oxide (Nararak et al., 2019).

Nararak et al. (2016, 2017) reported that essential oils of citronella, vetiver, hairy basil, and kaffir lime had good irritant and repellent effects on mosquito vectors compared to DEET. These studies suggested that plant-based substances have good potential efficacy to be alternative insect repellents. In the current study, mosquitoes displayed varying levels of behavioral escape responses to the β -caryophyllene oxide, indicating a clear dose response with different concentrations. The study showed that at higher concentrations (0.5 and 1.0%), β -caryophyllene oxide had significantly greater repellent and irritant effects compared to DEET. Moreover, *Ae. albopictus* exhibited much stronger escape responses against β -caryophyllene oxide than *An. dirus* for both contact and noncontact assays. Knockdown (37%) was also found only in non-escape *An. dirus* mosquitoes in the contact trial at 1.0% concentration of β -caryophyllene oxide, whereas no knockdown

and mortality at 24 h post-exposure were observed for *Ae. albopictus*. The results in contact and noncontact trials indicated that escape responses of mosquitoes to β -caryophyllene oxide were significantly greater than with DEET, similar to the previous study by Nararak et al. (2019) in which β -caryophyllene oxide was tested at concentrations of 0.1, 0.25, 0.5 and 1.0% (v/v) against *Ae. aegypti* and *An. minimus* and the results were compared to DEET at the same concentrations. The results showed that DEET displayed lower irritancy and repellent responses than β -caryophyllene oxide and *An. minimus* exhibited higher avoidance response rates (86–96% escape) at 0.5% and 1.0% concentrations in contact and noncontact trials compared with *Ae. aegypti* (22–59% escape). When comparing the results obtained with the four mosquito species tested with β -caryophyllene oxide, *An. minimus* presented the highest sensitivity to both types of escape responses (contact irritancy and noncontact-spatial repellency) at 0.5–1% (v/v), followed by *Ae. aegypti*, *Ae. albopictus*, and *An. dirus*. Comparatively, DEET was less efficient than β -caryophyllene oxide at 0.5–1% (v/v) for all 4 species as they presented lower escape responses in both trials, contact irritancy and noncontact-spatial repellency.

β -Caryophyllene oxide has been approved as a food additive by the Food and Drug Administration (FDA) and the European Food Safety Authority (EFSA) (Fidyt et al., 2016). The two most common plant-associated repellent compounds are p-menthane-3,8-diol (derived from the Australian lemon-scented gum tree) and picaridin (a synthetic derivative of pepper); these have been tested for toxicity (U.S. EPA Biopesticide Registration Documents 011550 and 7505C) (Zhu et al., 2009; EPA 2019). Phototoxic potential is assessed by comparing the differences in IC_{50} between negative control plates (not exposed to UVA) and test plates (exposed to UVA) (Roesler et al., 2010). The phototoxicity results obtained using the *in vitro* method are crucial because topical repellent formulations are mainly used during the day to protect against day-biting mosquitoes such as *Aedes* species, and this involves exposure to the sun and artificial light. The current study investigated the cytotoxicity and phototoxicity of β -caryophyllene oxide and showed that the compound was neither cytotoxic, nor phototoxic (PIF=0.38). The potential genotoxic effects from β -caryophyllene oxide have also been evaluated in mammalian cells. Likewise, the current study showed that β -caryophyllene oxide did not induce genotoxicity at the chromosomal level, as observed in the micronucleus assay. Di Sotto et al. (2013) reported that β -caryophyllene oxide was tested for mutagenic effects using the Ames test and micronucleus assay. Their results showed that the flavoring agent was devoid of mutagenic effects, both at the gene level (frameshift or based-substitution mutations) and on chromosomes (clastogenicity and aneuploidogenicity), suggesting that β -caryophyllene oxide is also safe when used as a flavoring/fragrance ingredient. Then, this finding highlights the fact this component will be safe for human topical applications.

β -Caryophyllene oxide is a bicyclic sesquiterpene generated from the oxidation of β -caryophyllene and is found in a large number of plants worldwide (Fidyt et al., 2016). β -Caryophyllene oxide appears to be common among the essential oils that exhibit mosquito repellent ability (Jaenson et al., 2006; Trongtokit et al., 2005). *Artabotrys hexapetalus* (L.f.) Bhandari oil, obtained from leave parts, contains β -caryophyllene oxide as one of its major constituents and displays strong repellent activity against females of *An. gambiae* (Suleiman et al., 2014). Strong repellency against *An. gambiae* was also reported from a combination of linalool, β -caryophyllene oxide, γ -terpinene, and 1-methylpyrrole (45:39:8:8), and essential oil of *Croton pseudopulchellus* Pax (Odalo et al., 2005). Moreover, (-)-caryophyllene oxide and (-)-limonene are the major chemical constituents found in essential oil extracted from the leaves of *Perilla frutescens* (L.) Britton, and provide good biting-deterrent activity (Tabanca et al., 2015). One study examining the repellent effect on the olfactory system of *Cimex lectularius* (Bed Bug) antennal sensilla neurons showed that (-)-caryophyllene oxide produces a strong neuronal response on $D\alpha$ sensilla (82 spikes/s) (Liu et al., 2014). Li et al. (2019) studied essential oils from *Sauaurea*

amara (L.) DC. and *Sigesbeckia pubescens* Makino: chemical compositions were analyzed by Gas Chromatography-Mass Spectrometry (GC-MS) and their repellent activities were shown against adults of the red flour beetle, *Tribolium castaneum* Herbst, and the booklouse, *Liposcelis bostrychophila* Badonnel. Results of GC-MS analysis indicated that both essential oils were characterized by high content of caryophyllene oxide (Synonyms: β -caryophyllene oxide) and exerted beneficial repellent effects on *T. castaneum* and *L. bostrychophila* at 2 and 4 h post-exposure, respectively. These works confirmed the potent repellent efficacy of β -caryophyllene oxide for controlling insects and suggested their potential to be developed into botanical repellents.

Based on these results, β -caryophyllene oxide had stronger repellent and irritant effects than DEET on four vector species at the same concentrations, suggesting the former has high potential for further development as an alternative active ingredient in mosquito repellent formulations, safe for humans and the environment. Such efficient repellent products are in need. In a study done in Vietnam, forest-goers were in favor of using repellent products to avoid mosquito-biting pressure (Ohrt et al., 2018). The use of repellent is a complementary vector control method to standard ones such as bednets, long-lasting insecticidal nets (LLINs), indoor residual spraying (IRS), which has the advantage of repelling outdoor-biting mosquitoes, then reducing residual malaria transmission risk (Durnez and Coosemans, 2013). Then, appropriate formulations using β -caryophyllene oxide await development for its use as repellent for a safe protection against mosquito bites.

Author Contributions

TC conceived and designed the experiments. JN, CS and CG performed the experiments. JN, CS and CG analyzed the data. JN, CS and CG wrote the manuscript. SM, VML, EO and TC consulted and edited the manuscript. All authors read and approved the manuscript.

Declaration of Competing Interest

The authors declare no conflict of interest.

Acknowledgments

We acknowledge the financial support provided for this study by the Thailand Research Fund through the International Research Network (Grant No. IRN58W0003-IRN5803PHDW04). This study was also funded by the French Ministry of Foreign Affairs (MEAE) through the Bio-Asie programme (BioVectrol project) and the PHC Siam (BioVecThai project, Campus France No 33765NG). The first author (JN) was also granted an Erasmus Mundus fellowship for 6 months.

References

- Abbott, W.S., 1987. A method of computing the effectiveness of an insecticide. 1925. J. Am. Mosq. Control Assoc. 3, 302–303.
- Amichai, B., Lazarov, A., Halevy, S., 1994. Contact dermatitis from diethyltoluamide. Dermatit 30, 188–189.
- Antignac, E., Nohynek, G.J., Re, T., Clouzeau, J., Toutain, H., 2011. Safety of botanical ingredients in personal care products/cosmetics. Food Chem. Toxicol. 49, 324–341.
- Baimai, V., Green, C., Andre, R., Harrison, B., Peyton, E., 1984. Cytogenetic studies of some species complexes of *Anopheles* in Thailand and Southeast Asia. Southeast Asian J. Trop. Med. Public Health 15, 536–546.
- Benelli, G., Mehlhorn, H., 2018. Mosquito-borne Diseases: Implications for Public Health. Springer.
- Boonyuan, W., Grieco, J.P., Bangs, M.J., Prabaripai, A., Tantakom, S., Chareonviriyaphap, T., 2014. Excito-repelleny of essential oils against an *Aedes aegypti* (L.) field population in Thailand. J. Vector Ecol. 39, 112–122.
- Briassoulis, G., Narlioglou, M., Hatzis, T., 2001. Toxic encephalopathy associated with use of DEET insect repellents: a case analysis of its toxicity in children. Hum. Exp. Toxicol. 20, 8–14.
- Chareonviriyaphap, T., Akranakul, P., Nattanomsak, S., Huntamai, S., 2003. Larval habitats and distribution patterns of *Aedes aegypti* (Linnaeus) and *Aedes albopictus* (Skuse), in Thailand. Southeast Asian. J. Trop. Med. Public Health 34, 529–535.
- Chareonviriyaphap, T., Bangs, M.J., Ratanatham, S., 2000. Status of malaria in Thailand.

- Southeast Asian J. Trop. Med. Public Health 31, 225–237.
- Chareonviriyaphap, T., Bangs, M.J., Suwonkerd, W., Kongmee, M., Corbel, V., Ngoen-Klan, R., 2013. Review of insecticide resistance and behavioral avoidance of vectors of human diseases in Thailand. *Parasites Vectors* 6, 280.
- Chareonviriyaphap, T., Prabaripai, A., Bangs, M.J., 2004. Excito-repelling of deltamethrin on the malaria vectors, *Anopheles minimus*, *Anopheles dirus*, *Anopheles swaiwongporni*, and *Anopheles maculatus*, in Thailand. *J. Am. Mosq. Control Assoc.* 20, 45–54.
- Chareonviriyaphap, T., Prabaripai, A., Sungvornyothisin, S., 2002. An improved excito-repelling test chamber for mosquito behavioral tests. *J. Vector Ecol.* 27, 250–252.
- Chareonviriyaphap, T., Roberts, D., Andre, R.G., Harlan, H., Manguin, S., Bangs, M., 1997. Pesticide avoidance behavior in *Anopheles albimanus*, a malaria vector in the Americas. *J. Am. Mosq. Control Assoc.* 13, 171–183.
- Chouin-Carneiro, T., Vega-Rua, A., Vazeille, M., Yebakima, A., Girod, R., Goindin, D., Dupont-Rouzeyrol, M., Lourenço-de-Oliveira, R., Failloux, A.-B., 2016. Differential susceptibilities of *Aedes aegypti* and *Aedes albopictus* from the Americas to Zika virus. *PLoS Negl. Trop. Dis.* 10, e0004543.
- Debboun, M., Strickman, D., 2013. Insect repellents and associated personal protection for a reduction in human disease. *Bull. Entomol. Res.* 27, 1–9.
- Di Sotto, A., Maffei, F., Hrelia, P., Castelli, F., Sarpietro, M.G., Mazzanti, G., 2013. Genotoxicity assessment of β -caryophyllene oxide. *Regul. Toxicol. Pharmacol.* 66, 264–268.
- Durnez, L., Coosemans, M., 2013. Residual transmission of malaria: An Old issue for new approaches. In: Manguin, S. (Ed.), *Anopheles mosquitoes—New insights into malaria vectors*. IntechOpen, London, UK, pp. 671–704.
- EPA, 2019. *Skin-Applied Repellent Ingredients*. <https://www.epa.gov/insect-repellents/skin-applied-repellent-ingredients>.
- Fidy, K., Fiedorowicz, A., Strzadala, L., Szumny, A., 2016. β -caryophyllene and β -caryophyllene oxide—natural compounds of anticancer and analgesic properties. *Cancer Med.* 5, 3007–3017.
- Garneau, F.-X., Collin, G.J., Jean, F.-I., Gagnon, H., Arze, J.B.L., 2013. Essential oils from Bolivia. XII. Asteraceae: *Ophrysopus piquerioides* (DC) Benth. ex Baker. *J. Essent. Oil Res.* 25, 388–394.
- Gertsch, J., Leonti, M., Raduner, S., Racz, I., Chen, J.-Z., Xie, X.-Q., Altmann, K.-H., Karsak, M., Zimmer, A., 2008. Beta-caryophyllene is a dietary cannabinoid. *Proc. Natl. Acad. Sci.* 105, 9099–9104.
- Grieco, J.P., Achee, N.L., Chareonviriyaphap, T., Suwonkerd, W., Chauhan, K., Sardelis, M.R., Roberts, D.R., 2007. A new classification system for the actions of IRS chemicals traditionally used for malaria control. *PLoS One* 2, e716.
- Isman, M.B., 2002. Plant essential oils as green pesticides for pest and disease management. *J. Am. Chem. Soc.* 223, U668–U669.
- Jaenson, T.G., Pålsson, K., Borg-Karlson, A.-K., 2006. Evaluation of extracts and oils of mosquito (Diptera: Culicidae) repellent plants from Sweden and Guinea-Bissau. *J. Med. Entomol.* 43, 113–119.
- Johnson, G.E., Jenkins, G.J., Thomas, A.D., Doak, S.H., 2010. Vinblastine and diethylstilbestrol tested in the in vitro mammalian cell micronucleus test (MNvit) at Swansea University UK in support of OECD draft Test Guideline 487. *Mutat. Res. Genet. Toxicol. Environ. Mutagen.* 702, 189–192.
- Jun, N.J., Mosaddik, A., Moon, J.Y., Ki-Chang, J., Dong-Sun, L., Ahn, K.S., Cho, S.K., 2011. Cytotoxic Activity of [beta]-Caryophyllene Oxide Isolated from Jeju Guava (*Psidium cattleianum* Sabine) Leaf. *Rec. Nat. Prod.* 5, 242.
- Li, Z.-H., Wang, Y., Sun, J.-S., Li, J.-G., Zou, K.-X., Liu, H., Li, G.-X., Hu, Z.-Z., Nong, L.-Z., Ning, Z.-X., 2019. Repellent activities of essential oils rich in sesquiterpenoids from *Saussurea amara* (L.) DC. and *Sibesbeckia pubescens* Makino against two stored-product insects. *Environ. Sci. Pollut. Res.* 26, 36048–36054. (2019). <https://doi.org/10.1007/s11356-019-06876-3>.
- Liang, Q., Liang, Z.-S., Wang, J.-R., Xu, W.-H., 2009. Essential oil composition of *Salvia miltiorrhiza* flower. *Food Chem. Toxicol.* 113, 592–594.
- Liu, F., Haynes, K.F., Appel, A.G., Liu, N., 2014. Antennal Olfactory Sensilla Responses to Insect Chemical Repellents in the Common Bed Bug, *Cimex lectularius*. *J. Chem. Ecol.* 40, 522–533. <https://doi.org/10.1007/s10886-014-0435-z>.
- Mantel, N., Haenszel, W., 1959. Statistical aspects of the analysis of data from retrospective studies of disease. *J. Natl. Cancer Inst.* 22, 719–748.
- Martinet, J.-P., Ferté, H., Failloux, A.-B., Schaffner, F., Depaquit, J., 2019. Mosquitoes of North-Western Europe as Potential Vectors of Arboviruses: A Review. *Viruses* 11, 1059.
- Mongkalagoon, P., Grieco, J.P., Achee, N.L., Suwonkerd, W., Chareonviriyaphap, T., 2009. Irritability and repellency of synthetic pyrethroids on an *Aedes aegypti* population from Thailand. *J. Vector Ecol.* 34, 217–224.
- Nararak, J., Sathantriphop, S., Chauhan, K., Tantakom, S., Eiden, A.L., Chareonviriyaphap, T., 2016. Avoidance Behavior to Essential Oils by *Anopheles minimus*, a Malaria Vector in Thailand. *J. Am. Mosq. Control Assoc.* 32, 34–43.
- Nararak, J., Sathantriphop, S., Kongmee, M., Bangs, M.J., Chareonviriyaphap, T., 2017. Excito-Repellency of *Citrus hystrix* DC Leaf and Peel Essential Oils Against *Aedes aegypti* and *Anopheles minimus* (Diptera: Culicidae), Vectors of Human Pathogens. *J. Med. Entomol.* 54, 178–186.
- Nararak, J., Sathantriphop, S., Kongmee, M., Mahiou-Leddé, V., Ollivier, E., Manguin, S., Chareonviriyaphap, T., 2019. Excito-repellent activity of β -caryophyllene oxide against *Aedes aegypti* and *Anopheles minimus*. *Acta Trop.* 197, 105030.
- OECD, 2004. *OECD Guidelines for the testing of chemical, No. 432: in vitro 3T3 NRU phototoxicity test*. Paris, France: Organization for economic cooperation and development. 4.
- Odalo, J.O., Omolo, M.O., Malebo, H., Angira, J., Njeru, P.M., Ndiege, I.O., Hassanali, A., 2005. Repellency of essential oils of some plants from the Kenyan coast against *Anopheles gambiae*. *Acta Trop.* 95, 210–218.
- Ohr, C., Ngo, T.D., Nguyen, T.Q., 2018. Preparing for the Next Global Threat: A Call for Targeted, Immediate Decisive Action in Southeast Asia to Prevent the Next Pandemic in Africa. In: Manquin, S., Dev, V. (Eds.), *Towards Malaria Elimination: A Leap Forward*. IntechOpen, London, UK, pp. 41–45.
- Patel, E., Gupta, A., Oswal, R., 2012. A review on: mosquito repellent methods. *Int. J. Pharm. Chem. Biol. Sci.* 2, 310–317.
- Polanco-Hernández, G., Escalante-Erosa, F., García-Sosa, K., Chan-Bacab, M.J., Sagua-Franco, H., González, J., Osorio-Rodríguez, L., Peña-Rodríguez, L.M., 2012. Metabolites from the leaf extract of *Serjania yucatanensis* with trypanocidal activity against *Trypanosoma cruzi*. *Parasitol.* Res. 111, 451–455.
- Roberts, D.R., Chareonviriyaphap, T., Harlan, H.H., Hsieh, P., 1997. Methods of testing and analyzing excito-repelling responses of malaria vectors to insecticides. *J. Am. Mosq. Control Assoc.* 13, 13–17.
- Roesler, R., Lorencini, M., Pastore, G., 2010. Brazilian cerrado antioxidant sources: cytotoxicity and phototoxicity in vitro. *Food Sci. Technol.* 30, 814–821.
- Sathantriphop, S., Ketavan, C., Prabaripai, A., Visetson, S., Bangs, M.J., Akranakul, P., Chareonviriyaphap, T., 2006. Susceptibility and avoidance behavior by *Culex quinquefasciatus* Say to three classes of residual insecticides. *J. Vector Ecol.* 31, 266–274.
- Shell, E.R., 1997. Resurgence of a deadly disease. *Atlantic Monthly* 45–60.
- Smith, C., 1956. The history of dengue in tropical Asia and its probable relationship to the mosquito *Aedes aegypti*. *Am. J. Trop. Med. Hyg.* 59, 243–251.
- Suleiman, R.A., Mgan, Q.A., Nyandoro, S.S., 2014. Chemical compositions and mosquito repellency of essential oils from *Artabotrys hexapetalus* and *Artabotrys rupestris*. *Int. J. Biol. Chem. Sci.* 8, 2804–2812.
- Suwansirisilp, K., Visetson, S., Prabaripai, A., Tanasinchayakul, S., Grieco, J.P., Bangs, M.J., Chareonviriyaphap, T., 2013. Behavioral responses of *Aedes aegypti* and *Culex quinquefasciatus* (Diptera: Culicidae) to four essential oils in Thailand. *J. Pest Sci.* 86, 309–320.
- Tabanca, N., Demirci, B., Ali, A., Ali, Z., Blythe, E.K., Khan, I.A., 2015. Essential oils of green and red *Perilla frutescens* as potential sources of compounds for mosquito management. *Ind. Crop. Prod.* 65, 36–44.
- Tainchum, K., Kongmee, M., Manguin, S., Bangs, M.J., Chareonviriyaphap, T., 2015. *Anopheles* species diversity and distribution of the malaria vectors of Thailand. *Trends Parasitol.* 31, 109–119.
- Tanachai, C., Pattanakul, M., Nararak, J., Sinou, V., Manguin, S., Chareonviriyaphap, T., 2019. Diversity and biting patterns of *Anopheles* species in a malaria endemic area, Umphang Valley, Tak Province, western Thailand. *Acta Trop.* 190, 183–192.
- Tanachai, C., Tisratog, R., Juntarajumnong, W., Grieco, J.P., Manguin, S., Prabaripai, A., Chareonviriyaphap, T., 2012. Species diversity and biting activity of *Anopheles dirus* and *Anopheles baimai* (Diptera: Culicidae) in a malaria prone area of western Thailand. *Parasites Vectors* 5, 211.
- Telang, T., Awasthi, S., Oswal, V., 2003. Qualitative improvement of the essential oil of *Chloroxylon swietenia* (Roxb. corom). *Indian Perfum.* 47, 79–82.
- Thanispong, K., Achee, N.L., Bangs, M.J., Grieco, J.P., Suwonkerd, W., Prabaripai, A., Chareonviriyaphap, T., 2009. Irritancy and repellency behavioral responses of three strains of *Aedes aegypti* exposed to DDT and alpha-cypermethrin. *J. Med. Entomol.* 46, 1407–1414.
- Tisratog, R., Sanguanpong, U., Grieco, J.P., Ngoen-Klan, R., Chareonviriyaphap, T., 2016. Plants traditionally used as mosquito repellents and the implication for their use in vector control. *Acta Trop.* 157, 136–144.
- Tisratog, R., Sukkanon, C., Grieco, J.P., Sanguanpong, U., Chauhan, K.R., Coats, J.R., Chareonviriyaphap, T., 2018. Evaluation of the Constituents of Vetiver Oil Against *Anopheles minimus* (Diptera: Culicidae), a Malaria Vector in Thailand. *J. Med. Entomol.* 55, 193–199.
- Trongtokit, Y., Rongsriyam, Y., Komalamisra, N., Apiwathasorn, C., 2005. Comparative repellency of 38 essential oils against mosquito bites. *Phytother. Res.* 19, 303–309.
- Vairo, F., Di Pietrantonj, C., Pasqualini, C., Mammone, A., Lanini, S., Nicastri, E., Castillett, C., Ferraro, F., Di Bari, V., Puro, V., Scognamiglio, P., Di Caro, A., Capobianchi, M.R., Ippolito, G., 2018. The Surveillance of Chikungunya Virus in a Temperate Climate: Challenges and Possible Solutions from the Experience of Lazio Region. *Italy. Viruses* 10, 501.
- WHO, 2018. *World malaria report 2018*. World Health Organization, Geneva, Switzerland, pp. 165.
- Wiwanitkit, V., 2011. Concurrent malaria and dengue infection: a brief summary and comment. *Asian Pac. J. Trop. Biomed.* 1, 326–327.
- Yang, Y.C., Lee, H.S., Lee, S.H., Clark, J.M., Ahn, Y.J., 2005. Ovicidal and adulticidal activities of *Cinnamomum zeylanicum* bark essential oil compounds and related compounds against *Pedicularis humanus capitis* (Anoplura: Pediculidae). *Int. J. Parasitol.* 35, 1595–1600.
- Zhao, J., Zheng, X., Newman, R.A., Zhong, Y., Liu, Z., Nan, P., 2013. Chemical composition and bioactivity of the essential oil of *Artemisia anomala* from China. *J. Essen. Oil Res.* 25, 520–525.
- Zhu, J., Zeng, X.P., Berkebile, D., Du, H.J., Tong, Y., Qian, K., 2009. Efficacy and safety of catnip (*Nepeta cataria*) as a novel filth fly repellent. *Med. Vet. Entomol.* 23, 209–216.

Conclusion

Long-term use of the synthetic compounds can result in selection for resistance in an insect population. After years of application, the development of insecticide resistance has resulted in reduced effectiveness of traditional chemical control methods. For this reason, the potential for use of new environmental-friendly approaches as repellents is an attractive option to replace or supplement synthetic compounds for the control of vectors and pests in order to prevent disease transmission. Very few studies have been conducted to explore the active chemical molecules derived from plant-based compounds and health safety to consumer use. In this study, we report mosquito repellent activity of β -caryophyllene oxide, a common compound frequently found in many repellent plants. In addition, this study also reports an assay showing the non-toxicity of β -caryophyllene oxide to cell lines.

According to results reported in this Chapter, β -caryophyllene oxide had stronger repellent and irritant effect than DEET at the same concentration. *Anopheles minimus* was found to be more sensitive to β -caryophyllene oxide than that of *Aedes aegypti*, *Aedes albopictus* and *Anopheles dirus*. For the toxicity tests, β -caryophyllene oxide did not show any phototoxic and genotoxic activities. β -Caryophyllene oxide could be considered as a safe repellent, effective against mosquitoes. Based on the results of this chapter, the next step was to evaluate the repellent activity of this compound combined with vetiver essential oil, which also present repellent activities against several mosquito species. The best compound was then studied in semi-field tests in order to provide leads for the development of efficient mosquito repellent products that may be safer and better accepted by consumer than DEET.

Chapter 3. Behavioral avoidance and biological safety of vetiver oil and its constituents against *Aedes aegypti* (L.), *Aedes albopictus* (Skuse) and *Culex quinquefasciatus* (Say)

Jirod Nararak^{a,b}, Carole Di Giorgio^c, Kanutcharee Thanispong^d, Chutipong Sukkanon^e, Unchalee Sanguanpong^f, Valerie Mahiou-Leddet^c, Evelyne Ollivier^c, Theeraphap Chareonviriyaphap^a and Sylvie Manguin^b

^aDepartment of Entomology, Faculty of Agriculture, Kasetsart University, Bangkok 10900, Thailand

^bHydroSciences Montpellier (HSM), Institut de Recherche pour le Développement (IRD), CNRS, Université Montpellier, Montpellier, France

^cAix Marseille Univ, Avignon Université, CNRS, IRD, IMBE, FAC PHARM, Marseille, France

^dDivision of Vector Borne Diseases, Department of Disease Control, Ministry of Public Health, Nonthaburi, Thailand

^eMedical Technology, School of Allied Health Sciences, Walailak University, Nakhon Si Thammarat 80161, Thailand

^fMaejo University International College (MJU-IC) 63 Moo 4 Nongharn Sub district, Chaing Mai, 50290 Thailand

E-mail addresses: JN: (rgt532@gmail.com), CG: (carole.di-giorgio@univ-amu.fr), CS: (c.sukkanon@gmail.com), VM: (valerie.mahiou@univ-amu.fr), EO: (evelyne.ollivier@univ-amu.fr), SM: (sylvie.manguin@ird.fr), KT: (kanut47@gmail.com), US: (unchalee@rmutt.ac.th), TC: (faasthc@ku.ac.th)

*Corresponding author: Prof. Sylvie Manguin, Ph.D.

HydroSciences Montpellier (HSM), Institut de Recherche pour le Développement (IRD), CNRS, Université Montpellier, Montpellier, France

E-mail: sylvie.manguin@ird.fr

Abstract

Numerous plant-based repellents are widely used for personal protection against host-seeking mosquitoes. Vetiver oil and its constituents have demonstrated various mosquito repellent activities. In this study, three chemical actions of vetiver oil and five constituents (terpinen-4-ol, α -terpineol, valencene, vetiverol and vetivone) were characterized against *Aedes aegypti*, *Aedes albopictus* and *Culex quinquefasciatus* by the high-throughput screening assay system (HITSS). Significant contact escape responses in *Ae. aegypti* and *Ae. albopictus* to all test compounds at concentrations between 2.5 and 5% were observed. Spatial repellency responses were also observed in some test mosquito populations depending upon concentrations. The most significant toxic response on mosquitoes was found at the highest concentration, except for vetivone which had no toxic effect on *Ae. aegypti* and *Ae. albopictus*. Results on phototoxic and genotoxic hazard revealed that vetiver oil and their constituents showed no phototoxic potential or any significant genotoxic response. In conclusion, vetiver oil and two constituents (valencene and vetiverol) are potentials as active ingredients for mosquito repellents and present no toxicity.

Keywords: vetiver oil, contact irritancy, spatial repellent, phototoxic, genotoxic, mosquitoes

Introduction

Mosquitoes are the most detrimental insect in terms of public health concern. Some blood-feeding female mosquitoes play a role in the transmission of a large number of pathogens responsible of vector-borne diseases, such as malaria, filariasis, dengue, Japanese encephalitis, to cite a few, causing millions of deaths every year (WHO, 2017). *Aedes aegypti* (L) is the principal vector that carries arboviruses responsible for dengue, chikungunya, zika or other viruses (Sukhralia *et al.*, 2019). Moreover, *Aedes albopictus* (Skuse), the Asian tiger mosquito, originated from Southeast Asia, has the potential to transmit 14 arboviruses including those cited above for *Ae. aegypti* and is considered to be the fastest and most invasive mosquito species in the world as it is now well established on every continent (Kamal *et al.*, 2018; Pereira-dos-Santos *et al.*, 2020). *Culex quinquefasciatus* (Say) is an abundant nuisance night-biting mosquito in semi-urban and urban areas and is a potential vector of Japanese encephalitis (JEV) in Thailand (Phumee *et al.*, 2019). This species can transmit arboviruses such as several encephalitis and Bancroftian lymphatic filariasis in urban areas, where this species is widely distributed (Manguin *et al.*, 2010; Tawatsin *et al.*, 2019).

Personal protection using repellents is of considerable importance within the integrated disease-vector control program (Sangoro *et al.*, 2020). Widely used repellents are based on synthetic compounds. DEET (*N, N*-Diethyl-meta-toluamide, also called diethyltoluamide) is the most common active ingredient used in repellent products and is available to the public market in various forms such as lotions, gels, creams, aerosols sprays, sticks, and impregnated towelettes (Golenda *et al.*, 1999b). The concentrations of DEET in marketed products is high, varying between 5 to 100% (Corbel *et al.*, 2009). DEET is a broad-spectrum repellent against mosquitoes, biting flies, chiggers, fleas, and ticks (Davis, 1985). However, DEET plays a limited role in disease control in endemic areas because of its high cost, unpleasant odor, and inconvenience of a continuous application on the exposed skin at high doses, without mentioning the fact that DEET melt plastic materials (Deletre *et al.*, 2016; Leal, 2014). Therefore, varieties of plant-based products are of upmost interest for their effect to repel mosquitoes and other arthropod pests in many laboratories interested in developing new, efficient and more environmental-friendly repellents. Several essential oils have been reported to exhibit significant repellent activity against target insects including citronella, catnip, clove, cinnamon, kaffir lime, hairy basil, and vetiver

(Nararak *et al.*, 2016a; Polsomboon *et al.*, 2008; Suwansirisilp *et al.*, 2013; Tawatsin *et al.*, 2001) These essential oils are composed of a complex mixture blend of constituents among which some exhibit excellent mosquito repellent activity.

Vetiver (*Vitiveria zizaniodes*) oil consists of a complex mixture of more than 300 constituents. The major constituents of *V. zizaniodes* comprise vetiverol, vetivene, alpha-and beta-vetivone, khusimol, elemol, vetiselinol, beta-eudesmol, terpenes, zizanoic acid, vanillin, hydrocarbons, sesquiterpenes, alcohols, and ketones (Jain *et al.*, 1982). Vetiver oil has been reported to repel several insects such as termites, mosquitoes, weevils, beetles (Nararak *et al.*, 2016a; Sujatha, 2010; Zhu *et al.*, 2001). Tisgratog *et al.* (2018) reported that vetiverol, valencene, terpinen-4-ol and isolongifolene, which are constituents of vetiver, exhibited repellency and irritancy actions against *Anopheles minimus* at a concentration <5 %. A recent study showed that vetiver oil displayed a strong repellent activity (78%) against house flies (*Musca domestica*) and exhibited 100% contact toxicity to larval and adult house flies (Khater and Geden, 2019a).

Relatively, few studies have measured the types of responses of mosquitoes to chemicals (Carrasco *et al.*, 2019; Chareonviriyaphap *et al.*, 2002; Grieco *et al.*, 2005a; Roberts *et al.*, 1997). The excito-repellency system (ER) developed by Chareonviriyaphap *et al.* (2002) and later modified (Tanasinchayakul *et al.*, 2006) was used to characterize both types of mosquito behavioral responses, contact irritancy and spatial repellency, against test compounds. However, the ER test system requires a large amount of chemical on a treated paper surfaces due to the size of the interior surface of each test system. In 2005, a suite of the high throughput screening system (HITSS) was developed and used to quantitatively describe the responses of mosquitoes to different actions of chemicals, which are contact irritancy, spatial repellency, and toxicity to mosquitoes (Grieco *et al.*, 2005a). The HITSS was subsequently applied to determine the chemical behavioral actions on several mosquito species against selected synthetic compounds (Dusfour *et al.*, 2009; Grieco *et al.*, 2005a; Thanispong *et al.*, 2010). Relatively few studies have used the HITSS to characterize the chemical actions of natural plant-based repellents (Sathantriphop *et al.*, 2015; Tisgratog *et al.*, 2018). In the study, we used the HITSS to investigate three chemical actions: irritancy, spatial repellency and toxicity of vetiver oil and its constituents against *Ae. aegypti*, *Ae.*

albopictus and *Cx. quinquefasciatus*. In addition, the toxic safety of vetiver oil and vetiver constituents was determined using an *in vitro* phototoxicity test and an *in vitro* micronucleus assay.

Materials and Methods

Mosquito test populations

Laboratory strains of *Ae. aegypti* (USDA strain), *Ae. albopictus* (KU strain) and *Cx. quinquefasciatus* (NIH strain) were used in this study.

1. *Aedes aegypti* eggs were obtained from the U.S. Department of Agriculture, Gainesville, FL, U.S.A. The colony has been continuously maintained under laboratory-controlled conditions for over 50 years and is completely susceptible to all insecticides.

2. *Aedes albopictus* population was originally captured in 1996 in Chanthaburi Province, eastern Thailand by the staff from the Ministry of Public Health, Thailand. Representatives of this population have been maintained in the entomological laboratory at Kasetsart University since 2013 and females only were used in the current study.

3. *Culex quinquefasciatus*, recently obtained from the National Institute of Health (NIH), Ministry of Public Health, was originally collected from Pom Prap Sattru Phai, Bangkok, Thailand in 1978.

All three species were reared separately in the insectary of the Department of Entomology, Faculty of Agriculture, Kasetsart University under the conditions of $25 \pm 5^\circ\text{C}$ and $80 \pm 10\%$ relative humidity with a 12:12 light:dark photoperiod. Pupae were collected daily and placed in small cups until adult emergence in wire-mesh cages ($30 \times 30 \times 30$ cm). Adults were provided 10% sucrose solution *ad libitum*. Human blood was provided using an artificial membrane feeding system. Female mosquitoes with the age of three to five days old were starved for 24 hrs before testing.

Repellents

Sixty-four constituents of vetiver oils have been identified using Gas Chromatography/Mass Spectrometry (GC/MS). Vetiver oil and five constituents were tested with the high throughput assay system (HITSS) to characterize the repellent, irritant and toxic activity of each mosquito species. The repellents include:

1. Vetiver oil purchased from Thai-China Flavors and Fragrances Industry Co., Ltd. Company (TCFF, Phra Nakhon Si Ayutthaya Province, Thailand).
2. Valencene obtained from Sigma-Aldrich Company 3050 Spruce, St. Louis, MO 63103, USA.
3. Terpinen-4-ol provided by Professor Dr. Joel R. Coats from the Department of Entomology, Iowa State University, Ames, Iowa 50011-3140, USA.
4. Vetiverol, vetivone and α -terpineol: these three constituents were supplied from Dr. Kamlesh R. Chauhan, Invasive Insects Biocontrol & Behavior Laboratory, USDA-ARS, BARC-West Bldg. 007, room 303, 10300 Baltimore Avenue, Beltsville, MD 20705, USA. Three concentrations (1.0, 2.5 and 5% of components) of each constituent were investigated in this study.

Net impregnations

Vetiver oil and vetiver constituents were diluted with absolute ethanol into solutions of 0.5, 1.0 and 2.5% of active ingredient. Nylon netting was cut into 11×25 cm². A volume of 1.5 ml solution was applied to a strip using a 1000 μ l micropipette. The treated nets were air-dried for 15 min before being attached to the test cylinder. Control nets were treated with ethanol only.

High-throughput screening system (HITTS)

A complete set of high-throughput screening system (HITSS) consists of three test assays including toxicity, contact irritancy, and spatial repellency (Figure 16). Toxicity is indicative of knockdown or death after the mosquito makes tarsal contact with the test chemical. Contact irritancy stimulates directed movement away from the chemical source after the mosquito makes physical contact. Spatial repellency stimulates directed movement away from the chemical source without any physical contact of the mosquito with the treated surface (Grieco *et al.*, 2005a).

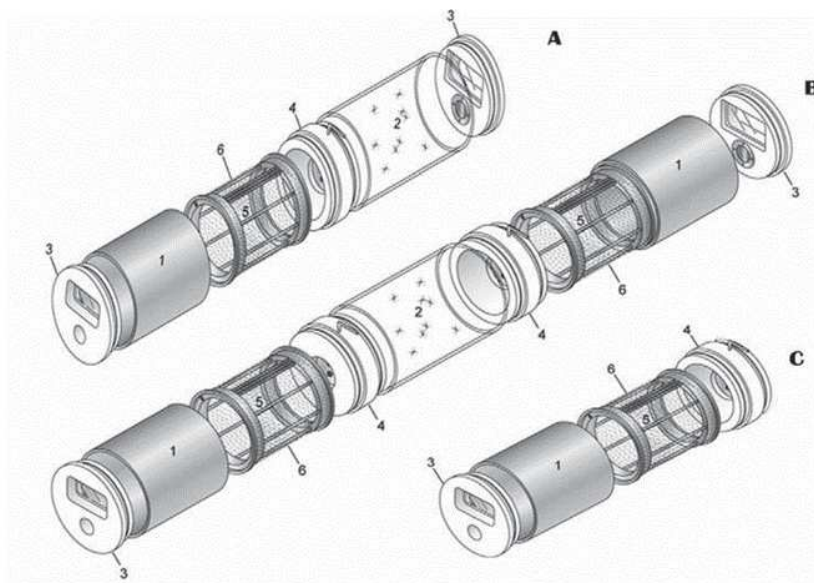

Figure 16 High throughput screening assay system (HITSS)

1=treatment (metal cylinder), 2=clear (Plexiglas) cylinder, 3=end cap, 4=linking section, 5=treatment drum, 6=treatment net; A=contact irritancy assay, B=spatial repellency assay, C=toxicity.

Source: Grieco *et al.* (2005a)

Contact Irritancy Assay (CIA)

In the CIA, a test metal cylinder lined with a treated net was fixed to a darkened control clear cylinder using a butterfly valve placed in the open position. Ten unfed female mosquitoes were released into the metallic cylinder with the treated net. After a 30 sec acclimation duration, the butterfly valve was opened and the distribution of the mosquitoes between the two compartments was recorded after 10 min. Individuals remaining in the clear cylinder at the end of the test were recorded as escaping mosquitoes, after which the butterfly valve was off. The number of mosquitoes that escaped into the clear cylinder, those still present in the metallic cylinder, and knockdown mosquitoes within both cylinders were counted (Thanispong *et al.*, 2010). Six replicates were conducted for each test and concentration.

Spatial Repellency Assay (SRA)

The SRA configuration contains three chambers, two metallic cylinders connected to a clear central cylinder using butterfly valves. Twenty unfed female mosquitoes were introduced into the central clear cylinder and allowed to rest for 30 sec, then the butterfly valves were opened for 10 min to allow free movement of mosquitoes in either direction of both ends of the test chamber. After a 10-min exposure time, the butterfly valves were closed and the number of mosquitoes in each chamber was counted. Spatial repellency is determined by considering the number of mosquitoes that have moved into the untreated, control chamber (away from the treated surface) relative to the total number of mosquitoes that have moved in either direction. Nine replicates for each compound and concentration were conducted (Achee *et al.*, 2009; Grieco *et al.*, 2005a).

Toxicity Assay (TOX)

TOX comprises a metallic cylinder only (control and treatment) fixed with an end cap. The treated net was fixed inside the cylinder of each treatment and matched control assay. Twenty starved female mosquitoes were transferred into test cylinders and exposed for 1 hr. Then, the number of knocked down mosquitoes was recorded and all (knocked down and those still mobile) were moved into clean plastic cups. These mosquitoes were provided a cotton ball soaked in 10% sucrose water and maintained in the insectary. Their mortality was monitored and recorded after 24 hrs. Six replicates were performed for each treatment combination including, a control test, and each compound at each concentration.

Data analysis

Contact irritancy data were analyzed using the Wilcoxon 2-sample test (SAS Institute, 1999) to calculate the difference in the number of escaped mosquitoes in the treated and untreated control cylinders. The spatial activity index (SAI) value was calculated for each chemical using the following equation: $SAI = (N_c - N_t) / (N_c + N_t)$, where N_c is the number of mosquitoes in the control chamber and N_t is the number of mosquitoes in the treated chamber. The SAI varies from -1 to 1, with 0 indicating no attractant or repellent response. When a SAI value is < zero, this indicates a greater proportion of mosquitoes that moved into the treatment chamber than the

control chamber, resulting in an attractant response. When a SAI value is > zero, this indicates a greater proportion of mosquitoes moving into the control chamber (away from the treatment end of the assay device), suggesting a repellent response (Kamal *et al.*, 2018). Spatial repellency data were analyzed by a nonparametric signed-rank test (SAS Institute, 1999) to calculate whether the mean spatial activity index for each treatment was significantly different from zero. Toxicity data, percentage of knockdown and mortality at 24 hrs were corrected using Abbott's formula and transformed using the arcsine square root of the data for analysis of variance (ANOVA). The knockdown and mortality of the treatment at each concentration were compared using Tukey's honestly significant difference test at $P=0.05$.

Safety evaluation procedures for Vetiver component

For safety reasons, the *in vitro* 3T3 NRU phototoxicity test (OECD N°432) was conducted to identify the toxicity of the test substances induced by the excited chemicals after exposure to light. The 3T3 NRU phototoxicity test is based on the comparison of a chemical when tested in the presence and in the absence of exposure to a non-cytotoxic dose of simulated solar light. Cytotoxicity is expressed as a concentration-dependent reduction of the uptake of the vital dye Neutral Red when measured 24 hrs after chemical treatment and irradiation.

The 3T3 NRU phototoxicity test

Mouse fibroblasts Balb/c 3T3 cell line (ATCC, USA, ATCC® CL-173™, N° P6110401, Lot. 09I006) was grown in DMEM (Dulbecco's Minimum Essential Medium, PAN BIOTECH, lot 1874561) and supplemented with penicillin 100 IU/mL, streptomycin 100 µg/mL (PAN BIOTECH, Lot 945514), 10% inactivated calf serum (PAN BIOTECH, Lot P56314) and 10% inactivated calf serum (PAN BIOTECH, Lot P56314). The *in vitro* 3T3 NRU phototoxicity of vetiver oil and vetiver components were measured to evaluate the relative reduction in viability of cells exposed to them in the presence of light *versus* absence of light. The results were expressed as a percentage of untreated control cell and concentration dependent curves in the presence and absence of light. The Photo-Irritation-Factor (PIF) was calculated with concentration (obtained by the software Phototox Version 2.0) of the test material causing a 50% release of the preloaded Neutral Red without irradiation ($IC_{50} -Irr$) and with irradiation ($IC_{50} +Irr$) as compared to the control culture using the following formula: $PIF = IC_{50}(-Irr)/IC_{50}(+Irr)$. Based on validation

studies, a test substance with a PIF < 2 is indicative of no phototoxicity, a PIF between 2 and 5 predicts a probable phototoxicity and a PIF > 5 predicts phototoxicity.

On the other hand, the degree of membrane damage (i.e. increase of released Neutral Red) was measured by a fluorescence-luminescence reader Infinite M200 Pro (TECAN). The Optical Density (OD) of each well was read at 540 nm. Results obtained for wells treated with the test material were compared to those of untreated control wells (HBSS, 100% viability) and converted to percentage values. Neutral Red desorbed solution serves as blank. The percentages of cell viability were calculated as: Viability (%) = (Mean OD of test wells - mean OD of blanks) / (Mean OD of negative control - mean OD of blanks).

***In vitro* micronucleus assay (MNvit)**

The *in vitro* micronucleus assay (MNvit) was used to detect the long-term toxicity of the chemical. The micronucleus assay MNvit is a mutagenicity assay based on the detection of micronuclei (MNC) in the cytoplasm of interphase cells and allows detecting the cytogenetic activity of clastogenic and/or aneugenic compounds in cell culture (Johnson et al. 2010). The micronucleus assay was performed on a Chinese Hamster Ovary cell line CHO-K1 (ATCC, USA). The CHO-K1 cells, suspended in Mac Coys'5A medium, were transferred into LabTek wells at a concentration of 100,000 cells/ml, and incubated for 24 hrs at 37°C in 5% CO₂. The test was performed in the presence (+) or absence (-) of the S9 metabolic activation system, and cultures were done in duplicate. When the test was performed without metabolic activation, the test substances were added into cell cultures at doses of 0.5-10 µg/mL. A negative control containing culture medium, a solvent control containing 1% ethanol and a positive control containing 0.06 µg/ml of mitomycin C were added. When the assay was performed in the presence of metabolic activation, S9 mix metabolizing mixture was added to cell cultures at a concentration of 10%. Then, the test substances were added to the cell cultures at doses previously defined. A negative control containing culture medium, a solvent control containing 1% ethanol, and a positive control containing 5 µg/ml of benzo-a-pyrene were added. After 3 hrs of incubation at 37 °C in CO₂ (5%), the culture medium was removed, the cells were rinsed with phosphate buffered saline (PBS), and then returned to culture in McCoy's 5A medium containing 3 µg/ml of cytochalasin B. After a 21-hrs incubation period at 37°C, cells were rinsed with phosphate buffered saline (PBS), fixed with

methanol and stained with 10% Giemsa for 20 min. The proliferation index (Cytokinesis Blocked Proliferative Index CBPI) was calculated. The antiproliferative activity of test substances was estimated by counting the number of binucleated cells relative to the number of mononucleated cells for 500 cells for each dose (250 cells counted per well).

The cytokinesis blocked proliferative index (CBPI) was calculated using the following formula: $CBPI = (2 \times (BI + MONO)) / 500$, where BI is the number of binucleated cells and MONO is the number of mononucleated cells. The cytostasis index (CI%) is the percentage of cell replication inhibition and was calculated using the following formula: $CI\% = 100 - [(100 \times (CBPI_{\text{test material}} - 1)) / (CBPI_{\text{solvent control}} - 1)]$. Statistical differences between negative controls and treated samples were determined using the χ^2 test. The assay was considered positive if a dose-response relationship was obtained between the rate of micronuclei and the doses tested, where at least one of these doses induced a statistically significant increase ($P < 0.05$) in the number of micronucleated cells compared to the negative control.

Results

Contact irritant, spatial repellent and toxic actions of six compounds of vetiver oil and five constituents (valencene, terpinen-4-ol, vetiverol, α -terpineol, and vetivone) were performed using the HITSS against *Ae. aegypti*, *Ae. albopictus* and *Cx. quinquefasciatus*. Responses of female mosquitoes in the contact irritancy, spatial repellency and toxicity assays to three different concentrations (1, 2.5 and 5%) of each component of vetiver oil are shown in Tables 6-8 and Figures 17-19.

Contact irritancy

Behavioral escape responses of *Ae. aegypti*, *Ae. albopictus* and *Cx. quinquefasciatus* varied drastically depending upon the concentration (1-5%) and tested species. For *Ae. aegypti*, the greater percent escape responses were observed in the treatment group compared to the control, except at 1% vetiver oil (19.35 ± 9.37), terpinen-4-ol (8.88 ± 5.13), α -terpineol (5.60 ± 7.99), vetiverol (9.12 ± 3.42) and vetivone (0.00) ($P > 0.05$) (Table 6). For *Ae. albopictus*, there was no significant difference in treatment group versus control group at 1% vetiver oil (6.64 ± 10.49), terpinen-4-ol (8.51 ± 4.78), valencene (17.65 ± 7.13), vetivone (5.83 ± 6.07) and 2.5% vetivone (6.85 ± 3.37) ($P > 0.05$) (Table 7). In contrast, *Cx. quinquefasciatus* females escaped significantly more ($P > 0.05$) in treatment compared to control tests, except at 1% α -terpineol (13.88 ± 8.00) and 1% and 2.5% terpinen-4-ol (0.00 and 12.27 ± 6.29 , respectively) (Table 8).

The strongest contact irritancy action (>87%) was observed from vetiver oil at 5% when exposed to *Ae. aegypti* and *Cx. quinquefasciatus*, as well as valencene at 2.5 and 5% for the latter species (Tables 1, 3). *Aedes albopictus* exhibited a strong contact irritancy action with valencene and vetiverol at 5% (Table 6). The rank corrected percent escaping was found higher when tested with vetiver oil (50.29-92.06%), valencene (66.11-98.33%) and vetiverol (52.54-82.82%) against *Ae. aegypti*, *Ae. albopictus* and *Cx. quinquefasciatus* at 2.5 and 5% compared to terpinen-4-ol, α -terpineol and vetivone (Tables 6-8).

Table 6 Escape response of *Aedes aegypti* in the contact irritancy assay to vetiver oil and vetiver components.

Repellent	Concentration (%)	Number of replicates (no. mosquitoes)	Number escaping (mean \pm SE)		Percent escaping (mean \pm SE)	P- value
			Treated	Control		
Vetiver oil	1	6	3.00 \pm 0.63	1.16 \pm 0.40	19.35 \pm 9.37	0.0866*
	2.5	6	6.10 \pm 0.70	1.83 \pm 0.30	52.21 \pm 9.37	0.0022
	5	6	9.10 \pm 0.40	2.16 \pm 0.30	91.53 \pm 5.41	0.0022
Terpinen-4-ol	1	6	1.83 \pm 0.40	1.00 \pm 0.23	8.88 \pm 5.13	0.0758*
	2.5	6	1.50 \pm 0.34	0.33 \pm 0.21	12.03 \pm 3.04	0.0476
	5	6	5.00 \pm 0.68	1.16 \pm 0.47	42.42 \pm 8.55	0.043
α -Terpineol	1	6	1.50 \pm 0.34	0.83 \pm 0.40	5.60 \pm 7.99	0.3723*
	2.5	6	2.16 \pm 0.40	0.66 \pm 0.21	16.11 \pm 3.75	0.0108
	5	6	4.88 \pm 1.16	0.33 \pm 0.21	47.22 \pm 11.54	0.0065
Valencene	1	6	2.83 \pm 0.30	0.50 \pm 0.34	23.52 \pm 6.06	0.0065
	2.5	6	6.83 \pm 0.47	0.50 \pm 0.34	66.15 \pm 5.53	0.0022
	5	6	6.83 \pm 0.70	0.83 \pm 0.40	66.11 \pm 7.75	0.0022
Vetiverol	1	6	1.83 \pm 0.40	1.00 \pm 0.36	9.12 \pm 3.42	0.2532*
	2.5	6	5.66 \pm 0.71	0.83 \pm 0.30	52.54 \pm 8.03	0.0022
	5	6	6.16 \pm 0.94	1.00 \pm 0.42	57.08 \pm 9.77	0.0022
Vetivone	1	6	0.83 \pm 0.30	1.00 \pm 0.0	0.0	0.4545*
	2.5	6	1.33 \pm 0.33	0.16 \pm 0.16	11.48 \pm 4.90	0.0411
	5	6	6.16 \pm 0.94	1.00 \pm 0.44	59.17 \pm 9.14	0.0022

*, $P > 0.05$

Table 7 Escape response of *Aedes albopictus* in the contact irritancy assay to vetiver oil and vetiver components

Repellent	Concentration (%)	Number of replicates (no. mosquitoes)	Number escaping (mean \pm SE)		Percent escaping (mean \pm SE)	P- value
			Treated	Control		
Vetiver oil	1	6	2.50 \pm 0.71	1.33 \pm 0.21	6.64 \pm 10.49	0.177*
	2.5	6	6.00 \pm 0.51	1.50 \pm 0.21	50.29 \pm 7.08	0.002
	5	6	6.33 \pm 0.33	1.33 \pm 0.21	65.34 \pm 6.53	0.002
Terpinen-4-ol	1	6	1.83 \pm 0.30	1.00 \pm 0.36	8.51 \pm 4.78	0.205*
	2.5	6	6.83 \pm 0.87	1.83 \pm 0.30	59.78 \pm 12.33	0.002
	5	6	4.50 \pm 0.92	0.33 \pm 0.21	42.77 \pm 10.37	0.006
α -Terpineol	1	6	3.00 \pm 0.51	1.00 \pm 0.36	21.99 \pm 5.20	0.028
	2.5	6	5.50 \pm 0.42	1.83 \pm 0.30	43.81 \pm 7.09	0.002
	5	6	6.83 \pm 0.33	1.33 \pm 0.21	68.14 \pm 5.27	0.002
Valencene	1	6	3.33 \pm 0.33	1.83 \pm 0.21	17.65 \pm 7.13	0.205*
	2.5	6	7.33 \pm 0.55	2.16 \pm 0.30	66.45 \pm 6.64	0.002
	5	6	8.50 \pm 0.56	0.50 \pm 0.34	84.02 \pm 5.87	0.002
Vetiverol	1	6	7.60 \pm 0.21	0.50 \pm 0.22	77.22 \pm 1.51	0.002
	2.5	6	8.16 \pm 0.60	0.83 \pm 0.54	75.47 \pm 9.23	0.002
	5	6	8.50 \pm 0.56	0.83 \pm 0.30	82.82 \pm 6.68	0.002
Vetivone	1	6	1.33 \pm 0.21	0.66 \pm 0.42	5.83 \pm 6.07	0.316*
	2.5	6	1.16 \pm 0.40	0.50 \pm 0.34	6.85 \pm 3.37	0.372*
	5	6	5.83 \pm 0.79	0.83 \pm 0.54	51.83 \pm 6.07	0.004

*, $P > 0.05$

Table 8 Escape response of *Culex quinquefasciatus* in the contact irritancy assay to vetiver oil and vetiver components

Repellent	Concentration (%)	Number of replicates (no. mosquitoes)	Number escaping (mean ± SE)		Percent escaping (mean ± SE)	P- value
			Treated	Control		
Vetiver oil	1	6	5.83±0.47	1.33±0.33	51.66±6.00	0.002
	2.5	6	7.66±0.42	1.33±0.33	72.17±5.69	0.002
	5	6	9.33±0.33	1.83±0.30	92.06±3.84	0.002
Terpinen-4-ol	1	6	1.00±0.36	1.00±0.36	0.0	1.000*
	2.5	6	6.00±0.36	1.33±0.55	12.27±6.29	0.138*
	5	6	5.66±0.76	1.00±0.36	50.55±9.66	0.002
α -Terpineol	1	6	3.33±0.49	2.16±0.30	13.88±8.00	0.138*
	2.5	6	2.66±0.42	1.00±0.36	17.03±7.53	0.002
	5	6	6.33±0.42	0.66±0.33	59.95±5.68	0.032
Valencene	1	6	7.00±0.51	1.50±0.42	62.77±8.32	0.002
	2.5	6	9.00±0.36	2.16±0.30	87.36±4.35	0.002
	5	6	9.83±0.17	0.66±0.21	98.33±1.66	0.002
Vetiverol	1	6	4.33±0.21	1.00±0.36	36.52±3.40	0.002
	2.5	6	7.16±0.30	1.00±0.36	68.05±4.18	0.002
	5	6	7.16±0.30	1.00±0.36	69.44±3.69	0.002
Vetivone	1	6	3.16±0.40	1.66±0.21	17.59±5.76	0.032
	2.5	6	6.83±0.47	1.00±0.36	64.30±6.07	0.002
	5	6	7.50±0.61	0.16±0.16	74.25±6.58	0.002

*, $P > 0.05$

Spatial repellency

Aedes aegypti was repelled by 2.5-5% vetiver oil, terpinen-4-ol and valencene as indicated by the positive value of SAI (Figure 17A). In contrast, *Ae. albopictus* was repelled at 1-5% vetiver oil and 2.5-5% terpinen-4-ol and valencene (Figure 17B). No significant differences in spatial repellency were found from terpineol, vetiverol and vetivone in *Ae. aegypti* and *Ae. albopictus* compared to control ($P>0.05$). Significant differences ($P<0.05$) in responses due to repellency were found between all treatment and control pairs for valencene and vetiverol against *Cx. quinquefasciatus* (Figure 17C). Overall, vetiver oil and valencene showed the most promising spatial repellency against *Aedes* mosquitoes, whereas *Cx. quinquefasciatus* was repelled by all test compounds (Figures 17A, 17B and 17C).

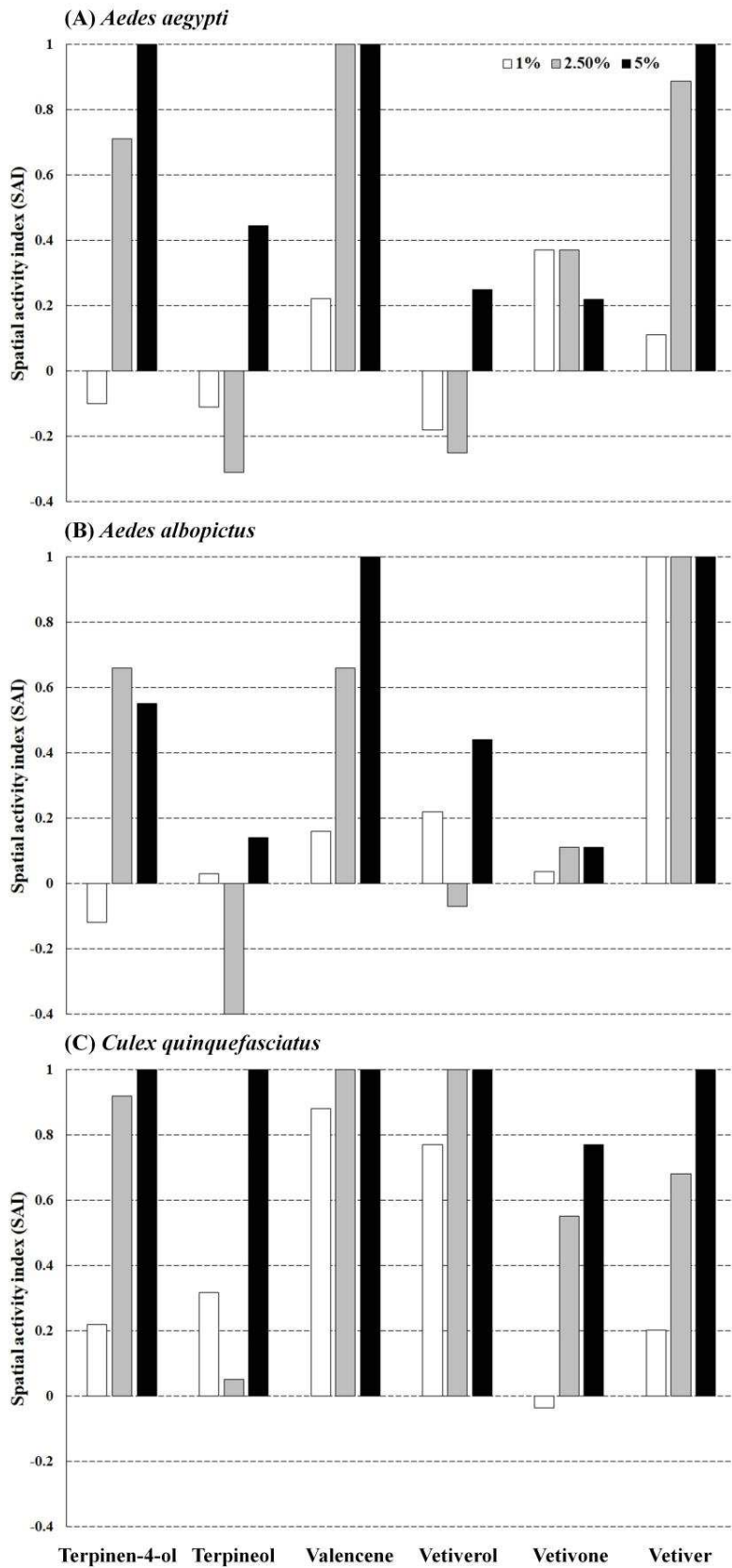

Figure 17 Spatial repellent responses of *Aedes aegypti*, *Aedes albopictus* and *Culex quinquefasciatus* exposed to six components of vetiver oil.

*, Denotes statistically significant (signed rank test, $P < 0.05$) repellent response compared with matched controls.

Toxicity assay

Positive relationship between knockdown and mortality rates and concentrations of test compound was observed for all three mosquito species (Figures 18-19). Vetiver oil and two constituents (valencene and vetiverol) produced highly knockdown and mortality effects at 2.5-5% on *Ae. aegypti*, *Ae. albopictus* and *Cx. quinquefasciatus*. Specifically, vetiver oil showed highest knockdown and mortality rate at 5%. Low toxicity, knockdown, or mortality was detected with vetivone in *Ae. aegypti* and *Ae. albopictus* (Figures 18-19).

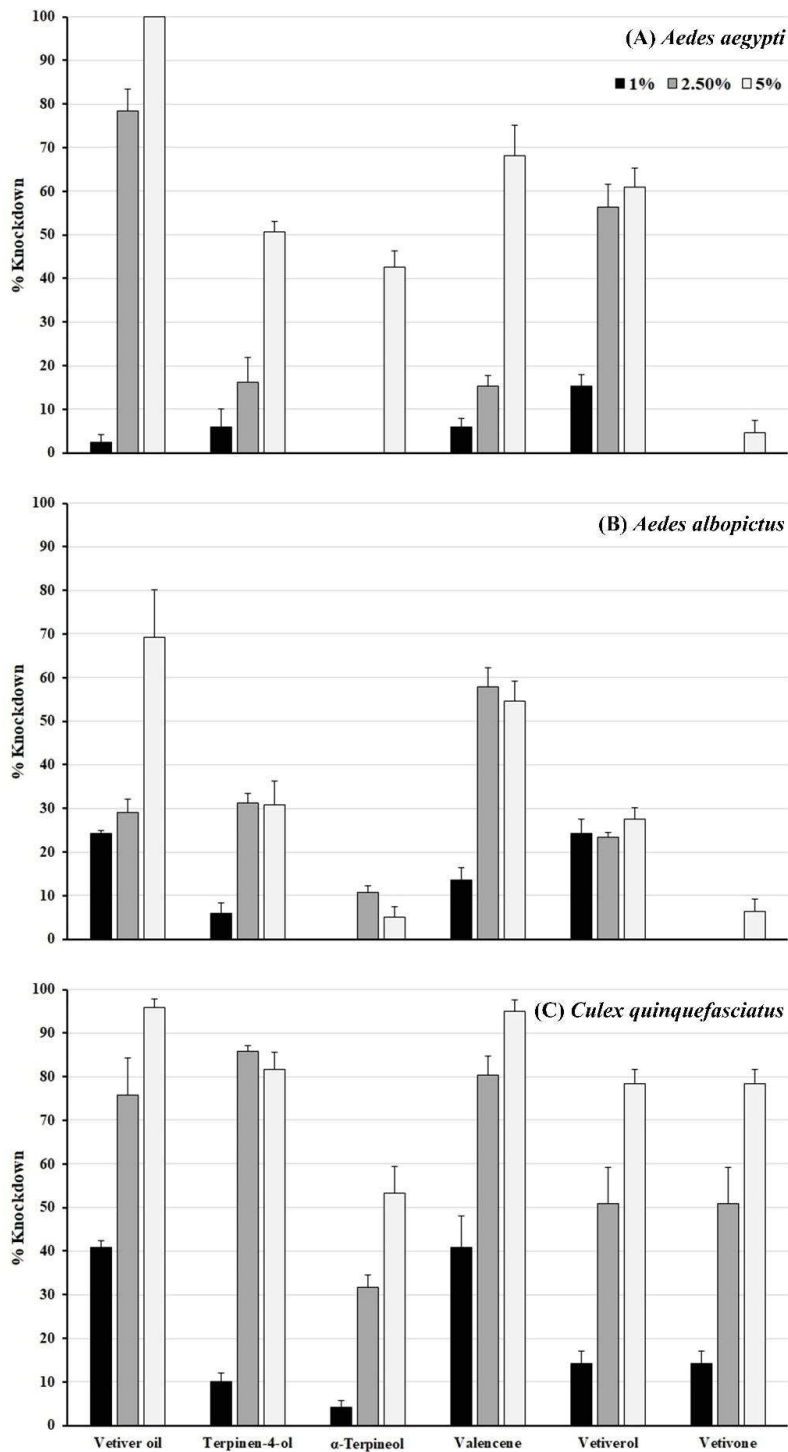

Figure 18 Percentage 1-hour Knock-down rates (TOX) with standard error (SE) in *Aedes aegypti*, *Aedes albopictus*, *Culex quinquefasciatus* laboratory strains exposed to three concentrations of vetiver oil, terpinen-4-ol, α -terpineol, valencene, vetiverol and vetivone

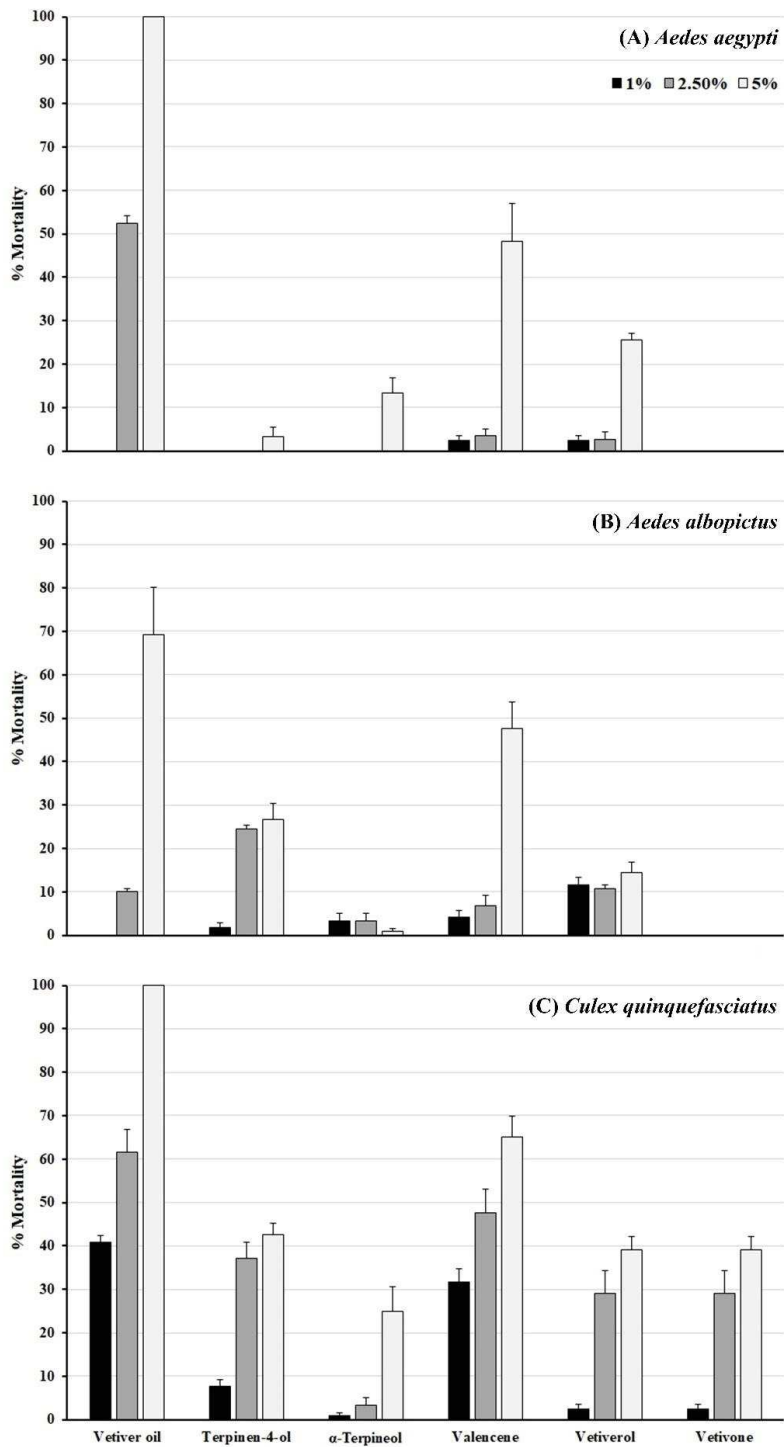

Figure 19 Percentage 24-hour mortality rates (TOX) with standard error (SE) in *Aedes aegypti*, *Aedes albopictus* and *Culex quinquefasciatus* laboratory strains exposed to three concentrations of vetiver oil, terpinen-4-ol, -terpineol, valencene, vetiverol and vetivone.

The 3T3 NRU phototoxicity test

The cytotoxic potential of vetiver oil and their constituents were evaluated in murine fibroblast (3T3) and tested in the presence and absence of exposure to a non-cytotoxic dose of simulated solar light. Results of phototoxicity were reported in Table 9. PIF values were used to categorize the phototoxicity potential. A total of six tested samples including vetiver oil, terpinen-4-ol, α -terpineol, valencene, vetiverol and vetivone, were investigated by the phototoxicity assay and all samples showed no sign of phototoxicity as indicated by the low PIF values as compared to the positive sample (chlorpromazine) (Table 9).

Table 9 *In vitro* cytotoxic and phototoxic activity of vetiver components oxide against mouse normal fibroblast (BALB/c 3T3) cell lines.

Compound	IC ₅₀ without irradiation	IC ₅₀ with irradiation	PIF	Phototoxicity
Vetiver oil	5.29 ± 0.98	13.74 ± 2.01	0.38	Non-phototoxic
Terpinen-4-ol	>100	>100	-	Non-phototoxic
α -Terpineol	>100	>100	-	Non-phototoxic
Valencene	>100	>100	-	Non-phototoxic
Vetiverol	96.09 ± 6.22	87.98 ± 8.26	1.09	Non-phototoxic
Vetivone	>100	>100	-	Non-phototoxic
Chlorpromazine	48.9 ± 3.26	1.05 ± 0.29	54.71	Phototoxic

Results are expressed as mean ± SD

***In vitro* micronucleus assay (MNvit)**

Genotoxicity was assayed starting from the highest concentration at which neither necrosis nor cytotoxic or cytostatic effect was observed. When tested on the Chinese hamster ovary (CHO)-K1 cell line, vetiver oil and its components did not produce any cytotoxic effects up to a concentration of 5 µg/mL. Percent micronucleated binucleated cells performed with and without S9 mix is presented in Table 10. Vetiver oil and all five constituents had no significant effect on the number of micronuclei induced at all the concentrations tested in the study when compared to the negative control. All the positive clastogens, mitomycin C and benzo-[a]-pyrene, significantly enhanced the number of micronuclei (Table 10). These results indicated that vetiver oil and all constituents were not derived from clastogenic/aneugenic activity and did not produce clastogenic/aneugenic metabolites, then they are safe to be used as repellent (Table 10).

Table 10 *In vitro* genotoxicity activity of vetiver components oxide on CHO-K1 cells.

Compound (% or $\mu\text{g.mL}^{-1}$)	Assay performed without S9 mix			Assay performed with S9 mix			
	Proliferative Index (%)	MNC (per 1,000)	<i>P</i>	Proliferative Index (%)	MNC (per 1,000)	<i>P</i>	
Negative control	100	10.5 \pm 0.7	-	100	10.5 \pm 2.1	-	
Positive control [§]	98.2	31.5 \pm 2.1	<0.001	97.6	24.0 \pm 1.4	<0.001	
Solvent control	98.6	9.5 \pm 0.7	NS ^a	98.4	10.0 \pm 1.4	NS	
Vetiver oil	0.1	98.6	10.5 \pm 0.7	NS	99.4	10.5 \pm 1.4	NS
	0.5	96.8	10 \pm 1.4	NS	97.5	9.5 \pm 0.7	NS
	1	81.2	12.5 \pm 0.7	NS	85.6	11.5 \pm 1.4	NS
	5	TOX	-	-	TOX	-	NS
Terpinen-4-ol	5	99.8	10 \pm 1.4	NS	99.9	10.5 \pm 2.1	NS
	10	99.1	11.5 \pm 0.7	NS	98.9	10.5 \pm 0.7	NS
	50	89.5	12.5 \pm 0.7	NS	86.4	12 \pm 2.8	NS
	100	82.4	13 \pm 2.8	NS	78.6	10.5 \pm 0.7	NS
α -Terpineol	5	99.3	12 \pm 1.4	NS	99.4	8.5 \pm 0.7	NS
	10	93.5	11 \pm 2.8	NS	95.3	9 \pm 1.4	NS
	50	78.4	8.5 \pm 2.1	NS	80.2	13 \pm 1.4	NS
	100	TOX	-	-	TOX	-	-
Valencene	5	100	12.5 \pm 2.1	NS	98.7	12.5 \pm 0.7	NS
	10	99.6	10.5 \pm 0.7	NS	99.4	12.5 \pm 0.7	NS
	50	94.5	9 \pm 2.8	NS	89.1	12 \pm 2.8	NS
	100	89.5	10 \pm 1.4	NS	86.6	12.5 \pm 0.7	NS
Vetiverol	5	98.7	11 \pm 2.8	NS	99.2	9 \pm 1.4	NS
	10	88.4	10.5 \pm 0.7	NS	97.8	12.5 \pm 2.1	NS
	50	81.2	13.5 \pm 2.1	NS	74.1	11.5 \pm 2.1	NS
	100	TOX	-	-	TOX	-	-
Vetivone	5	98.4	8.5 \pm 0.7	NS	97.4	10 \pm 1.4	NS
	10	92.2	10 \pm 1.4	NS	91.3	12.5 \pm 0.7	NS
	50	87.3	11.5 \pm 2.1	NS	87.3	12 \pm 2.8	NS
	100	78.5	9.5 \pm 2.1	NS	79.3	12.5 \pm 0.7	NS

[§]Positive controls: mitomycin C (0.05 $\mu\text{g.mL}^{-1}$) without S9 mix and benzo-[a]-pyrene (5 $\mu\text{g.mL}^{-1}$) with S9 mix; MNC: Micronucleated cells per 1,000; P: Probability of the comparison between the negative control and the tested dose using the Chi-squared test; TOX: Toxic.

^aNS: non-significant activity; Results are expressed as mean \pm SD

Discussion

Vetiveria zizanioides, commonly known as vetiver, is a year-round bunchgrass in the family Poaceae, and is native from India (Pareek and Kumar, 2013). The vetiver root system is quite structured and very powerful to protect soil against erosion and can grow downward up to the maximum of 3 m in depth (Zegeye *et al.*, 2018). Vetiver is mainly cultivated for the fragrant essential oil distilled from the roots. Due to its excellent fixative characteristic and fragrance property, vetiver oil is commonly used in perfume materials, cosmetics, and fragrance soaps, especially in European countries (de Groot and Weijland, 1997). In addition, vetiver essential oil has shown a promising repellent property against structural arthropod pests, e.g. termites, due to its long residual activity and blood-sucking insects, e.g. mosquitoes and flies, due to its high repellent activity from its unique smell (Nuchuchua *et al.*, 2009; Tisgratog *et al.*, 2016b). Chemical profile of vetiver oil investigated by the gas chromatography/mass spectrometry comprised a complex blend of different constituents in which some display insect repellent activity. In this study, we investigated the three chemical actions, comprising spatial repellency, contact irritancy, and toxic properties of vetiver oil and five constituents using the HITSS against three mosquito species, *Ae. aegypti*, *Ae. albopictus*, and *Cx. quinquefasciatus* under laboratory-controlled conditions.

Numerous plants with insect repellent property have been used to control or prevent biting from arthropod pests (Peterson and Coats, 2001). Several currently commercial repellent compounds have been originated and synthesized from plant extracts for example, 1) PMD (para-menthane-3,8-diol) from the waste distillate of lemon eucalyptus, 2) IR3535 [3-(N-acetyl-N-butyl) aminopropionic acid ethyl ester] from a substituted B-amino acid, a structure similar to naturally occurring B-alanine, which is an amino acid, and 3) Picaridin (1-piperidine carboxylic acid-2(2-hydroxyethyl)-1-methylpropylester) from piperidine-based compounds (Carroll and Loye, 2006; Moore and Debboun, 2007). In recent years, vetiver oil and four bioactive constituents: valencene, terpinen-4-ol, isolongifolene, and vetiverol, were investigated against *An. minimus*, a vector of malaria in Thailand using the HITSS (Tisgratog *et al.*, 2018). All four constituents of vetiver exhibited both behavioral and insecticidal actions depending upon the test concentrations. In our study, vetiver oil and five constituents showed variable behavioral responses, depending upon types of exposures (CIA, SRA, and TOX). Each mosquito species responded differently in escape patterns to the various test compounds. Barnard (1999) explained the differences in responses of mosquito species by their preference

of food sources. *Aedes aegypti* is mainly an anthropophilic species with high biting pressures in laboratory bioassays. *Culex quinquefasciatus* is mainly an ornithophilic species, which has only reduced appetite in laboratory trials. Therefore, using the plant-based insect repellent compounds against mosquitoes need thorough laboratory test evaluation on factors that may influence mosquito behavior, e.g. chemical compositions, test concentrations of the essential oils and the mosquito species (Rehman *et al.*, 2014).

Our result found that vetiver oil at 2.5 and 5% had a strong contact irritancy against *Cx. quinquefasciatus*, *Ae. aegypti*, and *Ae. albopictus*. Moreover, *Cx. quinquefasciatus* exhibited much stronger irritancy escape responses against vetiver oil and its constituents than *Ae. aegypti* and *Ae. albopictus*. In contrast, terpinen-4-ol and vetivone displayed the least contact irritancy on *Ae. aegypti* and *Ae. albopictus*. For spatial repellency, at 2.5 and 5% concentrations, vetiver, valencene, and vetiverol produced the highest SAI against all three mosquito species. Nararak *et al.* (2016a) observed a great excito-repellency activity of vetiver oil against *An. minimus*, using an excito-repellency test system. Vetiver oil at 1–5% showed strong irritant effects with >80% escape, while repellent effects of vetiver oil was observed at 5% concentration (83.9% escape). Sathantriphop *et al.* (2015) also tested CIA and SRA actions of six repellent compounds (citronella, hairy basil, catnip, vetiver, DEET and picaridin) against *Ae. aegypti* and *An. minimus* using HITSS. The results showed that vetiver oil had the greatest repellency effect against *An. minimus*, which was less pronounced against *Ae. aegypti*. This result is in contrast with ours showing that vetiver component presented strong repellency against *Ae. aegypti*. Guo *et al.* (2019) reported the biological activity of valencene (0.3%), which exhibited both toxicity and repellency actions against *Tribolium castaneum* adults (red flour beetles).

Vetiver oil and its constituents had strong spatial repellency, contact irritancy, and toxicity against *Cx. quinquefasciatus* at lower concentrations (1% and 2.5%). One study examining the repellent effect on the olfactory system of *Culex* mosquito antennal sensilla neurons showed that terpene-derived chemical repellents produce stronger behavioral avoidance than non-terpene-derived chemicals such as dimethyl phthalate (Liu *et al.*, 2013). In addition, our results showed a strong knockdown and mortality response by *Cx. quinquefasciatus* when exposed to valencene and vetiverol at 5%. These findings were similar to a study conducted by Tisgratog *et al.* (2018) in which valencene and vetiverol at 5% killed *An. minimus* up to 62% and 71%, respectively.

The greater responses of CIA, SRA, and TOX were seen when the vetiver oil alone was compared with their single constituent (terpinen-4-ol, α -terpineol, valencene, vetiverol and vetivone). More than 300 compounds have been identified in vetiver oil with α - and β -vetivones comprising the major constituents (Choi *et al.*, 2002; St. Pfau and Plattner, 1939). Similar study by Afshar *et al.* (2017) reported the toxicity of *Helosciadium nodiflorum* essential oil and its main constituents against the cabbage looper, *Trichoplusia ni* (Lepidoptera). The result showed that the complete oil was the most potent and showed the lower LD₅₀ values (LD₅₀=101.6-128.4 μ g/larva) than other components, which were limonene (LD₅₀=427.3 μ g/larva), (Z)- β -Ocimene (LD₅₀=771.9 μ g/larva), terpinolene (LD₅₀=699.7 μ g/larva), β -pinene (LD₅₀= 614.9 μ g/larva) and ecoTrol™ (LD₅₀=29.5 μ g/larva) (Afshar *et al.*, 2017).

Natural plant-based repellents are one of the best alternatives to chemical repellents. Many topical repellents contain essential oils, e.g. citronella, catnip, eucalyptus, etc. However, some essential oils or terpenes are known to irritate the skin and mucous membranes, and prolonged exposure to them had caused contact dermatitis (Choi *et al.*, 2002). The phototoxicity results obtained using the *in vitro* method are important because topical repellent formulations are also used during day-time to protect against day-biting mosquitoes such as *Aedes* species, and this involves exposure to the sun or artificial light. It is imperative to conduct extensive research to ensure the activity or effect on human users. The current study showed that the compounds were neither cytotoxic nor phototoxic. Likewise, this study also showed that all tested repellents did not induce genotoxicity at the chromosomal level, as observed in the micronucleus assay. Sinha *et al.* (2014) demonstrated that the vetiver oil induced cytotoxicity and genotoxicity at higher concentrations (400-800 μ g/ml). Based on the results, the vetiver oil is considered safe for human topical use at low concentrations (2.5-5%). Acute toxicity determination indicated that vetiver oil has LD₅₀ values of 2985.38 mg/kg, which is practically less toxic at oral doses in rat (Tripathi *et al.*, 2006).

Topical repellents offer much promise as potential tools for prevention against indoor and outdoor biting vectors. This study has identified vetiver oil and few of its constituents that could be used for plant-based repellent or green insecticide. Topical repellents could offer good personal protection to be potentially used as a complement to other vector control methods under an integrated vector control management strategy. Repellent products obtained from these studies should be tested in the field to further support the effectiveness of the test

compounds in natural settings because human host and environmental factors could potentially affect a repellent activity.

Chapter 4. Synergistic repellent and irritant effect of binary mixture of β -caryophyllene oxide and vetiver oil against mosquito vectors

Jirod Nararak^{a,b}, Michael J. Bangs^c, Unchalee Sanguanpong^d, Sylvie Manguin^b, Theeraphap Chareonviriyaphap^a

^aDepartment of Entomology, Faculty of Agriculture, Kasetsart University, Bangkok 10900, Thailand

^bHydroSciences Montpellier (HSM), Institut de Recherche pour le Développement (IRD), CNRS, Université Montpellier, Montpellier, France

^cPublic Health & Malaria Control Department, PT Freeport Indonesia/International SOS, Kuala Kencana, Papua, Indonesia

^dMaejo University International College (MJU-IC) 63 Moo 4 Nongharn Sub district, Chaing Mai, 50290 Thailand

E-mail addresses: JN: (rgt532@gmail.com), SM: (sylvie.manguin@ird.fr), US: (unchalee@rmutt.ac.th), MB: (bangs_michael@yahoo.com) TC: (faasthc@ku.ac.th)

*Corresponding author: Prof. Theeraphap Chareonviriyaphap, Ph.D.

Department of Entomology, Faculty of Agriculture,

Kasetsart University, Bangkok, Thailand, 10900.

E-mail: faasthc@ku.ac.th

Abstract

Mosquito repellents play a major role in preventing man-mosquito contact. In the present study, we evaluated the mosquito-repellent activity of β -caryophyllene oxide 1% (BCO), vetiver oil 2.5% (VO) and their binary mixtures [BCO+VO (1:1), BCO+VO (2:1), BCO+VO (1:2)] against four laboratory colonized mosquito species i.e. *Aedes aegypti* (L.), *Aedes albopictus* (Skuse), *Anopheles minimus* (Theobald), and *Culex quinquefasciatus* Say (Diptera: Culicidae) using an excito-repellency assay system. In general, mixture compounds produced a much stronger response by mosquitoes than that of the single, regardless of the test conditions and species. The great synergic effect was achieved for the combination of BCO+VO (1:2) in both contact and non-contact trials with *An. minimus* (74.07-78.18%) and *Cx. quinquefasciatus* (55.36-83.64%). Knockdown responses to binary mixture of BCO+VO were observed in *Ae. albopictus*, *An. minimus* and *Cx. quinquefasciatus*, ranging between 18.18 and 33.33%. The synergistic repellent activity of BCO and VO used in the study may increase the opportunity to develop safer alternatives to synthetic repellents for personal protection against mosquitoes.

Keywords: β -caryophyllene oxide; vetiver oil; excito-repellency; synergies; avoidance behavior; mosquito vectors

Introduction

Mosquitoes are the deadliest animals on the planet given the number and particular disease pathogens they are capable of transmitting (Braack *et al.*, 2018). Their ability to carry and spread diseases to humans is responsible for millions of deaths every year. These diseases include malaria, lymphatic filariasis, dengue, Japanese encephalitis, chikungunya, Zika, for the main ones. *Aedes aegypti* (L.) and *Aedes albopictus* (Skuse) are the primary vectors of dengue and Chikungunya in Thailand. *Anopheles minimus* (Theobald) is one of the most important malaria vectors in forested area of Thailand and other Greater Mekong Subregion (GMS) countries. *Culex quinquefasciatus* (Say) is the most common vector across urban and semi-urban areas and transmits *Wuchereria bancrofti*, *Plasmodium* (avian malaria), myxomatosis virus, and other disease agents across the world (Goddard *et al.*, 2002). Since most of these diseases do not have vaccines, one of the most efficient way to control them is to rely on vector control approaches as promoted by WHO for reducing disease transmission(WHO, 2009a).

Control strategies and innovations to reduce vector borne disease transmission may rely on several strategies used alone or in combination whenever possible such as vaccination, prophylactic drugs, and vector control. Among these tools, vector control is a widely used approach to prevent or control outbreaks for most vector-borne diseases (Organization, 2017). In general, mosquito control using chemical insecticides remains the most feasible technique in the control of many vectors. Unfortunately, many important mosquito species have developed resistance to different insecticides, especially *Ae. aegypti*, which has been found resistant to many active ingredients across much of Thailand (Chareonviriyaphap *et al.*, 2013; Saeung *et al.*, 2020). Therefore, one alternative method to combat blood-sucking insects is to use insect repellents as a form of personal protection to prevent transmission (Leal, 2014).

Mosquito repellents play a significant role in disrupting disease transmission by reducing human-vector contact. DEET, previously called *N,N*-diethyl-m-toluamide or now *N,N*-3-methylbenzamide, was first registered in the U.S. in 1957 for its use by military personnel in insect-infested areas. At present, DEET remains the "gold standard" insect repellent, a compound that is effective against most biting insects and other arthropod pests (e.g., mosquitoes, biting flies, ticks, fleas, and chigger mites) (Leal, 2014). DEET has a remarkable safety profile after 40 years of extensive use, but toxic reactions have been reported in highly sensitive people or whenever the product is misapplied or misused (Fradin, 1998).

Therefore, an alternative to synthetically-derived active ingredients is using plant parts and plant-based derivatives with repellent activity.

Essential oils are complex mixture of volatile organic compounds present in the plants. Repellent properties of several essential oils appear to be associated with specific compounds. Commercial uses of vetiver grass mainly pertain to the extraction of vetiver oil (VO) through the distillation of roots. VO consists of a complex mixture of more than 300 compounds, the major ones being vetiverol, vetivene, alpha-and beta-vetivone, khusimol, elemol, vetiselinol, beta-eudesmol, terpenes, zizanoic acid, vanillin, hydrocarbons, sesquiterpenes, alcohols, and ketones (Jain *et al.*, 1982). Vetiver grass (*Vetiveria zizanioides* (L.) Nash:syn. *Chrysopogon zizanioides* (L.) Roberty) has been reported to have insect repellent properties against ants, ticks, cockroaches, termites, mosquitoes, weevils, and beetles (Henderson *et al.*, 2005b; Sujatha, 2010; Trongtokit *et al.*, 2004; Zhu *et al.*, 2001). Besides essential oils, the pure compound named β -caryophyllene oxide (BCO) is a bicyclic sesquiterpenes, a representative of an epoxide derived from the olefin of (E)-caryophyllene. This compound is a common sesquiterpene present in many well-known aromatic repellent plants, such as cloves, basil, cinnamon, and citrus (Nguyen *et al.*, 2018). A more recent study showed that BCO is an efficient mosquito repellent (Nararak *et al.*, 2019) and other studies have shown that vetiver oil exhibits irritant and repellent activities against mosquitoes (Nararak *et al.*, 2016a).

An excito-repellency (ER) test system was used to evaluate the avoidance behavior of mosquitoes to test compounds (Chareonviriyaphap *et al.*, 1997; Rachou *et al.*, 1963; Roberts *et al.*, 1984b). This ER device allows insecticide avoidance behavior studies of female mosquitoes by testing contact irritancy and non-contact repellency of specific compounds. Contact irritability refers to direct tarsal contact with an insecticide that can cause a mosquito to escape from the test chamber. On the other hand, non-contact repellency results in insects detecting chemicals from a distance and escaping from the treated area without making physical contact with the insecticide.

Plant-based candidates, VO and BCO, were initially selected based on our previous studies (Nararak *et al.*, 2020; Nararak *et al.*, 2016a; Nararak *et al.*, 2019; Sathantriphop *et al.*, 2014). A more recent study reported that β -caryophyllene oxide at 1% showed spatial repellency against *Ae. aegypti* (29.9%), *Ae. albopictus* (25.45%), *An. dirus* (31.67%), *An. minimus* (86.9%) and exhibited high contact irritancy rates on *Ae. aegypti* (59.3%), *Ae. albopictus* (56.36%), *An. dirus* (32.73%), *An. minimus* (92.2%) (Nararak *et al.*, 2019). On the

other hand, essential oil from vetiver oil at 2.5% elicited great repellency responses in *Ae. albopictus* (63.7%) and *An. minimus* (66.05%) (Nararak *et al.*, 2016a; Sathantriphop *et al.*, 2014). Based on the spatial repellent activities previously showed by VO and BCO, this study used both compounds to compare the behavioral responses of *Ae. aegypti*, *Ae. albopictus*, *An. minimus* and *Cx. quinquefasciatus* to a single and binary mixtures of VO and BCO using ER test chambers.

Materials and Methods

Mosquito populations

Laboratory strains of *Ae. aegypti* (USDA strain), *Ae. albopictus* (KU strain), *An. minimus* and *Cx. quinquefasciatus* (NIH strain) were used in this study. *Aedes aegypti* eggs were obtained from the U.S. Department of Agriculture, Gainesville, FL for over 20 yrs. Samples of *Ae. albopictus* were originally captured in 1996 in Chanthaburi Province, eastern Thailand by staff from the Ministry of Public Health, Thailand. *Anopheles minimus* colony was originated from animal quarters in Rong Klnag District, Prae Province, Northern Thailand in 1993 and has been maintained in the Department of Entomology, Faculty of Agriculture, Kasetsart University, Thailand. *Culex quinquefasciatus* obtained from the National Institute of Health (NIH), Ministry of Public Health, Thailand, was originally collected from Pom Prap Sattru Phai, Bangkok, Thailand in 1978 (Sathantriphop *et al.*, 2014). Specimens of these four species were reared in the insectary of the Department of Entomology, Faculty of Agriculture, Kasetsart University under the conditions of $25 \pm 5^\circ\text{C}$ and $80 \pm 10\%$ relative humidity with a 12:12 light:dark photoperiod. Non-bloodfed, 3-5 day old females were used in all tests. Mosquitoes were deprived of a sugar meal for 24 hrs before testing but were provided with water-soaked cotton pads.

Test compounds

Vetiver oil was purchased from the Thai-China Flavours and Fragrances Industry Co., Ltd. β -caryophyllene oxide was purchased from the Acros Organics Company Ltd. (95% purity, Lot No: A0356135). Based on our previous studies (Nararak *et al.*, 2016a; Sathantriphop *et al.*, 2014), the concentrations of VO at 2.5% and BCO at 1 % were used to evaluated mosquito behavior. The treatment combinations of VO (2.5%) and BCO (1%) are shown in Table 11. Five treatments of VO and BCO were used in this study.

Table 11 Treatment and combinations of β -caryophyllene oxide and Vetiver oil

Treatments and treatment combinations	ratio	Symbol
β -caryophyllene oxide 1%	1	BCO
Vetiver oil 2.5%	1	VO
β -caryophyllene oxide 1%: Vetiver oil 2.5%	1:1	BCO+VO (1:1)
β -caryophyllene oxide 1%: Vetiver oil 2.5%	2:1	BCO+VO (2:1)
β -caryophyllene oxide 1%: Vetiver oil 2.5%	1:2	BCO+VO (1:2)

Filter paper treatment

A mixture of VO and BCO were diluted with absolute ethanol to provide concentrations mentioned in Table 11. Subsequently, 2.8 ml of test solution was spread evenly over the untreated filter paper (14.7×17.5 cm, manufacturing information) using a 5 ml pipette and pipette controller following the method described by Sathantriphop *et al.* (2014). Four similar sets of treated papers were prepared for each concentration whereas control papers were treated in the same manner using absolute ethanol only. All treated papers were air-dried in a horizontal position at room temperature for 1 hr before starting the test.

Contact irritancy and non-contact repellency tests

An excito-repellency test system was used to evaluate irritancy and repellency responses of mosquito vectors (Chareonviriyaphap *et al.*, 2002; Sukkanon *et al.*, 2020). This system consisted of two treatment chambers containing repellent-treated papers (one chamber for contact and another for non-contact treatment) and two matched control chambers containing only ethanol (non-repellent) treated papers (Figure 20). In the contact chambers, the four treated papers were placed in front of four inner screens where mosquitoes made direct physical contact on the treated areas. For the non-contact configuration, all treated papers were placed behind the inner screens where mosquitoes could not make physical contact with the treated surface.

All tests were performed between 0800 and 1600 hrs (Tainchum *et al.*, 2014). Fifteen starved female mosquitoes were introduced into each test chamber and exposed to the environmental conditions inside the chamber for 3 mins. The exit door of each test chamber was then opened to allow mosquitoes to exit from the test or control chamber to a receiving paper box connected to the chamber. Escaped mosquitoes were recorded at 1 min intervals up

until 30 mins. After the exposure time, escaping and remaining mosquitoes were separately removed from the chambers and kept in clean plastic holding cups, provided with cotton pads soaked with 10% sugar solution for 24 hrs. Knockdown after the 30 min exposure time and mortality at 24 hrs were noted. Four replicates were required for each concentration, treatment and control.

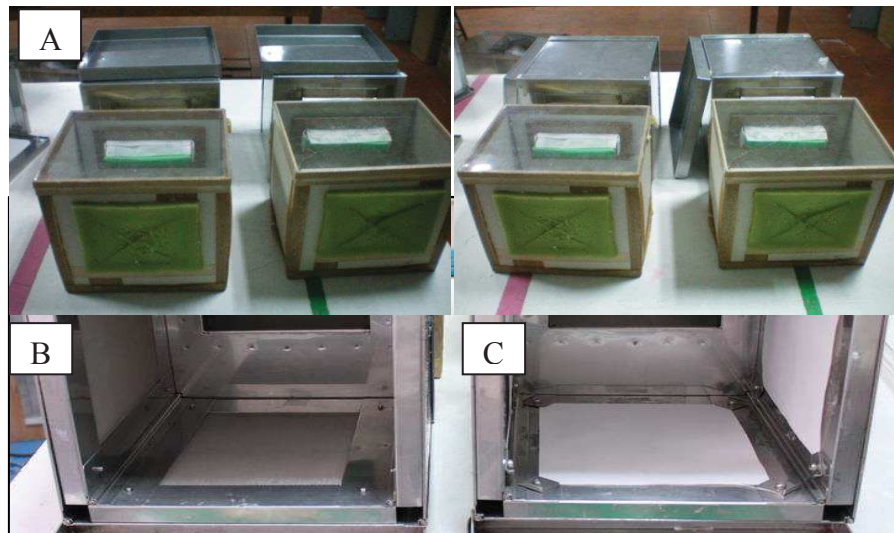

Figure 20 A) Excito-repellency (ER) test system in which the four chambers were ranged in sequence for each trial, one pair as non-contact and matched control, the other set as contact and control chamber. B) Treated and control papers were placed behind each screened portion of the inner chamber for non-contact repellency trials. C) Treated and control papers were attached to the inside portion of the screened inner chamber for contact irritancy trials.

Data analysis

Before analysis, each percent escape was adjusted based on paired control escape responses number using an Abbott's formula (Abbott, 1925). Kaplan-Meier survival analysis method was used to analyze and interpret mosquito behavioral response data. Multiple log-rank tests were used to compare two Kaplan-Meier survival curves for escape response data of mosquitoes exposed to contact and non-contact chambers, control and treatment, concentrations, substances and species using SAS version 9 (SAS Institute, Carv. NC) (Roberts *et al.*, 1997). Survival curve comparison patterns were considered to be significantly different at $P < 0.05$. The Escape Time (ET) in minutes from the beginning of test required for 25% (ET₂₅), 50% (ET₅₀) and 75% (ET₇₅) of the test mosquitoes to escape from the test chamber was estimated.

Results

Escape responses of four mosquito species were exposed to a single chemical or binary mixture of chemical repellents, specifically BCO 1% and VO 2.5%. The escape patterns during 30-mins exposure for the four mosquito species are given in Figures 21-24. The escape rates represent probabilities for mosquitoes escaping from a chamber with a particular chemical or mixture of chemicals and concentration. The percentage of four populations that escaped within a 30 mins period exposed to either single or combination of BCO and VO in contact and non-contact trials are present in Table 12. The percentage represents the probability of mosquitoes escaping from the chamber with a given chemical repellent and formulations. Strong escape responses were observed with concentrations of mixtures of BCO+VO (1:1) in both contact and non-contact trials for *An. minimus* (80.39-61.54%) and *Cx. quinquefasciatus* (75.47-51.85%), as well as BCO+VO (1:2) for *An. minimus* (78.18-74.07%) and *Cx. quinquefasciatus* (83.64-55.36%) respectively. For *Aedes* species, a higher percentage of escaped mosquitoes was observed with BCO+VO (2:1) from contact and non-contact trials for *Ae. aegypti* (53.70-40.35%) and from contact only for *Ae. albopictus* (67.27%), while at BCO+VO (1:1), the latter species showed high escape rates in contact and non-contacts trials (53.85-62.75%) (Table 12). Overall, *An. minimus* and *Cx. quinquefasciatus* exhibited more robust escape responses than *Ae. aegypti* and *Ae. albopictus*. With *Ae. albopictus*, a weak non-contact escape pattern was shown for BCO+VO (2:1) (Table 12, Figure 22).

Table 12 Percent escape responses of mosquitoes exposed to one compound or a combination of β -caryophyllene oxide (BCO) and vetiver oil (VO)

Compound	Test condition	<i>Ae. aegypti</i>		<i>Ae. albopictus</i>		<i>An. minimus</i>		<i>Cx. quinquefasciatus</i>	
		N	%Esc* (N)	N	%Esc (N)	N	%Esc (N)	N	%Esc (N)
BCO	TC	60	44.64(29)	60	60.00(40)	62	75.00(48)	60	81.48(50)
	CC	60	6.67(4)	60	16.67(10)	61	8.20(5)	60	10.00(6)
	TN	62	37.04(26)	60	59.62(39)	60	67.27(42)	60	58.18(37)
VO	CN	60	10.00(6)	60	13.33(8)	59	8.47(5)	60	8.33(5)
	TC	62	35.19(25)	60	60.78(40)	60	66.67(42)	60	71.19(43)
	CC	62	9.68(6)	60	15.00(9)	60	10.00(6)	60	1.67(1)
	TN	61	35.17(24)	60	55.56(36)	60	68.52(43)	60	39.62(28)
BCO+VO (1:1)	CN	61	6.56(4)	60	10.00(6)	60	10.00(6)	60	11.67(7)
	TC	61	25.19(25)	60	53.85(36)	60	80.39(50)	60	75.47(47)
	CC	61	9.84(6)	60	13.33(8)	60	15.00(9)	60	11.67(7)
	TN	61	27.45(23)	60	62.75(41)	60	61.54(40)	60	51.85(34)
BCO+VO (2:1)	CN	61	14.75(9)	60	15.00(9)	60	13.33(8)	60	10.00(6)
	TC	62	53.70(35)	60	67.27(42)	60	67.92(43)	60	60.71(38)
	CC	62	9.68(6)	60	8.33(5)	60	11.67(7)	60	6.67(4)
	TN	61	40.35(27)	60	29.09(21)	60	64.81(41)	60	50.88(32)
BCO+VO (1:2)	CN	61	4.92(3)	60	8.33(5)	60	9.84(6)	60	4.92(3)
	TC	61	31.15(19)	60	60.38(39)	62	78.18(50)	60	83.64(51)
	CC	60	0	60	11.67(7)	60	8.33(5)	60	8.33(5)
	TN	59	37.29(22)	60	58.00(39)	61	74.07(47)	60	55.36(35)
	CN	60	1.67(1)	60	16.67(10)	59	8.47(5)	60	6.67(4)

*Treatment percent escape adjusted based on paired control responses. BCO: β -caryophyllene oxide, VO: vetiver oil, Esc: escape mosquitoes, N: Number, TC: treatment contact, CC: contact control, TN: treatment non-contact. CN: control non-contact

Figure 21 Survival curves for *Ae. aegypti* in treated non-contact and contact excito-repellency assays. Escape responses were recorded at 1-min intervals for 30-min exposure to various combinations percent concentrations of BCO and VO. Paired control escape responses not shown.

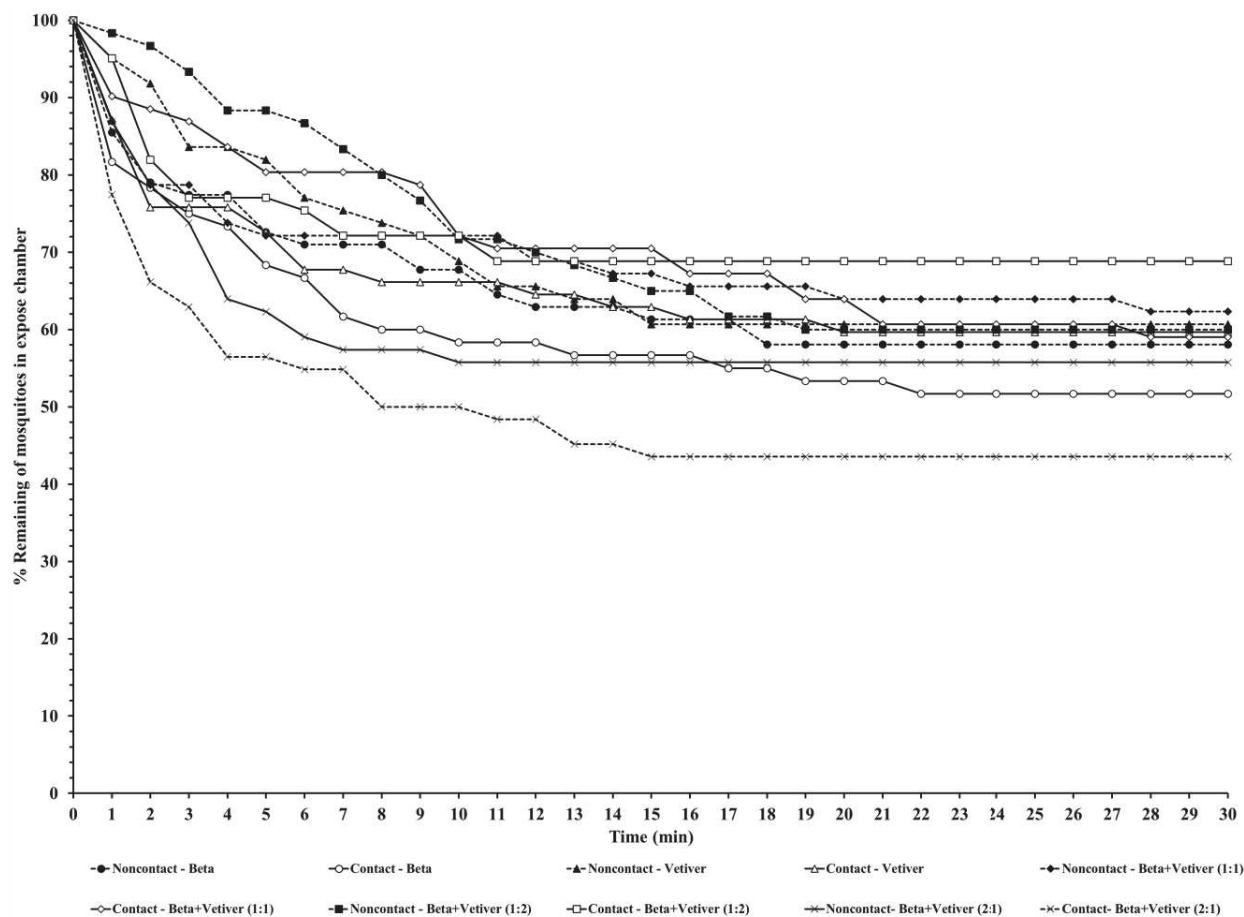

Figure 22 Survival curves for *Ae. albopictus* in treated non-contact and contact excito-repellency assays. Escape responses were recorded at 1-min intervals for 30-min exposure to various combinations percent concentrations of BCO and VO. Paired control escape responses not shown.

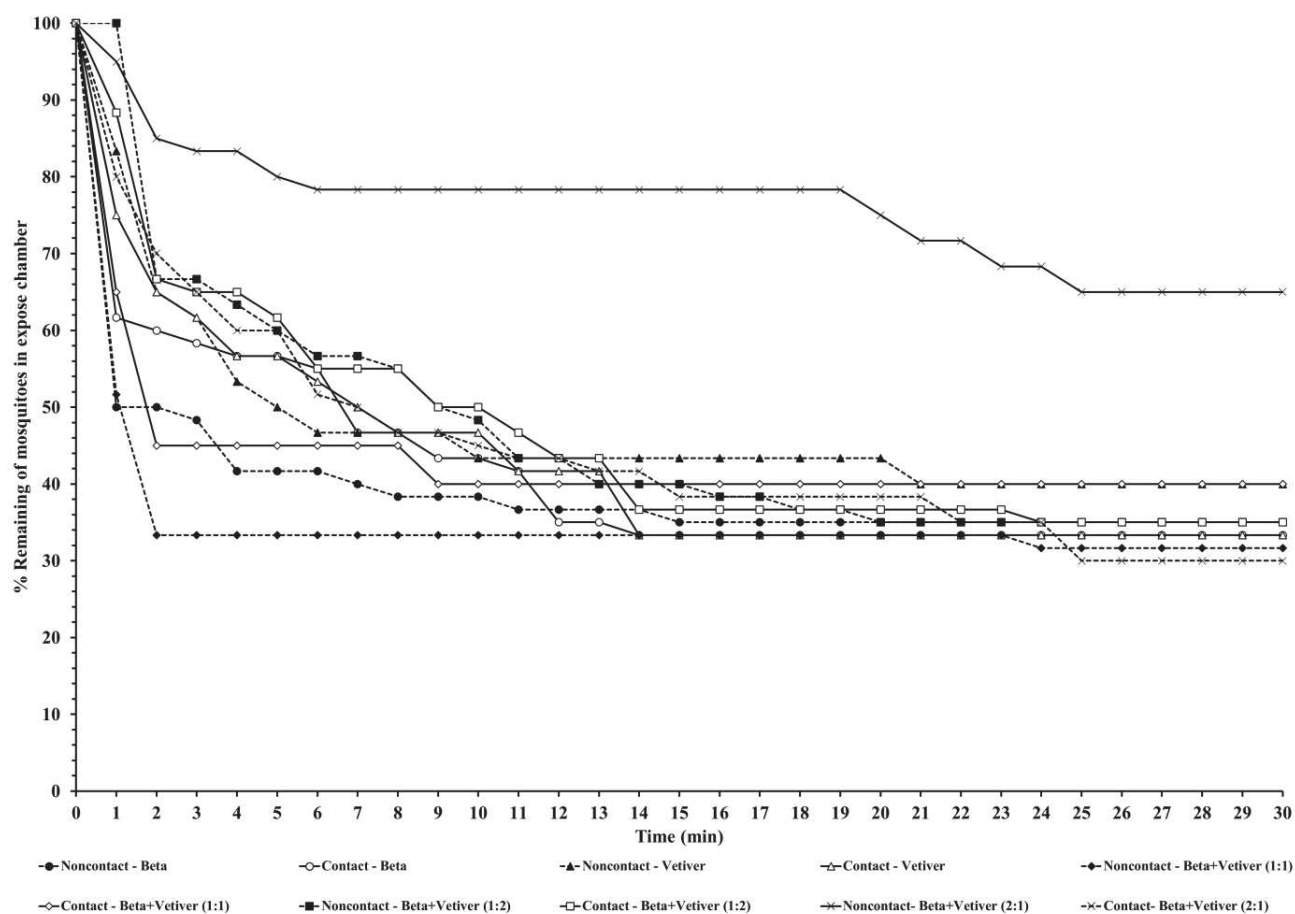

Figure 23 Survival curves for *An. minimus* in treated non-contact and contact excito-repellency assays. Escape responses were recorded at 1-min intervals for 30-min exposure to various combinations percent of BCO and VO. Paired control escape responses not shown.

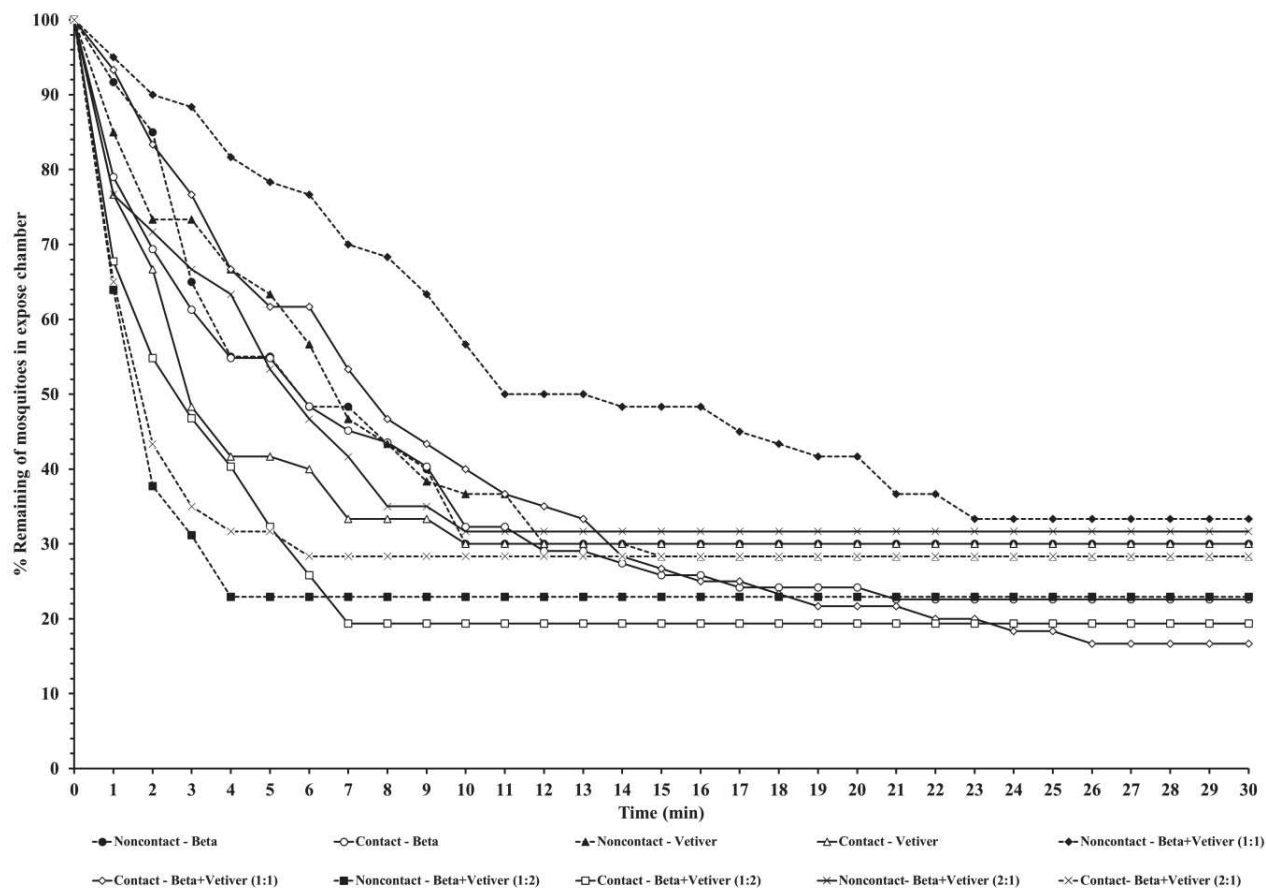
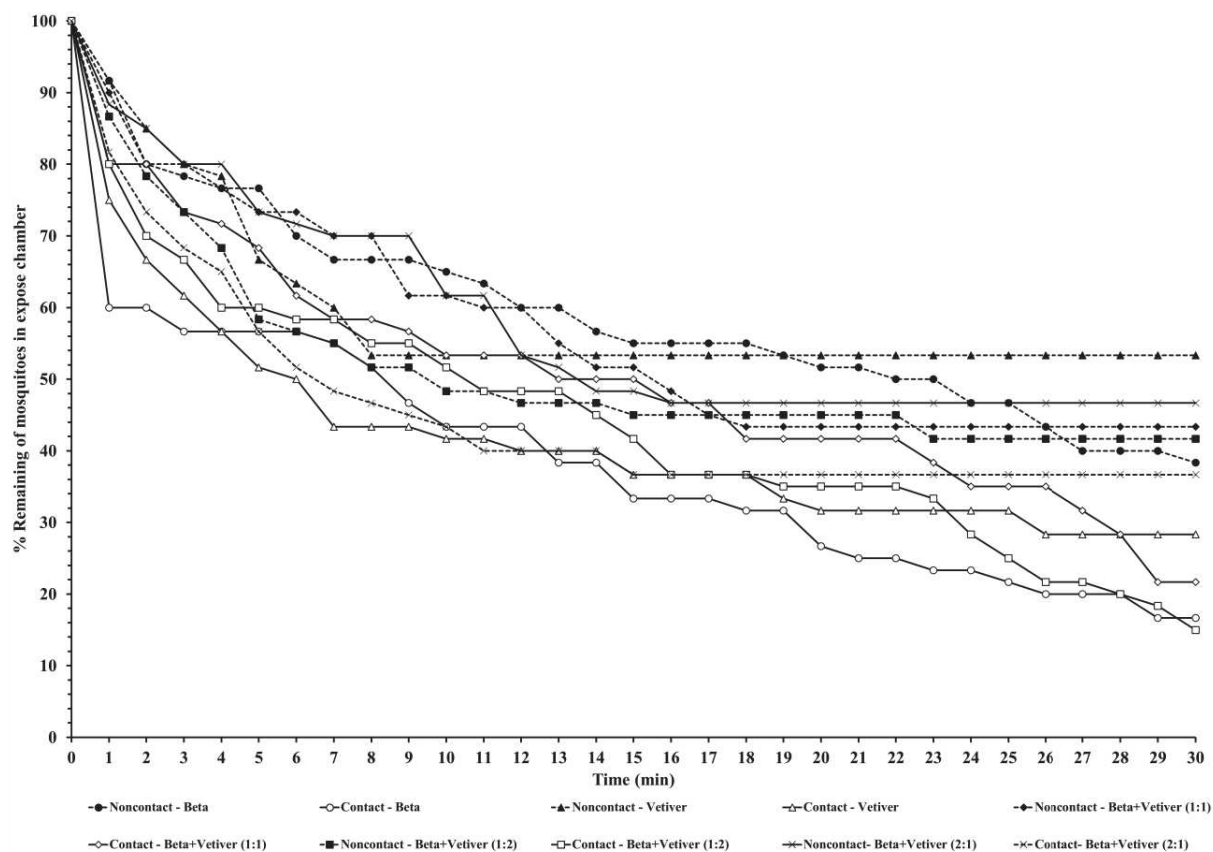

Figure 24 Survival curves for *Cx. quinquefasciatus* in treated non-contact and contact excito-repellency assays. Escape responses were recorded at 1-min intervals for 30-min exposure to various to various combinations percent of BCO and VO. Paired control escape responses not shown.



Knockdown of escaped and non-escaped mosquitoes were observed during the exposure period (30 min) (Table 13). Percent knockdown of non-escaped *Ae. albopictus* specimens in contact trials for BCO+VO (1:1) was 33.33%, BCO+VO (1:2) was 23.8%, and BCO+VO (2:1) was 22.22%. For *An. minimus* and *Cx. quinquefasciatus*, percent knockdown of non-escaped specimens in contact trials for BCO+VO (2:1) were 29.41% and 18.18%, respectively. No knockdown specimen was observed for *Ae. aegypti*. Overall, no mortality rate was found in all test populations when exposed to each plant-based repellent.

Table 13 Percent knockdown per mosquito species exposed to one compound or a combination of β -caryophyllene oxide (BCO) and vetiver oil (VO)

Compounds	Test condition*	% Knockdown (30 min)							
		<i>Ae. aegypti</i>		<i>Ae. albopictus</i>		<i>An. minimus</i>		<i>Cx. quinquefasciatus</i>	
		Es	NEs	Es	NEs	Es	NEs	Es	NEs
BCO	TC	-	-	-	-	-	-	-	-
	CC	-	-	-	-	-	-	-	-
	TN	-	-	-	-	-	-	-	-
	CN	-	-	-	-	-	-	-	-
VO	TC	-	-	-	-	-	-	-	-
	CC	-	-	-	-	-	-	-	-
	TN	-	-	-	-	-	-	-	-
	CN	-	-	-	-	-	-	-	-
BCO+VO (1:1)	TC	-	-	-	33.33	-	-	-	-
	CC	-	-	-	-	-	-	-	-
	TN	-	-	-	-	-	-	-	-
	CN	-	-	-	-	-	-	-	-
BCO+VO (2:1)	TC	-	-	-	22.22	-	29.41	-	18.18
	CC	-	-	-	-	-	-	-	-
	TN	-	-	-	-	-	-	-	-
	CN	-	-	-	-	-	-	-	-
BCO+VO (1:2)	TC	-	-	-	23.8	-	-	-	-
	CC	-	-	-	-	-	-	-	-
	TN	-	-	-	-	-	-	-	-
	CN	-	-	-	-	-	-	-	-

BCO: β -caryophyllene oxide, VO: vetiver oil, Es: escape mosquitoes, NEs: non-escape mosquitoes, N: Number, TC: treatment contact, CC: contact control, TN: treatment non-contact. CN: control non-contact

Multiple log-rank comparisons between any two species exposed to repellent compounds in either contact or non-contact trials are shown in Table 14. For contact trial, there were significant differences in escape responses when *Ae. aegypti* was compared to the other species at two concentrations BCO+VO (1:1 and 1:2), but not at BCO+VO (2:1) ($P < 0.05$). For non-contact, significant differences in escape responses between two species were found for most pairs of BCO+VO (1:2) ($P < 0.05$). Table 15 presented log-rank comparisons of mosquito escape responses between paired concentrations of BCO and VO in contact and non-contact trials. There were no significant differences in either paired contact or non-contact trials in *Cx. quinquefasciatus* for all comparisons ($P > 0.05$). No significant differences were found in all non-contact trials for *Ae. aegypti* and in all contact trials for *Ae. albopictus* at all compared concentrations (Table 15). Multiple log-rank comparisons between contact and non-contact for each single or mixtures were conducted (Table 16). Interestingly, no significant differences in escape patterns by *Ae. aegypti* were observed in paired comparisons between contact and non-contact trials. For *Ae. albopictus*, no significant differences in escape patterns were also found in paired comparisons between contact and non-contact trials, except for BCO+VO (2:1). Likewise, marked differences in escape response was present in paired contact and non-contact trials ($P < 0.05$), with BCO+VO (1:1) for *An. minimus*. Escape responses were also significantly different between contact and non-contact when *Cx. quinquefasciatus* was tested against BCO, VO, and BCO+VO (1:2) (Table 16).

Table 14 Comparisons of mosquito escape responses between contact and non-contact chambers for mosquito species exposed to BCO and VO

Compounds	Mosquito species	Contact treatment	Non-contact treatment
	<i>Ae. aegypti</i> vs <i>Ae. albopictus</i>	0.035	0.0031
	<i>Ae. aegypti</i> vs <i>An. minimus</i>	0.0017	0.0028
BCO	<i>Ae. aegypti</i> vs <i>Cx. quinquefasciatus</i>	0.0004	0.0945
	<i>Ae. albopictus</i> vs <i>An. minimus</i>	0.3834	0.6156
	<i>Ae. albopictus</i> vs <i>Cx. quinquefasciatus</i>	0.2308	0.1395
	<i>An. minimus</i> vs <i>Cx. quinquefasciatus</i>	0.8996	0.099
	<i>Ae. aegypti</i> vs <i>Ae. albopictus</i>	0.008	0.0064
	<i>Ae. aegypti</i> vs <i>An. minimus</i>	0.0017	0.0002
VO	<i>Ae. aegypti</i> vs <i>Cx. quinquefasciatus</i>	0.0018	0.2848
	<i>Ae. albopictus</i> vs <i>An. minimus</i>	0.4895	0.5086
	<i>Ae. albopictus</i> vs <i>Cx. quinquefasciatus</i>	0.6846	0.0734
	<i>An. minimus</i> vs <i>Cx. quinquefasciatus</i>	0.7974	0.0159
	<i>Ae. aegypti</i> vs <i>Ae. albopictus</i>	0.006	0.0001
	<i>Ae. aegypti</i> vs <i>An. minimus</i>	<0.0001	0.008
BCO+VO (1:1)	<i>Ae. aegypti</i> vs <i>Cx. quinquefasciatus</i>	<0.0001	0.0682
	<i>Ae. albopictus</i> vs <i>An. minimus</i>	0.3286	0.06
	<i>Ae. albopictus</i> vs <i>Cx. quinquefasciatus</i>	0.4551	0.0153
	<i>An. minimus</i> vs <i>Cx. quinquefasciatus</i>	0.1771	0.4685
	<i>Ae. aegypti</i> vs <i>Ae. albopictus</i>	0.2884	0.1919
	<i>Ae. aegypti</i> vs <i>An. minimus</i>	0.0289	0.0203
BCO+VO (2:1)	<i>Ae. aegypti</i> vs <i>Cx. quinquefasciatus</i>	0.6204	0.6583
	<i>Ae. albopictus</i> vs <i>An. minimus</i>	0.1802	<0.0001
	<i>Ae. albopictus</i> vs <i>Cx. quinquefasciatus</i>	0.6284	0.0336
	<i>An. minimus</i> vs <i>Cx. quinquefasciatus</i>	0.0525	0.0192
	<i>Ae. aegypti</i> vs <i>Ae. albopictus</i>	0.0004	0.0005
	<i>Ae. aegypti</i> vs <i>An. minimus</i>	0.0001	<0.0001
BCO+VO (1:2)	<i>Ae. aegypti</i> vs <i>Cx. quinquefasciatus</i>	<0.0001	0.0035
	<i>Ae. albopictus</i> vs <i>An. minimus</i>	0.0044	0.0016
	<i>Ae. albopictus</i> vs <i>Cx. quinquefasciatus</i>	0.1233	0.6618
	<i>An. minimus</i> vs <i>Cx. quinquefasciatus</i>	0.1706	0.0007

Table 15 Log-rank comparisons of escape responses between combinations of BCO and VO to four mosquito species

Mosquito species	Test compounds (Ratio)	Contact treatment	Non-contact treatment
<i>Ae. aegypti</i>	BCO vs VO	0.3984	0.6613
	BCO vs BCO+VO (2:1)	0.2912	0.6761
	BCO vs BCO+VO (1:2)	0.0603	0.3137
	BCO vs BCO+VO (1:1)	0.275	0.6419
	VO vs BCO+VO (2:1)	0.0588	0.3449
	VO vs BCO+VO (1:2)	0.2783	0.5343
	VO vs BCO+VO (1:1)	0.8499	0.9767
	BCO+VO (2:1) vs BCO+VO (1:2)	0.0038	0.1189
	BCO+VO (2:1) vs BCO+VO (1:1)	0.0284	0.4267
	BCO+VO (1:2) vs BCO+VO (1:1)	0.3798	0.5955
<i>Ae. albopictus</i>	BCO vs VO	0.67	0.2742
	BCO vs BCO+VO (2:1)	0.9747	0.0001
	BCO vs BCO+VO (1:2)	0.4986	0.186
	BCO vs BCO+VO (1:1)	0.661	0.6579
	VO vs BCO+VO (2:1)	0.7352	0.002
	VO vs BCO+VO (1:2)	0.8179	0.8971
	VO vs BCO+VO (1:1)	0.9292	0.0654
	BCO+VO (2:1) vs BCO+VO (1:2)	0.5881	0.0006
	BCO+VO (2:1) vs BCO+VO (1:1)	0.8006	< 0.0001
	BCO+VO (1:2) vs BCO+VO (1:1)	0.6916	0.0381
<i>An. minimus</i>	BCO vs VO	0.6909	0.9724
	BCO vs BCO+VO (2:1)	0.4881	0.8315
	BCO vs BCO+VO (1:2)	0.1166	0.0055
	BCO vs BCO+VO (1:1)	0.826	0.1207
	VO vs BCO+VO (2:1)	0.2122	0.8474
	VO vs BCO+VO (1:2)	0.0952	0.0173
	VO vs BCO+VO (1:1)	0.8674	0.0137
	BCO+VO (2:1) vs BCO+VO (1:2)	0.7613	0.1218
	BCO+VO (2:1) vs BCO+VO (1:1)	0.3607	0.1208
	BCO+VO (1:2) vs BCO+VO (1:1)	0.0485	0.0005
<i>Cx. quinquefasciatus</i>	BCO vs VO	0.2085	0.2843
	BCO vs BCO+VO (2:1)	0.0863	0.5878
	BCO vs BCO+VO (1:2)	0.6457	0.7996
	BCO vs BCO+VO (1:1)	0.1946	0.8176
	VO vs BCO+VO (2:1)	0.555	0.7484
	VO vs BCO+VO (1:2)	0.3195	0.212
	VO vs BCO+VO (1:1)	0.9356	0.5262
	BCO+VO (2:1) vs BCO+VO (1:2)	0.1285	0.3755
	BCO+VO (2:1) vs BCO+VO (1:1)	0.5108	0.7984
	BCO+VO (1:2) vs BCO+VO (1:1)	0.3062	0.5689

Table 16 Comparisons of mosquito escape responses between contact and non-contact chambers for *Ae. aegypti*, *Ae. albopictus*, *An. minimus* and *Cx. quinquefasciatus* exposed to BCO and VO

Compounds	Mosquito species			
	<i>Ae. aegypti</i>	<i>Ae. albopictus</i>	<i>An. minimus</i>	<i>Cx. quinquefasciatus</i>
BCO	0.467	0.8585	0.3947	0.0029
VO	0.733	0.7372	0.6486	0.0115
BCO+VO (1:1)	0.865	0.2418	0.0145	0.0539
BCO+VO (2:1)	0.1742	<0.0001	0.1484	0.1137
BCO+VO (1:2)	0.9072	0.8372	0.6154	0.0216

The escape patterns from chambers treated with test compounds were defined as an escape time for 25% (ET₂₅), 50% (ET₅₀), and 75% (ET₇₅) of the test populations to leave the treated chambers within 30 min (Table 16). *Aedes albopictus* showed a faster response to all single or combination of BCO and VO compounds with ET₂₅ values of 1-2 min in both contact and non-contact trials. *Aedes aegypti* had delayed escape responses to all comparisons with ET₂₅ values of 3-10 min in both contact and non-contact trials, except for BCO+VO (1:2) with lower values of 2-3 min, respectively. For ET₇₅ value, no response was observed in both contact and non-contact for *Ae. aegypti* and *Ae. albopictus* at all test compounds. *Anopheles minimus* showed fast escape responses of 1-3 min at ET₂₅-ET₅₀ to BCO+VO (1:2) in both contact and non-contact trials and at ET₂₅ for all compounds, except for BCO+VO (1:1). *Culex quinquefasciatus* displayed ET₂₅ values of 1-3 min in contact trials against all compounds tested (Table 17).

Table 17 Estimation of the escape time in minutes for 25% (ET₂₅), 50% (ET₅₀) and 75% (ET₇₅) of mosquito exposed to serial concentrations of BCO and VO in contact and non-contact chambers.

Mosquito species	Test	VO			BCO			BCO+VO (1:1)			BCO+VO (2:1)			BCO+VO (1:2)		
		ET ₂₅	ET ₅₀	ET ₇₅	ET ₂₅	ET ₅₀	ET ₇₅	ET ₂₅	ET ₅₀	ET ₇₅	ET ₂₅	ET ₅₀	ET ₇₅	ET ₂₅	ET ₅₀	ET ₇₅
<i>Ae. aegypti</i>	C	5	-	-	3	-	-	10	-	-	2	8	-	7	-	-
	NC	8	-	-	5	-	-	4	-	-	3	-	-	10	-	-
<i>Ae. albopictus</i>	C	1	7	-	1	7	-	1	2	-	1	2	-	2	9	-
	NC	2	5	-	1	-	-	1	-	-	1	-	-	2	9	-
<i>An. minimus</i>	C	2	3	-	2	6	17	4	8	16	1	2	-	1	3	7
	NC	2	7	-	3	6	-	7	11	-	2	6	-	1	2	4
<i>Cx. quinquefasciatus</i>	C	1	6	-	1	9	21	3	13	29	2	7	-	2	11	25
	NC	5	-	-	6	22	-	5	16	-	5	14	-	3	10	-

C=contact; NC=non-contact

Survival curves for *Ae. aegypti* in treated non-contact and contact excito-repellency assay. Escape responses recorded at 1-min intervals for 30-min exposure to various percent concentrations of vetiver and DEET. Paired control escape responses not show

Discussion

Currently, insecticide resistance appears as a serious threat for the success of vector control program and pressures the scientific society to develop new and enhanced vector control tools (Corbel *et al.*, 2019). Globally, numerous studies including the present investigation evidently suggest that the traditionally used plant-based insect repellents are promising and could potentially control arthropod pests and vectors transmitting diseases (Karunamoorthi *et al.*, 2010). Repellents play an important role in preventing or potentially reducing the incidence of vector-borne diseases by preventing man-vector contact. Synthetic repellent is a conventional means of personal protection against most biting insects and pests. The worldwide market for personal insect repellents has been estimated at more than \$2 billion annually (Gilbert and Firestein, 2002). One of the most effective and widely used insect repellents is *N,N*-diethyl-meta-toluamide (DEET) (Fradin and Day, 2002). Approximately, there are over 200 different DEET products available on the public market, ranging from concentrations of 5 to 100% (Nguyen *et al.*, 2018). However, critical concerns have been raised over the safety of DEET being reported in previous studies (Odaló *et al.*, 2005; Qiu *et al.*, 1998; Robbins and Cherniack, 1986).

In general, plant-based repellents are known to be safer and environment-friendlier alternative sources compared to chemical insect repellents. The plant products that are in use include a wide range of substances from crude plant extracts to essential oils and isolated compounds. In the present study, the combination of BCO and VO showed potential repellent efficacy against laboratory colonized mosquito populations. VO had shown a high repellent efficacy against mosquitoes and results were supported by several recent studies (Nararak *et al.*, 2016a; Sathantriphop *et al.*, 2014). The repellent properties of some plant-based repellents against many arthropods are based on their aromatic constituents (Maia and Moore, 2011). BCO is also widely found in plant-based essential oils and presents the capacity to repel mosquitoes (Garneau *et al.*, 2013; Gertsch *et al.*, 2008; Jun *et al.*, 2011; Liang *et al.*, 2009; Polanco-Hernández *et al.*, 2012; Shell, 1997; Telang *et al.*, 2003; Zhao *et al.*, 2013). More recent studies reported that *Ae. aegypti*, *Ae. albopictus*, *An. minimus* and *An. dirus* exhibited high avoidance response rates at 1% concentrations of BCO compared to DEET (Nararak *et al.*, 2020; Nararak *et al.*, 2019), showing the high repellent potential of this molecule.

Deploying synergistic combinations is aimed to reduce the dose substances and help reducing the risk of developing physiological resistance in any insect population. To support this phenomenon, two compounds with confirmed mosquito repellent activity were mixed to increase the repellent efficacy, i.e. three binary mixture forms of BCO (1%) and VO (2.5%) were prepared to test the excito-repellency activity on *Ae. aegypti*, *Ae. albopictus*, *An. minimus* and *Cx. quinquefasciatus* using an ER repellency test system. The combinations of BCO and VO (1:1), (2:1), and (1:2) showed a higher percent escape than a single compound. In this study, the combinations of mixture demonstrated the capability to repel mosquitoes, which is similar to that of Noosidum *et al.* (2014). They reported that the mixture of *Litsea cubeba* (LC) and *Litsea salicifolia* (LS) at 0.075% against *Ae. aegypti*, showed the highest synergistic action (65.5% escaped) compared to that with unmixed oil alone at the same concentration (LC=20% and LS=32.2%). In addition, mixtures of LC and LS at 0.075% demonstrated the highest non-contact repellency (62.7%) and showed a more significant effect than the use of LC (20%) or LS (20.3%) alone. In the study of protection period against mosquito bite, litsea (*L. cubeba*) + rosewood (*Aniba rosaeodora*) in the ratio of 1:1 (v/v) at 10% concentration showed 86% repellency for 4 hrs against *Ae. aegypti* using Human-skin test methods (K & D module) (Uniyal *et al.*, 2015). However, some combinations showed a reduction (antagonistic effect) compared with the pure compound. Pavela (2014) reported that L-carvone and gallic acid created an antagonistic effect with the other aromatic compounds to *Spodoptera littoralis* Boisid., a pest lepidoptera for crops. This implies that synergistic or additive effects of binary mixtures and the activity could be species-specific and, therefore, no generalization could be drawn from this study (Singh *et al.*, 2009).

The combination of BCO:VO were effective against four mosquito vector species, especially *Cx. quinquefasciatus* and *An. minimus*, but some of them were much weaker than when tested against *Ae. aegypti* and *Ae. albopictus*. However, the BCO:VO mixture was found to provide better protection against mosquito bites than with a repellent alone. *Cx. quinquefasciatus* exhibited much stronger escape responses against the mixtures of BCO:VO than other species. Phasomkusolsil and Soonwera (2011) found that *An. minimus* and *Cx. quinquefasciatus* were more sensitive to several different oils than were *Ae. aegypti*. Sathantriphop *et al.* (2014) revealed that *Cx. quinquefasciatus* and *An. minimus* exhibited much stronger behavioral responses to vetiver compared to *Ae. aegypti* and *Ae. albopictus*. One study examining the repellent effect on the olfactory system of *Culex* mosquito antennal sensilla neurons showed that β -caryophyllene and (-

)-caryophyllene oxide produced a strong response on short, blunt-tipped type I (SBT-I-B) neurons (Liu *et al.*, 2013).

In terms of toxicity, binary mixtures of BCO and VO showed a percent knockdown at 1 hr in the non-escape chamber. Notably, BCO+VO (2:1) showed knockdown activity with *Ae. albopictus*, *An. minimus* and *Cx. quinquefasciatus*. Noosidum *et al.* (2014) also tested ER with *L. cubeba* 0.175%, *L. salicifolia* 0.175% against *Ae. aegypti*. The synergist effect showed knockdown at 67.8%. Another study presented the comparison of the synergistic effect of *Rosmarinus officinalis* L. essential oil constituents against the larvae and an ovarian cell line of the cabbage looper, *Trichoplusia ni* (Lepidoptera: Noctuidae). The insecticidal activity of rosemary oil appears to be a consequence of the synergistic reaction between 1,8-cineole and (\pm)camphor (Tak *et al.*, 2016).

In summary, the binary combination of BCO and VO produces additive contact irritancy, non-contact repellency, and knockdown activities at low concentrations, suggesting that combinations of two repellent compounds may serve as more effective mosquito repellent than one only. The synergistic repellent activity of the essential oils used in the present study might be useful for alternatives to synthetic repellents for personal protection against mosquitoes. Such practice would reduce the chemical burden on the environment and promote sustainable use of locally available bioresource by rural communities. Further studies may be directed towards enhancing the efficacy of such repellents with the use of potentiating agents and their bio-efficacy evaluation in field conditions.

Chapter 5. Formulations and tests of natural mosquito repellent compounds using a non-contact repellency assay system (NCRAS)

Abstract

Increasing use of natural mosquito repellents as safe products for the prevention of mosquito-borne diseases has created positive acceptance by the local public. β -Caryophyllene oxide (BCO) and vetiver oil (VO) showed to be effective to repel mosquito and safe for their topical use. The aim of this work was to formulate an emulsion of oil in water (O/W) of repellent products with a longer protection time based on natural components such as BCO and VO. A non-contact repellency assay system (NCRAS) was used as a possible alternative method for testing the protection time of plant-based products against *Aedes aegypti* and *Culex quinquefasciatus*. The result showed that the plant-based product provided the great effective protection time against both mosquito species at 240 min. With additional improvement in physical and chemical characteristics in formulation, these compounds have substantial potentials to develop as novel plant-based repellents for personal protection against mosquito bites.

Key words: A non-contact repellency assay system (NCRAS), vetiver oil, β -caryophyllene oxide, formulation

Introduction

Mosquito-borne diseases are transmitted to humans by the bite of infected female mosquitoes. These diseases include malaria, dengue, Chikungunya, Zika, yellow fever, or West Nile, to cite a few, resulting in more than one million deaths every year (Benelli and Mehlhorn, 2016). The lack of effective and appropriate vaccines implies that the methods of personal prevention need be taken into account by avoiding areas with a high density of mosquitoes, wearing protective clothes, using insecticide treated nets (ITNs) and/or insecticide residual spraying (IRS), and, in the case of outdoor biting mosquitoes, applying mosquito repellents. Therefore, all kinds of personal protections are recommended for the key means of avoiding any discomfort and nuisance caused by mosquitoes (Goodyer *et al.*, 2010).

Repellent products are very common and considered to be the major tool of self-defense against mosquito bites, especially to repel outdoor biting mosquitoes, hard to reach by other means. Over 6,000 chemicals have been developed and tested in research institutions leading to the identification of multiple successful repellent compounds (Khater *et al.*, 2019). However, a few molecules provide great potential in protection against mosquito bites. As of today, the most used active ingredients for mosquito repellents are DEET (*N,N*-diethyl-*m*-methylbenzamide or *N,N*-diethyl-*m*-toluamide), IR3535 (Ethyl Butylacetylaminopropionate), Icaridin (Picaridin) and some essential oils. DEET is the oldest and most widely used for mosquito biting protection and it is now claimed as a standard mosquito repellent. In general, concentrations of 30% to 50% DEET will provide adequate protection (Han *et al.*, 2020). Although DEET is safe to humans, misapply or misuse of DEET revealed dermal toxic effects (Legeay *et al.*, 2018). A report has shown that up to 50% of DEET was absorbed into the skin within six hours after application (Qiu *et al.*, 1997). Moreover, DEET is not recommended for children up to 6 months and pregnant women (Koren *et al.*, 2003).

Two plant-based compounds, β -caryophyllene oxide and vetiver oil showed high potentials for being used as topical repellents. β -caryophyllene oxide is a bicyclic sesquiterpene, occurring naturally in essential oils from various medicinal and edible plants and used as a flavoring agent (Di Sotto *et al.*, 2013). This compound is a common sesquiterpene in many well-known aromatic repellent plants such as cloves, basil, cinnamon, and citrus (Nguyen *et al.* 2017; Sotto *et al.* 2013). β -caryophyllene oxide at 1% showed spatial repellency against *Ae. aegypti* (29.9%), *Ae. albopictus*

(25.45%), *An. dirus* (31.67%), *An. minimus* (86.9%) and exhibited high contact irritancy rates against *Ae. aegypti* (59.3%), *Ae. albopictus* (56.36%), *An. dirus* (32.73%), *An. minimus* (92.2%) (Nararak *et al.*, 2020; Nararak *et al.*, 2019). Vetiver oil was previously found to be a promising mosquito repellent (Tisgratog *et al.*, 2016a; Tisgratog *et al.*, 2018). Vetiver oil at 2.5% elicited a repellency response in *Ae. albopictus* (63.7%) and *An. minimus* (66.05%) (Nararak *et al.*, 2016a; Sathantriphop *et al.*, 2014). Moreover, VO has also been used as insect repellent properties against other insects and pests such as ants, ticks, cockroaches, termite, mosquitoes, weevils, and beetles (Henderson *et al.*, 2005a; Trongtokit *et al.*, 2004; Zhu *et al.*, 2001). β -caryophyllene oxide and vetiver oil produced much stronger irritant and repellent properties against laboratory mosquitoes compared to the standard reference repellent (DEET), thus these compounds have high potential for further development as alternative active ingredients in mosquito repellent formulations (Nararak *et al.*, 2020; Nararak *et al.*, 2016a; Nararak *et al.*, 2019).

Moreover, β -caryophyllene oxide and vetiver oil did not show neither phototoxic potential nor any significant genotoxic response as indicated by absolutely no increase in micro-nucleated cells with or without metabolic activation. Then, both β -caryophyllene oxide and vetiver are not only safe to humans, but also effective repellents against mosquitoes (Nararak *et al.*, 2020).

Repellents with oily volatile ingredients require a physiologically acceptable vehicle for skin administration. The main vehicles for those formulations are spray, lotion and gel (Tavares *et al.*, 2018). Lotions in the form of solution and liquid topical emulsions are acceptable and appropriate for employing the repellent in large areas of the body. In contrast, repellent gels and cream are more suitable for being applied in specific areas such as arms, face, hands, and neck for having better bio-adhesion and avoiding skin draining. The increasing demand for repellents and interest for more efficient, safe and eco-friendly products force researchers to create new formulations. Most of the marketed repellents are developed with alcohol-based systems, which enhance the penetration of the requested action through the skin layers and thus reduce the protection time and promotes epidermal irritations (Kalbitz *et al.*, 1996; Trommer and Neubert, 2006). The present study was undertaken to develop a new repellent oil in water (O/W) emulsion containing β -caryophyllene oxide (BCO) and vetiver oil (VO). The oil droplets of vetiver oil are dispersed in the aqueous phase and suitable emulsifiers were used to prevent any macroscopic phase separation (Barel *et al.*, 2014).

Several systems have been used to evaluate the mosquito repellent efficacy on test skin of human volunteers (Schreck and McGovern, 1989; Tawatsin *et al.*, 2001; Trongtokit *et al.*, 2005a; Witting-Bissinger *et al.*, 2008). All test systems have been developed by applying a repellent directly onto skin of human volunteers. These techniques may carry the risk for the volunteer to be in contact with mosquitoes. Thus, a non-contact repellency assay system (NCRAS) was designed by Tisgratog *et al.* (2016) and used as a possible alternative method for testing compounds that repel or inhibit mosquito bites. This new system uses a physical screen barrier that does not allow mosquitoes to land directly on the treated surface areas (forearms) of a human volunteer.

In this chapter, we developed a new formulation of mosquito repellent containing BCO and VO by using emulsifier (O/W). Subsequently, the repellent emulsion was investigated against *Ae. aegypti* and *Cx. quinquefasciatus* mosquitoes using NCRAS for efficacy testing.

Materials and Methods

Table 18 Formulations of a skin lotion based on plant-based repellent

Phase	Chemical name	Properties	Formulation % (w/w)
Oil phase	Sweet almond oil	Emollient	47.45
	Sesame oil	Emollient	15.96
	Vetiver oil	Repellent active ingredient	1.87
Water phase	Distilled water	Solvent	29.48
Emulsifier	Emulgin SG (sodium stearyl glutamate)	Emulsifier blend for O/W	0.99
Additives	Beewax	Emollient	4
	β - Caryophyllene oxide	Repellent active ingredient	0.25

Oil in water (O/W) repellent lotion preparation

The formulation components of skin lotion are listed in Table 18. Numerous trials were investigated to provide the best lotion form in terms of organoleptical (formulations without any active ingredients or preservatives) and physical properties. Formulations were tested for physical appearance, color, texture, phase separation, and homogeneity.

BCO and VO were prepared at concentrations of 2.5% and 1%, respectively. These concentrations of oil were selected based on preliminary test data and corroborated by the previous study (see Chapter 4). The formulation was prepared in two phases, the oil phase (phase A) and water phase (phase B), which were mixed at 70 °C. An emulsifier was added to the mixture and mixed until complete the dissolution of the pellets was achieved. The mixture was then homogenized using an Ultra Turax at 6,000 rpm for 2 min. The formulation was cooled down to room temperature.

Skin irritancy Test

For principal irritation potential of plant-based repellent, irritancy skin test was carried out on one forearms of each volunteer with a surface area of 5×4 cm. The plant-based repellent was applied to the specified area and time was noted. Presence of reactions, such as irritancy, erythema, edema was checked if any at regular intervals up to 24 hrs and reported.

Mosquito populations

Two laboratory strains of *Ae. aegypti* (USDA strain) and *Cx. quinquefasciatus* (NIH strain) were used in the study.

1. *Aedes aegypti* eggs were obtained from the U.S. Department of Agriculture, Gainesville, FL and this colony has been continuously maintained under laboratory condition for over 50 years and is completely susceptible to all insecticides.

2. *Culex quinquefasciatus*, recently obtained from the National Institute of Health (NIH), Ministry of Public Health, was originally collected from Pom Prap Sattru Phai, Bangkok, Thailand in 1978 and is susceptible to all insecticides.

Volunteers

Before the test, all information, details of the study and the potential risk of test were provided to human volunteers. Verbal consent was also performed before testing. Four different volunteers, 2 male and 2 female healthy adults, participated to this study. A mix of gender was sought in case of varying attractiveness and protection efficacy between sexes (Gilbert *et al.*, 1966; Golenda *et al.*, 1999). All volunteers were between 22-56 years old.

Test system: a non-contact repellency assay system (NCRAS)

A non-contact repellency assay system was used for all bioassays as previously described (Tisgratog *et al.*, 2016). NCRAS is comprised of two equal chambers. A is the Plexiglas® barrier to separate two smaller chambers, B is the exposure chambers (there are two chambers), and C is a section fitted with (or without depending on test design) an outer screen mesh barrier (Figure 25).

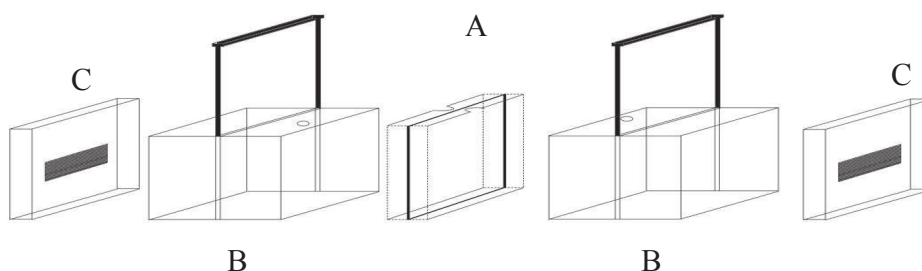

Figure 25 A non-contact repellency assay system (NCRAS)

The entire bilateral system is constructed of clear Plexiglas® (0.07 mm thickness), comprising of four sections of two smaller mosquito resting chambers (control and treatment), measuring $1,125 \text{ cm}^3$ each, attached to the two larger chambers (control and treatment), measuring $2,250 \text{ cm}^3$ each. In the middle of each Plexiglas sidewall of the two larger chambers, a screen barrier, measuring $3 \times 10 \text{ cm}^2$ diameters, is constructed of fine mesh metal (24 cells per cm^2). The entire assay system measures 44 cm length x 15 cm width x 15 cm height. Each smaller chamber (10 cm x 15 cm x 15 cm) has a door with 2 cm in diameter made of a split sheath of dental dam that allows mosquitoes to be placed inside the chamber and removed after testing. The two larger chambers are 10 cm x 15 cm in size and allow non-obstructive observation of mosquitoes that land on the screen barrier behind which either treated or untreated human arms are held in position. There is a metal support frame, which provides a gap of 1 cm (0.4 inch) between the treated arms and the screen barrier to prevent mosquitoes from making direct contact with the skin surface of human volunteer.

Test method

Before applying the test sample, the test area ($3 \times 10 \text{ cm}^2$) of both arms was initially cleaned with a 95% ethanol and distilled water to ensure the skin surface to be completely clean without dirt, perfumes, and soap residue. A $100 \mu\text{l}$ per 30 cm^2 of skin surface ($0.0349 \text{ mg}/\text{cm}^2$) of repellent sample was applied thoroughly onto one clean forearm of a human subject, while the other forearm was treated with $100 \mu\text{l}$ of solution-base as a control. For each test, female mosquitoes were exposed to a single concentration of test compound in a series of experiments to assess repellent

activity over time. Ten females, 4–5 days old, were transferred to one side of each of the 2 test chambers using an aspirator (a total of 20 mosquitoes per trial run). Treated skin surfaces were allowed to air dry for a minimum of 5 min before placing both arms in an identical, fixed position beside the chamber opposite the screen barrier. All volunteers were in a comfortable sitting position during the 3-min test (Figure 26). Right after the release of the mosquitoes into each chamber, the number that landed and/or visibly probed for up to 5 consecutive seconds on the screen during the entire 3 min period was recorded by the investigator for one chamber and the volunteer for the other. After the 3-min interval, the arms were removed from the test position. The 3-min test was repeated every 30 min until 8 hours. All four volunteers with the equal number of males and females performed 10 trial rounds in this study.



Figure 26 A non-contact repellency assay system (NCRAS) set-up (top view) with volunteer subject sitting in the testing position

Analysis

Landing or probing is considered as an endpoint in this trial. The mean number of landing or probing mosquitoes on human volunteers was compared. The result was analyzed by compiling all test volunteer subjects as 40 replicates. The ending point was decided in case of 1) the mean number of mosquito landing or probing in treatment site is more than the control site or 2) there is first no significantly different in the mean number of mosquito landing or probing between

treatment and control. Differences within study trials comparing treatment *versus* control skin were analyzed using a sample t-test. The tests were using SPSS version 22.0.

Ethic

This study was approved by the Kasetsart University Research Ethics Committee, Kasetsart University (COA No. COA61/041). All steps were carried out with the compliance of the international guidelines for human research protection as Declaration of Helsinki, the Belmont Report, CIOMS Guideline and International Conference on Harmonization in Good Clinical Practice (ICH-GCP).

Results

The present study was conducted to determine the mosquito protection time of a plant-based repellent emulsion product made from two active ingredients, BCO and VO in order to confirm the effectiveness of the herbal mosquito repellent formulations. Topical application using a skin toxicity test was performed on four human volunteers with 10 replicates. No sign of redness, itching or other unwanted signs were observed, indicating that this plant-based repellent could be potentially used as a topical application. The appearance of this plant-based repellent formulation was acceptable to the users, having a smooth texture, pleasant smell and easily spreadable property.

Mosquito protection time observed on four human volunteers against *Ae. aegypti* and *Cx. quinquefasciatus* by this plant-based product is shown in Tables 19 and 20. In this study, one forearm was treated with a repellent product, while the other forearm was treated with absolute ethanol only. Both arms were placed against opposite screen barriers (Figure 27). The result was analyzed by compiling the mean number of test subjects as 40 replicates per each subject. Table 19 presents the mean (\pm SE) landing or probing mosquito in minute over 3-min intervals during a period of 8 hrs by exposing the treated or untreated arm area to *Ae. aegypti*. The results revealed no statistically significant differences in mean number of mosquitos between paired arms comparing treated vs. untreated screened trials ($P=0.553$) at 270 minutes (4 ½ hrs). Therefore, the protection time was decided at 240 mins (4 hrs) as set criteria (Table 19). Similarly, the result from *Cx. quinquefasciatus* showed no statistically significant differences in mean number of mosquitoes between paired arms comparing treated vs. untreated screened trials ($P = 0.073$) at 270 minutes. Therefore, the protection time was considered at 240 mins (Table 20).

Figure 27 showed the comparison of mean number of mosquitoes between *Ae. aegypti* and *Cx. quinquefasciatus* in treated and untreated forearms. In general, the mean number was higher in untreated than that of treated one. The mean number of *Ae. aegypti* landing on screen barrier was much higher than that of *Cx. quinquefasciatus*. The repellent activity showed a gradual decreasing from 240 min onward.

Discussion

The core of vector control measures is to use insecticide intervention such as long-lasting insecticidal nets (LLINs), indoor residual spraying (IRS), ultra-low volume (ULV) spray application and larvicides. The extensive use of synthetic insecticides for vector control has placed key concerns over the selection pressure caused by the insecticides on resistance gene mechanisms (Chareonviriyaphap *et al.*, 2013). Insect resistance to insecticides was documented for all classes of insecticides, including biological agents and insect growth regulators (Hemingway *et al.*, 2004). In contrast, repellent strategy represents promising alternatives in preventing the spread of mosquito-borne disease without the logistical hurdles of the aforementioned novel mosquito control approaches (Norris and Coats, 2017; WHO, 2019a). Among these, spatial repellents are designed to interrupt human–vector contact through the airborne chemicals, potentially offering protection from the bites of vectors and nuisance pests (WHO, 2019a). Besides, topical repellent has been shown to offer personal protection against mosquito bites, as a stand-alone measure or in combination with other control methods (Gryseels *et al.*, 2015).

The use of topical insect repellents is a key recommendation by health authorities to prevent mosquito-borne diseases (Diaz, 2016). Nowadays, synthetic repellents such as DEET, IR3535, Icaridin and mix-pyrethroid containing formulations are the most generally sold in public supermarkets (Xue *et al.*, 2014). However, the side effects of synthetic ingredients in repellent were reported by many researchers (Brown and Hebert, 1997). Therefore, an alternative tool is to use natural products that possess good efficacy and are environmentally eco-friendly. Plants-based repellents often offer alternative safe and renewable resources for topical products. The essential oils with repellent activities have been demonstrated and the importance of the synergistic effects among their components showed also potential for future development and increase in their efficacy and persistence. Among those compounds of plant-based repellents, β -caryophyllene oxide is the substance acting as a very strong repellent against mosquitoes (Gillij *et al.*, 2008; Nararak *et al.*, 2020; Nararak *et al.*, 2019). In the other hand, vetiver oil also had shown a high repellent efficacy against mosquitoes as evidenced by the study from Nararak *et al.* (2016a). In addition, BCO and VO are also safe when used as a flavoring/fragrance ingredient. Thus, these findings highlight that these components would be safe for human when used as topical applications (Nararak *et al.*, 2020).

The choice of the mosquito repellent formulations depends on a series of factors such as types of active repellent (natural or synthetic), pharmaceutical forms (cream, gel, lotion, spray), effective time duration (short or long), environment of exposure (sunny, shade, hot, cold) and the user (adult, pregnant women, children, newborn) (Tavares *et al.*, 2018). In this study, we formulated the mosquito repellent products in the form of a classical plant-based repellent emulsion lotion. The lotion solution and liquid topical emulsion are suitable for applying the repellent in large areas of the body. Based on our test results, the new formulation of plant-based repellent lotion would provide prolonged efficacy in protecting humans from the bite of mosquitoes. Another possibility to increase the time-length of efficacy would be to use polymer microcapsules that present a cavity capable of storing volatile substances, which can be applied for insect repellent products. The polymer wall of the microcapsules resists repellent diffusion providing a slow release and prolonged action (Jing *et al.*, 2014).

In this study, we have attempted to evaluate the plant-based lotion formulation by using NCRAS on two species of mosquitoes, *Ae. aegypti* and *Cx. quinquefasciatus*. Results showed that the number of mosquitoes landing on the screen barrier between control and treatment are not significantly different at 270 min for both species. In this study, the ending point of the experiment was decided in case of 1) the mean number of mosquito landing or probing in treatment side is more than the control side, or 2) there is no significantly different mean number of mosquitoes landing or probing between treatment and control. However, after 270 min, we found that the number of mosquitoes landing on the treated screen barrier was significantly lower than that of the control. The possible explanation may be due to effective ingredient (s) that inhibited the blood feeding behavior at the activation and orientation states. This claim is supported by the study of Hao *et al.* (2014) who explained the phenomenon in that some plant-based repellents could significantly affect the activation and orientation stages of *Ae. albopictus* after exposed to them. It is probably that some of plant-based repellents may have inhibited or interrupted the ability of the female mosquito for host seeking (Hao *et al.*, 2014). Therefore, these initial laboratory results clearly showed that active ingredient (s) in plant-based repellent could also be used as spatial repellents against mosquito vectors and this tool could play a major role in the development the new mosquito repellent technology.

Due to the human risk and ethical issues, the NCRAS was developed as an alternative assay to the arm-in-cage system, a common tool to investigate the efficacy of mosquito repellent formulations (Tisgratog *et al.*, 2016). However, the NCRAS presented in this study needs complete standardization in physically and technically designed protocol to be comparable to the common arm-in-cage system. For example, the gap between mosquito landing screen barrier and volunteer's arm surface might be narrow down up to the point of allowing the tip (labellum) of the proboscis to touch the skin without actual penetration of mouthpart stylets. Therefore, increasing the size of the mesh (e.g., < 10 cells per cm^2) may drastically improve test performance (Tisgratog *et al.*, 2016).

Several studies on testing repellent products in human assays have been published (Barnard and Xue, 2004; Logan *et al.*, 2010; Masetti and Maini, 2006; Ranasinghe *et al.*, 2016; Trongtokit *et al.*, 2005b). However, direct comparison of results generated by different test systems may lead to differences in the estimation of protection times. Generally, the protection time is estimated by counting the number of landing/probing mosquitoes for three-min period and this observation is made every 30 min until two or more mosquitoes landed or probed, thereby ending the test (WHO, 2009b). The ending point was decided when the mean number of mosquito landing/probing of treatment site are equal (non-significantly difference) or greater than that of control site. In our study, the ending point was decided when the mean number of mosquito landing/probing of treatment site are equal (non-significantly difference) or greater than that of control site. Thus, our result may not be comparable to the other study due to the estimated protection method.

Numerous commercial repellents contain a number of plant-based compounds including plant extract, essential oil, plant based-synthetic and fragrance. The present study indicated that the new repellent lotion (O/W emulsion) containing BCO and VO is very promising as a new novel plant-based repellent. Moreover, the most efficient malaria vectors in Southeast Asia are outdoor biting mosquitoes with early feeding activity that cannot be targeted with the traditional IRN and ITN coverage. Therefore, new strategies to prevent these outdoor and early biting mosquitoes must be found in order to reduce malaria transmission. This might open up new opportunities for future development of more efficient and eco-sourced mosquito repellents, which meets the needs of today's consumers.

Table 19 Mean \pm SE landing *Ae. aegypti* mosquitoes in minute over 30-min intervals until 8 hrs after exposure to screened forearms treated with a repellent product

Time (Min)	Number of trials	Mean \pm SE landing mosquitoes		Sig. (2-tailed)
		Control	Treatment	
0	40	4.52 \pm 0.25	0.70 \pm 0.19	0.000
30	40	4.52 \pm 0.31	1.65 \pm 0.18	0.000
60	40	4.27 \pm 0.23	1.55 \pm 0.20	0.000
90	40	4.62 \pm 0.31	1.70 \pm 0.21	0.000
120	40	4.65 \pm 0.36	1.27 \pm 0.20	0.000
150	40	4.35 \pm 0.32	1.82 \pm 0.23	0.000
180	40	5.27 \pm 0.36	2.02 \pm 0.28	0.000
210	40	5.60 \pm 0.30	2.55 \pm 0.27	0.000
240	40	4.47 \pm 0.24	1.57 \pm 0.19	0.000
270	40	4.70\pm0.26	4.47\pm0.26	0.553
300	40	5.00 \pm 0.27	4.37 \pm 0.31	0.144
330	40	4.57 \pm 0.30	2.95 \pm 0.34	0.001
360	40	5.32 \pm 0.38	2.57 \pm 0.35	0.000
390	40	4.72 \pm 0.27	2.12 \pm 0.30	0.000
420	40	6.00 \pm 0.36	2.57 \pm 0.26	0.000
450	40	5.42 \pm 0.28	2.60 \pm 0.30	0.000
480	40	5.95 \pm 0.28	2.90 \pm 0.25	0.000

Table 20 Mean± SE landing *Cx. quinquefasciatus* mosquitoes in minute over 30-min intervals until 8 hrs after exposure to screened forearms treated with a repellent product

Time (Min)	Number of trials	Mean± SE landing mosquitoes		Sig. (2-tailed)
		Control	Treatment	
0	40	2.70±0.27	0.82±0.175	0.000
30	40	2.77±0.38	0.85±0.13	0.000
60	40	3.07±0.28	0.90±0.15	0.000
90	40	2.92±0.30	1.20±0.19	0.000
120	40	3.15±0.34	1.30±0.21	0.000
150	40	2.82±0.36	1.27±0.20	0.001
180	40	3.05±0.33	1.15±0.21	0.000
210	40	2.72±0.33	1.05±0.20	0.000
240	40	2.90±0.29	1.42±0.22	0.000
270	40	3.02±0.34	2.15±0.33	0.072
300	40	2.65±0.34	1.80±0.28	0.061
330	40	3.07±0.28	1.85±0.28	0.003
360	40	2.82±0.26	2.12±0.31	0.092
390	40	2.97±0.31	2.87±0.25	0.807
420	40	2.67±0.31	2.30±0.29	0.390
450	40	3.20±0.33	2.40±0.28	0.074
480	40	3.25±0.32	2.22±0.32	0.030

Figure 27 Mean \pm SE landing mosquito in minute over 30-min intervals until 8 hrs. after exposure to screened forearms untreated and treated with repellent to *Ae. aegypti* and *Cx. quinquefasciatus*.

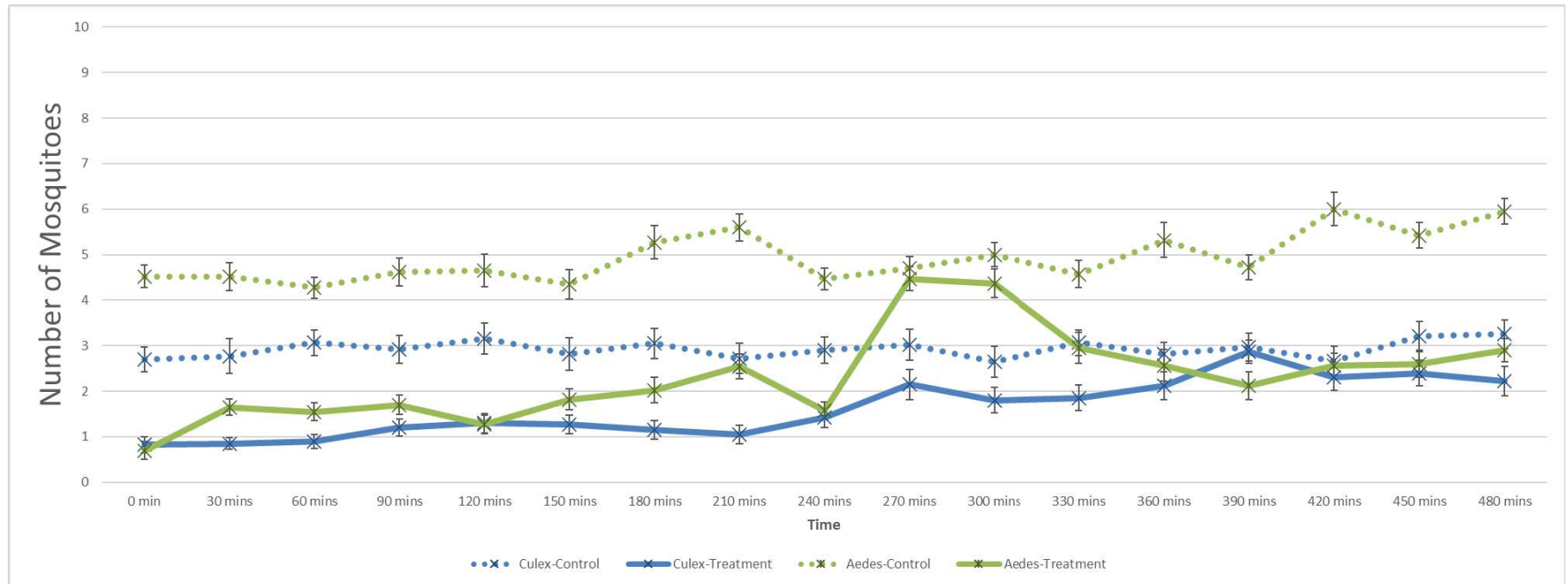

Chapter 6. Semi-field study of β -caryophyllene oxide and vetiver oil based topical repellent against *Aedes aegypti* (L.)

ABSTRACT

For decades, some plant-based derivatives have been renowned for their therapeutic and pharmaceutical values. Topical repellents derived from plant have proven to reduce the incidence of vector-borne disease transmission. In our study, new bioactive products from native plants were tested against the main dengue vector, *Aedes aegypti*, in a semi-field screen house (SFSH). *Aedes aegypti* specimens were marked with fluorescent color powder and released in the SFSH. Two collectors conducted human-landing collections were positioned at opposite ends of the SFSH. Results showed that β -caryophyllene oxide (BCO) and vetiver oil (VO) provided 87.27% greater protection ($P < 0.001$) for 12 hrs compared to the unprotected control. Findings of this study have shown that application of a mixture of BCO-VO has a significant impact on reducing *Ae. aegypti* biting pressure under semi-field condition. Then, BCO-VO topical repellent could be used as an alternative approach in dengue mosquito intervention for protecting people from mosquito bites.

Key words: Semi-field screen house, vetiver oil, β -caryophyllene oxide, *Aedes aegypti*

Introduction

Many areas of the world are at risk for a wide variety of vector-borne diseases, including dengue fever and dengue hemorrhagic fever (DF/DHF) with an estimated 2.5 billion people at risk of DF and DHF. Among them, 1.8 million cases were reported from the Southeast Asian region, primarily in crowded, impoverished urban areas (Supadmi *et al.*, 2019). In Southeast Asia, DHF cases have been increasing from an annual rate of <10,000 in the 1960s to >2,000,000 in the 2010s (Halstead, 2006; Shepard *et al.*, 2013). The whole set of viruses (DEN-1, 2, 3, 4) are transmitted primarily by *Aedes aegypti* (L.), a notoriously efficient vector mosquito that often resides in and near human dwellings.

In Thailand, dengue causes tremendous morbidity and mortality each year. In 2018 and 2019, 70,000 and 80,000 DHF cases respectively were reported by the Ministry of Public Health, Thailand (Bureau of Epidemiology, 2019; Kosoltanapiwat *et al.*, 2020). As yet no effective or commercial multi-valent dengue vaccine is readily available, prevention of this disease remains almost entirely dependent on various methods of vector control, which remains the most effective means of reducing virus transmission potential (Reiter *et al.*, 1997). Unfortunately, *Ae. aegypti* has proven very difficult to control because of its close association with humans and exploitation of domestic and peridomestic environments. One of the main vector control measures in Thailand is based on chemical means. However, the continued use of synthetic insecticides for vector control has raised major concern over the selection pressure induced by the insecticides on resistance gene mechanisms (Hemingway and Ranson, 2000; Jirakanjanakit *et al.*, 2014; Sanchez-Bayo, 2012). Besides insecticides, several topically applied repellents are available in most local markets and are used extensively to protect against biting mosquitoes (Isman, 2006). However, these compounds have shown significant adverse or toxic effects to humans, especially when misapplied (Briassoulis *et al.*, 2001; Shutty *et al.*, 2013; Snyder *et al.*, 1986). For these reasons, there has been a growing interest in developing insect repellents from natural plant extracts such as thyme, clove, celery, citronella, basil and others (Maia and Moore, 2011).

Essential oils extracted from plants have been evaluated for insect repellent activity for protection against mosquitoes and other arthropod pests in Thailand (Tisgratog *et al.*, 2016). These compounds are currently commercialized, becoming more commonly used as active ingredient for topical repellent such as para-Menthane-3, 8-diol (PMD), citronella, catnip, lemon eucalyptus, 2-undecanone (Patel *et al.*, 2016). In our larger program to discover and promote plant-origin

products for the replacement of synthetic topical repellents, studies were conducted on extracts from locally available plants in Thailand that showed a high degree of repellent activity. β -caryophyllene oxide (BCO) is a common sesquiterpene found in aromatic repellent plants, such as cloves, basil, cinnamon, and citrus (Di Sotto *et al.*, 2013). In previous studies, BCO has been reported to actively repel several species of mosquito vectors, including *Anopheles minimus* and *An. dirus* (vectors of malaria agents), *Aedes aegypti* and *Ae. albopictus* (vectors of dengue, chikungunya, zika viruses to cited a few) (Nararak *et al.*, 2020; Nararak *et al.*, 2019). Moreover, Vetiver oil (VO) is a promising active ingredient of plant origin in mosquito repellents (Tisgratog *et al.*, 2016).

The previous repellent investigation against female *Ae. aegypti* and *Culex quinquefasciatus* mosquitoes under laboratory conditions revealed that the best BCO-VO formulation provided the longest-lasting protection of 4 hrs by using a noncontact repellency assay system (NCRAS) (Chapter 5). Moreover, no potential skin irritation or other side effects of BCO-VO were observed during the experiment. Importantly, vetiver, an active ingredient of BCO-VO, did neither show any phototoxic activity, nor it induced a significant increase of micronucleated cells with or without metabolic activation (Chapters 2 and 3). Based on these results, BCO-VO has a considerable potential of being commercially developed as a potential natural alternative for protection against mosquitoes. The aim of this study was to evaluate the protective effects of plant-based repellent compared to untreated control against *Ae. aegypti* under a large cage in semi-field conditions. The objective of this semi-field study (SFS) was to extend the results obtained in laboratory conditions (Chapter 5) in order to estimate the effective and persistence of the BCO-VO repellent.

The SFS was performed in the large constructed enclosure under ambient conditions allowing mosquitoes to act with similar behavior responses as under natural conditions. The other benefit of SFS is that the products can be tested with the field collected mosquitoes under laboratory controlled-conditions. Furthermore, mosquito species, physiological status and number of mosquitoes can be standardized and this will help to generate stronger information to support the test results obtained from the laboratory study (Sangoro *et al.*, 2014).

Materials and Methods

The objective of the SFS was to confirm (or not) under different conditions if the selected dose of (BCO 1%: VO 2.5% 1:2) recently obtained from the laboratory is effective against *Ae. aegypti* under simulated indoor space condition.

Study site

The study was carried out in Pu Teuy Village, Sai Yok District, Kanchanaburi Province (14 °17'N 99 °11'E). Pu Teuy is located on a mountainous terrain, surrounded by a secondary forest. Local residents and occupations are closely linked to forests (Tananchai *et al.*, 2012).

Mosquito preparation

The mosquito species used in this study was *Ae. aegypti* (Kanchanaburi strain, Thailand). Immature stages of *Ae. aegypti* were collected from Pu Teuy Village and reared to adults at the on-site field insectary. Larvae were fed by fish food and maintained at a temperature of $25 \pm 1^\circ\text{C}$. Pupae were placed in emergence bowls inside a $30 \times 30 \times 30$ cm cubic netted cage. A 10% glucose solution was delivered for the emergent adults. The insectary was maintained at 12:12 (light: dark) photoperiod, from 0600 to 1800 hrs (light period) and 1800 to 0600 hrs (dark period). Adults of *Ae. aegypti* were deprived of sugar and provided with water cotton pad for approximately 12 hrs before testing. Six hours before the test, mosquitoes were marked with luminous marking powder (BioQuip Products, Rancho Dominguez, CA) following the protocol of Achee *et al.* (2005) to facilitate detection of knocked down individuals and distinguish them from wild mosquitoes that may have entered the screen house during experiments. One hundred *Ae. aegypti* specimens were transferred into 1.25 L plastic container, topped with mesh netting affixed with rubber bands. The marking powder is quickly brushed through the mesh netting of the container in a circular motion using a paintbrush and repeated 4 times. Marked mosquitoes in containers were covered with moistened towel until time of release at 5:30 am. One hundred active marked mosquitoes were released per replicate (night).

Semi-field Screen house (SFSH)

The SFSH was built to create a semi-field condition to facilitate the recapture of released mosquitoes (Figure 28). The SFSH is subdivided into four chambers, 10 m long cubicles, each

separated by folding metal screen partitions. The volume per cubicle section is 280 m³, 4 x 20 x 3.5 m. This is reasonably similar to the volume of the existing local houses for which female mosquitoes respond directly to visual cues at a 10-m distance (Clements, 1999). The SFSH floors are lined with white plastic sheeting to facilitate recovery of knocked down (*kd*) mosquitoes. The SFSH and the traps were cleaned regularly to remove predators that otherwise may consume *kd* or trapped mosquitoes.



Figure 28 A semi-field screen house (SFSH) measuring 4x3.5x40 m

Semi-field study of topically applied repellents

Two 18-60 years old Thai healthy male and female adults, without allergy to insecticides or repellents and with a certification of health given by a doctor, were recruited to participate in this study. Pregnancy, health problem and prisoners were excluded. Volunteers were trained on the method before conducting the semi-field study (SFS).

One hundred marked mosquitoes were released into the SFSH at its mid-point between sections A and B (20 m apart) at 5:30 am. Two volunteers, recruited each day, were positioned at the end of each section A or B (Figure 29). Each had shorts to the knee (to ensure that mosquitoes only have access to their lower legs), work shoes, and a long-sleeve shirt over an inner cotton T-shirt. The volunteers were assigned to evaluate the repellent efficacy of the plant-based products

within the SFSH. Treatment areas comprised each leg from knee to ankle, covering a leg surface area of about 782-826 cm². Approximately 3 mL of the plant-based repellent was applied to the test area of both legs of each volunteer. The other side of the SFSH was the control (ethanol for control). The product was applied every 4 hrs, which is the minimum protection time obtained from a noncontact repellency assay system (Chapter 5).

Collectors performed human landing collection (HLC) method uninterrupted for 45 min hourly from 06.00 to 18.00 h. To overcome tiredness and discomfort, volunteers took a 15-min break prior to the end of each hour, allowing them to use the toilet. Ambient temperature (°C) and relative humidity (%RH) were recorded for the duration of each replicate at the end of each collection interval. Recaptured mosquitoes were placed in separate holding cups and provided with sugar soak cotton and held at optimum temperature and humidity.

Fifteen replicates were conducted. Plastic sheeting was used to separate the semi-field compartments to ensure the independence of samples. Volunteers in the control and treatment rooms rotated daily to prevent interference among collection stations. Collected mosquitoes were placed into separate holding cups for each sampling period. All mosquitoes were held for 24 hrs at optimum temperature and humidity conditions for observation of mortality. Data was reported for knockdown, mortality, blood-fed status and location of collection.

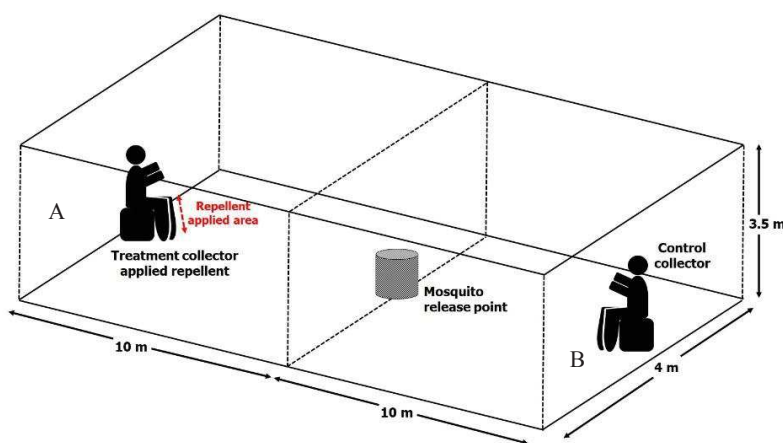

Figure 29 Scheme of a semi-field screen house (SFSH) for spatial repellent evaluation in two separate compartments

Data analyses

Data were quantified by fitting a generalized linear mixed effect model (GLMM) with a negative binomial distribution to account for the over dispersion of mosquito count data. This model was treated as independent variable with the number of mosquitoes caught among those released in SFSH. Variations associated with fluctuations in temperature and relative humidity were treated as fixed effects. Date, human volunteers, and hours were treated as random effects. All analyses were performed using SAS version 9 (SAS Institute, Cary, NC). All statistical significance was set at 5% ($P < 0.05$).

The landing inhibition (LI) or mean percent landing inhibition, and spatial activity index (SAI) was calculated. LI is $100 \times (C - T)/C$, where C and T are the number of mosquitoes landing on the control and treated collectors, respectively. The SAI is a measure of mosquitoes sampled at either end of the semi-field screened enclosure in plant-based repellent trials (Grieco *et al.*, 2005). SAI is calculated as $(C - T) / (C + T)$, where C is the number of mosquitoes collected from the control and T the number from the treated collector. The SAI ranges from -1 to +1, with zero, negative, and positive values representing no preference to either control or treated persons, a preference to treatment, or a preference to controls, respectively.

Ethical requirement

This study was approved by the Kasetsart University Research Ethics Committee, Kasetsart University COA No. COA61/041. All steps were carried out with the compliance of the international guidelines for human research protection as Declaration of Helsinki, the Belmont Report, CIOMS Guideline and International Conference on Harmonization in Good Clinical Practice (ICH-GCP).

Results

In the SFS, there was a greater number of released *Ae. aegypti* ($n = 1,500$) landed on the control (990) compared to the treatment (126). The landing inhibition (LI) rate was $> 40\%$ for all 15 replicates and $> 75\%$ in 12 out of 15 replicates (Table 21). The treated collector captured significantly fewer mosquitoes ($P < 0.0001$) than the control, indicating the highly decreased risk of mosquito landing on collector treated with plant-based repellent than control collector (Table 2). Moreover, the BCO-VO repellent showed a mean positive SAI value of 0.774 and $SAI > +0.6$ in 12 out of 15 experimental replicates meaning a high preference for untreated collectors *versus* treated ones (Table 21). No mortality was found in the control group of marked mosquitoes after the 24 hrs holding period and no knockdown mosquito was observed on an hourly basis on the floor sheets. Overall, the percentage of landing inhibition (% LI) between BCO-VO repellent and control was of 87.27% in semi-field condition, showing a very significant percentage of reduction in landing relative to controls (Table 22). Figure 30 shows the number of *Ae. aegypti* landing in semi-field study between treatment and control trials from 0600-1800 hrs. *Ae. aegypti* landing peaks was at 0700-0800 hrs for control and 0900-1000 hrs for treatment; these peaks cannot be interpreted at this point. The positive value of spatial activity index ($SAI > 0.2$) was observed in all 15 experimental replicates (Figure 31), indicating that released *Ae. aegypti* tended to land on the control collector rather than the treatment collector.

Table 21 Landing inhibition (LI) and spatial activity index (SAI) of *Aedes aegypti* against BCO-VO repellent released in semi-field screened house.

Replicate (day)	Mean recaptured/night*		%LI†	SAI°
	Control	Repellent		
1	61	13	78.68	0.649
2	62	15	75.80	0.610
3	71	1	98.59	0.986
4	33	19	42.42	0.269
5	77	2	97.40	0.949
6	39	3	92.30	0.857
7	46	16	65.21	0.484
8	92	3	96.73	0.937
9	78	3	96.15	0.926
10	63	4	93.65	0.881
11	78	19	75.64	0.608
12	94	1	98.93	0.979
13	78	10	87.17	0.773
14	86	4	95.34	0.911
15	32	13	59.37	0.422
Total	990	126	87.27	0.774

* 100 mosquitoes released per day

† The % Landing Inhibition (%LI) refers to percentage reduction in landing relative to controls.

° Spatial activity index (SAI) corresponds to the measure of mosquitoes sampled at either end of the semi-field screened enclosure during the plant-based repellent trials

Table 22 Statistic analysis of BCO-VO repellent product against *Aedes aegypti* in semi-field screen house.

experiment	N	Mean recaptured/day		p-value	%LI†
		Control	Repellent		
Repellent trial	15	66	8.4	<0.0001	87.27%

N refers to number of experimental nights (100 mosquitoes released per night).

*Both collectors wearing untreated vest in baseline experiment.

†The % Landing inhibition (%LI) refers to percentage reduction in landing relative to controls.

Figure 30 Mean \pm SE of *Aedes aegypti* landing in semi-field study between treatment and control trials from 0600-1800 hrs.

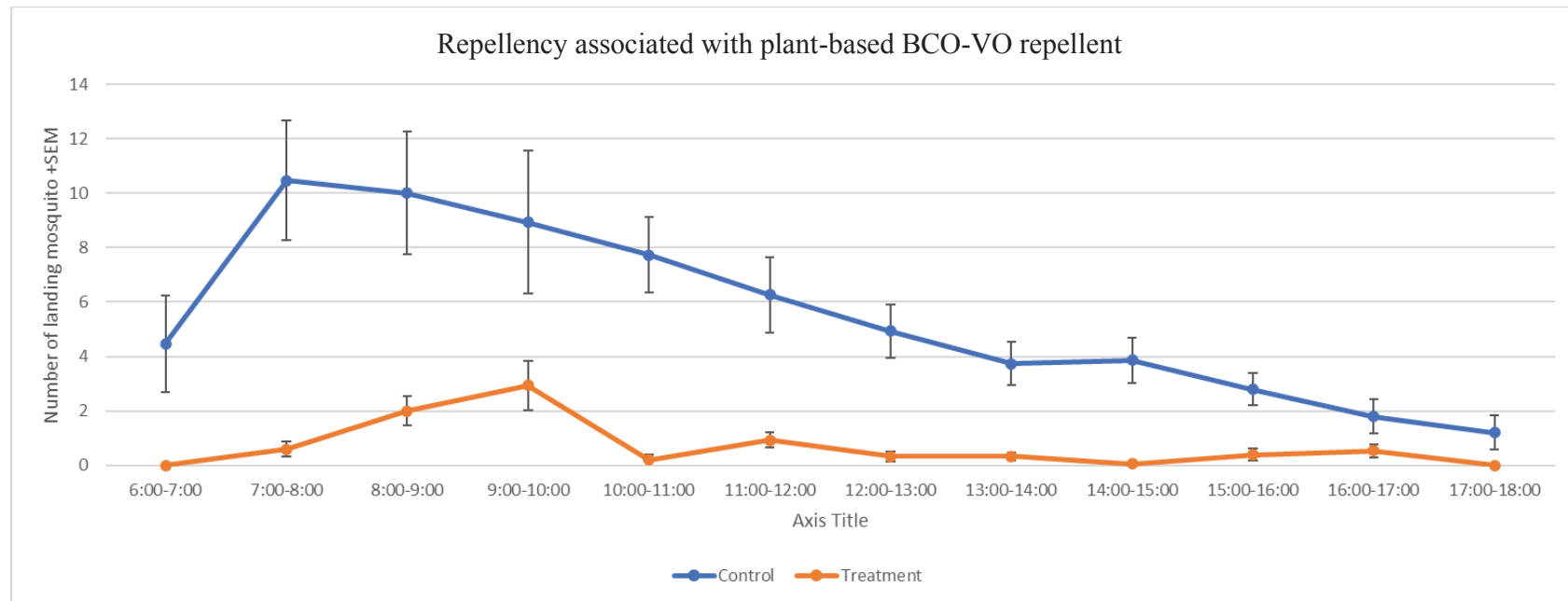

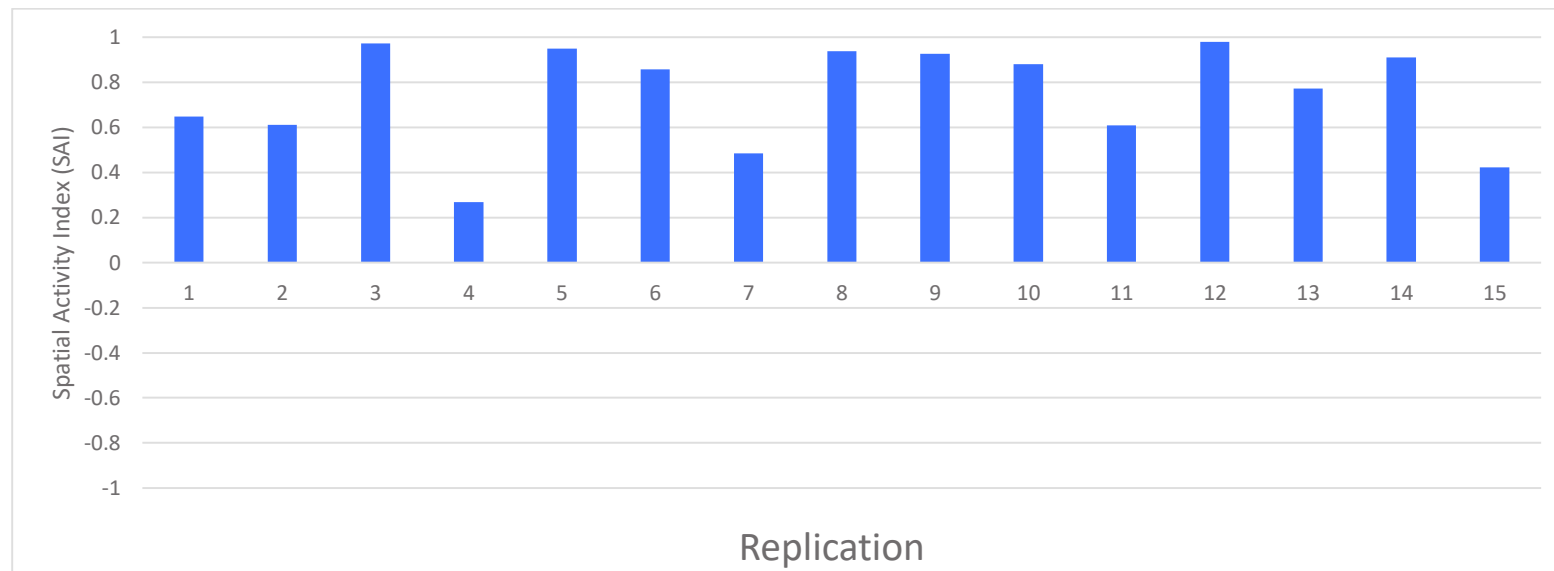

Figure 31 The spatial activity index (SAI) for semi-field trial during 15 consecutive replicates (nights). The SAI ranges from -1 to +1, with zero, negative, and positive values representing no preference to either control or treated collectors, preference to active treated collectors, and preference to untreated collectors, respectively.

Discussion

For centuries, traditional practices have been using medicinal plant-based products in order to prevent the nuisance caused by mosquito bites (Maia and Moore, 2011). Repellents have been claimed to be one of the most common intervention methods for repelling host seeking mosquitoes in the community (Seyoum *et al.*, 2002). Some plant extracts such as essential oils or terpenes have demonstrated to possess a natural repellent effect against various mosquito species and arthropod pests (Müller *et al.*, 2009; Müller *et al.*, 2008; Shukla *et al.*, 2018).

The efficacy of plant-based repellents must be established before being employed as commercial product intervention against mosquitoes. Nowadays, both laboratory and field trials on human volunteers are considered the main model for assessing the efficacy of topical repellents. However, laboratory tests only may not be representative of real natural conditions under which repellents are used and field-testing potentially exposes human volunteers to circulating diseases. There is, therefore, a need to develop methods to test the efficacy of repellents under field conditions while minimizing volunteer exposure to pathogens that mosquitoes may carry. Therefore, this chapter presents the results of laboratory assay from Chapter 5 using SFS.

Our findings showed that the SFSH appears useful for screening candidate repellent products under near-natural conditions. The results of NCRAS (Chapter 5) clearly confirmed these results. The landing inhibition of BCO-VO repellent was significantly different from control. The results are comparable with an earlier report of Nuchuchua *et al.* (2009) who observed repellent activity of combination of citronella oil (10 % w/w), hairy basil oil (5% w/w), and vetiver oil (5 % w/w), which showed not only the efficacy of this product, but also the prolonged mosquito protection time up to 4.7 hrs.

In this study, we recaptured 74% of mosquitoes from the SFSH. These results are in agreement with those of Salazar *et al.* (2012) who conducted the study in the same SFS using a *Ae. aegypti* laboratory-reared local field population and the BG-Sentinel™ mosquito trap (BGS) with an odor attractant. They released 100 marked (fluorescent powder) *Ae. aegypti* specimens per day that resulted in a high recapture rate, which was dependent on the number of BGS used, such as 77% recaptures for one trap and more than 96% for all four traps. However, the recapture rate of mosquitoes likely depends on many factors, including mosquito species, origin of populations (colony or wild-caught), physiological conditions (age, parity) (Clements, 1999).

Environmental conditions (temperature, humidity, air movement) can influence mosquito activity and behavior as well as possible effects of using marked or unmarked specimens (e.g., fluorescent powder). Lastly, the experimental design (e.g., method of recapture) can impact mosquito recovery success.

In Thailand, not many research studies have been focused on plant-based repellents under SFS and field conditions. In 2016, Champakaew *et al.* (2016) tested *Angelica sinensis* (AHE) for repellency action against *Ae. aegypti* under field conditions. The results revealed a strong repellency effect from 25 % of AHE supplemented with vanillin providing a complete protection (100 %) against a wide range of local mosquito populations in the field, thus no mosquito landing was found on the treatment site from 18:00-21:16 hrs.

Several other methods that have been suggested for testing topical repellents while reducing human exposure to mosquito bites, such as 1) use of synthetic mosquito attractants that mimic human volunteers, 2) use of animals instead of human volunteers, 3) use of *in vitro* blood feeding membrane, 4) *In vitro* olfactometry (Hill *et al.*, 1979; Kröber *et al.*, 2010; Obermayr *et al.*, 2014; Okumu *et al.*, 2009; Sangoro *et al.*, 2014). These four methods are convenient because of their high throughput in screening repellents and they do not use human volunteers. However, they have well-documented restrictions; as the skin is the site of action of topical repellents, and mosquitoes are attracted to cues produced by the host, different hosts will elicit varying degree of responses in the mosquito, which will affect both duration and degree of repellency observed (Sangoro *et al.*, 2014). Therefore, testing repellent efficacy needs the development of a robust methodology that represents conditions under which repellents are close to a natural community, yet does not expose individuals conducting these experiments to potential vector-borne diseases. However, our study has not evaluated the repellent compound against full-field conditions due to the risk of exposure of involved volunteers to field-circulating vector-borne diseases. Sangoro *et al.* (2014) compared the efficacy of topical repellent in both the semi-field and field studies and determined a correlation between these two settings. These findings support the hypothesis that repellent tested in semi-field conditions provides similar results than tests conducted in the field. Consequently, the semi-field trial could be used in place of field tests, to avoid unnecessary exposure of volunteers to potentially infectious disease vectors. Thus, a SFS confirmed the efficacy of plant-based product and comes as a necessary complement to laboratory testing. Moreover, the

SFS can estimate the effective dose and persistence of the BCO-VO product against *Ae. aegypti* in close-to-natural conditions.

Chapter 7 Conclusion and Perspectives

Conclusion

Mosquito-borne diseases, such as dengue and malaria, are a menace to human health worldwide, especially in tropical and sub-tropical areas. From the latest WHO record, vector-borne diseases are responsible for about 17% of the communicable diseases worldwide (WHO, 2020). Vector control, defined as the use of verified methods to control vector populations to decrease the spread and transmission of diseases, is essential to reduce the burden of mosquito-borne diseases in affected areas. Chemical-based techniques remain the most effective method to control mosquitoes through the use of either larvicides or adulticides. In Thailand, at least four groups of insecticides have been used in vector control such as organochlorines, organophosphates, carbamate and pyrethroids (Chareonviriyaphap *et al.*, 2013). However, several mosquito strains have developed resistance against these four groups of insecticides. Insecticide resistance is quickly reducing our available arsenal for mosquito control and undermines interventions used to prevent vector-transmitted diseases because of the high vector numbers that survive the insecticide treatment. Although disease control failure does not necessarily result from vector control failure (Rivero *et al.*, 2010), it should be noted that these diseases affect human beings with high mortality rates in certain parts of the world like malaria in Sub-Saharan Africa. Therefore, disease control must focus on preventing any mosquito bites that can potentially transmit pathogens. Moreover, insecticides have negative impacts such as toxic residues in food, water, air and soil, and may affect non-target organisms (Ansari *et al.*, 2014). In Thailand for example, several reports have been published about the adverse health impacts synthetic pesticides have had on Thai population, especially those directly engaged in farming and manufacturing sectors (Thundiyil *et al.* 2008, Dhananjayan & Ravichandran 2018). For this reason, it is imperative that new compounds with novel modes of action are explored to combat this growing problem.

The studies presented here represent my efforts over the last few years to identify potential naturally occurring insect repellents that are environment friendly and safe for public use. The two plant-based compounds reported here, β -caryophyllene oxide and vetiver oil, came to our attention *via* scientific research (Figure 32).

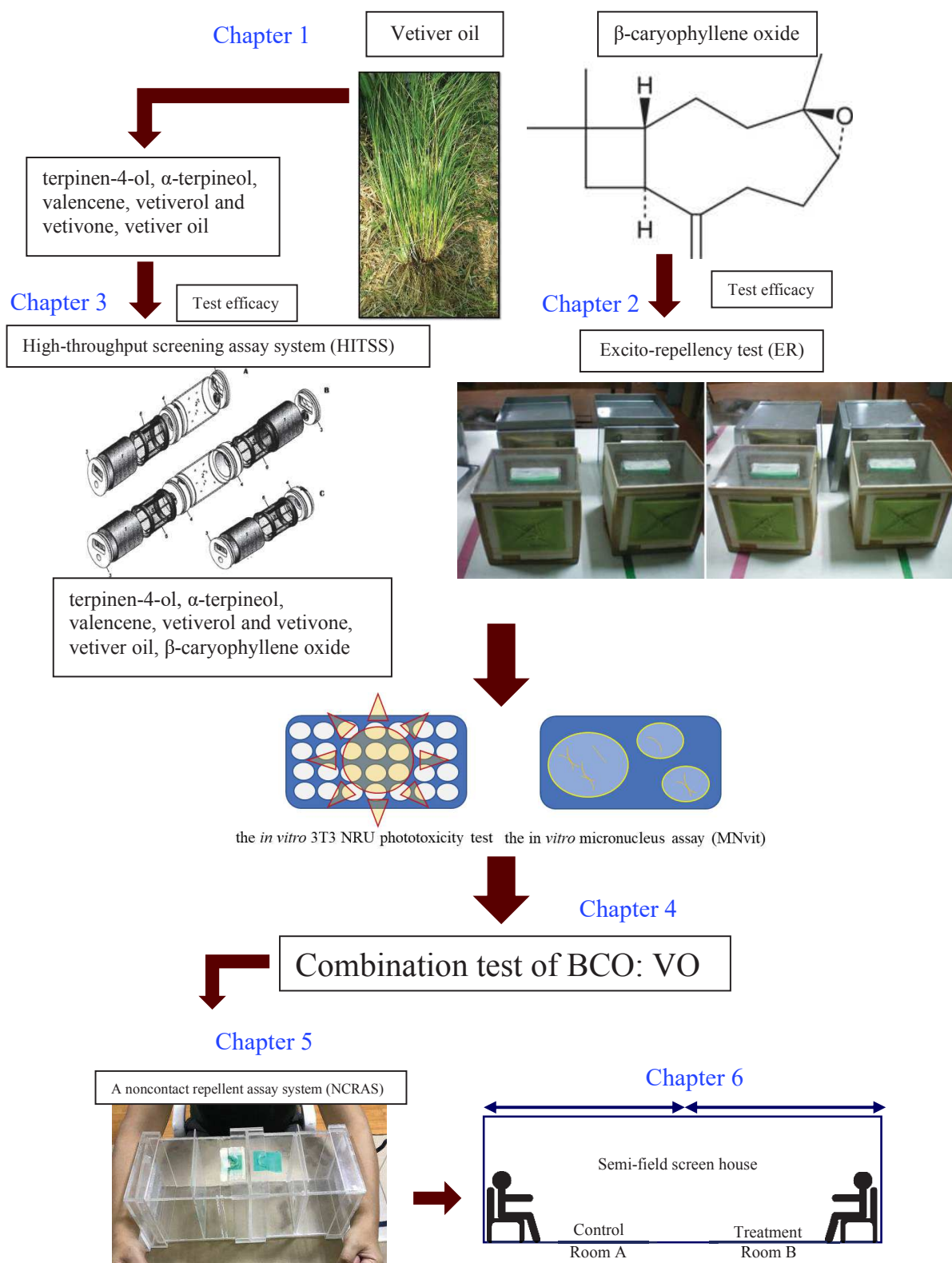

Figure 32 Outcome of thesis

β -Caryophyllene oxide (BCO) was investigated as plant-based repellent in the BioVectrol project (Bio-Asie program) in collaboration with French, Cambodian and Thai teams during 2012-2014, and through the Franco-Thai BioVecThai project (PHC Siam) in 2015-2016, both founded by French Ministry of Foreign Affairs.

During the BioVectrol project, some plants were selected through ethnobotanical surveys and chemotaxonomic data done in Cambodia. Then, active extracts of selected plants were analyzed in Thailand to find the BCO responsible for repellent activity. In addition, literature reviews were conducted (Chapter 1) in which it was expressed that BCO is generally found in essential oils that have the ability to repel mosquitoes, such as *Artemisia anomala* S. Moore, *Salvia miltiorrhiza* Bunge, *Chloroxylon swietenia* DC., *Psidium guajava* L., *Origanum vulgare* L., *Cinnamomum* spp., *Syzygium aromaticum* (L.) Merr. & L.M. Perry, *Piper nigrum* L. and *Serjania yucatanensis* Standl (Garneau *et al.*, 2013; Gertsch *et al.*, 2008; Jun *et al.*, 2011; Liang *et al.*, 2009; Polanco-Hernández *et al.*, 2012; Shell, 1997; Telang *et al.*, 2003; Zhao *et al.*, 2013). Beside these studies, our results showed that BCO was also present in one of the selected plants in Cambodia, *Micromelum falcatum*.

If the mosquito repellent action of BCO has been well described, the mechanistic action of BCO needs to be better investigated because it is far from being completely understood. Protection from mosquito bites could be achieved by avoiding physical contact with mosquitoes using insect repellents. However, little is known on how these chemical actions function to repel insects. The two forms of nontoxic properties of an insecticide, irritability (contact irritant) and repellency (non-contact repellent action), have previously been described in Davidson (1953). Contact irritability refers to direct tarsal contact with an insecticide that can cause a mosquito to escape from the test chamber. On the other hand, non-contact repellency results on insect detecting chemicals from a distance and escaping out of the treated area without making physical contact with the insecticide. An excito-repellency chamber (ER) system has been used in this study for testing both contact irritancy and non-contact repellency. In Chapter 2, we present the first study to investigate the excito-repellency behavioral response of BCO against difference mosquito species (colony populations). The ER system was used to test the contact irritant action and non-contact repellent action of BCO against four mosquito species, including *Ae. aegypti*, *Ae. albopictus*, *An. minimus*

and *An. dirus*. The BCO treatment doses were set at 0.1, 0.25, 0.5 and 1% concentrations. The study found that each mosquito species responded differently in escape patterns to both the compound tested and concentrations. Our results showed that at higher concentrations (0.5 and 1%), BCO had a significantly greater repellent and irritant effects compared to DEET (N,N-diethyl-3-méthylbenzamide), the standard repellent commonly used. When comparing the results obtained with the four mosquito species tested with BCO, *An. minimus* presented the highest sensitivity to both types of escape responses (contact irritancy and noncontact-spatial repellency) at 0.5-1% (v/v), followed by *Ae. aegypti*, *Ae. albopictus* and *An. dirus*. These results also showed that BCO had stronger repellent and irritant activity than DEET against the four vector species at the same concentrations, suggesting the former has high potential for further development as an alternative active ingredient in mosquito repellent formulations. This data generated from Chapter 2 will be useful in the screening of BCO to formulate mosquito repellents.

Several medical plant species have a history of use for personal protection against mosquito (Diaz, 2016). About 2,300 plant species from Southeast Asia have been found to possess mosquito repelling properties (Tisgratog *et al.*, 2016). Essential oils obtained from plants play a significant role as mosquito repellents (Nerio *et al.*, 2010). In Thailand, Tisgratog *et al.* (2016b) investigated 37 reported plant species from 14 plant families that revealed some mosquito repellent properties. Results from these reviews showed that five essential oils extracted from plants demonstrated promising insect repellent activity including clove, citronella, hairy basil, catnip and vetiver.

Vetiver grass has been reported as a potential solution for water and soil conservation in Thailand (Leknoi and Likitlersuang, 2020). Indeed, Vetiver's 3-meter (approximately) deep rooting system makes it a suitable natural erosion barrier especially across steep slopes. His Majesty King Bhumibol Adulyadej Rama IX statement on the 24th of July, 1997 "*The loss of top soil and soil erosion is one of the country's major agricultural problems, which caused damages to cultivated area leading to lack of soil fertility and humidity, hence, plant products did not meet the requirements in both quantity and quality aspect*". Therefore, His Majesty, through various stakeholders (especially the military and police officers) continuously granted various initiatives regarding vetiver grass applications. Currently, various royal development projects such as Huai Sai royal development study center, are research and demonstration centres for vetiver application in soil and water conservation (<http://www.rdpb.go.th/>). Moreover, essential oils from vetiver roots have a pleasant smell and medicinal properties. They have been widely utilized in the perfume and

aromatherapy industries. Older generations used to hang vetiver roots in their closets to keep the clothing smelling pleasant while repelling insects at the same time. Vetiver oil (VO) is also used as herbal medicines to relieve heart-burn symptom, excessive gas in the stomach, as well as to reduce fever symptoms. Various reports have shown that VO presents a high repellent efficacy against mosquitoes (Nararak *et al.*, 2016a; Tisgratog *et al.*, 2018; Zhu *et al.*, 2001). Vetiver oil at 2.5% concentration elicited the highest repellency responses in *Ae. albopictus* (63.7%), *An. minimus* (66.05%) (Sathantriphop *et al.*, 2014).

Tisgratog *et al.* (2018) reported that vetiverol, valencene, terpinen-4-ol and isolongifolene, which are major chemical constituents of vetiver oil, exhibited repellency and irritancy actions against *An. minimus* at a concentration <5 %. A recent study showed that vetiver oil displayed a strong repellent activity (78%) against house flies (*Musca domestica*) and exhibited 100% contact toxicity to larva and adult house flies (Khater and Geden, 2019). In Chapter 3, we investigated the spatial repellency, contact irritancy, and toxic properties of vetiver oil and its five constituents, including terpinen-4-ol, α -terpineol, valencene, vetiverol and vetivone. By using the high-throughput screening assay system (HITSS), efficacy of VO and its five constituents were tested against three mosquito species, *Ae. aegypti*, *Ae. albopictus*, and *Cx. quinquefasciatus*. The HITSS was used because the ER test system requires larger amount of chemical on a treated paper surfaces. The result showed that, significant contact escape (CIA) responses in *Ae. aegypti* and *Ae. albopictus*, to all test compounds at concentrations between 2.5 and 5%, were observed. Vetiver oil and valencene showed the most promising spatial repellency (SRA) against *Aedes* mosquitoes, whereas *Cx. quinquefasciatus* was repelled by all test compounds. Significant toxic (TOX) response was observed at the highest concentrations, except for vetivone, which had no toxic effect on *Ae. aegypti* and *Ae. albopictus*. Overall, this study confirmed that VO and two constituents (valencene and vetiverol) are potential candidates for use as active ingredients for mosquito repellents. In our study, each mosquito species responded differently in escape patterns to the various test compounds. Barnard (1999) described the differences in responses of mosquito species by their preference of food sources. For example, 1) *Aedes aegypti* is mainly an anthropophilic species with high biting pressures in laboratory bioassays; 2) *Culex quinquefasciatus* is mainly an ornithophilic species, which has only reduced appetite in laboratory trials. For this reason, using the plant-based insect repellent compounds against mosquitoes need thorough laboratory test evaluation on factors that may influence mosquito behavior. This study has identified VO and its

constituents for their use as plant-based repellent against mosquito vectors, to be developed for instance as topical repellent product.

Several documents claimed that plant-based insecticides would be safe to environment and customer use (Diaz, 2016), but some researchers reported that some plant products may be toxic to the user (Levin and York Jr, 1978). In any case, safety study is a prerequisite to the development of a new product as well as for registration in regulatory bodies (Tavares *et al.*, 2018). Although BCO, VO and its constituents are naturally sourced, they may produce toxic and adverse effects on humans or animals, or both. Consequently, potential cytotoxic effects of hazardous substances must be assessed prior to product development. Thus, in Chapters 2 and 3 we also investigated the phototoxic and genotoxic effects of BCO, VO, and its constituents on Balb/c 3T3 mouse fibroblasts (3T3-L1) for phototoxicity and Chinese hamster ovary cell line (CHO-K1) for the micronucleus assay (MNvit). In accordance with the Organization for Economic Co-operation and Development (OECD) 2004 guidelines for the identification of efficacy of plant-based repellents, the safety evaluation showed no prohibited or restricted components. The phototoxicity results obtained using the *in vitro* method are crucial because topical repellent formulations are mainly used during the day to protect against day-biting mosquitoes and this involves exposure to the sunlight or artificial light. The *in vitro* micronucleus assay (MNvit) was used to detect the long-term toxicity of each plant-based repellents. Our result revealed that all plant-based compounds did not show any phototoxic potential nor was there any significant genotoxic response as indicated by no increase in micro-nucleated cells with or without metabolic activation. Thus, BCO and VO could be considered as a safe repellent, effective against mosquitoes.

In term of efficacy and safety, this study has identified BCO and VO for being used as plant-based repellent or green insecticide. These compounds could offer good personal protection to be potentially used as a complement to other vector control methods under an integrated vector control management strategy.

In Chapter 4, we examined the efficacy of combining BCO and VO for developing a effective topical repellent. BCO 1%, VO 2.5% and their binary mixtures [BCO+VO (1:1), BCO+VO (2:1), BCO+VO (1:2)] were assayed against four laboratory colonized mosquito species i.e. *Ae. aegypti*, *Ae. albopictus*, *An. minimus*, and *Cx. quinquefasciatus*, using an ER system. Deploying synergistic combinations is aimed to reduce the dose substances and help reducing the

risk of developing physiological resistance in any insect population. The combinations of BCO and VO (1:1), (1:2), and (2:1) showed a higher percent escape than a single compound. The combinations of BCO:VO were effective against the four mosquito vector species, especially *Cx. quinquefasciatus* and *An. minimus*, but some of them were much weaker than when testing BCO or VO alone against *Ae. aegypti* or *Ae. albopictus*. This result is supported by Phasomkusolsil and Soonwera (2011) who found that *An. minimus* and *Cx. quinquefasciatus* were more sensitive to several different oils than was *Ae. aegypti*. Sathantriphop *et al.* (2014) also revealed that *Cx. quinquefasciatus* and *An. minimus* exhibited much stronger behavioral responses to VO compared to *Ae. aegypti* or *Ae. albopictus*. In terms of toxicity, binary mixtures of BCO and VO showed a percent knockdown at 1 hr in the non-escape chamber. Notably, BCO+VO (2:1) showed a knockdown activity with *Ae. albopictus*, *An. minimus* and *Cx. quinquefasciatus*. In summary, the binary combination of BCO and VO produces additive contact irritancy, non-contact repellency, and knockdown activities at low concentrations, suggesting that combinations of two repellent compounds may serve as a more effective mosquito repellent than one only. The synergistic repellent activity of the essential oils used in the present study might be useful for alternatives to synthetic repellents for personal protection against mosquitoes. Such practice would not only reduce the chemical burden on the environment, promote sustainable use of locally available bioresource by rural communities, but also provide a way to reduce outdoor biting pressure and pathogen transmission, for which vector control is poorly equipped (Durnez and Coosemans, 2013). Further studies may be directed towards enhancing the efficacy of such repellents with the use of potentiating agents and their bio-efficacy evaluation in field conditions.

In Chapter 5, the development of repellent formulation was extended to oil-in-water (O/W) emulsion. On an industrial scale, the most promising essential oil to be used as botanical repellents should fulfil the following requirements: (i) availability and cultivation on a large scale of the plant source; (ii) high essential oil yield; (iii) low prices of essential oil (generally correlated with the yield) and raw material from which essential oil are obtained (Pavela *et al.*, 2019). On this basis, in the present study, we selected BCO and VO for which we previously obtained very promising results for a possible use as plant-based repellent. BCO and VO were prepared at concentrations of 1% and 2.5% in ratio 1:2, respectively. These concentrations of oil were selected based upon preliminary test data and corroborated by the previous study presented in Chapter 4. The O/W based technique was used in this study because there are green, fast, easy, and cost-effective

process. The result showed that the BCO-VO formulation reached 240 min (4 hrs) complete protection against *Ae. aegypti* and *Cx. quinquefasciatus* by using a non-contact repellency assay system (NCRAS). Our research found there was a significant difference between treatment and control forearms. The benefit of NCRAS is to avoid human risk and other ethical issues. However, the reason of NCRAS is mainly due to the small mesh screen, which also prevent tarsal contact with treated skin. In addition, the gap between mosquito landing screen barrier and the volunteer's arm surface is narrow down to the point of allowing the tip (labellum) of the proboscis to touch the skin without actual penetration of mouthpart stylets. Thus, the NCRAS presented in this study needs complete standardization in physically and technically designed protocol to be comparable to the common arm-in-cage system.

In the last Chapter 6, we were encouraged to determine the efficacy of our plant-based formulation (BCO-VO) in the semi-field trial against *Ae. aegypti* (field strain). The objective of this study was to extend the result of laboratory testing (Chapter 5) to estimate the effective dose and persistence of the BCO-VO products against *Ae. aegypti* in semi-field conditions. The study findings showed that the semi-field screen enclosure appears quite useful for screening candidate repellent products under "close-to-natural" conditions. The result showed that BCO-VO provided 87.27% greater protection for 12 hrs compared to the unprotected control. The significant advantage of the semi-field trial is to test the efficacy of repellents under semi-natural conditions while minimizing volunteer exposure to pathogenic agents that mosquito may carry.

As a general conclusion, an extensive study on the repellent activity of BCO and VO has been performed ranging from a novel green synthesis process to the development of formulation systems to reach long-lasting protection against mosquitoes. The landing inhibition of BCO-VO repellent was significantly higher than for the control in laboratory and semi-field conditions. Another important result presented in this thesis is that these two compounds, BCO and VO, provide a significantly higher protection action against mosquito bites compared to DEET, the most common molecule currently used in repellent products.

Perspectives

In summary, the present study reveals and points out the high potential of plant-based insecticides as repellents against mosquito vectors and the nuisance caused by the biting pressure. These findings may lead to new and probably more effective strategies for protecting humans from the bites of mosquito vectors, especially outdoor-biting species against which very little control approaches are available.

This study on the investigation of plant-based repellents, focused on the chemical properties of a bioactive plant-constituent named β -caryophyllene oxide (BCO) and the vetiver essential oil (VO). The volatility of such metabolites from plants gives them appropriate properties to be used as insect repellents. The overriding aim of this work was to generate alternatives to synthetic repellents, although effective, but widely criticized for being at risk to human health and the environment. In our study, the efficacy of BCO and VO was comparable to the synthetic repellent (DEET). Perspective of study would be the evaluation of the shelf life of BCO-VO product. Furthermore, encapsulation technologies and other slow-release mechanisms should be explored as they could offer strong potential for improving residual activity. For example, Misni *et al.* (2017) developed encapsulated repellent essential oil lotion by using interfacial precipitation techniques. The findings of this study demonstrated that the application of the microencapsulation technique significantly increased the duration of the repellent effect of essential oils. Moreover, the combination of microencapsulate BCO-VO for the development of painting to be applied on outside walls, doors and windows would bring a new interesting approach against outdoor biting mosquitoes having a possible significant impact on outdoor vector-borne disease transmission. In addition, this strategy may be an option to be implemented in areas where malaria vectors are resistant to pyrethroids (Poda *et al.*, 2018).

BCO and VO were also investigated for their phototoxic and genotoxic activities. These substances did not show any phototoxic and genotoxic potentials and can safely be used as topical repellents. Further studies are required to prove that BCO and VO are “safe” for use on vertebrates, non-target invertebrate organisms and environment. Although reported in the literature (Di Sotto *et al.*, 2013; Nararak *et al.*, 2020; Sinha *et al.*, 2014), they have not yet been examined in the context of commercial development. However, the studies presented here provide a valuable springboard for further investigation.

The selected repellent should be evaluated for the protective efficacy repellent against dengue and malaria mosquito bites in real field conditions. This perspective of work will lean on the use of specific immunological (IgG) biomarkers as indicators of the level of individual protection against mosquito bites under repellent use (Brosseau *et al.*, 2012). The detection of mosquito salivary proteins in human populations constitutes an efficient and quite reliable indicator for evaluating and comparing the efficacy of vector control strategies and for analyzing the level of biting pressure within the human population before and after implementing any control method.

LITERATURE CITED

- Abbott, W.S. 1925. A method of computing the effectiveness of an insecticide. **Journal of Economic Entomology**. 18: 265-267.
- Achee, N.L., J.P. Grieco, R.G. Andre, E. Rejmankova and D.R. Roberts. 2005. A mark release-recapture study using a novel portable hut design to define the flight behavior of *Anopheles darlingi* in Belize, Central America. **Journal of the American Mosquito Control Association**. 21: 366-379.
- , N.L., M.R. Sardelis, I. Dusfour, K.R. Chauhan and J.P. Grieco. 2009. Characterization of Spatial Repellent, Contact Irritant, and Toxicant Chemical Actions of Standard Vector Control Compounds. **Journal of the American Mosquito Control Association**. 25: 156-167.
- Afshar, F.H., F. Maggi, R. Iannarelli, K. Cianfaglione and M.B. Isman. 2017. Comparative toxicity of *Helosciadium nodiflorum* essential oils and combinations of their main constituents against the cabbage looper, *Trichoplusia ni* (Lepidoptera). **Industrial Crops and Products**. 98: 46-52.
- Agnihotri, A., S.W. Ali, A. Das and R. Alagirusamy. 2019. "11 - Insect-repellent textiles using green and sustainable approaches," p. 307-325. B. S. Butola, eds. in **The Impact and Prospects of Green Chemistry for Textile Technology The Textile Institute Book Series**. Elsevier, The Impact and Prospects of Green Chemistry for Textile Technology The Textile Institute Book Series.
- Alonso, P.L., S. Eubank, A. Ghani, S.I. Hay, R. Sinden, D. Smith, T.A. Smith, M. Tanner and L. White. 2011. A research agenda for malaria eradication: modeling. **PLoS Medicine**. 8(1): e1000403. doi:10.1371/journal.pmed.1000403.
- Ansari, M.S., M.A. Moraiet and S. Ahmad. 2014. Insecticides: impact on the environment and human health, p. 99-123. R. Akhtar and E. Grohmann eds. **Environmental Deterioration and Human Health**. Springer.
- Antignac, E., G.J. Nohynek, T. Re, J. Clouzeau and H. Toutain. 2011. Safety of botanical ingredients in personal care products/cosmetics. **Food and Chemical Toxicology**. 49: 324-341.
- Aranda, C., R. Eritja and D. Roiz. 2006. First record and establishment of the mosquito *Aedes albopictus* in Spain. **Medical and Veterinary Entomology**. 20(1): 150-152.

- Ashwini, S., P. Jyoti, R. Pradnya, M. Ghadage and T. Sagar. 2013. Repellent efficacy against mosquitoes using natural biopesticide. **World Journal of Pharmaceutical Research**. 3(2): 1961-1967.
- Balogun, E.O., A.J. Nok and K. Kita. 2016. Global warming and the possible globalization of vector-borne diseases: a call for increased awareness and action. **Tropical Medicine and Health**. 44(1): 38.
- Bansidhi, J., U. Thavara, A. Tawatsin, P. Wongsinkongman, T. Boonruad, P. Chavalittumrong and W. Tiyaboonchai. 2005. **Plants: Protection for medical insects to essential oil**.
- Bar-Zeev, M. and S. Gothilf. 1974. Field evaluation of repellents against the tick *Ornithodoros tholozani* Labou. & Mégn. in Israel. **Journal of Medical Entomology**. 11(4): 389-392.
- Barel, A.O., M. Paye and H.I. Maibach. 2014. **Handbook of Cosmetic Science and Technology**. CRC Press.
- Barnard, D.R. 1999. Repellency of essential oils to mosquitoes (Diptera: Culicidae). **Journal of Medical Entomology**. 36: 625-629.
- , D.R. and R.-D. Xue. 2004. Laboratory evaluation of mosquito repellents against *Aedes albopictus*, *Culex nigripalpus*, and *Ochlerotatus triseriatus* (Diptera: Culicidae). **Journal of Medical Entomology**. 41(4): 726-730.
- Batish, D.R., H.P. Singh, R.K. Kohli and S. Kaur. 2008. Eucalyptus essential oil as a natural pesticide. **Forest Ecology and Management**. 256(12): 2166-2174.
- Ben-Shaul, Y. 2015. Extracting social information from chemosensory cues: consideration of several scenarios and their functional implications. **Frontiers in Neuroscience**. 9: 439. doi: 10.3389/fnins.2015.00439.
- Benelli, G. 2016. Spread of Zika virus: the key role of mosquito vector control. **Asian Pacific Journal of Tropical Biomedicine**. 6(6): 468-471.
- , G. and H. Mehlhorn. 2016. Declining malaria, rising of dengue and Zika virus: insights for mosquito vector control. **Parasitology Research**. 115: 1747-1754.
- Bernier, U.R., D.L. Kline, D.R. Barnard, C.E. Schreck and R.A. Yost. 2000. Analysis of human skin emanations by gas chromatography/mass spectrometry. 2. Identification of volatile compounds that are candidate attractants for the yellow fever mosquito (*Aedes aegypti*). **Analytical Chemistry**. 72(4): 747-756.
- , U.R., D.L. Kline and K.H. Posey. 2006. **Human emanations and related natural compounds that inhibit mosquito host-finding abilities**. CRC Press.

- Bhatt, S., P.W. Gething, O.J. Brady, J.P. Messina, A.W. Farlow, C.L. Moyes, J.M. Drake, J.S. Brownstein, A.G. Hoen and O. Sankoh. 2013. The global distribution and burden of dengue. **Nature**. 496: 504.
- Bock, G.R. and G. Cardew. 2008. **Olfaction in mosquito-host interactions**. John Wiley & Sons, Chichester, UK,.
- Boeckh, J. 1962. Elektrophysiologische untersuchungen an einzelnen geruchsrezeptoren auf den antennen des totengräbers (Necrophorus, Coleoptera). **Journal of Comparative Physiology** 46 (2): 212-248.
- Bohbot, J., L. Fu, T. Le, K. Chauhan, C. Cantrell and J. Dickens. 2011. Multiple activities of insect repellents on odorant receptors in mosquitoes. **Medical and Veterinary Entomology**. 25(4): 436-444.
- , J.D., D. Strickman and L.J. Zwiebel. 2014. The future of insect repellent discovery and development. **Outlooks on Pest Management**. 25 (4): 265-270.
- Boonyuan, W., J.P. Grieco, M.J. Bangs, A. Prabaripai, S. Tantakom and T. Chareonviriyaphap. 2014. Excito-repellency of essential oils against an *Aedes aegypti* (L.) field population in Thailand. **Journal of Vector Ecology**. 39 (1): 112-122. 10.1111/j.1948-7134.2014.12077.x.
- , S. Sathantriphop, K. Tainchum, V. Muenworn, A. Prabaripai, M.J. Bangs and T. Chareonviriyaphap. 2017. Insecticidal and behavioral avoidance responses of *Anopheles minimus* and *Culex quinquefasciatus* (Diptera: Culicidae) to three synthetic repellents. **Journal of Medical Entomology**. 54 (5): 1312-1322.
- Braack, L., A.P.G. de Almeida, A.J. Cornel, R. Swanepoel and C. De Jager. 2018. Mosquito-borne arboviruses of African origin: review of key viruses and vectors. **Parasites & Vectors**. 11: 29.
- Brady, O.J. and S.I. Hay. 2020. The global expansion of Dengue: how *Aedes aegypti* mosquitoes enabled the first pandemic arbovirus. **Annual Review of Entomology**. 65: 191-208.
- Briassoulis, G., M. Narlioglou and T. Hatzis. 2001. Toxic encephalopathy associated with use of DEET insect repellents: a case analysis of its toxicity in children. **Human & Experimental Toxicology**. 20 (1): 8-14.
- Brosseau, L., P.M. Drame, P. Besnard, J.-C. Toto, V. Foumane, J. Le Mire, F. Mouchet, F. Remoue, R. Allan and F. Fortes. 2012. Human antibody response to *Anopheles* saliva for comparing the efficacy of three malaria vector control methods in Balombo, Angola. **PLoS One**. 7: e44189.

- Brown, M. and A.A. Hebert. 1997. Insect repellents: an overview. **Journal of the American Academy of Dermatology**. 36 (2): 243-249.
- Bureau of Epidemiology, B. 2019. **National Disease Surveillance (Report 506)**. Available Source: <https://apps.doe.moph.go.th/>, 20 August 2020.
- Cano, J., M.P. Rebollo, N. Golding, R.L. Pullan, T. Crellen, A. Soler, L.A. Kelly-Hope, S.W. Lindsay, S.I. Hay and M.J. Bockarie. 2014. The global distribution and transmission limits of lymphatic filariasis: past and present. **Parasites & Vectors**. 7: 466.
- Carrasco, D., T. Lefèvre, N. Moiroux, C. Pennetier, F. Chandre and A. Cohuet. 2019. Behavioural adaptations of mosquito vectors to insecticide control. **Current Opinion in Insect Science**.
- Carroll, S.P. and J. Loye. 2006. PMD, a registered botanical mosquito repellent with deet-like efficacy. **Journal of the American Mosquito Control Association**. 22 (3): 507-515.
- CDC. 2008. **Insect repellent use and safety**. Available Source: <http://www.cdc.gov/westnile/faq/repellent.html> , 7 Mar 2015.
- . 2016. **Microcephaly and Other Birth Defects**. Centers for Disease Control and Prevention Available Source: <https://www.cdc.gov/media/releases/2016/s0413-zika-microcephaly.html>
- Chaiyasit, D., W. Choochote, E. Rattanachanpichai, U. Chaithong, P. Chaiwong, A. Jitpakdi, P. Tippawangkosol, D. Riyong and B. Pitasawat. 2006. Essential oils as potential adulticides against two populations of *Aedes aegypti*, the laboratory and natural field strains, in Chiang Mai province, northern Thailand. **Parasitology Research**. 99 (6): 715. <https://doi.org/10.1007/s00436-006-0232-x>.
- Champakaew, D., A. Junkum, U. Chaithong, A. Jitpakdi, D. Riyong, A. Wannasan, J. Intirach, R. Muangmoon, A. Chansang and B. Tuetun. 2016. Assessment of *Angelica sinensis* (Oliv.) Diels as a repellent for personal protection against mosquitoes under laboratory and field conditions in northern Thailand. **Parasites & Vectors**. 9 (1): 373.
- Chandra, G., I. Bhattacharjee, S. Chatterjee and A. Ghosh. 2008. Mosquito control by larvivorous fish. **Indian Journal of Medical Research**. 127 (1) 13-27.
- Chareonviriyaphap, T., D. Roberts, R.G. Andre, H. Harlan, S. Manguin and M. Bangs. 1997. Pesticide avoidance behavior in *Anopheles albimanus*, a malaria vector in the Americas. **Journal of the American Mosquito Control Association-Mosquito News**. 13: 171-183.

- Chareonviriyaphap, T., B. Aum-Aung and S. Ratanatham. 1999. Current insecticide resistance patterns in mosquito vectors in Thailand. **Southeast Asian Journal of Tropical Medicine and Public Health**. 30: 184-194.
- , M.J. Bangs and S. Ratanatham. 2000. Status of malaria in Thailand. **Southeast Asian Journal of Tropical Medicine and Public Health**. 31: 225-237.
- , T., A. Prabaripai and S. Sungvornyothin. 2002. An improved excito-repellency test chamber for mosquito behavioral tests. **Journal of Vector Ecology**. 27: 250-252.
- , M.J. Bangs, W. Suwonkerd, M. Kongmee, V. Corbel and R. Ngoen-Klan. 2013. Review of insecticide resistance and behavioral avoidance of vectors of human diseases in Thailand. **Parasites & Vectors**. 6: 280.
- Chaumeau, V., D. Cerqueira, J. Zadrozny, P. Kittiphanakun, C. Andolina, T. Chareonviriyaphap, F. Nosten and V. Corbel. 2017. Insecticide resistance in malaria vectors along the Thailand-Myanmar border. **Parasites & Vectors**. 10: 165. <https://doi.org/10.1186/s13071-017-2102-z>.
- Chen-Hussey, V., R. Behrens and J.G. Logan. 2014. Assessment of methods used to determine the safety of the topical insect repellent N, N-diethyl-m-toluamide (DEET). **Parasites & Vectors**. 7 (1): 173. <https://doi.org/10.1186/1756-3305-7-173>.
- Choi, W.-S., B.-S. Park, S.-K. Ku and S.-E. Lee. 2002. Repellent activities of essential oils and monoterpenes against *Culex pipiens pallens*. **Journal of the American Mosquito Control Association**. 18: 348-351.
- Choochote, W., D. Chaiyasit, D. Kanjanapothi, E. Rattanachanpichai, A. Jitpakdi, B. Tuetun and B. Pitasawat. 2005. Chemical composition and anti-mosquito potential of rhizome extract and volatile oil derived from *Curcuma aromatica* against *Aedes aegypti* (Diptera: Culicidae). **Journal of Vector Ecology**. 30(2): 302.
- , B. Tuetun, D. Kanjanapothi, E. Rattanachanpichai, U. Chaithong, P. Chaiwong, A. Jitpakdi, P. Tippawangkosol, D. Riyong and B. Pitasawat. 2004. Potential of crude seed extract of celery, *Apium graveolens* L., against the mosquito *Aedes aegypti* (L.)(Diptera: Culicidae). **Journal of Vector Ecology**. 29 (2): 340-346.
- Christophers, S.R. 1947. Mosquito repellents: being a report of the work of the mosquito repellent inquiry, Cambridge 1943–5. **Epidemiology & Infection**. 45 (2): 176-231.
- Chrustek, A., I. Hołyńska-Iwan, I. Dziembowska, J. Bogusiewicz, M. Wróblewski, A. Cwynar and D. Olszewska-Słonina. 2018. Current research on the safety of pyrethroids used as insecticides. **Medicina**. 54 (2): 61. <https://doi.org/10.3390/medicina54040061>.

- Chuaycharoensuk, T., W. Juntarajumnong, W. Boonyuan, M.J. Bangs, P. Akwatanakul, S. Thammapalo, N. Jirakanjanakit, S. Tanasinchayakul and T. Chareonviriyaphap. 2011. Frequency of pyrethroid resistance in *Aedes aegypti* and *Aedes albopictus* (Diptera: Culicidae) in Thailand. **Journal of Vector Ecology**. 36: 204-212.
- Chunsuttiwat, S. 1989. Japanese encephalitis in Thailand. **The Southeast Asian Journal of Tropical Medicine and Public Health**. 20 (4): 593-597.
- Clements, A.N. 1999. **The biology of mosquitoes. Volume 2: sensory reception and behaviour**. CABI Publishing.
- Corbel, V., C. Durot, N.L. Achee, F. Chandre, M.B. Coulibaly, J.-P. David, G.J. Devine, I. Dusfour, D.M. Fonseca and J. Griego. 2019. Second WIN International Conference on “Integrated approaches and innovative tools for combating insecticide resistance in vectors of arboviruses”, October 2018, Singapore. **Parasites & Vectors**. 12: 331.
- , M. Stankiewicz, C. Pannetier, D. Fournier, J. Stojan, E. Girard, M. Dimitrov, J. Molgó, J.-M. Hougard and B. Lapied. 2009. Evidence for inhibition of cholinesterases in insect and mammalian nervous systems by the insect repellent deet. **BMC Biology**. 7: 1-11.
- Curtis, C., J. Lines, L. Baolin and A. Renz. 1990. Natural and synthetic repellents, p. 75-92. *In* C. F. Curtis, eds. **Appropriate Technology in Vector Control**. CRC Press, Florida (1989).
- Davidson, G. 1953. Experiments on the effect of residual insecticides in houses against *Anopheles gambiae* and *A. funestus*. **Bulletin of Entomological Research**. 44: 231-254.
- Davis, E.E. 1985. Insect repellents: concepts of their mode of action relative to potential sensory mechanisms in mosquitoes (Diptera: Culicidae). **Journal of Medical Entomology**. 22: 237-243.
- De Groot, A.C. and J.W. Weijland. 1997. Conversion of common names of cosmetic allergens to the INCI nomenclature. **Contact Dermatitis**. 37: 145-150.
- Debboun, M. and D. Strickman. 2013. Insect repellents and associated personal protection for a reduction in human disease. **Medical and Veterinary Entomology**. 27 (1): 1-9.
- Deletre, E., T. Martin, P. Campagne, D. Bourguet, A. Cadin, C. Menut, R. Bonafos and F. Chandre. 2013. Repellent, irritant and toxic effects of 20 plant extracts on adults of the malaria vector *Anopheles gambiae* mosquito. **PloS One**. 8 (12): e82103.

- Deletre, E., B. Schatz, D. Bourguet, F. Chandre, L. Williams, A. Ratnadass and T. Martin. 2016. Prospects for repellent in pest control: current developments and future challenges. **Chemoecology**. 26: 127-142.
- Dethier, V. 1948. Chemical insect attractants and repellents, p. *In* H. K. Lewis, eds. LWW, London.
- , 1956. Repellents. **Annual Review of Entomology**. 1: 181-202. <https://doi.org/10.1146/annurev.en.01.010156.001145>.
- , B.L. Browne and C.N. Smith. 1960. The designation of chemicals in terms of the responses they elicit from insects. **Journal of Economic Entomology**. 53 (1): 134-136.
- Dhang, P. 2014. **Urban Insect Pests: Sustainable Management Strategies: Sustainable Management Strategies**. CABI.
- Di Sotto, A., F. Maffei, P. Hrelia, F. Castelli, M.G. Sarpietro and G. Mazzanti. 2013. Genotoxicity assessment of β -caryophyllene oxide. **Regulatory Toxicology and Pharmacology**. 66: 264-268.
- Diaz, J.H. 2016. Chemical and plant-based insect repellents: efficacy, safety, and toxicity. **Wilderness & Environmental Medicine**. 27: 153-163.
- Dickson, B.F., P.M. Graves and W.J. McBride. 2017. Lymphatic filariasis in mainland Southeast Asia: a systematic review and meta-analysis of prevalence and disease burden. **Tropical Medicine and Infectious Disease**. 2 (3): 32. <https://doi.org/10.3390/tropicalmed2030032>.
- Durnez, L. and M. Coosemans. 2013. Residual transmission of malaria: an old issue for new approaches, p. 671-704. S. Manguin, eds. **Anopheles mosquitoes: new insights into malaria vectors**. InTechOpen Access.
- Dusfour, I., N.L. Achee, D.R. Roberts and J.P. Grieco. 2009. Contact irritancy and spatial repellency behaviors in *Anopheles albimanus* Wiedemann (Diptera: Culicidae) collected in Orange Walk, Belize, CA. **Journal of Vector Ecology**. 34: 232-237.
- DVBD. 2109. **Database of Malaria**. Available Source: Department of Disease Control, Ministry of public health, Nonthaburi, Thailand. http://203.157.41.215/malariar10/index_newversion.php?fbclid=IwAR3DUEKRn5CDA12ovpYTDxqngYKJtWTTTpdSDRKwLqOzdq5hL0rog4XOadw, 6 Dec 2019.
- Eiras, A.E. and P. Jepson. 1994. Responses of female *Aedes aegypti* (Diptera: Culicidae) to host odours and convection currents using an olfactometer bioassay. **Bulletin of Entomological Research**. 84 (2): 207-211.

- Eisner, T. 1964. Catnip: its raison d'etre. **Science**. 146: 1318-1320.
- Endy, T.P., S. Chunsuttiwat, A. Nisalak, D.H. Libraty, S. Green, A.L. Rothman, D.W. Vaughn and F.A. Ennis. 2002. Epidemiology of inapparent and symptomatic acute dengue virus infection: a prospective study of primary school children in Kamphaeng Phet, Thailand. **American Journal of Epidemiology**. 156 (1): 40-51.
- EPA. U.S. Environmental Protection Agency 1980. Special pesticides review division. N,N-diethyl-m-toluamide (DEET) Pesticide Registration standard (EPA-540/RS-81-004). . Washington, DC. US. Environmental Protection Agency, 1980 (PB81-207722):
- Fallatah, S. and E. Khater. 2010. Potential of medicinal plants in mosquito control. **Journal of the Egyptian Society of Parasitology**. 40 (1): 1-26.
- Farajollahi, A., D.M. Fonseca, L.D. Kramer and A.M. Kilpatrick. 2011. “Bird biting” mosquitoes and human disease: a review of the role of *Culex pipiens* complex mosquitoes in epidemiology. **Infection, Genetics and Evolution**. 11 (7): 1577-1585.
- Faye, O., C.C. Freire, A. Iamarino, O. Faye, J.V.C. de Oliveira, M. Diallo and P.M. Zannoto. 2014. Molecular evolution of Zika virus during its emergence in the 20th century. **PLoS Neglected Tropical Diseases**. 8 (1): e2636. 10.1371/journal.pntd.0002636.
- FEAO. Foreign Workers Administration Office. 2019. Statistic databased of foreign workers. Foreign Workers Administration Office. Department of Employment, Ministry of Labour. Available sources: https://www.doe.go.th/prd/alien/statistic/param/site/152/cat/82/sub/74/pull/sub_category/view/list-label?fbclid=IwAR1rAmRBHG7-tuceCHDuNWmJY6IfSgwUBdQ9IRYTG8LM_XJZFciJmfw1VUo. Accessed 1 January 2020.
- Fidy, K., A. Fiedorowicz, L. Strzdała and A. Szumny. 2016. β -caryophyllene and β -caryophyllene oxide—natural compounds of anticancer and analgesic properties. **Cancer Medicine**. 5 (10): 3007-3017.
- Fornace, K.M., T.R. Abidin, N. Alexander, P. Brock, M.J. Grigg, A. Murphy, T. William, J. Menon, C.J. Drakeley and J. Cox. 2016. Association between landscape factors and spatial patterns of *Plasmodium knowlesi* infections in Sabah, Malaysia. **Emerging Infectious Diseases**. 22 (2): 201-209.
- Fradin, M.S. 1998. Mosquitoes and mosquito repellents: a clinician's guide. **Annals of Internal Medicine**. 128: 931-940.
- , and J.F. Day. 2002. Comparative efficacy of insect repellents against mosquito bites. **New England Journal of Medicine**. 347: 13-18.

- Frances, S.P., R.M. Marlow, C.C. Jansen, R.L. Huggins and R.D. Cooper. 2005. Laboratory and field evaluation of commercial repellent formulations against mosquitoes (Diptera: Culicidae) in Queensland, Australia. **Australian Journal of Entomology**. 44: 431-436.
- Gaffigan Thomas V., R.C. Wilkerson, Pecor James E., J.A. Stoffer and Anderson Thomas. 2015. **Systematic Catalog of Culicidae**. Available Source: <http://www.mosquitocatalog.org/default.aspx?pgID=10>, 13 January 2020.
- Galán-Huerta, K., A. Rivas-Estilla, I. Fernández-Salas, J. Farfan-Ale and J. Ramos-Jiménez. 2015. Chikungunya virus: A general overview. **Medicina Universitaria**. 17 (68): 175-183.
- Garelli, F.M., M.O. Espinosa, D. Weinberg, M.A. Trinelli and R.E. Gürtler. 2011. Water use practices limit the effectiveness of a temephos-based *Aedes aegypti* larval control program in Northern Argentina. **PLoS Neglected Tropical Diseases**. 5 (3): e991. 10.1371/journal.pntd.0000991.
- Garneau, F.-X., G.J. Collin, F.-I. Jean, H. Gagnon and J.B.L. Arze. 2013. Essential oils from Bolivia. XII. Asteraceae: *Ophryosporus piquerioides* (DC) Benth. ex Baker. **Journal of Essential Oil Research**. 25: 388-394.
- Genchi, C., L. Rinaldi, M. Mortarino, M. Genchi and G. Cringoli. 2009. Climate and Dirofilariasis infection in Europe. **Veterinary Parasitology**. 163: 286-292.
- Gertsch, J., M. Leonti, S. Raduner, I. Racz, J.-Z. Chen, X.-Q. Xie, K.-H. Altmann, M. Karsak and A. Zimmer. 2008. Beta-caryophyllene is a dietary cannabinoid. **Proceedings of the National Academy of Sciences**. 105: 9099-9104.
- Ghosh, D. and A. Basu. 2009. Japanese encephalitis—a pathological and clinical perspective. **PLoS Neglected Tropical Diseases**. 3 (9): e437. 10.1371/journal.pntd.0000437.
- Gilbert, A.N. and S. Firestein. 2002. Dollars and scents: commercial opportunities in olfaction and taste. **Nature Neuroscience**. 5: 1043-1045.
- Gilbert, I.H., H.K. Gouck and N. Smith. 1966. Attractiveness of men and women to *Aedes aegypti* and relative protection time obtained with DEET. **Florida Entomologist**. 49: 53-66.
- Gillies, M. 1980. The role of carbon dioxide in host-finding by mosquitoes (Diptera: Culicidae): a review. **Bulletin of Entomological Research**. 70 (4): 525-532.
- , and T. Wilkes. 1972. The range of attraction of animal baits and carbon dioxide for mosquitoes. Studies in a freshwater area of West Africa. **Bulletin of Entomological Research**. 61 (3): 389-404.

- Gillij, Y., R. Gleiser and J. Zygadlo. 2008. Mosquito repellent activity of essential oils of aromatic plants growing in Argentina. **Bioresource Technology**. 99: 2507-2515.
- Goddard, L.B., A.E. Roth, W.K. Reisen and T.W. Scott. 2002. Vector competence of California mosquitoes for West Nile virus. **Emerging Infectious Diseases**. 8: 1385.
- Golenda, C.F., V.B. Solberg, R. Burge, J.M. Gambel and R.A. Wirtz. 1999. Gender-related efficacy difference to an extended duration formulation of topical N, N-diethyl-m-toluamide (DEET). **The American Journal of Tropical Medicine and Hygiene**. 60: 654-657.
- Goodyer, L.I., A.M. Croft, S.P. Frances, N. Hill, S.J. Moore, S.P. Onyango and M. Debboun. 2010. Expert review of the evidence base for arthropod bite avoidance. **Journal of Travel Medicine**. 17: 182-192.
- Grieco, J.P., N.L. Achee, M.R. Sardelis, K.R. Chauhan and D.R. Roberts. 2005. A Novel High-Throughput Screening System to Evaluate the Behavioral Response of Adult Mosquitoes to Chemicals. **Journal of the American Mosquito Control Association**. 21: 404-411.
- Gross, L. 2006. A novel design principle for the insect odorant receptor. **PLoS Biology**. 4 (2): e34. 10.1371/journal.pbio.0040034
- Gryseels, C., S. Uk, V. Sluydts, L. Durnez, P. Phoeuk, S. Suon, S. Set, S. Heng, S. Siv and R. Gerrets. 2015. Factors influencing the use of topical repellents: implications for the effectiveness of malaria elimination strategies. **Scientific Reports**. 5: 16847.
- Guo, S.-s., Y. Wang, X. Pang, Z.-f. Geng, J.-q. Cao and S.-s. Du. 2019. Seven herbs against the stored product insect: Toxicity evidence and the active sesquiterpenes from *Atractylodes lancea*. **Ecotoxicology and Environmental Safety**. 169: 807-813.
- Halstead, S.B. 2006. Dengue in the Americas and Southeast Asia: do they differ? **Revista Panamericana de Salud Publica**. 20: 407-415.
- Han, J.-S., Y.-B. Kim, H. Park, W.-J. Im, W.-J. Kim, Y. Kim, J.-Y. Won, H.-Y. Son and B.-S. Lee. 2020. In vitro skin irritation assessment using EpiDerm™: applicability for updating toxicity information of oxybenzone and N, N-diethyl-m-toluamide. **Drug and Chemical Toxicology**. 43: 361-368.
- Hansson, B.S. and M.C. Stensmyr. 2011. Evolution of insect olfaction. **Neuron**. 72 (5): 698-711.
- Hao, H., J. Wei, J. Dai and J. Du. 2014. Host-seeking and blood-feeding behavior of *Aedes albopictus* (Diptera: Culicidae) exposed to vapors of geraniol, citral, citronellal, eugenol, or anisaldehyde. **Journal of Medical Entomology**. 45: 533-539.

- Harinasuta, C., P. Charoenlarp, S. Sucharit, T. Deesin, K. Surathin and S. Vutikes. 1970. Studies on Malayan filariasis in Thailand. **Southeast Asian Journal of Tropical Medicine and Public Health**. 1 (1): 29-39.
- Harrison, G. 1978. **Mosquitoes, malaria and man: a history of the hostilities since 1880**.
- Hawley, W.A. 1988. The biology of *Aedes albopictus*. **Journal of the American Mosquito Control Association**. 1: 1-39.
- Haynes, K.F. 1988. Sublethal effects of neurotoxic insecticides on insect behavior. **Annual Review of Entomology**. 33 (1): 149-168.
- Hemingway, J., N.J. Hawkes, L. McCarroll and H. Ranson. 2004. The molecular basis of insecticide resistance in mosquitoes. **Insect Biochemistry and Molecular Biology**. 34: 653-665.
- , and H. Ranson. 2000. Insecticide resistance in insect vectors of human disease. **Annual Review of Entomology**. 45: 371-391.
- Henderson, G., D.O. Heumann, R.A. Laine, L. Maistrello, B.C. Zhu and F. Chen. 2005a. **Extracts of vetiver oil as repellent and toxicant to ants, ticks, and cockroaches**.
เลขที่
- Heymann, D.L., A. Hodgson, D.O. Freedman, J.E. Staples, F. Althabe, K. Baruah, G. Mahmud, N. Kandun, P.F. Vasconcelos and S. Bino. 2016. Zika virus and microcephaly: why is this situation a PHEIC? **The Lancet**. 387: 719-721.
- Hidayatulfathi, O., A. Shamsuddin, N. Rajab, Z. Nor, H. Nur, A. Nur, S. Lau and A. Nor. 2017. Three repellent gels that contain essential oils from local Malaysian plants against dengue vector. **Tropical Biomedicine**. 34: 540-549.
- Hii, J., I. Vythilingam and A. Roca-Feltrer. 2018. Human and simian malaria in the Greater Mekong Subregion and challenges for elimination, p. 95-127. S. Manguin, eds. **Towards Malaria Elimination—A Leap Forward**. IntechOpen, London, UK.
- Hill, J.A., P.B. Robinson, D.L. McVEY, W.A. Akers and W. Reifenthrath. 1979. Evaluation of mosquito repellents on the hairless dog. **Mosquito News**. 39: 307-310.
- Hill, N., A. Lenglet, A. Arnez and I. Carneiro. 2007. Plant based insect repellent and insecticide treated bed nets to protect against malaria in areas of early evening biting vectors: double blind randomised placebo controlled clinical trial in the Bolivian Amazon. **British Medical Journal**. 335: 1023.
<https://doi.org/10.1136/bmj.39356.574641.55>

- Hills, S.L., E.B. Walter, R.L. Atmar, M. Fischer, A.J.E.V.W. Group, A.J.E.V.W. Group, E. Walter Jr, R.L. Atmar, E. Barnett and A. Barrett. 2019. Japanese encephalitis vaccine: recommendations of the advisory committee on immunization practices. **MMWR Recommendations and Reports**. 68 (2): 1.
- Hodgson, E., J. Lettvin and K. Roeder. 1955. Physiology of a primary chemoreceptor unit. **Science**. 122 (3166): 417-418.
- Hoel, D.F., J.F. Butler, E. Fawaz, N. Watany, S. El-Hossary and J. Villinski. 2007. Response of phlebotomine sand flies to light-emitting diode-modified light traps in southern Egypt. **Journal of Vector Ecology**. 32: 302-308.
- Huang, A.S.-E., P.-Y. Shu and C.-H. Yang. 2016. A new reportable disease is born: Taiwan Centers for Disease Control's response to emerging Zika virus infection. **Journal of the Formosan Medical Association**. 115 (4): 223-225.
- Isman, M.B. 2006. Botanical insecticides, deterrents, and repellents in modern agriculture and an increasingly regulated world. **Annual Review of Entomology**. 51: 45-66.
- Jaenson, T.G., K. Pålsson and A.-K. Borg-Karlson. 2006. Evaluation of extracts and oils of mosquito (Diptera: Culicidae) repellent plants from Sweden and Guinea-Bissau. **Journal of Medical Entomology**. 43 (1): 113-119.
- Jain, S.C., S. Nowicki, T. Eisner and J. Meinwald. 1982. Insect repellents from vetiver oil: I. Zizanal and epizizanal. **Tetrahedron Letters**. 23 (45): 4639-4642.
- Javelle, E., S.-A. Florescu, H. Asgeirsson, S. Jmor, G. Eperon, E. Leshem, J. Blum, I. Molina, V. Field and N. Pietroski. 2019. Increased risk of chikungunya infection in travellers to Thailand during ongoing outbreak in tourist areas: cases imported to Europe and the Middle East, early 2019. **Eurosurveillance**. 24 (10):
- Jing, H., D. Weijun, L. Liqin and X. Zuobing. 2014. Synthesis and application of polyacrylate nanocapsules loaded with linal. **Journal of Applied Polymer Science**. 131: 40182.
- Jirakanjanakit, N., P. Rongnoparut, S. Saengtharatip, T. Chareonviriyaphap, S. Duchon, C. Bellec and S. Yoksan. 2014. Insecticide susceptible/resistance status in *Aedes* (Stegomyia) *aegypti* and *Aedes* (Stegomyia) *albopictus* (Diptera: Culicidae) in Thailand during 2003–2005. **Journal of Economic Entomology**. 100 (2): 545-550.
- Joshi, P. 2018. Epidemiology of Lymphatic Filariasis, p. 1-14. B.K. Tyagi eds. **Lymphatic Filariasis**. Springer.
- Josseran, L., C. Paquet, A. Zehgnoun, N. Caillere, A.T. Le, J.-L. Solet and M. Ledrans. 2006. Chikungunya disease outbreak, Reunion Island. **Emerging Infectious Diseases**. 12: 1994-1995.

- Jun, N.J., A. Mosaddik, J.Y. Moon, J. Ki-Chang, L. Dong-Sun, K.S. Ahn and S.K. Cho. 2011. Cytotoxic activity of [beta]-caryophyllene oxide isolated from Jeju Guava (*Psidium cattleianum* Sabine) Leaf. **Records of Natural Products**. 5: 242.
- Kaehler, N., B. Adhikari, P.Y. Cheah, L. von Seidlein, N.P. Day, D.H. Paris, M. Tanner and C. Pell. 2019. Prospects and strategies for malaria elimination in the Greater Mekong Sub-region: a qualitative study. **Malaria Journal**. 18 (1): 203. <https://doi.org/10.1186/s12936-019-2835-6>.
- Kalbitz, J., R. Neubert and W. Wohlrab. 1996. Modulation of drug penetration in the skin. **Die Pharmazie**. 51: 619-637.
- Kamal, M., M.A. Kenawy, M.H. Rady, A.S. Khaled and A.M. Samy. 2018. Mapping the global potential distributions of two arboviral vectors *Aedes aegypti* and *Ae. albopictus* under changing climate. **PloS One**. 13: e0210122.
- Kantachuvessiri, A. 2002. Dengue hemorrhagic fever in Thai society. **Southeast Asian Journal of Tropical Medicine and Public Health**. 33: 56-62.
- Karr, J.I., T.J. Speaker and G.B. Kasting. 2012. A novel encapsulation of *N, N*-diethyl-3-methylbenzamide (DEET) favorably modifies skin absorption while maintaining effective evaporation rates. **Journal of Controlled Release**. 160 (3): 502-508.
- Karunajeewa, H. and J. Berman. 2019. Is the Epidemiology of *Plasmodium knowlesi* Changing, and What Does This Mean for Malaria Control in Southeast Asia? **Clinical Infectious Diseases**. 70 (3): 368-369.
- Karunamoorthi, K., K. Ilango and K. Murugan. 2010. Laboratory evaluation of traditionally used plant-based insect repellent against the malaria vector *Anopheles arabiensis* Patton (Diptera: Culicidae). **Parasitology Research**. 106: 1217-1223.
- Katz, T.M., J.H. Miller and A.A. Hebert. 2008. Insect repellents: historical perspectives and new developments. **Journal of the American Academy of Dermatology**. 58 (5): 865-871.
- Keswani, R. and J. Bellare. 2010. A review of mosquito attraction studies: important parameters and techniques. **Research Journal of Parasitology**. 5 (3): 186-196.
- Khan, A. 1977. Mosquito attractants and repellents, p. 91–98. M. J. Shorey HH, eds. **Chemical Control of Insect Behavior**. John Wiley & Sons, New York.
- , H.I. Maibach and D.L. Skidmore. 1975. Addition of vanillin to mosquito repellents to increase protection time. **Mosquito News**. 35 (1975): 223-225.
- Khan, N.Y. 1983. An assessment of the hazard of synthetic pyrethroid insecticides to fish and fish habitat, p. 436-450. In J. Miyamoto and P. C. Kearney, eds. **Pesticide chemistry:**

- Human welfare and the environment.** Mode of action, metabolism and toxicology, Pergamon Press, Oxford
- Khater, H.F. and C.J. Geden. 2019. Efficacy and repellency of some essential oils and their blends against larval and adult house flies, *Musca domestica* L. (Diptera: Muscidae). **Journal of Vector Ecology.** 44: 256-263.
- , H.F., A.M. Selim, G.A. Aboueilella, N.A. Aboueilella, K. Murugan, N.P. Vaz and M. Govindarajan. 2019b. Commercial mosquito repellents and their safety concerns, F. Kasenga, eds. **Malaria.** IntechOpen.
- King, W.V. 1951. Repellents and insecticides available for use against insects of medical importance. **Journal of Economic Entomology.** 44 (3): 338-343.
- Kittayapong, P., U. Chansang, C. Chansang and A. Bhumiratana. 2006. Community participation and appropriate technologies for dengue vector control at transmission foci in Thailand. **Journal of the American Mosquito Control Association.** 22 (3): 538-547.
- Kongmee, M., W. Boonyuan, N.L. Achee, A. Prabaripai, K. Lerdthusnee and T. Chareonviriyaphap. 2012. Irritant and repellent responses of *Anopheles harrisoni* and *Anopheles minimus* upon exposure to bifenthrin or deltamethrin using an excito-repellency system and a live host. **Journal of the American Mosquito Control Association.** 28 (1): 20-30.
- , K. Thanispong, S. Sathantriphop, C. Sukkanon, M.J. Bangs and T. Chareonviriyaphap. 2019. Enhanced mortality in deltamethrin-resistant *Aedes aegypti* in Thailand using a piperonyl butoxide synergist. **Acta Tropica.** 189: 76-83.
- Koren, G., D. Matsui and B. Bailey. 2003. DEET-based insect repellents: safety implications for children and pregnant and lactating women. **Canadian Medical Association Journal.** 169: 209-212.
- Kosoltanapiwat, N., J. Tongshoob, P. Singkhaimuk, C. Nitatsukprasert, S.A. Davidson and A. Ponlawat. 2020. Entomological Surveillance for Zika and Dengue Virus in *Aedes* Mosquitoes: Implications for Vector Control in Thailand. **Pathogens.** 9: 442.
- Kröber, T., S. Kessler, J. Frei, M. Bourquin and P.M. Guerin. 2010. An in vitro assay for testing mosquito repellents employing a warm body and carbon dioxide as a behavioral activator. **Journal of the American Mosquito Control Association.** 26: 381-386.
- Kroeger, A., A. Gerhardus, G. Kruger, M. Mancheno and K. Pesse. 1997. The contribution of repellent soap to malaria control. **The American Journal of Tropical Medicine and Hygiene.** 56 (5): 580-584.

- Kruger, B. and K. Sasse. 1988. **Agents for repelling insects and mites European**. European patent, 1988, 281.908:2.3.
- Kumblad, L., A. Olsson, V. Koutny and H. Berg. 2001. Distribution of DDT residues in fish from the Songkhla Lake, Thailand. **Environmental Pollution**. 112 (2): 193-200.
- Lacher, V. 1967. Elektrophysiologische Untersuchungen an einzelnen Geruchsrezeptoren auf den Antennen weiblicher Moskitos (*Aedes aegypti* L.). **Journal of Insect Physiology**. 13 (10): 1461-1470.
- Latreille, A.C., P. Milesi, H. Magalon, P. Mavingui and C.M. Atyame. 2019. High genetic diversity but no geographical structure of *Aedes albopictus* populations in Réunion Island. **Parasites & Vectors**. 12: 597. 10.1186/s13071-019-3840-x.
- Leal, W.S. 2014. The enigmatic reception of DEET—the gold standard of insect repellents. **Current Opinion in Insect Science**. 6: 93-98.
- Legeay, S., N. Clere, V. Apaire-Marchais, S. Faure and B. Lapied. 2018. Unusual modes of action of the repellent DEET in insects highlight some human side effects. **European Journal of Pharmacology**. 825: 92-98.
- Leknoi, U. and S. Likitlersuang. 2020. Good practice and lesson learned in promoting vetiver as solution for slope stabilisation and erosion control in Thailand. **Land Use Policy**. 99: 105008.
- Levin, D.A. and B.M. York Jr. 1978. The toxicity of plant alkaloids: an ecogeographic perspective. **Biochemical Systematics and Ecology**. 6: 61-76.
- Levinson, H.Z. 1975. Possibilities of using insectistics and pheromones in pest control. **Naturwissenschaften**. 62 (6): 272-282.
- Li, Z., J. Yang, X. Zhuang and Z. Zhang. 1974. Studies on the repellent quwenling. **Malaria Research**. 6:
- Liang, Q., Z.-S. Liang, J.-R. Wang and W.-H. Xu. 2009. Essential oil composition of *Salvia miltiorrhiza* flower. **Food Chemistry**. 113: 592-594.
- Liu, C., R.J. Pitts, J.D. Bohbot, P.L. Jones, G. Wang and L.J. Zwiebel. 2010. Distinct olfactory signaling mechanisms in the malaria vector mosquito *Anopheles gambiae*. **PLoS biology**. 8(8): e1000467.
- Liu, F., L. Chen, A.G. Appel and N. Liu. 2013. Olfactory responses of the antennal trichoid sensilla to chemical repellents in the mosquito, *Culex quinquefasciatus*. **Journal of Insect Physiology**. 59: 1169-1177.

- Logan, J.G., N.M. Stanczyk, A. Hassanali, J. Kemei, A.E. Santana, K.A. Ribeiro, J.A. Pickett and A.J. Mordue. 2010. Arm-in-cage testing of natural human-derived mosquito repellents. **Malaria Journal**. 9 (1): 239.
- Loke, S.R., W. Andy-Tan, S. Benjamin, H. Lee and M. Sofian-Azirun. 2010. Susceptibility of field-collected *Aedes aegypti* (L.)(Diptera: Culicidae) to *Bacillus thuringiensis israelensis* and temephos. **Tropical Biomedicine**. 27: 493-503.
- Loyd, R.A. and S.J. Kaewpitoon. 2015. Malaria risk areas in Thailand border. **Journal of Medical Association of Thailand**. 98 (1): S1.
- Lu, T., Y.T. Qiu, G. Wang, J.Y. Kwon, M. Rutzler, H.-W. Kwon, R.J. Pitts, J.J. van Loon, W. Takken and J.R. Carlson. 2007. Odor coding in the maxillary palp of the malaria vector mosquito *Anopheles gambiae*. **Current Biology**. 17 (18): 1533-1544.
- Lupi, E., C. Hatz and P. Schlagenhauf. 2013. The efficacy of repellents against *Aedes*, *Anopheles*, *Culex* and *Ixodes* spp.—A literature review. **Travel Medicine and Infectious Disease**. 11 (6): 374-411.
- Maia, M.F. and S.J. Moore. 2011a. Plant-based insect repellents: a review of their efficacy, development and testing. **Malaria Journal**. 10: S11. <https://doi.org/10.1186/1475-2875-10-S1-S11>.
- Manguin, S., M. Bangs, J. Pothikasikorn and T. Chareonviriyaphap. 2010. Review on global co-transmission of human *Plasmodium* species and *Wuchereria bancrofti* by *Anopheles* mosquitoes. **Infection, Genetics and Evolution**. 10 (2): 159-177.
- Masetti, A. and S. Maini. 2006. Arm in cage tests to compare skin repellents against bites of *Aedes albopictus*. **Bulletin of Insectology**. 59: 157.
- Mattingly, P. 1957. Genetical Aspects of the *Aedes aegypti* Problem: I.—Taxonomy and Bionomics. **Annals of Tropical Medicine & Parasitology**. 51 (4): 392-408.
- Meigen, J.W. 1871. **Systematische Beschreibung der bekannten europäischen zweiflügeligen Insekten**. HW Schmidt.
- Meinwald, J. and T. Eisner. 1995. The chemistry of phyletic dominance. **Proceedings of the National Academy of Sciences**. 92 (1): 14-18.
- Miller, J., P. Siegert, F. Amimo and E. Walker. 2009. Designation of chemicals in terms of the locomotor responses they elicit from insects: an update of Dethier et al.(1960). **Journal of Economic Entomology**. 102: 2056-2060.
- Misni, N., Z.M. Nor and R. Ahmad. 2017. Repellent effect of microencapsulated essential oil in lotion formulation against mosquito bites. **Journal of Vector Borne Diseases**. 54: 44.

- Mnzava, A.P., T.B. Knox, E.A. Temu, A. Trett, C. Fornadel, J. Hemingway and M. Renshaw. 2015. Implementation of the global plan for insecticide resistance management in malaria vectors: progress, challenges and the way forward. **Malaria Journal**. 14 (1): 173.
- Moore, S.J. and M. Debboun. 2007. History of insect repellents, p. 3-29. Debboun M., *et al.*, eds. **Insect repellents: principles, methods, and uses**. CDC Press.
- , A. Lenglet and N. Hill. 2014. Plant-based insect repellents, Debboun M., *et al.*, eds. **Insect Repellents Handbook**. CDC Press.
- Morin, C.W., A.C. Comrie and K. Ernst. 2013. Climate and dengue transmission: evidence and implications. **Environmental Health Perspectives**. 121: 1264-1272.
- Muangchana, C., N. Henprasertthae, K. Nurach, K. Theppang, P. Yoocharoen, P. Varinsathien, S. Techathawat, S. Sanohsieng and S. Anantapreecha. 2012. Effectiveness of mouse brain-derived inactivated Japanese encephalitis vaccine in Thai National Immunization Program: a case-control study. **Vaccine**. 30 (2): 361-367.
- Müller, G.C., A. Junnila, J. Butler, V.D. Kravchenko, E.E. Revay, R.W. Weiss and Y. Schlein. 2009. Efficacy of the botanical repellents geraniol, linalool, and citronella against mosquitoes. **Journal of Vector Ecology**. 34: 2-8.
- , A. Junnila, V.D. Kravchenko, E.E. Revay, J. Butler, O.B. Orlova, R.W. Weiss and Y. Schlein. 2008. Ability of essential oil candles to repel biting insects in high and low biting pressure environments. **Journal of the American Mosquito Control Association**. 24: 154-160.
- Murty, U.S. and K. Jamil. 1986. Effect of the South Indian vetiver oil (*Vetiveria zizanioides* (L) Nash) against the immatures of *Culex quinquefasciatus* (Diptera: Culicidae) Say. **International Pest Control**. 29 (1): 8-9.
- Naowarat, S., P. Thongjaem and I.M. Tang. 2012. Effect of mosquito repellent on the transmission model of Chikungunya fever. **American Journal of Applied Sciences**. 9: 563-569.
- Nararak, J., C. Di Giorgio, C. Sukkanon, V. Mahiou-Leddé, E. Ollivier, S. Manguin and T. Chareonviriyaphap. 2020. Excito-repellency and biological safety of β -caryophyllene oxide against *Aedes albopictus* and *Anopheles dirus* (Diptera: Culicidae). **Acta Tropica**. 105556.
- , S. Sathantriphop, M. Kongmee, V. Mahiou-Leddé, E. Ollivier, S. Manguin and T. Chareonviriyaphap. 2019. Excito-repellent activity of β -caryophyllene oxide against *Aedes aegypti* and *Anopheles minimus*. **Acta Tropica**. 197: 105030.

- , S. Sathantriphop, M. Kongmee, M.J. Bangs and T. Chareonviriyaphap. 2017. Excito-repellency of *Citrus hystrix* DC leaf and peel essential oils against *Aedes aegypti* and *Anopheles minimus* (Diptera: Culicidae), vectors of human pathogens. **Journal of Medical Entomology**. 54 (1): 178-186.
- , S. Sathantriphop, K. Chauhan, S. Tantakom, A.L. Eiden and T. Chareonviriyaphap. 2016. Avoidance behavior to essential oils by *Anopheles minimus*, a malaria vector in Thailand. **Journal of the American Mosquito Control Association**. 32: 34-43.
- Nentwig, G. 2003. Use of repellents as prophylactic agents. **Parasitology Research**. 90 (1): S40-S48.
- Nerio, L.S., J. Olivero-Verbel and E. Stashenko. 2010. Repellent activity of essential oils: a review. **Bioresource Technology**. 101: 372-378.
- Nguyen, Q.-B.D., M.-A.N. Vu and A.A. Hebert. 2018. Insect Repellents: An Updated Review for the Clinician. **Journal of the American Academy of Dermatology**.
- Niebylski, M. and C. Meek. 1992. Blood-feeding of *Culex* mosquitoes in an urban environment. **Journal of the American Mosquito Control Association**. 8 (2): 173-177.
- Nitatpattana, N., A. Dubot-Pérès, M.A. Gouilh, M. Souris, P. Barbazan, S. Yoksan, X. De Lamballerie and J.-P. Gonzalez. 2008. Change in Japanese encephalitis virus distribution, Thailand. **Emerging Infectious Diseases**. 14 (11): 1762.
- Njiru, B.N., W.R. Mukabana, W. Takken and B.G. Knols. 2006. Trapping of the malaria vector *Anopheles gambiae* with odour-baited MM-X traps in semi-field conditions in western Kenya. **Malaria Journal**. 5 (1): 39.
- Noosidum, A., T. Chareonviriyaphap and A. Chandrapatya. 2014. Synergistic repellent and irritant effect of combined essential oils on *Aedes aegypti* (L.) mosquitoes. **Journal of Vector Ecology**. 39: 298-305.
- , A. Prabaripai, T. Chareonviriyaphap and A. Chandrapatya. 2008. Excito-repellency properties of essential oils from *Melaleuca leucadendron* L., *Litsea cubeba* (Lour.) Persoon, and *Litsea salicifolia* (Nees) on *Aedes aegypti* (L.) mosquitoes. **Journal of Vector Ecology**. 33 (2): 305-313.
- Norris, D.E. 2004. Mosquito-borne diseases as a consequence of land use change. **EcoHealth**. 1: 19-24.
- Norris, E.J. and J.R. Coats. 2017. Current and future repellent technologies: the potential of spatial repellents and their place in mosquito-borne disease control. **International Journal of Environmental Research and Public Health**. 14 (2): 124.

- Novak, R.J. and E.J. Gerberg. 2005. Natural-based repellent products: efficacy for military and general public uses. **Journal of the American Mosquito Control Association**. 21 (1): 7-12.
- Nuchprayoon, S., V. Sanprasert, C. Porksakorn and I. Nuchprayoon. 2003. Prevalence of bancroftian filariasis on the Thai-Myanmar border. **Asian Pacific Journal of Allergy and Immunology**. 21 (3): 179-188.
- Nuchuchua, O., U. Sakulku, N. Uawongyart, S. Puttipipatkachorn, A. Soottitantawat and U. Ruktanonchai. 2009. *In vitro* characterization and mosquito (*Aedes aegypti*) repellent activity of essential-oils-loaded nanoemulsions. **Aaps Pharmscitech**. 10: 1234.
- Obermayr, U., J. Ruther, U. Bernier, A. Rose and M. Geier. 2014. Laboratory evaluation techniques to investigate the spatial potential of repellents for push and pull mosquito control systems. **Journal of Medical Entomology**. 49: 1387-1397.
- Odalo, J.O., M.O. Omolo, H. Malebo, J. Angira, P.M. Njeru, I.O. Ndiege and A. Hassanali. 2005. Repellency of essential oils of some plants from the Kenyan coast against *Anopheles gambiae*. **Acta Tropica**. 95 (3): 210-218.
- Ogoma, S.B., H. Ngonyani, E.T. Simfukwe, A. Mseka, J. Moore, M.F. Maia, S.J. Moore and L.M. Lorenz. 2014. The mode of action of spatial repellents and their impact on vectorial capacity of *Anopheles gambiae* sensu stricto. **PLoS One**. 9: e110433.
- Okumu, F.O., E. Titus, E. Mbeyela, G.F. Killeen and S.J. Moore. 2009. Limitation of using synthetic human odours to test mosquito repellents. **Malaria Journal**. 8: 150.
- Olsen, S.J., K. Supawat, A.P. Campbell, S. Anantapreecha, S. Liamsuwan, S. Tunlayadechanont, A. Visudtibhan, S. Lupthikulthum, K. Dhiravibulya and A. Viriyavejakul. 2010. Japanese encephalitis virus remains an important cause of encephalitis in Thailand. **International Journal of Infectious Diseases**. 14 (10): e888-e892.
- Owen, W.B. 1963. The contact chemoreceptor organs of the mosquito and their function in feeding behaviour. **Journal of Insect Physiology**. 9 (1): 73-87.
- Oyen, L. and N.X. Dung. 1999. **PROSEA: Plant Resources of South-East Asia 19, Essential-oil Plants**. Yayasan Obor Indonesia.
- Paeporn, P., K. Supaphathom, S. Sathantriphop, P. Mukkhun and S. Sangkitporn. 2005. Insecticide Susceptibility of *Aedes aegypti* in Tsunami-affected Areas in Thailand. **Dengue Bulletin**. 29: 210-213.
- Paluch, G., L. Bartholomay and J. Coats. 2010. Mosquito repellents: a review of chemical structure diversity and olfaction. **Pest Management Science**. 66 (9): 925-935.

- Pareek, A. and A. Kumar. 2013. Ethnobotanical and pharmaceutical uses of *Vetiveria zizanioides* (Linn) Nash: a medicinal plant of Rajasthan. **International Journal of Life science and Pharma** 50: L12-L18.
- Patel, E., A. Gupta and R. Oswal. 2012. A review on: mosquito repellent methods. **International Journal of Pharmaceutical, Chemical and Biological Sciences**. 2 (3): 310-317.
- Patel, R.V., K.M. Shaer, P. Patel, A. Garmaza, K. Wiangkham, R.B. Franks, O. Pane and N.W. Carris. 2016. EPA-registered repellents for mosquitoes transmitting emerging viral disease. **Pharmacotherapy: The Journal of Human Pharmacology and Drug Therapy**. 36: 1272-1280.
- Pavela, R. 2014. Acute, synergistic and antagonistic effects of some aromatic compounds on the *Spodoptera littoralis* Boisd.(Lep., Noctuidae) larvae. **Industrial Crops and Products**. 60: 247-258.
- , G. Benelli, L. Pavoni, G. Bonacucina, M. Cespi, K. Cianfaglione, I. Bajalan, M.R. Morshedloo, G. Lupidi and D. Romano. 2019. Microemulsions for delivery of *Apiaceae* essential oils—towards highly effective and eco-friendly mosquito larvicides? **Industrial Crops and Products**. 129: 631-640.
- Pereira-dos-Santos, T., D. Roiz, R. Lourenço-de-Oliveira and C. Paupy. 2020. A Systematic Review: Is *Aedes albopictus* an Efficient Bridge Vector for Zoonotic Arboviruses? **Pathogens**. 9: 266.
- Peterson, C. and J. Coats. 2001. Insect repellents-past, present and future. **Pesticide Outlook**. 12 (4): 154-158.
- Phasomkusolsil, S. and M. Soonwera. 2010. Insect repellent activity of medicinal plant oils against *Aedes aegypti* (Linn.), *Anopheles minimus* (Theobald) and *Culex quinquefasciatus* Say based on protection time and biting rate. **Southeast Asian Journal of Tropical Medicine and Public Health**. 41 (4): 831.
- , 2011. Comparative mosquito repellency of essential oils against *Aedes aegypti* (Linn.), *Anopheles dirus* (Peyton and Harrison) and *Culex quinquefasciatus* (Say). **Asian Pacific Journal of Tropical Biomedicine**. 1: S113-S118.
- Philip, C., J. Paul and A. Sabin. 1944. Dimethyl Phthalate as a Repellent in Control of Phlebotomus (Pappataci or Sandfly) Fever. **War Medicine**. 6 (1): 27-33.
- Phukerd, U. and M. Soonwera. 2014. Repellency of essential oils extracted from Thai native plants against *Aedes aegypti* (Linn.) and *Culex quinquefasciatus* (Say). **Parasitology Research**. 113 (9): 3333-3340.

- Phumee, A., J. Chomposri, P. Intayot, R. Boonserm, S. Boonyasuppayakorn, R. Buathong, U. Thavara, A. Tawatsin, Y. Joyjinda and S. Wacharapluesadee. 2019. Vertical transmission of Zika virus in *Culex quinquefasciatus* Say and *Aedes aegypti* (L.) mosquitoes. **Scientific Reports**. 9: 1-9.
- Phyo, A.P. and F. Nosten. 2018. The artemisinin resistance in Southeast Asia: An imminent global threat to malaria elimination, p. 15-39. *In* S. Manguin, eds. **Towards Malaria Elimination—A Leap Forward**. IntechOpen.
- Pitts, R.J., A.N. Fox and L.J. Zwiebel. 2004. A highly conserved candidate chemoreceptor expressed in both olfactory and gustatory tissues in the malaria vector *Anopheles gambiae*. **Proceedings of the National Academy of Sciences**. 101 (14): 5058-5063.
- Plernsub, S., J. Saingamsook, J. Yanola, N. Lumjuan, P. Tippawangkosol, C. Walton and P. Somboon. 2016. Temporal frequency of knockdown resistance mutations, F1534C and V1016G, in *Aedes aegypti* in Chiang Mai city, Thailand and the impact of the mutations on the efficiency of thermal fogging spray with pyrethroids. **Acta Tropica**. 162: 125-132.
- Poda, S.B., D.D. Soma, A. Hien, M. Namountougou, O. Gnankiné, A. Diabaté, F. Fournet, T. Baldet, S. Mas-Coma and B. Mosqueira. 2018. Targeted application of an organophosphate-based paint applied on windows and doors against *Anopheles coluzzii* resistant to pyrethroids under real life conditions in Vallée du Kou, Burkina Faso (West Africa). **Malaria Journal**. 17: 136.
- Polanco-Hernández, G., F. Escalante-Erosa, K. García-Sosa, M.J. Chan-Bacab, H. Sagua-Franco, J. González, L. Osorio-Rodríguez and L.M. Peña-Rodríguez. 2012. Metabolites from the leaf extract of *Serjania yucatanensis* with trypanocidal activity against *Trypanosoma cruzi*. **Parasitology Research**. 111: 451-455.
- Polsomboon, S., J.P. Grieco, N.L. Achee, K.R. Chauhan, S. Tanasinchayakul, J. Pothikasikorn and T. Chareonviriyaphap. 2008. Behavioral responses of catnip (*Nepeta cataria*) by two species of mosquitoes, *Aedes aegypti* and *Anopheles harrisoni*, in Thailand. **Journal of the American Mosquito Control Association**. 24 (4): 513-520.
- Ponlawat, A. and L.C. Harrington. 2005. Blood feeding patterns of *Aedes aegypti* and *Aedes albopictus* in Thailand. **Journal of Medical Entomology**. 42 (5): 844-849.
- Potapov, A. and V. Vladimirova. 1965. Comparative tests of repellents against horse flies and black flies using olfactometer and traps. **Biology Medicine Seriya**. 2: 99-104.
- Potter, C.J. 2014. Stop the biting: targeting a mosquito's sense of smell. **Cell**. 156 (5): 878-881.

- Powell, J.R., A. Gloria-Soria and P. Kotsakiozi. 2018. Recent history of *Aedes aegypti*: vector Genomics and Epidemiology records. **BioScience**. 68 (11): 854-860.
- , and W.J. Tabachnick. 2013. History of domestication and spread of *Aedes aegypti*-a review. **Memórias do Instituto Oswaldo Cruz**. 108: 11-17.
- Purdy, M., M. Robinson, K. Wei and D. Rublin. 2013. The economic case for combating malaria. **The American Journal of Tropical Medicine and Hygiene**. 89 (5): 819-823.
- Qiu, H., H.W. Jun and J. McCall. 1998. Pharmacokinetics, formulation, and safety of insect repellent N, N-diethyl-3-methylbenzamide (DEET): a review. **Journal of the American Mosquito Control Association**. 14: 12-27.
- Qiu, H., H.W. Jun and J. Tao. 1997. Pharmacokinetics of insect repellent N, N-diethyl-m-toluamide in beagle dogs following intravenous and topical routes of administration. **Journal of Pharmaceutical Sciences**. 86: 514-516.
- Rachou, R.G., M. Moura-Lima, J.P. Duret and J.A. Kerr. 1963. Experiences with the excito-repellency test box-model OPS, p. 442–447. **50th Annual Meeting of the New Jersey Mosquito**. Exterminators Association and the 19th Annual Meeting of the American Mosquito Control Association,
- Rafatjah, H. 1976. Environmental management for malaria control. **Iranian Journal of Public Health**. 113-120.
- Raji, J.I. and M. DeGennaro. 2017. Genetic analysis of mosquito detection of humans. **Current Opinion in Insect Science**. 20: 34-38.
- Ramaiah, K. and E.A. Ottesen. 2014. Progress and impact of 13 years of the global programme to eliminate lymphatic filariasis on reducing the burden of filarial disease. **PLoS Neglected Tropical Diseases**. 8 (11): e3319.
- Ramdzan, A., A. Ismail and Z.M. Zanib. 2020. Prevalence of malaria and its risk factors in Sabah, Malaysia. **International Journal of Infectious Diseases**. 91: 68-72.
- Ranasinghe, M., L. Arambewela and S. Samarasinghe. 2016. Development of herbal mosquito repellent formulations. **International Journal Pharmaceutical Science Research**. 7: 3643-3648.
- Rattanarithikul, R. and P. Panthusiri. 1994. Illustrated keys to the medically important mosquitos of Thailand. **The Southeast Asian Journal of Tropical Medicine and Public Health**. 25: 1-66.
- Ray, A. 2015. Reception of odors and repellents in mosquitoes. **Current Opinion in Neurobiology**. 34: 158-164.

- Rehman, J.U., A. Ali and I.A. Khan. 2014. Plant based products: use and development as repellents against mosquitoes: a review. **Fitoterapia**. 95: 65-74.
- Reiter, P., D. Gubler and G. Kuno. (1997) **Surveillance and control of urban dengue vectors**, pp. 425–162, CABI Wallingford, United Kingdom.
- Rianthavorn, P., K. Prianantathavorn, N. Wuttirattanakowit, A. Theamboonlers and Y. Poovorawan. 2010. An outbreak of chikungunya in southern Thailand from 2008 to 2009 caused by African strains with A226V mutation. **International Journal of Infectious Diseases**. 14: e161-e165.
- Riotte, L. 1998. **Carrots love tomatoes: secrets of companion planting for successful gardening**. Storey Publishing, North Adams,.
- Rivero, A., J. Vezilier, M. Weill, A.F. Read and S. Gandon. 2010. Insecticide control of vector-borne diseases: when is insecticide resistance a problem? **PLoS Pathog**. 6: e1001000.
- Robbins, P.J. and M.G. Cherniack. 1986. Review of the biodistribution and toxicity of the insect repellent *N, N*-diethyl-m-toluamide (DEET). **Journal of Toxicology and Environmental Health, Part A Current Issues**. 18: 503-525.
- Roberts, D., W. Alecrim, A. Tavares and K. McNeill. 1984. Influence of physiological condition on the behavioral response of *Anopheles darlingi* to DDT. **Mosquito News (USA)**.
- and R.G. Andre. 1994. Insecticide resistance issues in vector-borne disease control. **The American Journal of Tropical Medicine and Hygiene**. 50: 21-34.
- , T. Chareonviriyaphap, H.H. Harlan and P. Hshieh. 1997. Methods of testing and analyzing excito-repellency responses of malaria vectors to insecticides. **Journal of the American Mosquito Control Association**. 13 (1): 13-17.
- Robertson, H.M., C.G. Warr and J.R. Carlson. 2003. Molecular evolution of the insect chemoreceptor gene superfamily in *Drosophila melanogaster*. **Proceedings of the National Academy of Sciences**. 100: 14537-14542.
- Rowland, M., T. Freeman, G. Downey, A. Hadi and M. Saeed. 2004. DEET mosquito repellent sold through social marketing provides personal protection against malaria in an area of all-night mosquito biting and partial coverage of insecticide-treated nets: a case-control study of effectiveness. **Tropical Medicine & International Health**. 9 (3): 343-350.
- Rozendaal, J.A. 1997. **Vector control: methods for use by individuals and communities**. World Health Organization. Geneva, Swizerland.

- Saeung, M., R. Ngoen-Klan, K. Thanispong, V. Muenworn, M.J. Bangs and T. Chareonviriyaphap. 2020. Susceptibility of *Aedes aegypti* and *Aedes albopictus* (Diptera: Culicidae) to temephos in Thailand and surrounding countries. **Journal of Medical Entomology**. <https://doi.org/10.1093/jme/tjaa035>.
- Sakamoto, R., T. Tanimoto, K. Takahashi, T. Hamaki, E. Kusumi and A. Crump. 2019. Flourishing Japanese Encephalitis, Associated with Global Warming and Urbanisation in Asia, Demands Widespread Integrated Vaccination Programmes. **Annals of Global Health**. 85 (1): 111. 10.5334/aogh.2580.
- Salazar, F.V., N.L. Achee, J.P. Grieco, A. Prabaripai, L. Eisen, P. Shah and T. Chareonviriyaphap. 2012. Evaluation of a peridomestic mosquito trap for integration into an *Aedes aegypti* (Diptera: Culicidae) push-pull control strategy. **Journal of Vector Ecology**. 37: 8-19.
- Sanchez-Bayo, F. 2012. Insecticides mode of action in relation to their toxicity to non-target organisms. **Journal of Environmental & Analytical Toxicology**.
- Sangoro, O., D. Lweitojera, E. Simfukwe, H. Ngonyani, E. Mbeyela, D. Lugiko, J. Kihonda, M. Maia and S. Moore. 2014. Use of a semi-field system to evaluate the efficacy of topical repellents under user conditions provides a disease exposure free technique comparable with field data. **Malaria Journal**. 13: 159.
- Sangoro, O.P., T. Gavana, M. Finda, W. Mponzi, E. Hape, A. Limwagu, N.J. Govella, P. Chaki and F.O. Okumu. 2020. Evaluation of personal protection afforded by repellent-treated sandals against mosquito bites in south-eastern Tanzania. **Malaria Journal**. 19: 1-12.
- Santhanam, A., M.A. Miller and G.B. Kasting. 2005. Absorption and evaporation of N, N-diethyl-m-toluamide from human skin in *vitro*. **Toxicology and Applied Pharmacology**. 204 (1): 81-90.
- Sathantriphop, S., N.L. Achee, U. Sanguanpong and T. Chareonviriyaphap. 2015. The effects of plant essential oils on escape response and mortality rate of *Aedes aegypti* and *Anopheles minimus*. **Journal of Vector Ecology**. 40: 318-326.
- , C. Ketavan, A. Prabaripai, S. Visetson, M.J. Bangs, P. Akkratanakul and T. Chareonviriyaphap. 2006. Susceptibility and avoidance behavior by *Culex quinquefasciatus* Say to three classes of residual insecticides. **Journal of Vector Ecology**. 31 (2): 266-274.
- , S.A. White, N.L. Achee, U. Sanguanpong and T. Chareonviriyaphap. 2014. Behavioral responses of *Aedes aegypti*, *Aedes albopictus*, *Culex quinquefasciatus*, and

- Anopheles minimus* against various synthetic and natural repellent compounds. **Journal of Vector Ecology**. 39: 328-339.
- Schiller, A., M. Allen, J. Coffey, A. Fike and F. Carballo. 2019. Updated Methods for the Production of *Toxorhynchites rutilus septentrionalis* (Diptera, Culicidae) for Use as Biocontrol Agent Against Container Breeding Pest Mosquitoes in Harris County, Texas. **Journal of Insect Science**. 19 (2): 8. <https://doi.org/10.1093/jisesa/iez011>.
- Scholte, E.-J. and F. Schaffner. 2007. Waiting for the tiger: establishment and spread of the *Aedes albopictus* mosquito in Europe. **Emerging pests and vector-borne diseases in Europe**. 1: 241.
- Schreck, C. 1977. Techniques for the evaluation of insect repellents: a critical review. **Annual Review of Entomology**. 22 (1): 101-119.
- Schreck, C.E. and T. McGovern. 1989. Repellents and other personal protection strategies against *Aedes albopictus*. **Journal of the American Mosquito Control Association**. 5: 247-250.
- Seyoum, A., K. Pålsson, S. Kung'a, E. Kabiru, W. Lwande, G. Killeen, A. Hassanali and B. Knots. 2002. Traditional use of mosquito-repellent plants in western Kenya and their evaluation in semi-field experimental huts against *Anopheles gambiae*: ethnobotanical studies and application by thermal expulsion and direct burning. **Transactions of the Royal Society of Tropical Medicine and Hygiene**. 96: 225-231.
- Sharma, S., K. Tandel, P.K. Dash and M. Parida. 2017. Zika virus: A public health threat. **Journal of medical virology**. 89 (10): 1693-1699.
- Shell, E.R. 1997. Atlantic Monthly. **Resurgence of a Deadly Diseases**. 45-60.
- Shepard, D.S., E.A. Undurraga and Y.A. Halasa. 2013. Economic and disease burden of dengue in Southeast Asia. **PLoS Neglected Tropical Diseases**. 7: e2055.
- Shinohara, K., S. Kutsuna, T. Takasaki, M.L. Moi, M. Ikeda, A. Kotaki, K. Yamamoto, Y. Fujiya, M. Mawatari and N. Takeshita. 2016. Zika fever imported from Thailand to Japan, and diagnosed by PCR in the urine. **Journal of travel medicine**. 23 (1): tav011. <https://doi.org/10.1093/jtm/tav011>.
- Shukla, D., S. Wijayapala and P.S. Vankar. 2018. Effective mosquito repellent from plant based formulation. **International Journal of Mosquito Research**. 5: 19-24.
- Shutty, B., D. Swender, L. Chernin, H. Tcheurekdjian and R. Hostoffer. 2013. Insect repellents and contact urticaria: differential response to DEET and picaridin. **Cutis**. 91: 280-282.

- Sikka, V., V.K. Chattu, R.K. Popli, S.C. Galwankar, D. Kelkar, S.G. Sawicki, S.P. Stawicki and T.J. Papadimos. 2016. The emergence of Zika virus as a global health security threat: a review and a consensus statement of the INDUSEM Joint Working Group (JWG). **Journal of Global Infectious Diseases**. 8 (1): 3-15.
- Singh, R., O. Koul, P.J. Rup and J. Jindal. 2009. Toxicity of some essential oil constituents and their binary mixtures against *Chilo partellus* (Lepidoptera: Pyralidae). **International Journal of Tropical Insect Science**. 29: 93-101.
- Sinha, S., M. Jothiramajayam, M. Ghosh and A. Mukherjee. 2014. Evaluation of toxicity of essential oils palmarosa, citronella, lemongrass and vetiver in human lymphocytes. **Food and Chemical Toxicology**. 68: 71-77.
- Snyder, J., R. Poe, J. Stubbins and L. Garrettson. 1986. Acute manic psychosis following the dermal application of *N, N*-diethyl-*m*-toluamide (DEET) in an adult. **Journal of Toxicology: Clinical Toxicology**. 24: 429-439.
- Solomon, T., N.M. Dung, R. Kneen, M. Gainsborough, D.W. Vaughn and V.T. Khanh. 2000. Japanese encephalitis. **Journal of Neurology, Neurosurgery & Psychiatry**. 68 (4): 405-415.
- Somboon, P., L.-a. Prapanthadara and W. Suwonkerd. 2003. Insecticide susceptibility tests of *Anopheles minimus* sl, *Aedes aegypti*, *Aedes albopictus*, and *Culex quinquefasciatus* in northern Thailand. **Southeast Asian Journal of Tropical Medicine and Public Health**. 34 (1): 87-93.
- Soonwera, M. 2015. Efficacy of essential oils from Citrus plants against mosquito vectors *Aedes aegypti* (Linn.) and *Culex quinquefasciatus* (Say). **Journal of Agricultural Technology**. 11 (3): 669-681.
- , G. Botsko, D.R. Swale, L.M. Boland, S.S. Patel and J.C. Dickens. 2018. Membrane proteins mediating reception and transduction in chemosensory neurons in mosquitoes. **Frontiers in Physiology**. 9: 1309.
- , and J.C. Dickens. 2017. Mini review: Gustatory reception of chemicals affecting host feeding in aedine mosquitoes. **Pesticide Biochemistry and Physiology**. 142: 15-20.
- , B.T. Vinyard and J.C. Dickens. 2013. Gustatory receptor expression in the labella and tarsi of *Aedes aegypti*. **Insect Biochemistry and Molecular Biology**. 43 (12): 1161-1171.
- Sritabutra, D., M. Soonwera, S. Waltanachanobon and S. Pongjai. 2011. Evaluation of herbal essential oil as repellents against *Aedes aegypti* (L.) and *Anopheles dirus* Peyton & Harrion. **Asian Pacific Journal of Tropical Biomedicine**. 1: S124-S128.

- St. Pfau, A. and P.A. Plattner. 1939. Etudes sur les matières végétales volatiles X. Sur les vétivones, constituants odorants des essences de vétiver. **Helvetica Chimica Acta**. 22: 640-654.
- Strickman, D., S.P. Frances and M. Debboun. 2009. **Prevention of bug bites, stings, and disease**. Oxford University Press.
- Sudomo, M., S. Chayabejara, S. Duong, L. Hernandez, W.-P. Wu and R. Bergquist. 2010. Elimination of lymphatic filariasis in Southeast Asia. **Advances in Parasitology**. 72: 205-233. [https://doi.org/10.1016/S0065-308X\(10\)72008-X](https://doi.org/10.1016/S0065-308X(10)72008-X).
- Suh, E., J.D. Bohbot and L.J. Zwiebel. 2014. Peripheral olfactory signaling in insects. **Current Opinion in Insect Science**. 6: 86-92.
- Sujatha, S. 2010. Essential oil and its insecticidal activity of medicinal aromatic plant *Vetiveria zizanioides* (L.) against the red flour beetle *Tribolium castaneum* (Herbst). **Asian Journal of Agricultural Sciences**. 2: 84-88.
- Sukhralia, S., M. Verma, S. Gopirajan, P. Dhanaraj, R. Lal, N. Mehla and C.R. Kant. 2019. From dengue to Zika: The wide spread of mosquito-borne arboviruses. **European Journal of Clinical Microbiology & Infectious Diseases**. 38: 3-14.
- Sukkanon, C., T. Karpkird, M. Saeung, T. Leepasert, A. Panthawong, W. Suwonkerd, M.J. Bangs and T. Chareonviriyaphap. 2020. Excito-repellency activity of *Andrographis paniculata* (Lamiales: Acanthaceae) against colonized mosquitoes. **Journal of Medical Entomology**. 57: 192-203.
- Suleiman, R.A., Q.A. Mgani and S.S. Nyandoro. 2014. Chemical compositions and mosquito repellency of essential oils from *Artabotrys hexapetalus* and *Artabotrys rupestris*. **International Journal of Biological and Chemical Sciences**. 8 (6): 2804-2812.
- Sumarnrote, A., Overgaard HJ, Corbel V, Thanispong K, Chareonviriyaphap T and M. S. 2020. Diversity of species within the *Anopheles hyrcanus* group in Ubon Ratchathani Province, Thailand. . **Parasites & Vectors**. (In press)
- Sumarnrote, A., H.J. Overgaard, N. Marasri, B. Fustec, K. Thanispong, T. Chareonviriyaphap and V. Corbel. 2017. Status of insecticide resistance in *Anopheles* mosquitoes in Ubon Ratchathani province, Northeastern Thailand. **Malaria Journal**. 16 (1): 299.
- Supadmi, W., A.A. Suwantika, D.A. Perwitasari and R. Abdulah. 2019. Economic Evaluations of Dengue Vaccination in the Southeast Asia Region: Evidence From a Systematic Review. **Value in health regional issues**. 18: 132-144.
- Sutthanont, N., W. Choochote, B. Tuetun, A. Junkum, A. Jitpakdi, U. Chaithong, D. Riyong and B. Pitasawat. 2010. Chemical composition and larvicidal activity of edible plant-

- derived essential oils against the pyrethroid-susceptible and-resistant strains of *Aedes aegypti* (Diptera: Culicidae). **Journal of Vector Ecology**. 35 (1): 106-115.
- Suwannachote, N., J.P. Grieco, N.L. Achee, W. Suwonkerd, S. Wongtong and T. Chareonviriyaphap. 2009. Effects of environmental conditions on the movement patterns of *Aedes aegypti* (Diptera: Culicidae) into and out of experimental huts in Thailand. **Journal of Vector Ecology**. 34 (2): 267-275.
- Suwansirisilp, K., S. Visetson, A. Prabaripai, S. Tanasinchayakul, J.P. Grieco, M.J. Bangs and T. Chareonviriyaphap. 2013. Behavioral responses of *Aedes aegypti* and *Culex quinquefasciatus* (Diptera: Culicidae) to four essential oils in Thailand. **Journal of Pest Science**. 86: 309-320.
- Tabanca, N., B. Demirci, A. Ali, Z. Ali, E.K. Blythe and I.A. Khan. 2015. Essential oils of green and red *Perilla frutescens* as potential sources of compounds for mosquito management. **Industrial Crops and Products**. 65: 36-44.
- Tainchum, K., M. Kongmee, S. Manguin, M.J. Bangs and T. Chareonviriyaphap. 2015. *Anopheles* species diversity and distribution of the malaria vectors of Thailand. **Trends in Parasitology**. 31 (3): 109-119.
- , W. Ritthison, S. Sathantriphop, S. Tanasilchayakul, S. Manguin, M.J. Bangs and T. Chareonviriyaphap. 2014. Influence of time of assay on behavioral responses of laboratory and field populations *Aedes aegypti* and *Culex quinquefasciatus* (Diptera: Culicidae) to DEET. **Journal of Medical Entomology**. 51: 1227-1236.
- Tak, J.H., E. Jovel and M.B. Isman. 2016. Comparative and synergistic activity of *Rosmarinus officinalis* L. essential oil constituents against the larvae and an ovarian cell line of the cabbage looper, *Trichoplusia ni* (Lepidoptera: Noctuidae). **Pest Management Science**. 72: 474-480.
- Takken, W. and N.O. Verhulst. 2013. Host preferences of blood-feeding mosquitoes. **Annual Review of Entomology**. 58: 433-453.
- Tananchai, C., S. Manguin, M.J. Bangs and T. Chareonviriyaphap. 2019. Malaria Vectors and Species Complexes in Thailand: Implications for Vector Control. **Trends in Parasitology**.
- , R. Tisgratog, W. Juntarajumnong, J.P. Grieco, S. Manguin, A. Prabaripai and T. Chareonviriyaphap. 2012. Species diversity and biting activity of *Anopheles dirus* and *Anopheles baimaii* (Diptera: Culicidae) in a malaria prone area of western Thailand. **Parasites & Vectors**. 5: 211.

- Tanasinchayakul, S., S. Polsomboon, A. Prabaripai and T. Chareonviriyaphap. 2006. An automated, field-compatible device for excito-repellency assays in mosquitoes. **Journal of Vector Ecology**. 31: 210-212.
- Tavares, M., M.R.M. da Silva, L.B.d.O. de Siqueira, R.A.S. Rodrigues, L. Bodjolle-d'Almeida, E.P. Dos Santos and E. Ricci-Júnior. 2018. Trends in insect repellent formulations: A review. **International Journal of Pharmaceutics**. 539: 190-209.
- Tawatsin, A., P. Asavadachanukorn, U. Thavara, P. Wongsinkongman, J. Bansidhi, T. Boonruad, P. Chavalittumrong, N. Soonthornchareonnon, N. Komalamisra and M.S. Mulla. 2006. Repellency of essential oils extracted from plants in Thailand against four mosquito vectors (Diptera: Culicidae) and oviposition deterrent effects against *Aedes aegypti* (Diptera: Culicidae). **Southeast Asian Journal of Tropical Medicine and Public Health**. 37 (5): 915.
- Tawatsin, A., U. Thavara, P. Siriyasatien and S. Permpoonburana. 2019. Development of A Novel Ultrasonic Sound-Generated Device-The Physical Tool for Controlling Immature Stages of Mosquitoes Transmitting Dengue Haemorrhagic Fever (*Aedes aegypti*) and Filariasis (*Culex quinquefasciatus*). **Biomedical Journal of Scientific & Technical Research**. 19: 14308-14314.
- Tawatsin, A., S.D. Wratten, R.R. Scott, U. Thavara and Y. Techadamrongsin. 2001. Repellency of volatile oils from plants against three mosquito vectors. **Journal of Vector Ecology**. 26: 76-82.
- Telang, T., S. Awasthy and V. Oswal. 2003. Qualitative improvement of the essential oil of *Chloroxylon swietenia* (Roxb. corom). **Indian Perfumer**. 47: 79-82.
- Thanispong, K., N.L. Achee, J.P. Grieco, M.J. Bangs, W. Suwonkerd, A. Prabaripai, K.R. Chauhan and T. Chareonviriyaphap. 2010. A high throughput screening system for determining the three actions of insecticides against *Aedes aegypti* (Diptera: Culicidae) populations in Thailand. **Journal of Medical Entomology**. 47: 833-841.
- , K. Pankaew and P. Sukchote. 2013. Insecticide susceptibility/resistance status in *Aedes aegypti* L. to insecticide used in public health. **Journal of Vector Borne Disease**. 8: 351-356 (in Thai).
- , S. Sathantriphop and T. Chareonviriyaphap. 2008. Insecticide resistance of *Aedes aegypti* and *Culex quinquefasciatus* in Thailand. **Journal of Pesticide Science**. 33 (4): 351-356.
- Thavara, U., A. Tawatsin, C. Chansang, W. Kong-ngamsuk, S. Paosriwong, J. Boon-Long, Y. Rongsriyam and N. Komalamisra. 2001a. Larval occurrence, oviposition behavior

- and biting activity of potential mosquito vectors of dengue on Samui Island, Thailand. **Journal of Vector Ecology**. 26: 172-180.
- , A. Tawatsin and J. Chompoonsri. 2002. Phytochemicals as repellents against mosquitoes in Thailand, 21-26. **Journal of the American Mosquito Control Association-Mosquito News**
- Thavara, U., A. Tawatsin, J. Chompoonsri, W. Suwonkerd, U. Chansang and P. Asavadachanukorn. 2001b. Laboratory and field evaluations of the insect repellent 3535 (ethyl butylacetylaminopropionate) and deet against mosquito vectors in Thailand. **Journal of the American Mosquito Control Association-Mosquito News**. 17 (3): 190-195.
- Thongdara, R., T. Limsoontorn, C. Imvitthaya, L. Samarakoon, S. Ranamukhaarachchi, M. Almvik, O.M. Eklo, N.S. Johansen, E. Nordhus and H.J. Overgaard. 2009. **Bioforsk Report: Pesticides, Agriculture and Health in Thailand**.
- Tisgratog, R., M. Kongmee, U. Sanguanpong, A. Prabaripai, M.J. Bangs and T. Chareonviriyaphap. 2016a. Evaluation of a Noncontact, Alternative Mosquito Repellent Assay System. **Journal of the American Mosquito Control Association**. 32 (3): 177-185.
- , U. Sanguanpong, J.P. Grieco, R. Ngoen-Kluan and T. Chareonviriyaphap. 2016b. Plants traditionally used as mosquito repellents and the implication for their use in vector control. **Acta Tropica**. 157: 136-144.
- , C. Sukkanon, J.P. Grieco, U. Sanguanpong, K.R. Chauhan, J.R. Coats and T. Chareonviriyaphap. 2018. Evaluation of the Constituents of Vetiver Oil Against *Anopheles minimus* (Diptera: Culicidae), a Malaria Vector in Thailand. **Journal of Medical Entomology**. 55 (1): 193-199.
- Trigg, J. 1996. Evaluation of a eucalyptus-based repellent against *Anopheles* spp. in Tanzania. **Journal of the American Mosquito Control Association-Mosquito News**. 12 (2) 243-246.
- Tripathi, R., D. Kaushik, A. Tripathi, V.P. Rasal and S.A. Khan. 2006. Acute and subacute toxicity studies on vetiver oil in rats. **FABAD Journal of Pharmaceutical Sciences**. 31: 71.
- Trommer, H. and R. Neubert. 2006. Overcoming the stratum corneum: the modulation of skin penetration. **Skin Pharmacology and Physiology**. 19: 106-121.

- Trongtokit, Y., C.F. Curtis and Y. Rongsriyam. 2005a. Efficacy of repellent products against caged and free flying *Anopheles stephensi* mosquitoes. **Southeast Asian Journal of Tropical Medicine and Public Health**. 36 (6): 1423.
- , Y. Rongsriyam, N. Komalamisra and C. Apiwathnasorn. 2005b. Comparative repellency of 38 essential oils against mosquito bites. **Phytotherapy Research: An International Journal Devoted to Pharmacological and Toxicological Evaluation of Natural Product Derivatives**. 19 (4): 303-309.
- , Y. Rongsriyam, N. Komalamisra, P. Krisadaphong and C. Apiwathnasorn. 2004. Laboratory and field trial of developing medicinal local Thai plant products against four species of mosquito vectors. **Southeast Asian Journal of Tropical Medicine and Public Health**. 35: 325-333.
- Uniyal, A., S.N. Tikar, R. Singh, S. Vinay, O.P.A. Shukla, D. Sukumaran and V. Veer. 2015. Synergistic effect of effective oils against *Aedes aegypti* female mosquito, vector of dengue and chikungunya. **International Journal of Mosquito Research**. 2: 29-35.
- Vazeille, M., C. Jeannin, E. Martin, F. Schaffner and A.-B. Failloux. 2008. Chikungunya: a risk for Mediterranean countries? **Acta Tropica**. 105 (2): 200-202.
- Volta, P., P. Tremolada, M.C. Neri, G. Giussani and S. Galassi. 2009. Age-dependent bioaccumulation of organochlorine compounds in fish and their selective biotransformation in top predators from Lake Maggiore (Italy). **Water, Air, and Soil Pollution**. 197 (1-4): 193-209.
- Weiss, E.A. 1997. **Essential oil crops**. Oxford University Press, London.
- Weldon, P.J. 2004. Defensive anointing: extended chemical phenotype and unorthodox ecology. **Chemoecology**. 14 (1): 1-4.
- Weldon, P.J., J.R. Aldrich, J.A. Klun, J.E. Oliver and M. Debboun. 2003. Benzoquinones from millipedes deter mosquitoes and elicit self-anointing in capuchin monkeys (*Cebus* spp.). **Naturwissenschaften**. 90 (7): 301-304.
- , J.F. Carroll, M. Kramer, R.H. Bedoukian, R.E. Coleman and U.R. Bernier. 2011. Anointing chemicals and hematophagous arthropods: responses by ticks and mosquitoes to Citrus (Rutaceae) peel exudates and monoterpene components. **Journal of Chemical Ecology**. 37 (4): 348-359.
- Wernsdorfer, W.H. and I. Mac Gregor. 1988. **Malaria: principles and practice of malariology**. Churchill Livingstone.
- WHO [World Health Organization]. 1975. **Manual on Practical Entomology in Malaria. Part II. Methods and Techniques**. World Health Organization, Geneva, Switzerland.

- , 1998. **Test procedures for insecticide resistance monitoring in malaria vectors, bio-efficacy and persistence of insecticides on treated surfaces: report of the WHO informal consultation, Geneva, 28-30 September 1998.** World Health Organization, Geneva, Switzerland.
- , 2009. **Guidelines for efficacy testing of mosquito repellents for human skin.** World Health Organization, Geneva, Switzerland.
- , 2010. **Global programme to eliminate lymphatic filariasis: progress report 2000–2009 and strategic plan 2010–2020.** World Health Organization. Geneva, Switzerland.
- , 2016. **Test procedures for insecticide resistance monitoring in malaria vector mosquitoes.** World Health Organization. Geneva, Switzerland.
- , W.H.O. 2017. **Global vector control response 2017-2030.** World Health Organization. Geneva, Switzerland.
- , 2018. **World malaria report 2018.** World Health Organization. Geneva, Switzerland.
- , 2019a. **Tenth meeting of the WHO Vector Control Advisory Group: meeting report, 13-15 May 2019.** World Health Organization. Geneva, Switzerland.
- , 2019b. **Vector-borne diseases.** World Health Organization. Geneva, Switzerland. Available Source: <https://www.who.int/en/news-room/fact-sheets/detail/vector-borne-diseases>,
- , 2019c. **World Malaria report: 2019.** World Health Organization. Geneva, Switzerland.
- , 2020. **Vector-borne diseases.** World Health Organization. Geneva, Switzerland. Available Source: <https://www.who.int/campaigns/world-health-day/2014/vector-borne-diseases/en/>,
- Wicher, D. and F. Marion-Poll. 2018. Function and regulation of chemoreceptors. **Frontiers in Cellular Neuroscience**. 12: 496. <https://doi.org/10.3389/fncel.2018.00496>.
- Witting-Bissinger, B., C. Stumpf, K. Donohue, C. Apperson and R. Roe. 2008. Novel arthropod repellent, BioUD, is an efficacious alternative to deet. **Journal of Medical Entomology**. 45: 891-898.
- Wongsiri, S. and R. Andre. 1984. Biological control of mosquitoes in Thailand. **Journal of the Science Society of Thailand**. 10: 73-88.
- Xue, R.-D., G.C. Muller and J.F. Day. 2014. Commercially Available Insect repellents and Criteria for their Use. **Insect Repellents Handbook**. 339-342.

- Zegeye, A.D., E.J. Langendoen, S.A. Tilahun, W. Mekuria, J. Poesen and T.S. Steenhuis. 2018. Root reinforcement to soils provided by common Ethiopian highland plants for gully erosion control. **Ecohydrology**. 11: e1940.
- Zhao, J., X. Zheng, R.A. Newman, Y. Zhong, Z. Liu and P. Nan. 2013. Chemical composition and bioactivity of the essential oil of *Artemisia anomala* from China. **Journal of Essential Oil Research**. 25: 520-525.
- Zheng, G.-Q., P.M. Kenney and L.K. Lam. 1992. Sesquiterpenes from clove (*Eugenia caryophyllata*) as potential anticarcinogenic agents. **Journal of Natural Products**. 55 (7): 999-1003.
- Zhu, B.C., G. Henderson, F. Chen, L. Maistrello and R.A. Laine. 2001a. Nootkatone is a repellent for Formosan subterranean termite (*Coptotermes formosanus*). **Journal of Chemical Ecology**. 27: 523-531.
- Zielinski-Gutierrez, E., R.A. Wirtz, R.S. Nasci and W.G. Brogdon. 2012. Protection against mosquitoes, ticks, and other insects and arthropods, G. W. Brunette, eds. **International Travel 2012: The Yellow Book**. Oxford University Press.

Résumé

Efficacité et persistance de répulsifs à base de plantes pour des stratégies vertes de lutte antivectorielle

Les maladies transmissibles par les moustiques représentent un danger majeur pour des millions de personnes dans le monde. Les répulsifs utilisés contre les moustiques jouent un rôle important dans le contrôle de la transmission de ces maladies en réduisant le contact humain-vecteur. Toutefois, l'utilisation de répulsifs synthétiques a soulevé un certain nombre de questions préoccupantes en termes de risques pour l'environnement et la santé humaine. Ainsi, les répulsifs anti-moustiques à base de plantes représentent une alternative de choix aux répulsifs synthétiques, qui nécessitent donc une plus grande attention. Après une intense procédure de sélection de plantes et de certains de leurs composés, deux d'entre eux ont été sélectionnés pour une analyse approfondie de leurs activités répulsives contre cinq espèces de moustiques des genres *Anopheles*, *Aedes* et *Culex*, tous étant les vecteurs majeurs d'agents pathogènes humains, respectivement responsables de la transmission du paludisme, de la dengue et de l'encéphalite japonaise. Les résultats ont démontré qu'un des deux composés avaient, à concentration égale, un effet répulsif plus élevé sur ces moustiques que le DEET, molécule la plus utilisée dans les répulsifs actuels. De plus, ces deux composés ne présentent aucune réponse phototoxique, ni génotoxique, suggérant leur potentiel élevé pour le développement ultérieur de répulsifs verts, plus sûrs pour l'homme et l'environnement.

Mots-clés : Moustiques vecteurs, *Anopheles*, *Aedes*, *Culex*, Composés naturels, Répulsifs dérivés de plantes.

Summary

Efficacy and persistence of promising plant-based mosquito repellents towards green vector control strategies

Mosquito-borne diseases present a key biohazard to millions of people worldwide. Mosquito repellents play a significant role in disrupting the disease cycle by reducing human-vector contact. However, the use of synthetic repellents has raised several concerns in terms of environmental and human health risks. Therefore, plant-based mosquito repellents represent a suitable alternative to synthetic repellents that need further attention. Following an intense selection procedure of plants and some of their compounds, two of them were selected for a thorough analysis of their repellent activities against five mosquito species of the genera *Anopheles*, *Aedes* and *Culex*, all being main vectors of human pathogens, respectively responsible for the transmission of malaria, dengue and Japanese encephalitis. The results demonstrated that one of the two compounds had, at the same concentration, stronger repellent effect on mosquitoes than DEET, the gold standard molecule most used in repellents. Moreover, these two compounds showed neither any phototoxic nor genotoxic response, suggesting their high potential for further development as green repellents, safer for human and the environment.

Keywords: Mosquito vectors, *Anopheles*, *Aedes*, *Culex*, Natural compounds, Plant-based repellents