



HAL
open science

Améliorer la créativité par le jeu : Cadre théorique et apports empiriques

Maxence Mercier

► **To cite this version:**

Maxence Mercier. Améliorer la créativité par le jeu : Cadre théorique et apports empiriques. Psychologie. Université Paris Cité, 2023. Français. NNT : 2023UNIP7260 . tel-04717764

HAL Id: tel-04717764

<https://theses.hal.science/tel-04717764v1>

Submitted on 2 Oct 2024

HAL is a multi-disciplinary open access archive for the deposit and dissemination of scientific research documents, whether they are published or not. The documents may come from teaching and research institutions in France or abroad, or from public or private research centers.

L'archive ouverte pluridisciplinaire **HAL**, est destinée au dépôt et à la diffusion de documents scientifiques de niveau recherche, publiés ou non, émanant des établissements d'enseignement et de recherche français ou étrangers, des laboratoires publics ou privés.

Université Paris Cité

École doctorale 261-3CH

« Cognition, Comportements, Conduites Humaines »

Laboratoire de Psychologie et d'Ergonomie Appliquées - LaPEA

Améliorer la créativité par le jeu

Cadre théorique et apports empiriques

Par Maxence Mercier

Thèse de doctorat de Psychologie

Dirigée par Todd Lubart

Et par Samira Bourgeois-Bougrine

Présentée et soutenue publiquement le 12 décembre 2023

Devant un jury composé de :

Maud Besançon	Professeure - Université Rennes 2	Rapporteuse
Michael Hanchett Hanson	Professeur - Teachers College, Columbia University	Rapporteur
Stéphanie Buisine	Directrice de Recherche - Université Paris Nanterre	Examinatrice
Xabi Borteyrou	Professeur - Université Paris Cité	Examineur
Mikaël Le Bourhis	Docteur - Asmodee	Membre invité
Todd Lubart	Professeur - Université Paris Cité	Directeur de thèse
Samira Bourgeois-Bougrine	Maîtresse de Conférences HDR - Université Paris Cité	Co-directrice de thèse

Remerciements

Je tiens tout d'abord à remercier les membres du jury : Maud Besançon, Michael Hanchett Hanson, Stéphanie Buisine, et Xabi Borteyrou. Merci d'avoir investi le temps et l'énergie nécessaires à l'évaluation de ma thèse. C'est un honneur d'avoir l'opportunité de présenter mon travail devant vous.

Mes remerciements vont bien sûr à mon directeur de thèse, Todd Lubart, et ma co-directrice de thèse, Samira Bourgeois-Bougrine. Todd m'accompagne depuis ma première année de Master, et c'est une véritable chance d'avoir pu poursuivre les résultats obtenus dès lors jusqu'à aujourd'hui. Merci pour vos conseils, votre façon de me pousser et de m'encourager à aller plus loin. Je vous dois beaucoup, tant dans ma manière d'approcher la recherche et l'exploration, que dans ma tolérance à l'ambiguïté, qui a sans l'ombre d'un doute vastement explosée depuis votre rencontre en 2018. Merci enfin pour votre adage « le mieux est l'ennemi du bien », qui m'a beaucoup aidé dans mes moments d'obstinations et d'entêtements. Merci énormément à Samira, qui a rejoint l'aventure à la fin de ma deuxième année de Master. Ta vision d'ergonome m'a beaucoup challengé, moi qui reste parfois enfermé dans ma perspective de psychologue. Les idées que tu m'as apportées, et l'inspiration qui en a découlé et qui en découle toujours sont pour moi inestimables. Merci à vous deux pour votre soutien, vos conseils et votre accompagnement tout au long de ce projet.

Je tiens à remercier l'ensemble des membres du LaPEA, et tout particulièrement Marion Botella, qui m'a toujours apporté une vision différente de mon travail doctoral. Prendre du recul est un exercice difficile et une capacité qui m'a parfois manqué. Merci d'avoir su m'offrir une telle perspective.

Je tiens également à remercier Asmodee et son soutien dans le cadre de la Chaire Homo Creativus, qui a permis le financement d'une partie de ce travail de thèse. Sans ce soutien, plusieurs de mes études n'auraient tout simplement pas vu le jour. Je souhaite également remercier Asmodee Research, qui m'ont donné à plusieurs reprises l'occasion de diffuser mes travaux à un public plus large.

Je remercie les doctorants auprès de qui j'ai partagé ces quelques années. Mes remerciements vont tout particulièrement à Florent Vinchon, qui me soutient et me supporte depuis nos années de Master, et sans qui j'aurais pété les plombs au moins trois fois plus souvent. Merci pour ta disponibilité et pour ton aide indispensable, qui m'ont rendu maintes

fois confiance en moi. Un grand merci à mes camarades du collège d'experts, Xavier, Marie et Agathe, qui m'ont accompagné contre vents et marées, que ce soit dans la salle des doctorants ou dans un PMU perdu en Loire-Atlantique.

Un immense merci à Clément, le sang de la veine et meilleur ami depuis dix ans. De nombreux moments au cours de cette thèse auraient été difficilement surmontables sans ta présence, et j'ai arrêté de compter le nombre d'Eurékas qui me sont apparus grâce à toi. Merci aussi à mes amis dijonnais, en particulier Louise-Marie et Hugo, ainsi qu'à Thibault, qui m'ont permis de m'échapper de ma thèse quand j'en avais besoin (i.e., très régulièrement).

Enfin, je tiens à remercier du fond du cœur ma famille. Merci à mes parents, qui m'ont toujours apporté leur soutien inconditionnel et indéfectible, et à mes deux petits frères, qui, loin de comprendre grand-chose à mes bêtises et l'entreprise bizarre qu'est cette thèse, n'ont jamais manqué de s'y intéresser et de me soutenir.

Résumé

La créativité est, à bien des égards, une des compétences les plus importantes de nos jours. À l'échelle sociale, cette capacité à générer des idées nouvelles et adaptées à leur contexte est à la source du progrès humain. À l'échelle individuelle, la créativité est source de performance, de satisfaction, de plaisir, de bien-être, et de résilience. En somme, la créativité nous enrichit personnellement et collectivement, ce dans différents domaines. Trouver des moyens de développer et de renforcer cette capacité s'avère d'une importance particulière. De nombreuses méthodes et interventions ont ainsi été élaborées, dans le but d'améliorer la créativité. Ces méthodes partagent généralement le même point commun : un apprentissage optimal de la créativité passe par la pratique et l'expérience concrète. Sur la base de ce constat, cette thèse envisage l'utilisation des jeux comme une manière efficace et aisément applicable d'améliorer la créativité.

Pour examiner cette hypothèse, les contributions scientifiques de cette thèse s'articulent en trois volets. Le premier volet a pour objectif de développer un cadre théorique intégratif de l'amélioration de la créativité par le jeu. L'objectif du cadre théorique consiste à décrire et à expliquer comment les jeux peuvent améliorer la créativité, en adoptant une approche entrée – processus - sortie. Deux entrées sont présentées : les attributs personnels, et les attributs des jeux. Le processus renvoie à la situation d'apprentissage par le jeu. La sortie renvoie aux améliorations de la créativité. Le deuxième volet propose d'étudier l'effet des jeux sur la créativité. Ce volet a pour objectif de déterminer la validité du cadre théorique intégratif et de son hypothèse globale : les jeux sont-ils un bon moyen d'améliorer la créativité ? En utilisant les jeux de société comme outil d'amélioration, les résultats de deux études expérimentales de ce volet montrent un effet de la pratique des jeux de société sur la pensée divergente, d'abord à l'échelle individuelle, puis à l'échelle du groupe. Le troisième volet s'intéresse spécifiquement à expliquer les liens entre pratique des jeux et créativité, qui renvoie à l'entrée « attributs personnels » du cadre théorique. Plus précisément, l'objectif est d'identifier les dénominateurs communs entre ces deux notions, en termes de ressources conatives. Deux études corrélationnelles identifient deux de ces dénominateurs communs, par le biais d'analyses de médiations. La première étude identifie le capital psychologique comme médiateur du lien entre pratique des jeux vidéo et créativité au travail. La seconde étude démontre le rôle du caractère joueur en tant que médiateur du lien entre pratique des jeux de société et deux mesures de la créativité : le concept de soi créatif et la créativité au travail.

Mots-clés : créativité, jeux, apprentissage expérientiel, apprentissage par le jeu, jeux de société

Abstract

Creativity is, in many ways, one of today's most important skills. On a social scale, this ability to generate new and contextually-relevant ideas is the source of human progress. On an individual level, creativity is a source of performance, satisfaction, pleasure, well-being and resilience. In short, creativity enriches us personally and collectively, in many different ways. Finding ways to enhance and develop this capacity is therefore of particular importance. Numerous methods and interventions have been developed to enhance creativity. What these methods generally have in common is that creativity is best learned through practice and hands-on experience. On the basis of this observation, this thesis considers the use of games as an effective and easily applicable way of enhancing creativity.

To examine this hypothesis, the scientific contributions of this thesis are divided into three parts. The first part aims to develop an integrative theoretical framework for enhancing creativity through games. The aim of the theoretical framework is to describe and explain how games can enhance creativity, using the input-process-output approach. Two inputs are presented: personal attributes and game attributes. The process refers to the in-game learning situation. The outputs refer to improvements of creativity. The second part proposes to study the effect of games on creativity. Using board games as a tool for improvement, the results of two experimental studies in this section show a positive effect of board game practice on divergent thinking, first at the individual level, then at the group level. The aim is to determine the validity of the integrative theoretical framework and its overall hypothesis: are games an effective way of improving creativity? The third part focuses specifically on explaining the links between gaming habits and creativity. More precisely, the aim is to identify the common denominators between these two concepts, in terms of conative resources. Two correlational studies identify two of these common denominators, using mediation analyses. The first study identifies psychological capital as a mediator of the link between video game play and creativity in the workplace. The second study demonstrates the role of playfulness as a mediator of the relationship between board game play and two measures of creativity: creative self-concept and creativity in the workplace.

Keywords: creativity, games, experiential learning, game-based learning, board games

Publications et communications

Publications

Publications incluses dans la thèse

- A1. Mercier, M.,** Bourgeois-Bougrine, S., & Lubart, T. (submitted). Games and Creativity: A Theoretical Framework. *Review of General Psychology*.
- A2. Mercier, M.,** & Lubart, T. (2023). Board games enhance creativity: Evidence from two studies. *Psychology of Aesthetics, Creativity, and the Arts*. Advance online publication.
- A3. Mercier, M.,** Bourgeois-Bougrine, S., Lubart, T. (in prep.). The effects of board games on group creativity.
- A4. Mercier, M.,** & Lubart, T. (2023). Video Games and Creativity: The Mediating Role of Psychological Capital. *Journal of Creativity*, 100050.
- A5. Mercier, M.,** & Bourgeois-Bougrine, S. (major revision). Board Games and Creativity: Playfulness as a Mediator. *Learning and Individual Differences*.

Publications en annexe de la thèse

Thornhill-Miller, B., Camarda, A., **Mercier, M.,** Burkhardt, J.-M., Morisseau, T., Bourgeois-Bougrine, S., Vinchon, F., El Hayek, S., Augereau-Landais, M., Mourey, F., Feybesse, C., Sundquist, D., & Lubart, T. (2023). Creativity, Critical Thinking, Communication, and Collaboration: Assessment, Certification, and Promotion of 21st Century Skills for the Future of Work and Education. *Journal of Intelligence*, 11(3), 54.

Autres publications

- Mercier, M.,** & Lubart, T. (2021). The effects of board games on creative potential. *Journal of Creative Behavior*, 55(3), 875-885.
- Mercier, M.,** Vinchon, F., Pichot, N., Bonetto, E., Bonnardel, N., Girandola, F., & Lubart, T. (2021). COVID-19: A Boon or a Bane for Creativity? *Frontiers in Psychology*, 11, 3916.
- Botella, M., Bourgeois-Bougrine, S., Burkhardt, J. M., Caroff, X., Guegan, J., **Mercier, M.,** Vinchon, F., & Lubart, T. (2023). Homo creativus: an overview of research on creativity. *Revista Ibero-Americana de Criatividade e Inovação-RECRIAI*, 4.

Patterson, J. D., Merseal, H. M., Johnson, D. R., Agnoli, S., Baas, M., Baker, B. S., Barbot, B., Benedek, M., Bohrani, K., Chen, Q., Christensen, J. F., Corazza, G. E., Forthmann, B., Karwowski, M., Kazemian, N., Kreisberg-Nitzav, A., Kenett, Y. N., Link, A., Lubart, T., **Mercier, M.**, Miroshnik, K., Ovando-Tellez, M., Primi, R., Puente-Diaz, R., Said-Metwaly, S., Stevenson, C., Vartanian, M., Volle, E., van Hell, J. G., & Beaty, R. E. (2023). Multilingual Semantic Distance: Automatic Verbal Creativity Assessment in Many Languages. *Psychology of Aesthetics, Creativity, and the Arts*, 17(4), 495-507.

Chapitres de livre

Mercier, M., Vinchon, F., Pichot, N., Bonetto, E., Bonnardel, N., Girandola, F., & Lubart, T. (2023). Créativité en situation de confinement. Dans N. Bonnardel, F. Girandola, E. Bonetto, & T. Lubart (dir.). *La créativité en situations : théories et applications* (p. 360-367). Malakoff : Dunod.

Bourgeois-Bougrine, S., Bonnardel, N., Girandola, F., Bonetto, E., Pichot, N., Schauder, S., Tordjman, S., Vinchon, F., **Mercier, M.**, Lubart, T. (2023). Innovations individuelles et collectives en situations de crise : cas de l'innovation participative à l'université pendant la crise de Covid-19. Dans N. Bonnardel, F. Girandola, E. Bonetto, & T. Lubart (dir.). *La créativité en situations : théories et applications* (p. 368-375). Malakoff : Dunod.

Communications

Communications orales

Mercier, M., & Lubart, T. (2020, Septembre). *Board games: a new tool for improving creativity?* MIC Conference 2020.

Mercier, M., & Lubart, T. (2021, Juillet). *Board games and creativity: Evidence of positive effects of game play.* 2021 Creativity Conference.

Mercier, M., & Lubart, T. (2021, Septembre). *Video games and creativity: the mediating role of psychological capital.* MIC Conference 2021.

Mercier, M., Lubart, T., & Bourgeois-Bougrine, S. (2022, Septembre). *The Relations between Games and Creativity: A Theoretical Basis.* MIC Conference 2022.

Mercier, M., & Lubart, T. (2022, Septembre). *Creativity in the Workplace: A Necessary Condition Analysis.* MIC Conference 2022.

Lubart, T., Bourgeois-Bougrine, S., **Mercier, M.**, & Le Bourhis, M. (2022, Septembre). *Homo creativus meets Homo ludens: creativity and game.* MIC Conference 2022.

Mercier, M., Bourgeois-Bougrine, S., & Lubart, T. (2023, Mai). *Games for Creativity: A Comprehensive Framework based on the General Learning Model*. 2023 Creativity Conference.

Mercier, M., & Bourgeois-Bougrine, S. (2023, Septembre). *Board Games and Creativity : The Mediating Role of Playfulness*. MIC Conference 2023.

Sundquist, D., **Mercier, M.**, Bourgeois-Bougrine, S., & Lubart, T. (2023, Septembre). *Creativity in Virtual Environments: Aspects Promoting Creative Work Alone and in a Group Setting*. MIC Conference 2023.

Posters

Liu, J., Bourgeois-Bougrine, S., & **Mercier, M.** (2023, Avril). *Salles Créatives en Réalité Virtuelle*. Journée R&T Cognition 2023.

Lubart, T., Maggio, S., & **Mercier, M.** (2023, Avril). *EPoC-MATH – Epreuves du Potentiel Créatif en Mathématiques*. Journée R&T Cognition 2023.

Mercier, M., & Lubart, T. (2023, Mai). *Psychological Capital and Creativity in the Workplace: Gaming Habits as an Antecedent*. 21st EAWOP Congress.

Vulgarisation

Mercier, M., Bourgeois-Bougrine, S., & Lubart, T. (2022, Avril). *Les jeux et le développement de la créativité : ce que la recherche nous apprend*. Journée Mondiale de la Créativité et de l'Innovation 2022.

Bourgeois-Bougrine, S., **Mercier, M.**, & Lemaire, A. (2022, Avril). *Découverte de la science participative : Jeux et créativité*. Journée Mondiale de la Créativité et de l'Innovation 2022.

Lubart, T., & **Mercier, M.** (2022, Novembre). *Jeux de société: un levier pour le développement de la créativité*. Salon du Jouet et du Jeu 2022.

Lubart, T., & **Mercier, M.** (2023, Février). *Homo creativus : Lien entre créativité et jeux*. Festival International des Jeux de Cannes, 2023.

Lubart, T., **Mercier, M.**, Besançon, M., Le Bourhis, M., Merieux, A., Guerreiro, R., & Thornhill-Miller, B. (2023, Avril). *Homo Creativus*. Journée Mondiale de la Créativité et de l'Innovation 2023.

Lubart, T., & **Mercier, M.** (2023, Octobre). *Homo Creativus*. SPIEL 2023.

Chapitre 1 : Introduction générale	12
Introduction	13
1. La créativité	15
1. Définitions et théories de la créativité	15
2. Les 7C's de la créativité.....	16
1. Créateur	17
2. Créer	20
3. Collaboration.....	20
4. Contexte	21
5. Création	22
6. Consommation	22
7. Curriculum	23
2. Curriculum : Améliorer la créativité	24
1. Pourquoi améliorer la créativité ?	24
2. Comment améliorer la créativité.....	25
1. Techniques, outils et méthodes de créativité.....	25
2. Pédagogies et créativité.....	27
3. Entraînement de la créativité.....	28
3. L'apprentissage expérientiel.....	30
1. Théorie et principes de l'apprentissage expérientiel.....	30
2. Apprentissage expérientiel et créativité	31
4. L'apprentissage par le jeu.....	33
1. Jeu et apprentissage	33
2. Apprentissage par le jeu : principes	33
3. Modèles de l'apprentissage par le jeu	35
1. General Learning Model (GLM).....	35
2. Game-based learning Evaluation Model (GEM)	37
4. Apprentissage par le jeu et apprentissage expérientiel	39
5. Problématiques et objectifs.....	41
1. Problématique et objectif général	41
2. Plan des articles	42

Chapitre 2 : Contributions scientifiques	44
Partie 1 : Résumés des contributions.....	45
Volet n° 1 : Cadre théorique	46
Article A1 – Élaboration d’un cadre théorique.....	46
Volet n° 2 : Effets des jeux sur la créativité	50
Article A2 – Effets des jeux de société sur la créativité	51
Article A3 - Effets des jeux de société sur la créativité de groupe	56
Volet n° 3 : Médiateurs conatifs du lien entre jeux et créativité.....	58
Article A4 – Jeux vidéo et créativité : le capital psychologique comme médiateur.....	59
Article A5 – Jeux de société et créativité : le caractère joueur comme médiateur	62
Partie 2 : Articles scientifiques.....	65
Article A1 – Games and Creativity: A Theoretical Framework	66
Article A2 – Board Games Enhance Creativity: Evidence from Two Studies.....	107
Article A3 – The Effects of Board Games on Group Creativity	140
Article A4 – Video Games and Creativity: The Mediating Role of Psychological Capital	166
Article A5 – Board Games and Creativity : Playfulness as a Mediator	181
Chapitre 3 : Discussion générale.....	200
1. Résumé synthétique.....	201
1. Premier volet.....	201
2. Deuxième volet	202
3. Troisième volet	203
2. Cadre théorique : implications, limites et perspectives	205
3. Conclusion.....	209
Bibliographie.....	210
Annexe : Article complémentaire.....	224

Chapitre 1 :

Introduction générale

Introduction

La créativité est, à bien des égards, une des compétences les plus importantes de nos jours (Kaufman et al., 2017). Historiquement, cette capacité de générer des idées nouvelles et adaptées à leur contexte (Lubart et al., 2015; Runco & Jaeger, 2012) est à la source des grandes inventions et des chefs d'œuvres artistiques. Sans créativité, le monde tel qu'on le connaît n'existerait pas, bon gré mal gré (Glăveanu & Kaufman, 2019). Mais la créativité n'est pas l'apanage des grands de ce monde. Au contraire, celle-ci influence tout particulièrement notre vie de tous les jours (Beghetto & Kaufman, 2007; Kaufman & Beghetto, 2009). Au travail, la créativité est source de performance, d'innovation et de satisfaction (Yee et al., 2014). A la maison, la créativité est source de plaisir, de débrouillardise et de projets personnels (Benedek et al., 2020). En temps troubles, la créativité est source de résilience et d'adaptation aux circonstances (Orkibi, 2021). En somme, la créativité nous enrichit personnellement, et collectivement, à de nombreux niveaux. Trouver des moyens d'améliorer et de développer cette capacité semble ainsi une idée judicieuse et salutaire. Fort heureusement, la créativité est malléable et susceptible au développement (Barbot, 2019). De nombreuses méthodes et techniques ont ainsi été élaborées, avec plus ou moins de succès, et plus ou moins de moyens (Haase et al., 2023; Meinel & Voigt, 2017). Ces méthodes partagent généralement le même point commun : la créativité n'est améliorable que par la pratique et l'expérience concrète. Sur la base de ce constat, cette thèse envisage l'utilisation des jeux comme une manière efficace et rentable d'améliorer la créativité des individus et des groupes.

Le premier chapitre de ce travail de thèse consiste en une introduction théorique en cinq parties. Une première présente la notion de créativité et les différentes théories qui lui sont associées, en situant cette dernière dans l'approche des 7 C's de la créativité (Lubart & Thornhill-Miller, 2019). Après une présentation globale des 7 C's, la deuxième partie vient élaborer sur l'amélioration de la créativité, situant la thèse spécifiquement sur le Curriculum dans l'approche des 7 C's. Cette partie présente les différentes techniques, pédagogies et méthodes mises au point pour tenter d'améliorer et de développer cette compétence clé. La troisième partie introduit la notion d'apprentissage expérientiel. Cette partie avance l'idée que la créativité n'est véritablement améliorable et ne peut être apprise que par la pratique et l'expérience concrète. La quatrième partie s'intéresse à l'apprentissage par le jeu, une forme de pédagogie s'appuyant sur les mécanismes inhérents aux jeux, et leur capacité à motiver et engager les apprenants. Cette partie postule que l'apprentissage par le jeu est une opérationnalisation efficace et rentable de l'apprentissage expérientiel. Enfin, la cinquième

Introduction générale

partie expose et résume la problématique générale de cette thèse, en présentant les différentes études menées et les articles rédigés.

Le deuxième chapitre de la thèse est divisé en trois volets, permettant d'étayer la proposition suivante : **l'apprentissage par le jeu représente une manière efficace et rentable d'améliorer la créativité, en permettant un apprentissage expérientiel optimal de cette capacité.** Le premier volet consiste en l'élaboration d'un cadre théorique intégratif de l'amélioration de la créativité par les jeux, sous la forme d'un article théorique (A1). Ce cadre théorique permet de décrire et d'expliquer comment et pourquoi les jeux peuvent améliorer efficacement la créativité. Les deux volets conséquents sont dédiés à étayer empiriquement les propositions de ce cadre théorique. Le deuxième volet s'intéresse spécifiquement à l'effet de la pratique des jeux sur le potentiel créatif, en termes de ressources cognitives. Un type de jeu en particulier est utilisé ici : le jeu de société. Deux articles utilisant la méthode expérimentale sont présentés, évaluant d'abord les effets des jeux de société sur la pensée divergente des individus (A2), puis sur la pensée divergente de groupe (A3). Enfin, le troisième volet s'intéresse aux liens et dénominateurs communs entre jeux et potentiel créatif, en termes de ressources cognitives spécifiquement. Deux articles empiriques sont présentés dans ce volet, et examinent deux formes de jeux : les jeux vidéo (A4) et les jeux de société (A5).

Enfin, le troisième et dernier chapitre consiste en une discussion générale, qui vient d'abord résumer les travaux entrepris durant la thèse. Les contributions théoriques et appliquées sont ensuite discutées. Le cadre théorique intégratif est revisité à la lumière des éléments empiriques rapportés dans les deux volets empiriques. Les limites du cadre théorique et des études sont abordées, et des perspectives de recherche sont proposées pour compléter les résultats de ce travail de thèse.

1. La créativité

1.1. Définition et théories de la créativité

La créativité correspond à la capacité à réaliser une production à la fois nouvelle et adaptée au contexte dans lequel elle se manifeste (Lubart et al., 2015; Runco & Jaeger, 2012). La créativité est à la source du progrès humain. Elle nous a apporté la grande majorité des inventions et découvertes faites par l'Homme et a rendu possible les différentes avancées technologiques. De même, la créativité a permis les grandes contributions artistiques. En dehors des apports grandioses de la créativité, celle-ci joue également un rôle important dans notre vie de tous les jours (Kaufman & Beghetto, 2009). Nous sommes tous créatifs, du moins nous avons tous un potentiel créatif. Nous utilisons la créativité quand nous confrontons de nouveaux défis, résolvons des problèmes, ou essayons d'améliorer notre quotidien. De nos jours, la créativité n'est pas à considérer comme un luxe, et davantage comme une nécessité, dans un monde en rapide et perpétuel changement (Kaufman & Glăveanu, 2019).

La créativité n'a été conceptualisée et étudiée qu'assez récemment. Les phénomènes associés avec ce qu'on appelle la créativité aujourd'hui ont cependant fait l'objet de discussions depuis l'Antiquité : la création, l'imagination, les arts, la technique, le génie (Glăveanu & Kaufman, 2019). La première mention du terme apparaît en 1875 dans l'ouvrage *History of Dramatic English Literature* de Adolphus William Ward, en référence à la « créativité poétique » de Shakespeare (Weiner, 2000). L'adresse de Guilford devant l'APA (Guilford, 1950) marque un tournant dans l'étude de la créativité en psychologie, en la positionnant par rapport au concept d'intelligence. A la suite de cette impulsion, de nombreuses théories et modèles ont émergé (Kaufman & Glăveanu, 2019).

Une des premières théorisations a été proposée par Rhodes (1961), en introduisant le modèle 4P. Ce modèle synthétise les différentes manières d'étudier la créativité jusqu'à alors, en quatre catégories primaires, les quatre Ps : *Person*, *Process*, *Product*, *Press* (i.e., l'environnement). *Person* renvoie aux caractéristiques individuelles de la personne créative, à savoir les aspects cognitifs, conatifs et affectifs. *Process* correspond aux étapes du processus créatif et les facteurs associés. *Product* renvoie aux caractéristiques des productions créatives, leur évaluation et leur réception. Enfin, *Press* renvoie aux caractéristiques des environnements et leur impact sur les trois précédents P. L'impact et le succès de ce modèle réside dans sa simplicité, en répondant à quatre questions : Qu'est-ce qui rend une personne créative ?

Comment crée-t-on ? Qu'est-ce qui est considéré comme créatif ? Comment l'environnement influence la créativité ?

Plus récemment, Glăveanu (2013) proposa une mise à jour de cette approche avec le modèle des 5A : Acteurs, Audiences, Actions, Artefacts, Affordances. Ce modèle s'inscrit dans l'approche socio-culturelle de la créativité (Glăveanu et al., 2019), et cherche à rendre compte des façons dont la créativité se manifeste dans l'environnement social et matériel. Dans ce modèle, la personne devient « Acteur », qui agit au sein d'un contexte précis. Le processus devient « Action », le produit devient « Artefact ». L'environnement (*Press*) est décomposé en deux A : l'environnement social devient « Audience », et l'environnement physique et matériel devient « Affordance ». Là où le modèle 4P propose à structurer et catégoriser l'étude de la créativité en quatre axes statiques, le modèle 5A propose d'articuler les relations entre ces éléments de manière dynamique. Autrement dit, le modèle 5A nous indique que la créativité commence par l'Action d'un ou plusieurs Acteurs, en interaction constante avec différentes Audiences et les Affordances du monde matériel, culminant en la génération d'Artefacts originaux et adaptés (Glăveanu, 2013).

1.2. Les 7 C's de la créativité

Cette thèse s'inscrit particulièrement dans une conceptualisation dans la continuité des modèles de Guilford (1950) et de Glăveanu (2013) : les 7 C's de la créativité (Lubart, 2017; Lubart & Thornhill-Miller, 2019). Cette approche décrit sept facettes – ou sept champs – de la créativité (Figure 1): les Créateurs (*Creators*), le processus créatif ou l'acte de Créer (*Creating*), les Collaborations requises à l'activité créative (*Collaborations*), le Contexte d'expression de la créativité (*Contexts*), les produits créatifs ou Créations (*Creations*), la Consommation et l'usage des produits créatifs (*Consumptions*), et le Curriculum, c'est-à-dire l'amélioration et le développement de la créativité (*Curricula*).

Figure 1.
Les 7 C's de la créativité

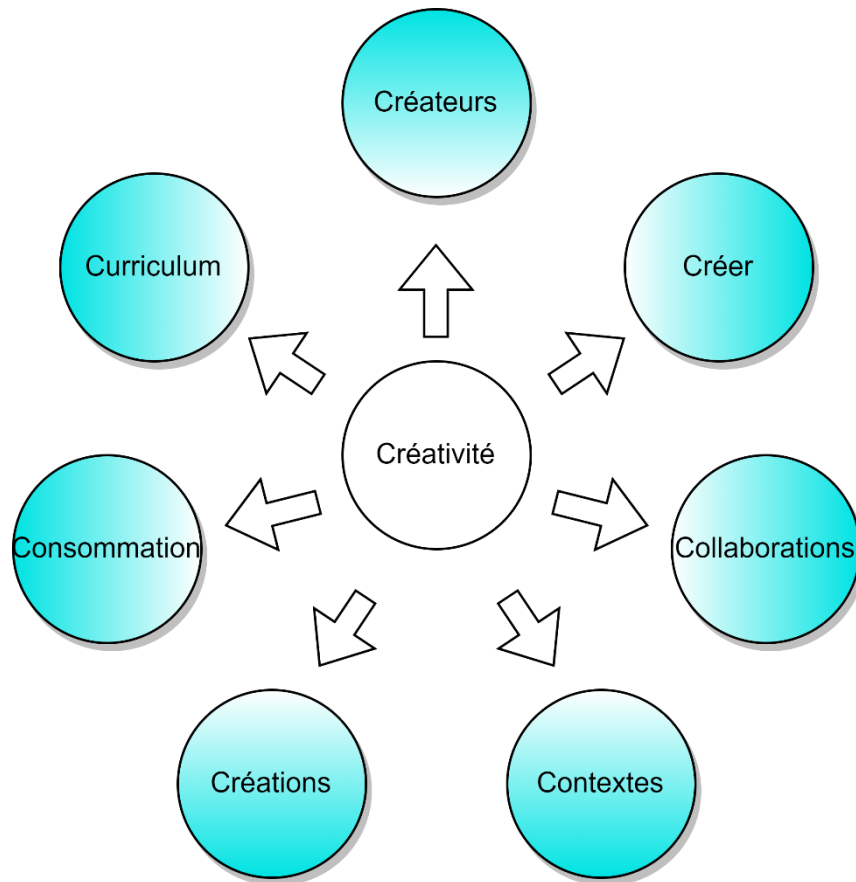

1.2.1. Créateurs

Les Créateurs correspondent à tous les individus s'engageant dans une activité créative ou faisant preuve de pensée créative. Tout individu peut être considéré comme un créateur et comme « créatif », indépendamment du niveau d'éminence de sa créativité. Par « créateur », nous avons tendance à penser aux grands créatifs, comme Picasso, Beethoven ou Steve Jobs. Cependant, la créativité n'est pas cantonnée qu'aux illustres créateurs, qui ne représentent en somme que la partie émergée de l'iceberg. La créativité peut ainsi être catégorisée par quatre niveaux distincts mais reliés : *Big-C*, *Pro-C*, *little-c*, et *mini-c* (Kaufman & Beghetto, 2009). La créativité *Big-C* fait référence aux grandes contributions, artistiques ou technologiques, réalisées par d'éminents créateurs, dont l'œuvre a un impact durable dans leurs domaines respectifs. Les travaux de Pablo Picasso ou de Marie Curie sont de bons exemples de cette forme de créativité. La créativité *Pro-C* fait référence à l'expertise professionnelle et aux réalisations créatives des personnes qui maîtrisent un domaine spécifique. Par exemple, un ingénieur qui trouve une solution originale et rentable à un problème (Cropley, 2015), ou une hôtesse de l'air qui trouve une manière originale de présenter les consignes de sécurité, captant l'attention des passagers, tout en respectant les procédures à suivre (Waples & Friedrich, 2011).

Introduction générale

La créativité *little-c* est souvent appelée créativité de tous les jours. Cette forme de créativité se manifeste dans la vie de tous les individus, et peut apparaître dans n'importe quel domaine de la vie (Diedrich et al., 2018). Il peut s'agir par exemple de trouver une nouvelle façon de décorer son salon, ou de mélanger deux cuisines totalement différentes pour concocter un nouveau plat. Finalement, la créativité *mini-c* fait référence aux idées et découvertes personnelles que les individus font lorsqu'ils s'engagent dans la résolution créative de problèmes ou l'expression de soi. Les manifestations de cette mini-créativité ne sont pas forcément publiques ou tangibles, mais demeurent significatives pour leur créateur (Cotter et al., 2018). Le modèle des quatre C souligne l'importance de reconnaître et d'encourager la créativité à différents niveaux et dans différents contextes, en mettant l'accent sur l'idée que la créativité n'est pas limitée à des individus exceptionnels, mais qu'il s'agit d'une capacité inhérente à chacun.

Tout individu possède ainsi un certain potentiel. Ce potentiel créatif est constitué de différentes ressources, plus ou moins nécessaires à la créativité, qui permettent de décrire et d'expliquer les différences inter- et intra-individuelles dans l'expression de la créativité. Ces ressources sont aux nombres de quatre : cognitives, conatives, affectives et environnementales. Ces ingrédients sont à la base du potentiel créatif, qui renvoie dès lors à l'ensemble des ressources qu'un individu peut allouer et investir dans une activité ou situation donnée, de manière à agir de façon créative. Les ressources cognitives et conatives sont d'un intérêt tout particulier dans le cadre de cette thèse.

Les ressources cognitives correspondent à des capacités de traitement de l'information qui permettent l'encodage, la comparaison et la combinaison d'information, pour générer une production créative (Sternberg & Davidson, 1995). La ressource cognitive la plus étudiée est sûrement la pensée divergente (Runco, 2010). Selon Guilford (1967), la pensée divergente est une composante essentielle à la créativité, qui correspond au processus permettant de rechercher de manière pluridirectionnelle de nombreuses réponses ou idées à partir d'un unique point de départ. Elle est complétée par la pensée convergente, un processus qui se concentre sur la déduction d'une réponse unique et optimale à partir d'un ensemble de possibilités, un concept également articulé par Guilford dans son modèle de structure de l'intellect (Guilford, 1961). Notre potentiel créatif est également enrichi par la flexibilité mentale, qui correspond à l'aptitude à passer d'une perspective à une autre et à s'adapter aux informations reçues (Spiro & Jehng, 1990). Une telle agilité dans le processus de pensée aide à naviguer dans la vaste étendue des connaissances et des idées. La pensée analogique et métaphorique vient approfondir cette

Introduction générale

compréhension en reconnaissant les corrélations structurelles ou symboliques entre divers concepts (Gentner, 1983). La pensée associative, l'acte de corréler des sujets et des idées distincts pour obtenir une compréhension plus interconnectée (Mednick, 1962), nous aide à « tisser » ces éléments ensembles. Enfin, les connaissances sont au cœur de l'ensemble de ces processus cognitifs. Elles englobent à la fois des informations générales et spécifiques à un domaine et sont considérées comme la clé de voûte pour décoder les défis et formuler des solutions créatives (Amabile & Pratt, 2016; Anderson, 1987).

Les ressources conatives renvoient à des « façons préférentielles et/ou habituelles de se comporter » (Lubart et al., 2015, p. 47), contribuant à l'expression de la créativité. Parmi ces ressources conatives se retrouvent des traits de personnalité, des croyances et de la motivation. Le trait de personnalité le plus souvent relié au potentiel créatif est l'ouverture aux expériences (Feist, 2019). Ce trait renvoie à des caractéristiques telles que l'imagination, la curiosité et l'ouverture d'esprit (Costa & McCrae, 1992). Les personnes dotées d'une ouverture aux expériences élevée sont également plus sensibles esthétiquement et moins conventionnelles. Faire preuve de créativité peut s'avérer complexe et impliquer une grande part de risque. Ainsi, disposer d'une certaine tendance à prendre des risques participe également au potentiel créatif (Tyagi et al., 2017). Similairement, l'audace caractéristique des individus créatifs est souvent soutenue par une grande tolérance à l'ambiguïté (Altinay et al., 2012; Zenasni et al., 2008), leur permettant d'affronter les situations incertaines et/ou ambiguës avec plus de sérénité. Une autre forme de ressource conative importante est le concept de soi créatif. Cette forme de croyance correspond aux convictions d'un individu à propos de ses capacités créatives et de la nature de la créativité (Karwowski & Barbot, 2016). Deux facettes du concept de soi créatif ont fait l'objet de nombreuses études : l'auto-efficacité créative et l'identité personnelle créative. L'auto-efficacité créative renvoie à la croyance qu'a un individu de sa capacité à être créatif (Tierney & Farmer, 2002). L'identité personnelle créative correspond à la croyance dans le fait que la créativité est un élément important de la définition de soi, autrement dit à quel point être créatif est important pour définir sa propre identité (Jaussi et al., 2007). Enfin, la motivation joue un rôle crucial dans le potentiel créatif. C'est particulièrement le cas de la motivation intrinsèque, qui renvoie à la volonté de s'engager dans une activité principalement pour elle-même, parce qu'elle est intéressante, engageante, satisfaisante ou agréable (Amabile et al., 1994; Deci et al., 1989). Elle a souvent été conceptualisée comme le moteur de l'acte créatif (Amabile & Pratt, 2016) : la motivation intrinsèque est ce qui fait la différence entre ce qu'un individu *peut faire* et ce qu'il *fera*.

1.2.2. Créer

Créer renvoie au processus créatif, à la séquence d'étapes qui rendent compte et caractérisent l'activité créative, résultant en une production originale et adaptée. Le processus créatif est traditionnellement décomposé en termes de phases ou d'étapes. Wallas (1926) propose par exemple quatre phases : préparation, incubation, illumination, vérification. La préparation renvoie à l'accumulation de connaissances et la réflexion au début du projet créatif. L'incubation correspond à une forme d'activité mentale d'association d'idées, de manière subconsciente (Ritter & Dijksterhuis, 2014). L'illumination correspond au moment d'Euréka ou d'insight, où l'idée ou la solution apparaît. Enfin, la vérification renvoie à la partie d'essai et de d'amélioration de l'idée. De nombreux auteurs également ont proposé et étudié une multitude d'étapes et de sous-étapes, parmi lesquelles : recherche et formulation du problème, frustration, association, synthèse (Lubart & Thornhill-Miller, 2019). Le manque d'accord et le nombre important de modélisation peut s'expliquer en partie par la spécificité du processus selon le domaine d'intérêt. Selon Baer (2010), les compétences nécessaires à la créativité dans un domaine précis ne sont pas forcément transférables ou nécessaires dans un autre domaine. Ainsi, un bon sculpteur ne sera pas forcément un bon musicien, bien que très créatif et compétent dans son domaine créatif d'appartenance. De la même manière, le processus créatif associé à un domaine ne sera pas forcément le même, par exemple entre la créativité artistique et scientifique (Botella et al., 2022).

1.2.3. Collaboration

La collaboration renvoie au processus à travers lequel deux ou plusieurs individus, souvent munis de compétences différentes et/ou complémentaires, s'engagent dans un acte de création partagée, en produisant généralement quelque chose qu'ils ne pouvaient pas ou n'auraient pas pu créer individuellement (Lubart & Thornhill-Miller, 2019). De nombreux exemples de collaboration créative existent, tels que la collaboration de Pierre et Marie Curie ou la relation entre Rimbaud et Verlaine. Les exemples de collaboration créative les plus parlants peuvent être retrouvés dans les groupes de musique. Qu'il s'agisse des Beatles ou d'AC/DC, des One Direction ou du Oscar Peterson Trio, la musique ne se fait que très rarement seul. De la même manière, la science ne se fait que rarement par des individus isolés, comme l'indique le nombre croissant de co-auteurs dans les articles scientifiques (Wuchty et al., 2007). Nous pourrions aller jusqu'à considérer que la créativité ne peut exister sans collaboration, sans l'autre. Toute œuvre artistique, toute découverte scientifique, ne peuvent se faire qu'en se basant sur les fondations posées par nos prédécesseurs, leurs idées et leurs méthodes. Pour reprendre

la métaphore attribuée à Bernard de Chartres, nous sommes comme des « nains sur des épaules de géants ». Les travaux révolutionnaires d'Einstein n'existeraient pas sans l'histoire de la science avant lui. Le dodécaphonisme et l'atonalité n'auraient jamais vu le jour, sans musique tonale à remettre en cause.

1.2.4. Contexte

Le contexte renvoie à l'environnement physique et social dans lequel la créativité se manifeste. Ce contexte inclut des environnements proximaux, comme la famille, l'école et le travail, ainsi que des environnements davantage distaux, comme la société, la culture ou le pays. Ce contexte peut influencer la créativité de manière positive ou négative, et ce de nombreuses manières (Harrington, 2011). Le contexte physique fournit notamment de nombreuses affordances rendant possible ou facilitant la créativité. C'est particulièrement le cas dans l'environnement de travail : la luminosité, la présence de fenêtres ou la couleur des murs sont toutes des variables pouvant influencer la créativité des employés (Dul & Ceylan, 2011). Dul (2019) propose que les environnements puissent soutenir la créativité de trois manières fondamentales : la fonctionnalité, le sens et l'humeur. La fonctionnalité renvoie à l'accès aux ressources et moyens nécessaires, par exemple à la conduite d'un projet. Le sens renvoie au contenu et objets symboliques présents dans l'environnement, qui peuvent fournir un sentiment de liberté, d'inspiration, et de valorisation de la créativité. L'humeur renvoie à un contexte socio-émotionnel qui favorise la créativité : une ambiance chaleureuse, des couleurs joyeuses, de la musique. La fonctionnalité de l'environnement est à considérer comme une condition nécessaire, garantissant la tenue d'une activité créative (Dul, 2019), qui rend ensuite possible l'apparition des bénéfices fournis par les deux autres dimensions de l'environnement.

Outre le contexte physique, une évolution majeure concerne le contexte virtuel, notamment via la réalité virtuelle (RV), qui offre un espace supplémentaire à l'expression de la créativité. C'est notamment le cas des environnements virtuels multi-utilisateurs (MUVes), qui sont des espaces numériques où les interactions avec les objets et les utilisateurs se fait par le biais de représentations – de soi, des autres et de l'environnement – générées par ordinateur (Bourgeois-Bougrine et al., 2022). Ces environnements offrent de nombreuses possibilités, qui vont au-delà du contexte physique réel ; les possibilités de customisation de l'environnement et des avatars en sont une illustration parlante. Par exemple, incarner l'apparence d'un personnage créatif, comme celui d'un inventeur, améliore considérablement la performance créative des groupes, en termes de quantité et d'originalité des idées (Buisine & Guegan, 2020; Guegan et al., 2016).

1.2.5. Création

La création correspond au produit du processus créatif. Cette création peut être tangible (e.g., une sculpture), ou intangible (e.g., une idée philosophique). Toutes les créations ne sont pas créatives. La nature du produit potentiellement créatif est déterminée par l'appréciation et l'évaluation de son originalité et de son caractère adapté. Prenons l'exemple d'un ingénieur civil, auquel on demande de concevoir un pont avec un design créatif. Si l'ingénieur propose un pont copiant entièrement le design créatif déjà existant (e.g., le Gateshead Millenium Bridge, ou le pont transbordeur du Martrou), celui-ci ne sera pas considéré comme créatif car n'étant pas nouveau (bien qu'adapté). Inversement, si l'ingénieur propose un pont nécessitant aux voitures de réaliser un looping, l'idée sera certes très originale mais loin d'être adaptée. Ainsi, des productions bizarres ou étranges mais sans caractère adapté, valeur ou pertinence ne peuvent être considérées comme créatives. L'appréciation de la créativité peut se faire par l'auteur lui-même, mais elle sera généralement faite socialement. Autrement dit, le jugement de la créativité d'une œuvre dépendra de l'audience, naïve ou experte, qui sera exposée au produit ou à l'œuvre. L'histoire regorge ainsi d'idées jugées créatives par leur créateur, mais pas par l'audience cible. Citons par exemple le Coca-Cola BlaK au café, le stylo Bic pour femme, ou encore les Google Glass.

1.2.6. Consommation

Les productions créatives sont situées dans un contexte notamment social, et seront potentiellement adoptées en son sein. C'est particulièrement le cas dans la créativité professionnelle, où l'implémentation et l'adoption d'un produit ou service sont la raison-même de sa création (Tanev & Frederiksen, 2014). La consommation fait ainsi la connexion, de la créativité vers l'innovation, cette dernière considérant la créativité dans son contexte appliquée de consommation (Lubart & Thornhill-Miller, 2019). Cette consommation peut être étudiée par le prisme de l'économie, de manière macro-économique ou micro-économique. Au niveau macro-économique, la production et la consommation de productions créatives sont fortement liées à la croissance économique (Lubart & Getz, 2011) : un nouveau produit entraîne de la compétition et l'apparition de concurrents potentiellement créatifs eux-mêmes. Au niveau micro-économique, l'intérêt pour les produits créatifs peut être une source de valeur pour le consommateur. Le cas des primo-adoptants va dans ce sens, leur profil étant souvent similaire à ceux des créateurs, notamment en termes d'ouverture aux expériences (Busic-Sontic & Fuerst, 2017)

1.2.7. Curriculum

Le curriculum correspond ici à l'amélioration et au développement de la créativité. La créativité est de plus importante, valorisée et recherchée (Archibugi et al., 2013). Trouver des moyens pour améliorer la créativité est ainsi devenu un sujet vaste et grandissant dans la littérature comme sur le terrain (Haase et al., 2023). Nombre de méthodes d'entraînement et d'amélioration de la créativité ont été théorisées et testées, et cette thèse s'inscrit tout particulièrement dans la perspective de ce Curriculum. Ainsi, la prochaine partie est dédiée à une description plus élaborée et détaillée cette notion. Nous aborderons ainsi différentes manifestations de ce Curriculum : les techniques, outils et méthodes de créativité, les pédagogies en lien avec la créativité, et enfin l'entraînement de la créativité.

Idée n°1 : La créativité peut être améliorée.

2. Curriculum : Améliorer la créativité

Les méthodes d'amélioration de la créativité ont pour objectif d'aider les individus et les groupes à développer davantage leur potentiel créatif. Cette définition est large et recouvre une vaste diversité d'approches et de méthodes, dans le but d'améliorer voire de développer la créativité. Ces approches peuvent viser différents aspects de la créativité : cognitifs, conatifs, environnementaux, sociaux (Haase et al., 2023).

2.1. Pourquoi améliorer la créativité ?

La question « pourquoi améliorer la créativité » est rarement posée (Forgeard & Kaufman, 2016; Kaufman, 2018). La créativité est généralement traitée comme un résultat, une variable dépendante. Elle est cependant moins communément considérée comme un antécédent, un prédicteur. Être plus créatif entraîne de nombreux bénéfices, au niveau individuel comme collectif. La créativité est le moteur du progrès, notamment au niveau économique et technologique (Archibugi et al., 2013; Florida, 2014). La créativité contribue à la performance au travail, qu'elle soit évaluée de manière objective ou par le supérieur (Gong et al., 2009; Martinaityte & Sacramento, 2013). Offrir un environnement qui encourage activement la créativité des employés est associé à davantage de satisfaction au travail, qui en retour entraîne une performance plus élevée (Yee et al., 2014). La créativité des leaders influence également positivement la créativité de leurs subordonnés (Koseoglu et al., 2017). Une méta-analyse également a montré que la créativité était positivement associée à la performance académique (Gajda et al., 2017).

Les effets de la créativité sur le bien-être et la santé mentale sont certainement les plus documentés. Une méta-analyse récente a notamment observé un lien positif entre créativité et bien-être (Acar et al., 2021). Ce lien était d'autant plus fort dans les études mesurant spécifiquement la créativité de tous les jours (e.g., Conner et al., 2018). Durant la pandémie de COVID-19, de nombreuses études ont souligné le rôle important de la créativité. Les individus plus créatifs ont notamment mieux vécu cette période, en termes de bien-être et d'affects positifs (Fiori et al., 2022). Ils étaient plus à même de s'adapter créativement à cette situation jamais vue auparavant, réduisant ainsi le stress vécu (Orkibi, 2021). Cette capacité d'adaptation créative a été également associée à une meilleure résilience, une meilleure régulation des émotions, et un meilleur ratio émotions positives – émotions négatives (Orkibi et al., 2021).

2.2. Comment améliorer la créativité

2.2.1. Techniques, outils et méthodes de créativité

Les techniques, outils et méthodes de créativité ont pour objectif d'améliorer la performance créative d'un individu ou d'un groupe, en encourageant la production d'idées et la recherche de solution. Une des premières techniques de développement de la créativité est attribuable à Osborn (1953) : le *brainstorming*. Le principe est relativement simple : donner libre cours à l'imagination, en s'abstenant de critiquer les idées. Le brainstorming est généralement utilisé dans un groupe, où les individus peuvent rebondir sur les idées des autres membres du groupe. Le groupe peut ainsi arriver à construire des idées ensemble, et trouver des solutions qu'ils n'auraient pas pu trouver individuellement. L'absence de critique permet de maximiser le nombre d'idées, et en théorie de réduire la pression sociale. Rohrbach (1969) proposa une version alternative au brainstorming, le *brainwriting*. Cette variante cherche à réduire véritablement la pression sociale et l'inhibition. La première étape consiste à écrire ses idées de manière individuelle et anonyme. Les idées sont ensuite regroupées et partagées à l'ensemble du groupe, et les échanges peuvent alors commencer.

Le brainstorming peut être efficace dans certaines situations (Paulus & Kenworthy, 2019), mais reste un outil limité. Premièrement, il s'agit d'une solution visant principalement les groupes, pas les individus. Deuxièmement, le brainstorming repose uniquement sur la pensée divergente. Certains auteurs définissent ainsi le brainstorming comme une technique de pensée divergente de groupe (P. Paulus, 2000). Cette technique ne peut donc être utilisée que comme un outil d'exploration (Nickerson, 1999), qui ne représente qu'une partie du processus créatif. Enfin, cette technique demeure relativement générique : le brainstorming se résume à demander au groupe d'être créatif et de laisser libre cours à leur imagination, sans consignes spécifiques (Sternberg, 2019).

À l'opposé des techniques reposant sur le brainstorming et la pensée divergente se situe la TRIZ (Théorie de la Résolution Inventive de Problèmes), qui trouve ses origines en Russie avec l'ingénieur Genrich Altshuller dans les années 1940. Contrairement à d'autres techniques, la TRIZ repose sur une analyse systématique des innovations passées pour déceler des modèles universels de résolution de problèmes (Terninko et al., 1998). Le cœur de cette méthode est l'idée que la plupart des problèmes ne sont pas uniques, mais ont déjà été résolus ailleurs (Mann, 2001). En cataloguant ces solutions, TRIZ offre un ensemble d'outils et de principes qui peuvent être appliqués à de nouveaux défis. Plutôt que de s'appuyer sur la pensée divergente, la TRIZ

Introduction générale

incite à la pensée convergente, en recherchant des solutions éprouvées. L'objectif est d'éliminer les contradictions dans un design ou un processus, en utilisant des principes généraux et des solutions standard (Ilevbare et al., 2013). Alors que le brainstorming peut être vu comme une exploration ouverte, la TRIZ est un process structuré pour trouver une solution optimale.

La pensée latérale (De Bono, 1970, 2014) est à la source de plusieurs techniques et outils plus spécifiques pour améliorer la créativité, individuelle et de groupe. La pensée latérale s'oppose à un mode de pensée linéaire (vertical) plus habituel. Dans la pensée linéaire, les associations faites par rapport à un concept sont basiques et usuelles. La pensée latérale cherche à s'en éloigner et permet d'approcher le concept sous un angle différent. De Bono propose plusieurs outils pour faciliter le déploiement de la pensée latérale et donc la créativité, dont la méthode des six chapeaux (De Bono, 2017). Le but de cette méthode est d'amener l'individu ou le groupe à revêtir et alterner six chapeaux différents, qui représentent six modes de pensée différents. Le chapeau blanc représente une forme de pensée objective et neutre : seuls les faits priment, les opinions n'ont pas leur place. Le chapeau rouge correspond à une pensée émotionnellement chargée, et approche le problème en fonction des effets affectifs possibles. Le chapeau noir renvoie à un mode de pensée prudente, qui va se projeter sur les conséquences de la solution trouvée. Ce chapeau peut se résumer à jouer « l'avocat du diable ». Le chapeau jaune correspond à une pensée positive et optimiste, qui s'attache à trouver les bénéfiques et les effets positifs apportés par la solution. Le chapeau vert est directement associé à la créativité, le but étant d'être le plus divergent possible et de sortir des sentiers battus. Enfin, le chapeau bleu est calme et rationnel ; il sert habituellement d'organisateur, de meneur de jeu.

La synectique (*Synectics*) est une autre technique visant à booster la créativité, développée dans les années 1960 par Prince et Gordon. Elle se distingue par sa philosophie d'accueillir l'étrange et l'inhabituel. Basée sur le processus de pensée analogique, la synectique encourage les groupes et leurs membres à établir des liens entre des idées apparemment non liées (Gordon, 1961). En établissant des analogies entre des domaines différents, il est possible de trouver des solutions créatives à des problèmes existants. Contrairement au brainstorming qui valorise spécifiquement la quantité d'idées, la synectique complète cette démarche en mettant l'accent sur la qualité et la profondeur de la réflexion.

Le Creative Problem Solving (CPS), ou résolution créative de problèmes, est une méthode structurée, qui trouve ses origines dans les travaux d'Osborn (1953). Elle est basée sur une systématisation du processus créatif. Le processus peut être décrit en trois composantes principales : comprendre le défi, générer des idées, préparer un plan d'action (Treffinger, 1995).

Durant chacune de ces étapes, la démarche du CPS implique à la fois la pensée divergente, où de nombreuses idées sont générées, et la pensée convergente, où ces idées sont évaluées et affinées (Isaksen & Treffinger, 1985). La force du CPS réside dans sa flexibilité ; il peut être adapté à différents problèmes, généralement en groupe mais possiblement individuellement. Contrairement à la liberté inhérente au brainstorming, le CPS cherche à offrir une structure pour guider la créativité à travers des étapes spécifiques, permettant ainsi une approche plus ciblée et efficace de la résolution de problèmes.

2.2.2. Pédagogies et créativité

L'approche pédagogique traditionnelle ne laisse que très peu de place à la créativité (Besançon & Lubart, 2008). L'accent est mis sur un apprentissage magistral et frontal de la part du professeur, et les connaissances abstraites priment sur l'expérience concrète (Danvers, 2003). En réponse à ce manque apparent, différentes pédagogies sont apparues durant la deuxième moitié du 20^{ème} siècle. Ces pédagogies s'inscrivent dans le mouvement de l'Education Nouvelle (Annebeau, 2004; Temple & Rodero, 1995). Dans ces formes de pédagogie alternative, l'accent est mis sur l'expérience directe et l'apprentissage actif. Certaines formes de pédagogies cherchent à stimuler la créativité de manière plus globale, et se retrouvent généralement dans l'enseignement primaire. Nous pouvons citer deux exemples notables, basés sur le principe de l'apprentissage actif et de la découverte « par soi-même » : l'approche de Maria Montessori, et celle de Célestin Freinet.

Montessori propose que l'imagination se construit sur la base du contact avec la réalité et de l'expérience sensorielle chez l'enfant (Montessori, 1936). Qui plus est, l'accent est mis sur la liberté de l'enfant dans le choix de ses projets et ses activités. Bien que la créativité ne soit pas enseignée directement dans la pédagogie Montessori, il est fort probable que ces écoles apportent un environnement socio-cognitif favorable à la construction des ressources cognitives et conatives du potentiel créatif des élèves (Besançon et al., 2013). Cette hypothèse de l'efficacité de ces pédagogies soutenue par plusieurs études, montrant notamment un potentiel créatif plus élevé au sein des écoles Montessori, comparé aux élèves d'écoles traditionnelles (Besançon et al., 2013; Besançon & Lubart, 2008). Qui plus est, cette supériorité semble se maintenir dans le temps.

L'approche de Freinet est animée par deux postulats (Freinet & Freinet, 1994) : l'enfant est naturellement dynamique et rien ne devrait s'y opposer ; l'erreur et l'expérimentation sont au cœur de l'apprentissage. La créativité est activement encouragée dans cette pédagogie, en

proposant de nombreuses activités où l'enfant peut s'engager dans un processus créatif. Cette approche se révèle également efficace sur le court-terme (Besançon & Lubart, 2008), mais semble s'atténuer à l'échelle de plusieurs années.

2.2.3. Entraînement de la créativité

Les méthodes d'amélioration de la créativité cherchent à aider les individus et les groupes à développer davantage leur potentiel créatif. Parmi les différentes interventions visant à améliorer la créativité, deux types se distinguent : entraînement et manipulation (Haase et al., 2023). Ces deux approches diffèrent en termes d'efforts de la part des participants, ainsi que de rigueur dans le protocole.

L'entraînement correspond à un processus systématique – un programme – au travers duquel un individu apprend et acquiert des compétences spécifiques (Pike, 2003). L'entraînement a généralement pour but d'avoir un effet à moyen ou long-terme (Kirkpatrick & Mann, 1999).. Dans le contexte du travail, l'entraînement renvoie à l'acquisition systématique d'attitudes, concepts, connaissances, rôles ou compétences ayant pour résultat une amélioration de la performance au travail (Goldstein, 1991). L'entraînement à la créativité peut ainsi être défini comme l'apprentissage et l'acquisition d'attitudes, concepts, connaissances, rôles ou compétences ayant pour résultat une amélioration de la créativité. Cela implique une compréhension du processus créatif, facilitée par une meilleure confiance dans ses capacités créatives et l'acquisition de compétences et techniques relatives à la créativité (Plucker & Runco, 2011).

La manipulation est généralement moins complexe que l'entraînement, moins coûteuse en termes de temps, et les participants sont en principe moins conscients de l'impact attendu sur la créativité (Haase et al., 2023). Les effets sont immédiats et peu durables dans le temps, généralement. Le mécanisme sous-jacent est souvent une activation d'un état d'esprit créatif, c'est-à-dire un état mental dans lequel la personne peut penser de manière divergente, faire davantage d'associations, et être capable de plus de flexibilité mentale (Sassenberg et al., 2017). La manipulation correspond donc à un amorçage plus ou moins court, tandis que l'entraînement correspond à l'apprentissage et l'acquisition de compétences relatives à la créativité.

L'entraînement à la créativité repose principalement sur l'apprentissage et la mise en pratique de compétences relatives à la créativité. L'étude de l'efficacité de l'entraînement sur la créativité fut d'abord formalisée par la méta-analyse de Scott et al. (2004a). Les entraînements basés sur la résolution créative de problèmes étaient les plus efficaces ($d = 0,84$),

Introduction générale

et les programmes focalisés sur le changement d'attitude les moins efficaces ($d = 0,24$). Dans l'ensemble, l'effet moyen des programmes d'entraînement à la créativité était de taille moyenne à large ($d = 0,68$).

Plus récemment, une nouvelle méta-analyse (Haase et al., 2023) a révélé que, sur 332 tailles d'effet provenant de 84 études, la créativité pouvait en effet être améliorée et entraînée. La taille de l'effet des programmes d'entraînement à la créativité était moyenne ($g = 0,61$). En transformant cette taille d'effet via l'U3 de Cohen (Hanel & Mehler, 2019), ces résultats montrent que 72,09% des participants dans les conditions expérimentales étaient plus créatifs que les participants dans les groupes de contrôle. Les programmes les plus complexes semblent les plus efficaces ($g = 0,66$), par rapport à des programmes plus courts ($g = 0,47$). Finalement, les entraînements à la créativité sont de manière générale plus efficaces que les manipulations ($g = 0,45$), telles que l'activité physique, les stimulations cérébrales ou les interventions visant à mettre les participants dans un état d'esprit créatif.

Idée n°2 : L'amélioration de la créativité repose en grande partie sur l'apprentissage par la pratique et l'expérience concrète.

3. L'apprentissage expérientiel

3.1. Théorie et principes de l'apprentissage expérientiel

L'apprentissage expérientiel peut être décrit comme le processus au travers duquel de nouvelles connaissances sont créées par la transformation d'expériences. Ces connaissances résultent de la combinaison de la préhension et de la transformation d'expériences (Kolb, 1984). La théorie de l'apprentissage expérientiel propose une vision holistique du processus d'apprentissage, notamment chez l'adulte. Cette théorie souligne l'importance et le rôle central de l'expérience dans le processus d'apprentissage.

Selon cette théorie, l'apprentissage se déroule au cours d'un processus en quatre étapes (Figure 2). Il y a en premier lieu l'expérience concrète (EC), au cours de laquelle l'apprenant participe et s'engage dans une nouvelle expérience. Vient ensuite l'observation réflexive (OR), où l'apprenant réfléchit et assimile les réponses cognitives et affectives face à la nouvelle expérience. En troisième lieu, se trouve la conceptualisation abstraite (CA), dans laquelle l'apprenant connecte ses connaissances et expériences passées à la nouvelle expérience et les pensées et sentiments associés. Le but étant de conceptualiser la situation selon une nouvelle perspective. La dernière étape correspond à l'expérimentation active (EA), où l'apprenant applique ses nouvelles idées à d'autres expériences.

Figure 2.

Cycle de l'apprentissage expérientiel

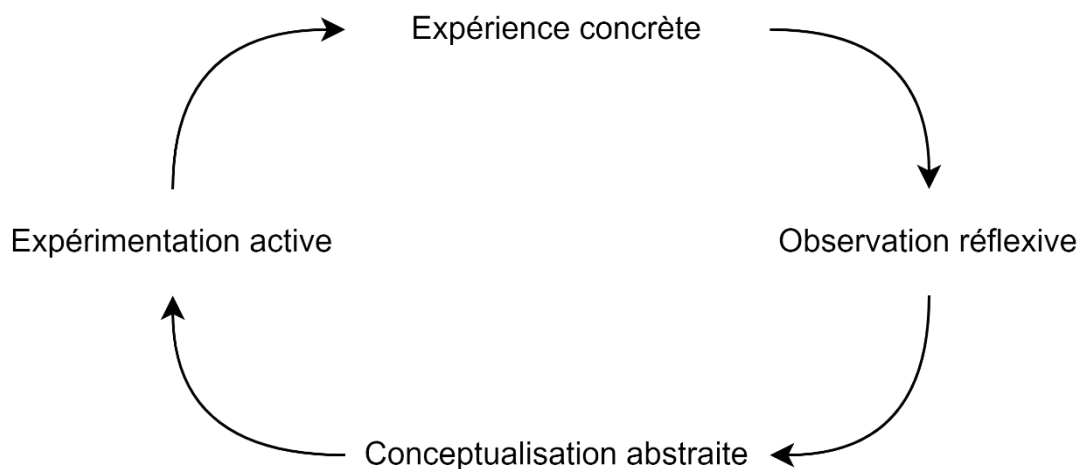

Introduction générale

Ces quatre étapes se répètent au cours du processus d'apprentissage : une expérience spécifique est transformée en conceptualisation abstraite après réflexion, pour être ensuite testée au travers de nouvelles expériences. Les expériences concrètes et immédiates servent de base à l'observation et la réflexion. Ces réflexions sont assimilées et transformées en concepts abstraits, à partir desquels des implications sont déduites. Ces implications sont ensuite testées activement et servent de guide pour les expériences nouvelles à venir.

L'apprentissage dépend de la combinaison de préhension et transformation de l'expérience. La préhension correspond au processus d'intégration de l'information contenue dans l'expérience, tandis que la transformation renvoie à la manière dont l'apprenant interprète et agit sur la base de cette information. La théorie de l'apprentissage expérientiel propose deux oppositions dialectiques. Il y a deux modes opposés de préhension de l'information : l'expérience concrète et la conceptualisation abstraite. De même, deux modes de transformation s'opposent : observation réflexive et expérimentation active. Cette théorie suggère ainsi que l'apprentissage requiert des capacités/processus qui sont symétriquement opposés.

3.2. Apprentissage expérientiel et créativité

Comme précédemment indiqué (idée n°1), la créativité peut être améliorée et enseignée. Cependant, toutes les techniques n'ont pas la même efficacité. Les techniques visant à mettre en pratique et expérimenter soi-même avec la créativité (i.e., l'entraînement) s'avèrent nettement plus efficaces que les approches plus passives ou indirectes. Les pédagogies de l'Éducation Nouvelle semblent être les premières à tenir compte de cet état de fait. Selon Montessori, l'imagination se construit sur la base du contact avec la réalité, et surtout grâce à l'expérience sensorielle de l'enfant. La pédagogie de Freinet met un accent fort sur la créativité, en proposant de nombreuses activités pour s'engager activement dans le processus créatif.

Outre ces approches pédagogiques globales, de nombreuses techniques pour enseigner la créativité directement se basent sur l'apprentissage expérientiel, sans y faire nécessairement référence. Ces techniques incluent notamment (Sternberg, 2019) : redéfinir le problème, remettre en question les présuppositions, vendre ses idées. *Redéfinir un problème* demande un changement de perspective. Les individus, au cours de leur vie, seront nécessairement confrontés à des problèmes auxquels ils ne trouvent pas de solution. Pour reprendre l'adage commun, dans cette situation, ils sont comme coincés dans une boîte. Redéfinir le problème revient alors à sortir de la boîte. L'éducation traditionnelle amène souvent l'enseignant à définir le problème pour l'apprenant. Au contraire, pour développer cette capacité de remise en

Introduction générale

perspective, il faut encourager l'apprenant à définir et redéfinir le problème par lui-même. Plutôt que d'imposer des sujets fermés, les enseignants ont fort à gagner en offrant la possibilité aux étudiants de choisir leurs projets ou leurs présentations, par exemple. *Remettre en question les présuppositions* est également un exercice important au développement de la créativité. Nous faisons tous des présuppositions, et souvent celles-ci demeurent inchangées. Au contraire, les individus créatifs mettent au défi leurs hypothèses et présuppositions. Ce questionnement peut être aisément intégré dans le curriculum. Savoir *vendre ses idées* est crucial pour la valorisation de ses idées. Nous présupposons souvent que nos idées innovantes se vendront d'elles-mêmes, à n'importe qui y prêtant attention. Au contraire, les idées créatives sont plus souvent perçues avec méfiance et scepticisme (Sternberg & Lubart, 1995). Les individus sont généralement plus confortables avec leur manière déjà établie de penser et d'agir, et peuvent avoir tendance à résister au changement. Apprendre à vendre ses idées devient alors une nécessité pratique. Quand un élève présente un projet, il doit non seulement savoir expliquer ce qu'il a trouvé, mais également pourquoi ce projet a de la valeur. Les étudiants doivent ainsi apprendre à convaincre les autres de la valeur et de l'intérêt de leurs idées. Toutes ces méthodes ne prennent leur sens que par la pratique et l'expérience. Autrement dit, pour améliorer la créativité, les individus doivent s'entraîner et pratiquer activement ses différentes composantes, ainsi que les habitudes des individus créatifs.

Idée n°3 : L'apprentissage par le jeu constitue une des opérationnalisations les plus efficaces et rentables de l'apprentissage expérientiel.

4. L'apprentissage par le jeu

L'apprentissage par le jeu (*game-based learning* en anglais) est une approche pédagogique visant à intégrer les jeux dans le processus d'apprentissage, dans le but d'engager l'apprenant et améliorer leurs compétences, connaissances et motivation (Prensky, 2001). L'apprentissage par le jeu tire parti des facteurs intrinsèques et extrinsèques des jeux, comme le challenge, la compétition et les récompenses, pour fournir un environnement d'apprentissage interactif, immersif et adaptatif (Plass et al., 2015).

4.1. Jeu et apprentissage

Le rôle et l'importance du jeu dans l'apprentissage ont été reconnus depuis longtemps (Plass et al., 2015). Piaget (1962) décrit par exemple le jeu comme partie intégrante du développement des stades cognitifs. Selon Piaget, le jeu devient de plus en plus abstrait et symbolique au fur et à mesure du développement de l'enfant. La contribution du jeu dans l'apprentissage provient notamment de sa capacité à activer des schèmes et représentations éloignés de la réalité concrète de l'enfant. Le jeu du « faire-semblant » est intégral en ce sens. Le « faire-semblant » est un comportement symbolique dans lequel l'enfant considère un objet comme étant quelque chose d'autre (Fein, 1987). Par exemple, un bâton en bois devient une épée, un lacet devient un serpent. Cette forme de jeu encourage l'enfant à emmagasiner plusieurs représentations d'un même objet, une capacité essentielle au développement de la pensée symbolique (DeLoache, 1987). Cette capacité à garder simultanément à l'esprit plusieurs représentations de la réalité précède le développement de nombreuses capacités essentielles, comme l'acquisition de la théorie de l'esprit (Astington et al., 1988) et l'émergence des capacités verbales et numériques (Homer & Hayward, 2008).

4.2. Apprentissage par le jeu : principes

Le potentiel de l'apprentissage par le jeu réside principalement dans sa capacité à motiver et à engager l'apprenant/joueur. Les jeux ont en effet démontré leur capacité à motiver les joueurs, via différents mécanismes et caractéristiques inhérents aux jeux (Plass et al., 2015). Ces caractéristiques correspondent d'abord aux *incentives* proposés par les jeux, comme les étoiles, points, badges, trophées et leader-boards, qui peuvent créer un sentiment de compétence et d'accomplissement (Kapp, 2012). La présence d'activités appréciables et intéressantes pour

l'apprenant, participe également à la motivation (Rotgans & Schmidt, 2011), ainsi qu'à l'engagement.

Les jeux fournissent effectivement de nombreuses manières d'engager les apprenants. Le type et la modalité d'engagement choisis dépendent de l'objectif d'apprentissage, du contexte et des caractéristiques de l'apprenant. L'engagement correspond ici à la manière dont les efforts de l'apprenant sont impliqués, dirigés et maintenus dans une activité d'apprentissage (Schunk & Mullen, 2012). Le modèle de l'activité de l'apprenant INTERACT (Domagk et al., 2010) distingue trois formes d'engagement : l'engagement cognitif, i.e., les opérations mentales et la métacognition au cours de l'apprentissage ; l'engagement affectif, l'état émotionnel ressenti et les processus de régulation ; l'engagement comportemental, renvoyant aux actions, mouvements et gestes mis en place dans l'apprentissage. Plass et al. (2015) ajoutent une quatrième forme d'engagement, l'engagement socio-culturel, correspondant aux interactions sociales et au contexte socioculturel au sein du jeu. Selon ce modèle, l'apprentissage découle principalement de l'engagement cognitif avec l'activité d'apprentissage. Les autres formes d'engagement ont une fonction de facilitation, pour atteindre cet engagement cognitif. Le jeu peut amener les gens à faire des mouvements et des gestes spécifiques, participant à l'engagement comportemental du joueur. Les personnages et l'histoire d'un jeu peuvent engager affectivement l'apprenant, tandis que les opportunités de coopération avec d'autres joueurs peuvent participer à plus d'engagement socio-culturel.

Le potentiel de l'apprentissage par le jeu est également dû au caractère adaptatif des jeux. Cette notion correspond à la capacité d'un jeu à engager chaque apprenant d'une manière à refléter sa propre situation spécifique (Plass et al., 2015). Dans le contexte d'apprentissage, cela renvoie à la capacité du jeu à s'adapter aux connaissances et compétences préalables du joueur (Andersen, 2012). De nombreux jeux permettent au joueur de sélectionner la difficulté désirée en fonction de ses compétences et de son auto-efficacité. De même, nombreux de jeux fournissent une évolution graduelle des demandes, par exemple en introduisant les mécaniques une par une (Barzilai & Blau, 2014). Qui plus est, l'apprentissage par le jeu fournit aux apprenants une opportunité de pratiquer et répéter, ce qui est essentiel dans l'acquisition et la maîtrise de nouvelles connaissances et compétences. Certains jeux fournissent un feedback récurrent voire immédiat, permettant à l'apprenant de reconnaître ses erreurs, comprendre les réponses correctes, pour s'ajuster en fonction (Shute et al., 2009).

La présence de l'échec est indissociable des jeux, en ceci qu'il constitue une mécanique quasi-omniprésente. Un jeu comprend un défi, un conflit (Kinzie & Joseph, 2008; Salen &

Zimmerman, 2003), et l'issue n'est pas systématiquement positive. L'apprentissage par le jeu donne à l'apprenant la possibilité de vivre ces échecs, dans un environnement sécurisé et sans risque (Hoffman & Nadelson, 2010; Whitton, 2012). Au lieu de considérer l'échec comme un résultat indésirable, l'échec devient une mécanique intégrante, prévisible et nécessaire au processus d'apprentissage (Kapur, 2008). L'échec est acceptable et est reconnu comme tel au cours du jeu.

4.3. Modèles de l'apprentissage par le jeu

L'apprentissage par le jeu a fait l'objet de nombreuses études, et plusieurs modèles ont été élaborés pour expliquer comment et pourquoi l'apprentissage a lieu durant le jeu. Une approche particulièrement intéressante correspond au paradigme entrée-processus-sortie (*input-process-output*), qui propose de prendre en compte la nature dynamique de l'apprentissage par le jeu. Cette approche considère les relations et interactions entre différentes formes d'entrées, comme les caractéristiques des joueurs et les mécaniques de jeu, avec le processus d'apprentissage, le tout entraînant un résultat (la sortie) : une nouvelle connaissance ou compétence, une amélioration, un changement d'attitude. Deux modèles en particulier, le General Learning Model (GLM) et le Game-Based Learning Evaluation Model (GEM), proposent des points de vue complémentaires et détaillés sur la manière dont l'apprentissage par le jeu fonctionne.

4.3.1. General Learning Model (GLM)

Le Modèle Général de l'Apprentissage (GLM, Gentile et al., 2014) est un modèle intégratif de l'apprentissage par les jeux. À l'origine, il fut développé pour montrer et expliquer les effets négatifs des jeux vidéo violents, notamment en rapport avec l'agressivité (Buckley & Anderson, 2012; Swing et al., 2011). Le modèle a ensuite été véritablement généralisé, pour considérer l'effet potentiel des jeux sur d'autres variables, comme les comportements prosociaux (Gentile et al., 2009). Ce modèle est basé sur les aspects cognitifs, affectifs et sociaux de l'apprentissage, en étant basé sur le paradigme entrée-processus-sortie. Le GLM considère l'apprentissage par le jeu en tant qu'environnement complexe et interactif, dans lequel des facteurs variés influencent le processus d'apprentissage. Le modèle est constitué de quatre composants (Figure 3) : deux entrées, les facteurs personnels et situationnels ; un processus, appelé « état interne présent » ; une sortie, les acquis d'apprentissage.

Figure 3.
Modèle Général de l'Apprentissage

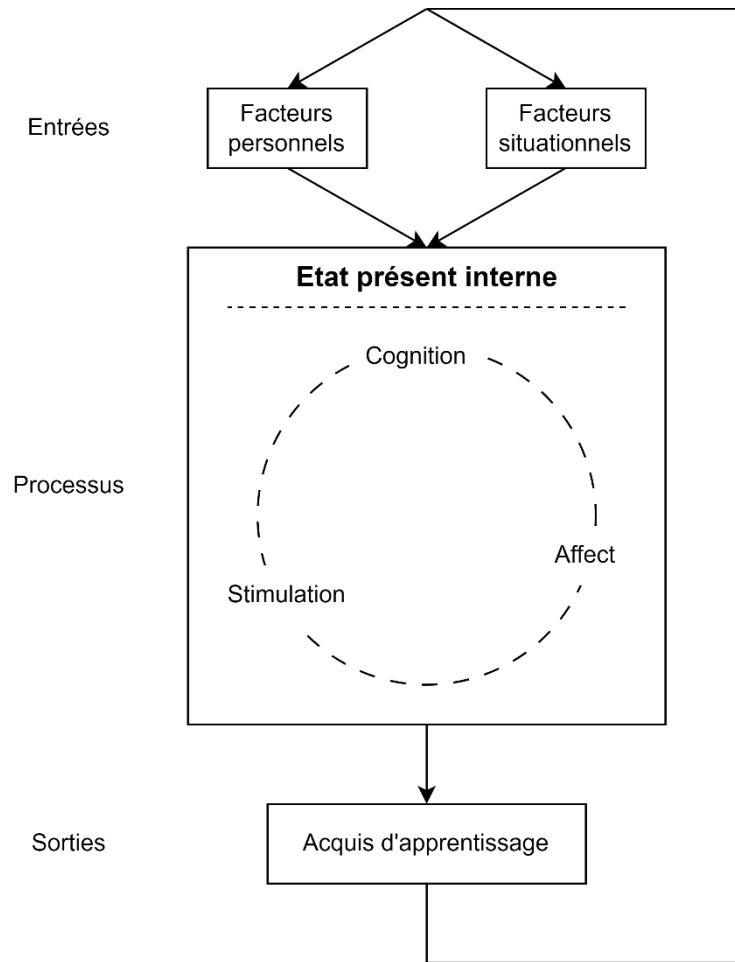

Les facteurs personnels correspondent aux caractéristiques individuelles du joueur/apprenant, comme ses connaissances, capacités, motivations préalables. Ces facteurs peuvent influencer l'expérience d'apprentissage de nombreuses façons. Par exemple, un joueur avec une forte motivation sera plus susceptible de persévérer face à des tâches ardues. Un joueur avec de fortes connaissances préalables dans un domaine particulier sera plus à même de transférer ces connaissances dans d'autres situations au sein du jeu.

Les facteurs situationnels renvoient aux caractéristiques du jeu, tels que le contenu du jeu, sa structure et son contexte. Ces facteurs impactent le processus d'apprentissage dans la mesure où ils vont façonner l'expérience, les interactions et les perceptions du joueur. Par exemple, l'histoire d'un jeu, ses objectifs ou sa difficulté peuvent affecter la motivation et l'engagement d'un joueur, qui impactera en retour la qualité de l'apprentissage.

L'état présent interne correspond à la partie « processus » du GLM, et fait office de pont entre les facteurs personnels et situationnels. Il s'agit d'un état dynamique reflétant les réponses cognitives, affectives et physiologiques du joueur face à l'environnement du jeu. Ce processus joue un rôle clé dans l'expérience d'apprentissage, car il représente les pensées, émotions et réactions physiques immédiates du joueur pendant qu'il joue. Différents sous-processus interviennent au sein de cet état présent interne, pouvant être divisés en trois catégories : cognitifs, impliquant l'attention, la mémoire et la résolution de problème ; affectifs, dont les émotions, la motivation et les attitudes ; physiologiques, correspondant aux réponses physiques comme l'état d'éveil ou le niveau de stress. Cet état est influencé par les facteurs personnels et situationnels, ainsi que par les interactions continues avec le jeu. Au fur et à mesure que le joueur avance dans le jeu, son état présent interne évolue et change en réponse aux nouvelles informations, activités et expériences.

Les acquis d'apprentissage sont le résultat des interactions entre facteurs personnels, facteurs situationnels et l'état présent interne du joueur. Dans le contexte du GLM, ces acquis peuvent être de nature cognitive, affective ou sociale. Les acquis cognitifs correspondent aux nouvelles connaissances, compétences et stratégies apprises à l'issue de l'expérience de jeu. Les acquis affectifs renvoient aux changements en termes d'émotions, d'attitudes et de motivations. Les acquis sociaux correspondent aux changements en termes de relations sociales, de collaboration et de communication.

4.3.2. Game-based learning Evaluation Model (GEM)

Le Modèle d'Évaluation de l'apprentissage par le Jeu (GEM, Oprins et al., 2015) est un autre modèle compréhensif, conçu pour évaluer l'efficacité de l'apprentissage par le jeu en étudiant les relations entre attributs du joueur, caractéristiques du jeu, indicateurs d'apprentissage et acquis d'apprentissage (Figure 4). Son objectif principal est de rendre compte de la façon dont différents éléments de conception contribuent au processus d'apprentissage, pour potentiellement optimiser l'efficacité des outils d'apprentissage par le jeu.

Les attributs du joueur sont une entrée importante dans le GEM, et incluent la personnalité, les expériences et la capacité du joueur (Roe, 2017). Ces attributs déterminent la façon dont l'apprenant interagit avec le jeu et la façon dont le jeu façonne l'expérience d'apprentissage.

Figure 4.

Modèle de l'Évaluation de l'apprentissage par le Jeu

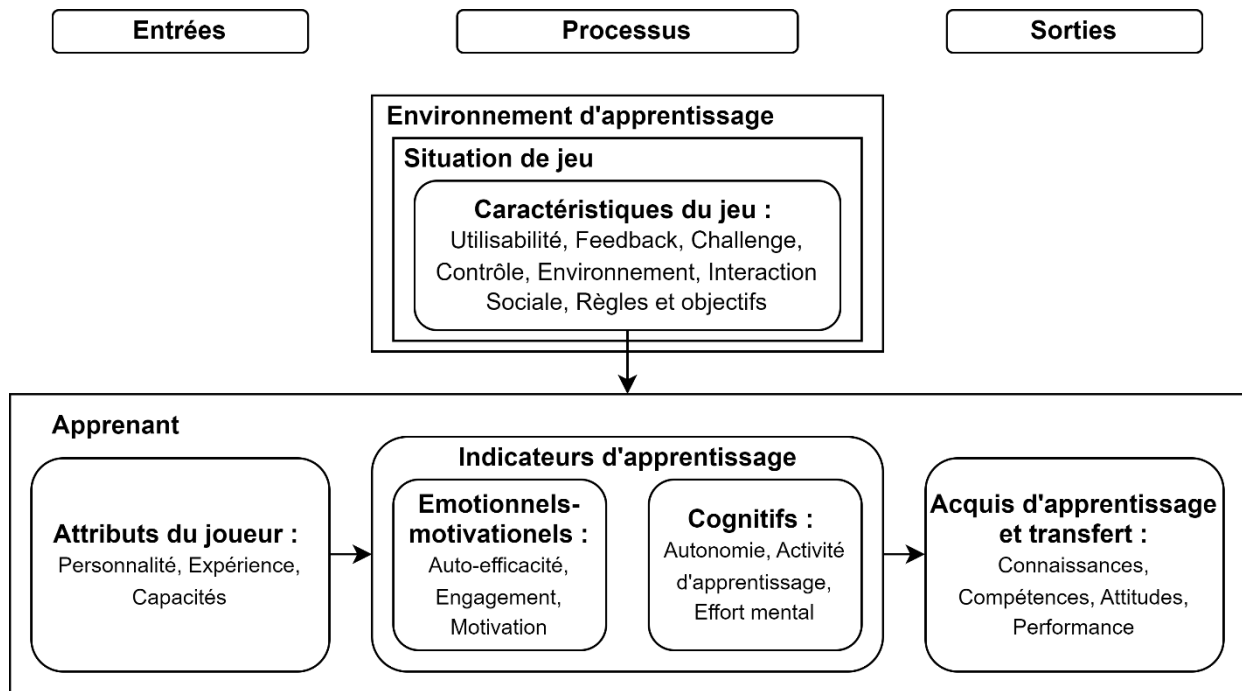

Le GEM identifie des éléments de conceptions cruciaux pour améliorer l'expérience et la qualité d'apprentissage au sein des jeux. Ces éléments de conceptions sont au nombre de sept : utilisabilité, feedback, challenge, contrôle, environnement, interaction sociale, règles et objectifs. Ces indicateurs incluent en premier lieu l'utilisabilité du jeu (Bedwell et al., 2012). Il s'agit d'un prérequis essentiel : si le jeu n'est pas jouable, le processus d'apprentissage ne pourra évidemment pas commencer (Wang et al., 2009). Le feedback est un autre élément essentiel de conception, qui renvoie aux éléments au sein du jeu fournissant de l'information à propos de la progression, de l'accomplissement (via des scores) ou encore du soutien, sous formes d'indices. Le challenge renvoie ici au contenu du jeu et à l'équilibre entre la difficulté du jeu et les compétences du joueur. Le jeu ne doit être ni trop facile ni trop difficile, et le jeu doit pouvoir fournir une progression de ses demandes en fonction de l'évolution du joueur. Le contrôle renvoie au sentiment d'agentivité, à savoir le niveau de contrôle du joueur sur le contenu et l'influence qu'il a sur les stratégies qu'il peut adopter (Graesser et al., 2009), ou les outils qu'il peut utiliser (Squire, 2011). L'environnement renvoie au contexte du jeu : le lieu, l'histoire, le rôle du joueur et des autres joueurs. Ces éléments peuvent être réalistes ou fantastiques, tant que les objectifs d'apprentissage restent présents (Graesser et al., 2009). Les interactions sociales correspondent à la modalité de communication entre joueurs, en face-à-

face, dans le cas d'un jeu de société, ou médiatisé par un ordinateur, dans le cas d'un jeu vidéo. Enfin, les règles et objectifs fournissent une structure au jeu et à l'expérience d'apprentissage par le jeu. Ces objectifs sont la raison première de l'interaction initiale des joueurs avec le jeu, et leur motivation pour continuer et progresser au fil du jeu (Bedwell et al., 2012).

Ce modèle met en avant deux catégories principales d'indicateurs d'apprentissage : les facteurs émotionnels-motivationnels et les facteurs cognitifs. Les indicateurs émotionnels et motivationnels incluent le sentiment d'auto-efficacité, la motivation et l'engagement. L'auto-efficacité renvoie à la confiance de l'individu dans sa capacité à réaliser une tâche ou une activité spécifique (Bandura et al., 1999). La motivation renvoie ici l'importance ou l'intérêt perçu attribué au sujet d'apprentissage (Oprins et al., 2015). Enfin, l'engagement renvoie ici à l'implication active dans l'activité (Reeve et al., 2004). Les indicateurs cognitifs incluent l'autonomie (*self-directedness*), l'activité d'apprentissage et l'effort mental. L'autonomie (ou auto-gestion) indique dans quelle mesure l'apprenant assume la responsabilité de son processus d'apprentissage (Stubbé & Theunissen, 2008). Les activités d'apprentissage englobent les différentes activités et processus cognitifs engagés par l'apprenant pour apprendre. Cela inclut notamment l'application de différentes stratégies d'apprentissage durant le jeu (Barnard et al., 2009). Enfin, l'effort mental correspond au niveau d'attention et de concentration alloué au cours de l'apprentissage, influençant le traitement et la rétention d'information (e.g., Hockey, 1997).

Le GEM souligne l'importance de mesurer des acquis d'apprentissage spécifiques, tout en incluant la possibilité de transfert à d'autres domaines (Oprins et al., 2015). Ces acquis incluent les connaissances, les compétences, les attitudes et l'amélioration de la performance.

4.4. Apprentissage par le jeu et apprentissage expérientiel

Les principes de l'apprentissage par le jeu s'alignent fortement avec la théorie de l'apprentissage expérientiel. Ces deux approches considèrent l'apprentissage comme un processus dynamique qui requiert un engagement actif et une mise en application. Qui plus est, l'apprentissage par le jeu rend possible un terrain propice à l'apprentissage expérientiel. Les apprenants/joueurs peuvent traverser et expérimenter les différentes étapes du processus d'apprentissage expérientiel, et répéter ce processus grâce à la nature itérative des jeux. Dans la première étape (expérience concrète), les apprenants sont engagés dans une nouvelle expérience, correspondant ici à la découverte d'un jeu, son environnement et ses règles. Les apprenants interagissent avec le jeu et ses mécaniques, relèvent des défis, prennent des

Introduction générale

décisions. La seconde étape (observation réflexive) s'aligne directement avec les éléments de feedback inhérent aux jeux. L'apprenant réfléchit sur ses actions et les résultats, et considère ce qui a fonctionné ou pas. Dans un jeu au tour par tour, les temps de pause facilitent grandement cette phase de réflexion. L'étape de conceptualisation abstraite intervient au moment où l'apprenant formule des théories, des stratégies, sur la base de leurs connaissances actuelles et du feedback reçu. Enfin, l'expérimentation active intervient au moment de la mise en application des stratégies conçues lors de l'étape précédente. Le joueur teste ses hypothèses, regarde le résultat, et ajuste ses stratégies en fonction. Ce cycle peut se répéter aussi longtemps que l'apprenant peut rester engagé et concentré dans le jeu.

5. Problématique et objectifs

5.1. Problématique et objectif général

Cette thèse est basée sur trois idées principales. Tout d'abord, la créativité est malléable et il est ainsi possible de l'améliorer. Deuxièmement, l'amélioration de la créativité repose principalement sur l'apprentissage par la pratique et l'expérience concrète. Troisièmement, cette thèse propose que l'apprentissage par le jeu constitue une des opérationnalisations les plus efficaces et rentables de l'apprentissage expérientiel. Tenant compte de ces trois idées, cette thèse avance la proposition suivante : l'apprentissage par le jeu représente une manière efficace et rentable d'améliorer la créativité, en permettant un apprentissage expérientiel optimal de cette capacité.

La première idée se fonde sur la notion que la créativité n'est pas une aptitude fixe et innée, mais qu'elle peut être développée et améliorée au fil du temps. Cette perspective reconnaît la malléabilité de la créativité et l'existence de stratégies et d'approches qui favorisent son développement. **La deuxième idée** met en avant l'importance de l'apprentissage par la pratique et l'expérience concrète dans le développement de la créativité. L'idée centrale est que la créativité s'améliore grâce à l'engagement actif dans des activités créatives et à l'exploration de nouvelles idées et de nouveaux domaines. L'apprentissage expérientiel permet alors de développer de nouvelles connaissances et compétences relatives à la créativité. **La troisième idée** propose que l'apprentissage par le jeu représente une des formes les plus efficaces et rentables d'apprentissage expérientiel pour améliorer la créativité. Les jeux offrent un environnement motivant et engageant où les apprenants peuvent explorer, expérimenter et pratiquer les compétences visées. Les caractéristiques intrinsèques des jeux, telles que les défis, les récompenses, les mécanismes d'adaptation et la normalisation de l'échec participent et facilitent le processus d'apprentissage. Les apprenants peuvent également recevoir un feedback immédiat sur leurs idées et leurs actions, ce qui leur permet d'ajuster leur approche et de développer leur pensée créative de manière itérative.

Sur la base de ces trois idées, la proposition générale avancée est que l'apprentissage par le jeu constitue une approche efficace et rentable pour améliorer la créativité. **En intégrant l'apprentissage expérientiel avec les mécanismes des jeux, ces derniers offrent un cadre propice à la pratique et l'expérimentation de la créativité.** Les jeux fournissent un cadre motivant, engageant et adaptatif, permettant aux apprenants d'explorer, d'expérimenter et d'améliorer leur pensée créative de manière interactive et itérative.

5.2. Plan des articles

Pour investiguer et étayer cette proposition, les contributions scientifiques de cette thèse s'articulent en trois volets. **Le premier volet** a pour objectif de développer un cadre théorique intégratif de l'amélioration de la créativité par le jeu. Ce volet prend la forme d'un **article théorique** (A1), en cours de soumission. L'objectif du cadre théorique est premièrement de décrire et d'expliquer comment les jeux peuvent améliorer la créativité, sous l'angle des ressources cognitives. Deuxièmement, ce cadre théorique a pour objectif de rendre compte du lien entre les jeux et la créativité, sous l'angle des ressources conatives. Outre les arguments avancés précédemment, la créativité présente un certain nombre de liens avec les jeux, et le jeu plus généralement. Le cadre théorique reprend l'approche entrée-processus-sortie. Deux types d'entrées sont intégrés : (1) les attributs personnels, qui correspondent ici aux dispositions et variables conatives communes à la créativité et à la pratique des jeux ; (2) les attributs des jeux, qui renvoient aux affordances impliquant la créativité et les mécanismes pouvant faciliter la créativité. Le processus renvoie à la situation d'apprentissage par le jeu. Ce processus intègre l'apprentissage expérientiel au sein des jeux comme moteur de l'amélioration de la créativité. Cette amélioration correspond ainsi au résultat du cadre théorique, la « sortie ». Dans l'article, cette partie prend la forme d'une revue de la littérature des études examinant l'effet des jeux sur la créativité.

Les deux volets suivants cherchent à explorer et à valider empiriquement différents aspects du cadre théorique. **Le deuxième volet** propose ainsi d'étudier l'effet des jeux sur la créativité. Ce volet a pour objectif de déterminer la validité du cadre théorique intégratif et de son hypothèse globale : les jeux sont-ils un bon moyen d'améliorer la créativité ? Ce volet prend la forme de **deux articles utilisant la méthode expérimentale**, respectivement publié et en cours de préparation. La première étude (A2) s'intéresse à l'effet des jeux de société sur la pensée divergente, à l'échelle individuelle. L'étude expérimentale compare trois conditions : jeu créatif, jeu non-créatif, contrôle. Dans la condition « jeu créatif », les participants jouent pendant 30 minutes à un jeu supposé faire pratiquer et améliorer la créativité, avant de remplir des tâches de pensée divergente. La condition « jeu non-créatif » implique de jouer à des jeux sans aucun effet supposé sur la créativité. Enfin, dans la condition contrôle, les participants ne jouent à aucun jeu. Le deuxième article expérimental (A3) explore l'effet des jeux de société sur la créativité de groupe. Par essence, les jeux de *société* sont une activité sociale et de groupe. Il apparaît ainsi pertinent d'investiguer leurs effets sur une performance créativité à l'échelle du groupe. Cette étude compare deux conditions : jeux créatifs et jeux non-créatifs. Après avoir

Introduction générale

joué pendant 30 minutes au jeu correspondant à leur condition, les participants réalisent une tâche de brainstorming, permettant d'évaluer la créativité du groupe.

Le troisième volet s'intéresse spécifiquement aux liens entre jeux et créativité. Plus précisément, l'objectif est d'identifier les dénominateurs communs entre ces deux concepts, en termes de ressources conatives. Ce volet vise donc à valider la partie « Attributs personnels » du cadre théorique. Ce volet prend la forme de **deux articles empiriques**, respectivement publié et en cours de révision. Le premier article (A4) explore le lien entre pratique des jeux vidéo et créativité au travail. L'article fait l'hypothèse d'une médiation par le capital psychologique. Le second article (A5) explore les relations entre pratique des jeux de société et deux opérationnalisations de la créativité : le concept de soi créatif et la créativité au travail. Le médiateur et dénominateur commun identifié ici est le caractère joueur.

En préambule des trois volets et des articles, les résumés détaillés de chacun des cinq articles sont proposés. Les cadres généraux des deux volets empiriques sont également présentés.

À la suite de ce deuxième chapitre et les trois volets le composant, un troisième chapitre présente une discussion générale des travaux entrepris au cours la thèse. Cette discussion vient d'abord résumer les contributions scientifiques des cinq articles présentés dans le deuxième chapitre. Les contributions théoriques et appliquées sont ensuite discutées. Le cadre théorique intégratif est revisité à la lumière des éléments empiriques rapportés dans les deux volets empiriques (volet n° 2 et n° 3). Cette discussion met également en évidence les limites des contributions et du cadre théorique. Enfin, des perspectives de recherche sont proposées, pour enrichir et compléter les résultats de ce travail de thèse.

Synthèse des contributions		
Volet n°1	Article A1	Élaboration d'un cadre théorique
Volet n°2	Article A2	Effets des jeux de société sur la créativité individuelle
	Article A3	Effets des jeux de société sur la créativité de groupe
Volet n°3	Article A4	Jeux vidéo et créativité : le capital psychologique comme médiateur
	Article A5	Jeux de société et créativité : le caractère joueur comme médiateur

Chapitre 2 :

Contributions scientifiques

Partie 1 :
Résumés des contributions

Volet n° 1 : Cadre théorique

Article A1 – Élaboration d'un cadre théorique

Résumé détaillé

Objectifs

Cet article vise à proposer un cadre théorique, basé sur la théorie de l'apprentissage par l'expérience et l'apprentissage par le jeu, tout en se concentrant spécifiquement sur l'amélioration de la créativité : le cadre théorique d'amélioration de la créativité par le jeu (Game-based Creativity Enhancement Framework – G-CEF). Conformément à cet objectif, le cadre théorique adopte un paradigme entrée-processus-sortie (Figure 5) : deux entrées (attributs personnels et attributs du jeu), une étape du processus (la situation d'apprentissage) et des sorties (i.e., les améliorations et acquis d'apprentissage).

Attributs personnels

La première entrée correspond aux attributs personnels. La créativité est influencée par de nombreux facteurs, en termes de ressources conatives : ouverture à l'expérience, tolérance à l'ambiguïté, imagination, etc. Les attributs personnels renvoient donc à des dispositions et ressources conatives communes à la pratique des jeux et à la créativité : le caractère joueur, l'imagination, l'errance mentale, la pleine conscience, le capital psychologique, et les motivations. Ces attributs permettent d'expliquer pourquoi la pratique des jeux et la créativité sont étroitement liées. Prenons par exemple le capital psychologique. Le capital psychologique est un construit d'ordre supérieur, caractérisé par quatre composantes : l'auto-efficacité, l'optimisme, l'espoir et la résilience. L'optimisme est particulièrement intéressant ici. Ce style attributionnel, qui considère les revers comme temporaires et spécifiques à une situation, est essentiel tant dans les jeux et que pour la créativité. Ces deux activités impliquent souvent des échecs et des revers, et il est essentiel d'avoir un style optimiste : les expériences négatives sont considérées comme surmontables et passagères. Les jeux sont ainsi parmi les premières activités qui enseignent aux individus que les échecs sont acceptables et normaux. En tant que tels, les jeux devraient être associés à un plus grand optimisme, qui conduirait ensuite à une plus grande créativité.

Figure 5.
Cadre théorique

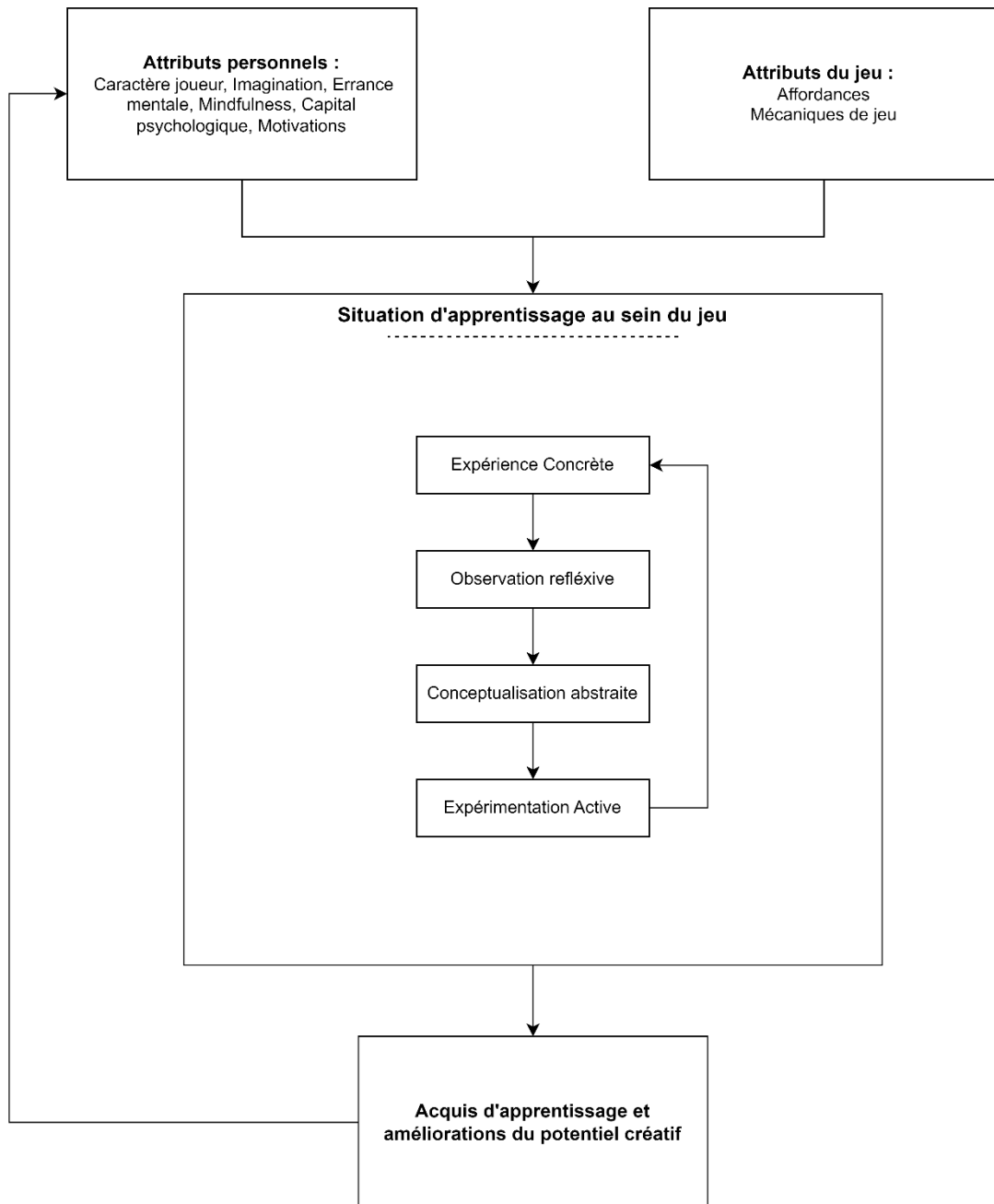

Attributs des jeux

Deuxièmement, les attributs des jeux. Le présent cadre théorique se concentre sur trois types de jeux : les jeux vidéo, les jeux de société et les jeux de rôle. Les jeux vidéo sont des jeux électroniques qui impliquent une interaction humaine avec une interface utilisateur, générant un retour visuel sur un écran. Ils englobent une grande variété de genres, de plateformes et de niveaux d'interactivité. Les jeux vidéo se caractérisent par des objectifs, des défis, des règles et des données générées par l'utilisateur qui affectent les résultats à l'écran (Li, 2008; Tavinor, 2008). Un jeu de société est un jeu comportant un certain nombre de règles qui

limitent les possibilités, qui nécessite un support physique (par exemple, un plateau, des cartes, des dés) et qui se joue à deux joueurs ou plus (Gobet et al., 2004). Les jeux de rôle sont des jeux narratifs dans lesquels les joueurs jouent le rôle de personnages dans un cadre fictif, dirigé et raconté par un maître de jeu (Hughes, 1988; Karwowski & Soszynski, 2008). Les actions et les résultats sont déterminés par la combinaison des décisions des personnages, des règles et des jets de dés, ce qui permet aux joueurs de cocréer des histoires et d'y naviguer.

Cette section est divisée en deux parties : les affordances et les mécaniques des jeux. La première se concentre sur les affordances, c'est-à-dire sur la manière dont les jeux peuvent offrir des opportunités de créativité, à l'intérieur et à l'extérieur du jeu. Ces affordances peuvent contribuer à expliquer les liens entre la fréquence de jeu et la créativité. Huit types d'affordances sont identifiés et présentés : degré de flexibilité, narration, outils, environnement, création de contenu, avatar, progression et rejouabilité. Étant donné que de nombreux jeux peuvent offrir de telles possibilités, les personnes qui jouent à un plus grand nombre de jeux les rencontrent plus souvent, ce qui peut avoir une incidence sur leur créativité. La seconde partie, sur les mécaniques de jeux, se concentre plus spécifiquement sur les jeux qui sont explicitement bénéfiques pour la créativité. Il s'agit de la manière dont certains jeux ciblent, sollicitent et requièrent certains aspects de la créativité dans leurs mécanismes, améliorant ainsi le potentiel créatif en dehors du jeu. Cinq types de mécaniques de jeux sont identifiés et présentés : l'originalité, la pensée divergente, la pensée convergente, la flexibilité mentale, et les dispositions créatives.

Situation d'apprentissage

La situation d'apprentissage au sein du jeu intègre l'apprentissage par l'expérience et son processus cyclique en quatre étapes : expérience concrète, observation réflexive, conceptualisation abstraite et expérimentation active. La première étape est l'expérience concrète (EC), qui demande aux apprenants de participer/de s'engager dans une nouvelle expérience. La deuxième est l'observation réflexive (OR), qui demande aux apprenants de prendre conscience de leur réaction cognitive et affective à la nouvelle expérience. La troisième étape est la conceptualisation abstraite (AC), qui demande aux apprenants de relier leurs anciennes connaissances et expériences à de nouvelles pensées, sentiments et expériences, afin de conceptualiser les situations d'un point de vue nouveau. Enfin, il y a l'expérimentation active (AE), lorsque les apprenants appliquent leurs nouvelles idées à d'autres expériences.

Résumés des contributions

Ce processus cyclique en quatre étapes correspond à l'expérience au sein du jeu et aux processus d'apprentissage qui s'y déroulent. Ce processus est mieux compris si l'on prend l'exemple des jeux au tour par tour. Il y a d'abord l'expérience concrète, au cours de laquelle le joueur découvre le jeu et en expérimente les mécanismes et les règles. Vient ensuite l'observation réflexive, au cours de laquelle le joueur examine et réfléchit à la première expérience, à ses actions et à ses résultats, ainsi qu'à ceux des autres joueurs. Ces observations et réflexions sont ensuite synthétisées dans une conceptualisation abstraite, telle que des théories, des stratégies et des représentations du jeu. Le joueur peut utiliser ses expériences et observations antérieures pour formuler de nouvelles stratégies pour les tours à venir et s'adapter à la progression du jeu. Enfin, le joueur expérimente activement en appliquant les stratégies formulées à l'étape précédente, en essayant de nouvelles solutions au problème ou en trouvant de nouvelles actions pour surmonter le défi. Ce cycle se répète tout au long de l'expérience de jeu, au cours de laquelle les mécanismes de jeu donnés seront pratiqués et expérimentés par les joueurs, ce qui débouchera sur une amélioration, ici de la créativité.

Améliorations et acquis d'apprentissage

Enfin, les améliorations et acquis d'apprentissage font référence aux différents aspects et manifestations de la créativité qui sont ou pourraient être améliorés par le jeu. Il s'agit des effets immédiats et à court-terme du jeu, ainsi que des effets potentiels à plus long-terme et du transfert de l'apprentissage. Une revue de la littérature est présentée, résumant les travaux scientifiques publiés sur l'effet de trois types de jeux (jeux vidéo, jeux de société, jeux de rôle) sur la créativité.

Volet n° 2 : Effets des jeux sur la créativité individuelle

Cadre général

Ce volet a pour objectif de déterminer la validité du cadre théorique et de son hypothèse globale : les jeux sont-ils un bon moyen d'améliorer la créativité ? Ce volet vise ainsi explorer l'effet des jeux sur la créativité, plus particulièrement l'effet des jeux de société. Le potentiel d'autres formes de jeux a commencé à être documenté, notamment concernant les jeux vidéo et les jeux de rôle. Cependant, la littérature scientifique n'a pratiquement pas exploré l'effet des jeux de société. Ce volet cherche ainsi à plus amplement valider la sortie « Améliorations et acquis d'apprentissage » du cadre théorique.

Ce volet prend la forme de deux articles utilisant la méthode expérimentale, respectivement publié et en cours de préparation. Le premier article (A2) s'intéresse à l'effet des jeux de société sur la créativité, opérationnalisée par une tâche de pensée divergente, à l'échelle individuelle. Le deuxième article expérimental (A3) explore l'effet des jeux de société sur la créativité de groupe, opérationnalisée à l'aide d'une tâche de brainstorming, autrement dit une tâche de pensée divergente de groupe.

Article A2 – Effets des jeux de société sur la créativité

Résumé détaillé

Objectifs

Cet article a deux objectifs principaux. Tout d'abord, vérifier que la pratique des jeux de société est liée à un potentiel créatif plus élevé, dans la population générale. Ensuite, explorer l'effet de la pratique de plusieurs types de jeux de société sur la performance créative. À ces deux objectifs correspondent deux études, combinant ainsi deux méthodes complémentaires. La première étude est une étude corrélacionnelle, menée au moyen d'une enquête en ligne. Elle explore les liens entre la fréquence de pratique de différents types de jeux de société et plusieurs indicateurs du potentiel créatif : pensée divergente, ouverture aux expériences, auto-efficacité créative et identité personnelle créative. La seconde étude utilise la méthode expérimentale et complète cette étude préliminaire, en examinant l'effet de la pratique de deux types de jeux de société sur la performance créative, tout en prenant en compte le potentiel créatif des participants a priori.

Cet article compare deux types de jeux de société différents, sur la base d'une définition pragmatique. Nous avons ainsi pris la décision de distinguer deux types de jeux de société, sur la base de la définition de la créativité (Runco & Jaeger, 2012) : les jeux de société créatifs et non-créatifs. Un jeu de société créatif est un jeu qui nécessite de produire des idées originales et adaptées pour avoir une bonne performance. A l'inverse, un jeu de société non-créatif ne nécessite pas cette production créative pour avoir une bonne performance.

Étude 1

Hypothèses. L'étude 1 a pour objectif d'étudier les liens entre fréquence de pratiques des jeux de société et plusieurs composantes du potentiel créatif. Nous faisons quatre hypothèses : (H1) la fréquence de pratique des jeux de société en général est corrélée positivement au potentiel créatif ; (H2) la fréquence de pratique des jeux de société créatifs est corrélée positivement au potentiel créatif ; (H3) la fréquence de pratique des jeux de société non-créatifs n'est pas corrélée au potentiel créatif ; (H4) les corrélations entre potentiel créatif et fréquence de pratique des jeux créatifs sont plus élevées que les corrélations entre potentiel créatif et jeux non-créatifs.

Résumés des contributions

Méthode. Nous avons récolté les données de 284 participants, recrutés via les réseaux sociaux. L'âge moyen était de 35,1 ans ($ET = 12,5$). 88% étaient des femmes. Le potentiel créatif a d'abord été opérationnalisé via une tâche de pensée divergente, l'Alternative Uses Task (AUT, Guilford, 1967). Les participants devaient donner des utilisations originales à deux objets : une ceinture, puis une brouette. Deux critères de la pensée divergente ont été mesurés : la fluidité et l'originalité. Trois autres aspects du potentiel créatif ont été mesurés : l'ouverture aux expériences (Ashton & Lee, 2009), l'auto-efficacité créative et l'identité personnelle créative (Karwowski et al., 2018). Enfin, nous avons mesuré la fréquence de pratiques de trois catégories de jeux de société : les jeux de société en général, les jeux de société créatifs et les jeux de société non-crétatifs.

Tableau 1.

Matrice de corrélation

	Originalité	Fluidité	CSE	CPI	Ouverture	FJS	FJSC	FJSN
Originalité	—							
Fluidité	0.198 ***	—						
CSE	0.165 **	0.059	—					
CPI	0.154 *	-0.001	0.683 ***	—				
Ouverture	0.198 ***	0.031	0.358 ***	0.501 ***	—			
FJS	0.087	0.005	0.143 *	0.149 *	0.177 **	—		
FJSC	0.154 *	0.052	0.277 ***	0.317 ***	0.283 ***	0.621 ***	—	
FJSN	0.071	0.030	0.126 *	0.109	0.086	0.828 ***	0.501 ***	—

Note 1. * $p < .05$, ** $p < .01$, *** $p < .001$.

Note 2. CSE : auto-efficacité créative, CPI : identité personnelle créative, FJS : fréquence de pratique des jeux de société en général, FJSC : fréquence de pratique des jeux de société créatifs, FJSN : fréquence de pratique des jeux de société non-crétatifs.

Note 3. Les corrélations continue-continue ont été calculées à l'aide du coefficient de Pearson. Les corrélations continue-ordinales et ordinales-ordinales ont été calculées à l'aide du rho de Spearman.

Résultats. Les résultats obtenus sont globalement concordants avec ces différentes hypothèses (Tableau 1). La fréquence générale corréle faiblement mais significativement avec trois indicateurs du potentiel créatif. Il semblerait donc que fait de jouer à des jeux de société plus régulièrement va de pair avec un potentiel créatif plus élevé. Plus particulièrement, la pratique de jeux créatifs corréle avec l'ensemble de nos indicateurs, à l'exception de la fluidité. Ce lien est donc observé à la fois pour des mesures auto-rapportées du potentiel créatif, mais

également pour des mesures plus « objectives » de performance créative, ici via la pensée divergente. Comme nous en avons fait l'hypothèse, la pratique de jeux non-crétatifs ne corrèle pas avec la plupart des indicateurs du potentiel créatif. Nous avons également fait l'hypothèse de différences significatives entre les corrélations des jeux créatifs et des jeux non-crétatifs (H4). Cette hypothèse est également confirmée : parmi les quatre corrélations entre indicateurs du potentiel créatif et fréquence de pratique des jeux créatifs, trois sont significativement supérieures aux corrélations avec la fréquence de pratique des jeux non-crétatifs. Ces résultats contribuent ainsi à la pertinence d'une distinction entre jeu créatif et jeu non-crétatif.

Étude 2

Hypothèses. Nous avons donc constaté un lien corrélationnel entre pratique des jeux de société en général et potentiel créatif, un lien plus prononcé entre pratique des jeux de société créatifs et potentiel créatif, et une absence de lien avec la pratique des jeux de société non-crétatifs. L'étude 2 a pour objectif d'explorer l'effet des jeux de société sur le potentiel créatif, à l'aide de la méthode expérimentale. Nous utiliserons la performance à une tâche de pensée divergente comme indicateur de performance créative, et les mêmes mesures auto-rapportées comme indicateur du potentiel créatif a priori. Nous faisons les hypothèses suivantes : (H5) jouer à un jeu de société créatif ou non-crétatif n'entraîne pas d'amélioration de la fluidité, comparé à une condition contrôle ; (H6) jouer à un jeu de société créatif entraîne une amélioration de l'originalité, comparé aux conditions contrôle et jeu non-crétatif ; (H7) cette amélioration est d'autant plus forte que le potentiel créatif des participants a priori est faible.

Méthode. Nous avons fait appel à 239 participants, étudiant à l'Institut de Psychologie de l'Université Paris Cité en Licence 1 et 2 (âge moyen = 20,1, $ET = 3,86$, 85,1 % de femmes). Les participants étaient distribués dans des groupes de 3 ou 4 personnes. Nous avons utilisé un plan expérimental inter-sujets, chaque groupe de participants étant aléatoirement assigné à l'une des trois conditions suivantes : condition contrôle ($N = 76$), condition jeu créatif ($N = 81$), condition jeu non-crétatif ($N = 82$). Nous avons choisi de comparer l'effet de deux jeux de société créatifs à deux jeux non-crétatifs, chacun des jeux étant appariés en termes de stimuli impliqués. Les deux jeux créatifs étaient : The Big Idea (Funforge, 2011) et Imagine (Cocktail Games, 2016). Les deux jeux non-crétatifs étaient : Deutsch et Twin It (Cocktail Games, 2017).

Dans les conditions jeu créatif et jeu non-crétatif, les participants jouaient d'abord à un des jeux correspondant à leur condition pendant 30 minutes. Après ce temps de jeux, les participants ont rempli, dans cet ordre : une mesure d'état émotionnel (Bradley & Lang, 1994),

deux mesures de pensée divergente (ceinture puis brouette), une mesure d'appréciation du jeu (Ryan et al., 1983), une mesure d'auto-efficacité créative et d'identité personnelle créative (Karwowski et al., 2018), une mesure d'ouverture aux expériences (Ashton & Lee, 2009), et enfin des informations socio-démographiques. En condition contrôle, les participants ne jouaient à aucun jeu, et ont rempli ces mêmes mesures dans le même ordre, à l'exception de la mesure de l'appréciation du jeu. Pour compenser l'absence de mesures pré-test du potentiel créatif, un indicateur a priori a été estimé sur la base des scores aux mesures d'ouverture, d'auto-efficacité créative et d'identité personnelle créative.

Figure 6.

Variations de l'originalité en fonction de la condition et du potentiel créatif

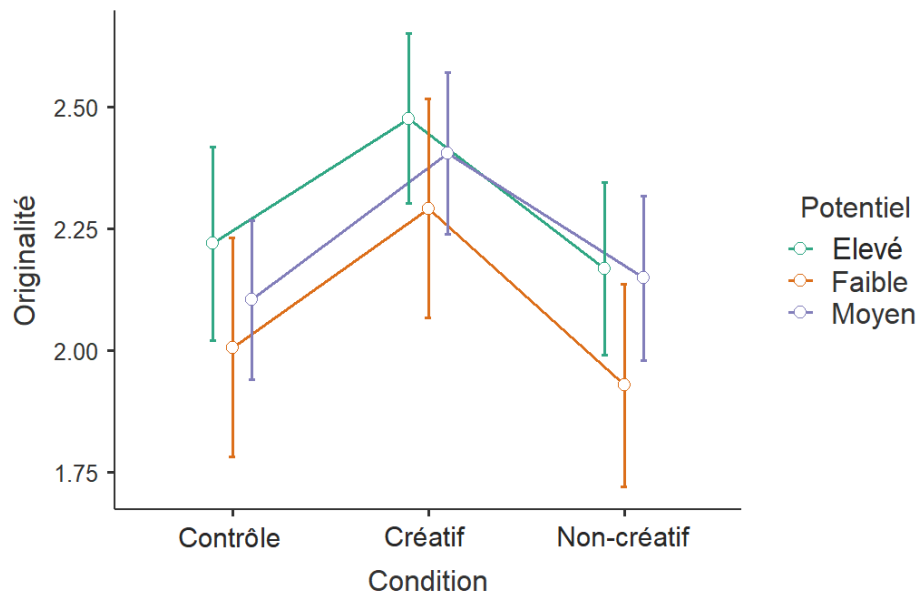

Résultats. Nous avons fait l'hypothèse d'une absence d'effet de la pratique des jeux sur la fluidité (H5). Cette hypothèse est globalement confirmée. De manière générale, il n'y a effectivement pas de différence entre la condition contrôle et les deux conditions de jeux. Nous avons fait l'hypothèse d'une amélioration de l'originalité uniquement après avoir joué à un jeu créatif (H6). Cette hypothèse est confirmée. Nous avons constaté, de manière globale, une amélioration significative grâce aux jeux créatifs sur l'originalité, de taille intermédiaire (Table 6). Enfin, nous avons fait l'hypothèse que cet effet serait d'autant plus fort que le potentiel créatif des participants a priori serait bas (H7). Cette hypothèse n'est pas confirmée par nos résultats : les améliorations constatées s'observent de manière uniforme, indépendamment du potentiel a priori. Au niveau de nos variables contrôles, malgré des différences constatées au niveau de l'état émotionnel, nos résultats suggèrent que les différences observées sont

attribuables au contenu des jeux de société en eux-mêmes, et non à un changement d'état émotionnel provoqué par ces jeux.

Conclusion

Pour conclure, les résultats de cet article suggèrent que les jeux de société constituent un moyen efficace pour développer la pensée divergente. L'effet d'entraînement concerne plus particulièrement l'originalité, qui reste la manifestation fondamentale de la créativité, à savoir la génération d'idées nouvelles, surprenantes, originales (Besemer & O'Quin, 1999; Diedrich et al., 2015).

Article A3 – Effets des jeux de société sur la créativité de groupe

Résumé détaillé

Objectifs

Sur la base de l'article précédent, les jeux de société semblent ainsi efficaces pour améliorer la créativité des individus. Cependant, cette forme de jeu implique intrinsèquement une dimension collective qui pourrait s'avérer potentiellement fructueuse pour l'amélioration de la créativité de groupe. En effet, le français, comme bien d'autres langues, nomment ces jeux en mettant l'accent sur l'aspect social de cette activité. Le français les appelle "jeu de société", que l'on retrouve également en roumain "jocuri de societate", et ils sont connus en Croatie sous le nom de "društvene igre" (jeux sociaux). Qui plus est, par définition, les jeux de société sont joués par deux joueurs ou plus (Gobet et al., 2004). Les jeux de société sont ainsi par nature et par définition une activité sociale, contrairement à d'autres formes de jeux comme les jeux vidéo, qui peuvent être joués en solo ou en multi-joueurs. Cet article vise donc à davantage explorer les effets des jeux de société, en se concentrant cette fois sur la créativité de groupe, opérationnalisée à l'aide d'une tâche de pensée divergente de groupe (i.e., une tâche de brainstorming).

Hypothèses

Nous avons émis l'hypothèse que jouer à un jeu de société créatif aurait un effet positif sur trois critères de la pensée divergente de groupe (fluidité, élaboration et originalité), par rapport la condition contrôle, contenant des jeux de société non créatifs.

Méthode

Nous avons fait appel à 120 participants, étudiant à l'Institut de Psychologie de l'Université Paris Cité en Licence 1 et 2 (âge moyen = 18,9, $ET = 2,02$, 83,31 % de femmes). Les participants ont été répartis en 40 groupes de trois. Nous avons utilisé un plan expérimental inter-sujets, chaque groupe de participants étant assigné au hasard à l'une des deux conditions suivantes : la condition « jeu de société créatif » ($N = 20$) et la condition contrôle ($N = 20$), dans laquelle les groupes ont joué à des jeux de société non-créatifs. Les deux jeux créatifs étaient : The Big Idea (Funforge, 2011) et Dixit (Libellud, 2008). Les deux jeux non-créatifs étaient : Deutsch and Twin It (Cocktail Games, 2017).

Dans les deux conditions, les groupes jouaient d'abord à un des jeux correspondant à leur condition, pendant 30 minutes. À l'issue de cette session de jeu, les participants ont participé à

Résumés des contributions

une tâche de brainstorming (Paulus, 2000). Les participants étant des étudiants d'une université publique, un problème adapté à cette population a été choisi. Il a ainsi été demandé aux participants de trouver des idées pour améliorer l'enseignement et l'apprentissage dans leur université (Bechtoldt et al., 2010, 2012). Ils disposaient de 15 minutes. Pour chaque groupe, trois critères de la pensée divergente ont été mesurés : la fluidité, l'élaboration et l'originalité globale des réponses. Enfin, les participants de chaque groupe ont rempli plusieurs mesures liées à des variables contrôles.

Résultats

Les résultats de cette étude démontrent de manière convaincante que les jeux de société créatifs ont un impact positif sur la créativité du groupe dans le cadre d'une tâche de brainstorming. Les groupes qui ont joué à des jeux de société créatifs ont montré des niveaux significativement plus élevés de pensée divergente de groupe, en termes de fluidité, d'élaboration et d'originalité (Tableau 2). Qui plus est, les trois tailles d'effet étaient toutes larges et significatives.

Tableau 2.
Tests T pour échantillons indépendants

	t	ddl	p	M_{diff}	ES_{diff}	d_{cohen}
Fluidité	3	38	0,005	7,5	2,499	0,949
Elaboration	3,29	38	0,002	120,4	36,628	1,039
Originalité	3,26	38	0,002	1,1	0,338	1,030

Conclusion

Ce résultat confirme notre hypothèse et suggère que les jeux de société, en particulier les jeux de société dits « créatifs », s'avèrent être un outil précieux pour promouvoir la créativité au sein des groupes.

Volet n° 3 : Médiateurs conatifs du lien entre jeux et créativité

Cadre général

Le troisième volet s'intéresse spécifiquement aux liens entre jeux et créativité. Plus précisément, l'objectif est d'identifier les dénominateurs communs entre ces deux concepts, en termes de ressources conatives. Ce volet vise donc à valider la partie « Attributs personnels » du cadre théorique.

Ce volet prend la forme de deux articles, respectivement publié et en cours de révision. Le premier article (A4) explore le lien entre pratique des jeux vidéo et créativité au travail. L'article fait l'hypothèse d'une médiation par le capital psychologique. Le second article (A5) explore les relations entre pratique des jeux de société et deux opérationnalisations de la créativité : le concept de soi créatif et la créativité au travail. Le médiateur et dénominateur commun identifié ici est le caractère joueur.

Article A4 – Jeux vidéo et créativité : le capital psychologique comme médiateur

Résumé détaillé

Objectifs

La pratique des jeux est associée à une créativité plus élevée. C'est le cas des jeux de société, mais également des jeux vidéo. Malgré ces liens apparents, l'ample majorité des études porte sur une population d'enfants, d'adolescents ou de jeunes adultes. L'impact des jeux sur une population plus âgée reste ainsi en suspens. Cette étude a pour objectif d'explorer le lien entre pratique des jeux vidéo et créativité au travail, chez une population adulte. Qui plus est, aucune étude à l'heure actuelle ne propose d'expliquer empiriquement le lien entre pratique des jeux et créativité. Certains arguments théoriques ont été apportés, mais jamais vérifiés. Cette étude propose d'expliquer le lien entre jeux et créativité, en identifiant un dénominateur commun : le capital psychologique (PsyCap).

Le capital psychologique est un construit conatif, d'ordre supérieur, qui se caractérise par quatre grandes composantes (Luthans et al., 2007a) : la confiance qu'un individu a de sa capacité à réussir et faire face aux défis (auto-efficacité), une perspective positive sur sa capacité à avoir du succès maintenant et à l'avenir (optimisme), la persévérance vers ses objectifs, et quand cela est nécessaire, la capacité à retravailler son cheminement vers l'atteinte de ses objectifs (espoir), et la capacité à résister à rebondir face aux problèmes et à l'adversité (résilience). Le capital psychologique et ses composantes sont associés à plusieurs aspects du potentiel créatif, notamment en termes de pensée divergente (Sweetman et al., 2011), ainsi qu'à la créativité au travail (Yu et al., 2019). Le capital psychologique est également relié à la pratique des jeux. Plusieurs études ont notamment montré que les jeux peuvent s'avérer un outil efficace au développement du capital psychologique (Hsu & Chang, 2022; Luthans & Youssef-Morgan, 2017).

Hypothèses

Deux hypothèses ont été formulées. Premièrement, la fréquence de pratique des jeux vidéo est associée positivement à la créativité au travail. Deuxièmement, le capital psychologique global et ses composantes jouent un rôle de médiateur à la relation entre les jeux vidéo et la créativité au travail.

Méthode

Les données ont été recueillies auprès de 370 travailleurs recrutés en ligne sur les réseaux sociaux français (âge moyen = 39,2, *ET* = 10,6, 85,1 % de femmes). Selon la nomenclature des professions de l'Institut National de la Statistique et des Études Économiques (INSEE), 27 % des participants étaient des cadres et professions intellectuelles supérieures, 28,9 % des professions intermédiaires et cadres moyens, 3,3 % des ouvriers qualifiés, 4,1 % des artisans, commerçants, chefs d'entreprise et professions libérales, 35,7 % des employés et personnel de service, et 1,1 % des étudiants (avec un emploi à temps partiel). Les participants ont répondu à un questionnaire en ligne, contenant trois mesures en particulier : une échelle de créativité au travail (Zhou & George, 2001a), une échelle mesurant le capital psychologique (Luthans et al., 2007a), et une mesure de la fréquence de jeu, en heures par semaine, aux jeux vidéo.

Table 3.

*Analyse de médiation***Effets directs**

		B	ES	z	p	IC 95%	
						Inférieur	Supérieur
GF	→ Créativité	0.075	0.051	1.454	0.146	-0.026	0.175

Effets indirects

				B	ES	z	p	IC 95%	
		Inférieur	Supérieur						
GF	→ Optimisme	→	Créativité	0.033	0.013	2.440	0.015	0.006	0.059

Effets totaux

		B	ES	z	p	IC 95%	
						Inférieur	Supérieur
GF	→ Créativité	0.107	0.052	2.074	0.038	0.006	0.209

Note. GF : Fréquence de pratique des jeux vidéo

Résultats

Nos résultats soutiennent la première hypothèse : les résultats indiquent une corrélation positive et significative entre fréquence de jeu et créativité au travail. Qui plus est la fréquence de jeu corrèle positivement avec trois des quatre composantes du capital psychologique : l'efficacité, la résilience et l'optimisme ; cette corrélation est également observée avec le capital psychologique global. Le capital psychologique global corrèle avec la créativité au travail, et les trois mêmes composantes corrélées avec la fréquence de jeu. Dans le cas des jeux et de la créativité, l'optimisme s'est ensuite avéré le meilleur prédicteur, du moins le plus parcimonieux. Nous avons donc pris en compte l'optimisme spécifiquement, plutôt que le capital psychologique dans son ensemble. Après avoir effectué une analyse de médiation, nous avons constaté une médiation complète des effets de la fréquence de pratique des jeux vidéo sur la créativité au travail, par le biais de l'optimisme (Tableau 3).

Conclusion

Cette étude apporte une première explication empirique quant au lien entre jeux et créativité. En adoptant une approche conative, nous avons examiné le rôle du capital psychologique comme potentiel médiateur du lien entre jeux vidéo et créativité au travail. Une médiation complète a été observée : la pratique des jeux vidéo est positivement associée à un optimisme plus élevé, qui à son tour est associé à une plus grande créativité au travail.

Article A5 – Jeux de société et créativité : le caractère joueur comme médiateur

Résumé détaillé

Objectifs

Dans la continuité de l'étude précédente, le présent article propose cette fois-ci d'étudier la relation entre pratique des jeux de société et créativité. En étant toujours situé sur une approche conative, cette étude identifie un autre médiateur potentiel : le caractère joueur (*playfulness*). Le caractère joueur peut être défini comme une disposition permettant aux individus de voir et concevoir leurs situations quotidiennes de manière à ce qu'elles soient divertissantes, intellectuellement stimulantes et personnellement intéressantes (Proyer, 2017). Les personnes joueuses ont tendance à rechercher et à créer des situations dans lesquelles elles peuvent interagir de manière ludique avec les autres et leur environnement. Le caractère joueur peut être compris comme étant composé de trois dimensions principales (Shen et al., 2014a, 2014b) : une motivation à rechercher du plaisir (*fun-seeking motivation*), la désinhibition, et la spontanéité. La motivation à rechercher du plaisir fait référence à la tendance à être "intrinsèquement motivé et mû par une valeur profondément ancrée", qui priorise l'amusement et le plaisir. La désinhibition correspond à la capacité à susciter un sentiment de liberté et de libérer son esprit en ignorant et en surmontant les contraintes et les obstacles perçus. Enfin, la spontanéité fait référence à la propension mentale à agir rapidement, sans réflexion profonde ni préméditation.

Le caractère joueur est conceptuellement et explicitement lié aux jeux, les individus joueurs recherchant le type d'activités que les jeux proposent (Proyer et al., 2019), mais aucun résultat empirique ne vient encore étayer cette affirmation théorique. Le caractère joueur est également liée à la créativité, plusieurs études ayant notamment montré des liens avec la créativité au quotidien et avec l'engagement dans des activités créatives.

Hypothèses

Deux hypothèses ont été formulées. Premièrement, la fréquence de pratique des jeux de société est associée positivement à la créativité. Deuxièmement, le caractère joueur agit comme médiateur du lien entre pratique des jeux et créativité.

Méthode

Les données ont été recueillies auprès de 327 travailleurs, recrutés en ligne sur les réseaux sociaux français (âge moyen = 41,3, *ET* = 9,83, 90 % de femmes). Selon la

Résumés des contributions

nomenclature des professions de l'Institut national de la statistique et des études économiques (INSEE), 28,1 % des participants étaient des cadres et professions intellectuelles supérieures, 26 % des professions intermédiaires et cadres moyens, 6,1 % des ouvriers qualifiés, 3,1 % des artisans, commerçants, chefs d'entreprise et profession libérale, 35,5 % des employés et personnel de service, et 1,2 % des étudiants (avec un emploi à temps partiel).

Cette étude adopte une mesure plus complète des habitudes de pratique des jeux de société, en mesurant trois aspects : la fréquence de jeu, le nombre total de jeux auquel l'individu a joué (la diversité), et le temps passé sur ses jeux préférés (la sélectivité). Cette étude utilise deux mesures pour opérationnaliser la créativité : la créativité au travail (Zhou & George, 2001a) et le concept de soi créatif (Karwowski et al., 2018), composé de l'auto-efficacité créative et de l'identité personnelle créative. L'utilisation de ces deux opérationnalisations de la créativité nous fournit à la fois des croyances et des perceptions sur la créativité d'une personne, ainsi que sa manifestation potentielle sur le lieu de travail. Les participants ont également rempli une mesure du caractère joueur chez l'adulte (Shen et al., 2014b).

Résultats

Les résultats observés corroborent nos hypothèses. Les habitudes en matière de jeux de société corrélaient avec deux dimensions du caractère joueur, la motivation à rechercher le plaisir et la désinhibition, mais pas avec la spontanéité (Tableau 5). En outre, la créativité au travail et le concept de soi créatif corrélaient tous les deux avec les habitudes de jeu de société. Enfin, ces deux indicateurs de créativité corrélaient avec toutes les dimensions du caractère joueur.

Tableau 4.

Matrice de corrélation

	Fréquence	Sélectivité	Diversité	FSM	Désinhibition	Spontanéité	CW	CSC
Fréquence	—							
Sélectivité	0.631 ***	—						
Diversité	0.824 ***	0.637 ***	—					
FSM	0.185 ***	0.156 **	0.206 ***	—				
Désinhibition	0.172 **	0.153 **	0.204 ***	0.511 ***	—			
Spontanéité	0.077	0.068	0.091	0.438 ***	0.524 ***	—		
CW	0.146 **	0.143 **	0.167 **	0.416 ***	0.266 ***	0.231 ***	—	
CSC	0.160 **	0.141 *	0.226 ***	0.373 ***	0.248 ***	0.244 ***	0.694 ***	—

Note 1. * $p < .05$, ** $p < .01$, *** $p < .001$

Note 2. FSM : Motivation à rechercher du plaisir, CW : Créativité au travail, CSC : Concept de soi créatif.

Résumés des contributions

Après avoir effectué une analyse de médiation, les deux dimensions du caractère joueur identifiées (motivation à rechercher le plaisir et désinhibition) médiatisent complètement les liens entre les habitudes en matière de jeux de société et la créativité au travail, et partiellement les liens entre les jeux de société et le concept de soi créatif (Figure 7). Les effets indirects totaux étaient à la fois larges et significatifs.

Figure 7.
Analyse de médiation

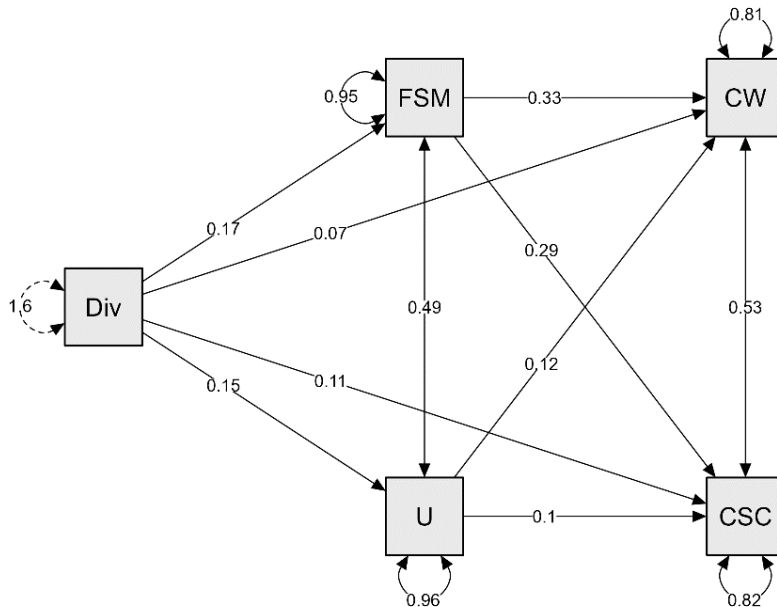

Note 1. Div : Habitudes de jeux (diversité), FSM : Motivation à rechercher du plaisir, U : Désinhibition, CW : Créativité au travail, CSC : Concept de soi créatif.

Conclusion

Cet article contribue à l'explication de la relation entre la pratique des jeux, plus spécifiquement les jeux de société, et la créativité. Une approche conative et dispositionnelle a été adoptée dans cette étude, en examinant le caractère joueur et ses dimensions. Dans les deux cas, les habitudes de jeu de société sont associées à une plus grande motivation à rechercher le plaisir et à plus de désinhibition, qui sont associées à leur tour à un concept de soi créatif plus élevé et une plus grande créativité au travail.

Partie 2 :
Articles scientifiques

Games and Creativity: A Theoretical Framework

Maxence Mercier^{1*}, Samira Bourgeois-Bougrine¹, and Todd Lubart¹

¹ Université Paris Cité and Univ Gustave Eiffel, LaPEA, F-92100 Boulogne-Billancourt,
France

Author Note

Maxence Mercier  <https://orcid.org/0000-0001-9045-2032>

Samira Bourgeois-Bougrine  <https://orcid.org/0000-0001-5083-1177>

Todd Lubart  <https://orcid.org/0000-0002-8776-8797>

We have no known conflict of interests to disclose.

Correspondence concerning this article should be addressed to Maxence Mercier, Université Paris Cité, LaPEA, 71 avenue Edouard Vaillant, 92100 Boulogne-Billancourt Cedex, France.
Email: mercier.maxence96@gmail.com

APA Reference:

Mercier, M., Bourgeois-Bougrine, S., & Lubart, T. (submitted). Games and Creativity: A Theoretical Framework. *Review of General Psychology*.

Abstract

This article introduces a theoretical framework centered on enhancing creativity through gaming, termed the Game-based Creativity Enhancement Framework (G-CEF). Rooted in experiential learning and game-based learning theories, the framework adopts an input-process-output paradigm: two inputs (personal attributes and game attributes), one process stage (learning situation), and outputs (learning improvements and acquisitions). Personal attributes take the form of conative dispositions and variables common to both creativity and games, which help explain why gaming habits and creativity are linked, particularly outside the laboratory. Several variables are identified and presented: playfulness, imagination, mind wandering, mindfulness, psychological capital and motives. The second input corresponds to game attributes, which help explain why and how games can help improve creativity. Two forms of game attributes are presented: affordances and game mechanics. Eight types of affordances were identified: degree of flexibility, narrative, tools, environment, content creation, avatar, progression and replayability. Five types of game mechanics were also identified: originality, divergent thinking, convergent thinking, mental flexibility and creative dispositions. The learning situation within games embodies a four-step cyclical experiential learning process: concrete experience, reflective observation, abstract conceptualization, and active experimentation. Lastly, the framework details enhancements in creativity due to gaming, supported by a literature review examining the impact of different game types on creativity.

Keywords: creativity, games, theoretical framework, game-based learning, experiential learning

Introduction

Creativity is arguably one of the most critical skills of our contemporary era (Kaufman et al., 2017). Throughout history, the capacity to generate novel and contextually relevant ideas has served as the driving force behind artistic masterpieces and societal progress (Archibugi et al., 2013). From Leonardo da Vinci's visionary concepts to Marie Curie's scientific breakthroughs, creative individuals have shaped the course of human civilization (Kaufman & Beghetto, 2009).

The significance of creativity extends far beyond its association with renowned figures. It permeates our daily lives, influencing both personal and professional spheres (Conner et al., 2018). In the professional sphere, creativity is associated with enhanced performance, innovation, and job satisfaction (Gong et al., 2019; Yee et al., 2014). Forward-thinking organizations recognize the value of fostering a creative work environment that encourages employees to think outside the box, explore new possibilities, and generate innovative solutions (Amabile, 1988, 2018). Moreover, creativity holds profound implications for personal well-being and fulfillment. Engaging in creative pursuits at home cultivates a sense of pleasure, self-expression, and fulfillment (Benedek et al., 2020). Whether it involves painting, writing, or cooking, creative endeavors provide an avenue for individuals to unleash their imagination, channel their emotions, and engage in meaningful self-expression (Kaufman & Beghetto, 2009; Silvia et al., 2014). The impact of creativity also extends to resilience and adaptability during challenging times. In the face of adversity and uncertainty, creative individuals possess the ability to think differently, find unconventional solutions, and adapt to changing circumstances (Orkibi, 2021).

Recognizing the potential for enhancing creativity, researchers and practitioners have developed various methods and techniques to nurture this skill (Sternberg, 2019). The common thread among these methods is the acknowledgment that creativity is not an innate talent but a trainable skill that can be honed through practice and experience. This paper adopts the view that effective creativity training and enhancement aligns with experiential learning.

In other words, creativity gains stem from active engagement and hands-on, concrete experience with creative activities. Furthermore, this paper argues that game-based learning constitutes an effective and cost-efficient operationalization of experiential learning. This is because games provide an engaging and stimulating environment, where learners can explore, practice and experiment with target skills. The main proposition of the paper is as follows:

games constitute an effective and cost-efficient way to improve and learn creativity, through optimal experiential learning. As such, a comprehensive framework is introduced : the Game-based Creativity Enhancement Framework (G-CEF).

Creativity

Creativity is a complex and multifaceted construct that has captured the interest of researchers, educators, and practitioners across various disciplines. At its core, creativity involves the generation of novel and useful ideas, products, or solutions to problems (Sternberg & Lubart, 1999). Given its importance in driving innovation, problem-solving, and adaptability, understanding the nature of creativity and the factors that promote its development has become an essential area of inquiry in psychology and related fields.

One influential model that offers a comprehensive understanding of creativity is the Four C Model, proposed by Kaufman and Beghetto (2009). This model categorizes creativity into four distinct but interrelated levels: mini-c, little-c, Pro-c, and Big-C creativity. Mini-c creativity refers to the personal insights and discoveries that individuals make as they engage in creative problem-solving or self-expression. Little-c creativity involves everyday problem-solving and the generation of novel ideas or solutions within familiar contexts. Pro-c creativity refers to the professional expertise and creative accomplishments demonstrated by individuals who have mastered a specific domain. Finally, Big-C creativity represents the groundbreaking, transformative contributions made by eminent creators, whose work has a lasting impact on their respective fields. The Four C Model underscores the importance of recognizing and fostering creativity at different levels and in various contexts, highlighting the idea that creativity is not limited to exceptional individuals but is a capacity inherent in everyone (Kaufman & Beghetto, 2009). This perspective aligns with the multivariate approach of creativity (Lubart et al., 2015).

A multivariate approach to understanding creativity encompasses cognitive, conative/dispositional, affective/volition-related, and contextual factors. This approach emphasizes the complex interplay of these factors in shaping creative thinking and behavior, while recognizing that creativity is not limited to exceptional individuals but is a capacity inherent in everyone (Kaufman & Beghetto, 2009).

Cognitive factors involved in creativity include the ability to engage in divergent thinking, which involves generating multiple, varied solutions to open-ended problems (Runco & Acar, 2019), as well as convergent thinking, which entails synthesizing diverse ideas,

evaluating and selecting the most effective solution from a range of alternatives (Cropley, 2006). Creative thinking also requires the ability to make remote associations, draw on analogical reasoning, and shift between various perspectives or mental states (Ward & Kolomyts, 2010). Research on cognitive factors has also expanded to include the role of cognitive flexibility and executive functions in facilitating creative thinking (Benedek et al., 2014).

Conative or dispositional factors, such as personality traits have also been linked to creativity. For instance, traits such as openness to experience, tolerance for ambiguity, and self-efficacy have been associated with higher levels of creative thinking and behavior (Feist, 2010; Karwowski & Lebuda, 2016). Additionally, research has highlighted the role of cognitive style, or the preferred way individuals process information and approach problem-solving, in shaping creativity (Kozbelt et al., 2010).

Affective and volition-related factors, including motivation and emotion, play a significant role in creativity as well. Intrinsic motivation, or the inherent drive to engage in an activity for its own sake, has been consistently linked to enhanced creativity (Amabile, 1996; Hennessey & Amabile, 2010). Furthermore, specific emotional states, such as positive affect, can promote cognitive flexibility and the generation of novel ideas (De Dreu et al., 2008).

Contextual factors encompass social, cultural, and environmental influences that can shape creativity by either facilitating or constraining the expression of creative ideas and behavior (Glăveanu, 2010). For example, supportive and diverse environments that encourage risk-taking, collaboration, and the exchange of ideas can foster creativity (Amabile, 1996; Hunter et al., 2007). Moreover, cultural values, norms, and expectations can influence the perception, evaluation, and development of creative ideas and products (Glăveanu, 2010).

Creativity Enhancement

Creativity is increasingly important, valuable, and valued (Archibugi et al., 2013). It is equally important to examine if and how creativity can be enhanced. Creativity enhancement methods are designed to help people develop more of their potential. Different approaches exist and target various aspects of creativity (Haase et al., 2023): cognitive, social, attitudinal, motivational, environmental. Training creativity entails an understanding of the creative process and the acquisition of creativity-related skills and techniques enabling creative effort.

A recent meta-analysis (Haase et al., 2023), found that, across 332 effect sizes from 84 studies, creativity could indeed be improved and trained, furthering Scott et al. (2004) previous review. The effect size was medium ($g = 0.53$) and demonstrated that 70.09% of participants in experimental conditions were more creative than participants in control groups. Furthermore, 32% of studies found an effect larger than the average effect size found by Scott et al., of 0.68.

Experiential Learning

This paper proposes that most creativity enhancement methods are aligned with experiential learning theory. Experiential learning can be described as “the process whereby knowledge is created through the transformation of experience. Knowledge results from the combination of grasping and transforming experience” (Kolb, 1984, p. 41). Experiential Learning Theory (ELT) provides a holistic model of the learning process, notably in adult development. It emphasizes the central role of experience in the learning process. As such, ELT is distinct from cognitive learning theories that emphasize cognition over affect, and from behaviorist learning theories which deny any role for subjective experience (Kolb, 1984). ELT argues learning cannot occur without “hands-on” experience (Morris, 2020).

Learning occurs in a four-part cyclical process. First is concrete experience (CE) which asks students to participate/engage in a new experience. Second is reflective observation (RO), which asks students to gain a self-awareness of their cognitive and affective response to the new experience. Third is abstract conceptualization (AC), which asks students to connect their old knowledge and experience to new thoughts, feelings, and experiences, in order to conceptualize situations from a fresh perspective. Finally, there is active experimentation (AE), when students apply their new ideas to other experiences.

These four stages repeat themselves throughout the learning process, in both bottom-up and top-down dynamics. Specific experience is transferred to an abstract conceptualization upon reflection, which is then actively tested through new experiences. Immediate or concrete experiences serve as the basis for observation and reflection. These reflections are then assimilated and distilled into abstract concepts from which new implications for action can be drawn. Afterwards, these implications can then be actively tested and serve as guides for new experiences to come.

Game-Based Learning

Game-Based Learning (GBL) is an instructional approach that integrates digital or non-digital games into the learning process to engage learners and enhance their knowledge, skills, and motivation (Prensky, 2001). GBL leverages the intrinsic and extrinsic motivational factors of games, such as challenge, competition, and rewards, to foster a learning environment that is interactive, immersive, and adaptive (Plass et al., 2015).

The potential of game-based learning lies in its ability to motivate and engage learners. Games often include elements such as points, badges, leaderboards, and levels that create a sense of competition and achievement, thereby enhancing learner motivation (Kapp, 2012). They also provide immersive narratives and rich, interactive environments that captivate learners' attention and stimulate their imagination.

Game-based learning can facilitate both individual learning and collaborative learning. Single-player games can offer personalized learning experiences that adapt to individual learners' needs and progress. On the other hand, multiplayer games can promote teamwork, communication, and negotiation skills as learners work together to achieve common goals (Plass et al., 2015).

Importantly, game-based learning offers learners opportunities for practice and repetition, which are essential for mastering new skills and knowledge. Well-designed games provide immediate feedback, allowing learners to recognize their mistakes, understand the correct responses, and adjust their strategies accordingly (Shute et al., 2009).

Integrating Experiential Learning and Game-Based Learning

Both approaches view learning as a dynamic process that requires active engagement and application. What's more, game-based learning provides a fertile ground for experiential learning. Learners/players can go through and experience the different stages of the experiential learning process, and repeat this process thanks to the iterative nature of games.

Concrete Experience. Concrete experience is the cornerstone of experiential learning theory. In EL, learners are involved, active and engaged participants in the learning process. This participation is central, as learning by doing cannot occur without it (Munge et al., 2018). It is a hands-on task-oriented process (Blair, 2016), based on direct experience, and thus requires active participation from learners. In the context of game-based learning, this stage involves learners physically and intellectually engaging with the game mechanics and

dynamics. They not only interact with the game environment but also with other players, thus enabling a multifaceted, hands-on experience (Blair, 2016; Jordan et al., 2018). Knowledge is situated in contexts, and interactions with the material and with other participants are key (Harper, 2018).

Learning involves risk, as EL incorporates novel and challenging experiences. The uncertainty and unpredictability inherent in games resonate with the risk-taking element of experiential learning (Davidson et al., 2016). The challenges posed by games require learners to step outside their comfort zones and confront novel experiences, which can already stimulate creativity (Cropley, 2006).

Reflective Observation. Reflective Observation (RO), the second phase of Kolb's experiential learning cycle, involves introspective analysis and critical reflection on the experiences from the first stage (Kolb, 1984). This involves examining one's own reactions and the situation's consequences, thereby extracting insights from the concrete experience. This process of reflection allows learners to view the experience from different perspectives and gain a holistic understanding of the event (Kolb et al., 2001). In the context of game-based learning, this stage requires learners to reflect upon their actions, decisions, and outcomes within the game (Whitton, 2012). They scrutinize their strategies, interpret feedback, analyze their successes and failures.

Games tend to involve complex, multifaceted scenarios that require players to adopt different perspectives and approaches. This process allows them to identify patterns, question assumptions, and develop new insights (Moon, 2004). Furthermore, the social aspect of many games encourages players to reflect not only on their own actions but also on their interactions with other players (Steinkuehler & Duncan, 2008). Reflective observation serves as a bridge between practical, hands-on experiences and the abstract cognitive processes of learning, allowing learners to transform their experiences into valuable insights that inform the next stages of learning.

Abstract Conceptualization. The third phase in Kolb's experiential learning cycle, Abstract Conceptualization (AC), involves cognitive structuring of reflections into coherent, abstract concepts (Kolb, 1984). In this phase, the learner synthesizes reflections from the RO stage into structured theories, creating or modifying existing conceptual frameworks to make sense of their experience. This cognitive transformation of experiential insights into intellectual constructs allows learners to understand the underlying principles and relationships that govern

the experienced event (Kolb et al., 2001). In the context of game-based learning, players draw upon their reflective observations and formulate theories or strategies that they can employ in the game. These theories involve novel approaches to overcoming game obstacles or achieving objectives. Games provide learners opportunities to and require them to understand complex systems and rules, pushing them to develop and refine their abstract thinking abilities (Squire, 2006).

This stage enables learners to generalize and apply their learning across different contexts. In games, learners also generalize their experiences and abstract theories, finding connections between game scenarios and real-world contexts (Garris et al., 2002). This process of abstraction promotes transferable skills that can be applied beyond the game environment.

Active Experimentation. Active Experimentation (AE), the final stage of Kolb's experiential learning cycle, entails applying the abstract concepts formulated in the previous stage to new situations (Kolb, 1984). In this stage, learners test the validity and applicability of their abstract theories, refining further their understanding through the outcomes of these applications (Kolb et al., 2001). Within game-based learning, this phase involves the application of conceptualized strategies and solutions to new game scenarios or challenges (Whitton, 2012).

The iterative nature of games, with multiple levels or scenarios, allows learners to experiment with their strategies, adapt to new situations, and refine their understanding based on the outcomes. The dynamic and often unpredictable game environment fosters a culture of trial-and-error, encouraging learners to take risks (Henriksen et al., 2021). Moreover, the collaborative nature of many games facilitates collective experimentation, where learners can test their solutions in a social context and learn from their peers' strategies (Steinkuehler & Duncan, 2008). This stage fosters a pragmatic approach to learning, encouraging learners to actively engage with their environment and learn from their interactions (McCarthy, 2010). Active experimentation concludes one cycle of learning, paving the way for the next cycle to begin with a new concrete experience.

Figure 1.
Game-based Creativity Enhancement Framework

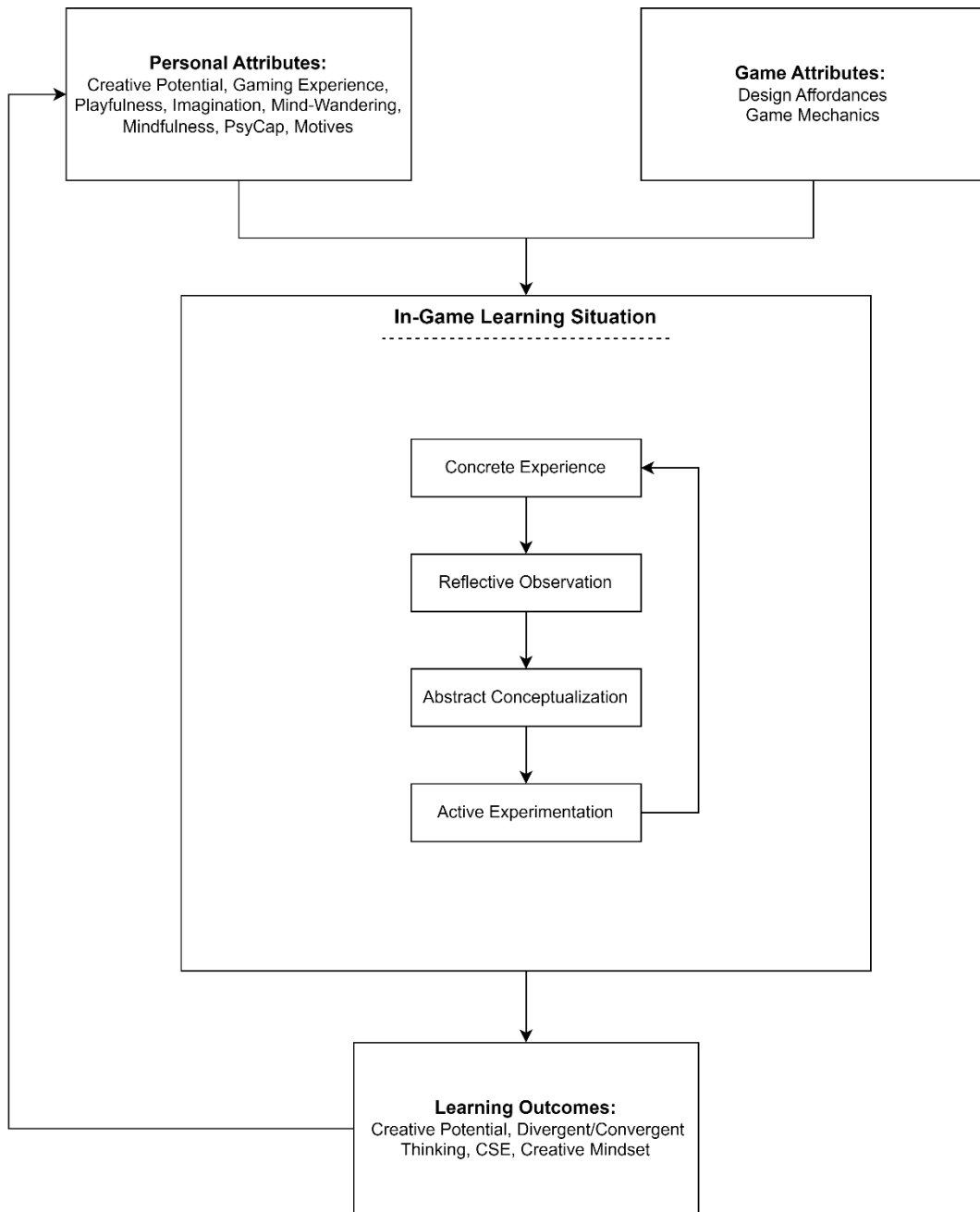

The Game-based Creativity Enhancement Framework (G-CEF)

This paper aims to propose a comprehensive framework, based on experiential learning theory and game based-learning, while focusing specifically on creativity enhancement: the Game-based Creativity Enhancement Framework (G-CEF). In line with this objective, the framework adopts an input-process-output paradigm (Figure 1): two inputs (personal and game attributes), a process stage (the in-game learning situation) and outputs (i.e., learning

outcomes). The first input corresponds to the person attributes. Creativity is influenced by numerous factors: openness to experience, tolerance of ambiguity, imagination, etc. Personal attributes refer thus to dispositional constructs common to both gaming habits and creativity: playfulness, imagination, mind-wandering, mindfulness, and psychological capital. Second are situational factors/game attributes. This second input refers to elements in games that are conducive to creativity and participate to improve or facilitate it. This includes game design affordances, and game mechanics. Three forms of games are included in the present framework: video games, board games, and role-playing games.

The in-game learning situation integrates experiential learning and its four-stage process: concrete experience, reflective observation, abstract conceptualization, and active experimentation. This four-stage process corresponds to the actual game experience, and the learning processes which occur within. Finally, learning outcomes refers to different aspects and manifestations of creativity that are or could be improved upon through game play. This includes both short-term and immediate effects of game play, as well as potential long-term and transfer of learning.

Personal factors

Several cross-sectional studies have linked creativity and gaming habits, examining various game types. Cross-sectional studies examining the relationship between video game play and creativity have produced mixed findings. On one hand, Jackson et al. (2012) and Blanco-Herrera (2019) found significant positive correlations between video game play and indicators of divergent thinking and graphic creativity, respectively, suggesting that habitual engagement in video games may contribute to the development of specific dimensions of creativity. Similarly, Mercier & Lubart (2023b) conducted a questionnaire-based survey of 370 workers and found that playing video games was associated with higher creativity in the workplace. On the other hand, Čábelková et al. (2020) reported a negative correlation between video game play time and emotional creativity, indicating that excessive video game play may be associated with decreased emotional creativity.

Cross-sectional research on role-playing games has also shown associations with creative outcomes. Chung (2013) compared the creativity of tabletop role-playing game players, online role-playing game players, and nonplayers. Results showed that tabletop gamers were more creative than non-gamers, with online gamers falling between the two groups. This

finding implies that engagement in role-playing games, particularly in their tabletop form, may be associated with enhanced creativity.

Lastly, preliminary evidence has appeared regarding board games. Mercier & Lubart (2023a) found significant positive correlations between the frequency of playing board games and various indicators of creative potential, such as openness, originality in divergent thinking, creative self-efficacy, and creative personal identity. These correlations suggest that engaging in board game play over time may contribute to the development and strengthening of creative abilities and dispositions. Although causality cannot be inferred from these correlations, the findings imply a potential link between habitual board game play and the enhancement of creative potential.

Here we propose some common denominator that could explained the links between gaming habits and creativity : playfulness, imagination, mind-wandering, mindfulness, psychological capital, and motives.

Playfulness

Playfulness can be understood as an individual difference variable that allows people to frame or reframe everyday situations in a way to experience them as entertaining, intellectually stimulating and personally interesting (Proyer, 2017). They have a preference for complexity over simplicity, and for unusual activities, topics and persons (Proyer et al., 2019a). Furthermore, they are capable of using their playfulness under difficult conditions to resolve tension. Early playfulness research focused predominantly on children (Guitard et al., 2005), leading to sporadic research for adults. This could be explained because of two perceptions. First, social manifestation of playfulness can be seen as less acceptable among adults (Lieberman, 1977). Second, playfulness seems to lack apparent practical usefulness (Olsen, 1981). However, playfulness is ubiquitous among adults as much as it is in children (Sutton-Smith, 1966), and seems to be even more permeating as we grow older. The forms of playfulness behaviors expand from sensorimotor play to more frequent social, imaginative and cognitive play (Lieberman, 1977). The expression of playfulness increasingly crosses the boundaries of work and leisure, and “extends to all life situations” (Guitard et al., 2005, p. 19).

Playfulness is explicitly linked to games, as playful individuals seek the kind of activities that games provide (Proyer et al., 2019a), however no empirical results yet support this theoretical assertion. Additionally, playfulness is also linked to creativity. Proyer (2012) conducted a princeps study on students ($N = 212$). He observed that playfulness was correlated

to self-rated creativity ($r = .26$). However, it was not correlated with either fluency or originality. The links between playfulness and creative activities were also examined (Proyer et al., 2019b), using the K-DOCS (Kaufman, 2012), a measure of creative behaviors in five domains. Focusing on adult employees, playfulness was associated with everyday creativity ($R^2 = .18$), performance creativity ($R^2 = .24$) and artistic creativity ($R^2 = .26$).

Imagination

Imagination is another construct that can be associated with both games and creativity. Imagination refers to the “formation of ideas, images and concepts in one’s mind’s eye” (Zabelina & Condon, 2020). It is conceptually close to mental imagery, which refers to the extent to which one is able to generate a sensory experience from information stored in memory (Kosslyn et al., 2001). Imagination has long been construed as the ability to conjure such mental imagery, that is, visualization in the absence of stimuli (Pearson et al., 2015). However, Zabelina & Condon (2020) argue that imagination encompasses a wide range of sensory modalities and affects an equally wide range of outcomes. Imagination refers broadly to the capacity to construct that which is not currently present to the senses (R. J. Gotlieb et al., 2019). We engage in it intentionally and unintentionally, solitarily, and collectively.

Imagination can be seen as the seed of creativity (R. J. Gotlieb et al., 2019). Imagination lays the foundations for and is important to creativity. One notable form of imagination in that regard is social-emotional imagination, broadly defined as the ability to conceive and reflect on various social perspectives and scenarios, and their implications (Gotlieb et al., 2016). The manifestations of this form of imagination, such as perspective-taking, support individuals’ and groups’ creativity by helping them understand the variety of experiences and situations, inside and outside themselves (Sawyer, 2017; Taylor et al., 2003), and appreciate the diversity of views and approaches to problems (Hoever et al., 2012).

Individuals need enriching environments to provide fodder for their imagination, to produce creativity. We argue that games can help nurture and nourish imagination, notably through exposition to worlds and stories. Hayes et al. (2015) argued imagination was the catalyst that links abstract consciousness to the generation of material experience. Through imagination, individuals become immersed in a space of play in which possible worlds and selves can be imagined. Video games offer a great opportunity to enable the presentation of imaginary scenes and help transport players to different worlds and spaces, thus enriching imagination (Cheng, 2021). Role-playing games are particularly apt in this regard. Role-playing

games are games in which players create and embody an imaginary character, who then acts and moves in a defined world and in situations created and narrated by a game master (Karwowski & Soszynski, 2008). By their very nature, role-playing games involve a notion of shared fantasy, engaging individual imagination, through the guidance of the game master (Hughes, 1988).

One particularly relevant area of research on imagination and creativity concerns the study of the links between pretend play and creativity (Russ & Doernberg, 2019). Pretend play is a symbolic behavior in which “one thing is playfully treated as if it were something else” (Fein, 1987, p. 25). For example, a piece of wood becomes a sword, or a shoelace becomes a snake. At its core, pretend play represents a natural form of creativity in childhood (Fein, 1987). Pretend play represents a vehicle for the expression of many processes important in creative production (Russ, 2016), as well as a vehicle for practicing with ideas and images (D. G. Singer & Singer, 2009). In pretend play, children use objects to represent other objects, make up stories, use fantasy and role-play, feel and express affects. Play introduces the child to the feeling that accompanies creative expression.

There has been notable focus on the relation between play and divergent thinking, the ability to generate multiple ideas or solutions (Guilford, 1967). Play is practice with divergent thinking (Singer & Singer, 2005). Singer (Singer & Rummo, 1973) found a relation between play and DT in kindergarten boys; Wyver & Spence (Wyver & Spence, 1999) found the same results in preschoolers. There have been longitudinal studies, showing that pretend play predicts divergent thinking four years later (Russ et al., 1999; Wallace & Russ, 2015). Notably, Wallace showed components such as affect expression and narrative organization were associated with creativity over time. Fehr & Russ (2016) found correlations between pretend play and creative storytelling in preschoolers, and Hoffman & Russ (2012)(2012) found similar results in primary school students. Therefore, there seems to be good evidence for the link and its stability over time (Russ & Doernberg, 2019).

Mind-wandering

Creativity can stem from seemingly contradictory processes (Agnoli et al., 2018). It can occur from lack of executive control over one’s mental activity, which could be described as getting lost in one’s own thoughts; in other words, mind-wandering. On the other hand, it can be the awareness of one’s own thoughts, affects and sensory experiences, as well as the exclusion of distractions that can lead to finding creative solutions and ideas ; this is

mindfulness. This part will focus on the first phenomenon, mind-wandering. Mind-wandering occurs when attention drifts away from an on-going task and external environment towards internal thoughts unrelated to the task, such as memories and prospective thoughts (Smallwood, 2013). This experience can also be described as “having one’s attention shifting away from the objective world and its related perceptual input, and towards internal reflection” (McMillan et al., 2013).

Mind-wandering has been associated with maladaptive outcomes, such as reduced executive and attentional controls, but it can be also seen as a valuable cognitive capacity. Notably, mind-wandering might help better one’s performance when occurring during an incubation period (Baird et al., 2011). Links between mind-wandering and creativity can be explained by an increase in unconscious associated processing, which produces a spreading activation conducive to higher creativity (Baird et al., 2012). However, results have sometimes been contradictory (Hao et al., 2015), which can be attributed to the unidimensional view of mind-wandering as involuntary. Mind-wandering should instead be decomposed in deliberate or spontaneous forms. That is, whether it emerges spontaneously or, somehow, under the individual’s mental control. In deliberate mind-wandering, attention is intentionally shifted from the focal task towards internal thoughts (Chiorri & Vannucci, 2017), as opposed to the uncontrolled shift observed in spontaneous mind-wandering. Agnoli et al. (2018) showed that deliberate mind-wandering was a positive predictor of creativity (notably originality), whereas spontaneous mind-wandering was a negative predictor instead. The control over mind-wandering can be considered a central element in the creative production, as it may be increasing originality by increasing new and unrelated thoughts into the thinking process (Preiss et al., 2020).

Mind-wandering intersects with the realm of games through the concept of Game Transfer Phenomena (GTP). GTP refers to the carryover of game elements, images, and experiences from virtual environments to the real world, blurring the line between game-related mental content and daily life (Ortiz de Gortari & Griffiths, 2016). This phenomenon can be seen as a manifestation of mind-wandering, where players' attention shifts from the external environment to their internal thoughts, often containing elements of gameplay, even when not actively engaged in gaming. This phenomenon occurs in virtually all players. As shown in Ortiz de Gortari & Griffiths’ descriptive analysis (2015), 96.6% of video game players reported having experienced GTP, and the majority reported having experienced it more than once (95.3%).

Mindfulness

In contrast to mind-wandering, there is mindfulness. Mindfulness refers to a state of conscious, sustained, and focused awareness resulting in a nonjudgmental attention to the present moment (Tang et al., 2015). This concept stems from the Buddhist meditation tradition, which suggests this state can be reached and improved upon through meditation. Mindfulness is a non-elaborative, present-centered awareness where all thoughts and feelings are acknowledged and accepted (Bishop et al., 2004). In mindfulness, attention is regulated such that increased awareness is brought to the current field of thoughts, feelings, and sensations, while additionally being immersed non-judgmentally in the present moment. This specific state of mind can be very useful in disengaging individuals from automatic thoughts and habits (Baer et al., 2004).

Early studies on the links between mindfulness and creativity have produced mixed results. Ostafin & Kassman (2012) observed that mindfulness benefitted the ability to solve insight problems. This might be due to the reduced tendency to rely on habitual responses when searching for a solution. In contrast, Zedelius & Schooler (2015) found opposite results, i.e., a decrease in performance on insight problems. These contradictions are probably due to the multidimensional nature of mindfulness. It is composed of five dimensions : observing, acting with awareness, describing, being non-reactive, and not judging. Drawing on this multidimensional approach, Baas et al. (2014) found very consistent findings, as only the ability to observe and attend to the stimuli (observing) predicted creativity, across a series of four studies. In a study by Agnoli et al. (2018), results indicated that the ability to describe one's feelings and beliefs with words (describing) was the main predictor of creative achievements, as measured by the CAQ (Carson et al., 2005). On the other hand, the ability to not react to inner experiences (being non-reactive) was negatively associated with originality. Originality is associated with the ability to feel and recognize intense new feelings that might be externalized, especially so in the arts (Silvia, 2005). Mood states affect evidently creativity; being non-reactive to such states blocks their beneficial effects on originality.

Mindfulness can be linked conceptually to flow, a mental state occurring when there exists a balance between challenge and skills, which includes awareness, a sense of calm control and absorption in the present activity (Marks, 2008). Gackenbach (2008a) found frequent players reported more flow experiences than infrequent or non-players. Sherry (2004) argued that games, "particularly video games", possess ideal characteristics to create and maintain flow experiences, which can be extrapolated to mindful states as well. Gackenbach (2008b) likened

games to a form of meditation practice. Due to the absorption in meditation, mindfulness should be associated with playing games, through immersion and/or absorption.

Psychological Capital

Psychological Capital (PsyCap) has long been associated with creativity, notably in the workplace. PsyCap is a higher-order construct that can be referred to as a person's positive psychological state (Luthans et al., 2007). PsyCap is characterized by four components: “(1) having confidence (efficacy) to take on and put in the necessary effort to succeed at challenging tasks; (2) making a positive attribution (optimism) about succeeding now and in the future; (3) persevering toward goals and, when necessary, redirecting paths to goals (hope) in order to succeed; and (4) when beset by problems and adversity, sustaining and bouncing back and even beyond (resiliency) to attain success” (Luthans et al., 2015, p. 4). Several studies found links between creativity and overall PsyCap. For instance, Sweetman et al. (2011) found that overall PsyCap predicted divergent thinking over and above the four individual components. This finding was observed as well for self-reported creativity (Cai et al., 2019). Using a component-focused approach, Yu et al. (2019) found that components contribute in different ways to creativity, with hope and optimism as the strongest predictors, and resilience acting as a mediator between these two components (hope and optimism) and creativity.

Similarly, PsyCap and its components can be linked to games. Adversity is a core aspect of games, and notably video games. To face setbacks and difficulty, a specific mindset is necessary. Failure or loss is commonplace and often encountered while playing most games, and thus hope and resilience are often required, else one would usually quit easily. The importance of defeat can also be reflected in another component of PsyCap, optimism. To persevere through adversity, an optimistic style is essential. There may be a temptation to give up when playing games and experiencing failure. In such situations, being optimistic can prove helpful, as an optimistic style enables one to see negative events as temporary and thus surmountable, even more so when such efforts usually end in rewarding outcomes.

Mercier & Lubart (2023b) conducted a questionnaire-based study, examining the links between video games and creativity, with a potential mediation via PsyCap explaining this relationship. Their findings show a full mediation of the link between playing video games and workplace creativity, through optimism: playing video games was positively associated with higher optimism, which in turn was associated with more creativity in the workplace.

Motives

What motivates people to engage in creativity (and in games)? Creativity has been consistently linked to intrinsic motivation, suggesting creative work is often interesting and satisfying in itself. This does not imply the contrary with extrinsic motivation, as they can act independently (Amabile et al., 1994). However, overall mixed results have been found for extrinsic motivation (Hegarty & Plucker, 2012). Beyond these two types of motivation, one can wonder as to what exactly motivates people to pursue creative endeavors. Benedek et al. (2020) conducted a comprehensive review of the literature, in which they identified nine specific motives for creativity: enjoyment, expression, challenge, coping, social, prosocial, recognition, material, and duty. First is enjoyment, that is, doing something because it is enjoyable, fun, pleasurable (Amabile et al., 1994). Expression refers to the motive to express one's feelings, emotions or thoughts towards others or oneself (Gould et al., 2008; Hegarty, 2009). Challenge corresponds to the desire to achieve something, to expand one's skills or knowledge, and to prove one's competence (Beard & Ragheb, 1983; Manfredi et al., 1996). It is akin to the need for competence (Ryan & Deci, 2000). Coping corresponds to the need for tension reduction and the desire for emotional calm (McGuire, 1974; Reiss, 2000). The social motive refers to the wish to spend time with others and be close to them. This is one of the most consistent motives (Tay & Diener, 2011) and one that is akin to the need for relatedness (Reiss, 2000; Sheldon et al., 2001). The prosocial motive is an altruistic aim to help and/or bring pleasure to others (Auger & Woodman, 2016; Beard & Ragheb, 1983). Recognition refers to the desire to gain acceptance, acknowledgement or even admiration from others (Reiss, 2000; Sheldon et al., 2001). The material motive means carrying out activities in pursuance of monetary rewards and/or material compensation (Gould et al., 2008). Finally, duty corresponds to the general feelings of responsibility or obligation, the feeling that "something has to be done" (Bernard et al., 2008; Ryan & Deci, 2000).

These nine motives for creativity could, for the most part, be equivalent to the motives that people possess for playing games. Early on, Beard & Ragheb (1983) identified common motives for leisure activities, such as games: intellectual challenge (challenge), social contact (social and prosocial), the experience of competency (challenge) and the wish to relieve stress and tension (coping). Enjoyment is also the evident and primary motivation behind playing games (Cheah et al., 2022; Sweetser & Wyeth, 2005). Expression can also be driving some individuals to play, notably in the case of sandbox games. Challenge is a core aspect of games, and thus a main motivation for people who like playing games of all sorts (Cheah et al., 2022).

Coping is also present in many gaming habits, as playing soothing games can help reduce tensions and promote well-being (Barr & Copeland-Stewart, 2022; Pearce et al., 2022), and more violent games could be seen as cathartic as well (Lee et al., 2021). The social motive is one that is shared by many who play massively multiplayer online role-playing games (Cheah et al., 2022; Cole & Griffiths, 2007). Furthermore, games provide an occasion to reunite friends around a board game or play with long-distance friends in online video games. Prosocial motives are best exemplified in people who opt to play support or healing roles in games, notably video games. Recognition can be seen in players who engage in highly competitive games. Material and duty motives, although rare, could also be construed as motives to play games. Esports (electronic sports) are one such example, referring to competitive video gaming where teams or individuals compete against each other in a video game (Bányai et al., 2020). This is highlighted by the colossal expansion of high school esports developmental programs (e.g., Hennick, 2019) and the high earning potential of esports players, in terms of salaries, cash prizes and sponsorships (Bányai et al., 2020; Newzoo, 2019).

Game Attributes

Three types of games are included in this framework: video games, board games and role-playing games. Video games refer to electronic games that involve human interaction with a user interface, generating visual feedback on a screen. They encompass a wide variety of genres, platforms, and interactivity levels. Video games are characterized by goals, challenges, rules, and user-generated inputs that affect on-screen outcomes (Li, 2008; Tavinor, 2008). A board game is a game with a certain number of rules that limit the possibilities, that requires a physical medium (e.g., a board, cards, dice) and that is played by two players or more (Gobet et al., 2004). Role-playing games are narrative-driven storytelling games where players assume the roles of characters in a fictional setting, directed and narrated by a game master (Hughes, 1988; Karwowski & Soszynski, 2008). Actions and outcomes are determined via the combination of character decisions, rules, and dice rolls, enabling players to co-create and navigate through narratives.

This section is divided into two parts. The first one focused on how games can provide opportunities to be creative, inside and outside of the game. These affordances can help explain the links between gaming frequency of play and creativity. As many games can provide such affordances, people who play more games encounter them more often, in turn this affects potentially their creativity. The second part focuses more specifically on games that are

explicitly beneficial for creativity. That is, how particular games target, solicit and require some aspects of creativity within their mechanics, in turn improving creative potential outside of the game.

Design Affordances

Many definitions for affordances have been proposed over the years, from Gibson's (1977) actionable properties of an environment, to Cardona-Rivera and Young (2013) simpler definition as "opportunities for action" or Kim & Shute's (2015) opportunities for a certain behavior. In many cases, affordances are contextually defined and domain-specific. In this paper, we will use Hall et al. (2021) definition of affordances, which corresponds to the opportunities provided by a game for creative actions, behaviors, or thoughts.

Affordances play a key role in creative behavior, as interactions with the situation or environment can affect creativity (Amabile, 1996). Glăveanu (2013) argued that affordances can either allow or constrain creativity, as a creative individual can utilize available affordances in a novel manner. Cardona-Rivera and Young (2013) proposed a theory of affordances in games and identified three types: (1) real affordances, relating to actual game actions; (2) perceived affordances, relating to what a player perceives as possible in the game; (3) feedback affordances, relating to perceptual information targeted at promoting real affordances. The relation between perceived and real affordances is affected by wider factors, as a player's experience, history and beliefs will affect how they perceive affordances in a specific game. For instance, having played a similar type of game previously might affect the extent to which they perceive affordances.

Multiple forms of design affordances for creativity in digital games have been identified by Hall et al. (2020, 2021). Namely, they identified eight specific affordances: degree of flexibility, narrative, tools, environment, content creation, avatar, progression, and replayability. In this paper, we argue that these affordances also apply to board games and role-playing games.

Degree of flexibility. This encompasses affordances in relation to autonomy over the play trajectory: having different routes, side quests, proposing different playstyles. This corresponds to what a game affords in terms of how the player can choose to play, and how accessible it is to test the boundaries imposed by the developers. Games with a degree of flexibility usually are those that propose task flexibility, in which you can complete challenges in multiple ways. Flexibility can be achieved through the alteration/modification of characteristics, abilities, to enable various valid play styles. This affordance ties in to the

possibility thinking aspect of creativity (Caillois, 2001), and involves experimenting through play, and asking “what if” (Craft et al., 1997).

Non-linear games are the main candidates, as they offer a variety of routes, and opportunities for diverging from the main narrative. Open-world video games allow players to create their own path through the game and define their routes. They often are the most engaging games, and those who grant the highest sense of achievement.

Narrative. Narrative affordances relate to opportunities for creative engagement with the game’s narrative. Namely, how the story and characters prompt emotional engagement, reflection, and further exploration of challenging issues.

They characterize video games with strong narratives but can also occur in MMOs and non-narrated video games, in which players uncover the story and lore through gameplay, or even create their own personal narrative. Open-world games without a voiced protagonist can also provide more creative room and let the player engage and bring more to the story. For instance, choice-based dialogues give opportunities to make decisions that can affect the unfolding of events. This allows players to make meaningful choices and provide further opportunities for narrative exploration.

Tools. This refers to affordances for the use of different types of tools. They relate to the variety of items, abilities, and range of movements. They add to the customization of the gaming experience and offer possibilities for problem-solving and potential creative expression within the game. They are often a precursor for task flexibility, as they allow challenges and missions to be solved and completed in different ways. Put simply, the more tools available, the more combinations and ways to solve ill-defined problems and challenges.

They can also take the form of alternative modes of transport in video games and an extended range of movements (e.g., swimming, climbing), which can encourage the player to explore its surroundings and the world at large. Tools should be useful: useless or weak tools might not help and thus not be used for progressing. However, they can potentially be used for personal challenges, for example winning the game with the weakest weapon available.

Environment. This refers to opportunities to both explore and interact with the environment, such as utilizing terrain and environmental objects. Exploration is not sufficient, as interaction with the environment and objects is also important. Such affordances allow for an active experience and the possibility for discovering different game aspects. This is linked

to the notion of ludic space (Aarseth, 2012). Games contain both a ludic space, referring to the playable area, and an extra-ludic space, the surrounding space the player cannot explore. In a linear game, most of the space is extra-ludic, whereas the opposite is true in open-world games. Extending this ludic space might provide greater opportunities for creative behaviors.

Open-world video games, in which the player is not restricted to a predetermined path, are particularly tailored to this form of affordances. The aesthetics of the game can also facilitate creative inspiration, inside and outside the game.

Content creation. This type of affordance refers to opportunities for creating in-game content, like building and crafting. Furthermore, they include possibilities for creating and integrating mods (modifications which add custom items, levels, characters, objects and interfaces) and add-ons. The possibility to create allows for in-game occurrence and manifestation of little-c creativity. They provide opportunities to pursue one's curiosity, through exploration and experimentation.

Sandbox and simulation video games are the ideal games, as they allow players to tailor the game experience to their own goals, creating "anything" they wish within the game. This can also take the form of creating your own maps and levels. Finally, games that are open to mods can add functionalities and customize further the experience. Having functional yet customizable items also participates in the engagement within the game: decoration is interesting, but interaction is preferable as it can help provide a more realistic experience.

Avatar. This refers to possibilities for customization of the character appearance, personality, dialogue options and classes. This can become an additional goal within the game itself.

Different dialogue options can enable the exploration of different selves and personalities (Klimmt et al., 2009), sometimes clashing with one's habitual behaviors and attitudes. This can take the form of appearance modifications: clothes, hairstyles, physique, voice. Such options and liberty can lead to portrayals that can either be faithful or weird. This can be an outlet for personal expression.

Progression. This kind of affordance is indirectly linked to creativity, as it is related to aspects that help maintain player motivation. For example, progression provides a scaffolding mechanic that helps balance challenges, in line with the development of a player's skills. The presence and achievements and their completion can also help in that sense, as skill learning

becomes essential to complete successfully challenges, to bring a sense of self-efficacy and competence.

Replayability. Replayability refers to what possibilities for replay there are: different endings, different playstyles, allowing for the experiences of different playthroughs. This refers also to the renewal of gaming experience: updates, patches, extensions. They provide opportunities for further engagement and help maintain motivation as well. Replayability is determined by the structure of the game (open vs linear) and the structure of the narrative (divergent vs linear). Games with different endings and divergent narratives enable players to explore the game differently. Such affordances allow the player to envisage and imagine possible outcomes to the story (Cardona-Rivera & Young, 2013), in turn encouraging creativity.

This can take the form of games that encourage players to replay them to discover the outcome of different actions, making each playthrough a unique experience. Linear games might provide less opportunities for renewal of gaming experience, but this can still happen in the case of different endings. This can also take the form of DLCs and add-ons that provide new storylines or maps, and thus further possibilities for exploration.

Game Mechanics

This section is based on the 4Cs Evaluation Framework for Games (Thornhill-Miller et al., 2023), which is itself based on the 4Cs framework, consisting of four 21st century skills: creativity, critical thinking, communication, and collaboration. The focus here will be on creativity specifically. The evaluation grid assesses a game's effectiveness for training and improving creativity, based on the mechanics directed towards the practice and realization of this skill. If a game implicates and requires creativity to a considerable degree to perform well, it will be considered as helpful and effective to improve creative potential.

The grid is based on the multivariate approach of creativity (Lubart et al., 2015), and is composed of five factors, among which four cognitive factors and one conative factor: *originality*, *divergent thinking*, *convergent thinking*, *mental flexibility*, and *creative dispositions*.

Originality involves generating ideas that are new, rare, or unexpected in relation to the ideas of other players, what one would naturally expect, and one's own previous ideas. Video games like "Minecraft", board games such as "Dixit" and "Codenames", and role-playing games like "Dungeons & Dragons" all encourage players to think outside the box and come up with new and unique strategies or solutions. These gaming environments should foster creativity by

continuously challenging players to develop novel ideas and expand their imaginative capabilities.

Divergent Thinking refers to the ability to generate a large number of different ideas, explore multiple solutions to a problem, break free from conventional thinking, and explore various possibilities. Board games like "Scattergories" and role-playing games such as "Fiasco" encourage divergent thinking by challenging players to think broadly and generate numerous ideas or approaches. These games often involve open-ended problems and require players to experiment with different strategies, leading to an expansion of creative thinking and problem-solving skills.

Mental Flexibility encompasses changing perspectives on a problem, understanding it from different angles, detaching from initial ideas, generating ideas from diverse categories, and shifting between modes of thinking. Puzzle-based video games like "Portal" and "Braid", as well as board games like "Hanabi" and "Pandemic", require players to adapt their thinking and strategies based on the game's evolving dynamics. These games often involve complex and shifting situations that demand continuous adaptation and the ability to think in multiple ways, promoting cognitive agility and adaptability.

Convergent Thinking involves observing similarities between different approaches to a problem, joining multiple elements to create a new idea, connecting seemingly unrelated elements, combining ideas with a common mediator, and evaluating ideas to select the best or most creative one. Strategy board games like "Ticket to Ride" and video games such as "The Talos Principle" promote convergent thinking by helping players refine their ideas and solutions by synthesizing and integrating diverse perspectives or concepts. These games enhance players' ability to find connections, make sense of complex situations, and ultimately develop more creative and effective solutions.

Creative Dispositions relate to being open to new experiences and ideas, trying unknown things, taking calculated risks, and tolerating ambiguous situations, ill-defined problems, and contradictory information. Open-world video games such as "The Legend of Zelda: Breath of the Wild" and role-playing games like "Pathfinder" encourage creative dispositions by fostering a mindset that embraces experimentation, exploration, and learning. Players are more inclined to take risks and push their boundaries, which can lead to innovative thinking and novel approaches to problem-solving.

In-Game Learning Situation: Illustrations with Board Games

Learning cannot occur without experience. Learners, if they are to be effective, must be able to : (1) involve themselves fully and openly in new experiences, (2) reflect on and observe their experiences from many perspectives, (3) create concepts that integrate their observations into logical “theories”, and (4) use these theories to make decisions and solve further problems. Game-based learning provides players with an optimal and engaging environment for learning, allowing them to experience the experiential learning process and its stages, and repeat this process thanks to the iterative nature of games

To understand how the game-based experiential learning process takes place with regard to creativity, let us take two examples derived from existing board games : Time’s Up, and The Big Idea.

Time’s Up. Time's Up is a fast-paced, charade-based guessing game for a minimum of four players, divided into teams. The game proceeds in three rounds, each with a different method of hint-giving, using the same set of name cards: people, places, books, movies, etc. In the first round, players give unlimited verbal clues to their team, trying to get them to guess the name on the card, without saying any part of the name. Each team has 30 seconds to guess as many cards as they can, then play moves to the next team. Once all cards are used, they're reshuffled for the next round. The second round involves players giving only one-word hints. If the team guesses correctly, they can guess again until their time runs out. The third and final round involves charades. Clue-givers must act out the name on their card without using any verbal clues. Teams guess within their 30-second interval.

“Time’s Up” involves several game mechanics conducive to creativity, for both the clue-giver and the guesser. The clue-giver must find ways to express the concept, in a non-explicit way. As such, they need to find novel ways to describe it. Furthermore, these clues must be relevant and adapted towards the guesser. If the idea is too remote from the guesser’s frame of reference, too random or not elaborated enough, the players will not advance or perform well. On the other side, the guesser must make associations and generate ideas from the clues given to them. They need to be flexible and make associations and analogies, in a similar way to insight tasks. Finally, they need to converge into the correct answer, based on this process.

The concrete experience corresponds to the discovery of the game mechanics and the other players. The clue-giver receives the cards, and tries to find ways to express indirectly the concepts that are. This first exercise can be arduous, even more so when the clue-giver and the

guesser do not know each other. After the first 30 seconds, the second team gets to play. There, the clue-giver reflects on what worked and what failed, and observes the other team as they play. For example, the clues given might be too “out there” for the guesser, or in contrast too straight forward and unoriginal, making it hard to make associations and find the concepts. Then, abstract conceptualization comes into play, as the clue-giver tries to adapt more to the guesser, finding strategies that better fit their duo. After the opposing round, the clue-giver gets to play once again, and apply the strategies that were generated in the meantime. If the clues were too straightforward, the player might try to be more original. Alternatively, they can adapt to the references and culture of the partner. This cycle goes on, up until the end of the game.

The Big Idea. The Big Idea is a party game designed for 3-6 players, in which they take the roles of inventors, creating new products for a skeptical audience. In it, players need to come up with products based on cards, and then present and sell their inventions to the rest of the players. At the beginning of each round, players get six cards: three “Thing” cards and three “Qualifying” cards, that must be combined to create an invention. Each player is free to use as many cards as he or she wishes and in any order they see fit, if they can provide meaning for the invention. The inventors then give a persuasive pitch to the other players, describing what their product is and why it's great. Once every player has pitched their ideas, they vote for the best invention. A second round then starts, and so on. In The Big Idea, players need to find ways to combine seemingly unrelated cards and concepts, in a manner that is meaningful and compelling. The game is divided into two creation phases: the invention itself, then the pitch and its arguments.

The concrete experience again starts with the discovery of the game mechanics and materials. Here, this involves facing the six cards and their potential randomness/remoteness to each other. They then must find ways to connect them and select the best invention. Then, the player comes up with a pitch, to sell their product to the other players. After everybody is done working on their invention, the player begins to pitch their invention. Afterwards, the player listens to the other players' pitches and inventions. During this part, the player engages in reflective observation, as he/she reflects on what they could have done better, compared to the ways the other players used their cards. They then enter abstract conceptualization, to come up with theories and strategies for what to do next turn. For example, if the player only used two cards out of the six available, they might want to try combining more cards. If their invention was interesting but the pitch did not sell well, they may be inspired by stories proposed by the better pitchers of the group. Once everybody has voted, players get new cards, with new

possibilities of invention. At this point, active experimentation starts and players try to implement what they derived from the last step. This process repeats itself, as long as players are engaged in the board game.

Learning Outcomes

Board Games

Experimental and quasi-experimental studies have demonstrated the potential of board games for fostering short-term learning and improvement of creativity. Park & Lee (2017) found that incorporating board game play into the curriculum of two fifth-grade classes led to significant improvements in mathematical creativity, particularly when students could engage in free-play. Gonzalo-Iglesia et al. (2018) explored the impact of introducing commercial board games related to university course content on motivation and creativity. Their findings indicate that students who played these games reported higher motivation to learn and an enhancement in their creativity. This highlights the potential of integrating board games into educational settings to support both motivational and creative outcomes.

In Mercier & Lubart's (2023a) experimental study, they compared the effects of playing creative board games, non-creative board games, and a no-game control condition on participants' originality. The results showed a significant, medium-sized improvement in originality after playing creative board games compared to the other two conditions. This finding suggests that board games specifically designed to elicit original and relevant ideas may have a stronger impact on fostering creativity than their non-creative counterparts or not playing games at all.

Kuo et al. (2023) investigated the impact of having high school students create board games based on their interests and the content of an 18-week civic education course. They found that the process of creating board games led to increased verbal and figural creativity, as well as enhanced civic competencies. This finding suggests that incorporating board game design into educational curricula can promote both creativity and domain-specific learning.

Video Games

Though research on the connection between video games and creativity is relatively limited, initial findings have been promising. Blanco-Herrera (2019) conducted an experimental study comparing the effects of playing Minecraft (with or without instructions) to two control conditions: playing a non-creative video game (NASCAR) and watching a TV show

(Crocodile Hunter). Results indicated that playing Minecraft without instructions improved graphic creativity compared to both control conditions. However, no effect was found for either verbal divergent or convergent thinking. This finding suggests that certain types of video games, particularly those that promote exploration and unstructured play, may facilitate the development of specific dimensions of creativity, such as graphic creativity.

Experimental studies have explored the impact of various types of video games on divergent thinking. Yeh (2015) found that playing an action video game resulted in enhanced divergent thinking compared to playing a non-action video game. Similarly, Moffat et al. (2017) observed that playing a first-person shooter or a puzzle game led to increased divergent thinking, in terms of flexibility specifically. Though these studies had small sample sizes, they provide preliminary evidence that certain genres of video games may foster creativity.

Tabletop Role-playing Games

In the realm of tabletop role-playing games, Karwowski and Soszynski (2008) developed the Role Play Training in Creativity (RPTC), a creativity training program based on the mechanics of role-playing games. The program was integrated into workshops and resulted in a clear improvement in divergent thinking, particularly in terms of fluency. A replication of the RPTC program (Dyson et al., 2016) yielded similar results on overall divergent thinking. These findings indicate that incorporating role-playing game mechanics into creativity training programs can effectively enhance divergent thinking.

Discussion

The Framework

This paper proposes a comprehensive framework, based on experiential learning theory and game-based learning, which aims to explain how games can help improve and develop creativity. The model is structured using the input-process-output approach. As such, two inputs are proposed: personal attributes and game attributes. Personal attributes refer to dispositional constructs that are common to both gaming habits and creativity, which could also be labeled as “common denominators”. These factors include: playfulness, imagination, mind-wandering, mindfulness, psychological capital, and motives. These attributes explain why gaming habits and creativity are associated together. For example, psychological capital is a higher-order construct, characterized by four components: self-efficacy, optimism, hope, and resilience. Optimism is of particular interest here. This attribution style, that views setbacks as temporary

and specific to a situation, is essential in both games and creativity. Those two activities often involve failures and setbacks, and having an optimistic style is essential: negative experiences are seen as surmountable and passing. Games are among the first activities that teach individuals that failures are acceptable and normal. Analogously, game-based learning is founded on the idea that these failures serve as feedback and core to the learning process. As such, games should be associated with higher optimism, which then leads to higher creativity, which was demonstrated for video games (Mercier & Lubart, 2023b).

The second input is labeled game attributes. They refer to elements in games that are conducive to creativity (design affordances), or actively encourage and elicit it (game mechanics). Design affordances are here defined as opportunities provided by a game for creative actions and behaviors. They can be present in any games, be they specifically focused on creativity or not. For instance, the degree of flexibility inherent to open-world games allows players to create their own path and explore the game in a way that fits them personally. They provide opportunities for risk-taking and diverging from the pre-established path offered to the player. Content creation are another particularly interesting design affordances, as they allow for in-game manifestation of little-c creativity. Building and crafting, notably in sandbox games, allow players to create anything they wish within the game. Minecraft is often considered as the main candidate here, but these could also apply with building block games or toys, such as Lego, Playmobil, or Kapla. The second form of game attributes refer to game mechanics, more explicitly beneficial for creativity. That is, how particular games target, solicit and require some aspects of creativity within their mechanics, in turn improving creative potential outside of the game. For instance, games that involve originality and convergent thinking at their core, like the board game Dixit. These game mechanics are essential and key to the next element of the framework : the game/learning situation.

The process stage of the framework integrates the four steps of experiential learning into the game experience. This four-step process is most easily understood when using turn-based games as an example. First comes the concrete experience, in which the player discovers the game and experiments with the game mechanics and rules. Consequently, the reflective observation occurs, in which the player examines and reflects upon the first experience, their actions and outcomes, as well as the other players'. These observations and reflections are then synthesized into abstract conceptualization, such as theories, strategies, and representations of the game. The player can use previous experience and observations to formulate new strategies for the coming turns and adapt to the game's progression. At last, the player actively

experiments by applying the strategies formulated in the previous stage, trying out new solutions to the problem, or finding new actions to overcome the challenge. This cycle repeats itself throughout the game experience, in which the given game mechanics will be practiced and experimented upon by the players, leading here to improved creativity. The learning outcomes refer here to improvements of creative potential through game play. This includes short-term gains, but also transfer of learning towards other situations.

To grasp the whole picture, it is essential to perceive the dynamics between personal attributes, game attributes, and the learning process. It's a well-coordinated dance that allows for games to amplify and enhance creativity. Personal attributes, like optimism, serve as a foundation. For example, when a player faces a challenging scenario in a game, their optimistic nature might encourage them to perceive this challenge as an opportunity to innovate. This optimistic outlook is reinforced by game attributes, which either provide a platform for creative actions (design affordances) or specifically solicit creative responses (game mechanics). The experiential learning process then facilitates the weaving of these attributes into a cohesive learning experience. To illustrate, consider a game like Minecraft. A player might start by exploring (concrete experience), then reflect upon the materials they've collected (reflective observation). With this information, they can then formulate a plan, like building a castle (abstract conceptualization), and finally, they actively try to build it (active experimentation). Through this cycle, the player is not only using the game attributes provided by Minecraft but also their personal attributes to iteratively and creatively solve problems.

Furthermore, the framework also underscores the potential longevity and generalizability of the learning outcomes. The benefits aren't just constrained within the gaming environment. Let's think about the board game Dixit. In Dixit, players describe cards in their hands using creative and sometimes abstract phrases, while other players try to match their cards to these descriptions. Over time, consistent play can sharpen a player's ability to think divergently and make abstract connections. This skill, honed in the game environment, can then be transferred and applied to other real-world scenarios, such as brainstorming sessions or creative problem-solving. Essentially, the game's mechanics are training the player to think in broader, more creative patterns, benefiting the player beyond just the game. It is this potent combination of personal attributes, game attributes, and experiential learning that makes games such a valuable tool for cultivating creativity.

Further Directions

This framework, integrating experiential learning theory with game-based learning offers a promising direction in understanding the intricate relationship between gameplay and creativity enhancement. However, as with all models, several facets require deeper exploration and refinement to capture the various interactions at play.

At the forefront, the spectrum of personal attributes calls for delineation. Differences in age, gender, and socio-economic backgrounds could modulate the relationship between gameplay and creativity. It is plausible that certain populations engage differently with games due to variances or undiscovered personal attributes, which play a pivotal role in fostering creativity. Furthermore, whereas the mediating role of PsyCap has been investigated (Mercier & Lubart, 2023b), it remains to be seen whether and how the other personal attributes of the framework mediate the relationship between games and creativity, such as imagination or playfulness.

A deeper dive into game attributes is also warranted. Different game genres, given their unique design affordances and mechanics, might influence creativity in distinct ways. Role-playing games, emphasizing narrative and character development, might yield outcomes that starkly contrast with strategy games. Moreover, the alignment of gaming choices with intrinsic motivations may amplify the creative benefits accrued, emphasizing the importance of player motivation in this equation.

Temporal dynamics of creative enhancement through game play present another fertile ground for investigation. Longitudinal studies could elucidate potential plateaus or growth spurts in creativity over prolonged engagement periods. Moreover, a "saturation point" for creativity enhancement might exist, where periodic disengagement leads to more consistent creative growth.

A major issue concerns the enhancement of collective creativity. Currently, all results published at this time pertain to individual creativity. The place of group and team creativity needs to be considered as well. Notably, board games and role-playing games are inherently social activities, and it might be the case their effectiveness is even more pronounced when assessing the group's creative performance.

Comparing digital games with their non-digital counterparts could also unravel unique avenues of creative enhancement. The tactile engagement in analog and tabletop games,

combined with sensory engagement and direct social interactions, might foster spatial and kinesthetic creativity. In contrast, the immersive environments in digital games might offer a rich bed for abstract and conceptual creativity.

In sum, while the presented framework provides a robust foundation, these highlighted avenues for further exploration can refine our understanding and harness the potential of games as tools for creativity enhancement.

References

- Aarseth, E. (2012). A narrative theory of games. *Proceedings of the International Conference on the Foundations of Digital Games*, 129–133.
- Agnoli, S., Vanucci, M., Pelagatti, C., & Corazza, G. E. (2018). Exploring the link between mind wandering, mindfulness, and creativity: A multidimensional approach. *Creativity Research Journal*, 30(1), 41–53.
- Amabile, T. M. (1988). A model of creativity and innovation in organizations. *Research in Organizational Behavior*, 10(1), Article 1.
- Amabile, T. M. (1996). *Creativity in context* (Boulder, CO, Westview Press). westview press.
- Amabile, T. M. (2018). *Creativity in context: Update to the social psychology of creativity*. Routledge.
- Amabile, T. M., Hill, K. G., Hennessey, B. A., & Tighe, E. M. (1994). The Work Preference Inventory: Assessing intrinsic and extrinsic motivational orientations. *Journal of Personality and Social Psychology*, 66(5), Article 5. <https://doi.org/10.1037/0022-3514.66.5.950>
- Archibugi, D., Filippetti, A., & Frenz, M. (2013). Economic crisis and innovation: Is destruction prevailing over accumulation? *Research Policy*, 42(2), 303–314.
- Auger, P., & Woodman, R. W. (2016). Creativity and intrinsic motivation: Exploring a complex relationship. *The Journal of Applied Behavioral Science*, 52(3), 342–366.
- Baas, M., Nevicka, B., & Ten Velden, F. S. (2014). Specific mindfulness skills differentially predict creative performance. *Personality and Social Psychology Bulletin*, 40(9), 1092–1106.
- Baer, R. A., Smith, G. T., & Allen, K. B. (2004). Assessment of mindfulness by self-report: The Kentucky Inventory of Mindfulness Skills. *Assessment*, 11(3), 191–206.
- Baird, B., Smallwood, J., Mrazek, M. D., Kam, J. W., Franklin, M. S., & Schooler, J. W. (2012). Inspired by distraction: Mind wandering facilitates creative incubation. *Psychological Science*, 23(10), 1117–1122.
- Baird, B., Smallwood, J., & Schooler, J. W. (2011). Back to the future: Autobiographical planning and the functionality of mind-wandering. *Consciousness and Cognition*, 20(4), 1604–1611.
- Bányai, F., Zsila, Á., Griffiths, M. D., Demetrovics, Z., & Király, O. (2020). Career as a professional gamer: Gaming motives as predictors of career plans to become a professional esports player. *Frontiers in Psychology*, 11, 1866.
- Barr, M., & Copeland-Stewart, A. (2022). Playing video games during the COVID-19 pandemic and effects on players' well-being. *Games and Culture*, 17(1), 122–139.
- Beard, J. G., & Ragheb, M. G. (1983). Measuring leisure motivation. *Journal of Leisure Research*, 15(3), 219–228.
- Benedek, M., Bruckdorfer, R., & Jauk, E. (2020). Motives for creativity: Exploring the what and why of everyday creativity. *The Journal of Creative Behavior*, 54(3), 610–625.
- Benedek, M., Jauk, E., Sommer, M., Arendasy, M., & Neubauer, A. C. (2014). Intelligence, creativity, and cognitive control: The common and differential involvement of executive functions in intelligence and creativity. *Intelligence*, 46, 73–83.

- Bernard, L. C., Mills, M., Swenson, L., & Walsh, R. P. (2008). Measuring motivation multidimensionally: Development of the assessment of individual motives–questionnaire (AIM-Q). *Assessment, 15*(1), 16–35.
- Bishop, S. R., Lau, M., Shapiro, S., Carlson, L., Anderson, N. D., Carmody, J., Segal, Z. V., Abbey, S., Speca, M., & Velting, D. (2004). Mindfulness: A proposed operational definition. *Clinical Psychology: Science and Practice, 11*(3), 230.
- Blair, D. J. (2016). Experiential learning for teacher professional development at historic sites. *Journal of Experiential Education, 39*(2), 130–144.
- Blanco-Herrera, J. A., Gentile, D. A., & Rökkum, J. N. (2019). Video games can increase creativity, but with caveats. *Creativity Research Journal, 31*(2), 119–131.
- Bruckdorfer, R. (2017). *Challenge, joy, or health – the common artist’s wealth?* Unpublished master thesis. University of Graz, Austria.
- Čábelková, I., Strielkowski, W., Rybakova, A., & Molchanova, A. (2020). Does playing video games increase emotional creativity? *International Journal of Environmental Research and Public Health, 17*(7), 2177.
- Cai, W., Lysova, E. I., Bossink, B. A. G., Khapova, S. N., & Wang, W. (2019). Psychological capital and self-reported employee creativity: The moderating role of supervisor support and job characteristics. *Creativity and Innovation Management, 28*(1), Article 1. <https://doi.org/10.1111/caim.12277>
- Caillois, R. (2001). *Man, play, and games*. University of Illinois press.
- Cardona-Rivera, R. E., & Young, R. M. (2013). A Cognitivist Theory of Affordances for Games. *DiGRA Conference*.
- Carson, S. H., Peterson, J. B., & Higgins, D. M. (2005). Reliability, validity, and factor structure of the creative achievement questionnaire. *Creativity Research Journal, 17*(1), 37–50.
- Cheah, I., Shimul, A. S., & Phau, I. (2022). Motivations of playing digital games: A review and research agenda. *Psychology & Marketing, 39*(5), 937–950.
- Cheng, Y.-H. (2021). Effects of playing internet games on imagination. *Thinking Skills and Creativity, 41*, 100924.
- Chiorri, C., & Vannucci, M. (2017). Replicability of the psychometric properties of trait-levels measures of spontaneous and deliberate mind wandering. *European Journal of Psychological Assessment*.
- Chung, T. (2013). Table-top role playing game and creativity. *Thinking Skills and Creativity, 8*, 56–71. <https://doi.org/10.1016/j.tsc.2012.06.002>
- Cole, H., & Griffiths, M. D. (2007). Social interactions in massively multiplayer online role-playing gamers. *Cyberpsychology & Behavior, 10*(4), 575–583.
- Conner, T. S., DeYoung, C. G., & Silvia, P. J. (2018). Everyday creative activity as a path to flourishing. *The Journal of Positive Psychology, 13*(2), Article 2. <https://doi.org/10.1080/17439760.2016.1257049>
- Craft, A., Dugal, J., Dyer, G., Jeffrey, B., & Lyons, T. (1997). *Can you teach creativity?* Education Now.
- Cropley, A. (2006). In praise of convergent thinking. *Creativity Research Journal, 18*(3), Article 3.
- Davidson, C., Ewert, A., & Chang, Y. (2016). Multiple methods for identifying outcomes of a high challenge adventure activity. *Journal of Experiential Education, 39*(2), 164–178.

- De Dreu, C. K., Baas, M., & Nijstad, B. A. (2008). Hedonic tone and activation level in the mood-creativity link: Toward a dual pathway to creativity model. *Journal of Personality and Social Psychology, 94*(5), 739.
- Dyson, S. B., Chang, Y.-L., Chen, H.-C., Hsiung, H.-Y., Tseng, C.-C., & Chang, J.-H. (2016). The effect of tabletop role-playing games on the creative potential and emotional creativity of Taiwanese college students. *Thinking Skills and Creativity, 19*, 88–96. <https://doi.org/10.1016/j.tsc.2015.10.004>
- Fehr, K. K., & Russ, S. W. (2016). Pretend play and creativity in preschool-age children: Associations and brief intervention. *Psychology of Aesthetics, Creativity, and the Arts, 10*(3), 296.
- Fein, G. G. (1987). *Pretend play: Creativity and consciousness*.
- Feist, G. J. (2010). *The function of personality in creativity: The nature and nurture of the creative personality*.
- Gackenbach, J. (2008a). The relationship between perceptions of video game flow and structure. *Loading..., 2*(3).
- Gackenbach, J. (2008b). Video game play and consciousness development: A transpersonal perspective. *Journal of Transpersonal Psychology, 40*(1).
- Garris, R., Ahlers, R., & Driskell, J. E. (2002). Games, motivation, and learning: A research and practice model. *Simulation & Gaming, 33*(4), 441–467.
- Gibson, J. J. (1977). The theory of affordances. *Hilldale, USA, 1*(2), 67–82.
- Glăveanu, V. P. (2010). Paradigms in the study of creativity: Introducing the perspective of cultural psychology. *New Ideas in Psychology, 28*(1), 79–93.
- Glăveanu, V. P. (2013). Rewriting the language of creativity: The Five A's framework. *Review of General Psychology, 17*(1), 69–81.
- Gobet, F., Retschitzki, J., & de Voogt, A. (2004). *Moves in mind: The psychology of board games*. Psychology Press.
- Gong, H., Zhou, H., & Zhang, X. (2019). Creativity Booster: How Time versus Money Impacts Creative Performances. *The Journal of Creative Behavior, jobc.399*. <https://doi.org/10.1002/jobc.399>
- Gonzalo-Iglesia, J. L., Lozano-Monterrubio, N., & Prades-Tena, J. (2018). The usage of game-based learning in university education. How to motivate and foster creativity among adult students through board games. *Proceedings of Play2Learn, 67–84*.
- Gotlieb, R., Hyde, E., Immordino-Yang, M. H., & Kaufman, S. B. (2016). Cultivating the social–emotional imagination in gifted education: Insights from educational neuroscience. *Annals of the New York Academy of Sciences, 1377*(1), 22–31.
- Gotlieb, R. J., Hyde, E., Immordino-Yang, M. H., & Kaufman, S. B. (2019). *Imagination is the seed of creativity*.
- Gould, J., Moore, D., McGuire, F., & Stebbins, R. (2008). Development of the serious leisure inventory and measure. *Journal of Leisure Research, 40*(1), 47–68.
- Guilford, J. P. (1967). *The nature of human intelligence*.
- Guitard, P., Ferland, F., & Dutil, É. (2005). Toward a better understanding of playfulness in adults. *OTJR: Occupation, Participation and Health, 25*(1), 9–22.
- Haase, J., Hanel, P. H., & Gronau, N. (2023). Creativity enhancement methods for adults: A meta-analysis. *Psychology of Aesthetics, Creativity, and the Arts*.

- Hall, J., Stickler, U., Herodotou, C., & Iacovides, I. (2020). Expressivity of creativity and creative design considerations in digital games. *Computers in Human Behavior, 105*, 106206.
- Hall, J., Stickler, U., Herodotou, C., & Iacovides, I. (2021). Using reflexive photography to investigate design affordances for creativity in digital entertainment games. *International Journal of Human–Computer Interaction, 37*(9), 867–883.
- Hao, N., Wu, M., Runco, M. A., & Pina, J. (2015). More mind wandering, fewer original ideas: Be not distracted during creative idea generation. *Acta Psychologica, 161*, 110–116.
- Harper, N. J. (2018). Locating self in place during a study abroad experience: Emerging adults, global awareness, and the Andes. *Journal of Experiential Education, 41*(3), 295–311.
- Hayes, M. T., Sameshima, P., & Watson, F. (2015). Imagination as method. *International Journal of Qualitative Methods, 14*(1), 36–52.
- Hegarty, C. B. (2009). The value and meaning of creative leisure. *Psychology of Aesthetics, Creativity, and the Arts, 3*(1), 10.
- Hegarty, C. B., & Plucker, J. A. (2012). Creative leisure and self-expression. *The International Journal of Creativity and Problem Solving, 22*(2), 63–79.
- Hennessey, B. A., & Amabile, T. M. (2010). Creativity. *Annual Review of Psychology, 61*, 569–598.
- Hennick, C. (2019). eSports Programs Start to Pop up in K–12 Schools. *Esports Programs Start to Pop Up in K–12 Schools/ EdTech Magazine Accessed From*.
- Henriksen, D., Henderson, M., Creely, E., Carvalho, A. A., Cernochova, M., Dash, D., Davis, T., & Mishra, P. (2021). Creativity and risk-taking in teaching and learning settings: Insights from six international narratives. *International Journal of Educational Research Open, 2*, 100024.
- Hoever, I. J., Van Knippenberg, D., Van Ginkel, W. P., & Barkema, H. G. (2012). Fostering team creativity: Perspective taking as key to unlocking diversity’s potential. *Journal of Applied Psychology, 97*(5), 982.
- Hoffmann, J., & Russ, S. (2012). Pretend play, creativity, and emotion regulation in children. *Psychology of Aesthetics, Creativity, and the Arts, 6*(2), Article 2.
- Hughes, J. (1988). Therapy is fantasy: Roleplaying, healing and the construction of symbolic order. *Anthropology IV Honours, Medical Anthropology Seminar, Dept. of Prehistory & Anthropology, Australian National University*.
- Hunter, S. T., Bedell, K. E., & Mumford, M. D. (2007). Climate for creativity: A quantitative review. *Creativity Research Journal, 19*(1), 69–90.
- Jackson, L. A., Witt, E. A., Games, A. I., Fitzgerald, H. E., Von Eye, A., & Zhao, Y. (2012). Information technology use and creativity: Findings from the Children and Technology Project. *Computers in Human Behavior, 28*(2), Article 2. <https://doi.org/10.1016/j.chb.2011.10.006>
- Jordan, K. A., Gagnon, R. J., Anderson, D. M., & Pilcher, J. J. (2018). Enhancing the college student experience: Outcomes of a leisure education program. *Journal of Experiential Education, 41*(1), 90–106.
- Kapp, K. M. (2012). *The gamification of learning and instruction: Game-based methods and strategies for training and education*. John Wiley & Sons.

- Karwowski, M., & Lebuda, I. (2016). The big five, the huge two, and creative self-beliefs: A meta-analysis. *Psychology of Aesthetics, Creativity, and the Arts*, 10(2), 214.
- Karwowski, M., & Soszynski, M. (2008). How to develop creative imagination?: Assumptions, aims and effectiveness of Role Play Training in Creativity (RPTC). *Thinking Skills and Creativity*, 3(2), Article 2. <https://doi.org/10.1016/j.tsc.2008.07.001>
- Kaufman, J. C. (2012). Counting the muses: Development of the Kaufman domains of creativity scale (K-DOCS). *Psychology of Aesthetics, Creativity, and the Arts*, 6(4), Article 4.
- Kaufman, J. C., & Beghetto, R. A. (2009). Beyond Big and Little: The Four C Model of Creativity. *Review of General Psychology*, 13(1), Article 1. <https://doi.org/10.1037/a0013688>
- Kaufman, J. C., Glăveanu, V. P., & Baer, J. (2017). *The Cambridge handbook of creativity across domains*. Cambridge University Press.
- Kim, Y. J., & Shute, V. J. (2015). Opportunities and challenges in assessing and supporting creativity in video games. In *Video games and creativity* (pp. 99–117). Elsevier.
- Klimmt, C., Hefner, D., & Vorderer, P. (2009). The video game experience as “true” identification: A theory of enjoyable alterations of players’ self-perception. *Communication Theory*, 19(4), 351–373.
- Kolb, D. A. (1984). The process of experiential learning. *Experiential Learning: Experience as the Source of Learning and Development*, 20–38.
- Kolb, D. A., Boyatzis, R. E., & Mainemelis, C. (2001). Experiential learning theory: Previous research and new directions. *Perspectives on Thinking, Learning, and Cognitive Styles*, 1(8), 227–247.
- Kosslyn, S. M., Ganis, G., & Thompson, W. L. (2001). Neural foundations of imagery. *Nature Reviews Neuroscience*, 2(9), 635–642.
- Kozbelt, A., Beghetto, R. A., & Runco, M. A. (2010). *Theories of creativity*.
- Kuo, H.-C., Weng, T.-L., Chang, C.-C., & Chang, C.-Y. (2023). Designing Our Own Board Games in the Playful Space: Improving High School Student’s Citizenship Competencies and Creativity through Game-Based Learning. *Sustainability*, 15(4), 2968.
- Lee, E.-J., Kim, H. S., & Choi, S. (2021). Violent video games and aggression: Stimulation or catharsis or both? *Cyberpsychology, Behavior, and Social Networking*, 24(1), 41–47.
- Li, F. W. (2008). *Computer Games*. Citeseer.
- Lieberman, J. N. (1977). *Playfulness: Its relationship to imagination and creativity*. Academic Press.
- Lubart, T., Mouchiroud, C., Tordjman, S., & Zenasni, F. (2015). *Psychologie de la créativité- 2e édition*. Armand Colin.
- Luthans, F., Avolio, B. J., Avey, J. B., & Norman, S. M. (2007). Positive psychological capital: Measurement and relationship with performance and satisfaction. *Personnel Psychology*, 60(3), Article 3.
- Luthans, F., Youssef, C. M., & Avolio, B. J. (2015). *Psychological capital and beyond*. Oxford University Press, USA.
- Manfredo, M. J., Driver, B. L., & Tarrant, M. A. (1996). Measuring leisure motivation: A meta-analysis of the recreation experience preference scales. *Journal of Leisure Research*, 28(3), 188–213.

- Marks, D. R. (2008). The Buddha's extra scoop: Neural correlates of mindfulness and clinical sport psychology. *Journal of Clinical Sport Psychology*, 2(3), 216–241.
- McCarthy, M. (2010). Experiential learning theory: From theory to practice. *Journal of Business & Economics Research (JBER)*, 8(5).
- McGuire, W. J. (1974). Psychological motives and communication gratification. *The Uses of Mass Communications: Current Perspectives on Gratifications Research*, 3, 167–196.
- McMillan, R. L., Kaufman, S. B., & Singer, J. L. (2013). Ode to positive constructive daydreaming. *Frontiers in Psychology*, 4, 626.
- Mercier, M., & Lubart, T. (2023a). Board games enhance creativity: Evidence from two studies. *Psychology of Aesthetics, Creativity, and the Arts*.
- Mercier, M., & Lubart, T. (2023b). Video games and creativity: The mediating role of psychological capital. *Journal of Creativity*, 33(2), 100050.
- Moffat, D. C., Crombie, W., & Shabalina, O. (2017). Some video games can increase the player's creativity. *International Journal of Game-Based Learning (IJGBL)*, 7(2), Article 2. <https://doi.org/10.4018/IJGBL.2017040103>
- Moon, J. (2004). Using reflective learning to improve the impact of short courses and workshops. *Journal of Continuing Education in the Health Professions*, 24(1), 4–11.
- Morris, T. H. (2020). Experiential learning—a systematic review and revision of Kolb's model. *Interactive Learning Environments*, 28(8), 1064–1077.
- Munge, B., Thomas, G., & Heck, D. (2018). Outdoor fieldwork in higher education: Learning from multidisciplinary experience. *Journal of Experiential Education*, 41(1), 39–53.
- Newzoo. (2019). *Global Esports Market Report*.
- Olsen, E. T. (1981). *An exploratory study of adult playfulness and some personality correlates*. Michigan State University.
- Orkibi, H. (2021). Creative adaptability: Conceptual framework, measurement, and outcomes in times of crisis. *Frontiers in Psychology*, 11, 588172.
- Ortiz de Gortari, A. B., & Griffiths, M. D. (2016). Prevalence and characteristics of Game Transfer Phenomena: A descriptive survey study. *International Journal of Human-Computer Interaction*, 32(6), 470–480.
- Ortiz de Gortari, A. B. O., & Griffiths, M. D. (2015). Game Transfer Phenomena and its associated factors: An exploratory empirical online survey study. *Computers in Human Behavior*, 51, 195–202.
- Ostafin, B. D., & Kassman, K. T. (2012). Stepping out of history: Mindfulness improves insight problem solving. *Consciousness and Cognition*, 21(2), 1031–1036.
- Park, J., & Lee, K. (2017). Using board games to improve mathematical creativity. *International Journal of Knowledge and Learning*, 12(1), 49–58.
- Pearce, K. E., Yip, J. C., Lee, J. H., Martinez, J. J., Windleharth, T. W., Bhattacharya, A., & Li, Q. (2022). Families playing animal crossing together: Coping with video games during the COVID-19 pandemic. *Games and Culture*, 17(5), 773–794.
- Pearson, J., Naselaris, T., Holmes, E. A., & Kosslyn, S. M. (2015). Mental imagery: Functional mechanisms and clinical applications. *Trends in Cognitive Sciences*, 19(10), 590–602.
- Plass, J. L., Homer, B. D., & Kinzer, C. K. (2015). Foundations of game-based learning. *Educational Psychologist*, 50(4), Article 4.

- Preiss, D. D., Cosmelli, D., & Kaufman, J. C. (2020). *Creativity and the wandering mind: Spontaneous and controlled cognition*. Academic Press.
- Prensky, M. (2001). Fun, play and games: What makes games engaging. *Digital Game-Based Learning*, 5(1), 5–31.
- Proyer, R. T. (2012). Examining playfulness in adults: Testing its correlates with personality, positive psychological functioning, goal aspirations, and multi-methodically assessed ingenuity. *Psychological Test and Assessment Modeling*, 54(2), 103–127.
- Proyer, R. T. (2017). A new structural model for the study of adult playfulness: Assessment and exploration of an understudied individual differences variable. *Personality and Individual Differences*, 108, 113–122.
- Proyer, R. T., Tandler, N., & Brauer, K. (2019a). Playfulness and Creativity. In *Creativity and Humor* (pp. 43–60). Elsevier. <https://doi.org/10.1016/B978-0-12-813802-1.00002-8>
- Proyer, R. T., Tandler, N., & Brauer, K. (2019b). Playfulness and Creativity. In *Creativity and Humor* (pp. 43–60). Elsevier. <https://doi.org/10.1016/B978-0-12-813802-1.00002-8>
- Reiss, S. (2000). *Who am I: The 16 basic desires that motivate our actions and define our personalities*, New York: Tarcher/Putnam. ISBN 1-58542-045-X.
- Runco, M. A., & Acar, S. (2019). *Divergent thinking*.
- Russ, S. W. (2016). Pretend play: Antecedent of adult creativity. *New Directions for Child and Adolescent Development*, 2016(151), 21–32.
- Russ, S. W., & Doernberg, E. A. (2019). Play and Creativity. In J. C. Kaufman & R. J. Sternberg (Eds.), *The Cambridge Handbook of Creativity* (2nd ed., pp. 607–622). Cambridge University Press. <https://doi.org/10.1017/9781316979839.030>
- Russ, S. W., Robins, A. L., & Christiano, B. A. (1999). Pretend play: Longitudinal prediction of creativity and affect in fantasy in children. *Creativity Research Journal*, 12(2), 129–139.
- Ryan, R. M., & Deci, E. L. (2000). Self-determination theory and the facilitation of intrinsic motivation, social development, and well-being. *American Psychologist*, 55(1), 68.
- Sawyer, K. (2017). *Group genius: The creative power of collaboration*. Basic books.
- Scott, G., Leritz, L. E., & Mumford, M. D. (2004). The effectiveness of creativity training: A quantitative review. *Creativity Research Journal*, 16(4), Article 4. https://doi.org/10.1207/s15326934crj1604_1
- Sheldon, K. M., Elliot, A. J., Kim, Y., & Kasser, T. (2001). What is satisfying about satisfying events? Testing 10 candidate psychological needs. *Journal of Personality and Social Psychology*, 80(2), 325.
- Sherry, J. L. (2004). Flow and media enjoyment. *Communication Theory*, 14(4), 328–347.
- Shute, V. J., Ventura, M., & Bauer, M. (2009). Melding the power of serious games and embedded assessment to monitor and foster learning: Flow and grow. In *Serious games* (pp. 317–343). Routledge.
- Silvia, P. J. (2005). Emotional responses to art: From collation and arousal to cognition and emotion. *Review of General Psychology*, 9(4), 342–357.
- Silvia, P. J., Beaty, R. E., Nusbaum, E. C., Eddington, K. M., Levin-Aspenson, H., & Kwapil, T. R. (2014). Everyday creativity in daily life: An experience-sampling study of “little c” creativity. *Psychology of Aesthetics, Creativity, and the Arts*, 8(2), Article 2.

- Singer, D. G., & Singer, J. L. (2009). *The house of make-believe: Children's play and the developing imagination*. Harvard University Press.
- Singer, D. L., & Rummo, J. (1973). Ideational creativity and behavioral style in kindergarten-age children. *Developmental Psychology*, 8(2), 154.
- Singer, J. L., & Singer, D. G. (2005). Preschoolers' imaginative play as precursor of narrative consciousness. *Imagination, Cognition and Personality*, 25(2), 97–117.
- Smallwood, J. (2013). Distinguishing how from why the mind wanders: A process–occurrence framework for self-generated mental activity. *Psychological Bulletin*, 139(3), 519.
- Squire, K. (2006). From content to context: Videogames as designed experience. *Educational Researcher*, 35(8), 19–29.
- Steinkuehler, C., & Duncan, S. (2008). Scientific habits of mind in virtual worlds. *Journal of Science Education and Technology*, 17, 530–543.
- Sternberg, R. J. (2019). Enhancing people's creativity. *The Cambridge Handbook of Creativity*, 88–103.
- Sternberg, R. J., & Lubart, T. I. (1999). The concept of creativity: Prospects and paradigms. *Handbook of Creativity*, 1(3–15).
- Sutton-Smith, B. (1966). Piaget on play: A critique. *Psychological Review*, 73(1), 104.
- Sweetman, D., Luthans, F., Avey, J. B., & Luthans, B. C. (2011). Relationship between positive psychological capital and creative performance. *Canadian Journal of Administrative Sciences / Revue Canadienne Des Sciences de l'Administration*, 28(1), Article 1. <https://doi.org/10.1002/cjas.175>
- Sweetsers, P., & Wyeth, P. (2005). GameFlow: A model for evaluating player enjoyment in games. *Computers in Entertainment (CIE)*, 3(3), 3–3.
- Tang, Y.-Y., Hölzel, B. K., & Posner, M. I. (2015). The neuroscience of mindfulness meditation. *Nature Reviews Neuroscience*, 16(4), 213–225.
- Tavinor, G. (2008). Definition of videogames. *Contemporary Aesthetics (Journal Archive)*, 6(1), 16.
- Tay, L., & Diener, E. (2011). Needs and subjective well-being around the world. *Journal of Personality and Social Psychology*, 101(2), 354.
- Taylor, M., Hodges, S. D., & Kohányi, A. (2003). The illusion of independent agency: Do adult fiction writers experience their characters as having minds of their own? *Imagination, Cognition and Personality*, 22(4), 361–380.
- Thornhill-Miller, B., Camarda, A., Mercier, M., Burkhardt, J.-M., Morisseau, T., Bourgeois-Bougrine, S., Vinchon, F., El Hayek, S., Augereau-Landais, M., & Mourey, F. (2023). Creativity, Critical Thinking, Communication, and Collaboration: Assessment, Certification, and Promotion of 21st Century Skills for the Future of Work and Education. *Journal of Intelligence*, 11(3), 54.
- Wallace, C. E., & Russ, S. W. (2015). Pretend play, divergent thinking, and math achievement in girls: A longitudinal study. *Psychology of Aesthetics, Creativity, and the Arts*, 9(3), 296.
- Ward, T. B., & Kolomyts, Y. (2010). Cognition and creativity. *The Cambridge Handbook of Creativity*, 93–112.
- Whitton, N. (2012). The place of game-based learning in an age of austerity. *Electronic Journal of E-Learning*, 10(2), pp249-256.

- Wyver, S. R., & Spence, S. H. (1999). Play and divergent problem solving: Evidence supporting a reciprocal relationship. *Early Education and Development, 10*(4), 419–444.
- Yee, W. F., Pink, L. S., & Sern, M. L. C. (2014). The effect of a psychological climate for creativity on job satisfaction and work performance. *International Journal of Economics and Management, 8*(3), 97–116.
- Yeh, C. S.-H. (2015). Exploring the effects of videogame play on creativity performance and emotional responses. *Computers in Human Behavior, 53*, 396–407.
- Yu, X., Li, D., Tsai, C.-H., & Wang, C. (2019). The role of psychological capital in employee creativity. *Career Development International*.
- Zabelina, D. L., & Condon, D. M. (2020). The Four-Factor Imagination Scale (FFIS): A measure for assessing frequency, complexity, emotional valence, and directedness of imagination. *Psychological Research, 84*, 2287–2299.
- Zedelius, C. M., & Schooler, J. W. (2015). Mind wandering “Ahas” versus mindful reasoning: Alternative routes to creative solutions. *Frontiers in Psychology, 6*, 834.

Board Games Enhance Creativity : Evidence from Two Studies

Maxence Mercier^{1*} and Todd Lubart¹

¹ Université Paris Cité and Univ Gustave Eiffel, LaPEA, F-92100 Boulogne-Billancourt,
France

Author Note

Maxence Mercier  <https://orcid.org/0000-0001-9045-2032>

Todd Lubart  <https://orcid.org/0000-0002-8776-8797>

We have no known conflict of interests to disclose.

Correspondence concerning this article should be addressed to Maxence Mercier, Université Paris Cité, LaPEA, 71 avenue Edouard Vaillant, 92100 Boulogne-Billancourt Cedex, France.
Email: mercier.maxence96@gmail.com

APA Reference:

Mercier, M., & Lubart, T. (2023). Board games enhance creativity: Evidence from two studies. *Psychology of Aesthetics, Creativity, and the Arts*. Advance online publication.

Abstract

Creativity is a crucial skill in the 21st century. Finding ways to develop and improve it is therefore an important issue. Games are powerful educational tools, and several early studies have shown the potential of video games and role-playing games to improve creativity. However, the question of the potential of board games is still open. The aim of this paper was therefore to explore this topic, through two studies. Using a self-report questionnaire ($N = 284$), the first study showed that the frequency of playing board games was positively correlated with several components of creative potential: divergent thinking, openness to experiences, creative self-efficacy and creative personal identity. Using an experimental approach ($N = 239$), the second study demonstrated that playing creative games - requiring the generation of creative ideas - had a beneficial effect on participants' originality, compared to playing non-creative games and a control condition. This result was observed independently of the participants' baseline creative potential, derived using latent profile analysis. This beneficial effect, obtained after 30 minutes of play, could be used to temporarily improve creative performance, in education or in business.

Keywords: creativity, creative potential, board game, cross-sectional study, experimental method, latent profile analysis.

Introduction

Creativity plays an increasingly important role in our lives. This observation is shared in many domains, both in the scientific literature and in the field (Kaufman et al., 2017). As evidenced by the recent addition of creativity to the Program for International Student Assessment (PISA) 2021 survey, this skill is a major educational goal. It is therefore crucial to find ways to improve and develop creativity. A meta-analysis by Scott, Leritz & Mumford (2004) showed that it is possible to improve creativity. More recent work has added to this initial review (e.g., Sun et al., 2020). However, most studies have focused on traditional or direct methods, such as training that directly targets divergent thinking or convergent thinking (for a review, see Scott et al., 2004b). The question of the effectiveness of less traditional methods therefore remains largely unexplored. One such method - games - represents a powerful educational tool, which has repeatedly shown its effectiveness in teaching diverse skills and knowledge (Plass et al., 2015). A recent report by the French National Agency for Research and Technology (ANRT, Nemessany, 2019) supports the strong pedagogical potential of games, which would help to foster "the transmission of knowledge and cognitive faculties often neglected by traditional pedagogy" (p. 11), such as creativity. This potential has been empirically demonstrated for different types of games, such as video games (e.g. Yeh, 2015) or role playing games (e.g. Karwowski & Soszynski, 2008). However, the literature has essentially not explored the links between board games and creativity, even though they have been proven to be useful for many other skills, such as mathematics (Lin et al., 2013) and nursing (Yoon et al., 2014). This paper therefore aims to investigate the links between creativity and board games, combining two complementary methods: a questionnaire-based approach and an experimental study.

Board games as a learning tool

Defining the concepts of play and game is not an easy task. Some languages, such as English, use several terms to distinguish sub-concepts ("I play a game"), whereas others use variants of a single reference root, as in French ("Je joue à un jeu") and German ("Ich spiele ein Spiel"). An exhaustive review by Salen & Zimmerman (2003) led to the following definitions: play refers to "freedom of movement within a more rigid structure" (p. 301); a game is "a system in which players engage in an artificial conflict, defined by rules and which results in a quantifiable outcome" (p. 80). It follows that games are a subset of play, through their formalization of activities considered as play, the latter being itself the experiential aspect of games. We will use a more operational definition of a game, proposed by Kinzie & Joseph

(2008): a game is an immersive, voluntary and enjoyable activity, in which a challenge is pursued according to previously established rules.

This paper focuses on board games, which we will distinguish from role-playing games. A board game is a game with a certain number of rules that limit the possibilities, requiring an analogical support (a board, cards, etc.) and which is played by two or more players (Gobet et al., 2004). A role-playing game is not - strictly speaking - a board game, but rather a leisure activity in its own right. A role-playing game is a game in which players must create and embody a character, who moves in a universe and situations created and controlled by a game master (Karwowski & Soszynski, 2008).

The use and effectiveness of games to facilitate learning have been studied extensively and substantially (for a review, see De Freitas, 2018). This can be best exemplified with the rising research on game-based learning (Qian & Clark, 2016; Vandercruysse et al., 2012). Notably, many studies have used board games as educational tools, with success. The classic example remains Monopoly, originally invented to demonstrate the harmful effects of land ownership in the early 20th century (Magie, 1924). This board game has since been reused and repurposed several times, to teach skills in health (Yoon et al., 2014), accounting (Shanklin & Ehlen, 2007a), finance (Shanklin & Ehlen, 2007b), mathematics (Lin et al., 2013) or computational thinking (Berland & Lee, 2011). The effectiveness of games lies mainly in their ability to engage players in the activity (e.g. Chiang et al., 2011). In particular, the effectiveness of *Game-Based Learning* is theoretically based on the principle that a competitive situation requires players to be actively involved, which leads to an increase in willingness to learn (Lin et al., 2013). Chiarello & Castellano (2016) report six characteristics of board games that help explain their effectiveness, and notably the fact that (1) immersion facilitates concentration, and (2) suspension of disbelief establishes an environment conducive to the introduction of new ideas. Based on this framework, Chiarello & Castellano (2016) have successfully used board games to introduce and teach their students complex topics, such as the immune system, quantum mechanics or general relativity.

Games and creativity

Thus, games are effective pedagogical tools applicable to many knowledge domains and skills. Creativity, on the other hand, is a crucial and malleable skill that is not readily developed by traditional educational methods (Nemessany, 2019). This is notably illustrated by the difficulty of teaching creativity in the classroom (Beghetto, 2013). Using an alternative and

powerful method such as games would then seem to make sense for developing and improving creativity. However, few studies have looked at the links between games and creativity.

In terms of video games, Jackson et al. (2012) conducted a survey of a large sample of 12-year-old children ($N = 491$), and found significant and positive correlations between frequency of video game play and divergent thinking. Mercier & Lubart (2022) conducted a questionnaire-based survey of 370 workers, and observed that playing video games was associated with higher creativity in the workplace. This relation was fully mediated by a measure of Psychological Capital, a higher-order construct consisting of four positive psychological resources: hope, efficacy, resilience and optimism. Experimental studies appear to corroborate this relationship. Yeh (2015) observed an improvement in several indicators of non-verbal divergent thinking (originality, flexibility, and elaboration) of participants ($N = 31$) after playing an action video game, compared to playing a "non-action" video game. The action game was *Light Heroes*, a shooting game where the player must destroy enemies on a battlefield. The non-action game was *Clusterz*, where the player must destroy colored bubbles before they fill the game space, by popping groups of three or more bubbles. Moffat et al (2017) conducted also an experiment investigating the effects of three types of video games (a first-person shooter, a sandbox game, and a puzzle game) on divergent thinking. The first-person shooter was *Serious Sam*, where the player fights waves of enemies in an open environment. The sandbox game was *Minecraft*, where the player can create, modify and destroy their environment. The puzzle game was *Portal 2*, where the player must solve puzzles by placing portals and teleporting through them. Each participant ($N = 21$) completed a verbal divergent thinking task before and after playing one of the three games. The results suggest a significant improvement in flexibility after playing the puzzle-solving and first-person shooter games. As the sample sizes for these two experiments were small, these results would need to be replicated in order to draw solid conclusions about the effect of video games. A larger study ($N = 352$) was conducted was conducted by Blanco-Herrera et al. (2019). They compared the effects of playing Minecraft with no instructions, playing Minecraft with instructions to be creative, playing a racing game (NASCAR), and watching a TV show. All conditions had participants engage in their respective activities for 45 minutes. They then completed measures of verbal and figural divergent thinking, as well as verbal convergent thinking. Participants showed increased figural divergent thinking, specifically in the undirected Minecraft conditions. Surprisingly, the "be creative" directed condition did not lead to increased creativity. This

suggests that although the content of the game is important, the way it is played also plays a key role.

Regarding role-playing games, Karwowski & Soszynski (2008) developed the Role Play Training in Creativity (RPTC), a creativity training program based on the mechanics of role-playing games. They integrated these game-play mechanics into workshops that lasted a total of eight hours, conducting across four 2-hour meetings or one 8-hour meeting. Their results show a very clear improvement in divergent thinking after the program, especially in terms of fluency. A replication of the RPTC program was conducted by Dyson et al. (2016), and resulted in similar results on overall divergent thinking. Chung (2013) conducted an investigation comparing the creativity of three groups: tabletop role-playing game players, online role-playing game players, and non-players. Their results show that tabletop gamers were more creative than non-gamers, with online gamers falling between these two groups.

Objectives of the paper

Regarding the relationship with board games, a quasi-experimental study (Mercier & Lubart, 2021) showed that playing board games improved participants' divergent thinking ($N = 55$), for individuals below average in terms of fluency or originality. Although encouraging, these results are based on a small sample size and deserve further investigation. This paper therefore aims to explore further this topic by combining two complementary methods. The first study is questionnaire-based, conducted using an online survey. It explored the links between the frequency of playing different types of board games and several indicators of creative potential: divergent thinking, openness to experiences, creative self-efficacy, and creative personal identity. The second study used an experimental design and complemented this initial study by examining the effect of playing board games on creative performance, while considering the creative potential of the participants a priori.

Although classifications of board games exist, such as the ESAR system (Filion, 2015), there is currently no categorization that is rigorous enough to be used in a scientific study. We chose to distinguish between two types of board games, based on the consensus definition of creativity (Runco & Jaeger, 2012): creative and non-creative board games. A creative board game is one that requires the production of original and relevant ideas to perform well. Conversely, a non-creative board game does not require this creative production to have a good performance.

Study 1

The objective of Study 1 was to investigate the relationship between the frequency of playing board games and several components of creative potential. We made four hypotheses: (H1) frequency of playing board games in general is positively correlated with creative potential; (H2) frequency of playing creative board games is positively correlated with creative potential; (H3) frequency of playing non-creative board games is not correlated with creative potential; (H4) correlations between creative potential and frequency of playing creative games are higher than the correlations between creative potential and non-creative games.

Method

Participants and data collection

We had neither requirements nor hypotheses regarding the sample, hence we recruited participants through convenience sampling. We collected data from 284 participants, recruited via social networks. The mean age was 35.1 years ($SD = 12.5$). 97.2% of the participants were of French nationality and 88% were women. The sample was composed of 68.3% workers, 21.8% students, 8.1% unemployed and 1.8% retired. The data collection complied with the RGPD EU 2016/679.

Material

Divergent thinking. To measure divergent thinking, we used the Alternative Uses Task (AUT, Guilford, 1967). Participants were asked to give original uses to two objects: a belt and then a wheelbarrow. The instructions given were (Forthmann et al., 2016): "For the objects you are about to see, give as many unusual uses as possible in this task. It is important that you are as creative as possible and generate interesting uses that one would not necessarily think of." Participants were given two minutes per object. We assessed two criteria of divergent thinking, fluency and originality, by averaging their respective scores on the two tasks.

Openness to experience. Openness was assessed using the Openness subscale of the French version of the HEXACO-60 (Ashton & Lee, 2009), with a 7-point Likert scale. It is a 10-item scale. The internal consistency of the scale was satisfactory ($\alpha = .76$).

Creative Self Concept. Creative self-efficacy (CSE) and creative personal identity (CPI) were measured using the Short Scale of Creative Self (SSCS, Karwowski, 2012; Karwowski et al., 2018), on a 7-point Likert scale. It is an 11-item scale, with 6 items measuring creative self-efficacy and 5 measuring creative personal identity. The scale was translated using

the back-translation method (Brislin, 1986). Both subscales had satisfactory internal consistency (CSE - $\alpha = .72$; CPI - $\alpha = .88$).

Frequency of playing board games. We measured the frequency of playing three categories of board games: general board games, creative board games, and non-creative board games. Participants were first asked to read the definition associated with each type of game (see Appendix A). They were then asked to indicate their frequency of practice using an ordinal scale (Afifi et al., 2014), consisting of the following values: never, 1-5 times a year, 6-11 times a year, once a month, 2-3 times a month, once a week, 2-6 times a week, every day.

Preliminary analyses

We quantified divergent thinking in terms of fluency and originality. To assess fluency, we counted the number of responses given by the participant, excluding incomplete and irrelevant (i.e., redundant or unrelated) responses. We calculated the fluency score by averaging the fluency scores for both items.

To assess the originality of the answers, we used three judges, Master students who had completed courses on creativity. In accordance with the instructions of Nusbaum et al. (2014), the spelling of the answers given by the participants had been corrected beforehand, and sorted in alphabetical order. The judges were required to first read the entire set of responses before evaluating them (Nusbaum et al., 2014). They then assessed independently the originality of each answer, on a 5-point scale, based on the following instruction: 'You should assess the originality of the set of answers given by the person, i.e. the unusual, novel character of the ideas given, without worrying about the appropriateness or overall creativity of these ideas'.

We calculated inter-rater consistency using Cronbach's alpha, previously checking the unidimensionality of the measure using an Exploratory Factor Analysis (EFA), extracted via the maximum likelihood method. Bartlett's test of sphericity was significant, $\chi^2(3) = 1545.64$, $p < .001$. The KMO was acceptable (KMO = .68). Based on Horn's (1965) parallel analysis, we found a one-factor solution, explaining 50.5% of the variance, confirming the unidimensionality of the originality measure. The internal consistency was satisfactory ($\alpha = .75$). We averaged the three ratings for each response. The individual responses of each subject were then averaged, yielding an originality score for each of the two items. These two scores were finally averaged, to obtain the originality score.

Results

To test our hypotheses, we calculated the correlation coefficients between the different variables of interest (Table 1). Because the frequency scales are ordinal and the rest of the variables are continuous, we used Spearman's rho to calculate the correlations between these variables. Regarding the frequency of playing board games in general (FBG), it correlated positively with creative self-efficacy ($r = .14, p = .016$), creative personal identity ($r = .15, p = .012$), and openness to experience ($r = .18, p = .003$). However, it did not correlate significantly with either fluency or originality. Frequency of playing creative board games (FBGC) correlated significantly with originality ($r = .15, p = .010$), creative self-efficacy ($r = .28, p < .001$), creative personal identity ($r = .32, p < .001$), and openness to experiences ($r = .28, p < .001$). However, it did not correlate with fluency. Finally, frequency of playing non-creative board games (FBGN) did not significantly correlate with any of the measured creative potential components, with the exception of creative self-efficacy ($r = .13, p = .034$). Our results are therefore consistent with our hypotheses 1, 2, and 3.

Table 1.
Correlation matrix

	Originality	Fluency	CSE	CPI	Openness	FBG	FBGC	FBGN
Originality	- —							
Fluency	0.198 ***	- —						
CSE	0.165 **	0.059	- —					
CPI	0.154 *	-0.001	0.683 ***	- —				
Openness	0.198 ***	0.031	0.358 ***	0.501 ***	- —			
FBG	0.087	0.005	0.143 *	0.149 *	0.177 **	- —		
FBGC	0.154 *	0.052	0.277 ***	0.317 ***	0.283 ***	0.621 ***	- —	
FBGN	0.071	0.030	0.126 *	0.109	0.086	0.828 ***	0.501 ***	- —

Note 1. * $p < .05$, ** $p < .01$, *** $p < .001$.

Note 2. CSE: creative self-efficacy, CPI: creative personal identity, FBG: frequency of playing board games in general, FBGC: frequency of playing creative board games, FBGN: frequency of playing non-creative board games.

Note 3. Continuous-continuous correlations were calculated using Pearson's coefficient. Continuous-ordinal and ordinal-ordinal correlations were calculated using Spearman's rho.

We then calculated the presence of significant differences between the correlations observed between creative games and creative potential, and non-creative games and creative potential (Eid et al., 2011). Regarding creative self-efficacy, the correlation with creative games is significantly higher than the correlation with non-creative games, $Z = 1.87, p = .03$. Regarding creative personal identity, the correlation with creative games is significantly higher than the correlation with non-creative games, $Z = 2.59, p = .005$. Regarding openness to experiences, the correlation with creative games is significantly higher than the correlation with non-creative games, $Z = 2.43, p = .008$. Regarding originality, the correlation with creative games is not significantly different from the correlation with non-creative games, $Z = 0.997, p = .16$. Although surprising, this result might be attributable to a sample size not adequate to detect such effect size. Overall, these results are largely consistent with our fourth hypothesis.

Discussion

We hypothesized a relationship between the frequency of playing games in general (H1) and creative games in particular (H2) on creative potential, as well as an absence of relationship concerning the frequency of playing non-creative games (H3). The results obtained are globally consistent with these three hypotheses. The overall frequency correlates weakly but significantly with three indicators of creative potential. It would seem that, like playing video games and role-playing games, playing board games more regularly is associated with higher creative potential. In particular, playing creative games correlates significantly with all of our indicators, except for fluency. This link is thus observed both for self-reported measures of creative potential, but also for more "objective" measures of creative performance, in this case divergent thinking originality. As we hypothesized, non-creative play does not correlate with indicators of creative potential, with one notable exception for creative self-efficacy. We hypothesized also that there would be significant differences between the correlations of creative and non-creative games (H4). This hypothesis was also confirmed: among the four correlations between indicators of creative potential and frequency of playing creative games, three were significantly higher than the correlations with the frequency of playing non-creative games. These results thus contribute to the validity of a distinction between creative and non-creative games.

Study 2

In Study 1, we found a correlational link between playing board games in general and creative potential, a stronger link between playing creative board games and creative potential,

and no link with playing non-creative board games. Although we hypothesized that playing creative games improves creativity, we cannot ignore an alternative hypothesis: creative people enjoy games that solicit this skill. Study 2 aimed to explore the effect of board games on creative potential, using the experimental method. We used performance on a divergent thinking task as an indicator of creative performance, and the same self-reported measures as an indicator of a priori creative potential. We made the following hypotheses: (H5) playing a creative or non-creative board game does not lead to an improvement in fluency, compared to a control condition, regardless of participants' a priori creative potential; (H6) playing a creative board game leads to an improvement in originality, compared to the control and non-creative game conditions; (H7) this improvement is stronger the lower participants' a priori creative potential. We chose to compare the effect of two creative board games to two non-creative games, each of the games being matched in terms of the stimuli involved. These four games all share the following characteristics, derived from Mercier & Lubart (2021): they are games that are not well known to the general public, with rules that are easy to understand without being childish, playful and engaging, can be played by three or four players, are competitive games, relatively short to finish, and whose number of rounds can be defined in advance.

Method

Participants and experimental design

We enrolled 239 participants, all students at the Institute of Psychology of the University of Paris Cité in the first or second year undergraduate program, in exchange for course credit. The mean age was 20.1 years ($SD = 3.83$). 92.1% of the participants were women, and 92.5% of the participants had French as their mother tongue. Participants were distributed in groups of 3 or 4 people. We used a between-subjects experimental design, i.e., each group of participants was randomly assigned to one of three conditions: control condition ($N = 76$), creative play condition ($N = 81$), non-creative play condition ($N = 82$).

Material

Creative board games. We chose two creative games, basing our selection on the definition stated earlier: a creative game requires the production of original and relevant ideas to perform well. The two games were The Big Idea (Funforge, 2011) and Imagine (Cocktail Games, 2016). The rules for each of the games are available in Appendix B. Of the 81 participants in the creative game condition, 44 played The Big Idea, and 37 played Imagine. None of the participants had played nor heard of the games used beforehand.

Non-creative board games. We chose two non-creative games, basing our selection on our definition: a non-creative game does not require the production of creative ideas to perform well. The two games were: *Deutsch* and *Twin It* (Cocktail Games, 2017). Each of the games was matched to creative games in terms of the stimuli involved, respectively to *The Big Idea* and *Imagine*. Rules for each of the games in Appendix B. Of the 82 participants in the non-creative game condition, 42 played *Deutsch*, and 40 played *Twin It*. 17 participants had previously played the games used, of which 16 had previously played *Deutsch* and one *Twin It*.

Divergent thinking, openness, and creative self-concept. We used the same measures as Study 1. We assessed two criteria of divergent thinking, fluency and originality. The internal consistency of the openness scale was acceptable ($\alpha = .66$). Both subscales of the creative self-concept had satisfactory internal consistency (CSE - $\alpha = .76$; CPI - $\alpha = .89$).

Enjoyment of the game. We measured the enjoyment of the game using the "Enjoyment" subscale of the Intrinsic Motivation Inventory (IMI, Ryan et al., 1983), on a 7-point Likert scale. This is a 7-item scale. The internal consistency of the scale was satisfactory ($\alpha = .82$).

Emotional state. We measured participants' emotional state after the game, using two subscales of the Self-Assessment Manikin (SAM, Bradley & Lang, 1994): valence (joy/sadness) and arousal level. Each dimension was measured using a 9-point figurative scale (1 = high valence and arousal, 9 = low valence and arousal), by asking the participant to rate their immediate feelings.

Procedure

Creative and non-creative play conditions. After welcoming the group and seating them around a table, we told the participants that they would be taking part in a study on the relationship between play and fun. Before starting, participants signed a consent form. After that, we explained the rules of the game they were going to play, using standardized explanations. They then played the game for 30 minutes, randomly selected from the two games corresponding to the group condition. During this time, the experimenter remained nearby and available in case of questions or forgotten rules. After these 30 minutes, the participants completed on paper, in this order: the measure of emotional state, the two measures of divergent thinking (belt then wheelbarrow), the measure of appreciation of the game, the measure of creative self-concept, the measure of openness to experiences and finally the socio-

demographic information form. After the experiment was completed, we explained the objectives of the study and answered any questions the participants might have.

Control condition. After welcoming the group and seating them around a table, participants were told that they would be participating in a study of idea generation in the presence of others. Because participants did not participate in a group activity beforehand, we used a different reasoning for the control than the experimental conditions, knowing that social inhibition phenomena weakly affect creativity tasks (Amabile et al., 1990). Before starting, participants signed a consent form. After that, participants completed directly on paper, in this order: the emotional state measure, the two divergent thinking measures (belt and then wheelbarrow), the creative self-concept measure, the openness to experience measure, and finally the socio-demographic information form. Once the experiment was completed, we explained the objectives of the study and answered any questions the participants might have.

Preliminary analyses

Divergent thinking. To assess fluency, we counted the number of answers given by each participant, excluding incomplete and irrelevant (i.e., redundant or unrelated) answers. For originality, we used three judges, all of whom were Master's students and had completed courses in creativity. We calculated the inter-judge consistency using Cronbach's alpha, by performing an EFA beforehand, via the maximum likelihood method. Bartlett's test of sphericity was significant, $\chi^2(3) = 2357.03, p < .001$. The KMO was acceptable (KMO = .69). Based on Horn's parallel analysis (1965), we found a one-factor solution, explaining 58.9% of the variance, confirming the unidimensionality of the originality measure. Internal consistency was satisfactory ($\alpha = .80$). We computed the fluency and originality scores in the same way as for Study 1.

A priori creative potential. To obtain an a priori indicator of the creative potential of our participants, we applied latent profile analysis (LPA, Gibson, 1959) on the scores of openness to experience, creative self-efficacy and creative personal identity. LPA is a clustering technique that identifies groups of individuals in a given sample who have similar values on a number of variables (Muthén, 2001). Each of these groups, called profiles, represents a latent variable explaining the correlations between these different variables, in this case our three indicators of creative potential. The choice of the number of profiles is based, analogously to CFA, on the analysis of the fit indices to the specified model. Using an iterative procedure, LPA compares an increasing number of profiles to determine the optimal number. The choice of

indices used in this paper was based on Analytic Hierarchy Procedure (AHP, Akogul & Erisoglu, 2017), which combines the analysis of five of the most commonly used criteria for evaluating the number of profiles or clusters: Akaike's information criterion (AIC, Akaike, 1998), approximate evidence weight (AWE, Banfield & Raftery, 1993), Bayesian information criterion (BIC, Schwarz, 1978), classification likelihood criterion (CLC, Biernacki & Govaert, 1997), and Kullback information criterion (KIC, Cavanaugh, 1999). Akogul & Erisoglu (2017) demonstrated empirically that AHP was more accurate and effective in identifying the optimal number of profiles compared to using the criteria separately. Once the number of profiles is determined, each individual is assigned to the profile that most closely matches their scores on the variables of interest. The analyses were performed on R, using the tidyLPA package (Rosenberg et al., 2019). We compared the results of eight solutions, ranging from one to eight profiles, standardizing the scores. Based on AHP, the best solution was found to be the three-profile model (see Appendix C, Table C1). The three profiles are (Figure 1): *low creative potential* ($N = 58$), characterized by a uniformly low level on all three variables; *medium creative potential* ($N = 99$), characterized by a uniformly medium level; *high creative potential*, characterized by a uniformly high level ($N = 88$).

Figure 1.
Solution to three profiles of creative

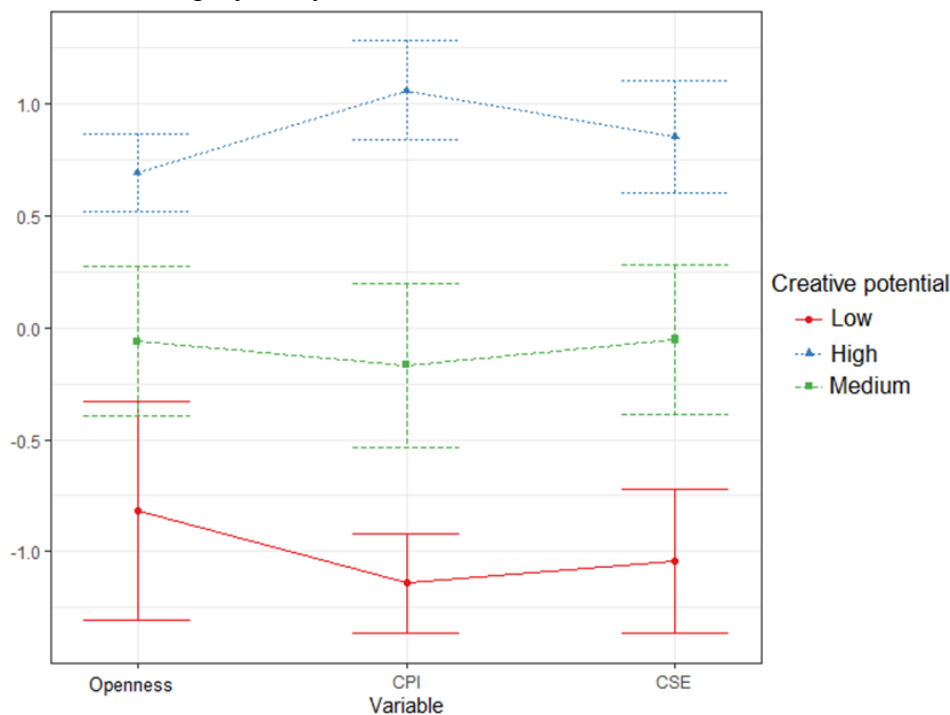

Note 1. The variables have been standardized beforehand. Error bars correspond to standard deviations.

Note 2. CSE: creative self-efficacy, CPI: creative personal identity.

Hypothesis testing. To test our hypotheses, we proceeded in a hierarchical manner, conducting two ANOVAs for fluency and originality. For each indicator, we performed first a one-factor ANOVA considering only the condition (control, non-creative play, creative play). Then, we performed a second ANOVA, in which we considered the condition (control, non-creative game, creative game), the creative potential of the participants a priori (low, medium, high creative potential), and the interaction between these two factors.

Results

Fluency

Based on Study 1, we expected that playing a board game would have no effect on participants' fluency (H5). The first one-factor ANOVA revealed no main effect of condition type on fluency, $F(2, 236) = 1.50, p = .23$. There was no significant difference between control condition and creative play ($M = -0.08, SE = 0.31$), $t(236) = -0.26, p = .80$. There was also no significant difference between the control condition and non-creative play ($M = .41, SE = .31$), $t(236) = 1.33, p = .11$. These results therefore appear to be consistent with our hypothesis 5.

We performed a second ANOVA, adding as a variable the participants' profile, in terms of creative potential (Figure 2). There was still no main effect of condition type on fluency scores, $F(2, 230) = 0.98, p = .38$. There was a significant main effect of participant profile, $F(2, 230) = 11.24, p < .001$. Participants with low creative potential scored significantly lower than

Figure 2.

Variations in fluency according to condition and creative potential

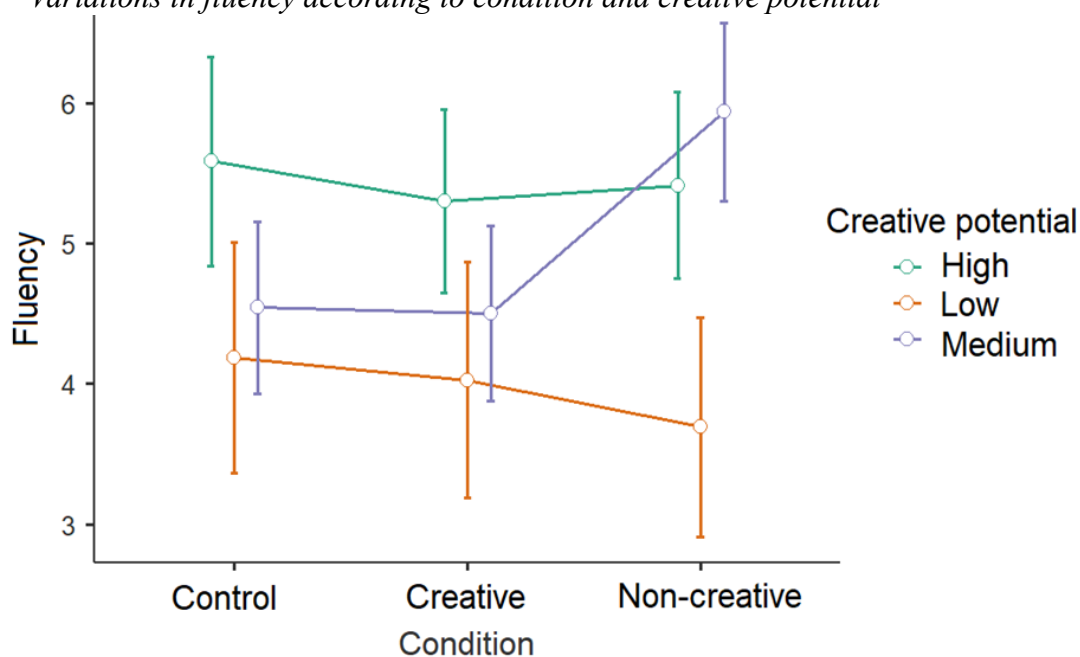

average participants ($M = -1.03$, $SE = 0.30$), $t(230) = -3.41$, $p < .001$. Participants with low creative potential have a significantly lower score than high creative potential participants ($M = -1.47$, $SE = 0.31$), $t(230) = -4.69$, $p < .001$. However, there was no significant difference between medium and high participants ($M = -0.44$, $SE = 0.27$), $t(230) = -1.62$, $p = .11$. Finally, we found an interaction effect between condition and profile, $F(4, 230) = 2.64$, $p = .035$. For participants with low creative potential, there was no significant difference between the three conditions. Similarly, high participants performed equally well on all three conditions, with no significant difference. However, we did observe a different pattern for the medium participants. There was no difference in fluency between the control condition and the creative play condition ($M = 0.04$, $SE = 0.44$), $t(230) = 0.10$, $p = .92$; performance in the non-creative play condition was superior to the control condition ($M = 1.39$, $SE = 0.45$), $t(230) = 3.12$, $p = .002$, and also superior to the creative play condition ($M = 1.44$, $SE = 0.45$), $t(230) = 3.19$, $p = .002$. Thus, participants with medium creative potential appear to benefit from an improvement after playing a non-creative game, whereas low and high potential participants maintain the same performance. The effect size of the improvement for medium participants between the control and noncreative game conditions is large, based on Cohen (1988), $d_{cohen} = 0.92$, $CI_{95\%} [0.42;1.43]$. Moreover, in the non-creative condition, there was no difference between medium baseline and high baseline participants ($M = -0.52$, $SE = 0.47$), $t(230) = -1.13$, $p = .26$. After playing a non-creative game, medium baseline participants were equivalent to high baseline participants. Our hypothesis 5 is thus partially confirmed, with a differential effect to be further explored in future research.

Originality

Based on the results of Study 1, we had hypothesized that playing a creative board game would improve participants' originality compared to the other two conditions (H6). The one-way ANOVA revealed a main effect of condition type on participants' originality score, $F(2, 235) = 10.22$, $p < .001$. There was no significant difference between performance in the control and non-creative game condition, $t(235) = 0.22$, $p = .83$. After playing a creative game, participants performed better than those in the control condition ($M = 0.29$, $SE = 0.08$), $t(235) = 3.74$, $p < .001$. Also, participants in the creative game condition performed more originally than participants in the non-creative game condition ($M = 0.31$, $SE = 0.08$), $t(235) = 4.05$, $p < .001$. The effect size of the improvement, between control and creative play conditions, was intermediate in size, according to Cohen (1988), $d_{cohen} = 0.54$, $CI_{95\%} [0.22;0.86]$. Our hypothesis 6 is therefore supported.

We conducted furthermore a second ANOVA, adding as a variable the profile of the participants, in terms of creative potential (Figure 3). We hypothesized that the lower the creative potential of the participants, the greater the improvement (H7). The main effect of condition type was still significant $F(2, 229) = 9.49, p < .001$. The main effect of creative potential was also significant, $F(2, 229) = 3.27, p = .04$. However, the interaction effect between condition and creative potential was not significant, $F(4, 229) = 0.14, p = .97$. In other words, the improvement observed was independent of participants' creative potential a priori. Therefore, these results do not support our seventh hypothesis.

Figure 3.

Variations of originality according to condition and creative potential

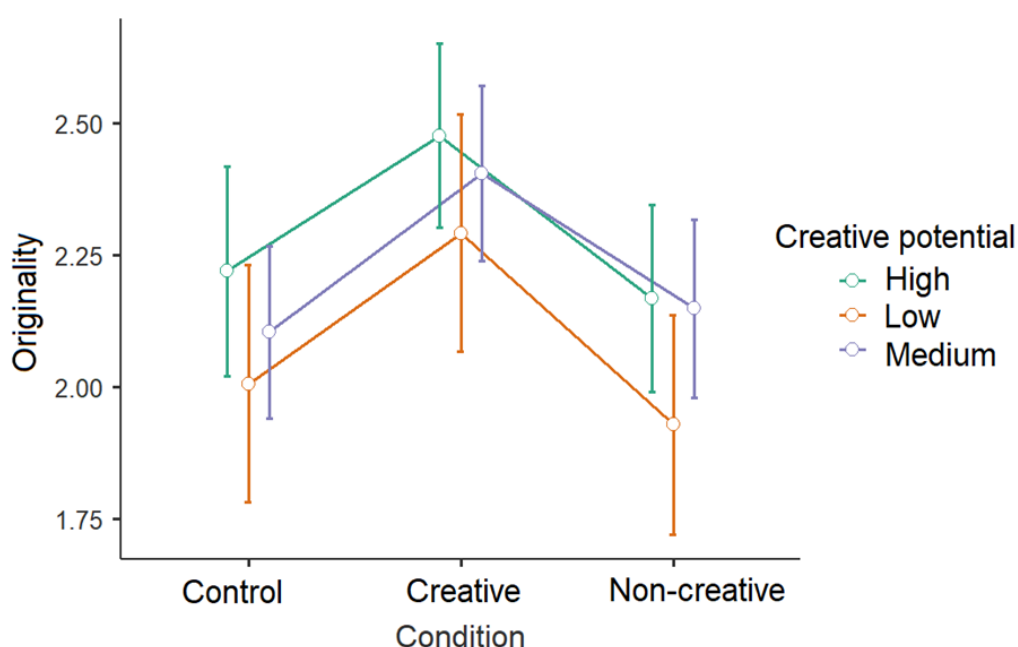

Control variables

Because our experimental design did not incorporate pretest measures, variation across conditions could be attributed to initial differences in creative potential across conditions. To control for potential sampling bias, we conducted one-way ANOVAs for each of our three indicators of a priori creative potential, including condition type as an independent variable. For openness to experience, the main effect of condition type was not significant, $F(2, 236) = 0.63, p = .53$. For creative self-efficacy, the main effect of condition type was not significant, $F(2, 236) = 1.51, p = .22$. For creative personal identity, the main effect of condition type was not significant, $F(2, 236) = 0.44, p = .64$. In summary, there were no significant differences

between the different conditions. These results allow us to rule out this sampling bias in a reasonable way.

We considered also three control variables: emotional valence, arousal level, and game appreciation. To explore possible differences generated by condition, we performed one-way ANOVAs for valence, arousal level, and a t-test for game appreciation. As the participants in the control condition did not complete this measure, a t-test for two independent samples was considered sufficient. For emotional valence, the ANOVA revealed a main effect of condition type, $F(2, 236) = 21.46, p < .001$. Creative games generated more positive valence than the control condition, $M = 1.25, t(236) = 6.29, p < .001$, as did non-creative games compared to the control condition, $M = 0.96, t(236) = 4.83, p < .001$. There was no difference in emotional valence between the creative and non-creative play conditions, $t(236) = -1.50, p = .14$. For arousal level, the ANOVA revealed a main effect of condition type, $F(2, 236) = 10.68, p < .001$. Creative play generated a higher level of arousal than in the control condition, $M = 1.21, t(236) = 4.57, p < .001$. There was no difference between non-creative games and control condition, $t(236) = 1.77, p = .08$. Creative games generated a higher level of arousal than non-creative games, $M = 0.74, t(236) = 2.86, p = .01$. For game appreciation, there was no significant difference between creative and non-creative games, $t(161) = 1.17, p = .24$. Following the effects found for valence and arousal, we calculated the correlation coefficients between these two measures and the two indicators of divergent thinking (Table 3). No significant correlations were found between the emotional state measures and the divergent thinking measures.

Table 3.
Correlation matrix

	Fluency	Originality	Valence	Arousal
Fluency	- —			
Originality	-0.052	- —		
Valence	-0.038	-0.038	- —	
Arousal	-0.037	-0.117	0.406 ***	- —

Note. $p < .05$, ** $p < .01$, *** $p < .001$

We performed two ANCOVAs on the fluency and originality scores, including the type of game as a factor, with valence and arousal level as covariates. As the interactions between the covariates and the factor were not significant for the two indicators (see Appendix 3, Table

C2 and C3), we considered a model without interaction. Regarding fluency, the ANCOVA revealed no main effect of condition type, $F(2, 234) = 1.58, p = .21$. There was also no effect of valence $F(1, 234) = 0.09, p = .77$, or of arousal $F(1, 234) = 0.37, p = .54$. Regarding originality, ANCOVA revealed a main effect of condition type, $F(2, 233) = 9.07, p < .001$. There was no effect of valence $F(1, 233) = 0.74, p = .39$, or arousal, $F(1, 233) = 0.95, p = .33$.

Because participants were either distributed into groups of three or four players, we conducted t-tests to control for potential bias. There was no significant difference in fluency between groups of three or four players, $t(237) = -0.68, p = 0.495$. There was also no significant difference in originality, $t(236) = 0.52, p = .60$. A bias due to group size was therefore reasonably ruled out.

Finally, we found that a relatively large number of participants had played Deutsch before the study ($N = 16$). To control for a possible bias related to prior knowledge of the game on participants' performance, we checked for significant differences in fluency and originality. There was no significant difference in fluency between participants who had never heard of Deutsch and those who had played it before, $t(157) = 1.26, p = .21$. There was also no significant difference in originality, $t(157) = -0.73, p = .47$. We can therefore reasonably rule out a bias related to knowledge of this particular game.

Discussion

We hypothesized that there was no effect of playing games on fluency (H5). This hypothesis is partially confirmed. Overall, there was no difference between the control condition and the two test conditions. However, we did find an effect when further investigating these results, namely an effect of non-creative games specifically for participants with medium creative potential (Cohen, 1988). We hypothesized an improvement in originality only after playing a creative game (H6). This hypothesis was confirmed. Overall, we found a significant training effect through creative games on originality, of intermediate size. Finally, we hypothesized that this effect would be stronger the lower the a priori creative potential (H7). This hypothesis was not confirmed by our results: the improvements observed were uniform, independently of the a priori potential, contrary to the differential effect observed for fluency. For our control variables, despite differences in emotional state, our results suggest that the differences observed were due to the content of the board games themselves, and not to a change in emotional state caused by the games.

General discussion

Can board games help improve creativity? This paper aimed to answer this question by combining two complementary perspectives. Study 1 aimed to explore, in the general population, correlations between several indicators of creative potential and the frequency of playing different types of board games. Study 2 complemented these results by using the experimental method to study the beneficial effect of playing board games on creative performance.

The first study showed a relationship between creative potential and the frequency of playing board games in general, and creative board games in particular, while finding no relationship with the practice of non-creative games. These results therefore confirm our hypotheses. Thus, there seems to be a relationship between games and creativity: the more one plays creative board games, the more creative one tends to be. This relationship is likely bidirectional: it can be argued that individuals with higher creative potential are attracted to creative board games. This relationship appeared for different kinds of measures: self-reported and dispositional measures, i.e., openness, creative self-efficacy, and creative personal identity; a more objectified measure, divergent thinking, in terms of originality. However, we did not observe any relationship with fluency. In addition, the strength of the correlations for all three self-reported indicators of creative potential were significantly different by game type, whereas it was not the case for originality. Overall, this seems to support the value of differentiating games in general from the two creative and non-creative subtypes.

The second study investigated further this relationship and its directionality, showing different effects of playing board games on creative performance, operationalized using divergent thinking. In terms of fluency, we hypothesized that there was no effect of board games (H5), based on the results of Study 1. This hypothesis was confirmed *in kind* but needs to be qualified by approaching it *in degree*. Indeed, by integrating the condition, the potential of the participants and the interaction between these two factors, the results show a beneficial effect for a specific category of individuals: the participants with medium creative potential. After playing a non-creative game, they had a higher level of fluency than those in the control and creative game conditions, and a level equivalent to the most creative participants. This training effect is large ($d_{cohen} = 0.92$), suggesting that it may not be a statistical artifact. This result is surprising and could mean that, regarding fluency, the people who would benefit from training would specifically be "neither the weakest nor the strongest" individuals. However, currently

no sufficient explanation seems to account for this unexpected finding. Thus, further investigations and replications are warranted.

In terms of originality, we hypothesized that only playing a creative board game would lead to an improvement, compared to the other conditions (H6), and that this effect would be stronger for participants with a lower base-level potential (H7). Our hypothesis 6 was confirmed by our results: creative games allow for the improvement of individuals' originality. However, our hypothesis 7 was not confirmed: creative games therefore help improve originality, regardless of the base-level potential of individuals. This result diverges from the differential effect found for fluency but is very encouraging. Indeed, it indicates that with the help of board games, an intermediate size improvement ($d_{cohen} = 0.54$) is possible after only 30 minutes of practice. In comparison, in the meta-analysis by Scott et al. (2004a), the average effect size for originality was relatively large ($d_{cohen} = 0.81$), given that the majority of studies focused on more direct creativity training methods. Karwowski & Soszynski (2008) had obtained, on the other hand, a small effect size after eight hours of their role-playing based program ($d = 0.28$), regarding originality. Thus, we obtain a consequent improvement in individuals' originality, in a relatively short time span (30 minutes).

Theoretical and methodological contributions

With regard to the existing literature, this paper makes several notable contributions, at the theoretical and methodological levels. On the theoretical level, this paper is part of a line of scientific studies on the effect of games on learning, and on creativity in particular. It is one of the first efforts to study the specific effect of board games on creativity. In line with the results obtained for video games and role-playing games, this paper sheds similar light on the effect of board games on creativity, combining cross-sectional survey and experimental methods. These perspectives both support the same observation: there is indeed a relationship between board games and creative potential, and moreover there seems to be an effect of the practice of board games on divergent thinking. Our paper avoids a pitfall that is regularly found in the literature, especially concerning video games. Many experimental studies have indeed shown the beneficial effects of video games on multiple cognitive abilities (Sala et al., 2018). If playing a video game improves experimentally a cognitive ability, then it can be hypothesized that individuals who play more video games will perform better than those who play less, in a correlational manner (Sala et al., 2018). In the case of video games, this assumption has been repeatedly rejected empirically (Hambrick et al., 2010; Unsworth et al., 2015), calling into question the relevance of video games as a tool for sustainably developing cognitive abilities.

Our results, on the contrary, are in line with this hypothesis: board games improve experimentally one aspect of creative potential (divergent thinking), and we find a similar trend in the general population, as shown by the different positive correlations obtained in Study 1, between board games and multiple aspects creative potential.

Another contribution is methodological. In Study 2, we evaluated a training effect on divergent thinking, measured in the post-test but not in the pre-test. This may be perceived as a drawback, but this choice is justified. The repeated measures protocol is generally viewed as a gold standard to study the development of creativity (Barbot, 2019), but it faces several limitations in the case of divergent thinking. This lies mainly in the choice of stimuli to be used, here in an alternative uses task (Guilford, 1967). Using the same objects before and after would risk affecting the validity of the measured construct: while the pre-test measure will indeed be a measure of divergent thinking, the post-test measure is very likely to be biased by conscious or unconscious recall phenomena of the responses given in the pre-test (Barbot, Lubart, et al., 2016). Using different objects before and after then appears to be a satisfactory solution, however divergent thinking tasks are subject to low reliability of parallel forms (e.g. Barbot, Besançon, et al., 2016), rarely exceeding .50 (Barbot, 2019). The differences obtained could then be attributable to variations in the task stimuli, and not to the protocol conditions. Conducting a measurement only in post-test avoids these pitfalls, provided that there is satisfactory sampling across conditions. We verified this by ensuring that the three groups did not differ in terms of openness, creative self-efficacy, or creative personal identity. Removing the bias of repeated measures comes at the cost of one important piece of data: the baseline level of the participants. To obtain a proxy, we used our self-reported measures of creative potential and LPA (Gibson, 1959). LPA has been used several times to extract different creative profiles, applying it on divergent thinking (Paek & Runco, 2018) or creative achievements (Silvia et al., 2009; Von Stumm et al., 2011). In Study 2, we used this method on all three measures of creative potential, allowing us to distinguish three different profiles using an empirical approach. This allowed us to perform finer-grained analyses in the absence of a pre-test. To our knowledge, this is the first study to use the LPA in this way in the field of creativity.

Limitations and prospects

This paper is not without its limitations but opens the way for further and more extensive research. The main limitation most certainly lies in our operationalization of creativity. We have opted for an essentially general approach to creative performance, through relatively generic divergent thinking tasks. This has many advantages, including being completable by the largest

number of respondents. However, it has the disadvantage of being relatively unrepresentative of individuals' actual competence (Zeng et al., 2011), in which case a specific approach to creativity proves more relevant (Baer, 2014). To extend the external validity of our measure, it would then be interesting to test the effect of board games on more specific creative performance tasks, using more applied and realistic problems (e.g. Mumford et al., 1998; Reiter-Palmon et al., 2009), or even in a real situation, before a brainstorming session for example. Another way to improve the external validity of our results concerns the sample used in Study 2. Although our results are consistent with those of Study 1, our second study is based on a relatively homogeneous sample, consisting of psychology students and mostly women. The homogeneity of a sample has its advantages when exploring a new phenomenon. In particular, it allows us to control for many extraneous factors and thus reduce the amount of irrelevant variance (Highhouse & Gillespie, 2009; Shen et al., 2011). However, this reduces also the ability to generalize. Studying these effects on a more representative sample of the general population is therefore necessary. Another important limitation concerns our definition of creative and non-creative board games, and its validity. In the absence of scientific categorization, we decided to use a pragmatic definition, based on the consensus definition of creativity (Runco & Jaeger, 2012). We obtained results consistent with our definitions, allowing us to validate them by inference. However, a more robust and extensive definition is essential, as the quality of the beneficial effects depends on the quality of the choice of games involved. Examining more board games based on such a definition would certainly help in that regard. Furthermore, having a robust definition for creative board games could afterwards be expanded to other types of games, especially video games. This could enable studies on the effects of creative board games compared to creative video games.

Finally, two limitations warrant interesting future directions. First, we obtained very interesting results in the short term, but the question of the effect of the games in the medium to long term remains unanswered. Experimental studies with a longitudinal design could prove useful in exploring this avenue. Second, we defined board games as played by two or more players. Thus, board games are inherently a social activity, compared to video games that can be either solo or multiplayer. However, we did not account for social elements in the experimental study, nor did we study the effects of board games on group creativity. It may be the case that board games better improve group creativity than individual creativity. Future research could include the measure of social elements (e.g., group involvement, quality of

collaboration, closeness to others), while assessing group creativity through brainstorming tasks (Paulus, 2000).

Conclusion

In conclusion, the results of this paper suggest that board games are an effective means of improving creative potential. In particular, the training effect concerns originality, which remains the fundamental manifestation of creativity, namely the generation of new, surprising, original ideas (Besemer & O'Quin, 1999; Diedrich et al., 2015). Being able to improve tangibly this aspect in a short period of time could be an undeniable asset. Before a meeting that requires creative problem solving, those 30 minutes of games could prove to be a valuable aid. Board games could be used directly, but also more indirectly. In particular, games are becoming more and more important in companies (Nemessany, 2019), and adopting leisure activities that are both enjoyable and beneficial to employees and the company could offer additional support for creativity and innovation.

References

- Afifi, T. O., LaPlante, D. A., Taillieu, T. L., Dowd, D., & Shaffer, H. J. (2014). Gambling involvement: Considering frequency of play and the moderating effects of gender and age. *International Journal of Mental Health and Addiction*, *12*(3), 283–294.
- Akaike, H. (1998). Information theory and an extension of the maximum likelihood principle. In *Selected papers of Hirotugu Akaike* (pp. 199–213). Springer.
- Akogul, S., & Erisoglu, M. (2017). An approach for determining the number of clusters in a model-based cluster analysis. *Entropy*, *19*(9), 452.
- Amabile, T. M., Goldfarb, P., & Brackfield, S. C. (1990). Social influences on creativity: Evaluation, coaction, and surveillance. *Creativity Research Journal*, *3*(1), 6–21.
- Ashton, M. C., & Lee, K. (2009). The HEXACO–60: A short measure of the major dimensions of personality. *Journal of Personality Assessment*, *91*(4), 340–345.
- Baer, J. (2014). *Creativity and divergent thinking: A task-specific approach*. Psychology Press.
- Banfield, J. D., & Raftery, A. E. (1993). Model-based Gaussian and non-Gaussian clustering. *Biometrics*, 803–821.
- Barbot, B. (2019). Measuring creativity change and development. *Psychology of Aesthetics, Creativity, and the Arts*, *13*(2), 203. <https://doi.org/10.1037/aca0000232>
- Barbot, B., Besançon, M., & Lubart, T. (2016). The generality-specificity of creativity: Exploring the structure of creative potential with EPoC. *Learning and Individual Differences*, *52*, 178–187.
- Barbot, B., Lubart, T. I., & Besançon, M. (2016). “Peaks, slumps, and bumps”: Individual differences in the development of creativity in children and adolescents. *New Directions for Child and Adolescent Development*, *2016*(151), 33–45.
- Beghetto, R. A. (2013). *Killing ideas softly?: The promise and perils of creativity in the classroom*. IAP.
- Berland, M., & Lee, V. R. (2011). Collaborative strategic board games as a site for distributed computational thinking. *International Journal of Game-Based Learning (IJGBL)*, *1*(2), 65–81.
- Besemer, S. P., & O’Quin, K. (1999). Confirming the three-factor creative product analysis matrix model in an American sample. *Creativity Research Journal*, *12*(4), 287–296. https://doi.org/10.1207/s15326934crj1204_6
- Biernacki, C., & Govaert, G. (1997). Using the classification likelihood to choose the number of clusters. *Computing Science and Statistics*, 451–457.
- Blanco-Herrera, J. A., Gentile, D. A., & Rokkum, J. N. (2019). Video games can increase creativity, but with caveats. *Creativity Research Journal*, *31*(2), 119–131.
- Bradley, M. M., & Lang, P. J. (1994). Measuring emotion: The self-assessment manikin and the semantic differential. *Journal of Behavior Therapy and Experimental Psychiatry*, *25*(1), 49–59. [https://doi.org/10.1016/0005-7916\(94\)90063-9](https://doi.org/10.1016/0005-7916(94)90063-9)
- Brislin, R. W. (1986). The wording and translation of research instruments. In *Field methods in cross-cultural research* (pp. 137–164). Sage Publications, Inc.
- Cavanaugh, J. E. (1999). A large-sample model selection criterion based on Kullback’s symmetric divergence. *Statistics & Probability Letters*, *42*(4), 333–343.

- Chiang, Y.-T., Lin, S. S., Cheng, C.-Y., & Liu, E. Z.-F. (2011). Exploring Online Game Players' Flow Experiences and Positive Affect. *Turkish Online Journal of Educational Technology-TOJET*, *10*(1), 106–114.
- Chiarello, F., & Castellano, M. G. (2016). Board games and board game design as learning tools for complex scientific concepts: Some experiences. *International Journal of Game-Based Learning (IJGBL)*, *6*(2), 1–14. <https://doi.org/10.4018/IJGBL.2016040101>
- Chung, T. (2013). Table-top role playing game and creativity. *Thinking Skills and Creativity*, *8*, 56–71. <https://doi.org/10.1016/j.tsc.2012.06.002>
- Cocktail Games. (2016). *Imagine*.
- Cocktail Games. (2017). *Twin It*.
- Cohen, J. (1988). *Statistical power analysis for the social sciences*.
- De Freitas, S. (2018). Are games effective learning tools? A review of educational games. *Journal of Educational Technology & Society*, *21*(2), 74–84.
- Diedrich, J., Benedek, M., Jauk, E., & Neubauer, A. C. (2015). Are creative ideas novel and useful? *Psychology of Aesthetics, Creativity, and the Arts*, *9*(1), 35. <https://doi.org/10.1037/a0038688>
- Dyson, S. B., Chang, Y.-L., Chen, H.-C., Hsiung, H.-Y., Tseng, C.-C., & Chang, J.-H. (2016). The effect of tabletop role-playing games on the creative potential and emotional creativity of Taiwanese college students. *Thinking Skills and Creativity*, *19*, 88–96. <https://doi.org/10.1016/j.tsc.2015.10.004>
- Eid, M., Gollwitzer, M., & Schmitt, M. (2011). *Statistik und Forschungsmethoden Lehrbuch*. Beltz. Weinheim.
- Filion, R. (2015). *Le système ESAR: Pour analyser, classifier des jeux et aménager des espaces*. À la page.
- Forthmann, B., Gerwig, A., Holling, H., Çelik, P., Storme, M., & Lubart, T. (2016). The be-creative effect in divergent thinking: The interplay of instruction and object frequency. *Intelligence*, *57*, 25–32. <https://doi.org/10.1016/j.intell.2016.03.005>
- Funforge. (2011). *The Big Idea*.
- Gibson, W. A. (1959). Three multivariate models: Factor analysis, latent structure analysis, and latent profile analysis. *Psychometrika*, *24*(3), 229–252.
- Gobet, F., Retschitzki, J., & de Voogt, A. (2004). *Moves in mind: The psychology of board games*. Psychology Press.
- Guilford, J. P. (1967). *The nature of human intelligence*.
- Hambrick, D. Z., Oswald, F. L., Darowski, E. S., Rench, T. A., & Brou, R. (2010). Predictors of multitasking performance in a synthetic work paradigm. *Applied Cognitive Psychology*, *24*(8), 1149–1167.
- Highhouse, S., & Gillespie, J. Z. (2009). Do samples really matter that much. *Statistical and Methodological Myths and Urban Legends: Doctrine, Verity and Fable in the Organizational and Social Sciences*, 247–265.
- Horn, J. L. (1965). A rationale and test for the number of factors in factor analysis. *Psychometrika*, *30*(2), 179–185. <https://doi.org/10.1007/BF02289447>
- Jackson, L. A., Witt, E. A., Games, A. I., Fitzgerald, H. E., Von Eye, A., & Zhao, Y. (2012). Information technology use and creativity: Findings from the Children and Technology

- Project. *Computers in Human Behavior*, 28(2), 370–376.
<https://doi.org/10.1016/j.chb.2011.10.006>
- Karwowski, M. (2012). Did curiosity kill the cat? Relationship between trait curiosity, creative self-efficacy and creative personal identity. *Europe's Journal of Psychology*, 8(4), 547–558.
- Karwowski, M., Lebudá, I., & Wiśniewska, E. (2018). Measuring creative self-efficacy and creative personal identity. *The International Journal of Creativity & Problem Solving*.
- Karwowski, M., & Soszynski, M. (2008). How to develop creative imagination?: Assumptions, aims and effectiveness of Role Play Training in Creativity (RPTC). *Thinking Skills and Creativity*, 3(2), 163–171. <https://doi.org/10.1016/j.tsc.2008.07.001>
- Kaufman, J. C., Glăveanu, V. P., & Baer, J. (2017). *The Cambridge handbook of creativity across domains*. Cambridge University Press.
- Kinzie, M. B., & Joseph, D. R. (2008). Gender differences in game activity preferences of middle school children: Implications for educational game design. *Educational Technology Research and Development*, 56(5–6), 643–663.
<https://doi.org/10.1007/s11423-007-9076-z>
- Lin, C.-H., Liu, E. Z.-F., Chen, Y.-L., Liou, P.-Y., Chang, M., Wu, C.-H., & Yuan, S.-M. (2013). Game-based remedial instruction in mastery learning for upper-primary school students. *Journal of Educational Technology & Society*, 16(2), 271–281.
- Magie, P. E. (1924). *Game board*. Google Patents.
- Mercier, M., & Lubart, T. (2021). The effects of board games on creative potential. *The Journal of Creative Behavior*, 55(3), 875–885.
- Mercier, M., & Lubart, T. (2022). Video Games Can Enhance Creativity: The Mediating Role of Psychological Capital. *PsyArXiv*.
- Moffat, D. C., Crombie, W., & Shabalina, O. (2017). Some video games can increase the player's creativity. *International Journal of Game-Based Learning (IJGBL)*, 7(2), 35–46. <https://doi.org/10.4018/IJGBL.2017040103>
- Mumford, M. D., Marks, M. A., Connelly, M. S., Zaccaro, S. J., & Johnson, J. F. (1998). Domain-based scoring in divergent-thinking tests: Validation evidence in an occupational sample. *Creativity Research Journal*, 11(2), 151–163.
- Muthén, B. O. (2001). Latent variable mixture modeling. In *New developments and techniques in structural equation modeling* (pp. 21–54). Psychology Press.
- Nemessany, V. (2019). *La pédagogie par le jeu: Comment remettre les apprentissages en jeu ?*
<https://doi.org/10.13140/RG.2.2.29883.98081>
- Nusbaum, E. C., Silvia, P. J., & Beaty, R. E. (2014). Ready, set, create: What instructing people to “be creative” reveals about the meaning and mechanisms of divergent thinking. *Psychology of Aesthetics, Creativity, and the Arts*, 8(4), 423–432.
<https://doi.org/10.1037/a0036549>
- Paek, S. H., & Runco, M. A. (2018). A latent profile analysis of the criterion-related validity of a divergent thinking test. *Creativity Research Journal*, 30(2), 212–223.
- Paulus, P. (2000). Groups, teams, and creativity: The creative potential of idea-generating groups. *Applied Psychology*, 49(2), Article 2.
- Plass, J. L., Homer, B. D., & Kinzer, C. K. (2015). Foundations of game-based learning. *Educational Psychologist*, 50(4), 258–283.

- Qian, M., & Clark, K. R. (2016). Game-based Learning and 21st century skills: A review of recent research. *Computers in Human Behavior*, *63*, 50–58.
- Reiter-Palmon, R., Illies, M. Y., Kobe Cross, L., Buboltz, C., & Nimps, T. (2009). Creativity and domain specificity: The effect of task type on multiple indexes of creative problem-solving. *Psychology of Aesthetics, Creativity, and the Arts*, *3*(2), 73.
- Rosenberg, J., Beymer, P., Anderson, D., van Lissa, C. J., & Schmidt, J. (2019). tidyLPA: An R package to easily carry out Latent Profile Analysis (LPA) using open-source or commercial software. *Journal of Open Source Software*, *4*(44), 978.
- Runco, M. A., & Jaeger, G. J. (2012). The standard definition of creativity. *Creativity Research Journal*, *24*(1), 92–96. <https://doi.org/10.1080/10400419.2012.650092>
- Ryan, R. M., Mims, V., & Koestner, R. (1983). Relation of reward contingency and interpersonal context to intrinsic motivation: A review and test using cognitive evaluation theory. *Journal of Personality and Social Psychology*, *45*(4), 736. <https://doi.org/10.1037/0022-3514.45.4.736>
- Sala, G., Tatlidil, K. S., & Gobet, F. (2018). Video game training does not enhance cognitive ability: A comprehensive meta-analytic investigation. *Psychological Bulletin*, *144*(2), 111.
- Salen, K., & Zimmerman, E. (2003). Rules of play: Fundamentals of game design. *MIT Press Cambridge*.
- Schwarz, G. (1978). Estimating the dimension of a model. *The Annals of Statistics*, *6*(2), 461–464.
- Scott, G., Leritz, L. E., & Mumford, M. D. (2004a). The effectiveness of creativity training: A quantitative review. *Creativity Research Journal*, *16*(4), 361–388. https://doi.org/10.1207/s15326934crj1604_1
- Scott, G., Leritz, L. E., & Mumford, M. D. (2004b). Types of creativity training: Approaches and their effectiveness. *The Journal of Creative Behavior*, *38*(3), Article 3.
- Shanklin, S. B., & Ehlen, C. R. (2007a). Using the Monopoly board game as an efficient tool in introductory financial accounting instruction. *Journal of Business Case Studies (JBACS)*, *3*(3), 17–22. <https://doi.org/10.19030/jbacs.v3i3.4852>
- Shanklin, S. B., & Ehlen, C. R. (2007b). Using the Monopoly board game as an in-class economic simulation in the Introductory Financial Accounting course. *Journal of College Teaching & Learning (TLC)*, *4*(11).
- Shen, W., Kiger, T. B., Davies, S. E., Rasch, R. L., Simon, K. M., & Ones, D. S. (2011). Samples in applied psychology: Over a decade of research in review. *Journal of Applied Psychology*, *96*(5), 1055.
- Silvia, P. J., Kaufman, J. C., & Pretz, J. E. (2009). Is creativity domain-specific? Latent class models of creative accomplishments and creative self-descriptions. *Psychology of Aesthetics, Creativity, and the Arts*, *3*(3), 139.
- Sun, M., Wang, M., & Wegerif, R. (2020). Effects of divergent thinking training on students' scientific creativity: The impact of individual creative potential and domain knowledge. *Thinking Skills and Creativity*, *37*, 100682.
- Unsworth, N., Redick, T. S., McMillan, B. D., Hambrick, D. Z., Kane, M. J., & Engle, R. W. (2015). Is playing video games related to cognitive abilities? *Psychological Science*, *26*(6), 759–774.

- Vandercruysse, S., Vandewaetere, M., & Clarebout, G. (2012). Game-based learning: A review on the effectiveness of educational games. *Handbook of Research on Serious Games as Educational, Business and Research Tools*, 628–647.
- Von Stumm, S., Chung, A., & Furnham, A. (2011). Creative ability, creative ideation and latent classes of creative achievement: What is the role of personality? *Psychology of Aesthetics, Creativity, and the Arts*, 5(2), 107.
- Yeh, C. S.-H. (2015). Exploring the effects of videogame play on creativity performance and emotional responses. *Computers in Human Behavior*, 53, 396–407.
- Yoon, B., Rodriguez, L., Faselis, C. J., & Liappis, A. P. (2014). Using a board game to reinforce learning. *The Journal of Continuing Education in Nursing*, 45(3), 110–111. <https://doi.org/10.3928/00220124-20140224-14>
- Zeng, L., Proctor, R. W., & Salvendy, G. (2011). Can traditional divergent thinking tests be trusted in measuring and predicting real-world creativity? *Creativity Research Journal*, 23(1), 24–37.

Appendix A

Board game

A board game is a game with a certain number of rules that limit the possibilities, that requires a physical support (in the form of a board, cards, etc.) and that is played by two or more people (example: Monopoly, poker ...).

Creative board game

A creative board game is a board game that requires the production of original and relevant ideas to have a good performance (example: Pictionary ...).

Non-creative board game

A non-creative board game does not require the production of original and relevant ideas to have a good performance (example: Monopoly, poker, Uno ...).

Appendix B

The Big Idea

The Big Idea (Funforge, 2011) is a game where each player has six cards in front of him/her, three "Thing" cards and three "Qualifier" cards, which the player must combine to create an invention. The player is free to use as many cards as he/she wishes and in any order he/she wishes, as long as he/she is able to make sense of his/her invention. After this phase, the player must present his/her invention and argue its interest to the other players, and so on. The most convincing player wins the round.

Imagine

Imagine (Cocktail Games, 2016) is a game where the goal is to make players guess a riddle, which can take the form of a movie, an expression, an object, etc., using transparent cards representing various basic forms. These cards are placed all over the table. To make the other players guess their riddle, the active player must use and combine the cards of his/her choice. He/she is free to use them as he/she wishes (assembly, superimposition, movements, three-dimensional shapes, etc.), but is not allowed to make sounds or to mime with his/her fingers. The other players can make as many suggestions as they like, until one of the players guesses the riddle. The player who made the guess and the player who guessed it each get one point.

Deutsch

Deutsch is a card game using a classic deck of 52 cards. The players have four cards face down and can each look at two of their cards. They also have a deck in the center. The first player turns over the first card in the deck and places it next to it (in the discard pile) and has two choices: either swap the card on top of the discard pile with one of his/her four or draw another card and place it on top of the discard pile. After performing one of these actions, the next person does the same. At any time, players may discard one of their cards, if it matches the value of the discard pile, and place it on top. If a player makes a mistake, they must retrieve their card and draw an additional one, without being able to see it. The red heads each have a "power", which is activated when the card appears in the discard pile (valid once per card): red jacks allow to exchange one card with another, red queens allow to look at a card from a deck, and red kings are worth zero points. At any time, a player may call "Deutsch", after which the game will end at the end of that player's next turn. The object of the game is to have as few

points as possible (jacks are worth 11 points, queens 12, black kings 13, other cards are worth their face value).

Twin It

Twin It (Cocktail Games, 2017) is a game in which the goal is to detect pairs of patterns/symbols present on cards laid out on the table as quickly as possible. Each player starts with a deck of cards, with patterns printed on the front and back. Players take turns turning over a card from their deck and placing it on the table, visible to all players. If a pair of patterns appears, the player who detects it must place a hand or a finger on each of the two cards to win the pair. He/she then places it next to him/her, with the top card still visible to the others. As the cards are printed in one, two or three copies, if a third card with the same symbol as a pair already taken appears, the players can steal the pair from the opponent. The player who has the card in his possession must protect his/her pairs if a third pattern appears. A round ends when one of the players reaches five captures.

Appendix C

Table C1.

Latent profile analysis - Comparisons of different solutions

Number of profiles	AIC	AWE	BIC	CLC	KIC
1	2043.75	2113.47	2064.61	2033.75	2052.75
2	1862.66	1980.65	1897.42	1844.2	1875.66
3	1835.12	2001.02	1883.79	1808.57	1852.12
4	1836.21	2050.05	1898.79	1801.53	1857.21
5	1836.42	2097.97	1912.9	1793.84	1861.42
6	1832.62	2141.98	1923.01	1782.04	1861.62
7	1829.45	2186.61	1933.74	1770.88	1862.45
8	1832.17	2237.14	1950.37	1765.6	1869.17

Table C2.

ANCOVA - Fluency

	Sum of squares	ddl	Medium square	F	p
Condition	2.558	2	1.279	0.340	0.712
Valence	0.426	1	0.426	0.113	0.737
Arousal	1.128	1	1.128	0.300	0.584
Condition * Valence	0.999	2	0.500	0.133	0.876
Condition * Arousal	1.629	2	0.815	0.217	0.805
Residual	864.184	230	3.757		

Table C3.

ANCOVA - Originality

	Sum of squares	ddl	Medium square	F	p
Condition	0.457	2	0.228	0.952	0.387
Valence	0.183	1	0.183	0.761	0.384
Arousal	0.221	1	0.221	0.923	0.338
Condition * Arousal	0.025	2	0.013	0.052	0.949
Condition * Valence	0.070	2	0.035	0.146	0.864
Residual	54.928	229	0.240		

The effects of board games on group creativity

Maxence Mercier^{1*}, Samira Bourgeois-Bougrine¹ and Todd Lubart¹

¹ Université Paris Cité and Univ Gustave Eiffel, LaPEA, F-92100 Boulogne-Billancourt,
France

Author Note

Maxence Mercier  <https://orcid.org/0000-0001-9045-2032>

Samira Bourgeois-Bougrine  <https://orcid.org/0000-0001-5083-1177>

Todd Lubart  <https://orcid.org/0000-0002-8776-8797>

We have no known conflict of interests to disclose.

Correspondence concerning this article should be addressed to Maxence Mercier, Université Paris Cité, LaPEA, 71 avenue Edouard Vaillant, 92100 Boulogne-Billancourt Cedex, France.
Email: mercier.maxence96@gmail.com

APA Reference:

Mercier, M., Bourgeois-Bougrine, S., Lubart, T. (in prep.). The effects of board games on group creativity.

Abstract

Games have shown potential for helping improve individuals' creativity. However, creativity spans both individual and collective efforts. Due to the complexity facing organizations and more specialized work roles, creative work is often carried out in groups. Because games are effective at improving creativity, and many of them are social activities by design, this paper argues that board games can prove especially fruitful for improving group creativity. Using an experimental design, this study explored the effects of creative board games (i.e., conducive to creativity) on group creativity, compared to a control condition, with non-creative board games. Group creativity was operationalized using a group divergent thinking task based on brainstorming. Ideas produced were assessed on three criteria: fluency, elaboration and originality. Groups of three participants played a creative or non-creative board game for 30 minutes, then partook in a 15-minute brainstorming task, and finally completed several scales as control variables. The findings of this study provide compelling evidence that creative board games positively impact group creativity in a brainstorming-like task. Groups who engaged in playing creative board games demonstrated significantly higher levels of group divergent thinking, in all three criteria. This outcome suggests that board games can be a valuable tool for promoting creativity within groups.

Keywords: board games, creativity, group creativity, divergent thinking, brainstorming

Introduction

Creative endeavors span both individual and collective efforts. Whereas the value of individual creativity is undeniable (Oppert et al., 2023), iconic groups like Beatles or the team responsible for the Human Genome Project highlight the potential of collective creativity. In fact, much creative work is done in groups. The importance for organizational adaptability to changing environments is widely recognized (Zhou & Shalley, 2011). Due to the complexity facing organizations and more specialized work roles, creative work is often carried out in teams (Hoever et al., 2012). To solve problems, adapt to their environment and innovate, both groups and their members need creativity (Amabile, 2018). Furthermore, many project teams desire to produce creative outcomes (Joo et al., 2012; Zhu et al., 2018), be they incremental or radical. As such, interest in group and team creativity has increased (Reiter-Palmon & Murugavel, 2018; Shalley et al., 2004) Finding ways to improve this collective creativity is crucial, and a major goal of 21st century's organizations. Group creativity is influenced by the creative inputs of its individual members (Pirola-Merlo & Mann, 2004; Taggar, 2001), but the collective synergy can sometimes be greater than the sum of its parts. Therefore, strategies aimed at bolstering both individual and collective creativity are worth exploring. One potential tool for this dual enhancement is games. Games have started to prove their potential as an effective improvement tool for individual creativity (e.g., Rahimi & Shute, 2021). Games offer an opportunity to experience and practice creativity in an optimal and playful situation, in a risk-free environment (Whitton, 2012, 2018). This paper argues that games, especially board games, can prove especially fruitful for the improvement of group creativity as well.

Group Creativity

Group creativity can be defined as the joint novelty and usefulness of ideas developed by a group of people (Hoever et al., 2012). Groups are generally defined as collections of individuals focused on a specific goal or task (Forsyth, 2018). In this paper, the focus is on groups performing a specific creative task. Group creativity occurs then when a bounded and recognizable collection of individuals works interdependently towards a shared goal (Hackman, 1987). Creative outputs can range from incremental improvements to radical ideas for new products, services, and processes (George, 2007; Madjar et al., 2011). Whereas individual creativity centers on the cognitive processes and insights of a solitary mind, group creativity leverages the diverse cognitive resources, expertise, and perspectives of its members to produce outcomes that go beyond individual capabilities (Amabile, 2012). Within a group, creativity flourishes as members interact, share knowledge, and collectively contribute, fostering the

emergence of original and useful ideas (Paulus & Brown, 2007). Optimizing such group creativity usually requires targeted interventions and improvements, and an overall comprehension of its antecedents.

Antecedents and Improvement of Group Creativity

The antecedents of group creativity are a blend of individual, group, and environmental factors that stimulate or impede the creative process. At the individual level, individuals with a high level of creative self-efficacy, the belief in one's ability to produce creative outcomes, tend to contribute more innovative ideas to the group (Tierney & Farmer, 2011). Leadership also plays a key role. Leaders employing a participative style, engaging group members in decision-making processes, foster higher levels of creativity (Zhou et al., 2010). Moreover, servant leadership, characterized by prioritizing the growth and well-being of group members, has also shown a positive impact on group creativity (Chiniara & Bentein, 2018). On a group level, factors such as group diversity, cohesion, and norms determine the breadth and depth of ideas generated (Hoever et al., 2012). Effective group processes, such as structured brainstorming, idea sharing, and creative problem-solving techniques, can enhance group creativity (for a review, see Paulus & Nijstad, 2019). Work climate also plays a vital role in determining creative output, with psychological safety being an important antecedent (Han et al., 2019). This ensures that members feel secure in sharing novel ideas without fear of being ridiculed, thus promoting the free flow of thoughts.

Board Games and Creativity

Most effective interventions designed to improve creativity (individual or collective) are systematic training programs that necessitate procedural rigor (Haase et al., 2023). Although useful, they can prove quite time-consuming (Scott et al., 2004) and thus potentially difficult to use. Although organizations, private or public, might desire more group creativity from their members, time constraints can be a deal breaker depending on the resources at their disposal. If a teacher wants to promote group creativity from its pupil, a 30-hour drama course (Karakelle, 2009) might be judged unfeasible and thus not approved. If a manager wants to improve the creative output of his or her team, a lengthy Creative-Problem Solving training (Wang & Horng, 2002) might meet reticence due to time and financial costs.

One effective and easily applicable method for improving creativity has appeared in recent years: board games. The field of game-based learning has gained traction in the past decades (De Freitas, 2006; Whitton, 2012), and creativity has started to receive attention as

one key skill that can be improved through games (Qian & Clark, 2016). A game corresponds here to an immersive, voluntary and enjoyable activity, in which a challenge is pursued according to previously established rules (Kinzie & Joseph, 2008). Board games are games with a certain number of rules that limit the possibilities, require an analogical support, and are played by two or more players (Gobet et al., 2004).

Recent experimental studies have demonstrated the potential of board games for improving individual creativity. Park & Lee (2017) carried out an experimental study implementing board game sessions in the curriculum of two fifth-grade classes, as well as a control-group class. The students engaged in 30-minute daily board game sessions for a span of four weeks. Whereas one class was instructed by the teacher, the other was left to free-play. Both groups displayed substantial enhancements in mathematical creativity. The-play group, particularly, demonstrated superior results in terms of flexibility compared to the control group. Gonzalo-Iglesia et al. (2018) performed three separate interventions involving various commercial board games that were relevant to their courses, with a participant group of 196 university students. Post-intervention, 89.7% of the participants reported a significant boost in learning motivation, and 67% perceived an improvement in their creative skills.

In a quasi-experimental study, Mercier & Lubart (2021) observed that board games played a role in enhancing the divergent thinking capabilities of participants ($N = 55$), particularly those who displayed average or less-than-average fluency or originality. This finding was further explored in a subsequent experimental study (Mercier & Lubart, 2023), in which they compared the impact of creative board games (i.e., games that require the production of original and relevant ideas to perform well) to non-creative board games, and a no-game control group. The result was a notable medium-sized improvement in originality for the participants engaging in creative board games compared to the other two groups ($N = 239$).

In a quasi-experimental study involving 76 high school students, Kuo et al. (2023) tasked them with designing board games based on their personal interests and the syllabus of an 18-week civic education course. The findings showed an enhancement in both verbal and figural creativity as well as civic competencies, compared to the control group which received -traditional teaching methods.

The Present Study

Board games appear therefore to be effective to teach or improve individual creativity, but this form of game play also implies a collective dimension that could prove especially

fruitful for the improvement of group creativity. By their very definition (Gobet et al., 2004), board games are played by two or more players. Thus, board games are inherently a social activity, compared to other forms of games like video games, which can be either solo or multiplayer. This paper therefore aims to explore further the effects of board games, this time focusing on group creativity, operationalized using a group divergent thinking task.

In order to conduct an experimental study, two types of board games were chosen, based on their potential for improving creativity. Previous studies have used a pragmatic approach to defining what constitutes a “creative board game” (Mercier & Lubart, 2021, 2023). Based on the consensual definition of creativity, a creative board game is a game that requires the production of original and relevant ideas to perform well. In contrast, non-creative board games do not require such creative generation to perform well. Recently, a grid was developed to assess the potential of board games to improve the 4Cs skills (creativity, critical thinking, communication, and collaboration), the 4Cs Evaluation Framework for Games (Thornhill-Miller et al., 2023). . The grid evaluates a game’s effectiveness for training and improving creativity, based on the game’s mechanics towards the experience and practice of each of the four skills. Regarding creativity, if a game solicits and requires creativity to a large enough degree to perform well and to win the game, it will be considered as a creative board game. Based on the grid, two creative games were chosen: The Big Idea and Dixit. In contrast, two non-creative board games were chosen for the control condition: Deutsch and Twin It!. Furthermore, all four games were rated on the Collaboration grid and found to lack collaboration mechanics; collaboration could occur occasionally in these games, but in no way was necessary or particularly helpful for performing well and/or winning the games.

Furthermore, several control variables were also assessed, relating to individual creative potential and group dynamics. Because individual creative potential influences the creative output of the group (Taggar, 2001; Tierney & Farmer, 2011), two aspects of creative self-concept were measured: creative self-efficacy, which is the belief in one’s own creative abilities, and creative personal identity, that reflects the belief that creativity is an important element of the individual’s functioning (Karwowski, 2012; Karwowski et al., 2018). These two constructs are key to creative potential (Karwowski et al., 2019), and could very well influence the effectiveness of the intervention. Openness to experience was also considered for the same reason (Grajzel et al., 2023). Gaming habits were measured, as they correlate with all three prior variables (Mercier & Lubart, 2023) and could also influence the effectiveness of the intervention. Two other personality factors were considered and measured, for their potential

effects on group dynamics in creative tasks: extraversion and agreeableness (Bechtoldt et al., 2007). At the group level, enjoyment of the brainstorming task and group cohesion were also assessed, to detect enhanced collaboration after a particular game (Joo et al., 2012; Rodríguez-Sánchez et al., 2017).

Method

Participants and Experimental Design

In exchange for course credit, 120 students in the first- or second-year undergraduate program were recruited, at the Institute of Psychology of the University of Paris Cité. The mean age was 18.9 years ($SD = 2.02$) and 83.3% of the participants were women. Most participants were native French speakers (88.3%) . Participants were distributed in 40 groups of three. We used a between-subjects experimental design, i.e., each group of participants was randomly assigned to one of two conditions: creative board game condition ($N = 20$), and control condition ($N = 20$), in which participants played non-creative board games.

Material

Creative Board Games. Two creative game were chosen, basing our selection on the 4Cs Evaluation Framework for Games (Thornhill-Miller et al., 2023). The two games were The Big Idea (Funforge, 2011) and Dixit (Libellud, 2008). The rules for each of the games are available in Appendix A. Of the groups in the creative game condition, 10 played The Big Idea, and 10 played Imagine.

Non-creative Board Games. We chose two non-creative games: Deutsch and Twin It (Cocktail Games, 2017). Rules for each of the games in Appendix A. Of the groups in the control condition, 10 played Deutsch, and 10 played Twin It.

Group Divergent Thinking. Group divergent thinking was assessed using a brainstorming task, derived from Bechtoldt et al. (2010, 2012). Because participants were students in a public university, a problem tailored to this sample was chosen. Participants were requested to generate ideas about how to improve teaching and learning at their university. They had 15 minutes to do so. One participant was tasked with reporting the ideas on paper sheets. The detailed instructions are provided in the procedure section. The session was recorded. For each group, the list of ideas was reported based on the paper sheets, then double-checked and completed by transcribing the video and audio recording.

Three criteria of divergent thinking were assessed: fluency, elaboration, and originality. Fluency corresponded to the total number of ideas given by the group. Elaboration corresponded to the total length of all ideas given. Originality was assessed using snapshot scoring (Silvia et al., 2009), in which judges rate the originality of the entire set of responses, given here by one group, instead of rating responses individually. Two judges, both creativity researchers and faculty members (one male, one female) rated independently the originality of the ideas. We asked the judges to rate originality using the following instructions: "You must rate the originality of the entire set of responses given by the participant, meaning the unusualness, the novelty of the ideas they gave, without regard to the relevance of those ideas." They rated originality using a seven-point scale. Intraclass correlation coefficients were calculated using the *icc* function of R package *psy* (Falissard, 2022). Consistency was good (0.81), as was absolute agreement (0.77).

Frequency of Playing Board Games. We measured the frequency of playing board games, using an ordinal scale (Afifi et al., 2014), consisting of the following values: never, 1-5 times a year, 6-11 times a year, once a month, 2-3 times a month, once a week, 2-6 times a week, every day.

Enjoyment of the Brainstorming Task. We measured the enjoyment of the brainstorming session using the "Enjoyment" subscale of the Intrinsic Motivation Inventory (IMI, Ryan et al., 1983), on a 7-point Likert scale. This 7-item scale was translated using the back-translation method (Brislin, 1986). The internal consistency of the scale was good ($\alpha = .84$).

Creative Self-Concept. Creative self-efficacy (CSE) and creative personal identity (CPI) were measured using the Short Scale of Creative Self (SSCS, Karwowski, 2012; Karwowski et al., 2018), on a 7-point Likert scale. It is an 11-item scale, with 6 items measuring creative self-efficacy and 5 measuring creative personal identity. The scale was translated using the back-translation method (Brislin, 1986). Both subscales had satisfactory to good internal consistency (CSE - $\alpha = .78$; CPI - $\alpha = .90$).

Personality Dimensions. Three factors of the Big-Five model were measured: openness, extraversion, and agreeableness. These factors were measured using their corresponding subscale in the French Big Five Inventory (BFI-Fr; Plaisant et al., 2010), using a 7-point Likert scale. All three factors showed satisfactory to good internal consistency (Openness - $\alpha = .82$; Extraversion - $\alpha = .89$; CPI - $\alpha = .90$; Agreeableness - $\alpha = .74$).

Group Cohesion. Group cohesion was assessed using the Classroom Cohesion Questionnaire (CCQ, Rosenfeld & Gilbert, 1989), on a 7-point Likert scale. This scale was first designed to measure the perceived cohesion in classroom groups, in an undergraduate environment. Because this study's sample and setting corresponded to the target audience of the CCQ, this 10-item scale was translated into French using the back-translation method (Brislin, 1986). The internal consistency of the scale was good ($\alpha = .90$).

Procedure

After welcoming the group and seating them around a table, participants learned that they would be taking part in a study on games and idea generation. Before starting, participants signed a consent form. After that, the experimenter explained the rules of the game they were going to play, using standardized explanations. They then played the game for 30 minutes, randomly selected from the two games corresponding to the group condition. During this time, the experimenter remained nearby and available in case of questions or forgotten rules.

After these 30 minutes, participants were told they would next participate in a brainstorming session, for 15 minutes. All participants were given the same standardized instructions. These were as follows: *“The goal of brainstorming is to gather several individuals and have them come up with ideas to a given problem. Yours will be to generate ideas about how to improve teaching and learning in your university. These ideas can apply to lectures, tutorials, the library, or whatever, as long as you can link it back to the improvement of teaching and learning. These ideas can be stupid and farfetched, or straightforward and practical. We don't care about the quality of the ideas: if you have one, say it. There are two principles that you need to follow, to ensure the smooth running of the brainstorming session. First, no self-criticism of your ideas. You will surely come up with ideas that you find utterly stupid. Even so, give the idea, as it can prove useful to the rest of the group: even a so-called bad idea can lead to good ideas afterwards. Second, no criticism of others' ideas. You can of course disagree with their ideas, but you must first listen and accept the idea as is, before eventually saying anything.”*

One of the three participants was tasked with reporting the ideas on paper sheets, and the session (audio and video) was recorded on a secured server as well. The participants then completed on paper the scales presented previously. After the experiment was completed, the experimenter explained the objectives of the study and answered any questions the participants might have.

Table 1.
Correlation Matrix - Individual scores

	Fluency	Elaboration	Originality	Age	Frequency	Enjoyment	Group Cohesion	E	A	O	CSE	CPI
Fluency	—											
Elaboration	0.787 ***	—										
Originality	0.672 ***	0.670 ***	—									
Age	0.115	0.187 *	0.010	—								
Frequency	0.158	0.117	0.150	-0.047	—							
Enjoyment	0.234 *	0.269 **	0.318 ***	-0.023	0.192 *	—						
Group Cohesion	0.377 ***	0.299 ***	0.354 ***	-0.010	0.073	0.276 **	—					
E	-0.026	0.074	0.081	-0.020	0.234 *	0.214 *	-0.042	—				
A	0.060	0.115	0.074	-0.024	0.067	0.113	0.352 ***	-0.101	—			
O	0.074	-0.025	0.094	-0.255 **	0.162	0.127	0.017	0.160	0.146	—		
CSE	0.131	0.045	0.065	-0.152	0.165	0.124	0.043	0.135	0.089	0.613 ***	—	
CPI	0.150	0.027	0.164	-0.105	0.182 *	0.147	0.027	0.078	-0.007	0.749 ***	0.617 ***	—

Note 1. * $p < .05$, ** $p < .01$, *** $p < .001$

Note 2. E: Extraversion, A: Agreeableness, O: Openness, CSE: Creative Self-Efficacy, CPI: Creative Personal Identity

Table 2.
Correlation Matrix - Group scores

	Fluency	Elaboration	Originality	Age	Frequency	Enjoyment	Group Cohesion	E	A	O	CSE	CPI
Fluency	—											
Elaboration	0.787 ***	—										
Originality	0.672 ***	0.670 ***	—									
Age	0.203	0.330 *	0.018	—								
Frequency	0.272	0.202	0.259	0.058	—							
Enjoyment	0.367 *	0.423 **	0.499 **	0.021	0.126	—						
Group Cohesion	0.481 **	0.382 *	0.451 **	-0.077	0.132	0.246	—					
E	-0.053	0.149	0.163	0.061	0.113	0.229	-0.029	—				
A	0.095	0.183	0.118	-0.028	-0.154	-0.106	0.363 *	-0.313 *	—			
O	0.134	-0.046	0.170	-0.222	-0.160	0.102	0.006	-0.025	-0.007	—		
CSE	0.258	0.089	0.128	-0.004	-0.225	0.076	0.131	0.027	0.098	0.459 **	—	
CPI	0.266	0.048	0.290	0.052	-0.033	0.139	0.068	0.020	-0.058	0.746 ***	0.514 ***	—

Note 1. * p < .05, ** p < .01, *** p < .001

Note 2. E: Extraversion, A: Agreeableness, O: Openness, CSE: Creative Self-Efficacy, CPI: Creative Personal Identity

Results

Descriptive and Correlation Analyses

Due to the nested nature of the study's variables, two correlational models were tested. The first uses all 120 participants' responses and correlates them to fluency, elaboration and originality as obtained by their respective group (Table 1). The second model uses the averaged responses of each group, so that only the 40 groups' scores are correlated (Table 2).

In both cases, Fluency correlated positively with Elaboration ($r = .79, p < .001$) and with Originality ($r = .67, p < .001$), and Elaboration correlated positively with Originality ($r = .67, p < .001$). In both correlation matrices, Fluency correlated positively with Enjoyment of the task ($r_{indiv} = .23, p = .01; r_{group} = .37, p = .02$), as well as with Group Cohesion ($r_{indiv} = .238, p < .001; r_{group} = .48, p = .002$). In both models, Elaboration correlated positively with Age ($r_{indiv} = .19, p = .04; r_{group} = .33, p = .04$), Enjoyment of the task ($r_{indiv} = .27, p = .003; r_{group} = .42, p = .007$), as well as with Group Cohesion ($r_{indiv} = .30, p < .001; r_{group} = .38, p = .015$). In both correlation matrix models, Originality correlated positively with Enjoyment of the task ($r_{indiv} = .32, p < .001; r_{group} = .50, p = .001$), as well as with Group Cohesion ($r_{indiv} = .35, p < .001; r_{group} = .45, p = .003$). Fluency, Elaboration and Originality did not correlate with the rest of the control variables, in both scenarios.

Experimental Effects

Hypotheses Testing. We hypothesized that playing creative board games would have a positive effect on three criteria of divergent thinking (fluency, elaboration, and originality) compared to non-creative board games. To test these hypotheses, we proceeded in a hierarchical manner. The main hypotheses were tested via independent samples t-tests, with Fluency, Elaboration, and Originality as dependent variables, and the two conditions (creative vs non-creative games) as the grouping variable (Table 3). A power analysis indicated the sensitivity of the study and thus the minimum detectable effect size. With $\alpha = 0.05$, 80% power and 20 samples in each condition, the minimum detectable effect size was $d = 0.80$ ($t = 1.69$). Then, to account for the control variables correlating with Fluency, Elaboration and Originality, three mediation analyses were conducted with the conditions as the factor, Fluency, Elaboration, or Originality as the dependent variable, and the corresponding control variables as mediators.

Main Hypotheses. Regarding Fluency, the t-test showed a significant difference between control and experimental conditions, $M = 7.5$, $SE = 2.5$, $t = 3.001$, $p = .005$. Furthermore, the effect size was large and above the sensitivity threshold ($d = .95$). Regarding Elaboration, the t-test again showed a significant difference between control and experimental conditions, $M = 120.4$, $SE = 36.6$, $t = 3.29$, $p = .002$. Furthermore, the effect size was very large and above the sensitivity threshold ($d = 1.04$).) Regarding Originality, the t-test again showed a significant difference between control and experimental conditions, $M = 1.1$, $SE = 0.34$, $t = 3.26$, $p = .002$. Furthermore, the effect size was again very large and above the sensitivity threshold ($d = 1.03$).

As such, all three main hypotheses were corroborated: playing a creative board game led to improved Fluency, Elaboration, and Originality in the brainstorming task, compared to the control group.

Control Variables. Because our experimental design did not incorporate pretest measures, variation across conditions could be attributed to initial differences in the participants and the groups. To control for potential sampling bias, we conducted independent samples t-tests, with the two conditions as the grouping variable, and all control variables. A first round of t-tests was conducted using the 120 individuals' responses, and a second using the 40 averaged responses of each group. In both scenarios, and for all control variables, no significant differences were observed between the two conditions. For details, see Appendix B, Tables B1 and B2.

Based on the correlations observed in Table 2, the observed effects might still have been attributable to differences in either Enjoyment of the task and Group Cohesion for Fluency, Elaboration and Originality, as well as differences in Age for Elaboration. Therefore, mediation analyses were conducted to test whether these variables played a significant role in the observed effects. For details, see Appendix B, Tables B3, B4 and B5.

Regarding Fluency, no indirect effects were found, for Enjoyment ($\beta = 0.03$, $p = .42$) or Group Cohesion ($\beta = 0.08$, $p = .19$). Accounting for the presence of mediators, the direct effect of conditions on Fluency was still positive and significant ($M = 5.57$, $\beta = 0.33$, $p = .01$). Regarding Elaboration, no indirect effects were found, for Enjoyment ($\beta = 0.04$, $p = .40$), Group Cohesion ($\beta = 0.06$, $p = .22$), or Age ($\beta = 0.01$, $p = .82$). Accounting for the presence of mediators, the direct effect of conditions on Fluency was still positive and significant ($M = 98.5$, $\beta = 0.38$, $p < .001$). Regarding originality, no indirect effects were found, for Enjoyment ($\beta =$

0.05, $p = .39$) or Group Cohesion ($\beta = 0.06, p = .21$). Accounting for the presence of mediators, the direct effect of conditions on Originality was still positive and significant ($M = 0.825, \beta = 0.47, p = .003$).

Discussion

The primary aim of this study was to explore the potential effects of board games on group creativity. Given the growing interest in enhancing collective creativity, the study investigated whether playing creative board games would lead to improvements in group divergent thinking, operationalized with a three-person brainstorming task. We hypothesized that playing creative board games would have a positive effect on both fluency, elaboration, and originality compared to non-creative board games.

Main Results

The findings of this study provide compelling evidence that creative board games positively impact group creativity in a brainstorming task. Groups who engaged in playing creative board games demonstrated significantly higher levels of group divergent thinking, as measured by fluency, elaboration, and originality. This outcome supports our hypothesis and suggests that board games, particularly those requiring the production of original and relevant ideas, can be a valuable tool for promoting creativity within groups.

The results of this study revealed a significant positive effect of engaging in creative board games on group fluency during the brainstorming task. Participants in the creative board game condition generated a significantly higher number of ideas compared to those in the control condition, where non-creative board games were played. This finding is interesting, as previous research showed no effects on individual fluency (Mercier & Lubart, 2023).

The increased fluency observed in the creative board game condition can be attributed to several factors. First, creative board games allow for concrete experience and practice of idea generation. For instance, *The Big Idea* requires participants to find a way to sell their ideas, which is in itself an efficient way to improve creativity in students (Sternberg, 2019). They need to come up with ideas to sell, and then with ways to sell them. Other players are encouraged to surf on ideas, come up with questions and challenge the player trying to sell their invention. *Dixit* encourages players to think outside the box and explore unconventional solutions, leading to a wider range of ideas, which then lead to an evaluation and selection phase. Additionally, the immersive and playful nature of board games creates a risk-free environment where

participants feel comfortable expressing their creativity, without fear of judgment or criticism (Paulus & Brown, 2007). This atmosphere of psychological safety allows for the uninhibited flow of ideas, contributing to the observed increase in fluency.

In addition to increased fluency, engaging in creative board games also had a significant positive effect on elaboration. Groups in the creative board game condition produced longer and more detailed ideas during the brainstorming task compared to those in the control condition. This is among the first studies on games and creativity to include elaboration as an evaluation criterion. Several features of The Big Idea seem instrumental in fostering this heightened elaboration. For instance, this board compels participants to be both creative and persuasive, prompting them to elaborate extensively on their ideas to make them appealing to others. The game inherently pushes players to detail their concepts beyond mere presentation, requiring them to anticipate questions and challenges from other players. The need to "sell" their ideas forces a deeper engagement with their concepts, promoting richer exploration and presentation.

Finally, engaging in creative board games had a significant positive effect on originality. Participants did not just produce more ideas or expand upon them; they ventured into unique and unconventional territories, showcasing a higher degree of originality than those in the control group. This finding aligns with prior results on the effect of creative board games on originality at the individual level (Mercier & Lubart, 2023). Games like Dixit, with abstract illustrations that leave ample room for interpretation seem particularly tailored to improve originality. For instance, the ambiguity of the imagery and the various possibilities obligate players to think divergently and find remote associations, which plays an important role in originality (Kenett, 2019; Mednick, 1962).

Control Variables

In this study, we identified several control variables that could potentially influence the relationship between board games and group creativity. These control variables included age, gaming habits, enjoyment of the brainstorming task, group cohesion, creative self-efficacy, creative personal identity, and three personality factors, openness, extraversion, and agreeableness. No significant differences were observed between the conditions, at the individual or the group level. This indicates the observed effects are not due to sampling bias.

Age was found to be positively correlated with elaboration, indicating that older participants tended to generate longer and more detailed ideas during the brainstorming task. However, age did not mediate the relationship between board games and elaboration. Therefore, it is unlikely that age confounded the observed effects of creative board games on elaboration.

We also examined whether enjoyment of the brainstorming task and group cohesion mediated the relationship between the two conditions and group divergent thinking. Whereas both enjoyment and group cohesion were positively correlated with all three criteria, our mediation analyses revealed that these variables did not mediate the relationship between creative board games and group divergent thinking. The impact of creative board games on group divergent thinking is thus not explained by participants' enjoyment of the task or the level of group cohesion. Instead, the positive effects appear to be direct and independent of these variables.

The study also explored the potential influence of gaming habits, creative self-efficacy, creative personal identity, and personality factors (openness, extraversion, and agreeableness) on group divergent thinking. None of these variables showed a significant correlation with any of the three criteria. Therefore, it is unlikely that these individual-level characteristics influenced the observed effects of creative board games on group divergent thinking.

The absence of mediation in this study indicates that the relationship between creative board games and group divergent thinking is not contingent on any of the examined control variables. Whereas enjoyment of the task and group cohesion were positively associated with group divergent thinking, they did not account for the improvements observed in the creative board game condition. This finding suggests that the effects of creative board games on group divergent thinking are robust and not reliant on participants' enjoyment of the task or the level of group cohesion.

Implications

The significant effects of creative board games on group divergent thinking have important practical implications for organizations, educators, and possibly managers seeking to promote group creativity. By incorporating creative board games into team-building activities, brainstorming sessions, and workshops, organizations may create a stimulating and supportive environment that fosters creative thinking and idea generation among groups of employees. For educators, integrating creative board games into the curriculum provides students with a fun, time- and cost-efficient way to develop their creative thinking skills, as a collective.

Furthermore, this can be a method through which educators can make their students actively participate in creativity. Creativity is too often seen in the classroom as an individual capacity, due to preconceptions about the nature of creativity and the prevalence of great creative individuals (Hanchett Hanson, 2015). One way to deconstruct this notion is to give the opportunity for students to participate in creativity (Clapp & Hanchett Hanson, 2019). According to this participatory perspective, students can then “participate in creativity, rather than ‘having’ creativity” (Clapp & Hanchett Hanson, 2019, p. 35). Creative board games could be construed as a relatively simple way to achieve this result. Creative board games could help students realize even they can be creative, in a way that is ludic and risk-free.

Moreover, the direct impact of creative board games on group divergent thinking, independent of individual-level characteristics and group dynamics, underscores the accessibility and effectiveness of these interventions. Organizations and educators could more confidently implement creative board games as easily applicable and efficient tools to enhance group creativity and innovation.

Limitations and Prospects

This study on the effects of creative board games on group divergent thinking is not without its limitations. First and foremost, the sample consisted primarily of undergraduate students from a specific university, which limits the generalizability of the findings to other populations. Whereas the student sample allowed for the investigation of group creativity within an educational context, future research should aim to replicate the study with diverse samples from various organizational and cultural settings to assess the external validity of the results.

Furthermore, the study relied on a single brainstorming task and focused on the immediate effects of playing creative board games. Future research could explore the long-term effects of incorporating creative board games into regular group activities and assess the sustainability of the observed improvements in group creativity over time. Additionally, comparing the efficacy of creative board games with other creativity-enhancing interventions, such as traditional brainstorming techniques or creative problem-solving workshops, would offer valuable insights into the relative effectiveness of different approaches for enhancing group creativity.

Conclusion

Engaging in creative board games has a significant positive impact on divergent thinking. Groups who played creative board games during the study's brainstorming task generated a higher quantity of ideas, provided more elaborate contributions, and came up with more unique and novel ideas, compared to those who played non-creative board games. The effects of creative board games on group divergent thinking appear to be large and independent of individual characteristics and group cohesion. The results highlight the potential of creative board games as a targeted intervention for enhancing group creativity, and their integration into team-building activities and brainstorming sessions holds practical value for organizations and educators alike.

References

- Affifi, T. O., LaPlante, D. A., Taillieu, T. L., Dowd, D., & Shaffer, H. J. (2014). Gambling involvement: Considering frequency of play and the moderating effects of gender and age. *International Journal of Mental Health and Addiction*, *12*(3), 283–294.
- Amabile, T. M. (2012). Componential theory of creativity. *Harvard Business School*, *12*(96), Article 96.
- Amabile, T. M. (2018). *Creativity in context: Update to the social psychology of creativity*. Routledge.
- Bechtoldt, M. N., Choi, H.-S., & Nijstad, B. A. (2012). Individuals in mind, mates by heart: Individualistic self-construal and collective value orientation as predictors of group creativity. *Journal of Experimental Social Psychology*, *48*(4), 838–844.
- Bechtoldt, M. N., De Dreu, C. K., & Nijstad, B. A. (2007). Team personality diversity, group creativity, and innovativeness in organizational teams. *The Fondazione Eni Enrico Mattei Series, SUSDIV Paper, 1*.
- Bechtoldt, M. N., De Dreu, C. K., Nijstad, B. A., & Choi, H.-S. (2010). Motivated information processing, social tuning, and group creativity. *Journal of Personality and Social Psychology*, *99*(4), 622.
- Brislin, R. W. (1986). The wording and translation of research instruments. In *Field methods in cross-cultural research* (pp. 137–164). Sage Publications, Inc.
- Chiniara, M., & Bentein, K. (2018). The servant leadership advantage: When perceiving low differentiation in leader-member relationship quality influences team cohesion, team task performance and service OCB. *The Leadership Quarterly*, *29*(2), 333–345.
- Clapp, E. P., & Hanchett Hanson, M. (2019). Participatory Creativity: Supporting Dynamic Roles and Perspectives in the Classroom. In R. A. Beghetto & G. E. Corazza (Eds.), *Dynamic Perspectives on Creativity* (Vol. 4, pp. 27–46). Springer International Publishing. https://doi.org/10.1007/978-3-319-99163-4_3
- Cocktail Games. (2017). *Twin It*.
- De Freitas, S. (2006). *Learning in immersive worlds: A review of game-based learning*.
- Forsyth, D. R. (2018). *Group dynamics*. Cengage Learning.
- Funforge. (2011). *The Big Idea*.
- George, J. M. (2007). 9 Creativity in organizations. *The Academy of Management Annals*, *1*(1), 439–477.
- Gobet, F., Retschitzki, J., & de Voogt, A. (2004). *Moves in mind: The psychology of board games*. Psychology Press.
- Gonzalo-Iglesia, J. L., Lozano-Monterrubio, N., & Prades-Tena, J. (2018). The usage of game-based learning in university education. How to motivate and foster creativity among adult students through board games. *Proceedings of Play2Learn*, 67–84.
- Grajzel, K., Acar, S., & Singer, G. (2023). The Big Five and divergent thinking: A meta-analysis. *Personality and Individual Differences*, *214*, 112338.
- Haase, J., Hanel, P. H., & Gronau, N. (2023). Creativity enhancement methods for adults: A meta-analysis. *Psychology of Aesthetics, Creativity, and the Arts*.
- Hackman, J. (1987). R.(1987). The design of work teams. *Handbook of Organizational Behavior*, 315–342.

- Han, S. J., Lee, Y., & Beyerlein, M. (2019). Developing team creativity: The influence of psychological safety and relation-oriented shared leadership. *Performance Improvement Quarterly*, 32(2), 159–182.
- Hanchett Hanson, M. H. (2015). *Worldmaking: Psychology and the ideology of creativity*. Springer.
<https://books.google.fr/books?hl=en&lr=&id=P1veCgAAQBAJ&oi=fnd&pg=PP1&dq=michael+hanchett+hanson&ots=72oA0HFPyX&sig=LRfxHek1symYatixz3tqD402HBU>
- Hoever, I. J., Van Knippenberg, D., Van Ginkel, W. P., & Barkema, H. G. (2012). Fostering team creativity: Perspective taking as key to unlocking diversity's potential. *Journal of Applied Psychology*, 97(5), 982.
- Joo, B.-K., Song, J. H., Lim, D. H., & Yoon, S. W. (2012). Team creativity: The effects of perceived learning culture, developmental feedback and team cohesion. *International Journal of Training and Development*, 16(2), 77–91.
- Karakelle, S. (2009). Enhancing fluent and flexible thinking through the creative drama process. *Thinking Skills and Creativity*, 4(2), 124–129.
- Karwowski, M. (2012). Did curiosity kill the cat? Relationship between trait curiosity, creative self-efficacy and creative personal identity. *Europe's Journal of Psychology*, 8(4), 547–558.
- Karwowski, M., Lebudá, I., & Beghetto, R. A. (2019). 19 Creative Self-Beliefs. *The Cambridge Handbook of Creativity*, 396.
- Karwowski, M., Lebudá, I., & Wiśniewska, E. (2018). Measuring creative self-efficacy and creative personal identity. *The International Journal of Creativity & Problem Solving*.
- Kenett, Y. N. (2019). What can quantitative measures of semantic distance tell us about creativity? *Current Opinion in Behavioral Sciences*, 27, 11–16.
- Kinzie, M. B., & Joseph, D. R. (2008). Gender differences in game activity preferences of middle school children: Implications for educational game design. *Educational Technology Research and Development*, 56(5–6), Article 5–6.
<https://doi.org/10.1007/s11423-007-9076-z>
- Kuo, H.-C., Weng, T.-L., Chang, C.-C., & Chang, C.-Y. (2023). Designing Our Own Board Games in the Playful Space: Improving High School Student's Citizenship Competencies and Creativity through Game-Based Learning. *Sustainability*, 15(4), Article 4.
- Libellud. (2008). *Dixit*.
- Madjar, N., Greenberg, E., & Chen, Z. (2011). Factors for radical creativity, incremental creativity, and routine, noncreative performance. *Journal of Applied Psychology*, 96(4), Article 4.
- Mednick, S. (1962). The associative basis of the creative process. *Psychological Review*, 69(3), 220.
- Mercier, M., & Lubart, T. (2021). The effects of board games on creative potential. *The Journal of Creative Behavior*, 55(3), Article 3.
- Mercier, M., & Lubart, T. (2023). Board games enhance creativity: Evidence from two studies. *Psychology of Aesthetics, Creativity, and the Arts*.

- Oppert, M., O’Keeffe, V., Bensnes, M., Grecu, A., & Cropley, D. (2023). The Value of Creativity: A Scoping Review. *Journal of Creativity*, 33, 100059. <https://doi.org/10.1016/j.yjoc.2023.100059>
- Park, J., & Lee, K. (2017). Using board games to improve mathematical creativity. *International Journal of Knowledge and Learning*, 12(1), Article 1.
- Paulus, P. B., & Brown, V. R. (2007). Toward more creative and innovative group idea generation: A cognitive-social-motivational perspective of brainstorming. *Social and Personality Psychology Compass*, 1(1), 248–265.
- Paulus, P. B., & Nijstad, B. A. (2019). *The Oxford handbook of group creativity and innovation*. Oxford Library of Psychology.
- Pirola-Merlo, A., & Mann, L. (2004). The relationship between individual creativity and team creativity: Aggregating across people and time. *Journal of Organizational Behavior*, 25(2), 235–257.
- Plaisant, O., Courtois, R., Réveillère, C., Mendelsohn, G. A., & John, O. P. (2010). Validation par analyse factorielle du Big Five Inventory français (BFI-Fr). Analyse convergente avec le NEO-PI-R. *Annales Médico-Psychologiques, Revue Psychiatrique*, 168(2), 97–106.
- Qian, M., & Clark, K. R. (2016). Game-based Learning and 21st century skills: A review of recent research. *Computers in Human Behavior*, 63, 50–58.
- Rahimi, S., & Shute, V. J. (2021). The effects of video games on creativity: A systematic review. *Handbook of Lifespan Development of Creativity*, 37.
- Reiter-Palmon, R., & Murugavel, V. (2018). The effect of problem construction on team process and creativity. *Frontiers in Psychology*, 9, 2098.
- Rodríguez-Sánchez, A. M., Devloo, T., Rico, R., Salanova, M., & Anseel, F. (2017). What makes creative teams tick? Cohesion, engagement, and performance across creativity tasks: A three-wave study. *Group & Organization Management*, 42(4), 521–547.
- Rosenfeld, L. B., & Gilbert, J. R. (1989). The measurement of cohesion and its relationship to dimensions of self-disclosure in classroom settings. *Small Group Behavior*, 20(3), 291–301.
- Ryan, R. M., Mims, V., & Koestner, R. (1983). Relation of reward contingency and interpersonal context to intrinsic motivation: A review and test using cognitive evaluation theory. *Journal of Personality and Social Psychology*, 45(4), 736. <https://doi.org/10.1037/0022-3514.45.4.736>
- Scott, G., Leritz, L. E., & Mumford, M. D. (2004). The effectiveness of creativity training: A quantitative review. *Creativity Research Journal*, 16(4), Article 4. https://doi.org/10.1207/s15326934crj1604_1
- Shalley, C. E., Zhou, J., & Oldham, G. R. (2004). The effects of personal and contextual characteristics on creativity: Where should we go from here? *Journal of Management*, 30(6), 933–958.
- Silvia, P. J., Martin, C., & Nusbaum, E. C. (2009). A snapshot of creativity: Evaluating a quick and simple method for assessing divergent thinking. *Thinking Skills and Creativity*, 4(2), Article 2.
- Sternberg, R. J. (2019). Enhancing people’s creativity. *The Cambridge Handbook of Creativity*, 88–103.

- Taggar, S. (2001). Group composition, creative synergy, and group performance. *The Journal of Creative Behavior*, 35(4), 261–286.
- Thornhill-Miller, B., Camarda, A., Mercier, M., Burkhardt, J.-M., Morisseau, T., Bourgeois-Bougrine, S., Vinchon, F., El Hayek, S., Augereau-Landais, M., & Mourey, F. (2023). Creativity, Critical Thinking, Communication, and Collaboration: Assessment, Certification, and Promotion of 21st Century Skills for the Future of Work and Education. *Journal of Intelligence*, 11(3), 54.
- Tierney, P., & Farmer, S. M. (2011). Creative self-efficacy development and creative performance over time. *Journal of Applied Psychology*, 96(2), Article 2.
- Wang, C.-W., & Horng, R.-Y. (2002). The effects of creative problem solving training on creativity, cognitive type and R&D performance. *R&D Management*, 32(1), 35–45.
- Whitton, N. (2012). The place of game-based learning in an age of austerity. *Electronic Journal of E-Learning*, 10(2), pp249-256.
- Whitton, N. (2018). Playful learning: Tools, techniques, and tactics. *Research in Learning Technology*, 26.
- Zhou, C.-F., Luo, L.-L., Du, X., & Kolmos, A. (2010). Factors influencing group creativity in project-organized teams in engineering education in China. *The International Journal of Engineering Education*, 26(6), 1524–1535.
- Zhou, J., & Shalley, C. E. (2011). *Deepening our understanding of creativity in the workplace: A review of different approaches to creativity research*.
- Zhu, Y.-Q., Gardner, D. G., & Chen, H.-G. (2018). Relationships between work team climate, individual motivation, and creativity. *Journal of Management*, 44(5), 2094–2115.

Appendix A

The Big Idea

The Big Idea (Funforge, 2011) is a game where each player has six cards in front of him/her, three "Thing" cards and three "Qualifier" cards, which the player must combine to create an invention. The player is free to use as many cards as he/she wishes and in any order he/she wishes, as long as he/she is able to make sense of his/her invention. After this phase, the player must present his/her invention and argue its interest to the other players, and so on. The most convincing player wins the round.

Dixit

Dixit (Libellud, 2008) is a game centered around storytelling and interpretation, in which players are tested on their ability to read between the lines and understand subtle nuances. Each player begins the game with a hand of six illustrated cards, rich in imagery and devoid of text. During each round, one player takes on the role of the "Storyteller," who selects one card from their hand and gives a clue in the form of a word, phrase, or story that represents the image on the card. They place this card face-down on the table. The other players then select a card from their own hands that they feel best matches the Storyteller's clue and hand it to the Storyteller, who shuffles and then reveals all submitted cards face-up on the table.

Players, excluding the Storyteller, then vote on which card they believe was the Storyteller's original card. Points are awarded based on the number of correct and incorrect guesses; the Storyteller and the players who correctly identified the Storyteller's card receive points, as do players whose cards receive votes from others. The goal for the Storyteller is to give a clue that is neither too obscure nor too obvious, while the other players aim to mislead the voters with their own cards. The game continues for a predetermined number of rounds or until the cards run out, and the player with the most points at the end of the game emerges as the winner.

Deutsch

Deutsch is a card game using a classic deck of 52 cards. The players have four cards face down and can each look at two of their cards. They also have a deck in the center. The first player turns over the first card in the deck and places it next to it (in the discard pile) and has two choices: either swap the card on top of the discard pile with one of his/her four or draw another card and place it on top of the discard pile. After performing one of these actions, the

next person does the same. At any time, players may discard one of their cards, if it matches the value of the discard pile, and place it on top. If a player makes a mistake, they must retrieve their card and draw an additional one, without being able to see it. The red heads each have a "power", which is activated when the card appears in the discard pile (valid once per card): red jacks allow to exchange one card with another, red queens allow to look at a card from a deck, and red kings are worth zero points. At any time, a player may call "Deutsch", after which the game will end at the end of that player's next turn. The object of the game is to have as few points as possible (jacks are worth 11 points, queens 12, black kings 13, other cards are worth their face value).

Twin It

Twin It (Cocktail Games, 2017) is a game in which the goal is to detect pairs of patterns/symbols present on cards laid out on the table as quickly as possible. Each player starts with a deck of cards, with patterns printed on the front and back. Players take turns turning over a card from their deck and placing it on the table, visible to all players. If a pair of patterns appears, the player who detects it must place a hand or a finger on each of the two cards to win the pair. He/she then places it next to him/her, with the top card still visible to the others. As the cards are printed in one, two or three copies, if a third card with the same symbol as a pair already taken appears, the players can steal the pair from the opponent. The player who has the card in his possession must protect his/her pairs if a third pattern appears. A round ends when one of the players reaches five captures.

Appendix B

Table B1.*Independent Samples T-Tests - Control Variables - Individual Scores*

	Statistic	df	p	Mean difference	SE difference		Effect Size
Age	-0.2253	118	0.822	-0.08333	0.370	Cohen's d	-0.04113
Frequency	1.8320	118	0.069	0.50000	0.273	Cohen's d	0.33447
Enjoyment	0.9736	118	0.332	0.16190	0.166	Cohen's d	0.17776
Group Cohesion	1.9767	118	0.050	0.29130	0.147	Cohen's d	0.36089
E	-0.3905	118	0.697	-0.08542	0.219	Cohen's d	-0.07130
A	0.2598	118	0.795	0.03556	0.137	Cohen's d	0.04744
O	0.6349	118	0.527	0.10333	0.163	Cohen's d	0.11591
CSE	-0.0717	118	0.943	-0.01333	0.186	Cohen's d	-0.01309
CPI	0.0380	118	0.970	0.01000	0.263	Cohen's d	0.00694

Note 1. $H_a \mu_{\text{Creative}} \neq \mu_{\text{Non-Creative}}$

Note 2. E: Extraversion, A: Agreeableness, O: Openness, CSE: Creative Self-Efficacy, CPI: Creative Personal Identity

Table B2.*Independent Samples T-Tests - Control Variables - Group Scores*

	Statistic	df	p	Mean difference	SE difference		Effect Size
Age	-0.2255	38.0	0.823	-0.0833	0.370	Cohen's d	-0.0713
Frequency	1.8453	38.0	0.073	0.5000	0.271	Cohen's d	0.5835
Enjoyment	0.8731	38.0	0.388	0.1619	0.185	Cohen's d	0.2761
Group Cohesion	1.4469	38.0	0.156	0.2913	0.201	Cohen's d	0.4576
E	-0.4472	38.0	0.657	-0.0854	0.191	Cohen's d	-0.1414
A	0.2351	38.0	0.815	0.0356	0.151	Cohen's d	0.0743
O	0.6538	38.0	0.517	0.1033	0.158	Cohen's d	0.2067
CSE	-0.0802	38.0	0.937	-0.0133	0.166	Cohen's d	-0.0254
CPI	0.0382	38.0	0.970	0.0100	0.262	Cohen's d	0.0121

Note 1. $H_a \mu_{\text{Creative}} \neq \mu_{\text{Non-Creative}}$

Note 2. E: Extraversion, A: Agreeableness, O: Openness, CSE: Creative Self-Efficacy, CPI: Creative Personal Identity

Table B3.
Mediation - Fluency

Type	Effect	Estimate	SE	95% C.I.		β	z	p
				Lower	Upper			
Indirect	Condition \Rightarrow Enjoyment \Rightarrow Fluency	-0.567	0.703	-1.944	0.8104	-0.0331	-0.807	0.420
	Condition \Rightarrow Group Cohesion \Rightarrow Fluency	-1.364	1.049	-3.420	0.6925	-0.0796	-1.300	0.194
Component	Condition \Rightarrow Enjoyment	-0.162	0.181	-0.516	0.1923	-0.1402	-0.896	0.370
	Enjoyment \Rightarrow Fluency	3.500	1.888	-0.201	7.2016	0.2358	1.853	0.064
	Condition \Rightarrow Group Cohesion	-0.291	0.196	-0.676	0.0933	-0.2285	-1.484	0.138
	Group Cohesion \Rightarrow Fluency	4.682	1.739	1.273	8.0913	0.3484	2.692	0.007
Direct	Condition \Rightarrow Fluency	-5.569	2.171	-9.824	-1.3151	-0.3251	-2.566	0.010
Total	Condition1 \Rightarrow Fluency	-7.500	2.467	-12.335	-2.6654	-0.4377	-3.040	0.002

Note 1. Confidence intervals computed with method: Standard (Delta method)

Note 2. Betas are completely standardized effect sizes

Table B4.
Mediation - Elaboration

Type	Effect	Estimate	SE	95% C.I.		β	z	p
				Lower	Upper			
Indirect	Condition \Rightarrow Enjoyment \Rightarrow Elaboration	-10.7803	12.704	-35.680	14.1198	-0.0421	-0.849	0.396
	Condition \Rightarrow Group Cohesion \Rightarrow Elaboration	-14.4932	11.877	-37.771	8.7846	-0.0566	-1.220	0.222
	Condition \Rightarrow Age \Rightarrow Elaboration	3.3407	14.478	-25.035	31.7161	0.0131	0.231	0.818
Component	Condition \Rightarrow Enjoyment	-0.1619	0.181	-0.516	0.1923	-0.1402	-0.896	0.370
	Enjoyment \Rightarrow Elaboration	66.5843	25.153	17.286	115.8827	0.3004	2.647	0.008
	Condition \Rightarrow Group Cohesion	-0.2913	0.196	-0.676	0.0933	-0.2285	-1.484	0.138
	Group Cohesion \Rightarrow Elaboration	49.7541	23.217	4.250	95.2586	0.2479	2.143	0.032
	Condition \Rightarrow Age	0.0833	0.360	-0.623	0.7894	0.0366	0.231	0.817
	Age \Rightarrow Elaboration	40.0885	12.336	15.911	64.2662	0.3572	3.250	0.001
	Direct	Condition \Rightarrow Elaboration	-98.4672	28.891	-155.092	-41.8421	-0.3848	-3.408
Total	Condition \Rightarrow Elaboration	-	120.4000	-191.263	-49.5373	-0.4705	-3.330	< .001

Note 1. Confidence intervals computed with method: Standard (Delta method)

Note 2. Betas are completely standardized effect sizes

Table B5.
Mediation - Originality

Type	Effect	Estimate	SE	95% C.I.		β	z	p
				Lower	Upper			
Indirect	Condition \Rightarrow Enjoyment \Rightarrow Originality	-0.126	0.146	-0.4122	0.1601	-0.0535	-0.863	0.388
	Condition \Rightarrow Group Cohesion \Rightarrow Originality	-0.149	0.120	-0.3839	0.0851	-0.0634	-1.249	0.212
Component	Condition \Rightarrow Enjoyment	-0.162	0.181	-0.5161	0.1923	-0.1402	-0.896	0.370
	Enjoyment \Rightarrow Originality	0.778	0.241	0.3058	1.2511	0.3816	3.228	0.001
	Condition \Rightarrow Group Cohesion	-0.291	0.196	-0.6759	0.0933	-0.2285	-1.484	0.138
	Group Cohesion \Rightarrow Originality	0.513	0.222	0.0775	0.9481	0.2776	2.309	0.021
Direct	Condition \Rightarrow Originality	-0.825	0.277	-1.3678	-0.2813	-0.3501	-2.975	0.003
Total	Condition \Rightarrow Originality	-1.100	0.333	-1.7536	-0.4464	-0.4670	-3.298	< .001

Note 1. Confidence intervals computed with method: Standard (Delta method)

Note 2. Betas are completely standardized effect sizes

Video Games Can Enhance Creativity: the Mediating Role of Psychological Capital

Maxence Mercier^{1*} and Todd Lubart¹

¹ Université Paris Cité and Univ Gustave Eiffel, LaPEA, F-92100 Boulogne-Billancourt,
France

Author Note

Maxence Mercier  <https://orcid.org/0000-0001-9045-2032>

Todd Lubart  <https://orcid.org/0000-0002-8776-8797>

We have no known conflict of interests to disclose.

Correspondence concerning this article should be addressed to Maxence Mercier, Université Paris Cité, LaPEA, 71 avenue Edouard Vaillant, 92100 Boulogne-Billancourt Cedex, France.
Email: mercier.maxence96@gmail.com

APA Reference:

Mercier, M., & Lubart, T. (2023). Video Games and Creativity: The Mediating Role of Psychological Capital. *Journal of Creativity*, 100050.

Abstract

Video games play a big part in many individuals' lives, children and adults alike. Research as shown video games have, inarguably, effects on our minds. A large body of research has investigated both the potential negative and positive effects of video games. This paper examined whether playing more to video games can lead to higher creativity, with a focus in adults' creativity in the workplace. Furthermore, it was posited that this link could be explained through the mediating effect Psychological Capital (PsyCap). Using a cross-sectional study (N = 370), the results were consistent with these hypotheses. Namely, results showed a full mediation of the link between video games frequency of play and creativity, through optimism specifically: playing video games is positively associated with higher optimism, which in turn is associated with more creativity in the workplace.

Keywords: video games, creativity, psychological capital, optimism, mediation

Video Games and Creativity: the Mediating Role of Psychological Capital

Video games play a big part in virtually all children's and adolescents' lives, and adults aren't exempt either. In 2020, the global population of gamers numbered 2.7 billion, with an increase of more than 6% from the previous year (Newzoo, 2020). This begs the question of the potential effects of playing video games, be they negative or positive. Research on video games has mostly focused on their negative effects. They have notably been criticized for promoting violence and nurturing aggressivity (Anderson & Warburton, 2012). They have sometimes been shown to correlate negatively with well-being and adjustment (Wenzel et al., 2009), although some of these results have been rebutted in academic settings (e.g., Drummond et al., 2018). Research on the benefits of video games has expanded over the last decade, pointing out positive effects in cognitive, motivational, emotional, and social domains (Granic et al., 2014). This paper aims to examine further 21st century skills, and study whether that they can help to and nurture important skills in our era. One such 21st century skills, that has been emphasized time and time again, is creativity.

Creativity corresponds to the ability to achieve a production that is both original and adapted to the context in which it occurs (Lubart et al., 2015). This bipartite definition is the subject of a relative consensus in the scientific community (Runco & Jaeger, 2012). Originality refers to the unusual, novel character of the production. Adaptability, on the other hand, refers to usefulness (Runco, 1988), value (Ford, 1996), appropriateness (Runco et al., 2005) or the ability to solve a problem (Besemer & Treffinger, 1981). It is the conjunction of these two criteria that leads to creativity. Creativity plays an important role in all levels of life (Kaufman & Beghetto, 2009). At the most eminent level, creativity is often what led to scientific discoveries (take, for example, Marie Curie's contribution to physics and chemistry), and obviously to the numerous works of art, be they Beethoven's symphonies or Picasso's paintings. But creativity is not restricted to great achievements, and can occur in various spheres of life. Creativity often occur in the workplace, has most if not all occupations allow for creativity to emerge. Creativity in the workplace can take several forms, such as a lawyer using creative tactics in a case to reach a favorable outcome for their client, an accountant developing a new system for organizing financial data that streamlines the process and saves time, or a teacher coming up with a unique lesson plan that engages students and helps them retain information more effectively. Finally, creativity also plays an important part in our everyday life and is practiced by virtually everyone: finding a new idea for a meal, writing a poem or a song, decorating one's bedroom.

Concerning creativity and video games, there has been relatively little research. Jackson et al. (2012) surveyed a sample of 491 children, around the age of 12. They found significant positive correlations between frequency of video game play and multiple indicators of divergent thinking, the ability to generate multiple ideas from a single point of origin (Guilford, 1967). Blanco-Herrera (2019) examined the links between the amount of time playing video games and trait creativity, as operationalized by the Imaginative Capability Scale (ICS, Liang & Chia, 2014), and observed a positive correlation ($r = .26, p < .01$). In the same study ($N = 352$), they compared the effect of playing Minecraft (with or without instructions) to two control conditions : playing a non-creative video game (NASCAR) and watching a TV show (Crocodile Hunter). Results indicate that playing Minecraft without instructions improve graphic creativity, compared to both control conditions. However, no effect was found for either verbal divergent or convergent thinking. Although low-powered, two studies adopt the experimental method to further these findings. Yeh (2015) observed enhanced divergent thinking, after participants ($N = 36$) had played to an action video game, compared to a non-action video game. Moffat et al. (2017) examined the effect of three types of video games on divergent thinking. In their study, they had participants ($N = 21$) play either a first-person shooter, a puzzle game, or a sandbox game. The first-person shooter was *Serious Sam*, where the player fights waves of enemies in an open environment. The sandbox game was *Minecraft*, where the player can create, modify and destroy their environment. The puzzle game was *Portal 2*, where the player must solve puzzles by placing portals and teleporting through them. Results seemed to indicate enhanced flexibility, after playing the first-person shooter and the puzzle game. While these initial results are encouraging, additional evidence remains to be gathered, as sample sizes were small. Furthermore, to generalize the links and the potential effects of video games on creativity, cross-sectional studies are needed. Indeed, whereas experimental studies may indicate causal short-term effect in a within-subject controlled context, this does not mean their findings will translate into people's everyday life. Such is the case for many cognitive aspects supposedly enhanced through video games practice (Sala et al., 2018). For example, although numerous experimental studies have shown improved capacities in attentional aspects and spatial awareness after playing video games, no correlations can be found in the general population, between these very variables and video games practice, when using cross-sectional studies. One notable example can be found in a correlational study ($N = 453$) between video games play time and emotional creativity, which reflects the originality and appropriateness in emotional experience (Čábelková et al., 2020). More time devoted to playing video games was associated with lower emotional creativity for the whole sample. However, surprisingly, this result was

moderated by gender. For women, playing more video games was positively correlated with the originality component of emotional creativity (i.e., the ability to experience new and unusual emotions).

To further these findings, a cross-sectional methodology was adopted to study the links between video games frequency of play and creativity in people's habitual everyday contexts. Workplace was the primary focus, as an important context in which 21st century skills are solicited, notably creativity.

In addition to the first question - whether video games are related to creativity - another important issue concerns the reason as to why video games would be linked to and improve creativity. Whereas some theoretical explanations have been proposed (for a review, see Jackson & Games, 2015), no study has actually attempted to verify such claims in an empirical manner. This study focalized on a particular variable, Psychological Capital (PsyCap), which has long been associated with creativity in the workplace. PsyCap can be referred to as a higher-order construct, defined as an individual's positive psychological state (Luthans et al., 2007), and is characterized by: "(1) having confidence (efficacy) to take on and put in the necessary effort to succeed at challenging tasks; (2) making a positive attribution (optimism) about succeeding now and in the future; (3) persevering toward goals and, when necessary, redirecting paths to goals (hope) in order to succeed; and (4) when beset by problems and adversity, sustaining and bouncing back and even beyond (resiliency) to attain success" (Luthans et al., 2015, p. 4). Sweetman et al. (2010) initial empirical study ($N = 899$) showed correlation between divergent thinking and all four components of PsyCap, as well as with overall PsyCap. Furthermore, results indicated that PsyCap predicted divergent thinking over and above the four individual components. Cai et al. (2019) found similar results, as higher overall PsyCap was associated with higher self-reported creativity in the workplace. Additionally, this link was moderated by high supervisor support and more diverse and significant to others job characteristics. Yu et al. (2019) furthered these findings by adopting a finer-grained approach, to study the structure of the components with relations to their effects on creativity in the workplace. Their findings indicate that components contribute differently to creativity. Hope and optimism were the strongest predictors of creativity, whereas self-efficacy did not contribute at all. Finally, resilience acted as a mediator of the effect of hope and optimism on creativity.

Playing video games requires a certain mindset. Adversity is a core and quintessential aspect of video games. Thus, hope and resilience are often required in order to play any games,

be it a platformer game such as Super Mario Bros, which requires precise inputs and punishes the player when making mistakes, a First-Person Shooter (FPS) game, where being defeated by other players is a key aspect of the game experience. In extreme cases, this can take the form of games that incorporate high difficulty as a core feature, such as Dark Souls, a game known for its difficulty and considered by many to be one of the hardest games to complete, which requires a tremendous amount of trial-and-error to progress, failure being the rule rather than the exception here. The importance of defeat and failure in video games leads us to another component of PsyCap: optimism. To persevere through adversity, an optimistic style is essential. When playing a videogame and being confronted with failure, it can be tempting to just give up. Being optimistic is thus very helpful in this sort of situation, as optimism helps see negative events as temporary and thus surmountable. Even more so when such efforts usually end in rewarding outcomes. Self-efficacy is also linkable to video games. Attaining a sense of competency is another important aspect of video games. Starting from being a beginner to a veteran player is a path many players venture on when discovering a game which they end up particularly enjoying. Luthans & Youssef-Morgan (2017) argued that games and gamification could help support PsyCap, through the use of games like SuperBetter (McGonigal, 2015), which is explicitly designed to develop resilience. Players can also create and take part in online communities. Social interaction is an important feature in online video games, and even more so in massively multiplayer online role-playing games (MMORPGs). These video games require group effort to achieve game goals (Eklund, 2015): collaboration, competition, and interaction are core aspects of the game experience in MMORPGs. Hsu & Chang (2022) argue that PsyCap can be built in such a context, through the establishment of social capital. They conducted an online questionnaire survey with 548 MMORPGs players, examining the effect of social interaction on PsyCap, through the mediation of social capital. Consistent with their hypotheses, MMORPGS online social interactions helped players establish more social capital, which in turn led to higher PsyCap, across all four components of the PsyCap. For these reasons, it was hypothesized that overall PsyCap and its components would mediate the relationship between video games and creativity in the workplace.

Method

Participants

Data was collected from 370 workers, who were recruited online through French social networks ($M_{age} = 39.2$, $SD_{age} = 10.6$, 85.1% female). 359 participants (97%) were French, and 334 participants (90.3%) reported French as their native language. The data collection respected

the General Data Protection Regulation (EU) 2016/679 (GDPR). According to the French National Institute of Statistics and Economic Studies (INSEE) classification of occupations, 27% of participants were managers and higher intellectual professionals, 28.9% were intermediate professions and middle management, 3.3% were qualified workers, 4.1% were craftsmen, merchants, company managers and liberal profession, 35.7% were employees and service personnel, and 1.1% were students (with a part-time job).

Material

Creativity in the workplace. Creativity was assessed with a 13-item scale developed by Zhou & George (2001), using a 7-point Likert Scale. It was originally designed for supervisors to assess employee creativity. The instructions were modified to obtain a self-report version, as they were shown to yield satisfactory results (see Ng & Feldman, 2012). It was translated to French using a back-translation procedure (Brislin, 1986). A sample item is “I am a good source of creative ideas”. The internal consistency of the scale was high ($\alpha = .93$).

Psychological Capital. PsyCap was measured with the French version of the Psychological Capital Questionnaire (PCQ; Luthans et al., 2007), using a 7-point Likert scale. The PCQ assesses all four components of PsyCap, each comprised of six items, for a total of 24 items. According to Luthans et al. (2007) conception, PsyCap can be conceived as a unified construct, an overall score can be thus calculated. To estimate overall internal consistency, McDonald’s omega was used (McDonald, 1999). It is a better alternative to Cronbach’s alpha, when one wants to estimate the overall internal consistency of a multidimensional scale. It posits the existence of a common factor on which all items load, in addition to the specific factors. This operationalization is in accordance with recent research, that has shown such a bifactor model outperforms the classic second-order model (Choisy et al., 2021). A Confirmatory Factor Analysis (CFA) was conducted, with four first-order factors and one common factor. This model yielded satisfactory indices: $\chi^2(217) = 342.24, p < .001$, CFI = .88, GFI = .93, RMSEA = .039, SRMR = .046. The overall internal consistency was satisfactory ($\omega = .77$).

Gaming frequency. Participants were first asked whether they played video games, independently of the support used. For those who did ($N = 171$), video game play frequency was then assessed with two items. The participant was first asked about the number of days they played in a typical week. They then reported the average time they played video games per day, in minutes. The product of these two values was used as the indicator of gaming frequency.

Using boxplot-based outlier analyses, three participants were identified as presenting abnormally large values. They were subsequently removed from further analyses.

Results

Correlation analyses

Before observing correlations between gaming frequency, PsyCap and creativity, age was examined as a potential confounding variable. It was observed that age was in fact correlated negatively to gaming frequency ($r = -0.13, p = .012$) and positively to creativity ($r = .15, p = .004$). No correlations were observed with PsyCap or its components. To account for these findings, partial correlation analyses were performed, conditioned on age (Table 1). Gaming frequency was positively correlated with overall PsyCap ($r = .16, p = .003$), and with three of its components: Efficacy ($r = .12, p = .02$), Resiliency ($r = .10, p = .049$), and Optimism ($r = .16, p = .003$). “Hope” was the only PsyCap component that did not correlate with gaming frequency ($p = .21$). Gaming frequency correlated significantly with creativity ($r = .11, p = .04$). As expected, overall PsyCap correlated positively with creativity ($r = .20, p < .001$). Creativity also correlated with the same three components: Efficacy ($r = .155, p = .003$), Resiliency ($r = .11, p = .04$), and Optimism ($r = .22, p < .001$).

Table 1.

Pearson's Partial Correlation Matrix

Variable	GF	Hope	Efficacy	Resiliency	Optimism	PsyCap	Creativity
GF	—						
Hope	0.066	—					
Efficacy	0.123 *	0.418 ***	—				
Resiliency	0.103 *	0.316 ***	0.324 ***	—			
Optimism	0.157 **	0.475 ***	0.328 ***	0.333 ***	—		
PsyCap	0.156 **	0.773 ***	0.704 ***	0.641 ***	0.771 ***	—	
Creativity	0.108 *	0.083	0.155 **	0.107 *	0.221 ***	0.200 ***	—

Note 1. Conditioned on variables: Age.

Note 2. GF: Gaming Frequency, PsyCap: Psychological Capital.

Note 3. * $p < .05$, ** $p < .01$, *** $p < .001$

With both gaming and creativity, optimism correlation coefficients were higher than for overall PsyCap. Accordingly, a linear regression was conducted to understand which variables was the best predictor of creativity in the workplace, and thus the mediator to be examined. As seen in Table 2, when put in a regression model, optimism emerged as the sole predictor of creativity in the workplace.

Table 2.
Linear Regression (Creativity in the Workplace)

Predictor	Estimate	SE	t	p
Intercept	3.440	0.5215	6.597	< .001
Optimism	0.200	0.0947	2.115	0.035
PsyCap	0.139	0.1507	0.922	0.357

Mediation analyses

Based on results obtained through correlation analyses, a mediation model was tested, with gaming frequency as the predictor, optimism as the mediator, creativity as the outcome, and age as a background confounder. Ten thousand bootstrap samples were used to create 95% bias corrected confidence interval (CI). The total effect of gaming frequency on creativity was significant, $B = 0.11$, $SE = 0.05$, $z = 2.18$, $p = .029$, 95% CI [0.01, 0.2]. The direct effect of gaming frequency on creativity was not significant, $B = 0.08$, $SE = 0.05$, $z = 1.53$, $p = .125$. The indirect effect of gaming frequency on creativity through optimism was significant, $B = 0.03$, $SE = 0.01$, $z = 2.54$, $p = .01$, 95% CI [0.01, 0.06]. The result supported that optimism fully mediated the relationship between gaming frequency and creativity in the workplace.

Discussion

Playing video games is an omnipresent activity, regardless of age or gender. Children, adolescents, adults, the elderly, male or female, most have come across or regularly play to video games. As research as shown, video games have, inarguably, effects on our minds. A large body of research has investigated both the potential negative and positive effects of video games. In line with previous research, the study coupled video games with creativity, a 21st century skill. Furthermore, it attempted to explain empirically the links between video games and creativity, positing that Psychological Capital could function as a mediator.

Our results partly supported this hypothesis. Video game frequency of play correlated positively with three out of four components of PsyCap: efficacy, resiliency, and optimism; it

correlated with overall PsyCap as well. Furthermore, creativity correlated positively with gaming frequency, albeit to a lower degree. As expected, PsyCap correlated with creativity, as did the same three components correlated with gaming frequency. Interestingly, optimism accounted for most of the explained variance. We thus considered optimism specifically, as opposed to overall PsyCap. After performing a mediation analysis, our results indicated a full mediation of the effects of gaming frequency on creativity, through optimism. The effect size was small, but significant.

The main contribution regards the explanation of the relationship between video games and creativity. In their review, Jackson & Games (2015) posited that video game playing could increase creativity through four types of benefits provided by video games: cognitive, social, emotional and motivational. However, although they raise theoretical points, no empirical support was provided. A conative approach was adopted, by examining Psychological Capital, a resource important for everyday life, work, and creativity. Connecting this with creativity, this provides one explanation about the link between gaming habits and creativity, here in the workplace. A full mediation was observed: playing video games was positively associated with higher optimism, which in turn was associated with more creativity in the workplace. Once again, it is worth noting the effect size was small, so further replications are need to provide more solid evidence.

Optimism can be understood as a specific explanatory style (Gillham et al., 2001; Seligman, 2006). Optimistic individuals have positive explanatory styles: they attribute prior and present as external, temporary and situation-specific. In the other hand, positive events are perceived as internal, durable and general. Because of this, optimists are better equipped to take initiative, persevere in the face of difficulty, take risk, apply efficient problem-solving techniques, and be more assertive and bolder than pessimistic people. This mediation could be first explained by the fact that failures in video games can be used as motivational tools, leading to higher optimism (Granic et al., 2014). Players generally do not respond negatively or angrily to failure, instead they tend to respond with excitement, interest and joy (Salminen & Ravaja, 2008). They become highly motivated to return to the task and win, and can be “relentlessly optimistic” about reaching their goals (McGonigal, 2011). On the other hand, being creative is an intrinsically difficult task, which requires persistence and tenacity (Zhou & George, 2003). When faced with such difficult tasks, optimistic individuals are better able to move forward towards completing creative endeavors, as they are perceived as achievable (Le et al., 2015).

Furthermore, optimistic individuals perceive difficult tasks as challenges rather than obstacles or threats (Ickson et al., 2014).

Although tempting, these findings does not necessarily imply a causal relationship. It is likely the relationship is bidirectional. In absence of replications and more solid evidence, optimism should be considered carefully, as a common denominator between video games and creativity.

Additionally, this is among the first studies examining their relationship on an adult working population, with the average participant being 39.2 years old. This differs greatly from the young adult samples adopted by Yeh (2015), Moffat et al. (2017) and Blanco-Herrera et al. (2019), and even more so compared to Jackson et al. (2012) sample of 12-year-old children. Studying these samples is important and necessary, as they are most subject to playing video games (Gentile et al., 2011; Lui et al., 2011). However, they are not the only population concerned by video games, as adults also partake in this activity. Adults engaged in game play should thus be studied at least as thoroughly as children, with regards to video games habits (Pallavicini et al., 2018). Half of our sample played video games. Noticeably, the more they played video games, the more creative they were in the workplace. This consolidates and expands results, previously obtained using divergent thinking as the primary indicator of creativity.

Noticeably, the relationships were lower than previously obtained by Jackson et al. (2012). This serious limitation can be attributed to the self-reported nature of this study's operationalization of creativity. Although having shown satisfactory validity (Ng & Feldman, 2012), more objective assessment of creativity, such as divergent thinking tasks, may provide better insights and explain more variance than the small effect we obtained here. Further could investigate this mediation relationship using Alternative Uses Tasks (Guilford, 1967), or adopt a more domain-specific approach. For instance, might this finding lead to more engagement in creative endeavors, or higher achievements? Measures such as the Inventory of Creative Activities and Achievements (Diedrich et al., 2018), or the Creative Achievement Questionnaire (Carson et al., 2005).

Age had to be factored out in correlation and mediation analyses, as it was negatively associated with gaming frequency, and positively to creativity in the workplace. Although still playing, the older one gets, the less time is devoted to playing video games. This result echoes most sociodemographic data on the topic of age and gaming habits. The positive association

with age and creativity is most interesting. It may be the case that as one gets older, they accrue more experience and expertise in their line of work. It has been argued, notably in the Componential Model of Creativity (Amabile, 2018; Amabile & Pratt, 2016), that expertise is a necessary condition for creativity to occur, along with intrinsic motivation and creativity-relevant processes and dispositions, like openness to experience, tolerance to ambiguity, or optimism.

This study furthers the idea that video games have positive effects. Instead of examining cognitive benefits, which comprise most of the research on video games, creativity was examined. Creativity is an important skill in our era, that can be useful in several settings, and in both our private and work-related endeavors. Creativity is one of the most sought-after skills in many industries nowadays and is valorized globally. Further studies could investigate the possible differential relationship of video games and creativity as a function of subtypes of videogames and subgroups of jobs or work-related tasks.

References

- Amabile, T. M. (2018). *Creativity in context: Update to the social psychology of creativity*. Routledge.
- Amabile, T. M., & Pratt, M. G. (2016). The dynamic componential model of creativity and innovation in organizations: Making progress, making meaning. *Research in Organizational Behavior*, 36, 157–183.
- Anderson, C. A., & Warburton, W. A. (2012). The impact of violent video games: An overview. *Growing up Fast and Furious: Reviewing the Impacts of Violent and Sexualised Media on Children*, 56–84.
- Besemer, S. P., & Treffinger, D. J. (1981). Analysis of creative products: Review and synthesis. *The Journal of Creative Behavior*, 15(3), 158–178.
- Blanco-Herrera, J. A., Gentile, D. A., & Rökkum, J. N. (2019). Video games can increase creativity, but with caveats. *Creativity Research Journal*, 31(2), 119–131.
- Brislin, R. W. (1986). The wording and translation of research instruments. In *Field methods in cross-cultural research* (pp. 137–164). Sage Publications, Inc.
- Čábelková, I., Strielkowski, W., Rybakova, A., & Molchanova, A. (2020). Does playing video games increase emotional creativity? *International Journal of Environmental Research and Public Health*, 17(7), 2177.
- Cai, W., Lysova, E. I., Bossink, B. A. G., Khapova, S. N., & Wang, W. (2019). Psychological capital and self-reported employee creativity: The moderating role of supervisor support and job characteristics. *Creativity and Innovation Management*, 28(1), Article 1. <https://doi.org/10.1111/caim.12277>
- Carson, S. H., Peterson, J. B., & Higgins, D. M. (2005). Reliability, validity, and factor structure of the creative achievement questionnaire. *Creativity Research Journal*, 17(1), 37–50.
- Choisay, F., Fouquereau, E., Coillot, H., & Chevalier, S. (2021). Validation of the French Psychological Capital Questionnaire (F-PCQ-24) and its measurement invariance using bifactor exploratory structural equation modeling framework. *Military Psychology*, 1–16.
- Diedrich, J., Jauk, E., Silvia, P. J., Gredlein, J. M., Neubauer, A. C., & Benedek, M. (2018). Assessment of real-life creativity: The Inventory of Creative Activities and Achievements (ICAA). *Psychology of Aesthetics, Creativity, and the Arts*, 12(3), Article 3.
- Drummond, A., Sauer, J. D., & Garea, S. S. (2018). The infamous relationship between violent video game use and aggression: Uncharted moderators and small effects make it a far cry from certain. In *Video game influences on aggression, cognition, and attention* (pp. 23–40). Springer.
- Eklund, L. (2015). Bridging the online/offline divide: The example of digital gaming. *Computers in Human Behavior*, 53, 527–535.
- Ford, C. M. (1996). A theory of individual creative action in multiple social domains. *Academy of Management Review*, 21(4), 1112–1142.
- Gentile, D. A., Choo, H., Liau, A., Sim, T., Li, D., Fung, D., & Khoo, A. (2011). Pathological video game use among youths: A two-year longitudinal study. *Pediatrics*, 127(2), e319–e329.

- Gillham, J. E., Shatté, A. J., Reivich, K. J., & Seligman, M. E. (2001). *Optimism, pessimism, and explanatory style*.
- Granic, I., Lobel, A., & Engels, R. C. (2014). The benefits of playing video games. *American Psychologist*, *69*(1), 66.
- Guilford, J. P. (1967). *The nature of human intelligence*.
- Hsu, C.-P., & Chang, C.-W. (2022). Does the social platform established by MMORPGs build social and psychological capital? *Computers in Human Behavior*, *129*, 107139.
- Icekson, T., Roskes, M., & Moran, S. (2014). Effects of optimism on creativity under approach and avoidance motivation. *Frontiers in Human Neuroscience*, *8*, 105.
- Jackson, L. A., & Games, A. I. (2015). Video Games and Creativity. In *Video Games and Creativity* (pp. 3–38). Elsevier.
- Jackson, L. A., Witt, E. A., Games, A. I., Fitzgerald, H. E., Von Eye, A., & Zhao, Y. (2012). Information technology use and creativity: Findings from the Children and Technology Project. *Computers in Human Behavior*, *28*(2), Article 2. <https://doi.org/10.1016/j.chb.2011.10.006>
- Kaufman, J. C., & Beghetto, R. A. (2009). Beyond Big and Little: The Four C Model of Creativity. *Review of General Psychology*, *13*(1), Article 1. <https://doi.org/10.1037/a0013688>
- Le, D. H., Cropley, D. H., & Gleaves, D. H. (2015). Examining the relationship between mental health, creative thought, and optimism. *The International Journal of Creativity and Problem Solving*, *25*(1), 5–21.
- Liang, C., & Chia, T.-L. (2014). Reliability, validity, and factor structure of the imaginative capability scale. *Creativity Research Journal*, *26*(1), 106–114.
- Lubart, T., Mouchiroud, C., Tordjman, S., & Zenasni, F. (2015). *Psychologie de la créativité- 2e édition*. Armand Colin.
- Lui, D. P., Szeto, G. P., & Jones, A. Y. (2011). The pattern of electronic game use and related bodily discomfort in Hong Kong primary school children. *Computers & Education*, *57*(2), 1665–1674.
- Luthans, F., Avolio, B. J., Avey, J. B., & Norman, S. M. (2007). Positive psychological capital: Measurement and relationship with performance and satisfaction. *Personnel Psychology*, *60*(3), 541–572.
- Luthans, F., Youssef, C. M., & Avolio, B. J. (2015). *Psychological capital and beyond*. Oxford University Press, USA.
- Luthans, F., & Youssef-Morgan, C. M. (2017). Psychological capital: An evidence-based positive approach. *Annual Review of Organizational Psychology and Organizational Behavior*, *4*, 339–366.
- McDonald, R. P. (1999). *Test theory: A unified approach*.
- McGonigal, J. (2011). *Reality is broken: Why games make us better and how they can change the world*. Penguin.
- McGonigal, J. (2015). *SuperBetter: A revolutionary approach to getting stronger, happier, braver and more resilient*. Penguin.
- Moffat, D. C., Crombie, W., & Shabalina, O. (2017). Some video games can increase the player's creativity. *International Journal of Game-Based Learning (IJGBL)*, *7*(2), Article 2. <https://doi.org/10.4018/IJGBL.2017040103>

- Newzoo. (2020). *Global Games Market Report*.
- Ng, T. W., & Feldman, D. C. (2012). A comparison of self-ratings and non-self-report measures of employee creativity. *Human Relations*, 65(8), Article 8.
- Pallavicini, F., Ferrari, A., & Mantovani, F. (2018). Video games for well-being: A systematic review on the application of computer games for cognitive and emotional training in the adult population. *Frontiers in Psychology*, 2127.
- Runco, M. A. (1988). *Creativity research: Originality, utility, and integration*. Taylor & Francis.
- Runco, M. A., Illies, J. J., & Eisenman, R. (2005). Creativity, originality, and appropriateness: What do explicit instructions tell us about their relationships? *The Journal of Creative Behavior*, 39(2), 137–148.
- Runco, M. A., & Jaeger, G. J. (2012). The standard definition of creativity. *Creativity Research Journal*, 24(1), 92–96.
- Sala, G., Tatlidil, K. S., & Gobet, F. (2018). Video game training does not enhance cognitive ability: A comprehensive meta-analytic investigation. *Psychological Bulletin*, 144(2), Article 2.
- Salminen, M., & Ravaja, N. (2008). Increased oscillatory theta activation evoked by violent digital game events. *Neuroscience Letters*, 435(1), 69–72.
- Seligman, M. E. (2006). *Learned optimism: How to change your mind and your life*. Vintage.
- Sweetman, D., Luthans, F., Avey, J. B., & Luthans, B. C. (2010). Relationship between positive psychological capital and creative performance. *Canadian Journal of Administrative Sciences/Revue Canadienne Des Sciences de l'Administration*, 28(1), 4–13.
- Wenzel, H. G., Bakken, I. J., Johansson, A., Götestam, K. G., & Øren, A. (2009). Excessive computer game playing among Norwegian adults: Self-reported consequences of playing and association with mental health problems. *Psychological Reports*, 105(3_suppl), 1237–1247.
- Yeh, C. S.-H. (2015). Exploring the effects of videogame play on creativity performance and emotional responses. *Computers in Human Behavior*, 53, 396–407.
- Yu, X., Li, D., Tsai, C.-H., & Wang, C. (2019). The role of psychological capital in employee creativity. *Career Development International*.
- Zhou, J., & George, J. M. (2001). When job dissatisfaction leads to creativity: Encouraging the expression of voice. *Academy of Management Journal*, 44(4), Article 4.
- Zhou, J., & George, J. M. (2003). Awakening employee creativity: The role of leader emotional intelligence. *The Leadership Quarterly*, 14(4–5), 545–568.

Board Games and Creativity : Playfulness as a Mediator

Maxence Mercier^{1*} and Samira Bourgeois-Bougrine¹

¹ Université Paris Cité and Univ Gustave Eiffel, LaPEA, F-92100 Boulogne-Billancourt,
France

Author Note

Maxence Mercier  <https://orcid.org/0000-0001-9045-2032>

Samira Bourgeois-Bougrine  <https://orcid.org/0000-0001-5083-1177>

Todd Lubart  <https://orcid.org/0000-0002-8776-8797>

We have no known conflict of interests to disclose.

Correspondence concerning this article should be addressed to Maxence Mercier, Université Paris Cité, LaPEA, 71 avenue Edouard Vaillant, 92100 Boulogne-Billancourt Cedex, France.
Email: mercier.maxence96@gmail.com

APA Reference:

Mercier, M., & Bourgeois-Bougrine, S. (major revision). Board Games and Creativity: Playfulness as a Mediator. *Learning and Individual Differences*.

Abstract

Board games have shown themselves to be a promising avenue to help improve creative potential. This study examined whether board games habits are positively related to two creativity measures: creative self-concept and creativity in the workplace. Furthermore, it was hypothesized that playfulness would have a mediating effect between board games habits and creativity outcomes. Data was collected from 327 French workers using online recruitment through social networks. Results show that board game playing habits are positively correlated with both creativity in the workplace and creative self-concept. Furthermore, adult playfulness dimensions of fun-seeking motivation and uninhibitedness mediate the relationship between board game playing diversity and both creativity in the workplace and creative self-concept. Playing to a large variety of board games is associated with higher playfulness, which in turn is associated with more creativity in the workplace and higher creative self-concept. These findings suggest that encouraging board game play, notably playing to a broader range of board games, could help foster playfulness and thus improve creativity.

Keywords: board games, creativity, playfulness, mediation

Board Games and Creativity : Playfulness as a Mediator

The significance of creativity in our lives has been steadily growing, a notion acknowledged both within scientific research and practical applications (Kaufman et al., 2017). Creativity, the ability to generate original and contextually relevant ideas (Lubart et al., 2015), not only paves the way for groundbreaking discoveries and iconic masterpieces but also permeates our daily lives, influencing how we think, act, and interact with others. Given the impact of creativity on both individual and societal levels, finding ways to enhance and nurture this capacity appears important and necessary. One avenue that holds potential for cultivating creativity lies in the realm of play and games. While often overlooked and dismissed as frivolous, playfulness and engaging in playful activities can facilitate the development of divergent thinking (Wallace & Russ, 2015), cognitive flexibility (Moffat et al., 2017; Park & Lee, 2017), and other components of creative potential (Proyer et al., 2019). Board games, in particular, offer a unique platform for stimulating creativity, with their diverse range of mechanics, challenges, strategic thinking, and social interactions. Recent studies have started examining the links between board games and creativity, and the potential effects the former could have on the latter. This paper fits into this line of research, and aims to explore and explain the relationships between board games and creativity.

Creativity corresponds to the capacity to generate productions that are both original and relevant, in the context in which they manifest (Lubart et al., 2015). This dual-faceted definition has garnered agreement within the scientific community, with numerous researchers exploring the cognitive, emotional, and social factors that contribute to creative expression (Runco & Jaeger, 2012). Originality pertains to the unique, novel nature of a creation. In the other hand, adaptability encompasses aspects such as usefulness (Runco, 1988), value (Ford, 1996), appropriateness (Runco et al., 2005), and problem-solving ability (Besemer & Treffinger, 1981), reflecting the capacity to evaluate and refine ideas based on contextual constraints. The integration of these two criteria, along with the interplay of various personal, environmental, and cultural factors, gives rise to creativity.

Creativity plays a pivotal role across various aspects of life, driving progress and transformation on both individual and societal levels (Kaufman & Beghetto, 2009). At the highest level, it is linked with groundbreaking scientific discoveries, such as Marie Curie's contributions to physics and chemistry, as well as iconic works of art like Chopin's sonatas or Van Gogh's paintings. These eminent examples of creativity showcase the human capacity for ingenuity and the power of perseverance in the face of challenges. However, creativity extends

beyond monumental achievements and permeates numerous facets of life, influencing daily interactions, decision-making, and personal growth.

In the workplace, creativity is an essential component for fostering innovation and adaptability across various professions (Amabile, 1988). Most occupations allow for creative expression to varying extents (Ohly, 2018), and this creativity can manifest itself in numerous ways. For instance, a marketing team might develop a unique campaign that effectively engages the target audience, a software engineer could design a user-friendly interface that optimizes user experience, or a nurse may devise an efficient approach to improve healthcare outcomes. As industries evolve and become increasingly interconnected, creative thinking remains vital for maintaining competitiveness and driving progress.

Creativity plays also a significant role in everyday life, contributing to well-being (S. Acar et al., 2021), adaptability (Orkibi, 2021), and personal development (Sarnoff & Cole, 1983). Practiced by virtually everyone, creativity can be found in a multitude of activities and experiences (Diedrich et al., 2018; Silvia et al., 2014). For example, individuals might express creativity through designing and sewing their own clothing, experimenting with gardening techniques, or participating in local theater productions. These creative pursuits not only enrich our lives but also offer opportunities for self-expression, stress reduction, and cognitive engagement (Benedek et al., 2020). As individuals nurture their creative abilities, they contribute to the collective creativity of their communities, fostering a dynamic society. In essence, creativity enriches our experiences, connects us to one another, and drives human progress across a wide array of contexts.

A small number of studies have examined the links between board games and creativity. Park & Lee (2017) conducted an experimental study, by introducing board game play in the currus of two fifth-grade classes, compared to one control class. Students played 30 minutes a day, during four weeks. One class was teacher-led, the other was free-play. In both experimental groups, they observed significant improvements on mathematical creativity. When comparing to the control group, they found it was especially the case in the free-play group, for flexibility specifically. Gonzalo-Iglesia et al. (2018) conducted three experimental interventions, in multiples courses of university students ($N = 196$). Teachers introduced various commercial board games, related to the respective courses they were teaching. Afterwards, a vast majority of participants (89.7%) reported higher motivation to learn, and 67% reported finding that their creativity had been enhanced as a consequence.

Mercier & Lubart (2021) conducted a quasi-experimental study, which showed that playing board games improved participants' divergent thinking ($N = 55$), for individuals below average in terms of fluency or originality. This was further examined in an experimental study (Mercier & Lubart, 2023a). They compared creative board games (i.e., games that require the production of original and relevant ideas to perform well), to non-creative board games, and to a no-game control condition. They observed a significant and medium-sized improvement in originality, after playing creative board games, compared to the two other conditions ($N = 239$). Furthermore, a cross-sectional study by Mercier & Lubart (2023a) showed significant positive correlations between frequency of playing board games and several indicators of creative potential: openness to experience, divergent thinking originality, creative self-efficacy, and creative personal identity. Finally, Kuo et al. (2023), in a quasi-experimental study ($N = 76$), asked high school students to create board games based on their interests and the content of a 18-week civic education course. They observed an increase in both verbal and figural creativity, as well as increased civic competencies, compared to the control group, which received traditional teaching.

Although conclusive in many regards, these findings do not attempt to explain the reason as to why board games would be linked to or improve creativity. In an attempt to explain the links between board games and creativity, this paper focuses on one particular candidate: playfulness.

Playfulness can be understood as being composed of three main dimensions: fun-seeking motivation, uninhibitedness, and spontaneity (Shen et al., 2014b). Fun-seeking motivation refers to the tendency to be “intrinsically motivated and driven by a deeply-held value” (Shen et al., 2021, p. 406) that prioritizes fun, pleasure and enjoyment in life, a strong motive to pursue fun and amusement, through initiating or reacting to fun stimuli. Uninhibitedness correspond to an ability to invoke a sense of freedom and liberate one's mindset, through disregarding and overcoming perceived constraints and impediments. Finally, spontaneity refers to the mental propensity to act promptly, without deep thoughts or premeditation. Playfulness can therefore be defined as a personality trait that underlies the individual's tendency to be intrinsically motivated, with a clear fun orientation, and to engage themselves spontaneously in an unconstrained manner.

Individuals who are playful tend to seek and form situations in which they can interact playfully with others and their environments. Additionally, they are able to reduce and ease tensions by using their playfulness under duress. Playful individuals have a preference for

complexity over simplicity, and for unusual activities, topics and persons (Proyer et al., 2019). While we value our leisure time and can devote a lot of time and resources to a numerous activities and hobbies, we tend to see play as frivolous. This can be explained because of two perceptions. First, it might be argued that social manifestations of playfulness can be less acceptable among adults (Lieberman, 1977) Second, playfulness seems to lack obvious practical applications or usefulness (Olsen, 1981). But playfulness is as common and present in adults as it is in children (Sutton-Smith, 1966). The forms of playfulness behaviors expand from sensorimotor play to more frequent social, imaginative and cognitive play, as we grow older (Lieberman, 1977).

The expression of playfulness crosses the boundaries of work and leisure. Norsworthy and Whitley (1918) argued the difference between play and work was a matter of attitude rather than about the kind of activities pursued; “Listening to a concert, working problems in mathematics, sewing or painting, attending a reception, playing a game of whist, taking a walk, working in the garden, — any one of these may be work of the hardest kind to one person and the most delightful play to another” (p. 212). There is an overlap, and therefore the possibility to play at work while being productive (Mainemelis & Ronson, 2006), or even creative. One can be serious while playing, and playful while doing serious work (Bateson et al., 2013).

Csikszentmihalyi (1996) argued creative people can combine both playfulness and discipline. This opens the door to the idea that playfulness and creativity can go hand in hand, and be associated. Bishop and Chace (1971), on the relationship between play and creativity, summarized it as follows: “the motives and processes involved in play (purposelessness, fantasy, imagination, novel actions) are similar to those attributed to the creative process. The child that experiences “playful play” learning cognitive and behavioral processes that enhances his creative potential” (p.321, need to verify the quote). Lieberman (1977) argued the “joyful spontaneity” experienced in play may contribute to other tasks, like those who require divergent thinking. Play is practice with divergent thinking (Singer & Singer, 2005). Singer and Rummo (1973) found a positive relation between play and divergent thinking in kindergarten boys; Wyver & Spence (1999) found the same results in preschoolers. There have been longitudinal studies, showing that pretend play predicts divergent thinking four years later (Russ et al., 1999; Wallace & Russ, 2015), leading credence to the stability of this relationship.

The experience of positive emotions broadens people’s current actions and thought repertoire, in turn facilitating the building of resources (Fredrickson, 2001). Playfulness and playful activities, such as games, can facilitate the experience of positive emotions and in turn

improve creativity (Fredrickson, 2001; Panksepp, 1993). Play creates a suspension of reality, drawing people to imagine and breaking habitual patterns and thoughts (Brown, 2009). This imagination and suspension of reality allow individuals inhabit a new world, which can also open the door to creativity. Empirical evidence appears to corroborate these assertions, although this field of research is still young. Proyer (2012b) conducted a study on students ($N = 212$), and observed that playfulness was correlated to self-rated creativity ($r = .26$). However, playfulness was not correlated with either fluency or originality. Using an alternative way of assessing creativity, making use of art class grades, Proyer (2012a) found a significant association with overall playfulness ($r^2 = .06$) in a first sample ($N = 59$), but not in another ($N = 527$). The links between playfulness and creative activities were also examined (Proyer et al., 2019), using the K-DOCS (Kaufman, 2012). Focusing on adult employees, playfulness was associated with everyday creativity ($R^2 = .18$), performance creativity ($R^2 = .24$) and artistic creativity ($R^2 = .26$).

In this paper, a cross-sectional methodology was adopted, to examine the links between board games habits of play, and creativity. Furthermore, it was hypothesized that playfulness would mediate these relationships. This study uses two constructs to operationalize creativity: creativity in the workplace and creative self-concept, composed of creative self-efficacy and creative personal identity. Creativity in the workplace involves the development of novel and useful ideas in a professional environment. Creative self-efficacy encapsulates an individual's confidence in their ability to generate creative outputs, while creative personal identity represents the degree to which an individual perceives creativity as central and integral to their identity (Karwowski et al., 2018). Using these two operationalization of creativity provides us with both beliefs and perceptions about one's creativity, as well as its potential manifestation in the workplace.

Method

Participants

Data was collected from 327 workers, who were recruited online through French social networks ($M_{age} = 41.3$, $SD_{age} = 9.83$, 90% female). 321 participants (98.2%) were French, and 303 participants (92.7%) reported French as their native language. The data collection respected the General Data Protection Regulation (EU) 2016/679 (GDPR). According to the French National Institute of Statistics and Economic Studies (INSEE) classification of occupations, 28.1% of participants were managers and higher intellectual professionals, 26% were

intermediate professions and middle management, 6.1% were qualified workers, 3.1% were craftsmen, merchants, company managers and liberal profession, 35.5% were employees and service personnel, and 1.2% were students (with a part-time job).

Material

Creativity in the workplace. Creativity was assessed with a 13-item scale developed by Zhou & George (2001), using a 7-point Likert Scale. It was originally designed for supervisors to assess employee creativity. The instructions were modified to obtain a self-report version, as they were shown to yield satisfactory results (see Ng & Feldman, 2012). It was translated to French using a back-translation procedure (Brislin, 1986). A sample item is “I am a good source of creative ideas”. The internal consistency of the scale was high ($\omega = .94$).

Creative Self-Concept. Creative self-efficacy (CSE) and creative personal identity (CPI) were measured using the Short Scale of Creative Self (SSCS, Karwowski, 2012; Karwowski et al., 2018), on a 7-point Likert scale. It is an 11-item scale, with 6 items measuring creative self-efficacy and 5 measuring creative personal identity. The scale was translated using the back-translation method (Brislin, 1986). Both subscales had satisfactory internal consistency (CSE - $\omega = .86$; CPI - $\omega = .92$). Because CSE and CPI correlated very highly ($r = .91, p < .001$), overall creative self-concept (CSC - $\omega = .93$) was used instead in further analysis. 19 participants did not complete the SSCS scale.

Adult Playfulness. Adult playfulness was measured using the Adult Playfulness Trait Scale (APTS, Shen et al., 2014a), on a 7-point Likert scale. It is a 19-item scale, composed of three dimensions: fun-seeking motivation (9 items), uninhibitedness (5 items), and spontaneity (5 items). The scale was translated using the back-translation method (Brislin, 1986). Internal consistency was good for fun-seeking motivation ($\omega = .85$), acceptable for uninhibitedness ($\omega = .69$), and satisfactory for spontaneity ($\omega = .74$).

Board games playing habits. We opted for a more detailed approach to examining gaming habits. In most instances, the main index used is the frequency of play, for example using Afifi's (2014) ordinal scale, consisting of the following values: never, 1-5 times a year, 6-11 times a year, once a month, 2-3 times a month, once a week, 2-6 times a week, every day. Although necessary and informative, this measure does not cover the entirety of an individual's gaming habits. This study examined frequency, as well as two supplementary variables: the amount of time dedicated to one's favorite games (selectivity), and the total number of games one has played (diversity). Adding these variables helps cover a wider range of behaviors. For

instance, a player could play a lot in a week, but only to a specific game. In contrast, another individual could play less frequently, but to more different games compared to the first. Due to the leptokurtic nature of the distribution of selectivity (6.11) and diversity (13.9), decision was made to transform and ordinate these two variables, as well as frequency, into quartiles

Results

Correlation analyses

Descriptive and correlational analyses are available in Table 1. All three gaming habits variables correlated significantly and positively, indicative of both shared and specific variance. In all three cases, gaming habits correlated with the fun-seeking motivation and uninhibitedness dimensions of APTS, but not with spontaneity. Similarly, all three gaming habit variables correlated with creativity in the workplace (CW) and creative self-concept (CSC). Creativity in the workplace correlated with all three aspects of APTS. The same finding was observed for creative self-concept.

Table 1.
Correlation Matrix and Descriptives

	Frequency	Selectivity	Diversity	FSM	U	S	CW	CSC	Mean	SD
Frequency	—									
Selectivity	0.631 ***	—								
Diversity	0.824 ***	0.637 ***	—							
FSM	0.185 ***	0.156 **	0.206 ***	—					5.18	0.817
U	0.172 **	0.153 **	0.204 ***	0.511 ***	—				4.25	1.11
S	0.077	0.068	0.091	0.438 ***	0.524 ***	—			4.67	1.01
CW	0.146 **	0.143 **	0.167 **	0.416 ***	0.266 ***	0.231 ***	—		5.00	0.936
CSC	0.160 **	0.141 *	0.226 ***	0.373 ***	0.248 ***	0.244 ***	0.694 ***	—	4.78	1.09

Note 1. * $p < .05$, ** $p < .01$, *** $p < .001$

Note 2. FSM: Fun-Seeking Motivation, U: Uninhibitedness, S: Spontaneity CW: Creativity in the Workplace, CSC: Creative Self-Concept.

Mediation analyses

With regards to playfulness, creativity in the workplace and creative self-concept, diversity correlation coefficients appeared to be higher than frequency or selectivity. Accordingly, we compared two mediation models. First, a mediation model (Model 1) with frequency, selectivity and diversity as predictors, fun-seeking motivation and uninhibitedness as mediators, and creativity in the workplace and creative self-concept as outcomes. Second, a mediation model (Model 2) with only diversity as the predictor, fun-seeking motivation and

uninhibitedness as mediators, and creativity in the workplace and creative self-concept as outcomes. Aikake Information Criterion (AIC) and Bayesian Information Criterion (BIC) were both lower in the more parsimonious Model 2 (see Table 2). Diversity as the sole predictor was thus considered in the mediation analysis (Figure 1). One thousand bootstraps samples were used to establish a 95% bias-corrected confidence interval (CI).

Figure 1.
Mediation analysis

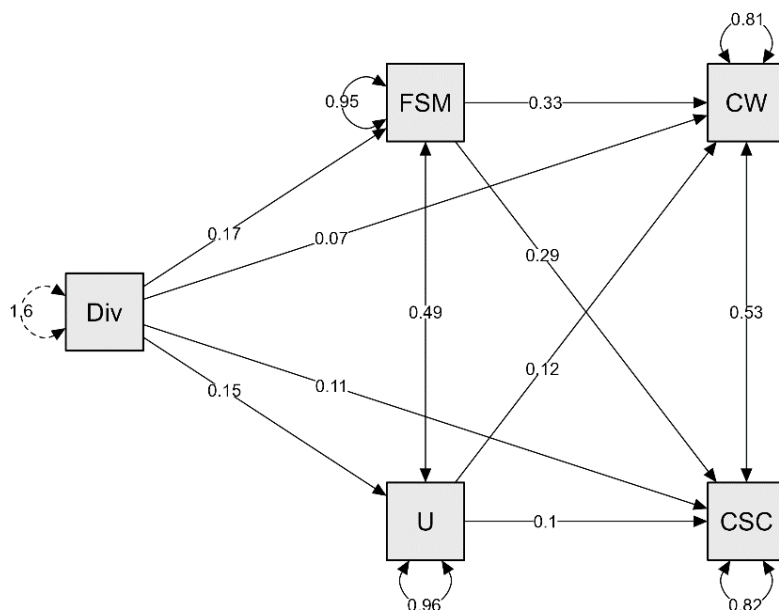

Note 1. Div : Diversity, FSM: Fun-Seeking-Motivation, U: Uninhibitedness, CW: Creativity in the Workplace, CSC: Creative Self-Concept

The total effect of diversity on creativity in the workplace was moderate and significant, $B = 0.14$, $SE = .043$, $z = 3.27$, $p = .001$, $CI [0.05 ; 0.2]$. The direct effect of diversity on creativity in the workplace was small and not significant, $B = 0.065$, $SE = .04$, $z = 1.62$, $p = .11$, $CI [-0.02 ; 0.145]$. The indirect effect of diversity on CW through fun-seeking motivation was large and significant, $B = 0.06$, $SE = .017$, $z = 3.25$, $p = .001$, $CI [0.025 ; 0.1]$. The indirect effect of diversity on CW through uninhibitedness was moderate yet non-significant, $B = 0.02$, $SE = .011$, $z = 1.78$, $p = .075$, $CI [0.001 ; 0.05]$. The total indirect effect of diversity on CW was large and significant, $B = 0.075$, $SE = .02$, $z = 3.8$, $p < .001$, $CI [0.04;0.23]$.

The total effect of diversity on creative self-concept was moderate and significant, $B = 0.18$, $SE = .043$, $z = 4.13$, $p < .001$, $CI [0.1 ; 0.275]$. The direct effect of diversity on creative

self-concept was small-to-moderate and significant, $B = 0.11$, $SE = .04$, $z = 2.71$, $p = .007$, $CI [0.04 ; 0.2]$. The indirect effect of diversity on CSC through fun-seeking motivation was moderate and significant, $B = 0.05$, $SE = .016$, $z = 3.1$, $p = .0020$, $CI [0.02 ; 0.09]$. The indirect effect of diversity on CSC through uninhibitedness was small-to-moderate yet non-significant, $B = 0.015$, $SE = .01$, $z = 1.78$, $p = .145$, $CI [-0.005 ; 0.035]$. The total indirect effect of diversity on CSC was large and significant, $B = 0.065$, $SE = .02$, $z = 3.61$, $p < .001$, $CI [0.1;0.25]$.

Table 2.
Information criteria

	Model 1	Model 2
Akaike (AIC)	3072.760	3059.146
Bayesian (BIC)	3154.822	3111.368
Sample-size adjusted Bayesian (SSABIC)	3085.048	3066.966

Discussion

This paper focused on one particular type of game, board games, and investigated their links with creativity. Although conclusive, previous studies did not provide theoretical or empirical explanations as to the links between playing board games and creativity. This paper attempted to provide such an explanation, by hypothesizing that playfulness would mediate this relationship.

Our results are consistent with this hypothesis. Board game habits correlated with two dimensions of playfulness, fun-seeking motivation and uninhibitedness, but not with spontaneity. Furthermore, both creativity in the workplace and creative self-concept correlated with board game habits. Finally, both creativity indicators correlated with all three aspects of playfulness. After conducting a mediation analyses, playfulness dimensions fully mediated the links between board games habits and creativity in the workplace, and partially mediated the links between board games and creative self-concept. The total indirect effects were both large and significant.

This paper contributes to the explanation of the relationship between games, more specifically board games, and creativity. Whereas the literature on video games and creativity has started providing theoretical (Jackson & Games, 2015) and empirical (Mercier & Lubart, 2023b) evidence on the links between the two of them, the same was not the case for board games. A conative and dispositional approach was adopted in this study, by examining

playfulness. Connecting it with creativity, it provides a first explanation to the relationship between board games habits and creativity, operationalized here with the creative self-concept as well as creativity in the workplace. In both cases, board games playing habits were associated with higher fun-seeking motivation and uninhibitedness, which in turn was associated with more creativity in the workplace and higher creative self-concept. Both were characterized by large total indirect effect sizes.

All three operationalizations of board games habits correlated with playfulness and creativity indicators. However, we observed that diversity was a better predictor of creativity than frequency. As it appears in the results, playing to more board games seems even more beneficial for creativity than just dedicating more time to games. The main implication of this finding is that rather than encouraging individuals to play more to board games, it would be more efficient to encourage them to look for and play to more diverse board games. Challenging oneself and experiencing more types of board games might therefore be one key to becoming more creative. It has been well established that openness to experience is a strong predictor of creativity and creative potential more generally (Feist, 1998; Hammond et al., 2011). This tendency to actively seek out new and cognitively challenging experiences (McCrae & Sutin, 2009) could also be touched upon by trying out more gaming experiences.

Fun-seeking motivation can be understood as a specific form of intrinsic motivation, inherent to playfulness and defined around fun. Intrinsic motivation is potentially the most frequently identified attribute of playfulness (Shen et al., 2014b). This is the process-oriented quality found in playful individuals, who tend to focus on play itself rather than external and extrinsic outcomes that might derive from play. Players are self-motivated and concerned only with the intrinsic process and purpose of play and game (Caillois, 1980; Hutt, 1970). We can see the player as being devoid of “material interest” (Huizinga, 1955). This intrinsic, fun-seeking motivation initiates and sustains the pursuit of the playful activity for its own sake (Deci 2002). Our findings indicate first that individuals showing higher fun-seeking motivation are attracted to games and will be drawn to search new and interesting board games. Intrinsic motivation has long been associated with creativity (Hammond et al., 2011). Furthermore, it has been conceptualized as a key driver of creative performance (Amabile & Pratt, 2016; Ford, 1996). Creative endeavors are inherently challenging (Zhou & George, 2003), and require a driving force, to “propel individuals toward creative action” (Farmer & Tierney, 2017, p. 36), and sustain perseverance. Playful individuals appear better equipped to face such challenges and rise to the creative task. Notably, their ability to initiate and react to fun stimuli (Shen et

al., 2021) might help them pursue such endeavors, by reframing them as fun and enjoyable. This can be likened to playful work design (PWD, Bakker et al., 2020; Scharp et al., 2023). PWD is a form of job-crafting, whereby employees proactively create conditions within work activities to foster enjoyment and challenge, without changing the job design itself (Bakker et al., 2020). In the same way, playful individuals are able to frame and reframe creative activities as fun and pleasurable.

Whereas fun-seeking motivation points towards what is desired within play, uninhibitedness stems from the disregard for consequences outside of play. Freedom is often attributed to playfulness, and refers to the player's mental state, free of concerns about real-life consequences (Bishop & Chace, 1971; Olsen, 1981). Whereas freedom refers to the state, uninhibitedness would be its equivalent as a trait (Shen et al., 2014b). Uninhibitedness allows the individual to subdue potentially constrained situational factors, and create a free and unimpeded mental state. Such a state is often the main motivation to engage in leisure activities (Beard & Ragheb, 1983), and notably to play games, in our case board games. Play creates a suspension of reality. Playing games enables individuals to be, momentarily, free of concerns about the real life, without consequences outside of the game. In other words, games provide a safe space. This suspension of reality in turn draws people to imagine and breaks usual patterns, thoughts and behaviors (Brown, 2009). This suspension and ensuing imagination let individuals inhabit a new world, opening the door for creativity. Having a free mental state is key for creativity, whereas inhibition impedes creativity, notably idea generation (Radel et al., 2015). Creative endeavors entails risks, setbacks and failures. Allowing oneself to take risk can help individuals attain better creativity (Tyagi et al., 2017), and especially so in the workplace (Dewett, 2007). In the organizational settings, the perception that one's organization is willing to take risks and encourages its employees to do so greatly contribute to creativity and innovation (Hunter et al., 2007). Conversely, applying too much pressure and constraints is most often linked to lower creativity (Acar et al., 2019). As such, uninhibitedness is profitable to creativity at the individual level, but also at the organizational level.

Although intriguing and interesting, these findings alone do not suggest a causal relationship. One alternative interpretation could be that creative individuals tend to be more playful, and thus more attracted to board games. In any case, the relationship is most likely bidirectional. Additionally, this study is not without limitations, which warrant careful consideration. One limitation of this study is its cross-sectional method, which cannot establish causality between the variables. Although mediation analyses were conducted to explore the

relationship between variables, the results do not allow for causal inferences. Longitudinal studies or experimental designs would be more suitable to establish causal relationships between variables. Another limitation is the operationalization of creativity in the workplace. Creativity was measured using a self-reported scale, which might be subject to response bias or social desirability. Moreover, the scale used in this study was originally designed for supervisors to assess employee creativity and was modified for self-report use. Alternative measures, such as peer or supervisor ratings, or more objective measures of creative output, could be used in future studies to provide a more comprehensive evaluation of creativity in the workplace.

In conclusion, this study highlights the importance of diversifying one's board game playing habits for enhancing creative self-concept and creativity in the workplace. This finding suggests that playing different board games may expose individuals to diverse experiences and foster a playful mindset, promoting creativity in various contexts. Overall, these findings offer insights into how a leisure activity, such as board games, can have positive impact on creativity, potentially leading to innovative solutions and better adaptability in the workplace. Future research could further explore the underlying mechanisms of this relationship and investigate the potential benefits of other leisure activities for creativity and professional development.

References

- Acar, O. A., Tarakci, M., & Van Knippenberg, D. (2019). Creativity and innovation under constraints: A cross-disciplinary integrative review. *Journal of Management*, *45*(1), 96–121.
- Acar, S., Tadik, H., Myers, D., Van der Sman, C., & Uysal, R. (2021). Creativity and well-being: A meta-analysis. *The Journal of Creative Behavior*, *55*(3), 738–751.
- Afifi, T. O., LaPlante, D. A., Taillieu, T. L., Dowd, D., & Shaffer, H. J. (2014). Gambling involvement: Considering frequency of play and the moderating effects of gender and age. *International Journal of Mental Health and Addiction*, *12*(3), Article 3.
- Amabile, T. M. (1988). A model of creativity and innovation in organizations. *Research in Organizational Behavior*, *10*(1), Article 1.
- Amabile, T. M., & Pratt, M. G. (2016). The dynamic componential model of creativity and innovation in organizations: Making progress, making meaning. *Research in Organizational Behavior*, *36*, 157–183.
- Bakker, A. B., Scharp, Y. S., Breevaart, K., & De Vries, J. D. (2020). Playful work design: Introduction of a new concept. *The Spanish Journal of Psychology*, *23*, e19.
- Bateson, P., Bateson, P. P. G., & Martin, P. (2013). *Play, playfulness, creativity and innovation*. Cambridge University Press.
- Beard, J. G., & Ragheb, M. G. (1983). Measuring leisure motivation. *Journal of Leisure Research*, *15*(3), 219–228.
- Benedek, M., Bruckdorfer, R., & Jauk, E. (2020). Motives for creativity: Exploring the what and why of everyday creativity. *The Journal of Creative Behavior*, *54*(3), 610–625.
- Besemer, S. P., & Treffinger, D. J. (1981). Analysis of creative products: Review and synthesis. *The Journal of Creative Behavior*, *15*(3), Article 3.
- Bishop, D. W., & Chace, C. A. (1971). Parental conceptual systems, home play environment, and potential creativity in children. *Journal of Experimental Child Psychology*, *12*(3), 318–338.
- Brislin, R. W. (1986). The wording and translation of research instruments. In *Field methods in cross-cultural research* (pp. 137–164). Sage Publications, Inc.
- Brown, S. L. (2009). *Play: How it shapes the brain, opens the imagination, and invigorates the soul*. Penguin.
- Caillois, R. (1980). *Man and the Sacred* (Transl. M. Barash). Westport, Connecticut: Greenwood Press.
- Csikszentmihalyi, M. (1996). *Flow and the psychology of discovery and invention* (Vol. 56). New York: Harper Collins.
- Dewett, T. (2007). Linking intrinsic motivation, risk taking, and employee creativity in an R&D environment. *R&d Management*, *37*(3), Article 3.
- Diedrich, J., Jauk, E., Silvia, P. J., Gredlein, J. M., Neubauer, A. C., & Benedek, M. (2018). Assessment of real-life creativity: The Inventory of Creative Activities and Achievements (ICAA). *Psychology of Aesthetics, Creativity, and the Arts*, *12*(3), Article 3.

- Farmer, S. M., & Tierney, P. (2017). Considering Creative Self-Efficacy: Its Current State and Ideas for Future Inquiry. In *The Creative Self* (pp. 23–47). Elsevier. <https://doi.org/10.1016/B978-0-12-809790-8.00002-9>
- Feist, G. J. (1998). A meta-analysis of personality in scientific and artistic creativity. *Personality and Social Psychology Review*, 2(4), Article 4. https://doi.org/10.1207/s15327957pspr0204_5
- Ford, C. M. (1996). A theory of individual creative action in multiple social domains. *Academy of Management Review*, 21(4), Article 4.
- Fredrickson, B. L. (2001). The role of positive emotions in positive psychology: The broaden-and-build theory of positive emotions. *American Psychologist*, 56(3), 218.
- Gonzalo-Iglesia, J. L., Lozano-Monterrubio, N., & Prades-Tena, J. (2018). The usage of game-based learning in university education. How to motivate and foster creativity among adult students through board games. *Proceedings of Play2Learn*, 67–84.
- Hammond, M. M., Neff, N. L., Farr, J. L., Schwall, A. R., & Zhao, X. (2011). Predictors of individual-level innovation at work: A meta-analysis. *Psychology of Aesthetics, Creativity, and the Arts*, 5(1), Article 1. <https://doi.org/10.1037/a0018556>
- Huizinga, J. (1955). *Homo Ludens: A Study of the Play-element in Culture*. Beacon Press.
- Hunter, S. T., Bedell, K. E., & Mumford, M. D. (2007). Climate for creativity: A quantitative review. *Creativity Research Journal*, 19(1), 69–90.
- Hutt, C. (1970). Specific and diversive exploration. *Advances in Child Development and Behavior*, 5, 119–180.
- Jackson, L. A., & Games, A. I. (2015). Video Games and Creativity. In *Video Games and Creativity* (pp. 3–38). Elsevier.
- Karwowski, M. (2012). Did curiosity kill the cat? Relationship between trait curiosity, creative self-efficacy and creative personal identity. *Europe's Journal of Psychology*, 8(4), 547–558.
- Karwowski, M., Lebeda, I., & Wiśniewska, E. (2018). Measuring creative self-efficacy and creative personal identity. *The International Journal of Creativity & Problem Solving*.
- Kaufman, J. C. (2012). Counting the muses: Development of the Kaufman domains of creativity scale (K-DOCS). *Psychology of Aesthetics, Creativity, and the Arts*, 6(4), Article 4.
- Kaufman, J. C., & Beghetto, R. A. (2009). Beyond Big and Little: The Four C Model of Creativity. *Review of General Psychology*, 13(1), Article 1. <https://doi.org/10.1037/a0013688>
- Kaufman, J. C., Glăveanu, V. P., & Baer, J. (2017). *The Cambridge handbook of creativity across domains*. Cambridge University Press.
- Kuo, H.-C., Weng, T.-L., Chang, C.-C., & Chang, C.-Y. (2023). Designing Our Own Board Games in the Playful Space: Improving High School Student's Citizenship Competencies and Creativity through Game-Based Learning. *Sustainability*, 15(4), 2968.
- Lieberman, J. N. (1977). *Playfulness: Its relationship to imagination and creativity*. Academic Press.
- Lubart, T., Mouchiroud, C., Tordjman, S., & Zenasni, F. (2015). *Psychologie de la créativité-2e édition*. Armand Colin.

- Mainemelis, C., & Ronson, S. (2006). Ideas are born in fields of play: Towards a theory of play and creativity in organizational settings. *Research in Organizational Behavior*, 27, 81–131.
- McCrae, R. R., & Sutin, A. R. (2009). *Openness to experience*.
- Mercier, M., & Lubart, T. (2021). The effects of board games on creative potential. *The Journal of Creative Behavior*, 55(3), 875–885.
- Mercier, M., & Lubart, T. (2023a). Board games enhance creativity: Evidence from two studies. *Psychology of Aesthetics, Creativity, and the Arts*.
- Mercier, M., & Lubart, T. (2023b). Video games and creativity: The mediating role of psychological capital. *Journal of Creativity*, 33(2), 100050.
- Moffat, D. C., Crombie, W., & Shabalina, O. (2017). Some video games can increase the player's creativity. *International Journal of Game-Based Learning (IJGBL)*, 7(2), Article 2. <https://doi.org/10.4018/IJGBL.2017040103>
- Ng, T. W., & Feldman, D. C. (2012). A comparison of self-ratings and non-self-report measures of employee creativity. *Human Relations*, 65(8), Article 8.
- Norsworthy, N., & Whitley, M. T. (1918). *The psychology of childhood*. Macmillan Company.
- Ohly, S. (2018). Promoting creativity at work—implications for scientific creativity. *European Review*, 26(S1), S91–S99.
- Olsen, E. T. (1981). *An exploratory study of adult playfulness and some personality correlates*. Michigan State University.
- Orkibi, H. (2021). Creative adaptability: Conceptual framework, measurement, and outcomes in times of crisis. *Frontiers in Psychology*, 11, 588172.
- Panksepp, J. (1993). Rough and tumble play: A fundamental brain process. *Parent-Child Play: Descriptions and Implications*, 147–184.
- Park, J., & Lee, K. (2017). Using board games to improve mathematical creativity. *International Journal of Knowledge and Learning*, 12(1), 49–58.
- Proyer, R. T. (2012a). Development and initial assessment of a short measure for adult playfulness: The SMAP. *Personality and Individual Differences*, 53(8), 989–994.
- Proyer, R. T. (2012b). Examining playfulness in adults: Testing its correlates with personality, positive psychological functioning, goal aspirations, and multi-methodically assessed ingenuity. *Psychological Test and Assessment Modeling*, 54(2), 103–127.
- Proyer, R. T., Tandler, N., & Brauer, K. (2019). Playfulness and Creativity. In *Creativity and Humor* (pp. 43–60). Elsevier. <https://doi.org/10.1016/B978-0-12-813802-1.00002-8>
- Radel, R., Davranche, K., Fournier, M., & Dietrich, A. (2015). The role of (dis) inhibition in creativity: Decreased inhibition improves idea generation. *Cognition*, 134, 110–120.
- Runco, M. A. (1988). *Creativity research: Originality, utility, and integration*. Taylor & Francis.
- Runco, M. A., Illies, J. J., & Eisenman, R. (2005). Creativity, originality, and appropriateness: What do explicit instructions tell us about their relationships? *The Journal of Creative Behavior*, 39(2), Article 2.
- Runco, M. A., & Jaeger, G. J. (2012). The standard definition of creativity. *Creativity Research Journal*, 24(1), Article 1. <https://doi.org/10.1080/10400419.2012.650092>

- Russ, S. W., Robins, A. L., & Christiano, B. A. (1999). Pretend play: Longitudinal prediction of creativity and affect in fantasy in children. *Creativity Research Journal*, *12*(2), 129–139.
- Sarnoff, D. P., & Cole, H. P. (1983). Creativity and personal growth. *The Journal of Creative Behavior*.
- Scharp, Y. S., Bakker, A. B., Breevaart, K., Kruup, K., & Uusberg, A. (2023). Playful work design: Conceptualization, measurement, and validity. *Human Relations*, *76*(4), 509–550.
- Shen, X., Liu, H., & Song, R. (2021). Toward a culture-sensitive approach to playfulness research: Development of the Adult Playfulness Trait Scale-Chinese version and an alternative measurement model. *Journal of Leisure Research*, *52*(4), 401–423.
- Shen, X. S., Chick, G., & Zinn, H. (2014a). Validating the Adult Playfulness Trait Scale (APTS): An Examination of Personality, Behavior, Attitude, and Perception in the Nomological Network of Playfulness. *American Journal of Play*, *6*(3), 345–369.
- Shen, X. S., Chick, G., & Zinn, H. (2014b). Playfulness in Adulthood as a Personality Trait: A Reconceptualization and a New Measurement. *Journal of Leisure Research*, *46*(1), Article 1. <https://doi.org/10.1080/00222216.2014.11950313>
- Silvia, P. J., Beaty, R. E., Nusbaum, E. C., Eddington, K. M., Levin-Aspenson, H., & Kwapil, T. R. (2014). Everyday creativity in daily life: An experience-sampling study of “little c” creativity. *Psychology of Aesthetics, Creativity, and the Arts*, *8*(2), Article 2.
- Singer, D. L., & Rummo, J. (1973). Ideational creativity and behavioral style in kindergarten-age children. *Developmental Psychology*, *8*(2), 154.
- Singer, J. L., & Singer, D. G. (2005). Preschoolers’ imaginative play as precursor of narrative consciousness. *Imagination, Cognition and Personality*, *25*(2), 97–117.
- Sutton-Smith, B. (1966). Piaget on play: A critique. *Psychological Review*, *73*(1), 104.
- Tyagi, V., Hanoach, Y., Hall, S. D., Runco, M., & Denham, S. L. (2017). The risky side of creativity: Domain specific risk taking in creative individuals. *Frontiers in Psychology*, *8*, 145.
- Wallace, C. E., & Russ, S. W. (2015). Pretend play, divergent thinking, and math achievement in girls: A longitudinal study. *Psychology of Aesthetics, Creativity, and the Arts*, *9*(3), 296.
- Wyver, S. R., & Spence, S. H. (1999). Play and divergent problem solving: Evidence supporting a reciprocal relationship. *Early Education and Development*, *10*(4), 419–444.
- Zhou, J., & George, J. M. (2003). Awakening employee creativity: The role of leader emotional intelligence. *The Leadership Quarterly*, *14*(4–5), 545–568.

Appendix A

Table A1.
Mediation analysis

Direct effects							95% Confidence Interval			
			Estimate	SE	z-value	p	Lower	Upper		
Diversity	→	CW	0.065	0.040	1.616	0.106	-0.016	0.147		
Diversity	→	CSC	0.113	0.042	2.706	0.007	0.032	0.190		
Indirect effects							95% Confidence Interval			
				Estimate	SE	z-value	p	Lower	Upper	
Diversity	→	FSM	→	CW	0.056	0.017	3.252	0.001	0.026	0.098
Diversity	→	Uninhibitedness	→	CW	0.019	0.011	1.782	0.075	0.002	0.054
Diversity	→	FSM	→	CSC	0.050	0.016	3.069	0.002	0.024	0.090
Diversity	→	Uninhibitedness	→	CSC	0.015	0.010	1.456	0.145	-0.004	0.046
Total effects							95% Confidence Interval			
			Estimate	SE	z-value	p	Lower	Upper		
Diversity	→	CW	0.140	0.043	3.272	0.001	0.047	0.235		
Diversity	→	CSC	0.178	0.043	4.128	<.001	0.087	0.260		
Total indirect effects							95% Confidence Interval			
			Estimate	SE	z-value	p	Lower	Upper		
Diversity	→	CW	0.075	0.020	3.805	<.001	0.039	0.122		
Diversity	→	CSC	0.065	0.018	3.610	<.001	0.034	0.108		
Residual covariances							95% Confidence Interval			
			Estimate	SE	z-value	p	Lower	Upper		
FSM	↔	Uninhibitedness	0.491	0.059	8.273	<.001	0.386	0.619		
CW	↔	CSC	0.532	0.054	9.780	<.001	0.437	0.661		
Path coefficients							95% Confidence Interval			
			Estimate	SE	z-value	p	Lower	Upper		
FSM	→	CW	0.328	0.060	5.513	<.001	0.190	0.451		
Uninhibitedness	→	CW	0.121	0.059	2.049	0.040	0.008	0.253		
Diversity	→	CW	0.065	0.040	1.616	0.106	-0.016	0.147		
FSM	→	CSC	0.290	0.061	4.739	<.001	0.161	0.424		
Uninhibitedness	→	CSC	0.096	0.060	1.591	0.112	-0.050	0.229		
Diversity	→	CSC	0.113	0.042	2.706	0.007	0.032	0.190		
Diversity	→	FSM	0.172	0.043	4.028	<.001	0.087	0.265		
Diversity	→	Uninhibitedness	0.154	0.043	3.610	<.001	0.065	0.242		

Note 1. Delta method standard errors, bias-corrected percentile bootstrap confidence intervals, ML estimator.

Note 2. FSM: Fun-Seeking Motivation, CW: Creativity in the Workplace, CSC: Creative Self-Concept.

Chapitre 3 :

Discussion générale

Comme nous l'avons indiqué et expliqué tout au long de cette thèse, la créativité est une capacité importante voire essentielle de nos jours, et il est primordial de trouver des moyens efficaces pour l'améliorer. Dans ce but, une méthode particulière a récemment commencé à faire ses preuves : les jeux. Le but de cette thèse était d'explorer plus amplement l'effet des jeux sur la créativité.

Ce travail de thèse et les contributions scientifiques qui en découlent étaient fondés sur trois grandes idées. Tout d'abord, la créativité est malléable et améliorable. Deuxièmement, une amélioration tangible de la créativité repose sur l'apprentissage par la pratique et l'expérience concrète. Enfin, la troisième idée considère l'apprentissage par le jeu comme une opérationnalisation optimale et rentable de cet apprentissage par l'expérience. Sur ces bases, cette thèse visait à examiner l'utilisation des jeux comme une manière efficace d'améliorer la créativité, en permettant un apprentissage expérientiel optimal. Pour ce faire, trois objectifs principaux, organisés en trois volets, ont été proposés et explorés grâce à une combinaison de méthodologies complémentaires.

1. Résumé synthétique

1.1. Premier volet

Le premier volet consistait en l'élaboration d'un cadre théorique intégratif de l'amélioration de la créativité par le jeu (A1). Ce cadre théorique, basé sur le paradigme entrée-processus-sortie, propose de décrire, expliquer et potentiellement prédire l'effet des jeux sur la créativité. Il comprend deux entrées : les attributs personnels et les attributs des jeux. Les attributs personnels prennent la forme de dispositions et variables conatives communes à la fois à la créativité et aux jeux. Ces « dénominateurs communs » permettent d'expliquer la raison pour laquelle la pratique des jeux et la créativité sont liées, notamment à l'extérieur du laboratoire. Plusieurs variables ont ainsi été identifiées et présentées : le caractère joueur, l'imagination, l'errance mentale, la pleine conscience, le capital psychologique et les motivations. La seconde entrée correspond aux attributs des jeux, qui permettent d'expliquer pourquoi et comment les jeux peuvent participer à améliorer la créativité. Deux formes d'attributs des jeux ont été présentées : les affordances et les mécaniques des jeux. Huit types d'affordances ont été identifiés : degré de flexibilité, narration, outils, environnement, création de contenu, avatar, progression et rejouabilité. Cinq types de mécaniques de jeu ont également été identifiées : l'originalité, la pensée divergente, la pensée convergente, la flexibilité mentale, et les dispositions créatives. Le processus renvoie ici à la situation d'apprentissage au sein du jeu. Ce processus intègre l'apprentissage expérientiel et l'applique à la créativité. Autrement

dit, ce processus décrit comment les mécaniques des jeux sont pratiquées et expérimentées par le joueur/apprenant. Ce processus cyclique est composé de quatre étapes : expérience concrète, observation réfléchie, conceptualisation abstraite et expérimentation active. Enfin, les acquis d'apprentissage font référence aux différents aspects et manifestations de la créativité qui sont ou pourraient être améliorés par le jeu.

1.2. Deuxième volet

Le deuxième volet portait sur la vérification de l'hypothèse principale du cadre théorique, concernant la « sortie », à savoir tester et valider si les jeux sont bel et bien un outil efficace pour améliorer la créativité. Pour répondre à cette question, deux études expérimentales ont été menées, utilisant une forme de jeu peu étudiée à l'heure actuelle : les jeux de société. La première étude expérimentale (A2) portait sur la créativité individuelle et a permis de comparer trois conditions : situation sans jeu, jeux créatifs et jeux non-créatifs. La performance créative individuelle a été évaluée lors d'une tâche de pensée divergente en mesurant la fluidité et l'originalité des réponses. Les jeux dits créatifs présentent des mécaniques impliquant activement de la créativité, en *nécessitant* par exemple de la génération d'idées originales de la part du joueur. Deux spécimens de ces jeux créatifs furent ainsi comparés à deux jeux non-créatifs, ne nécessitant aucune créativité de la part du joueur. L'hypothèse principale formulée était la suivante : seuls les jeux créatifs stimuleraient positivement et significativement la pensée divergente des participants, en particulier leur originalité. Les résultats présentés dans cet article corroborent effectivement cette hypothèse, en montrant un effet des jeux de société créatifs sur l'originalité des réponses données par les participants ($N = 239$). Qui plus est, cet effet a été observé pour l'ensemble des participants dans la condition créative, indépendamment de leur potentiel créatif de base. Autrement dit, tous les participants ont bénéficié de l'activité de jeu créatif, qu'ils soient faibles ou excellents en termes de créativité. La fluidité n'était globalement pas affectée par le type de jeu.

La seconde étude de ce volet (A3) vient compléter ces résultats, en adoptant un parti-pris complémentaire. Les jeux de société étant par définition une activité collective, il apparaît intéressant de tester leurs effets sur une forme de créativité collective. Dans ce but, 120 étudiants à l'université, réunis en groupe de trois, ont réalisé une session de brainstorming, autrement dit une tâche de pensée divergente de groupe. La tâche était particulièrement adaptée à l'échantillon de l'étude, en demandant aux groupes de trouver des manières d'améliorer l'enseignement et l'apprentissage à l'université. Ainsi, la tâche utilisée nous a permis d'évaluer la pensée divergente de manière écologique, en évaluant les groupes d'étudiants sur une

problématique pertinente et correspondant véritablement à leur situation. Deux spécimens de jeux créatifs furent comparés à deux jeux non-créatifs. Cette fois-ci, la définition de ces jeux créatifs était plus précise, nous aidant à formuler des choix de jeux potentiellement plus valides. Ainsi, un des jeux créatifs était le même que l'étude A2, et un nouveau jeu créatif fut intégré. Les deux jeux non-créatifs de l'étude précédente (A2) furent conservés et ont constitué la condition contrôle. Pour comparer l'effet des jeux créatifs, trois critères de la pensée divergente à l'échelle du groupe ont été évalués : la fluidité, l'élaboration et l'originalité. Pour hypothèses, les jeux créatifs étaient censés avoir un effet positif sur ces trois critères, comparé à la condition contrôle. Ces trois hypothèses ont été vérifiées : le fait de jouer à un jeu créatif améliore positivement la fluidité, l'élaboration et l'originalité des idées données par les groupes d'étudiants. Les tailles d'effet étaient toutes larges et proches de $d = 1$ dans les trois cas. Nous pouvons ainsi considérer les jeux comme efficaces pour améliorer la pensée divergente, à la fois pour les individus et pour les groupes. L'effet des jeux créatifs semble également plus complet à l'échelle du groupe, tous les critères de la pensée divergente évalués ayant bénéficié de l'intervention, là où seule l'originalité fut impactée à l'échelle individuelle.

1.3. Troisième volet

Le troisième volet portait sur la première entrée du cadre théorique, à savoir les « Attributs Personnels ». Le but de ce volet était d'expliquer les liens entre pratique des jeux et créativité, en adoptant une approche davantage conative. Le cadre théorique identifie ainsi plusieurs médiateurs potentiels, ou dénominateurs communs. À travers deux études corrélationnelles, ce volet explore deux médiateurs : le capital psychologique et le caractère joueur. . La première étude (A4) examine ainsi le rôle médiateur du capital psychologique entre la pratique des jeux vidéo et la créativité au travail. Le capital psychologique est constitué de quatre composantes : auto-efficacité, optimisme, espoir, résilience (Luthans et al., 2007b). Chacune de ces composantes a été ou peut être reliée à la fois à la pratique des jeux et à la créativité au travail. Dans la majorité des cas, ces liens s'expliquent par la difficulté inhérente à la fois aux jeux et à la créativité. L'adversité fait partie intégrante des jeux, que ce soit par la présence de monstres dans un jeu de plateforme comme Super Mario Bros, de vaisseaux ennemis dans un jeu d'arcade comme Galaga ou Space Invaders, d'une contrainte temporelle lors d'une course contre la montre dans un jeu de course comme Need For Speed, ou la présence de joueurs ennemis dans un jeu de tir multijoueur comme Call of Duty. Dans tous les cas, la difficulté est présente et la victoire n'est jamais garantie. Les différentes composantes du capital psychologique se révèlent ainsi nécessaires, et potentiellement entraînaibles. De l'autre côté, la

Discussion générale

créativité s'avère similaire, en ceci que la réussite n'est jamais garantie. La poursuite de l'acte créatif est généralement semée d'embûches, et la persévérance malgré les revers est souvent caractéristique des individus créatifs. Cette étude a donc examiné les liens entre jeux vidéo et créativité au travail, en explorant le rôle potentiellement médiateur des différentes composantes du capital psychologique. Les résultats montrent qu'il s'agit spécifiquement de l'optimisme qui joue ce rôle, au-delà des autres composantes ou du capital psychologique global. Il s'agit entre autres d'une médiation complète : la pratique des jeux vidéo est associée à un optimisme plus élevé, qui est associé en retour à une plus grande créativité au travail.

Le second article de ce volet (A5) examine un autre médiateur, le caractère joueur. Le caractère joueur est une disposition permettant aux individus de voir et concevoir les situations quotidiennes de manière à ce qu'elles soient divertissantes, stimulantes et intéressantes. Il est constitué de trois sous-composantes dispositionnelles : une motivation à rechercher du plaisir (*fun-seeking motivation*), la désinhibition et la spontanéité. Les individus joueurs recherchent le type d'activités que les jeux proposent (Proyer et al., 2019), et voient l'engagement dans les activités créatives une opportunité d'assouvir leur besoin d'activités nouvelles et stimulantes (e.g., Brauer et al., 2022). Ainsi, cette étude exploratoire examine le rôle médiateur du caractère joueur, entre jeux et créativité. Les jeux sont ici opérationnalisés par les habitudes de pratique des jeux de société, par trois mesures : la fréquence de jeu, le nombre total de jeux auquel l'individu a joué (la diversité), et le temps passé sur ses jeux préférés (la sélectivité). La créativité est opérationnalisée par deux mesures : le concept de soi créatif et la créativité au travail. Les résultats observés ont permis d'identifier le rôle médiateur de deux composantes du caractère joueur en particulier : la motivation à rechercher du plaisir et la désinhibition. Ces deux dimensions médiatisent de manière partielle la relation entre pratiques des jeux de société et le concept de soi créatif, et de manière complète dans le cas de la créativité au travail. Qui plus est, les résultats montrent que parmi les différentes mesures des habitudes de pratique des jeux de société, le meilleur prédicteur de la créativité étant dans les deux cas la diversité. Autrement dit, le fait de jouer à une large variété de jeux de société est associé à un caractère joueur plus élevé, en retour associé à un concept de soi créatif plus élevé et une plus grande créativité au travail.

2. Cadre théorique : implications, limites et perspectives

Le cadre théorique présenté comprenait quatre composants : les attributs personnels, les attributs du jeu, le processus d'apprentissage au sein du jeu, et l'amélioration de la créativité.

Cette thèse apporte des éléments de validation sur deux de ces quatre composantes. D'abord, la créativité est bel et bien reliée à la pratique des jeux, et il est possible d'expliquer comment et pourquoi. Ainsi, plusieurs des dénominateurs communs identifiés théoriquement existent bien empiriquement, comme le montrent les études A4 et A5. Il reste évidemment d'autres attributs personnels à tester. De futures études pourraient s'intéresser à examiner la place de l'imagination, de l'errance mentale ou de la pleine conscience. D'autres mesures pourraient également être intégrées. Dans les deux études du troisième volet, les mesures de la créativité étaient toutes auto-rapportées. Bien que satisfaisantes et valides (Ng & Feldman, 2012), ces mesures peuvent souffrir d'un grand nombre de biais, comme la variance de méthode commune (Podsakoff et al., 2003). Elle correspond à une part d'erreur systématique partagée entre les variables, attribuable à la méthode de mesure et non aux construits étudiés. Ce biais peut avoir pour conséquence, entre autres, d'augmenter artificiellement les corrélations entre les variables (Williams & Brown, 1994). Le recours à des mesures hétéro-rapportées, comme préconisé initialement par Zhou & George (2001b), pourrait participer à réduire ces différents biais. L'utilisation de mesures de performance créative, comme les tâches de pensée divergente, pourrait s'avérer plus objectivantes, tout en apportant une information complémentaire concernant le potentiel créatif des individus. Une approche intéressante serait également d'utiliser des mesures de la créativité quotidienne, comme l'Inventaire d'Activités et d'Accomplissement Créatifs (ICAA, Diedrich et al., 2018), qui mesure différents domaines de la créativité, en termes d'engagement dans des activités créatives et d'accomplissements créatifs obtenus dans chaque domaine.

La deuxième composante validée du modèle est l'amélioration de la créativité. Cette thèse montre que les jeux de société sont efficaces pour améliorer la créativité individuelle et la créativité de groupe. Les différentes études expérimentales montrent qu'il ne s'agit pas simplement de l'acte de jouer qui améliore la créativité, mais bien le fait de jouer en appliquant et en expérimentant avec les différentes mécaniques du jeu relatives à la créativité. Les jeux offrent certes un cadre propice à l'amélioration de la créativité, mais cela n'est pas suffisant. Leur impact est issu de la pratique de mécaniques de jeu spécifiques (comme l'originalité ou la pensée divergente) et de l'entraînement qui en résulte, qui apporte une amélioration de la créativité. Cette conclusion est étayée par l'absence d'effet des jeux non-créatifs sur la

créativité. Dans l'étude expérimentale de l'article A2, les effets des jeux de société non-créatifs étaient globalement au même niveau que la condition contrôle (sans jeu). De la même manière, l'étude de l'article A3 montre une supériorité des jeux de société créatifs comparés à la condition contrôle, où les groupes jouaient à un jeu non-créatif similaire à ceux utilisés dans l'étude A2.

Les tailles d'effets constatés montrent également que les jeux fournissent un cadre optimal à l'amélioration de la créativité. En effet, les tailles d'effets observés sont généralement supérieures à celles observées dans les différentes méta-analyses de programmes spécifiques d'entraînement à la créativité. La première méta-analyse sur l'effet des entraînements à la créativité indiquait, en moyenne, une taille d'effet modérée à large, $d = 0,68$ (Scott et al., 2004b). Cette méta-analyse reposait sur l'analyse de 70 études. Une méta-analyse plus restreinte sur 34 études fut conduite par Ma (2006), trouvant une taille d'effet légèrement plus élevée, $d = 0,77$. Une méta-analyse plus récente et menée sur 84 études (Haase et al., 2023) a trouvé un effet moyen de taille modérée, $d = 0,53$. Dans notre cas, la taille d'effet de l'étude A2 sur l'originalité était équivalente à celle de Haase et al. (2023), $d = 0,54$. Les effets étaient beaucoup plus marqués dans le cas de l'étude A3 : les tailles d'effet pour les trois critères étaient larges ($d_{fluidité} = 0,95$) voire très larges ($d_{elaboration} = 1,04$; $d_{originalité} = 1,03$). Autrement dit, les jeux ne servent pas seulement d'environnement de pratique et d'entraînement à la créativité. Au contraire, les caractéristiques inhérentes aux jeux entraînent un meilleur engagement avec le matériel, en retour entraînant une plus grande amélioration de la créativité, en un temps réduit.

Malgré ces résultats encourageants, de nombreuses questions restent sans réponse. Jusque-là, toutes les études menées ne portent que sur un effet immédiat de la pratique des jeux. L'effet d'une pratique répétée reste encore un mystère. Deux phénomènes pourraient apparaître. Typiquement, la performance s'améliore avec la pratique (Newell & Rosenbloom, 1993). Ainsi, une pratique répétée pourrait avoir pour effet une amélioration continue de la créativité, jusqu'à l'atteinte d'un certain plateau au-delà d'un niveau suffisamment élevé. À l'inverse, il se peut qu'un ennui apparaisse et entraîne ce phénomène de plateau voire une diminution de la créativité, selon la rejouabilité des jeux. Généralement, l'ennui est associé aux tâches que l'on trouve inintéressantes ou trop pénibles (Haager et al., 2018). Il est également possible d'être ennuyé par une tâche initialement intéressante et agréable, mais qui, après une trop grande répétition, devient désagréable et peu stimulante (Fisherl, 1993). Après un certain nombre de sessions d'un même jeu, un ennui lié à la tâche pourrait ainsi s'installer, ayant en retour un effet délétère sur la créativité (e.g., Haager et al., 2018).

Également, l'opérationnalisation de la créativité par la pensée divergente, bien que valide, peut sembler insuffisante. Les jeux pourraient avoir des effets sur certains aspects conatifs et davantage malléables du potentiel créatif. Il est par exemple fort probable que jouer à un jeu créatif ait des effets bénéfiques sur l'auto-efficacité créative des individus. L'auto-efficacité créative correspond à la confiance qu'un individu a de sa capacité à être créatif, dans une situation donnée (Karwowski et al., 2018). Bien qu'ayant été considéré comme relativement stable et proche d'un trait par le passé, cet aspect crucial du potentiel créatif s'avère en réalité relativement malléable, et semblable à un état (He & Wong, 2022; Zandi et al., 2022). Outre la pensée divergente, certains jeux pourraient également avoir un effet sur d'autres ressources cognitives du potentiel créatif telles que la pensée convergente, la flexibilité mentale, la pensée analogique, ainsi que dans différents domaines autres que la créativité verbale, comme les domaines graphiques ou numériques.

Deux aspects du modèle restent en suspens. Le premier correspond aux attributs du jeu. Ces attributs, évoqués dans le cadre théorique, renvoient aux affordances et aux mécaniques des jeux liées à la créativité. Les affordances correspondent aux opportunités d'agir de manière créative, dans un jeu en particulier. Les mécaniques renvoient elle à la manière dont certains jeux ciblent, sollicitent et requièrent certains aspects de la créativité dans leurs mécanismes, améliorant ainsi le potentiel créatif, au-delà du jeu. Le choix des jeux testés dans l'étude expérimentale A2 et plus particulièrement dans l'étude A3 s'appuient sur ces mécaniques. Nous avons ainsi fait référence à plusieurs définitions de ce qui fait qu'un jeu soit efficace pour améliorer la créativité. Au-delà de ces définitions holistiques, cinq mécaniques ont été identifiées, dans un article co-écrit mis en annexe (Thornhill-Miller et al., 2023). Bien que l'article A3 y fasse référence de manière globale, l'effet spécifique de ces cinq mécaniques n'a pas été examiné. Il y a fort à penser qu'un jeu spécifiquement concentré sur la pensée convergente n'aura que peu d'effet sur une tâche de pensée divergente. De même, certains jeux, comme les jeux de puzzle pourraient solliciter et entraîner la flexibilité mentale en particulier. Des premiers résultats vont dans ce sens, Moffat et al. (2017) ayant notamment observé une amélioration de la flexibilité après avoir joué à Portal 2, un jeu vidéo de résolutions de puzzle. Il serait ainsi possible et intéressant de tester les effets différentiels de ces mécaniques de jeux, sur des composantes cognitives et spécifiques du potentiel créatif.

L'autre aspect reste le processus d'apprentissage. En théorie, les individus passent par quatre étapes au cours du jeu : l'expérience concrète, l'observation réflexive, la conceptualisation abstraite, et l'expérimentation active. Il s'agit là d'une analyse à un niveau

Discussion générale

d'avantage micro, plus difficile à évaluer, mais néanmoins intéressante à évaluer. Cela pourrait être fait premièrement de manière qualitative, par la méthode des entretiens et des carnets de bord. Cette analyse qualitative a déjà été utilisée avec succès pour comprendre le processus créatif (Botella et al., 2013, 2019, 2022). Il est possible d'imaginer que cela soit également applicable pour le processus d'apprentissage expérientiel de la créativité, au cours d'une partie de jeu. Par exemple, plusieurs joueurs pourraient jouer à un jeu au tour par tour, dans lequel ils apprendraient au fur et à mesure les mécaniques du jeu et à exprimer leur créativité au sein de celui-ci (un exemple intéressant pourrait être Dixit). Des questions seraient ensuite posées au cours d'un entretien, ou l'analyse des traces dans le carnet de bord serait menée pour retranscrire le processus d'apprentissage au sein du jeu.

3. Conclusion

En conclusion, cette thèse a abordé un domaine de recherche essentiel dans notre société contemporaine : la créativité. Dans un monde en constante évolution, la créativité est devenue une compétence cruciale, que ce soit dans le domaine professionnel, éducatif ou personnel. Cette étude a cherché à explorer en profondeur l'impact des jeux comme moyen d'améliorer la créativité, en se basant sur un cadre théorique intégratif.

Les résultats obtenus apportent des connaissances nouvelles sur la manière dont les jeux peuvent contribuer à stimuler la créativité et ouvrent un large champ d'explorations futures. De manière générale, les deux études expérimentales menées ont montré que les jeux de société créatifs ont un impact notable sur la créativité, que ce soit à l'échelle individuelle ou collective. L'effet des jeux créatifs semble également plus complet à l'échelle du groupe, l'ensemble des critères de la pensée divergente évalués (fluidité, originalité et élaboration) ayant bénéficié positivement de l'intervention, là où seule l'originalité fut améliorée à l'échelle individuelle.

De plus, cette thèse a mis en lumière le rôle médiateur de certains attributs personnels, tels que le caractère joueur et le capital psychologique, dans la relation entre la pratique des jeux et la créativité. L'optimisme a notamment été identifié comme un médiateur clé, montrant que la pratique des jeux vidéo peuvent favoriser un état d'esprit plus positif, ce qui, à son tour, stimule la créativité au travail. Cela suggère que les jeux ne sont pas seulement des activités ludiques, mais qu'ils peuvent avoir un impact réel sur le développement de ressources conatives liées à la créativité.

Néanmoins, cette thèse souligne également la nécessité de poursuivre les recherches dans ce domaine. Certaines questions restent ainsi en suspens, telles que l'effet à long terme de la pratique répétée des jeux sur la créativité, ainsi que l'effet différentiel des mécaniques de jeu sur différentes composantes de la créativité. Enfin, il est important d'investiguer les aspects inexplorés du cadre théorique, notamment les affordances des jeux liées à la créativité, et le processus d'apprentissage expérientiel au sein des jeux. Les jeux offrent un environnement unique pour développer la créativité, mais il reste à comprendre comment les caractéristiques spécifiques des jeux peuvent être exploitées de manière optimale pour favoriser cet apprentissage.

Bibliographie

Bibliographie

- Acar, S., Tadik, H., Myers, D., Van der Sman, C., & Uysal, R. (2021). Creativity and well-being : A meta-analysis. *The Journal of Creative Behavior*, 55(3), Article 3.
- Altinay, L., Madanoglu, M., Daniele, R., & Lashley, C. (2012). The influence of family tradition and psychological traits on entrepreneurial intention. *International Journal of hospitality management*, 31(2), 489-499.
- Amabile, T. M., Hill, K. G., Hennessey, B. A., & Tighe, E. M. (1994). The Work Preference Inventory : Assessing intrinsic and extrinsic motivational orientations. *Journal of Personality and Social Psychology*, 66(5), Article 5. <https://doi.org/10.1037/0022-3514.66.5.950>
- Amabile, T. M., & Pratt, M. G. (2016). The dynamic componential model of creativity and innovation in organizations : Making progress, making meaning. *Research in Organizational Behavior*, 36, 157-183.
- Andersen, E. (2012). Optimizing adaptivity in educational games. *Proceedings of the international conference on the foundations of digital games*, 279-281.
- Anderson, J. R. (1987). Skill acquisition : Compilation of weak-method problem situations. *Psychological review*, 94(2), 192.
- Annebeau, J. (2004). *La problématique de l'éducation à la paix à la lumière de deux représentants de l'Education nouvelle : Célestin Freinet et Maria Montessori* [PhD Thesis]. Lyon 2.
- Archibugi, D., Filippetti, A., & Frenz, M. (2013). Economic crisis and innovation : Is destruction prevailing over accumulation? *research Policy*, 42(2), 303-314.
- Ashton, M. C., & Lee, K. (2009). The HEXACO-60 : A short measure of the major dimensions of personality. *Journal of personality assessment*, 91(4), Article 4.
- Astington, J. W., Harris, P. L., & Olson, D. R. (1988). *Developing theories of mind*. CUP Archive.
- Baer, J. (2010). Is creativity domain specific? *The Cambridge handbook of creativity*, 321-341.
- Bandura, A., Freeman, W. H., & Lightsey, R. (1999). *Self-efficacy : The exercise of control*. Springer.
- Barbot, B. (2019). Measuring creativity change and development. *Psychology of Aesthetics, Creativity, and the Arts*, 13(2), Article 2. <https://doi.org/10.1037/aca0000232>
- Barnard, L., Lan, W. Y., To, Y. M., Paton, V. O., & Lai, S.-L. (2009). Measuring self-regulation in online and blended learning environments. *The internet and higher education*, 12(1), 1-6.

Bibliographie

- Barzilai, S., & Blau, I. (2014). Scaffolding game-based learning : Impact on learning achievements, perceived learning, and game experiences. *Computers & Education, 70*, 65-79.
- Bechtoldt, M. N., Choi, H.-S., & Nijstad, B. A. (2012). Individuals in mind, mates by heart : Individualistic self-construal and collective value orientation as predictors of group creativity. *Journal of Experimental Social Psychology, 48*(4), 838-844.
- Bechtoldt, M. N., De Dreu, C. K., Nijstad, B. A., & Choi, H.-S. (2010). Motivated information processing, social tuning, and group creativity. *Journal of personality and social psychology, 99*(4), 622.
- Bedwell, W. L., Pavlas, D., Heyne, K., Lazzara, E. H., & Salas, E. (2012). Toward a taxonomy linking game attributes to learning : An empirical study. *Simulation & Gaming, 43*(6), 729-760.
- Beghetto, R. A., & Kaufman, J. C. (2007). Toward a broader conception of creativity : A case for " mini-c" creativity. *Psychology of Aesthetics, Creativity, and the Arts, 1*(2), Article 2.
- Benedek, M., Bruckdorfer, R., & Jauk, E. (2020). Motives for creativity : Exploring the what and why of everyday creativity. *The Journal of Creative Behavior, 54*(3), Article 3.
- Besançon, M., & Lubart, T. (2008). Differences in the development of creative competencies in children schooled in diverse learning environments. *Learning and individual differences, 18*(4), 381-389.
- Besançon, M., Lubart, T., & Barbot, B. (2013). Creative giftedness and educational opportunities. *Educational and Child Psychology, 30*(2), 79-88.
- Besemer, S. P., & O'Quin, K. (1999). Confirming the three-factor creative product analysis matrix model in an American sample. *Creativity Research Journal, 12*(4), Article 4. https://doi.org/10.1207/s15326934crj1204_6
- Botella, M., Glaveanu, V., Zenasni, F., Storme, M., Myszkowski, N., Wolff, M., & Lubart, T. (2013). How artists create : Creative process and multivariate factors. *Learning and Individual Differences, 26*, 161-170. <https://doi.org/10.1016/j.lindif.2013.02.008>
- Botella, M., Nelson, J., & Zenasni, F. (2019). It is time to observe the creative process : How to use a creative process report diary (CRD). *The Journal of Creative Behavior, 53*(2), Article 2.
- Botella, M., Zenasni, F., Nelson, J., & Lubart, T. (2022). Creative processes in five domains : Art, design, scriptwriting, music and engineering. In *Homo Creativus : The 7 C's of Human Creativity* (p. 69-86). Springer.

Bibliographie

- Bourgeois-Bougrine, S., Bonnardel, N., Burkhardt, J.-M., Thornhill-Miller, B., Pahlavan, F., Buisine, S., Guegan, J., Pichot, N., & Lubart, T. (2022). Immersive Virtual Environments' Impact on Individual and Collective Creativity. *European Psychologist*.
- Bradley, M. M., & Lang, P. J. (1994). Measuring emotion : The self-assessment manikin and the semantic differential. *Journal of behavior therapy and experimental psychiatry*, 25(1), Article 1. [https://doi.org/10.1016/0005-7916\(94\)90063-9](https://doi.org/10.1016/0005-7916(94)90063-9)
- Brauer, K., Sendatzki, R., Kaufman, J. C., & Proyer, R. T. (2022). Counting the muses in German speakers—Evaluation of the German-language translation of the Kaufman Domains of Creativity Scales (K-DOCS). *Psychological Test Adaptation and Development*. <https://psycnet.apa.org/record/2022-93940-001>
- Buckley, K. E., & Anderson, C. A. (2012). A theoretical model of the effects and consequences of playing video games. In *Playing video games* (p. 427-446). Routledge.
- Buisine, S., & Guegan, J. (2020). Proteus vs. Social identity effects on virtual brainstorming. *Behaviour & Information Technology*, 39(5), 594-606.
- Busic-Sontic, A., & Fuerst, F. (2017). *The personality profiles of early adopters of energy-efficient technology*. SOEPpapers on Multidisciplinary Panel Data Research.
- Cocktail Games. (2016). *Imagine*.
- Cocktail Games. (2017). *Twin It*.
- Conner, T. S., DeYoung, C. G., & Silvia, P. J. (2018). Everyday creative activity as a path to flourishing. *The Journal of Positive Psychology*, 13(2), Article 2. <https://doi.org/10.1080/17439760.2016.1257049>
- Costa, P. T., & McCrae, R. R. (1992). The Five-Factor Model of Personality and Its Relevance to Personality Disorders. *Journal of Personality Disorders*, 6(4), Article 4. <https://doi.org/10.1521/pedi.1992.6.4.343>
- Cotter, K. N., Christensen, A. P., & Silvia, P. J. (2018). Creativity's role in everyday life. *Cambridge handbook of creativity*.
- Cropley, D. H. (2015). Teaching engineers to think creatively. *The International Handbook of Research on Teaching Thinking*, 402-410.
- Danvers, J. (2003). Towards a radical pedagogy : Provisional notes on learning and teaching in art & design. *International Journal of Art & Design Education*, 22(1), 47-57.
- De Bono, E. (1970). *Lateral thinking*. New York.
- De Bono, E. (2014). *Lateral thinking : An introduction*. Random House.
- De Bono, E. (2017). *Six Thinking Hats : The multi-million bestselling guide to running better meetings and making faster decisions*. Penguin uk.

Bibliographie

- Deci, E. L., Connell, J. P., & Ryan, R. M. (1989). Self-determination in a work organization. *Journal of applied psychology*, 74(4), Article 4.
- DeLoache, J. S. (1987). Rapid change in the symbolic functioning of very young children. *Science*, 238(4833), 1556-1557.
- Diedrich, J., Benedek, M., Jauk, E., & Neubauer, A. C. (2015). Are creative ideas novel and useful? *Psychology of Aesthetics, Creativity, and the Arts*, 9(1), Article 1. <https://doi.org/10.1037/a0038688>
- Diedrich, J., Jauk, E., Silvia, P. J., Gredlein, J. M., Neubauer, A. C., & Benedek, M. (2018). Assessment of real-life creativity: The Inventory of Creative Activities and Achievements (ICAA). *Psychology of Aesthetics, Creativity, and the Arts*, 12(3), Article 3.
- Domagk, S., Schwartz, R. N., & Plass, J. L. (2010). Interactivity in multimedia learning : An integrated model. *Computers in Human Behavior*, 26(5), 1024-1033.
- Dul, J. (2019). The physical environment and creativity : A theoretical framework. *Cambridge Handbook of Creativity (2nd Edition)*, 481-509.
- Dul, J., & Ceylan, C. (2011). Work environments for employee creativity. *Ergonomics*, 54(1), 12-20.
- Fein, G. G. (1987). *Pretend play : Creativity and consciousness*.
- Feist, G. J. (2019). The Function of Personality in Creativity : Updates on the Creative Personality. In J. C. Kaufman & R. J. Sternberg (Éds.), *The Cambridge Handbook of Creativity* (Version 2, 2^e éd., p. 353-373). Cambridge University Press. <https://doi.org/10.1017/9781316979839.019>
- Fiori, M., Fischer, S., & Barabasch, A. (2022). Creativity is associated with higher well-being and more positive COVID-19 experience. *Personality and Individual Differences*, 194, 111646.
- Fisherl, C. D. (1993). Boredom at Work : A Neglected Concept. *Human Relations*, 46(3), 395-417. <https://doi.org/10.1177/001872679304600305>
- Forgeard, M. J., & Kaufman, J. C. (2016). Who cares about imagination, creativity, and innovation, and why? A review. *Psychology of Aesthetics, Creativity, and the Arts*, 10(3), 250.
- Freinet, C., & Freinet, M. (1994). Oeuvres pédagogiques. (*No Title*).
- Funforge. (2011). *The Big Idea*.
- Gajda, A., Karwowski, M., & Beghetto, R. A. (2017). Creativity and academic achievement : A meta-analysis. *Journal of educational psychology*, 109(2), 269.

Bibliographie

- Gentile, D. A., Anderson, C. A., Yukawa, S., Ichori, N., Saleem, M., Ming, L. K., Shibuya, A., Liao, A. K., Khoo, A., & Bushman, B. J. (2009). The effects of prosocial video games on prosocial behaviors : International evidence from correlational, longitudinal, and experimental studies. *Personality and Social Psychology Bulletin*, 35(6), 752-763.
- Gentile, D. A., Groves, C. L., & Gentile, J. R. (2014). The general learning model : Unveiling the teaching potential of video games. *Learning by playing: Video gaming in education*, 121-142.
- Gentner, D. (1983). Structure-mapping : A theoretical framework for analogy. *Cognitive science*, 7(2), 155-170.
- Glăveanu, V. P. (2013). Rewriting the language of creativity : The Five A's framework. *Review of general psychology*, 17(1), 69-81.
- Glăveanu, V. P., Hanchett Hanson, M., Baer, J., Barbot, B., Clapp, E. P., Corazza, G. E., Hennessey, B., Kaufman, J. C., Lebeda, I., Lubart, T., Montuori, A., Ness, I. J., Plucker, J., Reiter-Palmon, R., Sierra, Z., Simonton, D. K., Neves-Pereira, M. S., & Sternberg, R. J. (2019). Advancing Creativity Theory and Research : A Socio-cultural Manifesto. *The Journal of Creative Behavior*, jocb.395. <https://doi.org/10.1002/jocb.395>
- Glăveanu, V. P., & Kaufman, J. C. (2019). A historical perspective. *The Cambridge handbook of creativity*, 9-26.
- Gobet, F., Retschitzki, J., & de Voogt, A. (2004). *Moves in mind : The psychology of board games*. Psychology Press.
- Goldstein, I. L. (1991). *Training in work organizations*. Consulting Psychologists Press.
- Gong, Y., Huang, J.-C., & Farh, J.-L. (2009). Employee learning orientation, transformational leadership, and employee creativity : The mediating role of employee creative self-efficacy. *Academy of management Journal*, 52(4), Article 4.
- Gordon, W. J. (1961). *Synectics : The development of creative capacity*.
- Graesser, A., Chipman, P., & Leeming, F. (2009). Deep learning and emotion in serious games. In *Serious games* (p. 105-124). Routledge.
- Guegan, J., Buisine, S., Mantelet, F., Maranzana, N., & Segonds, F. (2016). Avatar-mediated creativity : When embodying inventors makes engineers more creative. *Computers in Human Behavior*, 61, 165-175. <https://doi.org/10.1016/j.chb.2016.03.024>
- Guilford, J. P. (1950). Creativity. *American psychologist*, 5(9), 444.
- Guilford, J. P. (1961). *Three faces of intellect*.
- Guilford, J. P. (1967). *The nature of human intelligence*.

Bibliographie

- Haager, J. S., Kuhbandner, C., & Pekrun, R. (2018). To Be Bored or Not To Be Bored—How Task-Related Boredom Influences Creative Performance. *The Journal of Creative Behavior*, 52(4), 297-304. <https://doi.org/10.1002/jocb.154>
- Haase, J., Hanel, P. H., & Gronau, N. (2023). Creativity enhancement methods for adults : A meta-analysis. *Psychology of Aesthetics, Creativity, and the Arts*.
- Hanel, P. H., & Mehler, D. M. (2019). Beyond reporting statistical significance : Identifying informative effect sizes to improve scientific communication. *Public understanding of science*, 28(4), 468-485.
- Harrington, D. M. (2011). *Creative environments, conditions, and settings*.
- He, W., & Wong, W. (2022). Affective state contributes to creative self-efficacy : Evidence from an experimental study of emotion induction. *Thinking Skills and Creativity*, 45, 101061.
- Hockey, G. R. J. (1997). Compensatory control in the regulation of human performance under stress and high workload : A cognitive-energetical framework. *Biological psychology*, 45(1-3), 73-93.
- Hoffman, B., & Nadelson, L. (2010). Motivational engagement and video gaming : A mixed methods study. *Educational Technology Research and Development*, 58, 245-270.
- Homer, B. D., & Hayward, E. (2008). Cognitive and representational development in children. *Literacy processes: Cognitive flexibility in learning and teaching*, 19-41.
- Hsu, C.-P., & Chang, C.-W. (2022). Does the social platform established by MMORPGs build social and psychological capital? *Computers in Human Behavior*, 129, 107139.
- Hughes, J. (1988). Therapy is fantasy : Roleplaying, healing and the construction of symbolic order. *Anthropology IV Honours, Medical Anthropology Seminar, Dept. of Prehistory & Anthropology, Australian National University*.
- Ilevbare, I. M., Probert, D., & Phaal, R. (2013). A review of TRIZ, and its benefits and challenges in practice. *Technovation*, 33(2-3), 30-37.
- Isaksen, S. G., & Treffinger, D. J. (1985). *Creative problem solving : The basic course*. Bearly,.
- Jaussi, K. S., Randel, A. E., & Dionne, S. D. (2007). I am, I think I can, and I do : The role of personal identity, self-efficacy, and cross-application of experiences in creativity at work. *Creativity Research Journal*, 19(2-3), Article 2-3.
- Kapp, K. M. (2012). *The gamification of learning and instruction : Game-based methods and strategies for training and education*. John Wiley & Sons.
- Kapur, M. (2008). Productive failure. *Cognition and instruction*, 26(3), 379-424.

Bibliographie

- Karwowski, M., & Barbot, B. (2016). *Creative self-beliefs : Their nature, development, and correlates*.
- Karwowski, M., Lebeda, I., & Wiśniewska, E. (2018). Measuring creative self-efficacy and creative personal identity. *The International Journal of Creativity & Problem Solving*.
- Karwowski, M., & Soszynski, M. (2008). How to develop creative imagination? : Assumptions, aims and effectiveness of Role Play Training in Creativity (RPTC). *Thinking Skills and Creativity*, 3(2), Article 2. <https://doi.org/10.1016/j.tsc.2008.07.001>
- Kaufman, J. C. (2018). Creativity's need for relevance in research and real life : Let's set a new agenda for positive outcomes. *Creativity. Theories–Research–Applications*, 5(2), 124-137.
- Kaufman, J. C., & Beghetto, R. A. (2009). Beyond Big and Little : The Four C Model of Creativity. *Review of General Psychology*, 13(1), Article 1. <https://doi.org/10.1037/a0013688>
- Kaufman, J. C., & Glăveanu, V. P. (2019). *A review of creativity theories : What questions are we trying to answer?*
- Kaufman, J. C., Glăveanu, V. P., & Baer, J. (2017). *The Cambridge handbook of creativity across domains*. Cambridge University Press.
- Kinzie, M. B., & Joseph, D. R. (2008). Gender differences in game activity preferences of middle school children : Implications for educational game design. *Educational Technology Research and Development*, 56(5-6), Article 5-6. <https://doi.org/10.1007/s11423-007-9076-z>
- Kirkpatrick, C., & Mann, P. (1999). Knowledge, training and development : An overview. *Public Administration & Development*, 19(1), 1.
- Kolb, D. A. (1984). The process of experiential learning. *Experiential learning: Experience as the source of learning and development*, 20-38.
- Koseoglu, G., Liu, Y., & Shalley, C. E. (2017). Working with creative leaders : Exploring the relationship between supervisors' and subordinates' creativity. *The Leadership Quarterly*, 28(6), 798-811.
- Li, F. W. (2008). *Computer Games*. Citeseer.
- Libellud. (2008). *Dixit*.
- Lubart, T. (2017). The 7 C's of creativity. *The Journal of Creative Behavior*, 51(4), 293-296.
- Lubart, T., & Getz, I. (2011). *Economic perspectives on creativity*.
- Lubart, T., Mouchiroud, C., Tordjman, S., & Zenasni, F. (2015). *Psychologie de la créativité- 2e édition*. Armand Colin.

Bibliographie

- Lubart, T., & Thornhill-Miller, B. (2019). Creativity : An overview of the 7C's of creative thought. *The psychology of human thought: An introduction*, 277-306.
- Luthans, F., Avolio, B. J., Avey, J. B., & Norman, S. M. (2007a). Positive psychological capital : Measurement and relationship with performance and satisfaction. *Personnel psychology*, 60(3), 541-572.
- Luthans, F., Avolio, B. J., Avey, J. B., & Norman, S. M. (2007b). Positive psychological capital : Measurement and relationship with performance and satisfaction. *Personnel psychology*, 60(3), Article 3.
- Luthans, F., & Youssef-Morgan, C. M. (2017). Psychological Capital : An Evidence-Based Positive Approach. *Annual Review of Organizational Psychology and Organizational Behavior*, 4(1), 339-366. <https://doi.org/10.1146/annurev-orgpsych-032516-113324>
- Ma, H.-H. (2006). A synthetic analysis of the effectiveness of single components and packages in creativity training programs. *Creativity Research Journal*, 18(4), Article 4.
- Mann, D. (2001). An introduction to TRIZ : The theory of inventive problem solving. *Creativity and Innovation Management*, 10(2), 123-125.
- Martinaityte, I., & Sacramento, C. A. (2013). When creativity enhances sales effectiveness : The moderating role of leader-member exchange. *Journal of Organizational Behavior*, 34(7), 974-994.
- Mednick, S. (1962). The associative basis of the creative process. *Psychological review*, 69(3), 220.
- Meinel, M., & Voigt, K.-I. (2017). What do we really know about creativity techniques? A review of the empirical literature. *The Role of Creativity in the Management of Innovation: State of the Art and Future Research Outlook*, 181-203.
- Moffat, D. C., Crombie, W., & Shabalina, O. (2017). Some video games can increase the player's creativity. *International Journal of Game-Based Learning (IJGBL)*, 7(2), Article 2. <https://doi.org/10.4018/IJGBL.2017040103>
- Montessori, M. (1936). *L'enfant* (2^e éd.). Desclée de Brouwer.
- Newell, A., & Rosenbloom, P. (1993). Mechanisms of skill acquisition and the law of practice. *Cognitive Skills and Their Acquisition*, Vol. 1.
- Ng, T. W., & Feldman, D. C. (2012). A comparison of self-ratings and non-self-report measures of employee creativity. *Human Relations*, 65(8), Article 8.
- Nickerson, R. S. (1999). *Enhancing creativity*.
- Oprins, E., Visschedijk, G., Roozeboom, M. B., Dankbaar, M., Trooster, W., & Schuit, S. C. (2015). The game-based learning evaluation model (GEM): Measuring the

Bibliographie

- effectiveness of serious games using a standardised method. *International journal of technology enhanced learning*, 7(4), 326-345.
- Orkibi, H. (2021). Creative adaptability : Conceptual framework, measurement, and outcomes in times of crisis. *Frontiers in psychology*, 11, 588172.
- Orkibi, H., Ben-Eliyahu, A., Reiter-Palmon, R., Testoni, I., Biancalani, G., Murugavel, V., & Gu, F. (2021). Creative adaptability and emotional well-being during the COVID-19 pandemic : An international study. *Psychology of Aesthetics, Creativity, and the Arts*.
- Osborn, A. F. (1953). Applied imagination. Scribner's. *Charles Scribner, New York*.
- Paulus, P. (2000). Groups, teams, and creativity : The creative potential of idea-generating groups. *Applied psychology*, 49(2), Article 2.
- Paulus, P. B., & Kenworthy, J. B. (2019). Effective brainstorming. *The Oxford handbook of group creativity and innovation*, 287-386.
- Piaget, J. (1962). Play, Dreams, and Imitation in Childhood. *W. W. Norton & Co. New York*.
- Pike, R. W. (2003). *Creative training techniques handbook : Tips, tactics, and how-to's for delivering effective training*. Human Resource Development.
- Plass, J. L., Homer, B. D., & Kinzer, C. K. (2015). Foundations of game-based learning. *Educational Psychologist*, 50(4), Article 4.
- Plucker, J., & Runco, M. (2011). Enhancement of Creativity. In *Encyclopedia of creativity* (Vol. 1, p. 669-675). <https://doi.org/10.1016/B978-0-12-375038-9.00090-X>
- Podsakoff, P. M., MacKenzie, S. B., Lee, J.-Y., & Podsakoff, N. P. (2003). Common method biases in behavioral research : A critical review of the literature and recommended remedies. *Journal of applied psychology*, 88(5), 879.
- Prensky, M. (2001). Fun, play and games : What makes games engaging. *Digital game-based learning*, 5(1), 5-31.
- Proyer, R. T. (2017). A new structural model for the study of adult playfulness : Assessment and exploration of an understudied individual differences variable. *Personality and Individual Differences*, 108, 113-122.
- Proyer, R. T., Tandler, N., & Brauer, K. (2019). Playfulness and Creativity. In *Creativity and Humor* (p. 43-60). Elsevier. <https://doi.org/10.1016/B978-0-12-813802-1.00002-8>
- Reeve, J., Jang, H., Carrell, D., Jeon, S., & Barch, J. (2004). Enhancing students' engagement by increasing teachers' autonomy support. *Motivation and emotion*, 28, 147-169.
- Rhodes, M. (1961). An analysis of creativity. *The Phi delta kappan*, 42(7), 305-310.
- Ritter, S. M., & Dijksterhuis, A. (2014). Creativity—The unconscious foundations of the incubation period. *Frontiers in human neuroscience*, 8, 215.

Bibliographie

- Roe, R. A. (2017). The design of selection systems : Context, principles, issues. *The Blackwell handbook of personnel selection*, 73-97.
- Rohrbach, B. (1969). *Creativity by rules—Method 635, a new technique for solving problems*. Absatzwirtschaft.
- Rotgans, J. I., & Schmidt, H. G. (2011). Situational interest and academic achievement in the active-learning classroom. *Learning and Instruction*, 21(1), 58-67.
- Runco, M. A. (2010). Divergent thinking, creativity, and ideation. *The Cambridge handbook of creativity*, 413, 446.
- Runco, M. A., & Jaeger, G. J. (2012). The standard definition of creativity. *Creativity research journal*, 24(1), Article 1. <https://doi.org/10.1080/10400419.2012.650092>
- Ryan, R. M., Mims, V., & Koestner, R. (1983). Relation of reward contingency and interpersonal context to intrinsic motivation: A review and test using cognitive evaluation theory. *Journal of personality and Social Psychology*, 45(4), Article 4. <https://doi.org/10.1037/0022-3514.45.4.736>
- Salen, K., & Zimmerman, E. (2003). *Rules of play : Fundamentals of game design*. MIT Press Cambridge.
- Sassenberg, K., Moskowitz, G. B., Fetterman, A., & Kessler, T. (2017). Priming creativity as a strategy to increase creative performance by facilitating the activation and use of remote associations. *Journal of Experimental Social Psychology*, 68, 128-138.
- Schunk, D. H., & Mullen, C. A. (2012). Self-efficacy as an engaged learner. *Handbook of research on student engagement*, 219-235.
- Scott, G., Leritz, L. E., & Mumford, M. D. (2004a). The effectiveness of creativity training : A quantitative review. *Creativity Research Journal*, 16(4), Article 4. https://doi.org/10.1207/s15326934crj1604_1
- Scott, G., Leritz, L. E., & Mumford, M. D. (2004b). The effectiveness of creativity training : A quantitative review. *Creativity Research Journal*, 16(4), Article 4. https://doi.org/10.1207/s15326934crj1604_1
- Shen, X. S., Chick, G., & Zinn, H. (2014a). Playfulness in Adulthood as a Personality Trait : A Reconceptualization and a New Measurement. *Journal of Leisure Research*, 46(1), Article 1. <https://doi.org/10.1080/00222216.2014.11950313>
- Shen, X. S., Chick, G., & Zinn, H. (2014b). Validating the Adult Playfulness Trait Scale (APTS) : An Examination of Personality, Behavior, Attitude, and Perception in the Nomological Network of Playfulness. *American Journal of Play*, 6(3), 345-369.

Bibliographie

- Shute, V. J., Ventura, M., & Bauer, M. (2009). Melding the power of serious games and embedded assessment to monitor and foster learning : Flow and grow. In *Serious games* (p. 317-343). Routledge.
- Spiro, R. J., & Jehng, J.-C. (1990). Cognitive flexibility and hypertext : Theory and technology for the nonlinear and multidimensional traversal of complex subject matter. *Cognition, education, and multimedia: Exploring ideas in high technology*, 205, 163-205.
- Squire, K. (2011). *Video Games and Learning : Teaching and Participatory Culture in the Digital Age. Technology, Education–Connections (the TEC Series)*. ERIC.
- Sternberg, R. J. (2019). Enhancing people's creativity. *The Cambridge handbook of creativity*, 88-103.
- Sternberg, R. J., & Davidson, J. E. (1995). *The nature of insight*. The MIT Press.
- Sternberg, R. J., & Lubart, T. I. (1995). *Defying the crowd : Cultivating creativity in a culture of conformity*. Free Press.
- Stubbé, H. E., & Theunissen, N. C. (2008). Self-directed adult learning in a ubiquitous learning environment : A meta-review. *Proceedings of the First Workshop on Technology Support for Self-Organized Learners*, 5-28.
- Sweetman, D., Luthans, F., Avey, J. B., & Luthans, B. C. (2011). Relationship between positive psychological capital and creative performance. *Canadian Journal of Administrative Sciences / Revue Canadienne Des Sciences de l'Administration*, 28(1), Article 1. <https://doi.org/10.1002/cjas.175>
- Swing, E. L., Gentile, D. A., & Anderson, C. A. (2011). Learning processes and violent video games. In *Gaming and Simulations : Concepts, Methodologies, Tools and Applications* (p. 1807-1822). IGI Global.
- Tanev, S., & Frederiksen, M. H. (2014). Generative innovation practices, customer creativity, and the adoption of new technology products. *Technology Innovation Management Review*, 4(2).
- Tavinor, G. (2008). Definition of videogames. *Contemporary Aesthetics (Journal Archive)*, 6(1), 16.
- Temple, C., & Rodero, M. L. (1995). Reading around the world : Active learning in a democratic classroom: The " pedagogical invariants" of Célestin Freinet. *The Reading Teacher*, 49(2), 164-167.
- Terninko, J., Zusman, A., & Zlotin, B. (1998). *Systematic innovation : An introduction to TRIZ (theory of inventive problem solving)*. CRC press.

Bibliographie

- Thornhill-Miller, B., Camarda, A., Mercier, M., Burkhardt, J.-M., Morisseau, T., Bourgeois-Bougrine, S., Vinchon, F., El Hayek, S., Augereau-Landais, M., & Mourey, F. (2023). Creativity, Critical Thinking, Communication, and Collaboration: Assessment, Certification, and Promotion of 21st Century Skills for the Future of Work and Education. *Journal of Intelligence*, 11(3), 54.
- Tierney, P., & Farmer, S. M. (2002). Creative self-efficacy: Its potential antecedents and relationship to creative performance. *Academy of Management journal*, 45(6), Article 6.
- Treffinger, D. J. (1995). Creative problem solving: Overview and educational implications. *Educational psychology review*, 7, 301-312.
- Tyagi, V., Hanoch, Y., Hall, S. D., Runco, M., & Denham, S. L. (2017). The risky side of creativity: Domain specific risk taking in creative individuals. *Frontiers in psychology*, 8, 145.
- Wallas, G. (1926). *The art of thought* (Vol. 10). Harcourt, Brace.
- Wang, H., Shen, C., & Ritterfeld, U. (2009). Enjoyment of digital games: What makes them “seriously” fun? In *Serious games* (p. 47-69). Routledge.
- Waples, E. P., & Friedrich, T. L. (2011). Managing creative performance: Important strategies for leaders of creative efforts. *Advances in Developing Human Resources*, 13(3), Article 3.
- Weiner, R. (2000). *Creativity and beyond: Cultures, values, and change*. SUNY Press.
- Whitton, N. (2012). The place of game-based learning in an age of austerity. *Electronic Journal of e-Learning*, 10(2), pp249-256.
- Williams, L. J., & Brown, B. K. (1994). Method variance in organizational behavior and human resources research: Effects on correlations, path coefficients, and hypothesis testing. *Organizational Behavior and Human Decision Processes*, 57(2), 185-209.
- Wuchty, S., Jones, B. F., & Uzzi, B. (2007). The increasing dominance of teams in production of knowledge. *Science*, 316(5827), 1036-1039.
- Yee, W. F., Pink, L. S., & Sern, M. L. C. (2014). The effect of a psychological climate for creativity on job satisfaction and work performance. *International Journal of Economics and Management*, 8(3), 97-116.
- Yu, X., Li, D., Tsai, C.-H., & Wang, C. (2019). The role of psychological capital in employee creativity. *Career Development International*.
- Zandi, N., Karwowski, M., Forthmann, B., & Holling, H. (2022). How stable is the creative self-concept? A latent state-trait analysis. *Psychology of Aesthetics, Creativity, and the*

Bibliographie

Arts. https://www.researchgate.net/profile/Boris-Forthmann/publication/361952505_How_Stable_is_the_Creative_Self-Concept_A_Latent_State-Trait_Analysis/links/62ceb74a6151ad090b99312c/How-Stable-is-the-Creative-Self-Concept-A-Latent-State-Trait-Analysis.pdf

Zenasni, F., Besançon, M., & Lubart, T. (2008). Creativity and tolerance of ambiguity : An empirical study. *The Journal of Creative Behavior*, 42(1), 61-73.



Zhou, J., & George, J. M. (2001a). When job dissatisfaction leads to creativity : Encouraging the expression of voice. *Academy of Management journal*, 44(4), Article 4.

Zhou, J., & George, J. M. (2001b). When job dissatisfaction leads to creativity : Encouraging the expression of voice. *Academy of Management journal*, 44(4), Article 4.

Annexe :
Article complémentaire

Review

Creativity, Critical Thinking, Communication, and Collaboration: Assessment, Certification, and Promotion of 21st Century Skills for the Future of Work and Education

Branden Thornhill-Miller^{1,2,*}, Anaëlle Camarda^{3,4} , Maxence Mercier³, Jean-Marie Burkhardt⁵ , Tiffany Morisseau^{3,6} , Samira Bourgeois-Bougrine³, Florent Vinchon³, Stephanie El Hayek⁷, Myriam Augereau-Landais⁷, Florence Mourey³, Cyrille Feybesse⁸, Daniel Sundquist³ and Todd Lubart³

- ¹ Faculty of Philosophy, University of Oxford, Oxford OX2 6GG, UK
² International Institute for Competency Development, 75001 Paris, France
³ LaPEA, Université Paris Cité and Univ Gustave Eiffel, 92100 Boulogne-Billancourt, France
⁴ Institut Supérieur Maria Montessori, 94130 Nogent-Sur-Marne, France
⁵ LaPEA, Univ Gustave Eiffel and Université Paris Cité, CEDEX, 78008 Versailles, France
⁶ Strane Innovation, 91190 Gif-sur-Yvette, France
⁷ AFNOR International, 93210 Saint-Denis, France
⁸ Centre Hospitalier Guillaume Regnier, Université de Rennes 1, 35200 Rennes, France
* Correspondence: thornhill-miller@post.harvard.edu



Citation: Thornhill-Miller, Branden, Anaëlle Camarda, Maxence Mercier, Jean-Marie Burkhardt, Tiffany Morisseau, Samira Bourgeois-Bougrine, Florent Vinchon, Stephanie El Hayek, Myriam Augereau-Landais, Florence Mourey, and et al. 2023. Creativity, Critical Thinking, Communication, and Collaboration: Assessment, Certification, and Promotion of 21st Century Skills for the Future of Work and Education. *Journal of Intelligence* 11: 54. <https://doi.org/10.3390/jintelligence11030054>

Received: 17 December 2022
Revised: 16 February 2023
Accepted: 23 February 2023
Published: 15 March 2023



Copyright: © 2023 by the authors. Licensee MDPI, Basel, Switzerland. This article is an open access article distributed under the terms and conditions of the Creative Commons Attribution (CC BY) license (<https://creativecommons.org/licenses/by/4.0/>).

Abstract: This article addresses educational challenges posed by the future of work, examining “21st century skills”, their conception, assessment, and valorization. It focuses in particular on key soft skill competencies known as the “4Cs”: creativity, critical thinking, collaboration, and communication. In a section on each C, we provide an overview of assessment at the level of individual performance, before focusing on the less common assessment of *systemic support* for the development of the 4Cs that can be measured at the institutional level (i.e., in schools, universities, professional training programs, etc.). We then present the process of official assessment and certification known as “labelization”, suggesting it as a solution both for establishing a publicly trusted assessment of the 4Cs and for promoting their cultural valorization. Next, two variations of the “International Institute for Competency Development’s 21st Century Skills Framework” are presented. The first of these comprehensive systems allows for the assessment and labelization of the extent to which development of the 4Cs is supported by a formal educational program or institution. The second assesses informal educational or training experiences, such as playing a game. We discuss the overlap between the 4Cs and the challenges of teaching and institutionalizing them, both of which may be assisted by adopting a dynamic interactionist model of the 4Cs—playfully entitled “Crea-Critical-Collab-ication”—for pedagogical and policy-promotion purposes. We conclude by briefly discussing opportunities presented by future research and new technologies such as artificial intelligence and virtual reality.

Keywords: 21st century skills; 4Cs; assessment; certification; collaboration; communication; creativity; critical thinking; education; future of work; games; labelization; soft skills; training

1. Introduction

There are many ways of describing the massive educational challenges faced in the 21st century. With the appearance of computers and digital technologies, new means of interacting between people, and a growing competitiveness on the international level, organizations are now requiring new skills from their employees, leaving educational systems struggling to provide appropriate ongoing training. Indeed, according to the World Economic Forum’s 2020 “Future of Jobs Report”, studying 15 industries in 26 advanced and emerging countries, up to 50% of employees will need some degree of “reskilling” by 2025

(World Economic Forum 2020). Although many national and international educational efforts and institutions now explicitly put the cultivation of new kinds of skills on their educational agendas, practical means of assessing such skills remains underdeveloped, thus hampering the valorization of these skills and the development of guidance for relevant pedagogy (Care et al. 2018; Vincent-Lancrin et al. 2019; for overviews and discussion of higher education in global developmental context, see Blessinger and Anchan 2015; Salmi 2017).

This article addresses some of these challenges and related issues for the future of education and work, by focusing on so-called “21st Century Skills” and key “soft skills” known as the “4Cs” (creativity, critical thinking, communication, and collaboration), more particularly. It begins with a brief discussion of these skills, outlining their conceptual locations and potential roles in the modern educational context. A section on each “C” then follows, defining the C, summarizing research and methods for its scientific assessment at the individual level, and then outlining some means and avenues at the systemic level for fostering its development (e.g., important aspects of curriculum, institutional structure, or of the general environment, as well as pedagogical methods) that might be leveraged by an institution or program in order to promote the development of that C among its students/trainees. In the next section, the certification-like process of “labelization” is outlined and proposed as one of the best available solutions both for valorizing the 4Cs and moving them towards the center of the modern educational enterprise, as well as for benchmarking and monitoring institutions’ progress in fostering their development. The International Institute for Competency Development’s 4Cs Framework is then outlined as an example of such a comprehensive system for assessing and labelizing the extent to which educational institutions and programs support the development of the 4Cs. We further demonstrate the possibility of labelizing and promoting support for the development of the 4Cs by activities or within less formal educational settings, presenting a second framework for assessment of the 4Cs in games and similar training activities. Our discussion section begins with the challenges to implementing educational change in the direction of 21st century skills, focusing on the complex and overlapping nature of the 4Cs. Here, we propose that promoting a “Dynamic Interactionist Model of the 4Cs” not only justifies grouping them together, but it might also assist more directly with some of the challenges of pedagogy, assessment, policy promotion, and ultimately, institutionalization, faced by the 4Cs and related efforts to modernize education. We conclude by suggesting some important future work for the 4Cs individually and also as an interrelated collective of vital skills for the future of education and work.

“21st Century Skills”, “Soft Skills”, and the “4Cs”

For 40 years, so-called “21st century skills” have been promoted as those necessary for success in a modern work environment that the US Army War College (Barber 1992) has accurately described as increasingly “VUCA”—“volatile, uncertain, complex and ambiguous”. Various lists of skills and competencies have been formulated on their own or as part of comprehensive overarching educational frameworks. Although a detailed overview of this background material is outside the scope of this article (see Lamri et al. 2022; Lucas 2022 for summaries), one of the first prominent examples of this trend was the Partnership for 21st Century Skills (P21), whose comprehensive “Framework for 21st Century Learning” is presented in Figure 1 (Battelle for Kids 2022). This framework for future-oriented education originated the idea of the “4Cs”, placing them at its center and apex as “Learning and Innovation Skills” that are in need of much broader institutional support at the foundational level in the form of new standards and assessments, curriculum and instructional development, ongoing professional development, and appropriately improved learning environments (Partnership for 21st Century Skills 2008). These points are also consistent with the approach and assessment frameworks presented later in this article.

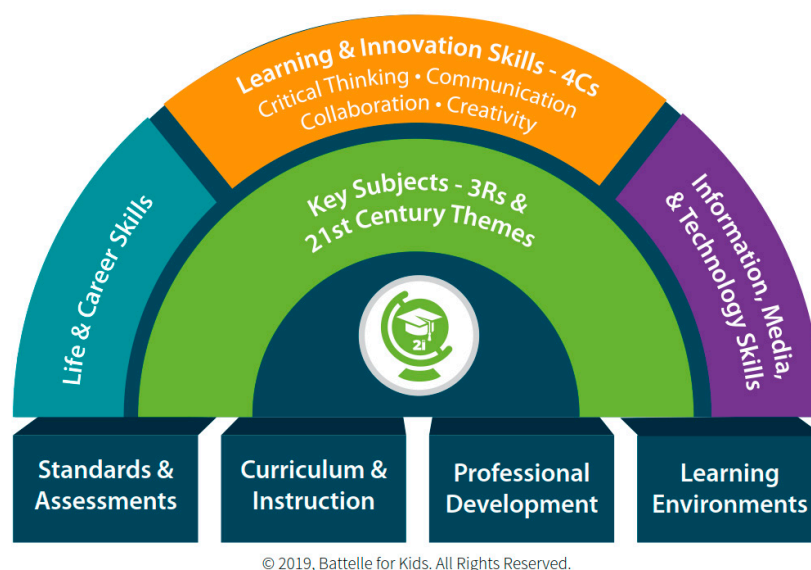

Figure 1. The P21 Framework for 21st Century Learning. (© 2019, Battelle for Kids. All Rights Reserved. <https://www.battelleforkids.org/>; accessed on 17 January 2023).

Other important organizations such as the [World Economic Forum \(2015\)](#) have produced similar overarching models of “21st century skills” with the 4Cs at their center, but the term “21st century skills” has been rightly criticized for a several reasons: the skills referred to are not actually all unique to, or uniquely important to, the 21st century, and it is a term that is often used more as an advertising or promotional label for systems that sometimes conflate and confuse different kinds of skills with other concepts that users lump together ([Lucas 2019](#)). Indeed, though there is no absolute consensus on the definition of a “skill”, they are often described as being multidimensional and involve the ability to solve problems in context and to perform tasks using appropriate resources at the right time and in the right combination ([Lamri and Lubart 2021](#)). At its simplest, a skill is a “learned capacity to do something useful” ([Lucas and Claxton 2009](#)), or an ability to perform a given task at a specified performance level, which develops through practice, experience, and training ([Lamri et al. 2022](#)).

The idea of what skills “are”, however, has also evolved to some extent over time in parallel to the nature of the abilities required to make valued contributions to society. The digital and information age, in particular, has seen the replacement by machines of much traditional work sometimes referred to as “hard skills”—skills such as numerical calculation or driving, budget-formulating, or copyediting abilities, which entail mastery of fixed sets of knowledge and know-how of standard procedures, and which are often learned on the job. Such skills are more routine, machine-related, or technically oriented and not as likely to be centered on human interaction. In contrast, the work that has been increasingly valued in the 21st century involves the more complex, human interactive, and/or non-routine skills that [Whitmore \(1972\)](#) first referred to as “soft skills”.

Unfortunately, researchers, educators, and consultants have defined, redefined, re-grouped, and expanded soft skills—sometimes labeling them “transversal competencies”, “generic competencies”, or even “life skills” in addition to “21st century skills”—in so many different ways within and across different domains of research and education (as well as languages and national educational systems) that much progress towards these goals has literally been “lost in translation” ([Cinque 2016](#)).

Indeed, there is also a long-standing ambiguity and confusion between the terms “competency” (also competence) and “skill” due to their use across different domains (e.g., learning research, education, vocational training, personnel selection) as well as different epistemological backgrounds and cultural specificities ([Drisko 2014](#); [Winterton et al. 2006](#); [van Klink and Boon 2003](#)). The term “competency” is, however, often used as a broader

concept that encompasses skills, abilities, and attitudes, whereas, in a narrower sense, the term “skill” has been defined as “goal-directed, well-organized behavior that is acquired through practice and performed with economy of effort” (Proctor and Dutta 1995, p. 18). For example, whereas the command of a spoken language or the ability to write are skills (hard skills, to be precise), the ability to communicate effectively is a competence that may draw on an individual’s knowledge of language, writing skills, practical IT skills, and emotional intelligence, as well as attitudes towards those with whom one is communicating (Rychen and Hersch 2003). Providing high-quality customer service is a competency that relies on listening skills, social perception skills, and contextual knowledge of products. Beyond these potential distinctions, the term “competency” is predominant in Europe, whereas “skill” is more commonly used in the US. Yet it also frequently occurs that both are used as rough synonyms. For example, Voogt and Roblin (2012, p. 299) examine the “21st century competences and the recommended strategies for the implementation of these skills”, and Graesser et al. (2022, p. 568) state that twenty-first-century skills “include self-regulated learning, collaborative problem solving, communication (...) and other competencies”. In conclusion, the term “competencies” is often used interchangeably with “skills” (and can have a particularly large overlap with “soft skills”), but it is also often considered in a broader sense as a set of skills, knowledge, and attitudes that, together, meet a complex demand (Ananiadoui and Claro 2009). From this perspective, one could argue that the 4Cs, as complex, “higher-order” soft skills, might best be labeled competencies. For ease and convenience, however, in this text, we consider the two terms interchangeable but favor the term “skills”, only using “competency” in some instances to avoid cumbersome repetition.

Even having defined soft skills as a potentially more narrow and manageable focus, we are still aware of no large-scale study that has employed a comprehensive enough range of actual psychometric measures of soft skills in a manner that might help produce a definitive empirical taxonomy. Some more recent taxonomic efforts have, however, attempted to provide additional empirical grounding for the accurate identification of key soft skills (see e.g., Joie-La Marle et al. 2022). Further, recent research by JobTeaser (see Lamri et al. 2022) surveying a large, diverse sample of young workers about a comprehensive, systematic list of soft skills *as actually used in their professional roles* represents a good step towards some clarification and mapping of this domain on an empirical basis. Despite the fact that both these studies necessarily involved assumptions and interpretive grouping of variables, the presence and importance of the 4Cs as higher-order skills is evident in both sets of empirical results.

Various comprehensive “21st century skills” systems proposed in the past without much empirical verification also seem to have been found too complex and cumbersome for implementation. The 4Cs, on the other hand, seem to provide a relatively simple, persuasive, targetable core that has been found to constitute a pedagogically and policy-friendly model by major organizations, and that also now seems to be gaining some additional empirical validity. Gathering support from researchers and industry alike, we suggest that the 4Cs can be seen as highest-level transversal skills—or “meta-competencies”—that allow individuals to remain competent and to develop their potential in a rapidly changing professional world. Thus, in the end, they may also be one of the most useful ways of summarizing and addressing the critical challenges faced by the future of work and education (National Education Association 2011).

Taking them as our focus, we note, however, that the teaching and development of the 4Cs will require a complex intervention and mobilization of educational and socio-economic resources—both a major shift in pedagogical techniques and even more fundamental changes in institutional structures (Ananiadoui and Claro 2009). One very important issue for understanding the 4Cs and their educational implementation related to this, which can simultaneously facilitate their teaching but be a challenge for their assessment, is the multidimensionality, interrelatedness, and transdisciplinary relevance of the 4Cs. Thus, we address the relationships between the Cs in the different C sections and later in our Discussion, we present a “Dynamic Interactionist Model of the 4Cs” that we hope will

assist in their understanding, in the further development of pedagogical processes related to them, and in their public promotion and related policy. Ultimately, it is partly due to their complexity and interrelationships, we argue, that it is important and expedient that the 4Cs are taught, assessed, and promoted together.

2. The 4Cs, Assessment, and Support for Development

2.1. Creativity

In psychology, creativity is usually defined as the capacity to produce novel, original work that fits with task constraints and has value in its context (for a recent overview, see [Lubart and Thornhill-Miller 2019](#)). This basic definition, though useful for testing and measurement, is largely incomplete, as it does not contain any information about the individual or groups doing the creating or the nature of physical and social contexts ([Glăveanu 2014](#)). Moreover, [Corazza \(2016\)](#) challenged this standard definition of creativity, arguing that as it focuses solely on the existence of an original and effective outcome, it misses the dynamics of the creative process, which is frequently associated with periods of creative inconclusiveness and limited occasions of creative achievements. To move away from the limitations of the standard definition of creativity, we can consider Bruner's description of creativity as "figuring out how to use what you already know in order to go beyond what you currently think" (p. 183 in [Weick 1993](#)). This description echoes the notion of potential, which refers to a latent state that may be put to use if a person has the opportunity.

Creativity is a multifaceted phenomenon that can be approached from many different angles. There are three main frameworks for creativity studies: the 4Ps ([Rhodes 1961](#)), the 5As ([Glăveanu 2013](#)), and the 7Cs model ([Lubart 2017](#)). These frameworks share at least four fundamental and measurable dimensions: the act of creating (process), the outcome of the creative process (product), the characteristics of creative actor(s) enacting the process (person), and the social and physical environment that enable or hinder the creative process (press). Contrary to many traditional beliefs, however, creativity can be trained and taught in a variety of different ways, both through direct, active teaching of creativity concepts and techniques and through more passive and indirect means such as the development of creativity-supporting contexts ([Chiu 2015](#); [Thornhill-Miller and Dupont 2016](#)). Alongside intelligence, with which it shares some common mechanisms, creativity is now recognized as an indispensable element for the flexibility and adaptation of individuals in challenging situations ([Sternberg 1986](#)).

2.1.1. Individual Assessment of Creativity

Drawing upon previous efforts to structure creativity research, [Batey \(2012\)](#) proposed a taxonomic framework for creativity measurement that takes the form of a three-dimensional matrix: (a) the level at which creativity may be measured (the individual, the team, the organization, and the culture), (b) the facets of creativity that may be assessed (person/trait, process, press, and product), and (c) the measurement approach (objective, self-rating, other ratings). It is beyond the scope of this article to offer a literature review of all these dimensions, but for the purposes of this paper, we address some important aspects of individual-level and institutional-level assessment here.

Assessing creativity at an individual level encompasses two major approaches: (1) creative accomplishment based on production and (2) creative potential. Regarding the first approach focusing on *creative accomplishment*, there are at least four main assessment techniques (or tools representing variations of assessment techniques): (a) the historiometric approach, which applies quantitative analysis to historically available data (such as the number of prizes won or times cited) in an effort to understand eminent, field-changing creativity ([Simonton 1999](#)); (b) the Consensual Assessment Technique (CAT) ([Amabile 1982](#)), which offers a method for combining and validating judges' subjective evaluations of a set of (potentially) creative productions or ideas; (c) the Creative Achievement Questionnaire ([Carson et al. 2005](#)), which asks individuals to supply a self-reported assessment of their

publicly recognizable achievement in ten different creative domains; and (d) the Inventory of Creative Activities and Achievements (ICAA) (Jauk et al. 2014; Diedrich et al. 2018), which includes self-report scales assessing the frequency of engagement in creative activity and also levels of achievement in eight different domains.

The second major approach to individual assessment is based on *creative potential*, which measures the cognitive abilities and/or personality traits that are important for creative work. The two most popular assessments of creative potential are the Remote Associations Test (RAT) and the Alternative Uses Task (AUT). The RAT, which involves identifying the fourth word that is somehow associated with each of three given words, underscores the role that the ability to convergently associate disparate ideas plays as a key capacity for creativity. In contrast, the AUT, which requires individuals to generate a maximum number of ideas based on a prompt (e.g., different uses for a paperclip), is used to assess divergent thinking capacity. According to multivariate models of creative potential (Lubart et al. 2013), there are cognitive factors (e.g., divergent thinking, mental flexibility, convergent thinking, associative thinking, selective combination), conative factors (openness, tolerance of ambiguity, intuitive thinking, risk taking, motivation to create), and environmental factors that all support creativity. Higher creative potential is predicted by having more of the ingredients for creativity. However, multiple different profiles among a similar set of these important ingredients exist, and their weighting for optimal creative potential varies according to the profession, the domain, and the task under consideration. For example, Lubart and Thornhill-Miller (2021) and Lubin et al. (Forthcoming) have taken this creativity profiling approach, exploring the identification and training of the components of creative potential among lawyers and clinical psychologists, respectively. For a current example of this sort of comprehensive, differentiated measurement of creative potential in adults in different domains and professions, see CreativityProfiling.org. For a recent battery of tests that are relevant for children, including domain-relevant divergent-exploratory and convergent-integrative tasks, see Lubart et al. (2019). Underscoring the growing recognition of the importance of creativity assessment, measures of creative potential for students were introduced internationally for the first time in the PISA 2022 assessment (OECD 2019a).

2.1.2. Institutional and Environmental Support for Development of Creativity

The structural support that institutions and programs can provide to promote the development of creativity can be described as coming through three main paths: (1) through design of the physical environment in a manner that supports creativity, (2) through teaching about creativity, the creative process, and creativity techniques, and (3) through training opportunities to help students/employees develop personal habits, characteristics, and other ingredients associated with creative achievement and potential.

Given the multi-dimensionality of the notion of creativity, the environment can positively influence and help develop creative capacities. Studies have shown that the physical environment in which individuals work can enhance their positive emotions and mood and thus their creativity. For example, stimulating working environments might have unusual furniture and spaces that have natural light, windows open to nature, plants and flowers, a relaxing atmosphere and colors in the room (e.g., green and blue), or positive sounds (e.g., calm music or silence), as well as inspiring and energizing colors (e.g., yellow, pink, orange). Furthermore, the arrangement of physical space to promote interpersonal exchange rather than isolation, as well as the presence of tools, such as whiteboards, that support and show the value of exchange, are also important (for reviews, see Dul and Ceylan 2011; Samani et al. 2014).

Although it has been claimed that “creativity is intelligence having fun” (Scialabba 1984; Reiman 1992), for most people, opportunities for fun and creativity, especially in their work environment, appear rather limited. In fact, the social and physical environment often hinders creativity. Corazza et al. (2021)’s theoretical framework concerning the “Space-Time Continuum”, related to support for creativity, suggests that traditional education

systems are an example of an environment that is “tight” both in the conceptual “space” it affords for creativity and in the available time allowed for creativity to happen—essentially leaving little room for original ideas to emerge. Indeed, though world-wide data suggest that neither money nor mere time spent in class correlate well with educational outcomes, both policies and pedagogy that direct the ways in which time is spent make a significant difference (Schleicher 2022). Research and common sense suggest that teachers, students, and employees need more space and time to invest energy in the creative process and the development of creative potential.

Underscoring the importance of teaching the creative process and creativity techniques is the demonstration, in a number of contexts, that groups of individuals who generate ideas without a specific method are often negatively influenced by their social environment. For example, unless guarded against, the presence of others tends to reduce the number of ideas generated and to induce a fixation on a limited number of ideas conforming to those produced by others (Camarda et al. 2021; Goldenberg and Wiley 2011; Kohn and Smith 2011; Paulus and Dzindolet 1993; Putman and Paulus 2009; Rietzschel et al. 2006). To overcome these cognitive and social biases, different variants of brainstorming techniques have shown positive effects (for reviews of methods, see Al-Samarraie and Hurmuzan 2018; Paulus and Brown 2007). These include: using (Osborn 1953) initial brainstorming rules (which aim to reduce spontaneous self-judgment of ideas and fear of this judgment by others); drawing attention to ideas generated by others by writing them down independently (e.g., the technique known as “brainwriting”); and requiring incubation periods between work sessions by forcing members of a problem-solving group to take breaks (Paulus and Yang 2000; Paulus and Kenworthy 2019).

It is also possible to use design methods that are structured to guide the creative process and the exploration of ideas, as well as to avoid settling on uncreative solution paths (Chulvi et al. 2012; Edelman et al. 2022; Kowaltowski et al. 2010; see Cotter et al. 2022 for a valuable survey of best practices for avoiding the suppression of creativity and fostering creative interaction and metacognition in the classroom). Indeed, many helpful design thinking-related programs now exist around the world and have been shown to have a substantial impact on creative outcomes (Bourgeois-Bougrine 2022).

Research and experts suggest the utility of many additional creativity enhancement techniques (see, e.g., Thornhill-Miller and Dupont 2016), and the largest and most rapid effects are often attributed to these more method- or technique-oriented approaches (Scott et al. 2004). More long-term institutional and environmental support for the development of creativity, however, should also include targeted training and understanding of personality and emotional traits associated with the “creative person” (e.g., empathy and exploratory habits that can expand knowledge, as well as increase tolerance of ambiguity, openness, and mental flexibility; see Lubart and Thornhill-Miller 2021). Complementing these approaches and focusing on a more systemic level, recent work conducted by the OECD exemplifies efforts aimed to foster creativity (and critical thinking) by focusing simultaneously on curriculum, educational activities, and teacher support and development at the primary, secondary, and higher education levels (see Vincent-Lancrin et al. 2019; Saroyan 2022).

2.2. Critical Thinking

Researchers, teachers, employers, and public policymakers around the world have long ranked the development of critical thinking (CT) abilities as one of the highest educational priorities and public needs in modern democratic societies (Ahern et al. 2019; Dumitru et al. 2018; Pasquinelli et al. 2021). CT is central to better outcomes in daily life and general problem solving (Hitchcock 2020), to intelligence and adaptability (Halpern and Dunn 2021), and to academic achievement (Ren et al. 2020). One needs to be aware of distorted or erroneous information in the media, of the difference between personal opinions and proven facts, and how to handle increasingly large bodies of information required to understand and evaluate information in the modern age.

Although much research has addressed both potentially related constructs, such as intelligence and wisdom, and lists of potential component aspects of human thought, such as inductive or deductive reasoning (for reviews of all of these, see [Sternberg and Funke 2019](#)), reaching a consensus on a definition has been difficult, because CT relies on the coordination of many different skills ([Bellaera et al. 2021](#); [Dumitru et al. 2018](#)) and is involved in, and sometimes described from the perspective of, many different domains ([Lewis and Smith 1993](#)). Furthermore, as a transversal competency, having the skills to perform aspects of critical thinking in a given domain does not necessarily entail also having the metacognitive ability to know when to engage in which of its aspects, or having the disposition, attitude, or “mindset” that motivates one to actually engage in them—all of which are actually required to be a good critical thinker ([Facione 2011](#)).

As pointed out by the American Philosophical Association’s consensus definition, the ideal “critical thinker” is someone who is inquisitive, open-minded, flexible, fair-minded, and keeps well-informed, thus understanding different points of view and perspectives ([Facione 1990b](#)). These characteristics, one might note, are also characteristic of the “creative individual” ([Facione 1990b](#); [Lai 2011](#)), as is the ability to imagine alternatives, which is often cited as a component of critical thinking ability ([Facione 1990b](#); [Halpern 1998](#)). Conversely, creative production in any domain needs to be balanced by critical appraisal and thought at each step of the creative process ([Bailin 1988](#)). Indeed, it can be argued that creativity and critical thinking are inextricably linked and are often two sides of the same coin. Representing different aspects of “good thought” that are linked and develop in parallel, it seems reasonable that they should, in practice, be taught and considered together in teaching and learning ([Paul and Elder 2006](#)).

Given its complexity, many definitions of critical thinking have been offered. However, some more recent work has helpfully defined critical thinking as “the capacity of assessing the epistemic quality of available information and—as a consequence of this assessment—of calibrating one’s confidence in order to act upon such information” ([Pasquinelli et al. 2021](#)). This definition, unlike others proposed in the field (for a review, see: [Bellaera et al. 2021](#); [Liu et al. 2014](#)), is specific (i.e., it limits the use of poorly defined concepts), as well as consensual and operational (i.e., it has clear and direct implications for the education and assessment of critical thinking skills; [Pasquinelli et al. 2021](#); [Pasquinelli and Bronner 2021](#)). Thus, this approach assumes that individuals possess better or worse cognitive processes and strategies that make it possible to judge the reliability of the information received, by determining, for example, what the arguments provided actually are. Are the arguments convincing? Is the source of information identifiable and reliable? Does the information conflict with other information held by the individual?

It should also be noted that being able to apply critical thinking is necessary to detect and overcome the cognitive biases that can constrain one’s reasoning. Indeed, when solving a problem, it is widely recognized that people tend to automate the application of strategies that are usually relevant in similar and analogous situations that have already been encountered. However, these heuristics (i.e., automatisms) can be a source of errors, in particular, in tricky reasoning situations, as demonstrated in the field of reasoning, arithmetic problems ([Kahneman 2003](#)) or even divergent thinking tasks ([Cassotti et al. 2016](#); for a review of biases, see [Friedman 2017](#)). Though some cognitive biases can even be seen as normal ways of thinking and feeling, sometimes shaping human beliefs and ideologies in ways that make it completely normal—and even definitely human—*not* to be objective (see [Thornhill-Miller and Millican 2015](#)), the mobilization of cognitive resources such as those involved in critical reasoning on logical bases usually makes it possible to overcome cognitive biases and adjust one’s reasoning ([West et al. 2008](#)).

According to [Pasquinelli et al. \(2021\)](#), young children already possess cognitive functions underlying critical thinking, such as the ability to determine that information is false. However, until late adolescence, studies have demonstrated an underdevelopment of executive functions involved in resistance to biased reasoning ([Casey et al. 2008](#)) as well as some other higher-order skills that underlie the overall critical thinking process ([Bloom](#)

1956). According to Facione and the landmark American Philosophical Association's task force on critical thinking (Facione 1990b; Facione 2011), these components of critical thinking can be organized into six measurable skills: the ability to (1) interpret information (i.e., meaning and context); (2) analyze information (i.e., make sense of why this information has been provided, identify pro and con arguments, and decide whether we can accept the conclusion of the information); (3) make inferences (i.e., determine the implications of the evidence, its reliability, the undesirable consequences); (4) evaluate the strength of the information (i.e., its credibility, determine the trust in the person who provides it); (5) provide explanations (i.e., summarize the findings, determine how the information can be interpreted, and offer verification of the reasoning); (6) self-regulate (i.e., evaluate the strength of the methods applied, determine the conflict between different conclusions, clarify the conclusions, and verify missing elements).

2.2.1. Individual Assessment of Critical Thinking

The individual assessment of critical thinking skills presents a number of challenges, because it is a multi-task ability and involves specific knowledge in the different areas in which it is applied (Liu et al. 2014; Willingham 2008). However, the literature provides several tools with which to measure different facets of cognitive functions and skills involved in the overarching critical thinking process (Lai 2011; Liu et al. 2014). Most assessments involve multiple-choice questions requiring reasoning within a particular situation based upon a constrained set of information provided. For example, in one of the most widely used tests, the California Critical Thinking Skills Test (Facione 1990a), participants are provided with everyday scenarios and have to answer multiple questions targeting the six higher-order skills described previously. Similarly, the Watson–Glaser Critical Thinking Appraisal (Watson 1980; Watson and Glaser 2010) presents test takers with passages and scenarios measuring their competencies at recognizing assumptions, evaluating arguments, and drawing conclusions. Although the Watson–Glaser is one of the oldest and most frequently used assessments internationally for hiring and promotion in professional contexts, its construct validity, like many other measures of this challenging topic, has some limitations (Possin 2014).

Less frequently, case study or experiential methods of assessment are also used. This approach may involve asking participants to reflect on past experiences, analyze the situations they faced and the way they behaved or made judgments and decisions and then took action (Bandyopadhyay and Szostek 2019; Brookfield 1997). These methods, often employed by teachers or employers on students and employees, usually involve the analysis of qualitative data that can cast doubt on the reliability of the results. Consequently, various researchers have suggested ways to improve analytic methods, and they emphasize the need to create more advanced evaluation methods (Brookfield 1997; Liu et al. 2014).

For example, Liu et al. (2014) reviewed current assessment methods and suggest that future work improves the operational definition of critical thinking, aiming to assess it both in different specific contexts and in different formats. Specifically, assessments could be contextualized within the major areas addressed by education programs (e.g., social sciences, humanities, and/or natural sciences), and the tasks themselves should be as practically connected to the “real world” as possible (e.g., categorizing a set of features, opinions, or facts based on whether or not they support an initial statement). Moreover, as Brookfield (1997) argues, because critical thinking is a social process that takes place in specific contexts of knowledge and culture, it should be assessed as a social process, therefore, involving a multiplicity of experiences, perceptions, and contributions. Thus, Brookfield makes three recommendations for improving the assessment of critical thinking that are still relevant today: (1) to assess critical thinking in specific situations, so one can study the process and the discourse related to it; (2) to involve students/peers in the evaluation of critical thinking abilities, so that the evaluation is not provided only by the instructor; and (3) to allow learners or participants in an experiment to document, demonstrate, and justify

their engagement in critical thinking, because this learning perspective can provide insight into basic dimensions of the critical thinking process.

Finally, another more recent and less widely used form of assessment targets the specific executive functions that underlie logical reasoning and resistance to cognitive biases, as well as the ability of individuals to resist these biases. This form of assessment is usually done through specific experimental laboratory tasks that vary depending on the particular executive function and according to the domain of interest (Houdé and Borst 2014; Kahneman 2011; West et al. 2008).

2.2.2. Institutional and Environmental Support for Development of Critical Thinking Skills

The executive functions underlying general critical thinking, the ability to overcome bias (Houdé 2000; Houdé and Borst 2014), and meta-cognitive processes (i.e., meta information about our cognitive strategies) can all be trained and enhanced by educational programs (Abrami et al. 2015; Ahern et al. 2019; Alsaleh 2020; Bellaera et al. 2021; Uribe-Enciso et al. 2017; Popil 2011; Pasquinelli and Bronner 2021; Yue et al. 2017).

Educational programs and institutions can support the development of critical thinking in several different ways. The process of developing critical thinking focuses on the interaction between personal dispositions (attitudes and habits), skills (evaluation, reasoning, self-regulation), and finally, knowledge (general and specific knowledge, as well as experience) (Thomas and Lok 2015). It is specifically in regard to skills and knowledge that institutions are well suited to develop critical thinking through pedagogical elements such as rhetoric training, relevance of information evaluation (e.g., media literacy, where and how to check information on the internet, dealing with “fake news”, etc.), deductive thinking skills, and inductive reasoning (Moore and Parker 2016). A few tools, such as case studies or concept mapping, can also be used in conjunction with a problem-based learning method, both in individual and team contexts and in person or online (Abrami et al. 2015; Carmichael and Farrell 2012; Popil 2011; Thorndahl and Stentoft 2020). According to Marin and Halpern (2011), training critical thinking should include explicit instruction involving at least the four following components and objectives: (1) working on attitudes and encouraging individuals to think; (2) teaching and practicing critical thinking skills; (3) training for transfer between contexts, identifying concrete situations in which to adopt the strategies learned; and (4) suggesting metacognition through reflection on one’s thought processes. Supporting these propositions, Pasquinelli and Bronner (2021), in a French national educational report, proposed practical advice for creating workshops to stimulate critical thinking in school classrooms, which appear relevant even in non-school intervention situations. For example, the authors suggest combining concrete examples and exercises with general and abstract explanations, rules and strategies, which can be transferred to other areas beyond the one studied. They also suggest inviting learners to create examples of situations (e.g., case studies) in order to increase the opportunities to practice and for the learner to actively participate. Finally, they suggest making the process of reflection explicit by asking the learner to pay attention to the strategies adopted by others in order to stimulate the development of metacognition.

2.3. Communication

In its most basic definition, communication consists of exchanging information to change the epistemic context of others. In cooperative contexts, it aims at the smooth and efficient exchange of information contributing to the achievement of a desired outcome or goal (Schultz 2010). But human communication involves multiple dimensions. Both verbal and non-verbal communication can involve large quantities of information that have to be both formulated and deciphered with a range of purposes and intentions in mind (Jones and LeBaron 2002). These dimensions of communication have as much to do with the ability to express oneself, both orally and in writing and the mastering of a language (linguistic competences), as with the ability to use this communication system appropriately (pragmatic skills; see Grassmann 2014; Matthews 2014), and with social skills,

based on the knowledge of how to behave in society and on the ability to connect with others, to understand the intentions and perspectives of others (Tomasello 2005).

Like the other 4Cs, according to most authorities, communication skills are ranked by both students and teachers as skills of the highest priority for acquisition in order to be ready for the workforce in 2030 (OECD 2019b; Hanover Research 2012). Teaching students how to communicate efficiently and effectively in all the new modalities of information exchange is an important challenge faced by all pedagogical organizations today (Morreale et al. 2017). All dimensions of communication (linguistic, pragmatic, and social) are part of what is taught in school curricula at different levels. But pragmatic and social competencies are rarely explicitly taught as such. Work on social/emotional intelligence (and on its role in students' personal and professional success) shows that these skills are both disparate and difficult to assess (Humphrey et al. 2007). Research on this issue is, however, becoming increasingly rigorous, with the potential to provide usable data for the development of science-based practice (Keefer et al. 2018). Teachers and pedagogical teams also have an important, changing role to play: they also need to master new information and communication technologies and the transmission of information through them (Zlatic et al. 2014).

Communication has an obvious link with the three other Cs. Starting with critical thinking, sound communication implies fostering the conditions for a communicative exchange directed towards a common goal, which is, at least in educational and professional contexts, based on a fair evaluation of reality (Pornpitakpan 2004). Collaboration too has a strong link with communication, because successful collaboration is highly dependent on the quality of knowledge sharing and trust that emerges between group members. Finally, creativity involves the communication of an idea to an audience and can involve high-quality communication when creative work occurs in a team context.

2.3.1. Individual Assessment of Communication

Given the vast field of communication, an exhaustive list of its evaluation methods is difficult to establish. A number of methods have been reported in the literature to assess an individual's ability to communicate non-verbally and verbally. But although these two aspects are intrinsically linked, they are rarely measured together with a single tool. Moreover, as Spitzberg (2003) pointed out, communication skills are supported by different abilities, classically conceptualized as motivational functions (e.g., confidence and goal-orientation), knowledge (e.g., content and procedural knowledge), or cognitive and socio-cognitive functions (e.g., theory of mind, verbal cognition, emotional intelligence, and empathy; McDonald et al. 2014; Rothermich 2020), implying different specific types of evaluations. Finally, producing vs. receiving communication involve different skills and abilities, which can also vary according to the context (Landa 2005).

To overcome these challenges, Spitzberg (2003) recommends the use of different assessment criteria. These criteria include the clarity of interaction, the understanding of what was involved in the interaction, the satisfaction of having interacted (expected to be higher when communication is effective), the efficiency of the interaction (the more competent someone is, the less effort, complexity, and resources will be needed to achieve their goal), its effectiveness or appropriateness (i.e., its relevance according to the context), as well as criteria relative to the quality of the dialogue (which involves coordination, cooperation, coherence, reciprocity, and mutuality in the exchange with others). Different forms of evaluation are also called for, such as self-reported questionnaires, hetero-reported questionnaires filled out by parents, teachers, or other observers, and tasks involving exposure to role-playing games, scenarios or videos (for a review of these assessment tools, see Cömert et al. 2016; Landa 2005; Sigafos et al. 2008; Spitzberg 2003; van der Vleuten et al. 2019). Results from these tools must then be associated with others assessing underlying abilities, such as theory of mind and metacognition.

2.3.2. Institutional and Environmental Support for Development of Communication Skills

Although communication appears to be a key employability skill, the proficiency acquired during studies rarely meets the expectations of employers (Jackson 2014). Communication must therefore become a priority in the training of students, beyond the sectors in which it is already known as essential (e.g., in medicine, nursing, engineering, etc.; Bourke et al. 2021; D'Alimonte et al. 2019; Peddle et al. 2018; Riemer 2007), and also through professional development (Jackson 2014). Training programs involving, for example, communication theory classes (Kruijver et al. 2000) and self-assessment tools that can be used in specific situations (Curtis et al. 2013; Rider and Keefer 2006) have had convincingly positive results. The literature suggests that interactive approaches in small groups, in which competencies are practiced explicitly in an open and feedback-safe environment, are more effective (Bourke et al. 2021; D'Alimonte et al. 2019; AbuSeileek 2012; Fryer-Edwards et al. 2006). These can take different forms: project-based work, video reviews, simulation or role-play games (see Hathaway et al. 2022 for a review; Schlegel et al. 2012). Finally, computer-assisted learning methods can be relevant for establishing a secure framework (especially, for example, when learning another language): anonymity indeed helps to overcome anxiety or social blockages linked to fear of public speaking or showing one's difficulties (AbuSeileek 2012). Each of these methods tackles one or more dimensions of communication that must then be assessed as such, by means of tools specifically developed and adapted to the contexts in which these skills are expressed (e.g., see the two 4Cs evaluation grids for institutions and for games outlined in Sections 4 and 5, below).

2.4. Collaboration

Collaborative problem solving—and more generally, collaboration—has gained increasing attention in national and international assessments (e.g., PISA) as an educational priority encompassing social, emotional, and cognitive skills critical to efficiency, effectiveness, and innovation in the modern global economy (Graesser et al. 2018; OECD 2017). Understanding what makes effective collaboration is of crucial importance for professional practice and training (Détienne et al. 2012; Graesser et al. 2018), as evidenced by the long line of research on group or team collaboration over the past 40 years (for a review, see e.g., Salas et al. 2004; Mathieu et al. 2017). Although there is no consensus on a definition of collaboration, scholars often see it as mutual engagement in a coordinated effort to achieve a common goal that involves the sharing of goals, resources, and representations relating to the joint activity of participants; and other important aspects relate to mutual respect, trust, responsibilities, and accountability within situational rules and norms (Détienne et al. 2012).

In the teamwork research literature, skills are commonly described across three classes most often labeled Knowledge, Behavior, and Attitudes (e.g., Cannon-Bowers et al. 1995). Knowledge competencies refer to the skills related to elaborating the knowledge content required for the group to process and successfully achieve the task/goal to which they are assigned. Behavior includes skills related to the actualization of actions, coordination, communication, and interactions within the group as well as with any other relevant interlocutors for the task at hand. Note here that effective collaboration involves skills that have also been identified elsewhere as essential competencies, including communication, creativity, and critical thinking. Finally, several attitudes have been evidenced or hypothesized as desirable competencies in the team context, for example, attitude towards teamwork, collective orientation, cohesion/team morale, etc. Another common distinction lies between teamwork and taskwork. Teamwork refers to the collaborative, communicative, or social skills required to coordinate the work within the participants in order to achieve the task, whereas taskwork refers to specific aspects related to solving the task such as using the tools and knowing the procedure, policies, and any other task-related activities (Salas et al. 2015; Graesser et al. 2018). Furthermore, collaborative competences can have specific (to a group of people or to a task) and general dimensions (i.e., easily transferable to any group or team situation and to other tasks). For example, skills related

to communication, information exchange, conflict management, maintaining attention and motivation, leadership, etc. are present and transferable to a large number of group work situations and tasks (team-generic and task-contingent skills). Other skills can, on the other hand, be more specific to a team or group, such as internal organization, motivation, knowledge of the skills distributed in the team, etc.

2.4.1. Individual Assessment of Collaboration

Assessing collaboration requires capturing the dynamic and multi-level nature of the collaboration process, which is not as easily quantifiable as group/team inputs and outputs (task performance, satisfaction, and changes at group/team and individual level). There are indeed multiple interactions between the context, the collaboration processes, the task processes, and their (various) outcomes (Détienne et al. 2012). The integrative concept of “quality of collaboration” (Burkhardt et al. 2009) encapsulates much of what is currently known about collaborative processes and what constitutes effective collaboration. According to this approach, collaborative processes can be grouped along several dimensions concerning communication processes such as grounding, task-related processes (e.g., exchanges of knowledge relevant for the task at hand), and organization/coordination processes (Burkhardt et al. 2009). Communication processes are most important for ensuring the construction of a common referential within a group of collaborators. Task-related processes relate to how the group resolves the task at hand by sharing and co-elaborating knowledge, by confronting their various perspectives, and by converging toward negotiated solutions. Collaboration also involves group management activities such as: (a) common goal management and coordination activities, e.g., allocation and planning of tasks; (b) meeting/interaction management activities, e.g., ordering and postponing of topics in the meeting. Finally, the ability to pursue reflexive activity, in the sense of reflecting not only on the content of a problem or solution but on one’s collaboration and problem-solving strategies, is critical for the development of the team and supports them in changing and improving their practices. Graesser et al. (2018) identify collaborative skills based on the combination of these dimensions with a step in the problem-solving process.

A large body of methodology developed to assess collaboration processes and collaborative tools has been focused on quantifying a restricted subset of fine-grained interactions (e.g., number of speakers’ turns; number of words spoken; number of interruptions; amount of grounding questions). This approach has at least two limitations. First, because these categories of analysis are often ad hoc with respect to the considered situation, they are difficult to apply in all situations and make it difficult to compare between studies. Second, quantitative variations of most of these indicators are non-univocal: any increase or decrease of them could signify either an interactive–intensive collaboration or else evidence of major difficulties in establishing and/or maintaining the collaboration (Détienne et al. 2012). Alternatively, qualitative approaches based on multidimensional views of collaboration provide a more elaborated or nuanced view of collaboration and are useful for identifying potential relationships between distinctive dimensions of collaboration and aspects of team performance, in order to identify processes that could be improved. Based on the method of Spada et al. (2005) in Computer-Supported Collaborative Learning (CSCL) research, Burkhardt et al. (2009) have proposed a multi-dimensional rating scheme for evaluating the quality of collaboration (QC) in technology-mediated design. QC distinguishes seven dimensions, grouped along five aspects, identified as central for collaboration in a problem-solving task such as design: communication (1, 2), task-oriented processes (3, 4), group-oriented processes (5), symmetry in interaction—an orthogonal dimension—(6), and individual task orientation (7). This method has recently been adapted for use in the context of assessing games as a support to collaborative skills learning.

2.4.2. Institutional and Environmental Support for Development of Collaboration and Collaborative Skills

Support for individuals' development of collaborative skills provided by institutions and programs can take a variety of forms: (a) through the social impact of the physical structure of the organization, (b) the nature of the work required within the curriculum, (c) content within the curriculum focusing on collaboration and collaborative skills, and (d) the existence and promotion of extracurricular and inter-institutional opportunities for collaboration.

For instance, institutional support for collaboration has taken a variety of forms in various fields such as healthcare, engineering, public participation, and education. Training and education programs such as Interprofessional Education or Team Sciences in the health domain (World Health Organization 2010; Hager et al. 2016; O'Carroll et al. 2021), Peer-Led Team Learning in chemistry and engineering domains (Wilson and Varma-Nelson 2016), or Collaborative Problem Solving in education (Peña-López 2017; Taddei 2009) are notable examples.

Contextual support recently arose from the deployment of online digital media and new mixed realities in the workplace, in the learning environments and in society at large—obviously stimulated and accentuated with the COVID-19 pandemic. This has led many organizations to invest in proposing support for synchronous and asynchronous collaboration (notably remote, between employees, between students and educators or within group members, etc.) in various ways, including the provision of communication hardware and software, computer-supported cooperative work and computer-supported collaborative learning platforms, training and practical guides, etc. Users can collaborate through heterogeneous hybrid collaborative interaction spaces that can be accessed through virtual or augmented reality, but also simple video conferencing or even a voice-only or text-only interface. These new spaces for collaboration are, however, often difficult to use and less satisfactory than face-to-face interactions, suggesting the need for more research on collaborative activities and on how to support them (Faidley 2018; Karl et al. 2022; Kemp and Grieve 2014; Singh et al. 2022; Waizenegger et al. 2020).

A substantive body of literature on teams, collaborative learning, and computer-supported technologies provides evidence related to individual, contextual, and technological factors impacting the collaboration quality and efficiency. For example, teacher-based skills that are critical for enhancing collaboration are, among others, the abilities to plan, monitor, support, consolidate, and reflect upon student interaction in group work (Kaendler et al. 2016). Research focuses also on investigating the most relevant tasks and evaluating the possibilities offered by technology to support, to assess (e.g., Nouri et al. 2017; Graesser et al. 2018), and/or to learn the skills involved in pursuing effective and satisfying collaboration (see e.g., Schneider et al. 2018; Doyle 2021; Ainsworth and Chounta 2021).

3. Labelization: Valorization of the 4Cs and Assessing Support for Their Development

Moving from the nature of the 4Cs and their individual assessment and towards the ways in which institutions can support their development in individuals, we can now address the fundamentally important question of how best to support and promote this 21st century educational mission within and among institutions themselves. This also raises the question of the systemic recognition of educational settings that are conducive to the development of the 4Cs. In response to these questions, the nature and value of labelization is now presented.

A label is “a special mark created by a trusted third party and displayed on a product intended for sale, to certify its origin, to guarantee its quality and to ensure its conformity with the standards of practices in force” (Renard 2005). A label is therefore a way of informing the public about the objective properties and qualities of a product, service, or system. The label is usually easily identifiable and can be seen as a proof that a product or service, a company, or an organization complies with defined criteria. Its effectiveness is

therefore closely linked to the choice of requirements set out in its specifications, as well as to the independence and rigor of the body that verifies compliance with the criteria.

3.1. Labeling as a Means of Trust and Differentiation

As a sign of recognition established by a third party, the label or certification can constitute a proof of trust aiming to reassure the final consumer. According to [Sutter \(2005\)](#), there are different means of signaling trust. First, the brand name of a product or service and its reputation can, in itself, constitute a label when this brand name is recognized on the market. Second, various forms of self-declaration, such as internal company charters, though not statements assessed by a third party, show an internal commitment that can provide reassurance. Finally, there is certification or labeling, which is awarded by an external body and requires a third-party assessment by a qualified expert, according to criteria set out in a specific reference framework. It is this external body, a trusted third party, which guarantees the reliability of the label and constitutes a guarantee of credibility. Its objectivity and impartiality are meant to guarantee that the company, organization, product, or service meets defined quality or reliability criteria ([Jahn et al. 2005](#)).

Research on populations around the world (e.g., [Amron 2018](#); [Sasmita and Suki 2015](#)) show that the buying decisions of consumers are heavily influenced by the trust they have in a brand. More specifically, third-party assurances and labelization have been shown to strongly influence customer buying intentions and purchasing behavior (e.g., [Kimery and McCord 2002](#); [Lee et al. 2004](#)). Taking France as an example, research shows that quality certification is seen as “important” or “significant” by 76% of companies ([Chameroy and Veran 2014](#)), and decision makers feel more confident and are more willing to invest with the support of third-party approval than if their decision is merely based on the brand’s reputation or its demonstrated level of social responsibility ([Etilé and Teyssier 2016](#)). Indeed, French companies with corporate social responsibility labels have been shown to have higher than average growth rates, and the adoption of quality standards is linked with a 7% increase in the share of export turnover ([Restout 2020](#)).

3.2. Influence on Choice and Adoption of Goods and Services

Studies diverge in this area, but based on the seminal work of [Parkinson \(1975\)](#); [Chameroy and Veran \(2014\)](#), in their research on the effect of labels on willingness to pay, found that in 75% of cases, products with labels are chosen and preferred to those without labels, demonstrating the impact of the label on customer confidence—provided that it is issued by a recognized third party. Thus, brands that have good reputations tend to be preferred over cheaper new brands, because they are more accepted and valued by the individual social network ([Zielke and Dobbelstein 2007](#)).

3.3. Process of Labelizing Products and Services

The creation of a label may be the result of a customer or market need, a request from a private sector of activity or from the government. Creating a label involves setting up a working group including stakeholders who are experts in the field, product managers, and a certification body in order to elaborate a reference framework. This is then reviewed by a specialized committee and validated by the stakeholders. The standard includes evaluation criteria that must be clearly defined ([Mourad 2017](#)). An audit system is set up by a trusted third party. It must include the drafting of an audit report, a system for making decisions on labeling, and a system for identifying qualified assessors. The validity of the assessment process is reinforced by this double evaluation: a first level of audit carried out by a team of experts according to a clearly defined set of criteria and a second level of decision making assuring that the methodology and the result of the audit are in conformity with the defined reference framework.

3.4. Labelization of 21st Century Skills

The world of education is particularly concerned by the need to develop and assess 21st century skills, because it represents the first link in the chain of skills acquisition, preparing the human resources of tomorrow. One important means of simultaneously offering a reliable, independent assessment of 21st century skills and valorizing them by making them a core target within an educational system (schools, universities, and teaching and training programs of all kinds) is labelization. Two examples of labelization processes related to 21st century skills were recently developed by the [International Institute for Competency Development \(2021\)](#); see [iicd.net](#); accessed on 20 November 2022) working with international experts, teachers, and researchers from the University of Paris Cité (formerly Université Sorbonne Paris Cité), Oxford University, and AFNOR UK (an accredited certification body and part of AFNOR International, a subsidiary of the AFNOR group, the only standards body in France).

The last two or three decades has seen the simultaneous rise of international ranking systems and an interest in quality assurance and assessment in an increasingly competitive educational market ([Sursock 2021](#)). The aim of these labelization frameworks is to assist in the development of “quality culture” in education by offering individual programs, institutions, and systems additional independent, reliable means of benchmarking, charting progress, and distinguishing themselves based on their capacity to support and promote the development of crucial skills. Importantly, the external perspectives provided by such assessment system should be capable of being individually adapted and applied in a manner that can resist becoming rigidly imposed external standards ([Sursock and Vettori 2017](#)). Similarly, as we have seen in the literature review, the best approach to understanding and assessing a particular C is from a combination of different levels and perspectives in context. For example, important approaches to critical thinking have been made from educationally, philosophically, and psychologically focused vantage points ([Lai 2011](#)). We can also argue that understandings of creativity are also results of different approaches: the major models in the literature (e.g., the “4Ps” and “7Cs” models; see [Lubart and Thornhill-Miller 2019](#)) explicitly result from and include the objectives of different education-focused, process-focused, and “ingredient” or component-focused approaches.

The two assessment frameworks outlined in the sections that follow were formulated with these different perspectives and objective needs in mind. Given the complexity and very different natures of their respective targets (i.e., one assessing entire formal educational contexts such as institutions or programs, whereas the other targets the less multi-dimensional, informal educational activities represented by games), the assessment of the individual Cs also represents what experts consider a target-appropriate balance of education- and curriculum-focused, process-focused, and component-focused criteria for assessing each different C.

4. The International Institute for Competency Development’s 21st Century Competencies 4Cs Assessment Framework for Institutions and Programs

One comprehensive attempt to operationalize programmatic-level and institutional-level support for the development of the 4Cs is the International Institute for Competency Development’s 4Cs Assessment Framework ([International Institute for Competency Development 2021](#)). Based upon expert opinion and a review of the available literature, this evaluation grid is a practical tool that divides each of the 4Cs into three “user-friendly” but topic-covering components (see [Table 1](#) and definitions and further discussion in the sections that follow). Each of these components is then assessed across seven dimensions (see [Table 2](#), below), designed to cover concisely the pedagogical process and the educational context. Examples for each point level are provided within the evaluation grid in order to offer additional clarity for educational stakeholders and expert assessors.

Table 1. Three different components of each C in IICD’s 21st Century Skills 4Cs Assessment Framework.

Creativity	Creative Process	Creative Environment	Creative Product
Critical Thinking	Critical thinking about the world	Critical thinking about oneself	Critical action and decision making
Collaboration	Engagement and participation	Perspective taking and openness	Social regulation
Communication	Message formulation	Message delivery	Message and communication feedback

Table 2. Seven dimensions evaluated for the 3 different components of each C.

Teaching Curriculum	Aspects of the overall educational program teaching, emphasizing, and promoting the 4Cs
Tools and Techniques	Availability and access to different means, materials, space, and expertise, digital technologies, mnemonic and heuristic methods, etc. to assist in the proper use and exercise of the 4Cs
Implementation	Actual student and program use of available resources promoting the 4Cs
Meta-reflection	Critical reflection and metacognition on the process being engaged in around the 4Cs
Competence of Actors	The formal and informal training, skills, and abilities of teachers/trainers and staff and their program of development as promoters of the 4Cs
Outside community contact	Use and integration of the full range of resources external to the institution available to enhance the 4Cs
User Initiative *	Availability of resources for students to create and actualize products, programs, events, etc. that require the exercise, promotion, or manifestation of the 4Cs

* Educational-level dependent and potentially less available for younger students or in some contexts.

The grid itself can be used in several important and different ways by different educational stakeholders: (1) by the institution itself in its self-evaluation and possible preparation for a certification or labelization process, (2) as an explicit list of criteria for external evaluation of the institution and its 4Cs-related programs, and (3) as a potential long-term development targeting tool for the institution or the institution in dialogue with the labelization process.

4.1. Evaluation Grid for Creativity

Dropping the component of “creative person” that is not relevant at the institutional level, this evaluation grid is based on Rhodes’ (1961) classic “4P” model of creativity, which remains the most concise model today (Lubart and Thornhill-Miller 2019). The three “P” components retained are: *creative process*, *creative environment*, and *creative product*. Creative process refers to the acquisition of a set of tools and techniques that students can use to enhance the creativity of their thinking and work. Creative environment (also called “Press” in earlier literature) is about how the physical and social surroundings of students can help them be more creative. Finally, creative product refers to the evaluation of actual “productions” (e.g., a piece of art, text, speech, etc.) generated through the creative process.

4.2. Evaluation Grid for Critical Thinking

Our evaluation grid divides critical thinking into three main components: *critical thinking about the world*, *critical thinking about oneself* (self-reflection), as well as *critical action and decision making*. The first component refers to having an evidence-based view of the exterior world, notably by identifying and evaluating sources of information and using them to question current understandings and solve problems. Self-reflection refers to thinking critically about one’s own life situation, values, and actions; it presupposes the autonomy

of thought and a certain distance as well as the most objective observation possible with regard to one's own knowledge ("meta-cognition"). The third and final component, *critical action and decision making*, is about using critical thinking skills more practically in order to make appropriate life decisions as well as to be open to different points of view. This component also addresses soft skills and attitudes such as trusting information.

Our evaluation framework for critical thinking was in part inspired by Barnett's "curriculum for critical being" (2015), whose model distinguishes two axes: one defined by the qualitative differences in the level of criticality attained and the second comprised of three different domains of application: formal knowledge, the self, and the world. The first two components of our framework (and the seven dimensions on which they are rated) reflect and encompass these three domains. Similar to Barrett's proposal, our third rubric moves beyond the "skills-plus-dispositions" model of competency implicit in much theorizing about critical thinking and adds the importance of "action"—not just the ability to think critically and the disposition to do so, but the central importance of training and practicing "critical doing" (Barnett 2015). Critical thinking should also be exercised collectively by involving students in collective thinking, facilitating the exchange of ideas and civic engagement (Huber and Kuncel 2016).

4.3. Evaluation Grid for Collaboration

The first component of collaboration skills in the IICD grid is *engagement and participation*, referring to the active engagement in group work. *Perspective taking and openness* concerns the flexibility to work with and accommodate other group members and their points of view. The final dimension—*social regulation*—is about being able to reach for a common goal, notably through compromise and negotiation, as well as being aware of the different types of roles that group members can hold (Hesse et al. 2015; Rusdin and Ali 2019; Care et al. 2016). (These last two components include elements of leadership, character, and emotional intelligence as sometimes described in other soft-skill and competency-related systems.) Participation, social regulation, and perspective taking have been identified as central social skills in collaborative problem solving (Hesse et al. 2015). Regarding social regulation in this context, recognizing and profiting from group diversity is key (Graesser et al. 2018). When describing an assessment in an educational setting of collaborative problem solving (with a task in which two or more students have to collaborate in order to solve it, each using a different set of resources), two main underpinning skills were described for the assessment: the social skill of audience awareness ("how to adapt one's own behavior to suit the needs of the task and the partner's requirements", Care et al. 2016, p. 258) and the cognitive skill of planning and executing (developing a plan to reach for a goal) (Care et al. 2016). The former is included in the perspective taking and openness rubric and the latter in the social regulation component in the IICD grid. Evans (2020) identified four main collaboration skills consistently mentioned in the scientific literature that are assessed in the IICD grid: the ability to plan and make group decisions (example item from the IICD grid: teachers provide assistance to students to overcome differences and reach a common goal during group work); the ability to communicate about thinking with the group (assessed notably in the meta-reflection strand of the IICD grid); the ability to contribute resources, ideas, and efforts and support group members (included notably in the engagement and participation as well as the social regulation components); and finally, the ability to monitor, reflect, and adapt individual and group processes to benefit the group (example item from the IICD grid: students use perspective-taking tools and techniques in group activities).

4.4. Evaluation Grid for Communication

The evaluation grid for communication is also composed of three dimensions: *message formulation*, *message delivery*, and *message and communication feedback*. *Message formulation* refers to the ability to design and structure a message to be sent, such as outlining the content of an argument. *Message delivery* is about effectively transmitting verbal and non-

verbal aspects of a message. Finally, *message and communication feedback* refers to the ability of students and teachers to understand their audience, analyze their social surroundings, and interpret information in context. Other components of communication skills such as theory of mind, empathy, or emotional intelligence are also relevant and included in the process of applying the grid. Thompson (2020) proposes a four-component operationalized definition of communication for its assessment in students. First, they describe a comprehension strand covering the understanding and selection of adequate information from a range of sources. Message formulation in the IICD grid captures this dimension through its focus on content analysis and generation. Second, the presentation of information and ideas is mentioned in several different modes, adjusted to the intended audience, verbally as well as non-verbally. The message delivery component of the IICD grid focuses on these points. Third, the authors note the importance of communication technology and its advanced use. The IICD grid also covers the importance of technology use in its tools and techniques category, with, for example, an item that reads: students learn to effectively use a variety of formats of communication (social media, make a video, e-mail, letter writing, creating a document). Finally, Thompson (2020) describes the recognition of cultural and other differences as an important aspect of communication. The IICD grid aims at incorporating these aspects, notably in the meta-reflection category under each of the three dimensions.

5. Assessing the 4Cs in Informal Educational Contexts: The Example of Games

5.1. The 4Cs in Informal Educational Contexts

So far, the focus has been on rather formal ways of nurturing the 4Cs. Although institutions and training programs are perhaps the most significant and necessary avenues of education, they are not the sole context in which 4Cs' learning and improvement can manifest. One other important potential learning context is game play. Games are activities that are present and participated in throughout human society—by those of all ages, genders, and socio-economic statuses (Bateson and Martin 2013; Huizinga 1949; Malaby 2007). This informal setting can also provide favorable conditions to help improve the 4Cs (van Rosmalen et al. 2014) and should not be under-appreciated. Games provide a unique environment for learning, as they can foster a space to freely explore possibilities and one's own potential (de Freitas 2006). We argue that games are a significant potential pathway for the improvement of the 4Cs, and as such, they merit the same attention as more formal ways of learning and developing competencies.

5.2. 4Cs Evaluation Framework for Games

Compared to schools and educational institutions, the focus of IICD's evaluation framework for games (see International Institute for Competency Development 2021) is more narrow. Thus, it is fundamentally different from the institutional grid: games, complex and deep as they can sometimes be, cannot directly be compared to the complexity of a school curriculum and all the programs it contains. The evaluation of a game's effectiveness for training/improving a given C rests on the following principle: if a game presents affordances conducive to exercising a given skill, engaged playing of that game should help improve that skill.

The game's evaluation grid is scored based on two criteria. For example, as a part of a game's rating as a tool for the development of creativity, we determine the game must first meet two conditions. First, whether or not the game allows the opportunity for creativity to manifest itself: if creativity cannot occur in the game, it is obviously not eligible to receive ratings for that C. Second, whether or not creativity is needed in order to perform well in the game: if the players can win or achieve success in the game without needing creativity, this also means it cannot receive a rating for that C. If both conditions are met, however, the game will be considered potentially effective to improve creativity through the practice of certain components of creative behavior. This basic principle applies for all four of the Cs.

As outlined in Table 3, below, the evaluation grid for each of the four Cs is composed of five components relevant to games that are different for each of the Cs. The grid

works as follows: for each of the five components of each C, we evaluate the game on a list of sub-components using two yes/no scales: one for whether it is “possible” for that subcomponent to manifest and one for whether that sub-component is “required for success” in the game. This evaluation is done for all sub-components. After this, each general component is rated on the same two indicators. If 60% (i.e., three out of five) or more sub-components are positively rated as required, the general component is considered required. Then, the game is evaluated on its effectiveness for training and improving each of the 4Cs. If 60% or more components are positively rated as required, the game will be labeled as having the potential to be effective for training and improving the corresponding C.

Table 3. Five different components evaluated for each C by the 4Cs assessment framework for games.

Creativity	Originality	Divergent Thinking	Convergent Thinking	Mental Flexibility	Creative Dispositions
Critical Thinking	Goal-adequate judgment/ discernment	Objective thinking	Metacognition	Elaborate reasoning	Uncertainty management
Collaboration	Collaboration fluency	Well-argued deliberation and consensus-based decision	Balance of contribution	Organization and coordination	Cognitive syncing, input, and support
Communication	Social Interactions	Social cognition	Mastery of written and spoken language	Verbal communication	Non-verbal communication

The evaluation grid for creativity is based on the multivariate model of creative potential (see Section 2.1.1 and Lubart et al. 2013 for more information) and is composed of four cognitive factors and one conative factor: *originality*, *divergent thinking*, *convergent thinking*, *mental flexibility*, and *creative dispositions*. *Originality* refers to the generation of ideas that are novel or unexpected, depending on the context. *Divergent thinking* corresponds to the generation of multiple ideas or solutions. *Convergent thinking* refers to the combination of multiple ideas and the selection of the most creative idea. *Mental flexibility* entails changing perspectives on a given problem and breaking away from initial ideas. Finally, *creative dispositions* concerns multiple personality-related factors conducive to creativity, such as openness to experience or risk taking.

The evaluation grid for critical thinking echoes Halpern’s (1998) as well as Marin and Halpern’s (2011) considerations for teaching this skill, that is, taking into consideration thinking skills, metacognition, and dispositions. The five components of the critical thinking grid are: goal-adequate discernment, objective thinking, metacognition, elaborate reasoning, and uncertainty management. Goal-adequate discernment entails the formulation of inferences and the discernment of contradictions when faced with a problem. Objective thinking corresponds to the suspension of one’s own judgment and the analysis of affirmations and sources in the most objective manner possible. Metacognition, here, is about questioning and reassessing information, as well as the awareness of one’s own cognitive biases. Elaborate reasoning entails reasoning in a way that is cautious, thorough, and serious. Finally, uncertainty management refers to the dispositional propensity to tolerate ambiguity and accept doubt.

The evaluation grid for collaboration is based on the quality of collaboration (QC) method (Burkhardt et al. 2009; see Section 2.4.2 for more details) and is composed of the following five components: collaboration fluidity, well-argued deliberation and consensus-based decision, balance of contribution, organization and coordination, and cognitive syncing, input, and support. Collaboration fluidity entails the absence of speech overlap and the presence of a good flow in terms of turns to speak. Well-argued deliberation and consensus-based decision is about contributing to the discussion and task at hand, as well as participating in discussions and arguments, in order to obtain a consensus. Balance of contribution refers to having equal or equivalent contributions to organization,

coordination, and decision making. Organization and coordination refers to effective management of roles, time, and “deadlines”, as well as the attribution of roles depending on participants’ skills. Finally, cognitive syncing, input, and support is about bringing ideas and resources to the group, as well as supporting and reinforcing other members of the group.

The five components used to evaluate communication in games include both linguistic, pragmatic, and social aspects. Linguistic skills per se are captured by the mastery of written and spoken language component. This component assesses language comprehension and the appropriate use of vocabulary. Pragmatic skills are captured by the verbal and non-verbal communication components and refer to the efficient use of verbal and body signals in the context of the game to achieve one’s communicative goals (Grassmann 2014; Matthews 2014). Finally, the grid also evaluates social skills with its two last components, social interactions and social cognition, which, respectively, refer to the ability to interact with others appropriately—including by complying with the rules of the game—and to the understanding of other people’s mental states (Tomasello 2005).

6. Discussion and Conclusions

Each of the 4Cs is a broad, multi-faceted concept that is the subject of a tremendous amount of research and discussion by a wide range of stakeholders in different disciplines, professions, and parts of the educational establishment. The development of evaluation frameworks to allow support for the 4Cs to be assessed and publicly recognized, using a label, is an important step for promoting and fostering these skills in educational contexts. As illustrated by IICD’s 4Cs Framework for educational institutions and programs, as well as its games/activities evaluation grid, the specific criteria to detect support for each C can vary depending upon the educational context (e.g., formal and institutional level or informal and at the activity level). Yet considering the 4Cs together highlights some additional observations, current challenges, and opportunities for the future that are worthy of discussion.

6.1. *Interrelationships between the 4Cs and a New Model for Use in Pedagogy and Policy Promotion*

One very important issue for understanding the 4Cs and their educational implementation that can be simultaneously a help and a hindrance for teaching them—and also a challenge when assessing them—is their multidimensionality and interrelatedness. In other words, the 4Cs are not entirely separate entities but instead, as Figure 2 shows, should be seen as four interlinked basic “elements” for future-oriented education that can help individuals in their learning process and, together, synergistically “bootstrap” the development of their cognitive potentials. Lamri and Lubart (2021), for example, found a certain base level of creativity was a necessary but not sufficient condition for success in managerial tasks, but that high-level performance required a combination of all four Cs. Some thinkers have argued that one cannot be creative without critical thinking, which also requires creativity, for example, to come up with alternative arguments (see Paul and Elder 2006). Similarly, among many other interrelationships, there is no collaboration without communication—and even ostensibly individual creativity is a “collaboration” of sorts with the general culture and precursors in a given field. As a result, it ranges from impossible to suboptimal to teach (or teach towards) one of the 4Cs without involving one or more of the others, and this commingling also underscores the genuine need and appropriateness of assessing them together.

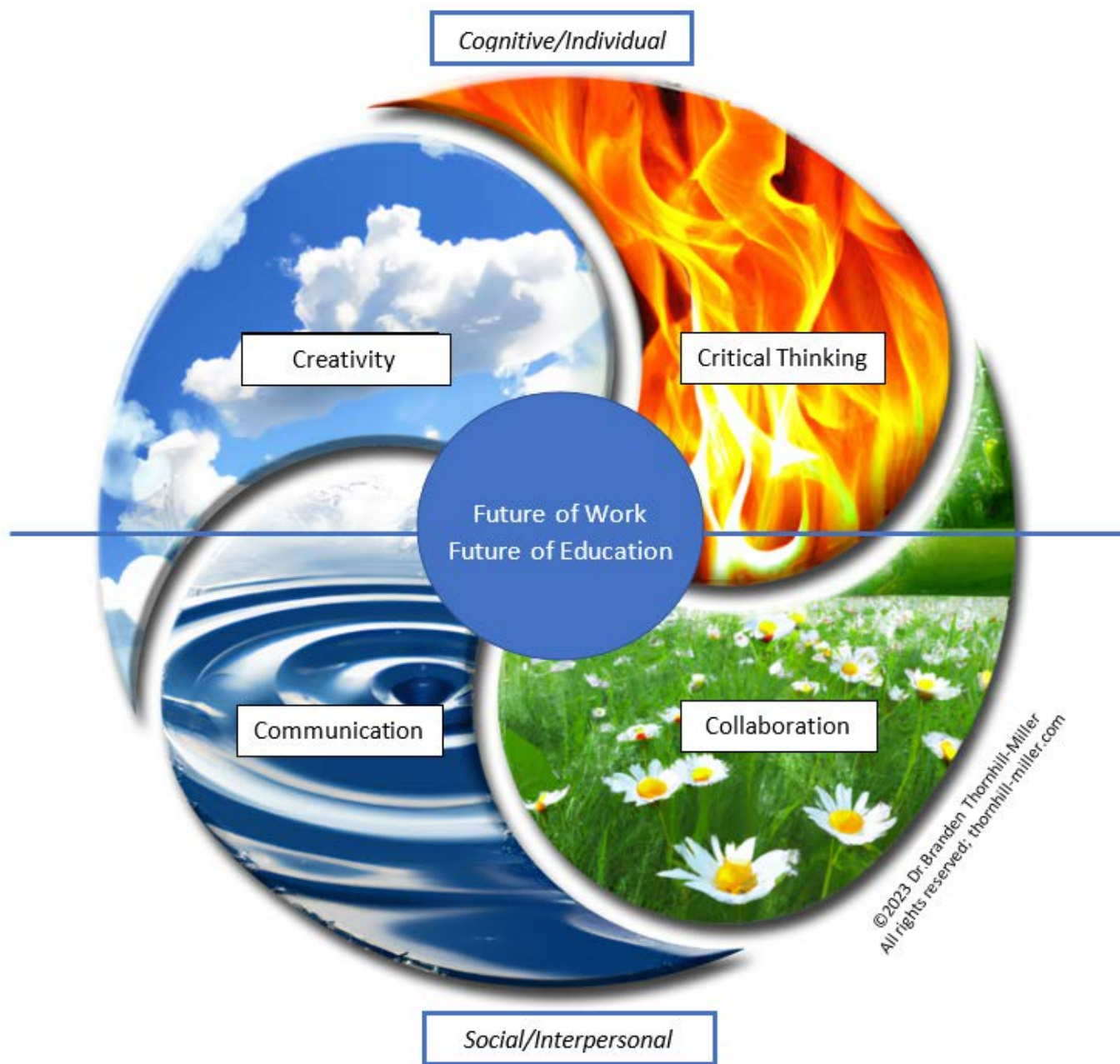

Figure 2. “Crea-Critical-Collab-ication”: a Dynamic Interactionist Model of the 4Cs”. (Illustration of the interplay and interpenetration of creativity, critical thinking, collaboration, and communication shown in dimensional space according to their differing cognitive/individual vs. social/interpersonal emphases; (© 2023, Branden Thornhill-Miller. All Rights Reserved. thornhill-miller.com; accessed on 20 January 2023)).

From this perspective, [Thornhill-Miller \(2021\)](#) proposed a “dynamic interactionist model of the 4Cs” and their interrelated contributions to the future of education and work. Presented in [Figure 2](#), this model is meant to serve as a visual and conceptual aid for understanding the 4Cs and their interrelationships, thereby also promoting better use and understanding of them in pedagogical and policy settings. In addition to suggesting the portmanteau of “crea-critical thinking” as a new term to describe the overlap of much of the creative and critical thinking processes, the title of this model, “Crea-Critical-Collab-ication”, is a verbal representation of the fluid four-way interrelationship between the 4Cs visually represented in [Figure 2](#) (a title meant to playfully repack the 4Cs for important

pedagogical and policy uses). This model goes further to suggest some dimensional differences in emphases that, roughly speaking, also often exist among the 4Cs: that is to say, the frequently greater emphasis on cognitive or individual elements at play in creativity and critical thinking in comparison to the social and interpersonal aspects more central to communication and collaboration (Thornhill-Miller 2021).

Similarly focused on the need to promote a phase change towards future-oriented education, Lucas (2019) and colleagues have suggested conflating creative thinking and critical thinking in order to propose “3Cs” (creative thinking, communication, and collaboration) as new “foundational literacies” to symmetrically add to the 3Rs (Reading, wRiting, and aRithmetic) of previous educational eras. Although we applaud these efforts, from our applied research perspective, we believe that the individual importance of, and distinct differences between, creative thinking and critical thinking support preserving them both as separate constructs in order to encourage the greatest development of each of them. Moreover, if only three categories were somehow required or preferable, one could argue that uniting communication and collaboration (as “collab-ication” suggests) might be preferable—particularly also given the fact that substantial aspects of communication are already covered within the 3Rs. In any case, we look forward to more such innovations and collaborations in this vibrant and important area of work at the crossroads between research, pedagogy, and policy development.

6.2. *Limitations and Future Work*

The rich literature in each of the 4Cs domains shows the positive effects of integrating these dimensions into educational and professional curricula. At the same time, the complexity of their definitions makes them difficult to assess, both in terms of reliability (assessment must not vary from one measurement to another) and of validity (tests must measure that which they are intended to measure). However, applied research in this area is becoming increasingly rigorous, with a growing capacity to provide the necessary tools for evidence-based practice. The development of these practices should involve interdisciplinary teams of teachers and other educational practitioners who are equipped and trained accordingly. Similarly, on the research side, further exploration and clarification of subcomponents of the 4Cs and other related skills will be important. Recent efforts to clarify the conceptual overlap and hierarchical relations of soft skills for the future of education and work, for example, have been helpful and promising (e.g., Joie-La Marle et al. 2022; Lamri et al. 2022). But the most definitive sort of taxonomy and measurement model that we are currently lacking might only be established based on the large-scale administration of a comprehensive battery of skill-measuring psychometric tests on appropriate cross sections of society.

The rapid development and integration of new technologies will also aid and change the contexts, resources, and implementation of the 4Cs. For example, the recent developments make it clear that the 4Cs will be enhanced and changed by interaction with artificial intelligence, even as 4Cs-related skills will probably, for the same reason, increasingly constitute the core of available human work in the future (see, e.g., Ross 2018). Similarly, research on virtual reality and creativity suggest that VR environments assist and expand individual and collaborative creativity (Bourgeois-Bougrine et al. 2022). Because VR technologies offer the possibility of enhanced and materially enriched communication, collaboration, and information availability, they not only allow for the enhancement of creativity techniques but also for similar expansions and improvements on almost all forms of human activity (see Thornhill-Miller and Dupont 2016)—including the other three Cs.

6.3. *Conclusion: Labelization of the 4Cs and the Future of Education and Work*

Traditional educational approaches cannot meet the educational needs of our emergent societies if they do not teach, promote, and assess in line with the new learner characteristics and contexts of the 21st century (Sahin 2009). The sort of future-oriented change and development required by this shift in institutional practices, programming, and struc-

ture will likely meet with significant resistance from comfortably entrenched (and often outdated) segments of traditional educational and training establishments. Additional external evaluation and monitoring is rarely welcome by workers in any context. We believe, however, that top-down processes from the innovative and competition-conscious administrative levels will be met by bottom-up demands from students and education consumers to support these institutional changes. And we contend that efforts such as labeling 4C processes will serve to push educators and institutions towards more relevant offerings, oriented towards the future of work and helping build a more successful future for all.

In the end, the 4Cs framework seems to be a manageable, focused model for modernizing education, and one worthy of its growing prevalence in the educational and research marketplace for a number of reasons. These reasons include the complexity and cumbersome nature of larger alternative systems and the 4Cs' persuasive presence at the core of a number of early and industry-driven frameworks. In addition, the 4Cs have benefited from their subsequent promotion by organizations such as the OECD and the World Economic Forum, as well as some more direct support from recent empirical research. The promotion, teaching, and assessment of the 4Cs will require a complex social intervention and mobilization of educational resources—a major shift in pedagogy and institutional structures. Yet the same evolving digital technologies that have largely caused the need for these massive, rapid changes can also assist in the implementation of solutions (van Laar et al. 2017). To the extent that future research also converges on such a model (that has already been found pedagogically useful and policy-friendly by so many individuals and organizations), the 4Cs framework has the potential to become a manageable core for 21st century skills and the future of education and work—one that stakeholders with various agendas can already begin building on for a better educational and economic future together.

Author Contributions: Conceptualization, B.T.-M. and T.L.; writing—original draft preparation, B.T.-M., A.C., M.M., J.-M.B., T.M., S.B.-B., S.E.H., F.V., M.A.-L., C.F., D.S., F.M.; writing—review and editing, B.T.-M., A.C., T.L., J.-M.B., C.F.; visualization, B.T.-M.; supervision, B.T.-M., T.L.; project administration, B.T.-M., T.L. All authors have read and agreed to the published version of the manuscript.

Funding: This research received no external funding.

Institutional Review Board Statement: Not applicable.

Informed Consent Statement: Not applicable.

Data Availability Statement: Not Applicable.

Conflicts of Interest: B.T.-M. and T.L. are unpaid academic co-founder and project collaborator for the International Institute for Competency Development, whose labeling frameworks (developed in cooperation with Afnor International and the LaPEA lab of Université Paris Cité and Université Gustave Eiffel) are used as examples in this review. S.E.H. and M.A.-L. are employees of AFNOR International. No funding was received to support this research or article, which reflects the views of the scientists and researchers and not their organizations or companies.

References

- Abrami, Philip C., Robert M. Bernard, Eugene Borokhovski, David I. Waddington, C. Anne Wade, and Tonje Persson. 2015. Strategies for Teaching Students to Think Critically: A Meta-Analysis. *Review of Educational Research* 85: 275–314. [CrossRef]
- Abuseleek, Ali Farhan. 2012. The Effect of Computer-Assisted Cooperative Learning Methods and Group Size on the EFL Learners' Achievement in Communication Skills. *Computers & Education* 58: 231–39. [CrossRef]
- Ahern, Aoife, Caroline Dominguez, Ciaran McNally, John J. O'Sullivan, and Daniela Pedrosa. 2019. A Literature Review of Critical Thinking in Engineering Education. *Studies in Higher Education* 44: 816–28. [CrossRef]
- Ainsworth, Shaaron E., and Irene-Angelica Chounta. 2021. The roles of representation in computer-supported collaborative learning. In *International Handbook of Computer-Supported Collaborative Learning*. Edited by Ulrike Cress, Carolyn Rosé, Alyssa Friend Wise and Jun Oshima. Cham: Springer, pp. 353–69. [CrossRef]
- Alsaleh, Nada J. 2020. Teaching Critical Thinking Skills: Literature Review. *The Turkish Online Journal of Educational Technology* 19: 21–39. Available online: <http://files.eric.ed.gov/fulltext/EJ1239945.pdf> (accessed on 1 November 2022).

- Al-Samarraie, Hosam, and Shuhaila Hurmuzan. 2018. A Review of Brainstorming Techniques in Higher Education. *Thinking Skills and Creativity* 27: 78–91. [CrossRef]
- Amabile, Teresa M. 1982. Social Psychology of Creativity: A Consensual Assessment Technique. *Journal of Personality and Social Psychology* 43: 997–1013. [CrossRef]
- Amron, Manajemen Pemasaran. 2018. The influence of brand image, brand trust, product quality, and price on the consumer's buying decision of MPV cars. *European Scientific Journal* 14: 228–39. [CrossRef]
- Ananiadou, Katerina, and Magdalean Claro. 2009. *21st Century Skills and Competences for New Millennium Learners in OECD Countries*. OECD Education Working Papers, No. 41. Paris: OECD Publishing. [CrossRef]
- Bailin, Sharon. 1988. *Achieving Extraordinary Ends: An Essay on Creativity*. Dordrecht: Springer. [CrossRef]
- Bandyopadhyay, Subir, and Jana Szostek. 2019. Thinking Critically about Critical Thinking: Assessing Critical Thinking of Business Students Using Multiple Measures. *Journal of Education for Business* 94: 259–70. [CrossRef]
- Barber, Herbert F. 1992. Developing Strategic Leadership: The US Army War College Experience. *Journal of Management Development* 11: 4–12. [CrossRef]
- Barnett, Ronald. 2015. A Curriculum for Critical Being. In *The Palgrave Handbook of Critical Thinking in Higher Education*. New York: Palgrave Macmillan US, pp. 63–76. [CrossRef]
- Bateson, Patrick, and Paul Martin. 2013. *Play, Playfulness, Creativity and Innovation*. Cambridge: Cambridge University Press. [CrossRef]
- Batey, Mark. 2012. The Measurement of Creativity: From Definitional Consensus to the Introduction of a New Heuristic Framework. *Creativity Research Journal* 24: 55–65. [CrossRef]
- Battelle for Kids. 2022. Framework for 21st Century Learning Definitions. Available online: http://static.battelleforkids.org/documents/p21/P21_Framework_DefinitionsBKF.pdf (accessed on 1 November 2022).
- Bellaera, Lauren, Yana Weinstein-Jones, Sonia Ilie, and Sara T. Baker. 2021. Critical Thinking in Practice: The Priorities and Practices of Instructors Teaching in Higher Education. *Thinking Skills and Creativity* 41: 100856. [CrossRef]
- Blessinger, Patrick, and John P. Anchan. 2015. *Democratizing Higher Education: International Comparative Perspectives*, 1st ed. Edited by Patrick Blessinger and John P. Anchan. London: Routledge. Available online: <https://www.routledge.com/Democratizing-Higher-Education-International-Comparative-Perspectives/Blessinger-Anchan/p/book/9781138020955> (accessed on 1 November 2022).
- Bloom, Benjamin Samuel, ed. 1956. *Taxonomy of Educational Objectives: The Classification of Educational Goals: Handbook I, Cognitive Domain*. New York: Longmans.
- Bourgeois-Bougrine, Samira. 2022. Design Thinking. In *The Palgrave Encyclopedia of the Possible*. Cham: Springer International Publishing. [CrossRef]
- Bourgeois-Bougrine, Samira, Nathalie Bonnardel, Jean-Marie Burkhardt, Branden Thornhill-Miller, Farzaneh Pahlavan, Stéphanie Buisine, Jérôme Guegan, Nicolas Pichot, and Todd Lubart. 2022. Immersive Virtual Environments' Impact on Individual and Collective Creativity: A Review of Recent Research. *European Psychologist* 27: 237–53. [CrossRef]
- Bourke, Sharon L., Simon Cooper, Louisa Lam, and Lisa McKenna. 2021. Undergraduate Health Professional Students' Team Communication in Simulated Emergency Settings: A Scoping Review. *Clinical Simulation in Nursing* 60: 42–63. [CrossRef]
- Brookfield, Stephen D. 1997. Assessing Critical Thinking. *New Directions for Adult and Continuing Education* 75: 17–29. [CrossRef]
- Burkhardt, Jean-Marie, Françoise Détienné, Anne-Marie Hébert, and Laurence Perron. 2009. Assessing the 'Quality of Collaboration' in Technology-Mediated Design Situations with Several Dimensions. In *Human-Computer Interaction—INTERACT 2009*. Berlin/Heidelberg: Springer, pp. 157–60. [CrossRef]
- Camarda, Anaëlle, Lison Bouhours, Anaïs Osmont, Pascal Le Masson, Benoît Weil, Grégoire Borst, and Mathieu Cassotti. 2021. Opposite Effect of Social Evaluation on Creative Idea Generation in Early and Middle Adolescents. *Creativity Research Journal* 33: 399–410. [CrossRef]
- Cannon-Bowers, Janis, Scott I. Tannenbaum, Eduardo Salas, and Catherine E. Volpe. 1995. Defining team competencies and establishing team training requirements. In *Team Effectiveness and Decision Making in Organizations*. Edited by Richard A. Guzzo and Eduardo Salas. San Francisco: Jossey-Bass, pp. 333–80.
- Care, Esther, Claire Scoular, and Patrick Griffin. 2016. Assessment of Collaborative Problem Solving in Education Environments. *Applied Measurement in Education* 29: 250–64. [CrossRef]
- Care, Esther, Helyn Kim, Alvin Vista, and Kate Anderson. 2018. *Education System Alignment for 21st Century Skills: Focus on Assessment*. Washington, DC: Brookings Institution.
- Carmichael, Erst, and Helen Farrell. 2012. Evaluation of the Effectiveness of Online Resources in Developing Student Critical Thinking: Review of Literature and Case Study of a Critical Thinking Online Site. *Journal of University Teaching and Learning Practice* 9: 38–55. [CrossRef]
- Carson, Shelley H., Jordan B. Peterson, and Daniel M. Higgins. 2005. Reliability, Validity, and Factor Structure of the Creative Achievement Questionnaire. *Creativity Research Journal* 17: 37–50. [CrossRef]
- Casey, Betty J., Sarah Getz, and Adriana Galvan. 2008. The Adolescent Brain. *Developmental Review: DR* 28: 62–77. [CrossRef] [PubMed]
- Cassotti, Mathieu, Anaëlle Camarda, Nicolas Poirel, Olivier Houdé, and Marine Agogué. 2016. Fixation Effect in Creative Ideas Generation: Opposite Impacts of Example in Children and Adults. *Thinking Skills and Creativity* 19: 146–52. [CrossRef]
- Chameroy, Fabienne, and Lucien Veran. 2014. Immatérialité de La Qualité et Effet Des Labels Sur Le Consentement à Payer. *Management International* 18: 32–44. [CrossRef]

- Chiu, Fa-Chung. 2015. Improving Your Creative Potential without Awareness: Overinclusive Thinking Training. *Thinking Skills and Creativity* 15: 1–12. [CrossRef]
- Chulvi, Vicente, Elena Mulet, Amaresh Chakrabarti, Belinda López-Mesa, and Carmen González-Cruz. 2012. Comparison of the Degree of Creativity in the Design Outcomes Using Different Design Methods. *Journal of Engineering Design* 23: 241–69. [CrossRef]
- Cinque, Maria. 2016. 'Lost in Translation'. Soft Skills Development in European Countries. *Tuning Journal for Higher Education* 3: 389–427. [CrossRef]
- Cömert, Musa, Jördis Maria Zill, Eva Christalle, Jörg Dirmaier, Martin Härter, and Isabelle Scholl. 2016. Assessing Communication Skills of Medical Students in Objective Structured Clinical Examinations (OSCE) - A Systematic Review of Rating Scales. *PLoS ONE* 11: e0152717. [CrossRef]
- Corazza, Giovanni Emanuele. 2016. Potential Originality and Effectiveness: The Dynamic Definition of Creativity. *Creativity Research Journal* 28: 258–67. [CrossRef]
- Corazza, Giovanni Emanuele, Frédéric Darbellay, Todd Lubart, and Chiara Panciroli. 2021. Developing Intelligence and Creativity in Education: Insights from the Space–Time Continuum. In *Creativity and Learning*. Edited by Soila Lemmetty, Kaija Collin, Vlad Glăveanu and Panu Forsman. Cham: Springer International Publishing, pp. 69–87. [CrossRef]
- Cotter, Katherine N., Ronald A. Beghetto, and James C. Kaufman. 2022. Creativity in the Classroom: Advice for Best Practices. In *Homo Creativus*. Edited by Todd Lubart, Marion Botella, Samira Bourgeois-Bougrine, Xavier Caroff, Jérôme Guégan, Christohe Mouchiroud, Julien Nelson and Franck Zenasni. Cham: Springer International Publishing, pp. 249–64. [CrossRef]
- Curtis, J. Randall, Anthony L. Back, Dee W. Ford, Lois Downey, Sarah E. Shannon, Ardith Z. Doorenbos, Erin K. Kross, Lynn F. Reinke, Laura C. Feemster, Barbara Edlund, and et al. 2013. Effect of Communication Skills Training for Residents and Nurse Practitioners on Quality of Communication with Patients with Serious Illness: A Randomized Trial. *JAMA: The Journal of the American Medical Association* 310: 2271. [CrossRef]
- D'Alimonte, Laura, Elizabeth McLaney, and Lisa Di Prospero. 2019. Best Practices on Team Communication: Interprofessional Practice in Oncology. *Current Opinion in Supportive and Palliative Care* 13: 69–74. [CrossRef]
- de Freitas, Sara. 2006. *Learning in Immersive Worlds: A Review of Game-Based Learning*. Bristol: JISC. Available online: http://www.jisc.ac.uk/media/documents/programmes/elearninginnovation/gamingreport_v3.pdf (accessed on 1 November 2022).
- Détienne, Françoise, Michael Baker, and Jean-Marie Burkhardt. 2012. Perspectives on Quality of Collaboration in Design. *CoDesign* 8: 197–99. [CrossRef]
- Diedrich, Jennifer, Emanuel Jauk, Paul J. Silvia, Jeffrey M. Gredlein, Aljoscha C. Neubauer, and Mathias Benedek. 2018. Assessment of Real-Life Creativity: The Inventory of Creative Activities and Achievements (ICAA). *Psychology of Aesthetics, Creativity, and the Arts* 12: 304–16. [CrossRef]
- Doyle, Denise. 2021. Creative and Collaborative Practices in Virtual Immersive Environments. In *Creativity in the Twenty First Century*. Edited by Anna Hui and Christian Wagner. Cham: Springer International Publishing, pp. 3–19. [CrossRef]
- Drisko, James W. 2014. Competencies and Their Assessment. *Journal of Social Work Education* 50: 414–26. [CrossRef]
- Dul, Jan, and Canan Ceylan. 2011. Work Environments for Employee Creativity. *Ergonomics* 54: 12–20. [CrossRef] [PubMed]
- Dumitru, Daniela, Dragos Bigu, Jan Elen, Aoife Ahern, Ciaran McNally, and John O'Sullivan. 2018. *A European Review on Critical Thinking Educational Practices in Higher Education Institutions*. Vila Real: UTAD. Available online: <http://repositorio.utad.pt/handle/10348/8320> (accessed on 2 November 2022).
- Edelman, Jonathan, Babajide Owoyele, and Joaquin Santuber. 2022. Beyond Brainstorming: Introducing Medgi, an Effective, Research-Based Method for Structured Concept Development. In *Design Thinking in Education*. Cham: Springer International Publishing, pp. 209–32. [CrossRef]
- Etilé, Fabrice, and Sabrina Teyssier. 2016. Signaling Corporate Social Responsibility: Third-Party Certification versus Brands: Signaling CSR: Third-Party Certification versus Brands. *The Scandinavian Journal of Economics* 118: 397–432. [CrossRef]
- Evans, Carla. 2020. *Measuring Student Success Skills: A Review of the Literature on Collaboration*. Dover: National Center for the Improvement of Educational Assessment.
- Facione, Peter Arthur. 1990a. The California Critical Thinking Skills Test—College Level. Technical Report# 1. Experimental Validation and Content Validity. Available online: <https://files.eric.ed.gov/fulltext/ED327549.pdf> (accessed on 2 November 2022).
- Facione, Peter Arthur. 1990b. *Critical Thinking: A Statement of Expert Consensus for Purposes of Educational Assessment and Instruction. Research Findings and Recommendations*. Washington, DC: ERIC, Institute of Education Sciences, pp. 1–112. Available online: <https://eric.ed.gov/?id=ED315423> (accessed on 2 November 2022).
- Facione, Peter Arthur. 2011. Critical thinking: What it is and why it counts. *Insight Assessment* 2007: 1–23.
- Faidley, Joel. 2018. Comparison of Learning Outcomes from Online and Face-to-Face Accounting Courses. Ph.D. dissertation, East Tennessee State University, Johnson City, TN, USA.
- Friedman, Hershey H. 2017. Cognitive Biases That Interfere with Critical Thinking and Scientific Reasoning: A Course Module. *SSRN Electronic Journal* 1–60. [CrossRef]
- Fryer-Edwards, Kelly, Robert M. Arnold, Walter Baile, James A. Tulsy, Frances Petracca, and Anthony Back. 2006. Reflective Teaching Practices: An Approach to Teaching Communication Skills in a Small-Group Setting. *Academic Medicine: Journal of the Association of American Medical Colleges* 81: 638–44. [CrossRef]
- Glăveanu, Vlad Petre. 2013. Rewriting the Language of Creativity: The Five A's Framework. *Review of General Psychology: Journal of Division 1, of the American Psychological Association* 17: 69–81. [CrossRef]

- Glăveanu, Vlad Petre. 2014. The Psychology of Creativity: A Critical Reading. *Creativity Theories Research Applications* 1: 10–32. [CrossRef]
- Goldenberg, Olga, and Jennifer Wiley. 2011. Quality, Conformity, and Conflict: Questioning the Assumptions of Osborn's Brainstorming Technique. *The Journal of Problem Solving* 3: 96–118. [CrossRef]
- Graesser, Arthur C., John P. Sabatini, and Haiying Li. 2022. Educational Psychology Is Evolving to Accommodate Technology, Multiple Disciplines, and Twenty-First-Century Skills. *Annual Review of Psychology* 73: 547–74. [CrossRef]
- Graesser, Arthur C., Stephen M. Fiore, Samuel Greiff, Jessica Andrews-Todd, Peter W. Foltz, and Friedrich W. Hesse. 2018. Advancing the Science of Collaborative Problem Solving. *Psychological Science in the Public Interest* 19: 59–92. [CrossRef] [PubMed]
- Grassmann, Susanne. 2014. The pragmatics of word learning. In *Pragmatic Development in First Language Acquisition*. Edited by Danielle Matthews. Amsterdam: John Benjamins Publishing Company, pp. 139–60. [CrossRef]
- Hager, Keri, Catherine St Hill, Jacob Prunuske, Michael Swanoski, Grant Anderson, and May Nawal Lutfiyya. 2016. Development of an Interprofessional and Interdisciplinary Collaborative Research Practice for Clinical Faculty. *Journal of Interprofessional Care* 30: 265–67. [CrossRef] [PubMed]
- Halpern, Diane F. 1998. Teaching Critical Thinking for Transfer across Domains: Disposition, Skills, Structure Training, and Metacognitive Monitoring. *The American Psychologist* 53: 449–55. [CrossRef] [PubMed]
- Halpern, Diane F., and Dana S. Dunn. 2021. Critical Thinking: A Model of Intelligence for Solving Real-World Problems. *Journal of Intelligence* 9: 22. [CrossRef]
- Hanover Research. 2012. A Crosswalk of 21st Century Skills. Available online: <http://www.hanoverresearch.com/wp-content/uploads/2011/12/A-Crosswalk-of-21st-Century-Skills-Membership.pdf> (accessed on 15 August 2022).
- Hathaway, Julia R., Beth A. Tarini, Sushmita Banerjee, Caroline O. Smolkin, Jessica A. Koos, and Susmita Pati. 2022. Healthcare Team Communication Training in the United States: A Scoping Review. *Health Communication* 1–26. [CrossRef]
- Hesse, Friedrich, Esther Care, Juergen Buder, Kai Sassenberg, and Patrick Griffin. 2015. A Framework for Teachable Collaborative Problem Solving Skills. In *Assessment and Teaching of 21st Century Skills*. Edited by Patrick Griffin and Esther Care. Dordrecht: Springer Netherlands, pp. 37–56.
- Hitchcock, David. 2020. Critical Thinking. In *The Stanford Encyclopedia of Philosophy (Fall 2020 Edition)*. Edited by Nouri Zalta Edward. Stanford: Stanford University.
- Houdé, Olivier. 2000. Inhibition and cognitive development: Object, number, categorization, and reasoning. *Cognitive Development* 15: 63–73. [CrossRef]
- Houdé, Olivier, and Grégoire Borst. 2014. Measuring inhibitory control in children and adults: Brain imaging and mental chronometry. *Frontiers in Psychology* 5: 616. [CrossRef]
- Huber, Christopher R., and Nathan R. Kuncel. 2016. Does College Teach Critical Thinking? A Meta-Analysis. *Review of Educational Research* 86: 431–68. [CrossRef]
- Huizinga, Johan. 1949. *Homo Ludens: A Study of the Play-Elements in Culture*. London: Routledge.
- Humphrey, Neil, Andrew Curran, Elisabeth Morris, Peter Farrell, and Kevin Woods. 2007. Emotional Intelligence and Education: A Critical Review. *Educational Psychology* 27: 235–54. [CrossRef]
- International Institute for Competency Development. 2021. 21st Century Skills 4Cs Labelization. Available online: <https://icd-hr21.org/offers/21st-century-competencies/> (accessed on 2 November 2022).
- Jackson, Denise. 2014. Business Graduate Performance in Oral Communication Skills and Strategies for Improvement. *The International Journal of Management Education* 12: 22–34. [CrossRef]
- Jahn, Gabriele, Matthias Schramm, and Achim Spiller. 2005. The Reliability of Certification: Quality Labels as a Consumer Policy Tool. *Journal of Consumer Policy* 28: 53–73. [CrossRef]
- Jauk, Emanuel, Mathias Benedek, and Aljoscha C. Neubauer. 2014. The Road to Creative Achievement: A Latent Variable Model of Ability and Personality Predictors. *European Journal of Personality* 28: 95–105. [CrossRef]
- Joie-La Marle, Chantal, François Parmentier, Morgane Coltel, Todd Lubart, and Xavier Borteyrou. 2022. A Systematic Review of Soft Skills Taxonomies: Descriptive and Conceptual Work. Available online: <https://doi.org/10.31234/osf.io/mszgj> (accessed on 2 November 2022).
- Jones, Stanley E., and Curtis D. LeBaron. 2002. Research on the Relationship between Verbal and Nonverbal Communication: Emerging Integrations. *The Journal of Communication* 52: 499–521. [CrossRef]
- Kaendler, Celia, Michael Wiedmann, Timo Leuders, Nikol Rummel, and Hans Spada. 2016. Monitoring Student Interaction during Collaborative Learning: Design and Evaluation of a Training Program for Pre-Service Teachers. *Psychology Learning & Teaching* 15: 44–64. [CrossRef]
- Kahneman, Daniel. 2003. A Perspective on Judgment and Choice: Mapping Bounded Rationality. *The American Psychologist* 58: 697–720. [CrossRef]
- Kahneman, Daniel. 2011. *Thinking, Fast and Slow*. New York: Macmillan.
- Karl, Katherine A., Joy V. Peluchette, and Navid Aghakhani. 2022. Virtual Work Meetings during the COVID-19 Pandemic: The Good, Bad, and Ugly. *Small Group Research* 53: 343–65. [CrossRef]
- Keefer, Kateryna V., James D. A. Parker, and Donald H. Saklofske. 2018. Three Decades of Emotional Intelligence Research: Perennial Issues, Emerging Trends, and Lessons Learned in Education: Introduction to Emotional Intelligence in Education. In *The Springer Series on Human Exceptionality*. Cham: Springer International Publishing, pp. 1–19.

- Kemp, Nenagh, and Rachel Grieve. 2014. Face-to-Face or Face-to-Screen? Undergraduates' Opinions and Test Performance in Classroom vs. Online Learning. *Frontiers in Psychology* 5: 1278. [CrossRef]
- Kimery, Kathryn, and Mary McCord. 2002. Third-Party Assurances: Mapping the Road to Trust in E-retailing. *The Journal of Information Technology Theory and Application* 4: 63–82.
- Kohn, Nicholas W., and Steven M. Smith. 2011. Collaborative Fixation: Effects of Others' Ideas on Brainstorming. *Applied Cognitive Psychology* 25: 359–71. [CrossRef]
- Kowaltowski, Doris C. C. K., Giovana Bianchi, and Valéria Teixeira de Paiva. 2010. Methods That May Stimulate Creativity and Their Use in Architectural Design Education. *International Journal of Technology and Design Education* 20: 453–76. [CrossRef]
- Kruijver, Irma P. M., Ada Kerkstra, Anneke L. Francke, Jozien M. Bensing, and Harry B. M. van de Wiel. 2000. Evaluation of Communication Training Programs in Nursing Care: A Review of the Literature. *Patient Education and Counseling* 39: 129–45. [CrossRef] [PubMed]
- Lai, Emily R. 2011. Critical thinking: A literature review. *Pearson's Research Reports* 6: 40–41. [CrossRef]
- Lamri, Jérémy, and Todd Lubart. 2021. Creativity and Its' Relationships with 21st Century Skills in Job Performance. *Kindai Management Review* 9: 75–91.
- Lamri, Jérémy, Michel Barabel, Olivier Meier, and Todd Lubart. 2022. *Le Défi Des Soft Skills: Comment les Développer au XXIe Siècle?* Paris: Dunod.
- Landa, Rebecca J. 2005. Assessment of Social Communication Skills in Preschoolers: Assessing Social Communication Skills in Children. *Mental Retardation and Developmental Disabilities Research Reviews* 11: 247–52. [CrossRef]
- Lee, Sang M., Jeongil Choi, and Sang-Gun Lee. 2004. The impact of a third-party assurance seal in customer purchasing intention. *Journal of Internet Commerce* 3: 33–51. [CrossRef]
- Lewis, Arthur, and David Smith. 1993. Defining Higher Order Thinking. *Theory into Practice* 32: 131–37. [CrossRef]
- Liu, Ou Lydia, Lois Frankel, and Katrina Crofts Roohr. 2014. Assessing Critical Thinking in Higher Education: Current State and Directions for next-Generation Assessment: Assessing Critical Thinking in Higher Education. *ETS Research Report Series 2014*: 1–23. [CrossRef]
- Lubart, Todd. 2017. The 7 C's of Creativity. *The Journal of Creative Behavior* 51: 293–96. [CrossRef]
- Lubart, Todd, and Branden Thornhill-Miller. 2019. Creativity: An Overview of the 7C's of Creative Thought. *Heidelberg: Heidelberg University Publishing*. [CrossRef]
- Lubart, Todd, Baptiste Barbot, and Maud Besançon. 2019. Creative Potential: Assessment Issues and the EPoC Battery/Potencial Creativo: Temas de Evaluación y Batería EPoC. *Estudios de Psicología* 40: 540–62. [CrossRef]
- Lubart, Todd, Franck Zenasni, and Baptiste Barbot. 2013. Creative potential and its measurement. *International Journal of Talent Development and Creativity* 1: 41–51.
- Lubart, Tubart, and Branden Thornhill-Miller. 2021. Creativity in Law: Legal Professions and the Creative Profiler Approach. In *Mapping Legal Innovation: Trends and Perspectives*. Edited by Antoine Masson and Gavin Robinson. Cham: Springer International Publishing, pp. 1–19. [CrossRef]
- Lubin, Jeffrey, Stephan Hendrick, Branden Thornhill-Miller, Maxence Mercier, and Todd Lubart. Forthcoming. Creativity in Solution-Focused Brief Therapy.
- Lucas, Bill. 2019. *Why We Need to Stop Talking about Twenty-First Century Skills*. Melbourne: Centre for Strategic Education.
- Lucas, Bill. 2022. *Creative Thinking in Schools across the World*. London: The Global Institute of Creative Thinking.
- Lucas, Bill, and Guy Claxton. 2009. *Wider Skills for Learning: What Are They, How Can They Be Cultivated, How Could They Be Measured and Why Are They Important for Innovation?* London: NESTA.
- Malaby, Thomas M. 2007. Beyond Play: A New Approach to Games. *Games and Culture* 2: 95–113. [CrossRef]
- Marin, Lisa M., and Diane F. Halpern. 2011. Pedagogy for developing critical thinking in adolescents: Explicit instruction produces greatest gains. *Thinking Skills and Creativity* 6: 1–13. [CrossRef]
- Mathieu, John E., John R. Hollenbeck, Daan van Knippenberg, and Daniel R. Ilgen. 2017. A Century of Work Teams in the Journal of Applied Psychology. *The Journal of Applied Psychology* 102: 452–67. [CrossRef]
- Matthews, Danielle. 2014. *Pragmatic Development in First Language Acquisition*. Amsterdam: John Benjamins Publishing Company. [CrossRef]
- McDonald, Skye, Alison Gowland, Rebekah Randall, Alana Fisher, Katie Osborne-Crowley, and Cynthia Honan. 2014. Cognitive Factors Underpinning Poor Expressive Communication Skills after Traumatic Brain Injury: Theory of Mind or Executive Function? *Neuropsychology* 28: 801–11. [CrossRef]
- Moore, Brooke Noel, and Richard Parker. 2016. *Critical Thinking*, 20th ed. New York: McGraw-Hill Education.
- Morreale, Sherwyn P., Joseph M. Valenzano, and Janessa A. Bauer. 2017. Why Communication Education Is Important: A Third Study on the Centrality of the Discipline's Content and Pedagogy. *Communication Education* 66: 402–22. [CrossRef]
- Mourad, Maha. 2017. Quality Assurance as a Driver of Information Management Strategy: Stakeholders' Perspectives in Higher Education. *Journal of Enterprise Information Management* 30: 779–94. [CrossRef]
- National Education Association. 2011. *Preparing 21st Century Students for a Global Society: An Educator's Guide to the "Four Cs"*. Alexandria: National Education Association.

- Nouri, Jalal, Anna Åkerfeldt, Uno Fors, and Staffan Selander. 2017. Assessing Collaborative Problem Solving Skills in Technology-Enhanced Learning Environments—The PISA Framework and Modes of Communication. *International Journal of Emerging Technologies in Learning (IJET)* 12: 163. [CrossRef]
- O'Carroll, Veronica, Melissa Owens, Michael Sy, Alla El-Awaisi, Andreas Xyrichis, Jacqueline Leigh, Shobhana Nagraj, Marion Huber, Maggie Hutchings, and Angus McFadyen. 2021. Top Tips for Interprofessional Education and Collaborative Practice Research: A Guide for Students and Early Career Researchers. *Journal of Interprofessional Care* 35: 328–33. [CrossRef]
- OECD. 2017. PISA 2015 collaborative problem-solving framework. In *PISA 2015 Assessment and Analytical Framework: Science, Reading, Mathematic, Financial Literacy and Collaborative Problem Solving*. Paris: OECD Publishing. [CrossRef]
- OECD. 2019a. *Framework for the Assessment of Creative Thinking in PISA 2021: Third Draft*. Paris: OECD. Available online: <https://www.oecd.org/pisa/publications/PISA-2021-creative-thinking-framework.pdf> (accessed on 2 November 2022).
- OECD. 2019b. *Future of Education and Skills 2030: A Series of Concept Notes*. Paris: OECD Learning Compass. Available online: https://www.oecd.org/education/2030-project/teaching-and-learning/learning/learning-compass-2030/OECD_Learning_Compass_2030_Concept_Note_Series.pdf (accessed on 2 November 2022).
- Osborn, A. F. 1953. *Applied Imagination*. New York: Charles Scribner's Sons.
- Parkinson, Thomas L. 1975. The Role of Seals and Certifications of Approval in Consumer Decision-Making. *The Journal of Consumer Affairs* 9: 1–14. [CrossRef]
- Partnership for 21st Century Skills. 2008. *21st Century Skills Education and Competitiveness: A Resource and Policy Guide*. Tuscon: Partnership for 21st Century Skills.
- Pasquinelli, Elena, and Gérald Bronner. 2021. *Éduquer à l'esprit critique. Bases théoriques et indications pratiques pour l'enseignement et la formation*. Rapport du Conseil Scientifique de l'Éducation Nationale. Paris: Ministère de l'Éducation Nationale, de la JEUNESSE et des Sports.
- Pasquinelli, Elena, Mathieu Farina, Audrey Bedel, and Roberto Casati. 2021. Naturalizing Critical Thinking: Consequences for Education, Blueprint for Future Research in Cognitive Science. *Mind, Brain and Education: The Official Journal of the International Mind, Brain, and Education Society* 15: 168–76. [CrossRef]
- Paul, Richard, and Linda Elder. 2006. Critical thinking: The nature of critical and creative thought. *Journal of Developmental Education* 30: 34–35.
- Paulus, Paul B., and Huei-Chuan Yang. 2000. Idea Generation in Groups: A Basis for Creativity in Organizations. *Organizational Behavior and Human Decision Processes* 82: 76–87. [CrossRef]
- Paulus, Paul B., and Jared B. Kenworthy. 2019. Effective brainstorming. In *The Oxford Handbook of Group Creativity and Innovation*. Edited by Paul B. Paulus and Bernard A. Nijstad. New York: Oxford University Press. [CrossRef]
- Paulus, Paul B., and Mary T. Dzindolet. 1993. Social Influence Processes in Group Brainstorming. *Journal of Personality and Social Psychology* 64: 575–86. [CrossRef]
- Paulus, Paul B., and Vincent R. Brown. 2007. Toward More Creative and Innovative Group Idea Generation: A Cognitive-Social-Motivational Perspective of Brainstorming: Cognitive-Social-Motivational View of Brainstorming. *Social and Personality Psychology Compass* 1: 248–65. [CrossRef]
- Peddle, Monica, Margaret Bearman, Natalie Radomski, Lisa Mckenna, and Debra Nestel. 2018. What Non-Technical Skills Competencies Are Addressed by Australian Standards Documents for Health Professionals Who Work in Secondary and Tertiary Clinical Settings? A Qualitative Comparative Analysis. *BMJ Open* 8: e020799. [CrossRef]
- Peña-López, Ismaël. 2017. *PISA 2015 Results (Volume V): Collaborative Problem Solving*. Paris: PISA, OECD Publishing.
- Popil, Inna. 2011. Promotion of Critical Thinking by Using Case Studies as Teaching Method. *Nurse Education Today* 31: 204–7. [CrossRef]
- Pornpitakpan, Chanthika. 2004. The Persuasiveness of Source Credibility: A Critical Review of Five Decades' Evidence. *Journal of Applied Social Psychology* 34: 243–81. [CrossRef]
- Possin, Kevin. 2014. Critique of the Watson-Glaser Critical Thinking Appraisal Test: The More You Know, the Lower Your Score. *Informal Logic* 34: 393–416. [CrossRef]
- Proctor, Robert W., and Addie Dutta. 1995. *Skill Acquisition and Human Performance*. Thousand Oaks: Sage Publications, Inc.
- Putman, Vicky L., and Paul B. Paulus. 2009. Brainstorming, Brainstorming Rules and Decision Making. *The Journal of Creative Behavior* 43: 29–40. [CrossRef]
- Reiman, Joey. 1992. *Success: The Original Handbook*. Atlanta: Longstreet Press.
- Ren, Xuezhu, Yan Tong, Peng Peng, and Tengfei Wang. 2020. Critical Thinking Predicts Academic Performance beyond General Cognitive Ability: Evidence from Adults and Children. *Intelligence* 82: 101487. [CrossRef]
- Renard, Marie-Christine. 2005. Quality Certification, Regulation and Power in Fair Trade. *Journal of Rural Studies* 21: 419–31. [CrossRef]
- Restout, Emilie. 2020. Labels RSE: Un décryptage des entreprises labellisées en France. *Goodwill Management*. Available online: <https://goodwill-management.com/labels-rse-decryptage-entreprises-labellisees/> (accessed on 2 November 2022).
- Rhodes, Mel. 1961. An Analysis of Creativity. *The Phi Delta Kappan* 42: 305–10.
- Rider, Elizabeth A., and Constance H. Keefer. 2006. Communication Skills Competencies: Definitions and a Teaching Toolbox: Communication. *Medical Education* 40: 624–29. [CrossRef]
- Riemer, Marc J. 2007. Communication Skills for the 21st Century Engineer. *Global Journal of Engineering Education* 11: 89.

- Rietzschel, Eric F., Bernard A. Nijstad, and Wolfgang Stroebe. 2006. Productivity Is Not Enough: A Comparison of Interactive and Nominal Brainstorming Groups on Idea Generation and Selection. *Journal of Experimental Social Psychology* 42: 244–51. [CrossRef]
- Ross, David. 2018. Why the Four Cs Will Become the Foundation of Human-AI Interface. Available online: <https://www.gettingsmart.com/2018/03/04/why-the-4cs-will-become-the-foundation-of-human-ai-interface/> (accessed on 2 November 2022).
- Rothermich, Kathrin. 2020. Social Communication Across the Lifespan: The Influence of Empathy [Preprint]. *SocArXiv*. [CrossRef]
- Rusdin, Norazlin Mohd, and Siti Rahaimah Ali. 2019. Practice of Fostering 4Cs Skills in Teaching and Learning. *International Journal of Academic Research in Business and Social Sciences* 9: 1021–35. [CrossRef] [PubMed]
- Rychen, Dominique Simone, and Salganik Laura Hersch, eds. 2003. *Key Competencies for a Successful Life and a Well-Functioning Society*. Cambridge: Hogrefe and Huber.
- Sahin, Mehmet Can. 2009. Instructional Design Principles for 21st Century Learning Skills. *Procedia, Social and Behavioral Sciences* 1: 1464–68. [CrossRef]
- Salas, Eduardo, Kevin C. Stagl, and C. Shawn Burke. 2004. 25 Years of Team Effectiveness in Organizations: Research Themes and Emerging Needs. In *International Review of Industrial and Organizational Psychology*. Chichester: John Wiley & Sons, Ltd., pp. 47–91. [CrossRef]
- Salas, Eduardo, Marissa L. Shuffler, Amanda L. Thayer, Wendy L. Bedwell, and Elizabeth H. Lazzara. 2015. Understanding and Improving Teamwork in Organizations: A Scientifically Based Practical Guide. *Human Resource Management* 54: 599–622. [CrossRef]
- Salmi, Jamil. 2017. *The Tertiary Education Imperative: Knowledge, Skills and Values for Development*. Cham: Springer.
- Samani, Sanaz Ahmadpoor, Siti Zaleha Binti Abdul Rasid, and Saudah bt Sofian. 2014. A Workplace to Support Creativity. *Industrial Engineering & Management Systems* 13: 414–20. [CrossRef]
- Saroyan, Alenoush. 2022. *Fostering Creativity and Critical Thinking in University Teaching and Learning: Considerations for Academics and Their Professional Learning*. Paris: OECD. [CrossRef]
- Sasmita, Jumiati, and Norazah Mohd Suki. 2015. Young consumers' insights on brand equity: Effects of brand association, brand loyalty, brand awareness, and brand image. *International Journal of Retail & Distribution Management* 43: 276–92. [CrossRef]
- Schlegel, Claudia, Ulrich Woermann, Maya Shaha, Jan-Joost Rethans, and Cees van der Vleuten. 2012. Effects of Communication Training on Real Practice Performance: A Role-Play Module versus a Standardized Patient Module. *The Journal of Nursing Education* 51: 16–22. [CrossRef]
- Schleicher, Andreas. 2022. *Why Creativity and Creative Teaching and Learning Matter Today and for Tomorrow's World*. Creativity in Education Summit 2022. Paris: GloCT in Collaboration with OECD CERL.
- Schneider, Bertrand, Kshitij Sharma, Sebastien Cuendet, Guillaume Zufferey, Pierre Dillenbourg, and Roy Pea. 2018. Leveraging Mobile Eye-Trackers to Capture Joint Visual Attention in Co-Located Collaborative Learning Groups. *International Journal of Computer-Supported Collaborative Learning* 13: 241–61. [CrossRef]
- Schultz, David M. 2010. Eloquent Science: A course to improve scientific and communication skills. Paper presented at the 19th Symposium on Education, Atlanta, GA, USA, January 18–21.
- Scialabba, George. 1984. Mindplay. *Harvard Magazine* 16: 19.
- Scott, Ginamarie, Lyle E. Leritz, and Michael D. Mumford. 2004. The Effectiveness of Creativity Training: A Quantitative Review. *Creativity Research Journal* 16: 361–88. [CrossRef]
- Sigafoos, Jeff, Ralf W. Schlosser, Vanessa A. Green, Mark O'Reilly, and Giulio E. Lancioni. 2008. Communication and Social Skills Assessment. In *Clinical Assessment and Intervention for Autism Spectrum Disorders*. Edited by Johnny L. Matson. Amsterdam: Elsevier, pp. 165–92. [CrossRef]
- Simonton, Dean Keith. 1999. Creativity from a Historiometric Perspective. In *Handbook of Creativity*. Edited by Robert J. Sternberg. Cambridge: Cambridge University Press, pp. 116–34. [CrossRef]
- Singh, Pallavi, Hillol Bala, Bidit Lal Dey, and Raffaele Filieri. 2022. Enforced Remote Working: The Impact of Digital Platform-Induced Stress and Remote Working Experience on Technology Exhaustion and Subjective Wellbeing. *Journal of Business Research* 151: 269–86. [CrossRef] [PubMed]
- Spada, Hans, Anne Meier, Nikol Rummel, and Sabine Hauser. 2005. A New Method to Assess the Quality of Collaborative Process in CSCL. In *Proceedings of the 2005 Conference on Computer Support for Collaborative Learning Learning 2005: The next 10 Years!—CSCL'05, Taipei, Taiwan, May 30–June 4*. Morristown: Association for Computational Linguistics.
- Spitzberg, Brian H. 2003. Methods of interpersonal skill assessment. In *The Handbook of Communication and Social Interaction Skills*. Edited by John O. Greene and Brant R. Burlinson. Mahwah: Lawrence Erlbaum Associates.
- Sternberg, Robert. 1986. Intelligence, Wisdom, and Creativity: Three Is Better than One. *Educational Psychologist* 21: 175–90. [CrossRef]
- Sternberg, Robert J., and Joachim Funke. 2019. *The Psychology of Human Thought: An Introduction*. Heidelberg: Heidelberg University Publishing (heiUP). [CrossRef]
- Sursock, Andrée. 2021. Quality assurance and rankings: Some European lessons. In *Research Handbook on University Rankings*. Edited by Ellen Hazelkorn and Georgiana Mihut. Cheltenham: Edward Elgar Publishing, pp. 185–96. [CrossRef]
- Sursock, Andrée, and Oliver Vettori. 2017. Quo vadis, quality culture? Theses from different perspectives. In *Qualitätskultur. Ein Blick in Die Gelebte Praxis der Hochschulen*. Vienna: Agency for Quality Assurance and Accreditation, pp. 13–18. Available online: <https://www.aq.ac.at/de/ueber-uns/publikationen/sonstige-publikationen.php> (accessed on 2 November 2022).

- Sutter, Éric. 2005. Certification et Labellisation: Un Problème de Confiance. *Bref Panorama de La Situation Actuelle. Documentaliste-Sciences de l'Information* 42: 284–90. [CrossRef]
- Taddei, François. 2009. *Training Creative and Collaborative Knowledge-Builders: A Major Challenge for 21st Century Education*. Paris: OCDE.
- Thomas, Keith, and Beatrice Lok. 2015. Teaching Critical Thinking: An Operational Framework. In *The Palgrave Handbook of Critical Thinking in Higher Education*. Edited by Martin Davies and Ronald Barnett. New York: Palgrave Macmillan US, pp. 93–105. [CrossRef]
- Thompson, Jeri. 2020. *Measuring Student Success Skills: A Review of the Literature on Complex Communication*. Dover: National Center for the Improvement of Educational Assessment.
- Thorndahl, Kathrine L., and Diana Stentoft. 2020. Thinking Critically about Critical Thinking and Problem-Based Learning in Higher Education: A Scoping Review. *Interdisciplinary Journal of Problem-Based Learning* 14. [CrossRef]
- Thornhill-Miller, Branden. 2021. 'Crea-Critical-Collab-ication': A Dynamic Interactionist Model of the 4Cs (Creativity, Critical Thinking, Collaboration and Communication). Available online: <http://thornhill-miller.com/newWordpress/index.php/current-research/> (accessed on 2 November 2022).
- Thornhill-Miller, Branden, and Jean-Marc Dupont. 2016. Virtual Reality and the Enhancement of Creativity and Innovation: Underrecognized Potential Among Converging Technologies? *Journal for Cognitive Education and Psychology* 15: 102–21. [CrossRef]
- Thornhill-Miller, Branden, and Peter Millican. 2015. The Common-Core/Diversity Dilemma: Revisions of Humean Thought, New Empirical Research, and the Limits of Rational Religious Belief. *European Journal for Philosophy of Religion* 7: 1–49. [CrossRef]
- Tomasello, Michael. 2005. *Constructing a Language: A Usage-Based Theory of Language Acquisition*. Cambridge: Harvard University Press. [CrossRef]
- Uribe-Enciso, Olga Lucía, Diana Sofía Uribe-Enciso, and María Del Pilar Vargas-Daza. 2017. Pensamiento Crítico y Su Importancia En La Educación: Algunas Reflexiones. *Rastros Rostros* 19. [CrossRef]
- van der Vleuten, Cees, Valerie van den Eertwegh, and Esther Giroldi. 2019. Assessment of Communication Skills. *Patient Education and Counseling* 102: 2110–13. [CrossRef]
- van Klink, Marcel R., and Jo Boon. 2003. Competencies: The triumph of a fuzzy concept. *International Journal of Human Resources Development and Management* 3: 125–37. [CrossRef]
- van Laar, Ester, Alexander J. A. M. Van Deursen, Jan A. G. M. Van Dijk, and Jos de Haan. 2017. The Relation between 21st-Century Skills and Digital Skills: A Systematic Literature Review. *Computers in Human Behavior* 72: 577–88. [CrossRef]
- van Rosmalen, Peter, Elizabeth A. Boyle, Rob Nadolski, John van der Baaren, Baltasar Fernández-Manjón, Ewan MacArthur, Tiina Pennanen, Madalina Manea, and Kam Star. 2014. Acquiring 21st Century Skills: Gaining Insight into the Design and Applicability of a Serious Game with 4C-ID. In *Lecture Notes in Computer Science*. Cham: Springer International Publishing, pp. 327–34. [CrossRef]
- Vincent-Lancrin, Stéphan, Carlos González-Sancho, Mathias Bouckaert, Federico de Luca, Meritxell Fernández-Barrerra, Gwénaél Jacotin, Joaquin Urgel, and Quentin Vidal. 2019. *Fostering Students' Creativity and Critical Thinking: What It Means in School*. Paris: OECD Publishing. [CrossRef]
- Voogt, Joke, and Natalie Pareja Roblin. 2012. A Comparative Analysis of International Frameworks for 21st Century Competences: Implications for National Curriculum Policies. *Journal of Curriculum Studies* 44: 299–321. [CrossRef]
- Waizenegger, Lena, Brad McKenna, Wenjie Cai, and Taino Bendz. 2020. An Affordance Perspective of Team Collaboration and Enforced Working from Home during COVID-19. *European Journal of Information Systems: An Official Journal of the Operational Research Society* 29: 429–42. [CrossRef]
- Watson, Goodwin. 1980. *Watson-Glaser Critical Thinking Appraisal*. San Antonio: Psychological Corporation.
- Watson, Goodwin, and Edwin M. Glaser. 2010. Watson-Glaser TM II critical thinking appraisal. In *Technical Manual and User's Guide*. Kansas City: Pearson.
- Weick, Karl E. 1993. The collapse of sensemaking in organizations: The Mann Gulch disaster. *Administrative Science Quarterly* 38: 628–52. [CrossRef]
- West, Richard F., Maggie E. Toplak, and Keith E. Stanovich. 2008. Heuristics and Biases as Measures of Critical Thinking: Associations with Cognitive Ability and Thinking Dispositions. *Journal of Educational Psychology* 100: 930–41. [CrossRef]
- Whitmore, Paul G. 1972. What are soft skills. Paper presented at the CONARC Soft Skills Conference, Fort Bliss, TX, USA, December 12–13, pp. 12–13.
- Willingham, Daniel T. 2008. Critical Thinking: Why Is It so Hard to Teach? *Arts Education Policy Review* 109: 21–32. [CrossRef]
- Wilson, Sarah Beth, and Pratibha Varma-Nelson. 2016. Small Groups, Significant Impact: A Review of Peer-Led Team Learning Research with Implications for STEM Education Researchers and Faculty. *Journal of Chemical Education* 93: 1686–702. [CrossRef]
- Winterton, Jonathan, Françoise Delamare-Le Deist, and Emma Stringfellow. 2006. *Typology of Knowledge, Skills and Competences: Clarification of the Concept and Prototype*. Luxembourg: Office for Official Publications of the European Communities.
- World Economic Forum. 2015. *New Vision for Education: Unlocking the Potential of Technology*. Geneva: World Economic Forum.
- World Economic Forum. 2020. The Future of Jobs Report 2020. Available online: <https://www.weforum.org/reports/the-future-of-jobs-report-2020> (accessed on 2 November 2022).
- World Health Organization. 2010. *Framework for Action on Interprofessional Education and Collaborative Practice*. No. WHO/HRH/HPN/10.3. Geneva: World Health Organization.

- Yue, Meng, Meng Zhang, Chunmei Zhang, and Changde Jin. 2017. The Effectiveness of Concept Mapping on Development of Critical Thinking in Nursing Education: A Systematic Review and Meta-Analysis. *Nurse Education Today* 52: 87–94. [[CrossRef](#)]
- Zielke, Stephan, and Thomas Dobbelstein. 2007. Customers' Willingness to Purchase New Store Brands. *Journal of Product & Brand Management* 16: 112–21. [[CrossRef](#)]
- Zlatic, Lidija, Dragana Bjekic, Snezana Marinkovic, and Milevica Bojovic. 2014. Development of Teacher Communication Competence. *Procedia, Social and Behavioral Sciences* 116: 606–10. [[CrossRef](#)]

Disclaimer/Publisher's Note: The statements, opinions and data contained in all publications are solely those of the individual author(s) and contributor(s) and not of MDPI and/or the editor(s). MDPI and/or the editor(s) disclaim responsibility for any injury to people or property resulting from any ideas, methods, instructions or products referred to in the content.