



**HAL**  
open science

# Celestial amplitudes and holography

Yorgo Pano

► **To cite this version:**

Yorgo Pano. Celestial amplitudes and holography. Physics [physics]. Institut Polytechnique de Paris, 2024. English. NNT: 2024IPPAX032 . tel-04719897

**HAL Id: tel-04719897**

**<https://theses.hal.science/tel-04719897v1>**

Submitted on 3 Oct 2024

**HAL** is a multi-disciplinary open access archive for the deposit and dissemination of scientific research documents, whether they are published or not. The documents may come from teaching and research institutions in France or abroad, or from public or private research centers.

L'archive ouverte pluridisciplinaire **HAL**, est destinée au dépôt et à la diffusion de documents scientifiques de niveau recherche, publiés ou non, émanant des établissements d'enseignement et de recherche français ou étrangers, des laboratoires publics ou privés.



INSTITUT  
POLYTECHNIQUE  
DE PARIS

NNT : 2024IPPAX032

Thèse de doctorat



# Celestial Amplitudes and Holography

Thèse de doctorat de l'Institut Polytechnique de Paris  
préparée à l'École Polytechnique

École doctorale n°626 École doctorale de l'Institut Polytechnique de Paris (EDIPP)  
Spécialité de doctorat: Physique

Thèse présentée et soutenue à Palaiseau, le 28/06/2024, par

**YORGO PANO**

Composition du Jury :

Glenn Barnich Professeur, Université libre de Bruxelles	Président
Tim Adamo Chargé de recherche, Université d'Edinburgh	Rapporteur
Laura Donnay Professeur adjoint, École internationale d'études avancées, Trieste	Rapporteur
Guillaume Bossard Chargé de recherche, Ecole Polytechnique, Palaiseau	Examineur
Andrea Puhm Professeur, Université d'Amsterdam	Directrice de thèse
Marios Petropoulos Professeur, Ecole Polytechnique, Palaiseau	Co-directeur de thèse

## Acknowledgments

I would like to thank my supervisor Andrea Puhm for her encouragement and her support throughout my Ph.D. and the members of the jury, Tim Adamo, Laura Donnay, Glenn Barnich, Guillaume Bossard and Marios Petropoulos, for accepting the task of evaluating my work. I would also like to thank the (ex) Ph.D. students and postdocs at the CPHT strings group as well as the permanent researchers for the rich exchanges, work-related or not. I especially would like to thank Filippo Sottovia and Majdouline Borji for the endless discussions about physics and life.

I would like to thank the lab director Jean-René Chazottes as well as Fadila Debbou, Malika Lang and Florence Auger for their help during the past four years.

Je voudrais aussi remercier mes amis pour leur soutien ainsi que les bons moments passés ensemble.

Je voudrais surtout remercier mon compagnon, Killian Guern, qui a infiniment enrichi ma vie par sa pensée et son amour.

Je remercie aussi sa famille qui m'a accueilli avec générosité.

Enfin je remercie ma famille, Thérèse, Salim et Gaëlle, qui ont façonné la personne que je suis aujourd'hui.

يا عمال العالم اتحدوا

## Abstract

The holographic principle puts forward a duality between a theory of quantum gravity in the bulk of spacetime and a conformal field theory at its boundary. The most fruitful realization of this conjecture is the AdS/CFT correspondence where observables in the bulk of a negatively curved spacetime can be recast in a codimension-one CFT. This provides new insight into quantum gravity using the powerful tools of conformal symmetry. However we have motive to explore the possible holographic nature of asymptotically flat spacetimes since they serve as a good approximation for physical phenomena such as particle scattering.

We therefore explore holographic properties of the S-matrix in asymptotically flat spacetimes in this thesis. For massless particles, performing a Mellin transform on the energies of the external particles expresses the scattering process in a basis of Lorentz eigenstates. The resulting celestial amplitude transforms as a conformal correlator in a codimension-two *celestial CFT*. However the scattering amplitude in momentum space is divergent and should be treated as a tempered distribution, i.e. by smearing it against rapidly decreasing test functions (wave packets). We therefore provide a well-defined setting for constructing celestial amplitudes by considering the Mellin transform of tempered distributions. We do so by characterizing the Mellin transform  $\tilde{\mathcal{M}}^+$  of the Schwartz space. The smearing in momentum space can then be expressed in the new conformal space and the two brackets are shown to be completely equivalent using a Parseval-type relation.

After that, we study the symmetries of the putative celestial CFT in an arbitrary number of dimensions using soft theorems. We use tools from conformal representation theory to classify the symmetries associated to conformally soft operators in celestial CFT (CCFT) in general dimensions  $d$ . The conformal multiplets in  $d > 2$  take the form of *celestial necklaces* whose structure is much richer than the *celestial diamonds* in  $d = 2$ , it depends on whether  $d$  is even or odd and involves mixed-symmetric tensor representations of  $SO(d)$ . The existence of primary descendants in CCFT multiplets corresponds to (higher derivative) conservation equations for conformally soft operators. We lay out a unified method for constructing the conserved charges associated to operators with primary descendants. In contrast to the infinite local symmetry enhancement in  $CCFT_2$ , we find the soft symmetries in  $CCFT_{d>2}$  to be finite-dimensional. The conserved charges that follow directly from soft theorems are trivial in  $d > 2$ , while non trivial charges associated to (generalized) currents and stress tensor are obtained from the shadow transform of soft operators which we relate to (an analytic continuation of) a specific type of primary descendants. The symmetry group generated by these charges constitutes a subset of the asymptotic symmetry group. The charges in the complement are not symmetries of the celestial CFT but map one celestial CFT to another. This is analogous to having a conformal manifold.

Finally we study fermionic symmetries in  $\mathcal{N} = 1$  supersymmetric QED and supergravity in four spacetime dimensions. We construct boundary fermionic operators and build the appropriate conformal primary wavefunctions using adequate spinors/vectors. Large supersymmetry transformations are equivalent to the leading soft gravitino theorem and we cast its generator on the celestial sphere. We then provide a spacetime interpretation to the leading soft photino theorem and subleading soft gravitino theorem by building the associated soft charges using the covariant phase space formalism. We also elucidate the role played by global SUSY generators in conformal representation theory: they relate fermionic celestial diamonds to bosonic ones and the conformal multiplets stack into a celestial pyramid.

## Résumé

Le principe holographique propose une correspondance entre une théorie de gravitation (quantique) à l'intérieur de l'espace-temps et une théorie conforme des champs sur le bord. La meilleure réalisation de cette conjecture est la correspondance AdS/CFT où les observables à l'intérieur d'un espace-temps à courbure négative peuvent être exprimées dans une théorie conforme des champs de codimension 1. Cette correspondance a amené une meilleure compréhension de la gravitation quantique grâce à la symétrie conforme de la théorie du bord. En parallèle, beaucoup de processus physiques tel la diffusion des particules élémentaires sont modélisés dans un espace-temps asymptotiquement plat. Nous pouvons alors réfléchir sur leur nature holographique.

Dans cette thèse, nous explorons les propriétés holographiques des amplitudes de diffusion dans des espace-temps asymptotiquement plats. Pour les particules de masse nulle, l'amplitude de diffusion peut être exprimée dans une base d'états propres des transformations de Lorentz en appliquant des transformations de Mellin sur les énergies des particules externes. Nous obtenons ainsi une amplitude céleste qui a les propriétés de transformations d'une fonction de corrélation dans une théorie de champs conforme de codimension 2. Toutefois ce changement de base doit prendre en compte le fait que l'amplitude de diffusion exprimée en fonction des quantités de mouvement est divergente et doit être traitée comme une distribution tempérée, en l'intégrant contre des fonctions test à décroissance rapide à l'infini (packets d'ondes). Dans une première partie, nous construisons alors des amplitudes célestes bien définies en considérant la transformée de Mellin des distributions tempérées. Nous caractérisons alors la transformée de Mellin de l'espace de Schwartz et les amplitudes célestes sont des éléments de son dual topologique. Les crochets de dualité dans l'espace de translation et celle dans l'espace conforme sont ainsi complètement équivalents en utilisant la relation de Parseval pour la transformée de Mellin. On étudie par la suite les symétries de la théorie conforme céleste en un nombre de dimensions arbitraire en utilisant les théorèmes mous. Grâce à des outils de la théorie de représentation conforme nous pouvons classifier leurs symétries associées. Les multiplets conformes en dimension supérieure à deux peuvent être représentés par des colliers célestes dont la structure est beaucoup plus riche que celle en deux dimensions. Cela est dû à une représentation des opérateurs à symétrie mixte. L'existence de descendant primaire dans le multiplets correspond à la conservation des opérateurs mous. Nous présentons ensuite une méthode pour construire les charges topologiques associées. En deux dimensions, nous trouvons que le groupe de symétrie est infini-dimensionnel alors que seulement les groupes de symétrie de dimension finie sont présents en dimensions supérieures. Ces groupes de symétries constituent un sous-groupe des groupes des symétries asymptotiques. Les charges dans le complément de ce groupe ne sont pas des symétries de la théorie conforme céleste mais introduisent des déformations d'une théorie conforme à une autre.

Enfin, nous étudions les symétries fermioniques dans les théories  $\mathcal{N} = 1$  QED supersymétrique et supergravité. Nous construisons ainsi les opérateurs fermioniques sur le bord ainsi que les fonctions d'onde conformes à partir de spineurs/vecteurs judicieusement choisis. Les transformations larges de supersymétrie sont équivalentes au théorème mou du gravitino et nous identifions le générateur correspondant sur la sphère céleste. Ensuite, nous construisons les charges associées aux théorèmes mous du premier ordre pour le photino et du second ordre pour le gravitino en utilisant le formalisme covariant de l'espace de phase. Les charges SUSY globales lient les multiplets conformes bosoniques à ceux qui sont fermioniques.

# Contents

<b>Introduction</b>	<b>9</b>
<b>I Celestial Amplitudes and Distributions</b>	<b>22</b>
<b>1 The Mellin Transform of the Schwartz Space</b>	<b>22</b>
1.1 The Inversion Formula for the Mellin Transform	28
1.2 The Mellin transform of the Schwartz space $\mathcal{S}(\mathbb{R}^+)$	30
<b>2 The Mellin Transform of Tempered Distributions</b>	<b>33</b>
2.1 Parseval's Relation for the Mellin Transform	34
<b>3 Applications: Graviton Celestial Amplitudes</b>	<b>35</b>
3.1 Three-Graviton Celestial Amplitude	35
3.2 Four-Graviton Celestial Amplitude	37
<b>II Celestial Conformal Field Theory</b>	<b>40</b>
<b>4 Ward Identities and Charges in QFT and CCFT</b>	<b>40</b>
4.1 Topological Operators in QFT	40
4.2 Celestial Amplitudes and Embedding Space	42
4.2.1 Celestial Amplitudes for Particles with Mass and Spin	43
4.2.2 Celestial $in \leftrightarrow out$ States and the Antipodal Map	44
4.3 Soft Theorems and Celestial Ward Identities	44
<b>5 Symmetries in Celestial CFT<sub><math>d=2</math></sub></b>	<b>47</b>
5.1 Celestial Diamonds	47
5.2 Conserved Charges	49
5.3 CCFT <sub><math>d=2</math></sub> Ward Identities	50
5.3.1 Leading Soft Photon	51
5.3.2 Leading Soft Graviton	52
5.3.3 Subleading Soft Graviton	53
5.3.4 Subleading Soft Photon and Subsubleading Soft Graviton	54
5.4 The Soft, the Hard and the Topological Charge	55
<b>6 Symmetries in Celestial CFT<sub><math>d&gt;2</math></sub></b>	<b>58</b>
6.1 Technology for $SO(d)$ tensors	58
6.1.1 Traceless and Symmetric Tensors	58
6.1.2 Mixed-symmetric Tensors	59
6.2 Celestial Necklaces	60
6.2.1 Type I Operators	62

6.2.2	Type II Operators	64
6.2.3	Type S Operators	65
6.2.4	Type P Operators	65
6.3	Conserved Charges	66
6.3.1	Charges for Type II	66
6.3.2	Charges for Type I	68
6.4	CCFT <sub>d&gt;2</sub> Ward Identities	69
6.4.1	Leading Soft Photon Theorem	69
6.4.2	Leading Soft Graviton Theorem	70
6.4.3	Subleading Soft Graviton Theorem	70
6.5	CCFT <sub>d&gt;2</sub> Shadow Ward Identities	71
6.5.1	Shadows and Type S operators	72
6.5.2	Leading Soft Photon Theorem	75
6.5.3	Leading Soft Graviton Theorem	76
6.5.4	Subleading Soft Graviton Theorem	77
<b>III Celestial Fermions and Soft Symmetries</b>		<b>80</b>
<b>7</b>	<b>Celestial Fermions</b>	<b>80</b>
7.1	Conformal Primary Wavefunctions	80
7.2	Conformal Primary Operators	82
<b>8</b>	<b>From Bulk to Boundary</b>	<b>84</b>
8.1	Operator Expansion	84
8.2	Wavefunction Expansion	85
8.3	Extrapolate-Style Dictionary for Fermions	86
<b>9</b>	<b>Large Supersymmetry and Conformally Soft Gravitino</b>	<b>87</b>
9.1	Leading Conformally Soft Gravitino	87
9.2	Celestial Gravitino Diamond	88
9.3	Soft Charge for Large Supersymmetry	88
9.4	Soft Operator in the Gravitino Diamond	90
<b>10</b>	<b>Soft Charges without Goldstinos</b>	<b>92</b>
10.1	Conformally Soft Photino	92
10.2	Subleading Conformally Soft Gravitino	93
<b>11</b>	<b>Celestial Pyramids</b>	<b>94</b>
<b>Conclusion and Outlook</b>		<b>97</b>
<b>A</b>	<b>Appendix: Notations and Conventions</b>	<b>101</b>



<b>B Appendix: Part II</b>	<b>103</b>
B.1 Projectors	103
B.2 Type I Operators and Trivial Charges	105
B.3 Ward Identities and Dirac Delta Distribution	108
B.4 Two-Point Integral in $\text{CFT}_d$ Space	110
B.5 Shadow Transforms of Soft Factors	111
B.6 Type S Operators in Even Dimensions	112
<b>C Appendix: Part III</b>	<b>115</b>
C.1 Radial Expansions of Radiative Solutions	115
C.2 Chiral Photino	115
C.3 Chiral Gravitino	116
C.4 Radial Expansions of Conformal Primaries	116
C.5 Chiral Photino	117
C.6 Chiral Gravitino	117
C.7 Inner Products $(\Psi_{\Delta,J}, \Psi'_{\Delta',J'})$	118
C.8 Symplectic Structure $\Omega(\delta\Psi, \delta'\Psi)$	119

# Introduction

A lot of effort has been put into finding a consistent theory of quantum gravity which unites the gravitational force with the standard model of particle physics. One of the prominent directions is holography and it relies on a feature of gravity which can already be noticed at the classical level: gravitational theories like general relativity cannot have local observables because of diffeomorphism invariance; the only true observables are boundary objects. The question we could then ask is: can we understand spacetime as a bulk realisation of a boundary theory, i.e. could we model our universe as a hologram?

In 1997 Maldacena [1] discovered a correspondence between the Hilbert spaces of a supergravity theory in the bulk of a negatively curved spacetime and a superconformal field theory in one-fewer dimensions. This has led to the conjecture of a duality between the bulk of an anti-de Sitter (AdS) spacetime and a conformal field theory (CFT) at its boundary, more commonly known as the AdS/CFT correspondence. Physically, AdS spacetimes can be used to model the geometry close to the throats of near-extremal black holes and the correspondence provides important insight regarding integrability, quantum information, the counting of microstate geometries and much more...

However if we move far enough from matter sources and stay below the cosmological scale, then asymptotically flat spacetimes serve as a good approximation for modeling physical phenomena such as particle scattering, black hole formation and evaporation, gravitational wave detection... One could then wonder about the holographic nature of asymptotically flat spacetimes (AFS).

## AdS vs AFS

**Conformal Boundaries and Compactification** A lot of advancements have been made in understanding the AdS/CFT correspondence where we have explicit top-down realizations. However there are some obstructions to directly taking the flat limit (AdS radius to infinity) to describe asymptotically flat holography. To illustrate this, we consider the  $AdS$  metric in  $d + 2$  dimensions in Bondi gauge

$$ds_{AdS}^2 = -\left(1 + \frac{r^2}{l^2}\right)du^2 - 2du dr + r^2 d\Omega_d^2,$$

where  $l^2 = -\frac{(d-1)(d-2)}{2\Lambda}$ ,  $l$  is the AdS radius and  $\Lambda$  is the cosmological constant. Here  $r$  is the radial coordinate,  $u = t - r$  is the retarded Bondi time and  $\Omega_d$  denotes the  $d$ -dimensional sphere at infinity. To explore the asymptotic structure, we want to take the limit  $r \rightarrow \infty$ . However since there are divergences when directly taking this limit, we first perform a *conformal compactification*: consider the manifold obtained from rescaling our metric with a divergent factor

$$ds_{AdS}^2 = r^2 ds_{\widehat{AdS}}^2.$$

Here  $\widehat{AdS}$  is the unphysical manifold conformally equivalent to  $AdS$ , i.e. where the causal structure is preserved but  $r = \infty$  is brought to a finite distance. Therefore we can see that the structure at the *conformal boundary*, i.e. the boundary of  $\widehat{AdS}$ , is a Lorentzian cylinder

$$ds_{\partial AdS}^2 = -du^2 + d\Omega_d^2.$$

The boundary has a pseudo-Riemannian geometry with a time direction parameterized by the coordinate  $u$ .

The structure at infinity is different for flat spacetimes. Indeed taking the limit  $l \rightarrow \infty$  first

$$ds_{Mink}^2 = -du^2 - 2du dr + r^2 d\Omega_d^2, \tag{1}$$

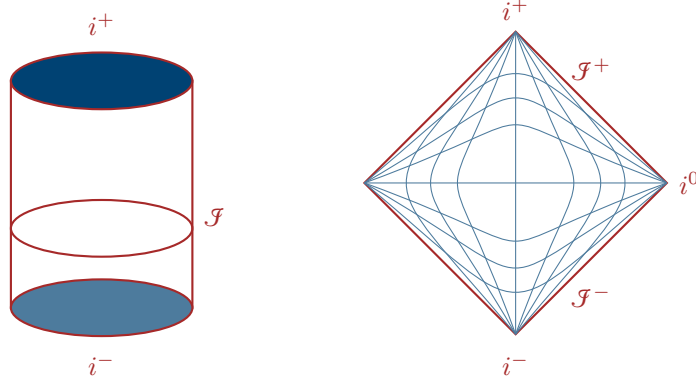

Figure 1: This figure illustrates the Penrose diagrams of AdS (left) and AFS (right) spacetimes. Massive particles travel from  $i^-$  to  $i^+$ . Light-like particles reach the boundary  $\mathcal{J}$  in AdS and are sent back inside the bulk while incoming massless particles come from  $\mathcal{J}^-$  and go to  $\mathcal{J}^+$  in AFS.

we obtain the metric for a  $d$ -dimensional flat spacetime. We can then see that the structure of the conformal boundary differs from that of the AdS case because the metric becomes degenerate.

$$ds_{\partial AFS}^2 = 0 du^2 + d\Omega_d^2.$$

Indeed, the manifold at conformal infinity is *Carrollian*: the geometry is parameterized by the sphere metric and a null vector which generates the null direction.

In addition, the choice of relevant boundary conditions of the AdS spacetimes usually differs from that of asymptotically flat spacetimes. The boundary of AdS spacetimes is usually taken to be *reflective*, it obeys Dirichlet boundary conditions. Therefore any particle that reaches the boundary is reflected again inside the bulk. In contrast, the boundary of asymptotically flat spacetimes obeys *leaky* conditions, and particles that reach the boundary can leave the bulk. This is nevertheless a feature for asymptotically flat spacetimes because it enriches its asymptotic structure.

**Mass Loss and Infinite Symmetries** Asymptotically flat spacetimes are manifolds whose metric at leading order goes to the Minkowski metric [\[1\]](#)

$$ds^2 \xrightarrow[r \rightarrow \infty]{} ds_{Mink}^2.$$

Therefore by allowing for subleading contributions and fixing the Bondi gauge we obtain in  $d + 2 = 4$  dimensions [\[2\]\[3\]](#)

$$ds_{AFS_4}^2 = \left(-1 + \frac{2m_B}{r}\right) du^2 - 2du dr + 2r^2 \gamma_{z\bar{z}} dz d\bar{z} + r C_{zz} dz^2 + \left[ D^z C_{zz} + \frac{1}{r} \left( \frac{4}{3} (N_z + u \partial_z m_B) - \frac{1}{4} D_z (C_{zz} C^{zz}) \right) \right] dudz + c.c. + \text{subleading}, \quad (2)$$

where we parameterized the 2-sphere by  $(z, \bar{z})$  which are obtained from the angular coordinates  $(\theta, \phi)$  by stereographic projection and  $D_a$  denotes the covariant derivative with respect to the sphere metric  $\gamma_{ab}$ . We refer to  $m_B(u, z, \bar{z})$ ,  $N_a(u, z, \bar{z})$  and  $C_{ab}(u, z, \bar{z})$  as the Bondi mass aspect, angular momentum aspect and shear respectively. They collectively constitute the radiative data at the conformal null boundary of AFS which we refer to as null infinity. The sphere at infinity is called the

*celestial sphere*. If we introduce the news tensor  $N_{ab}(u, z, \bar{z}) := \partial_u C_{ab}(u, z, \bar{z})$ , one of Einstein's equations then takes the form

$$\partial_u m_B = \frac{1}{4} (D_z^2 N^{zz} + D_{\bar{z}}^2 N^{\bar{z}\bar{z}}) - \frac{1}{8} N_{ab} N^{ab}, \quad (3)$$

which yields the Bondi mass loss formula. Indeed when a mass moves inside the spacetime, it radiates gravitons which can then leak through null infinity, decreasing the Bondi mass. And if we ask for the asymptotic symmetries of this metric, i.e. the set of vector fields that preserve [\[2\]](#) to leading order in  $r$ , we find an infinite enhancement of the Poincaré group. Bondi, van der Burg, Metzner and Sachs [\[2,3\]](#) showed that the so-called asymptotic symmetry group consists of supertranslations and Lorentz transformations

$$BMS_4 = SO(1, 3) \ltimes \mathcal{C}^\infty(S^2).$$

Indeed supertranslations are an enhancement of the 4 usual global translations to infinitely many local translations (arbitrary function on the 2-sphere). The leaky boundary conditions are therefore tightly related to the infinite enhancement of the symmetry group [\[1\]](#) which makes asymptotically flat holography more complicated but more interesting than AdS holography.

**Null Infinity and Matching Conditions** There is another notable difference between the boundaries of AdS and flat spacetimes. The AdS boundary is connected and unique, it consists of the cylinder  $\mathbb{R} \times S^2$ . However the boundary of AFS contains two connected components parameterized by  $u = t - r$  and  $v = t + r$  respectively, and the 2-sphere coordinates. The two connected parts are denoted by  $\mathcal{I}^+$  and  $\mathcal{I}^-$  and are referred to as future and past null infinity respectively. Each geodesic of a massless particle starts at  $\mathcal{I}^-$  and ends at  $\mathcal{I}^+$ . Quantum mechanically, *in* particles enter through  $\mathcal{I}^-$  and *out* particles exit through  $\mathcal{I}^+$ . Due to this separation, there are two BMS groups that act on the two different components, denoted by  $BMS^+$  and  $BMS^-$ . However the two spheres at  $\mathcal{I}^+$  and  $\mathcal{I}^-$  are not independent. Indeed scattering should be defined across  $i^0$  which denotes spatial infinity [\[2\]](#). The so-called matching conditions [\[5\]](#)

$$z \rightarrow -\frac{1}{\bar{z}} \text{ and } \bar{z} \rightarrow -\frac{1}{z},$$

provide a smooth transition of the data between  $\mathcal{I}^+$  and  $\mathcal{I}^-$ . We are then left with a single sphere at infinity, and the asymptotic symmetry group  $BMS$  contains elements of the diagonalization of  $BMS^+$  and  $BMS^-$

$$BMS = BMS^+ \times BMS^-.$$

Even though flat space holography is less developed than AdS holography because of what we have exposed so far, there are hints (even features) in asymptotically flat spacetimes that may help shed light on its holographic properties. The goal of the next section is to expose the setup of the *celestial holography* program, which posits a potential dual CFT on the celestial sphere for gravity in asymptotically flat spacetimes.

## From Momentum space to Conformal space

Scattering amplitudes have a feature which hints towards a codimension-two holography in asymptotically flat spacetimes. Consider the scattering amplitude

$$\langle out | S | in \rangle,$$

---

<sup>1</sup>This is not true in higher dimensions, the terms generated by the BMS vector fields are overleading with respect to the radiative data. By choosing certain boundary conditions we can thus have radiative data without considering local enhancements of the symmetry group [\[4\]](#).

<sup>2</sup>All Cauchy slices have  $i^0$  as a boundary.

where  $\langle out|$  denotes the product state of the outgoing particles,  $|in\rangle$  that of the incoming particles and  $S$  denotes the scattering matrix. This mathematical object is used to compute physical quantities such as cross sections and decay rates. In the usual study of scattering amplitudes, the asymptotic states are translation eigenstates: they are in a momentum basis. Translation invariance is therefore manifest and it takes the form of a  $\delta(\sum_i p_i)$  where  $p_i$  are the momenta of the external particles. Translation invariance thus implies momentum conservation.

The Lorentz group in  $d+2$  dimensions  $SO(d-1, 1)$  is another subgroup of the Poincaré group and is also a symmetry of the scattering amplitude. This symmetry is related to important physical phenomena such as angular momentum conservation and causality. However translation eigenstates do not diagonalize the generators of the Lorentz transformations  $M_{\mu\nu}$ . It is nevertheless possible to make this symmetry of the scattering amplitude manifest by taking the asymptotic states to be Lorentz eigenstates. This change of basis can be achieved for massless particles<sup>3</sup> using the Mellin transform

$$\mathcal{M}(\cdot)(\Delta) = \int_0^\infty d\omega \omega^{\Delta-1}(\cdot), \quad (4)$$

where  $\omega$  is the energy of the massless particle and  $\Delta$  its weight under Lorentz transformations. We can parameterize on-shell momenta by  $p^\mu = \omega q^\mu(x)$  where  $q^\mu(x)$  is a unit null vector and a function of the sphere coordinates  $x^\mu$ . We then have

$$|\omega, x\rangle \xrightarrow{\mathcal{M}} |\Delta, x\rangle.$$

If we split the Lorentz generators as follows

$$D = M_{d+1,0}, \quad K_a = M_{0,a} + M_{d+1,a}, \quad P_a = M_{0,a} - M_{d+1,a}, \quad R_{ab} = M_{ab},$$

the Lorentz algebra can be rewritten in the following way

$$\begin{aligned} [R_{ab}, R_{cd}] &= i(\delta_{ac}R_{bd} + \delta_{bd}R_{ac} - \delta_{bc}R_{ad} - \delta_{ad}R_{bc}), \\ [R_{ab}, P_c] &= i(\delta_{ac}P_b - \delta_{bc}P_a), \\ [R_{ab}, K_c] &= i(\delta_{ac}K_b - \delta_{bc}K_a), \\ [D, P_a] &= -iP_a, \\ [D, K_a] &= iK_a, \\ [P_a, K_b] &= -2i(\delta_{ab}D + R_{ab}). \end{aligned} \quad (5)$$

This is indeed the algebra of conformal transformations in  $d$ -dimensions with  $R_{ab}$  generating rotations,  $P_a$  translations,  $K_a$  special conformal transformations and  $D$  dilatations. The conformal group and the Lorentz group are isomorphic and Lorentz eigenstates therefore transform as conformal primaries on the celestial sphere.

**Conformal Primary Wavefunctions** Massless scalar wavefunctions are solutions to the equation

$$\square\phi = 0.$$

In the momentum basis, this equation is solved by plane waves<sup>4</sup>

$$\phi(\omega, x, X) = e^{ip \cdot X}$$

<sup>3</sup>For massive particles the change of basis is more complicated. The integral is three-dimensional and involves a bulk-to-boundary propagator [6, 7].

<sup>4</sup>Subtleties regarding incoming vs outgoing particles are ignored at this stage.

where  $p^\mu = \omega q^\mu(x)$  refers to the momentum and  $X^\mu$  is the position vector in  $d+2$  dimensions. Performing a Mellin transform on the energy of this solution we obtain the so-called *scalar conformal primary wavefunction* [6–11]

$$\tilde{\phi}_\Delta(x, X) = (-i)^\Delta \frac{\Gamma(\Delta)}{(-q \cdot X)^\Delta}. \quad (6)$$

This is also a solution of the wave equation and transforms covariantly under both bulk Lorentz transformations  $X^\mu \rightarrow \Lambda^\mu{}_\nu X^\nu$  and boundary global conformal transformations  $x^a \rightarrow x'^a(x)$  where the transformations are translations, rotations, dilatations and special conformal transformations. Higher spin conformal primary wavefunctions can be constructed from the scalar one by multiplying with the adequate vectors and/or spinors [12].

**From Bulk to Boundary** Boundary operators can be constructed from conformal primary wavefunctions. For scalar wavefunctions, we use the Klein-Gordon inner product

$$(\phi_1, \phi_2) = i \int_{NC_{d+1}} d^{d+1} \vec{X} \phi_1^*(X_0, \vec{X}) \partial_0 \phi_2(X_0, \vec{X}) - \phi_2(X_0, \vec{X}) \partial_0 \phi_1^*(X_0, \vec{X}),$$

where  $NC_{d+1}$  refers to the null cone embedded in  $\mathbb{R}^{d+1,1}$ . Integrating over the bulk coordinate  $X^\mu$ , we see that starting from a scalar bulk operator  $O_b(X)$  and a scalar conformal primary wavefunction  $\tilde{\phi}(\Delta, x, X)$  we obtain

$$\mathbb{O}_\Delta(x) = \left( \tilde{\phi}_\Delta(x, X), O_b(X) \right),$$

which is an operator that lives purely on the boundary and transforms covariantly under conformal transformations. We can obtain higher-spin operators  $\mathbb{O}_{\Delta, \ell \neq 0}$  by considering the appropriate inner product of higher-spin conformal primary wavefunctions and higher-spin bulk operators. Correlation functions of these operators on the boundary correspond exactly to the S-matrix expressed in a Lorentz-covariant basis. We will discuss a rigorous construction of these so-called *celestial amplitudes* in the following section.

These operators transform covariantly under global conformal transformations

$$\begin{aligned} [P^a, \mathbb{O}_{\Delta, \ell}(x)] &= \partial^a \mathbb{O}_{\Delta, \ell}(x), \\ [R^{ab}, \mathbb{O}_{\Delta, \ell}(x)] &= \left( (x^a \partial^b - x^b \partial^a) + i M^{ab} \right) \mathbb{O}_{\Delta, \ell}(x), \\ [D, \mathbb{O}_{\Delta, \ell}(x)] &= (x^a \partial_a + \Delta) \mathbb{O}_{\Delta, \ell}(x), \\ [K^a, \mathbb{O}_{\Delta, \ell}(x)] &= \left( (2x^a x_b - \delta_b^a x^2) \partial^b + 2\Delta x^a - 2i x_b M^{ba} \right) \mathbb{O}_{\Delta, \ell}(x), \end{aligned}$$

where  $M^{ab}$  denotes the spin part of the angular momentum of the operator  $\mathbb{O}_{\Delta, \ell}$  and  $\Delta$  is identified as the conformal dimension of the operator. These are therefore the primaries that go into defining our theory. Even though determining the data of the conformal theory, i.e. the quantum numbers  $\Delta$  and  $\ell$  as well as the coefficients of the three-point correlators is still an open problem, a lot of progress has been made in understanding the dictionary between bulk and boundary physics. Pasterski and Shao showed in [7] that taking the parameter  $\Delta$  on the principal series of the Lorentz group, i.e.  $\Delta \in \frac{d}{2} + i\mathbb{R}$ , provides a complete set of normalizable solutions of the wave equation. More recently [13], it was shown that taking  $\Delta \in \mathbb{R}$  also ensures completeness and normalizability upon replacing the Mellin transform by an appropriate contour integral in the complex- $\omega$  plane

$$\mathbb{O}_{\Delta, \ell}(x) = \int_{\mathbb{C}_\omega} d\omega \omega^{\Delta-1} \mathbb{O}_\ell(\omega, x).$$

**Carrollian Holography** Apart from celestial holography, there exists another approach to flat space holography. *Carrollian holography* puts forward a dual theory to the AFS bulk on the entire null surface at conformal infinity  $\mathbb{R} \times S^d$  [14][16]. By looking at the algebra of the vector fields that preserve this Carrollian structure, we obtain the BMS algebra. The so-called *conformal Carrollian group* in  $d + 1$  dimensions is indeed isomorphic to the BMS group in  $d + 2$  dimensions. Although Carrollian and celestial holography are two different attempts at flat space holography, they are complementary in the sense that each approach has its features: for example scattering data is more naturally represented on the celestial sphere whereas the evolution along the boundary such as Bondi mass loss is more evident on the Carrollian manifold. Nevertheless, they should be two sides of the same coin and a lot of progress has been made in establishing a dictionary between the two theories [17][20].

## Celestial Amplitudes and Distributions

Celestial amplitudes are obtained from momentum space amplitudes through a change of basis which is performed using the Mellin transform for massless particles. However scattering amplitudes in momentum space are not functions but rather tempered distributions and this should be taken into account when performing the Mellin transform. In order to properly define this procedure, we briefly discuss the nature of scattering amplitudes in momentum space before being able to properly define their Mellin transform. Rigorous proofs and an extended development of the arguments in this section as well as examples are given in part I of this thesis.

**Amplitudes and Tempered Distributions** Consider the scalar four-point momentum space amplitude at tree-level in a  $\phi^4$  theory in four dimensions

$$A_4(p_i) = \lambda \delta^{(4)}\left(\sum_{i=1}^4 p_i\right), \quad (7)$$

where  $\lambda$  denotes the coupling constant and  $p_i^\mu$  the momenta of the four external particles. The Dirac- $\delta$  appearing in this formula which is a consequence of translation invariance is defined by the divergent integral

$$\delta(x) = \int_{\mathbb{R}} dk e^{i k \cdot x}.$$

Indeed this integral cannot be given any meaning unless it acts on a certain class of functions. By having a well-defined action on a function  $f$  which is smooth and rapidly decreasing at infinity (i.e.  $f$  in Schwartz space)

$$\langle \delta, f \rangle = \int_{\mathbb{R}} dx \delta(x) f(x) = f(0) < \infty,$$

the Dirac- $\delta$  is considered a *tempered distribution*. In fact all finite (tree-level) scattering amplitudes in momentum space are tempered distributions since they consist of smooth functions multiplying the momentum-conserving Dirac- $\delta$ , i.e. they are defined by duality with respect to the Schwartz space.

The Schwartz space is denoted  $\mathcal{S}(\mathbb{R})$  and tempered distributions, which belong to its topological dual denoted by  $\mathcal{S}'(\mathbb{R})$ , are real- or complex-valued linear continuous functionals on  $\mathcal{S}(\mathbb{R})$ . And the action of a tempered distribution  $T \in \mathcal{S}'(\mathbb{R})$  on  $f \in \mathcal{S}(\mathbb{R})$  is denoted by

$$\langle T, f \rangle_{\mathcal{S}', \mathcal{S}} < \infty.$$

Therefore  $A_4$  in (7) belongs to the topological dual of a functional space which is  $[S^4(\mathbb{R})]^4$ <sup>5</sup> and should be understood as acting on the product of four functions  $f_i \in S^4(\mathbb{R})$ . This is equivalent to smearing the states with definite momenta that define the amplitude against Gaussian functions or wave packets.

**Massless Celestial Amplitudes** The momenta of massless particles can be parameterized as  $p^\mu = \omega q^\mu(z, \bar{z})$  as seen in the previous section. The null cone in 4-dimensions  $NC_3$  is thus parameterized by spherical coordinates  $\mathbb{R}^+ \times \Omega_2$  where  $\mathbb{R}^+ = [0, \infty)$  is the radial direction with coordinate  $\omega$  and  $\Omega_2$  refers to the 2-sphere coordinates  $(z, \bar{z})$ . Therefore the momentum space amplitude (7) has a part that is dual to  $\mathcal{S}(\mathbb{R}^+)$ . We denote that part by  $A_4^\omega \in \mathcal{S}'^4(\mathbb{R}^+)$  and we have<sup>6</sup>

$$\langle A_4^\omega, \{f_i\} \rangle_{\mathcal{S}', \mathcal{S}} = \prod_{i=1}^4 \left( \int_{\mathbb{R}^+} d\omega_i \omega_i f_i(\omega_i) \right) A_4^\omega(\{\omega_i\}, z, \bar{z}). \quad (8)$$

When going from the momentum basis to the boost basis, the Mellin transform is only performed on the energy of the particle involved, therefore this is the part on which we focus and the  $z, \bar{z}$  dependence goes through. As we will see, the celestial amplitude thus obtained will transform as a conformal correlator on the 2-sphere. For now, we have to consider how to take the Mellin transform of  $A_4^\omega(\{\omega_i, z_i, \bar{z}_i\})$  as defined by (8).

We were able to rigorously define the Mellin transform of distributions in  $\mathcal{S}(\mathbb{R}^+)$  and hence properly define massless celestial amplitudes in (21) and we lay out the main results in the following. One can define the celestial amplitude  $\tilde{A}_4^\omega$  through the relation

$$\langle A_4^\omega, \{f_i\} \rangle_{\mathcal{S}', \mathcal{S}} = \langle \tilde{A}_4^\omega, \{\tilde{f}_i\} \rangle_{\tilde{\mathcal{M}}^+, \tilde{\mathcal{M}}^+},$$

where  $\tilde{\mathcal{M}}^+$  is a functional space isomorphic to  $\mathcal{S}(\mathbb{R}^+)$  by the Mellin transform and its inverse,  $\tilde{\mathcal{M}}^+$  its topological dual, and  $\tilde{f}_i \in \tilde{\mathcal{M}}^+$  are functions obtained by applying the Mellin transform on the functions  $f_i$

$$\tilde{f}_i(\Delta_i) = \int_{\mathbb{R}^+} d\omega_i \omega_i^{\Delta_i - 1} f_i(\omega_i).$$

We characterized the space  $\tilde{\mathcal{M}}^+$  in (21). It is a space of meromorphic functions on the complex plane with poles at non-positive integers and specific fall-off properties in the imaginary direction. We also defined the bracket by a Parseval-type relation

$$\langle \tilde{A}_4^\omega, \{\tilde{f}_i\} \rangle_{\tilde{\mathcal{M}}^+, \tilde{\mathcal{M}}^+} = \prod_{i=1}^4 \left( \int_{c-i\infty}^{c+i\infty} \frac{d\Delta_i}{2i\pi} \tilde{f}_i(2 - \Delta_i) \right) \tilde{A}_4^\omega(\{\Delta_i, z_i, \bar{z}_i\}), \quad c \in (-\infty, 2).$$

Through this procedure and using the inversion theorem for the Mellin transform of functions in the Schwartz space  $\mathcal{S}(\mathbb{R}^+)$ , we find the usual definition of the four-point tree-level scalar celestial amplitude

$$\tilde{A}_4(\{\Delta_i, z_i, \bar{z}_i\}) = \prod_{i=1}^4 \left( \int_{\mathbb{R}^+} d\omega_i \omega_i^{\Delta_i - 1} \right) A_4(\{\omega_i, z_i, \bar{z}_i\}). \quad (9)$$

Again, the celestial amplitude (9) does not have any meaning unless smeared against functions in  $\tilde{\mathcal{M}}^+$  because it belongs to its dual. This is true for all celestial amplitudes which come from UV divergence-free scattering amplitudes in momentum space, be it tree-level or loop corrected. In the literature (22-30), it has been noticed that some celestial amplitudes analogous to (9) are divergent. One example is the tree-level three-point graviton MHV amplitude

$$\mathcal{A}_{--+}(\omega_i, z_i, \bar{z}_i) = \left( \frac{\omega_1 \omega_2}{\omega_3} \frac{z_{12}^3}{z_{23} z_{31}} \right)^2 \delta^{(4)} \left( \sum_{i=1}^3 \epsilon_i \omega_i q_i \right). \quad (10)$$

<sup>5</sup>Technically the functional space is  $Sym_4(S^4(\mathbb{R}))$  which accounts for the exchange symmetry of the bosonic scalar particles.

<sup>6</sup>The additional factor of  $\omega_i$  comes from the Lorentz-invariant phase space measure.



Strictly speaking, using the definition of the Dirac- $\delta$ , this momentum space amplitude is divergent. However, it does not contain UV divergences and as discussed, it can be well defined through a smearing against functions  $f_i \in \mathcal{S}(\mathbb{R}^+)$ , for  $i = 1, 2, 3$ . A change of basis shouldn't affect these properties. When performing a Mellin transform on the energies of the external particles, the following integral appears

$$\int_{\mathbb{R}^+} d\omega_3 \omega_3^{i\Lambda},$$

where  $\Lambda = \lambda_1 + \lambda_2 + \lambda_3$  and we chose  $\Delta_i = 1 + \lambda_i$ . This integral is divergent but when smeared against functions  $\tilde{f}_i \in \tilde{\mathcal{M}}^+$  for  $i = 1, 2, 3$ , the result is well-defined. Indeed we can rewrite this integral as

$$2\pi \sum_{j=0}^{\infty} \frac{(-i)^j}{j!} \partial_{\Lambda}^j \delta(\Lambda),$$

which shifts the argument of one of the functions  $\tilde{f}_i$  inside the bracket of duality. This shift is completely well-defined on complex functions because it happens in a region where they are holomorphic. We therefore obtain a rigorous definition of celestial amplitudes.

**Conformal Covariance** More generally in any dimension, celestial amplitudes thus obtained analogously to [9](#)

$$\tilde{A}_n(\{\Delta_i, x_i\}) = \prod_{i=1}^n \left( \int_{\mathbb{R}^+} d\omega_i \omega_i^{\Delta_i-1} \right) A_n(\{\omega_i, x_i\})$$

transform as conformal correlators on the celestial sphere

$$\langle \mathbb{O}_{\Delta_1, \ell_1}(x_1) \cdots \mathbb{O}_{\Delta_n, \ell_n}(x_n) \rangle,$$

where  $\mathbb{O}_{\Delta_i, \ell_i}$  are the operators inserted at a point  $x_i$  on the celestial sphere.

## Soft Symmetries

So far we have seen how amplitudes in the bulk of an asymptotically flat spacetime can be represented on the celestial sphere. However scattering hides another important feature for flat holography: it provides a setup for studying the asymptotic symmetries through long-wavelength particle exchange, i.e. soft physics. This is due to a relation between soft theorems and the Ward identities of asymptotic symmetries discovered by Strominger [5](#). Soft theorems are low-energy factorization theorems regarding scattering amplitudes. Indeed a scattering amplitude factorizes when the energy of one of the massless particles is taken to zero

$$\lim_{\omega \rightarrow 0} A_{n+1}(\{p_i\}_1^n, p) = \sum_k S^{(1-k)} A_n(\{p_i\}_1^n), \quad (11)$$

where  $A_n(\{p_i\}_1^n)$  denotes the scattering of the hard (finite energy) particles without the soft mode  $p = \omega q$ , and  $S^{(k)}$  denote the so-called *soft factors*. This is an expansion of the amplitude in terms of the soft energy  $\omega$  and the soft factors denote the order in the soft energy  $S^{(1-k)} \propto \omega^{-k}$ .

When expressed in the conformal basis, soft theorems take the form of Ward identities of asymptotic symmetries. Indeed each term of the soft-energy expansion is related to a pole in the conformal correlator at certain values of the conformal dimension  $\Delta$

$$\frac{1}{\omega^k} \xrightarrow{\mathcal{M}} \frac{1}{\Delta - k}.$$

In gravity the leading soft graviton theorem, i.e. the leading term in the expansion [11] proportional to  $\omega^{-1}$ , is related to supertranslation symmetry and the subleading term proportional to  $\omega^0$  to the so-called superrotation symmetry. Like supertranslations, superrotations are infinite-dimensional local enhancements of the Lorentz transformations. Two such extensions are usually considered in the literature: the enhancement of the global conformal algebra to the Virasoro algebra or to the algebra of diffeomorphisms on the celestial sphere  $Diff(S^d)$  [31, 32]. These local enhancements yield the so-called extended BMS group (eBMS) or the generalized BMS group (gBMS) respectively. From the point of view of celestial holography, these asymptotic symmetries are generated by boundary operators which live on the celestial sphere: the *conformally soft* limit  $\Delta \rightarrow k$  for  $k = 1, 0$  of boundary graviton operators relates them to the generators of supertranslations and superrotations, respectively. This is also true for gauge theory,  $\mathcal{N} = 1$  supersymmetric QED and supergravity. In these cases, local enhancements of the gauge group correspond to the asymptotic symmetry group and the corresponding leading soft theorem yields its generator on the celestial sphere. The value of  $k$  is integer for bosonic conformally soft operators and half-integer for fermionic ones. In particular, the subleading soft graviton theorem is related to the Ward identity of a stress tensor and the corresponding soft mode yields a stress tensor which lives on the celestial sphere and generates local conformal transformations.

A more detailed discussion on tree-level soft theorems in (supersymmetric) gauge theory and (super)gravity, their relation to asymptotic symmetries and their treatment on the celestial sphere is given in sections 4.3 [5] and [6]

**Infinite Soft Theorems and  $w_{1+\infty}$  Algebra** We've discussed the interpretation of the leading (and subleading for gravity) soft theorems as Ward identities of asymptotic symmetries. However recasting the infinite tower of tree-level soft factors on the celestial sphere in the conformal basis yields boundary operators with  $\Delta = -1, -2, -3, \dots$ . Except for the sub-subleading soft graviton theorem [32], the asymptotic symmetry interpretation of these soft theorems is still unclear. Interestingly, it was shown in [33] that this tower of soft operators on the Lorentzian boundary torus generates a  $w_{1+\infty}$  algebra, uncovering a symmetry that was thus far obscure. So far we know that this is an exact symmetry of self-dual gravity [34] but its realizations beyond that are still under investigation.

**Memory Effects and the IR Triangle** Memory effects are an interesting consequence of soft theorems and asymptotic symmetries. To illustrate this consider the shear tensor  $C_{zz}(u, z, \bar{z})$  which labels the different nonequivalent vacua of asymptotically flat spacetime. After the passage of a gravitational wave, the value of the shear tensor undergoes a permanent shift given by

$$\Delta C_{zz} = C_{zz}(u_f, z, \bar{z}) - C_{zz}(u_i, z, \bar{z}) = \int_{u_i}^{u_f} du \partial_u C_{zz}(u, z, \bar{z}) \neq 0.$$

It is exactly related to the fact that the news tensor  $N_{zz} = \partial_u C_{zz}$  which denotes the flux of radiation through  $\mathcal{I}$  is non-vanishing.

In fact, memory effects, soft theorems and asymptotic symmetries describe the same physics but each in a different basis. Consider for example the Weinberg pole, i.e. the leading soft theorem in gravity. Expressed in a momentum basis, it states that in the limit  $\omega \rightarrow 0$  of the energy of an external graviton, the amplitude has a pole:  $\frac{1}{\omega}$ . By applying a Fourier transform, we have

$$\partial_u \left[ \int_{\mathbb{R}^+} d\omega \frac{e^{i\omega u}}{\omega} \right] = i \int_{\mathbb{R}^+} d\omega e^{i\omega u} = 2\pi i \delta(u) \implies \int_{\mathbb{R}^+} d\omega \frac{e^{i\omega u}}{\omega} = 2\pi i \Theta(u),$$

where  $\Theta(u)$  is the step function. Indeed it indicates the constant shift in the position basis of the shear tensor. And to treat asymptotic symmetries, we saw that the Ward identity on the sphere exhibits a simple pole at  $\Delta = 1$  and that the spin-2 operator with that conformal dimension generates the asymptotic symmetry. This is indeed obtained by taking the Mellin transform of the Weinberg pole in the momentum basis. The equivalence of these three phenomena constitutes the so-called *infrared triangle* illustrated below.

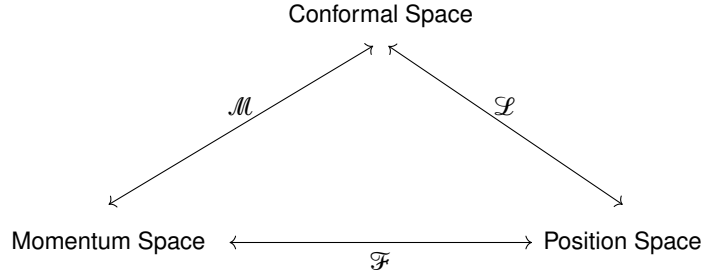

This IR structure proved to be very powerful in furthering our understanding of flat space holography, eventually having measurable consequences using memory effects. Curiously, this structure remains even in scenarios without Lorentz symmetry [35], showing it is more robust than previously thought.

For a review on the IR triangle see [36] and [37–40] for more recent reviews on celestial amplitudes and holography.

## Celestial Conformal Field Theory

Celestial holography puts forward a duality between a theory of quantum gravity in the bulk of an asymptotically flat spacetime and a conformal field theory living on the celestial sphere at its boundary. This dual theory is the putative *celestial conformal field theory* (CCFT). However the data of this CCFT is still to be determined: regarding the conformal dimension  $\Delta$ , we know that we have a complete and normalizable basis when considering the principal series of the Lorentz group  $\frac{d}{2} + i\mathbb{R}$  [7], but the soft modes which are related to the symmetries of theory are obtained at (half-)integer values of the conformal dimension. Some advancements have been made in this direction [13, 41, 42].

The study of the correlators in celestial CFT relies mainly on bulk scattering amplitudes: the symmetry generators are the soft modes and their action on generic operators in the theory comes from the soft factor, the OPE is obtained from the collinear limit of amplitudes and the OPE coefficients are identified with the splitting functions... Therefore celestial holography has mainly relied on a bottom-up approach thus far, while a top-down construction is less developed but made possible using twistor methods [43, 44]. When recasting bulk scattering as boundary observables we identify the requirements of the to-be celestial CFT in the hopes of a bulk-independent explicit construction. However conformal symmetry is very powerful and there is still a lot to say from formulating the scattering process on the celestial sphere. Some of the first questions one can ask at this stage are: given soft theorems and conformal symmetry, what are the full symmetries of the theory? Can we classify them? And what are the corresponding topological charges?

In four spacetime dimensions, classifying the tree-level soft symmetries was done in [45]. Consider a CFT with global conformal generators denoted by  $L_{0,\pm 1}$  and their anti-holomorphic counterparts  $\bar{L}_{0,\pm 1}$ . Through a redefinition, one can relate these stress tensor modes to the generators  $K, P, R$  and  $D$  introduced earlier. One can then define a highest weight

operator with respect to  $L_1$  and  $\bar{L}_1$  which are referred to as *primary operators*. We denote  $\mathcal{O}_{\Delta,\ell}$  an operator in the CCFT with conformal dimension  $\Delta$  and spin  $\ell$ . If  $\mathcal{O}_{\Delta,\ell}$  is a primary then we have

$$[L_1, \mathcal{O}_{\Delta,\ell}] = [\bar{L}_1, \mathcal{O}_{\Delta,\ell}] = 0.$$

We define the (anti-)holomorphic descendant operator  $O_{\Delta',\ell'}$  from the primary  $\mathcal{O}_{\Delta,\ell}$  as  $[L_{-1}, \mathcal{O}_{\Delta,\ell}]$  ( $[\bar{L}_{-1}, \mathcal{O}_{\Delta,\ell}]$ ). There exists in principle an infinite number of descendants of a primary operator and the action of  $L_{-1}$  or  $\bar{L}_{-1}$  amounts to taking holomorphic or anti-holomorphic derivatives of  $\mathcal{O}_{\Delta,\ell}(z, \bar{z})$ . However when one of the descendants becomes in turn a primary (i.e. is annihilated by  $L_1$  and  $\bar{L}_1$ ), the conformal multiplet is shortened and one can thus obtain a complete classification of the primary operators in the theory [46]. One can then consider three types of primary descendants by comparing the spins of the parent primary  $\ell$  to that of the primary descendant  $\ell'$ : type I operators have  $|\ell'| > |\ell|$  while type II operators satisfy  $|\ell'| < |\ell|$  and for type III operators we have  $|\ell'| = |\ell|$ .

Doing so allows one to represent the global conformal multiplets as a diamond-shaped descendanty structure [45]. Further details and comments can be found in section 5.1. In short, this provides a classification of the primary operators according to their conformal dimension and spin. We summarize the results of this classification for the soft graviton expansion in the table below.

Soft Expansion	Leading	Subleading	Subsubleading	Sub <sup>#</sup> leading
Type	II	II	III	I

The celestial diamonds take the form where the soft operators coming from the soft theorems appear at the corner of the

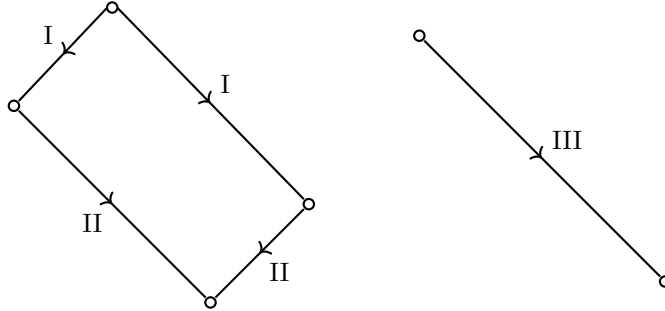

Figure 2: Celestial diamonds in  $d = 2$ . The picture shows the  $\Delta - \ell$  plane, where the nodes correspond to the position of primaries while the arrows pointing to the bottom right/left denote the action of derivatives  $\partial/\bar{\partial}$  (longer arrows correspond to higher numbers of derivatives). The diamond picture on the left shows the existence of a nested structure of descendants that are themselves primaries. The picture on the right is understood as a diamond with zero area.

diamonds for type II or at the top for type III. Even more, each corner of the diamond is related to the other by a so-called *shadow transform*

$$S[\mathcal{O}_{h,\bar{h}}](z, \bar{z}) \equiv \frac{K_{h,\bar{h}}}{2\pi} \int d^2w \frac{\mathcal{O}_{h,\bar{h}}(w, \bar{w})}{(z-w)^{2-2h}(\bar{z}-\bar{w})^{2-2\bar{h}}}. \quad (12)$$

For type III operators the shadow transform relates the top operator to the bottom one. This integral transform is extremely important in celestial CFT because its stress tensor is the shadow transform of the subleading conformally soft graviton

operator. In fact it is not clear if the soft operators or the shadow transformed ones should be the defining set of boundary observables even though there are arguments that hint towards the latter [47-50]. Other than bosonic gauge theories, one can look at fermionic soft symmetries. In [51] we focused on  $\mathcal{N} = 1$  supersymmetric QED and supergravity since they represent important examples of effective field theories. Soft theorems in those cases correspond to pole in the celestial amplitudes at half-integer values of the conformal dimension  $\Delta = \frac{1}{2}, -\frac{1}{2}$  for the leading and subleading terms respectively. The soft symmetries are then generated by the operators  $\mathbb{O}_{\Delta=\frac{1}{2}, \ell=\frac{3}{2}}$  and  $\mathbb{O}_{\Delta=-\frac{1}{2}, \ell=\frac{3}{2}}$  from the leading and subleading soft gravitino theorems and  $\mathbb{O}_{\Delta=\frac{1}{2}, \ell=\frac{1}{2}}$  from the leading soft photino theorem.  $\mathbb{O}_{\Delta=\frac{1}{2}, \ell=\frac{3}{2}}$  generates large SUSY transformations [52] while the asymptotic symmetry interpretation of the other fermionic generators is still unclear. Nevertheless, we were able to give a spacetime interpretation to the subleading soft gravitino theorem by building the corresponding charge using the covariant phase space formalism (see [53] for an introduction on the covariant phase space formalism). The operator  $\mathbb{O}_{\Delta=\frac{1}{2}, \ell=\frac{3}{2}}$  is of type II and  $\mathbb{O}_{\Delta=-\frac{1}{2}, \ell=\frac{3}{2}}, \mathbb{O}_{\Delta=\frac{1}{2}, \ell=\frac{1}{2}}$  are of type III. Following [52], we were also able to elucidate the role of the supersymmetry generators in the celestial diamond setting: while the global  $SL(2, \mathbb{C})$  modes relate operators within the same diamond, the global SUSY modes related operators with different diamonds, creating a pyramid shape where the diamonds stack one on top of the other.

We generalize the classification of soft symmetries to higher dimensions in [50]. The spin structure is more complicated in an arbitrary number of dimensions due to the action of the little group  $SO(d)$ . Indeed operators can be in a "mixed-symmetric" representation of the little group and the spin takes the form of a Young tableau

$$\mathbf{a} \equiv \begin{array}{cccccc} a_1^1 & \dots & \dots & \dots & \dots & a_{\ell_1}^1 \\ a_1^2 & \dots & \dots & \dots & a_{\ell_2}^2 & \\ \vdots & \vdots & \vdots & \ddots & & \\ a_1^k & \dots & a_{\ell_k}^k & & & \end{array}, \quad (13)$$

where  $k \leq \frac{d}{2}$ . Each row is symmetrized and column anti-symmetrized. Notice that it is always traceless and symmetric for higher spin operators in  $d = 2$ . The descendanty relations the soft operators obey are the conservation equations of the soft operators. In part II of this thesis, we present a classification of the soft operators in general dimensions  $d$  where the conformal multiplets take the form of a necklace as shown below.

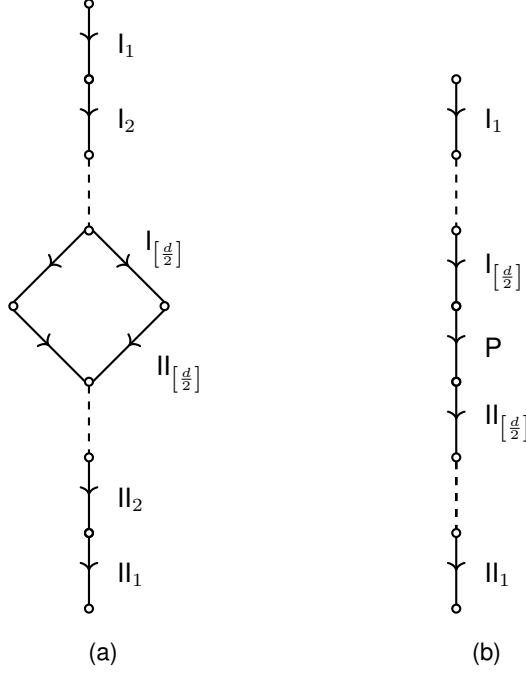

Figure 3: Celestial necklaces in even dimensions (a) and odd dimensions (b).

From the (generalized) conserved soft operators one can construct topologically invariant charges which correspond to the generators of the symmetries of the celestial CFT. In  $d > 2$ , only the shadow transform of the soft operators yield non-trivial charges [48] which correspond to the symmetries of the theory. We were also able to relate the shadow transform of soft operators to a certain type of descendant we refer to as a type S descendant. This recasts the shadow transform as a local relation in even dimensions

$$S[\mathbb{O}_{k,\ell}](x, e) = n_{k,\ell} \square^{\frac{d}{2}-\ell-k} \left( \partial_\epsilon \widehat{D}_{S, \frac{d}{2}-k-\epsilon} \right)_{\epsilon=0} \mathbb{O}_{k,\ell}(x, e), \quad (14)$$

where the differential operator  $\widehat{D}_S$  and the constants are defined in section 6.5

Constructing the charges and by doing a counting exercise we notice that the generators of the symmetries in celestial CFT are less than the ones obtained by an asymptotic symmetry analysis. Indeed the charges of the asymptotic symmetries do not all correspond to topological operators in the celestial CFT. In fact, the non-topological asymptotic symmetry charges map a CFT to a different one via deformations of its correlators and we thus obtain an infinite-dimensional geometry of theories corresponding to the infinite-dimensional vacuum manifold one obtains from supertranslation symmetry. For superrotations the story is less clear and still under investigation.

Elucidating these points is crucial for understanding the mixing of the holomorphic and anti-holomorphic sectors of the celestial CFT and to further understand the asymptotic symmetry group of AFS and its physical implications.

## Part I

# Celestial Amplitudes and Distributions

Before talking about celestial CFT and its associated symmetries, we need to have a well-defined notion of celestial amplitudes which serve as a gateway to study symmetries through soft theorems. In this first part of the thesis, we provide a mathematically rigorous definition of massless celestial amplitudes by constructing them as Mellin transforms of tempered distributions. We first define the appropriate space of test functions by taking the Mellin transform of the Schwartz class and construct the Mellin transform of their topological dual through a Parseval-type relation. We end this part by applications to the three- and four-point tree-level graviton celestial amplitudes.

## 1 The Mellin Transform of the Schwartz Space

In order to define massless celestial amplitudes, we need to define the space of test functions against which they will be smeared. In this section, we identify the space of conformal weight test functions as the Mellin transform of the Schwartz space  $\mathcal{S}(\mathbb{R}^+)$ . The main result of this section is theorem 2. First, we establish some basic properties of the Mellin transform  $\mathcal{M}(\phi)$  with  $\phi$  in  $\mathcal{S}(\mathbb{R}^+)$ , that we gather in the following proposition:

**Proposition 1.** *Given  $\phi$  in  $\mathcal{S}(\mathbb{R}^+)$ , the following properties hold:*

- i) *The fundamental strip<sup>7</sup> of  $\mathcal{M}(\phi)$  is  $St(0, +\infty)$  and  $\mathcal{M}(\phi)$  is holomorphic in  $St(0, +\infty)$ .*
- ii) *For all  $N \in \mathbb{N}$ ,  $\mathcal{M}(\phi)(s)$  has a meromorphic continuation to  $\Re(s) > -N$  with simple poles at  $s = -n$  with  $0 \leq n \leq N-1$  and no other singularities [54].*
- iii) *For  $c > 0$  we have*

$$\mathcal{M}(\phi)(c + i \cdot) \in \mathcal{S}(\mathbb{R}) \quad (1.1)$$

and for  $c \in \mathbb{R}^- \setminus \mathbb{Z}^-$

$$t^\alpha \mathcal{M}(\phi)(c + it) \quad (1.2)$$

is uniformly bounded with respect to  $t \in \mathbb{R}$  for all  $\alpha \in \mathbb{N}$ .

*Proof.* • First, we prove i). Given  $\phi \in \mathcal{S}(\mathbb{R}^+)$ , we have for  $s = c + it$

$$\left| \int_{\mathbb{R}^+} \phi(x) x^{s-1} dx \right| \leq \int_{\mathbb{R}^+} |\phi(x)| x^{c-1} dx. \quad (1.3)$$

Performing the change of variable  $u = \log x$ , we write

$$\int_{\mathbb{R}^+} |\phi(x)| x^{c-1} dx = \int_{\mathbb{R}} |\phi(e^u)| e^{cu} du. \quad (1.4)$$

Decomposing the integral in the right-hand side of (1.4) over the regions  $\mathbb{R}^+$  and  $\mathbb{R}^-$ , we obtain for  $c > 0$

$$|\mathcal{M}(\phi)(c + it)| \leq \frac{1}{c} \sup_{x \in \mathbb{R}^+} |\phi(x)| + \sup_{x \in \mathbb{R}^+} |\phi(x) x^{[c]+2}| < +\infty. \quad (1.5)$$

<sup>7</sup>defined as the largest open strip on which the Mellin transform  $\mathcal{M}(\phi)$  is defined.

This proves that  $\mathcal{M}(\phi)$  is well-defined for  $c > 0$ . In order to establish that  $\mathcal{M}(\phi)$  is holomorphic on  $St(0, +\infty)$ , we consider a triangle  $\Delta \subset St(0, +\infty)$  parameterized by  $\omega : [0, 1] \rightarrow \Delta$  with  $\omega$  being piecewise continuously differentiable. The function  $(u, y) \mapsto \phi(u)u^{\omega(y)-1}\omega'(y)$ ,  $u \in \mathbb{R}^+$ ,  $y \in [0, 1]$  is measurable with respect to the two-dimensional Lebesgue measure, and furthermore we have using [\(1.5\)](#)

$$\int_0^1 \int_{\mathbb{R}^+} |\phi(x)| x^{\omega(y)-1} |\omega'(y)| dx dy \leq \left( \int_0^1 \left| \frac{\omega'(y)}{\omega(y)} \right| dy \|\phi\|_\infty + \sup_{x \in \mathbb{R}^+} |\phi(x)x^{[\omega(\tilde{y})]+2}| \int_0^1 |\omega'(y)| dy \right) \quad (1.6)$$

with  $\omega(\tilde{y}) := \sup_{y \in [0, 1]} \omega(y)$ . Remembering that  $\omega(y) \in \Delta \subset St(0, +\infty)$ , we then deduce

$$\int_0^1 \int_{\mathbb{R}^+} |\phi(x)| x^{\omega(y)-1} |\omega'(y)| dx dy < +\infty. \quad (1.7)$$

Hence the assumptions of Fubini's theorem are satisfied and we write

$$\begin{aligned} \int_\Delta \mathcal{M}(\phi)(s) ds &= \int_0^1 \mathcal{M}(\phi)(\omega(y)) \omega'(y) dy \\ &= \int_{\mathbb{R}^+} \phi(x) \left( \int_0^1 x^{\omega(y)-1} \omega'(y) dy \right) dx \\ &= \int_{\mathbb{R}^+} \phi(x) \left( \int_\Delta x^{s-1} ds \right) dx = 0, \end{aligned}$$

where we used Cauchy's theorem together with the fact that  $u^{s-1}$  is holomorphic in  $St(0, +\infty)$  for all  $u > 0$ . Using lemma 2 from [\[55\]](#), we also have that  $\mathcal{M}(\phi)$  is continuous on its fundamental strip  $St(0, \infty)$ . Since  $\Delta \subset St(0, +\infty)$  is arbitrary, we deduce by Morera's theorem that  $\mathcal{M}(\phi)$  is holomorphic on  $St(0, +\infty)$ .

- The proof of ii) follows the same line of reasoning used in [\[54\]](#) in which  $\mathcal{M}(\phi)$  was shown to admit a meromorphic extension on  $\mathbb{C}$ . Given  $N \in \mathbb{N}$ , we perform a Taylor expansion of  $\phi$  in  $\mathcal{M}(\phi)$  as follows

$$\mathcal{M}(\phi)(c + it) = \int_0^1 \left( \phi(x) - \sum_{n=0}^{N-1} a_n x^n \right) x^{c+it-1} dx + \sum_{n=0}^{N-1} \frac{a_n}{n + c + it} + \int_1^{+\infty} \phi(x) x^{c+it-1} dx, \quad (1.8)$$

where  $a_n := \frac{\phi^{(n)}(0)}{n!}$  and  $\phi^{(n)}$  is the  $n^{\text{th}}$ -order derivative of  $\phi$ . Since  $\phi$  is in  $\mathcal{S}(\mathbb{R}^+)$ , we have by Taylor-Lagrange's inequality

$$\left| \phi(x) - \sum_{n=0}^{N-1} a_n x^n \right| \leq \|\phi^{(N)}\|_\infty x^N,$$

which implies that the first integral is well-defined for all  $c > -N$ . The second term contains the poles  $c + it = -n$  for  $n = 0, \dots, N-1$  and the third term is well-defined for all  $(c, t) \in \mathbb{R}^2$ . This holds for all  $N \in \mathbb{N}$  which directly gives that  $\mathcal{M}(\phi)$  has a meromorphic extension to  $\mathbb{C}$  with simple poles at  $s = c + it \in \mathbb{Z}^-$ .

- In this part, we establish iii). Given  $c > 0$ , we prove first that

$$\mathcal{M}(\phi)(c + i \cdot) \in \mathcal{S}(\mathbb{R}).$$

Lemma 2 in [\[55\]](#) gives that  $\mathcal{M}(\phi)$  is a continuous function on the line  $\{c\} \times i\mathbb{R}$ . Now, let us verify that for  $c > 0$ , the Mellin transform  $\mathcal{M}(\phi)(c + it)$  is infinitely differentiable with respect to  $t$  and furthermore we have for all  $\beta \in \mathbb{N}$

$$\partial_t^\beta \mathcal{M}(\phi)(c + it) = i^\beta \int_{\mathbb{R}^+} \phi(x) (\log x)^\beta x^{c+it-1} dx. \quad (1.9)$$



Let  $\mathcal{C}_\epsilon(it)$  be the circle with radius  $\epsilon < 1$  and origin  $s = it$ . Using Cauchy's integral formula for derivatives we have for  $u > 0$

$$\begin{aligned} (\log u)^\beta u^{it} &= (-i)^\beta \partial_t^\beta u^{it} = \frac{\beta!}{2\pi i} \int_{\mathcal{C}_\epsilon(it)} \frac{u^w}{(w-it)^{\beta+1}} dw \\ &= \frac{\beta!}{2\pi i} \int_0^{2\pi} \frac{u^{\psi(y)}}{(\psi(y)-it)^{\beta+1}} \psi'(y) dy, \end{aligned} \quad (1.10)$$

where  $\psi(y) = it + \epsilon e^{iy}$ . We write

$$\int_{\mathbb{R}^+} |\phi(u)| u^{c-1+\epsilon \cos y} du = \int_0^1 |\phi(u)| u^{c-1+\epsilon \cos y} du + \int_1^{+\infty} |u^{c-1+\epsilon \cos y} \phi(u)| du. \quad (1.11)$$

(1.11) is bounded by

$$\|\phi\|_\infty \int_0^1 u^{c-1+\epsilon \cos y} du + \int_1^{+\infty} u^c |\phi(u)| du = \frac{\|\phi\|_\infty}{c + \epsilon \cos y} + \int_1^{+\infty} u^c |\phi(u)| du.$$

Hence, we deduce

$$\int_{\mathbb{R}^+} |\phi(u) u^{c-1+\psi(y)}| du \leq K \quad (1.12)$$

with  $K := \frac{\|\phi\|_\infty}{c-\epsilon} + \int_{\mathbb{R}^+} u^c |\phi(u)| du$ . Thus we obtain for  $\beta \in \mathbb{N}$

$$\begin{aligned} \int_0^{2\pi} \int_{\mathbb{R}^+} \left| \phi(u) \frac{u^{\psi(y)}}{(\psi(y)-it)^{\beta+1}} \psi'(y) \right| du dy &\leq K \int_0^{2\pi} \left| \frac{\psi'(y)}{(\psi(y)-it)^{\beta+1}} \right| dy \\ &\leq 2\pi K \epsilon^{-\beta}. \end{aligned}$$

Therefore, the hypotheses of Fubini's theorem are fulfilled and we have by (1.10)

$$\int_{\mathbb{R}^+} \phi(x) (\log x)^\beta x^{c+it-1} dx = \frac{\beta!}{2\pi i} \int_0^{2\pi} \frac{\psi'(y)}{(\psi(y)-it)^{\beta+1}} \left( \int_{\mathbb{R}^+} \phi(u) u^{c+\psi(y)-1} du \right) dy. \quad (1.13)$$

For  $c > 0$ , we have

$$\mathcal{M}(\phi)(c + \psi(y)) = \int_{\mathbb{R}^+} \phi(u) u^{c+\psi(y)-1} du. \quad (1.14)$$

Hence, the right-hand side of (1.13) is given by

$$\frac{\beta!}{2\pi i} \int_0^{2\pi} \frac{\psi'(y)}{(\psi(y)-it)^{\beta+1}} \mathcal{M}(\phi)(c + \psi(y)) dy. \quad (1.15)$$

Applying again Cauchy's integral formula leads directly to (1.9) for any  $\beta \in \mathbb{N}$ . Now, let us verify for  $c > 0$

$$\sup_{t \in \mathbb{R}} \left| t^\alpha \partial_t^\beta \mathcal{M}(\phi)(c + it) \right| < +\infty.$$

Performing the change of variable  $x = e^u$  in (1.9), we have

$$t^\alpha \partial_t^\beta \mathcal{M}(\phi)(c + it) = i^{\beta-\alpha} \int_{\mathbb{R}} \phi(e^u) u^\beta e^{cu} \partial_u^\alpha (e^{itu}) du. \quad (1.16)$$

Using the relation

$$\partial_u^k (\phi(e^u)) = \sum_{p=1}^k \alpha_k(p) e^{pu} \phi^{(p)}(e^u) \quad (1.17)$$

with  $\alpha_k(p)$  denoting a positive constant, together with integration by parts and the general Leibniz formula, we deduce

$$\begin{aligned} \int_{\mathbb{R}} \phi(e^u) u^\beta e^{cu} \partial_u^\alpha (e^{itu}) du &= (-1)^\alpha \int_{\mathbb{R}} \partial_u^\alpha (\phi(e^u) u^\beta e^{cu}) e^{itu} du \\ &= (-1)^\alpha \sum_{k=0}^{\alpha} \sum_{n=0}^{\alpha-k} \sum_{p=1-\delta_{k,0}}^k \gamma(\alpha, k, p, n, \beta) \chi_{\{\beta \geq n\}} e^{\alpha-k-n} \int_{\mathbb{R}} e^{(c+p)u} e^{itu} \phi^{(p)}(e^u) u^{\beta-n} du, \end{aligned} \quad (1.18)$$

where

$$\chi_{\{\beta \geq n\}} = \begin{cases} 1 & \text{if } \beta \geq n \\ 0 & \text{otherwise} \end{cases}$$

and

$$\gamma(\alpha, k, p, n, \beta) := \binom{\alpha}{k} \binom{\alpha - k}{n} \frac{\beta!}{(\beta - n)!} \alpha_k(p).$$

We use the bound

$$u \leq e^u, \quad \forall u \in \mathbb{R}^+$$

to obtain for  $p \leq \alpha$

$$\left| \int_{\mathbb{R}^+} e^{(c+p)u} e^{itu} \phi^{(p)}(e^u) u^{\beta-n} du \right| \leq \frac{1}{c} \sup_{x \in \mathbb{R}^+} |x^{(2c+\alpha+\beta)} \phi^{(p)}(x)|. \quad (1.19)$$

We also have

$$\begin{aligned} \left| \int_{\mathbb{R}^-} e^{(c+p)u} e^{itu} \phi^{(p)}(e^u) u^{\beta-n} du \right| &\leq \frac{2}{c} \sup_{u \in \mathbb{R}^+} \left| e^{-\frac{cu}{2}} u^{\beta-n} \right| \|\phi^{(p)}\|_{\infty} \\ &\leq 2 \left( c^{-1} + \sup_{u \in \mathbb{R}^+} \left| e^{-\frac{u}{2}} u^{\beta} \right| c^{n-\beta-1} \right) \|\phi^{(p)}\|_{\infty} \\ &\leq O(1) \left( c^{-1} + c^{n-\beta-1} \right) \|\phi^{(p)}\|_{\infty}, \end{aligned} \quad (1.20)$$

where  $O(1)$  is a constant that depends only on  $\beta$ . Combining (1.16)-(1.20), we deduce

$$\begin{aligned} \left| t^{\alpha} \partial_t^{\beta} \mathcal{M}(\phi)(c + it) \right| &\leq O(1) \|\gamma\|_{\infty} \left( \sum_{k=0}^{\alpha} c^{k-1} \right) \\ &\quad \times \left\{ \sup_{x \in \mathbb{R}^+} |x^{(2c+\alpha+\beta)} \phi^{(p)}(x)| + (1 + c^{-\beta}) \|\phi^{(p)}\|_{\infty} \right\} < +\infty, \end{aligned} \quad (1.21)$$

where  $\|\gamma\|_{\infty} := \sup_{0 \leq k, p, n \leq \alpha} |\gamma(\alpha, k, p, n, \beta)|$  and  $O(1)$  is a positive constant that depends only on  $\alpha$  and  $\beta$ .

- In this part of the proof, we verify the last point of proposition 1 that is for  $c \in \mathbb{R}^- \setminus \mathbb{Z}^-$

$$t^{\alpha} \mathcal{M}(\phi)(c + it) \quad (1.22)$$

is uniformly bounded with respect to  $t \in \mathbb{R}$  for all  $\alpha \in \mathbb{N}$ .

For  $\alpha \in \mathbb{N}^*$  and  $c > 0$ , we have

$$\begin{aligned} t^{\alpha} \mathcal{M}(\phi)(c + it) &= (-i)^{\alpha} \int_{\mathbb{R}} \phi(e^u) e^{cu} \partial_u^{\alpha} (e^{itu}) du \\ &= i^{\alpha} \int_{\mathbb{R}} \partial_u^{\alpha} (\phi(e^u) e^{cu}) e^{itu} du. \end{aligned} \quad (1.23)$$

Using (1.17) together with the general Leibniz formula, we obtain that (1.23) is equal to

$$i^{\alpha} \sum_{k=0}^{\alpha} \sum_{p=1-\delta_{k,0}}^k \beta(\alpha, k, p) c^{\alpha-k} \int_{\mathbb{R}} \phi^{(p)}(e^u) e^{(c+p)u} e^{itu} du, \quad (1.24)$$

where  $\beta(\alpha, k, p) := \binom{\alpha}{k} \alpha_k(p)$ . Hence, we deduce for all  $c > 0$

$$t^{\alpha} \mathcal{M}(\phi)(c + it) = i^{\alpha} \sum_{k=0}^{\alpha} \sum_{p=1-\delta_{k,0}}^k \beta(\alpha, k, p) c^{\alpha-k} \mathcal{M}(\phi^{(p)})(c + p + it). \quad (1.25)$$

By the uniqueness of the meromorphic continuation of  $\mathcal{M}(\phi)$ , we deduce that

$$t^\alpha \mathcal{M}(\phi)(c+it) = i^\alpha \sum_{k=0}^{\alpha} \sum_{p=1-\delta_{k,0}}^k \beta(\alpha, k, p) c^{\alpha-k} \mathcal{M}(\phi^{(p)})(c+p+it) \quad (1.26)$$

holds for all  $c \in \mathbb{R} \setminus \mathbb{Z}^-$ . If  $c+p > 0$ , we use the bound [1.5](#) to obtain

$$\left| \mathcal{M}(\phi^{(p)})(c+p+it) \right| \leq \frac{1}{c+p} \left\| \phi^{(p)} \right\|_{\infty} + \sup_{x \in \mathbb{R}^+} \left| \phi^{(p)}(x) x^{[c+p]+2} \right|, \quad (1.27)$$

which can be bounded remembering that  $p \leq \alpha$  by

$$2 \max\left(\frac{1}{c+p}, 1\right) \sup_{1 \leq p \leq \alpha} \left\| \phi^{(p)} \right\|_{\infty} + \sup_{\substack{x \in \mathbb{R}^+ \\ 1 \leq p \leq \alpha}} \left| \phi^{(p)}(x) x^{[c+\alpha]+2} \right|. \quad (1.28)$$

Otherwise, we perform a Taylor expansion of  $\phi^{(p)}$  around 0 and we write

$$\begin{aligned} \mathcal{M}(\phi^{(p)})(c+p+it) &= \int_0^1 \left( \phi^{(p)}(x) - \sum_{n=0}^{N-1} \frac{\phi^{(p+n)}(0)}{n!} x^n \right) x^{c+p+it-1} dx + \sum_{n=0}^{N-1} \frac{\phi^{(p+n)}(0)}{n!(c+p+it+n)} \\ &\quad + \int_1^{+\infty} \phi^{(p)}(x) x^{c+p+it-1} dx, \end{aligned} \quad (1.29)$$

where the positive integer  $N$  verifies  $N+c+p > 0$ . Using Taylor-Lagrange's inequality and remembering that  $\phi \in \mathcal{S}(\mathbb{R}^+)$ , we deduce

$$\left| \mathcal{M}(\phi^{(p)})(c+p+it) \right| \leq \frac{\left\| \phi^{(p+N)} \right\|_{\infty}}{N+c+p} + \sum_{n=0}^{N-1} \frac{|\phi^{(p+n)}(0)|}{\sqrt{(c+p+n)^2+t^2}} + \frac{\sup_{x \in \mathbb{R}^+} |x^m \phi^{(p)}(x)|}{|c+p-m|}, \quad \forall m \in \mathbb{N}. \quad (1.30)$$

Hence, we obtain for  $N = -[c+p] + 2$  and  $m = 0$  the following bound

$$\begin{aligned} \left| \mathcal{M}(\phi^{(p)})(c+p+it) \right| &\leq O(1) \sup_{0 \leq n \leq \alpha + [-c+2]} \left\| \phi^{(n)} \right\|_{\infty} \\ &\quad \left( -[c+p] + 2 \right) \max\left( \frac{1}{|c+p - [c+p] + 1|}, \frac{1}{|c+p - [c+p]|} \right). \end{aligned} \quad (1.31)$$

Using [1.28](#) for the particular case of  $c > 0$ , we deduce

$$\begin{aligned} |t^\alpha \mathcal{M}(\phi)(c+it)| &\leq O(1) \left( \sum_{k=0}^{\alpha} c^{\alpha-k} \right) \\ &\quad \left\{ \max\left(\frac{1}{c}, 1\right) \sup_{1 \leq p \leq \alpha} \left\| \phi^{(p)} \right\|_{\infty} + \sup_{\substack{x \in \mathbb{R}^+ \\ 1 \leq p \leq \alpha}} \left| \phi^{(p)}(x) x^{[c+\alpha]+2} \right| \right\}, \end{aligned} \quad (1.32)$$

where  $O(1)$  denotes a positive constant that depends only on  $\alpha$ . For  $c \in \mathbb{R}^- \setminus \mathbb{Z}^-$ , we combine [1.26](#), [1.28](#) and [1.31](#) to deduce

$$\begin{aligned} |t^\alpha \mathcal{M}(\phi)(c+it)| &\leq O(1) \left( \sum_{k=0}^{\alpha} c^{\alpha-k} \right) \\ &\quad \left\{ \sum_{p=0}^{\alpha} \left( -[c+p] + 2 \right) \max\left( \frac{1}{|c+p - [c+p] + 1|}, \frac{1}{|c+p - [c+p]|} \right) \sup_{0 \leq n \leq \alpha + [-c+2]} \left\| \phi^{(n)} \right\|_{\infty} \right. \\ &\quad \left. + \sup_{\substack{x \in \mathbb{R}^+ \\ 1 \leq n \leq \alpha}} \left| \phi^{(n)}(x) x^{[c+\alpha]+2} \right| \right\}. \end{aligned} \quad (1.33)$$

□

In the proof of Theorem [1](#) we need the fundamental Lemma of Riemann-Lebesgue in the frame of Mellin transforms, which in our case we consider for particular values of  $\text{Re}(s) \in \mathbb{Z}^-$ :

**Lemma 1.** *If  $\phi \in \mathcal{S}(\mathbb{R}^+)$ , then*

$$\lim_{|t| \rightarrow +\infty} \mathcal{M}(\phi)(c+it) \rightarrow 0, \quad \forall c \in \mathbb{R}^- \setminus \{0\}. \quad (1.34)$$

For  $c = 0$ , we have

$$\lim_{t \rightarrow +\infty} t \mathcal{M}(\phi)(it) \rightarrow 0. \quad (1.35)$$

*Proof.* • We proceed as in [55](#) by using the same technique that proves the Lebesgue-Riemann Lemma by introducing the Mellin translation operator  $\tau_h^c$  for  $\phi : \mathbb{R}^+ \rightarrow \mathbb{C}$ ,  $c \in \mathbb{R}$  and  $h \in \mathbb{R}^+$  defined by

$$(\tau_h^c \phi)(x) := h^c \phi(hx), \quad x \in \mathbb{R}^+. \quad (1.36)$$

For  $s = c + it$ ,  $t \in \mathbb{R}^*$  and  $h := e^{-\frac{\pi}{t}}$ , we have

$$-\mathcal{M}(\phi)(s) = e^{i\pi} \mathcal{M}(\phi)(s) = h^{-it} \mathcal{M}(\phi)(s) = \mathcal{M}(\tau_h^c \phi)(s). \quad (1.37)$$

Using the linearity of the Mellin transform, we obtain

$$2 \mathcal{M}(\phi)(s) = \mathcal{M}(\phi)(s) - \mathcal{M}(\tau_h^c \phi)(s) = \mathcal{M}(\phi - \tau_h^c \phi)(s). \quad (1.38)$$

We write

$$\Phi_{h,c} := \phi - \tau_h^c \phi.$$

Performing a Taylor expansion of  $\Phi_{h,c}$  around 0, we obtain for  $c < 0$

$$\begin{aligned} \mathcal{M}(\Phi_{h,c})(c+it) &= \int_0^1 \left( \int_0^1 \frac{(1-t)^{N-1}}{(N-1)!} \partial_t^N \Phi_{h,c}(tx) dt \right) x^{c+it-1} dx + \sum_{n=0}^{N-1} \frac{\Phi_{h,c}^{(n)}(0)}{n!(c+it+n)} \\ &\quad + \int_1^{+\infty} \Phi_{h,c}(x) x^{c+it-1} dx, \end{aligned} \quad (1.39)$$

where  $N$  is a positive integer fixed such that  $N + c > 1$ . We have

$$\Phi_{h,c}^{(n)}(0) = (1 - h^{c+n}) \phi^{(n)}(0). \quad (1.40)$$

Since  $h^{c+n} = e^{-\frac{\pi(c+n)}{t}} \xrightarrow{|t| \rightarrow \infty} 1$ , we deduce that [1.40](#) converges to 0 if  $|t| \rightarrow \infty$ .

We rewrite

$$\int_1^{+\infty} \Phi_{h,c}(x) x^{c+it-1} dx, \quad (1.41)$$

as follows

$$(1 - h^c) \int_1^{+\infty} \phi(x) x^{c+it-1} dx + h^c \left( \int_1^{+\infty} (\phi(x) - \phi(hx)) x^{c+it-1} dx \right). \quad (1.42)$$

The first term on the right-hand side converges to 0 if  $|t| \rightarrow \infty$ . For the second term, we have

$$|\phi(x) - \phi(hx)| x^{c-1} \leq 2 \|\phi\|_{\infty} x^{c-1}, \quad (1.43)$$

Since  $\phi$  is in  $\mathcal{S}(\mathbb{R}^+)$ , then  $\phi(hx)$  converges pointwise to  $\phi(x)$  if  $|t| \rightarrow \infty$ . By Lebesgue's dominated convergence theorem we obtain

$$h^c \left( \int_1^{+\infty} (\phi(x) - \phi(hx)) x^{c+it-1} dx \right) \xrightarrow{|t| \rightarrow \infty} 0. \quad (1.44)$$

Hence, (1.41) converges to 0. In order to conclude that

$$\mathcal{M}(\Phi_{h,c})(c+it) \xrightarrow{|t| \rightarrow \infty} 0, \quad (1.45)$$

we need to establish that

$$\int_0^1 \left( \int_0^1 \frac{(1-t)^{N-1}}{(N-1)!} \partial_t^N \Phi_{h,c}(tx) dt \right) x^{c+it-1} dx \xrightarrow{|t| \rightarrow \infty} 0. \quad (1.46)$$

We have

$$\int_0^1 (1-t)^{N-1} \partial_t^N \Phi_{h,c}(tx) dt = \int_0^1 (1-t)^{N-1} x^N \left( \phi^{(N)}(tx) - h^{N+c} \phi^{(N)}(thx) \right) dt. \quad (1.47)$$

Proceeding as in (1.42), we decompose (1.47) as follows

$$(1-h^{N+c}) x^N \int_0^1 (1-t)^{N-1} \phi^{(N)}(tx) dt + h^{N+c} x^N \int_0^1 (1-t)^{N-1} \left( \phi^{(N)}(tx) - \phi^{(N)}(thx) \right) dt. \quad (1.48)$$

Choosing  $N$  such that  $N+c-1 > 1$  and using the bound

$$\left| \int_0^1 \frac{(1-t)^{N-1}}{(N-1)!} \phi^{(N)}(tx) dt \right| \leq \frac{\|\phi^{(N)}\|_\infty}{N!}, \quad (1.49)$$

we deduce that

$$\left| \int_0^1 \frac{(1-t)^{N-1}}{(N-1)!} \left( \phi^{(N)}(tx) - \phi^{(N)}(thx) \right) dt \right| \leq 2 \frac{\|\phi^{(N)}\|_\infty}{N!}. \quad (1.50)$$

Again by the Lebesgue's dominated convergence theorem, we obtain

$$\int_0^1 \int_0^1 \frac{(1-t)^{N-1}}{(N-1)!} \left( \phi^{(N)}(tx) - \phi^{(N)}(thx) \right) dt x^{c+it-1+N} dx \xrightarrow{|t| \rightarrow \infty} 0. \quad (1.51)$$

This together with (1.48) imply (1.46). Combining (1.45) with (1.38), we obtain

$$\mathcal{M}(\phi)(c+it) \xrightarrow{|t| \rightarrow \infty} 0, \quad \forall c \in \mathbb{R}^- \setminus \{0\}. \quad (1.52)$$

- For  $c = 0$  and  $t \in \mathbb{R}^*$ , the Mellin transform  $\mathcal{M}(\phi)(c+it)$  is well-defined through (1.8). Therefore, we write

$$\begin{aligned} t \mathcal{M}(\phi)(it) &= -i \int_{\mathbb{R}} \phi(e^u) \partial_u (e^{itu}) du \\ &= i \int_{\mathbb{R}} \phi'(e^u) e^u e^{itu} du \\ &= i \mathcal{M}(\phi')(1+it). \end{aligned} \quad (1.53)$$

By proposition 1 (1.53) converges to 0 if  $|t| \rightarrow +\infty$ . This proves (1.35). □

## 1.1 The Inversion Formula for the Mellin Transform

In this subsection, we prove the inversion formula of the Mellin transform for functions in the Schwartz space  $\mathcal{S}(\mathbb{R}^+)$ . Before stating the inversion Mellin formula Theorem, we need the following Lemma:

**Lemma 2.** For  $f$  in  $\mathcal{S}(\mathbb{R}^+)$  and  $c > 0$ , we have

$$e^{cx} f(e^x) \in \mathcal{S}(\mathbb{R}). \quad (1.54)$$

*Proof.* Let  $f$  in  $\mathcal{S}(\mathbb{R}^+)$ ,  $c > 0$  and  $n \in \mathbb{N}$ , we bound uniformly

$$x^n e^{cx} f(e^x).$$

If  $x \leq 0$ , then clearly we have

$$|x^n e^{cx} f(e^x)| \leq \sup_{x \in \mathbb{R}^+} x^n e^{-cx} \|f\|_\infty. \quad (1.55)$$

For  $x > 0$ , we have

$$|x^n e^{cx} f(e^x)| \leq e^{(c+1)x} f(e^x) \leq \sup_{x \in \mathbb{R}^+} |x^{[c]+2} f(x)|. \quad (1.56)$$

Combining (1.55) and (1.56) gives (1.54).  $\square$

**Theorem 1.** (Inversion formula) Given  $\phi$  in  $\mathcal{S}(\mathbb{R}^+)$  and  $\mathcal{M}(\phi)$  its Mellin transform. We have

$$\phi(x) = \frac{x^{-c}}{2\pi} \int_{\mathbb{R}} \mathcal{M}(\phi)(c+it) x^{-it} dt, \quad \forall c > 0, \quad \forall x > 0. \quad (1.57)$$

*Proof.* Let  $\phi$  in  $\mathcal{S}(\mathbb{R}^+)$  and  $c > 0$ . From proposition 1 the Mellin transform

$$\int_{\mathbb{R}^+} \phi(u) u^{s-1} du \quad (1.58)$$

is well-defined. Using (1.58) we write for  $x > 0$

$$\begin{aligned} \frac{x^{-c}}{2\pi} \int_{\mathbb{R}} \mathcal{M}(\phi)(c+it) x^{-it} dt &= \frac{x^{-c}}{2\pi} \int_{\mathbb{R}} \int_{\mathbb{R}^+} \phi(u) u^{c+it-1} du x^{-it} dt \\ &= \frac{x^{-c}}{2\pi} \int_{\mathbb{R}} \int_{\mathbb{R}} \phi(e^w) e^{cw} e^{itw} dw x^{-it} dt, \end{aligned}$$

where we perform the change of variable  $u = e^w$ . Using Lemma 2 we obtain

$$\frac{x^{-c}}{2\pi} \int_{\mathbb{R}} \int_{\mathbb{R}} \phi(e^w) e^{cw} e^{itw} dw x^{-it} dt = \frac{x^{-c}}{\sqrt{2\pi}} \int_{\mathbb{R}} \mathcal{F}(g)(t) e^{-it \log x} dt, \quad (1.59)$$

where  $g(v) := e^{cv} \phi(e^v)$ . Using the Fourier inversion integral, we deduce that the right-hand side of (1.59) is equal to

$$x^{-c} g(\log x) = \phi(x). \quad (1.60)$$

This ends the proof of Theorem 1.  $\square$

The method of proof of Theorem 1 does not hold if one considers the general case of the space  $X_c$  defined as

$$X_c := \left\{ f \mid \int_{\mathbb{R}^+} x^c |f(x)| dx < +\infty \right\} \quad (1.61)$$

For the general case, the proof of the inversion Mellin formula is based on approximation theory, in particular the properties of the Mellin-Gauss-Weistrass kernel. For further details, we refer the reader to [55]. In our setup we have for all  $c > 0$

$$\mathcal{S}(\mathbb{R}^+) \subset X_c,$$

which simplifies considerably the proof of Theorem 1.

## 1.2 The Mellin transform of the Schwartz space $\mathcal{S}(\mathbb{R}^+)$

Before stating the main result of this section, we introduce some definitions that will be used in the sequel.

**Definition 1.** (*Singular expansion*) Let  $\Phi(s)$  be meromorphic in some area  $\Omega$  with  $S$  including all the poles of  $\Phi$  in  $\Omega$ . A singular expansion of  $\Phi(s)$  in  $\Omega$  is a formal sum of singular elements of  $\Phi(s)$  at all points of  $S$ . We note it as follows:

$$\Phi(s) \asymp E.$$

Note that the singular expansion is only a formal sum, which only shows the poles of the function and its singularities.

Let us now define the space  $\mathcal{M}^+$  of functions with a fundamental strip in  $St(0, +\infty)$  and a meromorphic continuation to the strip  $St(-\infty, 0)$  such that for all  $N \in \mathbb{N}^0$ , a given function  $\psi$  in  $\mathcal{M}^+$  admits the singular expansion for  $s \in St(-N, 0)$

$$\psi(s) \asymp \sum_{n=0}^{N-1} \frac{a_n}{s+n}.$$

We also define the sub-space  $\tilde{\mathcal{M}}^+$  as follows

$$\tilde{\mathcal{M}}^+ := \left\{ \psi \in \mathcal{M}^+ \mid \forall c > 0 : \psi(c+i\cdot) \in \mathcal{S}(\mathbb{R}); \right. \\ \left. \forall \alpha \in \mathbb{N}, \forall c \in \mathbb{R}^- \setminus \mathbb{Z}^- : \sup_{t \in \mathbb{R}} |t^\alpha \psi(c+it)| < +\infty \right\}. \quad (1.62)$$

Our main result is summarized in the following Theorem:

**Theorem 2.** *The map*

$$\mathcal{M} : \mathcal{S}(\mathbb{R}^+) \longrightarrow \tilde{\mathcal{M}}^+ \\ \phi \longmapsto \mathcal{M}(\phi)(c+it) := \int_{\mathbb{R}^+} \phi(x) x^{c+it} dx \quad (1.63)$$

is an isomorphism with the following inverse map

$$\mathcal{M}^{-1} : \tilde{\mathcal{M}}^+ \longrightarrow \mathcal{S}(\mathbb{R}^+) \\ \psi \longmapsto \begin{cases} \mathcal{M}^{-1}(\psi)(x) &= \frac{x^{-c}}{2\pi} \int_{\mathbb{R}} \psi(c+it) x^{-it} dt, \quad \forall c > 0 \text{ and } x > 0 \\ \partial^k \mathcal{M}^{-1}(\psi)(0) &= k! a_k, \quad \forall k \in \mathbb{N}, \end{cases} \quad (1.64)$$

where  $a_k$  is the residue of  $\psi$  at  $s = -k$ .

*Proof.* (1.63) is well-defined by proposition 1. Now, we need to verify that the map (1.64) is also well-defined, that is for  $\psi$  in  $\tilde{\mathcal{M}}^+$  we have

$$\mathcal{M}^{-1}(\psi) \in \mathcal{S}(\mathbb{R}^+). \quad (1.65)$$

- First, we establish that  $\mathcal{M}^{-1}(\psi)$  is infinitely differentiable on  $\mathbb{R}^+$ . We start by studying the behaviour of the function

$$\mathcal{M}^{-1}(\psi)(x) = \frac{x^{-c}}{2\pi} \int_{\mathbb{R}} \psi(c+it) x^{-it} dt \quad (1.66)$$

as  $x \rightarrow 0$ . Given  $N \in \mathbb{N}^*$ , the set of poles in  $St(-N, +\infty)$  will be denoted in the sequel as  $S_N$ . Given  $\alpha > 0$ , we define the rectangular contour  $\mathcal{C}(T)$  by the segments

$$[\alpha - iT, \alpha + iT], \quad [\alpha + iT, \gamma + iT], \quad [\gamma + iT, \gamma - iT], \quad [\gamma - iT, \alpha - iT] \quad (1.67)$$

with  $\gamma := -N - \frac{1}{2}$ . Let us consider the integral

$$\mathcal{J}(T) := \frac{1}{2\pi i} \int_{\mathfrak{C}(T)} \psi(s) x^{-s} ds. \quad (1.68)$$

For  $T > 0$ , remembering that  $\psi \in \tilde{\mathcal{M}}^+$ , we obtain by Cauchy's theorem

$$\mathcal{J}(T) = \sum_{n=0}^{N-1} a_n \operatorname{Res} \left( \frac{x^{-s}}{s+n} \right) = \sum_{n=0}^{N-1} a_n x^n. \quad (1.69)$$

Using Theorem 1 together with the fact that  $\psi$  is holomorphic in  $St(0, +\infty)$ , we obtain for  $\alpha > 0$  and  $x > 0$

$$\lim_{T \rightarrow +\infty} \frac{1}{2\pi i} \int_{\alpha-iT}^{\alpha+iT} \psi(\alpha+it) x^{-\alpha-it} dt = \mathcal{M}^{-1}(\psi)(x). \quad (1.70)$$

Now, we consider the term

$$\int_{\alpha \pm iT}^{\gamma \pm iT} \psi(s) x^{-s} ds. \quad (1.71)$$

For  $0 < x < \eta$  with  $\eta > 0$ , we have

$$\left| \int_{\alpha+iT}^{\gamma+iT} \psi(s) x^{-s} ds \right| \leq \sup_{c \in (\gamma, \alpha)} |\psi(c+iT)| \frac{|x^{-\gamma} - x^{-\alpha}|}{|\log x|}. \quad (1.72)$$

For  $T \in \mathbb{R}^*$ ,  $\psi$  is continuous w.r.t. the variable  $c \in \mathbb{R}$  and this implies for fixed  $T$  in  $\mathbb{R}^*$  that

$$\exists \tilde{c} \in [\gamma, \alpha] : |\psi(\tilde{c} + iT)| := \sup_{c \in (\gamma, \alpha)} |\psi(c + iT)| \quad (1.73)$$

By proposition 1 and lemma 2 we deduce that

$$\lim_{T \rightarrow +\infty} \psi(\tilde{c} + iT) = 0, \quad (1.74)$$

which combined with 1.72 gives

$$\lim_{T \rightarrow +\infty} \int_{\alpha+iT}^{\gamma+iT} |\psi(s)| x^{-s} ds = 0, \quad \forall 0 < x < \eta. \quad (1.75)$$

Without loss of generality, we choose  $\eta = 1$ . Similar arguments lead to

$$\lim_{T \rightarrow +\infty} \int_{\alpha-iT}^{\gamma-iT} |\psi(s)| x^{-s} ds = 0, \quad \forall 0 < x < 1. \quad (1.76)$$

Combining 1.69, 1.75 and 1.76 we deduce for all  $0 < x < 1$  and  $N \in \mathbb{N}^*$  that

$$\mathcal{M}^{-1}(\psi)(x) = \sum_{n=0}^{N-1} a_n x^n - \frac{1}{2\pi} \int_{\mathbb{R}} \psi(\gamma+it) x^{-\gamma-it} dt. \quad (1.77)$$

Using that

$$\left| \psi(\gamma+it) x^{-it} \right| \leq |\psi(\gamma+it)| \quad (1.78)$$

together with

$$\int_{\mathbb{R}} |t|^\beta |\psi(\gamma+it)| dt \leq 2\pi \sup_{\substack{0 \leq \alpha \leq 2 \\ t \in \mathbb{R}}} |t^{\alpha+\beta} \psi(\gamma+it)| < +\infty, \quad (1.79)$$

we deduce that

$$\int_{\mathbb{R}} \psi(\gamma+it) x^{-it} dt \quad (1.80)$$

---

<sup>8</sup> $T$  must be larger than  $\operatorname{Im}(s)$  for all  $s \in S_N$ . In this case,  $\operatorname{Im}(s) = 0$



is infinitely differentiable w.r.t.  $x$ . Hence, we obtain<sup>9</sup> for all  $N \geq 2$  and  $0 < x < 1$

$$\partial_x^{N-1} \mathcal{M}^{-1}(\psi)(x) = (N-1)! a_{N-1} - x^{\frac{3}{2}} \int_{\mathbb{R}} \prod_{k=0}^{N-2} \left( N + \frac{1}{2} - it - k \right) \psi(\gamma + it) x^{-it} dt. \quad (1.81)$$

This establishes that  $\mathcal{M}^{-1}(\psi)$  is infinitely differentiable for  $x \in (0, 1)$ . Now let us verify that it is also the case for  $x = 0$ . Again using the bound (1.79), we deduce that the second term on the right-hand side of (1.81) vanishes if  $x \rightarrow 0$  which implies that

$$\lim_{x \rightarrow 0} \partial_x^{N-1} \mathcal{M}^{-1}(\psi)(x) = (N-1)! a_{N-1} = \partial_x^{N-1} \mathcal{M}^{-1}(\psi)(0), \quad \forall N \geq 2. \quad (1.82)$$

Using (1.77), we deduce that

$$\lim_{x \rightarrow 0} \mathcal{M}^{-1}(\psi)(x) = a_0 = \mathcal{M}^{-1}(\psi)(0). \quad (1.83)$$

(1.82) together with (1.83) prove that  $\mathcal{M}^{-1}(\psi)$  is infinitely differentiable at  $x = 0$ .

- For  $x > 0$ , we have

$$\phi(x) = \frac{x^{-c}}{2\pi} \int_{\mathbb{R}} dt \psi(c + it) x^{-it}. \quad (1.84)$$

(1.84) does not depend on  $c > 0$  according to proposition 5 of [55] with the fundamental strip  $St(0, \infty)$ . Hence, we write

$$\phi(x) = \frac{x^{-p}}{2\pi} \int_{\mathbb{R}} dt \psi(p + it) x^{-it}, \quad \forall p \in \mathbb{N}^*. \quad (1.85)$$

We can prove by induction using the theorem of the derivation inside the integral that the  $N^{\text{th}}$ -order derivative of  $\phi$  exists and is given for  $x \geq 1$  and  $p \in \mathbb{N}^*$  by

$$\partial_x^N \mathcal{M}^{-1}(\phi)(x) = \frac{(-1)^N}{2\pi} \int_{\mathbb{R}} \prod_{l=0}^{N-1} (it + p + l) \psi(p + it) x^{-it-p-N} dt. \quad (1.86)$$

Remembering that  $\psi \in \tilde{\mathcal{M}}^+$ , we have that (1.86) is well-defined for  $x \geq 1$ ,  $p \in \mathbb{N}^*$  and  $N \in \mathbb{N}^*$ . This together with (1.81) implies that  $\mathcal{M}^{-1}(\phi)$  is in  $\mathcal{C}^\infty(\mathbb{R}^+)$ .

- Now, we need to verify that for all  $(p, N) \in \mathbb{N}^2$

$$x^p \partial_x^N \mathcal{M}^{-1}(\phi)(x) \quad (1.87)$$

is uniformly bounded with respect to  $x$  in  $\mathbb{R}^+$ . For  $0 < x < 1$ , we use (1.81) to obtain that

$$\left| x^p \partial_x^N \mathcal{M}^{-1}(\phi)(x) \right| \leq O(1) \left( a_N + \sum_{\alpha=0}^{N-1} \mathcal{N}_\alpha(\psi) \right), \quad (1.88)$$

where  $\mathcal{N}_\alpha(\psi) := \sup_{t \in \mathbb{R}} |t^\alpha \psi(\gamma + it)|$ . For  $x \geq 1$ , we use (1.86) to deduce that

$$\left| x^p \partial_x^N \mathcal{M}^{-1}(\phi)(x) \right| \leq O(1) \sum_{\alpha=0}^{N-1} \mathcal{N}_\alpha(\psi). \quad (1.89)$$

$O(1)$  denotes in both (1.88)-(1.89) a constant that only depends on  $p$  and  $N$ . This ends the proof of (1.65)

The last point we need to verify to end the proof of Theorem 3 is that the maps  $\mathcal{M}$  and  $\mathcal{M}^{-1}$  satisfy

$$\mathcal{M}^{-1} \mathcal{M} \phi = \phi \quad \text{and} \quad \mathcal{M} \mathcal{M}^{-1} \psi = \psi, \quad (1.90)$$

---

<sup>9</sup>Remember that  $\gamma = -N - \frac{1}{2}$ .

for  $\phi \in \mathcal{S}(\mathbb{R}^+)$  and  $\psi \in \tilde{\mathcal{M}}^+$ . Let  $\phi$  in  $\mathcal{S}(\mathbb{R}^+)$ , we have by the definition of the map  $\mathcal{M}^{-1}$

$$\begin{aligned}\mathcal{M}^{-1}(\mathcal{M}(\phi))(x) &= \frac{x^{-c}}{2\pi} \int_{\mathbb{R}} \mathcal{M}(\phi)(c+it) x^{-it} dt, \quad \forall c > 0 \text{ and } x > 0 \\ \partial^k \mathcal{M}^{-1}(\mathcal{M}(\phi))(0) &= \phi^{(k)}(0), \quad \forall k \in \mathbb{N}.\end{aligned}\tag{1.91}$$

The second line in [1.91](#) is a consequence of the fact that  $\mathcal{M}(\phi)$  belongs to  $\tilde{\mathcal{M}}^+$ , which implies that it is meromorphic on the half-plane with simple poles at  $s = -k$  and residues  $\phi^{(k)}(0)$  for all  $k \in \mathbb{N}$ . Theorem [1](#) gives

$$\mathcal{M}^{-1} \mathcal{M} \phi = \phi$$

for  $\phi \in \mathcal{S}(\mathbb{R}^+)$ .

To show that  $\psi \in \tilde{\mathcal{M}}^+$ , we have for  $\psi \in \tilde{\mathcal{M}}^+$

$$\begin{aligned}[\mathcal{M}(\mathcal{M}^{-1}\psi)](c+i\lambda) &= \int_0^\infty d\omega \omega^{c+i\lambda-1} \int_{\mathbb{R}} \frac{d\lambda'}{2\pi} \omega^{c'+i\lambda'} \psi(c'+i\lambda'), \quad c, c' > 0 \\ &= \int_{\mathbb{R}} \frac{du}{2\pi} e^{i\lambda u} e^{(c-c')u} \int_{\mathbb{R}} d\lambda' e^{-i\lambda' u} \psi(c'+i\lambda') \\ &= \int_{\mathbb{R}} \frac{du}{2\pi} \mathcal{F}(\psi)(c'+iu) e^{i(\lambda-i(c-c'))u} = \psi(c+i\lambda),\end{aligned}\tag{1.92}$$

where in the second line we performed the change of variable  $\omega = e^u$  and we used the fact that  $\psi(c+i\cdot) \in \mathcal{S}(\mathbb{R})$  for  $c > 0$  to take its Fourier transform.  $\square$

## 2 The Mellin Transform of Tempered Distributions

Given two functions  $f, g \in \mathcal{S}(\mathbb{R})$ , we define the *generalized convolution product*  $f * g$  as follows

$$(f * g)(x) := \int_{\mathbb{R}} dt f(t) g(x+t) e^{-ita}.\tag{2.1}$$

We introduce the following lemma which will be used in establishing Parseval's relation:

**Lemma 3.** (*Generalized convolution theorem*) Given the functions  $f, g \in \mathcal{S}(\mathbb{R})$  and  $\hat{f}, \hat{g}$  their respective Fourier transforms, we have

$$\hat{f}(a-s) \hat{g}(s) = \mathcal{F}[(f * g)](s).\tag{2.2}$$

*Proof.* We start from the l.h.s. of [2.2](#)

$$\hat{f}(a-s) \hat{g}(s) = \int_{\mathbb{R}} dt \int_{\mathbb{R}} du e^{-it(a-s)} f(t) e^{-ius} g(u).\tag{2.3}$$

Performing a change of variable  $u = x + t$ , we obtain

$$\int_{\mathbb{R}} dt \int_{\mathbb{R}} dx e^{-ixs} f(t) g(x+t) e^{-ita}.\tag{2.4}$$

Since  $f, g \in \mathcal{S}(\mathbb{R})$ , we have

$$\int_{\mathbb{R}} dt \int_{\mathbb{R}} dx |e^{-ixs} f(t) g(x+t) e^{-ita}| = \int_{\mathbb{R}} dt |f(t)| \int_{\mathbb{R}} dx |g(x+t)| < \infty.\tag{2.5}$$

Fubini's theorem together with [2.4](#) concludes the proof of lemma [3](#).  $\square$

## 2.1 Parseval's Relation for the Mellin Transform

From this subsection onward, we change our notations to match the celestial holography literature:  $x$  is replaced by  $\omega$ ,  $s$  by  $\Delta$  and  $t$  by  $\lambda$ . In the new notation, the momenta of massless particles are parameterized as follows

$$p^\mu \equiv \omega q^\mu = \omega \left( \frac{1+x^2}{2}, x^a, \frac{1-x^2}{2} \right), \quad (2.6)$$

where Greek indices run over the  $d+2$  bulk spacetime dimensions and the Latin indices run over the  $d$  celestial sphere dimensions.  $\omega$  designates the energy of the massless particle.

**Lemma 4.** (Parseval's relation for the Mellin transform of Schwartz functions) Given two functions  $f, g \in \mathcal{S}(\mathbb{R}^+)$  and their respective Mellin transforms  $\tilde{f}, \tilde{g} \in \tilde{\mathcal{M}}^+$ , we have<sup>10</sup>

$$\int_0^\infty d\omega \omega f(\omega) g(\omega) = \int_{c-i\infty}^{c+i\infty} \frac{d\Delta}{2i\pi} \tilde{f}(2-\Delta) \tilde{g}(\Delta), \quad (2.7)$$

where  $c \in (0, 2)$ .

*Proof.* We start from the r.h.s. of equation (2.7) by writing the Mellin transforms  $\tilde{f}$  and  $\tilde{g}$  explicitly

$$\begin{aligned} \int_{c-i\infty}^{c+i\infty} \frac{d\Delta}{2i\pi} \tilde{f}(2-\Delta) \tilde{g}(\Delta) &= \int_{\mathbb{R}} \frac{d\lambda}{2\pi} \int_0^\infty d\omega d\omega' \omega^{1-c-i\lambda} \omega'^{c-1+i\lambda} f(\omega) g(\omega') \\ &= \int_{\mathbb{R}} \frac{d\lambda}{2\pi} \int_{\mathbb{R}} dx dx' e^{-i\lambda x} e^{i\lambda x'} F(x) G(x), \end{aligned} \quad (2.8)$$

where we performed in the last line the change of variables  $\omega = e^x$  and  $\omega' = e^{x'}$  and introduced the functions  $F(x) = e^{(2-c)x} f(e^x)$  and  $G(x) = e^{cx'} g(e^{x'})$ . Using lemma 2 we have that  $F, G \in \mathcal{S}(\mathbb{R})$ . Therefore, we obtain

$$\begin{aligned} \int_{c-i\infty}^{c+i\infty} \frac{d\Delta}{2i\pi} \tilde{f}(2-\Delta) \tilde{g}(\Delta) &= \int_{\mathbb{R}} \frac{d\lambda}{2\pi} \hat{F}(\lambda) \hat{G}(-\lambda) \\ &= \mathcal{F}^{-1} \left[ \hat{F}(\lambda) \hat{G}(-\lambda) \right] (0). \end{aligned} \quad (2.9)$$

Then using lemma 3 with  $a = 0$ , we have

$$\begin{aligned} \int_{c-i\infty}^{c+i\infty} \frac{d\Delta}{2i\pi} \tilde{f}(2-\Delta) \tilde{g}(\Delta) &= \int_{\mathbb{R}} dt F(t) G(t) \\ &= \int_{\mathbb{R}} dt e^{2t} f(e^t) g(e^t) \\ &= \int_0^\infty d\omega \omega f(\omega) g(\omega), \end{aligned} \quad (2.10)$$

where in the last line we performed the change of variable  $\omega = e^t$ . This concludes the proof of lemma 4  $\square$

We can generalize Parseval's relation to the action of tempered distributions on Schwartz functions.

**Theorem 3.** (Mellin transform of tempered distributions) Consider  $f \in \mathcal{S}(\mathbb{R}^+)$  and  $A \in \mathcal{S}'(\mathbb{R}^+)$ . If  $f$  is the inverse Mellin transform of  $\tilde{f} \in \tilde{\mathcal{M}}^+$  then we can define the Mellin transform  $\tilde{A}$  of  $A$  through

$$\langle \tilde{A}, \tilde{f} \rangle_{\tilde{\mathcal{M}}^+, \tilde{\mathcal{M}}^+} = \langle A, f \rangle_{\mathcal{S}'(\mathbb{R}^+), \mathcal{S}(\mathbb{R}^+)}, \quad (2.11)$$

<sup>10</sup>writing the Lorentz invariant phase space element  $\frac{d^3 p}{2p^0}$  we get the measure associated to the energy dependence  $\omega d\omega$ .

where the bracket on the l.h.s. is inspired by a Parseval-type relation

$$\langle \tilde{A}, \tilde{f} \rangle_{\tilde{\mathcal{M}}^+, \tilde{\mathcal{M}}^+} = \int_{c-i\infty}^{c+i\infty} \frac{d\Delta}{2i\pi} \tilde{A}(\Delta) \tilde{f}(2-\Delta), \quad 2-c \in St(0, \infty). \quad (2.12)$$

We thus obtain

$$\tilde{A} = \int_0^\infty d\omega \omega^{\Delta-1} A(\omega). \quad (2.13)$$

*Proof.*

$$\begin{aligned} \langle \tilde{A}, \tilde{f} \rangle_{\tilde{\mathcal{M}}^+, \tilde{\mathcal{M}}^+} &= \int_{c-i\infty}^{c+i\infty} \frac{d\Delta}{2i\pi} \tilde{A}(\Delta) \tilde{f}(2-\Delta) \\ &= \int_0^\infty d\omega \omega A(\omega) f(\omega) \\ &= \int_0^\infty d\omega \int_{c'-i\infty}^{c'+i\infty} \frac{d\Delta}{2i\pi} \omega^{1-\Delta} A(\omega) \tilde{f}(\Delta), \quad c' \in (0, \infty) \\ &= \int_0^\infty d\omega \int_{c-i\infty}^{c+i\infty} \frac{d\Delta}{2i\pi} \omega^{\Delta-1} A(\omega) \tilde{f}(2-\Delta), \quad 2-c \in (0, \infty), \end{aligned} \quad (2.14)$$

where in the last line we performed the change of variable  $\Delta \rightarrow 2-\Delta$ . The above expression is equal to equation [2.12](#) by defining  $\tilde{A}$  to be [2.13](#).  $\square$

**Theorem 4.** (Inverse Mellin transform of elements in  $\tilde{\mathcal{M}}^+$ ) Equivalently we can define the inverse Mellin transform  $A$  of  $\tilde{A} \in \tilde{\mathcal{M}}^+$  through

$$\langle A, f \rangle_{S'(\mathbb{R}^+), S(\mathbb{R}^+)} = \langle \tilde{A}, \tilde{f} \rangle_{\tilde{\mathcal{M}}^+, \tilde{\mathcal{M}}^+}, \quad (2.15)$$

where  $\tilde{f} \in \tilde{\mathcal{M}}^+$  is the Mellin transform of  $f \in S(\mathbb{R}^+)$ . Similarly we obtain

$$A(\omega) = \int_{c-i\infty}^{c+i\infty} \frac{d\Delta}{2i\pi} \omega^{-\Delta} \tilde{A}(\Delta), \quad 2-c \in (0, \infty). \quad (2.16)$$

### 3 Applications: Graviton Celestial Amplitudes

In this section, we compute rigorously tree-level graviton celestial amplitudes by taking the Mellin transform of momentum-space amplitudes, which are tempered distributions. In particular, we focus on results found in [24](#) where the graviton celestial amplitudes considered in  $d+2=4$  bulk dimensions. Our method is based on results from section [2](#)

#### 3.1 Three-Graviton Celestial Amplitude

The 3-point MHV tree-level graviton amplitude is

$$\mathcal{A}_{--+}(\omega_i, z_i, \bar{z}_i) = \left( \frac{\omega_1 \omega_2}{\omega_3} \frac{z_{12}^3}{z_{23} z_{31}} \right)^2 \delta^{(4)} \left( \sum_{i=1}^3 \epsilon_i \omega_i q_i \right), \quad (3.1)$$

where  $z_i = x_i^1 + ix_i^2$ ,  $z_{ij} = z_i - z_j$  and  $\epsilon_i = \pm 1$  if the particle is outgoing/incoming. Using the parameterization [2.6](#), the momentum conserving  $\delta$  can be written as

$$\delta^{(4)} \left( \sum_{i=1}^3 \epsilon_i \omega_i q_i \right) = \frac{1}{4\omega_3^2} \frac{\text{sgn}(z_{23} z_{31})}{z_{23} z_{31}} \delta(\omega_1 - \alpha_1 \omega_3) \delta(\omega_2 - \alpha_2 \omega_3) \delta(\bar{z}_{23}) \delta(\bar{z}_{31}), \quad (3.2)$$

where  $\alpha_1 = \frac{\epsilon_3 z_{23}}{\epsilon_1 z_{12}}$  and  $\alpha_2 = \frac{\epsilon_3 z_{31}}{\epsilon_2 z_{12}}$  and  $\bar{z}_{ij} = z_{ij}^*$ . Performing the integrals (Mellin transforms) on all  $\omega_i$ 's, we obtain [24](#)

$$\tilde{\mathcal{A}}_{--+}(\Delta_i, z_i, \bar{z}_i) = \frac{z_{12}^6}{|z_{23} z_{31}|^3} \delta(\bar{z}_{23}) \delta(\bar{z}_{31}) \alpha_1^{\Delta_1+1} \alpha_2^{\Delta_2+1} \Theta(\alpha_1) \Theta(\alpha_2) \int_0^\infty d\omega_3 \omega_3^{i\Delta+3c-3}, \quad (3.3)$$

where  $\Delta_i = c + i\lambda_i$  and  $\Lambda = \sum_{i=1}^3 \lambda_i \in \mathbb{R}$ . The integral in  $\omega_3$  is divergent at first glance. However this divergence is distributional. Indeed the scattering amplitude is a tempered distribution and should be treated as such when taking its Mellin transform.

Since the  $(z, \bar{z})$  dependence of the amplitude goes through when going from momentum to boost basis, we will only consider the energy dependence of the amplitude (3.1) with (3.2) as a tempered distribution, i.e. acting on functions in  $\mathcal{S}^3(\mathbb{R}^+)$ . We denote this energy dependence by

$$\Omega_3(\{\omega_i\}, \alpha_1, \alpha_2) = \frac{(\omega_1 \omega_2)^2}{\omega_3^4} \delta(\omega_1 - \alpha_1 \omega_3) \delta(\omega_2 - \alpha_2 \omega_3). \quad (3.4)$$

We can then write the bracket of duality between  $\Omega_3$  and functions  $f_i \in \mathcal{S}^3(\mathbb{R}^+)$

$$\begin{aligned} \langle \Omega_3, \{f_i\} \rangle_{\mathcal{S}', \mathcal{S}} &= \prod_{i=1}^3 \left( \int_0^\infty d\omega_i \omega_i \right) \frac{(\omega_1 \omega_2)^2}{\omega_3^4} \delta(\omega_1 - \alpha_1 \omega_3) \delta(\omega_2 - \alpha_2 \omega_3) f_1(\omega_1) f_2(\omega_2) f_3(\omega_3) \\ &= \alpha_1^3 \alpha_2^3 \int_0^\infty d\omega_3 \omega_3^3 f_1(\alpha_1 \omega_3) f_2(\alpha_2 \omega_3) f_3(\omega_3). \end{aligned} \quad (3.5)$$

The above integral is bounded since the functions  $f_i$  are in  $\mathcal{S}(\mathbb{R}^+)$ .

In the boost basis, we know from theorem 3 that the Mellin transform of  $\Omega$  is the part of (3.3) that depends on the conformal dimensions  $\Delta_i$

$$D_3(\{\Delta_i\}, \alpha_1, \alpha_2) = \prod_{i=1}^3 \left( \int_0^\infty d\omega_i \omega_i^{\Delta_i - 1} \right) \Omega_3(\{\omega_i\}, \alpha_1, \alpha_2) = \alpha_1^{\Delta_1 + 1} \alpha_2^{\Delta_2 + 1} \int_0^\infty d\omega_3 \omega_3^{i\Lambda + 3c - 3}. \quad (3.6)$$

Using

$$\begin{aligned} I_n &= \int_{\mathbb{R}} du e^{nu} e^{i\Lambda u} = \int_{\mathbb{R}} du \sum_{j=0}^{\infty} \frac{(nu)^j}{j!} e^{i\Lambda u} \\ &= \int_{\mathbb{R}} du \sum_{j=0}^{\infty} \frac{(-in)^j}{j!} \partial_\Lambda^j e^{i\Lambda u} = 2\pi \sum_{j=0}^{\infty} \frac{(-in)^j}{j!} \partial_\Lambda^j \delta(\Lambda), \end{aligned} \quad (3.7)$$

where  $n = 3c - 2$ , we can write its bracket with three functions  $\tilde{f}_i \in \tilde{\mathcal{M}}^+$  with  $i \in \{1, 2, 3\}$

$$\begin{aligned} D_f &\equiv \langle D_3, \{\tilde{f}_i\} \rangle_{\tilde{\mathcal{M}}^+, \tilde{\mathcal{M}}^+} = \prod_{i=1}^3 \left( \int_{c-i\infty}^{c+i\infty} \frac{d\Delta_i}{2i\pi} \right) \alpha_1^{\Delta_1 + 1} \alpha_2^{\Delta_2 + 1} \\ &\quad \times 2\pi \sum_{j=0}^{\infty} \frac{(-i(3c-2))^j}{j!} \delta^{(j)}(\Lambda) \tilde{f}_1(2 - \Delta_1) \tilde{f}_2(2 - \Delta_2) \tilde{f}_3(2 - \Delta_3), \end{aligned} \quad (3.8)$$

where the bracket is deduced from Parseval's relation. After performing the change of variable  $\Delta_3 \rightarrow \Delta = \sum_{i=1}^3 \Delta_i$  we obtain

$$\begin{aligned} D_f &= \int_{c-i\infty}^{c+i\infty} \frac{d\Delta_1}{2i\pi} \frac{d\Delta_2}{2i\pi} \int_{3c-i\infty}^{3c+i\infty} \frac{d\Delta}{2i\pi} \alpha_1^{\Delta_1 + 1} \alpha_2^{\Delta_2 + 1} \\ &\quad \times 2\pi \sum_{j=0}^{\infty} \frac{(-i(3c-2))^j}{j!} \delta^{(j)}(\Lambda) \tilde{f}_1(2 - \Delta_1) \tilde{f}_2(2 - \Delta_2) \tilde{f}_3(2 + \Delta_1 + \Delta_2 - \Delta). \end{aligned} \quad (3.9)$$

Rewriting the  $\Delta$  integral in terms of  $\Lambda = \Im(\Delta)$

$$\int_{3c-i\infty}^{3c+i\infty} \frac{d\Delta}{2i\pi} h(\Delta) = \int_{\mathbb{R}} \frac{d\Lambda}{2\pi} h(3c + i\Lambda), \quad (3.10)$$

and integrating by parts in the  $\Lambda$  variable yields the following result

$$D_f = \int_{c-i\infty}^{c+i\infty} \frac{d\Delta_1}{2i\pi} \frac{d\Delta_2}{2i\pi} \alpha_1^{\Delta_1 + 1} \alpha_2^{\Delta_2 + 1} \tilde{f}_1(2 - \Delta_1) \tilde{f}_2(2 - \Delta_2) \tilde{f}_3(\Delta_1 + \Delta_2). \quad (3.11)$$

In [\(3.11\)](#), the infinite sum shifts  $\Lambda$  by  $i(3c-2)$  in the argument of  $\tilde{f}_3$ . The integral is indeed well-defined since the functions  $\tilde{f}_i(c+i\cdot) \in \mathcal{S}(\mathbb{R})$ .

Now, we check that the bracket  $D_f$  is indeed equal to the bracket [\(3.5\)](#) in momentum space. From this we can confirm that  $D_3$  is indeed the Mellin transform of  $\Omega_3$ . We start by writing the  $\tilde{f}_i$ 's as the Mellin transforms of the functions  $f_i$  for  $i = 1, 2, 3$

$$\tilde{f}_i(\Delta_i) = \int_{\mathbb{R}^+} d\omega_i \omega_i^{\Delta_i-1} f_i(\omega_i). \quad (3.12)$$

Then, we have

$$D_f = \alpha_1^2 \alpha_2^2 \int_{c-i\infty}^{c+i\infty} \frac{d\Delta_1}{2i\pi} \frac{d\Delta_2}{2i\pi} \int_{(\mathbb{R}^+)^3} \prod_{i=1}^3 d\omega_i \left(\frac{\alpha_1 \omega_3}{\omega_1}\right)^{\Delta_1-1} \left(\frac{\alpha_2 \omega_3}{\omega_2}\right)^{\Delta_2-1} \omega_3 f_1(\omega_1) f_2(\omega_2) f_3(\omega_3). \quad (3.13)$$

Performing the change of variables  $u = \log(\omega_3)$ ,  $v = \log(\omega_1)$  and  $w = \log(\omega_2)$ , we deduce

$$D_f = (\alpha_1 \alpha_2)^{c+1} \int_{\mathbb{R}} \frac{d\lambda_1}{2\pi} \frac{d\lambda_2}{2\pi} e^{i(\lambda_1 \log \alpha_1 + \lambda_2 \log \alpha_2)} \times \int_{\mathbb{R}^3} du dv dw e^{iu(\lambda_1 + \lambda_2)} e^{-iv\lambda_1} e^{-iw\lambda_2} g_1(v) g_2(w) g_3(u), \quad (3.14)$$

with  $g_3(u) = e^{2cu} f_3(e^u)$ ,  $g_1(v) = e^{(2-c)v} f_1(e^v)$  and  $g_2(w) = e^{(2-c)w} f_2(e^w)$ . Using [\(3.24\)](#) and lemma [2](#) we have that  $g_i \in \mathcal{S}(\mathbb{R})$  for  $i \in \{1, 2, 3\}$ . The integrals over  $u$ ,  $v$  and  $w$  are then the Fourier transforms of the respective functions  $g_1$ ,  $g_2$  and  $g_3$ . Then we obtain

$$D_f = (\alpha_1 \alpha_2)^{c+1} \int_{\mathbb{R}} \frac{d\lambda_1}{2\pi} \frac{d\lambda_2}{2\pi} e^{i(\lambda_1 \log \alpha_1 + \lambda_2 \log \alpha_2)} \hat{g}_3(-\lambda_1 - \lambda_2) \hat{g}_1(\lambda_1) \hat{g}_2(\lambda_2). \quad (3.15)$$

Using lemma [3](#) we have

$$D_f = (\alpha_1 \alpha_2)^{c+1} \int_{\mathbb{R}} \frac{d\lambda_2}{2\pi} \int_{\mathbb{R}} dt g_3(t) g_1(\log \alpha_1 + t) e^{it\lambda_2} e^{i\lambda_2 \log \alpha_2} \hat{g}_2(\lambda_2). \quad (3.16)$$

Remembering that  $g_1$ ,  $g_3$  and  $\hat{g}_2$  are in  $\mathcal{S}(\mathbb{R})$  and using Fubini's theorem, we obtain

$$\begin{aligned} D_f &= (\alpha_1 \alpha_2)^{c+1} \int_{\mathbb{R}} dt g_3(t) g_1(\log \alpha_1 + t) g_2(\log \alpha_2 + t) \\ &= \alpha_1^3 \alpha_2^3 \int_{\mathbb{R}} dt e^{4t} f_3(e^t) f_1(\alpha_1 e^t) f_2(\alpha_2 e^t) \\ &= \alpha_1^3 \alpha_2^3 \int_0^\infty d\omega \omega^3 f_3(\omega) f_1(\alpha_1 \omega) f_2(\alpha_2 \omega), \end{aligned} \quad (3.17)$$

where in the last line we performed the change of variable  $\omega = e^t$  which indeed confirms that

$$D_f = \langle \Omega_3, \{f_i\}_{s',s} \rangle, \quad (3.18)$$

and also that  $D_3$  is the Mellin transform of  $\Omega_3$ .

## 3.2 Four-Graviton Celestial Amplitude

We proceed similarly with the 4-graviton amplitude. Its energy dependence can be expressed as follows [\(24\)](#)

$$\Omega_4 = \frac{\omega_1^3 \omega_2^3}{\omega_3^3 \omega_4^2} \delta(\omega_1 - \beta_1 \omega_3) \delta(\omega_2 - \beta_2 \omega_3) \delta(\omega_4 - \beta_4 \omega_3), \quad (3.19)$$

where  $\beta_i$  are functions of  $z_{ij}$  and  $\epsilon_i$ . Its action on functions in  $\mathcal{S}(\mathbb{R}^+)$  is

$$\begin{aligned} \langle \Omega_4, \{f_i\} \rangle_{\mathcal{S}', \mathcal{S}} &= \prod_{i=1}^4 \left( \int_0^\infty d\omega_i \omega_i f_i(\omega_i) \right) \Omega_4(\{\omega_i\}) \\ &= \frac{\beta_1^4 \beta_2^4}{\beta_4} \int_0^\infty d\omega_3 \omega_3^5 f_1(\beta_1 \omega_3) f_2(\beta_2 \omega_3) f_3(\omega_3) f_4(\beta_4 \omega_3). \end{aligned} \quad (3.20)$$

Taking the Mellin transform on each  $\omega_i$  in (3.19), we obtain

$$D_4 = \beta_1^{\Delta_1+2} \beta_2^{\Delta_2+2} \beta_4^{\Delta_4-3} \int_0^\infty d\omega_3 \omega_3^{\sum_{i=1}^4 \Delta_i - 3}, \quad (3.21)$$

where we can take  $\sum_{i=1}^4 \Delta_i = 4c + i\Lambda$  with  $\Lambda = \sum_{i=1}^4 \lambda_i$ . Using equation (3.7) as well as Parseval's formula, we obtain the following duality

$$\begin{aligned} \langle D_4, \{\tilde{f}_i\} \rangle_{\tilde{\mathcal{U}}+', \tilde{\mathcal{U}}+} &= \prod_{\substack{i=1 \\ i \neq 3}}^4 \left( \int_{c-i\infty}^{c+i\infty} \frac{d\Delta_i}{2i\pi} \right) \beta_1^{\Delta_1+2} \beta_2^{\Delta_2+2} \beta_4^{\Delta_4-3} \\ &\quad \times \tilde{f}_1(2 - \Delta_1) \tilde{f}_2(2 - \Delta_2) \tilde{f}_4(2 - \Delta_4) \tilde{f}_3(\Delta_1 + \Delta_2 + \Delta_4). \end{aligned} \quad (3.22)$$

The steps are similar to that of the 3-graviton case. Upon a similar check, we also have that

$$\langle D_4, \{\tilde{f}_i\} \rangle_{\tilde{\mathcal{U}}+', \tilde{\mathcal{U}}+} = \langle \Omega_4, \{f_i\} \rangle_{\mathcal{S}', \mathcal{S}}. \quad (3.23)$$

## The Existence of an Overlapping Holomorphic Strip

We saw that the functions  $\tilde{f}$  on which the celestial amplitudes act are holomorphic on the complex half-plane  $\mathbb{C}_+$  and have simple poles at  $\Delta = -n$  where  $n \in \mathbb{N}$ . However in our expressions, namely (3.11), we need to make sure that there is a holomorphic strip denoted by  $S_c$  common to all the functions appearing in the integrand and that encloses a contour along which we can integrate.

If the function  $\tilde{f}(\Delta)$  only has simple poles at  $\Delta = -n$  then  $\tilde{f}(2 - \Delta)$  has poles at  $\Delta = 2 + n$  (c.f. figure 4).

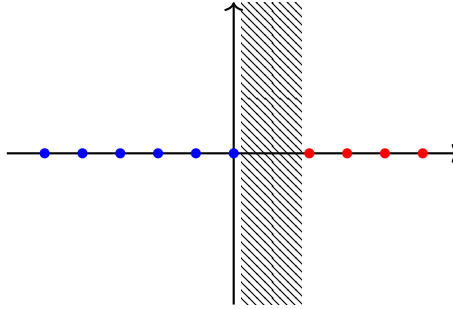

Figure 4: This figure represents the complex  $\Delta$ -plane. The blue dots are the poles of the functions  $\tilde{f}(\Delta)$  and the red dots are the poles of  $\tilde{f}(2 - \Delta)$ . The striped region represents the strip of holomorphy  $S_c$  common to both functions.

It is clear that the common strip of holomorphy is

$$S_c \supset \{\Delta \in \mathbb{C} \mid \Re(\Delta) \in (0, 2)\}, \quad (3.24)$$

and that for  $c = 1$ , the contour of integration in (3.11) lies within  $S_c$ . This is in accordance with the celestial holography literature where this choice was made.

## General Dimension $d + 2$

Notice that the holomorphic strip included the contour where  $c = 1$  for  $d = 2$  because the energy integral appearing had an additional factor of  $\omega$ . This comes from the Jacobian of the coordinate change ( $p^\mu$  to  $\omega, z$  and  $\bar{z}$ ). For general  $d$ , the factor that would appear is proportional to  $\omega^{d-1}$  and that shifts the argument of the second function in (4) so that we have  $\tilde{g}(d - \Delta)$ . Notice that for  $d = 2$  we have  $\tilde{g}(2 - \Delta)$  which appears in (3.8). This increases the width of the common strip of holomorphy such that

$$\{\Delta \in \mathbb{C} \mid \Re(\Delta) \in (0, d)\} \subset S_c. \quad (3.25)$$

In that case the putative choice  $c = \frac{d}{2}$  for the contour of integration remains inside of the common strip of holomorphy  $S_c$ .

## Summary: Part I

We treated the Mellin transform of distributions in  $\mathcal{S}'(\mathbb{R}^+)$  in order to have well-defined celestial amplitudes. Since tempered distributions are dual to the Schwartz space, we started by characterizing the Mellin transform of  $\mathcal{S}(\mathbb{R}^+)$  which we denote by  $\tilde{\mathcal{M}}^+$ . It is a class of meromorphic functions with simple poles at non-positive integer values of its argument with certain fall-offs in the direction of the imaginary axis. Then, we constructed distributions in  $\tilde{\mathcal{M}}^{+'}$  by duality through a Parseval-type relation. Celestial amplitudes belong to the dual space  $\tilde{\mathcal{M}}^{+'}$  and we applied the obtained results to the computation of tree-level three- and four-point graviton scattering amplitudes. Therefore, by accounting for their distributional nature when performing the Mellin transform, celestial amplitudes are well-defined by being in the dual of  $\tilde{\mathcal{M}}^+$ . This casts the Mellin transform on the energies as nothing but a change of basis which maps the scattering expressed in the momentum basis to the conformal basis, without the need to have a UV complete theory.



## Part II

# Celestial Conformal Field Theory

After giving a rigorous definition for massless celestial amplitudes, we will proceed to study the symmetries of the celestial conformal field theory. First we introduce the setup according to which we define symmetries and charges. We then move on to talk about soft theorems and the classification of soft symmetries in the  $d = 2$  dimensional celestial CFT. We then classify and construct the charges associated to soft theorems in generic dimensions, using projectors to manipulate the more complicated spin structure. At this point we comment on and highlight the importance of the shadow transform. For  $d \geq 2$  we find that the celestial CFT symmetries constitute a subset of the asymptotic symmetries. We comment on this point in the conclusion of the thesis.

## 4 Ward Identities and Charges in QFT and CCFT

The aim of this section is to review basic facts about symmetries in QFT and CCFT. In quantum field theory symmetries are associated to Ward identities and conserved charges are associated to topological surface operators. In section [4.1](#) we review the construction of conserved charges from operators satisfying conservation equations that follow from Ward identities. Of great interest for understanding quantum gravity in asymptotically flat spacetimes are asymptotic symmetries whose associated Ward identities can be understood from soft factorization theorems of QFT scattering amplitudes. Upon a basis change from plane wave asymptotic states to conformal boost eigenstates momentum space amplitudes can be recast as celestial amplitudes which take the form of correlation functions on the co-dimension two celestial sphere. We introduce celestial amplitudes in section [4.2](#) using the embedding space formalism.

### 4.1 Topological Operators in QFT

We start with an elementary review on symmetries in QFTs (see e.g. [56](#) for more details). Let us assume the existence of a conserved current  $\mathcal{F}^a$  satisfying the following condition

$$\partial_a \mathcal{F}^a = 0, \quad (4.1)$$

which must be understood as an operator equation valid inside correlation functions away from other insertions. A better definition for the conservation equation is provided by the Ward identity which also defines the contribution of  $\partial_a \mathcal{F}^a(x)$  when  $x$  coincides with another operator insertion. In general a Ward identity takes the form

$$\langle \partial_a \mathcal{F}^a(x) \mathcal{O}_1(x_1) \dots \mathcal{O}_N(x_N) \rangle = \sum_{i=1}^N \delta^{(d)}(x - x_i) \langle \mathcal{O}_1(x_1) \dots \delta \mathcal{O}_i(x_i) \dots \mathcal{O}_N(x_N) \rangle, \quad (4.2)$$

where the variation  $\delta \mathcal{O}(x)$  is some explicit operation on  $\mathcal{O}(x)$ .

Using the current  $\mathcal{F}$  it is possible to define a topological surface operator

$$Q_\Sigma = \int_\Sigma dS^a \mathcal{F}_a, \quad (4.3)$$

where  $\Sigma$  is a  $d - 1$  dimensional (hyper)surface in  $\mathbb{R}^d$  and  $dS^a$  is the surface element multiplied by the unit vector  $n^a$  normal to the surface  $\Sigma$  at each point.

The fact that  $\mathcal{F}_a$  is conserved is crucial to ensure that the operator  $Q_\Sigma$  is topological, namely it does not depend on the choice of  $\Sigma$ . To be precise  $Q_\Sigma$  in (4.3) is understood as an operator that should be inserted in a correlation function and  $Q_\Sigma = Q_{\Sigma'}$  as long as there exists a way to deform  $\Sigma$  to  $\Sigma'$  without crossing any other insertion in the correlation function. If  $\Sigma = \Sigma_i$  is a closed surface that contains a single point  $x_i$  with  $i \in [1, N]$ , from the definition (4.2) and (4.3) it is easy to see that

$$\langle Q_{\Sigma_i} \mathcal{O}_1(x_1) \dots \mathcal{O}_N(x_N) \rangle = \langle \mathcal{O}_1(x_1) \dots \delta \mathcal{O}_i(x_i) \dots \mathcal{O}_N(x_N) \rangle. \quad (4.4)$$

Here we used Gauss's law to express (4.3) as the divergence of the current

$$Q_\Sigma = \int_R d^d x \partial_a \mathcal{F}^a \quad (4.5)$$

integrated over a region  $R \in \mathbb{R}^d$  that is bounded by  $\Sigma = \partial R$ . Similarly, when  $\Sigma$  contains a set of points the right-hand-side of (4.4) would be a sum of terms with  $\delta$  acting on each operator insertion inside  $\Sigma$ . From the (integrated) Ward identity (4.4) we see that in practice  $Q_\Sigma$  just acts by taking a variation of the operators enclosed by  $\Sigma$

$$Q_\Sigma \mathcal{O}(x) = \delta \mathcal{O}(x). \quad (4.6)$$

When  $\Sigma$  contains all insertions and the Noether current is smooth in  $\mathbb{R}^d$  we can deform the integral to infinity and get zero. We find that the sum of the variations of each insertion gives zero

$$0 = \sum_{i=1}^N \langle \mathcal{O}_1(x_1) \dots \delta \mathcal{O}_i(x_i) \dots \mathcal{O}_N(x_N) \rangle, \quad (4.7)$$

which defines a symmetry transformation.

In the quantization picture  $Q_\Sigma$  is what defines a conserved charge. Let us see how this works. In order to quantize a theory we specify a foliation of the spacetime in hypersurfaces. The Hamiltonian allows us to evolve from one slice of the foliation to the others. The direction of the evolution is typically referred to as the quantization "time"  $t$  even if this does not need to be a time direction, e.g. in Euclidean signature we can pick any direction to be the quantization time. In CFTs it is often convenient to use the radial direction as a quantization time. On each slice, which will be labelled by coordinates  $\mathbf{x}$ , one can define a Hilbert space  $\mathcal{H}$  of states and Hilbert spaces at different times are all isomorphic. Correlation functions are computed as vacuum expectation values of time ordered products of operators

$$\langle \mathcal{O}_1(x_1) \dots \mathcal{O}_N(x_N) \rangle = \langle 0 | T \{ \hat{\mathcal{O}}_1(t_1, \mathbf{x}_1) \dots \hat{\mathcal{O}}_N(t_N, \mathbf{x}_N) \} | 0 \rangle, \quad (4.8)$$

where  $T\{\dots\}$  implements time ordering with respect to the quantization time,  $|0\rangle \in \mathcal{H}$  is the vacuum state and  $\hat{\mathcal{O}}_i$  are quantum operators  $\hat{\mathcal{O}}_i(t_i, \mathbf{x}_i) : \mathcal{H} \rightarrow \mathcal{H}$ .

In order to have  $Q_\Sigma$  as an operator acting on a single Hilbert space we pick  $\Sigma = \Sigma_t$  to be a slice at some time  $t$ . The fact that  $Q_{\Sigma_t}$  is topological means that it does not change if we consider it at a different time  $t'$ , or in other words that it is conserved in time  $Q_{\Sigma_t} = Q_{\Sigma_{t'}}$ . This of course should be considered again inside correlation functions and it assumes that no other insertion appeared between time  $t$  and  $t'$ . Indeed, if an insertion  $\mathcal{O}(t_*, \mathbf{x})$  is present with  $t < t_* < t'$ , the difference  $Q_{\Sigma_t} - Q_{\Sigma_{t'}}$  is not zero and is given by the commutator

$$\begin{aligned} \langle 0 | T \{ [\hat{Q}, \hat{\mathcal{O}}(t_*, \mathbf{x})] \hat{\mathcal{O}}_1(x_1) \dots \hat{\mathcal{O}}_N(x_N) \} | 0 \rangle &= \langle (Q_{\Sigma_t} - Q_{\Sigma_{t'}}) \mathcal{O}(t_*, \mathbf{x}) \mathcal{O}_1(x_1) \dots \mathcal{O}_N(x_N) \rangle \\ &= \langle 0 | T \{ \delta \hat{\mathcal{O}}(t_*, \mathbf{x}) \hat{\mathcal{O}}_1(x_1) \dots \hat{\mathcal{O}}_N(x_N) \} | 0 \rangle. \end{aligned} \quad (4.9)$$

Here we assumed that all points  $x_i$  have time coordinates  $t_i$  outside of the interval  $[t, t']$  and we used that the difference  $Q_{\Sigma_t} - Q_{\Sigma_{t'}}$  can be rewritten – by opportunely deforming the surfaces of integration – in terms of a single operator  $Q_\Sigma$  where  $\Sigma$  is a closed surface that surrounds the point  $(t_*, \mathbf{x})$ . In the following we will use less precise notation for the quantized picture and we will often write formulae like

$$[Q, \mathcal{O}(x)] = \delta \mathcal{O}(x), \quad (4.10)$$

which should be understood as (4.9) or as (4.4).

We thus find that given any operator that satisfies a generic Ward identity of the form (4.2), we can associate a topological operator  $Q_\Sigma$  which in the quantization picture has the meaning of a conserved charge. These statements are of course true for generic QFTs.

Ward identities of the form (4.2) appear by considering the soft theorems written in a boost basis. One of the main goals of this part is to classify the charges associated to such Ward identities. Before getting to this classification program, in the rest of this section, we review how the “soft” Ward identities arise.

## 4.2 Celestial Amplitudes and Embedding Space

Let us consider a scattering amplitude  $\mathcal{A}(p_i)$  in  $d + 2$  spacetime dimensions dependent on the momenta  $p_i \in \mathbb{R}^{1, d+1}$  and including the momentum conserving delta function. For simplicity let us focus on the case where all particles are massless scalars (we will generalize to massive and spinning particles below). The momenta are null  $p_i^2 = 0$  and can be conveniently parametrized as  $p_i^\mu = \omega_i q_i^\mu$  where  $q_i^2 = 0$ . The celestial amplitude is defined by the following change of basis<sup>11</sup>

$$\mathcal{M}_{\Delta_i}(q_i) \equiv \int_0^\infty \left( \prod_{i=1}^N d\omega_i \omega_i^{\Delta_i - 1} \right) \mathcal{A}(\omega_i q_i). \quad (4.11)$$

We notice that the function  $\mathcal{M}_{\Delta_i}(q_i)$ :

- is defined on the null cones  $q_i^2 = 0$ ,
- is Lorentz invariant, namely it can only depend on scalar products  $q_i \cdot q_j$ ,
- is homogeneous of degree  $-\Delta_i$  in  $q_i$ , namely  $\mathcal{M}_{\Delta_i}(\lambda_i q_i) = \left( \prod_{i=1}^N \lambda_i^{-\Delta_i} \right) \mathcal{M}_{\Delta_i}(q_i)$  for real coefficients  $\lambda_i$ .

These are exactly the transformation properties of correlation functions of operators in embedding space (57). So we can formally identify

$$\mathcal{M}_{\Delta_i}(q_i) \equiv \langle \mathcal{O}_{\Delta_1}(q_1) \dots \mathcal{O}_{\Delta_N}(q_N) \rangle, \quad (4.12)$$

where  $\mathcal{O}_\Delta(\lambda q) = \lambda^{-\Delta} \mathcal{O}_\Delta(q)$  are  $\text{CFT}_d$  primary operators uplifted to embedding space – which in the current context corresponds to the physical spacetime. Every light ray passing through the origin in embedding space corresponds to a point in  $\text{CFT}_d$  space. The  $\text{CFT}_d$  space is described by a section of the null cone. Different choices of sections correspond to different spaces where the CFT lives. One does not lose any information by restricting a correlation function to a section, in fact by homogeneity one can always uplift it to the full null cone. There are a few important sections which are frequently used:

- the Poincaré section  $q^0 + q^{d+1} = 1$ , parametrized by  $q_p^\mu = \left( \frac{1+x^2}{2}, x^a, \frac{1-x^2}{2} \right)$  where  $x^a \in \mathbb{R}^d$ ,
- the sphere section  $q^0 = 1$ , parametrized by  $q_s^\mu = \frac{2}{1+x^2} \left( \frac{1+x^2}{2}, x^a, \frac{1-x^2}{2} \right)$  where  $x^a \in \mathbb{R}^d$ ,

<sup>11</sup>The amplitudes in (4.11) should be understood to depend on sets of momenta  $\{p_i = \omega_i q_i\}$  or null vectors  $\{q_i\}$  and labels  $\{\Delta_i\}$ ; we omit the brackets to avoid notational clutter. The incoming and outgoing labels are also suppressed here; more about that in subsection (4.2.2)

- the cylinder section  $(q^0)^2 - (q^{d+1})^2 = 1$ , parametrized by  $q_c^\mu = (\cosh \tau, \Omega^a, \sinh \tau)$  with  $\Omega^2 = 1, \Omega^a \in \mathbb{R}^d$  and  $\tau \in \mathbb{R}$ .

It is easy to show that the induced metric on the Poincaré section is the flat space one, namely  $ds^2 = \delta_{ab} dx^a dx^b$ . In general, by appropriately choosing a section, one can obtain a correlation function defined in any conformally flat space. This is easy to see, indeed the section  $q^\mu = \Omega(x) q_p^\mu$  has induced metric given by the most generic conformally flat metric  $ds^2 = \Omega(x)^2 \delta_{ab} dx^a dx^b$ . The correlation functions in embedding space are in fact automatically Weyl covariant, which implies that the celestial amplitudes are also Weyl covariant.

#### 4.2.1 Celestial Amplitudes for Particles with Mass and Spin

The embedding space definition of celestial amplitudes can be generalized to the massive case. The celestial amplitude for scattering of massive scalar particles is defined by [6]

$$\mathcal{M}_{\Delta_i}(q_i) \equiv \int \left( \prod_{i=1}^N Dp_i \right) \frac{1}{(-p_i \cdot q_i)^{\Delta_i}} \mathcal{A}(p_i), \quad (4.13)$$

where the measure is over the mass shell  $Dp = d^D p \delta(p^2 + 1) \theta(p^0)$ . Also in this case  $\mathcal{M}_{\Delta_i}(q_i)$  is a homogeneous function of  $q_i$  with weight  $-\Delta_i$ . Therefore also massive celestial amplitudes transform as embedding space correlation functions. Massive celestial correlators [58, 59] have received far less attention in the literature than their massless counterparts and it would be desirable to study their properties more thoroughly. We leave this for future work.

Let us now consider a spin  $\ell$  massless bosonic field  $F_{\mu_1 \dots \mu_\ell}$ , where e.g. the case  $\ell = 1$  corresponds to photons  $A_\mu$  and  $\ell = 2$  to gravitons  $h_{\mu\nu}$ . Gauge invariance implies

$$F_{\mu_1 \dots \mu_\ell}(p) \rightarrow F_{\mu_1 \dots \mu_\ell}(p) + p_{(\mu_1} \Lambda_{\mu_2 \dots \mu_\ell)}(p). \quad (4.14)$$

For convenience we contract the field  $F_{\mu_1 \dots \mu_\ell}(p)$  with some polarization vectors  $\varepsilon^\mu$  such that  $\varepsilon^2 = 0$  and  $p \cdot \varepsilon = 0$ . We then define  $F(p, \varepsilon) \equiv F_{\mu_1 \dots \mu_\ell}(p) \varepsilon^{\mu_1} \dots \varepsilon^{\mu_\ell}$ . We can define celestial amplitudes associated to  $\mathcal{A}_{\ell_i}(p_i, \varepsilon_i)$ , where all indices of the particle  $i$  are contracted with  $\varepsilon_i$ , as

$$\mathcal{M}_{\Delta_i, \ell_i}(q_i, \varepsilon_i) \equiv \int_0^\infty \left( \prod_{i=1}^N d\omega_i \omega_i^{\Delta_i - 1} \right) \mathcal{A}_{\ell_i}(\omega_i q_i, \varepsilon_i). \quad (4.15)$$

The function  $\mathcal{M}_{\Delta_i, \ell_i}(q_i, \varepsilon_i)$  satisfies

$$\mathcal{M}_{\Delta_i, \ell_i}(\lambda_i q_i, \alpha_i \varepsilon_i + \beta_i q_i) = \left( \prod_{i=1}^N \lambda_i^{-\Delta_i} \alpha_i^{\ell_i} \right) \mathcal{M}_{\Delta_i, \ell_i}(q_i, \varepsilon_i), \quad (4.16)$$

and thus it again defines a correlation function of primary operators  $\mathbb{O}_{\Delta_i, \ell_i}$  with dimensions  $\Delta_i$  and spin  $\ell_i$  in embedding space,

$$\mathcal{M}_{\Delta_i, \ell_i}(q_i, \varepsilon_i) \equiv \langle \mathbb{O}_{\Delta_1, \ell_1}(q_1, \varepsilon_1) \dots \mathbb{O}_{\Delta_N, \ell_N}(q_N, \varepsilon_N) \rangle. \quad (4.17)$$

Here we are using a notation where the spinning operators in embedding space are contracted with polarization vectors  $\mathbb{O}_{\Delta, \ell}(q, \varepsilon) \equiv \mathbb{O}_{\Delta, \ell}^{\mu_1 \dots \mu_\ell}(q) \varepsilon_{\mu_1} \dots \varepsilon_{\mu_\ell}$ . Notice that in embedding space the spinning operators  $\mathbb{O}_{\Delta, \ell}^{\mu_1 \dots \mu_\ell}(q)$  are required to obey the same gauge condition [4.14], which from this construction is automatically satisfied.

To project the operator into  $\text{CFT}_d$  space we need to both set  $q$  to a section while at the same time projecting the embedding indices  $\mu_i = 0, \dots, d+1$  to  $\text{CFT}_d$  indices  $a_i = 1, \dots, d$ . This is achieved by contracting the indices with the Jacobian of the immersion. E.g. for the Poincaré section [57]

$$\mathbb{O}_{\Delta, \ell}^{\mu_1 \dots \mu_\ell}(q) \rightarrow \mathbb{O}_{\Delta, \ell}^{a_1 \dots a_\ell}(x) = \partial_{x^{a_1}}^{q_{\mu_1}} \dots \partial_{x^{a_\ell}}^{q_{\mu_\ell}} \mathbb{O}_{\Delta, \ell}^{\mu_1 \dots \mu_\ell}(q). \quad (4.18)$$

Often it is convenient to work in an index-free notation where all indices are contracted with polarization vectors both in embedding and in  $\text{CFT}_d$  space. To do so we can directly project a polarization vector  $\varepsilon$  associated to an operator inserted at a point  $q$  to  $\text{CFT}_d$  space. E.g. if  $q$  is projected to the Poincaré section (and similarly for other sections), then  $\varepsilon$  is projected as follows

$$\varepsilon^\mu \rightarrow e_a \partial_x^a q^\mu, \quad (4.19)$$

where  $e^a$  is a polarization vector in  $\mathbb{R}^d$ , generically not transverse to  $x^a$ , that satisfies  $e^a e_a = 0$  (see the discussion in section 6.1 to recover the indices of the tensor operators).

#### 4.2.2 Celestial $in \leftrightarrow out$ States and the Antipodal Map

Let us comment on the role of  $in$  and  $out$  states for celestial amplitudes. We can adopt an all- $out$  formalism where we write all momenta as outgoing and flip the sign of incoming momenta, namely the momenta are written as  $p^\mu = \eta \omega q^\mu$  where  $\eta = +1$  ( $\eta = -1$ ) for outgoing (incoming) particles. This implies that we can read off if a particle is  $in$  or  $out$  from the sign of the energy component of  $q^\mu$ :  $q^0 < 0$  for incoming and  $q^0 > 0$  for outgoing particles. We thus find that incoming operators naturally live on the null cone  $q^2 = 0$  with  $q^0 < 0$  while outgoing operators live on the flipped null cone with  $q^0 > 0$ . However, it is not necessary to use two different cones because homogeneity relates operators insertions at  $-q$  to insertions at  $q$  via  $\mathcal{O}_\Delta(-q) = (-1)^{-\Delta} \mathcal{O}_\Delta(q)$ . On the sphere section the map  $q \rightarrow -q$  which takes  $out \leftrightarrow in$  is achieved by flipping the sign of  $q^0$  and by performing the antipodal<sup>12</sup> map  $x^a \rightarrow -\frac{x^a}{x^2}$ , namely

$$-q_s^\mu = -\frac{2}{1+x^2} \left( \frac{1+x^2}{2}, x^a, \frac{1-x^2}{2} \right) \xrightarrow[q^0 \rightarrow -q^0]{x^a \rightarrow -\frac{x^a}{x^2}} q_s^\mu = \frac{2}{1+x^2} \left( \frac{1+x^2}{2}, x^a, \frac{1-x^2}{2} \right). \quad (4.20)$$

This map was discussed in the literature [5] as a continuity condition for the asymptotic data at past and future null infinities when connected across spatial infinity, and can be derived from the dynamics of the fields at spatial infinity [60, 61]. On the other hand in embedding space this comes about trivially. Indeed a single light ray passing through the origin defines a single point in  $\text{CFT}_d$  space so independently of the sign of  $q^0$  it is natural to consider  $in$  and  $out$  operators living in the same  $\text{CFT}_d$  space. Moreover, since a light ray intersects spherical sections with opposite values of  $q^0$  at antipodal points, the antipodal matching condition is automatically imposed by the formalism.

### 4.3 Soft Theorems and Celestial Ward Identities

Celestial amplitudes in gauge theory and gravity obey Ward identities [24, 48, 49, 52, 62, 66]. Their origin in momentum-space amplitudes is the soft, or zero-energy, limit of massless particles. The scattering amplitude of  $N$  hard particles and one soft particle factorizes into the amplitude for the hard particles times a soft factor<sup>13</sup>

$$\lim_{\omega \rightarrow 0} \mathcal{A}_{N+1}(\omega q, \varepsilon) = \sum_k S^{(1-k)}(\omega q, \varepsilon) \mathcal{A}_N, \quad (4.21)$$

where the soft factors scale with powers of the soft particle's energy,  $S^{(1-k)} \sim \omega^{-k}$  with the leading term given by Weinberg's soft pole  $\sim 1/\omega$ , and we have suppressed the dependence of the amplitude on the  $N$  hard particles to avoid clutter. In QED

<sup>12</sup>In  $d = 2$  using complex coordinates this map is written as  $z \rightarrow -1/\bar{z}$ ,  $\bar{z} \rightarrow -1/z$ .

<sup>13</sup>We restrict to tree-level scattering and express soft theorems in the  $SO(d)$  index-free notation.

the leading soft photon factor is given by [67]

$$S^{(0)}(\omega q, \varepsilon) = e \sum_{i=1}^N \mathbb{Q}_i \frac{1}{\omega} \frac{q_i \cdot \varepsilon}{q_i \cdot q}, \quad (4.22)$$

where  $p_i^\mu = \eta_i \omega_i q_i^\mu$  are the momenta of the hard particles and  $\mathbb{Q}_i$  are their charges. In gravity the leading and subleading soft graviton factors are [67-70]

$$S^{(0)}(\omega q, \varepsilon) = \frac{\kappa}{2} \sum_{i=1}^N \eta_i \frac{\omega_i}{\omega} \frac{(q_i \cdot \varepsilon)^2}{q_i \cdot q}, \quad S^{(1)}(\omega q, \varepsilon) = -i \frac{\kappa}{2} \sum_{i=1}^N \frac{(q_i \cdot \varepsilon)(q \cdot J_i \cdot \varepsilon)}{q_i \cdot q}, \quad (4.23)$$

where  $\eta_i = +1$  for *out* particles and  $\eta_i = -1$  for *in* particles. Here  $J_i^{\mu\nu}$  is the total angular momentum of particle  $i$  which can be decomposed as  $J_i^{\mu\nu} = \mathcal{L}_i^{\mu\nu} + S_i^{\mu\nu}$ , where  $\mathcal{L}_i^{\mu\nu} = -i \left( p_{i\mu} \frac{\partial}{\partial p_{i\nu}} - p_{i\nu} \frac{\partial}{\partial p_{i\mu}} \right)$  is the orbital momentum and  $S_i^{\mu\nu}$  is the spin representation of particle  $i$ . The leading soft factors in gauge theory and gravity are thus universal, in the sense that they only depend on the momenta, angular momenta and electromagnetic charges of the hard particles, but not on the details of the theory. The factorization property of the S-matrix persists to more subleading orders. The subleading soft photon [71-74] and subsubleading soft graviton [75] factors are respectively

$$S^{(1)}(\omega q, \varepsilon) = -ie \sum_{i=1}^N \eta_i \frac{\mathbb{Q}_i}{\omega_i} \frac{q \cdot J_i \cdot \varepsilon}{q_i \cdot q}, \quad S^{(2)}(\omega q, \varepsilon) = -\frac{\kappa}{4} \sum_{i=1}^N \eta_i \frac{\omega}{\omega_i} \frac{(q \cdot J_i \cdot \varepsilon)^2}{q_i \cdot q}, \quad (4.24)$$

but are subject to (non-universal) modifications in effective field theory [76]. More subleading soft theorems can also be studied but the expressions for the corresponding soft factors  $S^{(1-k)}$  are known to be non-universal [77-78]. Let us also mention that the leading soft factors  $S^{(0)}$  are tree-level exact while  $S^{(1)}$  receives a one-loop-exact correction in gravity [79-80]. All other soft theorems are corrected by further quantum corrections. In this part we will focus on the tree level contributions.

We can recast soft theorems as Ward identities for celestial amplitudes. The individual terms in the energetically soft expansion of momentum-space amplitudes get mapped under the Mellin transform to poles in the conformal dimension of massless operators in the celestial correlation function,

$$\frac{1}{\omega^k} \xrightarrow{\int_0^\infty d\omega \omega^{\Delta-1}} \frac{1}{\Delta - k} \quad (4.25)$$

with  $k = 1, 0, -1, \dots$ , and the lower-point amplitudes are extracted by the residues at  $\Delta = k$ <sup>14</sup>. The operators with these conformal dimensions obey conservation equations that take the form of CCFT Ward identities. Our interest lies in identifying all the conserved operators associated to conformally soft theorems in gauge theory and gravity. The (conformally) soft limit will capture the leading contributions – namely the contributions that determine the Ward identities – to the operator product expansion [62-83] (while the full tower of descendants can be accessed from soft-collinear limits [84]). This limit can be expressed as

$$\lim_{\Delta \rightarrow k} (\Delta - k) \langle \mathbb{O}_{\Delta, \ell}(q, \varepsilon) \mathbb{O}_{\Delta_1, \ell_1} \cdots \mathbb{O}_{\Delta_N, \ell_N} \rangle = \sum_{i=1}^N \hat{S}_i^{(1-k)}(q, \varepsilon) \langle \mathbb{O}_{\Delta_1, \ell_1} \cdots \delta \mathbb{O}_{\Delta_i, \ell_i} \cdots \mathbb{O}_{\Delta_N, \ell_N} \rangle, \quad (4.26)$$

where the conformally soft factor  $\hat{S}_i^{(1-k)}$  is defined as the  $i$ th soft factor in [4.21] stripped off its  $\omega$  dependence while the  $\omega_i$  dependence of [4.21] determines the operation  $\delta$  on  $\mathbb{O}_{\Delta_i, \ell_i}$ . As in [4.21] we have suppressed the arguments  $(q_i, \varepsilon_i)$  of the hard particles to avoid clutter.

<sup>14</sup>Here we focus on soft photons/gluons and gravitons. Conformally soft theorems for photinos and gravitinos in  $d = 2$  were discussed in [52] and their associated conformally soft charges in [51]; see also [81-82].

In what follows it will be most convenient to work in the Poincaré section where  $q^0 + q^{d+1} = 1$  such that the null vector determining the propagation direction of the soft particles is parameterized by

$$q^\mu(x) = \frac{1}{2} (1 + x^2, 2x^a, 1 - x^2), \quad (4.27)$$

and similarly for the massless hard particles. The spacetime polarization vector projected in the Poincaré section is

$$\varepsilon^\mu(x, e) = e^a \partial_a q^\mu(x) = (x \cdot e, e^a, -x \cdot e), \quad (4.28)$$

where the CCFT<sub>d</sub> polarization vectors  $e_a$  are normalized such that  $e \cdot e = 0$ . Note the following simple rules to project scalar products of vectors  $q_i^\mu$  and  $\varepsilon_i^\mu$  into the Poincaré section

$$q_i \cdot q_j \rightarrow -\frac{x_{ij}^2}{2}, \quad q_i \cdot \varepsilon_j \rightarrow e_j \cdot x_{ij}, \quad \varepsilon_i \cdot \varepsilon_j \rightarrow e_i \cdot e_j, \quad (4.29)$$

where  $x_{ij}^a = x_i^a - x_j^a$ . With that we can now easily express the  $d + 2$  dimensional soft theorems in CCFT<sub>d</sub> space in terms of operators  $\mathcal{O}_{\Delta, \ell}(x, e)$ , or in terms of operators  $\mathcal{O}_{\Delta, \ell}^{a_1 \dots a_\ell}(x)$  with explicit  $SO(d)$  indices that we may contract with polarization vectors  $e_{a_1} \dots e_{a_\ell}$ .

We define the following conformally soft operators [85][86]

$$R_k^a(x) := \lim_{\Delta \rightarrow k} (\Delta - k) \mathcal{O}_{\Delta, \ell=1}^a(x), \quad H_k^{ab}(x) := \lim_{\Delta \rightarrow k} (\Delta - k) \mathcal{O}_{\Delta, \ell=2}^{ab}(x), \quad (4.30)$$

where  $a, b = 1, \dots, d$  are the tensor indices for the spin 1 and spin 2 operators. Alternatively, we can define them via the residues of the operators  $\mathcal{O}_{\Delta, \ell=1,2}^a$  at  $\Delta = k$ . Contracting them with the polarization vectors in CFT<sub>d</sub> space we get in index-free notation

$$R_k(x, e) = R_k^a(x) e_a, \quad H_k(x, e) = H_k^{ab}(x) e_a e_b, \quad (4.31)$$

which are the operators appearing in the CCFT<sub>d</sub> Ward identities [4.26] for  $\ell = 1$  and  $\ell = 2$ .

Besides the conformally soft operators [4.30] it can be useful in CCFT to consider the associated shadow operators. The shadow transform (see expression [5.8] for CCFT<sub>2</sub> and [6.61] for CCFT<sub>d</sub>) maps a primary operator of dimension  $\Delta$  to a primary operator of dimension  $d - \Delta$ . In celestial CFT<sub>d</sub> we will see that conformally soft shadow operators are natural and physically important operators [48][49] as they directly give rise to the standard Ward identities for the global (local in  $d = 2$ ) symmetries of CFT<sub>d</sub>.

In summary, by going to the conformal basis, soft theorems can be recast as Ward identities of some operators with given integer dimensions  $\Delta$  (fixed by the order of the expansion in  $\omega$ ) and spin  $\ell$  (equal to the spin of the soft particle). The important observation is that these operators are special in the CFT description because their dimension must be protected. Indeed if  $\Delta$  acquired an anomalous dimension, it would no longer be possible to associate to it an integer power of the  $\omega$  expansion. We can thus conclude that in order to understand the soft operators one should look at the protected sector of CFT operators. Luckily this is already classified. Indeed an operator is protected when there exists a shortening condition of its conformal multiplet, which means that the operator must have a descendant that becomes a primary. This happens for special values of the labels  $\Delta, \ell$  of the primary. Our strategy is to use this classification to understand the properties of all soft operators relevant for celestial CFT<sub>d</sub> and to build their associated charges.

## 5 Symmetries in Celestial CFT<sub>d=2</sub>

The symmetries of  $d = 2$  dimensional celestial CFTs implied by  $d + 2 = 4$  dimensional soft theorems is the topic of a fairly large body of literature. Here we review some of the salient features within the unified framework of section 4.2 which serves two objectives: it allows us to write down a single formula for the Noether currents and conserved charges for all soft theorems and it contrasts the discussion of celestial symmetries in higher dimensions. We review in section 5.1 the global conformal multiplets that encode the operators responsible for conformally soft factorization theorems in gauge theory and gravity – the *celestial diamonds* introduced in in 45. These operators are conserved and when inserted in correlation functions they give rise to celestial Ward identities. We give a general expression for the associated Noether currents and infinite towers of topological charges in section 5.2 and discuss their explicit form in examples in section 5.3. We contrast this CFT approach with the equivalence between soft theorems and conservation laws for asymptotic symmetry charges in section 5.4.

### 5.1 Celestial Diamonds

Conformally soft operators in CCFT<sub>2</sub> have protected integer dimensions. The strategy in 45 was to compare these protected operators to global primary descendants in CFT<sub>2</sub> which also have protected integer dimensions and are associated to reducible global conformal multiplets that are classified by representation theory<sup>15</sup>

To review the primary descendant classification it is convenient to work in complex coordinates  $z = x_1 + ix_2$  and  $\bar{z} = x_1 - ix_2$ , define holomorphic and antiholomorphic derivatives  $\partial \equiv \partial_z$  and  $\bar{\partial} \equiv \partial_{\bar{z}}$ , and note that they implement the action of the Virasoro generators  $L_{-1}$  and  $\bar{L}_{-1}$ . The classification is then straightforward: we write the most general descendant operator  $\partial^n \bar{\partial}^{\bar{n}} \mathcal{O}_{\Delta, \ell}$ , and demand that it obeys the primary condition of being annihilated by the Virasoro generators  $L_1$  and  $\bar{L}_1$ . The result of the computation is schematically presented in Figure 5 where the nodes correspond to primary operators and the arrows to the right (left) denote the action of  $\partial \leftrightarrow L_{-1}$  ( $\bar{\partial} \leftrightarrow \bar{L}_{-1}$ ).

We distinguish three categories of primary descendants I, II, III (defined below) depending on whether the spin of the primary descendant is larger, smaller or equal in absolute value compared to the spin of the parent primary operator.

The conformally soft operators of section 4.3 are primary operators with primary descendants of one of these three types. The universal soft theorems which scale as  $\omega^{-k}$  for  $k = 1, 0, \dots, 1 - \ell$  (where  $\ell$  is the spin of the soft particle) are associated to operators with type II primary descendants. The subleading soft theorem scaling as  $\omega^{-1+\ell}$  are associated to type III operators that arise in zero-area celestial diamonds. All the ever more subleading soft theorems are related to primary descendants of type I.

**Type I** A descendant of type I has spin  $n$  units larger in absolute value than its parent primary. Type I descendant operators are further divided in Type Ia and Ib, where the former is a descendant at level  $n$  of the form

$$O_{\text{Ia}, n}(z, \bar{z}) \equiv \partial^n \mathcal{O}_{\Delta, +|\ell|}, \quad \text{or} \quad \mathcal{O}_{\text{Ia}, n}(z, \bar{z}) \equiv \bar{\partial}^n \mathcal{O}_{\Delta, -|\ell|}, \quad (5.1)$$

<sup>15</sup>While in standard CFT primary descendants are typically associated to null states, in CCFT for a conventional choice of inner product this is not automatically true – see the discussion in 45. In this work we are interested in the classification of reducible conformal multiplets in CCFT<sub>d</sub> which is independent of the choice of inner product.



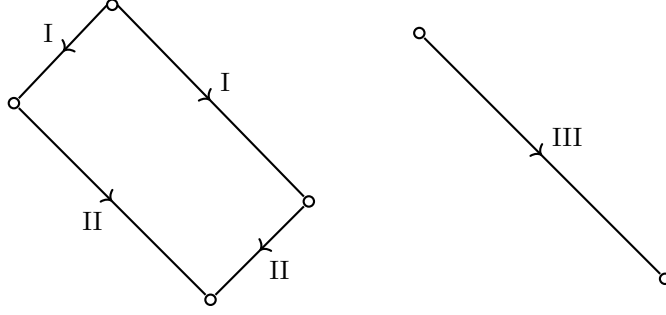

Figure 5: Celestial diamonds in  $d = 2$ . The picture shows the  $\Delta - \ell$  plane, where the nodes correspond to the position of primaries while the arrows pointing to the bottom right/left denote the action of derivatives  $\partial/\bar{\partial}$  (longer arrows correspond to higher numbers of derivatives). The diamond picture on the left shows the existence of a nested structure of descendants that are themselves primaries. The picture on the right is understood as a diamond with zero area.

while the latter is a descendant at level  $2|\ell| + n$  of the form

$$\mathcal{O}_{\text{Ib}, 2|\ell|+n}(z, \bar{z}) \equiv \partial^{2|\ell|+n} \mathcal{O}_{\Delta, -|\ell|}, \quad \text{or} \quad \mathcal{O}_{\text{Ib}, 2|\ell|+n}(z, \bar{z}) \equiv \bar{\partial}^{2|\ell|+n} \mathcal{O}_{\Delta, +|\ell|}. \quad (5.2)$$

The operators  $\mathcal{O}_{\text{Ia}, n}$  and  $\mathcal{O}_{\text{Ib}, 2|\ell|+n}$  become primary when

$$\Delta = 1 - |\ell| - n, \quad n \in \mathbb{Z}_{>0}. \quad (5.3)$$

**Type II** A level  $n$  descendant of type II has spin  $n$  smaller in absolute value than its parent. Type II descendant operators are of the form

$$O_{\text{II}, n} \equiv \bar{\partial}^n \mathcal{O}_{\Delta, +|\ell|}, \quad \text{or} \quad \mathcal{O}_{\text{II}, n} \equiv \partial^n \mathcal{O}_{\Delta, -|\ell|}, \quad (5.4)$$

and become primary when

$$\Delta = 1 + |\ell| - n, \quad n \in \{1, \dots, 2|\ell| - 1\}. \quad (5.5)$$

These primary descendants only exist for  $|\ell| \geq 1$  in the range  $1 - |\ell| < \Delta < 1 + |\ell|$ .

**Type III** A type III descendant has the same absolute value of spin as the parent primary and takes the form

$$O_{\text{III}, 2|\ell|} \equiv \bar{\partial}^{2|\ell|} \mathcal{O}_{\Delta, +|\ell|}, \quad \text{or} \quad \mathcal{O}_{\text{III}, 2|\ell|} \equiv \partial^{2|\ell|} \mathcal{O}_{\Delta, -|\ell|}. \quad (5.6)$$

It becomes primary when

$$\Delta = 1 - |\ell|. \quad (5.7)$$

Primary descendants of type I, II and III are associated to conserved operators from which we can construct Noether currents and topological charges.

Before moving on to their construction, let us point out a notable feature of celestial diamonds: the primary operators at the left and right corners are related by the shadow transform in  $d = 2$  CFT defined by the integral transform

$$S[\mathbb{O}_{h,\bar{h}}](z, \bar{z}) \equiv \frac{K_{h,\bar{h}}}{2\pi} \int d^2w \frac{\mathbb{O}_{h,\bar{h}}(w, \bar{w})}{(z-w)^{2-2h}(\bar{z}-\bar{w})^{2-2\bar{h}}}. \quad (5.8)$$

Here and below we may equivalently trade the labels  $\Delta, \ell$  of the operators for  $h \equiv \frac{1}{2}(\Delta + \ell)$  and  $\bar{h} \equiv \frac{1}{2}(\Delta - \ell)$ , and for the choice of normalization  $K_{h,\bar{h}} = 2 \max\{h, \bar{h}\} - 1$  the shadow squares to one up to a sign  $S[S[\mathbb{O}_{h,\bar{h}}]] = (-1)^{2(h-\bar{h})}$ . As we will see, shadow transformed conformally soft primary operators are naturally associated to standard conserved operators in CCFT.

## 5.2 Conserved Charges

Having reviewed how to classify all primary descendants in  $\text{CFT}_{d=2}$ , we are now in a position to show how to get topological charges from the knowledge of these primary descendants. We begin by rewriting formula [4.3](#) in  $d = 2$  where it is convenient to use complex variables. The topological charges obtained by integrating Noether currents can be expressed as [16](#)

$$Q_\Sigma = \int_\Sigma dS^a \mathcal{F}_a = -\frac{1}{2\pi i} \oint_\Sigma (dz \mathcal{F} - d\bar{z} \bar{\mathcal{F}}), \quad (5.9)$$

where we defined  $\mathcal{F} \equiv -2\pi \mathcal{F}_z$  and  $\bar{\mathcal{F}} \equiv -2\pi \mathcal{F}_{\bar{z}}$ , and  $\Sigma$  is just a contour in  $d = 2$ .

In the following we show how to build the Noether current  $\mathcal{F}(\bar{\mathcal{F}})$  by opportunely combining an operator  $\mathbb{O}$  which has a primary descendant, with a parameter  $\epsilon(\bar{\epsilon})$ . We start by considering a primary operator  $\mathbb{O}$  with dimension  $\Delta$  and spin  $|\ell|$  which has a level  $n$  primary descendant and thus satisfies the following shortening condition

$$\bar{\partial}^n \mathbb{O}(z, \bar{z}) = 0. \quad (5.10)$$

At this level, the shortening condition [5.10](#) (which should be considered as an operator equation valid away from contact points) can be of any type I, II or III depending on the value of  $\ell$  and  $\Delta$  (which we assume to be fixed to one of the values defined in the previous section). The rest of this section will hold regardless of the chosen type.

We can construct a Noether current  $\mathcal{F}$  by combining  $\mathbb{O}$  with a parameter  $\epsilon$  as follows

$$\mathcal{F}^\epsilon = \sum_{m=0}^{n-1} (-1)^m \bar{\partial}^m \epsilon(z, \bar{z}) \bar{\partial}^{n-m-1} \mathbb{O}(z, \bar{z}). \quad (5.11)$$

Conservation of the Noether current

$$\bar{\partial} \mathcal{F}^\epsilon = 0, \quad (5.12)$$

requires that  $\epsilon$  satisfies the same type of (higher-derivative) conservation equation as the operator  $\mathbb{O}$ , namely

$$\bar{\partial}^n \epsilon(z, \bar{z}) = 0, \quad (5.13)$$

which we shall call generalized Killing tensor equation. These conservation equations are solved by making a polynomial ansatz for both  $\mathbb{O}$  and  $\epsilon$ ,

$$\mathbb{O}(z, \bar{z}) = \sum_{m=0}^{n-1} \bar{z}^m \mathbb{O}^{(m)}(z), \quad \epsilon(z, \bar{z}) = \sum_{m=0}^{n-1} \bar{z}^m \epsilon^{(m)}(z), \quad (5.14)$$

<sup>16</sup>Replace the outward-directed differential  $dS_a$  orthogonal to  $\Sigma$  by a counterclockwise differential parallel to a choice of contour defined via  $dS_a = \epsilon_{ab} ds^b$  where  $\epsilon_{z\bar{z}} = -\epsilon_{\bar{z}z} = \frac{i}{2}$ , whose holomorphic (antiholomorphic) component is  $dz (d\bar{z})$ .

where each  $\mathcal{O}^{(m)}(z)$  and  $\epsilon^{(m)}(z)$  is holomorphic, and we further expand  $\epsilon^{(m)}(z) = \sum_{n \in \mathbb{Z}} \epsilon_{m,n} z^n$ . Integrating the Noether current [5.11](#) we obtain

$$Q_{\Sigma}^{\epsilon} = \frac{1}{2\pi i} \oint_{\Sigma} dz \mathcal{F}^{\epsilon}(z) \equiv \sum_{m=0}^{n-1} \sum_{n \in \mathbb{Z}} m!(n-m-1)! \epsilon_{m,n} Q^{m,n}, \quad (5.15)$$

with  $n$  towers ( $m = 0, \dots, n-1$ ) of infinitely many charges ( $n \in \mathbb{Z}$ ),

$$Q^{m,n} = \frac{(-1)^m}{2\pi i} \oint_{\mathcal{C}} dz z^n \mathcal{O}^{(n-m-1)}(z). \quad (5.16)$$

Following the same arguments for the analogous conservation equations with  $\bar{\partial}^n \rightarrow \partial^n$  we can construct a Noether current  $\bar{\mathcal{F}}^{\epsilon}(\bar{z})$  and associated topological charge  $\bar{Q}^{m,n}$ . The infinite tower is a special feature of  $d = 2$ .

While the construction of these charges is general for all types I, II and III of conserved operators [17](#) their insertion in correlation functions and the action of these charges on other operators depends on their type. Indeed, since the Ward identities associated to type I operators do not have contact terms (see appendix [B.2](#)), the charges associated to type I operators are trivial [18](#). In contrast, the charges for type II and III operators are non-trivial as we will exemplify in the following.

### 5.3 CCFT<sub>d=2</sub> Ward Identities

In this section we shall see how the construction of the charges applies to celestial CFT<sub>d=2</sub>. To start we want to recast the soft theorems reviewed in section [4.3](#) as correlation functions of conserved operators  $\mathcal{O}_{\Delta,\ell}(q, \epsilon)$  in celestial CFT<sub>d=2</sub>. To do so, we review some simple properties of the  $d = 2$  kinematics. The Poincaré section, expressed in  $z$  and  $\bar{z}$  coordinates, is given by

$$q^{\mu}(z, \bar{z}) = \frac{1}{2} (1 + z\bar{z}, z + \bar{z}, i(\bar{z} - z), 1 - z\bar{z}). \quad (5.17)$$

We take as CCFT<sub>2</sub> polarization vectors

$$e_{+}^{\alpha} = \frac{1}{\sqrt{2}} (1, -i) \quad \text{and} \quad e_{-}^{\alpha} = \frac{1}{\sqrt{2}} (1, i), \quad (5.18)$$

which are normalized such that  $e_{+} \cdot e_{-} = 1$  and verify  $e_{\pm}^2 = 0$ . They satisfy  $x \cdot e_{-} = \frac{1}{\sqrt{2}} z$  and  $x \cdot e_{+} = \frac{1}{\sqrt{2}} \bar{z}$ . In index-free notation, the embedding space polarization vectors of positive and negative helicity orthogonal to  $q^{\mu}$  are

$$\varepsilon_{+}^{\mu} = e_{+}^{\alpha} \partial_{\alpha} q^{\mu} = \frac{1}{\sqrt{2}} (\bar{z}, 1, -i, -\bar{z}), \quad \text{and} \quad \varepsilon_{-}^{\mu} = e_{-}^{\alpha} \partial_{\alpha} q^{\mu} = \frac{1}{\sqrt{2}} (z, 1, i, -z). \quad (5.19)$$

They are normalized such that  $\varepsilon_{+} \cdot \varepsilon_{-} = 1$  and satisfy  $\varepsilon_{+} \cdot \varepsilon_{+} = 0$ ,  $\varepsilon_{-} \cdot \varepsilon_{-} = 0$ . To express the  $d+2 = 4$  dimensional soft theorems in the Poincaré section [5.17](#) we use that  $q \cdot q_i = -\frac{1}{2}(z - z_i)(\bar{z} - \bar{z}_i)$ , as well as  $q_i \cdot \varepsilon_{+} = \frac{1}{\sqrt{2}}(\bar{z}_i - \bar{z})$  and  $q_i \cdot \varepsilon_{-} = \frac{1}{\sqrt{2}}(z_i - z)$ , and note that the helicity of massless particles in  $\mathbb{R}^{1,3}$  gets identified with the spin  $\ell$  in CCFT<sub>2</sub>.

Each soft theorem then corresponds to a spin  $\ell$  primary operator  $\mathcal{O}_{\Delta,\ell}(z, \bar{z})$  with a special conformal dimension  $\Delta$  which has a given level  $n$  primary descendant determined by conformal representation theory. We apply our general expression

<sup>17</sup>To be precise, for type I operators there are two shortening conditions (nameley Ia and Ib) for both holomorphic and anti-holomorphic derivatives. So the Noether current [5.11](#) for type I, secretly satisfies extra conservation equations in the  $z$  variable. In principle one could also define a type I Noether current which is annihilated by both  $\partial$  and  $\bar{\partial}$  by generalizing formula [5.11](#). The resulting current would not satisfy extra relations, but a function annihilated by both these derivatives should be constant. This is yet another way to see that type I operators should not be associated to non-trivial charges.

<sup>18</sup>In [84](#) non-trivial charges were defined, by using light transform of type I operators. A similar picture seems to hold in  $d > 2$ , where type I operators have trivial charges but their shadow transform give rise to non-trivial ones as we will discuss in section [6](#).

for the Noether current (5.11) to the soft theorems, and we show that our infinite towers of topological charges reproduce the results in the literature. For the conformally soft operators (4.30)-(4.31) with  $\Delta \rightarrow k = 1, 0, -1, \dots$  it will be useful to introduce the mode expansion (33, 86)<sup>19</sup>

$$R_k^+(z, \bar{z}) = \sum_{m=0}^{n-1} \bar{z}^m R_k^{(m)}(z), \quad H_k^+(z, \bar{z}) = \sum_{m=0}^{n-1} \bar{z}^m H_k^{(m)}(z), \quad (5.20)$$

where we have added a + label for the spin  $\ell = +|\ell|$  compared to (4.31). The corresponding  $\ell = -|\ell|$  modes have a - label in (5.20) and  $z \leftrightarrow \bar{z}$ . The leading soft photon theorem ( $\Delta = 1$ ) and the leading and subleading soft graviton theorems ( $\Delta = 1$  and  $\Delta = 0$ ) give rise to Ward identities for type II primary descendants. The subleading soft photon theorem ( $\Delta = 0$ ) and the subsubleading soft graviton theorem ( $\Delta = -1$ ) instead give rise to Ward identities for type III primary descendants. The conformally soft operators with ever more negative conformal dimensions give rise to type I primary descendants.

### 5.3.1 Leading Soft Photon

The leading positive-helicity soft photon theorem corresponds to the insertion of a  $U(1)$  current  $J(z) \equiv R_1^+(z)$  in the celestial correlation function, namely (87)

$$\langle J(z) \mathbb{O}_{\Delta_1, \ell_1} \cdots \mathbb{O}_{\Delta_N, \ell_N} \rangle = \sqrt{2e} \sum_{i=1}^N \mathbb{Q}_i \frac{1}{z - z_i} \langle \mathbb{O}_{\Delta_1, \ell_1} \cdots \mathbb{O}_{\Delta_i, \ell_i} \cdots \mathbb{O}_{\Delta_N, \ell_N} \rangle, \quad (5.21)$$

which satisfies  $\bar{\partial}J(z) = 0$  up to contact terms. The spin  $|\ell| = 1$  operator  $\bar{\partial}R_1(z)$  is a primary descendant of type II at level 1 and the Noether current (5.11) is simply

$$\mathcal{F}^\epsilon(z) = \epsilon(z)J(z). \quad (5.22)$$

Its conservation implies that the associated symmetry parameter has to satisfy  $\bar{\partial}\epsilon = 0$  which can therefore be expanded as  $\epsilon(z) = \sum_{n \in \mathbb{Z}} \epsilon_n z^n$  and we get one tower of charges

$$Q^{0,n} = \frac{1}{\sqrt{2e}} \frac{1}{2\pi i} \oint_{\Sigma} dz z^n J(z). \quad (5.23)$$

Similar statements are obtained for the negative-helicity soft photon upon  $z \leftrightarrow \bar{z}$  which gives  $\bar{\mathcal{F}}^{\bar{\epsilon}} = \bar{\epsilon}\bar{J}$  and another tower of charges  $\bar{Q}^n$  contributing to (5.9). Due to the symmetry of the celestial photon diamond (45) analogous statements hold for the shadow transformed soft photon operator. The charges act on an operator with conformal dimension  $\Delta$ , spin  $\ell$  and charge  $\mathbb{Q}$  as

$$[Q^{0,n}, \mathbb{O}_{\Delta, \ell}(z, z)] = \mathbb{Q} z^n \mathbb{O}_{\Delta, \ell}(z, z). \quad (5.24)$$

The enhancement from a global Noether current where  $\epsilon = \text{const}$  to a local one in  $\text{CCFT}_2$  corresponds to the large gauge symmetry in the  $D = 4$  dimensional bulk.

<sup>19</sup>Note that in the literature (33, 86) the labels are shifted, e.g. the sum there ranges between  $\frac{k-\ell}{2} \leq m \leq \frac{\ell-k}{2}$ .

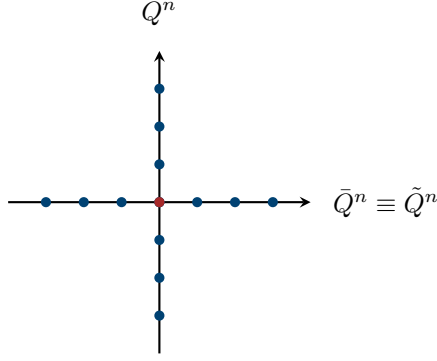

Figure 6: The soft photon theorem gives rise to an infinite tower of holomorphic charges  $Q^n$  and anti-holomorphic charges  $\bar{Q}^n$  (blue dots) which intersect at the global  $U(1)$  charge (red dot).

### 5.3.2 Leading Soft Graviton

The leading positive-helicity soft graviton theorem corresponds to the insertion of an operator  $H_1^+(z, \bar{z})$  in the celestial amplitude [88]

$$\langle H_1^+(z, \bar{z}) \mathbb{O}_{\Delta_1, \ell_1} \cdots \mathbb{O}_{\Delta_N, \ell_N} \rangle = -\frac{\kappa}{2} \sum_{i=1}^N \eta_i \frac{\bar{z} - \bar{z}_i}{z - z_i} \langle \mathbb{O}_{\Delta_1, \ell_1} \cdots \mathbb{O}_{\Delta_{i+1}, \ell_{i+1}} \cdots \mathbb{O}_{\Delta_N, \ell_N} \rangle, \quad (5.25)$$

that satisfies a non-standard (since higher-derivative) Ward identity with  $\bar{\partial}^2 H_1^+(z, \bar{z}) = 0$  up to contact terms. Note that  $P(z) \equiv \bar{\partial} H_1^+(z, \bar{z})$ , which satisfies the more standard conservation equation  $\bar{\partial} P(z) = 0$ , is a descendant but not a primary. Instead, the spin  $|\ell| = 2$  operator  $\bar{\partial}^2 H_1^+(z, \bar{z})$  is a primary descendant of type II at level 2. The associated symmetry parameter also satisfies a higher-derivative conservation equation  $\bar{\partial}^2 \epsilon = 0$  and can be expanded as  $\epsilon(z, \bar{z}) = \epsilon^{(0)}(z) + \bar{z} \epsilon^{(1)}(z)$  where  $\epsilon^{(m)}(z) = \sum_{n \in \mathbb{Z}} \epsilon_{m,n} z^n$  for  $m = 0, 1$ . The Noether current is

$$\mathcal{F}^\epsilon(z) = H_1^{(1)}(z) \epsilon^{(0)}(z) - H_1^{(0)}(z) \epsilon^{(1)}(z), \quad (5.26)$$

which yields two towers of charges

$$Q^{m,n} \equiv -\frac{2}{\kappa} \frac{(-1)^m}{2\pi i} \oint_{\Sigma} dz z^n H_1^{(1-m)}(z), \quad m = 0, 1. \quad (5.27)$$

From this we see that the operator  $P(z) = H_1^{(1)}(z)$  (which is usually called the supertranslation current) does not know about the infinite tower of conserved charges associated to  $H_1^{(0)}$ . This was emphasized in [89, 90] and is by now well-known in the celestial literature. It is crucial to use [5.26] so to take into account all possible generators. Similar statements hold for the negative-helicity soft graviton as well as for the shadow transform since the leading celestial graviton diamond is symmetric. Using [5.25] it is easy to see that the charges act as

$$[Q^{m,n}, \mathbb{O}_{\Delta, \ell}(z, \bar{z})] = \eta z^n \bar{z}^m \mathbb{O}_{\Delta+1, \ell}(z, \bar{z}). \quad (5.28)$$

In the above commutator,  $\eta = +1$  for *out* operators and  $\eta = -1$  for *in* operators. In some of the literature (see e.g. [89]) the global charges are called  $Q^{0,0} \equiv P_{-\frac{1}{2}, -\frac{1}{2}}$ ,  $Q^{0,1} \equiv P_{\frac{1}{2}, -\frac{1}{2}}$ ,  $Q^{1,0} \equiv P_{-\frac{1}{2}, \frac{1}{2}}$ ,  $Q^{1,1} \equiv P_{\frac{1}{2}, \frac{1}{2}}$ . The action [5.28] corresponds to the enhancement of the  $d + 2 = 4$  spacetime translations to BMS supertranslations. While  $m = 0, 1$  in [5.27], all other  $m \in \mathbb{Z}$  supertranslations can be obtained from the commutator with the Virasoro generators using the celestial OPE [89].

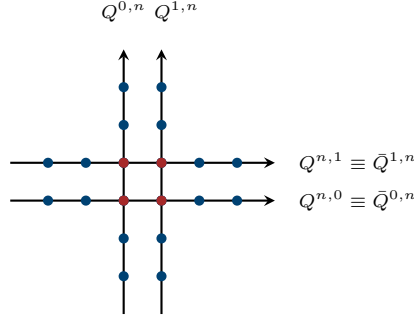

Figure 7: The leading soft graviton theorem gives rise to four towers of supertranslation charges  $Q^{m,n}$  and  $Q^{n,m}$  for  $m = 0, 1$  (blue dots), which intersect at the four global translations (red dots).

### 5.3.3 Subleading Soft Graviton

The subleading celestial graviton diamond is not symmetric [45] and so we get different conservation equations for the conformally soft primary and its shadow. The subleading negative-helicity soft graviton theorem corresponds to the correlation function

$$\langle H_0^-(z, \bar{z}) \mathbb{O}_{\Delta_1, \ell_1} \cdots \mathbb{O}_{\Delta_N, \ell_N} \rangle = \frac{\kappa}{2} \sum_{i=1}^N \frac{(z - z_i)^2}{\bar{z} - \bar{z}_i} \left( \frac{2h_i}{z - z_i} - \partial_{z_i} \right) \langle \mathbb{O}_{\Delta_1, \ell_1} \cdots \mathbb{O}_{\Delta_i, \ell_i} \cdots \mathbb{O}_{\Delta_N, \ell_N} \rangle, \quad (5.29)$$

while we recognize its shadow transform as a correlator with a stress tensor insertion [47, 91]

$$\langle T(z) \mathbb{O}_{\Delta_1, \ell_1} \cdots \mathbb{O}_{\Delta_N, \ell_N} \rangle = \kappa \sum_{i=1}^N \left( \frac{h_i}{(z - z_i)^2} + \frac{1}{z - z_i} \partial_{z_i} \right) \langle \mathbb{O}_{\Delta_1, \ell_1} \cdots \mathbb{O}_{\Delta_i, \ell_i} \cdots \mathbb{O}_{\Delta_N, \ell_N} \rangle. \quad (5.30)$$

The stress tensor  $T(z) \equiv S[H_0^-](z) \equiv \tilde{H}_2^+(z)$  is conserved  $\bar{\partial}T(z) = 0$  up to contact terms, as is the operator  $\tilde{T}(z, \bar{z}) \equiv H_0^-(z, \bar{z})$  albeit in the form of a higher-derivative conservation equation  $\partial^3 \tilde{T}(z, \bar{z}) = -\bar{\partial}T(z)$ . The spin  $|\ell| = 2$  operators  $\partial^3 H_0^-(z, \bar{z})$  and  $\bar{\partial} \tilde{H}_2^+(z)$  are primary descendants of type II at, respectively, level 3 and level 1. The symmetry parameter for the stress tensor is required to be holomorphic  $\bar{\partial}\epsilon = 0$  in order for the Noether current

$$\mathcal{F}^\epsilon(z) = \epsilon(z)T(z) \quad (5.31)$$

to be conserved. We obtain the tower of charges

$$Q^{0,n} = \frac{1}{\kappa} \frac{1}{2\pi i} \oint_{\Sigma} dz z^n T(z), \quad (5.32)$$

which act as Virasoro generators  $Q^{0,n+1} \equiv L_n$

$$[Q^{0,n+1}, \mathbb{O}_{\Delta, \ell}(z, \bar{z})] = z^n [(n+1)h + z\partial_z] \mathbb{O}_{\Delta, \ell}(z, \bar{z}). \quad (5.33)$$

They enhance the global to the local conformal transformations, or equivalently, Lorentz transformations to Virasoro superrotations. Meanwhile, the symmetry parameter for the shadow stress tensor satisfies the higher-derivative conservation equation  $\partial^3 \tilde{\epsilon} = 0$ . Expanding  $\tilde{\epsilon}(z, \bar{z}) = \tilde{\epsilon}^{(0)}(\bar{z}) + z\tilde{\epsilon}^{(1)}(\bar{z}) + z^2\tilde{\epsilon}^{(2)}(\bar{z})$  we can write the Noether current as [92]

$$\tilde{\mathcal{F}}^{\tilde{\epsilon}}(\bar{z}) = 2H_0^{(2)}(\bar{z})\tilde{\epsilon}^{(0)}(\bar{z}) - H_0^{(1)}(\bar{z})\tilde{\epsilon}^{(1)}(\bar{z}) + 2H_0^{(0)}(\bar{z})\tilde{\epsilon}^{(2)}(\bar{z}), \quad (5.34)$$

and get three towers of charges

$$\tilde{Q}^{m,n} = \frac{2}{\kappa} \frac{(-1)^m}{2\pi i} \oint_{\Sigma} d\bar{z} \bar{z}^n H_0^{(2-m)}(\bar{z}), \quad m = 0, 1, 2. \quad (5.35)$$

These charges act on generic operators as follows

$$\begin{aligned}
[\tilde{Q}^{0,n}, \mathbb{O}_{\Delta,\ell}(z, \bar{z})] &= -\bar{z}^n \partial_z \mathbb{O}_{\Delta,\ell}(z, \bar{z}), \\
[\tilde{Q}^{1,n}, \mathbb{O}_{\Delta,\ell}(z, \bar{z})] &= -\bar{z}^n (2h + 2z \partial_z) \mathbb{O}_{\Delta,\ell}(z, \bar{z}), \\
[\tilde{Q}^{2,n}, \mathbb{O}_{\Delta,\ell}(z, \bar{z})] &= -\bar{z}^n (2hz + z^2 \partial_z) \mathbb{O}_{\Delta,\ell}(z, \bar{z}).
\end{aligned} \tag{5.36}$$

Similar expressions are obtained for the opposite helicity charges.

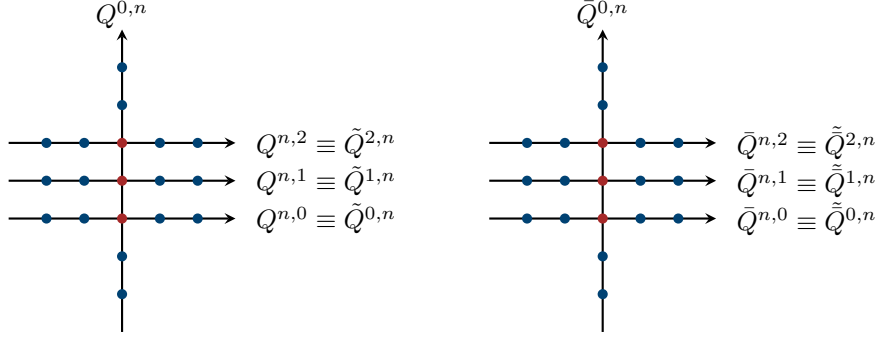

Figure 8: The six red dots represent the charges associated to global rotations and boosts. There exists one tower of charges for the stress tensor generating Virasoro superrotations and three towers for the shadow stress tensor generating shadow superrotations, and similarly for their antiholomorphic counterparts.

### 5.3.4 Subleading Soft Photon and Subsubleading Soft Graviton

There are further subleading soft theorems which correspond to correlation functions of conserved operators albeit with primary descendants of a different type. The positive-helicity subleading soft photon theorem can be expressed as [93](#)

$$\langle R_0^+(z, \bar{z}) \mathbb{O}_{\Delta_1, \ell_1} \cdots \mathbb{O}_{\Delta_N, \ell_N} \rangle = -\sqrt{2}e \sum_{i=1}^N \eta_i \frac{\mathbb{Q}_i}{z - z_i} (2\bar{h}_i - 1 - (\bar{z} - \bar{z}_i) \partial_{\bar{z}_i}) \langle \mathbb{O}_{\Delta_1, \ell_1} \cdots \mathbb{O}_{\Delta_{i-1}, \ell_{i-1}} \cdots \mathbb{O}_{\Delta_N, \ell_N} \rangle, \tag{5.37}$$

where the spin  $|\ell| = 1$  operator  $R_0^+(z, \bar{z})$  is conserved as  $\bar{\partial}^2 R_0^+(z, \bar{z}) = 0$  up to contact terms. This corresponds to a type III primary descendant at level 2. For a symmetry parameter satisfying  $\bar{\partial}^2 \epsilon = 0$  we can write the Noether current

$$\mathcal{F}^\epsilon(z) = R_0^{(0)}(z) \epsilon^{(1)}(z) - R_0^{(1)}(z) \epsilon^{(0)}(z), \tag{5.38}$$

and obtain two towers of charges in terms of the two modes  $R_0^{(m)}$  for  $m = 0, 1$ . Similar statements hold for the opposite helicity photon and its shadow. The associated charges

$$Q^{m,n} = -\frac{1}{\sqrt{2}e} \frac{(-1)^m}{2\pi i} \oint_{\Sigma} dz z^n R_0^{(1-m)} \quad m = 0, 1 \tag{5.39}$$

act on generic operators as follows [94](#)

$$\begin{aligned}
[Q^{0,n}, \mathbb{O}_{\Delta,\ell}(z, \bar{z})] &= -\eta \mathbb{Q} z^n \bar{\partial} \mathbb{O}_{\Delta-1,\ell}(z, \bar{z}), \\
[Q^{1,n}, \mathbb{O}_{\Delta,\ell}(z, \bar{z})] &= -\eta \mathbb{Q} z^n (2\bar{h} - 1 + \bar{z} \bar{\partial}) \mathbb{O}_{\Delta-1,\ell}(z, \bar{z}).
\end{aligned} \tag{5.40}$$

Meanwhile, the positive-helicity subsubleading soft graviton theorem takes the form [95](#)

$$\begin{aligned} \langle H_{-1}^+(z, \bar{z}) \mathcal{O}_{\Delta_1, \ell_1} \cdots \mathcal{O}_{\Delta_N, \ell_N} \rangle &= -\frac{\kappa}{4} \sum_{i=1}^N \eta_i \frac{\bar{z} - \bar{z}_i}{z - z_i} (2\bar{h}_i(2\bar{h}_i - 1) - 2(\bar{z} - \bar{z}_i)2\bar{h}_i\partial_{\bar{z}_i} \\ &\quad + (\bar{z} - \bar{z}_i)^2 \partial_{\bar{z}_i}^2) \langle \mathcal{O}_{\Delta_1, \ell_1} \cdots \mathcal{O}_{\Delta_{i-1}, \ell_{i-1}} \cdots \mathcal{O}_{\Delta_N, \ell_N} \rangle. \end{aligned} \quad (5.41)$$

The spin  $|\ell| = 2$  operator  $H_{-1}^+(z, \bar{z})$  is conserved as  $\bar{\partial}^4 H_{-1}^+ = 0$  up to contact terms which corresponds to a type III primary descendant at level 4. For  $\bar{\partial}^4 \epsilon = 0$  we get the Noether current

$$\mathcal{F}^\epsilon(z) = 6H_{-1}^{(0)}(z)\epsilon^{(3)}(z) - 2H_{-1}^{(1)}(z)\epsilon^{(2)}(z) + 2H_{-1}^{(2)}(z)\epsilon^{(1)}(z) - 6H_{-1}^{(3)}(z)\epsilon^{(0)}(z), \quad (5.42)$$

and obtain four towers of charges in terms of the four modes  $H_{-1}^{(m)}$  for  $m = 0, 1, 2, 3$ . Analogous expressions can be obtained for the opposite helicity graviton and its shadow. The associated charges

$$Q^{m,n} = -\frac{4}{\kappa} \frac{(-1)^m}{2\pi i} \oint_{\Sigma} dz z^n H_{-1}^{(3-m)}, \quad m = 0, 1, 2, 3 \quad (5.43)$$

act on generic operators as follows [90](#)

$$\begin{aligned} [Q^{0,n}, \mathcal{O}_{\Delta, \ell}(z, \bar{z})] &= \eta z^n \bar{\partial}^2 \mathcal{O}_{\Delta-1, \ell}(z, \bar{z}), \\ [Q^{1,n}, \mathcal{O}_{\Delta, \ell}(z, \bar{z})] &= \eta z^n (4\bar{h}\bar{\partial} + 3\bar{z}\bar{\partial}^2) \mathcal{O}_{\Delta-1, \ell}(z, \bar{z}), \\ [Q^{2,n}, \mathcal{O}_{\Delta, \ell}(z, \bar{z})] &= \eta z^n (2\bar{h}(2\bar{h} - 1) + 8\bar{h}\bar{z}\bar{\partial} + 3\bar{z}^2\bar{\partial}^2) \mathcal{O}_{\Delta-1, \ell}(z, \bar{z}), \\ [Q^{3,n}, \mathcal{O}_{\Delta, \ell}(z, \bar{z})] &= \eta z^n (2\bar{h}(2\bar{h} - 1)\bar{z} + 4\bar{h}\bar{z}^2\bar{\partial} + \bar{z}^3\bar{\partial}^2) \mathcal{O}_{\Delta-1, \ell}(z, \bar{z}). \end{aligned} \quad (5.44)$$

Again,  $\eta = +1$  if  $\mathcal{O}_{\Delta, \ell}(z, \bar{z})$  is *out* and  $\eta = -1$  if it is *in*. In both gravity and gauge theory cases to take into account all possible generators one again needs to use the Noether currents [5.38](#) and [5.42](#), or equivalently, keep track of all relevant modes in the expansion [5.20](#) as was emphasized in [90](#) [94](#). What sets these more subleading soft theorems apart is that the type III primary descendants of the conformally soft operators  $R_0^+$  and  $H_{-1}^+$  are also their shadows [45](#):

$$\frac{1}{2!} \bar{\partial}^2 R_0^+ = S[R_0^+] \equiv \tilde{R}_2^-, \quad \frac{1}{4!} \bar{\partial}^4 H_{-1}^+ = S[H_{-1}^+] \equiv \tilde{H}_3^-. \quad (5.45)$$

We will uncover a similar relation in higher dimensions in section [6.5](#) albeit in a much more subtle form.

## 5.4 The Soft, the Hard and the Topological Charge

Let us conclude this section by commenting on the relation between the standard CFT approach for computing charges from Ward identities and the charges associated to the asymptotic symmetries of gauge theory and gravity at null infinity in the “soft theorem = asymptotic symmetry” connection. The latter are constructed using the covariant phase space formalism. Upon imposing the antipodal matching condition [5](#) charges for asymptotic symmetries satisfy the classical conservation law

$$Q^+ = Q^- \quad (5.46)$$

between the past (−) and future (+) null boundary. At the level of the S-matrix the desired conservation law becomes

$$\langle out | Q^+ S - S Q^- | in \rangle = 0. \quad (5.47)$$

To prove this relation [20](#) one typically splits the charge on each null boundary into a “soft charge”  $Q_S^\pm$  that will be associated to zero energy modes and a “hard charge”  $Q_H^\pm$  that contains the fields carrying energetic excitations. The role of the soft

<sup>20</sup>See [36](#) for a review and references therein.



charge is to define a soft operator  $Q_S^\pm = \int d^2z \epsilon(z, \bar{z}) \cdot O_S^\pm(z, \bar{z})$  whose insertion in the S-matrix creates/annihilates soft particles, while  $Q_H^\pm$  implements the asymptotic symmetry transformations on the matter fields  $[Q^\pm, \cdot] = \delta_\epsilon(\cdot)$ . The symmetry parameter  $\epsilon(z, \bar{z})$  depends on the coordinates on the celestial sphere but not the (null) time coordinates. Upon a judicious choice of (singular) parameters one finds that the conservation law

$$\langle out|Q_S^+ S - S Q_S^-|in\rangle = -\langle out|Q_H^+ S - S Q_H^-|in\rangle \quad (5.48)$$

is equivalent to the associated soft theorem: the integral  $\int d^2z$  on the left-hand-side of (5.48), after integration by parts and using  $\bar{\partial}_z^1 = 2\pi\delta^{(2)}(z)$ , localizes to the insertion of a soft particle while the one on the right-hand-side becomes the soft factor times  $\langle out|S|in\rangle$ . Conversely, starting from the soft theorem we can “smear” both sides by integrating over the sphere with some parameter  $\epsilon(z, \bar{z})$  and recover the soft and hard charges which are then guaranteed to obey the conservation law (5.47).

The standard way in CFT to construct conserved charges is to identify a conserved operator satisfying a Ward identity and then integrating the associated Noether current over a region of the CFT space. Soft theorems are equivalent to the insertion of conserved operators in correlation functions and conformal representation theory tells us the corresponding Ward identities. Alternatively, these Ward identities can be obtained in the above language – without the need of introducing a special parameter  $\epsilon(z, \bar{z})$  – from an unintegrated version of (5.48). That is we define soft and hard operators,  $O_S$  and  $O_H$ , through

$$Q_S^\pm = \int_{S^2} d^2z \epsilon(z, \bar{z}) \cdot O_S^\pm(z, \bar{z}), \quad Q_H^\pm = \int_{S^2} d^2z \epsilon(z, \bar{z}) \cdot O_H^\pm(z, \bar{z}), \quad (5.49)$$

which satisfy the “unsmearred” conservation law

$$\langle out|O_S^+ S - S O_S^-|in\rangle = -\langle out|O_H^+ S - S O_H^-|in\rangle. \quad (5.50)$$

In Maxwell theory and Einstein gravity the hard operators  $O_H^\pm$  are given by  $u$ -integrals of the matter current  $j_u$  and stress tensor  $T_{uu}$  and  $T_{ua}$ , while the soft operators  $O_S^\pm$  involve ( $x^a$  derivatives of) the field strength  $F_{ua}$  and the news tensor  $N_{ab}$ . The relation (5.50) holds because of the constraint equation of the respective theory and the antipodal matching condition imposed between the *in* and *out* fields. From the embedding-to-CFT-space perspective, since a single light ray passing through the origin of spacetime defines a single point in CFT space it is natural to consider the *in* and *out* operators as living on the same celestial sphere. The right-hand-side of (5.50) computes the variation of the *in* and *out* operators with distributional support at their location, while the left-hand-side gives the conservation equation for the conformally soft operators discussed in section 5.3. In the standard CFT approach we would use this conservation equation, construct from it a Noether current and integrate it over some region on the sphere to obtain the surface charge. We can then relate this topological charge to the soft charge which integrates the soft operator over the entire sphere.

Let us illustrate this for the simplest example: the soft photon theorem associated to large gauge symmetry. From the constraint equation of Maxwell theory near future null infinity,  $\partial_u F_{ru}^{(2)} + \partial_z F_{uz}^{(0)} + \partial_{\bar{z}} F_{u\bar{z}}^{(0)} + e^2 j_u^{(2)} = 0$  and the integrand of the global electric charge  $\star F = F_{ru}^{(2)} d^2z$ , we find that the soft and hard operators are (36)

$$O_S^+(z, \bar{z}) = -\frac{1}{e^2} \int du (\partial_z F_{u\bar{z}}^{(0)} + \partial_{\bar{z}} F_{uz}^{(0)}), \quad O_H^+(z, \bar{z}) = \int du j_u^{(2)}, \quad (5.51)$$

where superscripts denote the inverse power of  $r$  in the large radius expansion. These operators are associated with fields on the future null boundary while similar expressions hold for the charges at the past boundary where the retarded time  $u$  is

replaced by the advanced time  $v$ . To compute the right-hand-side of (5.50) we use (36)(96)

$$[j_u^{(2)}(u', z, \bar{z}), \Phi_i(u, z_i, \bar{z}_i)] = -\mathbb{Q}_i \Phi_i(u, z_i, \bar{z}_i) \delta^{(2)}(z - z_i) \delta(u - u'), \quad (5.52)$$

where  $\Phi_i(u, z_i, \bar{z}_i)$  is a matter field of charge  $\mathbb{Q}_i$ . A similar expression holds for  $j_v^{(2)}(v, z, \bar{z})$  albeit with the opposite sign. We thus obtain for the hard operator insertion in the S-matrix

$$\begin{aligned} \langle out | O_H^+ S - S O_H^- | in \rangle &= \langle out | \int du j_u(u, z, \bar{z}) S - S \int dv j_v(v, z, \bar{z}) | in \rangle \\ &= \sum_{i=1}^n \delta^{(2)}(z - z_i) \eta_i \mathbb{Q}_i \langle \mathbb{O}_1 \dots \mathbb{O}_i \dots \mathbb{O}_n \rangle, \end{aligned} \quad (5.53)$$

where  $\eta_i = \pm$  distinguishes between *in* and *out* states. For the soft operator insertion we get

$$\begin{aligned} \langle out | O_S^+ S - S O_S^- | in \rangle &= \frac{1}{e^2} \partial_{\bar{z}} \langle out | \int du F_{uz}^{(0)} S - S \int dv F_{vz}^{(0)} | in \rangle + (z \leftrightarrow \bar{z}) \\ &= \partial_{\bar{z}} \langle out | J_z^+ S - S J_z^- | in \rangle + (z \leftrightarrow \bar{z}), \end{aligned} \quad (5.54)$$

where we defined the soft photon current

$$J_a^+ = \frac{1}{e^2} \int_{-\infty}^{+\infty} du F_{ua}^{(0)}, \quad (5.55)$$

and a similar expression for the fields on the past boundary. The equality of the soft and hard insertions (5.50) gives the following relation

$$\partial_{\bar{z}} \langle out | J_z^+ S - S J_z^- | in \rangle + (z \leftrightarrow \bar{z}) = \sum_{i=1}^n \delta^{(2)}(z - z_i) \eta_i \mathbb{Q}_i \langle \mathbb{O}_1 \dots \mathbb{O}_i \dots \mathbb{O}_n \rangle. \quad (5.56)$$

This takes the form of a conservation equation for a current

$$\langle \partial^a J_a(x) \mathbb{O}_1 \dots \mathbb{O}_n \rangle = \sum_{i=1}^n \delta^{(2)}(z - z_i) \eta_i \mathbb{Q}_i \langle \mathbb{O}_1 \dots \mathbb{O}_i \dots \mathbb{O}_n \rangle, \quad (5.57)$$

where  $x^a$  is written in terms of  $z, \bar{z}$ . This Ward identity can be used to build a Noether current  $\mathcal{F}^\epsilon$  by multiplying the current operator  $J \equiv J_z$  by a parameter  $\epsilon(z, \bar{z})$ . For  $\mathcal{F}^\epsilon(z) = \epsilon(z, z) J(z)$  such that  $\bar{\partial} \mathcal{F}^\epsilon(z) = 0$  (away from contact terms) we find that  $\bar{\partial} \epsilon(z, \bar{z}) = 0$  has to be satisfied and is thus holomorphic  $\epsilon(z, \bar{z}) = \epsilon(z)$ . This condition must hold inside the region bounded by  $\Sigma = \partial R$  where we are integrating the Noether current to construct the charge

$$Q_\Sigma^\pm = \int_R d^2 z \bar{\partial} (\epsilon(z) J^\pm(z)) = \oint_\Sigma dz \epsilon(z) J^\pm(z). \quad (5.58)$$

Recall that the label  $\pm$  refers to which operators (associated to *in* or *out* states) it acts on. One may want to define  $Q_\Sigma = Q_\Sigma^+ - Q_\Sigma^-$  as the total charge. Expanding  $\epsilon(z) = \sum_{n=-\infty}^{\infty} c_n z^n$  in a power series we can write a countable basis for the charges. Some of the charges are actual symmetries: this happens for smooth  $\epsilon(z)$  when  $Q_\Sigma$  is zero for a  $\Sigma$  that surrounds all the operators – these are the global charges. Outside the region containing all the operators  $\epsilon(z)$  may have a pole and such local charges do not vanish, however, they act in a precise way defined through the Ward identities.

Finally, to connect back to the above discussion note that the soft charge  $Q_S^\pm$  is defined as an integral over the entire  $S^2$ , while the topological charge  $Q_\Sigma^\pm$  is defined on a region  $R$  bounded by  $\Sigma = \partial R$  in  $S^2$ . We see that the two quantities are equivalent

$$Q_\Sigma^\pm = \int_R d^2 z \bar{\partial} (\epsilon J^\pm) \quad \longleftrightarrow \quad Q_S^\pm = \int_{S^2} d^2 z \epsilon \bar{\partial} J^\pm, \quad (5.59)$$

by assuming that  $\epsilon$  does not have poles in the region  $R$  and that this region surrounds all the operators. Notice that the definition of  $Q_\Sigma^\pm$  is more general than  $Q_S^\pm$  since it computes the charges contained in a region  $\Sigma$  of the celestial sphere, which

can be chosen at will. Similarly one can define a more general version of the hard charge by integrating the right-hand-side of (5.57) (times the parameter  $\epsilon$ ) on the same region  $R$ , which gives as a result the variation of all operators contained in such region. As a result, the Ward identity can be rewritten in the usual way as

$$[Q, \cdot] = \delta(\cdot), \quad (5.60)$$

where the left hand side arises from the soft operator and the right-hand-side from the hard one.

Let us wrap up by commenting on the special symmetry parameters  $\epsilon = \{\varepsilon, f, Y^z\}$  used in the literature to go from the charge conservation laws for large gauge transformations, BMS supertranslations and superrotations to the factorization theorems for the leading soft photon, leading soft graviton and subleading soft graviton. To localize the sphere integrals one takes  $\varepsilon = \frac{1}{z-w}$ ,  $f = \frac{\bar{z}-\bar{w}}{z-w}$ , and  $Y^z = \frac{(\bar{z}-\bar{w})^2}{z-w}$ . Their form is readily explained: they satisfy (up to contact terms)  $\bar{\partial}\epsilon = 0$ ,  $\bar{\partial}^2\epsilon = 0$  and  $\bar{\partial}^3\epsilon = 0$  as required by the conservation of the Noether currents. The choice of a parameter  $\epsilon$  that depends on new variables  $w, \bar{w}$  is non-canonical but it simply has the effect of mapping the charge with such  $\epsilon$  to the local conserved operator that defines them. In usual CFT manuals it is standard to reconstruct an operator by resumming the Laurent expansion of the charges. E.g. for a current  $J(w) = \sum_n w^{-n-1} Q^n$ , where the charges  $Q^n = \frac{1}{2\pi i} \oint dz z^n J(z)$  are defined by  $Q_\Sigma^{\epsilon(z)=z^n}$ . What is done in the CCFT literature is to consider the prescription  $J(w) = Q_\Sigma^{\epsilon(z)=1/(z-w)}$ , where  $\Sigma$  surrounds the pole at  $z = w$ , which is ultimately equivalent even if at a first sight it may look like the parameter is fine-tuned. While being equivalent we think that the usual CFT-inspired construction presented in this section is less confusing since it does not rely in the introduction of special parameters.

## 6 Symmetries in Celestial CFT<sub>d>2</sub>

We now discuss the symmetries in celestial CFTs in  $d > 2$  dimensions. We start in section 6.1 by reviewing useful technology to deal with  $SO(d)$  tensors. In section 6.2 we then classify the different types of primary descendant operators associated to CCFT symmetries using conformal representation theory. By demanding that they satisfy some (higher-derivative) conservation equations we construct in section 6.3 their associated charges. In section 6.4 and 6.5 we identify the types of conserved operators that soft theorems and their shadow transforms give rise to and we build the associated charges.

### 6.1 Technology for $SO(d)$ tensors

Henceforth, it will be convenient to use an efficient technology to deal with  $SO(d)$  tensors [57, 97, 99]. In this section we review how this works starting with the traceless and symmetric representations and then generalizing to the mixed-symmetric ones.

#### 6.1.1 Traceless and Symmetric Tensors

We will often encounter CFT<sub>d</sub> traceless and symmetric tensors contracted with polarization vectors  $e^a$  which square to zero. Let us review two ways to recover the indices either using a special differential operator or a projector. First we introduce the differential operator [100]

$$D_e^a \equiv \left( \frac{d}{2} - 1 + e \cdot \partial_e \right) \partial_e^a - \frac{1}{2} e^a \partial_e \cdot \partial_e. \quad (6.1)$$

This can be used to differentiate the vectors  $e^a$  and automatically renders the final expression traceless and symmetric. E.g. given a tensor  $t(e) \equiv t^{a_1 \dots a_\ell} e_{a_1} \dots e_{a_\ell}$ , we can recover the indices by

$$t^{a_1 \dots a_\ell} = \frac{1}{\ell! \left(\frac{d}{2} - 1\right)_\ell} D_e^{a_1} \dots D_e^{a_\ell} t(e). \quad (6.2)$$

Indeed by taking derivatives of the polarization vectors we get a projector into traceless and symmetric representations  $\pi_\ell$ ,

$$\pi_\ell \left( \boxed{a_1 \dots a_\ell}; \boxed{b_1 \dots b_\ell} \right) = \frac{1}{\ell! \left(\frac{d}{2} - 1\right)_\ell} D_e^{a_1} \dots D_e^{a_\ell} e^{b_1} \dots e^{b_\ell}. \quad (6.3)$$

This projector  $\pi_\ell$  is defined in such a way that if we contract its indices  $b_i$  with a tensor  $t$  (not necessarily in an irreducible representation) it gives back a tensor  $t'$  that depends on the indices  $a_i$  which are symmetric and traceless,

$$t'^{a_1 \dots a_\ell} = \pi_\ell \left( \boxed{a_1 \dots a_\ell}; \boxed{b_1 \dots b_\ell} \right) t^{b_1 \dots b_\ell}. \quad (6.4)$$

Another way to get back the open indices is to use the projector itself. Indeed the projector contracted with unconstrained vectors  $\hat{e}, \hat{f} \in \mathbb{R}^d$  (now  $\hat{e}^2, \hat{f}^2 \neq 0$ ) is known in a closed form

$$\pi_\ell(\hat{f}; \hat{e}) \equiv \pi_\ell \left( \boxed{a_1 \dots a_\ell}; \boxed{b_1 \dots b_\ell} \right) \hat{f}^{a_1} \hat{e}^{b_1} \dots \hat{f}^{a_\ell} \hat{e}^{b_\ell} \quad (6.5)$$

$$= \frac{\ell!}{2^\ell (d/2 - 1)_\ell} |\hat{e}|^\ell |\hat{f}|^\ell C_\ell^{d/2-1} \left( \frac{\hat{e} \cdot \hat{f}}{|\hat{e}| |\hat{f}|} \right), \quad (6.6)$$

where  $C_\ell^m(x)$  is a Gegenbauer polynomial. Now, since  $\hat{e}, \hat{f}$  are unconstrained, by taking simple derivatives  $\partial_{\hat{e}}, \partial_{\hat{f}}$  we can open the indices of the projector which can then be contracted with the tensor. E.g. a traceless and symmetric tensor  $t^{a_1 \dots a_\ell}$  can be recovered from its contracted form  $t(e)$  by<sup>21</sup>

$$t^{a_1 \dots a_\ell} = \frac{1}{(\ell!)^2} \partial_{\hat{f}}^{a_1} \dots \partial_{\hat{f}}^{a_\ell} \pi_\ell(\hat{f}; \partial_e) t(e). \quad (6.7)$$

This method is easily generalizable to the more complicated cases which we will need in the following.

### 6.1.2 Mixed-symmetric Tensors

In general, in  $d$  dimensions the representations of  $SO(d)$  of the spin of tensor operators can be more complicated with respect to the traceless and symmetric one. They are labelled by a set of  $[d/2]$  numbers  $\ell = (\ell_1, \dots, \ell_{[d/2]-1}, |\ell_{[d/2]}|)$  where  $\ell_i \geq \ell_{i+1}$  which can be associated to a Young tableau with  $\ell_i$  boxes in the  $i$ -th row. In odd dimensions all the labels  $\ell_i$  are greater or equal than zero while in even  $d$  the label  $\ell_{[d/2]}$  of the last row can be negative, so the Young tableau has to be labelled by its absolute value  $|\ell_{[d/2]}|$ . We can place the indices of the tensor in the boxes of the Young tableau, as follows

$$\mathbf{a} \equiv \begin{array}{cccccc} \boxed{a_1^1} & \dots & \dots & \dots & \dots & \boxed{a_{\ell_1}^1} \\ \boxed{a_1^2} & \dots & \dots & \dots & \boxed{a_{\ell_2}^2} & \\ \vdots & \vdots & \vdots & \ddots & & \\ \boxed{a_1^k} & \dots & \boxed{a_{\ell_k}^k} & & & \end{array}, \quad (6.8)$$

with  $k \leq [d/2]$ . The indices on the rows are symmetrized while the ones on the columns are antisymmetrized, all traces are then removed. Since the indices are not all symmetric or antisymmetric, these representations are sometimes called mixed-symmetric tensor representations. E.g. a traceless symmetric operator with spin  $\ell$  corresponds to  $(\ell_1 = \ell, \ell_2 = 0 \dots, \ell_{[d/2]} =$

<sup>21</sup>Notice that since we are in  $\mathbb{R}^d$  we may equivalently use upper or lower indices.

0). As before we can obtain an index-free notation by contracting the indices (6.8) with a set of polarization vectors  $e_i$  with  $i = 1, \dots, k$ , such that the indices  $a_j^i$  (for  $j = 1, \dots, \ell_i$ ) of the  $i$ -th row are contracted with  $\ell_i$  identical vectors  $e_i$ , such that  $e_i \cdot e_l = 0$  for  $i, l = 1, \dots, k$ . Using this method any mixed-symmetric tensor  $t^{\mathbf{a}}$  that depends on the indices  $\mathbf{a}$  in (6.8) can then be encoded by an index-free expression  $t(e_1, \dots, e_k) \equiv t(e)$ .

In order to recover the indices it is convenient to introduce projectors into mixed-symmetric representations  $\pi_\ell(\mathbf{a}; \mathbf{b})$  (97-98) which depend on two sets of indices  $\mathbf{a}, \mathbf{b}$  as in (6.8), namely

$$\pi_\ell(\mathbf{a}; \mathbf{b}) \equiv \pi_\ell \left( \begin{array}{cccccc} a_1^1 & \dots & \dots & \dots & \dots & a_{\ell_1}^1 \\ a_1^2 & \dots & \dots & a_{\ell_2}^2 & \dots & \dots \\ \vdots & \vdots & \vdots & \ddots & \vdots & \vdots \\ a_1^k & \dots & a_{\ell_k}^k & \dots & \dots & \dots \end{array} ; \begin{array}{cccccc} b_1^1 & \dots & \dots & \dots & \dots & b_{\ell_1}^1 \\ b_1^2 & \dots & \dots & b_{\ell_2}^2 & \dots & \dots \\ \vdots & \vdots & \vdots & \ddots & \vdots & \vdots \\ b_1^k & \dots & b_{\ell_k}^k & \dots & \dots & \dots \end{array} \right). \quad (6.9)$$

Upon contraction of a tensor with one of the two sets of indices, the projector gives back a tensor dependent on the other set of indices opportunely symmetrized  $t^{\mathbf{a}} = \pi_\ell(\mathbf{a}; \mathbf{b})t^{\mathbf{b}}$ . In particular, contracting two projectors we obtain the usual idempotence  $\pi_\ell(\mathbf{a}; \mathbf{b})\pi_\ell(\mathbf{b}; \mathbf{c}) = \pi_\ell(\mathbf{a}; \mathbf{c})$ . It is possible to compute the projectors in a closed form (97) when contracted with two sets of unconstrained vectors  $\hat{f} \equiv \{\hat{f}_1, \dots, \hat{f}_k\}$  and  $\hat{e} \equiv \{\hat{e}_1, \dots, \hat{e}_k\}$ ,

$$\pi_\ell(\hat{e}; \hat{f}) \equiv \pi_\ell(\mathbf{a}; \mathbf{b}) \prod_{i=1}^k \prod_{j=1}^{\ell_i} \hat{e}_i^{a_j^i} \hat{f}_i^{b_j^i}, \quad (6.10)$$

the simplest example being (6.5). To obtain an uncontracted projector we take derivatives of the vectors  $\hat{e}_i, \hat{f}_i$ .

Given the contracted tensor  $t(e)$  we can obtain the uncontracted one  $t^{\mathbf{a}}$  (opportunely symmetrized) by simply taking derivatives  $\partial_{e_i}$  of all  $e_i$  and symmetrizing the result with a projector, namely

$$t(\hat{f}) = \left( \prod_{i=1}^k \frac{1}{\ell_i!} \right) \pi_\ell(\hat{f}; \partial_e) t(e), \quad (6.11)$$

where  $\partial_e \equiv \{\partial_{e_1}, \dots, \partial_{e_k}\}$  and the normalization is introduced to compensate for the factorials coming from powers of derivatives (e.g.  $\partial_x^n x^n = n!$ ). In (6.11), the tensor  $t^{\mathbf{a}}$  is still contracted with a set of vectors  $\hat{f}$ , but since they are unconstrained one can simply recover the indices by taking usual derivatives

$$t^{\mathbf{a}} = \left( \prod_{i=1}^k \frac{1}{\ell_i!} \right) \partial_{\hat{f}_1}^{a_1^1} \dots \partial_{\hat{f}_1}^{a_{\ell_1}^1} \dots \partial_{\hat{f}_k}^{a_1^k} \dots \partial_{\hat{f}_k}^{a_{\ell_k}^k} t(\hat{f}). \quad (6.12)$$

## 6.2 Celestial Necklaces

The soft operators introduced in section 4.3 are protected operators with integer dimensions. Indeed, they belong to reducible conformal multiplets – that is multiplets that satisfy shortening conditions where a descendant in the multiplet becomes a primary. In this section we explain how to determine the symmetries of CCFT<sub>d</sub> by classifying primary descendants in CFT<sub>d</sub>.

The general logic is the same as the one discussed in section 5.1 for CCFT<sub>2</sub> but there are crucial differences in CCFT<sub>d>2</sub> which render the classification much more challenging. Let us give a flavor of the classification before going into the detailed discussion in the preceding subsections. Acting on a primary  $\mathcal{O}_{\Delta, \ell}$  with a combination of derivatives produces a descendant  $\mathcal{O}'_{\Delta', \ell'}$ . For this descendant to be itself a primary it has to be annihilated by the generator of special conformal transformations  $K^a$ , that is it has to satisfy  $[K^a, \mathcal{O}'_{\Delta', \ell'}(0)] = 0$ . The first major difference in  $d > 2$  is that the degeneracy of descendant operators at a given level and spin is typically larger than one, e.g. both  $\partial^\nu \partial_\mu \mathcal{O}_\Delta^\mu$  and  $\square \mathcal{O}_\Delta^\mu$  are level two descendants of  $\mathcal{O}_\Delta^\mu$  in the vector representation. This means that there may (and in fact does) exist a special linear combination of such

descendants that becomes primary when  $\Delta$  takes a special value. The second complication is the much richer structure of  $SO(d)$  spin representations. In  $d > 2$  we write derivatives with tensor indices and we should define the resulting tensor such that it transforms in an irreducible representation of  $SO(d)$ . This can be conveniently done using the projectors into irreducible  $SO(d)$  representations defined in section 6.1. Naively, we would now have to build the most general descendant operator in  $CFT_d$  and require it to be a primary.

Fortunately, our task is much less daunting since the quantum numbers  $\Delta, \ell, \Delta', \ell'$  for when a descendant  $\mathcal{O}'_{\Delta', \ell'}$  of a primary  $\mathcal{O}_{\Delta, \ell}$  becomes a primary itself are already classified by representation theory. This imposes a remarkably strong constraint on  $\mathcal{O}'$  which often – in fact every time  $\mathcal{O}'$  appears with degeneracy equal to one – can be used to fix the primary descendant's exact form even before checking that it is a primary. How to find the set of quantum numbers from representation theory is explained in 46 where many  $\mathcal{O}'$  are explicitly constructed. Here we will review and extend the construction of the different types of descendant operators and when they become primaries. In even  $d$  the independent types of descendant operators are I, II, III (as in  $CCFT_2$ ) while in odd  $d$  they are I, II, S, P<sup>22</sup>. Our main focus will then be on those types that arise from protected  $CCFT_d$  operators associated to soft theorems.

The most important primary descendants, associated to universal soft theorems, correspond to type I and II. In contrast to  $CCFT_2$ , we need a more refined definition of type I and II operators for  $CCFT_{d>2}$ . A level  $n$  descendant of type I has spin  $n$  units larger than its parent primary, while a type II descendant at level  $n$  has spin  $n$  units smaller than its parent primary. As discussed in section 4.2 in general dimensions  $d$  the representations of  $SO(d)$  of the spin of the operator can be more complicated than the traceless and symmetric one and a primary operator  $\mathcal{O}_{\Delta, \ell}$  is labeled by a set of  $[d/2]$  numbers  $\ell = (\ell_1, \dots, \ell_{[d/2]})$  where  $\ell_i \geq \ell_{i+1}$  in addition to its conformal dimension  $\Delta$ . The types I and II are thus refined by a label  $k$  corresponding to the  $\ell_k$  that is increased or decreased. In the following we construct these type  $I_k$  and  $II_k$  descendant operators and review the conditions for them to become primaries. They will arise in sections 6.4 and 6.5 when we discuss the universal soft theorems and their shadow transforms.

In this context there is another relevant primary descendant which we refer to as type S. Interestingly, we will show in section 6.5 that (an analytic continuation of) the type S operator can be used to compute shadow transforms of primaries which themselves have respectively type I and type II primary descendants.

In odd  $d$  there exists another type of descendant operator which we refer to as type P. For our purpose, the only relevant type P operators will arise for  $d = 3$ , but we will discuss it for completeness. A discussion on the role of charges for type I operators responsible for more subleading soft theorems that receive non-universal contributions is presented in appendix B.2. We leave the discussion of type III operators for future work.

We schematically illustrate in figure 9 the structure of a conformal multiplet in  $CFT_d$ . The conformal dimension grows downwards but the rest of the diagram is schematic since an accurate representation would require a  $[d/2] + 1$  dimensional picture labelled by the variables  $\Delta, \ell_1, \dots, \ell_{[d/2]}$ . Not all cases are presented: The type III descendants in even  $d$  are not depicted, and neither is the type S operator in odd  $d$  which would be represented by a separate diagram with just a single arrow – since it is the only one that relates operators with half integer conformal dimensions it cannot have nested primary descendants.

For the classification we will make use of operators contracted with polarization vectors  $\mathcal{O}_{\Delta, \ell}(x, e)$  where we use the

<sup>22</sup>We use a slightly different nomenclature with respect to 46: while the definition of types I, II here match the ones of 46 and 45, in odd  $d$  what is called type III in 46 is referred to as type S here (for shadow), type IV in 46 is called type P here (for parity) and in even  $d$  type V in 46 is referred to as type III here (in accordance with the nomenclature of 45 in  $d = 2$ ).

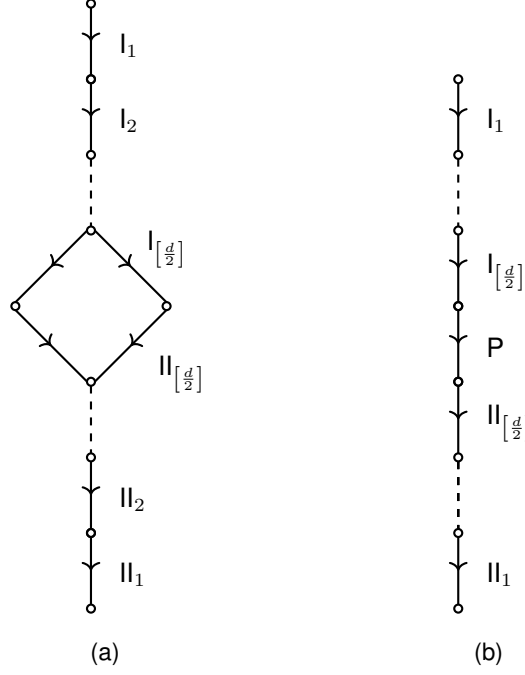

Figure 9: Celestial necklaces in even dimensions (a) and odd dimensions (b).

notation  $e \equiv \{e_1, \dots, e_{[d/2]}\}$  as in section 6.1.2. It is important to stress that these polarization vectors are just a book-keeping device to simplify equations and computations with tensor indices, making all expressions scalar. The logic is that the vectors  $e_i$  are contracted with the indices in the  $i$ -th row of the Young tableau. The operator  $\mathbb{O}_{\Delta, \ell}(x, e)$  is thus a homogeneous function of degree  $\ell_i$  in the variable  $e_i$ . In order to increase the spin  $\ell_i$  by one unit we need to introduce one extra vector  $e_i$ . Conversely, to reduce the spin  $\ell_i$  of the operator by one unit, we need to take one derivative in  $e_i$ . Finally, in order to opportunely symmetrize the indices we will make use of the projectors of section 6.1.2.

### 6.2.1 Type I Operators

Type I operators have larger spin compared to the parent primary they descend from. In particular given a primary  $\mathbb{O}_{\Delta, \ell}$  with dimension  $\Delta$  and spin  $\ell = (\ell_1, \dots, \ell_{[d/2]})$ , its type  $I_k$  descendant of level  $n$  is defined by the unique operator with spin  $\ell'$  such that  $\ell'_i = \ell_i + n\delta_{ik}$ , namely with the  $k$ -th spin label increased by  $n$  units. Let us consider the primary  $\mathbb{O}_{\Delta, \ell}(x, f)$  contracted with constrained polarization vectors  $f$ . In order to obtain its  $I_k, n$  descendant we need to introduce  $n$  new vectors  $f_k^a$  and  $n$  new derivatives  $\partial_x^a$ . Since  $f_k^2 = 0$ , there is a single way to do so, namely<sup>23</sup>

$$O_{I_k, n}(x, e) \equiv \left( \prod_{i=1}^{[d/2]} \frac{1}{\ell_i!} \right) \pi_{\ell'}(e; \partial_f) [ (f_k \cdot \partial_x)^n \mathbb{O}_{\Delta, \ell}(x, f) ]. \quad (6.13)$$

Here we use the notation introduced in section 6.1.2 namely  $e \equiv \{e_1, \dots, e_{[d/2]}\}$ ,  $f \equiv \{f_1, \dots, f_{[d/2]}\}$  and  $\partial_f \equiv \{\partial_{f_1}, \dots, \partial_{f_{[d/2]}}\}$ . The meaning of this formula is simple: the term  $(f_k \cdot \partial_x)^n$  increases the label  $\ell_k$  by  $n$  units while the projector is only used

<sup>23</sup>This formula generalizes the one of [46] to any  $k$ . Some examples of  $k = 2$  primary descendants were already defined in appendix B of [101].

to properly symmetrize the indices according to the prescription in (6.11) (here we used constrained vectors  $e$ , but the result would have been the same with unconstrained  $\hat{e}$ ). Notice that all the variables  $f_i$  (the ones contracted with the operator and the  $n$  extra vectors  $f_k$ ) are being removed by derivatives coming from the projector and the final expression is independent of  $f_i$ . By construction  $1 \leq n \leq \ell_{k-1} - \ell_k$  (the label  $\ell_0$  here is defined to be infinite), otherwise the descendant would be labelled by a Young tableau with row  $\ell_{k-1}$  shorter than  $\ell_k$ , which is not allowed. Type  $I_k$  descendants become primaries when

$$\Delta = \Delta_{I_k, n}^* \equiv k - \ell_k - n. \quad (6.14)$$

In the following we discuss examples of type  $I_k$  operators where the parent primary  $\mathbb{O}_{\Delta, \ell}$  is taken to be traceless and symmetric that will be relevant in section 6.4

**Example: Type  $I_1$  Operators** The simplest case corresponds to  $k = 1$ . The type  $I_1$  descendant operators at level  $n$  take the form

$$O_{I_{k=1}, n}(x, e) = (e \cdot \partial_x)^n \mathbb{O}_{\Delta, \ell}(x, e), \quad (6.15)$$

where  $e$  here is a single polarization vector. Equivalently, in index notation

$$O_{I_{k=1}, n}^{a_1 \dots a_{\ell+n}}(x) = \partial_x^{a_1} \partial_x^{a_2} \dots \partial_x^{a_n} \mathbb{O}_{\Delta, \ell}^{a_{n+1} \dots a_{\ell+n}}(x), \quad (6.16)$$

where the brackets implement symmetrization and subtraction of the traces. Using (6.14) we find that these operators are primaries when  $\Delta = 1 - \ell_1 - n$ . For a scalar operator  $\mathbb{O}_{\Delta}$  (labeled by  $\ell = (0, \dots, 0)$ ), its type  $I_1$  descendant at level  $n = 1$  takes the simple form  $O_{I_1, 1}^a = \partial^a \mathbb{O}_{\Delta}$ . It becomes primary when the parent operator  $\mathbb{O}_{\Delta}$  has dimension  $\Delta = 0$ , which is the dimension of the identity operator. Indeed  $\partial^a \mathbb{O} = 0$  when  $\mathbb{O}$  is the identity.

**Example: Type  $I_2$  Operators** Let us now proceed to  $k = 2$ . The simplest example of type  $I_2$  descendants arises when the parent primary is a vector operator  $\mathbb{O}_{\Delta}^a$  (i.e.  $\ell_1 = 1$  and  $\ell_i = 0$  for  $2 \leq i \leq [d/2]$ ). Since  $1 \leq n \leq \ell_1 - \ell_2 = 1$ , this operator has a single type  $I_{k=2}$  primary descendant at level  $n = 1$  which transforms in the  $(1, 1)$  representation, i.e. it is an antisymmetric tensor with two indices. This descendant in index notation takes the simple form  $O_{I_2, 1}^{ab} = \partial^{[a} \mathbb{O}_{\Delta}^{b]}$  and becomes primary when  $\Delta = 1$ . Another simple example which will play a role in the following is the type  $I_{k=2}$  primary descendant of a spin two tensor operator  $\mathbb{O}_{\Delta}^{a_1 a_2}$  (with  $\ell_1 = 2$  and  $\ell_i = 0$  for  $2 \leq i \leq [d/2]$ ). This has two possible type  $I_{k=2}$  descendants at level  $n = 1, 2$  which respectively increase by one or two units the label  $\ell_2$ . Restoring the indices (using the projectors (6.9) which are explicitly defined in appendix B.1) these descendants can be written as

$$O_{I_2, n=1}^{a_1 a_2, a_1} (x) = \pi_{(2,1)}(\mathbf{a}, \mathbf{b}) \partial^{b_1} \mathbb{O}_{\Delta}^{b_1 b_2} (x), \quad O_{I_2, n=2}^{a_1 a_2, a_1 a_2} (x) = \pi_{(2,2)}(\mathbf{a}, \mathbf{b}) \partial^{b_1} \partial^{b_2} \mathbb{O}_{\Delta}^{b_1 b_2} (x), \quad (6.17)$$

and become primaries respectively when  $\Delta = 1$  and  $\Delta = 0$ .

In general the level  $n$  type  $I_2$  descendants of symmetric and traceless operators (i.e. with  $\ell_2 = 0$ ) become primary when

$$\Delta = 2 - n, \quad n = 1, \dots, \ell_1. \quad (6.18)$$

Operators of type  $I_k$  for  $k = 1$  or  $k = 2$  can appear as descendants of traceless and symmetric primaries. Conversely the cases of  $k > 2$  can only appear if the parent primary is not traceless and symmetric (due to the condition  $1 \leq n \leq \ell_{k-1} - \ell_k$ ). We do not consider the latter since usual Lagrangian fields (such as photons and gravitons) transform in traceless and symmetric representations and thus define primaries  $\mathbb{O}_{\Delta, \ell}$  in symmetric and traceless representations.



## 6.2.2 Type II Operators

Type II operators have smaller spin compared to the parent primary they descend from. The level  $n$  descendant of type  $\text{II}_k$  of a primary  $\mathcal{O}_{\Delta,\ell}$  with dimension  $\Delta$  and spin  $\ell = (\ell_1, \dots, \ell_{[d/2]})$ , is defined by the unique operator with spin label  $\ell_k$  decreased by  $n$  units with respect to the parent primary, and it only exist for  $1 \leq n \leq \ell_k - \ell_{k+1}$  (to avoid  $\ell_{k+1}$  larger than  $\ell_k$ ). In order to build this operator in index-free notation we need to introduce  $n$  derivatives  $\partial_x^a$  and contract them with  $n$  derivatives of the  $k$ -th polarization vector<sup>24</sup>

$$O_{\text{II}_k,n}(x, \hat{e}) \equiv \frac{(\ell_k - n)!}{\ell_k!} (\partial_{\hat{e}_k} \cdot \partial_x)^n \mathcal{O}_{\Delta,\ell}(x, \hat{e}), \quad (6.19)$$

where we again make use of the notation  $\hat{e} \equiv \{\hat{e}_1, \dots, \hat{e}_{[d/2]}\}$  introduced in section 6.1.2. Here for clarity of the formula, we consider  $\mathcal{O}_{\Delta,\ell}$  to be contracted with unconstrained vectors  $\hat{e}_i$ , so that simple derivatives in  $\hat{e}_i$  open its indices<sup>25</sup>. Type  $\text{II}_k$  descendants become primaries when

$$\Delta = \Delta_{\text{II}_k,n}^* \equiv d + \ell_k - k - n. \quad (6.20)$$

In the following we discuss examples of type  $\text{II}_k$  operators where the parent primary  $\mathcal{O}_{\Delta,\ell}$  is taken to be traceless and symmetric that will be relevant in section 6.5

**Example: Type  $\text{II}_1$  Operators** In the simplest case of  $k = 1$ , descendant operators of type  $\text{II}_1$  take the form<sup>26</sup>

$$O_{\text{II}_{k=1},n}(x, e) = \frac{(D_e \cdot \partial_x)^n}{(2 - \frac{d}{2} - \ell)_n (-\ell)_n} \mathcal{O}_{\Delta,\ell}(x, e), \quad (6.21)$$

where  $e$  is a single (constrained) vector and the role of  $D_e^a$ , defined in (6.1), is to recover the tensor indices that are contracted with those constrained vectors. In index notation we can express them as

$$O_{\text{II}_{k=1},n}^{a_1 \dots a_{\ell-n}}(x) = \partial_{a_{\ell-n+1}} \dots \partial_{a_\ell} \mathcal{O}_{\Delta,\ell}^{a_1 \dots a_{\ell-n} a_{\ell-n+1} \dots a_\ell}(x). \quad (6.22)$$

For a vector (tensor) operator  $\mathcal{O}_{\Delta,\ell}^{a_1 \dots a_{\ell-n}}$  labeled by  $\ell = (\ell_1, 0, \dots, 0)$  with  $\ell_1 = 1$  ( $\ell_1 = 2$ ), its type  $\text{II}_1$  descendant at level  $n = 1$  takes the simple form  $O_{\text{II}_1,1} = \partial_a \mathcal{O}_{\Delta,\ell=1}^a$  ( $O_{\text{II}_1,1}^a = \partial_a \mathcal{O}_{\Delta,\ell=2}^{ab}$ ). It becomes a primary for  $\Delta = d - 1$  ( $\Delta = d$ ) corresponding to the dimension of a conserved current (stress tensor). The primary descendant implements the conservation of such operators.

When  $\mathcal{O}_{\Delta,\ell}$  is traceless and symmetric no possible  $\text{II}_{k \geq 2}$  primary descendant can be constructed since  $1 \leq n \leq \ell_{k+1} - \ell_k = 0$  for any  $k \geq 2$ . Therefore in this work we will not consider type  $\text{II}_{k \geq 2}$  primary descendants and formula (6.21) (or equivalently (6.22)) will be sufficient.

<sup>24</sup>In even dimensions, the type  $\text{I}_{k=d/2}$  would have two distinct realizations like the types Ia and Ib in  $\text{CFT}_2$ . The formula (6.19) gives the analogue of operator Ia in (5.1). In this part the type  $\text{I}_{k=d/2}$  operators are not needed, so we do not present the formula for the analogue of the type Ib operators.

<sup>25</sup>If we start with an operator contracted with constrained vectors  $f_i$ , we can recover the unconstrained ones  $\hat{e}_i$  by using a projector as follows  $\mathcal{O}_{\Delta,\ell}(x, \hat{e}) \equiv \left( \prod_{i=1}^{[d/2]} \frac{1}{\ell_i} \right) \pi_\ell(\hat{e}; \partial_f) \mathcal{O}_{\Delta,\ell}(x, f)$ . After taking the derivatives in  $\hat{e}_i$  in (6.19) we can get back to constrained vectors  $\hat{e}_i \rightarrow e_i$  with  $e_i \cdot e_j = 0$ .

<sup>26</sup>This expression is equivalent to (6.19) for  $k = 1$  upon using (6.1). The form (6.21) is often more convenient in explicit computations since working with constrained vectors  $e$  allows one to drop all terms proportional to  $e^2$ .

### 6.2.3 Type S Operators

Type S primary descendants have the same spin as their parent primaries and become primaries themselves when

$$\Delta = \Delta_{S,n}^* \equiv \frac{d}{2} - n, \quad n = 1, 2, \dots \quad (6.23)$$

For this part it will suffice to consider traceless symmetric parent primary operators  $\mathbb{O}_{\Delta,\ell}$  whose level  $n$  descendants of type S are given by

$$O_{S,n}(x, e) \equiv D_{S,n} \mathcal{V}_1 \cdots \mathcal{V}_{n-1} \mathbb{O}_{\Delta,\ell} \quad (6.24)$$

where

$$D_{S,n} \equiv \mathcal{V}_0 \cdot \mathcal{V}_1 \cdots \mathcal{V}_{n-1}, \quad \mathcal{V}_j \equiv \partial_x^2 - 2 \frac{(\partial_x \cdot e)(\partial_x \cdot D_e)}{(\frac{d}{2} + \ell + j - 1)(\frac{d}{2} + \ell - j - 2)}. \quad (6.25)$$

It is easy to see that the quantum numbers of the primary descendant ( $\Delta = \frac{d}{2} + n, \ell$ ) are shadow-related (namely  $\Delta \rightarrow d - \Delta$ ) to the ones of its parent primary ( $\Delta = \frac{d}{2} - n, \ell$ ). Indeed primary descendant operators of type S have an interesting relation with the shadow transform in CFT (hence the name S) which we discuss in section [6.4](#)

### 6.2.4 Type P Operators

The type P primary descendant exists only in odd  $d$ . It appears when the parent primary has dimension

$$\Delta = \Delta_{\mathcal{P},n}^* \equiv \frac{d+1}{2} - n, \quad n = 1, \dots, \ell_{[\frac{d}{2}]}. \quad (6.26)$$

The type P primary descendant appears at level  $2n - 1$  (thus it has dimension  $\Delta' = \frac{d-1}{2} + n$ , which is the shadow dimension of the parent operator), has the same spin as its parent and has the opposite parity (thus the name P). Indeed it is built using the  $\epsilon$  tensor, for this reason this operator has a strong dependence on  $d$  (e.g. we do not know how to analytically continue it in  $d$ ) and it is so far known only in  $d = 3$ .

For traceless and symmetric parent primaries  $\mathbb{O}_{\Delta,\ell}$  we have  $\ell_{[\frac{d}{2}]} = 0$  in all  $d > 3$ , and thus their primary descendants will not play a role in our discussion. However when  $d = 3$  we have  $\ell_{[\frac{d}{2}]} = \ell_1$  possible primary descendants of this type. The type P operator in this case, defined in formula (128) of [\[46\]](#), takes the form

$$O_{\mathcal{P},n}(x, e) \equiv \varepsilon(e, \partial_x, D_e) \mathcal{W}_0 \cdot \mathcal{W}_1 \cdots \mathcal{W}_{n-2} \mathbb{O}_{\Delta,\ell}(x, e), \quad (6.27)$$

where the label  $n$  takes the values  $n = 1 \dots \ell$  and we introduced  $\varepsilon(e, \partial_x, D_e) \equiv \varepsilon_{abc} e^a \partial_x^b D_e^c$  and

$$\mathcal{W}_j = \partial_x^2 - 2 \frac{(\partial_x \cdot e)(\partial_x \cdot D_e)}{(\ell + j + 1)(\ell - j - 1)}. \quad (6.28)$$

In  $\text{CFT}_3$  these operators appear when  $\Delta = 2 - n$ , which is the exact same condition as for type  $I_2$ ! This is not a coincidence<sup>[27](#)</sup> indeed type  $I_{k=2}$  operators do not exist in  $d = 3$  since they are only defined when  $k > [d/2]$  and type P operators take their place. This is easily explained, as in  $d = 3$  an operator with  $\ell_2 = 1$  can be dualized using the epsilon tensor and rewritten in term of a parity-odd operator with  $\ell_2 = 0$ . This means that in  $\text{CFT}_3$  the type  $I_2$  descendants will be replaced by type P.

The easiest instance of such an operator appears for a parent primary of spin  $\ell = 1$ . In this case the  $n = 1$  type P operator is given by

$$O_{\mathcal{P},n=1}^a = \varepsilon^a{}_{b_1 b_2} \partial_x^{b_1} \mathbb{O}_{\Delta}^{b_2}, \quad (6.29)$$

<sup>27</sup>See also the discussion in appendix E.6.4 of [\[102\]](#).

and becomes a primary when  $\Delta = 1$ . It is clear that this operator has the exact same properties as the type  $I_{k=2}$  operator, where the antisymmetrization of the indices  $b_i$  here is performed by the contraction with the epsilon tensor. Similarly for spin  $\ell = 2$  the  $n = 1$  type P operator takes the form

$$O_{\mathcal{P},n=1}^{a_1 a_2} = \varepsilon^{\{a_1 |}_{b_1 b_2} \partial_x^{b_1} \mathbb{O}_{\Delta}^{b_2 | a_2 \}}, \quad (6.30)$$

where the indices  $a_i$  are made symmetric and traceless. This descendant also becomes a primary when  $\Delta = 1$ . Finally we have the  $n = 2$  example

$$O_{\mathcal{P},n=2}^{a_1 a_2} = \varepsilon^{\{a_1 |}_{b_1 b_2} \partial_x^{b_1} (\partial_x^2 \delta_{b_3}^{a_2 \} - \partial_x b_3 \partial_x^{a_2 \}) \mathbb{O}_{\Delta}^{b_2 b_3 \}}, \quad (6.31)$$

which becomes primary at  $\Delta = 0$ .

## 6.3 Conserved Charges

In section [4.1](#) we saw that for a given Noether current  $\mathcal{F}_a$  with  $\partial^a \mathcal{F}_a = 0$  built from conserved operators we can define a topological charge  $Q_{\Sigma}$  by integrating  $\mathcal{F}_a$ . Unlike in  $\text{CFT}_2$  where all conservation equations for the operators take the same form, in  $\text{CFT}_{d>2}$  there are distinct types that gives rise to different expressions for the Noether currents and charges. In the following we discuss the different types of charges relevant for higher-dimensional soft theorems and  $\text{CCFT}_d$ .

### 6.3.1 Charges for Type II

Let us consider an operator  $\mathbb{O}_{\Delta,\ell}$  with a type  $\text{II}_k$  primary descendant at level  $n$  (thus we are implicitly setting  $\Delta = \Delta_{\text{II}_k,n}^*$ ) with spin  $\ell'$  such that  $\ell'_i = \ell_i - \delta_{ik} n$ . From  $\mathbb{O}_{\Delta,\ell}$  it is possible to construct a current operator,

$$\mathcal{F}^{\epsilon a}(x) = \frac{\pi_{\ell'}(\partial_e; \partial_{\hat{f}})}{\prod_{r=1}^{\lfloor d/2 \rfloor} (\ell_r!)^2} \partial_{\hat{f}_k}^a \sum_{j=0}^{n-1} (-1)^j (\partial_{\hat{f}_k} \cdot \partial_x)^{n-1-j} \epsilon(x, e) (\partial_{\hat{f}_k} \cdot \partial_x)^j \mathbb{O}_{\Delta,\ell}(x, \hat{f}), \quad (6.32)$$

where  $e$  and  $\hat{f}$  are sets of  $\lfloor d/2 \rfloor$  vectors,  $\partial_x$  acts on the expression immediately to the right while  $\partial_{\hat{f}}$  is understood to act on everything to the right. Here  $\epsilon$  is a function of  $x$  with tensor indices transforming in the representation  $\ell'$  with indices contracted with the vectors  $e$ .

This form of  $\mathcal{F}_a^{\epsilon}(x)$  may look complicated at first but it is rigidly fixed to have the most generic vector operator which can be conserved. Indeed the divergence of the current takes the following simple form

$$\partial^a \mathcal{F}_a^{\epsilon} = \frac{\pi_{\ell'}(\partial_e; \partial_{\hat{f}})}{\prod_{r=1}^{\lfloor d/2 \rfloor} (\ell_r!)^2} [(\partial_{\hat{f}_k} \cdot \partial_x)^n \epsilon(x, e) \mathbb{O}_{\Delta,\ell}(x, \hat{f}) + \epsilon(x, e) (-\partial_{\hat{f}_k} \cdot \partial_x)^n \mathbb{O}_{\Delta,\ell}(x, \hat{f})]. \quad (6.33)$$

This result is due to the cancellation of most terms in the sum on [6.32](#) because of the sign  $(-1)^j$ : in fact only the terms with  $j = 0$  and  $j = n - 1$  survive. Moreover, the second term in the square bracket in [6.33](#) vanishes because of the type  $\text{II}_k$  primary descendant condition. Therefore conservation  $\partial^a \mathcal{F}_a^{\epsilon}(x) = 0$  implies a condition on the parameter  $\epsilon$ , which, after some massaging [28](#) takes the form

$$\pi_{\ell}(e; \partial_{\hat{f}}) [(\hat{f}_k \cdot \partial_x)^n \epsilon(x, \hat{f})] = 0. \quad (6.34)$$

<sup>28</sup> We apply the following transformations. First we exchange  $\hat{f} \leftrightarrow \partial_{\hat{f}}$  in the following sense: e.g. for vectors  $A^a$  and  $B^a$  their scalar product can be written as  $A^a B_a = (A_a \partial_{\hat{f}}^a)(B_b \hat{f}^b) = (B_a \partial_{\hat{f}}^a)(A_b \hat{f}^b)$ . We apply the projector  $\pi_{\ell'}$  to  $\epsilon$  using [6.11](#). Finally we write the operator  $\mathbb{O}$  contracted with a new projector into the representation  $\pi_{\ell}$ .

This condition is the same as that of a descendant of type  $I_k$  at level  $n$ . The subscript of the projector does not match with [6.13](#) because here  $\ell'$  is the original spin of the tensor  $\epsilon$  while  $\ell$  is the spin of the new tensor obtained after acting with the derivatives (while in [6.13](#) it is the opposite). Thus to build a current with a type  $II_k$  operator we need a parameter  $\epsilon$  that satisfies a type  $I_k$  shortening condition. In summary, we found that a current of the form [6.32](#) is conserved if and only if the parameter satisfies [6.34](#). Using this current one can write conserved charges in the standard way as in [4.3](#).

**Example: Type  $II_1$  Noether Current** Of prime interest in celestial  $CFT_d$  are operators of type  $II_1$  and their associated charges which we will focus on in the following. In this case we spell out the form of the current in index notation. We consider a symmetric traceless spin  $\ell$  operator  $\mathbb{O}$  satisfying  $\partial_{a_1} \dots \partial_{a_n} \mathbb{O}^{a_1 \dots a_\ell} = 0$  with  $n \leq \ell$ . We construct a Noether current by combining it with a spin  $\ell - n$  symmetric traceless tensor parameter  $\epsilon_{a_1, \dots, a_{\ell-n}}(x)$ . The Noether current [6.32](#) reduces to the form [103](#)

$$\begin{aligned} \mathcal{J}^{\epsilon a} &= \mathbb{O}^{a a_1 \dots a_{\ell-1}} \partial_{a_1} \dots \partial_{a_{n-1}} \epsilon_{a_n \dots a_{\ell-1}} \\ &\quad - \partial_{a_1} \mathbb{O}^{a a_1 \dots a_{\ell-1}} \partial_{a_2} \dots \partial_{a_{n-1}} \epsilon_{a_n \dots a_{\ell-1}} \\ &\quad + \partial_{a_1} \partial_{a_2} \mathbb{O}^{a a_1 \dots a_{\ell-1}} \partial_{a_3} \dots \partial_{a_{n-1}} \epsilon_{a_n \dots a_{\ell-1}} \\ &\quad \vdots \\ &\quad + (-1)^{n-1} \partial_{a_1} \dots \partial_{a_{n-1}} \mathbb{O}^{a a_1 \dots a_{\ell-1}} \epsilon_{a_n \dots a_{\ell-1}}. \end{aligned} \tag{6.35}$$

Conservation of [6.35](#), i.e.  $\partial^a \mathcal{J}_a^\epsilon = 0$ , requires that  $\epsilon$  is a generalized conformal Killing tensor satisfying

$$\partial_{\{a_1} \dots \partial_{a_n} \epsilon_{a_{n+1} \dots a_\ell\}} = 0, \tag{6.36}$$

which is a level  $n$  type  $I_1$  primary descendant condition. The general solution to this equation is given by [103](#)

$$\epsilon_{a_1 \dots a_{\ell-n}} = q^{\mu_1} \dots q^{\mu_{\ell-1}} \partial_{a_1} q^{\nu_1} \dots \partial_{a_{\ell-n}} q^{\nu_{\ell-n}} c_{\mu_1 \dots \mu_{\ell-1}; \nu_1 \dots \nu_{\ell-n}}, \tag{6.37}$$

where  $q$  is defined in the Poincaré section [4.27](#) and the constant tensor  $c_{\mu_1 \dots \mu_{\ell-1}; \nu_1 \dots \nu_{\ell-n}}$  transforms in the irrep  $(\ell-1, \ell-n)$ . To see that [6.37](#) is a solution of [6.36](#), first notice that  $\partial_a \partial_b q^\mu = \delta_{ab}(1, \vec{0}, -1)$ , thus the result is proportional to  $\delta_{ab}$  which is removed when we consider traceless combinations of the indices  $a, b$ . This means that every time a derivative  $\partial_{a_i}$  (with  $i = 1, \dots, n$ ) in [6.36](#) acts on a  $\partial_{a_i} q^{\nu_i}$  (with  $i = 1, \dots, \ell - n$ ) in [6.37](#) the result is zero. All derivatives in [6.36](#) must then act on the  $q$ 's without derivatives in [6.37](#). The result is a product of  $\ell$  equal terms  $\partial_{b_i} q^{\sigma_i}$  symmetrized in the indices  $b_i$ , which is contracted with a tensor in the representation  $(\ell - 1, \ell - n)$ . This makes the result vanishing because of the mixed symmetrization (indeed a tensor in the  $(\ell - 1, \ell - n)$  irrep can be at most contracted with  $\ell - 1$  symmetrized vectors). The charge obtained by integrating [6.35](#) is given by

$$Q_\Sigma^\epsilon = \int_\Sigma dS_a \sum_{i=0}^{n-1} (-1)^i \partial_{a_1} \dots \partial_{a_i} \mathbb{O}^{a a_1 \dots a_{\ell-1}}(x) \partial_{a_{i+1}} \dots \partial_{a_{n-1}} \epsilon_{a_n \dots a_{\ell-1}}(x), \tag{6.38}$$

with  $\epsilon(x)$  given by [6.37](#). Often it will be more convenient to use Gauss' divergence theorem and compute the charge from the volume integral of the divergence of the current. Indeed using [6.36](#) the divergence can be simply written as  $\partial^a \mathcal{J}_a^\epsilon = (-1)^{n-1} \epsilon_{a_n \dots a_{\ell-1}} \partial_{a_1} \dots \partial_{a_n} \mathbb{O}^{a_1 \dots a_n \dots a_\ell}$  and thus the charge takes the simpler form<sup>29</sup>

$$Q_\Sigma^\epsilon = (-1)^{n-1} \int_R d^d x \epsilon_{a_{n+1} \dots a_\ell}(x) \partial_{a_1} \dots \partial_{a_n} \mathbb{O}^{a_1 \dots a_n \dots a_\ell}(x), \tag{6.39}$$

where  $\partial R = \Sigma$ . We will see examples of type  $II_1$  charges in section [6.5](#)

<sup>29</sup>Often we will redefine the charge by multiplying it by an overall coefficient to make its action look nicer which is equivalent to rescaling the constant coefficients in [6.37](#).

### 6.3.2 Charges for Type I

Here we explain a construction for charges associated to type I operators.

Let us consider a primary  $\mathbb{O}_{\Delta,\ell}$  with a primary descendant of type  $I_k$  at level  $n$ . As explained earlier the primary descendant has spin labelled by  $\ell'_i = \ell_i + n\delta_{ik}$ . It is formally possible to build an operator  $\mathcal{F}_a^\epsilon$  such that  $\partial^a \mathcal{F}_a^\epsilon = 0$  out of  $\mathbb{O}_{\Delta,\ell}$ . The construction goes as follows. First we define an operator  $\mathcal{F}_a^\epsilon$  by an opportune contraction of derivatives with the primary  $\mathbb{O}_{\Delta,\ell}$  and with a parameter function  $\epsilon$ ,

$$\mathcal{F}^{\epsilon a} = \frac{\pi_{\ell'}(\partial_e; \partial_f)}{\prod_{i=1}^{\lfloor d/2 \rfloor} (\ell'_i!)^2} \hat{f}_k^a \sum_{j=0}^{n-1} (-1)^j (\hat{f}_k \cdot \partial_x)^{n-1-j} \epsilon(x, e) (\hat{f}_k \cdot \partial_x)^j \mathbb{O}_{\Delta,\ell}(x, f). \quad (6.40)$$

Here  $\epsilon$  is a function of  $x$  transforming in the representation  $\ell'$  of  $SO(d)$  (like the primary descendant of  $\mathbb{O}_{\Delta,\ell}$ ) and it is contracted with polarization vectors  $e = \{e_1, \dots, e_{\lfloor d/2 \rfloor}\}$ . The divergence of  $\mathcal{F}_a^\epsilon$  takes the form

$$\partial^a \mathcal{F}_a^\epsilon = \frac{\pi_{\ell'}(\partial_e; \partial_f)}{\prod_{i=1}^{\lfloor d/2 \rfloor} (\ell'_i!)^2} [(\hat{f}_k \cdot \partial_x)^n \epsilon(x, e) \mathbb{O}_{\Delta,\ell}(x, f) + \epsilon(x, e) (-\hat{f}_k \cdot \partial_x)^n \mathbb{O}_{\Delta,\ell}(x, f)]. \quad (6.41)$$

The second term in the square bracket vanishes because of the primary descendant condition [\(6.13\)](#). We thus find that  $\mathcal{F}_a^\epsilon$  is divergenceless when [\(6.42\)](#)

$$(\partial_{\hat{f}_k} \cdot \partial_x)^n \epsilon(x, \hat{f}) = 0. \quad (6.42)$$

This condition on  $\epsilon$  is the same as that of a descendant of type  $II_k$  in [\(6.19\)](#). So in practice to construct a current from an operator with a primary descendant of type  $I_k$  we find that the associated parameter should satisfy a shortening condition of type  $II_k$ .

Let us give a couple of examples for this construction in some simple  $k = 1, 2$  cases.

**Example: Type  $I_1$  Noether Current** First we consider a vector operator  $\mathbb{O}_{\Delta,\ell=1}$ , with a primary descendant of the type  $I_{k=1}$  at  $n = 1$  defined by  $\partial^{\{a\}\mathbb{O}^b\} = 0$ . We can use this to build a Noether current

$$\mathcal{F}^{\epsilon a}(x) = \epsilon^{\{ab\}}(x) \mathbb{O}_b(x). \quad (6.43)$$

Conservation of  $\mathcal{F}$  can be written as

$$0 = \partial^a \mathcal{F}_a^\epsilon(x) = [\partial_a \epsilon^{\{ab\}}(x) \mathbb{O}_b(x) + \epsilon^{\{ab\}}(x) \partial_a \mathbb{O}_b(x)], \quad (6.44)$$

but the second term in the square bracket vanishes because of  $\partial^{\{a\}\mathbb{O}^b\} = 0$ . Therefore  $\partial^a \mathcal{F}_a^\epsilon(x) = 0$  implies that the parameter satisfies  $\partial_a \epsilon^{\{ab\}}(x) = 0$ .

**Example: Type  $I_2$  Noether Current** Let us now turn to a vector operator  $\mathbb{O}_{\Delta,\ell=1}$  with a type  $I_{k=2}$  primary descendant at level  $n = 1$ , defined by  $\partial^{\{a\}\mathbb{O}^b\}$ . The associated Noether current can be written as

$$\mathcal{F}^{\epsilon a} = \epsilon^{\{ab\}}(x) \mathbb{O}_b(x). \quad (6.45)$$

Using  $\partial^{\{a\}\mathbb{O}^b\} = 0$ , we find that  $\mathcal{F}^\epsilon$  is conserved if  $\partial_a \epsilon^{\{ab\}} = 0$ .

<sup>30</sup>This equation is obtained from a few manipulations of the first term of [\(6.41\)](#): 1) replacing  $\hat{f} \rightarrow \hat{f}$ , 2) exchanging  $\hat{f} \leftrightarrow \partial_{\hat{f}}$  as explained in footnote [\(28\)](#) 3) applying the projector to  $\epsilon$  using [\(6.11\)](#).

While the construction of type I charges works in principle, in practice these charges take a trivial form and so they do not represent actual symmetries of the theory. This is due to the fact that the Ward identities for type I operators do not contain contact terms as we explain in appendix [B.2](#)

## 6.4 CCFT<sub>d>2</sub> Ward Identities

Conformally soft theorems in CCFT<sub>d>2</sub> and their associated celestial Ward identities were discussed in [48](#) [49](#) [31](#). Here we make use of our primary descendant classification to explain systematically the origin of conserved operators.

### 6.4.1 Leading Soft Photon Theorem

In the Poincaré section, using equation [\(4.29\)](#), we can easily express the soft photon factor as

$$S_p^{(0)}(\omega, x, e) = -2e \sum_{i=1}^N \mathbb{Q}_i \frac{1}{\omega} \frac{(x_i - x) \cdot e}{(x_i - x)^2}. \quad (6.46)$$

The soft theorem [\(4.21\)](#) with the soft factor [\(4.22\)](#) can be mapped to the conformal basis where the power  $1/\omega$  selects the operator  $R_1^a(x)$  defined in [\(4.30\)](#). We thus obtain the following conformally soft theorem

$$\langle R_1(x, e) \mathbb{O}_{\Delta_1, \ell_1}(x_1, e_1) \dots \mathbb{O}_{\Delta_N, \ell_N}(x_N, e_N) \rangle = \sum_{i=1}^N \hat{S}_i^{(0)}(x, e) \langle \mathbb{O}_{\Delta_1, \ell_1}(x_1, e_1) \dots \mathbb{O}_{\Delta_N, \ell_N}(x_N, e_N) \rangle, \quad (6.47)$$

where  $R_1(x, e) = R_1^a(x) e_a$  and the hatted soft factor takes the form

$$\hat{S}_i^{(0)}(x, e) \equiv -2e \mathbb{Q}_i \frac{(x_i - x) \cdot e}{(x_i - x)^2}. \quad (6.48)$$

By acting on both sides of the equation with the operator  $\partial_e \cdot \partial_x$ , we can easily compute how the divergence of  $R_1^a(x)$  behaves when inserted in a correlation function,

$$\langle \partial_x^a R_{1a}(x) \mathbb{O}_{\Delta_1, \ell_1}(x_1, e_1) \dots \mathbb{O}_{\Delta_N, \ell_N}(x_N, e_N) \rangle = 2e \sum_{i=1}^N \mathbb{Q}_i \frac{d-2}{(x_i - x)^2} \langle \mathbb{O}_{\Delta_1, \ell_1}(x_1, e_1) \dots \mathbb{O}_{\Delta_N, \ell_N}(x_N, e_N) \rangle. \quad (6.49)$$

For  $d \neq 2$  the dependence on  $x$  of the right-hand-side of [\(6.49\)](#) is powerlaw, which is different from usual Ward identities where  $x$  only appears in the argument of a delta function. Thus from [\(6.49\)](#) it is clear that  $R_1^a(x)$  is not conserved for  $d \neq 2$ . However, from the classification of section [6.2](#) we notice that  $R_1^a(x)$  has a type  $I_2$  primary descendant at level  $n = 1$ . This descendant has dimensions  $\Delta = 2$ , spin  $(1, 1)$  (namely has two antisymmetric indices) and takes the form defined in section [6.2.1](#) [32](#)

$$\mathbb{O}_{I_2, 1}^{a, b}(x) = \frac{1}{2} (\partial^a R_1^b(x) - \partial^b R_1^a(x)), \quad (6.50)$$

and it is a primary according to [\(6.18\)](#) since the dimension of  $R_1$  is equal to one. Using formula [\(6.47\)](#) we can compute the insertion of [\(6.50\)](#) in a correlation function. The result is exactly zero and it is also easy to see that no contact terms arise from this procedure [33](#) (as noticed also in [48](#)). This means that we cannot write non-trivial charges for this operator – see

<sup>31</sup>See also [104](#) [105](#).

<sup>32</sup>See also equation (3.1) of [105](#).

<sup>33</sup>Indeed the type  $I_2$  operator annihilates the soft factor even when we introduce a regulator  $\epsilon$ ,

$$\partial^{[b} \frac{(x_i - x)^{a]}}{(x_i - x)^2 + \epsilon^2} = \frac{(x_i - x)^{[a} (x_i - x)^{b]} - ((x_i - x)^2 + \epsilon^2) \delta^{[ab]}}{(x_i - x)^2 + \epsilon^2} = 0. \quad (6.51)$$

appendix [B.2](#) for details. Notice that this primary can be defined in any dimension  $d \geq 4$ . In  $d = 3$  this should be replaced by the type P operator defined in [\(6.29\)](#).

### 6.4.2 Leading Soft Graviton Theorem

For gravity the soft factor expressed in the Poincaré section is

$$S_p^{(0)}(\omega, x, e) = -\kappa \sum_{i=1}^N \eta_i \frac{\omega_i}{\omega} \frac{((x_i - x) \cdot e)^2}{(x_i - x)^2}. \quad (6.52)$$

In the conformal basis the leading soft graviton theorem becomes

$$\langle H_1(x, e) \mathbb{O}_{\Delta_1, \ell_1} \dots \mathbb{O}_{\Delta_N, \ell_N} \rangle = \sum_{i=1}^N \hat{S}_i^{(0)}(x, e) \langle \mathbb{O}_{\Delta_1, \ell_1} \dots \mathbb{O}_{\Delta_i+1, \ell_i} \dots \mathbb{O}_{\Delta_N, \ell_N} \rangle, \quad (6.53)$$

where  $H_1(x, e) = H_1^{ab}(x) e_a e_b$ , the hatted soft factor takes the form

$$\hat{S}_i^{(0)}(x, e) \equiv -\kappa \eta_i \frac{((x_i - x) \cdot e)^2}{(x_i - x)^2}, \quad (6.54)$$

and the shift in  $\Delta_i$  of the  $i$ th operator is due to the factor of  $\omega_i$  in [\(6.52\)](#). From the divergence

$$\langle \partial_x^b \partial_x^a H_1^{ab}(x) \mathbb{O}_{\Delta_1, \ell_1} \dots \mathbb{O}_{\Delta_N, \ell_N} \rangle = -\kappa \sum_{i=1}^N \eta_i \frac{(d-1)(d-2)}{(x_i - x)^2} \langle \mathbb{O}_{\Delta_1, \ell_1} \dots \mathbb{O}_{\Delta_i+1, \ell_i} \dots \mathbb{O}_{\Delta_N, \ell_N} \rangle, \quad (6.55)$$

we see that  $H_1^{ab}(x)$  is not a conserved operator in  $d > 2$ .

As in the soft photon case, one can nevertheless use the classification of section [6.2.1](#) to show that  $H_1^{ab}(x)$  has a primary descendant. It is of type  $I_2$  and level  $n = 1$  with dimensions  $\Delta = 2$  and spin  $(2, 1)$  and takes the form  $\pi_{(2,1)}(\mathbf{a}, \mathbf{b}) \partial^{b_1} H_1^{b_1 b_2}(x)$  as defined in equation [\(6.17\)](#). By substituting the expression of the projector written in [\(B.7\)](#) the primary descendant can be written as follows

$$\begin{aligned} O_{I_2, n=1}^{a_1 a_2, a_1^2}(x) &= \frac{1}{3} (2\partial^{a_1} H_1^{a_1, a_2} - \partial^{a_2} H_1^{a_1, a_1} - \partial^{a_1} H_1^{a_1, a_2}) \\ &+ \frac{1}{3(d-1)} (2\delta^{a_1, a_2} \partial_c H_1^{ca_1} - \delta^{a_1, a_1} \partial_c H_1^{ca_2} - \delta^{a_1, a_2} \partial_c H_1^{ca_1}). \end{aligned} \quad (6.56)$$

Inserting this operator in correlation functions gives again zero without contact terms, so  $H_1$  does not give rise to non-trivial charges (see appendix [B.2](#)). This type of primary descendant operator was considered in equation (3.6) of [\[105\]](#) but there the full symmetrization of the indices was not performed, thus the resulting operator was not transforming in an irreducible representation of  $SO(d)$ . Again this primary descendant is only defined for  $d \geq 4$ , while in  $d = 3$  this should be replaced by the type P in [\(6.30\)](#).

### 6.4.3 Subleading Soft Graviton Theorem

The subleading soft graviton factor can be expressed in the Poincaré section as

$$\begin{aligned} S_p^{(1)}(\omega, x, e) &= -\kappa \sum_{i=1}^N \frac{(x_i - x) \cdot e}{(x_i - x)^2} \left[ \frac{(x_i - x)^2}{2} e \cdot \partial_{x_i} + (x_i - x) \cdot e (- (x_i - x) \cdot \partial_{x_i} + \omega_i \partial_{\omega_i}) \right. \\ &\quad \left. + i(x_i - x) \cdot M_i \cdot e \right], \end{aligned} \quad (6.57)$$

where we denote  $\partial_{x_i} \equiv \frac{\partial}{\partial x_i}$ ,  $\partial_{\omega_i} \equiv \frac{\partial}{\partial \omega_i}$  and  $M_i^{ab}$  is antisymmetric in its indices and implements rotations of the tensor indices of the  $i$ -th operator. The subleading conformally soft graviton theorem is given by

$$\langle H_0(x, \epsilon) \mathbb{O}_{\Delta_1, \ell_1} \dots \mathbb{O}_{\Delta_N, \ell_N} \rangle = \sum_{i=1}^N \hat{S}_i^{(1)}(x, \epsilon) \langle \mathbb{O}_{\Delta_1, \ell_1} \dots \mathbb{O}_{\Delta_i, \ell_i} \dots \mathbb{O}_{\Delta_N, \ell_N} \rangle, \quad (6.58)$$

where  $H_0(x, \epsilon) = H_0^{ab}(x) \epsilon_a \epsilon_b$  and since (6.57) is already of  $O(\omega^0)$  the hatted soft factor takes the same form

$$\hat{S}_i^{(1)}(x, \epsilon) = S_i^{(1)}(\omega, x, \epsilon). \quad (6.59)$$

Unlike in  $d = 2$  where insertions of  $H_0$  with  $\ell = -2$  ( $\ell = +2$ ) acted on by three (anti) holomorphic derivatives can be shown to vanish up to contact terms, in  $d > 2$  we cannot act with more than  $\ell$  derivatives  $\partial_x$  while decreasing the spin of the operator. Instead, in order to identify the conserved operators we make use of the primary descendant classification of section 6.2

We find that  $H_0^{ab}(x)$  has a primary descendant of type  $I_2$  and level  $n = 2$  with dimensions 2 and spin  $(2, 2)$  which takes the form  $\pi_{(2,2)}(\mathbf{a}, \mathbf{b}) \partial^{b_1} \partial^{b_2} H_0^{b_1 b_2}(x)$  defined in 6.17. Substituting the projector of appendix B.1 the operator can be written as<sup>34</sup>

$$\begin{aligned} O_{I_2, n=2}^{a_1 a_2, a_1 a_2}(x) &= \frac{1}{6} \left\{ -2 \left( \frac{\partial^2 \delta^{a_1, a_2}}{d-2} - \partial^{a_1} \partial^{a_2} \right) H_0^{a_1 a_2} - 2 \left( \frac{\partial^2 \delta^{a_1, a_1}}{d-2} - \partial^{a_1} \partial^{a_1} \right) H_0^{a_1 a_2} \right. \\ &+ \left( \frac{\partial^2 \delta^{a_1, a_2}}{d-2} - \partial^{a_1} \partial^{a_2} \right) H_0^{a_1 a_2} + \left( \frac{\partial^2 \delta^{a_2, a_1}}{d-2} - \partial^{a_2} \partial^{a_1} \right) H_0^{a_1 a_2} \\ &+ \left( \frac{\partial^2 \delta^{a_1, a_1}}{d-2} - \partial^{a_1} \partial^{a_1} \right) H_0^{a_2 a_2} + \left( \frac{\partial^2 \delta^{a_2, a_2}}{d-2} - \partial^{a_2} \partial^{a_2} \right) H_0^{a_1 a_2} \\ &- \left( \partial^{a_2} \delta^{a_1, a_1} + \partial^{a_1} \delta^{a_2, a_2} - 2 \partial^{a_1} \delta^{a_1, a_2} \right) \frac{\partial_c H_0^{c a_2}}{d-2} + \left( \partial^{a_2} \delta^{a_1, a_1} + \partial^{a_1} \delta^{a_2, a_2} - 2 \partial^{a_1} \delta^{a_1, a_2} \right) \frac{\partial_c H_0^{c a_1}}{d-2} \\ &- \left( \partial^{a_2} \delta^{a_1, a_2} + \partial^{a_1} \delta^{a_2, a_1} - 2 \partial^{a_1} \delta^{a_1, a_2} \right) \frac{\partial_c H_0^{c a_1}}{d-2} - \left( \partial^{a_2} \delta^{a_1, a_2} + \partial^{a_1} \delta^{a_2, a_1} - 2 \partial^{a_2} \delta^{a_1, a_2} \right) \frac{\partial_c H_0^{c a_2}}{d-2} \\ &\left. + 2 \left( \delta^{a_1, a_2} \delta^{a_1, a_2} - 2 \delta^{a_1, a_1} \delta^{a_2, a_2} + \delta^{a_1, a_1} \delta^{a_2, a_1} \right) \frac{\partial_b \partial_c H_0^{b c}}{(d-2)(d-1)} \right\}. \end{aligned} \quad (6.60)$$

This operator is exactly zero in correlation functions and thus does not yield non-trivial charges. As in the previous cases, this primary descendant operator exactly vanishes in correlation functions. This operator exists in  $d \geq 4$ , while in  $d = 3$  it should be replaced by 6.31.

## 6.5 CCFT<sub>d>2</sub> Shadow Ward Identities

In the previous section we showed that the conformally soft operators that arise from recasting soft theorems in a boost eigenbasis are operators of type  $I_2$ . These have shortening conditions which do not give rise to contact terms and thus we cannot build non-trivial charges from them. Moreover type  $I_2$  operators cannot define CFT<sub>d</sub> currents or stress tensors which are of type  $II_1$ . The latter however can be obtained from the shadow transformed Ward identities. Indeed the quantum labels of type  $I_2$  operators is related to the ones of type  $II_1$  by shadow transform (see figure 10).

<sup>34</sup>Again this type of operator was considered in equations (3.35) of 105 but there the full symmetrization of the indices was not performed.



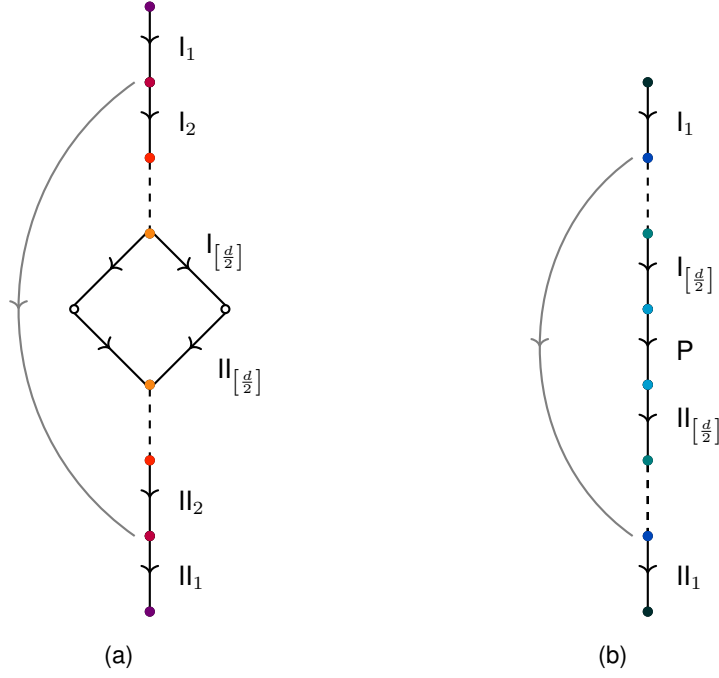

Figure 10: Shadow transform relating primary operators (indicated by the same color) in celestial necklaces in even dimensions (a) and odd dimensions (b). In our examples, the relation between the soft operators (type  $I_2$ ) and their shadows (type  $II_1$ ) is depicted by the curved arrow.

To show that conformally soft operators can be shadowed to obtain type  $II_1$  operators is rather subtle because the shadow integrals naively annihilate type I operators. The shadow is thus obtained by a regularization of the integral, which gives a finite result. In the following we will show that, very surprisingly, in even dimensions this regularization procedure gives rise to analytically continued type S operators (this relation generalizes to all values of  $\ell$  and  $k$  of the conformally soft operators [\(4.30\)](#)). Alternatively, we can directly compute the shadow transform of the soft factors in any dimensions which we detail in appendix [B.5](#). We will then use these results to compute the Ward identities for the shadow transform of the leading soft photon and the leading and subleading soft graviton operators.

### 6.5.1 Shadows and Type S operators

The shadow transform of a symmetric and traceless operator  $\mathcal{O}_{\Delta,\ell}$  corresponds to the following integral transform

$$S[\mathcal{O}_{\Delta,\ell}](x, e) = \frac{N_{\Delta,\ell}}{\ell! \left(\frac{d}{2} - 1\right)^\ell} \int d^d x' \frac{I(x' - x, e, D_{e'})^\ell}{[(x' - x)^2]^{d-\Delta}} \mathcal{O}_{\Delta,\ell}(x', e'), \quad (6.61)$$

where  $I(x, y, z) \equiv y \cdot z - 2(y \cdot x)(z \cdot x)/x^2$  is the inversion tensor. The choice of normalization of the shadow transform

$$N_{\Delta,\ell} = \frac{\pi^{-\frac{d}{2}} \Gamma(d - \Delta + \ell) \Gamma(\Delta - 1)}{\Gamma(\Delta - 1 + \ell) \Gamma(\Delta - \frac{d}{2})} \quad (6.62)$$

yields  $S[S[\mathcal{O}_{\Delta,\ell}]] = \mathcal{O}_{\Delta,\ell}$ . In appendix [B.5](#) we compute a regulated version of [\(6.61\)](#) which we apply to the universal soft theorems.

We now want to take a different route. Indeed in [48] it was shown that in even dimensions the shadow transform can be written in terms of local differential operators when acting on conformally soft operators. Here we want to generalize this result to any soft operator  $\mathcal{O}_{k,\ell}$  with dimensions  $k = 1, 0, -1, \dots$  and spin  $\ell$ . At the same time we will show that the local differential operators are actually written in terms of an analytic continuation of the type S operator.

To show the relation between the type S operator and the shadow transform, it is convenient to use an alternative definition (see [46]) for the differential operator  $D_{S,n}$  given in [6.25],

$$D_{S,n} \equiv \square^{n-\ell} \widehat{D}_{S,n}, \quad \widehat{D}_{S,n} \equiv \sum_{j=0}^{\ell} a_{j,n} \square^{\ell-j} (e \cdot \partial_x)^j (D_e \cdot \partial_x)^j, \quad (6.63)$$

where the coefficients  $a_{j,n}$  are written as

$$a_{j,n} = \frac{(-2)^j \ell! n!}{j!(\ell-j)!(n-j)!(-\ell)_j(-\frac{d}{2}-\ell+2)_j(\frac{d}{2}-j+\ell+n-1)_j}. \quad (6.64)$$

Since  $D_{S,n}$  contains  $\square^{n-\ell}$ , this operator makes sense only for  $n \geq \ell$ <sup>35</sup>. On the other hand, this representation is convenient since  $\widehat{D}_{S,n}$  can be analytically continued to complex values of  $n$ .

For  $n = \frac{d}{2} - \Delta$  we can thus use  $\widehat{D}_{S,n}$  to rewrite the shadow kernel in [6.61] as follows

$$\frac{I(x, e, v)^\ell}{(x^2)^{d-\Delta}} = c_{\Delta,\ell} \widehat{D}_{S,\frac{d}{2}-\Delta} \frac{(e \cdot v)^\ell}{(x^2)^{d-\Delta-\ell}}, \quad (6.65)$$

for vectors  $v$  in  $\text{CFT}_d$  with the property  $v^2 = 0$  and where

$$c_{\Delta,\ell} = -\frac{1}{2^{2\ell}(-\Delta+d+\ell-1)(-\frac{d}{2}+\Delta)_\ell(-d+\Delta+2)_{\ell-1}}. \quad (6.66)$$

So far we have not restricted the conformal dimension of the operator. In the following we are interested in the conformally soft values  $\Delta \in 1 - \mathbb{Z}_{\geq 0}$ . Performing the shadow integral [6.61] is subtle and to make the result finite we introduce an infinitesimal regulator  $\epsilon$ .

In the rest of this section we set  $\Delta = k + \epsilon$  where  $k = 1, 0, -1, \dots$  and we take  $\epsilon \rightarrow 0$  at the end. To proceed we specify to even dimensions  $d$  where we use the following identity

$$\frac{1}{(x^2)^{d-k-\epsilon-\ell}} = d_{k,\ell}^\epsilon \square^{\frac{d}{2}-\ell-k} \frac{1}{(x^2)^{\frac{d}{2}-\epsilon}} \quad (6.67)$$

for  $\frac{d}{2} - \ell - k \in \mathbb{Z}_{\geq 0}$  where

$$d_{k,\ell}^\epsilon = (-1)^{\ell+k+1} 4^{-\frac{d}{2}+\ell+k} \frac{(-\frac{d}{2}+\epsilon+1)_{\ell+k-1}}{(1-\epsilon)_{d-k-\ell-1}}. \quad (6.68)$$

Using these relations we first study what happens to the integral [6.61] for  $\epsilon = 0$  exactly. Integrating by parts in [6.61] using [6.65] with  $v = D_{e'}$  such that  $\frac{1}{\ell!(\frac{d}{2}-1)_\ell} (e \cdot D_{e'})^\ell \mathcal{O}_{\Delta,\ell}(x, e') = \mathcal{O}_{\Delta,\ell}(x, e)$  and the identity [6.67] gives

$$S[\mathcal{O}_{k,\ell}](x, e) = N_{k,\ell} c_{k,\ell} d_{k,\ell}^{\epsilon=0} \int d^d x' \frac{1}{|x' - x|^d} D_{S,\frac{d}{2}-k} \mathcal{O}_{k,\ell}(x', e). \quad (6.69)$$

Now one can argue that  $\widehat{D}_{S,\frac{d}{2}-k} \mathcal{O}_{k,\ell}$  is exactly zero (notice also that the integral  $\int d^d x' |x - x'|^{-d}$  by itself is divergent). The rough idea is that  $\widehat{D}_{S,\frac{d}{2}-k}$  in even dimensions acts like a type I differential operator which annihilates the primary, for more

<sup>35</sup>It is possible to extend the definition of  $D_{S,n}$  to  $n < \ell$  by replacing  $\square^{n-\ell} \square^{\ell-j} \rightarrow \square^{n-j}$  and replacing the upper limit of the sum  $\ell \rightarrow n$ . The resulting formula is written in (173) of [46]. Formula [6.63] however will be more convenient for our purposes.

details see the discussion in appendix B.6. This is also checked directly for the examples in sections 6.5.2-6.5.4 by explicitly acting with  $D_{S, \frac{d}{2}-k}$  on the soft factors associated to the insertion of  $\mathbb{O}_{k, \ell}$ .

In 48, 49 the shadow of soft modes is then regulated by keeping  $\epsilon$  infinitesimal and taking the limit  $\epsilon \rightarrow 0$  at the end. This gives

$$S[\mathbb{O}_{k+\epsilon, \ell}](x, e) = N_{k+\epsilon, \ell} c_{k+\epsilon, \ell} d_{k, \ell}^\epsilon \int d^d x' \frac{1}{|x' - x|^{d-2\epsilon}} \square^{\frac{d}{2}-\ell-k} \widehat{D}_{S, \frac{d}{2}-k-\epsilon} \mathbb{O}_{k+\epsilon, \ell}(x', e). \quad (6.70)$$

We expand the action of the differential operator to the first non-vanishing order in  $\epsilon$ ,

$$\widehat{D}_{S, \frac{d}{2}-k-\epsilon} \mathbb{O}_{k, \ell}(x, e) = \epsilon \left( \partial_\epsilon \widehat{D}_{S, \frac{d}{2}-k-\epsilon} \right)_{\epsilon=0} \mathbb{O}_{k, \ell}(x, e) + O(\epsilon^2). \quad (6.71)$$

We further discard the order  $\epsilon$  term in  $\mathbb{O}_{k+\epsilon, \ell}$  because the soft operators are actually defined by taking the residue of the operator  $\mathbb{O}_{\Delta, \ell}$  for  $\Delta = k$ , and if we shift  $k$  by  $\epsilon$ , the residue vanishes. We then notice that the remaining integral kernel in 6.70 is proportional to

$$\lim_{\epsilon \rightarrow 0} \frac{\epsilon}{|x' - x|^{d-2\epsilon}} = \frac{S_d}{2} \delta^{(d)}(x' - x), \quad (6.72)$$

where  $S_d \equiv \frac{2\pi^{d/2}}{\Gamma(\frac{d}{2})}$ . The integral in  $x'$  can now be trivially performed giving the result

$$S[\mathbb{O}_{k, \ell}](x, e) = n_{k, \ell} \square^{\frac{d}{2}-\ell-k} \left( \partial_\epsilon \widehat{D}_{S, \frac{d}{2}-k-\epsilon} \right)_{\epsilon=0} \mathbb{O}_{k, \ell}(x, e) \quad (6.73)$$

where  $n_{k, \ell} \equiv \frac{S_d}{2} \lim_{\epsilon \rightarrow 0} N_{k+\epsilon, \ell} c_{k+\epsilon, \ell} d_{k, \ell}^\epsilon$ . Formula 6.73 is very explicit since the derivative of  $\widehat{D}$  is obtained in a closed form by acting on the coefficients  $a_{j, n}$  in 6.64, namely

$$(\partial_\epsilon a_{j, \frac{d}{2}-k-\epsilon})_{\epsilon=0} = - \frac{\ell! \left( \frac{d}{2} - j - k + 1 \right)_j \left( H_{\frac{d}{2}-k} - H_{\frac{d}{2}-k-j} - H_{d-k+\ell-2} + H_{d-k+\ell-2-j} \right)}{(-2)^{-j} j! (\ell - j)! (-\ell)_j \left( -\frac{d}{2} - \ell + 2 \right)_j (d - j - k + \ell - 1)_j}, \quad (6.74)$$

where  $H_k$  are harmonic numbers. Formula 6.73 not only gives a nice interpretation of the differential operators in 48, but also extends those results to all  $k = 1, 0, -1, \dots$  and  $\ell$  (with the only constraint that  $d/2 - \ell - k \geq 0$ ), furnishing a very efficient tool to compute the shadow transform of bosonic soft operators.

Let us give the explicit expressions of 6.73 for  $\ell = 1$  with  $k = 1$  and  $\ell = 2$  with  $k = 1, 0$ , which correspond to the shadow transforms of respectively the leading soft photon and the leading and subleading soft graviton,

$$S[\mathbb{O}_{1,1}] = n_{1,1} \frac{2 \square^{\frac{d}{2}-2}}{(d-2)^2} (e \cdot \partial_x) (D_e \cdot \partial_x) \mathbb{O}_{1,1}(x, e), \quad (6.75)$$

$$S[\mathbb{O}_{1,2}] = n_{1,2} \frac{2 \square^{\frac{d}{2}-3}}{(d-1)^2} \left( \square (e \cdot \partial_x) (D_e \cdot \partial_x) - \frac{2d-5}{(d-2)^2} (e \cdot \partial_x)^2 (D_e \cdot \partial_x)^2 \right) \mathbb{O}_{1,2}(x, e), \quad (6.76)$$

$$S[\mathbb{O}_{0,2}] = n_{0,2} \frac{2 \square^{\frac{d}{2}-2}}{d^2} \left( \square (e \cdot \partial_x) (D_e \cdot \partial_x) - \frac{(2d^2 - 3d + 2)}{(d-2)(d-1)^2} (e \cdot \partial_x)^2 (D_e \cdot \partial_x)^2 \right) \mathbb{O}_{0,2}(x, e). \quad (6.77)$$

These results match the ones of 48 and slightly generalize them since in 48 it is only described how to get  $\partial_a S[\mathbb{O}_{0,2}]^{ab}$  and  $\partial_a S[\mathbb{O}_{1,2}]^{ab}$  as local operators.

To conclude let us mention that the relation 6.73 can also be expressed in a more compact but less transparent<sup>36</sup> fashion as,

$$S[\mathbb{O}_{k, \ell}](x, e) = n_{k, \ell} \lim_{\epsilon \rightarrow 0} \frac{1}{\epsilon} D_{S, \frac{d}{2}-k-\epsilon} \mathbb{O}_{k+\epsilon, \ell}(x, e). \quad (6.78)$$

<sup>36</sup> Notice that 6.78 contains a seemingly problematic term where  $\square$  is elevated to the non-integer power  $\frac{d}{2} - \ell - k - \epsilon$ . However the order  $O(\epsilon)$  contribution coming from expanding this term vanishes because, as we argued above,  $\widehat{D}_{S, \frac{d}{2}-k} \mathbb{O}_{k, \ell} = 0$ . So for any practical purposes one can (and should) use  $\square^{\frac{d}{2}-\ell-k}$  as in 6.73, which is well defined.

Here we did not assume that  $\mathbb{O}_{k+\epsilon,\ell}$  can be replaced by  $\mathbb{O}_{k,\ell}$  so (6.78) works not only for soft operators but also for generic primaries. This formula shows that the shadow transform of primary  $\mathbb{O}_{k,\ell}$  corresponds to the action of an analytically continued type S operator on the analytically continued primary  $\mathbb{O}_{k+\epsilon,\ell}$ . To be precise, we find a type S operator at level  $n = \frac{d}{2} - k - \epsilon$  but since  $n$  is not integer for non-vanishing  $\epsilon$  (and likewise the dimension  $\Delta = k + \epsilon$  of the operator), it is not a priori clear if this descendant is also a primary. Notice that if the shadow (6.78) were a (non-primary) descendant it would be extremely problematic, firstly because the shadow of a primary should be a primary, and secondly because in the following we want to argue that these shadowed operators define the stress tensor and currents in celestial CFT, which must be primaries. Fortunately we find that (6.78) defines a primary in the following sense

$$\lim_{\epsilon \rightarrow 0} \frac{1}{\epsilon} [K^a, D_{S, \frac{d}{2} - k - \epsilon} \mathbb{O}_{k+\epsilon,\ell}(0, e)] = 0, \quad (6.79)$$

where  $K^a$  is the generator of special conformal transformations (and we consider the remark of footnote 36). To show that this vanishes we take the  $\epsilon \rightarrow 0$  limit after computing the commutator and we further need to mod out by the module defined by the primary descendant of  $\mathbb{O}_{k,\ell}$ . Namely we have to require that the shortening conditions for the operator  $\mathbb{O}_{k,\ell}$  (derived in section 6.2) are satisfied. We checked this explicitly in several cases for various values of  $d, \ell, k$  corresponding to the leading soft photon and leading and subleading soft graviton operators. In all cases the result of computing (6.79) is proportional to a shortening condition for a type  $I_2$  operator, which we set to zero by modding out by the module defined by this primary descendant. In the simplest example of  $\ell = 1$  and  $k = 1$  in  $d = 4$  we have  $\widehat{D}_{S,1-\epsilon} \mathbb{O}_{1+\epsilon,1}(x, e) \propto e_b (\delta_c^b \square - \frac{2(\epsilon-1)}{\epsilon-2} \partial^b \partial_c) \mathbb{O}_{1+\epsilon,1}^c(x)$  and thus it is very easy to perform the commutation by simply replacing the derivative with the generator of translations and using the conformal algebra,

$$\lim_{\epsilon \rightarrow 0} \frac{1}{\epsilon} \left[ K^a, \left( \delta_c^b \square - \frac{2(\epsilon-1)}{\epsilon-2} \partial^b \partial_c \right) \mathbb{O}_{1+\epsilon,1}^c(0) \right] \propto \partial^a \mathbb{O}_{1,1}^b(0) - \partial^b \mathbb{O}_{1,1}^a(0) = 0. \quad (6.80)$$

The result is zero since it is proportional to the type  $I_2, n = 1$  shortening condition which the operator  $\mathbb{O}_{1,1}^a$  satisfies. Let us stress that (6.78) is not a canonical type of primary descendant and for this reason it escapes the conventional classification. Indeed the limiting prescription in (6.78) extracts the order  $O(\epsilon)$  term which appears by either expanding the differential operator or the primary operator:  $D_{S, \frac{d}{2} - k - \epsilon} \mathbb{O}_{k,\ell} + D_{S, \frac{d}{2} - k} \mathbb{O}_{k+\epsilon,\ell}$ . These two terms however define descendants of two different primaries. Thus by opportunely summing descendants of two different conformal multiplets (with arbitrarily close conformal dimensions) it is possible to define a new primary operator given by (6.78). This mechanism is very different from the one in standard CFTs in which the primary descendant arises because a single multiplet becomes degenerate. Moreover, the result of the commutator only vanishes when the shortening conditions are implemented, which is another feature that does not arise for usual primary descendants, where the result of the commutator is instead exactly zero.

## 6.5.2 Leading Soft Photon Theorem

The divergence of the conformally soft photon operator  $R_1^a(x)$  inside a correlation function (6.49) does not give a standard  $\text{CFT}_{d>2}$  Ward identity. Besides the fact that  $R_1^a(x)$  is not divergenceless, it does not have the correct conformal dimension to be a current. Indeed a current should have dimensions  $d - 1$ , while  $R_1^a(x)$  has dimension 1. It is thus natural to consider its shadow  $\tilde{R}_{d-1}^a(x)$  which instead has the correct conformal dimension. Shadowing the soft factor we obtain

$$\tilde{S}^{(0)}(x, e) = -2e [\Gamma(\frac{d}{2})]^2 \sum_{i=1}^N \mathbb{Q}_i \frac{1}{\omega} \frac{(x_i - x) \cdot e}{(x_i - x)^d}. \quad (6.81)$$

This computation can be performed either using [\(6.73\)](#) (which in principle requires even  $d$ ) or by the method detailed in appendix [B.5](#) (which works in any  $d$ ).

To determine the divergence of  $\tilde{R}_{d-1}^a(x)$  in a correlation function we act with  $\partial_\epsilon \cdot \partial_x$  on [\(6.81\)](#) and Mellin transform. The result is

$$\langle \partial_a \tilde{R}_{d-1}^a(x) \mathbb{O}_{\Delta_1, \ell_1} \dots \mathbb{O}_{\Delta_N, \ell_N} \rangle = 4e\pi^{\frac{d}{2}} \Gamma\left(\frac{d}{2}\right) \sum_{i=1}^N \mathbb{Q}_i \delta^{(d)}(x_i - x) \langle \mathbb{O}_{\Delta_1, \ell_1} \dots \mathbb{O}_{\Delta_N, \ell_N} \rangle, \quad (6.82)$$

where the appearance of the delta function follows from appendix [B.3](#). Clearly,  $\tilde{R}_{d-1}^a(x) \equiv J^a(x)$  is a conserved  $U(1)$  current, i.e. it satisfies  $\partial_a J^a(x) = 0$  away from contact points. Its primary descendant  $\partial_a \tilde{R}_{d-1}^a(x)$  at level  $n = 1$  is the simplest example of a spin  $\ell = 1$  operator of type  $\text{II}_1$ . The associated Noether current [\(6.35\)](#) can be expressed as

$$\mathcal{J}^{\epsilon a}(x) = \tilde{R}_{d-1}^a(x) \epsilon(x), \quad (6.83)$$

whose conservation equation  $\partial^a \mathcal{J}_a^\epsilon = 0$  implies that the associated symmetry parameter

$$\epsilon(x) = c \quad (6.84)$$

must be a constant in  $d > 2$ . Thus, following [\(6.39\)](#), we obtain a single charge  $Q_\Sigma^\epsilon = cQ$  defined as

$$Q = \frac{1}{4e\pi^{\frac{d}{2}} \Gamma\left(\frac{d}{2}\right)} \int_R d^d x \partial_a \tilde{R}_{d-1}^a(x). \quad (6.85)$$

for a region  $R$  in  $\mathbb{R}^d$  with boundary given by  $\Sigma$ . From the identity [\(6.82\)](#), we can deduce the charge action on an operator  $\mathbb{O}_{\Delta, \ell}(x)$

$$[Q, \mathbb{O}_{\Delta, \ell}(x)] = \mathbb{Q}_{\mathbb{O}_{\Delta, \ell}}(x). \quad (6.86)$$

For a non-abelian symmetry the current transforms in the adjoint representation of the symmetry group and so it has more components to each of which one can associate a conserved charge.

### 6.5.3 Leading Soft Graviton Theorem

The conformally soft graviton operator  $H_1^{ab}(x)$  is likewise not conserved in correlation functions [\(6.55\)](#) in  $d > 2$  and we consider instead its shadow  $\tilde{H}_{d-1}^{ab}(x)$  which has the correct dimension of a type  $\text{II}_1$  operator at level  $n = 2$ , according to equation [\(6.20\)](#). The shadow of the soft graviton factor is given by

$$\tilde{S}^{(0)}(x, e) = -\frac{\kappa}{2} d \left[ \Gamma\left(\frac{d}{2}\right) \right]^2 \sum_{i=1}^N \eta_i \frac{\omega_i [(x_i - x) \cdot e]^2}{(x_i - x)^d}. \quad (6.87)$$

Computing the divergence of  $\tilde{H}_{d-1}^{ab}(x)$  in correlation functions using appendix [B.3](#) yields

$$\langle \partial_a \partial_b \tilde{H}_{d-1}^{ab}(x) \mathbb{O}_{\Delta_1, \ell_1} \dots \mathbb{O}_{\Delta_N, \ell_N} \rangle = -2\kappa\pi^{\frac{d}{2}} (d-1) \Gamma\left(\frac{d}{2}\right) \sum_{i=1}^N \eta_i \delta^{(d)}(x_i - x) \langle \mathbb{O}_{\Delta_1, \ell_1} \dots \mathbb{O}_{\Delta_{i+1}, \ell_{i+1}} \dots \mathbb{O}_{\Delta_N, \ell_N} \rangle. \quad (6.88)$$

This higher-derivative Ward identity is associated to the level  $n = 2$  primary descendant operator of type  $\text{II}_1$  defined by  $\partial_a \partial_b \tilde{H}_{d-1}^{ab}(x)$ . The Noether current [\(6.35\)](#) can be written as

$$\mathcal{J}^{\epsilon a}(x) = \tilde{H}_{d-1}^{ab}(x) \partial_b \epsilon(x) - \partial_b \tilde{H}_{d-1}^{ab}(x) \epsilon(x), \quad (6.89)$$

and the conservation of  $\mathcal{J}_a^\epsilon$  requires the parameter to take the form [\(6.37\)](#), namely

$$\epsilon(x) = c_\mu q^\mu(x), \quad (6.90)$$

where  $q^\mu$  is defined in (4.27) and  $c_\mu$  is a constant vector  $c_\mu = (c_0, c_a, c_{d+1})$ . Using (6.39) the charge takes the form

$$Q_\Sigma^\epsilon = -\frac{1}{2\kappa} \frac{1}{\pi^{\frac{d}{2}} (d-1) \Gamma(\frac{d}{2})} \int_R d^d x \epsilon(x) \partial_a \partial_b \tilde{H}_{d-1}^{ab}(x), \quad (6.91)$$

where  $\partial R = \Sigma$ . This can be thus written as a sum of  $d+2$  independent charges  $Q_\Sigma^\epsilon = c_\mu Q^\mu$ . From the Ward identity (6.88), we can deduce the charge action on an operator  $\mathbb{O}_{\Delta, \ell}(x)$ ,

$$[Q^\mu, \mathbb{O}_{\Delta, \ell}(x)] = \eta q^\mu(x) \mathbb{O}_{\Delta+1, \ell}(x), \quad (6.92)$$

where the shift in the conformal dimension and the multiplication by  $\eta q^\mu$  is exactly what produces the translations in physical  $d+2$ -dimensional space<sup>37</sup>

### 6.5.4 Subleading Soft Graviton Theorem

Among the conserved operators of spin  $\ell = 2$  we expect the appearance of the stress tensor which has conformal dimension  $\Delta = d$ . Indeed, the shadow transform of the subleading soft graviton operator  $H_0^{ab}$ , denoted by  $\tilde{H}_d^{ab}(x)$ , has the right conformal dimension to be the stress tensor. Shadowing the subleading soft graviton factor gives

$$\begin{aligned} \tilde{S}^{(1)}(x, e) = \kappa [\Gamma(\frac{d}{2} + 1)]^2 \sum_{i=1}^N \frac{(x-x_i) \cdot e}{[(x-x_i)^2]^{\frac{d}{2}+1}} & \left[ \frac{1}{2} (x-x_i) \cdot e (-2\omega_i \partial_{\omega_i} + (d-2)(x-x_i) \cdot \partial_{x_i}) \right. \\ & \left. + (x-x_i)^2 e \cdot \partial_{x_i} - i(d-1) e \cdot M_i \cdot (x-x_i) \right]. \end{aligned} \quad (6.93)$$

We again use appendix B.3 to land, after Mellin transforming over the energies, on the following Ward identity

$$\begin{aligned} \langle \partial_a \tilde{H}_d^{ab}(x) \mathbb{O}_{\Delta_1, \ell_1} \dots \mathbb{O}_{\Delta_N, \ell_N} \rangle = \frac{\kappa}{2} \pi^{\frac{d}{2}} (d-1) \Gamma(\frac{d}{2} + 1) \sum_{i=1}^N & \left[ \delta^{(d)}(x-x_i) \partial_{x_i}^b \right. \\ & \left. - \frac{\Delta_i}{d} \partial^b \delta^{(d)}(x-x_i) + \frac{i}{2} M_i^{bc} \partial_c \delta^{(d)}(x-x_i) \right] \langle \mathbb{O}_{\Delta_1, \ell_1} \dots \mathbb{O}_{\Delta_N, \ell_N} \rangle. \end{aligned} \quad (6.94)$$

The first of the three terms in the square brackets corresponds to the usual Ward identity for a  $d$ -dimensional stress tensor  $T^{ab}$  which is conserved, traceless and symmetric away from other operator insertions. Instead our primary operator  $\tilde{H}_d^{ab}(x) \equiv -T^{\{ab\}} = -T^{ab} + T^{[ab]} + \frac{1}{d} \delta^{ab} T_c^c$  is *exactly* traceless and symmetric because we explicitly project it into the traceless and symmetric representation. This explains the two additional terms in the second line of (6.94). Here the square brackets denote anti-symmetrization, while the curly brackets make the indices symmetric and traceless. The primary descendant  $\partial_a \tilde{H}_d^{ab}(x)$  is the prime example of a spin  $\ell = 2$  operator of type II<sub>1</sub> at level  $n = 1$ . The Noether current (6.35) takes the form

$$\mathcal{J}^{\epsilon a}(x) = \tilde{H}_d^{ab}(x) \epsilon_b(x) \quad (6.95)$$

for some vector  $\epsilon_b(x)$  such that  $\partial^a \mathcal{J}_a^\epsilon = 0$ . Using the properties of the stress tensor, we find that  $\epsilon_a$  must satisfy the following equation

$$\frac{\partial_a \epsilon_b + \partial_b \epsilon_a}{2} - \frac{\eta_{ab}}{d} \partial_c \epsilon^c = 0. \quad (6.96)$$

<sup>37</sup>Given a momentum state  $|p^\mu\rangle$  with  $p^\mu = \eta \omega q^\mu$  and its Mellin transform  $|\Delta, \eta q^\mu\rangle$ , bulk translations  $\mathcal{P}^\nu$  act as

$$\mathcal{P}^\nu |p^\mu\rangle = p^\nu |p^\mu\rangle \quad \rightarrow \quad \mathcal{P}^\nu |\Delta, \eta q^\mu\rangle = \eta q^\nu |\Delta + 1, \eta q^\mu\rangle.$$

This is the conformal Killing equation, which can also be obtained by studying the transformations that preserve the flat metric up to a conformal factor. In  $d > 2$  this equation has a finite number of solutions

$$\epsilon_a(x) = c_a^P + c_{[a b]}^R x^b + c^D x_a + c_b^K (2x_a x^b - \eta_a^b x^2), \quad (6.97)$$

which are the conformal Killing vectors that are parametrized by  $\frac{(d+2)(d+1)}{2}$  coefficients  $c_a^P, c_{[a b]}^R, c^D, c_a^K$  with the brackets denoting anti-symmetrization. Notice that the equation for  $\epsilon_a(x)$  obtained in (6.37), which for the present case reduces to

$$\epsilon_a(x) = c_{[\mu \nu]} q^\mu \partial_a q^\nu, \quad (6.98)$$

is equivalent to (6.97) upon identifying

$$c^D \equiv c_{[d+1 0]}, \quad c_a^P \equiv \frac{1}{2}(c_{[0 a]} + c_{[d+1 a]}), \quad c_a^K \equiv \frac{1}{2}(c_{[a 0]} - c_{[a d+1]}), \quad c_{[a b]}^R \equiv c_{[a b]}. \quad (6.99)$$

From (6.39), the charge takes the form

$$Q_\Sigma^\xi = \frac{2}{\kappa \pi^{\frac{d}{2}} (d-1) \Gamma(\frac{d}{2} + 1)} \int_R d^d x \epsilon_a(x) \partial_b \tilde{H}_d^{ab}(x), \quad (6.100)$$

where  $\partial R = \Sigma$ . Using  $\epsilon_a$  as defined in (6.97) and (6.98) we shall expand the charge in terms of the independent constant coefficients as  $Q_\Sigma^\xi \equiv c_{[\mu \nu]} Q^{\mu \nu} \equiv c_D Q^D + c_a^P Q^{P a} + c_a^K Q^{K a} + c_{[a b]}^R Q^{R ab}$ . The action of the charges  $Q^{\mu \nu}$  on a primary operator  $\mathbb{O}_{\Delta, \ell}(x)$  can then be computed from (6.94) and takes the following form

$$[Q^{\mu \nu}, \mathbb{O}_{\Delta, \ell}(x)] = \left[ q^\mu (\partial^a q^\nu) \partial_a + \frac{\Delta}{d} [\partial^a (q^\mu \partial_a q^\nu)] - \frac{i}{2} (\partial_b q^\mu) (\partial_a q^\nu) M^{ab} \right] \mathbb{O}_{\Delta, \ell}(x). \quad (6.101)$$

This compact expression can then be rewritten – replacing  $q^\mu$  as in (4.27) and using the definition above for the charges – in terms of the more familiar  $\text{CFT}_d$  charges associated to translations  $P_a$ , rotations  $R_{ab}$ , dilations  $D$  and special conformal transformations  $K_a$ ,

$$\begin{aligned} [Q^{P a}, \mathbb{O}_{\Delta, \ell}(x)] &= \partial^a \mathbb{O}_{\Delta, \ell}(x), \\ [Q^{R ab}, \mathbb{O}_{\Delta, \ell}(x)] &= \left( (x^a \partial^b - x^b \partial^a) + i M^{ab} \right) \mathbb{O}_{\Delta, \ell}(x), \\ [Q^D, \mathbb{O}_{\Delta, \ell}(x)] &= (x^a \partial_a + \Delta) \mathbb{O}_{\Delta, \ell}(x), \\ [Q^{K a}, \mathbb{O}_{\Delta, \ell}(x)] &= \left( (2x^a x_b - \delta_b^a x^2) \partial^b + 2\Delta x^a - 2ix_b M^{ba} \right) \mathbb{O}_{\Delta, \ell}(x). \end{aligned} \quad (6.102)$$

We thus recovered the generators of the conformal algebra, which simply correspond to the Lorentz transformations in the bulk.

## Summary: Part II

In this part, we have focused on the universal soft theorems for gauge theory and gravity in  $d + 2$  spacetime dimensions and the classification of soft symmetries in the dual celestial  $\text{CFT}_d$ .

In the conformal basis, the universal soft theorems in  $d + 2 > 4$  dimensions take the form of  $d$  dimensional correlation functions with the insertion of a (conformally) soft operator with special integer dimension  $\Delta$  that transforms in a short representation. Soft operators have primary descendants of type  $\mathbb{1}_2$  at level  $n = 2 - \Delta$  which have the spin label  $\ell_2$  increased by  $n$  units and thus do not transform in traceless and symmetric representations. The conservation equations defined by

these primary descendants do not give rise to contact terms and so the associated charges are trivial. Non-trivial conserved charges can instead be built from their shadow transforms.

The shadow transform of the soft operators – which in even  $d$  acts as an analytic continuation of the type S differential operator – maps them to operators with type II<sub>1</sub> primary descendants whose spin label  $\ell_1$  is decreased by  $n = \Delta + \ell_1 - 1$  units. Conformally soft shadow operators define familiar conserved  $\text{CFT}_d$  operators such as currents and stress tensor as well as operators satisfying higher-derivative conservation equations such as those generating translations in  $d+2$  spacetime dimensions. For all such operators we explained how to construct the full set of associated conserved charges. Importantly, these shadow operators generate the symmetries corresponding to  $d+2$  dimensional Poincaré and global  $U(1)$  transformations – which are finite-dimensional groups. This is in contrast to the infinite local enhancement in  $d+2 = 4$  spacetime dimensions by BMS and large gauge transformations for which we have constructed Noether currents and infinite towers of charges.



## Part III

# Celestial Fermions and Soft Symmetries

In the last part we mainly focused on bosonic symmetries. However fermionic symmetries exist as well, the leading soft gravitino theorem being related to large supersymmetry transformations. We therefore explore this structure from the celestial CFT<sub>d=2</sub> point of view: we start by introducing an adequate null tetrad and spin frame to construct our fermionic conformal primary wavefunctions. We then construct boundary spin- $\frac{1}{2}$  and spin- $\frac{3}{2}$  operators. The conformal multiplets organize themselves into celestial diamonds which are related to bosonic celestial diamonds via global SUSY modes, we illustrate these relations by a pyramid-shaped structure. We also construct charges associated to the leading soft photino and subleading soft gravitino theorem using the covariant phase-space formalism.

## 7 Celestial Fermions

In this section, we set up the conformal primary wavefunctions for spin- $\frac{1}{2}$  and spin- $\frac{3}{2}$  fields and use these to construct the celestial operators corresponding to single particle scattering states.

### 7.1 Conformal Primary Wavefunctions

*Conformal primary wavefunctions* are functions on  $\mathbb{R}^{1,3} \times \mathbb{C}$  which depend on a spacetime vector  $X^\mu \in \mathbb{R}^{1,3}$  and a point  $(w, \bar{w}) \in S^2$ , which under simultaneous  $\text{SO}(1,3) \simeq \text{SL}(2, \mathbb{C})$  Lorentz transformations of  $X$  and Möbius transformation of  $(w, \bar{w})$  on the celestial sphere

$$X^\mu \mapsto \Lambda^\mu{}_\nu X^\nu, \quad w \mapsto \frac{aw + b}{cw + d}, \quad \bar{w} \mapsto \frac{\bar{a}\bar{w} + \bar{b}}{\bar{c}\bar{w} + \bar{d}}, \quad (7.1)$$

transform as 2D conformal primaries with  $\text{SL}(2, \mathbb{C})$  conformal dimension  $\Delta$  and 2D spin  $J$ . We focus here on fermionic wavefunctions and consider two types: *radiative* conformal primary wavefunctions which satisfy the equations of motion for massless spin- $s$  fields in the vacuum and have  $J = \pm s$ , and *generalized* conformal primary wavefunctions with  $|J| \leq s$  and in principle allow for sources and non-analytic behavior though here we restrict ourselves to analytic wavefunctions.

### A Covariant Tetrad and Spin Frame

Let us first introduce some useful notation. We start by embedding the celestial sphere into the  $\mathbb{R}^{1,3}$  lightcone via the null reference direction

$$q^\mu = (1 + w\bar{w}, w + \bar{w}, i(\bar{w} - w), 1 - w\bar{w}), \quad (7.2)$$

from which we construct the following null tetrad for Minkowski space [\[12\]](#)

$$l^\mu = \frac{q^\mu}{-q \cdot X}, \quad n^\mu = X^\mu + \frac{X^2}{2} l^\mu, \quad m^\mu = \epsilon_+^\mu + (\epsilon_+ \cdot X) l^\mu, \quad \bar{m}^\mu = \epsilon_-^\mu + (\epsilon_- \cdot X) l^\mu, \quad (7.3)$$

where  $\epsilon_+^\mu = \frac{1}{\sqrt{2}} \partial_w q^\mu$  and  $\epsilon_-^\mu = \frac{1}{\sqrt{2}} \partial_{\bar{w}} q^\mu$ . The vectors of this tetrad satisfy standard normalization conditions  $l \cdot n = -1$ ,  $m \cdot \bar{m} = 1$  with all other inner products vanishing and have the property that they transform covariantly under the  $\text{SL}(2, \mathbb{C})$

$$l^\mu \mapsto \Lambda^\mu{}_\nu l^\nu, \quad n^\mu \mapsto \Lambda^\mu{}_\nu n^\nu, \quad m^\mu \mapsto \frac{cw + d}{\bar{c}\bar{w} + \bar{d}} \Lambda^\mu{}_\nu m^\nu, \quad \bar{m}^\mu \mapsto \frac{\bar{c}\bar{w} + \bar{d}}{cw + d} \Lambda^\mu{}_\nu \bar{m}^\nu, \quad (7.4)$$

where  $\Lambda^\mu_\nu$  is the corresponding vector representation of  $SO(1,3) \simeq SL(2, \mathbb{C})$ . To discuss operators and wavefunctions of half-integer spin it is convenient to further decompose the tetrad into a spin frame

$$l_{ab} = o_a \bar{o}_b, \quad n_{ab} = \iota_a \bar{\iota}_b, \quad m_{ab} = o_a \bar{\iota}_b, \quad \bar{m}_{ab} = \iota_a \bar{o}_b, \quad (7.5)$$

where  $v_{ab} = v_\mu \sigma^\mu_{ab}$ ; for  $\sigma^\mu_{ab} = (1, \sigma^i)_{ab}$  with the Pauli matrices  $\sigma^i$ . This yields

$$o_a = \sqrt{\frac{2}{q \cdot X}} \begin{pmatrix} \bar{w} \\ -1 \end{pmatrix}, \quad \iota_a = \sqrt{\frac{1}{q \cdot X}} \begin{pmatrix} X^0 - X^3 - w(X^1 - iX^2) \\ -X^1 - iX^2 + w(X^0 + X^3) \end{pmatrix}, \quad (7.6)$$

up to an overall phase ambiguity which is fixed by setting  $\bar{o}_a = (o_a)^*$  and  $\bar{\iota}_a = (\iota_a)^*$  in the region where  $q \cdot X > 0$  and analytically continued from there. The elements of the spin frame transform as

$$o_a \mapsto (cw + d)^{\frac{1}{2}} (\bar{c}\bar{w} + \bar{d})^{-\frac{1}{2}} (Mo)_a, \quad \iota_a \mapsto (cw + d)^{-\frac{1}{2}} (\bar{c}\bar{w} + \bar{d})^{\frac{1}{2}} (M\iota)_a, \quad (7.7)$$

where  $M$  is an element of  $\overline{SL(2, \mathbb{C})}$ . We refer to appendix [A](#) for our spinor conventions.

## Radiative Conformal Primary Wavefunctions

The scalar conformal primary wavefunction corresponds to the Mellin transform of a plane wave,

$$\varphi^{\Delta, \pm} = \frac{1}{(-q \cdot X_\pm)^\Delta} = \frac{1}{(\mp i)^\Delta \Gamma(\Delta)} \int_0^\infty d\omega \omega^{\Delta-1} e^{\pm i\omega q \cdot X - \varepsilon q^0 \omega}, \quad (7.8)$$

where  $X_\pm^\mu = X^\mu \pm i\varepsilon\{-1, 0, 0, 0\}$  is used as a regulator. Except as necessary, we will omit the  $\pm$  label henceforth. In terms of [\(7.8\)](#) together with the null tetrad [\(7.3\)](#) and the spin frame [\(7.5\)](#) the radiative spin- $\frac{1}{2}$  and spin- $\frac{3}{2}$  wavefunctions are given by [\[12\]](#)

$$\begin{aligned} \psi_{\Delta, J=+\frac{1}{2}} &= o\varphi^\Delta, & \bar{\psi}_{\Delta, J=-\frac{1}{2}} &= \bar{o}\varphi^\Delta, \\ \chi_{\Delta, J=+\frac{3}{2}; \mu} &= m_\mu o\varphi^\Delta, & \bar{\chi}_{\Delta, J=-\frac{3}{2}; \mu} &= \bar{m}_\mu \bar{o}\varphi^\Delta, \end{aligned} \quad (7.9)$$

with the expressions on the left denoting left-handed spinors, while the ones on the right correspond to right-handed spinors. To simplify the notation we have omitted the spinor indices.

Related to the conformal primaries [\(7.8\)](#)-[\(7.9\)](#) via a shadow transform are wavefunctions of flipped and shifted conformal dimension and flipped spin. The scalar shadow wavefunction is given by

$$\tilde{\varphi}^\Delta = (-X^2)^{\Delta-1} \varphi^\Delta, \quad (7.10)$$

while we claimed in [\[12\]](#) that the shadow wavefunctions for spin- $\frac{1}{2}$  and spin- $\frac{3}{2}$  are given by [\[38\]](#)

$$\begin{aligned} \tilde{\psi}_{\Delta, J=-\frac{1}{2}} &= -\sqrt{2}\iota(-X^2)^{\Delta-\frac{3}{2}} \varphi^\Delta, & \tilde{\bar{\psi}}_{\Delta, J=+\frac{1}{2}} &= -\sqrt{2}\bar{\iota}(-X^2)^{\Delta-\frac{3}{2}} \varphi^\Delta, \\ \tilde{\chi}_{\Delta, J=-\frac{3}{2}; \mu} &= \sqrt{2}\bar{m}_\mu \iota(-X^2)^{\Delta-\frac{3}{2}} \varphi^\Delta, & \tilde{\bar{\chi}}_{\Delta, J=+\frac{3}{2}; \mu} &= \sqrt{2}m_\mu \bar{\iota}(-X^2)^{\Delta-\frac{3}{2}} \varphi^\Delta. \end{aligned} \quad (7.11)$$

We will explicitly verify the expressions [\(7.11\)](#) in an expansion near null infinity in appendix [C.4](#)

<sup>38</sup>We have chosen the normalization conventions of [\[45\]](#) which differ from those of [\[7, 12\]](#) by an overall sign in the  $s = \frac{1}{2}$  shadow wavefunctions.

## Generalized Conformal Primary Wavefunctions

Generalized bulk wavefunctions for half-integer spins  $s \leq |J|$  were discussed in [12, 45]. We focus here on the analytic wavefunctions built from the generalized scalar  $\varphi_\Delta^{gen} = f(X^2)\varphi^\Delta$ . For  $s = \frac{1}{2}$  they are given by

$$\psi_{\Delta, +\frac{1}{2}}^{gen} = o\varphi_\Delta^{gen}, \quad \psi_{\Delta, -\frac{1}{2}}^{gen} = \iota\varphi_\Delta^{gen}. \quad (7.12)$$

Enforcing the vacuum Weyl equation  $\bar{\sigma}^\mu \partial_\mu \psi_{\Delta, \pm\frac{1}{2}}^{gen} = 0$  yields the radiative conformal primary wavefunctions [7.9] and their shadows [7.11] for generic  $\Delta \in \mathbb{C}$  and  $J = \pm\frac{1}{2}$ . For  $s = \frac{3}{2}$  they are given by

$$\chi_{\Delta, +\frac{3}{2}; \mu}^{gen} = m_\mu o\varphi_\Delta^{gen}, \quad \chi_{\Delta, -\frac{3}{2}; \mu}^{gen} = \bar{m}_\mu \iota\varphi_\Delta^{gen}, \quad (7.13)$$

and

$$\chi_{\Delta, +\frac{1}{2}; \mu}^{gen} = l_\mu o\varphi_\Delta^{gen,1} + n_\mu o\varphi_\Delta^{gen,2} + m_\mu \iota\varphi_\Delta^{gen,3}, \quad \chi_{\Delta, -\frac{1}{2}; \mu}^{gen} = l_\mu \iota\varphi_\Delta^{gen,1} + n_\mu \iota\varphi_\Delta^{gen,2} + \bar{m}_\mu o\varphi_\Delta^{gen,3}, \quad (7.14)$$

where  $\varphi_\Delta^{gen,i} = f_i(X^2)\varphi^\Delta$ . Enforcing the chiral projection of the Rarita-Schwinger equation  $\varepsilon^{\mu\nu\rho\kappa} \bar{\sigma}_\nu \nabla_\rho \chi_{\Delta, J; \mu}^{gen} = 0$  as well as the gauge conditions

$$\nabla^\mu \chi_{\Delta, J; \mu}^{gen} = 0, \quad X^\mu \chi_{\Delta, J; \mu}^{gen} = 0, \quad \sigma^\mu \chi_{\Delta, J; \mu}^{gen} = 0, \quad (7.15)$$

yields the radiative conformal primary wavefunctions [7.9] and their shadows [7.11] for generic  $\Delta \in \mathbb{C}$  and  $J = \pm\frac{3}{2}$ , as well as a discrete set of solutions  $\Delta = \frac{5}{2}$  and  $J = \pm\frac{1}{2}$  which we will come back to in section [9]

## 7.2 Conformal Primary Operators

Given a 4D operator of spin- $s$  in the Heisenberg picture, we can define a 2D celestial CFT operator via a suitable inner product with the conformal primary wavefunctions. We need three ingredients: our primary wavefunctions, a bulk operator, and an appropriate inner product. We examined spinorial primary wavefunctions in the previous section, so let us move on to the operator mode expansions.

**Bulk Operator Mode Expansions** In the momentum basis, we have the following mode expansions for the spin- $\frac{1}{2}$  and spin- $\frac{3}{2}$  left-handed Weyl components of the Majorana fields. Parametrizing null momenta as  $k^\mu = \omega q^\mu$  we can express them as a product of spinor-helicity variables

$$k_{a\dot{a}} = \sigma_{a\dot{a}}^\mu k_\mu = -|k]_a \langle k|_{\dot{a}}, \quad (7.16)$$

where

$$|k]_a = \sqrt{\omega} [q]_a, \quad \langle k|_{\dot{a}} = \sqrt{\omega} \langle q|_{\dot{a}}, \quad (7.17)$$

with

$$|q]_a = \sqrt{q \cdot X} o_a, \quad \langle q|_{\dot{a}} = \sqrt{q \cdot X} \bar{o}_{\dot{a}}. \quad (7.18)$$

For the left-handed massless Weyl photino we have the mode expansion

$$\hat{\psi}_a(X) = e \int \frac{d^3 k}{(2\pi)^3} \frac{|k]_a}{2k^0} \left[ a_- e^{ik \cdot X} + a_+^\dagger e^{-ik \cdot X} \right], \quad (7.19)$$

while for the left-handed massless Weyl gravitino we have

$$\hat{\chi}_{\mu a}(X) = \kappa \int \frac{d^3 k}{(2\pi)^3} \frac{|k]_a}{2k^0} \epsilon_\mu^+ \left[ a_- e^{ik \cdot X} + a_+^\dagger e^{-ik \cdot X} \right]. \quad (7.20)$$

These mode operators obey the standard anti-commutation relations

$$\{a_{\pm}(k), a_{\pm}^{\dagger}(k')\} = (2\pi)^3 (2k^0) \delta^{(3)}(k - k'). \quad (7.21)$$

The opposite helicity modes are captured by the right-handed Weyl spinors.

**From Weyl to Dirac and Majorana Primaries** The spin  $s = \frac{1}{2}$  and  $\frac{3}{2}$  Weyl spinors corresponding to the photino and gravitino can be embedded into Dirac spinors

$$\Psi^{s=\frac{1}{2}} = \begin{pmatrix} \psi_a \\ \bar{\psi}^{\dot{a}} \end{pmatrix}, \quad \Psi_{\mu}^{s=\frac{3}{2}} = \begin{pmatrix} \chi_{\mu a} \\ \bar{\chi}_{\mu}^{\dot{a}} \end{pmatrix}, \quad (7.22)$$

on which we impose a Majorana condition (see appendix [A](#) for more details)

$$\bar{\psi}^{\dot{a}} = \varepsilon^{\dot{a}b} (\psi^{\dagger})_b, \quad \bar{\chi}_{\mu}^{\dot{a}} = \varepsilon^{\dot{a}b} (\chi^{\dagger})_{\mu b}. \quad (7.23)$$

The conformal primary wavefunctions of section [7.1](#) embed into Dirac spinors of definite conformal dimension and spin

$$\Psi_{\Delta, J}^{s=\frac{1}{2}} = \begin{pmatrix} \psi_{\Delta, J} \\ \bar{\psi}_{\Delta, J} \end{pmatrix}, \quad \Psi_{\Delta, J; \mu}^{s=\frac{3}{2}} = \begin{pmatrix} \chi_{\Delta, J; \mu} \\ \bar{\chi}_{\Delta, J; \mu} \end{pmatrix}, \quad (7.24)$$

where the component spinors are given by [7.9](#). Thus for fixed sign of the spin only one Weyl component is non-vanishing. Because these primaries obey

$$(\Psi_{\Delta, J})^C = \Psi_{\Delta^*, -J}, \quad (7.25)$$

where the charge conjugate  $\Psi^C$  is defined in [A.17](#), we can construct a Majorana primary for either  $s = \frac{1}{2}$  and  $\frac{3}{2}$  (omitting the spacetime index) as

$$\Psi_M(\Delta, J) = \Psi_{\Delta, J} + \Psi_{\Delta^*, -J}. \quad (7.26)$$

## Fermionic 2D Operators

With these ingredients, as well as the inner products which we review in appendix [C.7](#) we are now ready to construct fermionic primary operators generalizing the bosonic construction of [45,106](#). In terms of the Dirac spinors [7.24](#) we define the 2D fermionic operator

$$\mathbb{O}_{\Delta, J}^{s, \pm}(w, \bar{w}) \equiv i(\hat{\Psi}^s(X^\mu), \Psi_{\Delta^*, -J}(X_{\mp}^\mu; w, \bar{w})), \quad (7.27)$$

where  $\pm$  on the operator indicates whether it corresponds to an *in* or an *out* state. The inner products  $(\cdot, \cdot)$  for  $s = \frac{1}{2}$  and  $\frac{3}{2}$  Dirac spinors are given in [C.28](#) and [C.33](#), respectively. In terms of our Weyl spinors these take the explicit form

$$\mathbb{O}_{\Delta, J}^{s, \pm}(w, \bar{w}) = i \int d\Sigma_{\nu} \left( \psi_{\Delta, J}(X_{\pm}; w, \bar{w}) \sigma^{\nu} \hat{\psi}^{\dagger}(X) + \bar{\psi}_{\Delta, J}(X_{\pm}; w, \bar{w}) \bar{\sigma}^{\nu} \hat{\psi}(X) \right), \quad (7.28)$$

for the photino and

$$\mathbb{O}_{\Delta, J}^{s, \pm}(w, \bar{w}) = i \int d\Sigma_{\nu} \left( \chi_{\Delta, J; \mu}(X_{\pm}; w, \bar{w}) \sigma^{\nu} \hat{\chi}^{\dagger \mu}(X) + \bar{\chi}_{\Delta, J; \mu}(X_{\pm}; w, \bar{w}) \bar{\sigma}^{\nu} \hat{\chi}^{\mu}(X) \right), \quad (7.29)$$

for the gravitino, where we note that for fixed  $\Delta, J$  only one of the two terms in each expression will be non-zero. We will use  $\tilde{\mathbb{O}}_{\Delta, J}^{s, \pm}$  to denote the shadow operator constructed from [7.27](#) with [7.11](#) replacing [7.9](#) in the chiral Dirac spinor [7.24](#).

For integer spins  $s = 1, 2$  we showed in [106] that for certain values of  $\Delta$  the operators  $\mathbb{O}_{\Delta, J}^s(w, \bar{w})$  correspond to soft charges in the full (matter-coupled) theory when the Cauchy slice on which they are defined is taken to null infinity and the wavefunctions  $\Phi_{\Delta, J}^s$  are the Goldstone modes of the spontaneously broken asymptotic symmetries in gauge theory and gravity. Here, the operator (7.27) generates the shift<sup>39</sup>

$$\{\mathbb{O}_{\Delta, J}^{s, \pm}(w, \bar{w}), \hat{\Psi}^s(X)\} = i\Psi_{\Delta, J}^s(X_{\mp}; w, \bar{w}). \quad (7.30)$$

In section 9 we will show that the spin- $\frac{3}{2}$  operator (7.27) for certain values of  $\Delta$  corresponds to the soft charge for spontaneously broken large supersymmetry whose Ward identity is equivalent to the conformally soft gravitino theorem. Moreover, even in the absence of an asymptotic symmetry, we will identify (7.27) for  $s = \frac{1}{2}, \frac{3}{2}$  with soft charges associated to the conformally soft photino theorem and the subleading conformally soft gravitino theorem.

## 8 From Bulk to Boundary

Evaluating the fermionic 2D operators at null infinity requires knowing both the large- $r$  expansions of the 4D field operators and the conformal primary wavefunctions. Near  $\mathcal{I}^+$  we use retarded Bondi coordinates  $(u, r, z, \bar{z})$  which are related to the Cartesian coordinates  $(X^0, X^1, X^2, X^3)$  by the transformation

$$X^0 = u + r, \quad X^i = r\hat{X}^i(z, \bar{z}), \quad \hat{X}^i(z, \bar{z}) = \frac{1}{1 + z\bar{z}}(z + \bar{z}, i(\bar{z} - z), 1 - z\bar{z}), \quad (8.1)$$

which maps the line element to

$$ds^2 = -du^2 - 2dudr + 2r^2\gamma_{z\bar{z}}dzd\bar{z} \quad \text{with} \quad \gamma_{z\bar{z}} = \frac{2}{(1 + z\bar{z})^2}. \quad (8.2)$$

To discuss spinor fields we use the flat frame

$$e^0 = e_\mu^0 dX^\mu \equiv du + dr, \quad e^i = e_\mu^i dX^\mu \equiv \hat{X}^i dr + r\partial_z \hat{X}^i dz + r\partial_{\bar{z}} \hat{X}^i d\bar{z}, \quad (8.3)$$

for which the spin connection vanishes. The Gamma matrices in retarded Bondi coordinates are of the form  $\gamma_\mu \equiv e_\mu^0 \gamma_0 + e_\mu^i \gamma_i$  yielding

$$\gamma_u = \gamma_0, \quad \gamma_r = \gamma_0 + \hat{X}^i \gamma_i, \quad \gamma_z = r\partial_z \hat{X}^i \gamma_i, \quad \gamma_{\bar{z}} = r\partial_{\bar{z}} \hat{X}^i \gamma_i. \quad (8.4)$$

### 8.1 Operator Expansion

At the center of the equivalence between soft theorems and Ward identities of asymptotic symmetries lies the large- $r$  saddle point approximation

$$\lim_{r \rightarrow \infty} \sin \theta e^{i\omega q^0 r(1 - \cos \theta)} = \frac{i}{\omega q^0 r} \delta(\theta) + \mathcal{O}((\omega q^0 r)^{-2}), \quad (8.5)$$

which we use to evaluate the integrals (7.19)-(7.20) and their Hermitian conjugates. For spin- $\frac{1}{2}$  we have

$$\lim_{r \rightarrow \infty} r\hat{\psi} = -\frac{ie}{2(2\pi)^2} (1 + z\bar{z}) \int_0^\infty d\omega \omega^{\frac{1}{2}} \left[ a_-(\omega, z, \bar{z}) e^{-i\omega(1+z\bar{z})u} - a_+^\dagger(\omega, z, \bar{z}) e^{i\omega(1+z\bar{z})u} \right] |x], \quad (8.6)$$

<sup>39</sup>Recall that the mode operators are Grassmann valued while our conventions are such that the fermionic primary wavefunctions are not, as such one should multiply these generators by a Grassmann valued parameter to implement the supersymmetry transformations. See [52, 107, 109] for recent work on celestial superfields.

while for spin- $\frac{3}{2}$  we get

$$\lim_{r \rightarrow \infty} \hat{\chi}_{\bar{z}} = -\frac{i\kappa}{\sqrt{2}(2\pi)^2} \int_0^\infty d\omega \omega^{\frac{1}{2}} \left[ a_-(\omega, z, \bar{z}) e^{-i\omega(1+z\bar{z})u} - a_+^\dagger(\omega, z, \bar{z}) e^{i\omega(1+z\bar{z})u} \right] |x], \quad (8.7)$$

with the other components subleading. Replacing  $a_- \mapsto a_+$ ,  $a_+^\dagger \mapsto a_-^\dagger$  and  $|x]_a \mapsto |x]_{\dot{a}}$  yields the Hermitian conjugate Weyl spinors  $\hat{\psi}^\dagger$  and  $\hat{\chi}_{\bar{z}}^\dagger$  where we note that  $\epsilon_{\bar{z}}^+ = \epsilon_z^- = \frac{\sqrt{2}r}{1+z\bar{z}}$  while  $\epsilon_z^+ = \epsilon_{\bar{z}}^- = 0$ . The saddle point approximation has localized  $(w, \bar{w}) \mapsto (z, \bar{z})$  and we have introduced

$$|x]_a = \sqrt{2} \begin{pmatrix} \bar{z} \\ -1 \end{pmatrix}, \quad |x]_{\dot{a}} = -\sqrt{2} \begin{pmatrix} 1 \\ z \end{pmatrix}. \quad (8.8)$$

The above expressions (8.6)-(8.7) give the bulk operators near null infinity using a momentum basis mode expansion. The creation and annihilation operators with definite  $(\Delta, J)$  are obtained from  $a_\pm$  and  $a_\pm^\dagger$  via a Mellin transform

$$a_{\Delta, \pm s} = \int_0^\infty d\omega \omega^{\Delta-1} a_\pm(\omega), \quad a_{\Delta, \mp s}^\dagger = \int_0^\infty d\omega \omega^{\Delta-1} a_\pm^\dagger(\omega), \quad (8.9)$$

while the inverse Mellin transform

$$a_\pm(\omega) = \frac{1}{2\pi} \int_{1-i\infty}^{1+i\infty} (-id\Delta) \omega^{-\Delta} a_{\Delta, \pm s}, \quad a_\pm^\dagger(\omega) = \frac{1}{2\pi} \int_{1-i\infty}^{1+i\infty} (-id\Delta) \omega^{-\Delta} a_{\Delta, \pm s}^\dagger, \quad (8.10)$$

takes us back to the momentum basis. We have labeled both the creation and annihilation Mellin operators with the  $\Delta$  and  $J$  of the corresponding state on the celestial sphere.

## 8.2 Wavefunction Expansion

Finally, we need the expansion of the conformal primary wavefunctions near null infinity in order to evaluate the 2D operators and identify them for special values of  $\Delta$  with soft charges. To obtain the large  $r$  expansion for the fermions we note that the components of the spin frame can be written in terms of the scalar primary as

$$o = \sqrt{2}i\varphi^{\frac{1}{2}} \begin{pmatrix} \bar{w} \\ -1 \end{pmatrix}, \quad \iota = i\varphi^{\frac{1}{2}} \left[ 2r \frac{z-w}{1+z\bar{z}} \begin{pmatrix} \bar{z} \\ -1 \end{pmatrix} + u \begin{pmatrix} 1 \\ w \end{pmatrix} \right], \quad (8.11)$$

while the relevant tetrad vector components can be expressed as

$$m_z = -\sqrt{2}r(2r+u)\varphi^1 \frac{(\bar{z}-\bar{w})^2}{(1+z\bar{z})^2}, \quad m_{\bar{z}} = \sqrt{2}ru\varphi^1 \frac{(1+z\bar{w})^2}{(1+z\bar{z})^2}, \quad (8.12)$$

with the expressions for  $\bar{m}$  following from complex conjugation. The behavior near null infinity of the fermionic conformal primaries is thus dictated by the large- $r$  expansion of the scalar wavefunction. For the Mellin transformed plane wave the saddle-point approximation gives

$$\lim_{r \rightarrow \infty} \int_0^\infty d\omega \omega^{\Delta-1} e^{\pm i\omega q \cdot X - \varepsilon \omega(1+z\bar{z})} = r^{-1} \frac{u^{1-\Delta} \Gamma(\Delta-1)}{(\pm i)^\Delta (1+z\bar{z})^{\Delta-2}} \pi \delta^{(2)}(z-w) + \mathcal{O}(r^{-2}), \quad (8.13)$$

which implies for the scalar primary

$$\lim_{r \rightarrow \infty} \varphi^\Delta \Big|_{z=w} = r^{-1} \frac{u^{1-\Delta}}{\Delta-1} (1+z\bar{z})^{2-\Delta} \pi \delta^{(2)}(z-w) + \mathcal{O}(r^{-2}). \quad (8.14)$$

Note that the  $\omega$  integral in (8.13) converges so long as  $\text{Re}(\Delta) > 1$ , and we have taken the large  $r$  limit before integrating over  $\omega$ . Going from the plane wave to the conformal basis first it is easy to see that away from  $z = w$  we have the expansion

$$\lim_{r \rightarrow \infty} \varphi^\Delta \Big|_{z \neq w} = \left( \frac{1+z\bar{z}}{2(z-w)(\bar{z}-\bar{w})} \right)^\Delta r^{-\Delta} + \mathcal{O}(r^{-\Delta-1}), \quad (8.15)$$

which for  $\text{Re}(\Delta) < 1$  is leading compared to the contact term (8.13). For  $\text{Re}(\Delta) = 1$  the above expressions contribute at the same order<sup>40</sup> For the shadow transformed scalar primary (7.10) the roles of the contact and non-contact terms are reversed. Using  $-X^2 = u(2r + u)$  we find

$$\lim_{r \rightarrow \infty} \tilde{\varphi}^\Delta \Big|_{z=w} = r^{\Delta-2} \frac{2^{\Delta-1}}{\Delta-1} (1+z\bar{z})^{2-\Delta} \pi \delta^{(2)}(z-w) + \mathcal{O}(r^{\Delta-3}), \quad (8.16)$$

with the  $\omega$ -integral (8.13) again converging so long as  $\text{Re}(\Delta) > 1$ , while

$$\lim_{r \rightarrow \infty} \tilde{\varphi}^\Delta \Big|_{z \neq w} = r^{-1} u^{-1+\Delta} \frac{1}{2} \left( \frac{1+z\bar{z}}{(z-w)(\bar{z}-\bar{w})} \right)^\Delta + \mathcal{O}(r^{-2}). \quad (8.17)$$

Notice that at generic points ( $z \neq w$ ) the shadow primaries have the standard radiative fall offs near null infinity, e.g.  $\sim 1/r$  for scalar wavefunctions and this continues to hold for non-zero spin. Meanwhile the contact terms of the non-shadowed primaries are of radiative order.

The above ingredients determine the large- $r$  behavior of the photino and gravitino and their shadow transforms (see appendix C.4 for their detailed expressions). In particular, the photino arises from the scalar with conformal dimension shifted by  $\frac{1}{2}$  while the gravitino is proportional to the scalar with conformal dimension shifted by  $\frac{3}{2}$ . In section 9 and 10 we will be interested in the large- $r$  behavior for special half-integer values of the conformal dimension. For the leading conformally soft gravitino with  $\Delta = \frac{1}{2}$  both contact and non-contact terms will appear at the same order and yield finite contributions, while for the conformally soft photino with  $\Delta = \frac{1}{2}$  and the subleading conformally soft gravitino  $\Delta = -\frac{1}{2}$  the contact terms have simple poles, respectively,  $\frac{1}{\Delta-\frac{1}{2}}$  and  $\frac{1}{\Delta+\frac{1}{2}}$ .

### 8.3 Extrapolate-Style Dictionary for Fermions

We close this section by commenting on an extrapolate-style dictionary for fermions. Notice that states of definite conformal dimension are prepared with bulk operators integrated along a light ray of the form

$$\mathbb{O}_{\Delta,+\frac{1}{2}}^{\frac{1}{2},-} \propto \lim_{r \rightarrow \infty} r \int du u_+^{-\Delta+\frac{1}{2}} \hat{\psi}(u, r, z, \bar{z}), \quad \mathbb{O}_{\Delta,+\frac{3}{2}}^{\frac{3}{2},-} \propto \lim_{r \rightarrow \infty} \int du u_+^{-\Delta+\frac{1}{2}} \hat{\chi}_{\bar{z}}(u, r, z, \bar{z}), \quad (8.18)$$

for the  $+$  helicity modes, and similarly with the  $z$  component for the  $-$  helicity modes. Here we have defined  $u_{\pm} = u \pm i\epsilon$ . We note that a cancellation of phases selects the annihilation or creation operator in the integrals, namely

$$\int_{-\infty}^{\infty} du u_+^{-\Delta+\frac{1}{2}} \int_0^{\infty} d\omega \omega^{\frac{1}{2}} \left[ a_{\pm} e^{-i\omega(1+z\bar{z})u} - a_{\mp}^{\dagger} e^{i\omega(1+z\bar{z})u} \right] = \frac{2\pi(1+z\bar{z})^{\Delta-\frac{3}{2}}}{i^{\Delta-\frac{1}{2}} \Gamma(\Delta-\frac{1}{2})} a_{\Delta,\pm s}, \quad (8.19)$$

and

$$\int_{-\infty}^{\infty} du u_-^{-\Delta+\frac{1}{2}} \int_0^{\infty} d\omega \omega^{\frac{1}{2}} \left[ a_{\pm} e^{-i\omega(1+z\bar{z})u} - a_{\mp}^{\dagger} e^{i\omega(1+z\bar{z})u} \right] = -\frac{2\pi(1+z\bar{z})^{\Delta-\frac{3}{2}}}{(-i)^{\Delta-\frac{1}{2}} \Gamma(\Delta-\frac{1}{2})} a_{\Delta,\pm s}^{\dagger}. \quad (8.20)$$

Light ray operators at future (past) null infinity (with an appropriate analytic continuation off the real manifold) thus create the *out* (*in*) states from the vacuum. For example, the standard outgoing momentum eigenstates of a positive helicity photino is prepared via

$$\langle p, + | \propto \lim_{r \rightarrow \infty} r \int du e^{i\omega(1+z\bar{z})u} \langle 0 | \hat{\psi}, \quad (8.21)$$

where  $p_{\mu} = \omega q_{\mu}(z, \bar{z})$ . Here we are concerned with the state in the Hilbert space. The right hand side is also proportional to the spinor  $|p\rangle$ , which we can remove by contracting with  $\frac{1}{\omega(1+z\bar{z})} \langle p | \bar{\sigma}_u$ . Its analog for an outgoing boost eigenstate of  $\text{SL}(2, \mathbb{C})$

<sup>40</sup>The appearance of similar ‘‘resonances’’ were discussed e.g. in 110.

spin  $J = +\frac{1}{2}$  is

$$\langle \Delta, z, \bar{z}, + | \infty \lim_{r \rightarrow \infty} r \int du u_+^{-\Delta + \frac{1}{2}} \langle 0 | \hat{\psi}(u_+, r, z, \bar{z}) \rangle. \quad (8.22)$$

Similar expressions are obtained for the outgoing state of the gravitino with  $J = +\frac{3}{2}$ .

## 9 Large Supersymmetry and Conformally Soft Gravitino

In this section we investigate the celestial diamond corresponding to the leading soft gravitino theorem and large supersymmetry transformations. Recall that the massless Rarita-Schwinger equation has a fermionic gauge symmetry. Namely, it is invariant under the gauge transformation

$$\Psi_\mu \mapsto \Psi_\mu + \nabla_\mu \lambda, \quad (9.1)$$

where  $\lambda$  is an anti-commuting spinor. This is the local supersymmetry of supergravity<sup>41</sup> When the asymptotic behavior of  $\lambda$  is such that the inhomogeneous shift goes to an arbitrary function in  $(z, \bar{z})$  near null infinity, the gauge transformation (9.1) corresponds to a (spontaneously broken) *large* supersymmetry transformation and the Goldstino is the (conformally) soft gravitino.

### 9.1 Leading Conformally Soft Gravitino

For conformal dimension  $\Delta = \frac{1}{2}$  the left-handed conformal primary wavefunction with  $J = +\frac{3}{2}$  reduces to pure gauge (12 45)

$$\chi_{\frac{1}{2}, +\frac{3}{2}; \mu}^G = \nabla_\mu \Lambda_{\frac{1}{2}, +\frac{3}{2}}, \quad \Lambda_{\frac{1}{2}, +\frac{3}{2}} = (\epsilon_+ \cdot X) o \varphi^{\frac{1}{2}}. \quad (9.2)$$

Besides the harmonic and radial gauge conditions,  $\nabla_\mu \chi_\nu = 0$  and  $X^\mu \chi_\mu = 0$ , the conformally soft gravitino (9.2) satisfies the gauge condition  $\sigma^\mu \chi_\mu = 0$  (111). At future null infinity its angular components take the form

$$\chi_{\frac{1}{2}, +\frac{3}{2}; z}^G = \frac{-i}{(z-w)^2} \begin{pmatrix} \bar{w} \\ -1 \end{pmatrix}, \quad \chi_{\frac{1}{2}, +\frac{3}{2}; \bar{z}}^G = 2\pi i \delta^{(2)}(z-w) \begin{pmatrix} \bar{w} \\ -1 \end{pmatrix}, \quad (9.3)$$

while its temporal and radial components behave, respectively, as  $\mathcal{O}(1/r)$  and  $\mathcal{O}(1/r^2)$ . Hence the gravitino wavefunction  $\chi_{\frac{1}{2}, +\frac{3}{2}; \mu}^G$  obeys the standard fall-off conditions and obviously has vanishing ‘field strength’  $f_{\mu\nu} = \nabla_\mu \chi_\nu - \nabla_\nu \chi_\mu$ . Comparing this to (9.1) we recognize the  $(\Delta, J) = (\frac{1}{2}, +\frac{3}{2})$  gravitino (9.3) as the Goldstino for spontaneously broken large supersymmetry.

Related to the conformally soft gravitino (9.2) by a shadow transform is the conformal shadow primary of spin  $J = -\frac{3}{2}$  and conformal dimension  $\Delta = \frac{3}{2}$  which also reduces to pure gauge, albeit with a more complicated potential,

$$\tilde{\chi}_{\frac{3}{2}, -\frac{3}{2}; \mu}^G = \nabla_\mu \Lambda_{\frac{3}{2}, -\frac{3}{2}}, \quad \Lambda_{\frac{3}{2}, -\frac{3}{2}} = \sqrt{2} ((\epsilon_- \cdot X) \iota - \frac{1}{2} (\epsilon_- \cdot X)^2 o) \varphi^{\frac{3}{2}}, \quad (9.4)$$

<sup>41</sup>We assume a purely bosonic asymptotically flat background and have dropped the corresponding transformation on the frame field. Note that while the spinor  $\lambda$  here is anti-commuting, in the rest of the section we restrict to commuting component spinors which should be dressed with Grassmann variables to compare to (9.1).



and satisfies the harmonic and radial gauge condition as well as  $\bar{\sigma}^\mu \tilde{\chi}_\mu = 0$ . At future null infinity its angular components take the form<sup>42</sup>

$$\tilde{\chi}_{\frac{3}{2}, -\frac{3}{2}; z}^G = \pi i \delta^{(2)}(z-w) \begin{pmatrix} 1 \\ 0 \end{pmatrix} - \pi i \partial_{\bar{z}} \delta^{(2)}(z-w) \begin{pmatrix} \bar{z} \\ -1 \end{pmatrix}, \quad \tilde{\chi}_{\frac{3}{2}, -\frac{3}{2}; \bar{z}}^G = \frac{-i}{(\bar{z}-\bar{w})^3} \begin{pmatrix} \bar{z} \\ -1 \end{pmatrix}, \quad (9.5)$$

while its temporal and radial components behave, respectively, as  $\mathcal{O}(1/r)$  and  $\mathcal{O}(1/r^2)$  and the ‘field strength’ again vanishes. We recognize the  $(\Delta, J) = (\frac{3}{2}, -\frac{3}{2})$  gravitino (9.5) as the (shadow) Goldstino for spontaneously broken large supersymmetry.

## 9.2 Celestial Gravitino Diamond

The conformally soft gravitinos (9.2) and (9.4) form the left and right corners of the celestial gravitino diamond shown in figure 11 and descend to the same generalized conformal primary at the bottom of the diamond

$$\partial_w \tilde{\chi}_{\frac{3}{2}, -\frac{3}{2}}^G = \chi_{\frac{5}{2}, -\frac{1}{2}}^{gen, G} = \frac{1}{2!} \partial_{\bar{w}}^2 \chi_{\frac{1}{2}, +\frac{3}{2}}^G. \quad (9.6)$$

We can complete the diamond at the top corner with a generalized conformal primary wavefunction that descends to the radiative conformal primaries<sup>43</sup>

$$\tilde{\chi}_{\frac{3}{2}, -\frac{3}{2}}^G = \frac{1}{2!} \partial_{\bar{w}}^2 \chi_{-\frac{1}{2}, +\frac{1}{2}}^{gen, G}, \quad \chi_{\frac{1}{2}, +\frac{3}{2}}^G = \partial_w \chi_{-\frac{1}{2}, +\frac{1}{2}}^{gen, G}. \quad (9.7)$$

This is summarized in table 1

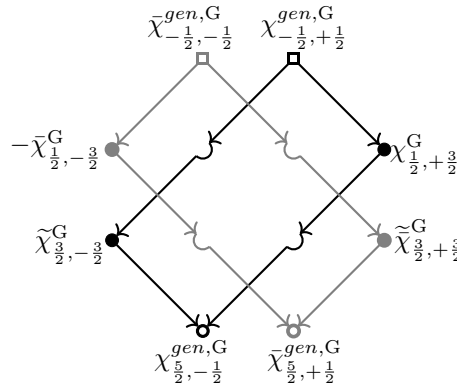

Figure 11: Goldstino diamond for the leading soft gravitino theorem [45].

## 9.3 Soft Charge for Large Supersymmetry

In the language of the covariant phase space formalism, computing the soft part of the large supersymmetry charge amounts to computing the symplectic structure for a generic gravitino perturbation with radiative fall-offs at null infinity and the Goldstino associated to large supersymmetry. This corresponds to the 2D operator (7.27) for (7.29) with the conformally soft

<sup>42</sup>Using (C.15) it is straightforward to check that the leading  $z$  component in the large- $r$  expansion of (9.4) is the shadow transform of (9.2), while to show this for the  $\bar{z}$  component it is convenient to write (9.2) as a sum over (derivatives of) conformal integrals and use (C.16) to solve them.

<sup>43</sup>The ambiguity in defining the top corner is discussed in [45].

Corner	$\Delta$	$J$	$\chi_{\Delta,J}^G$	$\Lambda_{\Delta,J}$
Top	$-\frac{1}{2}$	$+\frac{1}{2}$	$\frac{1}{\sqrt{2}} ol_\mu \varphi^{-\frac{1}{2}}$	$-\frac{1}{\sqrt{2}} o \varphi^{-\frac{1}{2}} \log \varphi^{-1}$
Left	$\frac{3}{2}$	$-\frac{3}{2}$	$\sqrt{2} l \bar{m}_\mu \varphi^{\frac{3}{2}}$	$\frac{1}{2!} \partial_{\bar{w}}^2 \Lambda_{-\frac{1}{2},+\frac{1}{2}}$
Right	$\frac{1}{2}$	$+\frac{3}{2}$	$om_\mu \varphi^{\frac{1}{2}}$	$\partial_w \Lambda_{-\frac{1}{2},+\frac{1}{2}}$
Bottom	$\frac{5}{2}$	$-\frac{1}{2}$	$2 \left[ \left( \frac{X^2}{2} l_\mu + n_\mu \right) \iota + \frac{X^2}{2} o \bar{m}_\mu \right] \varphi^{\frac{5}{2}}$	$\frac{1}{2!} \partial_w \partial_{\bar{w}}^2 \Lambda_{-\frac{1}{2},+\frac{1}{2}}$

Table 1: Elements of the celestial diamond corresponding to large supersymmetry [12, 45].

gravitinos (9.3) or (9.5).<sup>44</sup> For the left handed Goldstino diamond, only the first term in (7.29) contributes and we have (omitting the  $s$  label)

$$\mathcal{O}_{\Delta,J} = i \int dud^2z \hat{\chi}_z^{\dagger(0)} \sigma_u \chi_{\Delta,J;\bar{z}}^G, \quad (9.9)$$

generating the shift (7.30). This yields  $\mathcal{O}_{\frac{1}{2},+\frac{3}{2}}$  for the Goldstino

$$\chi_{\frac{1}{2},+\frac{3}{2},\bar{z}}^G = 2\pi i \delta^{(2)}(z-w) \begin{pmatrix} \bar{w} \\ -1 \end{pmatrix}, \quad (9.10)$$

which establishes the equivalence between the large supersymmetry Ward identity and the (conformally) soft gravitino theorem [52]. We see this as follows. After using the inverse Mellin transform to express the creation and annihilation operators in (8.7) in terms of  $a_{\Delta,+\frac{3}{2}}(z,\bar{z})$  and  $a_{\Delta,+\frac{3}{2}}^\dagger(z,\bar{z})$ , the  $\omega$ -integral takes the form

$$\int_0^\infty d\omega \omega^{\frac{1}{2}-\Delta} e^{\pm i\omega(1+z\bar{z})u_\pm} = (\mp i)^{\Delta-\frac{3}{2}} \Gamma(\frac{3}{2}-\Delta) u_\pm^{\Delta-\frac{3}{2}} (1+z\bar{z})^{\Delta-\frac{3}{2}}, \quad (9.11)$$

where we analytically continue  $u \mapsto u_\pm = u \pm i\varepsilon$  to guarantee convergence. Then using the generalized distribution [106]

$$\int_0^\infty du u^{\Delta-\frac{3}{2}} = 2\pi \delta(i(\Delta-\frac{1}{2})), \quad (9.12)$$

we find that the  $u$ -integrals in the soft charge  $\mathcal{O}_{\Delta,J}$  for  $\Delta = \frac{1}{2}$ ,  $J = +\frac{3}{2}$  gives<sup>45</sup>

$$\int_0^\infty d\omega \omega^{\frac{1}{2}} a_+(\omega) \int_{-\infty}^{+\infty} du e^{-i\omega(1+z\bar{z})u_-} = \pi \lim_{\Delta \rightarrow \frac{1}{2}} (\Delta - \frac{1}{2}) a_{\Delta,+\frac{3}{2}} (1+z\bar{z})^{-1}, \quad (9.13)$$

and

$$\int_0^\infty d\omega \omega^{\frac{1}{2}} a_-^\dagger(\omega) \int_{-\infty}^{+\infty} du e^{+i\omega(1+z\bar{z})u_+} = \pi \lim_{\Delta \rightarrow \frac{1}{2}} (\Delta - \frac{1}{2}) a_{\Delta,+\frac{3}{2}}^\dagger (1+z\bar{z})^{-1}. \quad (9.14)$$

<sup>44</sup>See appendix C.8 for details. Comparing to the results of appendix C.7 we see that

$$\mathcal{O}_{\Delta,J}^{s,\pm}(w,\bar{w}) \equiv i(\hat{\Psi}^s(X^\mu), \Psi_{\Delta^*,-J}^s(X_{\mp}^\mu; w,\bar{w})) = \Omega(\hat{\Psi}^s(X^\mu), \Psi_{\Delta,J}^s(X_{\pm}^\mu; w,\bar{w})), \quad (9.8)$$

after an appropriate complexification of the symplectic product to allow pairings between the Majorana field operators and the primaries (7.24).

<sup>45</sup>Setting  $\Delta = \frac{1}{2}$  before evaluating the integral in (8.18) gives the same factor of  $\frac{1}{2}$  that was encountered in the Ward identity papers [88]. This is effectively taking the average of the  $u_+$  and  $u_-$  integrals, giving us both positive and negative frequency contributions for the gravitino zero modes.

Plugging this into [\(9.9\)](#) and integrating over  $(z, \bar{z})$  yields the soft charge

$$\mathbb{O}_{\frac{1}{2}, +\frac{3}{2}}(w, \bar{w}) = \frac{i\kappa}{2} \lim_{\Delta \rightarrow \frac{1}{2}} (\Delta - \frac{1}{2}) (a_{\Delta, +\frac{3}{2}} - a_{\Delta, +\frac{3}{2}}^\dagger). \quad (9.15)$$

Meanwhile, the 2D operator  $\tilde{\mathbb{O}}_{\frac{3}{2}, -\frac{3}{2}}(w, \bar{w})$  obtained from [\(9.9\)](#) for the  $\Delta = \frac{3}{2}$  shadow Goldstino

$$\tilde{\chi}_{\frac{3}{2}, -\frac{3}{2}; \bar{z}}^G = \frac{-i}{(\bar{z} - \bar{w})^3} \begin{pmatrix} \bar{z} \\ -1 \end{pmatrix}, \quad (9.16)$$

gives rise to the  $(h, \bar{h}) = (0, \frac{3}{2})$  supercurrent.

This is similar to the situation in gravity where<sup>46</sup> the  $\Delta = 0$  Goldstone mode  $N_{0, +2; \bar{z}\bar{z}}^G = -2\pi\delta^{(2)}(z - w)$  generating  $\text{Diff}(S^2)$  symmetry yields equivalence with the subleading (conformally) soft graviton theorem while the  $\Delta = 2$  shadow Goldstone mode  $\tilde{N}_{2, -2; \bar{z}\bar{z}}^G = -\frac{1}{(\bar{z} - \bar{w})^4}$  gives rise to the  $(h, \bar{h}) = (0, 2)$  stress tensor [\[106\]](#). The soft charges generated by these superrotation and  $\text{Diff}(S^2)$  modes were shown to be related by a 2D shadow transform in celestial CFT. Here, similarly, the soft charges for the Goldstinos [\(9.10\)](#) and [\(9.16\)](#) are related by the shadow transform [\(C.15\)](#) as

$$\tilde{\mathbb{O}}_{\frac{3}{2}, -\frac{3}{2}}(w, \bar{w}) = \frac{1}{2\pi} \int d^2w' \frac{1}{(\bar{w} - \bar{w}')^3} \mathbb{O}_{\frac{1}{2}, +\frac{3}{2}}(w', \bar{w}'), \quad (9.17)$$

and the inverse

$$\mathbb{O}_{\frac{1}{2}, +\frac{3}{2}}(w, \bar{w}) = -\frac{1}{\pi} \int d^2w' \frac{(\bar{w} - \bar{w}')}{(w - w')^2} \tilde{\mathbb{O}}_{\frac{3}{2}, -\frac{3}{2}}(w', \bar{w}'). \quad (9.18)$$

## 9.4 Soft Operator in the Gravitino Diamond

Starting from [\(9.15\)](#), we see much like the superrotation/ $\text{Diff}(S^2)$  case that one of the corners of the diamond is isomorphic to the soft theorem. We can use descendanty relations to take us to the bottom corner of the diamond. Letting

$$[\mathbb{O}_{soft}]_{\bar{z}}^a = -\frac{\pi}{\sqrt{2}} D_{\bar{z}}^2 \int du \tilde{\chi}_{z\bar{c}}^\dagger \bar{\sigma}_u^{\dot{c}a}, \quad (9.19)$$

we construct the object<sup>47</sup>

$$\mathbb{Q}(\eta) = \int d^2z [\mathbb{O}_{soft}|\eta], \quad (9.20)$$

where we suppress the tensor index contractions between the soft operator [\(9.19\)](#) and spinor  $\eta_{\dot{a}}^{\bar{z}}$  since  $\eta_{\dot{a}}^z = 0$ . In terms of the creation and annihilation operators

$$\begin{aligned} [\mathbb{O}_{soft}|x] &= \frac{i\kappa}{8} \lim_{\Delta \rightarrow \frac{1}{2}} (\Delta - \frac{1}{2}) D_{\bar{z}}^2 \left[ (1 + z\bar{z})^{-1} (a_{\Delta, +\frac{3}{2}} - a_{\Delta, +\frac{3}{2}}^\dagger) \langle x | \bar{\sigma}_u \right], \\ &= \frac{i\kappa}{8} \lim_{\Delta \rightarrow \frac{1}{2}} (\Delta - \frac{1}{2}) (1 + z\bar{z})^{-1} \partial_{\bar{z}}^2 \left[ (a_{\Delta, +\frac{3}{2}} - a_{\Delta, +\frac{3}{2}}^\dagger) \right] \langle x | \bar{\sigma}_u. \end{aligned} \quad (9.21)$$

We see that the operator  $[\mathbb{O}_{soft}|x]$  is a level-2 primary descendant operator with  $\Delta = \frac{5}{2}$  and  $J = -\frac{1}{2}$ , and the smeared operator [\(9.20\)](#) gives the fermionic analogue of the charge operators of [\[104, 105, 112\]](#). Much like the spin-1 and spin-2 cases studied in [\[113\]](#) the spacetime descendants on the round sphere map to flattened celestial sphere descendants of the Mellin transformed modes.

<sup>46</sup>The Bondi news is  $N_{AB} = \lim_{r \rightarrow \infty} \frac{1}{r} \partial_u h_{AB}$ .

<sup>47</sup>Note our definition of  $\mathbb{Q}$  absorbs the measure coming from the round sphere metric into  $[\mathbb{O}_{soft}]_{\bar{z}}$ . The index structure of the right-hand side of [\(9.19\)](#) follows the convention of [\[91\]](#) where  $\sqrt{\gamma} = \gamma_{z\bar{z}}$  is used to simplify notation.

Moreover, we see from [9.21](#) that

$$\mathbb{Q}\left(\frac{\bar{w}-\bar{z}}{w-z}|x\right)=\pi\mathbb{O}_{\frac{1}{2},+\frac{3}{2}}, \quad \mathbb{Q}\left(\frac{1}{\bar{w}-\bar{z}}|x\right)=2\pi\tilde{\mathbb{O}}_{\frac{3}{2},-\frac{3}{2}}, \quad (9.22)$$

while

$$\mathbb{Q}(\delta^{(2)}(z-w)|x)=\partial_w\tilde{\mathbb{O}}_{\frac{3}{2},-\frac{3}{2}}=\frac{1}{2!}\partial_w^2\mathbb{O}_{\frac{1}{2},+\frac{3}{2}}. \quad (9.23)$$

This form of the charge where  $\eta=\varepsilon(z,\bar{z})|x$  is consistent with that of [111](#) [114](#). We are able to use  $\eta$  with such a simple form because there are various kernels of the integrated charge [9.20](#) coming from the kernels of the descendanty relations of the celestial diamond, as well as that of the spinor product<sup>48</sup>

The soft operator lies at the bottom of the leading soft gravitino memory diamonds, conveniently captured by the following diagram.

$$\begin{array}{c} \mathbb{O}_{-\frac{1}{2},+\frac{1}{2}} \\ \swarrow \quad \searrow \\ \tilde{\mathbb{O}}_{\frac{3}{2},-\frac{3}{2}} = \frac{1}{2!}\partial_w^2\mathbb{O}_{-\frac{1}{2},+\frac{1}{2}} \quad \mathbb{O}_{\frac{1}{2},+\frac{3}{2}} = \partial_w\mathbb{O}_{-\frac{1}{2},+\frac{1}{2}} \\ \searrow \quad \swarrow \\ [\mathbb{O}_{soft}|x]_{\frac{3}{2},-\frac{1}{2}} \end{array} \quad (9.27)$$

As shown in the diagram, from the definitions of the large supersymmetry current and its shadow we can formally write  $\tilde{\mathbb{O}}_{\frac{3}{2},-\frac{3}{2}}$  and  $\mathbb{O}_{\frac{1}{2},+\frac{3}{2}}$  as descendants of  $\mathbb{O}_{-\frac{1}{2},+\frac{1}{2}}$ , a generalized primary operator with conformal dimension  $\Delta=-\frac{1}{2}$  and spin  $J=+\frac{1}{2}$  that lies at the top of the gravitino memory diamond. This operator is formally defined via

$$\mathbb{O}_{-\frac{1}{2},+\frac{1}{2}}=i(\hat{\Psi}^s, \Psi_{\frac{1}{2},-\frac{1}{2}}^{s=\frac{3}{2}}), \quad \Psi_{\frac{1}{2},-\frac{1}{2}}^{s=\frac{3}{2}}=\begin{pmatrix} 0 \\ \frac{1}{\sqrt{2}}\partial_l\mu\varphi^{-\frac{1}{2}} \end{pmatrix}. \quad (9.28)$$

This operator is strictly speaking not part of the spectrum but its role is important for the theory, e.g. it can be used to define the other primary operators and (primary) descendants in the theory – see [45](#) [113](#) for a related discussion.

We close this section by noting that the the spin  $1, \frac{3}{2}$  and 2 symmetry currents

$$\tilde{\mathbb{O}}_{1,-1}, \tilde{\mathbb{O}}_{\frac{3}{2},-\frac{3}{2}}, \tilde{\mathbb{O}}_{2,-2}, \quad (9.29)$$

corresponding to large U(1), large SUSY and superrotation symmetry, respectively, all have the same symmetry parameter  $\propto\frac{1}{\bar{z}-\bar{w}}$  (called  $\varepsilon$  and  $Y^z$  for spin 1 and 2 in [113](#) and  $\eta$  for spin  $\frac{3}{2}$  above), for their appropriately normalized charges, since their first  $\partial_w$  descendants are the respective soft charges. We will investigate the relationship between the descendanty relations in celestial diamonds and the spin-shifting relations of SUSY in section [11](#)

<sup>48</sup>Note that the gauge potential of the conformally soft gravitino [9.2](#) at null infinity can indeed be written as

$$\Lambda_{\frac{1}{2},+\frac{3}{2}}|_{\mathcal{I}^+}\simeq D_A\eta_+^A, \quad \eta_+^z=0, \quad \eta_+^{\bar{z}}=i\frac{\bar{z}-\bar{w}}{z-w}\frac{1+z\bar{z}}{1+w\bar{w}}\begin{pmatrix} \bar{w} \\ -1 \end{pmatrix}, \quad (9.24)$$

where the equivalence is up to the kernel of the sphere derivatives giving  $\chi_A$ . The angular components of the Goldstino can then be expressed as

$$\chi_{\frac{1}{2},+\frac{3}{2};z}^G=D_zD_{\bar{z}}\eta_+^{\bar{z}}, \quad \chi_{\frac{1}{2},+\frac{3}{2};\bar{z}}^G=D_{\bar{z}}^2\eta_+^{\bar{z}}. \quad (9.25)$$

The soft charge [9.9](#) takes the form

$$\mathbb{O}_{\frac{1}{2},+\frac{3}{2}}=i\int dud^2zD_{\bar{z}}^2\hat{\chi}_z^{\dagger(0)}\bar{\sigma}_u\eta_+^{\bar{z}}. \quad (9.26)$$

## 10 Soft Charges without Goldstinos

In this section we examine the degenerate celestial diamonds corresponding to the soft photino<sup>49</sup> and subleading soft gravitino.

### 10.1 Conformally Soft Photino

The conformally soft spin  $s = \frac{1}{2}$  Weyl spinor  $\psi_{\frac{1}{2},+\frac{1}{2}}$  and its shadow  $\tilde{\psi}_{\frac{3}{2},-\frac{1}{2}}$  correspond to the zero-area celestial diamonds shown in figure 12. Using appendix C.8 we can write a 2D operator analogous to the soft charge (9.9). Namely, evaluating

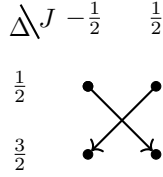

Figure 12: Photino ‘diamonds’.

expression (C.48) at null infinity yields

$$\mathbb{G}_{\frac{1}{2},+\frac{1}{2}} = i \int_{\mathbb{I}^+} dud^2z \sqrt{\gamma} \left[ \hat{\psi}^{\dagger(1)} \sigma_u \psi_{\frac{1}{2},+\frac{1}{2}}^{(1)} \right], \quad (10.1)$$

where the superscript on the photinos indicates the coefficient of the  $r^{-1}$  term in their large- $r$  expansions. The form of (10.1) is consistent with the soft charge in (115). At coincident points on the celestial sphere the contribution from the conformally soft photino is

$$\psi_{\frac{1}{2},+\frac{1}{2}}^{(1)} \Big|_{z=w} = i\pi \lim_{\Delta \rightarrow \frac{1}{2}} \frac{u^{\frac{1}{2}-\Delta}}{\Delta - \frac{1}{2}} (1 + z\bar{z}) \delta^{(2)}(z-w) |x], \quad (10.2)$$

while at non-coincident we have

$$\psi_{\frac{1}{2},+\frac{1}{2}}^{(1)} \Big|_{z \neq w} = \frac{i}{2} \frac{1 + z\bar{z}}{(z-w)(\bar{z}-\bar{w})} |q]. \quad (10.3)$$

Analogous expressions exist for the opposite helicity photino yielding  $\mathbb{G}_{\frac{1}{2},-\frac{1}{2}}$ . Furthermore, as indicated in figure 12 the  $\Delta = \frac{1}{2}$  conformally soft photino descend to the  $\Delta = \frac{3}{2}$  shadow photino as

$$\partial_{\bar{w}} \psi_{\frac{1}{2},+\frac{1}{2}} = -\tilde{\psi}_{\frac{3}{2},-\frac{1}{2}}, \quad \partial_w \bar{\psi}_{\frac{1}{2},-\frac{1}{2}} = -\tilde{\psi}_{\frac{3}{2},+\frac{1}{2}}, \quad (10.4)$$

for which we can write the 2D operators  $\tilde{\mathbb{G}}_{\frac{3}{2},\pm\frac{1}{2}}$ .

Note that the isomorphism with the conformally soft photino theorem (52) follows from the contact term (10.2). Indeed, if we renormalize the operator by  $(\Delta - \frac{1}{2})$ , the soft charge becomes<sup>50</sup>

$$\mathbb{G}_{\frac{1}{2},+\frac{1}{2}}^{ren}(w, \bar{w}) = -2\pi(1 + w\bar{w})^{-1} \int dw \hat{\psi}^{\dagger(1)} \sigma_u |q] = \frac{ie}{2} \lim_{\Delta \rightarrow \frac{1}{2}} (\Delta - \frac{1}{2}) (a_{\Delta,+\frac{1}{2}} - a_{\Delta,+\frac{1}{2}}^\dagger). \quad (10.5)$$

<sup>49</sup>Generalizing to the gluino case is straightforward for the soft charges constructed herein. Since they are linear in the perturbation, this amounts to adding a Lie algebra index.

<sup>50</sup>Without renormalizing the limit  $\Delta \rightarrow \frac{1}{2}$  furthermore yields a contribution to (10.2) involving a logarithm in  $u$  which will be discussed elsewhere.

## 10.2 Subleading Conformally Soft Gravitino

The conformally soft spin  $s = \frac{3}{2}$  Weyl spinor  $\chi_{-\frac{1}{2}, +\frac{3}{2}; \mu}$  and its shadow  $\tilde{\chi}_{\frac{5}{2}, -\frac{3}{2}; \mu}$  corresponds to the zero-area celestial diamond shown in figure [13](#). Using again appendix [C.8](#) we can write the 2D operator corresponding to a soft charge for the

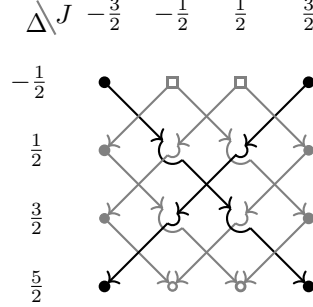

Figure 13: Subleading gravitino ‘diamonds’ (black) on top of leading gravitino diamonds (grey).

subleading conformally soft gravitino, namely expression [\(C.58\)](#) evaluated at null infinity. For the gravitino at  $\Delta = -\frac{1}{2}$  this yields

$$\begin{aligned} \mathbb{O}_{-\frac{1}{2}, +\frac{3}{2}} = i \int_{\mathcal{J}^+} dud^2z \left\{ \sqrt{\gamma} \left[ \hat{\chi}_r^{\dagger(2)} \left( \frac{1}{2} \sigma_r - \sigma_u \right) \chi_{-\frac{1}{2}, +\frac{3}{2}; u}^{(0)} + \hat{\chi}_u^{\dagger(1)} \left( \frac{1}{2} \sigma_r - \sigma_u \right) \chi_{-\frac{1}{2}, +\frac{3}{2}; r}^{(1)} \right] \right. \\ \left. - \hat{\chi}_{\bar{z}}^{\dagger(1)} \left( \frac{1}{2} \sigma_r - \sigma_u \right) \chi_{-\frac{1}{2}, +\frac{3}{2}; z}^{(-1)} + \hat{\chi}_z^{\dagger(0)} \sigma_u \chi_{-\frac{1}{2}, +\frac{3}{2}; \bar{z}}^{(0)} \right\}. \end{aligned} \quad (10.6)$$

Curiously, while the presence of a soft theorem at this dimension has been noticed in the amplitudes literature [\[52\]\[116\]](#), on the asymptotic symmetry side so far only the large supersymmetry charge for the leading soft gravitino has been computed [\[111\]\[117\]\[118\]](#). We are happy to contribute a spacetime interpretation of the subleading (conformally) soft gravitino theorem and its corresponding charge.

At coincident points on the celestial sphere the subleading conformally soft gravitino contributes

$$\chi_{-\frac{1}{2}, +\frac{3}{2}; \bar{z}}^{(0)} \Big|_{z=w} = \sqrt{2\pi} i \lim_{\Delta \rightarrow -\frac{1}{2}} \frac{u^{\frac{1}{2}-\Delta}}{\Delta + \frac{1}{2}} (1 + z\bar{z}) \delta^{(2)}(z - w) |q], \quad (10.7)$$

while all other components are subleading in the large  $r$  expansion. Again the superscript ( $n$ ) indicates the coefficient of the  $r^{-n}$  term. At non-coincident points the conformally soft gravitino has non-radiative fall-offs

$$\chi_{-\frac{1}{2}, +\frac{3}{2}; u}^{(0)} \Big|_{z \neq w} = -i \frac{1 + \bar{w}z}{\sqrt{2}(z - w)} |q], \quad \chi_{-\frac{1}{2}, +\frac{3}{2}; r}^{(1)} \Big|_{z \neq w} = iu \frac{1 + \bar{w}z}{\sqrt{2}(z - w)} |q], \quad (10.8)$$

and

$$\chi_{-\frac{1}{2}, +\frac{3}{2}; z}^{(-1)} \Big|_{z \neq w} = -\sqrt{2} i \frac{\bar{z} - \bar{w}}{(z - w)(1 + z\bar{z})} |q], \quad (10.9)$$

in addition to

$$\chi_{-\frac{1}{2}, +\frac{3}{2}; z}^{(0)} \Big|_{z \neq w} = iu \frac{(1 + \bar{w}z)(1 + \bar{z}w)}{(z - w)^2(1 + z\bar{z})} |q], \quad \chi_{-\frac{1}{2}, +\frac{3}{2}; \bar{z}}^{(0)} \Big|_{z \neq w} = iu \frac{(1 + \bar{w}z)^2}{\sqrt{2}(z - w)(\bar{z} - \bar{w})(1 + z\bar{z})} |q]. \quad (10.10)$$

Analogous expressions exist for the opposite helicity gravitino yielding  $\mathbb{O}_{-\frac{1}{2}, -\frac{3}{2}}$ . Furthermore, as indicated in figure [13](#) the  $\Delta = -\frac{1}{2}$  conformally soft gravitinos descend to the  $\Delta = \frac{5}{2}$  shadow gravitinos as

$$\frac{1}{3!} \partial_{\bar{w}}^3 \chi_{-\frac{1}{2}, +\frac{3}{2}} = -\tilde{\chi}_{\frac{5}{2}, -\frac{3}{2}}, \quad \frac{1}{3!} \partial_w^3 \tilde{\chi}_{-\frac{1}{2}, -\frac{3}{2}} = -\tilde{\chi}_{\frac{5}{2}, +\frac{3}{2}}, \quad (10.11)$$

for which we can write the 2D operators  $\tilde{\mathbb{O}}_{\frac{5}{2}, \pm\frac{3}{2}}$ .

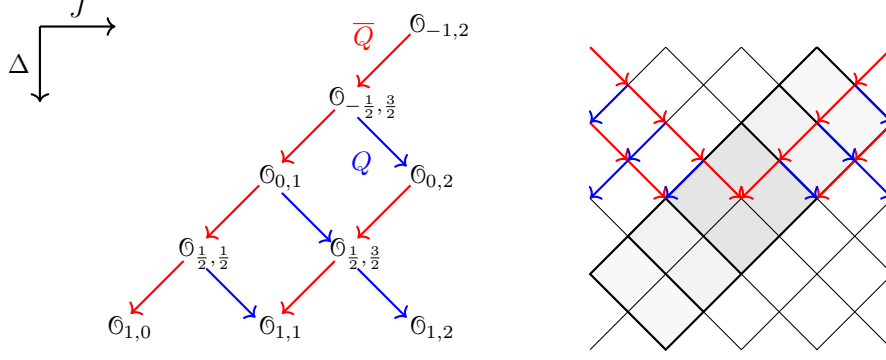

Figure 14: The SUSY generators shift between radiative primaries corresponding to conformally soft theorems within the same helicity sector. On the left is a zoomed in view of the action on the positive helicity sector which, in the figure on the right, corresponds to the upper right corner in the top-down view of the celestial pyramid. The diamonds corresponding to the positive helicity subleading soft graviton, leading soft gravitino, and leading soft photon are shaded in grey.

As in the case of the photino, the isomorphism with the subleading conformally soft gravitino theorem [52] follows from the contact term. We can renormalize the charge operator by  $(\Delta + \frac{1}{2})$  such that the limit  $\Delta \rightarrow -\frac{1}{2}$  is finite<sup>51</sup>

$$\mathcal{O}_{-\frac{1}{2}, +\frac{3}{2}}^{ren}(w, \bar{w}) = -\sqrt{2}\pi(1 + w\bar{w}) \int duv \hat{\chi}_w^{\dagger(0)} \sigma_u |q] = \frac{\kappa}{2} \lim_{\Delta \rightarrow -\frac{1}{2}} (\Delta + \frac{1}{2})(a_{\Delta, +\frac{3}{2}} + a_{\Delta, +\frac{3}{2}}^\dagger). \quad (10.12)$$

## 11 Celestial Pyramids

We have completed the soft charge analysis for each of the fermionic celestial diamonds. This gives us a nice opportunity to merge the investigations of spin-shifting relations in [12] and  $SL(2, \mathbb{C})$  descendants in [113]. Namely, when one adds supersymmetry to the mix the celestial diamonds stack into a celestial pyramid.

The starting point is the observation [52] that the SUSY charges map conformally soft theorems to one another. For radiative primaries (i.e.  $s = |J|$ ) they found the following sequences of soft limits for the gauge multiplet

$$\mathcal{O}_{0,1} \xrightarrow{\bar{Q}} \mathcal{O}_{\frac{1}{2}, \frac{1}{2}} \xrightarrow{Q} \mathcal{O}_{1,1}, \quad (11.1)$$

and for the gravity multiplet

$$\mathcal{O}_{-1,2} \xrightarrow{\bar{Q}} \mathcal{O}_{-\frac{1}{2}, \frac{3}{2}} \xrightarrow{Q} \mathcal{O}_{0,2} \xrightarrow{\bar{Q}} \mathcal{O}_{\frac{1}{2}, \frac{3}{2}} \xrightarrow{Q} \mathcal{O}_{1,2}. \quad (11.2)$$

These are summarized in a more geometric manner in figure [14] where we see that they are glued together by addition sequences starting from the fermionic primaries (which will require  $\mathcal{N} > 1$  SUSY). In the Mellin basis, the  $\mathcal{N} = 1$  supercharges have the following representation

$$Q = \partial_\theta |q\rangle e^{\partial\Delta/2}, \quad \bar{Q} = \theta |q\rangle e^{\partial\Delta/2}. \quad (11.3)$$

<sup>51</sup>Again, without renormalizing the limit  $\Delta \rightarrow -\frac{1}{2}$  yields a logarithm in  $u$ .

We would now like to explore how these supercharges interact with our descendency relations. From (11.3) we quickly see that

$$[\partial_{\bar{w}}, Q] = [\partial_w, \bar{Q}] = 0. \quad (11.4)$$

These observations follow from the  $\mathcal{N} = 1$  super-Poincaré algebra which adds the (anti)-commutation relations

$$\{\bar{Q}_a, Q_b\} = \sigma_{ab}^\mu P_\mu, \quad [M^{\mu\nu}, \bar{Q}_a] = \frac{1}{2}(\sigma^{\mu\nu})_a^b \bar{Q}_b. \quad (11.5)$$

In terms of the  $\text{SL}(2, \mathbb{C})$  indexing, we have the global part of the  $\mathfrak{sbms}_4$  algebra, namely (89,119)

$$\{G_k, \bar{G}_l\} = P_{k,l}, \quad [L_m, G_k] = \left(\frac{1}{2}m - k\right)G_{m+k}, \quad [\bar{L}_m, \bar{G}_k] = \left(\frac{1}{2}m - k\right)\bar{G}_{m+k}, \quad (11.6)$$

in addition to the bosonic  $\mathfrak{bms}_4$  subalgebra (52,120)

$$\begin{aligned} [L_m, L_n] &= (m - n)L_{m+n}, & [\bar{L}_m, \bar{L}_n] &= (m - n)\bar{L}_{m+n}, \\ [L_n, P_{k,l}] &= \left(\frac{1}{2}n - k\right)P_{k+n,l}, & [\bar{L}_n, P_{k,l}] &= \left(\frac{1}{2}n - l\right)P_{k,l+n}, \end{aligned} \quad (11.7)$$

restricted to  $\{P_{\pm\frac{1}{2}, \pm\frac{1}{2}}, G_{\pm\frac{1}{2}}, \bar{G}_{\pm\frac{1}{2}}, L_0, L_{\pm 1}, \bar{L}_0, \bar{L}_{\pm 1}\}$ . The observation (11.4) is just the relation

$$[L_m, \bar{G}_k] = [\bar{L}_m, G_k] = 0. \quad (11.8)$$

Our question about how the supercharges interact with the  $\text{SL}(2, \mathbb{C})$  multiplets is simply a question about descendency relations for a larger algebra.

The conditions for Poincaré primaries follows from a relaxation of the BMS primary construction in (121) for the Mellin transformed massless amplitudes. See also (58,122,123). A Poincaré primary is annihilated by

$$L_1, \bar{L}_1, P_{\frac{1}{2}, \frac{1}{2}}, P_{\frac{1}{2}, -\frac{1}{2}}, P_{-\frac{1}{2}, \frac{1}{2}}, \quad (11.9)$$

and has weights  $h, \bar{h}$  under  $L_0, \bar{L}_0$

$$L_0|h, \bar{h}\rangle = h|h, \bar{h}\rangle, \quad \bar{L}_0|h, \bar{h}\rangle = \bar{h}|h, \bar{h}\rangle, \quad (11.10)$$

while descendants are generated by

$$L_{-1}, \bar{L}_{-1}, P_{-\frac{1}{2}, -\frac{1}{2}}. \quad (11.11)$$

Analogously, a massless  $\mathcal{N} = 1$  super-Poincaré primary is annihilated by

$$L_1, \bar{L}_1, P_{\frac{1}{2}, \frac{1}{2}}, P_{\frac{1}{2}, -\frac{1}{2}}, P_{-\frac{1}{2}, \frac{1}{2}}, G_{\frac{1}{2}}, \bar{G}_{\frac{1}{2}}, \quad (11.12)$$

and has weights  $h, \bar{h}$  under  $L_0, \bar{L}_0$ , while descendants are generated by

$$L_{-1}, \bar{L}_{-1}, G_{-\frac{1}{2}}, \bar{G}_{-\frac{1}{2}}, \quad (11.13)$$

where we have used  $\{G_{-\frac{1}{2}}, \bar{G}_{-\frac{1}{2}}\} = P_{-\frac{1}{2}, -\frac{1}{2}}$  to remove the translation in (11.11) from our list. Here we will focus on the anti-chiral subalgebra spanned by  $\bar{L}_i, \bar{G}_{\pm\frac{1}{2}}$ , since this is enough to connect the fermionic soft charges to their supersymmetrically related bosonic counterparts.

Starting from a conformal primary  $\mathcal{O}_{\Delta, J}$  annihilated by  $\bar{L}_{+1}$  and  $\bar{G}_{+\frac{1}{2}}$

$$\bar{L}_1 \mathcal{O}_{\Delta, J}(0, 0) = 0, \quad \bar{G}_{\frac{1}{2}} \mathcal{O}_{\Delta, J}(0, 0) = 0 \quad (11.14)$$



we have the  $\mathcal{N} = 1$  doublet

$$\left( \mathbb{O}_{\Delta, J}, \bar{G}_{-\frac{1}{2}} \mathbb{O}_{\Delta, J} \right), \quad (11.15)$$

where we will suppress the  $(w, \bar{w}) = (0, 0)$  coordinate here and in what follows. In terms of

$$h = \frac{1}{2}(\Delta + J), \quad \bar{h} = \frac{1}{2}(\Delta - J), \quad (11.16)$$

we see that the second operator in the doublet has weights  $(h', \bar{h}') = (h, \bar{h} + \frac{1}{2})$ . Since

$$\bar{L}_1 \bar{G}_{-\frac{1}{2}} \mathbb{O}_{\Delta, J} = [\bar{L}_1, \bar{G}_{-\frac{1}{2}}] \mathbb{O}_{\Delta, J} = \bar{G}_{\frac{1}{2}} \mathbb{O}_{\Delta, J} = 0, \quad (11.17)$$

this is also an  $SL(2, \mathbb{C})$  primary. The operators corresponding to positive helicity soft theorems have  $J = +s$  and  $\Delta \in \{1 - s, \dots, s + 1\} \cap (-\infty, 1]$ , which we can label by the value  $\bar{k} \in \mathbb{Z}$

$$\bar{k} = 1 + J - \Delta, \quad (11.18)$$

the level of their  $\bar{L}_{-1}$  primary descendant. Meanwhile, the superpartner  $\bar{G}_{-\frac{1}{2}} \mathbb{O}_{\Delta, J}$  will have a primary descendant at level  $\bar{k}' = \bar{k} - 1$ .

This is consistent with the structure of spin- $s$  celestial diamonds. The observation that [52]

$$\bar{G}_{-\frac{1}{2}} \mathbb{O}_{\Delta, s}^s = \mathbb{O}_{\Delta + \frac{1}{2}, s - \frac{1}{2}}^{s - \frac{1}{2}}, \quad (11.19)$$

for an appropriate normalization of the operators, can be phrased in terms of the soft operators  $\mathbb{O}_{soft}^s$  residing at the bottom corner of the spin- $s$  diamonds. From section 3 of [45] we have the following descendancy relations

$$\mathbb{O}_{soft}^s = \frac{1}{k!} \partial_{\bar{w}}^{\bar{k}} \mathbb{O}_{\Delta, s}^s, \quad \mathbb{O}_{soft}^{s - \frac{1}{2}} = \frac{1}{(\bar{k} - 1)!} \partial_{\bar{w}}^{(\bar{k} - 1)} \mathbb{O}_{\Delta + \frac{1}{2}, s - \frac{1}{2}}^{s - \frac{1}{2}}. \quad (11.20)$$

Using [11.7], this implies that the soft charges are related via

$$\bar{k} \bar{G}_{-\frac{1}{2}} \mathbb{O}_{soft}^s = \bar{L}_{-1} \mathbb{O}_{soft}^{s - \frac{1}{2}}. \quad (11.21)$$

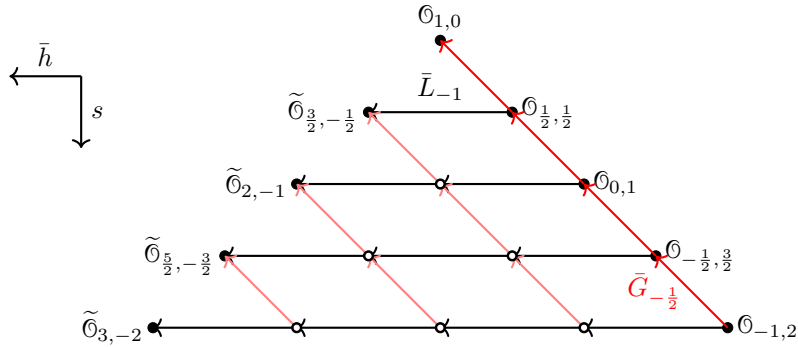

Figure 15: Vertical section of the celestial pyramid corresponding to the  $\Delta = 1 - J$  diagonal of figure [14]. The commuting generators  $\bar{G}_{-\frac{1}{2}}$  and  $\bar{L}_{-1}$  map between states in the positive helicity degenerate celestial diamonds corresponding to the most subleading soft theorems. More generally, the  $\Delta = k + 1 - J$  sections connect radiative  $J = +s$  primaries of different spins and their descendant  $\mathbb{O}_{soft}$ .

Moreover, from the celestial diamond perspective, it is clear that the observation [\(9.29\)](#) about the relation between the symmetry parameters of different spin- $s$  asymptotic symmetry currents extends to general  $\bar{k}$ . This is because the shadows of both of the operators  $\left(\mathbb{O}_{\Delta,s}^s, \mathbb{O}_{\Delta+\frac{1}{2},s-\frac{1}{2}}^{s-\frac{1}{2}}\right)$  appearing in the doublet [\(11.15\)](#), namely

$$\left(\tilde{\mathbb{O}}_{2-\Delta,-s}^s, \tilde{\mathbb{O}}_{\frac{3}{2}-\Delta,\frac{1}{2}-s}^{s-\frac{1}{2}}\right), \quad (11.22)$$

are both level  $k = k' = \Delta + s - 1$  ascendants of the corresponding soft operators with respect to the holomorphic subalgebra. We can further see that [\(11.21\)](#) together with [\(11.8\)](#) and the shadow/descendancy relations of [\(45\)](#) imply

$$\bar{k} \bar{G}_{-\frac{1}{2}} \tilde{\mathbb{O}}_{2-\Delta,-s}^s = -\bar{L}_{-1} \tilde{\mathbb{O}}_{\frac{3}{2}-\Delta,\frac{1}{2}-s}^{s-\frac{1}{2}}. \quad (11.23)$$

This analog of [\(11.19\)](#) for the shadow modes plays an important role in celestial CFT since both the stress tensor and the super-current are constructed via shadow transforms. For the particular case of  $\Delta = 0, s = 2$ , the relation [\(11.23\)](#) involves these two symmetry currents. It is a statement about how the global symmetry generators act on the representation of  $\mathfrak{sbms}_4$  arising from the soft theorem, consistent with

$$[\bar{G}_{-\frac{1}{2}}, \bar{L}_{-2}] - \frac{1}{2}[\bar{L}_{-1}, \bar{G}_{-\frac{3}{2}}] = 0 \quad (11.24)$$

upon restoring the normalization constants relating the stress tensor and super-current [\[52, 89\]](#) to our shadow operators [\[12, 45\]](#).

We thus see how the spin shifting relations of [\(113\)](#) and the celestial diamond story of [\[45, 113\]](#) fit together. The global  $SL(2, \mathbb{C})$  descendants shift within the  $(\Delta, J)$  plane while the SUSY charges translate in the transverse  $s$ -direction. This structure explains the connection between the gauge parameters used to demonstrate soft theorem/Ward identity equivalences for different spins. While we have focused on the  $\mathcal{N} = 1$  case connecting pairs of soft theorems, this structure can straightforwardly be extended to the  $\mathcal{N} > 1$  case.

## Summary: Part III

In this part we looked at conformally soft fermionic operators on the celestial sphere constructed from a large- $r$  expansion of bulk fermionic fields. We computed the large supersymmetry charge whose generator is the leading conformally soft gravitino. The subleading soft gravitino theorem as well as the leading soft photino theorem lack a clear asymptotic symmetry interpretation however they yield finite soft charges that can be constructed using the covariant phase-space formalism. Finally, we elucidated the role played by supersymmetry generators in the global conformal multiplets: the spin-shifting relations they induce on conformally soft operators relate conformal multiplets (celestial diamonds) of different spin, inducing a pyramid-shaped structure involving both fermionic and bosonic operators.

## Conclusion and Outlook

In this thesis we explored holographic properties of asymptotically flat spacetimes through a change of basis in the scattering amplitude. Going from translation eigenstates to Lorentz eigenstates the amplitude exhibits properties akin to conformal correlators in a codimension-two theory. In order to talk about the scattering amplitude in this new conformal basis, we need

to have a well-defined procedure for taking the Mellin transform because of the distributional nature of scattering amplitudes. This was the aim of the first part of the thesis: we defined the space of test functions to which celestial amplitudes will be the topological dual. It consists of functions which are meromorphic on the complex- $\Delta$  plane with poles at non-positive integer values of  $\Delta$ . This indeed shows that even though the domain of integration goes to infinity, the Mellin transform is just a change of basis and no knowledge of the UV is required when performing it on finite (tree-level) amplitudes in momentum space.

After that we explored the conformal aspects of celestial amplitudes. By only assuming soft theorems and conformal symmetry, one can classify all the so-called soft symmetries in the celestial CFT. In four bulk dimensions, the soft symmetries generated by operators of type II and III admit a local enhancement. In these cases, both the soft operators and their shadow transforms yield non-trivial associated charges. However this is not true in higher dimensions: soft operators are trivially conserved and non-trivial charges arise only from the shadow transform of soft operators.

Finally, we treated fermionic soft symmetries from the boundary perspective in four bulk spacetime dimensions: after casting the generator of large SUSY transformations as the leading conformally soft gravitino boundary operator, we considered the symmetries associated to the leading soft photino and subleading soft gravitino theorems. We were able to compute their corresponding soft charges using the covariant phase space formalism and we found that they were finite and no renormalization procedure was necessary. We then elucidated the role played by the global SUSY modes in conformal representation theory following [52]: they relate the conformal multiplets (celestial diamonds) of different spins, creating a pyramid shaped structure which we refer to as celestial pyramid.

Let us conclude with some comments and open questions.

**Massive distributional celestial amplitudes** Our framework for defining celestial amplitudes as distributions is only concerned with massless scattering since massive amplitudes require a more complicated transform involving bulk to boundary propagators. This essentially relies on taking a hyperbolic foliation of ASF and relating the intersection of a massive geodesic with the hyperbolic slice to a point on the boundary  $\mathcal{I}^+$ . A scalar massive conformal primary then takes the form [7]

$$\phi_{\Delta}^{\pm}(\vec{w}, X^{\mu}) = \int_{H_{d+1}} d\hat{p} G_{\Delta}(\hat{p}, \vec{w}) e^{\pm im\hat{p}\cdot X}.$$

Therefore it would be interesting but more difficult to address the same questions for massive scattering amplitudes.

**The top of the necklace** In CCFT<sub>2</sub> the conformal multiplets containing the universal soft operators were completed into a diamond by adding a primary at the top: the universal soft operators in figure 5 are at the left and right corners, with their type II primary descendant at the bottom corresponding to their conservation equation, and can themselves be understood as type I primary descendants of a new operator at the top. (For degenerate multiplets the soft operator, whose type III primary descendant corresponds to its conservation equation, already coincides with the top operator of a zero-area diamond and so no additional operator needs to be added.) This was a useful thing to do as it defines the Goldstone modes of spontaneously broken asymptotic symmetries which are used to dress celestial amplitudes to make them infrared finite [26]. The top operators have logarithmic correlation functions (similar to the ones of a free boson in  $d = 2$  which is the simplest example of a top operator in a celestial diamond) and should not be considered as part of the spectrum of the original theory (it may be thought as a primary of a logarithmic extension of the theory or just as an auxiliary operator); because of the logarithmic behaviour the arguments of appendix B.2 do not apply to this operator.

In a similar vein, we can complete the celestial necklaces in  $\text{CCFT}_{d>2}$  by adding a top primary operator - this is the one already shown in figure 9. Indeed, all universal soft operators have type  $I_2$  primary descendants and can themselves be understood as type  $I_1$  primary descendants of an operator at the top. As in  $d = 2$  this top operator has logarithmic correlation functions. Its quantum numbers are fixed by representation theory and the form of its primary descendant follows the classification in section 6.2.1. For the leading soft photon the top-of-the-necklace operator must be an operator  $\mathcal{O}_{\Delta=0,\ell=0}$  with type  $I_1, n = 1$  primary descendant  $\partial^a \mathcal{O}_{0,0}$ . This is set by the fact that its type  $I_1$  primary descendant has  $(\Delta, \ell) = (1, 1)$ . Similarly for the leading soft graviton the top-of-the-necklace operator is  $\mathcal{O}_{\Delta=-1,\ell=0}$  with a primary descendant of type  $I_1, n = 2$  that takes the form  $\partial^{\{a} \partial^{b\}} \mathcal{O}_{\Delta=-1,\ell=0}$ . For the subleading soft graviton we find  $\mathcal{O}_{\Delta=-1,\ell=1}$  with type  $I_1, n = 1$  primary descendant  $\partial^{\{a} \mathcal{O}_{\Delta=-1,\ell=1}^{b\}}$ . Note that the equations for the type  $I_1$  primary descendants appeared in the literature (e.g. 49 and 105). In 105 they were computed (see formulae (3.4), (3.26), (3.38)) as solutions of the type  $I_2$  shortening condition thought of as a ‘‘classical field equation’’ 52. For us they descend automatically from the necklace structure.

**Subleading soft photon and subsubleading soft graviton** In  $d + 2 = 4$  dimensions, the subleading soft photon ( $\Delta = 0$ ) and the subsubleading soft graviton ( $\Delta = -1$ ) theorems correspond to type III primary descendants in  $\text{CCFT}_2$ . In even  $d > 2$  there are descendants of type  $\text{III}_k$  which become primary for  $\Delta = k - \ell_k$  46. We thus expect these subleading soft photon and subsubleading soft graviton theorems in even  $d + 2 > 4$  dimensions to map to correlation functions of conserved operators with primary descendants of type  $\text{III}_1$  with  $\ell_1 = 1$  and  $\ell_1 = 2$ , respectively, in  $\text{CCFT}_{d>2}$ . The explicit form of these primary descendants is not known and we leave their construction for future work. The situation in odd  $d$  is even more tricky. There appears to be no primary descendant whose parent has the correct conformal dimension to match the conformally soft operators with  $\Delta = 0$  (for spin one) and  $\Delta = -1$  (for spin two). We leave the resolution of this puzzle for the future.

**Towers of ever more subleading soft theorems** Conformally soft operators beyond the subleading soft theorem in gauge theory and the subsubleading soft theorem in gravity have type  $I_1$  primary descendant operators at level  $n$ . Given a spin  $\ell$  particle they appear at  $\Delta = 1 - \ell - n$  for  $n = 1, 2, \dots, \infty$ , while in terms of the power expansion in  $\omega$  they arise at  $\omega^k$  for  $k = \ell + n - 1$ . In appendix B.2 we describe why from such operators we cannot construct non-trivial charges. However it would be interesting to see if the complete list of conformally soft operators (or their shadows) in  $d > 2$  forms an interesting algebra.

**Generalization to higher spin** As a proof of concept we can see how our technology can be used to study soft particles with generic spin  $\ell$  on the same footing. Given a spin  $\ell$  particle, we obtain a primary operator with dimension  $\Delta$  and spin  $\ell$ . Without doing any computations we expect  $\ell$  soft theorems associated to type  $I_2$  primary descendants at level  $n = 1, \dots, \ell$  which appear at dimensions  $\Delta = 2 - n$ . The shortening condition of these operators is of the form

$$O_{I_2, n}^{a_1^1 \dots a_\ell^1, a_1^2 \dots a_n^2}(x) = \pi_{(\ell, n)}(\mathbf{a}, \mathbf{b}) \partial^{b_1^2} \dots \partial^{b_n^2} \mathcal{O}_{\Delta, \ell}^{b_1^1 \dots b_\ell^1}(x). \quad (11.25)$$

The first  $\ell$  universal conformally soft theorems are exactly annihilated by the differential operators above and thus do not give rise to non-trivial conserved charges. However the shadow transform of these  $I_2, n$  operators gives rise to type  $\text{II}_1$  operators at level  $n' = \ell - n + 1$  which instead can be used to build non-trivial charges.

<sup>52</sup>In our language the type  $I_1$  primary descendants trivially solve the type  $I_2$  shortening conditions.

As an example, the leading soft factor, which generalizes the ones of photons [\(6.46\)](#) and gravitons [\(6.52\)](#) to spin  $\ell$  particles, is proportional to

$$\sum_{i=1}^N g_i \frac{(\eta_i \omega_i)^{\ell-1} ((x_i - x) \cdot e)^\ell}{\omega (x_i - x)^2}, \quad (11.26)$$

for some coefficients  $g_i$  [\[53\]](#). We associate this contribution to the insertion of a conformally soft operator  $\mathbb{O}_{\Delta=1,\ell}$ . One can indeed check that [\(11.26\)](#) is annihilated by the differential operator in [\(11.25\)](#) for  $n = 1$ . The resulting Ward identity does not produce contact terms and cannot be used to build non-trivial charges. The shadow transform of  $\mathbb{O}_{\Delta=1,\ell}$  is the operator  $\tilde{\mathbb{O}}_{\Delta=d-1,\ell}$  which following the classification of section [6.2.2](#) is of type  $\text{II}_1, n = \ell$ . Indeed by taking the shadow of expression [\(11.26\)](#) using formula [\(6.73\)](#), we obtain

$$S \left[ \frac{(x \cdot e)^\ell}{x^2} \right] = \frac{2(-1)^d \Gamma\left(\frac{d}{2}\right) \Gamma\left(\frac{d}{2} + \ell - 1\right)}{(\ell - 1)!} \frac{(e \cdot x)^\ell}{|x|^d}. \quad (11.27)$$

It is easy to check that by taking a descendant of type  $\text{II}_1, n = \ell$ , this equation gives rise to a contact term (see equation [\(B.30\)](#)),

$$(D_e \cdot \partial_x)^\ell \frac{(e \cdot x)^\ell}{|x|^d} \propto \delta^{(d)}(x). \quad (11.28)$$

The resulting Ward identity for  $\tilde{\mathbb{O}}_{\Delta=d-1,\ell}$  can thus be used to define non-trivial charges using equation [\(6.38\)](#). From formula [\(6.37\)](#), without doing any computations, we can also predict that the number of such charges is finite and equals the dimension of the  $SO(d+2)$  spin  $\ell - 1$  representation, namely  $\frac{(d+2\ell-2)\Gamma(d+\ell-1)}{\Gamma(d+1)\Gamma(\ell)}$ . Finally, using [\(6.37\)](#), [\(6.39\)](#) and [\(11.28\)](#) it is straightforward to see that the action of the (opportunedly normalized) charges on a primary  $\mathbb{O}_{\Delta,\ell}$  takes the form

$$[Q^{\mu_1 \dots \mu_{\ell-1}}, \mathbb{O}_{\Delta,\ell}(x)] = g \eta^{\ell-1} q^{\{\mu_1 \dots \mu_{\ell-1}\}} \mathbb{O}_{\Delta+\ell-1,\ell}(x). \quad (11.29)$$

This can be considered as an example of the power of the classification and techniques that we introduced in this paper. Because of the structure of primary descendants we know exactly which computations we should perform and often we can also predict their result.

**Soft symmetries and conformal geometry** The leading conformally soft operator in  $d = 2$  yields 2+2 towers of topological charges which intersect at the four global modes corresponding to the global translation generators (see figure [7](#)). This corresponds to a subset of the supertranslation group  $\mathcal{E}^\infty(S^2)$  which are generated by an arbitrary function on the sphere. Therefore not all supertranslations correspond to topological symmetries in the celestial CFT. We refer to those modes as non-topological supertranslations. Building on the works [\[124, 125\]](#), these modes correspond to deformations of the CCFT space which is in one-to-one correspondence with the moduli space generated by acting with a supertranslation on the Minkowski vacuum. Analogously to the conformal manifold where the deformations are made with a marginal operator, this infinite-dimensional CCFT manifold is generated by operators of the type

$$\int_R d^2 z (\bar{\partial}^2 \epsilon(z, \bar{z}) \mathbb{O}_{1,+2}(z, \bar{z}) + \partial^2 \bar{\epsilon}(z, \bar{z}) \mathbb{O}_{1,-2}(z, \bar{z})).$$

Indeed when the symmetry parameters  $\epsilon$  and  $\bar{\epsilon}$  satisfy the conservation equations  $\bar{\partial}^2 \epsilon(z, \bar{z}) = \partial^2 \bar{\epsilon}(z, \bar{z}) = 0$  inside of the region  $R$  then the above integral is zero and the deformation is trivial. However an arbitrary function on the sphere need not satisfy these constraints and lead to non-trivial deformations.

<sup>53</sup>When  $\ell = 1$ ,  $g_i = e \mathbb{Q}_i$  as in equation [\(6.46\)](#). Because of Weinberg's soft theorem  $g_i$  must be all equal for  $\ell = 2$ , giving  $g_i = \kappa$  as in [\(6.52\)](#). Finally  $g_i$  should vanish for  $\ell > 2$ . Still it is an instructive exercise to show what the soft operators and charges look like in the celestial basis in a closed form in  $\ell$ .

## A Appendix: Notations and Conventions

We use the following notations

$$\mathbb{N}^0 := \mathbb{N} \setminus \{0\}, \quad \mathbb{R}^+ := [0, +\infty), \quad \mathbb{R}^{+\ast} := \mathbb{R}^+ \setminus \{0\}, \quad \mathbb{Z}^- := \mathbb{Z} \setminus \mathbb{N}^0. \quad (\text{A.1})$$

We also use the notation

$$\|\phi\|_\infty = \sup_{x \in \mathbb{R}^+} |\phi(x)|. \quad (\text{A.2})$$

The following Fourier and inverse Fourier transforms conventions are also used: given  $\phi$  in  $L^2(\mathbb{R})$ , the Fourier transform of  $\phi$  is defined as follows

$$\mathcal{F}(\phi)(\xi) := \int_{\mathbb{R}} \phi(x) e^{-ix\xi} dx. \quad (\text{A.3})$$

Similarly, its inverse Fourier transform is defined as

$$\mathcal{F}^{-1}(\phi)(x) := \frac{1}{2\pi} \int_{\mathbb{R}} \phi(\xi) e^{ix\xi} d\xi. \quad (\text{A.4})$$

Given a function  $\phi$  that satisfies

$$\int_{\mathbb{R}^+} dx |\phi(x)| x^{c-1} < +\infty,$$

we define its Mellin transform as follows

$$\mathcal{M}(\phi)(c + it) = \int_{\mathbb{R}^+} \phi(x) x^{c+it-1} dx. \quad (\text{A.5})$$

The definition domain of a Mellin transform is a strip. Hence, we introduce the notation

$$St(\alpha, \beta) := \{s \in \mathbb{C}, \alpha < \Re(s) < \beta\},$$

where  $\Re(s)$  is the real part of  $s$ . We introduce the Schwartz spaces

$$\mathcal{S}(\mathbb{R}) := \left\{ \phi \in \mathcal{C}^\infty(\mathbb{R}) \mid \forall (\alpha, \beta) \in \mathbb{N}^2 : \sup_{x \in \mathbb{R}} |x^\alpha \partial_x^\beta \phi(x)| < +\infty \right\} \quad (\text{A.6})$$

and

$$\mathcal{S}(\mathbb{R}^+) := \{\chi^+(x)\phi(x) \mid \phi \in \mathcal{S}(\mathbb{R})\}, \quad (\text{A.7})$$

where  $\chi^+$  denotes the characteristic function of the semi-line  $\mathbb{R}^+$ . We denote the dual of  $\mathcal{S}(\mathbb{R}^+)$  by  $\mathcal{S}'(\mathbb{R}^+)$ , and call it the Schwartz space of tempered distributions over the half-line. For an extensive topological study of the space  $\mathcal{S}(\mathbb{R}^+)$  and its dual space  $\mathcal{S}'(\mathbb{R}^+)$ , we refer the reader to [\[126\]](#).

We use the conventions of [\[127\]](#) for fermionic particles. In the Weyl representation and using signature  $-+++$  we have

$$\gamma^\mu = \begin{pmatrix} 0 & (\sigma^\mu)_{ab} \\ (\bar{\sigma}^\mu)^{\dot{a}b} & 0 \end{pmatrix}, \quad \{\gamma^\mu, \gamma^\nu\} = -2\eta^{\mu\nu}, \quad (\text{A.8})$$

where we define

$$(\sigma^\mu)_{ab} = (\mathbb{1}, \sigma^i)_{ab}, \quad (\bar{\sigma}^\mu)^{\dot{a}b} = (\mathbb{1}, -\sigma^i)^{\dot{a}b}, \quad (\text{A.9})$$

in terms of the Pauli matrices  $\sigma^i$ . Undotted (dotted) indices refer to left (right) handed  $SL(2, \mathbb{C})$  spinors and are raised and lowered with

$$\varepsilon^{ab} = \varepsilon^{\dot{a}\dot{b}} = -\varepsilon_{ab} = -\varepsilon_{\dot{a}\dot{b}} = \begin{pmatrix} 0 & 1 \\ -1 & 0 \end{pmatrix}, \quad (\text{A.10})$$

which obey  $\varepsilon_{ab}\varepsilon^{bc} = \delta_a^c$ . For example, we have the spinor helicity identities

$$[k]^\alpha = \varepsilon^{ab}[k]_b, \quad |k\rangle^{\dot{a}} = \varepsilon^{\dot{a}b}\langle k|_{\dot{b}}. \quad (\text{A.11})$$

**From Weyl to Dirac and Majorana** The discussion in the main body considers Weyl photinos and gravitinos. We have the following embedding into four-component Dirac and Rarita-Schwinger fields

$$\Psi = \begin{pmatrix} \psi_a \\ \bar{\psi}^{\dot{a}} \end{pmatrix}, \quad \Psi_\mu = \begin{pmatrix} \chi_{\mu a} \\ \bar{\chi}_{\mu}^{\dot{a}} \end{pmatrix}, \quad (\text{A.12})$$

of the left-handed and right-handed Weyl photinos,  $\psi$  and  $\bar{\psi}$ , and the left-handed and right-handed Weyl gravitinos,  $\chi_\mu$  and  $\bar{\chi}_\mu$ . The Hermitian conjugate of  $\Psi$  is

$$\Psi^\dagger = \left( (\psi^\dagger)_{\dot{a}}, (\bar{\psi}^\dagger)^a \right). \quad (\text{A.13})$$

The Dirac conjugate is

$$\bar{\Psi} \equiv \Psi^\dagger \beta = \left( (\bar{\psi}^\dagger)^a, (\psi^\dagger)_{\dot{a}} \right), \quad (\text{A.14})$$

where

$$\beta \equiv \begin{pmatrix} 0 & \delta_{\dot{b}}^a \\ \delta_a^{\dot{b}} & 0 \end{pmatrix}, \quad (\text{A.15})$$

is numerically equal to  $\gamma^0$  but has different index structure. Introducing the charge conjugation matrix

$$\mathcal{C} \equiv \begin{pmatrix} \varepsilon_{ab} & 0 \\ 0 & \varepsilon^{\dot{a}\dot{b}} \end{pmatrix}, \quad (\text{A.16})$$

the charge conjugate of the Dirac field  $\Psi$  is given by

$$\Psi^C \equiv \mathcal{C} \bar{\Psi}^T = \begin{pmatrix} \varepsilon_{ab} (\bar{\psi}^\dagger)^b \\ \varepsilon^{\dot{a}\dot{b}} (\psi^\dagger)_{\dot{b}} \end{pmatrix} = \begin{pmatrix} (\bar{\psi}^\dagger)_a \\ (\psi^\dagger)^{\dot{a}} \end{pmatrix}. \quad (\text{A.17})$$

We will be interested in Majorana fields for which  $\Psi_M^C = \Psi_M$ . The Majorana condition thus amounts to

$$\Psi_M = \mathcal{C} \bar{\Psi}_M^T. \quad (\text{A.18})$$

These steps can be repeated for the Rarita-Schwinger field.

**Fermion Operator Mode Expansion** In the momentum basis, we have the following bulk mode expansions for a spin- $\frac{1}{2}$  Majorana field

$$\hat{\Psi}_M(X) = \sum_{s=\pm} \int \frac{d^3k}{(2\pi)^3} \frac{1}{2k^0} \left[ a_s u_s e^{ik \cdot X} + a_s^\dagger v_s e^{-ik \cdot X} \right], \quad (\text{A.19})$$

and a spin- $\frac{3}{2}$  Majorana field

$$\hat{\Psi}_{M\mu}(X) = \sum_{s=\pm} \int \frac{d^3k}{(2\pi)^3} \frac{1}{2k^0} \left[ \epsilon_\mu^{*s} a_s u_s e^{ik \cdot X} + \epsilon_\mu^s a_s^\dagger v_s e^{-ik \cdot X} \right], \quad (\text{A.20})$$

with polarization vectors  $\epsilon_\mu^\pm$ , and with the anti-commutation relations

$$\{a_s(\vec{k}), a_{s'}^\dagger(\vec{k}')\} = (2\pi)^3 (2k^0) \delta^{(3)}(\vec{k} - \vec{k}') \delta_{ss'}. \quad (\text{A.21})$$

For massless fields we can express the four-component spinors  $u_s$  and  $v_s$  in terms of two-component commuting spinors. In spinor-helicity notation the outgoing anti-fermions  $v_s$  with helicity  $s = \pm \frac{1}{2}$  are given by

$$v_+ = \begin{pmatrix} |k]_a \\ 0 \end{pmatrix}, \quad v_- = \begin{pmatrix} 0 \\ |k]_{\dot{a}} \end{pmatrix}, \quad (\text{A.22})$$

and the outgoing fermions  $\bar{u}_s$  with helicity  $s = \pm \frac{1}{2}$  are given by

$$\bar{u}_- = (0, \langle k | \dot{a} \rangle), \quad \bar{u}_+ = ([k]^a, 0). \quad (\text{A.23})$$

Crossing symmetry flips the sign of the helicity and exchanges incoming  $\leftrightarrow$  outgoing and fermion  $\leftrightarrow$  antifermion, thus

$$u_{\mp} = v_{\pm}, \quad \bar{v}_{\mp} = \bar{u}_{\pm}. \quad (\text{A.24})$$

The mode expansion of the left-handed massless Weyl photino is then

$$\hat{\psi}_a(X) = \int \frac{d^3 k}{(2\pi)^3} \frac{|k|_a}{2k^0} \left[ a_- e^{ik \cdot X} + a_+^\dagger e^{-ik \cdot X} \right], \quad (\text{A.25})$$

while for the right-handed massless Weyl photino it is

$$\hat{\psi}^{\dot{a}}(X) = \hat{\psi}^{\dagger \dot{a}}(X) = \int \frac{d^3 k}{(2\pi)^3} \frac{|k|^{\dot{a}}}{2k^0} \left[ a_+ e^{ik \cdot X} + a_-^\dagger e^{-ik \cdot X} \right]. \quad (\text{A.26})$$

The mode expansion for the left-handed massless Weyl gravitino is

$$\hat{\chi}_{\mu a}(X) = \int \frac{d^3 k}{(2\pi)^3} \frac{|k|_a}{2k^0} \epsilon_\mu^+ \left[ a_- e^{ik \cdot X} + a_+^\dagger e^{-ik \cdot X} \right], \quad (\text{A.27})$$

while for the right-handed massless Weyl gravitino it is

$$\hat{\chi}_\mu^{\dot{a}}(X) = \hat{\chi}_\mu^{\dagger \dot{a}}(X) = \int \frac{d^3 k}{(2\pi)^3} \frac{|k|^{\dot{a}}}{2k^0} \epsilon_\mu^- \left[ a_+ e^{ik \cdot X} + a_-^\dagger e^{-ik \cdot X} \right]. \quad (\text{A.28})$$

## B Appendix: Part II

### B.1 Projectors

In this appendix we exemplify the form of the projectors. We will use the results of [97] where a number of projectors were computed. These were found in the contracted form  $\pi_{(\ell_1, \ell_2, \ell_3, 0, \dots, 0)}(e, f)$  for generic  $\ell_1$  and for all  $\ell_2, \ell_3$  such that  $\ell_2 + \ell_3 \leq 4$ . Following the notation of section [6.1.2] the polarization vectors are defined by the sets  $e = \{e_1, \dots, e_{[d/2]}\}$ ,  $f = \{f_1, \dots, f_{[d/2]}\}$ , however in this appendix we consider these vectors as unconstrained, dropping the hats to avoid clutter. All projectors  $\pi_\ell(e, f)$  are polynomials in the scalar products  $(e_i \cdot e_j), (e_i \cdot f_j), (f_i \cdot f_j)$ . The results are in general quite lengthy but they can be readily used in computations in Mathematica. The easiest example of such projectors is the symmetric and traceless one defined in [6.5]. The next to easiest example is the projector in the hook representation  $\pi_{(\ell, 1)}$ ,

$$\begin{aligned} \pi_{(\ell, 1)}(e, f) &= \frac{(d-2)2^{-\ell} \ell!}{(\ell+1)(d+\ell-3) \left(\frac{d}{2}-1\right)_\ell} |f_1|^{\ell-2} |e_1|^{\ell-2} \times \\ &\times \left\{ - (d-2) |f_1| |e_1| (e_1 \cdot f_2 e_2 \cdot f_1 - e_1 \cdot f_1 e_2 \cdot f_2) C_{\ell-1}^{(\frac{d}{2})} \left( \frac{e_1 \cdot f_1}{|e_1| |f_1|} \right) \right. \\ &\quad + d \left[ f_1^2 (e_1 \cdot e_2 e_1 \cdot f_2 - e_1^2 e_2 \cdot f_2) + e_1^2 f_1 \cdot f_2 e_2 \cdot f_1 + e_2 \cdot f_2 (e_1 \cdot f_1)^2 \right. \\ &\quad \left. \left. - (e_1 \cdot f_2 e_2 \cdot f_1 + f_1 \cdot f_2 e_1 \cdot e_2) e_1 \cdot f_1 \right] C_{\ell-2}^{(\frac{d}{2}+1)} \left( \frac{e_1 \cdot f_1}{|e_1| |f_1|} \right) \right\}. \end{aligned} \quad (\text{B.1})$$

For our purposes it is enough to consider the projector  $\pi_{(\ell, 1)}$  in the cases  $\ell = 1, 2$ . The case  $\pi_{(1, 1)}$  is trivial and just gives antisymmetrization. In particular the contracted projector takes the form

$$\pi_{(1, 1)}(e, f) = \frac{1}{2} (e_1 \cdot f_1 e_2 \cdot f_2 - e_1 \cdot f_2 e_2 \cdot f_1), \quad (\text{B.2})$$



and similarly one recovers the indices by taking derivatives of the vectors as follows

$$\pi_{(1,1)}(\mathbf{a}, \mathbf{b}) = \partial_{e_1}^{a_1} \partial_{e_2}^{a_2} \partial_{f_1}^{b_1} \partial_{f_2}^{b_2} \pi_{(1,1)}(e_i, f_i) = \frac{1}{2} \left( \delta_{a_1, b_1} \delta_{a_2, b_2} - \delta_{a_1, b_2} \delta_{a_2, b_1} \right). \quad (\text{B.3})$$

For  $\pi_{(2,1)}$  the situation is more non-trivial. The contracted projector takes the form

$$\pi_{(2,1)}(e, f) = \frac{2}{3(d-1)} \left( (d-1)e_2 \cdot f_2 (e_1 \cdot f_1)^2 + f_1^2 (e_1 \cdot e_2 e_1 \cdot f_2 - e_1^2 e_2 \cdot f_2) \right. \quad (\text{B.4})$$

$$\left. - e_1 \cdot f_1 ((d-1)e_1 \cdot f_2 e_2 \cdot f_1 + f_1 \cdot f_2 e_1 \cdot e_2) + e_1^2 f_1 \cdot f_2 e_2 \cdot f_1 \right). \quad (\text{B.5})$$

The projector with open indices can be easily obtained by taking derivatives of all vectors  $e_i, f_i$ , namely

$$\pi_{(2,1)}(\mathbf{a}, \mathbf{b}) = \frac{1}{4} \partial_{e_1}^{a_1} \partial_{e_1}^{a_2} \partial_{e_2}^{a_2} \partial_{f_1}^{b_1} \partial_{f_1}^{b_2} \partial_{f_2}^{b_2} \pi_{(2,1)}(e_i, f_i), \quad (\text{B.6})$$

where the factor of 1/4 is included because there are two derivatives of the two vectors  $f_1$  which produce a factor of 2 in the numerator, and similarly for  $e_1$ . The result can be easily obtained in Mathematica and it reads

$$\begin{aligned} \pi_{(2,1)}(\mathbf{a}, \mathbf{b}) = \frac{-1}{6(d-1)} & \left[ -2(d-1)\delta_{a_2, b_1}^2 \left( \delta_{a_1, b_2} \delta_{a_2, b_1} + \delta_{a_1, b_1} \delta_{a_2, b_2} \right) \right. \\ & + \delta_{a_2, b_2} \left( (d-1)\delta_{a_1, b_2} \delta_{a_2, b_1} + \delta_{a_1, a_2} \delta_{b_1, b_2} \right) + \delta_{a_1, b_2} \left( (d-1)\delta_{a_2, b_1} \delta_{a_2, b_2} + \delta_{a_2, a_2} \delta_{b_1, b_2} \right) \\ & + \delta_{a_2, b_1} \left( (d-1)\delta_{a_1, b_2} \delta_{a_2, b_2} + \delta_{a_1, a_2} \delta_{b_2, b_2} \right) + \delta_{a_1, b_1} \left( (d-1)\delta_{a_2, b_2} \delta_{a_2, b_2} + \delta_{a_2, a_2} \delta_{b_2, b_2} \right) \\ & \left. - 2\delta_{b_1, b_2} (\delta_{a_2, a_2} \delta_{a_1, b_1} + \delta_{a_1, a_2} \delta_{a_2, b_2}) - 2\delta_{a_1, a_2} (\delta_{b_1, b_2} \delta_{a_2, b_2} - 2\delta_{b_1, b_2} \delta_{a_2, b_2} + \delta_{b_2, b_2} \delta_{a_2, b_1}) \right]. \quad (\text{B.7}) \end{aligned}$$

In this form one can easily check that taking traces over the indices  $a$  or over the indices  $b$  gives zero. Also one can check that  $\pi_{(2,1)}(\mathbf{a}, \mathbf{b})\pi_{(2,1)}(\mathbf{b}, \mathbf{c}) = \pi_{(2,1)}(\mathbf{a}, \mathbf{c})$ .

In [97] a result for the projector  $\pi_{(\ell,2)}$  is also presented, but we do not report it here since it is too lengthy. For this work we only need the simplest of such projectors, namely  $\pi_{(2,2)}$ , which in its contracted form reads

$$\begin{aligned} \pi_{(2,2)}(e, f) = \frac{(d-1)}{3(d-2)(d-1)} & \left[ (e_1 \cdot f_1)^2 ((d-2)(e_2 \cdot f_2)^2 - f_2^2 e_2^2) \right. \\ & - 2(d-1)e_1 \cdot e_2 (f_1 \cdot f_2 e_2 \cdot f_2 - f_2^2 e_2 \cdot f_1) e_1 \cdot f_1 + (d-1)(e_1 \cdot f_2)^2 ((d-2)(e_2 \cdot f_1)^2 - f_1^2 e_2^2) \\ & + 2de_1^2 f_1 \cdot f_2 e_2 \cdot f_1 e_2 \cdot f_2 - df_1^2 e_1^2 (e_2 \cdot f_2)^2 + f_2^2 (-(d-1)e_1^2 (e_2 \cdot f_1)^2 - 2f_1^2 ((e_1 \cdot e_2)^2 - e_1^2 e_2^2)) \\ & - 2(d-1)e_1 \cdot f_2 (e_1 \cdot f_1 ((d-2)e_2 \cdot f_1 e_2 \cdot f_2 - e_2^2 f_1 \cdot f_2) + e_1 \cdot e_2 (f_1 \cdot f_2 e_2 \cdot f_1 - f_1^2 e_2 \cdot f_2)) \\ & \left. + 2(f_1 \cdot f_2)^2 (e_1 \cdot e_2)^2 - 2e_1^2 f_1 \cdot f_2 e_2 \cdot f_1 e_2 \cdot f_2 - 2e_1^2 e_2^2 (f_1 \cdot f_2)^2 + f_1^2 e_1^2 (e_2 \cdot f_2)^2 \right]. \quad (\text{B.8}) \end{aligned}$$

To define the projector with open indices it again suffices to take derivatives of all the vectors,

$$\pi_{(2,2)}(\mathbf{a}, \mathbf{b}) = \frac{1}{16} \partial_{e_1}^{a_1} \partial_{e_1}^{a_2} \partial_{e_2}^{a_2} \partial_{e_2}^{a_2} \partial_{f_1}^{b_1} \partial_{f_1}^{b_2} \partial_{f_2}^{b_2} \pi_{(2,2)}(e_i, f_i). \quad (\text{B.9})$$

The result can be easily obtained in Mathematica but it is too lengthy to present here.

While we restricted to  $\ell_1 \leq 2$  because we are interested in photons and gravitons, for higher spin particles one would also need the projectors with  $\ell_1 > 2$ .

## B.2 Type I Operators and Trivial Charges

In this appendix we want to show that type I operators are associated to trivial charges.

Let us first explain what we mean by trivial charges. Let us consider an operator  $\mathcal{O}(x)$  with a primary descendant  $D\mathcal{O}(x)$ , where  $D$  is some differential operator that creates the descendant. Now let us assume that

$$\langle (D\mathcal{O}(x))\mathcal{O}_1(x_1) \dots \mathcal{O}_N(x_N) \rangle = 0, \quad (\text{B.10})$$

exactly without any contact term. We call (B.10) trivial Ward identity in contrast with the usual Ward identity (4.2), where delta functions are present on the right-hand-side. Now because of the absence of contact terms it is easy to see that no non-trivial charges can be defined. Indeed the interesting feature of the charges is that their insertion in a correlation function equals the variation of the operators which is computed through the integral of the delta functions on the right-hand-side of (4.2). When these are absent, the variations become trivial and so do the charges themselves. We thus conclude that (B.10) gives rise to trivial charges.

To clarify the discussion let us present the simplest example of a trivial charge, the one associated to the identity operator. The identity operator is a primary with a level-one primary descendant of type  $I_1$ , i.e. which takes the form  $\partial_a \mathbb{1}$ . We want to show that from this operator, as expected, it is not possible to build non-trivial conserved charges.

Using our construction of section 6.3.2 one can in principle define a Noether current  $\mathcal{J}^a(x) = \epsilon^a(x)\mathbb{1}$ , with  $\partial_a \epsilon^a(x) = 0$ , which has a constant solution  $\epsilon^a(x) = c^a$ .<sup>54</sup> One can then proceed in defining a set of topological charges  $Q_\Sigma^a = c_a Q_\Sigma^a$  with

$$Q_\Sigma^a \equiv \int_\Sigma dS^a \mathbb{1}. \quad (\text{B.11})$$

It is easy to see that  $Q_\Sigma^a = 0$  because of rotation invariance (e.g. by choosing  $\Sigma$  to be the surface of a sphere). In this case the triviality of the charge is obtained by saying that  $Q_\Sigma^a$  vanishes.

Let us also see how this can be obtained from the Ward identity (B.10). Of course since  $\mathbb{1}$  does not depend on an insertion point,

$$\langle (\partial_a \mathbb{1})\mathcal{O}_1(x_1) \dots \mathcal{O}_N(x_N) \rangle = 0. \quad (\text{B.12})$$

Now we integrate this Ward identity over the volume of a sphere and we also find that the insertion of the charge  $Q_\Sigma^a$  (defined by integrating the left hand side) acts like zero (by integrating the right-hand-side). Thus, as expected, we obtain the same result as above.

In this case it is automatic to know that  $\partial_a \mathbb{1} = 0$ . Conversely for other operators the fact that  $D\mathcal{O}(x) = 0$  inside a correlation function must be proven. This is what we plan to do in the rest of the appendix. There are two strategies. For (standard) CFTs we will study the  $N$ -point functions with the insertion of  $\mathcal{O}(x)$  and prove that they are polynomial in  $x$ , and thus they are annihilated by  $D$  (since derivatives of a polynomial cannot give contact terms). For celestial CFTs we will make use of the wavefunction formalism to define the operators and show that, since the corresponding wavefunction vanishes, then also  $D\mathcal{O}(x)$  must vanish when inserted in a correlation function.

<sup>54</sup>One could also consider the case in which the parameter is not smooth  $\epsilon^a(x) \propto x^a |x|^{-d}$  which satisfies  $\partial_a \epsilon^a(x) \propto \delta^{(d)}(x)$ . In this case  $Q_\Sigma^a$  is equal to a constant if  $\Sigma$  contains the origin and vanishes otherwise. Thus the result is still trivial.

## Trivial Type I Ward Identities in CFTs

In this subsection we show that equation (B.10) holds in CFTs, by proving that correlation functions with the insertion of type I operators are polynomial as a function of their insertion point.

Let us start with the case of  $d = 2$ . The idea of the proof is simple. We consider an  $N$ -point function with a type I operator inserted at  $z, \bar{z}$ . This function must satisfy conservation equations in both  $z$  and  $\bar{z}$  (type Ia and Ib) which imply that the function is polynomial in these variables (and thus it cannot give rise to contact terms from the conservation equations). Let us however give a more concrete argument, by considering the OPE of type I operators which is fixed by the three-point function and can be explicitly written down. We consider a generic three-point function in a usual  $\text{CFT}_2$  where the operator  $\mathbb{O}$  has  $h = \frac{1-k}{2}$  and  $\bar{h} = \frac{1-\bar{k}}{2}$ . For simplicity, since the holomorphic and antiholomorphic behaviours factorize and are of the same form we consider only the holomorphic part (but we should remember in the end to include the antiholomorphic one). The holomorphic dependence of the three-point function on the primaries  $\mathbb{O}, \mathbb{O}_2, \mathbb{O}_3$  is (here we consider usual three-point functions which are not distributions in  $z_i$ )

$$\langle \mathbb{O}(z_1) \mathbb{O}_2(z_2) \mathbb{O}_3(z_3) \rangle = c_{123} \frac{1}{z_{12}^{h+h_2-h_3} z_{13}^{h+h_3-h_2} z_{23}^{h_2+h_3-h}}. \quad (\text{B.13})$$

Now we consider  $h = \frac{1-k}{2}$  and we ask for  $\partial^k \mathbb{O} = 0$  (keeping all the  $z_i$  distinct, which means that the result is zero away from contact points). It is easy to see that this shortening condition implies that  $h_3 - h_2 = \frac{1-k}{2} + i$  with  $i = 0, \dots, k-1$ . We thus get

$$\langle \mathbb{O}(z_1) \mathbb{O}_2(z_2) \mathbb{O}_3(z_3) \rangle = c_{123} \delta_{h_3-h_2-\frac{1-k}{2}-i} z_{12}^{k-1-i} z_{13}^{k-1-i} z_{23}^{-2h_3+i+1-k}. \quad (\text{B.14})$$

The result is clearly polynomial in  $z_1$  for any allowed value of  $i$ . We can then expand this expression e.g. for  $z_1 \rightarrow z_2$  using the binomial  $z_{13}^a = (z_{12} + z_{23})^a = \sum_{b=0}^a \binom{a}{b} z_{12}^b z_{23}^{a-b}$ . The result is

$$\langle \mathbb{O}(z_1) \mathbb{O}_2(z_2) \mathbb{O}_3(z_3) \rangle = c_{123} \delta_{h_3-h_2-\frac{1-k}{2}-i} \sum_{j=0}^{k-1-i} \binom{k-1-i}{j} z_{12}^{i+j} z_{23}^{-2h_3-j}. \quad (\text{B.15})$$

The OPE can thus be recast as

$$\mathbb{O}(z) \mathbb{O}_2(0) \sim c_{123} \delta_{h_3-h_2-\frac{1-k}{2}-i} \sum_{j=0}^{k-1-i} \binom{k-1-i}{j} \frac{\Gamma(1-2h_3)}{\Gamma(1-2h_3-j)} z^{i+j} \partial^j \mathbb{O}_3(0). \quad (\text{B.16})$$

This OPE is polynomial in  $z$  of order  $k-1$ , thus by applying  $\partial_z^k$  to this expression we find exactly zero. No contact term can be generated. Notice that this would also happen when the operators depend on the antiholomorphic coordinates. Starting with  $\mathbb{O}$  with  $h = \frac{1-k}{2}$  and  $\bar{h} = \frac{1-\bar{k}}{2}$  and conservations  $\partial^k \mathbb{O} = 0 = \bar{\partial}^{\bar{k}} \mathbb{O}$  we find

$$\begin{aligned} \mathbb{O}(z, \bar{z}) \mathbb{O}_2(0, 0) &\sim c_{123} \delta_{h_3-h_2-\frac{1-k}{2}-i} \delta_{\bar{h}_3-\bar{h}_2-\frac{1-\bar{k}}{2}-\bar{i}} \sum_{j=0}^{k-1-i} \sum_{\bar{j}=0}^{\bar{k}-1-\bar{i}} \binom{k-1-i}{j} \binom{\bar{k}-1-\bar{i}}{\bar{j}} \times \\ &\times \frac{\Gamma(1-2h_3)}{\Gamma(1-2h_3-j)} \frac{\Gamma(1-2\bar{h}_3)}{\Gamma(1-2\bar{h}_3-\bar{j})} z^{i+j} \bar{z}^{\bar{i}+\bar{j}} \partial^j \bar{\partial}^{\bar{j}} \mathbb{O}_3(0, 0), \end{aligned} \quad (\text{B.17})$$

where  $\bar{i} = 0, \dots, \bar{k}-1$ . The crucial observation is that no negative powers of  $z$  or  $\bar{z}$  are present in this OPE thus there is no possible way to get a delta function by applying derivatives in  $\partial_z$  and  $\partial_{\bar{z}}$ . We therefore conclude that when we insert the operator  $\mathbb{O}(z, \bar{z})$  in any  $N$ -point function we still get that the dependence in  $z$  and  $\bar{z}$  is polynomial. Therefore

$$\langle (\partial^k \mathbb{O}(z, \bar{z})) \mathbb{O}_1 \dots \mathbb{O}_N \rangle = 0, \quad (\text{B.18})$$

without contact terms and similarly for  $\bar{\partial}^{\bar{k}}\mathbb{O}(z, \bar{z})$ .

For this computation we required minimal assumptions like the usual form of the three-point function which is fixed by symmetry, and the fact that the  $\mathbb{O}$  is a type I operator which thus satisfies the type I shortening conditions. Notice that for operators of type II and type III the same logic does not work because these have shortening conditions which only involve either  $\partial_z$  or  $\partial_{\bar{z}}$ , but not both of them. To ensure a polynomial behavior it is instead necessary to have shortening conditions in both variables.

Let us now turn to  $d > 2$ . As for  $d = 2$ , the idea behind the demonstration is that an  $N$ -point correlation function with a type I operator inserted at a position  $x^a$  should have a polynomial dependence in  $x^a$  because it has to satisfy the type I conservation equation (one can project the indices of the  $d > 2$  type I conservation equation into a plane, e.g. using coordinates  $x^1 \pm ix^2$ , and use a similar argument as in  $d = 2$ ). Again we find it useful to rephrase this argument in terms of three-point functions and OPE, where all computations can be explicitly performed. To exemplify why the OPE of type I operators is polynomial let us consider the next to trivial example after the identity. We take a vector operator with a type  $I_1, n = 1$  primary descendant. This operator must have  $\Delta = -1$ . The OPE of such an operator is fixed by its three-point functions with all other two operators. For simplicity let us consider the example of the three-point function with two scalar operators,

$$\langle \mathbb{O}_{\Delta=-1}^a(x_1)\mathbb{O}_{\Delta_2}(x_2)\mathbb{O}_{\Delta_3}(x_3) \rangle \propto \frac{x_{12}^a x_{13}^2 - x_{13}^a x_{12}^2}{|x_{12}|^{\Delta_2-\Delta_3}|x_{13}|^{\Delta_3-\Delta_2}|x_{23}|^{\Delta_2+\Delta_3+2}}. \quad (\text{B.19})$$

We require that  $\partial^{\{b}\}\mathbb{O}_{\Delta=-1}^a(x_1) = 0$  away from possible contact terms. It is easy to see that this requirement implies that the three-point function vanishes unless  $\Delta_2 = \Delta_3$ , and therefore that the three-point function is a polynomial in the distances  $x_{12}$  and  $x_{13}$ . This means that the OPE takes the simple form

$$\mathbb{O}_{\Delta=-1}^a(x)\mathbb{O}_{\Delta_2}(0) \sim \delta_{\Delta_2, \Delta_3} \left[ x^a - \frac{1}{2\Delta_2} (2x^a x^b - x^2 \delta^{ab}) \partial_b \right] \mathbb{O}_{\Delta_3}(0), \quad (\text{B.20})$$

where the square bracket contains all the possible descendants. We clearly see that the square bracket is a polynomial in  $x$ . Of course if we now take  $\partial^{\{b}\}\mathbb{O}_{\Delta=-1}^a(x)$  on the OPE we get exactly zero and no possible contact terms can be generated. By considering spinning operators  $\mathbb{O}_2$  and  $\mathbb{O}_3$  it is easy to see that similar results are obtained. Therefore we proved that

$$\left\langle \left( \partial^{\{b}\}\mathbb{O}_{\Delta=-1}^a(x) \right) \mathbb{O}_1(x_1) \dots \mathbb{O}_N(x_N) \right\rangle = 0, \quad (\text{B.21})$$

without any contact term on the right-hand-side.

This demonstration can be repeated for different spins  $\ell$  of the operator  $\mathbb{O}$  and different levels  $n$  of the type I shortening condition.

## Trivial Type I Ward Identities from CCFT Wavefunctions

In this subsection we want to show that equation [B.10](#) can be obtained in CCFTs by studying the wavefunctions associated to the operators of type I.

To start we quickly review the wavefunction formalism in CCFTs. The CCFT operators  $\mathbb{O}_{\Delta, \ell}(x)$  can be obtained [106](#) as a convolution of usual QFT  $d+2$  operators  $O(X)$  in position space with so called ‘‘primary’’ wavefunctions  $f_{\Delta, \ell}(X; q)$  [7](#),

$$\mathbb{O}_{\Delta, \ell}(q) = i(O(X), f_{\Delta, \ell}(X; q)), \quad (\text{B.22})$$

where the inner product  $(\cdot, \cdot)$  is given by a standard integral in  $X^\mu$ , e.g. for spin zero this is related to the Klein Gordon inner product. The wavefunctions  $f_{\Delta, \ell}$  must satisfy a set of conditions (e.g. they should transform as  $d$  dimensional primary

operators in CCFT) which allows one to classify them. For this appendix we consider the most standard (“radiative”) wavefunctions  $f_{\Delta,\ell}$  which are defined when  $\ell$  is equal to the spin of the bulk primary  $O(X)$  (generalized wavefunctions can also be defined [12,45], but will not play a role here).

Equation (B.22) generates operators inserted at a point  $q^\mu$  in the embedding space which can then be projected to any given section, e.g. the Poincaré section  $q^\mu \rightarrow x^\alpha$  (4.27). In this formulation the only dependence on the  $CFT_d$  coordinate  $x^\alpha$  is encoded in the wavefunction. The idea of [45] is that in order to classify the types of operators one can simply classify the respective wavefunctions. E.g. for a bulk scalar operator, the correspondent wavefunction takes the form  $f_{\Delta,\ell=0}(X, q) \propto (X \cdot q)^{-\Delta}$ . It is very easy to classify the shortening conditions of such wavefunctions. E.g. when  $\Delta = 0$  the wavefunction  $f_{\Delta,\ell=0}$  becomes constant and is annihilated by  $\partial^\alpha$ . This means that the operator  $\partial^\alpha \mathbb{O}_{\Delta=0,\ell=0}$  inserted in a celestial correlator is computed by the convolution of a vanishing wavefunction, and thus it is zero.

In [45] it was shown that in  $d = 2$  all wavefunctions of type I, are annihilated by the differential operators that create the primary descendants. This is in contrast with the wavefunctions of type II and III where the differential operators give new (generalized) wavefunctions which are not vanishing. This is in perfect agreement with the fact that type I operators have trivial Ward identities while type II and III have non-trivial Ward identities with delta functions on the right-hand-side.

Here we want to show using the same CCFT wavefunction approach that also in  $d > 2$  the Ward identities for type  $I_1, n$  operators are trivial. To this end we introduce the massless radiative wavefunctions in  $d > 2$ . These take the form of spin  $\ell$  bulk-to-boundary propagators [7,128],

$$f_{\Delta,\ell}(X, Z; q, \varepsilon) \propto \frac{[(X \cdot q)(Z \cdot \varepsilon) - (X \cdot \varepsilon)(q \cdot Z)]^\ell}{(X \cdot q)^{\Delta+\ell}}, \quad (\text{B.23})$$

where  $Z$  is a polarization vector that contracts the indices of the bulk operator  $O(X)$ , while  $\varepsilon$  is a polarization vector for the CCFT operator in embedding space  $\mathbb{O}_{\Delta,\ell}(q, \varepsilon)$ .

It is easy to see that, after setting  $q$  and  $\varepsilon$  to the Poincaré section (4.27) and (4.28), the following relation holds

$$(e \cdot \partial_x)^n f_{\Delta=1-\ell-n,\ell}(X, Z; q, \varepsilon) = 0. \quad (\text{B.24})$$

To prove (B.24) we use the relations  $(e \cdot \partial_x)q^\mu = \varepsilon^\mu$  and  $(e \cdot \partial_x)\varepsilon^\mu = 0$  which imply that  $(e \cdot \partial_x)$  annihilates the term inside the square parentheses in (B.23). The rest of the proof is basically that  $(e \cdot \partial_x)^n (X \cdot q)^{n-1} = 0$  because we are taking  $n$  derivative of a polynomial of order  $n - 1$ . Therefore we conclude that the type  $I_{k=1}, n$  shortening condition annihilates the wavefunction. This implies that the associated CCFT operators constructed from (B.22) must satisfy a trivial Ward identity of the form (B.10). For completeness let us also mention that (B.24) is special to type I and that we checked that for other types (like II or S) the shortening of the wavefunction gives rise to non vanishing contributions proportional to (generalized) primary wavefunctions.

Finally let us mention that in section 6.4 we have various examples of type  $I_2$  operators inserted in a correlation function (these are the primary descendants of soft operators) and we can explicitly see that also these operators have trivial Ward identities. For all such operators with trivial Ward identities we expect the associated charges to be trivial.

### B.3 Ward Identities and Dirac Delta Distribution

A more careful treatment of the conservation equations for conformally soft shadow operators shows that the statements

$$\partial_a \tilde{S}^{(0),a} = 0, \quad \partial_a \partial_b \tilde{S}^{(0),ab} = 0, \quad \partial_a \tilde{S}^{(1),ab} = 0 \quad (\text{B.25})$$

only hold up to contact terms. Indeed accounting for the Dirac delta distributions is necessary to obtain standard Ward identities. This is the purpose of this appendix.

The leading soft photon and graviton cases can be treated in one go since  $\partial_a \tilde{S}^{(0),ab}$  and  $\tilde{S}^{(0),b}$  have the same behaviour. We need to show that  $\partial_a \left( \frac{x^a}{x^{\frac{d}{2}}} \right)$  has distributional support. To do so we define the regulated expression

$$\partial_a \left( \frac{x^a}{(x^2)^{\frac{d}{2}}} \right) = \lim_{\varepsilon \rightarrow 0} \partial_a \left( \frac{x^a}{(x^2 + \varepsilon^2)^{\frac{d}{2}}} \right) = \lim_{\varepsilon \rightarrow 0} d \frac{\varepsilon^2}{(x^2 + \varepsilon^2)^{\frac{d}{2}+1}}, \quad (\text{B.26})$$

Integrating (B.26) against a test function  $f$ , we obtain

$$\int_{\mathbb{R}^d} d^d x \lim_{\varepsilon \rightarrow 0} d \frac{\varepsilon^2}{(x^2 + \varepsilon^2)^{\frac{d}{2}+1}} f(x) = d \int_{S^{d-1}} d\Omega \int_0^\infty dr \frac{r^{d-1}}{(r^2 + 1)^{\frac{d}{2}+1}} \lim_{\varepsilon \rightarrow 0} f(\varepsilon x), \quad (\text{B.27})$$

where  $\Omega$  denotes the solid angle in  $d$  dimensions,  $r$  is the radial direction and we have performed the change of variable  $x^a \rightarrow \varepsilon x^a$ . Taking the limit  $\varepsilon \rightarrow 0$ , the above integral yields

$$\int_{S^{d-1}} d\Omega f(0) = \frac{2\pi^{\frac{d}{2}}}{\Gamma(\frac{d}{2})} f(0). \quad (\text{B.28})$$

Therefore, we find

$$\partial_a \left( \frac{x^a}{(x^2)^{\frac{d}{2}}} \right) = \frac{2\pi^{\frac{d}{2}}}{\Gamma(\frac{d}{2})} \delta^{(d)}(x). \quad (\text{B.29})$$

Following the same logic we can generalize this formula to any spin as

$$\frac{1}{(-1)^\ell \ell! \left(-\frac{d}{2} - \ell + 2\right)_\ell} (\partial_x \cdot D_e)^\ell \frac{(e \cdot x)^\ell}{(x^2)^{\frac{d}{2}}} = \frac{\pi^{d/2} (-1)^\ell (\ell - 1)! (d - 2)_\ell \left(\frac{d}{2}\right)_\ell}{\Gamma\left(\frac{d}{2} + \ell\right) \left(-\frac{d}{2} - \ell + 2\right)_\ell} \delta^{(d)}(x). \quad (\text{B.30})$$

For the subleading soft graviton theorem, the situation is more tricky. Taking a derivative of the shadow transformed subleading soft graviton factor (6.93) we define

$$V^b(x) \equiv \partial_a \left[ \frac{\partial_{x_i}^{(a} x^{b)}}{(x^2)^{\frac{d}{2}}} + \frac{1}{2} (d - 2) x \cdot \partial_{x_i} \frac{x^a x^b}{(x^2)^{\frac{d}{2}+1}} - \frac{1}{2} x \cdot \partial_{x_i} \frac{\delta^{ab}}{(x^2)^{\frac{d}{2}}} - \omega_i \partial_{\omega_i} \left( \frac{x^a x^b - \frac{\delta^{ab}}{d} x^2}{(x^2)^{\frac{d}{2}+1}} \right) + i(d - 1) \frac{x_c M_i^c ({}^a x^b)}{(x^2)^{\frac{d}{2}+1}} \right], \quad (\text{B.31})$$

where we dropped various prefactors which are irrelevant for this calculation and we set  $x_i = 0$  for simplicity. In the above formula the round brackets denote a symmetrization of the indices. The terms in the second line of (B.31) are proportional to the derivative of the Dirac distribution. We can see this as follows. For the  $\omega_i \partial_{\omega_i}$  term we have

$$\begin{aligned} \partial_a \left( \frac{x^a x^b - \frac{\delta^{ab}}{d} x^2}{(x^2)^{\frac{d}{2}+1}} \right) &= \lim_{\varepsilon \rightarrow 0} \partial_a \left( \frac{x^a x^b - \frac{\delta^{ab}}{d} x^2}{(x^2 + \varepsilon^2)^{\frac{d}{2}+1}} \right) \\ &= \lim_{\varepsilon \rightarrow 0} \frac{(d + 2)(d - 1)}{d} \frac{x^b \varepsilon^2}{(x^2 + \varepsilon^2)^{\frac{d}{2}+2}}. \end{aligned} \quad (\text{B.32})$$

Noticing that  $(d + 2) \frac{x^b}{(x^2 + \varepsilon^2)^{\frac{d}{2}+2}} = -\partial^b \frac{1}{(x^2 + \varepsilon^2)^{\frac{d}{2}+1}}$  and integrating against a test function we obtain

$$\begin{aligned} -\frac{d - 1}{d} \int_{\mathbb{R}^d} d^d x \lim_{\varepsilon \rightarrow 0} \partial^b \frac{\varepsilon^2}{(x^2 + \varepsilon^2)^{\frac{d}{2}+1}} f(x) &= \frac{d - 1}{d} \int_{\mathbb{R}^d} d^d x \frac{1}{(x^2 + 1)^{\frac{d}{2}+1}} \lim_{\varepsilon \rightarrow 0} \frac{\partial}{\partial(\varepsilon x_b)} f(\varepsilon x) \\ &= \frac{d - 1}{d^2} \frac{2\pi^{\frac{d}{2}}}{\Gamma(\frac{d}{2})} \left( \partial^b f \right) (0). \end{aligned} \quad (\text{B.33})$$

Therefore we have the following relation

$$\partial_a \left( \frac{x^a x^b - \frac{\delta^{ab}}{d} x^2}{x^{d+2}} \right) = -\frac{d-1}{d^2} \frac{2\pi^{\frac{d}{2}}}{\Gamma(\frac{d}{2})} \partial^b \delta^{(d)}(x). \quad (\text{B.34})$$

For the  $M_i$  term we have

$$\begin{aligned} \lim_{\varepsilon \rightarrow 0} \partial_a \frac{-x_c M_i^{c(a} x^b)}{(x^2 + \varepsilon^2)^{\frac{d}{2}+1}} &= \frac{1}{2}(d+2) M_i^{bc} \lim_{\varepsilon \rightarrow 0} \frac{\varepsilon^2 x_c}{(x^2 + \varepsilon^2)^{\frac{d}{2}+2}} \\ &= -\frac{1}{2d} M_i^{bc} \lim_{\varepsilon \rightarrow 0} \partial_c \frac{d\varepsilon^2}{(x^2 + \varepsilon^2)^{\frac{d}{2}+1}}. \end{aligned} \quad (\text{B.35})$$

Then using (B.26), we obtain

$$\lim_{\varepsilon \rightarrow 0} \partial_a \frac{-x_c M_i^{c(a} x^b)}{(x^2 + \varepsilon^2)^{\frac{d}{2}+1}} = -\frac{\pi^{\frac{d}{2}}}{d\Gamma(\frac{d}{2})} M_i^{bc} \partial_c \delta^{(d)}(x). \quad (\text{B.36})$$

Having shown that the second line of (B.31) gives a derivative of the Dirac delta distribution, it remains to show that the first line of (B.31) gives a delta distribution (not a derivative thereof). The first line of (B.31) can be written as

$$\lim_{\varepsilon \rightarrow 0} \frac{1}{2} \left[ \frac{d\varepsilon^2}{(x^2 + \varepsilon^2)^{\frac{d}{2}+1}} \partial_{x_i}^b + (d^2 - 4) \frac{\varepsilon^2 x^b x^c}{(x^2 + \varepsilon^2)^{\frac{d}{2}+2}} \partial_{x_i c} \right]. \quad (\text{B.37})$$

The first term can be evaluated using (B.26). For the second term, we have that

$$\frac{\varepsilon^2 x^b x^c}{(x^2 + \varepsilon^2)^{\frac{d}{2}+2}} = -\frac{1}{d+2} \left[ -\frac{1}{d} \partial^b \partial^c \frac{\varepsilon^2}{(x^2 + \varepsilon^2)^{\frac{d}{2}}} - \frac{\varepsilon^2 \delta^{bc}}{(x^2 + \varepsilon^2)^{\frac{d}{2}+1}} \right]. \quad (\text{B.38})$$

The second term in the above equation can be clearly evaluated using equation (B.26). The first term vanishes identically in the limit  $\varepsilon \rightarrow 0$ .

Putting everything together we land on the result

$$V^b(x) = (d-1) \frac{\pi^{\frac{d}{2}}}{\Gamma(\frac{d}{2}+1)} \left( \delta^{(d)}(x) \partial_{x_i}^b - \frac{1}{d} \omega_i \partial_{\omega_i} \partial^b \delta^{(d)}(x) + \frac{i}{2} M_i^{bc} \partial_c \delta^{(d)}(x) \right). \quad (\text{B.39})$$

## B.4 Two-Point Integral in $\text{CFT}_d$ Space

The computations of the shadow transformed soft factors in section 6.5 and appendix B.5 make use of the following result for two-point integrals in  $\text{CFT}_d$  space

$$\int_{\mathbb{R}^d} \frac{d^d x_1}{(x_{12}^2)^\alpha (x_{13}^2)^\beta} = \frac{\pi^{\frac{d}{2}} \Gamma(\alpha + \beta - \frac{d}{2}) \Gamma(\frac{d}{2} - \alpha) \Gamma(\frac{d}{2} - \beta)}{\Gamma(\alpha) \Gamma(\beta) \Gamma(d - \alpha - \beta)} \frac{1}{(x_{23}^2)^{\alpha + \beta - \frac{d}{2}}}, \quad (\text{B.40})$$

where  $x_{12}^a \equiv (x_1 - x_2)^a$ . To obtain this result note that the shift  $x_1 \rightarrow x_1 + x_2$  in (B.40) is inconsequential and we may as well compute

$$I(x_2, x_3) \equiv \int_{\mathbb{R}^d} \frac{d^d x_1}{(x_1^2)^\alpha ((x_1 + x_{23})^2)^\beta}. \quad (\text{B.41})$$

Using the Feynman-Schwinger parametrization and going to spherical coordinates we find

$$\begin{aligned} I(x_2, x_3) &= \frac{\Gamma(\alpha + \beta)}{\Gamma(\alpha) \Gamma(\beta)} \int_0^1 dt t^{\alpha-1} (1-t)^{\beta-1} \int_{\mathbb{R}^d} d^d x_1 \frac{1}{[(x_1 + (1-t)x_{23})^2 + t(1-t)x_{23}^2]^{\alpha+\beta}} \\ &= \frac{\Gamma(\alpha + \beta)}{\Gamma(\alpha) \Gamma(\beta)} \int_0^1 dt t^{\alpha-1} (1-t)^{\beta-1} \int d\Omega_d \int_0^\infty dr \frac{r^{d-1}}{[r^2 + t(1-t)x_{23}^2]^{\alpha+\beta}} \\ &= \frac{\pi^{\frac{d}{2}} \Gamma(\alpha + \beta - \frac{d}{2})}{\Gamma(\alpha) \Gamma(\beta)} (x_{23}^2)^{\frac{d}{2} - \alpha - \beta} \int_0^1 dt t^{\frac{d}{2} - \beta - 1} (1-t)^{\frac{d}{2} - \alpha - 1} \\ &= \frac{\pi^{\frac{d}{2}} \Gamma(\alpha + \beta - \frac{d}{2}) \Gamma(\frac{d}{2} - \alpha) \Gamma(\frac{d}{2} - \beta)}{\Gamma(\alpha) \Gamma(\beta) \Gamma(d - \alpha - \beta)} \frac{1}{(x_{23}^2)^{\alpha + \beta - \frac{d}{2}}} \end{aligned} \quad (\text{B.42})$$

which is the result on the right-hand-side of (B.40).

## B.5 Shadow Transforms of Soft Factors

In this appendix we give a complementary derivation of the shadow transformed soft theorems that applies for any spacetime dimension  $d$  – that is for both even and odd. While in section [6.5](#) we have worked in the index-free notation, here we give the shadow transformed soft photon and graviton factors in their alternative form with the indices made explicit.

### Leading Soft Photon

The shadow transform of the soft photon operator expressed in index form is

$$\tilde{R}_1^a(x) = \lim_{\Delta \rightarrow 1} N_{\Delta,1} \int_{\mathbb{R}^d} d^d y \frac{I^{ab}(x-y)}{[(x-y)^2]^{d-\Delta}} R_{1b}(y), \quad (\text{B.43})$$

where  $I^{ab}(x) = \delta^{ab} - 2\frac{x^a x^b}{x^2}$ . To obtain the shadow transformed soft photon theorem we need to compute the shadow of the soft photon factor [\(6.46\)](#) which is given by

$$\tilde{S}_p^{(0)a}(\omega, x) = -2e \sum_{i=1}^N \mathbb{Q}_i \frac{1}{\omega} \lim_{\Delta \rightarrow 1} N_{\Delta,1} \mathcal{S}_{\Delta,1}^a, \quad (\text{B.44})$$

where

$$\mathcal{S}_{\Delta,1}^a = \int_{\mathbb{R}^d} d^d y \frac{I^{ab}(x-y)}{[(x-y)^2]^{d-\Delta}} \frac{(x_i - x)_b}{(x_i - x)^2}. \quad (\text{B.45})$$

The shadow kernel can be rewritten as follows

$$\frac{I^{ab}(x-y)}{[(x-y)^2]^{d-\Delta}} = \hat{D}_S^{ab} \frac{1}{[(x-y)^2]^{d-\Delta-1}}, \quad (\text{B.46})$$

where we defined the differential operator  $c_{\Delta,1} \hat{D}_S, \frac{d}{2} - \Delta$  in index form

$$\hat{D}_S^{ab} = \frac{1}{2(1+\Delta-d)(d-\Delta)} \left( \partial^a \partial^b - \frac{1+\Delta-d}{2\Delta-d} \delta^{ab} \square \right). \quad (\text{B.47})$$

Then, integrating by parts and using equation [\(B.40\)](#), we obtain

$$\mathcal{S}_{\Delta,1}^a = \frac{\pi^{\frac{d}{2}} \Gamma(\frac{d}{2}) \Gamma(\frac{d}{2} - \Delta + 1) \Gamma(\Delta - \frac{d}{2})}{\Gamma(\Delta) \Gamma(d - \Delta + 1)} (\Delta - 1) \frac{(x_i - x)^a}{[(x_i - x)^2]^{\frac{d}{2} - \Delta + 1}}. \quad (\text{B.48})$$

Plugging this result into [\(B.44\)](#) we obtain in the limit  $\Delta \rightarrow 1$  the shadow transformed soft photon factor [\(6.81\)](#)<sup>55</sup> Taking the divergence of [\(B.44\)](#) and using equation [\(B.29\)](#), we obtain the Ward identity [\(6.82\)](#).

### Leading Soft Graviton

The shadow transform on the leading soft graviton operator is

$$\tilde{H}_1^{ab}(x) = \lim_{\Delta \rightarrow 1} N_{\Delta,2} \int_{\mathbb{R}^d} d^d y \frac{I^{aa'}(x-y) I^{bb'}(x-y)}{[(x-y)^2]^{d-\Delta}} H_{1a'b'}(y). \quad (\text{B.49})$$

Applying this transform to the leading soft graviton factor [\(6.52\)](#) yields

$$\tilde{S}_p^{(0)ab}(\omega, x) = -\kappa \sum_{i=1}^N \frac{\omega_i}{\omega} \lim_{\Delta \rightarrow 1} N_{\Delta,2} \mathcal{S}_{\Delta,2}^{ab}, \quad (\text{B.50})$$

<sup>55</sup>Notice that in even dimensions both  $\mathcal{S}_{\Delta,1}^a$  and  $N_{\Delta,1}$  are finite in the limit  $\Delta \rightarrow 1$ . In odd dimensions,  $\mathcal{S}_{\Delta,1}^a$  goes to zero and  $N_{\Delta,1}$  diverges as  $\Delta \rightarrow 1$  but their product is still finite. A similar subtlety occurs for the shadow transform of the leading and subleading conformally soft graviton.



where

$$S_{\Delta,2}^{ab} = \int_{\mathbb{R}^d} d^d y \frac{I^{aa'}(x-y)I^{bb'}(x-y)}{[(x-y)^2]^{d-\Delta}} \left( \frac{(x_i-y)_{a'}(x_i-y)_{b'}}{(x_i-y)^2} - \frac{\delta_{a'b'}}{d} \right). \quad (\text{B.51})$$

The shadow kernel can be expressed as

$$\frac{I^{aa'}(x-y)I^{bb'}(x-y)}{[(x-y)^2]^{d-\Delta}} = \widehat{D}_S^{aa'bb'} \frac{1}{[(x-y)^2]^{d-\Delta-2}}, \quad (\text{B.52})$$

where we defined the differential operator  $c_{\Delta,2} \widehat{D}_{S, \frac{d}{2}-\Delta}$  in index form

$$\begin{aligned} \widehat{D}_S^{aa'bb'} = & \alpha_1 \left( \partial^a \partial^{a'} \partial^b \partial^{b'} \right. \\ & - \alpha_2 \left( \delta^{a'b'} \partial^a \partial^b + \delta^{a'b} \partial^a \partial^{b'} + \delta^{ab} \partial^{a'} \partial^{b'} + \delta^{ab'} \partial^{a'} \partial^b + (\Delta-d) \left( \delta^{aa'} \partial^b \partial^{b'} + \delta^{bb'} \partial^a \partial^{a'} \right) \right) \square \\ & \left. + \alpha_3 \left( \delta^{a'b'} \delta^{ab} + \delta^{a'b} \delta^{ab'} + [(\Delta-d)(\Delta-d+1) - 1] \delta^{aa'} \delta^{bb'} \right) \square^2 \right), \end{aligned} \quad (\text{B.53})$$

with

$$\begin{aligned} \alpha_1 &= \frac{1}{4(\Delta-d)(\Delta-d-1)(1+\Delta-d)(2+\Delta-d)}, \\ \alpha_2 &= \frac{1}{2+2\Delta-d}, \\ \alpha_3 &= \frac{1}{(2\Delta-d)(2+2\Delta-d)}. \end{aligned} \quad (\text{B.54})$$

Using integration by parts, the result (B.40) and taking the limit  $\Delta \rightarrow 1$ , the shadow leading soft graviton factor becomes equation (6.87). The result is finite with a similar subtlety mentioned in footnote 55 regarding odd dimensions. Using equation (B.26), we can show the Ward identity (6.88).

## Subleading Soft Graviton

The shadow transformed subleading soft graviton operator and the soft graviton factor (6.57) can also be computed in index notation but the expressions are much more cumbersome to write down. Let us outline the necessary steps starting from the index-free expression for the shadow transform of the subleading soft graviton factor, equation (6.57), which is given by

$$\tilde{S}_p^{(1)}(\omega, x, e) = \lim_{\Delta \rightarrow 0} N_{\Delta,2} \int_{\mathbb{R}^d} d^d y \frac{1}{[(x-y)^2]^{d-\Delta-2}} \widehat{D}_S^{aa'bb'} S_{p,ab}^{(1)}(\omega, y) e_{a'} e_{b'}. \quad (\text{B.55})$$

Note that we used integration by parts to move the differential operator  $D_S^{aa'bb'}$  on the soft factor. This operator was defined in (B.53) and acting with it on the soft factor using (B.40) to evaluate the integrals and taking the limit  $\Delta \rightarrow 0$ , we obtain the shadow subleading soft graviton factor (6.93). We obtain a finite result in both even and odd dimensions (see footnote 55). Using equation (B.39), we can show the Ward identity (6.94).

## B.6 Type S Operators in Even Dimensions

There is a puzzle about type S primary descendants. They can be defined in any dimensions but from representation theory one knows that this type of operator should exist only in odd  $d$ . How is this possible? What happens to these operators in even  $d$ ? The most plausible answer is that in even  $d$  a type S operator can be written as a composite of other primary descendants. We now show in a few examples that indeed this is what happens.

In the following we will focus on spin  $\ell$  primary operators  $\mathbb{O}_{\Delta,\ell}$  with dimensions  $\Delta = 2 - \ell$  with type S primary descendants at level  $n = \frac{d}{2} - 2 + \ell$ . These primary descendants are only defined when  $n$  is integer, and therefore for even  $d$ . First we show that the type S operators can be written in a very simple form in term of projectors which makes manifest many of their properties. For the sake of clarity we exemplify the form of  $D_{S,\frac{d}{2}-2+\ell}$  for  $\ell = 0, 1, 2$  (up to overall normalization factors),

$$\square^{\frac{d}{2}-2}, \quad (\ell = 0), \quad (\text{B.56})$$

$$\square^{\frac{d}{2}-2}[e \cdot \partial_x \partial_{\hat{f}} \cdot \partial_x - \square(e \cdot \partial_{\hat{f}})], \quad (\ell = 1), \quad (\text{B.57})$$

$$\begin{aligned} \square^{\frac{d}{2}-2}[(d-2)(e \cdot \partial_x)^2(\partial_x \cdot \partial_{\hat{f}})^2 - 2(d-1)\square(e \cdot \partial_x)(e \cdot \partial_{\hat{f}})(\partial_x \cdot \partial_{\hat{f}}) \\ + (d-1)\square^2(e \cdot \partial_{\hat{f}})^2 + \square(e \cdot \partial_x)^2(\partial_{\hat{f}} \cdot \partial_{\hat{f}})], \quad (\ell = 2). \end{aligned} \quad (\text{B.58})$$

The differential operators  $D_{S,\frac{d}{2}-2+\ell}$  above are defined such that they act on a spin  $\ell$  primary  $\mathbb{O}_{\Delta,\ell}(x, \hat{f})$  whose tensor indices are contracted with unconstrained vectors  $\hat{f}$ . The resulting descendants are spin  $\ell$  operators with indices contracted with constrained vectors  $e$  (such that  $e^2 = 0$ ). As stated above, they become primaries when  $\Delta = 2 - \ell$ . For any even  $d > 2$  these differential operators can be written in terms of projectors as follows<sup>56</sup>

$$D_{S,\frac{d}{2}-2+\ell} \propto \pi_{\frac{d}{2}-2+\ell,\ell} \left( \begin{array}{ccc|ccc} \partial_x & \dots & \dots & \partial_x & \partial_x & \dots & \dots & \partial_x \\ \hline e & \dots & e & \partial_{\hat{f}} & \dots & \partial_{\hat{f}} & \dots & \partial_{\hat{f}} \end{array} \right) \quad (\text{B.60})$$

$$\propto \square^{\frac{d}{2}-2} \pi_{\ell,\ell} \left( \begin{array}{ccc|ccc} \partial_x & \dots & \partial_x & \partial_x & \dots & \partial_x \\ \hline e & \dots & e & \partial_{\hat{f}} & \dots & \partial_{\hat{f}} \end{array} \right). \quad (\text{B.61})$$

From this form it is straightforward to see that the resulting operators are conserved. Indeed, conservation is obtained by acting with  $(\partial_x \cdot D_e)$  on the projector which is ensured by the symmetry properties of the projector.

One can also show that the operator in [\(B.61\)](#) is related to other types of primary descendants of  $\mathbb{O}_{\Delta=2-\ell,\ell}$ . Indeed the projector  $\pi_{\ell,\ell}$  can be written as the consecutive action of two other operators that create primary descendants, namely

$$\pi_{\ell,\ell} \left( \begin{array}{ccc|ccc} \partial_x & \dots & \partial_x & \partial_x & \dots & \partial_x \\ \hline e & \dots & e & \partial_{\hat{f}} & \dots & \partial_{\hat{f}} \end{array} \right) \propto D_{\text{II}_{k=2,n=\ell}} D_{\text{I}_{k=2,n=\ell}}. \quad (\text{B.62})$$

Therefore we obtain that

$$D_{S,\frac{d}{2}-2+\ell} \mathbb{O}_{\Delta=2-\ell,\ell} \propto D_{\text{II}_{k=2,n=\ell}} \square^{\frac{d}{2}-2} D_{\text{I}_{k=2,n=\ell}} \mathbb{O}_{\Delta=2-\ell,\ell}. \quad (\text{B.63})$$

The type  $\text{I}_2$  operator at level  $n = \ell$  is acting on a primary with dimensions  $\Delta = 2 - \ell = \Delta_{\text{I}_2,n=\ell}^*$ , which thus has the correct dimension to define a primary descendant according to equation [\(6.14\)](#). When  $d = 4$ , the  $\square$  disappears and the type S operator becomes equal to the action of type  $\text{I}_2$  and  $\text{II}_2$  primary descendants. Moreover the type  $\text{I}_2, n = \ell$  primary descendant has dimension  $\Delta = 2$  which is the correct dimension for a primary with a type  $\text{II}_2, n = \ell$  primary descendant according to [\(6.20\)](#). In  $d = 4$  we can thus prove that the action of  $D_{S,\frac{d}{2}-2+\ell}$  can be decomposed in terms of more basic primary descendants. For even  $d > 4$  one needs to write the powers of the  $\square$  in terms of other primary descendants, but we did not attempt this here. However let us mention that in any even  $d \geq 4$  the operator [\(B.63\)](#) always starts with the action  $D_{\text{I}_{k=2,n=\ell}} \mathbb{O}_{\Delta=2-\ell,\ell}$ . Since  $D_{\text{I}_{k=2,n=\ell}}$  is of type I, we expect it to annihilate the primary without generating contact terms. If this is taken into account, then the action of the rest of the terms in [\(B.63\)](#) would be trivial.

<sup>56</sup>In the following we will use a notation in which a vector contracted with an index inside a box is represented as the vector inside the box, e.g.

$$\boxed{a} \boxed{b} \boxed{c} \dots e^b \equiv \boxed{a} \boxed{e} \boxed{c} \dots. \quad (\text{B.59})$$

Finally let us mention that the values  $\Delta_{S,n}^*$  for which the type S operator becomes a primary descendant in even dimensions always coincides with the ones of either type  $I_k$  or  $III_k$ , but never of type  $II_k$ . We thus expect that the composite primary descendant of type  $S,n$  will start with the action of differential operators of either type  $I_k$  or  $III_k$ . For all type  $I_k$  we expect the differential operator to annihilate the primary without generating contact terms. In these cases we thus conclude that the full action of  $D_{S,n}$  should annihilate the primary.

In summary, in this appendix we exemplified why the type S operator is not considered a new type in even dimensions, by showing that in explicit cases it can be understood as the action of more fundamental types such as  $I_{k=2}$  and  $II_{k=2}$ .

## C Appendix: Part III

### C.1 Radial Expansions of Radiative Solutions

In this section we explore the radial expansions for standard radiative solutions to the chiral Dirac and Rarita-Schwinger equations. This will let us identify the free data which get promoted to the mode operators seen in section 8.1 as well as provide more context for the shadow versus non-shadow fall offs explored in section 8.2 and appendix C.4 below.

### C.2 Chiral Photino

The massless Dirac equation decouples into the following equations for left and right-handed Weyl spinors  $\psi$  and  $\bar{\psi}$ , respectively

$$\bar{\sigma}^\mu \partial_\mu \psi = 0, \quad \sigma^\mu \partial_\mu \bar{\psi} = 0. \quad (\text{C.1})$$

Here we will focus on the left-handed photinos for which we make the following ansatz for the radial expansion

$$\psi(u, r, z, \bar{z}) = \sum_n r^{-n} \left[ \psi^{(n)}(u, z, \bar{z}) + \log r \hat{\psi}^{(n)}(u, z, \bar{z}) \right]. \quad (\text{C.2})$$

For these towers to truncate and to have sensible boundary conditions we should impose the vanishing of modes  $\psi^{(n)}$  and  $\hat{\psi}^{(n)}$  starting at some values of  $n$ . Introducing  $\bar{D} = r\sigma^A \partial_A$ , whose  $r$  dependence cancels, we have the compact relation

$$\bar{\sigma}_r \partial_u \psi^{(n)} + (\bar{\sigma}_r - \bar{\sigma}_u) \left( (n-1) \psi^{(n-1)} - \hat{\psi}^{(n-1)} \right) - \bar{D} \psi^{(n-1)} = 0. \quad (\text{C.3})$$

The same equation holds for the log modes after substituting  $\hat{\psi}^{(n)} \mapsto 0$  and  $\psi^{(n)} \mapsto \hat{\psi}^{(n)}$ . Meanwhile

$$\{\sigma^\mu, \bar{\sigma}^\nu\} = -2\eta^{\mu\nu} \mathbb{1} \Rightarrow \sigma^\nu \partial_\nu \bar{\sigma}^\mu \partial_\mu = -2\Box, \quad (\text{C.4})$$

so our solutions also satisfy the Klein-Gordon equation for each component. This implies that the radial order of the free data should match that of the massless scalar. We can thus impose  $\psi^{(n \leq 0)}(u, z, \bar{z})$  and  $\hat{\psi}^{(n \leq 1)}(u, z, \bar{z})$  vanishing, and will find constraints on the components of  $\psi^{(1)}(u, z, \bar{z})$  which we now identify. Since

$$\bar{\sigma}_r = -\frac{2}{1+z\bar{z}} \begin{pmatrix} 1 & \bar{z} \\ z & z\bar{z} \end{pmatrix} = -\frac{1}{1+z\bar{z}} |x\rangle^{\dot{a}} [x]_a, \quad (\text{C.5})$$

we see that equation C.3 imposes the constraint

$$\partial_u (\psi^{1(1)} + \bar{z} \psi^{2(1)}) = 0. \quad (\text{C.6})$$

This enforces

$$\psi^{(1)} \propto \begin{pmatrix} \bar{z} \\ -1 \end{pmatrix}, \quad (\text{C.7})$$

such that the free data is proportional to the spinor  $|x]_a$ .

### C.3 Chiral Gravitino

The gravitino example has been worked out in [111] and we will use this appendix to translate notation. There, the following gauge fixing conditions are imposed on the Dirac spinor

$$\nabla^\mu \Psi_\mu = 0, \quad \gamma^\mu \Psi_\mu = 0. \quad (\text{C.8})$$

It is straightforward to check that the conformal primary wavefunctions also satisfy these constraints. Focusing here on the left-handed Weyl gravitinos, we have the radial expansion

$$\chi_\mu(u, r, z, \bar{z}) = \sum_n r^{-n} \left[ \chi_\mu^{(n)}(u, z, \bar{z}) + \log r \hat{\chi}_\mu^{(n)}(u, z, \bar{z}) \right]. \quad (\text{C.9})$$

As for the photino in [C.2], we will not need the log tower for generic gravitino perturbations without sources. On the modes  $\chi_\mu^{(n)}(u, z, \bar{z})$  we then impose fall-offs such that

$$\chi_r^{(0)} = \chi_u^{(0)} = \chi_r^{(1)} = 0. \quad (\text{C.10})$$

The Rarita-Schwinger equation together with the gauge conditions [C.8] impose further constraints. The projection operators introduced in [111] take the form

$$P_0 = -\frac{1}{2} \gamma_r \gamma_u = -\frac{1}{2} \begin{pmatrix} \sigma_r & 0 \\ 0 & \bar{\sigma}_r \end{pmatrix}, \quad P_1 = -\frac{1}{2} \gamma_u \gamma_r = -\frac{1}{2} \begin{pmatrix} \bar{\sigma}_r & 0 \\ 0 & \sigma_r \end{pmatrix}, \quad (\text{C.11})$$

where  $\bar{\sigma}_r$  is given in [C.5] and

$$\sigma_r = -\frac{2}{1+z\bar{z}} \begin{pmatrix} z\bar{z} & -\bar{z} \\ -z & 1 \end{pmatrix} = -\frac{1}{1+z\bar{z}} |x\rangle_a \langle x|_{\dot{a}}. \quad (\text{C.12})$$

In our notation, the constraints  $r \gamma^A P_0 \Psi_A^{(0)} = 0$  and  $P_1 \Psi_A^{(0)} = 0$  in (3.11) of [111] demand on the components of  $\chi_z^{(0)}$  and  $\chi_{\bar{z}}^{(0)}$  that

$$z\chi_{1z}^{(0)} - \chi_{2z}^{(0)} = 0, \quad \text{and} \quad \chi_{1\bar{z}}^{(0)} + \bar{z}\chi_{2\bar{z}}^{(0)} = 0, \quad \chi_{1z}^{(0)} + \bar{z}\chi_{2z}^{(0)} = 0. \quad (\text{C.13})$$

This yields  $\chi_{1z}^{(0)} = \chi_{2z}^{(0)} = 0$  and

$$\chi_{\bar{z}}^{(0)} \propto \begin{pmatrix} \bar{z} \\ -1 \end{pmatrix}, \quad (\text{C.14})$$

such that the free data is proportional to the spinor  $|x\rangle_a$ .

### C.4 Radial Expansions of Conformal Primaries

We detail here the leading large- $r$  data of our radiative conformal primary wavefunctions from section [7.1] and use it as an opportunity to check the shadow relations for massless fermions. In 2D CFT the shadow transform of a primary operator  $\mathcal{O}_{\Delta, J}$  is given by a  $(\tilde{\Delta}, \tilde{J}) = (2 - \Delta, -J)$  primary operator [129]

$$\tilde{\mathcal{O}}_{\tilde{\Delta}, \tilde{J}}(w, \bar{w}) = \frac{k_{\Delta, J}}{2\pi} \int d^2 w' \frac{\mathcal{O}_{\Delta, J}(w', \bar{w}')}{(w - w')^{2-\Delta-J} (\bar{w} - \bar{w}')^{2-\Delta+J}}. \quad (\text{C.15})$$

Using the integral relation [130]

$$\int d^2 z \prod_{i=1}^2 \frac{1}{(z - z_i)^{h_i}} \frac{1}{(\bar{z} - \bar{z}_i)^{\bar{h}_i}} = \frac{\Gamma(1 - h_1) \Gamma(1 - h_2)}{\Gamma(\bar{h}_1) \Gamma(\bar{h}_2)} (-1)^{h_1 - \bar{h}_1} (2\pi)^2 \delta^{(2)}(z_1 - z_2), \quad (\text{C.16})$$

where  $h_1 + h_2 = \bar{h}_1 + \bar{h}_2 = 2$ ,  $h_i - \bar{h}_i \in \mathbb{Z}$ , we see that for the normalization factor [7](#)

$$k_{\Delta,J} = \Delta - 1 + |J|, \quad (\text{C.17})$$

the shadow transform [C.15](#) squares to  $(-1)^{2J}$ . Comparing to [7.27](#) we see that these shadow relations should hold at the level of the wavefunctions as well, namely  $\mathbb{O}_{\Delta,J} \mapsto \Psi_{\Delta,J}$ . We will now verify that [7.9](#) and [7.11](#) when expanded near null infinity using the saddle point approximation [8.5](#) are indeed related by a 2D shadow transform on the celestial sphere.

## C.5 Chiral Photino

Near future null infinity the left-handed  $J = +\frac{1}{2}$  Weyl spinor has the expansion

$$\begin{aligned} \psi_{\Delta,J=+\frac{1}{2}} \Big|_{z=w} &= \sqrt{2}i \frac{\pi}{\Delta - \frac{1}{2}} (1 + z\bar{z})^{\frac{3}{2}-\Delta} \begin{pmatrix} \bar{w} \\ -1 \end{pmatrix} u^{\frac{1}{2}-\Delta} r^{-1} \delta^{(2)}(z-w) + \dots, \\ \psi_{\Delta,J=+\frac{1}{2}} \Big|_{z \neq w} &= \sqrt{2}i \left( \frac{1 + z\bar{z}}{2(z-w)(\bar{z}-\bar{w})} \right)^{\Delta+\frac{1}{2}} \begin{pmatrix} \bar{w} \\ -1 \end{pmatrix} r^{-\Delta-\frac{1}{2}} + \dots, \end{aligned} \quad (\text{C.18})$$

while its  $J = -\frac{1}{2}$  shadow transformed spinor falls off as

$$\begin{aligned} \tilde{\psi}_{\Delta,J=-\frac{1}{2}} \Big|_{z=w} &= i2^{\Delta-1} \frac{\pi}{\frac{1}{2}-\Delta} (1 + z\bar{z})^{\frac{5}{2}-\Delta} \left[ \begin{pmatrix} 1 \\ 0 \end{pmatrix} + \frac{1}{\frac{3}{2}-\Delta} \begin{pmatrix} \bar{z} \\ -1 \end{pmatrix} \partial_{\bar{z}} \right] r^{\Delta-\frac{5}{2}} \delta^{(2)}(z-w) + \dots, \\ \tilde{\psi}_{\Delta,J=-\frac{1}{2}} \Big|_{z \neq w} &= -\frac{i}{\sqrt{2}(\bar{z}-\bar{w})} \left( \frac{1 + z\bar{z}}{(z-w)(\bar{z}-\bar{w})} \right)^{\Delta-\frac{1}{2}} \begin{pmatrix} \bar{z} \\ -1 \end{pmatrix} u^{\Delta-\frac{3}{2}} r^{-1} + \dots \end{aligned} \quad (\text{C.19})$$

Using [C.15](#) we see the shadow transform exchanges the leading contact and non-contact terms.

## C.6 Chiral Gravitino

For spin- $\frac{3}{2}$  we have more components to keep track of. For the purposes of verifying the shadow relations for radiative modes, it is sufficient to write down what would be the leading terms in the expansion when  $-\frac{1}{2} < \text{Re}(\Delta)$ . Near future null infinity the left-handed  $J = +\frac{3}{2}$  wavefunction has the expansion

$$\chi_{\Delta,J=+\frac{3}{2};z} = -2^{-\Delta+\frac{1}{2}} \frac{i}{(z-w)^2} \left( \frac{1 + z\bar{z}}{(z-w)(\bar{z}-\bar{w})} \right)^{\Delta-\frac{1}{2}} \begin{pmatrix} \bar{w} \\ -1 \end{pmatrix} r^{-\Delta+\frac{1}{2}} + \dots, \quad (\text{C.20})$$

and

$$\chi_{\Delta,J=+\frac{3}{2};\bar{z}} = 2i \frac{\pi}{\Delta + \frac{1}{2}} (1 + z\bar{z})^{\frac{1}{2}-\Delta} \begin{pmatrix} \bar{w} \\ -1 \end{pmatrix} u^{\frac{1}{2}-\Delta} \delta^{(2)}(z-w) + \dots, \quad (\text{C.21})$$

for the angular components while the temporal and radial components are subleading. Similarly, the angular components of the shadow transformed  $J = -\frac{3}{2}$  wavefunctions have the expansion

$$\tilde{\chi}_{\Delta,J=-\frac{3}{2};z} = 2^{\Delta-\frac{1}{2}} i \frac{\pi}{\Delta + \frac{1}{2}} (1 + z\bar{z})^{\frac{3}{2}-\Delta} \left[ \begin{pmatrix} 1 \\ 0 \end{pmatrix} + \frac{1}{\frac{1}{2}-\Delta} \begin{pmatrix} \bar{z} \\ -1 \end{pmatrix} \partial_{\bar{z}} \right] r^{\Delta-\frac{3}{2}} \delta^{(2)}(z-w) + \dots, \quad (\text{C.22})$$

and

$$\tilde{\chi}_{\Delta,J=-\frac{3}{2};\bar{z}} = \frac{-i}{(\bar{z}-\bar{w})^3} \left( \frac{1 + z\bar{z}}{(z-w)(\bar{z}-\bar{w})} \right)^{\Delta-\frac{3}{2}} \begin{pmatrix} \bar{z} \\ -1 \end{pmatrix} u^{\Delta-\frac{3}{2}} + \dots \quad (\text{C.23})$$

Using [C.15](#) we can again verify the shadow relations for all radiative gravitinos, as promised in [12](#). The expansions above also suffice for computing the charge for the leading conformally soft gravitino at  $\Delta = \frac{1}{2}$ , or equivalently its shadow at  $\Delta = \frac{3}{2}$ . For the subleading soft gravitino at  $\Delta = -\frac{1}{2}$ , or its shadow at  $\Delta = \frac{5}{2}$ , some of the suppressed terms in the above expansions become the same order as the ones shown. We will revisit this in section [10.2](#) where we compute analogous soft charges.

## C.7 Inner Products ( $\Psi_{\Delta,J}, \Psi'_{\Delta',J'}$ )

As an alternative to the momentum basis mode expansions used in the main text, we can follow [106](#) and expand the free spin- $s$  Heisenberg picture operators in a conformal primary basis. In terms of the chiral Dirac spinors [7.24](#), we have

$$O^s(X^\mu) = \sum_{J=\pm s} \int d^2w \int_{1-i\infty}^{1+i\infty} (-id\Delta) \left[ \mathcal{N}_{2-\Delta,s}^+ \Psi_{2-\Delta,-J}^s(X_+^\mu; w, \bar{w}) b_{\Delta,J}(w, \bar{w}) + \mathcal{N}_{\Delta,s}^- \Psi_{\Delta,J}^s(X_-^\mu; w, \bar{w}) b_{\Delta,J}(w, \bar{w})^\dagger \right]. \quad (\text{C.24})$$

In this appendix we will evaluate the inner products for spins  $\frac{1}{2}$  and  $\frac{3}{2}$  on a spacelike Cauchy slice to find

$$(\Psi_{\Delta,J}^s(X_\pm), \Psi'_{\Delta',J'}(X_\pm)) = \pm (\mathcal{N}_{\Delta,s}^\pm)^{-2} \delta_{JJ'} \delta^{(2)}(w - w') \delta(i(\Delta + \Delta' - 2)), \quad (\text{C.25})$$

where the coefficients

$$\mathcal{N}_{\Delta,\frac{1}{2}}^\pm = \left[ \frac{(2\pi)^4 e^{\pm i\pi\Delta} \cos(\pi\Delta)}{\pi(\Delta - \frac{1}{2})(\frac{3}{2} - \Delta)} \right]^{-\frac{1}{2}}, \quad \mathcal{N}_{\Delta,\frac{3}{2}}^\pm = \left[ \frac{(2\pi)^4 e^{\pm i\pi\Delta} \cos(\pi\Delta)}{\pi(\Delta - \frac{1}{2})(\frac{3}{2} - \Delta)} \right]^{-\frac{1}{2}}, \quad (\text{C.26})$$

are designed to give the canonical commutation relations

$$\{b_{\Delta,J}(w, \bar{w}), b_{\Delta',J'}(w', \bar{w}')^\dagger\} = \delta_{JJ'} \delta^{(2)}(w - w') \delta(i(\Delta + \Delta' - 2)). \quad (\text{C.27})$$

The generalized distribution  $\delta$  which was defined in [106](#) reduces to the ordinary Dirac delta function for  $\Delta, \Delta' \in 1 + i\mathbb{R}$  on the principal series.

### Spin- $\frac{1}{2}$

Starting from the spin- $\frac{1}{2}$  inner product [131](#)<sup>57</sup>

$$(\Psi, \Psi') = \int d\Sigma^\mu \bar{\Psi}' \gamma_\mu \Psi, \quad (\text{C.28})$$

and using a constant time Cauchy slice, we see that for  $J = +\frac{1}{2}$  we have

$$(\Psi_{\Delta,+\frac{1}{2}}^\pm, \Psi'_{\Delta',+\frac{1}{2}}^\pm) = \langle \pm q' | \hat{\sigma}^{0\hat{a}\hat{a}} | \pm q \rangle_\alpha \int d^3X \frac{1}{(-q \cdot X_\pm)^{\Delta+\frac{1}{2}} (-q' \cdot X_\mp)^{\Delta'+\frac{1}{2}}}, \quad (\text{C.29})$$

while for  $J = -\frac{1}{2}$

$$(\Psi_{\Delta,-\frac{1}{2}}^\pm, \Psi'_{\Delta',-\frac{1}{2}}^\pm) = [\pm q' | \hat{\sigma}^0_{\hat{a}\hat{a}} | \pm q]^\dot{\alpha} \int d^3X \frac{1}{(-q \cdot X_\pm)^{\Delta+\frac{1}{2}} (-q' \cdot X_\mp)^{\Delta'+\frac{1}{2}}}, \quad (\text{C.30})$$

giving

$$(\Psi_{\Delta,J}(X_\pm), \Psi'_{\Delta',J'}(X_\pm)) = \pm \frac{(2\pi)^4 e^{\pm i\pi\Delta} \cos(\pi\Delta)}{\pi(\Delta - \frac{1}{2})(\frac{3}{2} - \Delta)} \delta_{JJ'} \delta^{(2)}(w - w') \delta(i(\Delta + \Delta' - 2)), \quad (\text{C.31})$$

so that

$$\mathcal{N}_{\Delta,\frac{1}{2}}^\pm = \left[ \frac{(2\pi)^4 e^{\pm i\pi\Delta} \cos(\pi\Delta)}{\pi(\Delta - \frac{1}{2})(\frac{3}{2} - \Delta)} \right]^{-\frac{1}{2}}. \quad (\text{C.32})$$

<sup>57</sup>Because we want an inner product on positive frequency solutions, this is essentially a complexification of  $-i\Omega(\Psi, \Psi')$ , where  $\Omega$  is the symplectic product, and the  $\Psi$  are Majorana. The symplectic product will be the focus of the next section.

## Spin- $\frac{3}{2}$

For spin- $\frac{3}{2}$  we start from

$$(\Psi, \Psi') = \int d\Sigma^\mu \bar{\Psi}^{\nu} \gamma_\mu \Psi_\nu, \quad (\text{C.33})$$

and again use a constant time Cauchy slice. We see that for  $J = +\frac{3}{2}$  we have

$$(\Psi_{\Delta, +\frac{3}{2}}^\pm, \Psi_{\Delta', +\frac{3}{2}}^\pm) = \langle \pm q' | \hat{a} \bar{\sigma}^{0\dot{a}a} | \pm q \rangle_a \int d^3 X \frac{m \cdot \bar{m}'}{(-q \cdot X_\pm)^{\Delta+\frac{1}{2}} (-q' \cdot X_\mp)^{\Delta'+\frac{1}{2}}}, \quad (\text{C.34})$$

while for  $J = -\frac{3}{2}$

$$(\Psi_{\Delta, -\frac{3}{2}}^\pm, \Psi_{\Delta', -\frac{3}{2}}^\pm) = [\pm q' |^a \sigma_{a\dot{a}}^0 | \pm q \rangle^{\dot{a}}] \int d^3 X \frac{\bar{m} \cdot m'}{(-q \cdot X_\pm)^{\Delta+\frac{1}{2}} (-q' \cdot X_\mp)^{\Delta'+\frac{1}{2}}}. \quad (\text{C.35})$$

Then using the fact

$$m_\mu \frac{1}{(-q \cdot X)^\Delta} = \left[ \epsilon_{+\mu} + \frac{1}{\sqrt{2}\Delta} q_\mu \partial_w \right] \frac{1}{(-q \cdot X)^\Delta}, \quad (\text{C.36})$$

and following the same manipulations as in appendix A of [\[106\]](#), which in this case allows us to drop the terms other than  $\epsilon_+ \cdot \epsilon'_-$ , we find

$$(\Psi_{\Delta, J}(X_\pm), \Psi'_{\Delta', J'}(X_\pm)) = \pm \frac{(2\pi)^4 e^{\pm i\pi\Delta} \cos(\pi\Delta)}{\pi(\Delta - \frac{1}{2})(\frac{3}{2} - \Delta)} \delta_{JJ'} \delta^{(2)}(w - w') \delta(i(\Delta + \Delta'^* - 2)), \quad (\text{C.37})$$

so that

$$\mathcal{N}_{\Delta, \frac{3}{2}}^\pm = \left[ \frac{(2\pi)^4 e^{\pm i\pi\Delta} \cos(\pi\Delta)}{\pi(\Delta - \frac{1}{2})(\frac{3}{2} - \Delta)} \right]^{-\frac{1}{2}}. \quad (\text{C.38})$$

## C.8 Symplectic Structure $\Omega(\delta\Psi, \delta'\Psi)$

Starting from the action for Grassmann-valued spin  $s = \frac{1}{2}$  and  $\frac{3}{2}$  Dirac fields<sup>58</sup>

$$S = i \int d^4 X \bar{\Psi}^s \not{\partial} \Psi^s, \quad (\text{C.39})$$

where  $\not{\partial} \equiv \gamma^\mu \partial_\mu$ , we compute the symplectic structure

$$\Omega(\delta\Psi^s, \delta'\Psi^s) = \int_{\mathcal{I}^+} dud^2 z \omega(\delta\Psi^s, \delta'\Psi^s), \quad (\text{C.40})$$

for the Grassmann-valued perturbations  $\delta\Psi^s$  and  $\delta'\Psi^s$ . In [\[C.40\]](#), the presymplectic form  $\omega(\delta\Psi^s, \delta'\Psi^s)$  is a codimension-1 form which we integrate on a spatial slice pushed to future null infinity  $\mathcal{I}^+$ . The null normal to  $\mathcal{I}^+$  is  $n^\mu \partial_\mu = \partial_u - \frac{1}{2} \partial_r$  and so the integrand of [\[C.40\]](#) becomes  $-(\frac{1}{2} \omega^u + \omega^r)$ . In this appendix, we evaluate  $\Omega(\delta\Psi^s, \delta'\Psi^s)$  for  $s = \frac{1}{2}, \frac{3}{2}$  to obtain the soft charges related to the leading soft photino and gravitino theorems and to the subleading soft gravitino theorem. For the Majorana spinors we consider here we have  $\bar{\Psi}_M = \Psi_M^T \mathcal{C}$  and the Majorana flip relation

$$\delta' \bar{\Psi}_M \gamma_\mu \delta \Psi_M = -\delta \bar{\Psi}_M \gamma_\mu \delta' \Psi_M. \quad (\text{C.41})$$

The appropriate normalization of the kinetic term thus differs by a factor of  $\frac{1}{2}$  from the Dirac case.

<sup>58</sup>Note that our gauge fixing brings the Rarita-Schwinger action to the form [\[C.39\]](#), and we omit there the spacetime indices in the contraction between the gravitinos.



## Spin- $\frac{1}{2}$

Using the conventions in appendix A the presymplectic structure can be written as

$$\omega^\nu(\delta\psi, \delta'\psi) = -\frac{i}{2}r^2\sqrt{\gamma}\left(\delta'\psi_a^\dagger\sigma^{\nu\dot{a}b}\delta\psi_b + \delta'\bar{\psi}^{\dagger a}\sigma_{ab}^\nu\delta\bar{\psi}^{\dot{b}} - (\delta' \leftrightarrow \delta)\right). \quad (\text{C.42})$$

Using the Majorana condition (A.18), and the Majorana flip relation we can write (C.42) as  $\omega = \ell + \ell^\dagger$ , we can focus on calculating

$$\ell^\nu(\delta\psi, \delta'\psi) = ir^2\sqrt{\gamma}\delta\psi_a^\dagger\sigma^{\nu\dot{a}b}\delta'\psi_b. \quad (\text{C.43})$$

We consider the following fall-offs for the field variations

$$\delta\psi = \frac{1}{r}\delta\psi^{(1)}(u, z, \bar{z}) + \mathcal{O}(1/r^2), \quad (\text{C.44})$$

and

$$\delta'\psi = \frac{1}{r}\delta'\psi^{(1)}(u, z, \bar{z}) + \mathcal{O}(1/r^2). \quad (\text{C.45})$$

Therefore, we find

$$\begin{aligned} \ell^u &= -i\sqrt{\gamma}\left[\delta\psi^{\dagger(1)}\sigma_r\delta'\psi^{(1)}\right] + \mathcal{O}(1/r), \\ \ell^r &= i\sqrt{\gamma}\left[\delta\psi^{\dagger(1)}(\sigma_r - \sigma_u)\delta'\psi^{(1)}\right] + \mathcal{O}(1/r). \end{aligned} \quad (\text{C.46})$$

Using (C.6) and noticing that

$$\begin{pmatrix} z & -1 \end{pmatrix} \sigma_r = \sigma_r \begin{pmatrix} \bar{z} \\ -1 \end{pmatrix} = 0, \quad (\text{C.47})$$

we can see that  $\ell^u$  becomes subleading and the expression of  $\omega^r$  is reduced. This yields the symplectic structure

$$\Omega(\delta\psi, \delta'\psi) = i\int_{\text{I}^+} du d^2z \sqrt{\gamma}\left[\delta\psi^{\dagger(1)}\sigma_u\delta'\psi^{(1)}\right] + h.c.. \quad (\text{C.48})$$

In section 10.1 we are interested in the case where  $\delta'\psi$  is replaced by the conformally soft photino primary.

## Spin- $\frac{3}{2}$

The presymplectic form for the gravitino field can be written as

$$\omega^\nu(\delta\chi, \delta'\chi) = -\frac{i}{2}r^2\sqrt{\gamma}\left(\delta'\chi_a^\dagger\sigma^{\nu\dot{a}b}\delta\chi_{b\mu} + \delta'\bar{\chi}^{\dagger a\mu}\sigma_{ab}^\nu\delta\bar{\chi}_\mu^{\dot{b}} - (\delta' \leftrightarrow \delta)\right). \quad (\text{C.49})$$

Using similar arguments as for the photino presymplectic form, we can focus on

$$\ell^\nu(\delta\chi, \delta'\chi) = ir^2\sqrt{\gamma}\delta\chi_a^\dagger\sigma^{\nu\dot{a}b}\delta'\chi_{b\mu}. \quad (\text{C.50})$$

We consider the following fall-offs for the generic gravitino field<sup>59</sup>

$$\begin{aligned} \delta\chi_{\bar{z}} &= \delta\chi_{\bar{z}}^{(0)}(u, z, \bar{z}) + \frac{1}{r}\delta\chi_{\bar{z}}^{(1)}(u, z, \bar{z}) + \mathcal{O}(1/r^2), \\ \delta\chi_z &= \frac{1}{r}\delta\chi_z^{(1)}(u, z, \bar{z}) + \mathcal{O}(1/r^2), \\ \delta\chi_u &= \frac{1}{r}\delta\chi_u^{(1)}(u, z, \bar{z}) + \mathcal{O}(1/r^2), \\ \delta\chi_r &= \frac{1}{r^2}\delta\chi_r^{(2)}(u, z, \bar{z}) + \mathcal{O}(1/r^3). \end{aligned} \quad (\text{C.51})$$

For the fall-offs of  $\delta'\chi$ , we are interested in two cases: one that is compatible with the fall-offs of the leading soft gravitino and another with that of the subleading soft gravitino.

<sup>59</sup>Notice that  $\delta\chi_{\bar{z}}^{(0)} \neq 0$  and  $\delta\chi_z^{\dagger(0)} \neq 0$  follow from  $\epsilon_{\bar{z}}^+ = \epsilon_z^- \neq 0$  at first order in the saddle point approximation.

**Leading** For the leading case, we consider

$$\delta' \chi_A = \delta' \chi_A^{(0)}(z, \bar{z}) + \mathcal{O}(1/r). \quad (\text{C.52})$$

The radial and temporal components are subleading and do not contribute to the presymplectic form. We get

$$\begin{aligned} \ell^u &= -i \left[ \delta \chi_z^{\dagger(0)} \sigma_r \delta' \chi_{\bar{z}}^{(0)} \right] + \mathcal{O}(1/r), \\ \ell^r &= i \left[ \delta \chi_z^{\dagger(0)} (\sigma_r - \sigma_u) \delta' \chi_{\bar{z}}^{(0)} \right] + \mathcal{O}(1/r). \end{aligned} \quad (\text{C.53})$$

Using (C.47), this simplifies to

$$\begin{aligned} \ell^u &= \mathcal{O}(1/r), \\ \ell^r &= -i \delta \chi_z^{\dagger(0)} \sigma_u \delta' \chi_{\bar{z}}^{(0)} + \mathcal{O}(1/r). \end{aligned} \quad (\text{C.54})$$

This yields the symplectic structure for the leading soft gravitino

$$\Omega(\delta \chi, \delta' \chi) = i \int_{I^+} dud^2 z \left[ \delta \chi_z^{\dagger(0)} \sigma_u \delta' \chi_{\bar{z}}^{(0)} \right] + h.c.. \quad (\text{C.55})$$

In section 9.3 we replace  $\delta' \chi$  by the conformally soft gravitino primary to obtain the leading soft charge for spontaneously broken large supersymmetry.

**Subleading** For the subleading soft gravitino, we consider the following fall-offs

$$\begin{aligned} \delta' \chi_{\bar{z}} &= \delta' \chi_{\bar{z}}^{(0)}(u, z, \bar{z}) + \mathcal{O}(1/r), \\ \delta' \chi_z &= r \delta' \chi_z^{(-1)}(z, \bar{z}) + \delta' \chi_z^{(0)}(u, z, \bar{z}) + \mathcal{O}(1/r), \\ \delta' \chi_u &= \delta' \chi_u^{(0)}(u, z, \bar{z}) + \mathcal{O}(1/r), \\ \delta' \chi_r &= \frac{1}{r} \delta' \chi_r^{(1)}(u, z, \bar{z}) + \mathcal{O}(1/r^2). \end{aligned} \quad (\text{C.56})$$

Notice that there will be contributions from the  $u$  and  $r$  components of the gravitino field. Using (C.47), the presymplectic form can be written as

$$\begin{aligned} \ell^u &= i\sqrt{\gamma} \left[ \delta \chi_r^{\dagger(2)} \sigma_r \delta' \chi_u^{(0)} + \delta \chi_u^{\dagger(1)} \sigma_r \delta' \chi_r^{(1)} \right] \\ &\quad - i \delta \chi_{\bar{z}}^{\dagger(1)} \sigma_r \delta' \chi_z^{(-1)} + \mathcal{O}(1/r), \\ \ell^r &= -i\sqrt{\gamma} \left[ \delta \chi_r^{\dagger(2)} (\sigma_r - \sigma_u) \delta' \chi_u^{(0)} + \delta \chi_u^{\dagger(1)} (\sigma_r - \sigma_u) \delta' \chi_r^{(1)} \right] \\ &\quad + i \delta \chi_{\bar{z}}^{\dagger(1)} (\sigma_r - \sigma_u) \delta' \chi_z^{(-1)} - i \delta \chi_z^{\dagger(0)} \sigma_u \delta \chi_{\bar{z}}^{(0)} + \mathcal{O}(1/r). \end{aligned} \quad (\text{C.57})$$

Looking at (C.56), we notice an overleading behavior in  $\delta' \chi_z$ , however the overall contribution to the presymplectic form is finite because we can see from (C.51) that  $\delta \chi_z^{\dagger}$  is subleading. The fact that  $\epsilon_z^+ = \epsilon_z^-$  and  $\epsilon_{\bar{z}}^- = \epsilon_{\bar{z}}^+$  ensures that the anti-chiral part of the charge is also finite. This yields the following symplectic structure

$$\begin{aligned} \Omega(\delta \chi, \delta' \chi) &= i \int_{\mathcal{J}^+} dud^2 z \left\{ \sqrt{\gamma} \left[ \delta \chi_r^{\dagger(2)} \left( \frac{1}{2} \sigma_r - \sigma_u \right) \delta' \chi_u^{(0)} + \delta \chi_u^{\dagger(1)} \left( \frac{1}{2} \sigma_r - \sigma_u \right) \delta' \chi_r^{(1)} \right] \right. \\ &\quad \left. - \delta \chi_{\bar{z}}^{\dagger(1)} \left( \frac{1}{2} \sigma_r - \sigma_u \right) \delta' \chi_z^{(-1)} + \delta \chi_z^{\dagger(0)} \sigma_u \delta \chi_{\bar{z}}^{(0)} \right\} + h.c.. \end{aligned} \quad (\text{C.58})$$

In section 10.2 we are interested in the case where  $\delta' \chi$  is replaced by the subleading conformally soft gravitino primary.

## References

- [1] J. M. Maldacena, “The Large N limit of superconformal field theories and supergravity,” *Adv. Theor. Math. Phys.* **2** (1998) 231–252, [arXiv:hep-th/9711200](#).
- [2] H. Bondi, M. G. J. van der Burg, and A. W. K. Metzner, “Gravitational waves in general relativity. 7. Waves from axisymmetric isolated systems,” *Proc. Roy. Soc. Lond.* **A269** (1962) 21–52.
- [3] R. K. Sachs, “Gravitational waves in general relativity. 8. Waves in asymptotically flat space-times,” *Proc. Roy. Soc. Lond.* **A270** (1962) 103–126.
- [4] S. Hollands, A. Ishibashi, and R. M. Wald, “BMS Supertranslations and Memory in Four and Higher Dimensions,” *Class. Quant. Grav.* **34** no. 15, (2017) 155005, [arXiv:1612.03290 \[gr-qc\]](#).
- [5] A. Strominger, “On BMS Invariance of Gravitational Scattering,” *JHEP* **07** (2014) 152, [arXiv:1312.2229 \[hep-th\]](#)
- [6] S. Pasterski, S.-H. Shao, and A. Strominger, “Flat Space Amplitudes and Conformal Symmetry of the Celestial Sphere,” *Phys. Rev.* **D96** no. 6, (2017) 065026, [arXiv:1701.00049 \[hep-th\]](#)
- [7] S. Pasterski and S.-H. Shao, “Conformal basis for flat space amplitudes,” *Phys. Rev.* **D96** no. 6, (2017) 065022, [arXiv:1705.01027 \[hep-th\]](#)
- [8] J. de Boer and S. N. Solodukhin, “A Holographic reduction of Minkowski space-time,” *Nucl. Phys.* **B665** (2003) 545–593, [arXiv:hep-th/0303006 \[hep-th\]](#).
- [9] C. Cheung, A. de la Fuente, and R. Sundrum, “4D scattering amplitudes and asymptotic symmetries from 2D CFT,” *JHEP* **01** (2017) 112, [arXiv:1609.00732 \[hep-th\]](#)
- [10] M. Campiglia, “Null to time-like infinity Green’s functions for asymptotic symmetries in Minkowski spacetime,” *JHEP* **11** (2015) 160, [arXiv:1509.01408 \[hep-th\]](#).
- [11] M. Campiglia, L. Coito, and S. Mizera, “Can scalars have asymptotic symmetries?,” *Phys. Rev. D* **97** no. 4, (2018) 046002, [arXiv:1703.07885 \[hep-th\]](#)
- [12] S. Pasterski and A. Puhm, “Shifting spin on the celestial sphere,” *Phys. Rev. D* **104** no. 8, (2021) 086020, [arXiv:2012.15694 \[hep-th\]](#)
- [13] P. Mitra, “Celestial Conformal Primaries in Effective Field Theories,” [arXiv:2402.09256 \[hep-th\]](#)
- [14] A. Bagchi, “Correspondence between Asymptotically Flat Spacetimes and Nonrelativistic Conformal Field Theories,” *Phys. Rev. Lett.* **105** (2010) 171601, [arXiv:1006.3354 \[hep-th\]](#)
- [15] A. Bagchi, R. Basu, A. Kakkar, and A. Mehra, “Flat Holography: Aspects of the dual field theory,” *JHEP* **12** (2016) 147, [arXiv:1609.06203 \[hep-th\]](#)
- [16] L. Ciambelli, C. Marteau, A. C. Petkou, P. M. Petropoulos, and K. Siampos, “Flat holography and Carrollian fluids,” *JHEP* **07** (2018) 165, [arXiv:1802.06809 \[hep-th\]](#)
- [17] L. Donnay, A. Fiorucci, Y. Herfray, and R. Ruzziconi, “Carrollian Perspective on Celestial Holography,” *Phys. Rev. Lett.* **129** no. 7, (2022) 071602, [arXiv:2202.04702 \[hep-th\]](#)
- [18] A. Bagchi, S. Banerjee, R. Basu, and S. Dutta, “Scattering Amplitudes: Celestial and Carrollian,” *Phys. Rev. Lett.* **128** no. 24, (2022) 241601, [arXiv:2202.08438 \[hep-th\]](#)

- [19] L. Donnay, A. Fiorucci, Y. Herfray, and R. Ruzziconi, “Bridging Carrollian and celestial holography,” *Phys. Rev. D* **107** no. 12, (2023) 126027 [arXiv:2212.12553 \[hep-th\]](#)
- [20] L. Mason, R. Ruzziconi, and A. Yellespur Srikant, “Carrollian Amplitudes and Celestial Symmetries,” [arXiv:2312.10138 \[hep-th\]](#)
- [21] Y. Pano and M. Borji, “Distributional Celestial Amplitudes,” [arXiv:2401.08877 \[hep-th\]](#)
- [22] S. Pasterski, S.-H. Shao, and A. Strominger, “Gluon Amplitudes as 2d Conformal Correlators,” *Phys. Rev.* **D96** no. 8, (2017) 085006, [arXiv:1706.03917 \[hep-th\]](#)
- [23] A. Schreiber, A. Volovich, and M. Zlotnikov, “Tree-level gluon amplitudes on the celestial sphere,” *Phys. Lett.* **B781** (2018) 349–357, [arXiv:1711.08435 \[hep-th\]](#)
- [24] A. Puhm, “Conformally Soft Theorem in Gravity,” *JHEP* **09** (2020) 130, [arXiv:1905.09799 \[hep-th\]](#)
- [25] S. Albayrak, C. Chowdhury, and S. Kharel, “On loop celestial amplitudes for gauge theory and gravity,” *Phys. Rev. D* **102** (2020) 126020. DOI: 10.1103/PhysRevD.102.126020.
- [26] N. Arkani-Hamed, M. Pate, A.-M. Raclariu, and A. Strominger, “Celestial Amplitudes from UV to IR,” [arXiv:2012.04208 \[hep-th\]](#)
- [27] H. A. González, A. Puhm, and F. Rojas, “Loops on the Celestial Sphere,” [arXiv:2009.07290 \[hep-th\]](#)
- [28] S. Stieberger and T. R. Taylor, “Strings on Celestial Sphere,” *Nucl. Phys.* **B935** (2018) 388–411, [arXiv:1806.05688 \[hep-th\]](#)
- [29] L. Donnay, G. Giribet, H. González, A. Puhm, and F. Rojas, “Celestial open strings at one-loop,” *JHEP* **10** (2023) 047. DOI: 10.1007/JHEP10(2023)047.
- [30] N. Banerjee, S. Banerjee, S. Atul Bhatkar, and S. Jain, “Conformal Structure of Massless Scalar Amplitudes Beyond Tree level,” *JHEP* **04** (2018) 039, [arXiv:1711.06690 \[hep-th\]](#)
- [31] G. Barnich and C. Troessaert, “Supertranslations call for superrotations,” *PoS CNCFG* (2010) 010, [arXiv:1102.4632 \[gr-qc\]](#) [Ann. U. Craiova Phys.21,S11(2011)].
- [32] M. Campiglia and A. Laddha, “Sub-subleading soft gravitons and large diffeomorphisms,” *JHEP* **01** (2017) 036, [arXiv:1608.00685 \[gr-qc\]](#)
- [33] A. Strominger, “ $w(1+\text{infinity})$  and the Celestial Sphere,” [arXiv:2105.14346 \[hep-th\]](#)
- [34] A. Ball, S. A. Narayanan, J. Salzer, and A. Strominger, “Perturbatively exact  $w_{1+\infty}$  asymptotic symmetry of quantum self-dual gravity,” *JHEP* **01** (2022) 114, [arXiv:2111.10392 \[hep-th\]](#).
- [35] A. Pérez, S. Prohazka, and A. Seraj, “Fracton infrared triangle,” [arXiv:2310.16683 \[hep-th\]](#)
- [36] A. Strominger, *Lectures on the Infrared Structure of Gravity and Gauge Theory*. Princeton University Press, 2018. [arXiv:1703.05448 \[hep-th\]](#)
- [37] A.-M. Raclariu, “Lectures on Celestial Holography,” [arXiv:2107.02075 \[hep-th\]](#)
- [38] S. Pasterski, M. Pate, and A.-M. Raclariu, “Celestial Holography,” in *Snowmass 2021*. 11, 2021. [arXiv:2111.11392 \[hep-th\]](#)

- [39] S. Pasterski, “A Chapter on Celestial Holography,” [arXiv:2310.04932 \[hep-th\]](#)
- [40] T. McLoughlin, A. Puhm, and A.-M. Raclariu, “The SAGEX review on scattering amplitudes chapter 11: soft theorems and celestial amplitudes,” *J. Phys. A* **55** no. 44, (2022) 443012, [arXiv:2203.13022 \[hep-th\]](#)
- [41] L. Freidel, D. Pranzetti, and A.-M. Raclariu, “A discrete basis for celestial holography,” *JHEP* **02** (2024) 176, [arXiv:2212.12469 \[hep-th\]](#)
- [42] J. Cotler, N. Miller, and A. Strominger, “An integer basis for celestial amplitudes,” *JHEP* **08** (2023) 192, [arXiv:2302.04905 \[hep-th\]](#)
- [43] K. Costello, N. M. Paquette, and A. Sharma, “Top-Down Holography in an Asymptotically Flat Spacetime,” *Phys. Rev. Lett.* **130** no. 6, (2023) 061602, [arXiv:2208.14233 \[hep-th\]](#)
- [44] K. Costello, N. M. Paquette, and A. Sharma, “Burns space and holography,” *JHEP* **10** (2023) 174, [arXiv:2306.00940 \[hep-th\]](#)
- [45] S. Pasterski, A. Puhm, and E. Trevisani, “Celestial Diamonds: Conformal Multiplets in Celestial CFT,” [arXiv:2105.03516 \[hep-th\]](#)
- [46] J. Penedones, E. Trevisani, and M. Yamazaki, “Recursion Relations for Conformal Blocks,” *JHEP* **09** (2016) 070, [arXiv:1509.00428 \[hep-th\]](#)
- [47] D. Kapec, P. Mitra, A.-M. Raclariu, and A. Strominger, “2D Stress Tensor for 4D Gravity,” *Phys. Rev. Lett.* **119** no. 12, (2017) 121601, [arXiv:1609.00282 \[hep-th\]](#)
- [48] D. Kapec and P. Mitra, “A  $d$ -Dimensional Stress Tensor for  $\text{Mink}_{d+2}$  Gravity,” *JHEP* **05** (2018) 186, [arXiv:1711.04371 \[hep-th\]](#)
- [49] D. Kapec and P. Mitra, “Shadows and soft exchange in celestial CFT,” *Phys. Rev. D* **105** no. 2, (2022) 026009, [arXiv:2109.00073 \[hep-th\]](#)
- [50] Y. Pano, A. Puhm, and E. Trevisani, “Symmetries in Celestial CFT $_d$ ,” *JHEP* **07** (2023) 076, [arXiv:2302.10222 \[hep-th\]](#)
- [51] Y. Pano, S. Pasterski, and A. Puhm, “Conformally soft fermions,” *JHEP* **12** (2021) 166, [arXiv:2108.11422 \[hep-th\]](#)
- [52] A. Fotopoulos, S. Stieberger, T. R. Taylor, and B. Zhu, “Extended Super BMS Algebra of Celestial CFT,” *JHEP* **09** (2020) 198, [arXiv:2007.03785 \[hep-th\]](#)
- [53] G. Compère, *Advanced Lectures on General Relativity* vol. 952. Springer, Cham, Cham, Switzerland, 2, 2019.
- [54] D. Zagier, “Appendix. the Mellin transform and related analytic techniques,” <https://people.mpim-bonn.mpg.de/zagier/files/tex/MellinTransform/fulltext.pdf>
- [55] P. L. Butzer and S. Jansche, “A direct approach to the Mellin transform,” *The Journal of Fourier analysis and applications* **3** (1997) 325–376. DOI: 10.1007/BF02649101.
- [56] D. Simmons-Duffin, “The Conformal Bootstrap,” in *Theoretical Advanced Study Institute in Elementary Particle Physics: New Frontiers in Fields and Strings*, pp. 1–74. 2017. [arXiv:1602.07982 \[hep-th\]](#)
- [57] M. S. Costa, J. Penedones, D. Poland, and S. Rychkov, “Spinning Conformal Correlators,” *JHEP* **11** (2011) 071, [arXiv:1107.3554 \[hep-th\]](#)

- [58] Y. A. Law and M. Zlotnikov, “Poincaré constraints on celestial amplitudes,” *JHEP* **20** (2020) 085, [arXiv:1910.04356](#) [[hep-th](#)].
- [59] Y. A. Law and M. Zlotnikov, “Massive Spinning Bosons on the Celestial Sphere,” *JHEP* **06** (2020) 079, [arXiv:2004.04309](#) [[hep-th](#)].
- [60] M. Campiglia and R. Eyheralde, “Asymptotic  $U(1)$  charges at spatial infinity,” *JHEP* **11** (2017) 168, [arXiv:1703.07884](#) [[hep-th](#)].
- [61] F. Capone, K. Nguyen, and E. Parisini, “Charge and Antipodal Matching across Spatial Infinity,” [arXiv:2204.06571](#) [[hep-th](#)].
- [62] W. Fan, A. Fotopoulos, and T. R. Taylor, “Soft Limits of Yang-Mills Amplitudes and Conformal Correlators,” *JHEP* **05** (2019) 121, [arXiv:1903.01676](#) [[hep-th](#)].
- [63] D. Nandan, A. Schreiber, A. Volovich, and M. Zlotnikov, “Celestial Amplitudes: Conformal Partial Waves and Soft Limits,” *JHEP* **10** (2019) 018, [arXiv:1904.10940](#) [[hep-th](#)].
- [64] M. Pate, A.-M. Raclariu, and A. Strominger, “Conformally Soft Theorem in Gauge Theory,” *Phys. Rev. D* **100** no. 8, (2019) 085017, [arXiv:1904.10831](#) [[hep-th](#)].
- [65] T. Adamo, L. Mason, and A. Sharma, “Celestial amplitudes and conformal soft theorems,” *Class. Quant. Grav.* **36** no. 20, (2019) 205018, [arXiv:1905.09224](#) [[hep-th](#)].
- [66] A. Guevara, “Notes on Conformal Soft Theorems and Recursion Relations in Gravity,” [arXiv:1906.07810](#) [[hep-th](#)].
- [67] S. Weinberg, “Infrared photons and gravitons,” *Phys. Rev.* **140** (1965) B516–B524.
- [68] D. J. Gross and R. Jackiw, “Low-Energy Theorem for Graviton Scattering,” *Phys. Rev.* **166** (1968) 1287–1292.
- [69] R. Jackiw, “Low-Energy Theorems for Massless Bosons: Photons and Gravitons,” *Phys. Rev.* **168** (1968) 1623–1633.
- [70] C. D. White, “Factorization Properties of Soft Graviton Amplitudes,” *JHEP* **05** (2011) 060, [arXiv:1103.2981](#) [[hep-th](#)].
- [71] F. E. Low, “Scattering of light of very low frequency by systems of spin 1/2,” *Phys. Rev.* **96** (1954) 1428–1432.
- [72] F. E. Low, “Bremsstrahlung of very low-energy quanta in elementary particle collisions,” *Phys. Rev.* **110** (1958) 974–977.
- [73] T. H. Burnett and N. M. Kroll, “Extension of the low soft photon theorem,” *Phys. Rev. Lett.* **20** (1968) 86.
- [74] M. Gell-Mann and M. L. Goldberger, “Scattering of low-energy photons by particles of spin 1/2,” *Phys. Rev.* **96** (1954) 1433–1438.
- [75] F. Cachazo and A. Strominger, “Evidence for a New Soft Graviton Theorem,” [arXiv:1404.4091](#) [[hep-th](#)].
- [76] H. Elvang, C. R. T. Jones, and S. G. Naculich, “Soft Photon and Graviton Theorems in Effective Field Theory,” *Phys. Rev. Lett.* **118** no. 23, (2017) 231601, [arXiv:1611.07534](#) [[hep-th](#)].
- [77] Z.-Z. Li, H.-H. Lin, and S.-Q. Zhang, “Infinite Soft Theorems from Gauge Symmetry,” *Phys. Rev. D* **98** no. 4, (2018) 045004, [arXiv:1802.03148](#) [[hep-th](#)].
- [78] Y. Hamada and G. Shiu, “Infinite Set of Soft Theorems in Gauge-Gravity Theories as Ward-Takahashi Identities,” *Phys. Rev. Lett.* **120** no. 20, (2018) 201601, [arXiv:1801.05528](#) [[hep-th](#)].

- [79] S. He, Y.-t. Huang, and C. Wen, “Loop Corrections to Soft Theorems in Gauge Theories and Gravity,” *JHEP* **12** (2014) 115 [arXiv:1405.1410 [hep-th]]
- [80] Z. Bern, S. Davies, and J. Nohle, “On Loop Corrections to Subleading Soft Behavior of Gluons and Gravitons,” *Phys. Rev. D* **90** no. 8, (2014) 085015 [arXiv:1405.1015 [hep-th]]
- [81] L. Iacobacci and W. Mück, “Conformal Primary Basis for Dirac Spinors,” *Phys. Rev. D* **102** no. 10, (2020) 106025 [arXiv:2009.02938 [hep-th]]
- [82] S. A. Narayanan, “Massive Celestial Fermions,” [arXiv:2009.03883 [hep-th]]
- [83] M. Pate, A.-M. Raclariu, A. Strominger, and E. Y. Yuan, “Celestial Operator Products of Gluons and Gravitons,” [arXiv:1910.07424 [hep-th]]
- [84] E. Himwich, M. Pate, and K. Singh, “Celestial operator product expansions and  $w_{1+\infty}$  symmetry for all spins,” *JHEP* **01** (2022) 080 [arXiv:2108.07763 [hep-th]]
- [85] L. Donnay, A. Puhm, and A. Strominger, “Conformally Soft Photons and Gravitons,” *JHEP* **01** (2019) 184 [arXiv:1810.05219 [hep-th]]
- [86] A. Guevara, E. Himwich, M. Pate, and A. Strominger, “Holographic Symmetry Algebras for Gauge Theory and Gravity,” [arXiv:2103.03961 [hep-th]]
- [87] T. He, P. Mitra, A. P. Porfyriadis, and A. Strominger, “New Symmetries of Massless QED,” *JHEP* **10** (2014) 112 [arXiv:1407.3789 [hep-th]]
- [88] T. He, V. Lysov, P. Mitra, and A. Strominger, “BMS supertranslations and Weinberg’s soft graviton theorem,” *JHEP* **05** (2015) 151, [arXiv:1401.7026 [hep-th]]
- [89] A. Fotopoulos, S. Stieberger, T. R. Taylor, and B. Zhu, “Extended BMS Algebra of Celestial CFT,” *JHEP* **03** (2020) 130 [arXiv:1912.10973 [hep-th]]
- [90] S. Banerjee, S. Ghosh, and S. S. Samal, “Subsubleading soft graviton symmetry and MHV graviton scattering amplitudes,” *JHEP* **08** (2021) 067 [arXiv:2104.02546 [hep-th]]
- [91] D. Kapec, V. Lysov, S. Pasterski, and A. Strominger, “Semiclassical Virasoro symmetry of the quantum gravity  $\mathcal{S}$ -matrix,” *JHEP* **08** (2014) 058, [arXiv:1406.3312 [hep-th]]
- [92] S. Banerjee, S. Ghosh, and P. Paul, “MHV Graviton Scattering Amplitudes and Current Algebra on the Celestial Sphere,” [arXiv:2008.04330 [hep-th]]
- [93] V. Lysov, S. Pasterski, and A. Strominger, “Low’s Subleading Soft Theorem as a Symmetry of QED,” *Phys. Rev. Lett.* **113** no. 11, (2014) 111601, [arXiv:1407.3814 [hep-th]]
- [94] S. Banerjee and S. Ghosh, “MHV gluon scattering amplitudes from celestial current algebras,” *JHEP* **10** (2021) 111, [arXiv:2011.00017 [hep-th]]
- [95] M. Campiglia and A. Laddha, “Sub-subleading soft gravitons: New symmetries of quantum gravity?,” *Phys. Lett.* **B764** (2017) 218–221, [arXiv:1605.09094 [gr-qc]]
- [96] A. Strominger, “Asymptotic Symmetries of Yang-Mills Theory,” *JHEP* **07** (2014) 151 [arXiv:1308.0589 [hep-th]]

- [97] M. S. Costa, T. Hansen, J. a. Penedones, and E. Trevisani, “Projectors and seed conformal blocks for traceless mixed-symmetry tensors,” [JHEP 07 \(2016\) 018](#), [arXiv:1603.05551 \[hep-th\]](#)
- [98] M. S. Costa and T. Hansen, “Conformal correlators of mixed-symmetry tensors,” [JHEP 02 \(2015\) 151](#), [arXiv:1411.7351 \[hep-th\]](#)
- [99] E. Lauria, M. Meineri, and E. Trevisani, “Spinning operators and defects in conformal field theory,” [JHEP 08 \(2019\) 066](#), [arXiv:1807.02522 \[hep-th\]](#)
- [100] V. K. Dobrev, V. B. Petkova, S. G. Petrova, and I. T. Todorov, “Dynamical derivation of vacuum operator-product expansion in euclidean conformal quantum field theory,” [Phys. Rev. D 13 \(Feb, 1976\) 887–912](#), <https://link.aps.org/doi/10.1103/PhysRevD.13.887>
- [101] M. S. Costa, T. Hansen, J. a. Penedones, and E. Trevisani, “Radial expansion for spinning conformal blocks,” [JHEP 07 \(2016\) 057](#), [arXiv:1603.05552 \[hep-th\]](#)
- [102] A. Dymarsky, J. Penedones, E. Trevisani, and A. Vichi, “Charting the space of 3D CFTs with a continuous global symmetry,” [JHEP 05 \(2019\) 098](#), [arXiv:1705.04278 \[hep-th\]](#)
- [103] C. Brust and K. Hinterbichler, “Free  $\square^k$  scalar conformal field theory,” [JHEP 02 \(2017\) 066](#), [arXiv:1607.07439 \[hep-th\]](#)
- [104] S. Banerjee, P. Pandey, and P. Paul, “Conformal properties of soft operators: Use of null states,” [Phys. Rev. D 101 no. 10, \(2020\) 106014](#), [arXiv:1902.02309 \[hep-th\]](#)
- [105] S. Banerjee and P. Pandey, “Conformal properties of soft-operators. Part II. Use of null-states,” [JHEP 02 \(2020\) 067](#), [arXiv:1906.01650 \[hep-th\]](#)
- [106] L. Donnay, S. Pasterski, and A. Puhm, “Asymptotic Symmetries and Celestial CFT,” [JHEP 09 \(2020\) 176](#), [arXiv:2005.08990 \[hep-th\]](#)
- [107] H. Jiang, “Celestial superamplitude in  $\mathcal{N} = 4$  SYM theory,” [arXiv:2105.10269 \[hep-th\]](#)
- [108] A. Brandhuber, G. R. Brown, J. Gowdy, B. Spence, and G. Travaglini, “Celestial Superamplitudes,” [arXiv:2105.10263 \[hep-th\]](#)
- [109] Y. Hu, L. Ren, A. Y. Srikant, and A. Volovich, “Celestial Dual Superconformal Symmetry, MHV Amplitudes and Differential Equations,” [arXiv:2106.16111 \[hep-th\]](#)
- [110] D. Kutasov and N. Seiberg, “More comments on string theory on AdS(3),” [JHEP 04 \(1999\) 008](#), [arXiv:hep-th/9903219 \[hep-th\]](#)
- [111] V. Lysov, “Asymptotic Fermionic Symmetry From Soft Gravitino Theorem,” [arXiv:1512.03015 \[hep-th\]](#)
- [112] S. Banerjee, “Symmetries of free massless particles and soft theorems,” [Gen. Rel. Grav. 51 no. 9, \(2019\) 128](#), [arXiv:1804.06646 \[hep-th\]](#)
- [113] S. Pasterski, A. Puhm, and E. Trevisani, “Revisiting the Conformally Soft Sector with Celestial Diamonds,” [arXiv:2105.09792 \[hep-th\]](#)
- [114] S. G. Avery and B. U. W. Schwab, “Burg-Metzner-Sachs symmetry, string theory, and soft theorems,” [Phys. Rev. D 93 \(2016\) 026003](#), [arXiv:1506.05789 \[hep-th\]](#)



- [115] T. T. Dumitrescu, T. He, P. Mitra, and A. Strominger, “Infinite-Dimensional Fermionic Symmetry in Supersymmetric Gauge Theories,” [arXiv:1511.07429 \[hep-th\]](#).
- [116] Z.-W. Liu, “Soft theorems in maximally supersymmetric theories,” [Eur. Phys. J. C \*\*75\*\* no. 3, \(2015\) 105](#), [arXiv:1410.1616 \[hep-th\]](#)
- [117] O. Fuentealba, M. Henneaux, S. Majumdar, J. Matulich, and T. Neogi, “Local supersymmetry and the square roots of Bondi-Metzner-Sachs supertranslations,” [arXiv:2108.07825 \[hep-th\]](#)
- [118] S. G. Avery and B. U. Schwab, “Residual Local Supersymmetry and the Soft Gravitino,” [Phys. Rev. Lett. \*\*116\*\* no. 17, \(2016\) 171601](#), [arXiv:1512.02657 \[hep-th\]](#)
- [119] G. Barnich, “Centrally extended BMS<sub>4</sub> Lie algebroid,” [JHEP \*\*06\*\* \(2017\) 007](#), [arXiv:1703.08704 \[hep-th\]](#)
- [120] M. A. Awada, G. W. Gibbons, and W. T. Shaw, “Conformal Supergravity, Twistors and the Super BMS Group,” [Annals Phys. \*\*171\*\* \(1986\) 52](#).
- [121] S. Banerjee, S. Ghosh, and R. Gonzo, “BMS symmetry of celestial OPE,” [JHEP \*\*04\*\* \(2020\) 130](#), [arXiv:2002.00975 \[hep-th\]](#)
- [122] S. Stieberger and T. R. Taylor, “Symmetries of Celestial Amplitudes,” [Phys. Lett. B \*\*793\*\* \(2019\) 141–143](#), [arXiv:1812.01080 \[hep-th\]](#)
- [123] Y. T. A. Law and M. Zlotnikov, “Relativistic partial waves for celestial amplitudes,” [JHEP \*\*11\*\* \(2020\) 149](#), [arXiv:2008.02331 \[hep-th\]](#)
- [124] D. Kapec, Y. T. A. Law, and S. A. Narayanan, “Soft Scalars and the Geometry of the Space of Celestial CFTs,” [arXiv:2205.10935 \[hep-th\]](#)
- [125] D. Kapec, “Soft Particles and Infinite-Dimensional Geometry,” [arXiv:2210.00606 \[hep-th\]](#).
- [126] J. Potthof, “On differential operators in white noise analysis,” [Acta Applicandae Mathematicae \*\*63\*\* \(2000\) 333–347](#). DOI: 10.1023/A:1010779905082.
- [127] H. Elvang and Y.-t. Huang, “Scattering Amplitudes,” [arXiv:1308.1697 \[hep-th\]](#)
- [128] M. S. Costa, V. Gonçalves, and J. a. Penedones, “Spinning AdS Propagators,” [JHEP \*\*09\*\* \(2014\) 064](#), [arXiv:1404.5625 \[hep-th\]](#)
- [129] H. Osborn, “Conformal Blocks for Arbitrary Spins in Two Dimensions,” [Phys. Lett. \*\*B718\*\* \(2012\) 169–172](#), [arXiv:1205.1941 \[hep-th\]](#)
- [130] F. A. Dolan and H. Osborn, “Conformal Partial Waves: Further Mathematical Results,” [arXiv:1108.6194 \[hep-th\]](#)
- [131] L. Iacobacci and W. Mück, “Conformal Primary Basis for Dirac Spinors,” [Phys. Rev. D \*\*102\*\* no. 10, \(2020\) 106025](#), [arXiv:2009.02938 \[hep-th\]](#)

**Titre :** Amplitudes célestes et holographie

**Mots clés :** Holographie, gravitation quantique, amplitudes de diffusion

**Résumé :** Dans cette thèse, nous explorons les propriétés holographiques des amplitudes de diffusion dans des espace-temps asymptotiquement plats. Pour les particules de masse nulle, l'amplitude de diffusion peut être exprimée dans une base d'états propres des transformations de Lorentz en appliquant des transformations de Mellin sur les énergies des particules externes. Toutefois ce changement de base doit prendre en compte le fait que l'amplitude de diffusion exprimée en fonction des quantités de mouvement est une distribution tempérée. Dans une première partie, nous construisons des amplitudes célestes en considérant la transformée de Mellin des distributions tempérées. Nous caractérisons alors la transformée de Mellin de l'espace de Schwartz et les amplitudes célestes sont des éléments de son dual topologique.

On étudie par la suite les symétries de la théorie conforme céleste en un nombre de dimensions arbitraire en utilisant les théorèmes mous. Grâce à des

outils de la théorie de représentation conforme nous pouvons classifier leurs symétries associées. Nous présentons ensuite une méthode pour construire les charges topologiques associées. Ces groupes de symétries constituent un sous-groupe des groupes des symétries asymptotiques.

Enfin, nous étudions les symétries fermioniques dans les théories  $\mathcal{N} = 1$  QED supersymétrique et supergravité. Nous construisons ainsi les opérateurs fermioniques sur le bord ainsi que les fonctions d'onde conformes à partir de spineurs/vecteurs judicieusement choisis. Les transformations larges de supersymétrie sont équivalentes au théorème mou du gravitino et nous identifions le générateur correspondant sur la sphère céleste. Ensuite, nous construisons les charges associées aux théorèmes mous du premier ordre pour le photino et du second ordre pour le gravitino en utilisant le formalisme covariant de l'espace de phase. Les charges SUSY globales lient les multiplets conformes bosoniques à ceux qui sont fermioniques.

**Title :** Celestial amplitudes and holography

**Keywords :** Holography, quantum gravity, scattering amplitudes

**Abstract :** In this thesis we explore the holographic properties of scattering amplitudes in asymptotically flat spacetimes. For massless particles, the scattering amplitude can be expressed in a basis of Lorentz eigenstates by applying the Mellin transform on the energies of the external particles on the amplitude in the momentum basis. However this change of basis should take into account the distributional nature of momentum space amplitudes. Therefore we start by defining the Mellin transform for tempered distributions. We characterize the Mellin transform of the Schwartz space and celestial amplitudes are elements of its topological dual.

We then study the symmetries of the celestial conformal field theory in an arbitrary number of dimensions using soft theorems. We use tools from conformal re-

presentation theory to classify their associated symmetries and construct the corresponding topological charges. The group of symmetries thus obtained is a subgroup of the asymptotic symmetry group.

We finally study fermionic symmetries in  $\mathcal{N} = 1$  supersymmetric QED and SUGRA. We construct fermionic boundary operators on the celestial sphere as well as conformal primary wavefunctions using adequately chosen polarization vectors/spinors. Large gauge transformations being equivalent to the leading soft gravitino theorem, we identify its corresponding generator on the celestial sphere. We then construct the soft charges for the leading soft photino and leading/subleading soft gravitino theorems using the covariant phase space formalism. Global SUSY charges link bosonic conformal multiplets to fermionic ones.