



**HAL**  
open science

# Event-triggered control for nonlinear systems : Application to vehicle platoons

Rafael Nascimento Silva

► **To cite this version:**

Rafael Nascimento Silva. Event-triggered control for nonlinear systems: Application to vehicle platoons. Automatic. Université Polytechnique Hauts-de-France; Universidade Federal de Minas Gerais, 2024. English. NNT: 2024UPHF0022 . tel-04731021

**HAL Id: tel-04731021**

**<https://theses.hal.science/tel-04731021v1>**

Submitted on 10 Oct 2024

**HAL** is a multi-disciplinary open access archive for the deposit and dissemination of scientific research documents, whether they are published or not. The documents may come from teaching and research institutions in France or abroad, or from public or private research centers.

L'archive ouverte pluridisciplinaire **HAL**, est destinée au dépôt et à la diffusion de documents scientifiques de niveau recherche, publiés ou non, émanant des établissements d'enseignement et de recherche français ou étrangers, des laboratoires publics ou privés.

## PhD Thesis

Submitted for the degree of Doctor of Philosophy from  
**UNIVERSIDADE FEDERAL DE MINAS GERAIS Graduate Program in  
Electrical Engineering and UNIVERSITÉ POLYTECHNIQUE  
HAUTS-DE-FRANCE and INSA HAUTS-DE-FRANCE**

Subject: **Automatic control, Production**

**Rafael NASCIMENTO SILVA**

**Doctoral school:** PPGEE – Programa de Pós-Graduação em Engenharia Elétrica UFMG  
Doctoral School Polytechnique Hauts-de-France (ED PHF n°635)  
**Research units:** Laboratoire d'Automatique, de Mécanique et d'Informatique Industrielles  
et Humaines (LAMIH - UMR CNRS 8201)  
Laboratório de Detecção de Falhas, Controle, Otimização e Modelagem (DIFCOM)

# Event-triggered control for nonlinear systems: Application to vehicle platoons

<b>Jury:</b>	D'ANDRÉA-NOVEL, Brigitte	Professeure, Universités Mines ParisTech
<b>Reviewers:</b>	ADOUANE, Lounis	Professor, Université de Technologie de Compiègne
	DÓREA, Carlos	Professor, Universidade Federal do Rio Grande do Norte
<b>Examiners:</b>	D'ANDRÉA-NOVEL, Brigitte	Professor, Universités Mines ParisTech
	DEAECTO, Grace	Associate Professor, Universidade Estadual de Campinas
<b>Thesis directors:</b>	FREZZATO, Luciano	Adjunct Professor, Universidade Federal de Minas Gerais
	GUERRA, Thierry Marie	Professor, Université Polytechnique Hauts de France
<b>Thesis co-supervisor:</b>	NGUYEN, Anh-Tu	Associate Professor, Université Polytechnique Hauts de France
	SOUZA, Fernando	Associate Professor, Universidade Federal de Minas Gerais

Valenciennes  
2024



Tese de Doutorado

Para obter o grau de doutor pelo  
Programa de Pós-Graduação em Engenharia Elétrica UNIVERSIDADE  
FEDERAL DE MINAS GERAIS e UNIVERSITÉ POLYTECHNIQUE  
HAUTS-DE-FRANCE e a INSA HAUTS-DE-FRANCE

Tema: **Automática**

**Rafael NASCIMENTO SILVA**

**Escola de Doutorado:** PPGEE – Programa de Pós-Graduação em Engenharia Elétrica UFMG  
Doctoral School Polytechnique Hauts-de-France (ED PHF n°635)  
**Unidade de Pesquisa:** Laboratoire d'Automatique, de Mécanique et d'Informatique Industrielles  
et Humaines (LAMIH - UMR CNRS 8201)  
Laboratório de Detecção de Falhas, Controle, Otimização e Modelagem (DIFCOM)

## Controle acionado por evento para sistemas não lineares: Aplicação a comboio de veículos

<b>Juri:</b>	D'ANDRÉA-NOVEL, Brigitte	Professeure, Universités Mines ParisTech
<b>Revisores:</b>	ADOUANE, Lounis	Professor Titular, Université de Technologie de Compiègne
	DÓREA, Carlos	Professor Titular, Universidade Federal do Rio Grande do Norte
<b>Examinadores:</b>	D'ANDRÉA-NOVEL, Brigitte	Professora Titular, Universités Mines ParisTech
	DEAECTO, Grace	Professora Associada, Universidade Estadual de Campinas
<b>Orientadores:</b>	FREZZATO, Luciano	Professor Adjunto, Universidade Federal de Minas Gerais
	GUERRA, Thierry Marie	Professor Titular, Université Polytechnique Hauts de France
<b>Coorientadores:</b>	NGUYEN, Anh-Tu	Professor Associado, Université Polytechnique Hauts de France
	SOUZA, Fernando	Professor Associado, Universidade Federal de Minas Gerais

Valenciennes  
2024

Thèse de doctorat

Pour obtenir le grade de Docteur de  
l'UNIVERSIDADE FEDERAL DE MINAS GERAIS Graduate Program in  
Electrical Engineering et de l'UNIVERSITÉ POLYTECHNIQUE  
HAUTS-DE-FRANCE et de l'INSA HAUTS-DE-FRANCE

Spécialité: **Automatique, Productique**

**Rafael NASCIMENTO SILVA**

**École doctorale:** PPGEE – Programa de Pós-Graduação em Engenharia Elétrica UFMG  
Doctoral School Polytechnique Hauts-de-France (ED PHF n°635)  
**Unité de recherche:** Laboratoire d'Automatique, de Mécanique et d'Informatique Industrielles  
et Humaines (LAMIH - UMR CNRS 8201)  
Laboratório de Detecção de Falhas, Controle, Otimização e Modelagem (DIFCOM)

**Commande événementielle pour les systèmes non  
linéaires: Application au convoi de véhicules**

<b>Jury:</b>	D'ANDRÉA-NOVEL, Brigitte	Professeure, Universités Mines ParisTech
<b>Rapporteurs:</b>	ADOUANE, Lounis	Professeur, Université de Technologie de Compiègne
	DÓREA, Carlos	Professeur, Universidade Federal do Rio Grande do Norte
<b>Examineurs:</b>	D'ANDRÉA-NOVEL, Brigitte	Professeure, Universités Mines ParisTech
	DEAECTO, Grace	Maîtresse de conférences, Universidade Estadual de Campinas
<b>Directeurs de thèse :</b>	FREZZATO, Luciano	Professeur Adjoint, Universidade Federal de Minas Gerais
	GUERRA, Thierry Marie	Professeur, Université Polytechnique Hauts de France
<b>Co-encadrant:</b>	NGUYEN, Anh-Tu	Maître de conférences, Université Polytechnique Hauts de France
	SOUZA, Fernando	Maître de conférences, Universidade Federal de Minas Gerais

Valenciennes  
2024

Rafael Nascimento Silva

**EVENT-TRIGGERED CONTROL FOR  
NONLINEAR SYSTEMS: Application to vehicle  
platoons**

Thesis submitted to the joint PhD program from the Graduate Program in Electrical Engineering of the Universidade Federal de Minas Gerais, Université Polytechnique Hauts-de-France and INSA Hauts-de-France in partial fulfillment of the requirements for the degree of Doctor in Electrical Engineering.

Supervisor: Prof. Luciano Antonio Frezzatto Santos, PhD (UFMG)

Prof. Thierry-Marie Guerra, PhD (UPHF)

Co-Supervisor: Prof. Fernando de Oliveira Souza, PhD (UFMG)

Prof. Anh-Tu Nguyen, PhD (UPHF)

Valenciennes

2024

S586e	<p>Silva, Rafael Nascimento.  Event-triggered control for nonlinear systems [recurso eletrônico] : application to vehicle platoons / Rafael Nascimento Silva. – 2024.  1 recurso online (137 f. : il., color.) : pdf.</p>
	<p>Orientadores: Luciano Antonio Frezzatto Santos, Thierry-Marie Guerra.  Coorientadores: Fernando de Oliveira Souza, Anh-Tu Nguyen.</p>
	<p>Tese (doutorado) – Universidade Federal de Minas Gerais, Escola de Engenharia.</p>
	<p>Bibliografia: f. 129-137.</p>
	<p>1. Engenharia elétrica – Teses. 2. Sistemas não lineares – Teses. 3. Veículos a motor – Dispositivos de transmissão – Teses. 4. Controle remoto – Teses. 5. Simuladores (Computadores digitais) – Teses. I. Santos, Luciano Antonio Frezzatto. II. Guerra, Thierry-Marie, 1963-. III. Souza, Fernando de Oliveira. IV. Nguyen, Anh-Tu, 1954-. V. Universidade Federal de Minas Gerais. Escola de Engenharia. VI. Título.</p>
	<p>CDU: 621.3(043)</p>



UNIVERSIDADE FEDERAL DE MINAS GERAIS  
ESCOLA DE ENGENHARIA  
PÓS-GRADUAÇÃO EM ENGENHARIA ELÉTRICA  
**FOLHA DE APROVAÇÃO**

**"EVENT-TRIGGERED CONTROL FOR NONLINEAR SYSTEMS: APPLICATION TO PLATOONING"**

**RAFAEL NASCIMENTO SILVA**

Tese de Doutorado submetida à Banca Examinadora designada pelo Colegiado do Programa de Pós-Graduação em Engenharia Elétrica da Escola de Engenharia da Universidade Federal de Minas Gerais, como requisito para obtenção do grau de Doutor em Engenharia Elétrica. Aprovada em 05 de julho de 2024. Por:

Prof. Dr. Luciano Antonio Frezzatto Santos  
DELT (UFMG)

Prof. Dr. Thierry-Marie Guerra  
LAMIH-CNRS (Université Polytechnique Hauts-de-France)

Prof. Dr. Fernando de Oliveira Souza  
DELT (UFMG)

Prof. Dr. Anh-Tu Nguyen  
LAMIH-CNRS (Université Polytechnique Hauts-de-France)

Profa. Dra. Brigitte D'Andrea-Novel  
(Mines ParisTech)

Prof. Dr. Lounis Adouane  
LASMEA (Université de Technologie de Compigne)

Profa. Dra. Grace Silva Deaecto  
FEM (Universidade Estadual de Campinas)

Prof. Dr. Carlos Eduardo Trabuco Dórea  
DCA (Universidade Federal do Rio Grande do Norte)



Documento assinado eletronicamente por **Luciano Antonio Frezzatto Santos, Professor do Magistério Superior**, em 05/07/2024, às 11:40, conforme horário oficial de Brasília, com fundamento no art. 5º do [Decreto nº 10.543, de 13 de novembro de 2020](#).



Documento assinado eletronicamente por **Fernando de Oliveira Souza, Professor do Magistério Superior**, em 05/07/2024, às 11:42, conforme horário oficial de Brasília, com fundamento no art. 5º do [Decreto nº 10.543, de 13 de novembro de 2020](#).



Documento assinado eletronicamente por **Carlos Eduardo Trabuco Dórea, Usuário Externo**, em 05/07/2024, às 16:31, conforme horário oficial de Brasília, com fundamento no art. 5º do [Decreto nº 10.543, de 13 de novembro de 2020](#).



Documento assinado eletronicamente por **Thierry-Marie Guerra, Usuário Externo**, em 08/07/2024, às 09:34, conforme horário oficial de Brasília, com fundamento no art. 5º do [Decreto nº 10.543, de 13 de novembro de 2020](#).



Documento assinado eletronicamente por **Anh-Tu Nguyen, Usuário Externo**, em 10/07/2024, às 17:43, conforme horário oficial de Brasília, com fundamento no art. 5º do [Decreto nº 10.543, de 13 de novembro de 2020](#).



Documento assinado eletronicamente por **Grace Silva Deaecto, Usuária Externa**, em 12/07/2024, às 10:03, conforme horário oficial de Brasília, com fundamento no art. 5º do [Decreto nº 10.543, de 13 de novembro de 2020](#).



Documento assinado eletronicamente por **Brigitte D'Andrea Novel, Usuário Externo**, em 16/07/2024, às 05:16, conforme horário oficial de Brasília, com fundamento no art. 5º do [Decreto nº 10.543, de 13 de novembro de 2020](#).



Documento assinado eletronicamente por **Lounis Adouane, Usuário Externo**, em 17/07/2024, às 04:00, conforme horário oficial de Brasília, com fundamento no art. 5º do [Decreto nº 10.543, de 13 de novembro de 2020](#).



A autenticidade deste documento pode ser conferida no site [https://sei.ufmg.br/sei/controlador\\_externo.php?acao=documento\\_conferir&id\\_orgao\\_acesso\\_externo=0](https://sei.ufmg.br/sei/controlador_externo.php?acao=documento_conferir&id_orgao_acesso_externo=0), informando o código verificador **3348200** e o código CRC **723F7D6B**.



*Special thanks to my family*

# Acknowledgements

Firstly, I want to thank my family, especially my parents Jaime Marques and Maria Oliveira, for all opportunities they gave me, for education, trust, and the for always been by my side, regardless of distance.

I thank the professors Fernando, Luciano, Anh-Tu and Guerra for their excellent orientation, for their patience and for knowledge share; These factors helped me on the way to become a better researcher.

I thank all the professors of the Postgraduate Program in Electrical Engineering (PP-GEE) whose knowledge contributed to this work, in addition to the aid in the research process that underlies the same. And I thank UPHF for the support.

I thank all my friends and colleagues of D!Fcom and LAMIH, friends and teachers of IFBA Campus Vitória da Conquista. Special thanks to all my friends of many years, who were by my side and supported me in the difficulties that occurred during this time.

This work was supported by the French Ministry of Higher Education and Research, by the CNRS, by the Hauts-de-France region (Allocation de recherche 2020 de la région Hauts-de-France Convention 20003875), by the Coordination for the Improvement of Higher Education Personnel - Brazil (CAPES) through the Academic Excellence Program (PROEX), by the project InSAC (National Institute of Science and Technology for Cooperative Autonomous Systems Applied to Security and Environment) under the grants CNPq (Conselho Nacional de Desenvolvimento Científico e Tecnológico) 465755/2014-3 and 88887.513093/2020-00, Fundação de Amparo à Pesquisa do Estado de Minas Gerais (FAPEMIG), and São Paulo Research Foundation (FAPESP) 2014/50851-0, and also by the grants CNPq: 312034/2020-2, FAPEMIG: APQ-00543-217 and APQ-00630-23, and Universidade Federal de Minas Gerais.



*Special thanks to my family*

# Abstract

In this thesis we address the design of event-triggered control for nonlinear systems focusing on the application of nonhomogeneous vehicle platooning. Due to the presence of parametric uncertainties and unmeasured exogenous disturbances, the classical feedback linearization technique cannot be applied to attain linear and homogeneous platoon. To address this issue, we propose a disturbance observer (DOB) to estimate a lumped disturbance, representing the effects of both the parametric uncertainty and the unmeasured external signals. The estimated disturbance is directly incorporated into the feedback linearization control law for uncertainty compensation. Considering the compensation effects, to assess individual stability and string stability, we formulate an overlapping subsystem representing the interaction between vehicles, which directly exchange information. Through this modeling formulation, individual and string stability of the nonhomogeneous platoon can be studied using  $\mathcal{L}_2$  stability analysis of a single overlapping subsystem, ensuring the scalability of the proposed stability conditions. Considering event-based transmission for resource-efficient communication, we derive sufficient design conditions using suitable Lyapunov-Krasovskii functionals and relaxation techniques for dynamic event-triggered control (ETC) methods to ensure individual and string stability in cases with and without communication delays. To ensure Zeno-free behavior, a minimum time between consecutive transmissions is imposed. To account for the enforced time, the overlapping subsystem is rewritten as a switching system based on the intervals during which the triggering mechanism is active. As an extension of ETC methods for platooning applications, we propose a co-design ETC method for nonlinear systems, based on a feedback linearization technique. The co-design conditions for both the controller and the event-triggering mechanism are recast as an optimization problem subject to linear matrix inequality constraints. Extensive simulations and comparisons are presented for each proposed ETC control result to illustrate the advantages of the respective methods over the related literature.

Keywords: Nonlinear Systems; Networked Control; Event-Triggered Control; Vehicle Platoon; Disturbance Observer.

# Resumo

Nesta tese abordamos o projeto de controle acionado por eventos para sistemas não lineares, com foco na aplicação em comboio de veículos não homogêneos. Devido à presença de incertezas paramétricas e distúrbios exógenos, a técnica clássica de linearização por realimentação não pode ser aplicada para obter um comboio linear e homogêneo. Para resolver essa questão, propomos um observador de distúrbios (DOB : *Disturbance observer*) para estimar um distúrbio “virtual”, representando os efeitos tanto da incerteza paramétrica quanto dos sinais externos não medidos. O distúrbio estimado é incorporado diretamente na lei de controle de linearização por realimentação para compensação das incertezas. Considerando os efeitos da compensação, para avaliar a estabilidade individual e a estabilidade do comboio, formulamos um subsistema sobreposto que representa a interação entre veículos que trocam informações diretamente. Por meio dessa formulação, a estabilidade individual e do comboio não homogêneo pode ser estudada utilizando a análise de estabilidade  $\mathcal{L}_2$  de apenas um subsistema sobreposto, garantindo a escalabilidade das condições de estabilidade propostas. Considerando a transmissão baseada em eventos para comunicação eficiente em termos de recursos, derivamos condições suficientes usando funcionais de Lyapunov-Krasovskii adequados e técnicas de relaxamento para métodos de controle acionado por eventos dinâmicos (ETC : *Event-triggered control*) para garantir a estabilidade individual e do comboio nos casos, com e sem atrasos de comunicação. Para garantir um comportamento livre de Zenão, um tempo mínimo entre transmissões consecutivas é imposto. Para incluir esse tempo no modelo do subsistema sobreposto, o mesmo é reescrito como um sistema chaveado baseado nos intervalos durante os quais o mecanismo de disparo está ativo. Como uma extensão das abordagens ETC aplicada ao comboio, propomos um método para co-projeto de ETC aplicado a sistemas não lineares, baseado em uma técnica de linearização por realimentação. As condições de co-projeto para o controlador e o mecanismo de acionamento de eventos são reformuladas como um problema de otimização sujeito a restrições sob a forma de desigualdades matriciais lineares. Simulações extensivas e comparações são apresentadas para cada controlador ETC proposto com intuito de ilustrar as vantagens dos respectivos métodos em relação à literatura relacionada.

Palavras-chave: Sistemas Não Lineares; Controle Em Rede; Controle Acionado Por Evento; Comboio De Veículos; Observador De Distúrbios.

# Résumé

Cette thèse aborde la mise en œuvre d’une commande événementielle pour les systèmes non linéaires avec une application au convoi non homogène de véhicules. La commande linéarisante est appliquée pour homogénéiser le convoi. Néanmoins, elle a des limitations en présence d’incertitudes paramétriques et de perturbations exogènes non mesurées. Pour résoudre ce problème, nous proposons d’utiliser un observateur de perturbations (DOB : disturbance observer) qui estime une perturbation “virtuelle”, représentant les effets à la fois des incertitudes paramétriques et des signaux externes non mesurés. Cette estimation est directement intégrée dans la loi de commande linéarisante pour compenser les incertitudes. En tenant compte des effets de compensation, la stabilité individuelle de chaque véhicule et la stabilité du convoi de véhicules est formulée à partir d’un sous-système interconnecté. Ce dernier représente l’interaction entre deux véhicules consécutifs qui échangent directement des informations. Grâce à cette formulation, la stabilité individuelle et en convoi non homogène peut être étudiée en utilisant une analyse de stabilité  $\mathcal{L}_2$  d’un seul sous-système interconnecté, assurant la scalabilité des conditions de stabilité proposées. En considérant une transmission basée sur les événements pour réduire le taux de communication, des conditions suffisantes de stabilité sont proposées. Elles utilisent la théorie de Lyapunov et dans le cas de retards, des fonctionnelles de Lyapunov-Krasovskii. Pour éviter le phénomène de Zenon, un délai minimum entre les transmissions consécutives est imposé. Pour tenir compte du délai imposé, le sous-système interconnecté est réécrit sous forme d’un système à commutation basé sur les intervalles pendant lesquels le mécanisme de déclenchement est actif. En tant qu’extension des méthodes ETC pour les applications autour des convois de véhicules, une méthode de co-design pour les systèmes non linéaires est également proposée à partir d’une technique de commande linéarisante. Les conditions de synthèse à la fois pour le contrôleur et le mécanisme de déclenchement d’événements sont reformulées sous forme d’un problème d’optimisation écrit à l’aide de contraintes d’inégalité matricielle linéaire. Des simulations et des comparaisons sont présentées pour chaque partie du mémoire.

Mots clés: Systèmes Non Linéaires; Commande En Réseau; Commande Événementielle; Convoi Du Véhicule; Observateur Des Perturbations.

# List of figures

Figure 2.1 – Cooperative ACC vehicle platooning illustration where Vehicle $i$ receives information from Vehicle $i - 1$ and transmit to Vehicle $i + 1$ . . . . .	27
Figure 2.2 – Event triggering control loop . . . . .	30
Figure 3.1 – Vehicle platooning PF topology where $\Sigma_i$ receives information from $\Sigma_{i-1}$ and transmit to $\Sigma_{i+1}$ . Vehicle $i$ measures, the relative distance distance $\hat{p}_i = p_{i-1} - p_i - L_{c,i}$ and the velocity difference $\Delta v_i = v_{i-1} - v_i$ . . . . .	43
Figure 3.2 – Feedback linearization loop with DOB compensation. $\mathcal{V}_i$ Stand for the nominal dynamical system and $d_i$ is the <i>virtual</i> disturbance defined in (3.11). . . . .	46
Figure 3.3 – Vehicle communication and control loop. $\mathcal{C}_{fb}$ and $\mathcal{C}_{ff}$ stand, respectively, for the feedback and feedforward control law components. . . . .	48
Figure 3.4 – Test 1. Velocity (left) and distance policy error (right), of $\Sigma_0$ and $\Sigma_1$ for the nominal case. . . . .	56
Figure 3.5 – Test 1. Velocity, distance policy error vehicles without DOB compensation (top) , with DOB compensation (middle) and respective control input (bottom left) and disturbance estimation (bottom right) of $\Sigma_0$ and $\Sigma_1$ . . . . .	57
Figure 3.6 – Test 2.1: Platoon $\mathbb{J} = \{0, 4, 1, 3, 2, 4, 1\}$ . Velocity (top left), distance policy error (top right), control input (bottom left) and disturbance estimation (bottom right) of each vehicle with a controller designed according to Corollary 3.1. . . . .	59
Figure 3.7 – Test 2.2: Platoon $\mathbb{J} = \{0, 4, 1, 3, 2\}$ . Velocity (top left), distance policy error (top right), control input (bottom left) and disturbance estimation (bottom right) of each vehicle with $\bar{K}_1 = \begin{bmatrix} 0.2 & 0.7 & -0.42 & 0 \end{bmatrix}$ and $\bar{K}_2 = \begin{bmatrix} 0 & 1 \end{bmatrix}$ . . . . .	60
Figure 3.8 – Test 2.3: Velocity (left), and distance policy error (right), of vehicles $\Sigma_2$ , $\Sigma_7$ and $\Sigma_{10}$ designed considering the Interconnected (top) and Overlapping (bottom) systems. . . . .	61
Figure 3.9 – Test 2.4: Velocity (left), and distance policy error (right), of vehicles $\Sigma_1$ , to $\Sigma_{10}$ the Interconnected (top) and Overlapping (bottom) systems, stating with non zero initial conditions. . . . .	62
Figure 4.1 – Vehicle platooning PF topology where $\Sigma_i$ receives information from $\Sigma_{i-1}$ subjected to a time delay $\tau^*(t)$ and transmits to $\Sigma_i$ at time $t_{k,i}$ generated according to an event triggering mechanism. . . . .	64
Figure 4.2 – Communication loop of the proposed event-triggered CACC setup. . . . .	64

Figure 4.3 – Illustration of the transmission from vehicle $\Sigma_i$ and the receiving time intervals for $\Sigma_{i+1}$ with respective interval subdivisions. . . . .	66
Figure 4.4 – Emulation – Test 1. Velocity $v$ , acceleration $a$ and distance policy error $\Delta p$ of the platooning vehicles obtained with the switched dynamic ETM (4.6), designed based on Theorem 4.1. . . . .	83
Figure 4.5 – Emulation – Test 1. Platooning with a time-varying velocity reference, and inter-event time for each vehicle obtained with the switched dynamic ETC design from Theorem 4.1. . . . .	84
Figure 4.6 – Emulation – Test 2. Distance policy errors $\Delta p_i$ obtained using the four compared ETMs. . . . .	85
Figure 4.7 – Emulation – Test 2. Inter-event times obtained using the four compared ETMs. (a) Proposed dynamic ETM, (b) Static ETM, (c) Periodic ETM, (d) Dynamic ETM (DOLK <i>et al.</i> , 2017). . . . .	86
Figure 4.8 – Co-design – Test 2. Velocity $v$ , acceleration $a$ and distance policy error $\Delta p$ of the platooning vehicles obtained with the switched dynamic ETM (4.6), designed based on Theorem 4.3. . . . .	87
Figure 4.9 – Co-design – Test 2. Platooning with a time-varying velocity reference, and inter-event time for each vehicle obtained with the switched dynamic ETC design from Theorem 4.3. . . . .	88
Figure 4.10–Co-design – Test 2. Distance policy errors $\Delta p_i$ obtained using the three different ETCs. . . . .	89
Figure 4.11–Co-design – Test 2. Inter-event times obtained using the three ETCs. (a) Proposed dynamic ETC, (b) Static ETC, (c) Dynamic ETC of (DOLK <i>et al.</i> , 2017). . . . .	89
Figure 5.1 – Time response and control inputs applied to the closed-loop system (5.98) with the control design in Corollary 5.1. . . . .	113
Figure 5.2 – Inter event times for system (5.98) with the control law (5.24) and the event-triggering condition (5.71) designed from Corollary 5.1. . . . .	113
Figure 5.3 – Comparison of time responses and control signals applied to the closed-loop system (5.101) between the control design from Corollary 5.2 and the approach in (XU <i>et al.</i> , 2020). . . . .	114
Figure 5.4 – Comparison of IETs obtained with the closed-loop system (5.101) between the control design from Corollary 5.2 and the approach in (XU <i>et al.</i> , 2020). . . . .	115
Figure 5.5 – Comparison of stable initial conditions for system (5.104) between the control design from Corollary 5.2 and the approach in (XU <i>et al.</i> , 2020). . . . .	116
Figure 5.6 – Comparison of trajectories and control input signals applied to system (5.104) between the control design from Corollary 5.2 and the approach in (XU <i>et al.</i> , 2020). . . . .	117



Figure 5.7 – Comparison of IETs obtained with system (5.104) between the control design from Corollary 5.2 and the approach in (XU <i>et al.</i> , 2020). . . . .	117
Figure 5.8 – Comparison of time responses and control input applied to system (5.107) between the control design from Theorem 5.2 and the approach in (XU <i>et al.</i> , 2020). . . . .	119
Figure 5.9 – Comparison of IETs obtained with system (5.107) between the control design from Theorem 5.2 and the approach in (XU <i>et al.</i> , 2020). . . . .	119
Figure 6.1 – Feedback linearization loop with DOB compensation and control input saturation. . . . .	123
Figure 6.2 – Test 1: Platoon $\mathbb{J} = \{0, 2\}$ . Velocity (top left), distance policy error (top right) and torque input (bottom) for nominal case with saturation. . . . .	124
Figure 6.3 – Test 2: Platoon $\mathbb{J} = \{0, 2\}$ . Velocity (top left), distance policy error (top right), torque input (bottom) and disturbance estimation (bottom right) for the uncertain case with saturation. . . . .	124
Figure 6.4 – Vehicle platoon reconfiguration with two vehicles leaving formation. . . . .	126
Figure 6.5 – Vehicle platoon with bidirectional communication and two predecessor follower topology. . . . .	127

# List of tables

Table 3.1 – Vehicle model parameters. . . . .	44
Table 3.2 – Nominal values of the vehicle parameters ( $\Sigma_i$ columns) and respective values used for simulation ( $\tilde{\Sigma}_i$ ). . . . .	56
Table 3.3 – Nominal base values for the vehicle parameters ( $\Sigma_i^b$ columns) and respective values used for simulation ( $\tilde{\Sigma}_i^b$ ). . . . .	58
Table 4.1 – Nominal values of the vehicle parameters and respective true values. . .	82
Table 4.2 – ETC and Theorem 4.1 design parameters. . . . .	82
Table 4.3 – ETM parameters for the ETM in (DOLK <i>et al.</i> , 2017). . . . .	84
Table 4.4 – Average time between events during the transient phase $T_{\text{avg}}$ , number of events $N_{\text{event}}$ , and average events during the total simulation time $T_{\text{sim}}/N_{\text{event}}$ obtained with four ETC schemes. . . . .	85
Table 4.5 – ETC and Theorem 4.3 design parameters. . . . .	86
Table 4.6 – ETM parameters for the ETM in (DOLK <i>et al.</i> , 2017). . . . .	87
Table 4.7 – Average time between events during the transient phase $T_{\text{avg}}$ , number of events $N_{\text{event}}$ , obtained with three ETC schemes. . . . .	90
Table 6.1 – Nominal values for the vehicle parameters ( $\Sigma_i$ columns) and respective values used for simulation ( $\tilde{\Sigma}_i$ ). . . . .	123

# List of symbols and notations

$\in$	belong to
$\forall$	for all
$\mathbb{R}, \mathbb{N}, \mathbb{Z}$	set of real, natural and integers numbers
$\mathbb{R}^n$	$n$ dimensional vector space with real entries
$\mathbb{R}^{n \times m}$	$n \times m$ dimensional matrix space with real entries
$a > b$ ( $a < b$ )	$a$ is greater (less) than $b$
$a \geq b$ ( $a \leq b$ )	$a$ is greater (less) or equal to $b$
$A \succ 0$ ( $A \prec 0$ )	matrix $A$ is positive (negative) definite
$A \succeq 0$ ( $A \preceq 0$ )	matrix $A$ is positive (negative) semidefinite
$A \succ B$ ( $A \prec B$ )	$A - B$ is positive definite (negative definite)
$(\cdot)^T$	transpose
$(\cdot)^{-1}$	matrix inverse
$\text{Tr}(A)$	is the Trace of matrix $A$
$\text{diag}(A, B, C)$	is a block diagonal matrix with entries $A, B, C$
$\text{He}\{A\}$	represents $A^T + A$
$\text{col}\{x, y\}$	represents $\begin{bmatrix} x^T & y^T \end{bmatrix}^T$

# Summary

<b>List of figures</b> . . . . .	<b>11</b>
<b>List of tables</b> . . . . .	<b>14</b>
<b>List of symbols and notations</b> . . . . .	<b>15</b>
<b>Summary</b> . . . . .	<b>16</b>
<b>1 Introduction</b> . . . . .	<b>18</b>
1.1 Objective and contributions . . . . .	22
1.2 Organization . . . . .	23
1.2.1 Personal publications related to the PhD project . . . . .	23
<b>2 Basic aspects about platooning and event-triggering control</b> . . . . .	<b>25</b>
2.1 Introduction . . . . .	25
2.2 Introduction to longitudinal platooning . . . . .	26
2.3 Introduction to event-triggered control . . . . .	28
2.3.1 Input-to-state stability conditions . . . . .	29
2.3.2 Positive lower bound of inter event times . . . . .	31
2.4 $\mathcal{L}_2$ stability . . . . .	33
2.5 Sector nonlinearity . . . . .	34
2.6 System with time delays . . . . .	36
2.7 Linear matrix inequality . . . . .	38
2.8 Conclusion . . . . .	41
<b>3 Cooperative ACC with continuous communication</b> . . . . .	<b>42</b>
3.1 Introduction . . . . .	42
3.2 Platooning control framework . . . . .	42
3.2.1 Vehicle Dynamics and Distance Policy . . . . .	43
3.3 Control problem formulation . . . . .	45
3.3.1 DOB-Based Uncertainty Compensation . . . . .	45
3.3.2 Interconnected system . . . . .	47
3.3.3 Interconnected model control gain guidelines . . . . .	50
3.3.4 Overlapping model . . . . .	51
3.3.5 Overlapping model control gain guidelines . . . . .	53
3.4 Examples . . . . .	55
3.4.1 Test 1. Performance evaluation of the DOB . . . . .	55
3.4.2 Test 2. Platooning . . . . .	58
3.4.2.1 Test 2.1 - Interconnected system . . . . .	59
3.4.2.2 Test 2.2 - Overlapping system . . . . .	60
3.4.2.3 Test 2.3 - Comparison: Interconnected and Overlapping . . . . .	60

3.4.2.4	Test 2.4 - Comparison: Non zero initial conditions . . . . .	61
3.5	Conclusion . . . . .	62
<b>4</b>	<b>CACC platoon with event-triggering communication . . . . .</b>	<b>63</b>
4.1	Introduction . . . . .	63
4.2	Platoon modeling with event triggered control . . . . .	63
4.3	Event-triggered communication under time-delay effects . . . . .	65
4.4	Switching Model . . . . .	67
4.5	Individual and string stability with ETC . . . . .	68
4.5.1	Problem Formulation . . . . .	68
4.5.2	Delay free ETC emulation design conditions . . . . .	69
4.5.3	Delay free periodic ETC emulation design conditions . . . . .	72
4.5.4	ETC Co-design conditions . . . . .	74
4.6	Static ETC conditions . . . . .	81
4.7	Examples . . . . .	81
4.7.1	Case 1 – Emulation . . . . .	82
4.7.2	Case 2 – Co-design . . . . .	85
4.8	Conclusion . . . . .	91
<b>5</b>	<b>ETC feedback linearization . . . . .</b>	<b>92</b>
5.1	Introduction . . . . .	92
5.2	Preliminaries . . . . .	93
5.2.1	Feedback linearization . . . . .	93
5.2.2	Event-triggered feedback linearization control . . . . .	98
5.3	Problem formulation . . . . .	99
5.3.1	Polytopic representation of $\Delta F(s)$ . . . . .	100
5.3.2	Event-triggering mechanism . . . . .	103
5.3.3	Problem statement . . . . .	104
5.4	Results . . . . .	104
5.4.1	General case: Partial feedback linearization . . . . .	104
5.4.2	Particular cases: Full feedback linearization . . . . .	107
5.4.3	Existence of a lower bound for the inter-event time (IET) . . . . .	109
5.5	Examples . . . . .	112
5.6	Conclusion . . . . .	120
<b>6</b>	<b>Conclusion . . . . .</b>	<b>121</b>
6.1	Research perspectives . . . . .	122
	<b>References . . . . .</b>	<b>129</b>

# 1 Introduction

Traffic congestion and accidents have become more frequent as the population grows, resulting in problems such as transportation delays, traffic jams, and increased fuel consumption (GUANETTI *et al.*, 2018; BIAN *et al.*, 2019; CHEN *et al.*, 2023; VILCA *et al.*, 2015). In this context, high-level platoon coordination (JOHANSSON *et al.*, 2023; BAI *et al.*, 2023) together with physical-level platooning control (JIA *et al.*, 2016; FENG *et al.*, 2019) have been considered a promising solution. Through platooning, vehicles can travel in a string-like configuration, maintaining controlled short distances and velocity according to a predefined strategy/policy and safety constraints a feat that is often unattainable by humans alone (MAHFOUZ *et al.*, 2023; JU *et al.*, 2022a; WANG *et al.*, 2018). This shorter distancing facilitates aerodynamic drag reduction, subsequently decreasing fuel consumption (LESCH *et al.*, 2022). Furthermore, with optimized distance spacing, traffic flow improves, thereby avoiding congestion. These aspects motivate the study of vehicles equipped with adaptive cruise control (ACC) systems. In this setup, a leader is followed by  $N$  follower vehicles in a string-like formation. The vehicles have sensors that can measure the distance between themselves and the vehicle in front. The measured distances are compared with a pre-defined distance policy to ensure a safe distance between vehicles.

For platooning control, two main properties are of fundamental importance. One is individual stability, which refers to the ability of each vehicle in the platoon to achieve and maintain the desired distance policy. The other property is string stability, which ensures that small disturbances are not amplified throughout the platoon. While individual stability ensures platoon formation, string stability ensures that fast disturbances affecting the leader or other vehicles will not cause excessive changes in the formation, for example, avoiding vehicles suddenly braking.

While individual stability can be defined considering classical control theory or in the Lyapunov sense (KHALIL, 2002), string stability presents many mathematical definitions and has been analyzed under different frameworks in the literature (FENG *et al.*, 2019). Among these approaches, the main ones are frequency-domain analysis (in terms of  $\mathcal{H}_\infty$  norm) done in the works of (PLOEG *et al.*, 2011; NUNEN *et al.*, 2019; SAMII; BEKIARIS-LIBERIS, 2024) and time-domain methods (in terms of  $\mathcal{L}_p$  norms) used in (DOLK *et al.*, 2017; ZHU *et al.*, 2020; PLOEG *et al.*, 2014). The time-domain approach relies on evaluating the  $\mathcal{L}_p$  norm between the leader input or perturbations and the output of the last vehicle in the platoon. This can also be studied by evaluating the  $\mathcal{L}_p$  norm between the input and the output of the subsystems that composes the string.

## Feedback linearization of vehicle platoons with uncertainties

The homogeneity and linearity of the platoon are common assumptions employed to simplify individual and string stability analysis (DOLK *et al.*, 2017; PLOEG *et al.*, 2011; ZHENG *et al.*, 2016; WANG *et al.*, 2022b; SU *et al.*, 2024). Although this assumption can be achieved through feedback linearization techniques, the procedure requires precise knowledge of the vehicle parameters. Parametric uncertainties and unmeasured external variables can cause mismatches, resulting in nonhomogeneous platooning systems (GUO *et al.*, 2016; GAO *et al.*, 2016; HUANG; KARIMI, 2021; JU *et al.*, 2022b). To overcome these problems, (WANG *et al.*, 2022a) proposes an intermediate-based robust observer to jointly estimate the sensor and actuator faults as well as matched disturbances, whose effects can be compensated via a robust non-fragile fault-tolerant control method. (LUO *et al.*, 2021) utilizes a proportional multiple-integral observer to simultaneously estimate the state and a lumped disturbance, which is compensated via a tube-based model predictive control scheme. Alternatively, the authors in (GAO *et al.*, 2016) consider a filtering technique to attenuate the effects of disturbances, while the works (GUO *et al.*, 2016; HUANG; KARIMI, 2021) explore Lyapunov-like string stability conditions with disturbances. These works evaluate string stability based on the overall platoon dynamics describing the relationship between the input of the leader and the output of the last vehicle. In this case, whenever new vehicles are added to the platoon, the stability analysis conditions must be reevaluated. Moreover, as the number of vehicles in the platoon grows, more decision variables and constraints are involved in the stability analysis, which can increase the problem's solution complexity. These factors may compromise the scalability of the application.

## Wireless communication and event-triggered control

Ensuring individual and string stability while minimizing the distance between vehicles can be conflicting objectives, as a shorter distance can compromise stability. As some practical applications have demonstrated, this problem can be relaxed by incorporating communication devices within the vehicles and allowing information to be shared along the platoon, which can enhance platoon performance (DARBHA *et al.*, 2019; MILANES *et al.*, 2014; DEY *et al.*, 2016) and, theoretically, enable shorter distance policies (DARBHA *et al.*, 2019) without compromising safety. This inclusion of communication into ACC is known as cooperative ACC (CACC). In the CACC framework, communication plays an important role, and different flow typologies can be differentiated according to which vehicles are able to share information. Another fundamental component of communication is its quality and mechanism (FENG *et al.*, 2019). Communication quality refers to issues that can occur during communication. Some works in the literature (WU *et al.*, 2022; LINSENMAYER; DIMAROGONAS, 2015; ZHANG *et al.*, 2021; GE *et al.*, 2024) consider

perfect communication; however, phenomena such as packet dropouts, denial of service (PESSIM *et al.*, 2021), attacks (PEIXOTO *et al.*, 2023), and communication delays can compromise individual and, especially, string stability (LIU *et al.*, 2001; ONCU *et al.*, 2014).

The communication mechanism specifies how communication is established between vehicles. Most vehicular platoon control methods rely on periodic communication (FENG *et al.*, 2019), which can be assumed continuous with fast transmission (SWAROOP *et al.*, 1994; WANG *et al.*, 2023), causing high bandwidth and energy consumption. Alternatively, event-triggered control (ETC) makes communication more efficient by transmitting information based on a specified criterion. However, communication efficiency may trade off with performance. In applying ETC to CACC systems, minimizing communication requirements while maintaining stability, even in the presence of delays, is fundamental.

Event-triggered control schemes vary according to their event-triggering mechanisms (ETMs). Static ETMs involve parameters that do not change over time (LI *et al.*, 2021; SU *et al.*, 2024; PEIXOTO *et al.*, 2023; WEI *et al.*, 2017; WU *et al.*, 2022). Adaptive or dynamic ETMs consider parameters that change according to adaptive or dynamic triggering conditions, aiming to reduce the transmitted events (GIRARD, 2015; ZHANG *et al.*, 2021; LI *et al.*, 2019; DOLK *et al.*, 2017; XIAO *et al.*, 2022). In ETC design, two approaches can be distinguished, namely emulation approach and co-design approach (PENG; LI, 2018). The emulation approach consists of a two-step procedure where the controller is first designed assuming continuous communication, and in the second step, the ETM is designed based on the desired controller. In the co-design approach, both the controller and the ETM are jointly designed within the same optimization problem. The co-design approach offers more flexibility since it allows both control performance and communication efficiency to be incorporated as constraints or cost functions. Additionally, both individual and string stability can be evaluated directly from the optimization-based design problem.

When designing event-triggered controllers, it is essential to avoid Zeno behavior, which is the phenomenon of having an infinite number of events (transmissions) in a finite time interval, i.e., the time between events converges to zero. Many works regarding ETC derive their mechanisms from the classical conditions proposed by (TABUADA, 2007), where Zeno-free behavior can be ensured with minor assumptions. However, under uncertainties and disturbances, these ETMs can no longer guarantee a positive lower bound for the inter-event time (IET) to prevent Zeno behavior. Therefore, substantial investigations are required to ensure a minimum time between events in these scenarios (BORGERS; HEEMELS, 2014). To ensure Zeno-free behavior for dynamic systems with disturbances, a minimum waiting time can be enforced, so that the triggering condition is only evaluated after a specified time interval has elapsed (ABDELRAHIM *et al.*, 2016; DOLK *et al.*, 2017; CARNEVALE *et al.*, 2007). Alternatively, the triggering condition



can be verified periodically instead of continuously (HEEMELS *et al.*, 2011; GE *et al.*, 2020). This results in a periodic ETC, where Zeno behavior is avoided, as the inter-event time is limited by the sampling period.

Combining communication quality with communication mechanisms and system uncertainties makes the platooning control problem more challenging. Design conditions must account for both network-induced delays and event-triggered communication while ensuring Zeno-free behavior in the presence of uncertainties and disturbances. Additionally, it is crucial to ensure that information arrives in the correct sequence, avoiding packet reordering. This imposes further constraints on time delays and the minimum time between transmissions (WU *et al.*, 2022; WEI *et al.*, 2017).

In the literature, (LINSENMAYER; DIMAROGONAS, 2015) proposed a static event-triggered mechanism (ETM), while (ZHANG *et al.*, 2021) employed an adaptive ETM; however, both were developed in disturbance-free scenarios. In (DOLK *et al.*, 2017), a minimum waiting time was enforced to ensure Zeno-free behavior. Additionally, dynamic ETMs were developed to further reduce the number of triggering events. However, the event-triggered control (ETC) is designed based on a two-step approach (emulation), which can lead to more conservative design conditions. The work in (DOLK *et al.*, 2017) only accounted for network delays without considering uncertainties. Based on the discretization of the platooning system, another discrete-time ETC scheme was proposed in (LI *et al.*, 2019), which takes into account unreliable communication links. Due to the discretization and sampling nature of this co-design approach, Zeno behavior can be naturally avoided. However, this approach requires that all vehicles sample the information at the same time, which is not realistic, even with the same sampling frequency.

Accounting for external disturbances, effective ETC approaches were proposed for cooperative ACC in (SU *et al.*, 2024; GE *et al.*, 2024), considering periodic event-triggered control. These approaches can avoid Zeno behavior, as the inter-event time is limited by the sampling time. (WU *et al.*, 2021) developed a fully distributed ETM for distributed control of vehicular platoons with nonzero input of the leader vehicle and actuator uncertainties while ensuring Zeno-free behavior. The works in (WU *et al.*, 2021; SU *et al.*, 2024) considered static ETMs, while the ETM in (GE *et al.*, 2024) is adaptive, which can significantly reduce the number of transmitting events. Furthermore, in (SU *et al.*, 2024; WU *et al.*, 2021), multiple communication topologies were considered, while the work (GE *et al.*, 2024) focuses on the predecessor-follower (PF) topology. All the mentioned works evaluated individual and string stability considering the combined dynamics of all vehicles of the platoon, from the leader to the last vehicle, which can result in scalability issues. As shown in (DOLK *et al.*, 2017), the specificity of the PF topology can be exploited to reduce the analysis problem to a subset of vehicles, facilitating the scalability of the platoon.

## 1.1 Objective and contributions

The main objective of this thesis is to design string-stable controllers for cooperative ACC vehicle platoons subject to uncertainties under event-triggered communication. To address the uncertainty issue in platooning control, we propose a disturbance observer-based compensation technique that combines feedback linearization with disturbance compensation. Mismatches caused by parametric uncertainties and exogenous disturbance effects are modeled as a single virtual disturbance signal, which is estimated and compensated using a disturbance observer (DOB). The DOB-based disturbance estimate is directly integrated into the feedback control law. To address the impact of disturbance estimation error, we propose an extension of the  $\mathcal{L}_2$  norm stability conditions to assess string stability. Specifically, classical string stability can be ensured in the presence of significant uncertainties through effective disturbance compensation.

To increase communication efficiency, we propose dynamic event-triggered controllers for CACC platoons that ensures both individual vehicle stability and  $\mathcal{L}_2$  string stability of the platoon. We define interconnected subsystems that model the interaction between consecutive vehicles such that by evaluating the  $\mathcal{L}_2$  stability of a single subsystem, the individual and  $\mathcal{L}_2$  string stability can be ensured for the platoon independently of the number of vehicles, thus facilitating platoon scalability. To avoid Zeno behavior, a minimum waiting time is imposed between consecutive transmissions. Considering the communication time delay and the imposed waiting time, we define a switching ETC and consequently model the system as switching. Based on this switching, along with a proper choice of Lyapunov-Krasovskii functionals (LKF), both the controller and the ETM can be designed within a single optimization problem subject to linear matrix inequality (LMI) constraints. Additionally, we employ suitable relaxation techniques to achieve less conservative conditions. Furthermore, considering the feedback linearization technique employed in the vehicular platoon, we propose co-design conditions for event-triggered control of feedback linearizable systems, assuming that the states necessary for the feedback linearization procedure are updated based on the event-triggering conditions. Specifically, the main contributions of this PhD can be summarized as follows.

- A DOB-based disturbance compensation scheme is proposed for feedback linearization control of nonhomogeneous platoons, along with proper extensions to string stability analysis to account for disturbance estimation error.
- A switched dynamic ETM is proposed to ensure string stability of the platoon subject to network-induced delays, while minimizing the number of transmissions and avoiding Zeno behavior.
- Event-triggered control co-design conditions are proposed for nonlinear systems considering a feedback linearization control law, where the states utilized for feedback

linearization are updated according to an event-triggering condition.

## 1.2 Organization

This PhD manuscript is organized as follows.

In Chapter 2, we introduce the platooning control problem, discuss results about event-triggered control, and present properties used to prove Zeno-free behavior. Subsequently, a succinct introduction to the sector nonlinearity approach and delay systems is provided, with a brief explanation of the stability analysis utilizing LMI constraints.

In Chapter 3, we address the problem of control design for cooperative adaptive cruise control vehicular platoons, assuming continuous communication. Considering uncertain vehicle model parameters, we propose feedback linearization along with disturbance observer compensation to handle the effects of uncertainties. Various approaches to modeling vehicle interaction are presented and proposed, along with string stability analysis conditions that account for uncertainty compensation. Simulations are provided to validate the DOB compensation, and the platoon performance is evaluated.

In Chapter 4, communication is assumed to be event-based, and event-triggered controllers are designed for efficient communication between vehicles. We propose dynamic event-triggered control with an enforced minimum waiting time and a switching model of the problem to account for this enforced time. Design conditions are proposed for scenarios with and without delays, and numerical examples are provided to validate the proposed approach.

In Chapter 5, event-triggered controllers are proposed for a class of nonlinear feedback linearizable MIMO systems. In this approach, mismatches between nonlinearities arise from the sample-and-hold process intrinsic to the event-triggered controller. With some assumptions, these mismatches are explicitly incorporated into the controller and event-triggering mechanism design conditions. Numerical examples are provided to validate the proposed approach, and the results are compared with others in the literature.

Finally, in Chapter 6, we present the concluding remarks of this PhD work and provide an outlook on future perspectives for this research.

### 1.2.1 Personal publications related to the PhD project

Chapters 3 and 4 mainly address event-triggered control for nonhomogeneous CACC vehicular platoons using DOB-based uncertainty compensation. The materials in these chapters are presented in the following publication and submission.

- SILVA, R.; NGUYEN, A.; GUERRA, T.-M.; SOUZA, F.; FREZZATTO, L. Switched dynamic event-triggered control for string stability of nonhomogeneous vehicle

platoons with uncertainty compensation. *IEEE Transactions on Intelligent Vehicles*, doi: 10.1109/TIV.2024.3385575, p. 1–15, 2024.

- SILVA, R.; NGUYEN, A.; GUERRA, T.-M.; SOUZA, F.; FREZZATTO, L. Dynamic event-triggered CACC co-design for heterogeneous vehicular platoons under uncertainties and network delays, *IEEE Transactions on Intelligent Transportation Systems (Submitted)*, 2024.

The results of feedback linearization with event-triggered control in Chapter 5 pertain to the following submission.

- SILVA, R. N.; SOUZA, F. O.; NGUYEN, A.; GUERRA, T.; FREZZATTO, L. Event-triggered control co-design for MIMO systems via feedback linearization with tolerated nonlinearity mismatches, *IEEE Transactions on Automatic Control (Third revision)*, 2022.

Apart of the results presented in this work the following result was published and presented in a conference.

- SILVA, R. N.; FREZZATTO, L.; SOUZA, F. O.; CAMPOS, V. C. S. Event-triggered control of TS fuzzy systems with guaranteed membership function mismatch. *IFAC-PapersOnLine*, Elsevier BV, v. 54, n. 4, p. 74–79, out. 2021.

## 2 Basic aspects about platooning and event-triggering control

### 2.1 Introduction

As the manuscript is related to Event-Triggered Control (ETC) on one side and platooning on the other, this first chapter will describe some bases and technical aspects useful for both topics. Some mathematical preliminaries and notations used all along the work are summarized in the first section. The second section recalls the main challenges of control for platooning, including individual and string stability. As a part of the communication will be considered as event-triggered, the section three presents the main principles of ETC stability including the input-to-state stability conditions. As usual in this field, the so-called Zeno behavior has to be avoided, the section three also gives the way to determine a positive lower bound of inter event times. The systems used in this thesis are generally nonlinear and, excepted for pure feedback linearization, the way to deal with their stability analysis and/or stabilization will require a polytopic description. A quick recall of such a representation is done in section four. As the communication can also be delayed, section five gives some classical tools for time delay systems stability, especially the use of Lyapunov-Krasovskii functionals. At last, all along the thesis, in order to derive results, we use the framework of Linear Matrix Inequalities (LMI) constraints. Therefore, some definitions and useful technical lemmas conclude the chapter.

#### Notations:

**Sets:**  $\mathbb{N}$  denotes the set of natural numbers including zero,  $\mathbb{R}^n$  denotes the  $n$ -dimensional Euclidean space,  $\mathbb{R}^{n \times m}$  is the set of  $n \times m$  matrices with real entries.

**Vectors:** For  $x \in \mathbb{R}^n$  and  $y \in \mathbb{R}^m$ ,  $\|x\|$  stands for the vector Euclidean norm of  $x$ ,  $\text{col}\{x, y\}$  stands for  $[x^T \ y^T]^T$ .

**Matrices:** For a matrix  $X$ ,  $X^T$  denotes its transpose,  $X^{-1}$  its inverse,  $\text{Tr}(X)$  its trace, and  $\text{He}(X) = X^T + X$ . For a symmetric matrix  $P$ ,  $\lambda_{\min}(P)$  and  $\lambda_{\max}(P)$  stands for the minimum and maximum eigenvalues of  $P$ , respectively. For a symmetric matrix  $P$ ,  $P \succ 0$  (respectively,  $P \prec 0$ ) stands for a positive (respectively negative) definite matrix. The symbol  $*$  in a matrix denotes a symmetric component.  $[X]_{i,j}$  stands for the element of  $X$  in position  $i, j$ . For matrices  $Y_1, Y_2, \dots, Y_p$ , not necessarily square,  $\text{diag}(Y_1, Y_2, \dots, Y_p)$  stands for a block diagonal matrix with entries  $Y_i$  for  $i = 1, \dots, p$ . For matrices  $e_i$  and  $A_i$ , for  $i = 1, \dots, N$ , with appropriate dimensions,

we denote  $\text{col}\{\mathbf{e}_1, \dots, \mathbf{e}_n\} = \text{diag}(A_1, A_2, \dots, A_n)$ , which means that

$$\begin{bmatrix} \mathbf{e}_1 \\ \mathbf{e}_2 \\ \vdots \\ \mathbf{e}_n \end{bmatrix} = \begin{bmatrix} A_1 & 0 & \dots & 0 \\ 0 & A_2 & \dots & 0 \\ \vdots & \vdots & \ddots & \vdots \\ 0 & 0 & \dots & 0 & A_n \end{bmatrix}. \quad (2.1)$$

**Functions:** For  $x \in \mathcal{X}$  and  $\mathcal{S} \subseteq \mathbb{R}^{n \times m}$ , a function  $f: \mathcal{X} \rightarrow \mathcal{S}$  is denoted  $f(x)$ . Functions are denoted as  $f(x)$  whether they are scalar ( $n = m = 1$ ), vector-valued ( $m = 1$ ), or matrix functions ( $m, n > 1$ ). For a vector-valued function  $f(x)$ ,  $J_f(x)$  stands for the Jacobian of  $f$ . To avoid confusion between variables defined as  $e$  (error signals for example), exponential functions are denoted as  $e^x$ , where  $e$  is Euler's constant.

**$\mathcal{K}$  and  $\mathcal{K}_\infty$  functions:** A continuous function  $\alpha: [0, a] \rightarrow [0, \infty]$  is said to be a  $\mathcal{K}$ -function (on short  $\mathcal{K}$ -function), if:

- $\alpha(x)$  is strictly increasing;
- $\alpha(0) = 0$ .

Moreover, a continuous function  $\alpha: [0, \infty] \rightarrow [0, \infty]$  is said to be a  $\mathcal{K}_\infty$ -function if:

- $\alpha(x)$  is a  $\mathcal{K}$ -function;
- $\lim_{r \rightarrow \infty} \alpha(r) = \infty$ .

**Lie derivative:** For functions,  $f(x)$  and  $h(x)$ , the Lie derivative of  $h(x)$  in the direction of  $f(x)$  is defined as

$$\mathcal{L}_f h(x) = \frac{\partial h}{\partial x} f(x) \quad (2.2)$$

Moreover, the  $n$ -th Lie derivative of  $h(x)$  at  $f(x)$  direction is given by  $\mathcal{L}_f^{(n)} h(x) = \mathcal{L}_f \mathcal{L}_f^{(n-1)} h(x)$ .

**Simplex:** A unit simplex with  $m$  vertices is denoted as

$$\Upsilon_m = \left\{ v \in \mathbb{R}^n : \sum_{i=1}^m v_i = 1, \quad v_i \geq 0, \quad i = 1, \dots, m \right\}. \quad (2.3)$$

and, given  $v(x) = \text{col}\{v_1(x), \dots, v_n(x)\}$  a vector-valued function,  $v(x) \in \Upsilon_n$  for  $x \in \mathcal{X}$ , means that  $\sum_{i=1}^n v_i(x) = 1$ ,  $v_i(x) \geq 0$ , for  $i = 1, \dots, n$  and all  $x \in \mathcal{X}$ .

The notations being defined the first topic of the thesis is introduced in the next section.

## 2.2 Introduction to longitudinal platooning

With the increase of vehicle circulation, automatic and intelligent vehicles are still considered a promising approach to reduce traffic, reduce fuel consumption, and improve

safe transportation (LESCH *et al.*, 2022; YU; WANG, 2021; WANG *et al.*, 2018; MAHFOUZ *et al.*, 2023). These aspects motivated the study of vehicles with adaptive cruise control (ACC) and Cooperative ACC (CACC) systems. Both ACC and Cooperative ACC allow vehicles to travel in strings while maintaining a safe and short distance that, in most cases, is difficult to be achieved by the human alone (MAHFOUZ *et al.*, 2023; WANG *et al.*, 2018). This short distancing allows aerodynamic drag reduction, which in turn can reduce fuel consumption (YU; WANG, 2021; MAHFOUZ *et al.*, 2023; LESCH *et al.*, 2022). Furthermore, with an optimized distance spacing, traffic flow improves, avoiding congestion.

The ACC and Cooperative ACC systems needs to ensure a suitable distance between vehicles. In order to achieve this goal, a distance policy is defined which depends of the vehicle velocity. To achieve platooning the measurements required are the inter vehicles distance and the velocity difference. The Cooperative ACC differs from the ACC by introducing a communication system that allows vehicles to share information, Figure 2.1. As shown in some practical applications (DARBHA *et al.*, 2019; MILANES *et al.*, 2014; DEY *et al.*, 2016) sharing information can improve platoon performance and, from a theoretical point of view, allows shorter distance policies (DARBHA *et al.*, 2019) without compromising safety.

In addition to achieve and maintain the desired distance policy the string stability is a desired property, which ensures that small disturbances are not amplified throughout the platoon. While individual stability guarantee platoon formation, string stability ensures that fast disturbances affecting the leader or other vehicles will not cause excessive changes in the formation, for example, avoiding vehicles suddenly braking.

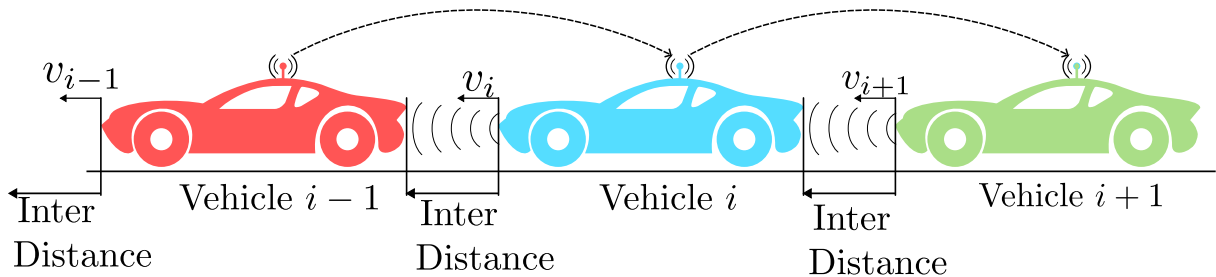

Figure 2.1 – Cooperative ACC vehicle platooning illustration where Vehicle  $i$  receives information from Vehicle  $i - 1$  and transmit to Vehicle  $i + 1$ .

For ACC and Cooperative ACC, ensuring distance policy has been achieved using methods such as Sliding Mode Control (XIAO; GAO, 2011; SAWANT *et al.*, 2021), Model Predictive Control (LIN; NGUYEN, 2020; ASADI; VAHIDI, 2011; MOSER *et al.*, 2018), Fuzzy Control (NARANJO *et al.*, 2003; PANANURAK *et al.*, 2009), Neuro-Fuzzy Control (LIN; NGUYEN, 2020), Model free approach (POLACK *et al.*, 2017; MENHOUR *et al.*, 2018) or Feedback Linearization (DOLK *et al.*, 2017; PLOEG *et al.*, 2014; ZHENG *et al.*, 2016; WANG *et al.*, 2022b; SU *et al.*, 2024; ZHU *et al.*, 2020). Among all the re-

ferenced approaches, feedback linearization is commonly used, often in combination with other methods such as Sliding Mode Control and Model Predictive Control. Linearization is primarily utilized to reduce the problem of designing controllers for longitudinal platoons to a linear control problem where all vehicle dynamics are homogeneous. However, parametric uncertainties and unmeasured external variables can interfere with the feedback linearization, causing mismatches and resulting in non-homogeneous platooning systems (GUO *et al.*, 2016; GAO *et al.*, 2016; HUANG; KARIMI, 2021; JU *et al.*, 2022b).

Works such as (WANG *et al.*, 2022a; LUO *et al.*, 2021) introduce disturbance compensation to handle uncertainties, but without addressing the issue of string stability. Alternative approaches handle the uncertainties via filtering (GAO *et al.*, 2016) or by proposing Lyapunov-like string stability conditions with disturbances. These works evaluate string stability based on the overall platoon dynamics, describing the relationship between the input of the leader and the output of the last vehicle. Note that the need to consider the overall platoon dynamics can significantly increase the complexity of stability analysis.

String stability is a property constantly referenced in this thesis. As there exist many mathematical definitions in the literature (FENG *et al.*, 2019), we formalize the string stability conditions considered in this thesis. They are based on the  $\mathcal{L}_2$  string stability proposed in (PLOEG *et al.*, 2014), and are defined as follows.

**Definition 2.1.** *Let  $\bar{x}_i$  be the states and  $\bar{x}(t) = \text{col}(\bar{x}_1, \dots, \bar{x}_N)$  be the lumped state of all vehicles. Moreover, let  $u_0$  be an exogenous input, and  $z_i = h(\bar{x}_i)$  be a performance output for vehicle  $i$ . The vehicular platoon is  $\mathcal{L}_2$  string stable if there exist a constant  $\gamma_0$  and a  $\mathcal{K}$ -function  $\rho(\cdot)$  such that for any initial condition  $\bar{x}(0)$ , we have*

$$\|z_i\|_{\mathcal{L}_2} \leq \gamma_0 \|u_0\|_{\mathcal{L}_2} + \rho(\|\bar{x}(0)\|), \quad i = 1, \dots, N. \quad (2.4)$$

In Definition 2.1, the exogenous input  $u_0$  refers to the leader input, while  $z_i$  is a performance output for each vehicle which can vary according to the model used for vehicle interaction. The different models used for the vehicles, the vehicles interactions, the measurements required, the considered uncertainties, individual and string stability will be detailed in Chapter 3.

In this thesis, we will explore the case where the communication between vehicles is event-triggered, next section presents the main principles of ETC

## 2.3 Introduction to event-triggered control

Event triggered control (ETC) stands for a control approach where the signals utilized for computing the control law are updated, according to a event triggering mechanism. The signals utilized by the control law are samples of the measured signals which are



held constant between updates and are only updated whenever a triggering conditions is achieved. This event conditions are functions based on the error between the signals current value and its last sample. The paper of (TABUADA, 2007) presents a methodology to design event-triggered controllers and conditions for nonlinear systems based on an input-to-state stability (ISS) criterion (PENG; LI, 2018; HEEMELS *et al.*, 2012). Those results were fundamental for other event-triggering conditions proposed in literature such as (GIRARD, 2015; MOREIRA *et al.*, 2016) applied for perturbed systems models. Different approaches can be considered with different modelings, like hybrid systems (ABDELRAHIM *et al.*, 2017), piecewise models (HEEMELS *et al.*, 2012), and time delay systems with Lyapunov-Krasoviskii functionals (YAN *et al.*, 2019).

### 2.3.1 Input-to-state stability conditions

For this thesis the event-triggered controller is designed similar to (TABUADA, 2007), based on ISS conditions. For a better comprehension we revisit the results and proofs in (TABUADA, 2007). To this end, consider the following nonlinear system

$$\dot{x} = f(x, u) \quad (2.5)$$

with  $x \in \mathbb{R}^{n_x}$  the system states and  $u \in \mathbb{R}^{n_u}$  the control input given by

$$u = \kappa(x + e) \quad (2.6)$$

where  $e \in \mathbb{R}^{n_x}$  can stand for an error in the measurement of  $x$ . Substituting (2.6) in (2.5), yields

$$\dot{x} = f(x, \kappa(x + e)), \quad (2.7)$$

therefore, the control law is designed to render an ISS closed-loop system with respect to  $e$ . The definition of input-to-state stability is given as follows.

**Definition 2.2** ((SONTAG; WANG, 1996)). *A smooth positive definite function  $V(x)$  is said to be an ISS Lyapunov function for the closed-loop system (2.7) if there exist  $\mathcal{K}_\infty$  functions  $\alpha_1(\cdot)$ ,  $\alpha_2(\cdot)$ ,  $\alpha_3(\cdot)$  and  $\gamma(\cdot)$  satisfying*

$$\alpha_1(\|x\|) \leq V(x) \leq \alpha_2(\|x\|) \quad (2.8)$$

$$\frac{\partial V}{\partial x} f(x, \kappa(x + e)) \leq -\alpha_3(\|x\|) + \gamma(\|e\|) \quad (2.9)$$

Consider the control loop shown in Figure 2.2. The event triggering mechanism measure all the states and, according to the difference between the measured states  $x(t)$  and the last transmitted (sampled) state  $x(t_k)$ , determine when to update the signal transmitted to the controller  $x(t_k)$ . The measurement error is caused by the difference between the transmitted (sampled) state  $x(t_k)$ , used to compute the control law, and the continuous state  $x(t)$ . Therefore the control input (2.6) can be written as  $u(t_k) = \kappa(x(t_k))$  and

$e(t) = x(t_k) - x(t)$  where  $t_k \in \{t_0, t_1, t_2, \dots\}$  is the time sequence of increasing sample instants. When the sampling is periodic, the difference  $t_{k+1} - t_k = T$ ,  $T > 0$ , is the sampling period. For the context of event-triggered control, the sampling time is neither periodic nor specified in advance. The sampling instants are achieved by an event-triggering condition based on the states of the system and the measurement error.

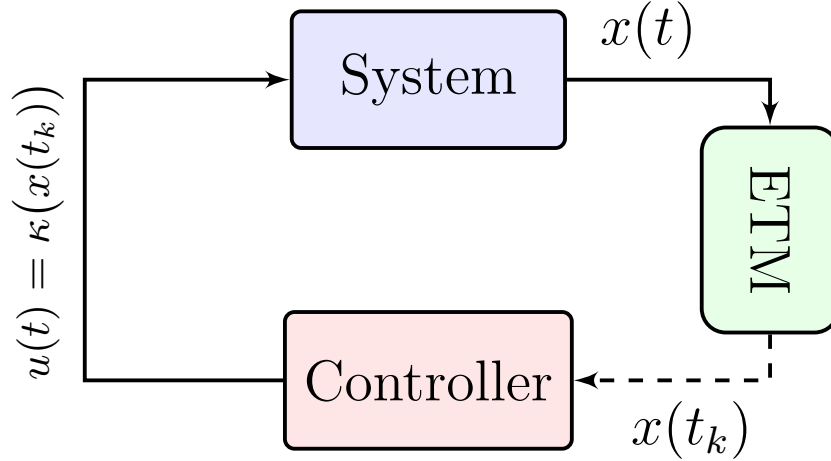

Figure 2.2 – Event triggering control loop

Assuming that the closed-loop system is ISS, the event conditions can be defined based on inequality (2.9). For this end, as in (TABUADA, 2007), let us rewrite (2.9) as

$$\frac{\partial V}{\partial x} f(x, \kappa(x + e)) \leq -(1 - \sigma)\alpha_3(\|x\|) + (\gamma(\|e\|) - \sigma\alpha_3(\|x\|)). \quad (2.10)$$

Notice that making

$$\gamma(\|e\|) - \sigma\alpha_3(\|x\|) \leq 0 \quad (2.11)$$

in (2.10) we have

$$\frac{\partial V}{\partial x} f(x, \kappa(x + e)) \leq -(1 - \sigma)\alpha_3(\|x\|). \quad (2.12)$$

For  $\sigma \in (0, 1)$ , the condition (2.12) implies that  $\dot{V} < 0$  for  $x \neq 0$ , *i.e.*, the system is asymptotically stable. To ensure that (2.11) holds an event condition can be defined

$$\begin{aligned} t_0 &= 0 \\ t_{k+1} &= \inf\{t > t_k : \underbrace{\gamma(\|x(t_k) - x(t)\|)}_{e(t)} - \sigma\alpha_3(\|x(t)\|) > 0\} \end{aligned} \quad (2.13)$$

The methodology consists in a two step approach: first it designs a control law (2.6) such that the closed-loop system (2.7) is ISS and in the second step defines an event-triggering condition. Alternatively both controller and ETM can be designed in a single step. We differentiate those two cases as follows:

- **Emulation:** Is a two step procedure where the controller is designed in the first step to ensure Input-to-State stability and in the second step the ETM is designed based on the controller.
- **Co-design:** Fixing the ETM structure, both controller and ETM parameters are designed within a single optimization problem

As an example of co-design consider  $f(x, u) = Ax + Bu$  in (2.5) and a control input  $u = \kappa(x + e) = Kx + Ke$  in (2.6) where  $K$  is a matrix to be designed, it follows from (2.7) that

$$\dot{x} = (Ax + BK)x + BKe. \quad (2.14)$$

Let  $Q_e, Q_x$  be positive definite matrices to be designed. Defining an event triggering condition

$$\begin{aligned} t_0 &= 0 \\ t_{k+1} &= \inf\{t > t_k : e(t)^T Q_e e(t) - x(t)^T Q_x x(t) > 0\} \end{aligned} \quad (2.15)$$

ensures that another sample is not taken from the system while  $e(t)^T Q_e e(t) - x(t)^T Q_x x(t) \leq 0$ . Choosing a Lyapunov function  $V(x) = x^T P x$ , with  $P$  a positive definite matrix, it suffices that

$$\dot{V} \leq e^T Q_e e - x^T Q_x x \quad (2.16)$$

to ensure asymptotic stability for the closed-loop system under ETM (2.15). In this approach  $Q_e, Q_x, P$  and  $K$  are design parameters that can be determined simultaneously via semi-definite programming.

### 2.3.2 Positive lower bound of inter event times

Throughout this thesis an important property to be ensured is Zeno-free behavior, this can be achieved ensuring the existence of a positive lower bound between events i.e., for  $t_k \in t_0, t_1, \dots$  a sequence generated by the event triggering mechanism, it exists a positive lower bound  $\varepsilon > 0$  such that  $t_{k+1} - t_k > \varepsilon$  for all  $k \geq 0$ . Ensuring the existence of a lower bound requires some assumptions regarding the system nonlinearities, the Lipschitz continuity being the main one. This assumption is commonly used in this thesis and its definition and properties are recalled thereafter (WEAVER, 1999).

**Definition 2.3.** A function  $f : \mathcal{X} \rightarrow \mathcal{Y}$  is Lipschitz continuous at  $\mathcal{X}$  if there is a positive constant  $L$  such that

$$\|f(x_1) - f(x_2)\| \leq L \|x_1 - x_2\| \quad (2.17)$$

for every  $x_1, x_2 \in \mathcal{X}$ .

**Remark 2.1.** Definition 2.3 is made considering a particular 2-norm, but a general definition for Lipschitz continuity considers a metric space, with its respective metrics.

**Lemma 2.1.** *Let  $a(x)$ ,  $b(x)$ ,  $f(x)$  and  $g(y)$  be Lipschitz continuous functions in compact sets  $\mathcal{X}$  and  $\mathcal{Y}$ . Then, the following properties hold*

- *Multiplication: The function  $a(x)b(x)$  is Lipschitz on  $\mathcal{X}$ ;*
- *Division: If  $a(x)^{-1}$  is bounded, then  $b(x)/a(x)$  is Lipschitz on  $\mathcal{X}$ ;*
- *Composition: If  $f : \mathcal{X} \rightarrow \mathcal{Y}$  and  $g : \mathcal{Y} \rightarrow \mathcal{X}$ , then the composition  $(g \circ f)(x)$  is Lipschitz continuous.*

Moreover to prove the existence of a lower bound of IET we consider a generalization of a well known result in literature named Grönwall-Bellman lemma (BELLMAN, 1943) or just Grönwall's lemma:

**Lemma 2.2.** (PACHPATTE, 1997) *Let  $v : [t_0, T] \rightarrow \mathbb{R}$  be a bounded nonnegative piecewise continuous function,  $\alpha : [t_0, T] \rightarrow \mathbb{R}$  a nonnegative integrable function and  $\beta : [t_0, T] \rightarrow \mathbb{R}$  a continuous positive nondecreasing function. If*

$$v(t) \leq \beta(t) + \int_{t_0}^t \alpha(\tau)v(\tau)d\tau \quad (2.18)$$

for all  $t \in [t_0, T]$ . Then

$$v(t) \leq \beta(t)e^{\int_{t_0}^t \alpha(\tau)d\tau} \quad (2.19)$$

Another important inequality refers to the exponential function  $e^x$ .

**Lemma 2.3.** *Let  $x \in \mathbb{R}$ , such that  $x < 1$ , then*

$$e^x < \frac{1}{1-x} \quad (2.20)$$

*Proof.* For the proof we distinguish the following two cases.

**Case 1)**  $0 \leq x < 1$ . For this case from power series expansion, we have

$$e^x = \sum_{n=0}^{\infty} \frac{x^n}{n!}. \quad (2.21)$$

Since  $0 \leq x < 1$ , the series converges, and since  $x^n/n! \leq x^n$ , from (2.21) it follows that

$$e^x = \sum_{n=0}^{\infty} \frac{x^n}{n!} \leq \sum_{n=0}^{\infty} x^n = \frac{1}{1-x} \quad (2.22)$$

**Case 2)**  $x < 0$ . Take  $y > 0$ , then we have that  $e^y > 1 + y$  and, consequently,  $e^{-y} < (1 + y)^{-1}$ . Making  $x = -y < 0$  yields

$$e^x < \frac{1}{1-x} \quad (2.23)$$

Combining Cases 1 and 2 it follows that (2.20) holds for  $x < 1$ , finishing the proof.

□

In this work, in many scenarios we are interested not only in the stability of the system, but in the relationship between an certain input and output. This can be evaluated in terms of  $\mathcal{L}_2$  stability analysis described in the next section.

## 2.4 $\mathcal{L}_2$ stability

From the definition presented in (KHALIL, 2002), a nonlinear system

$$\begin{aligned}\dot{x} &= f(x, u) \\ y &= h(x, u)\end{aligned}\tag{2.24}$$

with  $x$  being the states,  $u$  an input and  $y$  the output, is called finite gain  $\mathcal{L}_2$  stable ( $\mathcal{L}_2$  stable for short) from  $u$  to  $y$  if there exists a finite positive gain  $\gamma$  and a positive  $\beta$  such that

$$\|y\|_{\mathcal{L}_2} \leq \gamma \|u\|_{\mathcal{L}_2} + \beta\tag{2.25}$$

where  $\|y\|_{\mathcal{L}_2} = \sqrt{\int_0^\infty \|y(t)\|^2 dt}$ . Similarly to the Input-to-state stability conditions from Definition 2.2, the input-to-output stability can also be evaluated in terms of Lyapunov stability analysis.

**Lemma 2.4.** *Consider the nonlinear system (2.24). If there exists a positive definite function  $V(x)$  and positive constants  $\alpha_1$ ,  $\alpha_2$ , and  $\gamma$  such that*

$$\alpha_1 \|x\|^2 \leq V(x) \leq \alpha_2 \|x\|^2\tag{2.26}$$

$$\dot{V} = \frac{\partial V}{\partial x} f(x, \kappa(x + e)) \leq \gamma^2 \|u\| - \|y\|\tag{2.27}$$

*then the system is finite-gain  $\mathcal{L}_\infty$  stable, and its  $\mathcal{L}_2$  gain is less than or equal to  $\gamma$ .*

*Proof.* First, notice that for  $u = 0$  the conditions (2.26) and (2.27) imply asymptotic stability. Now, considering  $u \neq 0$ , integrating both sides of (2.27) from  $t = 0$  to  $t = \tau$  yields

$$V(x(\tau)) - V(x(0)) \leq \gamma^2 \int_0^\tau \|u(t)\|^2 dt - \int_0^\tau \|y(t)\|^2 dt\tag{2.28}$$

$$\int_0^\tau \|y(t)\|^2 dt + V(x(\tau)) \leq \gamma^2 \int_0^\tau \|u(t)\|^2 dt + V(x(0)).\tag{2.29}$$

Since  $V(x(t))$  is positive definite, i.e.,  $V(x(t)) \geq 0$ , we have that (2.29) implies

$$\int_0^\tau \|y(t)\|^2 dt \leq \gamma^2 \int_0^\tau \|u(t)\|^2 dt + V(x(0))\tag{2.30}$$

Taking the square root of both sides of (2.30), defining  $\beta = \sqrt{V(x(0))}$  and making  $t \rightarrow \infty$ , condition (2.30) implies

$$\|y\|_{\mathcal{L}_2} \leq \gamma \|u\|_{\mathcal{L}_2} + \beta\tag{2.31}$$

concluding the proof. □

The conditions of Lemma 2.4 will be referred to as  $\mathcal{L}_2$  stability conditions and, as will be further discussed in Section 2.7, in this work these conditions will be evaluated in terms of an optimization subject to LMI constraints. Moreover, the models considered throughout this work are nonlinear. When we do not use feedback linearization, the way to deal with their stability/stabilization is to build exact polytopic representations described in the next section.

## 2.5 Sector nonlinearity

In this thesis we consider the class of affine in the control systems with a constant input matrix:

$$\dot{x} = F(x)x + Bu \quad (2.32)$$

with  $x \in \mathbb{R}^{n_x}$  the system states,  $u \in \mathbb{R}^{n_u}$  the input and  $F(x) \in \mathbb{R}^{n_x \times n_x}$  a matrix such that  $[F(x)]_{i,j} = f_{i,j}(x)$  where  $f_{i,j}(x)$ , for  $i, j = 1, \dots, n_x$  are nonlinear functions of  $x$ . We assume that  $F(x)$  can be written as

$$F(x) = \sum_{i=1}^p v_i(x)M_i \quad (2.33)$$

where  $M_i$  are called vertices and  $v(x) = \text{col}\{v_1(x), \dots, v_p(x)\}$  is such that  $v(x) \geq 0$  belongs to a unity simplex (i.e.,  $v(x) \in \Upsilon_p$ ). This assumption seems restrictive but writing  $F(x)$  as in (2.33) is possible for a large class of systems. To this purpose we consider a sector nonlinearity approach as in (TANAKA; WANG, 2001) to write the nonlinearities as a convex sum of known vertices weighted by nonlinear functions that belong to an unit simplex.

For example, given a nonlinear function  $f(x)$  with  $x \in \mathbb{R}^{n_x}$ , we desire to write it as  $f(x) = (a_1v_1(x) + a_2v_2(x))x$ , with  $v(x) \in \Upsilon_p$  where  $v(x) = \text{col}\{v_1(x), v_2(x)\}$ . The main idea is to find a sector such that  $a_1x \leq f(x)x \leq a_2x$ . As pointed in (TANAKA; WANG, 2001) and (OHTAKE *et al.*, 2003), it may not be possible to achieve a sector globally, but it is possible for some bounded regions  $\|x\| \leq \bar{x}$ . This assumption is not restrictive for control purposes, since in real systems applications, signals are commonly bounded.

Following the steps of (OHTAKE *et al.*, 2003), assuming that  $f(x)$  is bounded such that  $f^{\min} \leq f(x) \leq f^{\max}$ , which allows to write

$$f(x) = v_1(x)f^{\min} + v_2(x)f^{\max}. \quad (2.34)$$

Imposing that  $v_1(x) + v_2(x) = 1$ , we can determine that

$$v_1(x) = \frac{f^{\max} - f(x)}{f^{\max} - f^{\min}}, \quad v_2(x) = 1 - v_1(x) = \frac{f(x) - f^{\min}}{f^{\max} - f^{\min}}. \quad (2.35)$$

where  $v_1(x), v_2(x) \geq 0$ . As an example, consider the nonlinearity  $f(x) = \frac{\sin(x)}{x}$ . The function  $f(x)$  has a maximum  $f^{\max} = 1$  and a minimum  $f^{\min} \approx -0.2172$ . Therefore

$f(x) = v_1(x)(-0.2172) + v_2(x)(1)$  with  $v_1(x) = (1 - \sin(x)/x)/1.21723$  and  $v_2(x) = 1 - v_1(x)$ .

For matrix functions, such as  $F(x)$ , the same methodology can be applied, considering each element of  $F(x)$ . Consider that

$$F(x) = \begin{bmatrix} f_{1,1}(x) & f_{1,2}(x) & \dots & f_{1,n_x}(x) \\ f_{2,1}(x) & f_{2,2}(x) & \dots & f_{2,n_x}(x) \\ \vdots & \vdots & \ddots & \vdots \\ f_{n_x,1}(x) & f_{n_x,2}(x) & \dots & f_{n_x,n_x}(x) \end{bmatrix} \quad (2.36)$$

and  $f_{i,j}(x)$  are bounded such that,  $f_{i,j}^{\min} \leq f_{i,j}(x) \leq f_{i,j}^{\max}$ , for  $i, j = 1, \dots, n_x$ . To simplify, let us consider the case where  $n_x = 2$  and

$$F(x) = \begin{bmatrix} 1 & f_{1,2}(x) \\ f_{2,1}(x) & 1 \end{bmatrix} \begin{bmatrix} x_1 \\ x_2 \end{bmatrix}. \quad (2.37)$$

From the sector nonlinearity approach we can write  $f_{1,2}(x) = v_1^1(x)f_{1,2}^{\min} + v_2^1(x)f_{1,2}^{\max}$  and  $f_{2,1}(x) = v_1^2(x)f_{2,1}^{\min} + v_2^2(x)f_{2,1}^{\max}$ . Hence  $F(x)$  in (2.37) can be rewritten as

$$F(x) = \begin{bmatrix} 1 & v_1^1(x)f_{1,2}^{\min} + v_2^1(x)f_{1,2}^{\max} \\ v_1^2(x)f_{2,1}^{\min} + v_2^2(x)f_{2,1}^{\max} & 1 \end{bmatrix} \quad (2.38)$$

with vectors  $v^1(x), v^2(x) \in \Upsilon_2$ . From (2.38) we can rewrite it as

$$F(x) = v_1^1(x) \begin{bmatrix} 1 & f_{1,2}^{\min} \\ v_1^2(x)f_{2,1}^{\min} + v_2^2(x)f_{2,1}^{\max} & 1 \end{bmatrix} + v_2^1(x) \begin{bmatrix} 1 & f_{1,2}^{\max} \\ v_1^2(x)f_{2,1}^{\min} + v_2^2(x)f_{2,1}^{\max} & 1 \end{bmatrix} \quad (2.39)$$

Repeating the same process we get

$$F(x) = \hat{v}_1(x)M_1 + \hat{v}_2(x)M_2 + \hat{v}_3(x)M_3 + \hat{v}_4(x)M_4 \quad (2.40)$$

with

$$\begin{aligned} \hat{v}_1(x) &= v_1^1(x)v_1^2(x), & \hat{v}_2(x) &= v_1^1(x)v_2^2(x), \\ \hat{v}_3(x) &= v_2^1(x)v_1^2(x), & \hat{v}_4(x) &= v_2^1(x)v_2^2(x), \\ M_1 &= \begin{bmatrix} 1 & f_{1,2}^{\min} \\ f_{2,1}^{\min} & 1 \end{bmatrix}, & M_2 &= \begin{bmatrix} 1 & f_{1,2}^{\min} \\ f_{2,1}^{\max} & 1 \end{bmatrix}, \\ M_3 &= \begin{bmatrix} 1 & f_{1,2}^{\max} \\ f_{2,1}^{\min} & 1 \end{bmatrix}, & M_4 &= \begin{bmatrix} 1 & f_{1,2}^{\max} \\ f_{2,1}^{\max} & 1 \end{bmatrix}. \end{aligned} \quad (2.41)$$

## 2.6 System with time delays

Throughout this thesis, in addition to event triggered control we consider also phenomena as transmission delays. To design controller under ETC along with time delays we use a Lyapunov-based approach (FRIDMAN, 2014; LIU *et al.*, 2019; GU; NICULESCU, 2003). The classical way to handle this problem is the Lyapunov–Krasovskii approach, which is used not only for time delay systems but for sampled data systems, networked connected systems and event triggered controller (FRIDMAN, 2014). The main idea is to use so called Lyapunov–Krasovskii functional (LKF) to evaluate stability conditions. In this section we present some classical lemmas related to LKF and also focus on the time derivative of the functionals.

**Lemma 2.5** (Jensen’s inequality (GU *et al.*, 2003)). *For a given matrix  $R \succ 0$  of appropriate dimension, and for a continuous function  $\phi \in [a, b] \rightarrow \mathbb{R}^n$ , the following inequality holds:*

$$\int_a^b \dot{\phi}(s)^T R \dot{\phi}(s) ds \geq \frac{1}{b-a} \psi(\phi)^T R \psi(\phi) \quad (2.42)$$

with  $\psi(\phi) = \int_a^b \dot{\phi}(s) ds$ .

**Lemma 2.6** (Delay-dependent reciprocally convex inequality (SEURET; GOUAISBAUT, 2018)). *Consider two matrices of appropriate dimensions  $R_1 \succ 0$  and  $R_2 \succ 0$ . If there are symmetric matrices  $X_1, X_2$ , and matrices  $Y_1, Y_2$  such that*

$$\begin{bmatrix} R_1 & 0 \\ 0 & R_2 \end{bmatrix} - \alpha \begin{bmatrix} X_1 & Y_1 \\ Y_1^T & 0 \end{bmatrix} - (1-\alpha) \begin{bmatrix} 0 & Y_2 \\ Y_2^T & X_2 \end{bmatrix} \succeq 0 \quad (2.43)$$

holds for  $\alpha = 0$  and  $\alpha = 1$ , then the following inequality holds for all  $\alpha \in (0, 1)$ :

$$\begin{bmatrix} \frac{1}{\alpha} R_1 & 0 \\ 0 & \frac{1}{1-\alpha} R_2 \end{bmatrix} \succeq \begin{bmatrix} R_1 & 0 \\ 0 & R_2 \end{bmatrix} + (1-\alpha) \begin{bmatrix} X_1 & Y_2 \\ Y_2^T & 0 \end{bmatrix} + \alpha \begin{bmatrix} 0 & Y_1 \\ Y_1^T & X_2 \end{bmatrix}. \quad (2.44)$$

**Lemma 2.7.** *Leibniz Integral Rule (PROTTER; MORREY, 1985)*

$$\frac{d}{dt} \left( \int_{a(t)}^{b(t)} f(t, s) ds \right) = f(t, b(t)) \frac{d}{dt} b(t) - f(t, a(t)) \frac{d}{dt} a(t) + \int_{a(t)}^{b(t)} \frac{\partial}{\partial t} f(t, s) ds \quad (2.45)$$

For Chapter 4 the following functionals are used for the proofs of the main Theorems in Section 4.5.

$$V_S = \int_{t-\tau_1}^{t-\tau_2} e^{2\alpha(s-t)} x^T(s) S x(s) ds \quad (2.46)$$

$$V_R = (\tau_1 - \tau_2) \int_{-\tau_1}^{-\tau_2} \int_{t+\theta}^t e^{2\alpha(s-t)} \dot{x}^T(s) R \dot{x}(s) ds d\theta \quad (2.47)$$

The time derivative of those functionals are important for the proofs and will be discussed in this Section. For this purpose we introduce the following lemmas.



**Lemma 2.8.** Let  $V_S$  be defined as in (2.46). Its time derivative is given by

$$\dot{V}_S = -2\alpha V_S + e^{-2\alpha\tau_2} x^T(t - \tau_2) Sx(t - \tau_2) - e^{-2\alpha\tau_1} x^T(t - \tau_1) Sx(t - \tau_1) \quad (2.48)$$

*Proof.* To prove, let  $a(t) = t - \tau_1$  and  $b(t) = t - \tau_2$  and  $f(s, t) = e^{2\alpha(s-t)} x^T(s) Sx(s) ds$ , then

$$\frac{d}{dt} a(t) = \frac{d}{dt} b(t) = 1, \quad (2.49)$$

$$\frac{\partial}{\partial t} f(t, s) = \frac{\partial}{\partial t} (e^{2\alpha(s-t)} x^T(s) Sx(s)) = -2\alpha \underbrace{e^{2\alpha(s-t)} x^T(s) Sx(s)}_{f(t,s)}. \quad (2.50)$$

Thus, from Lemma 2.7, we have that

$$\begin{aligned} \dot{V}_s &= f(t, t - \tau_2) - f(t, t - \tau_1) + \int_{t-\tau_1}^{t-\tau_2} -2\alpha f(t, s) ds \\ &= e^{2\alpha(-\tau_2)} x^T(t - \tau_2) Sx(t - \tau_2) - e^{2\alpha(-\tau_1)} x^T(t - \tau_1) Sx(t - \tau_1) - 2\alpha \underbrace{\int_{t-\tau_1}^{t-\tau_2} f(t, s) ds}_{V_s} \\ &= e^{-2\alpha\tau_2} x^T(t - \tau_2) Sx(t - \tau_2) - e^{-2\alpha\tau_1} x^T(t - \tau_1) Sx(t - \tau_1) - 2\alpha V_s \end{aligned} \quad (2.51)$$

concluding the proof.  $\square$

**Lemma 2.9.** Let  $V_R$  be defined as in (2.47) with  $\tau_1 > \tau_2$ . The time derivative of  $V_R$  is upper bounded such that

$$\dot{V}_R \leq -2\alpha V_R + (\tau_1 - \tau_2)^2 \dot{x}^T(t) R \dot{x}(t) - (\tau_1 - \tau_2) \inf_{s \in [\tau_2, \tau_1]} \{e^{-2\alpha s}\} \int_{t-\tau_1}^{t-\tau_2} \dot{x}^T(s) R \dot{x}(s) ds \quad (2.52)$$

*Proof.* To prove, let

$$v_R = \int_{t+\theta}^t e^{2\alpha(s-t)} \dot{x}^T(s) R \dot{x}(s) ds, \quad (2.53)$$

Invoking Lemma 2.7, the partial derivative of (2.53) with respect to  $t$  is

$$\begin{aligned} \frac{\partial}{\partial t} v_R &= \frac{\partial}{\partial t} \int_{t+\theta}^t e^{2\alpha(s-t)} \dot{x}^T(s) R \dot{x}(s) ds \\ &= -2\alpha v_R + \dot{x}^T(t) R \dot{x}(t) - e^{2\alpha\theta} \dot{x}^T(t + \theta) R \dot{x}(t + \theta) \end{aligned} \quad (2.54)$$

From the definition of (2.53) we can write  $V_R = (\tau_1 - \tau_2) \int_{-\tau_1}^{-\tau_2} v_R(t, \theta) d\theta$ . Therefore From Lemma 2.7 and (2.54) we have that

$$\begin{aligned} \frac{\dot{V}_R}{\tau_1 - \tau_2} &= \int_{-\tau_1}^{-\tau_2} \frac{\partial}{\partial t} v_R(t, \theta) d\theta \\ &= -2\alpha \int_{-\tau_1}^{-\tau_2} v_R d\theta + \int_{-\tau_1}^{-\tau_2} \dot{x}^T(t) R \dot{x}(t) d\theta - \int_{-\tau_1}^{-\tau_2} e^{2\alpha\theta} \dot{x}^T(t + \theta) R \dot{x}(t + \theta) d\theta \\ &= -2\alpha \frac{V_R}{\tau_1 - \tau_2} + (\tau_1 - \tau_2) \dot{x}^T(t) R \dot{x}(t) - \int_{-\tau_1}^{-\tau_2} e^{2\alpha\theta} \dot{x}^T(t + \theta) R \dot{x}(t + \theta) d\theta \\ &\leq -2\alpha \frac{V_R}{\tau_1 - \tau_2} + (\tau_1 - \tau_2) \dot{x}^T(t) R \dot{x}(t) - \inf_{s \in [\tau_2, \tau_1]} \{e^{-2\alpha s}\} \int_{-\tau_1}^{-\tau_2} \dot{x}^T(t + \theta) R \dot{x}(t + \theta) d\theta \end{aligned}$$

$$= -2\alpha \frac{V_R}{\tau_1 - \tau_2} + (\tau_1 - \tau_2) \dot{x}^T(t) R \dot{x}(t) - \inf_{s \in [\tau_2, \tau_1]} \left\{ e^{-2\alpha s} \right\} \int_{t-\tau_1}^{t-\tau_2} \dot{x}^T(s) R \dot{x}(s) ds \quad (2.55)$$

where, for the last line, we substitute  $t + \theta = s$ . Multiplying (2.55) by  $\tau_1 - \tau_2$  yields (2.52), concluding the proof.  $\square$

In this thesis the conditions are mainly written as an optimization subject to linear matrix inequalities constraints. A summary of LMI tools are presented in next section.

## 2.7 Linear matrix inequality

Linear matrix inequalities (LMI) is an important and powerful tool utilized in control area for stability analysis and control design. A large class of control problems can be written as an optimization problem subject to LMI constraints. To illustrate this tool we will present the design of controllers for a class of nonlinear system described by sector nonlinearity approach discussed in Section 2.5. Consider the affine in the control system

$$\dot{x} = F(x)x + Bu \quad (2.56)$$

let  $u = K(x)x$  be its control input. Therefore the closed loop system is

$$\dot{x} = (F(x) + BK(x))x. \quad (2.57)$$

Choosing a quadratic Lyapunov function candidate  $V = x^T P x$  with  $P \succ 0$ , taking its time derivative yields the condition

$$x^T \left( (F(x) + BK(x))^T P + P(F(x) + BK(x)) \right) x \leq 0 \quad (2.58)$$

and a sufficient condition of stability is given by the matrix inequality

$$(F(x) + BK(x))^T P + P(F(x) + BK(x)) \prec 0. \quad (2.59)$$

Notice that condition (2.59) need to be satisfied for all  $x$ . To achieve a finite number of conditions the sector nonlinear approach described in Section 2.5 can come at hand. Therefore we rewrite  $F(x)$  with functions  $v_i(x)$  belonging to a unity simplex and we define  $K(x)$  using the same functions  $v_i(x)$

$$F(x) = \sum_{i=1}^p v_i(x) M_i, \quad K(x) = \sum_{i=1}^p v_i(x) K_i \quad (2.60)$$

where  $F_i$  are known matrices and  $K_i$  to be designed. Therefore, we can recast (2.59) as

$$\sum_{i=1}^p v_i(x) \left( (M_i + BK_i)^T P x + P(M_i + BK_i) \right) \prec 0 \quad (2.61)$$

From the convexity of  $v(x)$  it follows that matrix inequalities defined at each vertex of the polytope

$$(M_i + BK_i)^T P + P(M_i + BK_i) \prec 0, \quad \text{for } i = 1, \dots, p \quad (2.62)$$

are sufficient to ensure (2.61). If matrices  $K_i$  are given a priori (2.62) provides a set of finite LMI conditions to evaluate the stability of (2.57). More commonly,  $K_i$  are matrices to be found, and are part of the optimization problem. To render LMIs from (2.62) we multiply on the left and on the right by  $P^{-1}$  which results in

$$P^{-1}M_i^T + P^{-1}K_i^T B^T + M_i P^{-1} + BK_i P^{-1} \prec 0 \quad (2.63)$$

since it is assumed that  $P \succ 0$  its inverse exist and it does not changes fact that the condition is negative definite. Performing the change of variables  $K_i P^{-1} = Y_i$  and  $P^{-1} = W$  in (2.63) results in

$$WM_i^T + Y_i^T B^T + M_i W + BY_i \prec 0, \quad \text{for } i = 1, \dots, p \quad (2.64)$$

which are linear matrix inequalities in  $W$  and  $M_i$ . Moreover, as long as the solution is feasible,  $K_i$  and  $P$  can always be recovered.

Linear matrix inequalities can also be helpful for time delay system via the Lyapunov–Krasovskii approach discussed in Section 2.6. To illustrate we are considering the case of stability analysis of a linear time delay system with constant and bounded time delay  $\tau$ .

$$\dot{x} = A_1 x + A_0 x(t - \tau). \quad (2.65)$$

The quadratic Lyapunov–Krasovskii functional is chosen as:

$$V = x^T P x + \int_{t-\tau}^t x^T(s) S x(s) ds \quad (2.66)$$

from Lemma (2.8) its derivative is

$$\dot{V} = 2x^T(t)P(A_1 x + A_0 x(t - \tau)) + x^T(t)Sx(t) - x^T(t - \tau)Sx(t - \tau) \quad (2.67)$$

which can be recast as the LMI constraint in  $P$  and  $S$

$$\begin{bmatrix} x(t) & x(t - \tau) \end{bmatrix} \begin{bmatrix} A_1^T P + P A_1 + S & P A_0 \\ * & -S \end{bmatrix} \begin{bmatrix} x(t) \\ x(t - \tau) \end{bmatrix} \leq 0 \quad (2.68)$$

Furthermore, as discussed in 2.4, the  $\mathcal{L}_2$ -stability from conditions from Lemma 2.4 can be written in terms of Linear matrix inequalities which will be frequently used in this work. For a simple illustration, consider a linear system

$$\begin{aligned} \dot{x} &= Ax + Bu + Dw \\ y &= Cx \end{aligned} \quad (2.69)$$

where  $x$  are the system states,  $u$  is the control input,  $y$  is the system output and  $w$  is an exogenous input for which we aim to evaluate  $\mathcal{L}_2$  stability. Let  $u = Kx$  be the control law. Hence, the closed loop system is

$$\begin{aligned}\dot{x} &= (A + BK)x + Dw \\ y &= Cx\end{aligned}\tag{2.70}$$

Choosing a quadratic Lyapunov function  $V(x) = x^T P^{-1}x$  with  $P^{-1} \succ 0$ , from Lemma 2.4 condition (2.27), we have

$$\dot{V} = \left( (A + BK)x + Dw \right)^T P^{-1}x + x^T P^{-1} \left( (A + BK)x + Dw \right) \leq \gamma^2 w^T w - y^T y.\tag{2.71}$$

Substituting  $y = Cx$  and rearranging the terms results in

$$\left( (A + BK)x + Dw \right)^T P^{-1}x + x^T P^{-1} \left( (A + BK)x + Dw \right) - \gamma^2 w^T w + x^T C C x \leq 0\tag{2.72}$$

which can be written as

$$\begin{bmatrix} x^T & w^T \end{bmatrix} \begin{bmatrix} (A + BK)^T P^{-1} + P^{-1}(A + BK) + C^T C & P^{-1}D \\ * & -\gamma^2 I \end{bmatrix} \begin{bmatrix} x \\ w \end{bmatrix} \leq 0,\tag{2.73}$$

resulting in the matrix inequality

$$\begin{bmatrix} (A + BK)^T P^{-1} + P^{-1}(A + BK) + C^T C & P^{-1}D \\ * & -\gamma^2 I \end{bmatrix} \prec 0\tag{2.74}$$

As previously discussed in the example with the sector nonlinear approach, the matrix inequality (2.74) is not a linear matrix inequality. In an attempt to render an LMI we multiply (2.74) on the left and on the right by  $\text{diag}(P, I)$ , resulting in

$$\begin{bmatrix} P(A + BK)^T + (A + BK)P + PC^T C P & D \\ * & -\gamma^2 I \end{bmatrix} \prec 0.\tag{2.75}$$

Performing a change of variables  $KP = Y$  we have

$$\begin{bmatrix} PA^T + Y^T B^T + AP + BY + PC^T C P & D \\ * & -\gamma^2 I \end{bmatrix} \prec 0.\tag{2.76}$$

However, (2.76) is not a LMI due to the term  $PC^T C P$ . This condition, as many control and observation problems, cannot be directly written as LMI constraints, however some technical lemmas can be used to recast these problems as LMI constraints. The two most useful lemmas are the Schur's complement and the Finsler's Lemma that are recalled thereafter.

**Lemma 2.10** (Schur's complement (BOYD *et al.*, 1994)). *Let  $\mathcal{M}$  be a block matrix such that*

$$\mathcal{M} = \begin{bmatrix} A & B \\ B^T & C \end{bmatrix} \quad (2.77)$$

*the following conditions are equivalent*

- $\mathcal{M} \succ 0$
- $A \succ 0$  and  $C - B^T A^{-1} B \succ 0$ ,
- $C \succ 0$  and  $A - B C^{-1} B^T \succ 0$ .

For example, turning back  $\mathcal{L}_2$  stability problem, condition (2.76) can be written as

$$\begin{bmatrix} PA^T + Y^T B^T + AP + BY & D \\ * & -\gamma^2 I \end{bmatrix} - \begin{bmatrix} PC^T \\ 0 \end{bmatrix} \begin{bmatrix} -I \\ CP \ 0 \end{bmatrix} \prec 0. \quad (2.78)$$

Hence, from Schur's complement, it can be recast as the LMI constraint

$$\begin{bmatrix} PA^T + Y^T B^T + AP + BY + PC^T CP & D & PC^T \\ * & -\gamma^2 I & 0 \\ * & * & -I \end{bmatrix} \prec 0. \quad (2.79)$$

**Lemma 2.11** (Finsler's lemma (OLIVEIRA; SKELTON, 2001)). *Let  $\phi \in \mathbb{R}^n$ ,  $\mathcal{M} \in \mathbb{R}^{n \times n}$  and  $\mathcal{B} \in \mathbb{R}^{m \times n}$ , such that  $\mathcal{B}\psi = 0$ . Then, the following conditions are equivalent:*

- $\psi^T \mathcal{M} \psi < 0$ , for all  $\phi \neq 0$ .
- $\exists \mathcal{X} \in \mathbb{R}^{n \times m}$  such that  $\mathcal{M} + \mathcal{X}\mathcal{B} + \mathcal{B}^T \mathcal{X}^T \prec 0$ .

All the optimization problems used in this thesis are solved with Matlab R2023a, with parser YALMIP R20190425 along with the solver Mosek 10.0.20.

## 2.8 Conclusion

This chapter has given an overview of the main topics addressed in our work. The issues related to platooning considering communication between them, have been described. Especially, it is important, not only to ensure individual vehicle stability but also to ensure the so-called string stability; in order to avoid inappropriate behaviors. When communication occurs, we consider it as event triggered, thus the need for some extra mathematical tools and properties are also described. Finally more technical aspects were also presented, concerning the polytopic description of nonlinear models, time delay systems stability, especially the Lyapunov-Krasovskii functional, and finally the optimization tools useful to derive stability/stabilization conditions. Next chapter will start with classical ACC without communication and we demonstrate how to derive individual and string stability conditions for a platoon.

## 3 Cooperative ACC with continuous communication

### 3.1 Introduction

In this chapter, we address the control problem of longitudinal cooperative Adaptive Cruise Control (ACC) with continuous communication between vehicles. The platoon formation consists of  $N$  vehicles and a leader. The objective is for the  $N$  vehicles to follow the leader while maintaining a safe distance between them. At the beginning of this chapter, we explain the platoon problem of interest, the respective distance policy that will be used to ensure a safe distance and present the vehicle longitudinal model. As discussed in the previous chapter, Section 2.2, in practice, vehicle parameters are not precisely known, leading to uncertainties in the model. Due to these uncertainties, the classical feedback linearization approach cannot be applied directly. To compensate for these uncertainties, we propose a disturbance observer to estimate the lumped effect caused by the uncertainties and possible exogenous inputs. Then, the feedback linearization approach is combined with disturbance-based compensation to ensure a linear and homogeneous dynamic. After linearization, we study the individual and string stability of the platoon. To this end, a model describing the interaction between two vehicles, vehicle  $i - 1$  and vehicle  $i$  (immediately behind) is presented. From this modeling, the control law and the signal that will be transmitted from one vehicle to another are defined. Considering this model, to evaluate individual and string stability, we propose an extension to the  $\mathcal{L}_2$  norm stability conditions, accounting for the effects of the disturbance compensation. By introducing a filter commonly used for cooperative ACC with non-constant distance policies, an alternative model for the interaction between vehicles is derived, and design conditions for this model are presented. Finally, simulations are performed to evaluate the effectiveness of the disturbance compensation and the platoon performance considering each model of vehicle interaction.

### 3.2 Platooning control framework

In this chapter we consider a platoon with a leader and  $N$  follower vehicles where each vehicle is denoted by  $\Sigma_i$ , with  $i = 0, \dots, N$ , where index  $i = 0$  is reserved for the leader. The objective is to maintain a safe distance, defined by a distance policy, between vehicle  $\Sigma_i$  and  $\Sigma_{i-1}$ . Consider the platoon shown in Fig 3.1, vehicle  $\Sigma_i$  measures  $\hat{p}_i = p_{i-1} - p_i$  and  $\Delta v_i = v_{i-1} - v_i$ , which are the relative distance and relative velocity between  $\Sigma_i$  and  $\Sigma_{i-1}$ . Vehicle  $\Sigma_i$  receives information only from  $\Sigma_{i-1}$  which will be used by  $\Sigma_i$  to calculate

its control law. This information can consist of internal states or even control inputs of  $\Sigma_{i-1}$  according to the modeling of interest and will be specified in subsequent sections. In the adopted predecessor-follower (PF) communication topology, vehicle  $\Sigma_i$  can only receive information from  $\Sigma_{i-1}$ , which implies that only  $\Sigma_1$  receives information from the leader  $\Sigma_0$ .

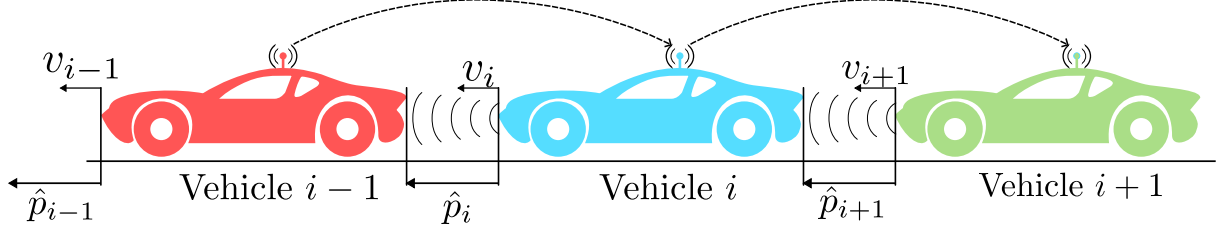

Figure 3.1 – Vehicle platooning PF topology where  $\Sigma_i$  receives information from  $\Sigma_{i-1}$  and transmit to  $\Sigma_{i+1}$ . Vehicle  $i$  measures, the relative distance  $\hat{p}_i = p_{i-1} - p_i - L_{c,i}$  and the velocity difference  $\Delta v_i = v_{i-1} - v_i$ .

### 3.2.1 Vehicle Dynamics and Distance Policy

For each vehicle in the platooning system, we consider the following dynamics (TOULLOTTE *et al.*, 2008; RAJAMANI, 2012):

$$\dot{p}_i = v_i \quad (3.1a)$$

$$\dot{v}_i = \frac{1}{\mathbf{W}_i} \left( \mathbf{R}_{h,i} T_i - \mathbf{m}_i \mathbf{g} F_{r,i} - \mathbf{B}_i v_i - \mathbf{C}_i v_i^2 \right) \quad (3.1b)$$

$$\dot{T}_i = -\frac{1}{\rho_i} T_i + \frac{1}{\rho_i} u_{e,i} \quad (3.1c)$$

with

$$\mathbf{W}_i = \frac{(\mathbf{m}_i \mathbf{h}_{w,i}^2 + \mathbf{J}_{r,i} + \mathbf{J}_{f,i}) \mathbf{R}_{g,i}^2 + \mathbf{J}_{e,i}}{\mathbf{h}_{w,i}^2 \mathbf{R}_{g,i}^2} \quad (3.2)$$

$$\mathbf{R}_{h,i} = (\mathbf{h}_{w,i} \mathbf{R}_{g,i})^{-1}. \quad (3.3)$$

where  $p_i$  is the vehicle position,  $v_i$  is the vehicle velocity,  $T_i$  is the engine torque, and  $u_{e,i}$  is the input torque (computed torque).  $F_{r,i}$  is the rolling resistance coefficient and is dependent on the conditions of the road and the tires, which can vary over time. As  $F_{r,i}$  is not known in real time, we consider it as an exogenous input of the system.

The vehicle parameters are explained in Table 3.1, where the subscript  $i$  is used to indicate that these values can change among vehicles. We assume that the real values of these parameters are not precisely known. The available values are only approximations, estimated values, or values provided by the manufacturer. In addition, some of those parameter values can change according to the circumstances. For example, the mass ( $\mathbf{m}_i$ )

Table 3.1 – Vehicle model parameters.

Parameters	Description
$m_i$	Mass of the vehicle (kg)
$\mathbf{R}_{g,i}$	Gear ratio (-)
$h_{w,i}$	Height of center of wheel (m)
$\mathbf{J}_{e,i}$	Engine/transmission inertia (kg·m <sup>2</sup> )
$\mathbf{J}_{r,i}$	Rear wheel inertia (kg·m <sup>2</sup> )
$\mathbf{g}$	Gravitational acceleration (m/s <sup>2</sup> )
$\mathbf{J}_{f,i}$	Front wheel inertia (kg·m <sup>2</sup> )
$\mathbf{B}_i, \mathbf{C}_i$	Resistance force coefficients (kg/s, kg/(m·s))
$\rho_i$	Time constant of the longitudinal dynamics (s)

can change according to the load transported and the friction changes according to the ground conditions.

Throughout this work, we propose a feedback linearization approach to handle the nonlinearities of the system. To write (3.1) in a feedback linearizable form, let us denote  $\dot{v}_i = a_i$ , then the acceleration dynamics can be derived from (3.1b) as

$$\dot{a}_i = \frac{1}{\mathbf{W}_i} \left( \mathbf{R}_{h,i} \dot{T}_i - (\mathbf{B}_i + 2\mathbf{C}_i v_i) a_i \right) \quad (3.4)$$

From (3.1b), we can write

$$T_i = \frac{1}{\mathbf{R}_{h,i}} \left( \mathbf{W}_i \dot{v}_i + m_i \mathbf{g} F_{r,i} + \mathbf{B}_i v_i + \mathbf{C}_i v_i^2 \right). \quad (3.5)$$

Substituting (3.5) in (3.1c) and then in (3.4), we obtain

$$\dot{p}_i = v_i \quad (3.6a)$$

$$\dot{v}_i = a_i \quad (3.6b)$$

$$\dot{a}_i = f_i(v_i, a_i) + b_i u_{e,i} - c_i F_{r,i} \quad (3.6c)$$

with

$$f_i(v_i, a_i) = - \left( \frac{1}{\rho_i} + \frac{1}{\mathbf{W}_i} \mathbf{C}_i v_i \right) a_i - \frac{1}{\mathbf{W}_i \rho_i} (\mathbf{B}_i + \mathbf{C}_i v_i) (v_i + \rho_i a_i), \quad (3.7)$$

$$b_i = \frac{\mathbf{R}_{h,i}}{\mathbf{W}_i \rho_i}, \quad c_i = \frac{m_i \mathbf{g}}{\mathbf{W}_i \rho_i},$$

Hence, expression (3.6) is in the feedback linearizing form allowing system nonlinearities to be canceled by an appropriate control law.

The main objective of the platoon is to ensure a safe distance. We define safe distance in terms of the distance policy

$$\Delta p_{d,i} = r_i + h v_i \quad (3.8)$$

where  $r_i$  is the standstill distance for each vehicle, and the time gap  $h$  is constant and identical for all vehicles of the platoon. This distance policy is referred in the literature



as constant-time headway (CTH), where the safe distance increases proportionally to the vehicle velocity. The case where  $h = 0$ , is referred to as constant disturbance (CD) and is normally applied to vehicles moving at slow velocities. From the distance policy (3.8), the distance policy error (or tracking error) is defined as

$$\Delta p_i = p_{i-1} - p_i - L_{c,i} - \Delta p_{d,i}. \quad (3.9)$$

where  $L_{c,i}$  is the length of the car. The distance error (3.9) is the difference between the vehicles inter distance (accounting for the vehicle length) and the distance policy. Vehicles move in a platoon formation at a safe distance when the distance police is close to zero ( $\Delta p_i \approx 0$ ).

### 3.3 Control problem formulation

In this section we present the feedback linearizing strategy with a DOB-based uncertainty compensation technique.

#### 3.3.1 DOB-Based Uncertainty Compensation

As discussed in Section 3.1, the vehicle parameters are not precisely known, resulting in an uncertainty associated to the parameters in (3.1). It results that the nonlinearities cannot be perfectly canceled. To account for the uncertainties we group their influence, along with the unmeasured exogenous input, we define nominal values  $f_i(v_i, a_i)$  and  $b_i$ , and real (possibly time varying)  $f_{i,r}(v_i, a_i) = f_i(v_i, a_i) + \Delta f_i$  and  $b_{i,r} = b_i + \Delta b_i$ . Hence we can write the system (3.6c) as

$$\dot{a}_i = f_i(v_i, a_i) + b_i u_{e,i} - d_i \quad (3.10)$$

where

$$d_i = \Delta f_i + \Delta b_i u_{e,i} + c_i F_{r,i} \quad (3.11)$$

is a *virtual* disturbance, that combines effects caused by parametric uncertainties, given by  $\Delta f_i + \Delta b_i u_{e,i}$  and exogenous input  $c_i F_{r,i}$ .

From expression (3.10), we propose the following disturbance observer;

$$\begin{aligned} \dot{\omega}_i &= \frac{\partial L_i(a_i)}{\partial a_i} (f_i(v_i, a_i) + b_i u_{e,i} - \hat{d}_i) \\ \hat{d}_i &= \omega_i - L_i(a_i) \end{aligned} \quad (3.12)$$

where  $\omega_i$  is the internal state of the disturbance observer,  $L_i(a_i)$  is the observer nonlinear gain, and  $\hat{d}_i$  is the estimated disturbance. To assess the convergence of disturbance estimation, let us define  $e_{d,i} = \hat{d}_i - d_i$  as the disturbance estimation error, then from (3.10) and (3.12) we can write the estimation error dynamics as

$$\dot{e}_{d,i} = -\frac{\partial L_i(a_i)}{\partial a_i} e_{d,i} - \dot{d}_i. \quad (3.13)$$

The gain  $L_i(a_i)$  is designed such that (3.13) is stable. A straightforward choice is to make  $L_i(a_i) = L_i a_i$  with  $L_i > 0$  a positive constant. In this case we have  $\dot{e}_{d,i} = -L_i e_{d,i} - \dot{d}_i$ , and, assuming that  $\|\dot{d}_i\| \leq \bar{\delta}_i$ , its solution satisfies;

$$\|e_{d,i}\| \leq e^{-L_i t} \|e_{d,i}(0)\| + \frac{1}{L_i} (e^{-L_i t} - 1) \bar{\delta}_i. \quad (3.14)$$

Hence, the error converges exponentially to a bounded region defined by  $\bar{\delta}_i$ . Moreover, for slow-varying disturbances (that is,  $\bar{\delta}_i \approx 0$ ), we have  $e_{d,i} \rightarrow 0$ .

Using the estimated disturbance (3.12), we propose the following linearizing control law for system (3.6):

$$u_{e,i} = \underbrace{\frac{1}{b_i} \left( -\frac{1}{\rho_d} a_i - f_i(v_i, a_i) + \frac{1}{\rho_d} u_i \right)}_{\text{linearization}} + \underbrace{\frac{1}{b_i} \hat{d}_i}_{\text{Compensation}} \quad (3.15)$$

where  $u_i$  is the control input and  $\rho_d$  is a desired platoon time constant, which is specified considering an estimation of the real time constant of the vehicle longitudinal dynamics. In Figure 3.2 we illustrate the feedback linearizing control loop along with the DOB.

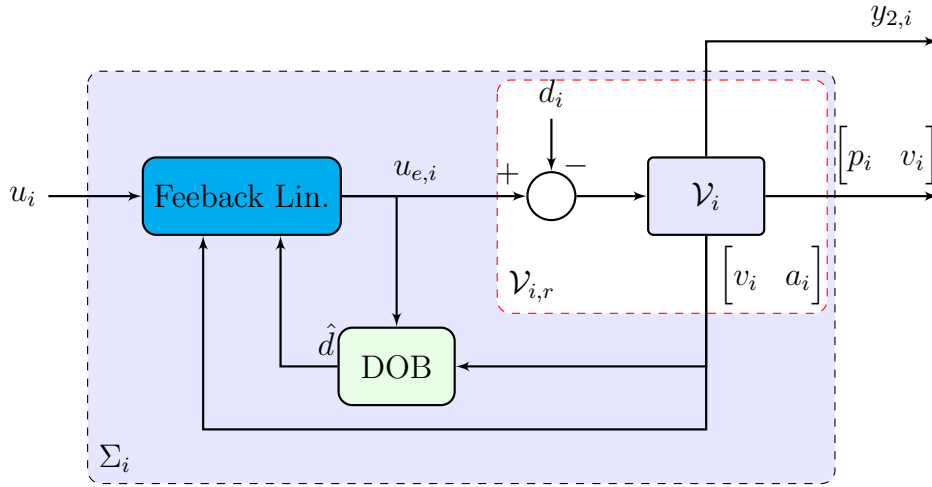

Figure 3.2 – Feedback linearization loop with DOB compensation.  $\mathcal{V}_i$  Stand for the nominal dynamical system and  $d_i$  is the *virtual* disturbance defined in (3.11).

Applying the control law (3.15) to (3.10) we obtain the linearized dynamics:

$$\begin{cases} \dot{p}_i = v_i \\ \dot{v}_i = a_i \\ \dot{a}_i = -\frac{1}{\rho_d} a_i + \frac{1}{\rho_d} u_i + e_{d,i} \end{cases} \quad (3.16)$$

Equation (3.16) for  $e_{d,i} = 0$  (no disturbance) or with  $e_{d,i} = d_i$  (no compensation) represents respectively the common linear dynamics for ACC and CACC.

Generally, the heterogeneity of the platoon is characterized according to  $\rho_d$ . There are two cases:  $\rho_d$  is constant (homogeneous),  $\rho_d$  varies according to the vehicles (heterogeneous,  $\rho_{d,i}$ ). In the second case, if  $\rho_{d,i}$  variation is small we can define  $\rho_{d,i} = \rho_d + \delta_i^\rho$  and include  $\delta_i^\rho$  into the disturbances. We bring to attention that this approach is only valid when  $\delta_i^\rho$  is small enough.

From (3.16), considering the distance policy error (3.9) and defining the velocity error as  $\Delta v_i = v_{i-1} - v_i$  we obtain the following dynamics:

$$\Sigma_i : \begin{cases} \Delta \dot{p}_i = \Delta v_i - h a_i \\ \Delta \dot{v}_i = a_{i-1} - a_i \\ \dot{a}_i = -\frac{1}{\rho_d} a_i + \frac{1}{\rho_d} u_i + e_{d,i} \end{cases} \quad (3.17)$$

for  $i = 1, \dots, N$  and for the leader vehicle, since the leader does not have a reference vehicle to follow, we have

$$\Sigma_0 : \begin{cases} \dot{v}_0 = a_0 \\ \dot{a}_0 = -\frac{1}{\rho_d} a_0 + \frac{1}{\rho_d} u_0 + e_{d,0} \end{cases} \quad (3.18)$$

Although the leader dynamics is known, its input behavior is considered unknown.

In CACC systems, the control input  $u_i$  of system (3.17) is composed of a feedback component  $u_{fb,i}(t)$  and a feedforward component  $u_{ff,i}(t)$ , defined as:

$$u_i(t) = u_{fb,i}(t) + u_{ff,i}(t) \quad (3.19)$$

The feedback component is computed using the signal measured by vehicle  $\Sigma_i$ , while the feedforward component uses information received from  $\Sigma_{i-1}$  as shown in Figure 3.3. We further denote each component as

$$u_{fb,i}(t) = K_1 y_{1,i} \quad u_{ff,i}(t) = K_2 y_{2,i-1} \quad (3.20)$$

where  $y_{1,i}$  and  $y_{2,i-1}$  are, respectively, the measured signals and information received by  $\Sigma_i$ . To deal with event triggered control, goal of the next chapter, we consider two approaches to model the interaction between vehicles. One called Interconnected and the other one called Overlapping. Their interest is related to the LMI constraints writing in Chapter 4.

### 3.3.2 Interconnected system

As illustrated in Figure 3.3 the information transmitted only goes from  $\Sigma_{i-1}$  to  $\Sigma_i$ , we define an interconnected system denoted  $\Sigma_{i,i-1}$  that represents vehicle  $\Sigma_i$  accounting from the information coming from  $\Sigma_{i-1}$ . Notice that from, system (3.17), we can write for  $\Sigma_{i-1}$

$$\dot{a}_{i-1} = -\frac{1}{\rho_d} a_{i-1} + \frac{1}{\rho_d} u_{i-1} + e_{d,i-1}. \quad (3.21)$$

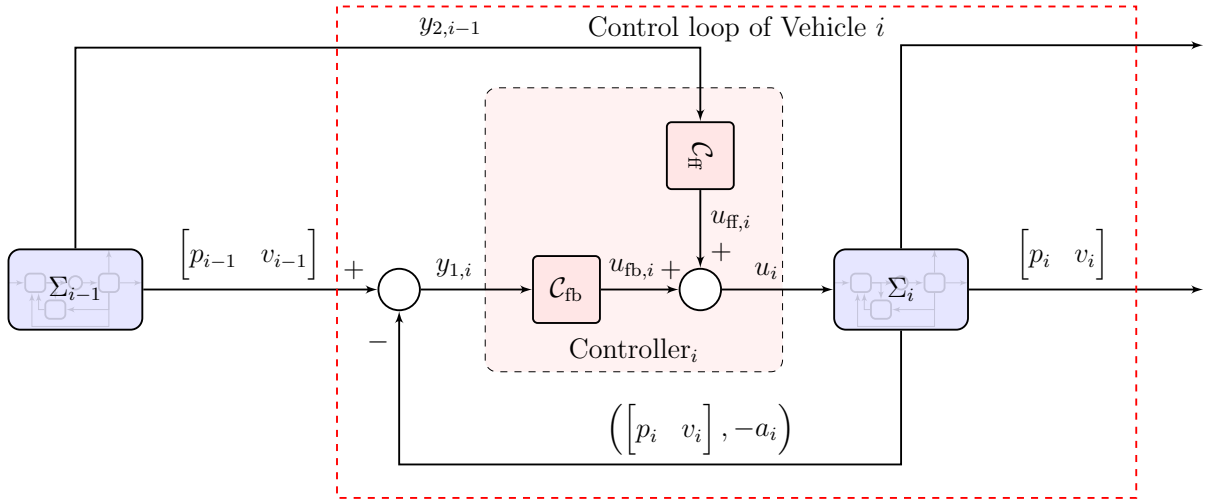

Figure 3.3 – Vehicle communication and control loop.  $\mathcal{C}_{fb}$  and  $\mathcal{C}_{ff}$  stand, respectively, for the feedback and feedforward control law components.

Due to  $a_{i-1}$  affecting  $\Sigma_i$  we combine (3.17) with (3.21) to write

$$\Sigma_{i,i-1} : \begin{cases} \dot{x}_i = Ax_i + Bu_i + Du_{i-1} + Ew_{d,i} \\ y_{1,i} = C_1x_i \\ y_{2,i-1} = C_2x_i \end{cases} \quad (3.22)$$

with  $x_i = \text{col}\{\Delta p_i, \Delta v_i, a_i, a_{i-1}\}$ ,  $w_i = \text{col}\{e_{d,i}, e_{d,i-1}\}$  and matrices

$$A = \begin{bmatrix} 0 & 1 & 0 & 0 \\ 0 & 0 & -1 & 0 \\ 0 & 0 & -\frac{1}{\rho_d} & 0 \\ 0 & 0 & 0 & -\frac{1}{\rho_d} \end{bmatrix} \quad B = \begin{bmatrix} 0 \\ 0 \\ \frac{1}{\rho_d} \\ 0 \end{bmatrix} \quad D = \begin{bmatrix} 0 \\ 0 \\ 0 \\ \frac{1}{\rho_d} \end{bmatrix} \quad E = \begin{bmatrix} 0 & 0 \\ 0 & 0 \\ 1 & 0 \\ 0 & 1 \end{bmatrix} \quad C_1 = \begin{bmatrix} 1 & 0 & 0 & 0 \\ 0 & 1 & 0 & 0 \\ 0 & 0 & 1 & 0 \end{bmatrix} \\ C_2 = \begin{bmatrix} 0 & 0 & 0 & 1 \end{bmatrix} \quad (3.23)$$

The output  $y_{1,i}$  corresponds to the states measured by  $\Sigma_i$ , while  $y_{2,i-1}$  is received from  $\Sigma_{i-1}$  via communication. Model (3.22) comprises the connection between vehicles  $\Sigma_i$  and  $\Sigma_{i-1}$ . It remains to properly define the performance inputs and outputs to evaluate the string stability of the system. First we set the performance output as the control input of  $\Sigma_i$

$$z_i = u_i \quad (3.24)$$

Hence, for string stability analysis we are going to evaluate the input-output stability between the input  $u_{i-1}$  and the output  $z_i = u_i$ .

Assuming that the communication is sufficiently fast, such that we can approximate the transmission as continuous,  $y_{2,i-1}$  is available in real time allowing us to define the control law of system (3.22) as

$$u_i = Kx_i = \underbrace{K_1 y_{1,i}}_{u_{fb,i}} + \underbrace{K_2 y_{2,i-1}}_{u_{ff,i}} \quad (3.25)$$

where  $u_{fb,i}$  and  $u_{ff,i}$  are, respectively, the feedback and feedforward component of  $u_i$ . Notice that we can write  $u_i = Kx_i$  since  $x_i = \text{col}\{y_{1,i}, y_{2,i-1}\}$ . Applying (3.25) to (3.22) and considering the performance output (3.24) we have

$$\Sigma_{i,i-1} : \begin{cases} \dot{x}_i = (A + BK)x_i + Du_{i-1} + Ew_{d,i} \\ z_i = Kx_i \end{cases} \quad (3.26)$$

Thus, for continuous communication, the structure of the system individual vehicle stability can be achieved using any appropriate technique (pole placement, LQR,  $H_\infty$  etc.). For  $w_{d,i} = 0$  the condition are the same as in (DOLK *et al.*, 2017; PLOEG *et al.*, 2014) and string stability analysis is straightforward. However, the results cannot be extended directly when  $w_{d,i} \neq 0$ . Based on the  $\mathcal{L}_p$  string stability condition

$$\|z_i\|_{\mathcal{L}_2} \leq \gamma_0 \|u_0\|_{\mathcal{L}_2} + \rho(\|\bar{x}(0)\|), \quad i = 1, \dots, N. \quad (3.27)$$

from Definition 2.1 in Section 2 we propose the following proposition to account for disturbances or estimation error in the platoon string stability analysis

**Proposition 3.1.** Consider the system  $\Sigma_{i,i-1}$  in (3.26). Assume that there exists an upper bound  $w_{\max} > 0$  such that  $\|w_{d,i}\|_{\mathcal{L}_2} \leq w_{\max}$ , for all  $i = 0, \dots, N$ . If there exists finite positive scalars  $\gamma \leq 1$  and  $\beta$ , such that

$$\|z_i\|_{\mathcal{L}_2} \leq \gamma \|z_{i-1}\|_{\mathcal{L}_2} + \beta \|w_{d,i}\|_{\mathcal{L}_2} \quad (3.28)$$

for all  $i = 1, \dots, N$ , with  $z_0 = u_0$ . Then,

$$\|z_i\|_{\mathcal{L}_2} \leq \|u_0\|_{\mathcal{L}_2} + i\beta w_{\max} \quad (3.29)$$

holds for, all  $i = 1, \dots, N$ .

*Proof.* By recursivity of expression (3.28) starting with  $i = 1$ , it follows that

$$\|z_i\|_{\mathcal{L}_2} \leq \gamma^i \|z_0\|_{\mathcal{L}_2} + \beta \sum_{j=1}^i \gamma^{i-j} \|w_{d,j}\|_{\mathcal{L}_2}. \quad (3.30)$$

Since  $\|w_{d,i}\|_{\mathcal{L}_2} \leq w_{\max}$ , for  $i = 1, \dots, N$  and  $\gamma \leq 1$  it follows that  $\gamma^i \leq 1$  and

$$\sum_{j=1}^i \gamma^{i-j} \|w_{d,j}\|_{\mathcal{L}_2} \leq \sum_{j=1}^i \|w_{d,j}\|_{\mathcal{L}_2} \leq iw_{\max} \quad (3.31)$$

Then, condition (3.30) implies (3.29) for  $z_0 = u_0$ . This completes the proof.  $\square$

Proposition 3.1 can be seen as an extension of the  $\mathcal{L}_2$  string stability defined in (PLOEG *et al.*, 2014; FENG *et al.*, 2019) including the effects of disturbances. The condition depends on  $w_{d,i} = \text{col}\{e_{d,i}, e_{d,i-1}\}$  and its upper bound. Hence, effective DOB compensation

can reduce the effects of  $w_{d,i}$  enabling platoon formations with more vehicles without compromising safety.

Moreover, there is a clear connection between condition (3.28) and the  $\mathcal{L}_2$ -gain stability conditions (KHALIL, 2002). Hence we can ensure string stability via  $\mathcal{L}_2$  stability analysis of system (3.26). The following theorem proposes design conditions to ensure that condition (3.28) in Proposition 3.1 holds for system (3.26)

**Theorem 3.1.** *Consider the interconnected system  $\Sigma_{i,i-1}$  in (3.26). If there exist positive scalars  $\beta, \gamma \leq 1$ , a matrix  $L$ , and a symmetric matrix  $P \succ 0$ , of appropriate dimensions, such that the following optimization problem is feasible:*

$$\min \beta \quad (3.32)$$

such that

$$\begin{bmatrix} \text{He}\{AP + BL\} + \alpha P & D & E & L^T \\ * & -\gamma^2 I & 0 & 0 \\ * & * & -\beta^2 I & 0 \\ * & * & * & -I \end{bmatrix} \prec 0 \quad (3.33)$$

Then, the closed-loop system (3.26), is  $\mathcal{L}_2$  stable and condition (3.28) in Proposition 3.1 holds under the control law (3.25) with the control gains  $K = LP^{-1}$ .

*Proof.* The proof is straightforward from the proof of  $\mathcal{L}_2$  gain condition in Section 2.  $\square$

The conditions from Theorem 3.1 provides a controller that satisfies the conditions from Proposition 3.1. However, the optimization will prove one solution from a set of possible ones. Without additional information to limit the set of solution, the controller performance might be inefficient. For this reason we provide some guidelines for the controller design introducing additional information achieved via the error dynamics analysis.

### 3.3.3 Interconnected model control gain guidelines

Based on Proposition 3.1 we can design the controller gain  $K$  in (3.25) such that condition (3.28) holds for the closed loop system (3.26). Although both  $K_1$  and  $K_2$  can be set as unrestricted variables, we can also impose some restrictions on  $K_2$  or even set its value a priori.

Consider the distance policy error  $\Delta p_i$  defined in (3.9). Taking its time derivative twice yields

$$\Delta p_i^{(2)} = a_{i-1} - a_i - \frac{h}{\rho_d} (-a_i + u_i) - h e_{d,i}. \quad (3.34)$$

Substituting the control law  $u_i$  (3.25) in (3.34) we have

$$\Delta p_i^{(2)} = \underbrace{-a_i - \frac{h}{\rho_d} (-a_i + K_1 y_{1,i})}_{\text{feedback}} + \underbrace{a_{i-1} - \frac{h}{\rho_d} K_2 y_{2,i-1}}_{\text{feedforward}} - h e_{d,i}. \quad (3.35)$$

Since  $y_{2,i-1} = a_{i-1}$  the effects of  $a_{i-1}$  in (3.35) can be canceled choosing  $K_2$  such that

$$K_2 \frac{h}{\rho_d} = 1. \quad (3.36)$$

Hence  $K_2$  can be set a priori to minimize the influence of  $a_{i-1}$  in the distance policy error dynamics. The main drawback is that the feedback contribution in (3.35) does not directly connect to the distance policy error or its derivative, which will become more evident in the overlapping approach explained in the next section.

Imposing a value to  $K_2$ , choosing  $P = \text{diag}(P_1, P_2)$  and taking advantage that  $K_1 C_1 P = K_1 P_1 C_1$ . The following Corollary provides design conditions for a predefined  $K_2$ .

**Corollary 3.1.** *Consider the interconnected system  $\Sigma_{i,i-1}$  in (3.26). If for a given  $K_2$ , there exist positive scalars  $\beta, \gamma \leq 1$ , a matrix  $L_1$ , symmetric matrix  $P = \text{diag}(P_1, P_2) \succ 0$ , of appropriate dimensions such that the following optimization problem is feasible:*

$$\min \beta \quad (3.37)$$

such that

$$\begin{bmatrix} \text{He} \{(A + BK_2 C_2)P + BL_1 C_1\} + \alpha P & D & E & (K_2 C_2 P + L_1 C_1)^T \\ * & -\gamma^2 I & 0 & 0 \\ * & * & -\beta^2 I & 0 \\ * & * & * & -I \end{bmatrix} \prec 0 \quad (3.38)$$

Then, the closed-loop system (3.26), is  $\mathcal{L}_2$  stable and condition (3.28) in Proposition 3.1 holds under the control law (3.25) with the control gain  $K_2$  and  $K_1 = L_1 P_1^{-1}$ .

Perfect canceling only occurs for continuous communication and in the absence of delays. Therefore, instead of using Corollary 3.1 with  $K_2$  fixed according to equality (3.36), we can use the conditions from Theorem 3.1 including a norm-bounded constraint in the optimization problem such as:

$$\|K_2^* - K_2\| \leq \bar{\kappa} \quad (3.39)$$

where  $K_2^* = \frac{\rho_d}{h}$  is the ideal given feedforward control gain from (3.36).

### 3.3.4 Overlapping model

The error dynamics analysis in the previous section allows to set  $K_2$  a priori but not  $K_1$ . In this section we show that, introducing a filter and augmenting the dynamics we can model the vehicles interaction such that both  $K_2$  and  $K_1$  can be designed a priori. To differentiate it from the interconnected model  $\Sigma_{i,i-1}$  we denote it as Overlapping model.

Before defining the interaction between vehicles for this approach we introduce the filter

$$h\dot{u}_i + u_i = \xi_i. \quad (3.40)$$

where  $\xi_i$  is the new control input to be designed. Filtering is a common approach in CACC systems with a CTH distance policy and is used for pre-compensation of distance policy (DOLK *et al.*, 2017; PLOEG *et al.*, 2011; PLOEG *et al.*, 2014). We will turn back to its interest in Section 3.3.5. Thus, we introduce  $u_i$  as a new state variable and from model (3.17) and filter (3.40), we have from  $\Sigma_{i-1}$

$$\begin{aligned} \dot{a}_{i-1} &= -\frac{1}{\rho_d}a_{i-1} + \frac{1}{\rho_d}u_{i-1} + e_{d,i-1}. \\ \dot{u}_{i-1} &= -\frac{1}{h}u_{i-1} + \frac{1}{h}\xi_i \end{aligned} \quad (3.41)$$

Combining (3.17) with (3.41) and (3.40) we write

$$\Xi_{i,i-1} : \begin{cases} \dot{\bar{x}}_i = \bar{A}\bar{x}_i + \bar{B}\xi_i + D\xi_{i-1} + \bar{E}w_{d,i} \\ \bar{y}_{1,i} = \bar{C}_1\bar{x}_i \\ \bar{y}_{2,i-1} = \bar{C}_2\bar{x}_i \end{cases} \quad (3.42)$$

with  $\bar{x}_i = \text{col}\{\Delta p_i, \Delta v_i, a_i, u_i, a_{i-1}, u_{i-1}\}$ ,  $w_{d,i} = \text{col}\{e_{d,i}, e_{d,i-1}\}$  and matrices

$$\begin{aligned} \bar{A} &= \begin{bmatrix} 0 & 1 & 0 & 0 & 0 & 0 \\ 0 & 0 & -1 & 0 & 0 & 0 \\ 0 & 0 & -\frac{1}{\rho_d} & \frac{1}{\rho_d} & 0 & 0 \\ 0 & 0 & 0 & -\frac{1}{h} & 0 & 0 \\ 0 & 0 & 0 & 0 & -\frac{1}{\rho_d} & 0 \\ 0 & 0 & 0 & 0 & 0 & -\frac{1}{h} \end{bmatrix}, \bar{B} = \begin{bmatrix} 0 \\ 0 \\ 0 \\ \frac{1}{h} \\ 0 \\ 0 \end{bmatrix}, \bar{D} = \begin{bmatrix} 0 \\ 0 \\ 0 \\ 0 \\ 0 \\ \frac{1}{h} \end{bmatrix}, \bar{E} = \begin{bmatrix} 0 & 0 \\ 0 & 0 \\ 1 & 0 \\ 0 & 0 \\ 0 & 1 \\ 0 & 0 \end{bmatrix}, \\ \bar{C}_1 &= \begin{bmatrix} 1 & 0 & 0 & 0 & 0 & 0 \\ 0 & 1 & 0 & 0 & 0 & 0 \\ 0 & 0 & 1 & 0 & 0 & 0 \\ 0 & 0 & 0 & 1 & 0 & 0 \end{bmatrix}, \bar{C}_2 = \begin{bmatrix} 0 & 0 & 0 & 0 & 1 & 0 \\ 0 & 0 & 0 & 0 & 0 & 1 \end{bmatrix} \end{aligned} \quad (3.43)$$

The output  $\bar{y}_{1,i}$  is the states measured by  $\Sigma_i$  including the filter state  $u_i$ . Meanwhile  $\bar{y}_{2,i-1} = [a_{i-1}, u_{i-1}]$  is the information sent to  $\Sigma_i$  by  $\Sigma_{i-1}$  via communication. We now define the performance output as

$$\bar{z}_i = \xi_i \quad (3.44)$$

which allows to assess the interaction between vehicles  $\Sigma_i$  and  $\Sigma_{i-1}$  via the input-output stability  $\xi_{i-1}$  to  $\xi_i$ . Similarly to the interconnected problem, for a sufficiently fast communication, control law of system (3.42) is decomposed with a feedback part ( $K_1$ ) and a feedforward part ( $K_2$ ):

$$\xi_i = \bar{K}\bar{x}_i = \underbrace{\bar{K}_1\bar{y}_{1,i}}_{\xi_{\text{fb},i}} + \underbrace{\bar{K}_2\bar{y}_{2,i-1}}_{\xi_{\text{ff},i}}, \quad (3.45)$$

with

$$\bar{K}_1 = \begin{bmatrix} \bar{K}_{11} & \bar{K}_{12} & \bar{K}_{13} & \bar{K}_{14} \end{bmatrix} \quad \bar{K}_2 = \begin{bmatrix} \bar{K}_{12} & \bar{K}_{22} \end{bmatrix} \quad (3.46)$$



and the closed-loop overlapping system can be written as

$$\Xi_{i,i-1} : \begin{cases} \dot{\bar{x}}_i = (\bar{A} + \bar{B}\bar{K})\bar{x}_i + D\xi_{i-1} + \bar{E}w_{d,i} \\ \bar{z}_i = \bar{K}\bar{x}_i \end{cases} \quad (3.47)$$

For the overlapping model individual and string stability analyses can be evaluated based on Proposition 3.1. However, special attention is necessary regarding the interaction between  $\Sigma_1$  and  $\Sigma_0$  (leader). The leader control input  $u_0$  is not a design parameter, hence we cannot introduce the filter in the control law. To handle this we assume that there exists  $\xi_0$ , such that  $h\dot{u}_0 = u_0 + \xi_0$ , which is not a strong assumption since, as long as  $u_0$  is continuously differentiable,  $\xi_0$  can always be found. We can now include the interaction between  $\Sigma_1$  and  $\Sigma_0$  in the  $\Xi_{i,i-1}$  system and stability can be evaluated based on Proposition 3.1 without further modifications.

The controller gain  $\bar{K}$  can be designed based optimization problem similar to the interconnected system that is not described here but is straightforward from Theorem 3.1. Also similar to the interconnected case we provide some guidelines for the controller design introducing additional information achieved via the error dynamics analysis.

### 3.3.5 Overlapping model control gain guidelines

As in Section 3.3.3 we can also attain some insights on the design of  $\bar{K}_1$  and  $\bar{K}_2$  studying the system error dynamics. Differentiating (3.34), and organizing the terms we have

$$\begin{aligned} \Delta p_i^{(3)} &= \frac{1}{\rho_d}(-a_{i-1} + u_{i-1}) + he_{d,i-1} - \frac{1}{\rho_d}(-a_i + u_i) + he_{d,i} \\ &\quad - \frac{h}{\rho_d} \left( -\frac{1}{\rho_d}(-a_i + u_i) + he_{d,i} + \dot{u}_i \right) + h\dot{e}_{d,i} \\ &= -\frac{1}{\rho_d} \underbrace{\left( a_{i-1} - a_i - \frac{h}{\rho_d}(-a_i + u_i) - he_{d,i} \right)}_{\Delta p_i^{(2)}} \\ &\quad - \frac{1}{\rho_d} \underbrace{(h\dot{u}_i + u_i - u_{i-1})}_{\xi_i} + e_{d,i-1} - e_{d,i} - h\dot{e}_{d,i}. \end{aligned} \quad (3.48)$$

Looking at (3.48) it is clear the filter (3.40) and we can write

$$\Delta p_i^{(3)} = -\frac{1}{\rho_d} \Delta p_i^{(2)} - \frac{1}{\rho_d} (\xi_i + u_{i-1}) + e_{d,i-1} - e_{d,i} - h\dot{e}_{d,i}. \quad (3.49)$$

Furthermore, substituting the control law (3.45) in the last line of (3.49) yields

$$\Delta p_i^{(3)} = -\frac{1}{\rho_d} (\Delta p_i^{(2)} - \bar{K}_1 \bar{y}_{1,i}) + \frac{1}{\rho_d} (u_{i-1} - \bar{K}_2 \bar{y}_{2,i-1}) + e_{d,i-1} - e_{d,i} - h\dot{e}_{d,i}. \quad (3.50)$$

Equivalently to the interconnected case, it is straightforward to cancel the effect of  $u_{i-1}$  by choosing  $\bar{K}_2 = [0 \ 1]$ . Nevertheless, the second degree of freedom can be used to

propose other appropriate choices. Notice that from the linearized dynamic (3.16)

$$\dot{a}_{i-1} = -\frac{1}{\rho_d}a_{i-1} + \frac{1}{\rho_d}u_{i-1} + e_{d,i-1}. \quad (3.51)$$

Hence in steady state,  $a_{i-1} \rightarrow u_{i-1} + \rho_d e_{d,i}$ . Therefore, the feedforward component in (3.45) converges to

$$\bar{K}_2 \bar{y}_{2,i-1} = (\bar{K}_{21} + \bar{K}_{22})u_{i-1} + \bar{K}_{21}\rho_d e_{d,i-1}. \quad (3.52)$$

Choosing  $\bar{K}_{21}$  and  $\bar{K}_{22}$  such that  $\bar{K}_{21} + \bar{K}_{22} = 1$ , and substituting (3.52) in (3.50) gives

$$\Delta p_i^{(3)} = -\frac{1}{\rho_d}(\Delta p_i^{(2)} - \bar{K}_1 \bar{y}_{1,i}) + \frac{1}{\rho_d}(u_{i-1} \xrightarrow{0} u_{i-1}) + (e_{d,i-1} - \bar{K}_{21}e_{d,i-1}) - e_{d,i} - h\dot{e}_{d,i} \quad (3.53)$$

Therefore, it is possible to compensate for the effects of both  $u_{i-1}$  and  $e_{d,i-1}$  in steady state.

**Remark 3.1.** Considering the system (3.47) with control law (3.45), the feedforward control gain  $\bar{K}_2 = [\bar{K}_{21} \ \bar{K}_{22}]$  can be chosen such that  $\bar{K}_{21} + \bar{K}_{22} = 1$ , to compensate for  $u_{i-1}$  and  $e_{d,i-1}$  in the distance policy error dynamics (3.50).

Due to the lower triangular structure of (3.49) the control gain  $\bar{K}_1$  can also be easily designed by imposing some structure to  $\bar{K}_1$  assuming that  $e_{d,i} = 0$ . From (PLOEG *et al.*, 2011) we have the following remark:

**Remark 3.2.** Considering the system (3.47) with control law (3.45), for every  $K_p, K_d > 0$  and  $K_d > K_p\rho_d$ , choosing  $\bar{K}_1 = [K_p \ K_d \ -hK_d \ 0]$  ensure individual vehicle stability and, consequently, stability of  $\Xi_{i,i-1}$ .

To demonstrate we set the structure for  $\bar{K}_1$  as  $\bar{K}_1 = [K_p \ K_d \ -hK_d \ 0]$  which produces the feedback control component

$$\bar{K}_1 \bar{y}_{1,i} = K_p \Delta p_i^{(0)} + K_d \Delta p_i^{(1)} = K_p \Delta p_i + K_d \Delta v_i - K_d h a_i \quad (3.54)$$

For simplicity, consider that the feedforward component  $u_{i-1}$  is perfectly canceled, moreover we assume that  $e_{d,i} = 0$ . From (3.51), filter (3.40) and introducing  $u_i$  as a new state we can write the augmented closed loop dynamics as

$$\begin{bmatrix} \Delta p_i^{(1)} \\ \Delta p_i^{(2)} \\ \Delta p_i^{(3)} \\ \dot{u}_i \end{bmatrix} = \begin{bmatrix} 0 & 1 & 0 & | & 0 \\ 0 & 0 & 1 & | & 0 \\ -\frac{K_p}{\rho_d} & -\frac{K_d}{\rho_d} & -\frac{1}{\rho_d} & | & 0 \\ \frac{K_p}{h} & \frac{K_d}{h} & 0 & | & -\frac{1}{h} \end{bmatrix} \begin{bmatrix} \Delta p_i^{(0)} \\ \Delta p_i^{(1)} \\ \Delta p_i^{(2)} \\ u_i \end{bmatrix} + \begin{bmatrix} 0 \\ 0 \\ 0 \\ \frac{1}{h} \end{bmatrix} u_{ff,i} \quad (3.55)$$

In view of the lower triangular structure, applying the Routh-Hurwitz stability criterion, we can conclude that (3.55) can be stabilized for  $h > 0$ , choosing  $K_p, K_d > 0$  and  $K_d > K_p\rho_d$ . Those conditions ensure individual vehicular stability and the study of string stability in the frequency domain is done in (PLOEG *et al.*, 2011; PLOEG *et al.*, 2014).

Imposing the above structures to  $\bar{K}_1$  and  $\bar{K}_2$ , simplifies the design conditions. However, translating those constraints into an optimization problem with LMI constraints necessitates bounds that may result in conservative conditions. The design proposed is a two-step procedure where  $\bar{K}_1$  and  $\bar{K}_2$  are designed a priori based on Remarks 3.2 and 3.1, and we evaluate the  $\mathcal{L}_2$  string stability conditions to verify whether the conditions hold in the presence of disturbances or for noncontinuous communication with communication delays, as will be discussed in Chapter 4.

In comparison to the interconnected model, the overlapping model introduces a filter to compensate for the effects of the constant time headway distance policy. Moreover, as individual stability can be ensured directly from Remark 3.2 and Remark 3.1, the controller is designed in a two-step approach, where in the first step the gains are designed according to Remark 3.2 and Remark 3.1, and string stability is evaluated using Theorem 3.1. Unlike the interconnect system, the constraints in the individual stability analysis difficult the designing conditions in an one-step approach.

The two systems, interconnected and overlapping, also differ in terms of convergence rate and maximum distance policy error, as will be shown in the next section.

## 3.4 Examples

This section presents illustrative results and comparative studies to show the effectiveness of the proposed DOB and controller design conditions. We present how different choices of DOB gains and control gains can influence the distance policy error. Moreover, we also illustrate the effectiveness of the design conditions based on the interconnected system  $\Sigma_{i,i-1}$  and the overlapping system  $\Xi_{i,i-1}$  and, how different choices of feedforward control can affect the system dynamics.

**Remark 3.3.** Whenever a  $\tilde{a}$  appears in a variable, it represents the values used for the simulation that may differ from the nominal values used to design the control.

### 3.4.1 Test 1. Performance evaluation of the DOB

In this section we show the interest of adding the DOB compensation, presented in Figure 3.3. We consider two vehicles the leader  $\Sigma_0$  and one follower  $\Sigma_1$ . Table 3.2 gives the parameters of each vehicle. In rows  $\Sigma_0$  and  $\Sigma_1$  are the values used to calculate the feedback linearizing control law. In rows  $\tilde{\Sigma}_0$  and  $\tilde{\Sigma}_1$  are the values used for the simulation. The rolling resistance coefficient  $F_r$  is considered constant for all vehicles, i.e.,  $F_r = 0.015$  (sec/kg). However, it is assumed to be unknown.

The desired distance policy  $\Delta p_{d,1} = r_1 + hv_1$  is set with  $r_1 = 2$  (m) and  $h = 0.6$  (sec), the platoon time constant is  $\rho_d = 0.1$ . For the DOB (3.12) we use a linear observer gain

Table 3.2 – Nominal values of the vehicle parameters ( $\Sigma_i$  columns) and respective values used for simulation ( $\tilde{\Sigma}_i$ ).

Vehicle	$r$	$m$	$h_w$	$J_r$	$J_e$	$R_g$	$B$	$C$	$\rho$
$\Sigma_0$	2.5	1724	0.28	0.75	0.14	0.10	7.35	0.05	0.05
$\tilde{\Sigma}_0$		1724	0.25	1.05	0.14	0.13	8.09	0.06	0.08
$\Sigma_1$	2.5	2241	0.63	0.97	0.35	0.18	13.96	0.11	0.10
$\tilde{\Sigma}_1$		2017	0.51	0.68	0.46	0.18	11.17	0.16	0.09

$L(a_1) = L_1 a_1$  with  $L_1 = 50$ . We choose the gains as

$$\bar{K}_1 = \begin{bmatrix} 0.2 & 0.7 & -0.42 & 0 \end{bmatrix} \quad \bar{K}_2 = \begin{bmatrix} 0 & 1 \end{bmatrix} \quad (3.56)$$

according to Remark 3.2 and 3.1. The speed profile is defined for the trials with three parts: Acceleration, constant speed and braking, Figure 3.4 left. In the nominal case, i.e. without uncertainties, the velocity of  $\Sigma_0$  and  $\Sigma_1$ , the distance policy error  $\Delta p$ , are shown Figure 3.4. As expected the distance policy error is very small, less than  $4 \times 10^{-3}$  (m).

The second trial considers the uncertainties in Table 3.2, i.e. the rows  $\tilde{\Sigma}_0$  and  $\tilde{\Sigma}_1$ . Figure 3.5 (top) gives the results without DOB and presents an error up to 4 (m); Figure 3.5 (middle) the results with DOB and the error up to 0.02 (m) that shows the importance of estimating the *virtual* disturbance. The bottom left part of Figure 3.5 shows the linear control input  $u_1$  (3.45) in both cases (blue without DOB and red with DOB). At last, bottom right shows the estimation of the disturbance  $\hat{d}_0$  and  $\hat{d}_1$ .

The next section presents results in simulation for platooning with disturbances and uncertainties.

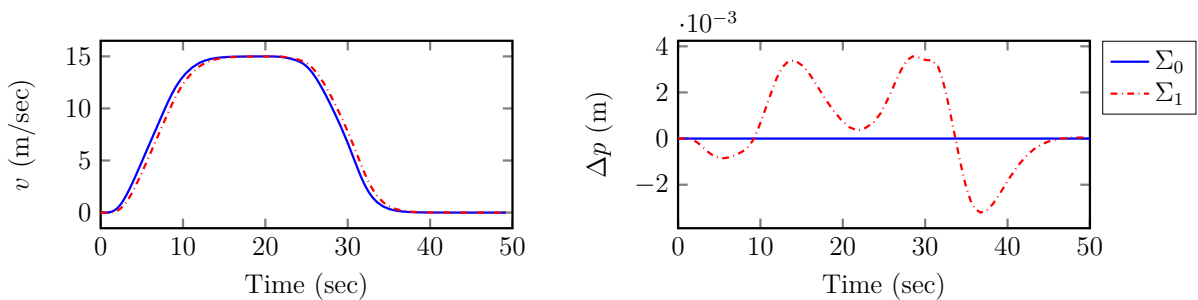
Figure 3.4 – Test 1. Velocity (left) and distance policy error (right), of  $\Sigma_0$  and  $\Sigma_1$  for the nominal case.

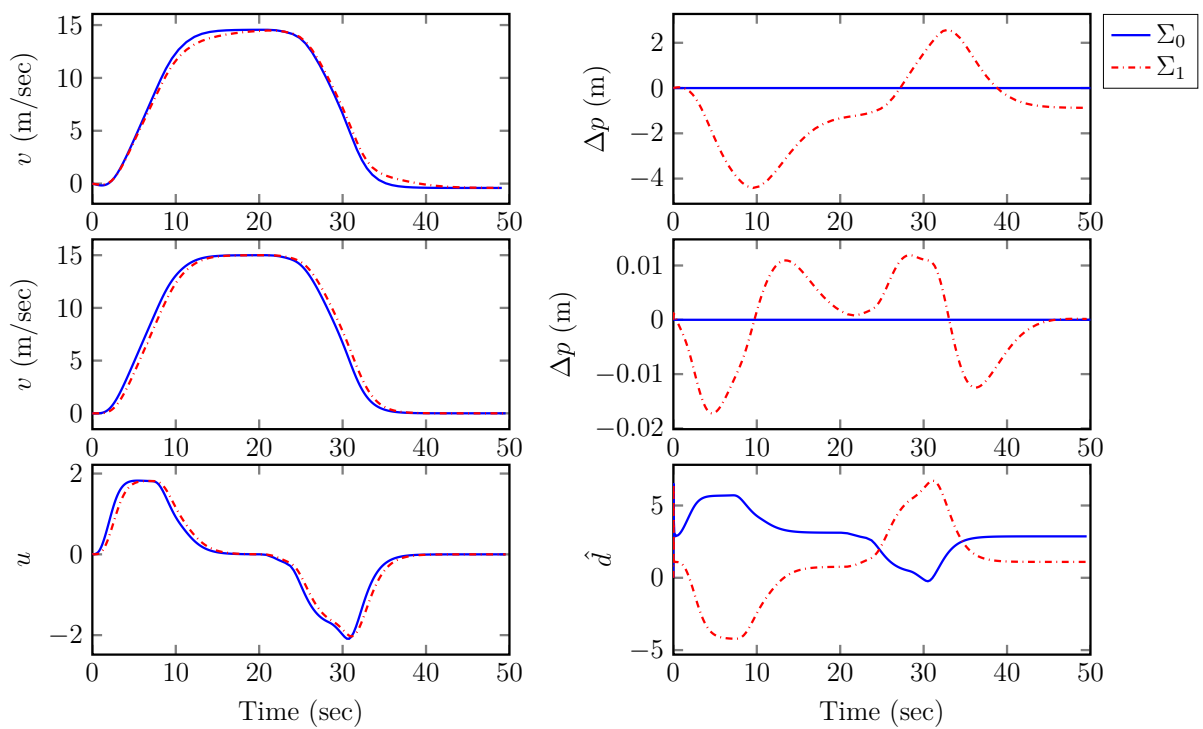

Figure 3.5 – Test 1. Velocity, distance policy error vehicles without DOB compensation (top) , with DOB compensation (middle) and respective control input (bottom left) and disturbance estimation (bottom right) of  $\Sigma_0$  and  $\Sigma_1$ .

### 3.4.2 Test 2. Platooning

In these tests, we consider platoon setups with one leader ( $\Sigma_0$ ) and four to ten followers ( $\Sigma_1$  to  $\Sigma_{10}$ ). In order to define different platoon formations we define a base of parameters denoted  $\Sigma_j^b$  for  $j = 0, \dots, 5$  whose parameters are described in Table 3.3. The rows  $\Sigma_0^b$  to  $\Sigma_4^b$  are the base values used to calculate the feedback linearizing control law, whereas rows  $\tilde{\Sigma}_0^b$  to  $\tilde{\Sigma}_4^b$  are the values used for the simulation.

We consider  $N$  followers and we define an ordered set of  $N + 1$  indexes,  $\mathbb{J}$ , with values belonging to the set  $\{0, \dots, 4\}$ . The platoon is defined with vehicles

$$\Sigma_i = \Sigma_{\mathbb{J}(i)}^b. \quad (3.57)$$

For example, with  $N = 4$  and  $\mathbb{J} = \{0, 3, 4, 1, 0\}$  the platooning is defined with the vehicles having the parameters

$$\{\Sigma_0, \Sigma_1, \Sigma_2, \Sigma_3, \Sigma_4\} = \{\Sigma_0^b, \Sigma_3^b, \Sigma_4^b, \Sigma_1^b, \Sigma_0^b\} \quad (3.58)$$

Similar to Test 1 the following parameters are chosen: the rolling resistance coefficient  $F_r$  is constant for all vehicles, i.e.,  $F_r = 0.015$  (sec/kg),  $h = 0.6$  (1/sec) and the platoon time constant is  $\rho_d = 0.1$ . The DOB is designed in the same way as in Test 1 with  $L_i = L = 50$  for all  $\Sigma_i$  with  $i \in \{0, 1, \dots, N\}$ . The speed profile is the same as for Test 1 with three portions: Acceleration, constant speed and braking.

Table 3.3 – Nominal base values for the vehicle parameters ( $\Sigma_i^b$  columns) and respective values used for simulation ( $\tilde{\Sigma}_i^b$ ).

Vehicle	$r$	$m$	$h_w$	$J_r$	$J_e$	$R_g$	$B$	$C$	$\rho$
$\Sigma_0^b$	2.5	1724	0.28	0.75	0.14	0.10	7.35	0.05	0.05
$\tilde{\Sigma}_0^b$		1724	0.25	1.05	0.14	0.13	8.09	0.06	0.08
$\Sigma_1^b$	2.5	2241	0.63	0.97	0.35	0.18	13.96	0.11	0.10
$\tilde{\Sigma}_1^b$		2017	0.51	0.68	0.46	0.18	11.17	0.16	0.09
$\Sigma_2^b$	2.5	2930	0.41	1.57	0.27	0.20	11.02	0.08	0.08
$\tilde{\Sigma}_2^b$		2637	0.33	1.26	0.40	0.30	8.82	0.05	0.06
$\Sigma_3^b$	2.5	3620	0.63	0.82	0.27	0.11	13.96	0.11	0.12
$\tilde{\Sigma}_3^b$		3258	0.89	1.15	0.40	0.08	15.36	0.16	0.12
$\Sigma_4^b$	2.5	3965	0.52	1.72	0.24	0.11	8.09	0.06	0.08
$\tilde{\Sigma}_4^b$		5947	0.63	2.41	0.29	0.14	11.32	0.08	0.11

We will investigate the two approaches to model the interaction between vehicles. We recall that their interest will be explicit in Chapter 4.

## 3.4.2.1 Test 2.1 - Interconnected system

Consider a platoon with one leader and  $N = 6$  followers we define the platoon as  $\Sigma_i = \Sigma_{\mathbb{J}(i)}^b$  with set  $\mathbb{J} = \{0, 4, 1, 3, 2, 4, 1\}$ . This platoon is voluntarily set with  $\Sigma_0$  the lighter vehicle followed by the heaviest one  $\Sigma_4$ , with  $\Sigma_4$  repeated at the penultimate position. The controller is designed according to Corollary 3.1 with  $K_2 = \frac{\tau_d}{h} = 0.1667$ . Solving the optimization problem (3.37) with  $\alpha = 0.001$  we obtain

$$P = \begin{bmatrix} 1.5797 & -0.3920 & -0.0398 & 0 \\ -0.3920 & 2.0983 & -0.1904 & 0 \\ -0.0398 & -0.1904 & 0.0211 & 0 \\ 0 & 0 & 0 & 0.1001 \end{bmatrix}, \quad \beta = 10.0108, \quad K_1 = \begin{bmatrix} 0.4620 & 1.5488 & -0.1760 \end{bmatrix} \quad (3.59)$$

Figure 3.6 gives the velocity (top left) and distance policy error (top right) for each vehicle and shows that the vehicles are able to follow the velocity profile with a distance policy error up to 0.2 (m). The bottom part of Figure 3.6 shows the control input (bottom left) and estimated disturbance  $\hat{d}$  (bottom right) of each vehicle. The values of  $\hat{d}(t)$  are larger for vehicles  $\Sigma_1$  and  $\Sigma_5$  since their base values are both  $\Sigma_4^b$ , which presents larger mass and uncertainty  $m$ .

Comparing the maximum values of distance policy error in Test 1 (up to 0.02) and Test 2.1 (up to 0.2) there is difference in the controller designed considering the Interconnected and the Overlapping model. Further comparison will be provided in Test 2.3.

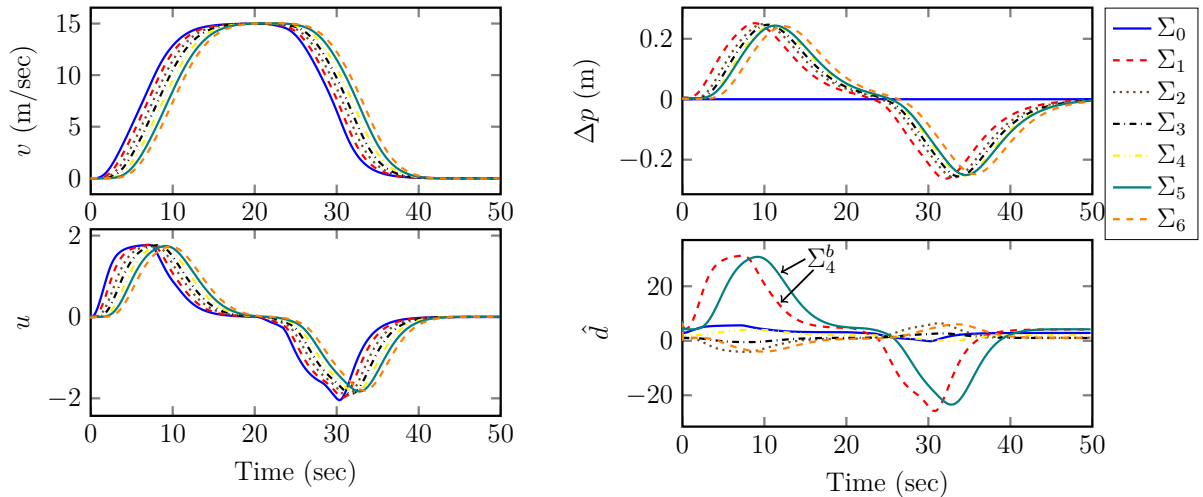

Figure 3.6 – Test 2.1: Platoon  $\mathbb{J} = \{0, 4, 1, 3, 2, 4, 1\}$ . Velocity (top left), distance policy error (top right), control input (bottom left) and disturbance estimation (bottom right) of each vehicle with a controller designed according to Corollary 3.1.

## 3.4.2.2 Test 2.2 - Overlapping system

Consider for this test a platoon with  $N = 4$  followers and platoon  $\Sigma_i = \Sigma_{\mathbb{J}(i)}^b$  with  $\mathbb{J} = \{0, 4, 1, 3, 2\}$  again the platoon is voluntarily set with  $\Sigma_0$  the lighter vehicle followed by the heaviest one  $\Sigma_4$ . The controller is chosen as in Test 1 with

$$\bar{K}_1 = \begin{bmatrix} 0.2 & 0.7 & -0.42 & 0 \end{bmatrix} \quad \bar{K}_2 = \begin{bmatrix} 0 & 1 \end{bmatrix} \quad (3.60)$$

Figure 3.7 (top left) gives the velocity, (top right) the distance policy error, (bottom right) the control input and (bottom left) the disturbance estimation  $\hat{d}$ . Similar to Test 2.1 the platoon is able to follow the speed profile, however, with smaller values of distance policy error, (up to 0.05 (m) in comparison to 0.2 (m) in Test 2.1 with the interconnected system). As in Test 2.1 the value of  $\hat{d}(t)$  is larger for vehicle  $\Sigma_1$  because of the larger uncertainty.

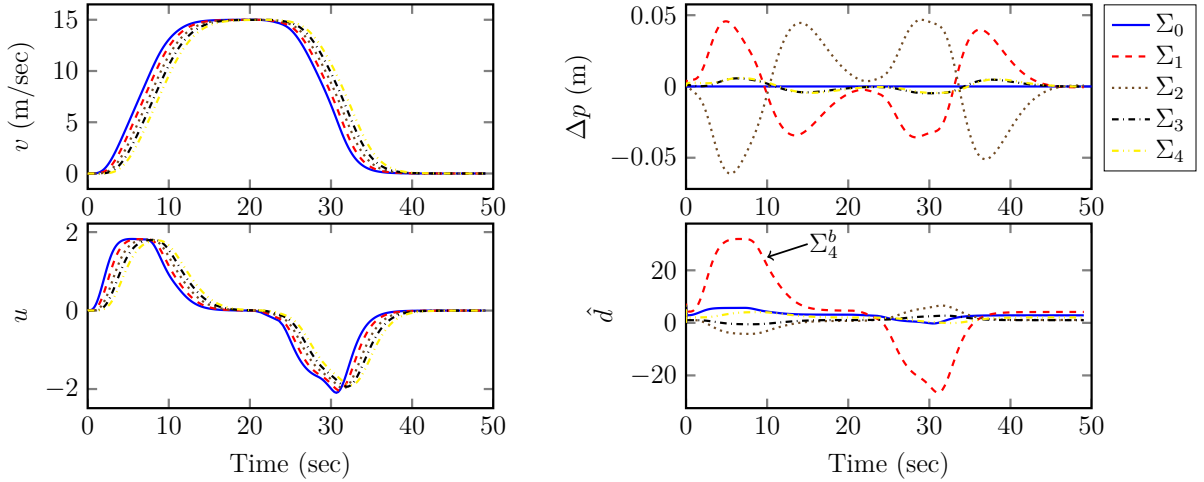

Figure 3.7 – Test 2.2: Platoon  $\mathbb{J} = \{0, 4, 1, 3, 2\}$ . Velocity (top left), distance policy error (top right), control input (bottom left) and disturbance estimation (bottom right) of each vehicle with  $\bar{K}_1 = \begin{bmatrix} 0.2 & 0.7 & -0.42 & 0 \end{bmatrix}$  and  $\bar{K}_2 = \begin{bmatrix} 0 & 1 \end{bmatrix}$ .

## 3.4.2.3 Test 2.3 - Comparison: Interconnected and Overlapping

In order to show a larger platoon, we use with  $N = 10$  followers and  $\Sigma_i = \Sigma_{\mathbb{J}(i)}^b$  with set  $\mathbb{J} = \{0, 4, 2, 1, 3, 3, 2, 4, 0, 3, 1\}$ . The controller for the interconnected system and overlapping system chosen, respectively, as in Tests 2.1 and 2.2. We select three vehicles for comparison:  $\Sigma_2$ ,  $\Sigma_7$  and  $\Sigma_{10}$ . Vehicle  $\Sigma_2$  is chosen since it provides the largest  $\Delta p$  in both modelings,  $\Sigma_7$  is chosen because its base value presents the largest uncertainty and  $\Sigma_{10}$  is chosen to evaluate the effects for the last vehicle.

Left side of Figure 3.8 shows the velocity and the right side the distance policy error  $\Delta p$  of the 4 selected vehicles. Comparing the results from the Interconnected system (top) with the overlapping (bottom), it is noticeable the difference in  $\Delta p$ , with the maximum value of



0.05 (m) for the Overlapping system, compared with a maximum value of 0.2 (m) for the Interconnected system. The behavior of  $\Delta p$  does not change significantly between vehicles for the interconnected system, while there are significant variations for the Overlapping ones.

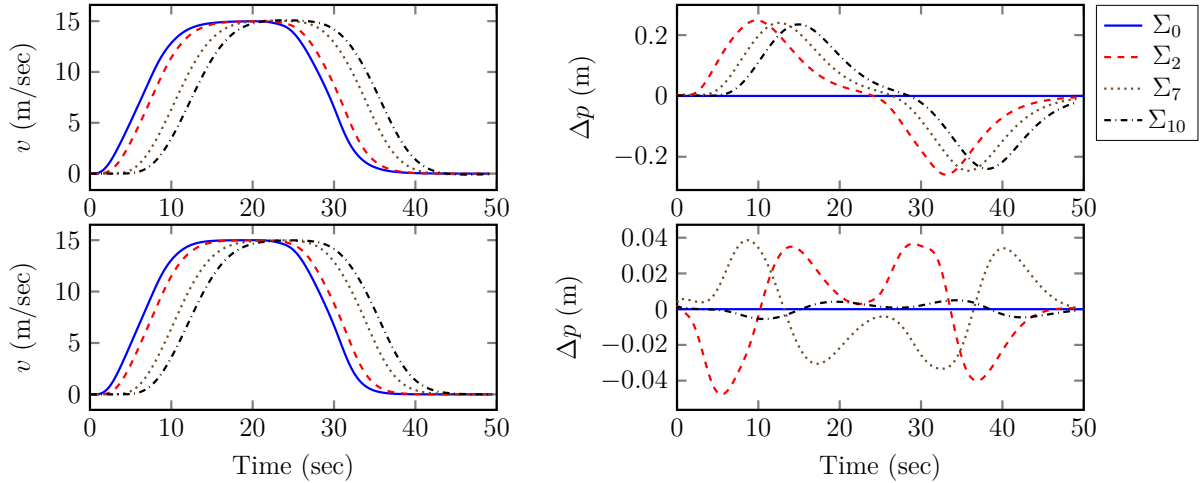

Figure 3.8 – Test 2.3: Velocity (left), and distance policy error (right), of vehicles  $\Sigma_2$ ,  $\Sigma_7$  and  $\Sigma_{10}$  designed considering the Interconnected (top) and Overlapping (bottom) systems.

#### 3.4.2.4 Test 2.4 - Comparison: Non zero initial conditions

The simulations until now were all performed with  $[\Delta p(0), \Delta v(0), a(0)] = 0$ , i.e., the platoon is already in the desired formation. In order to show the performance with non-zero initial conditions, we consider a platoon with the same setup as in Test 2.3 ( $\mathbb{J} = 0, 4, 2, 1, 3, 3, 2, 4, 0, 3, 1$ ) and the same controllers. In this test, the focus is on the transient behavior until the vehicles achieve formation. For this reason, all vehicles were selected, and we focus on the initial instants of the velocity profile.

The left side of Figure 3.9 shows the velocity, and the right side shows the distance policy error  $\Delta p$  of all vehicles. Looking at the velocity of each vehicle, we notice that, unlike in the other tests where the initial error is zero, the vehicles exhibit a transient behavior to adjust their positions and reduce the distance policy error. Comparing the results from the interconnected system (top) with the overlapping system (bottom), both approaches successfully drive the vehicles to formation. However, the overlapping approach provides faster convergence, with vehicles reaching formation within 10 seconds, while the interconnected approach required more time and, as in Test 2.3, presented high values of  $\Delta p$ .

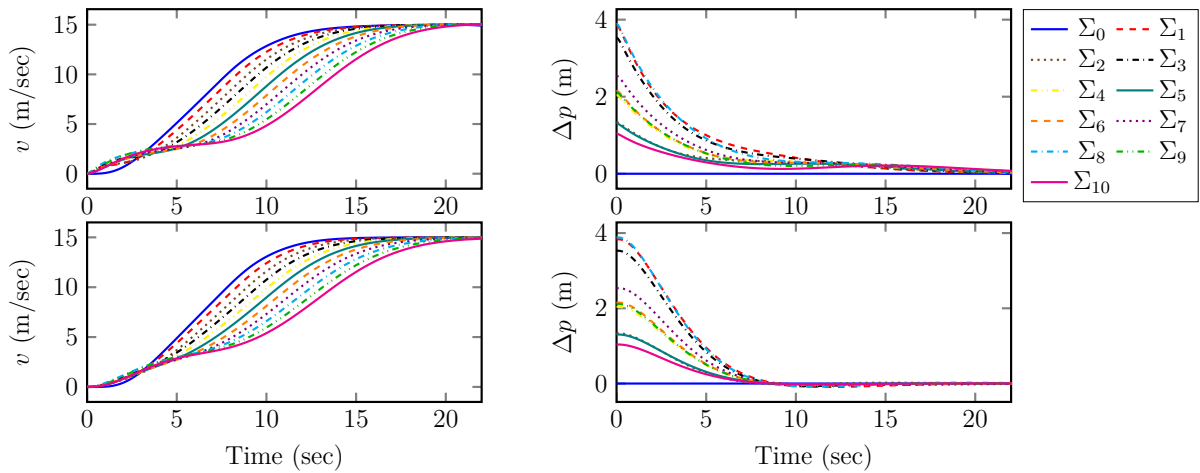

Figure 3.9 – Test 2.4: Velocity (left), and distance policy error (right), of vehicles  $\Sigma_1$ , to  $\Sigma_{10}$  the Interconnected (top) and Overlapping (bottom) systems, starting with non zero initial conditions.

### 3.5 Conclusion

Considering the control communication between vehicles in the predecessor-follower flow topology, extended  $\mathcal{L}_2$  string stability condition have been proposed for platoons subject to uncertainties. To effectively compensate for the uncertainties of the platooning system, treated as a virtual disturbance, a DOB-based uncertainty estimation is included in the feedback linearization control law. As a result, string stability and the stability of individual vehicles can be evaluated in a manner similar to the classical CACC design conditions. Moreover sufficient LMI conditions are presented to ensure  $\mathcal{L}_2$  stability between the vehicle systems  $\Sigma_i$  and  $\Sigma_{i-1}$  considering different models of vehicle interaction. Through simulations and comparisons, we illustrate that the proposed DOB-based compensation can effectively handle the system uncertainties, how each model can lead to different performances in the platoon system.

## 4 CACC platoon with event-triggering communication

### 4.1 Introduction

Cooperative adaptive cruise control differs from adaptive cruise control by introducing a communication system that allows vehicles to share information. Sharing information can improve platoon performance and allow shorter distance policies without compromising safety. Introducing communication requires accounting for possible delays and efficient use of the network. In this chapter, the main subject is the communication mechanism between vehicles in cooperative ACC. To improve communication efficiency, an event-triggered communication mechanism is considered. Since the system models are assumed to be affected by uncertainties, to avoid Zeno behavior, a minimum waiting time is enforced in the event-triggering mechanism. Because of time delays, information transmitted is only received after a time interval. Accounting for enforced time and delays, the time intervals of transmission and reception are divided into subintervals, and the vehicle linearized dynamics is modeled as a switching system that switches according to each time interval. The event-triggering control is designed considering this switching system model, and a dynamic event mechanism is proposed to reduce the number of events. To ensure individual and string stability, as proposed in the previous chapter Section 3.3.2, design conditions are derived for the cases with and without delay. Both conditions are formulated as an optimization problem subject to LMI constraints. Finally, simulations are performed to evaluate the efficiency of the designed controller and event mechanism.

### 4.2 Platoon modeling with event triggered control

As it was presented in Chapter 3, communication plays an important role in the CACC system. So far the communication was assumed to be continuous (fast enough), where information shared by vehicles is available in real time. However, even under periodic communication, transmitting data continuously can overload the communication network. Instead of continuous communication, we consider that states are transmitted according to an event triggering mechanism which evaluates under what conditions new information is transmitted. Moreover we account for possible communication delays induced by the network.

Consider a platoon with a leader and  $N$  follower vehicles denoted by  $\Sigma_i$ , with  $i = 0, \dots, N$  shown in Figure 4.1, as in Chapter 3. Vehicle  $\Sigma_i$  receives information from  $\Sigma_{i-1}$  and transmits to  $\Sigma_{i+1}$ , where the transmission is subject to network induced delays.

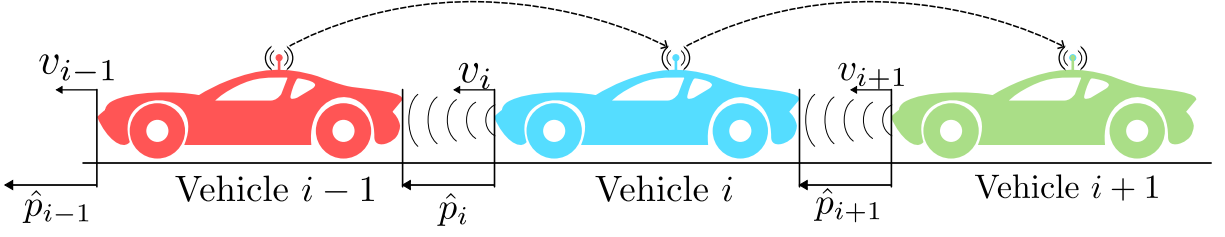

Figure 4.1 – Vehicle platooning PF topology where  $\Sigma_i$  receives information from  $\Sigma_{i-1}$  subjected to a time delay  $\tau^*(t)$  and transmits to  $\Sigma_i$  at time  $t_{k,i}$  generated according to an event triggering mechanism.

The control law of  $\Sigma_i$  is computed based on two signals. The signal  $y_{1,i}$  measured by  $\Sigma_i$  and  $y_{2,i-1}$  which is received from  $\Sigma_{i-1}$  by  $\Sigma_i$ . In addition, due to network-induced delays, the transmitted state  $y_{2,i-1}$  arrives at  $\Sigma_i$  after a time delay  $\tau_{i-1}^*(t)$ , Figure 4.2. Here we assume that  $\tau_i^*(t) \in (0, \tau_m]$  for all  $i$ , where the scalar  $\tau_m > 0$  is the maximum allowable delay.

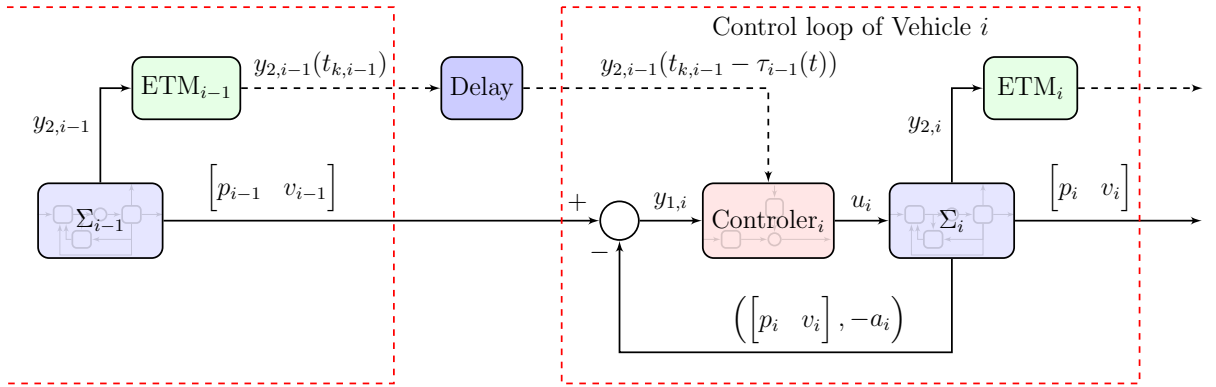

Figure 4.2 – Communication loop of the proposed event-triggered CACC setup.

We assume that all the states required for feedback linearization are not related to the communication, therefore available for computing the feedback linearizing control law. Therefore, both linearization and DOB compensation as defined in the previous chapter, can be applied rendering the linear systems  $\Sigma_i$

$$\Sigma_i : \begin{cases} \Delta \dot{p}_i = \Delta v_i - h a_i \\ \Delta \dot{v}_i = a_{i-1} - a_i \\ \dot{a}_i = -\frac{1}{\rho_d} a_i + \frac{1}{\rho_d} u_i + e_{d,i} \end{cases} \quad (4.1)$$

for  $i = 1, \dots, N$  and

$$\Sigma_0 : \begin{cases} \dot{v}_0 = a_0 \\ \dot{a}_0 = -\frac{1}{\rho_d} a_0 + \frac{1}{\rho_d} u_0 + e_{d,0} \end{cases} \quad (4.2)$$

for the leader  $\Sigma_0$ , which are repeated therein for clarity. However, since the information required for computing the feedforward component of the control law is not continuously

available, the control law is recast as

$$u_i(t) = \underbrace{K_1 y_{1,i}}_{u_{fb,i}} + \underbrace{K_2 y_{2,i-1}(t_{k,i-1})}_{u_{ff,i}} \quad (4.3)$$

where  $t_{k,i-1}$  is the time instant such that  $\Sigma_{i-1}$  transmits  $y_{2,i-1}$  to  $\Sigma_i$ , which is not the same time that the information is received due to network induced delay  $\tau_{i-1}^*(t)$ . Based on those conditions we propose an event triggered control law with an appropriate event triggering mechanism with Zeno-free behavior. The conditions are derived based on the Interconnected ( $\Sigma_{i,i-1}$ ) and Overlapping ( $\Xi_{i,i-1}$ ) models. Due to the similarity in structures we restrict the discussion in this Chapter concerning the  $\Sigma_{i,i-1}$  model.

Along with the ETC we also propose appropriate design conditions to ensure string stability of the platoon under the event-triggered communication. Two cases are considered based on the delay assumptions. In a delay free scenario we consider an emulation approach. In this case, a two-step procedure takes place: the controller is designed first to ensure string stability under continuous communication; second the ETC is designed with conditions to re-evaluate string stability under event triggering communication. In the presence of delays both control law and ETM are co-designed and the maximum admissible delay  $\tau_m$  is searched as the maximum value such that the design conditions are feasible.

Both emulation and co-design conditions can be applied to interconnected  $\Sigma_{i,i-1}$  and overlapping  $\Xi_{i,i-1}$  models. Nonetheless, as discussed in Section 3.4, designing the controller for  $\Xi_{i,i-1}$  is simpler and does not require further analysis, making it more appropriated for the emulation case. The model  $\Sigma_{i,i-1}$  will be used for co-design with additional constraints to account for norm bound condition (3.39).

### 4.3 Event-triggered communication under time-delay effects

In this section we first characterize the receiving and transmitting time intervals and the respective subdivision that will be used. According to those intervals we propose an ETM with an enforced minimum time between transmissions which ensures a Zeno-free behavior.

To characterize both the ETM communication and the transmission delay, let  $\{t_{k,i}\}$  for  $k \in \mathbb{N}^+$  be a strictly increasing sequence of sampling instants, i.e.,  $t_{k+1,i} > t_{k,i}$ , produced by the ETM of vehicle  $i$ . Moreover, let  $\tau_{k,i}^* \in (0, \tau_m]$  be a network-induced delay with  $\tau_m$  the maximum value. The signal  $y_{2,i+1}$  is transmitted by  $\Sigma_i$  at time  $t_{k,i}$  and, due to the network delay, it is received by  $\Sigma_{i+1}$  at time  $t_{k,i} + \tau_{k,i}^*$ . We then, respectively, define the following transmission  $\mathcal{T}$  and receiving  $\mathcal{R}$  time intervals:

$$\mathcal{T}_{k,i} = [t_{k,i}, t_{k+1,i}], \quad \mathcal{R}_{k,i} = [t_{k,i} + \tau_{k,i}^*, t_{k+1,i} + \tau_{k+1,i}^*]. \quad (4.4)$$

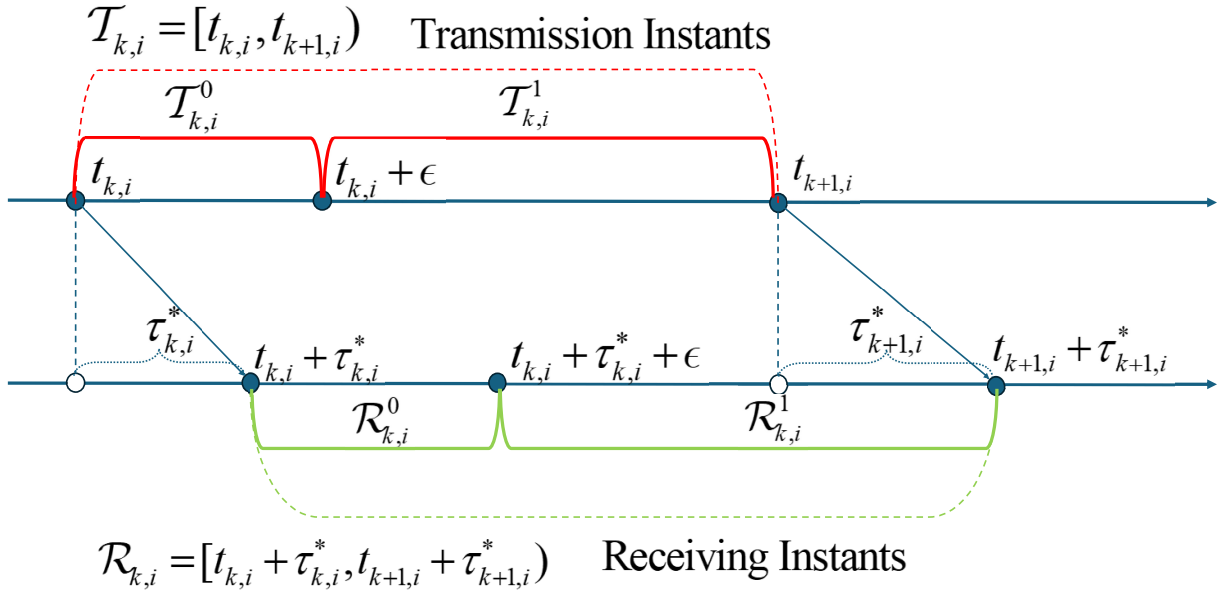

Figure 4.3 – Illustration of the transmission from vehicle  $\Sigma_i$  and the receiving time intervals for  $\Sigma_{i+1}$  with respective interval subdivisions.

Furthermore, considering a fixed time duration  $\epsilon > 0$  such that  $\Delta t_{k,i} = t_{k+1,i} - t_{k,i} \geq \epsilon$ , we can further divide the time intervals  $\mathcal{R}_{k,i}$  and  $\mathcal{T}_{k,i}$  as

$$\begin{aligned} \mathcal{T}_{k,i}^0 &= [t_{k,i}, t_{k,i} + \epsilon], & \mathcal{T}_{k,i}^1 &= [t_{k,i} + \epsilon, t_{k+1,i}], \\ \mathcal{R}_{k,i}^0 &= [t_{k,i} + \tau_{k,i}^*, t_{k,i} + \tau_{k,i}^* + \epsilon], & \mathcal{R}_{k,i}^1 &= [t_{k,i} + \tau_{k,i}^* + \epsilon, t_{k+1,i} + \tau_{k+1,i}^*] \end{aligned} \quad (4.5)$$

where the waiting time  $\epsilon > 0$  represents a minimum inter-event time (IET). In Figure 4.3, we illustrate the transmission and receiving time intervals. In the transmission time axis, information is transmitted by vehicle  $\Sigma_i$  at instant  $t_{k,i}$  defined by an event triggering mechanism and is received by vehicle  $\Sigma_{i+1}$  at instant  $t_{k,i} + \tau_{k,i}^*$ . No information is transmitted for a time interval given by  $\epsilon$ , and at  $t_{k+1,i} \geq t_{k,i} + \epsilon$  a new transmission occurs from  $\Sigma_i$ .

To ensure that  $\Delta t_{k,i} = t_{k+1,i} - t_{k,i} \geq \epsilon$ , the sequence  $\{t_{k,i}\}$  is generated according to the following proposed event triggering mechanism (ETM):

$$\begin{aligned} t_{0,i} &= 0 \\ t_{k+1,i} &= \inf\{t > t_{k,i} + \epsilon : \theta \Lambda_i(y_{2,i}(t), y_{2,i}(t_{k,i})) - \zeta_i > 0\} \end{aligned} \quad (4.6)$$

where  $\epsilon > 0$  and  $\theta > 0$  are design parameters, and

$$\Lambda_i(y_{2,i}(t), y_{2,i}(t_{k,i})) = (y_{2,i}(t) - y_{2,i}(t_{k,i}))^T Q_e (y_{2,i}(t) - y_{2,i}(t_{k,i})) - y_{2,i}^T(t) Q_x y_{2,i}(t) \quad (4.7)$$

for  $t \in \mathcal{T}_{k,i}$  with  $Q_e$  and  $Q_x$  symmetric positive definite matrices to be designed. The dynamic variable  $\zeta_i(t)$  has the following switching dynamics:

$$\dot{\zeta}_i = \begin{cases} -\lambda \zeta_i & \text{for } t \in \mathcal{T}_{k,i}^0 \\ -\lambda \zeta_i + \Lambda_i(y_{2,i}(t), y_{2,i}(t_{k,i})) & \text{for } t \in \mathcal{T}_{k,i}^1 \end{cases} \quad (4.8)$$

where  $\zeta_i(0) = 0$ , and  $\lambda$  is a positive scalar to be designed. Note that the positive constant  $\varepsilon$  enforces a minimum waiting time between consecutive events, i.e.,  $t_{k+1,i} - t_{k,i} \geq \varepsilon$ , to ensure Zeno-free behavior.

The following lemma states that  $\zeta_i(t)$ , as defined in (4.8), remains non-negative for all  $t \geq 0$  and will be important for the proofs in Section 4.5.

**Lemma 4.1.** *Consider the variable  $\zeta_i(t)$ , defined in (4.8), with  $\zeta_i(0) \geq 0$ . Then, we have  $\zeta_i(t) \geq 0$ , for all  $t \geq 0$ .*

*Proof.* We distinguish the following two cases.

- For  $t \in \mathcal{T}_{k,i}^0$ , it follows from (4.8) that  $\dot{\zeta}_i = -\lambda\zeta_i$ . Then, it is clear that, for  $\zeta_i(t_{k,i}) \geq 0$ , we have  $\zeta_i(t) \geq 0$ , for  $\forall t \in \mathcal{T}_{k,i}^0$ .
- For  $t \in \mathcal{T}_{k,i}^1$ , the ETM (4.6) imposes that

$$\Lambda_i < \zeta_i/\theta, \quad (4.9)$$

which, combining with the dynamic equation from (4.8), leads to

$$\dot{\zeta}_i \geq -\lambda\zeta_i - \frac{1}{\theta}\zeta_i \quad (4.10)$$

Then, by the comparison lemma (KHALIL, 2002), it follows that for  $\zeta_i(t_{k,i} + \varepsilon) \geq 0$ , we have  $\zeta_i(t) \geq 0$ , for  $\forall t \in \mathcal{T}_{k,i}^1$ .

Combining the above cases, and from the continuity of  $\zeta_i(t)$ , it follows that, for  $t_0 = 0$  and  $\zeta_i(0) \geq 0$ , then we have  $\zeta_i(t) \geq 0$ , for  $\forall t \geq 0$ .  $\square$

Accounting for the sub-division in the time intervals given in (4.5), we define two cases with their respective artificial delays.

- For  $t \in \mathcal{R}_{k,i}^0$  we define a virtual delay  $\tau_i(t) = t - t_{k,i}$  and write

$$y_{2,i}(t_{k,i}) = y_{2,i}(t - \tau_i(t)) \quad (4.11)$$

with  $\tau_i(t) \leq \tau_m + \varepsilon = \tau_M$ .

- For  $t \in \mathcal{R}_{k,i}^1$  we define the error between the continuous state and the last transmitted state as

$$e_i(t) = y_{2,i}(t - \eta_i(t)) - y_{2,i}(t_{k,i}) \quad (4.12)$$

where  $\eta_i(t)$  is an artificial delay, with  $t - \eta_i(t) \in \mathcal{T}_{k,i}^1$ . Consequently, we have  $\eta_i(t) \in (0, \tau_m]$ .

According to the ETC and the time interval divisions next section proposes a switching model that will be used for designing the ETM and the control law.

## 4.4 Switching Model

Based on (4.11) and (4.12), and inspired by (SELIVANOV; FRIDMAN, 2016), we can rewrite the control input (4.3) as

$$u_i(t) = K_1 y_{1,i} + (1 - \chi(t)) K_2 y_{2,i-1}(t - \tau_{i-1}(t))$$

$$+ \chi(t)K_2(y_{2,i-1}(t - \eta_{i-1}(t)) - e_{i-1}(t)) \quad (4.13)$$

where the switching variable  $\chi(t)$  is such that

$$\chi(t) = \begin{cases} 0 & \text{for } t \in \mathcal{R}_{k,i}^0 \\ 1 & \text{for } t \in \mathcal{R}_{k,i}^1 \end{cases} \quad (4.14)$$

The control law is defined as a switching control law, based on the partition of the receiving time interval. Then, applying the control law (4.13) to system  $\Sigma_{i,i-1}$  defined in (3.26), we can rewrite the closed-loop system as

$$\Sigma_{i,i-1}^X : \begin{cases} \dot{x}_i = (A + BK_1C_1)x_i + Du_{i-1} + Ew_{d,i} \\ \quad + (1 - \chi(t))BK_2C_2x_i(t - \tau_{i-1}(t)) \\ \quad + \chi(t)BK_2(C_2x_i(t - \eta_{i-1}(t)) - e_{i-1}) \\ z_i = K_1C_1x_i + (1 - \chi(t))K_2C_2x_i(t - \tau_{i-1}(t)) \\ \quad + \chi(t)BK_2(C_2x_i(t - \eta_{i-1}(t)) - e_{i-1}) \end{cases} \quad (4.15)$$

for  $t \in \mathcal{R}_{k,i}$ . Hence, for  $t \in \mathcal{R}_{k,i}^0$ , we have  $\Sigma_{i,i-1}^0$ , while we have  $\Sigma_{i,i-1}^1$ , for  $t \in \mathcal{R}_{k,i}^1$ . System (4.15) is a switching model of the Interconnected system (3.26) presented in Chapter 3 based on the partition of the time intervals and delay. Using the same switching modeling concept, and the error definition in (4.12), we can also rewrite the dynamics of  $\zeta_i$  as

$$\dot{\zeta}_i = -\lambda\zeta_i + \chi(t) \left( e_i^T Q_e e_i - x_i^T(t - \eta_i) C_2^T Q_x C_2 x_i(t - \eta_i) \right) \quad (4.16)$$

for  $t \in \mathcal{R}_{k,i}$ .

Our aim is to design the ETM (4.6) to ensure the individual stability of each vehicle and the string stability of the platoon.

## 4.5 Individual and string stability with ETC

### 4.5.1 Problem Formulation

The platooning control problem with cooperative adaptive cruiser control (CACC) is to design  $K_1$  and  $K_2$  of the control law (4.3) and the event-triggering mechanism (4.6) such the distance policy error  $\Delta p_i \rightarrow 0$ . Moreover, the conditions are derived by assessing the  $\mathcal{L}_2$  stability of  $\Sigma_{i,i-1}$ , and must verify the following requirements

- Ensure individual stability and string stability of the platoon.
- Minimize the influence of the disturbance estimation error via  $\mathcal{L}_2$  norm.
- Reduce the number of transmissions for the ETM and avoid Zeno behavior.



This section presents our main results of switched dynamic  $\mathcal{L}_2$  event-triggered control for vehicle platoons. The switched dynamic ETC design is recast as an optimization problem under LMI constraints. We consider two different cases, the emulation approach in a free delay scenario, and the co-design approach accounting for network-induced delays.

#### 4.5.2 Delay free ETC emulation design conditions

In the delay free case  $\tau^*(t) = 0$  for all  $t$ , therefore, from the time partition proposed in Section 4.4,  $\mathcal{T}_{k,i} = \mathcal{R}_{k,i} = [t_{k,i}, t_{k+1,i}]$ . The switching model (4.15) corresponds to  $\eta(t) = 0$  for all  $t$  and  $\tau_m = 0$ .

Under those conditions, considering the gain  $K_1$  and  $K_2$  designed a priori according to Remark 3.2 and Remark 3.1 respectfully, the following theorem provides conditions to ensure the  $\mathcal{L}_2$  stability defined in Proposition 3.1 of the switched system (4.15) under event triggering condition (4.6).

**Theorem 4.1.** *Consider the interconnected switching  $\Sigma_{i,i-1}^X$  in (4.15) and the event-triggering condition (4.6) with  $\zeta_i(0) = 0$ . For given positive scalars  $\delta, \alpha, \varepsilon$  and control gains  $K_1$  and  $K_2$ , if there exist positive scalars  $\beta, \gamma \leq 1$ , matrices  $P_1, P_2, X, X_1, Y_1, Y_2, Y_3$  and symmetric matrices  $P \succ 0, U \succ 0, Q_e \succ 0$  and  $Q_x \succ 0$  of appropriate dimensions such that the following optimization problem is feasible:*

$$\min \text{Tr}(Q_e) + \beta^2 \quad (4.17)$$

$$\Theta \succ 0, \quad \Psi \prec 0, \quad \Phi \prec 0, \quad \Omega \prec 0 \quad (4.18)$$

$$Q_x - \delta I \succ 0 \quad (4.19)$$

where

$$\Theta = \begin{bmatrix} P + \varepsilon\Theta_{11} & \varepsilon\Theta_{12} \\ * & \varepsilon\Theta_{22} \end{bmatrix} \quad (4.20)$$

$$\Phi = \begin{bmatrix} \Phi_{11} & \Phi_{12} & \Phi_{13} & P_1D & P_1E & C_1^T K_1^T \\ * & -P_2 - P_2^T + U & P_2BK_2C_2 + Y_2 + \varepsilon\Theta_{12} & P_2D & P_2E & 0 \\ * & * & Y_3 + Y_3^T + \Theta_{22} + 2\alpha\varepsilon\Theta_{22} & 0 & 0 & C_2^T K_2^T \\ * & * & * & -\gamma^2 I & 0 & 0 \\ * & * & * & * & -\beta^2 I & 0 \\ * & * & * & * & * & -I \end{bmatrix} \quad (4.21)$$

$$\Psi = \begin{bmatrix} \Psi_{11} & \Psi_{12} & \Psi_{13} & C_1^T K_1^T & P_1D & P_1E & \varepsilon Y_1^T \\ * & -P_2 - P_2^T & P_2BK_2C_2 + Y_2 & 0 & P_2D & P_2E & \varepsilon Y_2^T \\ * & * & Y_3 + Y_3^T + \Theta_{22} & C_2^T K_2^T & 0 & 0 & \varepsilon Y_3^T \\ * & * & * & -I & 0 & 0 & 0 \\ * & * & * & * & -\gamma^2 I & 0 & 0 \\ * & * & * & * & * & -\beta^2 I & 0 \\ * & * & * & * & * & * & -Te^{-2\alpha U} \end{bmatrix} \quad (4.22)$$

$$\Omega = \begin{bmatrix} \Omega_{11} & (A + BK_1C_1)^T P_2^T - P_1 & P_1BK_2 & P_1D & P_1E & K^T \\ * & -P_2 - P_2^T & P_2BK_2 & P_2D & P_2E & 0 \\ * & * & -Q_e & 0 & 0 & -K_2^T \\ * & * & * & -\gamma^2 I & 0 & 0 \\ * & * & * & * & -\beta^2 I & 0 \\ * & * & * & * & * & -I \end{bmatrix} \quad (4.23)$$

with

$$\begin{aligned} \Theta_{11} &= \frac{X+X^T}{2}, \quad \Theta_{12} = X_1 - X, \quad \Theta_{22} = -X_1 - X_2^T + \Theta_{11} \\ \Psi_{11} &= \text{He}\{(A + BK_1C_1)^T P_1^T\} + 2\alpha P - Y_1 - Y_1 - \Theta_{11} \\ \Psi_{12} &= (A + BK_1C_1)^T P_2^T - P_1 + P - Y_2^T \\ \Psi_{13} &= P_1BK_2C_2 + Y_1 - Y_3^T + \Theta_{12}, \\ \Phi_{11} &= \Psi_{11} + 2\alpha\varepsilon\Theta_{11}, \\ \Phi_{12} &= \Psi_{12} + \varepsilon\Theta_{11}, \\ \Phi_{13} &= \Psi_{13} + 2\alpha\varepsilon\Theta_{12} \\ \Omega_{11} &= \text{He}\{(A + BKC)^T P_1^T\} + 2\alpha P + C_2^T Q_x C_2 \end{aligned}$$

Then, the interconnected switching system  $\Sigma_{i,i-1}^x$  in (4.15) is stable under the event-triggering condition (4.6). Moreover, the dynamics of  $\zeta_i$  is stable and condition  $\|z_i\| \leq \gamma\|z_{i-1}\| + \beta\|\omega_{\max}\|$  (3.28) in Proposition 3.1 holds for system (4.15) with an  $\mathcal{L}_2$  gain less than or equal to  $\beta$ .

*Proof.* When there is no possible confusion, we omit the subscript  $i$  in  $x_i$ ,  $z_i$ ,  $e_{i-1}$ ,  $u_{i-1}$ ,  $t_{k,i}$  and  $w_{d,i}$ . For the stability analysis of system (4.15), we consider the Lyapunov-Krasovskii functional candidate

$$V^x(t, x, \zeta) = x^T P x + \zeta + (1 - \chi)(V_1 + V_2) \quad (4.24)$$

with

$$V_1 = (\varepsilon - \tau(t)) \begin{bmatrix} x \\ x(t_k) \end{bmatrix}^T \begin{bmatrix} \Theta_{11} & \Theta_{12} \\ * & \Theta_{22} \end{bmatrix} \begin{bmatrix} x \\ x(t_k) \end{bmatrix} \quad (4.25)$$

$$V_2 = (\varepsilon - \tau(t)) \int_{t-\tau(t)}^t e^{2\alpha(s-t)} \dot{x}^T(s) U \dot{x}(s) ds. \quad (4.26)$$

Notice that at switching instants  $t_k$  and  $t_k + \varepsilon$ , i.e.,  $\tau(t) = 0$  and  $\tau(t) = \varepsilon$  respectively,

$$V^0(t_k, x, \zeta) = x^T P x + \zeta + \cancel{V_1 + V_2} \overset{0}{=} x^T P x + \zeta = V^1(t_k, x, \eta) \quad (4.27)$$

$$V^0(t_k + \varepsilon, x, \zeta) = x^T P x + \zeta + \cancel{V_1 + V_2} \overset{0}{=} x^T P x + \zeta = V^1(t_k + \varepsilon, x, \eta) \quad (4.28)$$

therefore, during switching instants,  $V^0(t, x, \zeta) = V^1(t, x, \zeta)$ . Along with the fact that  $V^0(t, x, \zeta)$  and  $V^1(t, x, \zeta)$  are continuous, this implies that the functional  $V^\chi(t, x, \zeta)$  is continuous for all  $t \geq 0$ . Moreover  $V^\chi(t, x, \zeta)$  in (4.24) is a proper LKF for  $\Theta \succ 0$  and  $P \succ 0$ . This can be verified noticing that  $V_2 \geq 0$  by construction in (4.26) and from Lemma 4.1,  $\zeta \geq 0$  for  $\forall t \geq 0$ . It remains to prove that  $x^T P x + V_1 \geq 0$ . Considering the definition of  $\Theta$  in (4.20), then  $\Theta \succ 0$  and  $P \succ 0$  is sufficient to ensure that

$$\frac{\varepsilon - \tau(t)}{\varepsilon} \Theta + \frac{\tau(t)}{\varepsilon} \begin{bmatrix} P & 0 \\ 0 & 0 \end{bmatrix} \succeq 0 \quad (4.29)$$

which on its turn, implies  $x^T P x + V_1 \geq 0$ . Therefore  $V^\chi(t, x, \zeta)$  is positive definite.

Due to the switching nature of the problem, we split the analysis based on the time intervals of interest.

**Case 1)** System  $\Sigma_{i,i-1}^0$  and  $t \in \mathcal{T}_{k,i} = [t_{k,i}, t_{k,i} + \varepsilon]$

For this time interval, one has  $V^0(t, x, \zeta) = x^T P x + \zeta + V_1 + V_2$ . We compute

$$\frac{d}{dt}(x^T P x + \zeta) = \dot{x}^T P x + x^T P \dot{x} - \lambda \zeta \quad (4.30)$$

$$\dot{V}_1 = - \begin{bmatrix} x \\ x(t_k) \end{bmatrix}^T \begin{bmatrix} \Theta_{11} & \Theta_{12} \\ * & \Theta_{22} \end{bmatrix} \begin{bmatrix} x \\ x(t_k) \end{bmatrix} + (\varepsilon - \tau(t)) \dot{x}^T [2\Theta_{11}x + 2\Theta_{12}x(t_k)] \quad (4.31)$$

$$\dot{V}_2 \leq -2\alpha V_2 - e^{2\alpha\varepsilon} \int_{t-\tau(t)}^t \dot{x}(s)^T U \dot{x}(s) ds + (\varepsilon - \tau(t)) \dot{x}^T U \dot{x}. \quad (4.32)$$

Let us define

$$\kappa(t) = \frac{1}{\tau(t)} \int_{t-\tau(t)}^t \dot{x}(s) ds \quad (4.33)$$

Then, invoking Jensen's inequality (Lemma 2.5), it follows that

$$-e^{2\alpha\varepsilon} \int_{t-\tau(t)}^t \dot{x}(s)^T U \dot{x}(s) ds \leq -\tau(t) e^{2\alpha\varepsilon} \kappa(t)^T U \kappa(t) \quad (4.34)$$

Moreover, from the definition of  $\kappa(t)$  in (4.33) we have  $x(t) = x(t_k) + \tau(t)\kappa(t)$ . Then, for any matrices  $Y_1, Y_2$  and  $Y_3$  of suitable dimensions, it follows that

$$0 = \text{He}\{(x^T Y_1 + \dot{x}^T Y_2 + x^T(t_k) Y_3)[x(t_k) - x + \tau\kappa(t)]\} \quad (4.35)$$

Similarly, from the expressions of  $\dot{x}$  and  $z$  in (4.15) substituting  $x(t - \tau_i) = x(t_k)$  we can directly obtain the following null terms:

$$0 = \text{He}\{(x^T P_1 + \dot{x}^T P_2)[(A + BK_1 C_1)x + BK_2 C_2 x(t_k) + Du + Ew_d - \dot{x}]\} \quad (4.36)$$

$$0 = \text{He}\{z^T [K_1 C_1 x + K_2 C_2 x(t_k) - z]\}. \quad (4.37)$$

Combining (4.30), (4.31), (4.32), the inequality (4.34), the performance output  $z$  in (4.15), and adding the null terms (4.35), (4.36) and (4.37), we can derive the following inequality:

$$\dot{V}^0 + 2\alpha V^0(t, x, 0) + \lambda \zeta + z^T z - \gamma^2 u^T u - \beta^2 w_d^T w_d \leq \mu_0^T \mathcal{L}(\tau(t)) \mu_0 \quad (4.38)$$

where  $\mu_0 = \text{col}\{x, \dot{x}, x(t_k), u, w_d, z, \kappa\}$ . The matrix  $\mathcal{L}(\tau(t))$  is affine on  $\tau(t)$ , and can be expressed as

$$\mathcal{L}(\tau(t)) = \frac{\tau(t)}{\varepsilon} \Psi + \frac{\varepsilon - \tau(t)}{\varepsilon} \begin{bmatrix} \Phi & 0 \\ * & 0 \end{bmatrix} \quad (4.39)$$

where  $\Phi$  and  $\Psi$  are defined in (4.21) and (4.22), respectively. Note from (4.39) that the conditions  $\Phi \prec 0$  and  $\Psi \prec 0$  from (4.18) ensure that  $\mathcal{L}(\tau(t)) \preceq 0$ , for all  $\tau(t) \in (0, \varepsilon]$ .

**Case 2)** System  $\Sigma_{i,i-1}^1$  and  $t \in \mathcal{T}_{k,i}^1$

For this time interval, we have  $V^\chi(t, x, \zeta) = x^T P x + \zeta$ . Taking its time derivative yields

$$\dot{V}^1 = \dot{x}^T P x + x^T P \dot{x} + x^T C_2^T R C_2 x - e_{i-1}^T Q e_{i-1} - \lambda \zeta. \quad (4.40)$$

As in the previous case, we can derive the following null terms from (4.15) for  $t \in \mathcal{T}_{k,i}^1$ :

$$0 = \text{He}\{(x^T P_1 + \dot{x}^T P_2)[(A + BKC)x + BK_2 e_{i-1} + Du + Ew_d - \dot{x}]\} \quad (4.41)$$

$$0 = \text{He}\{z^T [KCx + K_2 e_{i-1} - z]\}. \quad (4.42)$$

Adding the null terms (4.41) and (4.42) to (4.40), we can derive

$$\dot{V}^1 + 2\alpha V^1(t, x, 0) + \lambda_2 \zeta + z^T z - \gamma^2 u^T u - \beta^2 w_d^T w_d \leq \mu_1^T \Omega \mu_1 \quad (4.43)$$

where  $\mu_1 = \text{col}\{x, \dot{x}, e_{i-1}, u, w_d, z\}$ , and  $\Omega$  is defined in (4.23). Hence, the condition  $\Omega \prec 0$  in (4.18) ensures that  $\mu_1^T \Omega \mu_1 \leq 0$ .

Then, combining Case 1 and Case 2, from the continuity of the LKF (4.24), if the conditions (4.38) and (4.43) are satisfied, it follows that

$$\dot{V}^\chi + \bar{\alpha} V^\chi(t, x, \zeta) + z^T z - \gamma^2 u^T u - \beta^2 w_d^T w_d \leq 0 \quad (4.44)$$

for  $t \geq 0$ , with  $\bar{\alpha} = \min\{\lambda, 2\alpha\}$ . Hence, integrating both sides from 0 to  $\infty$  it follows that

$$\|z\|_{\mathcal{L}_2} \leq \gamma \|u\|_{\mathcal{L}_2} + \beta \|w\|_{\mathcal{L}_2} \quad (4.45)$$

for null initial conditions. Since  $\gamma \leq 1$  we recover the condition (3.28) in Proposition 3.1.

Moreover, the LMI constraint (4.19) and the minimization of  $\text{Tr}(Q_e)$  in (4.17) are used to maximize the inter-event time of the switched dynamic ETC scheme. This completes the proof.  $\square$

### 4.5.3 Delay free periodic ETC emulation design conditions

To show the generic feature of the proposed ETC method and for comparison purposes, we provide an adaptation of Theorem 4.1 to the case of static periodic ETC design. To this end, we consider the following event-triggering mechanism:

$$\begin{aligned} s_{0,i} &= 0 \\ t_{k+1,i} &= \inf\{t > t_{k,i} + j\varepsilon : j \in \mathbb{N} \wedge \Lambda_i(y_{2,i}(t_{k,i} + j\varepsilon), y_{2,i}(t_{k,i})) > 0\} \end{aligned} \quad (4.46)$$

where

$$\Lambda_i(y_{2,i}(t), y_{2,i}(t_{k,i})) = (y_{2,i}(t) - y_{2,i}(t_{k,i}))^T Q_e (y_{2,i}(t) - y_{2,i}(t_{k,i})) - y_{2,i}^T(t) Q_x y_{2,i}(t) \quad (4.47)$$

is defined in (4.7). In this case we substitute the continuous measured signal  $y_{2,i}(t)$  by its sampled variant  $y_{2,i}(t_{k,i} + j\varepsilon)$ . Let us then redefine  $\tau(t) = t - t_{k,i} - j\varepsilon$ , then the switching system (4.15) can be recast as

$$\Sigma_{i,i-1} : \begin{cases} \dot{x} = (A + BK_1C_1)x + BK_2C_2x(t - \tau(t)) - BK_2e_{i-1} + Du_{i-1} + Ew_d \\ z = K_1C_1x + K_2C_2x(t - \tau(t)) - K_2e_{i-1}. \end{cases} \quad (4.48)$$

Based on system (4.48) and the event-triggering condition (4.46), we provide the following theorem for static periodic ETC design.

**Theorem 4.2.** *For given positive scalars  $\delta$ ,  $\alpha$ ,  $\varepsilon$  and control gains  $K_1$  and  $K_2$ , if there exist positive scalars  $\beta$ ,  $\gamma \leq 1$ , matrices  $P_1$ ,  $P_2$ ,  $X$ ,  $X_1$ ,  $Y_1$ ,  $Y_2$ ,  $Y_3$ , and symmetric matrices  $P \succ 0$ ,  $U \succ 0$ ,  $Q_e \succ 0$  and  $Q_x \succ 0$  of appropriate dimensions such that the following optimization problem is feasible:*

$$\min \text{Tr}(Q_e) + \beta \quad (4.49)$$

$$H_0 \succ 0, \quad Q_x - \delta I \succ 0 \quad (4.50)$$

$$\tilde{\Phi} = \begin{bmatrix} \bar{\Phi} & \Upsilon_1 \\ * & -Q_e \end{bmatrix} \prec 0, \quad \tilde{\Psi} = \begin{bmatrix} \bar{\Psi} & \Upsilon_2 \\ * & -Q_e \end{bmatrix} \prec 0 \quad (4.51)$$

with

$$\begin{aligned} \bar{\Phi}_{22} &= \Phi_{22} + C^T Q_x C, & \bar{\Psi}_{22} &= \Psi_{22} + C^T Q_x C \\ \bar{\Phi}_{ij} &= \Phi_{ij}, & \bar{\Psi}_{ij} &= \Psi_{ij} \\ \Upsilon_1 &= \begin{bmatrix} K_2^T B^T P_1 & K_2^T B^T P_2 & 0 & 0 & 0 & -K_2^T \end{bmatrix}^T. \\ \Upsilon_2 &= \begin{bmatrix} K_2^T B^T P_1 & K_2^T B^T P_2 & 0 & 0 & 0 & 0 & -K_2^T \end{bmatrix}^T. \end{aligned}$$

where matrices  $\Phi_{ij}$  and  $\Psi_{ij}$  are defines in (4.21) and (4.22) in Theorem 4.1. Then, the closed-loop system (4.48) is stable under the periodic ETM (4.46). Moreover, condition (3.28) in Proposition 3.1 holds for system (4.48).

*Proof.* We provide a sketch of this proof in the following, since it follows similar steps to that of Theorem 4.1. Choosing a Lyapunov function candidate  $V = x^T P x + V_1 + V_2$ , and considering the same time derivatives as in (4.31) and (4.32), and the following null terms:

$$\begin{aligned} 0 &= \text{He}\{(x^T P_1 + \dot{x}^T P_2)[(A + BK_1C_1)x + BK_2C_2x(t - \tau) - BK_2e_{i-1} + Du + Ew_d - \dot{x}]\} \\ 0 &= \text{He}\{z^T [K_1C_1x + K_2C_2x(t - \tau) - K_2e_{i-1} - z]\} \end{aligned}$$

along with (4.35), as in the proof of Theorem 4.1, we can derive

$$\dot{V} + 2\alpha V + x^T C_2^T R C_2 x - e_{i-1}^T Q e_{i-1} + z^T z - \gamma^2 u^T u - \beta^2 w_d^T w_d \leq \tilde{\mu}^T \mathcal{H}(\tau(t)) \tilde{\mu} \quad (4.52)$$

with  $\tilde{\mu} = \text{col}(x, \dot{x}, x(t_k), \kappa, u, w_d, z, e_{i-1})$ , and

$$\mathcal{H}(\tau(t)) = \frac{\tau(t)}{\varepsilon} \tilde{\Psi} + \frac{\varepsilon - \tau(t)}{\varepsilon} \begin{bmatrix} \tilde{\Phi} & 0 \\ 0 & 0 \end{bmatrix} \quad (4.53)$$

for  $\tau(t) \in (0, \varepsilon]$ , where the matrices  $\tilde{\Psi}$  and  $\tilde{\Phi}$  are defined in (4.51). Notice that the matrix  $\mathcal{H}(\tau(t))$  is affine in  $\tau(t)$ , and condition (4.51) ensures that

$$\tilde{\mu}^T \mathcal{H}(\tau(t)) \tilde{\mu} \leq 0. \quad (4.54)$$

From (4.46) we have

$$x(t - \tau)^T C_2^T R C_2 x(t - \tau) - e_{i-1}^T Q e_{i-1} < 0. \quad (4.55)$$

then, it follows from (4.52), (4.54) and (4.55) that

$$\dot{V} + 2\alpha V + z^T z - \gamma^2 u^T u - \beta^2 w_d^T w_d \leq 0. \quad (4.56)$$

Integrating (4.56) from 0 to  $\infty$ , we obtain (3.28). This completes the proof.  $\square$

**Remark 4.1.** The designed conditions for the Overlapping system is similar to the interconnected system that is not described here but is straightforward from Theorem 4.1

#### 4.5.4 ETC Co-design conditions

The previous section presented results for switched dynamic  $\mathcal{L}_2$  event-triggered control in the delay-free case, next section introduces a communication delay and the way to handle it.

Considering that the communication is affected by network induced delays the following theorem provides conditions to ensure the  $\mathcal{L}_2$  stability of the switched system (4.15), as stated in Proposition 3.1 for a given maximum network delay  $\tau_m$ .

**Theorem 4.3.** *Consider the interconnected switching system  $\Sigma_{i,i-1}^x$  in (4.15) and the event-triggering condition (4.6). Given a maximum delay  $\tau_m$ , and positive scalars  $\delta, \alpha, \varepsilon$ , if there exist positive scalars  $\beta, \gamma \leq 1$ , matrices  $X = \text{diag}(X_1, X_2), L_1, L_2, \bar{Y}_1, \bar{Y}_2, \bar{W}_1, \bar{W}_2$  and symmetric matrices  $\bar{P} \succ 0, \bar{S}_0 \succ 0, \bar{S}_1 \succ 0, \bar{R}_0 \succ 0, \bar{R}_1 \succ 0, \bar{Q}_e \succ 0$  and  $\bar{Q}_x \succ 0$  of appropriate dimensions such that the following optimization problem is feasible:*

$$\min \text{Tr}(\bar{Q}_e) + \delta \text{Tr}(\bar{Q}_x) + \beta^2 \quad (4.57)$$

such that

$$\begin{bmatrix} \bar{\Phi}_0 + \bar{\Pi}_0(\tau_m) & \bar{Z}_0^T & \mathcal{F}_0^T \begin{bmatrix} \bar{Y}_1 \\ 0 \end{bmatrix} \\ * & -I & 0 \\ * & * & -e^{2\alpha\tau_m} \bar{R}_1 \end{bmatrix} \prec 0 \quad (4.58)$$

$$\begin{bmatrix} \bar{\Phi}_0 + \bar{\Pi}_0(\tau_M) & \bar{Z}_0^T & \mathcal{F}_0^T \begin{bmatrix} 0 \\ \bar{Y}_2^T \end{bmatrix} \\ * & -I & 0 \\ * & * & -e^{2\alpha\tau_M} \bar{R}_1 \end{bmatrix} \prec 0 \quad (4.59)$$

$$\begin{bmatrix} \bar{\Phi}_1 + \bar{\Pi}_1(0) & \bar{Z}_1^T & \mathbf{v}_5^T X_2^T C_2^T & \mathcal{F}_1^T \begin{bmatrix} \bar{W}_1 \\ 0 \end{bmatrix} \\ * & -I & 0 & 0 \\ * & * & -\bar{Q}_x & 0 \\ * & * & * & -e^{2\alpha\tau_m} \bar{R}_0 \end{bmatrix} \prec 0 \quad (4.60)$$

$$\begin{bmatrix} \bar{\Phi}_1 + \bar{\Pi}_1(\tau_m) & \bar{Z}_1^T & \mathbf{v}_5^T X_2^T C_2^T & \mathcal{F}_1^T \begin{bmatrix} 0 \\ \bar{W}_2^T \end{bmatrix} \\ * & -I & 0 & 0 \\ * & * & -\bar{Q}_x & 0 \\ * & * & * & -e^{2\alpha\tau_m} \bar{R}_0 \end{bmatrix} \prec 0 \quad (4.61)$$

with

$$\bar{\Phi}_0 = \mathbf{e}_2^T \bar{P} \mathbf{e}_1 + \mathbf{e}_1^T \bar{P} \mathbf{e}_2 - \varphi_m \mathcal{G}_0^T \bar{R}_0 \mathcal{G}_0 + \bar{\Omega}_0 + \text{He} \{ \bar{\mathcal{A}}_0 \},$$

$$\bar{\Phi}_1 = \mathbf{v}_2^T \bar{P} \mathbf{v}_1 + \mathbf{v}_1^T \bar{P} \mathbf{v}_2 - \varphi_M \mathcal{G}_1^T \bar{R}_1 \mathcal{G}_1 + \bar{\Omega}_1 + \text{He} \{ \bar{\mathcal{A}}_1 \},$$

$$\Pi_0(\tau) = -\varphi_M \mathcal{F}_0^T \bar{\mathcal{R}}_0(\tau) \mathcal{F}_0, \quad \mathcal{Z}_0 = L_1 C_1 \mathbf{e}_2 + L_2 C_2 \mathbf{e}_5,$$

$$\Pi_1(\tau) = -\varphi_m \mathcal{F}_1^T \bar{\mathcal{R}}_1(\tau) \mathcal{F}_1, \quad \mathcal{Z}_1 = L_2 C_1 \mathbf{v}_2 + L_2 C_2 \mathbf{v}_5 + L_2 \mathbf{v}_8,$$

$$\mathcal{G}_0 = \mathbf{e}_2 - \mathbf{e}_1, \quad \mathcal{F}_0 = \begin{bmatrix} \mathbf{e}_3 - \mathbf{e}_5 \\ \mathbf{e}_5 - \mathbf{e}_4 \end{bmatrix}, \quad \mathcal{F}_1 = \begin{bmatrix} \mathbf{v}_3 - \mathbf{v}_5 \\ \mathbf{v}_5 - \mathbf{v}_4 \end{bmatrix},$$

$$\bar{\Omega}_0 = \text{diag}(\bar{\mathcal{H}}, 2\alpha\bar{P} - \bar{S}_0, \bar{\mathcal{S}}, -\varphi_M \bar{S}_1, 0, -\gamma^2, -\beta^2),$$

$$\bar{\Omega}_1 = \text{diag}(\bar{\mathcal{H}}, 2\alpha\bar{P} - \bar{S}_0, \bar{\mathcal{S}}, -\varphi_M \bar{S}_1, 0, -\gamma^2, -\beta^2, -\bar{Q}_e),$$

$$\bar{\mathcal{H}} = \tau_m^2 \bar{R}_0 + \tau_M^2 \bar{R}_1, \quad \bar{\mathcal{S}} = \varphi_m (\bar{S}_1 - \bar{S}_0),$$

$$\bar{\mathcal{R}}_0(\tau) = \begin{bmatrix} \bar{R}_1 & 0 \\ 0 & \bar{R}_1 \end{bmatrix} + \frac{\tau_M - \tau(t)}{\varepsilon} \begin{bmatrix} \bar{R}_1 & \bar{Y}_2 \\ \bar{Y}_2^T & 0 \end{bmatrix} + \frac{\tau(t) - \tau_m}{\varepsilon} \begin{bmatrix} 0 & \bar{Y}_1 \\ \bar{Y}_1^T & \bar{R}_1 \end{bmatrix},$$

$$\bar{\mathcal{R}}_1(\tau) = \begin{bmatrix} \bar{R}_0 & 0 \\ 0 & \bar{R}_0 \end{bmatrix} + \frac{\tau_m - \tau(t)}{\tau_m} \begin{bmatrix} \bar{R}_0 & \bar{W}_2 \\ \bar{W}_2^T & 0 \end{bmatrix} + \frac{\tau(t)}{\tau_m} \begin{bmatrix} 0 & \bar{W}_1 \\ \bar{W}_1^T & \bar{R}_0 \end{bmatrix},$$

$$\bar{\mathcal{A}}_0 = \mathcal{Y}_0(-X \mathbf{e}_1 + (AX + BL_1 C_1) \mathbf{e}_2 + BL_2 C_2 \mathbf{e}_5 + D \mathbf{e}_6 + E \mathbf{e}_7),$$

$$\bar{\mathcal{A}}_1 = \mathcal{Y}_1(-X \mathbf{v}_1 + (AX + BL_1 C_1) \mathbf{v}_2 + BL_2 C_2 \mathbf{v}_5 + D \mathbf{v}_6 + E \mathbf{v}_7 - BL_2 \mathbf{v}_8),$$

$$\mathcal{Y}_0 = (\mathbf{e}_1^T \beta_1 + \mathbf{e}_2^T + \mathbf{e}_5^T \beta_2),$$

$$\begin{aligned}\mathcal{Y}_1 &= (\mathbf{v}_1^T \beta_1 + \mathbf{v}_2^T + \mathbf{v}_5^T \beta_2), \\ \varphi_m &= e^{-2\alpha\tau_m}, \quad \varphi_M = e^{-2\alpha\tau_M},\end{aligned}$$

where

$$\text{col}\{\mathbf{e}_1, \dots, \mathbf{e}_7\} = \text{diag}(I_3, I_3, I_3, I_3, I_3, I_1, I_1), \quad (4.62)$$

$$\text{col}\{\mathbf{v}_1, \dots, \mathbf{v}_8\} = \text{diag}(I_3, I_3, I_3, I_3, I_3, I_1, I_1, I_1). \quad (4.63)$$

Then, the closed-loop interconnected switching system (4.15), is  $\mathcal{L}_2$  stable under the event-triggering condition (4.6). Moreover, the condition (3.28) in Proposition 3.1 holds for system (4.15) with the control gains  $K_1 = L_1 X_1^{-1}$ ,  $K_2 = L_2 X_2^{-1}$ , and the ETM (4.6) with matrices  $Q_e = X_2^{-T} \bar{Q}_e X_2^{-1}$  and  $Q_x = \bar{Q}_x^{-1}$ .

*Proof.* For brevity, we omit the subscript in  $x_i$ ,  $z_i$ ,  $e_{i-1}$ ,  $u_{i-1}$ ,  $\zeta_{i-1}$ ,  $w_{d,i}$ . Moreover we denote  $\tau_{i-1}(t)$  and  $\eta_{i-1}(t)$  as  $\tau$ ,  $\eta$  and  $\varphi_m = e^{-2\alpha\tau_m}$ ,  $\varphi_M = e^{-2\alpha\tau_M}$ .

For the stability analysis of system (4.15), we consider the Lyapunov-Krasovskii functional candidate

$$V(t, x_i, \zeta) = V_P + V_{S_0} + V_{S_1} + V_{R_0} + V_{R_1} + \zeta \quad (4.64)$$

with  $V_P = x^T P x$ , and

$$V_{S_0} = \int_{t-\tau_m}^t e^{2\alpha(s-t)} x^T(s) S_0 x(s) ds \quad (4.65)$$

$$V_{R_0} = \tau_m \int_{-\tau_m}^0 \int_{t+\theta}^t e^{2\alpha(s-t)} \dot{x}^T(s) R_0 \dot{x}(s) ds d\theta \quad (4.66)$$

$$V_{S_1} = \int_{t-\tau_M}^{t-\tau_m} e^{2\alpha(s-t)} x^T(s) S_1 x(s) ds \quad (4.67)$$

$$V_{R_1} = \varepsilon \int_{-\tau_M}^{-\tau_m} \int_{t+\theta}^t e^{2\alpha(s-t)} \dot{x}^T(s) R_1 \dot{x}(s) ds d\theta \quad (4.68)$$

We compute the time-derivative of  $V$ , defined in (4.64), as

$$\dot{V} = \dot{x}^T V x + x^T V \dot{x} + \dot{V}_{S_0} + \dot{V}_{S_1} + \dot{V}_{R_0} + \dot{V}_{R_1} + \dot{\zeta} \quad (4.69)$$

with

$$\dot{V}_{S_0} = -2\alpha V_{S_0} + x^T(t) S_0 x(t) - \varphi_m x^T(t - \tau_m) S_0 x(t - \tau_m) \quad (4.70)$$

$$\dot{V}_{S_1} = -2\alpha V_{S_1} + \varphi_m x^T(t - \tau_m) S_1 x(t - \tau_m) - \varphi_M x^T(t - \tau_M) S_1 x(t - \tau_M) \quad (4.71)$$

$$\dot{V}_{R_0} \leq -2\alpha V_{R_0} + \tau_m^2 \dot{x}^T(t) R_0 \dot{x}(t) - \tau_m \varphi_m \int_{t-\tau_m}^t \dot{x}^T(s) R_0 \dot{x}(s) ds \quad (4.72)$$

$$\dot{V}_{R_1} \leq -2\alpha V_{R_1} + \tau_M^2 \dot{x}^T(t) R_1 \dot{x}(t) - \varepsilon \varphi_M \int_{t-\tau_M}^{t-\tau_m} \dot{x}^T(s) R_1 \dot{x}(s) ds. \quad (4.73)$$

Consider

$$\mathcal{D}_V = \dot{V} + 2\alpha V(t, x, 0) + \lambda \zeta + z^T z - \gamma^2 u^T u - \beta^2 w^T w. \quad (4.74)$$

We desire to prove that  $\mathcal{D}_V \leq 0$ , for  $t > 0$ . Due to the switching nature of the problem, we split analysis based on the time intervals of interest.



**Case 1)**  $\chi(t) = 0$  and  $\tau(t) \in (\tau_m, \tau_M]$

For this interval we define  $\mu_0(t) = \text{col}\{\dot{x}, x, x(t - \tau_m), x(t - \tau_M), x(t - \tau), u, w\}$  and  $\mathbf{e}_i$  as in (4.62). First, we split the integral term in (4.73) as

$$\int_{t-\tau_M}^{t-\tau_m} \dot{x}^T(s) R_1 \dot{x}(s) ds = \int_{t-\tau}^{t-\tau_m} \dot{x}^T(s) R_1 \dot{x}(s) ds + \int_{t-\tau_M}^{t-\tau} \dot{x}^T(s) R_1 \dot{x}(s) ds. \quad (4.75)$$

Then, applying Jensen's inequality (Lemma 2.5) to (4.72) and (4.75), we have

$$-\tau_m \int_{t-\tau_m}^t \dot{x}^T(s) R_0 \dot{x}(s) ds \leq -\mu_0^T \mathcal{G}_0^T R_0 \mathcal{G}_0 \mu_0 \quad (4.76)$$

$$-\varepsilon \int_{t-\tau_M}^{t-\tau_m} \dot{x}^T(s) R_1 \dot{x}(s) ds \leq -\mu_0^T \mathcal{F}_0^T \Gamma_0(\tau) \mathcal{F}_0 \mu_0 \quad (4.77)$$

with  $\mathcal{G}_0 = \mathbf{e}_2 - \mathbf{e}_3$  and

$$\mathcal{F}_0 = \begin{bmatrix} \mathbf{e}_3 - \mathbf{e}_5 \\ \mathbf{e}_5 - \mathbf{e}_4 \end{bmatrix}, \quad \Gamma_0(\tau) = \begin{bmatrix} \frac{\varepsilon}{\tau(t)-\tau_m} R_1 & 0 \\ 0 & \frac{\varepsilon}{\tau_M-\tau(t)} R_1 \end{bmatrix}.$$

Moreover, applying Lemma 2.6, with  $X_1 = R_1 - Y_1 R_1^{-1} Y_1^T$  and  $X_2 = R_1 - Y_2^T R_1^{-1} Y_2$ , it follows from (4.77) that

$$-\varepsilon \int_{t-\tau_M}^{t-\tau_m} \dot{x}^T(s) R_1 \dot{x}(s) ds \leq -\mu_0^T \mathcal{F}_0^T \Gamma_0(\tau) \mathcal{F}_0 \mu_0 \quad (4.78)$$

with  $\Gamma_0(\tau) = \mathcal{R}_0(\tau) - \mathcal{N}_0(\tau)$ ,

$$\mathcal{N}_0(\tau) = \begin{bmatrix} \frac{\tau_M-\tau(t)}{\varepsilon} Y_1 R_1^{-1} Y_1^T & 0 \\ 0 & \frac{\tau(t)-\tau_m}{\varepsilon} Y_2^T R_1^{-1} Y_2 \end{bmatrix},$$

$$\mathcal{R}_0(\tau) = \begin{bmatrix} R_1 & 0 \\ 0 & R_1 \end{bmatrix} + \frac{\tau_M - \tau(t)}{\varepsilon} \begin{bmatrix} R_1 & Y_2 \\ Y_2^T & 0 \end{bmatrix} + \frac{\tau(t) - \tau_m}{\varepsilon} \begin{bmatrix} 0 & Y_1 \\ Y_1^T & R_1 \end{bmatrix}.$$

Defining  $\mathcal{Z}_0 = [0 \ K_1 C_1 \ 0 \ 0 \ K_2 C_2 \ 0 \ 0]$  from the performance output ( $z_i = u_i$ ) in (4.15) we can write

$$z = \mathcal{Z}_0 \mu_0. \quad (4.79)$$

Combining into (4.74) relations equations (4.70) to (4.72) and (4.77) to (4.79) and the dynamic of  $\zeta_i$  in (4.8) yields

$$\mathcal{D}_V \leq \mu_0^T \left( \mathbf{e}_2^T P \mathbf{e}_1 + \mathbf{e}_1^T P \mathbf{e}_2 + \Omega_0 - \varphi_m \mathcal{G}_0^T R_0 \mathcal{G}_0 + \Pi_0(\tau) + \varphi_M \mathcal{F}_0^T \mathcal{N}_0(\tau) \mathcal{F}_0 + \mathcal{Z}_0^T \mathcal{Z}_0 \right) \mu_0 \quad (4.80)$$

with

$$\Pi_0(\tau) = -\varphi_M \mathcal{F}_0^T \mathcal{R}_0(\tau) \mathcal{F}_0, \quad \Omega_0 = \text{diag}(\mathcal{H}, 2\alpha P - S_0, \mathcal{S}, -\varphi_M S_1, 0, -\gamma^2, -\beta^2)$$

Furthermore, defining  $\mathcal{A}_0 = \begin{bmatrix} -I & A + BK_1C_1 & 0 & 0 & BK_2C_2 & D & E \end{bmatrix}$ , it is straightforward from system (4.15) that  $\mathcal{A}_0\mu_0 = 0$ . Then, for a matrix  $X = \text{diag}(X_1, X_2)$  of appropriate dimension, it follows from Lemma 2.11 that

$$\Phi_0 + \Pi_0(\tau) + \varphi_M \mathcal{F}_0^T \mathcal{N}_0(\tau) \mathcal{F}_0 + \mathcal{Z}_0^T \mathcal{Z}_0 \prec 0 \quad (4.81)$$

where

$$\Phi_0 = \mathbf{e}_2^T P \mathbf{e}_1 + \mathbf{e}_1^T P \mathbf{e}_2 + \Omega_0 - \varphi_m \mathcal{G}_0^T R_0 \mathcal{G}_0 + \text{He} \left\{ \mathcal{X}_0^T \mathcal{A}_0 \right\}, \quad \mathcal{X}_0 = \beta_1 X \mathbf{e}_1 + X \mathbf{e}_2 + \beta_2 X \mathbf{e}_5$$

ensures that  $\mathcal{D}_V \leq 0$ . By Schur complement lemma (BOYD *et al.*, 1994), we can show that condition (4.81) is equivalent to

$$\begin{bmatrix} \Phi_0 + \Pi_0(\tau) & \mathcal{Z}_0^T & \mathcal{F}_0^T \begin{bmatrix} Y_1 & 0 \\ 0 & Y_2^T \end{bmatrix} \\ * & -I & 0 \\ * & * & -e^{2\alpha\tau_M} \begin{bmatrix} \frac{\tau_M - \tau(t)}{\varepsilon} R_1 & 0 \\ 0 & \frac{\tau(t) - \tau_m}{\varepsilon} R_1 \end{bmatrix} \end{bmatrix} \prec 0 \quad (4.82)$$

From the convexity of (4.82), the conditions

$$\begin{bmatrix} \Phi_0 + \Pi_0(\tau_m) & \mathcal{Z}_0^T & \mathcal{F}_0^T \begin{bmatrix} Y_1 \\ 0 \end{bmatrix} \\ * & -I & 0 \\ * & * & -e^{2\alpha\tau_M} R_1 \end{bmatrix} \prec 0 \quad (4.83)$$

$$\begin{bmatrix} \Phi_0 + \Pi_0(\tau_M) & \mathcal{Z}_0^T & \mathcal{F}_0^T \begin{bmatrix} 0 \\ Y_2^T \end{bmatrix} \\ * & -I & 0 \\ * & * & -e^{2\alpha\tau_M} R_1 \end{bmatrix} \prec 0 \quad (4.84)$$

are sufficient to ensure (4.81). Multiplying (4.83) and (4.84) on the right by

$$\text{diag}(X, X, X, X, X, I, I, I, X),$$

and on the left by its transpose, making  $\bar{R}_i = X^T R_i X$ ,  $\bar{S}_i = X^T S_i X$ ,  $\bar{Y}_i = X^T Y_i X$ ,  $L_i C_i = K_i X_i C_i = K_i C_i X$ , for  $i = 1, 2$ , and  $\bar{P} = X^T P X$ , results in conditions (4.58) and (4.59).

**Case 2)**  $\chi(t) = 1$  and  $\eta(t) \in (0, \tau_m]$

For this interval, the proof is similar to Case 1, thus some steps are omitted. Let  $\mu_1(t) = \text{col}\{\dot{x}, x, x(t - \tau_m), x(t - \tau_M), x(t - \eta), u, w, e\}$  and  $\mathbf{v}_i$  as in (4.63). By splitting the integral term in (4.72) as

$$\int_{t-\tau_m}^t \dot{x}^T(s) R_0 \dot{x}(s) ds = \int_{t-\eta}^t \dot{x}^T(s) R_0 \dot{x}(s) ds + \int_{t-\tau_m}^{t-\eta} \dot{x}^T(s) R_0 \dot{x}(s) ds. \quad (4.85)$$

Invoking Jensen's inequality in Lemma 2.5 and the delay-dependent reciprocally convex inequality in Lemma 2.6, we can bound the integral terms (4.72) and (4.73) as

$$-\tau_m \int_{t-\tau_m}^t \dot{x}^T(s) R_0 \dot{x}(s) ds \leq -\mu_1^T \mathcal{F}_1^T \Gamma_1(\tau) \mathcal{F}_1 \mu_1 \quad (4.86)$$

$$-\tau_m \int_{t-\tau_M}^{t-\tau_m} \dot{x}^T(s) R_1 \dot{x}(s) ds \leq -\mu_1^T \mathcal{G}_1^T R_1 \mathcal{G}_1 \mu_1 \quad (4.87)$$

with

$$\begin{aligned} \mathcal{G}_1 &= \mathbf{v}_2 - \mathbf{v}_3, \quad \Gamma_1(\tau) = \mathcal{R}_1(\tau) - \mathcal{N}_1(\tau), \quad \mathcal{F}_1 = \begin{bmatrix} \mathbf{v}_3 - \mathbf{v}_5 \\ \mathbf{v}_5 - \mathbf{v}_4 \end{bmatrix} \\ \mathcal{N}_1(\tau) &= \begin{bmatrix} \frac{\tau_m - \tau(t)}{\tau_m} W_1 R_0^{-1} W_1^T & 0 \\ 0 & \frac{\tau(t)}{\tau_m} W_2^T R_0^{-1} W_2 \end{bmatrix} \\ \mathcal{R}_1(\tau) &= \begin{bmatrix} R_0 & 0 \\ 0 & R_0 \end{bmatrix} + \frac{\tau_m - \tau(t)}{\tau_m} \begin{bmatrix} R_0 & W_2 \\ W_2^T & 0 \end{bmatrix} + \frac{\tau(t)}{\tau_m} \begin{bmatrix} 0 & W_1 \\ W_1^T & R_0 \end{bmatrix}. \end{aligned}$$

By defining  $\mathcal{A}_1 = [\mathcal{A}_0 \quad -BK_2]$ ,  $\mathcal{Z}_1 = [\mathcal{Z}_0 \quad -K_2]$ , combining with the dynamics of  $\zeta$  in (4.8) and from Finsler Lemma 2.11, it follows that

$$\Phi_1 + \Pi_1(\tau) + \varphi_m \mathcal{F}_1^T \mathcal{N}_1(\tau) \mathcal{F}_1 + \mathcal{Z}_1^T \mathcal{Z}_1 + \mathbf{v}_5^T C_2^T Q_x C_2 \mathbf{v}_5 \prec 0 \quad (4.88)$$

with

$$\begin{aligned} \Phi_1 &= \mathbf{v}_2^T P \mathbf{v}_1 + \mathbf{v}_1^T P \mathbf{v}_2 - \varphi_m \mathcal{G}_1^T R_1 \mathcal{G}_1 + \Omega_1 + \text{He} \left\{ \mathcal{X}_1^T \mathcal{A}_1 \right\}, \quad \Pi_1(\tau) = -\varphi_M \mathcal{F}_1^T \mathcal{R}_1(\tau) \mathcal{F}_1 \\ \Omega_1 &= \text{diag}(\Omega_0, -Q_x), \quad \mathcal{X}_1 = \beta_1 X \mathbf{v}_1 + X \mathbf{v}_2 + \beta_2 X \mathbf{v}_5 \end{aligned}$$

which ensures  $\mathcal{D}_V \leq 0$ . Using again the convexity of the condition (4.88) and Schur complement lemma (BOYD *et al.*, 1994), we have that

$$\begin{bmatrix} \Phi_1 + \Pi_1(0) & \mathcal{Z}_1^T & \mathbf{v}_5^T C_2^T & \mathcal{F}_1^T \begin{bmatrix} W_1 \\ 0 \end{bmatrix} \\ * & -I & 0 & 0 \\ * & * & -Q_x^{-1} & 0 \\ * & * & * & -e^{2\alpha\tau_m} R_0 \end{bmatrix} \prec 0 \quad (4.89)$$

$$\begin{bmatrix} \Phi_1 + \Pi_1(\tau_m) & \mathcal{Z}_1^T & \mathbf{v}_5^T C_2^T & \mathcal{F}_1^T \begin{bmatrix} 0 \\ W_2^T \end{bmatrix} \\ * & -I & 0 & 0 \\ * & * & -Q_x^{-1} & 0 \\ * & * & * & -e^{2\alpha\tau_m} R_0 \end{bmatrix} \prec 0 \quad (4.90)$$

are sufficient to ensure (4.88). Multiplying (4.89) and (4.90) on the right by

$$\text{diag}(X, X, X, X, X, I, I, I, X_2, X) \quad (4.91)$$

and on the left by its transpose, making  $\bar{R}_i = X^T R_i X$ ,  $\bar{S}_i = X^T S_i X$ ,  $\bar{W}_i = X^T W_i X$ ,  $L_i C_i = K_i X_i C_i = K_i C_i X$  for  $i = 1, 2$ ,  $L_2 = K_2 X_2$  and  $\bar{P} = X^T P X$ , result in conditions (4.60) and (4.61).

Then, combining Case 1 and Case 2, from the continuity of the LKF (4.64), if the conditions (4.81) and (4.88) are satisfied it follows that

$$\dot{V} + \bar{\alpha}V(t, x, \zeta) + z^T z - \gamma^2 u^T u - \beta^2 w^T w \leq 0 \quad (4.92)$$

with  $\bar{\alpha} = \min\{\lambda, 2\alpha\}$ , for  $t \geq 0$ . Hence, integrating both sides from 0 to  $\infty$  we have

$$\|z\|_{\mathcal{L}_2} \leq \gamma \|u\|_{\mathcal{L}_2} + \beta \|w\|_{\mathcal{L}_2} \quad (4.93)$$

for null initial conditions. Since  $\gamma \leq 1$  we recover the condition (3.28) in Proposition 3.1. Moreover,  $\text{Tr}(\bar{Q}_e) + \delta \text{Tr}(\bar{Q}_x)$  in (4.57) is used to maximize the inter-event time of the switched dynamic ETC scheme. This completes the proof.  $\square$

As discussed in Section 3.3.3, we can set the feedforward gain as  $K_2 = K_2^* = \frac{\rho d}{h}$  as in (3.36) to compensate for the effect of  $a_{i-1}$  on error dynamics (3.35). However, since perfect compensation can only be possible in the absence of network-induced delays, instead of fixing  $K_2 = K_2^*$ , we consider a norm-bounded constraint as

$$\|K_2^* - K_2\|^2 < \kappa^2 \quad (4.94)$$

for a sufficient small  $\kappa > 0$ . Compared to the strict equality  $K_2 = K_2^*$ , constraint (4.94) provides more flexibility in searching for values of  $K_2$  close to  $K_2^*$ . Note that by Schur complement lemma (BOYD *et al.*, 1994), we can show that inequality (4.94) is equivalent to

$$\begin{bmatrix} \kappa^2 & K_2^* - K_2 \\ * & I \end{bmatrix} \succ 0. \quad (4.95)$$

Using the change of variable  $K_2 = L_2 X_2^{-1}$  as in Theorem 4.3 and multiplying (4.95) on the left by  $\text{diag}(I, X_2^T)$  and on the right by its transpose, it follows that

$$\begin{bmatrix} \kappa^2 & K_2^* X_2 - L_2 \\ * & X_2^T X_2 \end{bmatrix} \succ 0. \quad (4.96)$$

It is clear that the following constraint directly implies (4.96):

$$\begin{bmatrix} \kappa^2 & K_2^* X_2 - L_2 \\ * & X_2 + X_2^T - I \end{bmatrix} \succ 0. \quad (4.97)$$

As a result, when solving the optimization problem in Theorem 4.3, the LMI (4.97) can be directly included to ensure the constraint (4.94) of the feedforward gain  $K_2$ .

**Remark 4.2.** The design conditions for the Overlapping system is similar to the inter-connected system that is not described here but is straightforward from Theorem 4.3

## 4.6 Static ETC conditions

In both emulation and co-design synthesis conditions, retrieving the static ETM conditions is straightforward and it is comprised in the following Corollary.

**Corollary 4.1.** *Imposing  $\theta \rightarrow \infty$ , the following static ETM can be directly retrieved from (4.6):*

$$\begin{aligned} s_{0,i} &= 0 \\ t_{k+1,i} &= \inf\{t > t_{k,i} + \varepsilon : \Lambda_i(y_{2,i}(t), y_{2,i}(t_{k,i})) > 0\} \end{aligned} \quad (4.98)$$

where  $\Lambda_i(y_{2,i}(t), y_{2,i}(t_{k,i}))$  is defined in (4.7), and matrices  $Q_x$  and  $Q_e$  are obtained applying Theorem 4.1 or Theorem 4.3.

For the choice of the control design parameters in Theorem 4.1, Theorem 4.2 and Theorem 4.3, parameters  $\varepsilon$  (waiting time) and  $\delta$  are related to the maximum inter event times, while  $\alpha$  is related to the convergence. Considering a grid on those values, the conditions are evaluated, and the parameters are chosen considering the trade-off between convergence and the number of events. Moreover, for Theorem 4.3, the conditions are evaluated varying the value of  $\tau_m$  (maximum delay), to achieve the maximum values such that the conditions are still feasible.

## 4.7 Examples

In this section we present illustrative results and comparative studies to show the effectiveness of the proposed dynamic ETC platooning control method. We compare the achieved results utilizing the emulation and co-design conditions. We consider a platoon setup with one leader ( $\Sigma_0$ ) and four different followers ( $\Sigma_1$  to  $\Sigma_4$ ). Table 4.1 presents the parameters of the vehicles. In columns  $\Sigma_i$  are the values used to calculate the feedback linearizing control law. In columns  $\tilde{\Sigma}_i$  are the values used for the simulation. The rolling resistance coefficient  $F_r$  is considered constant for all vehicles, i.e.,  $F_r = 0.015$  (sec/kg). However, it is assumed to be unknown and is not used to compute the feedback linearizing control law (3.15). Moreover, the length of the vehicles,  $L_c = 2.5$  (m), is also known for all vehicles.

For disturbance compensation, we utilized the DOB proposed in Chapter 3 equation (3.12) with  $L_i = 50$  for all vehicles and simulations. The distance policy parameters from (3.8) are set as  $r_i = 2.5$  (m) for  $i = 1, 2, 3, 4$ ,  $h = 0.6$  (sec) and the desired time constant is  $\rho_d = 0.1$ .

We divided the examples in two study cases based on the two approaches discussed in Section 4.5.

- Case 1 – Emulation) We study the case of communication without delay and ETC designed based on Remark 4.1 presented in Section 4.5.2. In the examples we consi-

Table 4.1 – Nominal values of the vehicle parameters and respective true values.

Vehicle	$r$	$m$	$h_w$	$J_r$	$J_e$	$R_g$	$B$	$C$	$\rho$
$\Sigma_0$		1724	0.28	0.75	0.14	0.10	7.35	0.05	0.05
$\tilde{\Sigma}_0$		1724	0.25	1.05	0.14	0.13	8.09	0.06	0.08
$\Sigma_1$	2.5	2241	0.63	0.97	0.35	0.18	13.96	0.11	0.10
$\tilde{\Sigma}_1$		2017	0.51	0.68	0.46	0.18	11.17	0.16	0.09
$\Sigma_2$	2.5	2930	0.41	1.57	0.27	0.20	11.02	0.08	0.08
$\tilde{\Sigma}_2$		2637	0.33	1.26	0.40	0.30	8.82	0.05	0.06
$\Sigma_3$	2.5	3620	0.63	0.82	0.27	0.11	13.96	0.11	0.12
$\tilde{\Sigma}_3$		3258	0.89	1.15	0.40	0.08	15.36	0.16	0.12
$\Sigma_4$	2.5	3965	0.52	1.72	0.24	0.11	8.09	0.06	0.08
$\tilde{\Sigma}_4$		5947	0.63	2.41	0.29	0.14	11.32	0.08	0.11

der the overlapping model  $\Xi_{i,i-1}$  (3.42) and the controller defined a priori according to Remark 3.2 and Remark 3.1.

- Case 2 – Co-design) we consider the communication delay and the ETC is designed based on Theorem 4.3 presented in Section 4.5.4 considering the Interconnected model  $\Sigma_{i,i-1}$  (3.22).

#### 4.7.1 Case 1 – Emulation

For the emulation approach as discussed in Section 4.5.2 we consider the overlapping system  $\Xi_{i,i-1}$  defined in Section 3.3.4, equation (3.50). The controller gains  $\bar{K}_1$  and  $\bar{K}_2$  are chosen as

$$K_1 = \begin{bmatrix} 0.2 & 0.7 & -0.42 & 0 \end{bmatrix}, \quad K_2 = \begin{bmatrix} -0.2 & 1.2 \end{bmatrix}.$$

the event-triggering condition (4.6) is designed using Theorem 4.1. The optimization problem (4.17) results in  $\beta = 2.5$ , and

$$Q_e = \begin{bmatrix} 2.77 & -16.61 \\ * & 99.65 \end{bmatrix}, \quad Q_x = \begin{bmatrix} 0.0145 & -0.0132 \\ * & 0.0143 \end{bmatrix}. \quad (4.99)$$

Table 4.2 – ETC and Theorem 4.1 design parameters.

Parameter	$\varepsilon$	$\delta$	$\alpha$	$\theta$	$\lambda$
Value	0.1	0.005	0.01	5	0.01

Figure 4.4 shows the velocity  $v$ , the acceleration  $a$ , and the distance policy error  $\Delta p$  for each vehicle in the considered platoon. Note that the vehicles in the platoon are able

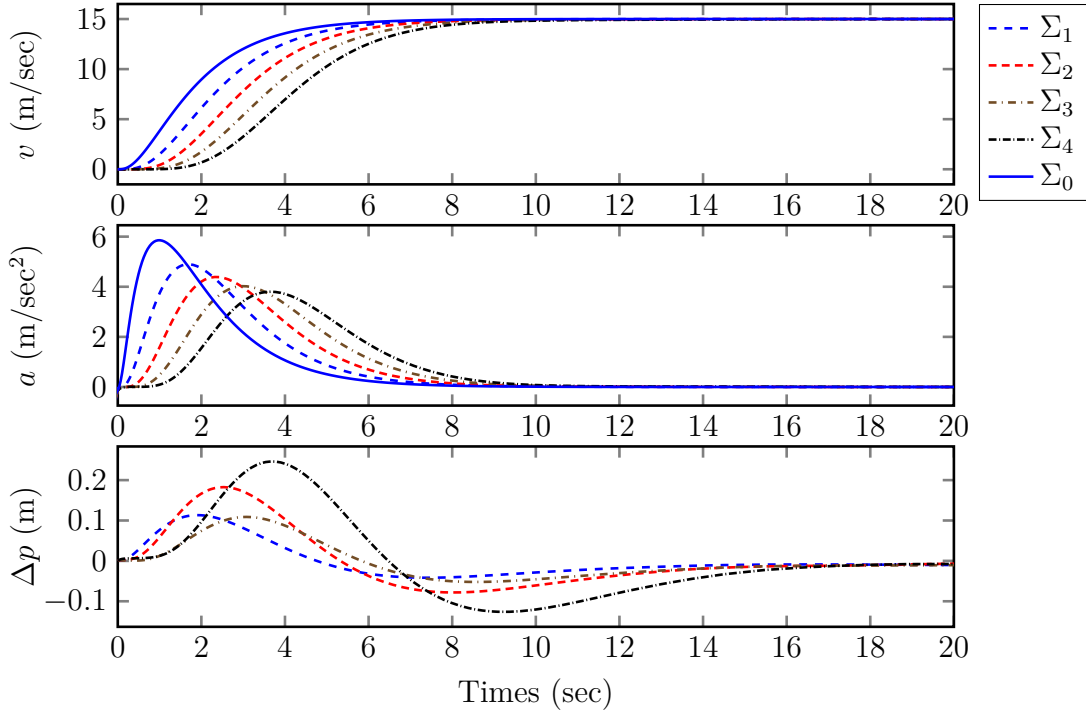

Figure 4.4 – Emulation – Test 1. Velocity  $v$ , acceleration  $a$  and distance policy error  $\Delta p$  of the platooning vehicles obtained with the switched dynamic ETM (4.6), designed based on Theorem 4.1.

to follow the leader velocity and the distance policy converges to zero without significant oscillations.

Now considering a time-varying velocity reference for a longer simulation time interval of  $t_{\text{sim}} = 320$  (sec), as illustrated in Figure 4.5, we observe that the follower vehicles can still correctly follow the leader and maintain the specified distance policy. Figure 4.5 also displays the inter-event time for transmissions to vehicles  $\Sigma_1$  to  $\Sigma_4$ . Notice that every time the leader changes its velocity, the inter-event time is reduced. However, as the vehicles reach a steady state, the number of transmissions considerably decreases, as evident in the last steady state after 220 seconds.

To further evaluate the platooning control performance, we compare the four following ETMs under the same test conditions as in Figure 4.4:

- Proposed dynamic ETM, designed with Theorem 4.1.
- Dynamic ETM, proposed in (DOLK *et al.*, 2017). Following the same search procedure as in (DOLK *et al.*, 2017), the parameters of the ETM can be determined, as depicted in Table 4.3.
- Static ETM, discussed in Corollary 4.1.
- Periodic ETM, designed with Theorem 4.2.

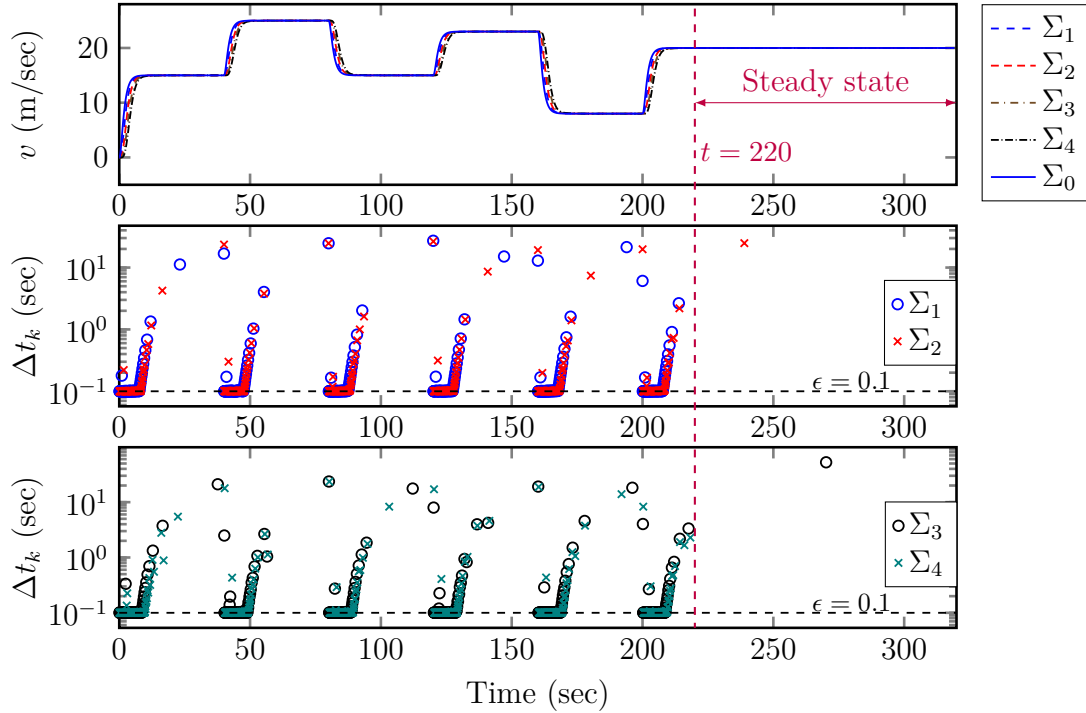

Figure 4.5 – Emulation – Test 1. Platooning with a time-varying velocity reference, and inter-event time for each vehicle obtained with the switched dynamic ETC design from Theorem 4.1.

Table 4.3 – ETM parameters for the ETM in (DOLK *et al.*, 2017).

Parameter	$\gamma$	$\tau_{\text{miet}}(\varepsilon)$	$\phi_1(0)$	$\varepsilon$	$\lambda$	$\rho$	$\tau_{\text{mad}}(\tau_m)$
Value	8.442	0.072	8.557	0.5	0.305	0.04	0.026

In Figure 4.6, we observe that the distance policy errors do not show significant differences among the considered event-triggering mechanisms. However, in terms of communication, there is a significant difference, as shown in Table 4.4, which summarizes the average time between events during the transient phase  $T_{\text{avg}}$ , and the number of events  $N_{\text{event}}$  obtained with the four ETC schemes. In particular, the switched dynamic ETC scheme shows a significant difference compared to the other cases, with almost less than a third of the number of events.

Furthermore, in Table 4.4, we present the ratio of total simulation time to the number of events, denoted as  $T_{\text{sim}}/N_{\text{event}}$ , with  $T_{\text{sim}} = 320$  (sec). When comparing this value with  $T_{\text{avg}}$ , a significant difference is observed only in the proposed switched dynamic ETC scheme. This is mainly due to the long interval without triggering communication, which is not included in the average. Furthermore, the dynamic ETC method presented in (DOLK *et al.*, 2017) yields a control performance similar to that of the compared static ETC scheme. To better illustrate this difference in triggering communication, Figure 4.7 depicts the inter-event times obtained with different ETMs. Except for the proposed method, the



number of events of the other compared ETMs does not reduce as the platooning system achieves steady state, and the transmission intervals are close to the minimum time.

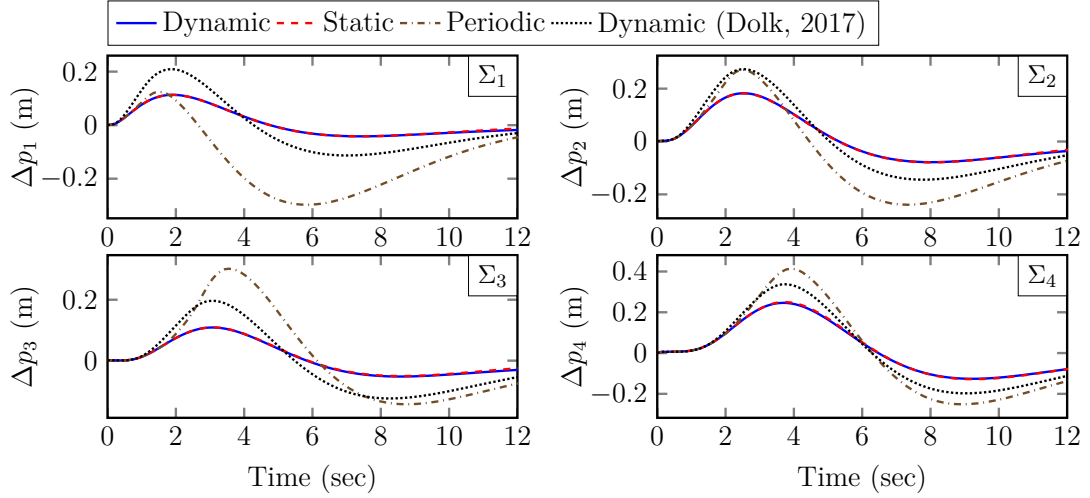

Figure 4.6 – Emulation – Test 2. Distance policy errors  $\Delta p_i$  obtained using the four compared ETMs.

Table 4.4 – Average time between events during the transient phase  $T_{\text{avg}}$ , number of events  $N_{\text{event}}$ , and average events during the total simulation time  $T_{\text{sim}}/N_{\text{event}}$  obtained with four ETC schemes.

ETC	Indicator	Vehicle			
		1	2	3	4
Dynamic	$T_{\text{avg}}$ (sec)	0.40	0.38	0.37	0.35
	$N_{\text{event}}$	534	559	589	617
	$T_{\text{sim}}/N_{\text{event}}$	0.60	0.57	0.54	0.52
Static	$T_{\text{avg}}$ (sec)	0.10	0.11	0.11	0.11
	$N_{\text{event}}$	3004	2817	2606	2729
	$T_{\text{sim}}/N_{\text{event}}$	0.11	0.11	0.12	0.12
Periodic	$T_{\text{avg}}$ (sec)	0.20	0.22	0.23	0.23
	$N_{\text{event}}$	1953	1701	1385	1439
	$T_{\text{sim}}/N_{\text{event}}$	0.16	0.19	0.23	0.22
Dynamic (DOLK <i>et al.</i> , 2017)	$T_{\text{avg}}$ (sec)	0.11	0.11	0.11	0.11
	$N_{\text{event}}$	2954	2912	2843	2885
	$T_{\text{sim}}/N_{\text{event}}$	0.11	0.11	0.11	0.11

#### 4.7.2 Case 2 – Co-design

For the co-design approach from Section 4.5.4 the controller gains  $K_1$  and  $K_2$  in (4.13) and the event-triggering condition (4.6) are designed using Theorem 4.3 including the LMI constraint (4.97). Moreover, in all simulations, for each transmission interval, the delay  $\tau_{k,i}^*$  is randomly selected between 0 and  $\tau_m = 0.006$ . Solving the optimization problem

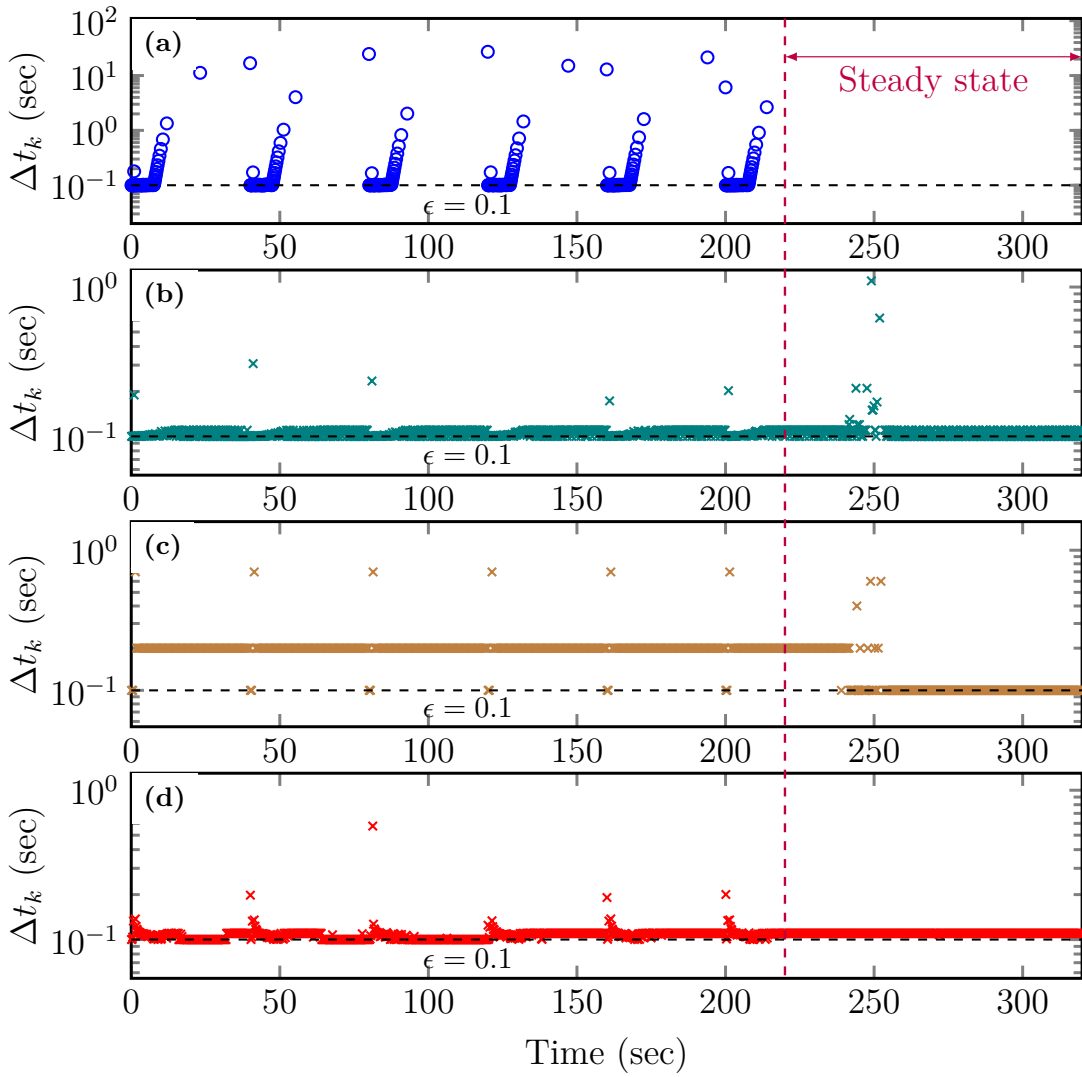

Figure 4.7 – Emulation – Test 2. Inter-event times obtained using the four compared ETMs. (a) Proposed dynamic ETM, (b) Static ETM, (c) Periodic ETM, (d) Dynamic ETM (DOLK *et al.*, 2017).

(4.57) with design parameters provided in Table 4.5, we obtain  $\beta = 6.2$ ,  $Q_e = 0.0341$ ,  $Q_x = 1.1 \times 10^{-3}$ , and

$$K_1 = \begin{bmatrix} 0.352 & 1.576 & -0.1778 \end{bmatrix}, \quad K_2 = 0.1598. \quad (4.100)$$

Table 4.5 – ETC and Theorem 4.3 design parameters.

Parameter	$\varepsilon$	$\tau_m$	$\delta$	$\alpha$	$\theta$	$\lambda$	$\beta_1$	$\beta_2$	$\kappa$	$K_2^*$
Value	0.15	0.06	0.1	0.006	1	0.5	0.3	0.2	$10^{-4}$	0.164

Figure 4.8 shows the velocity  $v$ , acceleration  $a$ , and the distance policy error  $\Delta p$  for each vehicle in the platoon. Note that the vehicles are able to follow the leader velocity, and the distance policy converges to zero without significant oscillations.

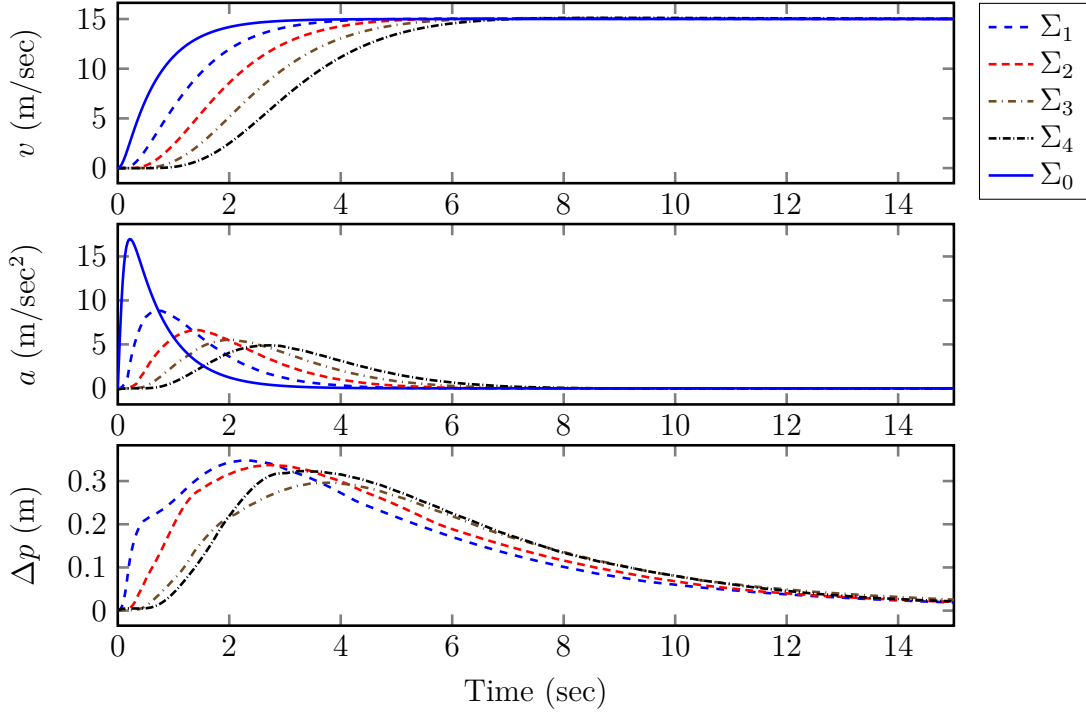

Figure 4.8 – Co-design – Test 2. Velocity  $v$ , acceleration  $a$  and distance policy error  $\Delta p$  of the platooning vehicles obtained with the switched dynamic ETM (4.6), designed based on Theorem 4.3.

Extending the simulation time to  $t_{\text{sim}} = 240$  (sec) and considering a time-varying velocity reference, as depicted in Figure 4.9, we observe that despite constant changes in velocity, the follower vehicles can still accurately follow the leader and maintain the specified distance policy. Figure 4.9 also displays the inter-event time for transmissions to vehicles  $\Sigma_1$  to  $\Sigma_4$ .

To further evaluate the platooning control performance, we compare the three following ETMs under the same test conditions as in Figure 4.8

- Proposed dynamic ETC, designed with Theorem 4.3.
- Dynamic ETC (controller and ETC), proposed in (DOLK *et al.*, 2017) with the ETC parameters provided in Table 4.6.
- Static ETC, discussed in Corollary 4.1.

Table 4.6 – ETM parameters for the ETM in (DOLK *et al.*, 2017).

Parameter	$\gamma$	$\tau_{\text{miet}}(\varepsilon)$	$\phi_1(0)$	$\epsilon$	$\lambda$	$\rho$	$\tau_{\text{mad}}(\tau_m)$
Value	8.442	0.072	8.557	0.5	0.305	0.04	0.026

In Figure 4.10, we observe that the distance policy errors do not show significant differences among the considered event-triggering mechanisms. Examining Table 4.5 and

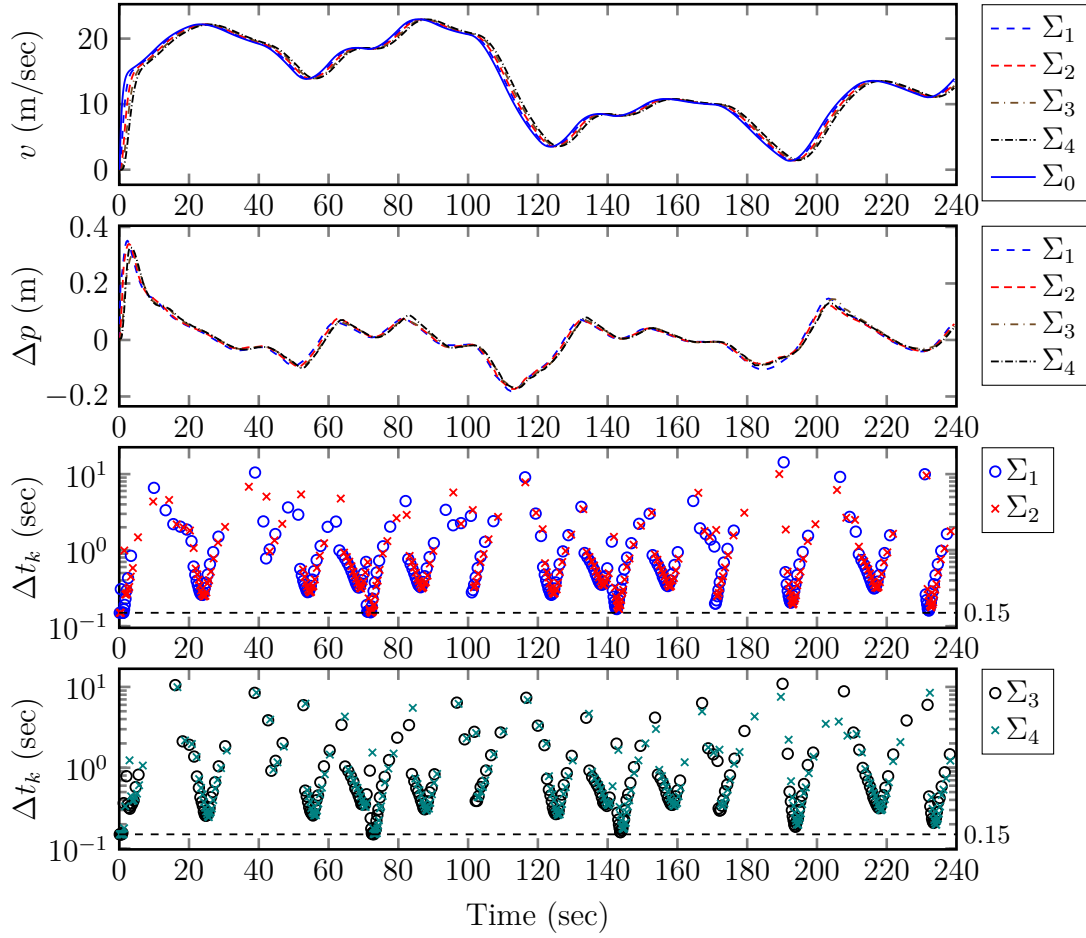

Figure 4.9 – Co-design – Test 2. Platooning with a time-varying velocity reference, and inter-event time for each vehicle obtained with the switched dynamic ETC design from Theorem 4.3.

Table 4.6 and comparing the maximum delay and waiting time (respectively, the  $\tau_{\text{mad}}$  and  $\tau_{\text{meit}}$  for (DOLK *et al.*, 2017)), the proposed approach results in a maximum delay of 0.06 ( $\tau_m$ ) and minimum inter event time of 0.15 ( $\varepsilon$ ), which is more than double of the values achieved by (DOLK *et al.*, 2017).

In terms of communication, there is a significant difference between the approaches. In Figure 4.11 we show the inter-event time for each approach, where it is clear the difference in terms of number of events. For a better comparison, Table 4.7 summarizes the average time between events  $T_{\text{avg}}$ , and the number of events  $N_{\text{event}}$  obtained with the three ETC schemes. The switched dynamic ETC scheme, when compared to the static case, renders 2/3 of the events and, consequently, a better average transmission time ( $T_{\text{avg}}$ ). Compared to (DOLK *et al.*, 2017), both dynamic and static ETC present significantly less events, with the dynamic ETM resulting in a tenth of the number of events than the ETM of (DOLK *et al.*, 2017).

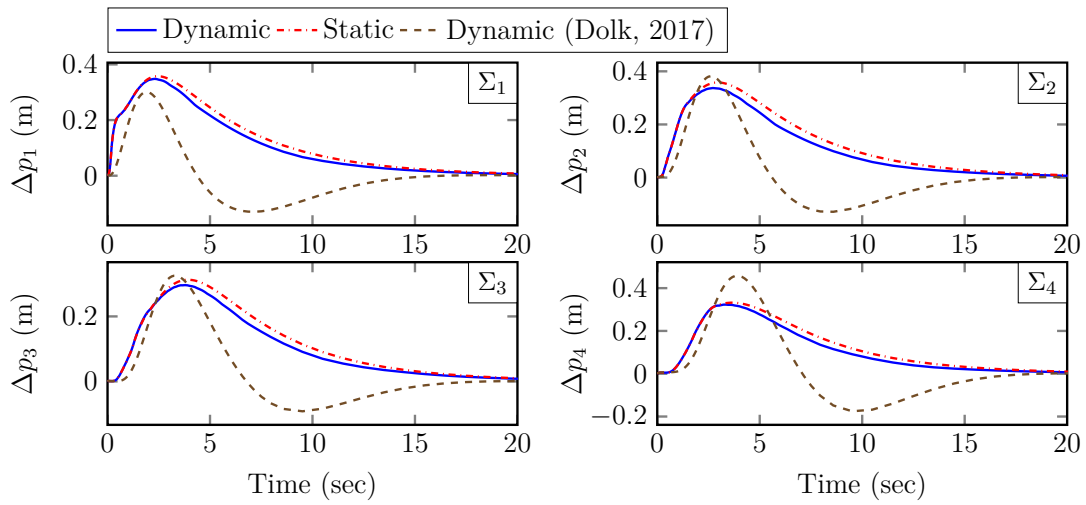

Figure 4.10 – Co-design – Test 2. Distance policy errors  $\Delta p_i$  obtained using the three different ETCs.

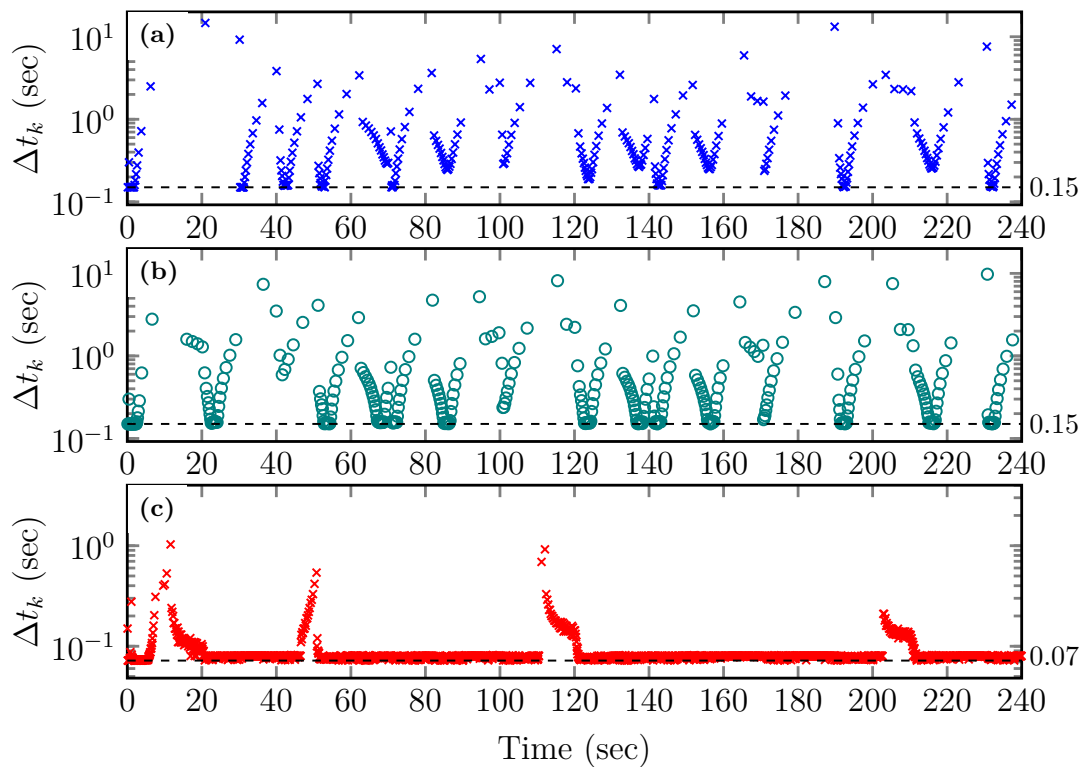

Figure 4.11 – Co-design – Test 2. Inter-event times obtained using the three ETCs. (a) Proposed dynamic ETC, (b) Static ETC, (c) Dynamic ETC of (DOLK *et al.*, 2017).

Table 4.7 – Average time between events during the transient phase  $T_{\text{avg}}$ , number of events  $N_{\text{event}}$ , obtained with three ETC schemes.

ETC	Indicator	Vehicle			
		1	2	3	4
Dynamic	$T_{\text{avg}}$ (sec)	0.92	0.93	0.93	0.92
	$N_{\text{event}}$	256	255	254	257
Static	$T_{\text{avg}}$ (sec)	0.61	0.62	0.61	0.61
	$N_{\text{event}}$	384	379	383	386
Dynamic (DOLK <i>et al.</i> , 2017)	$T_{\text{avg}}$ (sec)	0.08	0.09	0.08	0.08
	$N_{\text{event}}$	2849	2830	2875	2894

## 4.8 Conclusion

Considering the control communication between vehicles in the predecessor-follower flow topology, a switched dynamic ETC method has been proposed for heterogeneous platoons. To counteract the uncertainties within the platooning system, a DOB-based uncertainty estimation is incorporated into the feedback linearization control law. The communication between vehicles is established based on a dynamic event-triggering condition with a minimum time to ensure Zeno-free behavior accounting for the transmission delays. For platooning control design, we model the system with dynamic ETC as a switching interconnected system, representing the interaction between adjacent vehicles. Subsequently, using a Lyapunov-Krasovskii functional time delay relaxation technique, sufficient LMI conditions are derived to ensure  $\mathcal{L}_2$  stability between consecutive vehicles, as well as  $\mathcal{L}_2$  string stability. Through simulations and comparisons, we demonstrate that the proposed DOB-based event-triggered platooning control method can ensure string stability despite the modeling uncertainties. Furthermore, the dynamic switched ETC can significantly reduce the amount of communication compared to other ETM conditions.

## 5 ETC feedback linearization

### 5.1 Introduction

As explored in Chapter 3 and Chapter 4, feedback linearization is an useful control technique that can be used in several applications such as, robot manipulators (BAGHERI *et al.*, 2019), planar collective motion (SEPULCHRE *et al.*, 2007), marine vehicles (PALIOTTA *et al.*, 2019), maglev positioning system (NIELSEN *et al.*, 2010) and double rotors (CHANG *et al.*, 2019).

For the classical feedback linearization approach, the state measurement and the control law must be continuously updated (KHALIL, 2002; ISIDORI, 1995). For example, in the platoon application in the previous chapters, the states necessary for computing the linearizing control law were assumed to be available in real time. However, it can appear that, the information used to compute, the feedback linearizing control law is issued from a sampling process (GOEBEL *et al.*, 2009). Since the control action is computed with sampled signals, the system nonlinearities can no longer be perfectly canceled via feedback linearization between samples. This gives rise to the presence of nonlinear mismatch terms in the expression of the closed-loop system, leading to a new challenge for the control design (MAITY; BARAS, 2015; STÖCKER; LUNZE, 2011).

In the context of event-triggered control via feedback linearization the same phenomena occurs, due to the sample and hold nature of the event-triggering conditions. In addition, the event-triggering condition has to be designed together with the feedback gain to guarantee closed-loop stability. The authors in (STÖCKER; LUNZE, 2011) address an event-based feedback linearization problem, where a reference model is considered to compute the control law and the event-triggering condition. Specifically, the control signal is continuously computed in real-time using a reference model and the system state is updated whenever the event-triggering condition holds. Based on a Lyapunov function, both the controller and the event-triggering condition are proposed for affine nonlinear systems in (MAITY; BARAS, 2015). When the controlled plant is not completely known, the system unknown nonlinearities have been approximated using neural networks (SAHOO *et al.*, 2016; GAO *et al.*, 2020; CHEN *et al.*, 2021) or online Gaussian learning process (UMLAUFT; HIRCHE, 2020) for event-based control design. Both static and dynamic event-triggering conditions are considered for the control results in (XU *et al.*, 2020). However, the nonlinear mismatches, caused by the use of sampled state measurements for the computation of nonlinear control laws, are not considered in the previous event-triggered control approaches. This can lead to instability of the closed-loop systems as illustrated in this Chapter.



Motivated by the above theoretical and practical issues, we propose conditions to co-design feedback linearization controllers and event-triggered mechanisms for nonlinear MIMO systems. Based on Lyapunov stability theory, the design conditions, to guarantee the closed-loop asymptotic stability while minimizing the inter event time (IET), are reformulated as optimization problems under linear matrix inequality (LMI) constraints. Both *full* and *partial* feedback linearization cases are considered for the event-triggered control design. In particular, applying the fundamental theorem of calculus and a polytopic approach, some nonlinear mismatches between continuous and sampled nonlinearities are *explicitly* taken into account in the LMI-based control design instead of being incorporated in the event-triggering conditions, allowing conditions to be extrapolated to other triggering mechanisms. Moreover, under some assumptions on Lipschitzian properties of the system nonlinearities, the ETM is able to ensure Zeno-free behavior (DONKERS; HEEMELS, 2012) in closed-loop.

The main contributions presented in this Chapter can be summarized as follows.

- We propose sufficient conditions to co-design feedback controllers and event-triggered mechanisms for feedback linearizable MIMO systems
- The mismatches between continuous and sampled nonlinearities are explicitly considered in the co-design to prevent instability. The co-design conditions are recast as LMI-based optimization problems to minimize IET.
- A lower bound for IET can be guaranteed for systems with Lipschitzian nonlinearities to avoid Zeno behavior.

## 5.2 Preliminaries

In this section we present preliminaries on feedback linearization control of MIMO systems required throughout this chapter.

### 5.2.1 Feedback linearization

Consider a nonlinear MIMO system affine in the control given by

$$\begin{aligned} \dot{x} &= f(x) + g(x)u \\ y &= h(x), \quad x \in \mathcal{X} \end{aligned} \tag{5.1}$$

where  $x \in \mathbb{R}^{n_x}$ ,  $u \in \mathbb{R}^{n_u}$  and  $y \in \mathbb{R}^{n_y}$  are respectively the system states, control input and system output. The set  $\mathcal{X} \subset \mathbb{R}^{n_x}$  is a compact set that contains the origin, which can represent either the set of interest or a set where the linearization is valid. The nonlinear vector valued functions  $f(x)$ ,  $g(x)$ ,  $h(x)$  are smooth functions such that  $f : \mathbb{R}^{n_x} \rightarrow \mathbb{R}^{n_x}$ ,

$g : \mathbb{R}^{n_x} \rightarrow \mathbb{R}^{n_u}$  and  $h : \mathbb{R}^{n_x} \rightarrow \mathbb{R}^{n_y}$ . We assume that in the set of interest,  $x = 0$  is the unique equilibrium point, i.e.,  $f(0) = 0$  and  $f(x) \neq 0$  for all  $x \in \mathcal{X} - \{0\}$ .

**Definition 5.1.** System (5.1) is called linearizable if there is a diffeomorphism  $T : \mathcal{X} \rightarrow \mathcal{Z}$  which maps  $z = T(x)$  and leads system (5.1) into

$$\dot{z} = Az + B[\alpha(x) + \gamma(x)u] \quad (5.2)$$

with the pair  $(A, B)$  controllable and  $\gamma : \mathcal{X} \rightarrow \mathbb{R}^{n_y \times n_u}$  nonsingular for all  $x \in \mathcal{X}$  (ISIDORI, 1995).

For MIMO systems, one possible methodology to achieve this transformation is to take the time derivative of each output until the input signal appears (ISIDORI, 1995). To ensure the linearization of system (5.1) we assume the following

**Assumption 5.1.** We assume that  $f(x)$  and  $g(x)$  satisfies the involutive condition (KHALIL, 2002) for  $x \in \mathcal{X}$ .

**Remark 5.1.** Although Assumption 5.1 is restrictive, it is fundamental to ensure the existence of a static feedback linearizing control law. Some relaxations are discussed in the literature, however these are only applicable to systems with particular structures. Addressing the problem considering these structures is beyond the scope of this work and we consider only the cases of systems that can be feedback linearized with static conditions.

Following the procedure as described in (ISIDORI, 1995), we chose the output  $y_i = h_i(x)$ , with  $i \in \{1, 2, \dots, n_y\}$ . Taking the first time derivative results in

$$\begin{aligned} \dot{y}_i &= \frac{dh_i(x)}{dt} = \frac{\partial h_i}{\partial x} f(x) + \frac{\partial h_i}{\partial x} g(x)u \\ &= \mathcal{L}_f h_i(x) + \mathcal{L}_g h_i(x)u \end{aligned} \quad (5.3)$$

where  $\mathcal{L}_g h_i(x)u = \sum_{j=1}^{n_u} \mathcal{L}_{g_j} h_i(x)u_j$  and  $\mathcal{L}_{g_j} h_i(x)$  is the Lie derivative along the  $j$ -th column of  $g(x)$ . Assume that  $\mathcal{L}_g h_i(x) = 0$ , for  $\forall x \in \mathcal{X}$ , the derivative of  $y_i$  is taken until the control input appears, leading to  $y_i^{(r_i)} = \mathcal{L}_f^{(r_i)} h_i(x) + \mathcal{L}_g \mathcal{L}_f^{(r_i-1)} h_i(x)u$ , where  $\mathcal{L}_g \mathcal{L}_f^{(r_i-1)} h_i(x) \neq 0$  and  $y_i^{(r_i)}$  is the  $r_i$ -th time derivative of  $y_i$ . Repeating the outlined procedure to all outputs, we can group all equations in the form

$$\begin{bmatrix} y_1^{(r_1)} \\ y_2^{(r_2)} \\ \vdots \\ y_{n_y}^{(r_{n_y})} \end{bmatrix} = \begin{bmatrix} \mathcal{L}_f^{(r_1)} h_1(x) \\ \mathcal{L}_f^{(r_2)} h_2(x) \\ \vdots \\ \mathcal{L}_f^{(r_{n_y})} h_{n_y}(x) \end{bmatrix} + \begin{bmatrix} \mathcal{L}_g \mathcal{L}_f^{(r_1-1)} h_1(x) \\ \mathcal{L}_g \mathcal{L}_f^{(r_2-1)} h_2(x) \\ \vdots \\ \mathcal{L}_g \mathcal{L}_f^{(r_{n_y}-1)} h_{n_y}(x) \end{bmatrix} u, \quad (5.4)$$

defining  $\alpha_i(x) = \mathcal{L}_f^{(r_i)}$  and  $\gamma_i = \mathcal{L}_g \mathcal{L}_f^{(r_i-1)}$  we rewrite (5.4) as

$$\begin{bmatrix} y_1^{(r_1)} \\ y_2^{(r_2)} \\ \vdots \\ y_{n_y}^{(r_{n_y})} \end{bmatrix} = \begin{bmatrix} \alpha_1(x) + \gamma_1(x)u \\ \alpha_2(x) + \gamma_2(x)u \\ \vdots \\ \alpha_{n_y}(x) + \gamma_{n_y}(x)u \end{bmatrix} = \alpha(x) + \gamma(x)u. \quad (5.5)$$

The number of derivatives  $r_{n_i}$ , required for the control input to appear for the first time in  $y_i^{n_i}$  is called the relative degree of the output  $y_i$ . The sum of all relative degrees will define the relative degree of the system and will be important to find the diffeomorphism  $T(x)$  from Definition 5.1. Moreover, as a requirement to perform the linearization, we assume the following regarding  $\gamma(x)$

**Assumption 5.2.** The matrix  $\gamma(x)$  is assumed to be non-singular for all  $x \in \mathcal{X}$

**Remark 5.2.** This assumption can be relaxed assuming that  $\gamma(0)$  is non singular. Since  $\gamma(x)$  is continuous, there exists a neighborhood of the origin  $\mathcal{X}_0$  that is a subset of  $\mathcal{X}$  such that  $\gamma(x)$  is non-singular for all  $x \in \mathcal{X}_0$ . In this case the linearization is only valid in  $\mathcal{X}_0$ .

Before the next step we present a simple example to illustrate the procedure so far.

### Illustrative example part 1 – System and derivatives

Consider the following nonlinear MIMO system

$$\begin{cases} \dot{x}_1 = x_2 \\ \dot{x}_2 = x_1^2 + x_2^2 + u_1 + x_2 u_2 \\ \dot{x}_3 = -x_1 + \sin(x_3) + u_2 \\ y_1 = x_1 \\ y_2 = x_3. \end{cases} \quad (5.6)$$

In this case, the approach is straightforward as the system is already in the feedback linearized form. To verify, we take the time derivative of  $y_1$  and  $y_2$ , which results in

$$\begin{aligned} \dot{y}_1 &= \dot{x}_1 = x_2 \\ \dot{y}_2 &= \dot{x}_3 = -x_1 + \sin(x_3) + u_2 \end{aligned} \quad (5.7)$$

Notice the control input  $u_2$  already appeared in the first derivative of  $y_2$ , thus  $r_2 = 1$  (the relative degree of output  $y_2$ ). For  $y_1$ , differentiating it once more give us

$$\ddot{y}_1 = \dot{x}_2 = x_1^2 + x_2^2 + u_1 + x_2 u_2 \quad (5.8)$$

where both control inputs  $u_1$  and  $u_2$  appear. Since the procedure stopped at the second derivative of  $y_1$ , then  $r_1 = 2$  (the relative degree of output  $y_1$ ). As the control input is

achieved for both outputs, the procedure is finished and we have that

$$\begin{bmatrix} \ddot{y}_1 \\ \dot{y}_2 \end{bmatrix} = \underbrace{\begin{bmatrix} x_1^2 + x_2^2 \\ -x_1 + \sin(x_3) \end{bmatrix}}_{\alpha(x)} + \underbrace{\begin{bmatrix} 1 & x_2 \\ 0 & 1 \end{bmatrix}}_{\gamma(x)} \begin{bmatrix} u_1 \\ u_2 \end{bmatrix} \quad (5.9)$$

This example will be recalled in subsequent steps of the feedback linearization procedure

The next step is to find a diffeomorphism  $T(x)$  that maps the nonlinear system (5.1) into the linear system (5.2), i.e., find  $T(x)$  such that

$$\dot{x} = f(x) + g(x)u \xleftrightarrow{T(x)} \dot{z} = Az + B[\alpha(x) + \gamma(x)u], \quad (5.10)$$

Considering each output and its derivatives, a transformation can be achieved by considering  $y_i^{(j)}$  for  $j = 0, \dots, r_i - 1$  as states of the transformed system, thus, we can write

$$z_i = \psi_i(x) = \begin{bmatrix} y_i \\ \dot{y}_i \\ \vdots \\ y_i^{(r_i-1)} \end{bmatrix}, \quad (5.11)$$

with  $z_i = \text{col}\{z_{i,1}, z_{i,2}, \dots, z_{i,r_i}\}$  the linearized states. Differentiating  $z_i$  with respect to the time, it follows from (5.5) and (5.11) that

$$\dot{z}_i = \begin{bmatrix} \dot{y}_i \\ \ddot{y}_i \\ \vdots \\ y_i^{(r_i)} \end{bmatrix} = \begin{bmatrix} z_{i,2} \\ z_{i,3} \\ \vdots \\ \alpha_i(x) + \gamma_i(x)u \end{bmatrix}. \quad (5.12)$$

which can finally be written as

$$\begin{aligned} \dot{z}_i &= A_i z_i + B_i [\alpha_i(x) + \gamma_i(x)u] \\ y_i &= C_i z_i \end{aligned} \quad (5.13)$$

where

$$A_i = \begin{bmatrix} 0 & 1 & 0 & \dots & 0 \\ \vdots & \vdots & \vdots & \ddots & \vdots \\ 0 & 0 & 0 & \dots & 1 \\ 0 & 0 & 0 & \dots & 0 \end{bmatrix}, \quad B_i = \begin{bmatrix} 0 \\ \vdots \\ 0 \\ 1 \end{bmatrix}, \quad C_i = [1 \ 0 \ \dots \ 0]. \quad (5.14)$$

**Illustrative example part 2 – Transformation**

Recalling (5.8) in the illustrative example, the first and second derivatives of  $y_1$  are

$$\begin{aligned}\dot{y}_1 &= x_2 \\ \ddot{y}_1 &= x_1^2 + x_2^2 + u_1 + x_2 u_2\end{aligned}\quad (5.15)$$

thus, the transformation regarding output  $y_1$  is

$$z_1 = \psi_i(x) = \begin{bmatrix} y_1 \\ \dot{y}_1 \end{bmatrix} = \begin{bmatrix} x_1 \\ x_2 \end{bmatrix}\quad (5.16)$$

that is  $\psi_i(x) = x$ . Hence, for  $y_1$  and its derivative we can write

$$\dot{z}_1 = \underbrace{\begin{bmatrix} 0 & 1 \\ 0 & 0 \end{bmatrix}}_{A_1} z_1 + \underbrace{\begin{bmatrix} 0 \\ 1 \end{bmatrix}}_{B_1} \left( \underbrace{(x_1^2 + x_2^2)}_{\alpha_1(x)} + \underbrace{\begin{bmatrix} 1 & x_1 \end{bmatrix}}_{\gamma_1(x)} u \right)\quad (5.17)$$

repeating the same steps for output  $y_2$  gives

$$z_2 = \underbrace{-x_1 + \sin(x_3)}_{\alpha_2(x)} + \underbrace{\begin{bmatrix} 0 & 1 \end{bmatrix}}_{\gamma_2(x)} u\quad (5.18)$$

where  $A_2 = 0$  and  $B_2 = 1$ .

As previously commented the system relative degree is given by  $r = \sum_{i=1}^{n_y} r_i$  where  $r_i$  is the relative degree of each output. Depending of its value, two cases can be distinguished for control design: i) full feedback linearization ( $r = n_x$ ), and ii) partial feedback linearization ( $r < n_x$ ).

**Case 1:** If  $r = n_x$ , then system (5.1) is fully feedback linearizable and the transformation can be defined as  $z = \psi(x)$  where  $z = \text{col}\{z_1, z_2, \dots, z_{n_y}\}$  represents the states of the linearized dynamics. Thus the transformed system can be defined from (5.13) as

$$\begin{aligned}\dot{z} &= Az + B[\alpha(x) + \gamma(x)u] \\ y &= Cz\end{aligned}\quad (5.19)$$

with matrices  $A = \text{diag}(A_1, A_2, \dots, A_{n_y})$ ,  $B = \text{diag}(B_1, B_2, \dots, B_{n_y})$  and  $C = \text{diag}(C_1, C_2, \dots, C_{n_y})$ .

**Illustrative example part 3**

For the illustrative example the output relative degrees are  $r_1 = 2$  and  $r_2 = 1$  hence the system relative degree is  $r = 3$ , which is equal to the number of states, therefore the system is fully feedback linearizable. From (5.17) and (5.18) we have

that the diffeomorphism is  $T(x) = x$  and

$$A = \left[ \begin{array}{c|c} A_1 & 0 \\ \hline 0 & A_2 \end{array} \right] = \left[ \begin{array}{cc|c} 0 & 1 & 0 \\ 0 & 0 & 1 \\ \hline 0 & 0 & 0 \end{array} \right], \quad B = \left[ \begin{array}{c|c} B_1 & 0 \\ \hline 0 & B_2 \end{array} \right] = \left[ \begin{array}{c|c} 0 & 0 \\ \hline 1 & 0 \\ \hline 0 & 1 \end{array} \right] \quad (5.20)$$

$$\alpha(x) = \begin{bmatrix} \alpha_1(x) \\ \alpha_2(x) \end{bmatrix} = \begin{bmatrix} x_1^2 + x_2^2 \\ -x_1 + \sin(x_3) \end{bmatrix}, \quad \gamma(x) = \begin{bmatrix} \gamma_1(x) \\ \gamma_2(x) \end{bmatrix} = \begin{bmatrix} 1 & x_2 \\ 0 & 1 \end{bmatrix}$$

**Case 2:** If  $r < n_x$ , then the system (5.1) is partially feedback linearizable. In this case an extended transformation  $T : \mathcal{X} \rightarrow \mathcal{S}$  can be defined as

$$s = \begin{bmatrix} \eta \\ \vdots \\ z \end{bmatrix} = T(x) = \begin{bmatrix} \phi(x) \\ \psi(x) \end{bmatrix} = \begin{bmatrix} \phi_1(x) \\ \vdots \\ \phi_{n_x-r}(x) \\ \psi_1(x) \\ \vdots \\ \psi_{n_y}(x) \end{bmatrix}, \quad (5.21)$$

where  $\mathcal{S}$  is a compact set. The functions  $\phi_i(x)$  for  $i \in \{1, 2, \dots, n_x - r\}$  are selected such that  $T(x)$  is a diffeomorphism and

$$\frac{\partial \phi_i}{\partial x} g(x) = 0. \quad (5.22)$$

Then, the nonlinear system (5.1) can be transformed as

$$\begin{aligned} \dot{\eta} &= f_0(\eta, z) \\ \dot{z} &= Az + B[\alpha(x) + \gamma(x)u] \\ y &= Cz \end{aligned} \quad (5.23)$$

where  $f_0(\eta, z)$  and  $\eta$ , represents the system internal dynamic and internal dynamics states (KHALIL, 2002). For event-triggered control design purposes this non-observable dynamic is assumed to be exponentially stable.

**Remark 5.3.** As stated in (ISIDORI, 1995), due to Assumption (5.1) (involutive assumption), it is possible to find functions  $\phi_i$  for  $i \in \{1, 2, \dots, n_x - r\}$  such that  $T(x)$  is a diffeomorphism and the conditions  $\frac{\partial \phi_i}{\partial x} g(x) = 0$  hold.

## 5.2.2 Event-triggered feedback linearization control

For the transformed systems (5.19) and (5.23), the event-triggered feedback control law is defined as

$$u_k = u(x_k) = \gamma(x_k)^{-1}[Kz_k - \alpha(x_k)], \quad \forall t \in [t_k, t_{k+1}), \quad k \in \mathbb{N}, \quad (5.24)$$

where  $z_k$  and  $x_k$  are time samples of  $z$  and  $x$  at sampling instants  $t_k$  that are held constant until the next sampling. The feedback gain  $K$  is a matrix of appropriate dimension to be determined.

#### Illustrative example part 4 – Linearizing control input

Considering the expression (5.24) the linearizing control law for system (5.6) is

$$u_k = \underbrace{\begin{bmatrix} 1 & -x_{2,k} \\ 0 & 1 \end{bmatrix}}_{\gamma(x_k)^{-1}} \left( Kz_k - \underbrace{\begin{bmatrix} x_{1,k}^2 + x_{2,k}^2 \\ -x_{1,k} - \sin(x_{3,k}) \end{bmatrix}}_{\alpha(x_k)} \right) \quad (5.25)$$

Applying the control law (5.24), the closed-loop linearized dynamics in (5.19) and (5.23) are defined as

$$\dot{z} = Az + B[\alpha(x) + \gamma(x)\gamma(x_k)^{-1}(Kz_k - \alpha(x_k))], \quad (5.26)$$

which, by adding a null term, can be written in the form

$$\begin{aligned} \dot{z} &= Az + B[\alpha(x) + \gamma(x)\gamma(x_k)^{-1}(Kz_k - \alpha(x_k)) \\ &\quad + \gamma(x_k)\gamma(x_k)^{-1}(Kz_k - \alpha(x_k)) - \gamma(x_k)\gamma(x_k)^{-1}(Kz_k - \alpha(x_k))] \\ &= Az + BKz_k + B(\alpha(x) - \alpha(x_k)) + B(\gamma(x) - \gamma(x_k))\gamma(x_k)^{-1}(Kz_k - \alpha(x_k)). \end{aligned} \quad (5.27)$$

Finally, defining the mismatch terms  $\Delta\alpha(x) = \alpha(x) - \alpha(x_k)$ ,  $\Delta\gamma(x) = \gamma(x) - \gamma(x_k)$  and the error  $e_z = z - z_k$ , system (5.27) can be rewritten as

$$\dot{z} = (A + BK)z - BKe_z + B\Delta\alpha(x) + B\Delta\gamma(x)u_k. \quad (5.28)$$

For the case of partial feedback linearization (i.e.,  $r < n_x$ ), since the transformation  $T(\cdot)$  defined in (5.21) is a diffeomorphism, there is an inverse  $T^{-1} : \mathcal{S} \rightarrow \mathcal{X}$  with  $x = T^{-1}(s)$ . As a result, the system nonlinearities  $\alpha(x)$  and  $\gamma(x)$  can be rewritten as  $F(s) = \alpha(T^{-1}(s))$  and  $G(s) = \gamma(T^{-1}(s))$ . Hence, the closed-loop system (5.28) can be represented as

$$\dot{z} = (A + BK)z - BKe_z + B\Delta F(s) + B\Delta G(s)u_k, \quad (5.29)$$

where  $\Delta F(s) = F(s) - F(s_k)$  and  $\Delta G(s) = G(s) - G(s_k)$ . Note that for this case (partial feedback linearization), the mismatches depend on both internal and linearized dynamics of system (5.23). Also, system (5.29) can be easily adapted for the case of fully feedback linearization (i.e.,  $r = n_x$ ) by making  $s = z$ .

### 5.3 Problem formulation

This section first presents a method to convexly rewrite the nonlinear mismatch term  $\Delta F(s)$  in a polytopic representation. Next an event-triggered condition is proposed con-

sidering the effect of  $\Delta G(s)u_k$ . Finally the event-triggered design control problem is formulated.

### 5.3.1 Polytopic representation of $\Delta F(s)$

As a result of the smoothness of functions  $f(x)$ ,  $g(x)$  and  $h(x)$  and considering that  $T(s)$  is a diffeomorphism, the function  $F(s)$  is continuously differentiable for  $s \in \mathcal{S}$ . Let  $J_F(\cdot)$  be the Jacobian matrix of  $F(\cdot)$  and let us define  $e_s = s - s_k$ . From the fundamental theorem of calculus, it follows that

$$\begin{aligned}
 \Delta F(s) &= F(s) - F(s_k) = - \int_0^1 \frac{dF(s - \tau e_s)}{d\tau} d\tau \\
 &= - \int_0^1 J_F(s - \tau e_s) \frac{d(s - \tau e_s)}{d\tau} d\tau \\
 &= - \int_0^1 J_F(s - \tau e_s) (-e_s) d\tau \\
 &= \left( \int_0^1 J_F(s - \tau e_s) d\tau \right) e_s \\
 &= \underbrace{\left( \int_0^1 J_F(s - \tau(s - s_k)) d\tau \right)}_{\mathcal{A}(s, s_k)} e_s.
 \end{aligned} \tag{5.30}$$

where  $\tau \in [0, 1]$  and the integral is element-wise. Notice that  $\mathcal{A}(s, s_k)e_s$  only requires computing an integral that can be done by a symbolic software. For the purpose of achieving the polytopic form of  $\Delta F(s)$  we consider the following assumption for  $J_F(\cdot)$ .

**Assumption 5.3.** Let  $\mathcal{S} = T(\mathcal{X})$  be the set of interest after transformation and let  $\bar{\mathcal{S}}$  be a given convex set that contains  $\mathcal{S}$  ( $\mathcal{S} \subseteq \bar{\mathcal{S}}$ ). The Jacobian matrix  $J_F(\cdot)$  can be represented in the polytopic form

$$J_F(s) = \sum_{i=1}^m v_i(s) M_i \tag{5.31}$$

where  $s \in \bar{\mathcal{S}}$  and  $v_m(s) \in \Upsilon_m$  with  $\Upsilon_m$  a unit simplex with  $m$  vertices is denoted as

$$\Upsilon_m = \left\{ v \in \mathbb{R}^m : \sum_{i=1}^m v_i = 1, \quad v_i \geq 0, \quad i = 1, \dots, m \right\}. \tag{5.32}$$

**Remark 5.4.** Due to the compactness assumption of  $\mathcal{X} \subset \mathbb{R}^{n_x}$ , the polytopic representation (5.31) can be obtained for a large class of systems. Since  $\mathcal{X}$  is compact and  $T(x)$  is a diffeomorphism, the set  $\mathcal{S}$  is also compact. Hence,  $\mathcal{S}$  can be always contained in a convex set. Moreover the polytopic representation (5.31) can be determined using the sector nonlinearity approach (TANAKA; WANG, 2001).

To exemplify the procedure of achieving a convex representation via sector nonlinearity, we recall to the illustrative example.



### Illustrative example part 5 – Jacobian Convex representation

Let us consider the set of interest  $\mathcal{X} = \{x \mid |x_i| \leq 2, i = 1, 2, 3\}$ . As previously defined, the diffeomorphism for system (5.6) is  $T(x) = x$  (i.e.,  $T^{-1}(s) = s$ ), therefore  $\mathcal{X} = \mathcal{S}$  and  $F(s) = \alpha(T^{-1}(s)) = \alpha(s)$ . Moreover, since the system is fully feedback linearizable it implies that  $z = s$  (no internal dynamics). As  $\mathcal{X}$  is already convex (and consequently  $\mathcal{S}$ ), we can choose the convex set  $\bar{\mathcal{S}}$  equal to  $\mathcal{S}$ .

From (5.20) we have that

$$F(z) = \alpha(x) = \begin{bmatrix} z_1^2 + z_2^2 \\ -z_1 + \sin(z_3) \end{bmatrix}, \quad (5.33)$$

and its Jacobian matrix is

$$J_F(z) = \begin{bmatrix} 2z_1 & 2z_2 & 0 \\ -1 & 0 & \cos(z_3) \end{bmatrix}. \quad (5.34)$$

Considering the sector nonlinearity approach explained in Chapter 2 Section 2.5, the functions are  $2z_1$ ,  $2z_2$  and  $\cos(z_3)$ . In the set  $\|z_i\| \leq 2$  for  $i = 1, 2, 3$  (set  $\bar{\mathcal{S}}$ ) we have that

$$-4 \leq 2z_1 \leq 4, \quad -4 \leq 2z_2 \leq 4, \quad \cos(2) \leq \cos(z_3) \leq 1. \quad (5.35)$$

Following the procedure described in Section 2.5 we can write those functions as

$$\begin{aligned} 2z_i &= \underbrace{\left(\frac{4 - 2z_i}{8}\right)}_{v_1^i(z)}(-4) + \underbrace{\left(\frac{2z_i + 4}{8}\right)}_{v_2^i(z)}(4) \quad i = 1, 2 \\ \cos(z_3) &= \underbrace{\left(\frac{1 - \cos(z_3)}{1 - \cos(2)}\right)}_{v_1^3(z)}(\cos(2)) + \underbrace{\left(\frac{\cos(z_3) - \cos(2)}{1 - \cos(2)}\right)}_{v_2^3(z)}(1) \end{aligned} \quad (5.36)$$

To write  $F(z)$  in a convex representation (5.31) we need to find the vertices  $M_i$  and  $v_i$ . For this purpose we evaluate  $J_F(z)$  for all possible combinations of maximum and minimum values of  $2z_1$ ,  $2z_2$  and  $\cos(z_3)$  for  $\|z_i\| \leq 2$ , which results in

$M_1 = \begin{bmatrix} -4 & -4 & 0 \\ -1 & 0 & \cos(2) \end{bmatrix},$ $v_1 = v_1^1 v_1^2 v_1^3$	$M_2 = \begin{bmatrix} 4 & -4 & 0 \\ -1 & 0 & \cos(2) \end{bmatrix},$ $v_2 = v_2^1 v_1^2 v_1^3$	(5.37)
$M_3 = \begin{bmatrix} -4 & 4 & 0 \\ -1 & 0 & \cos(2) \end{bmatrix},$ $v_3 = v_1^1 v_2^2 v_1^3$	$M_4 = \begin{bmatrix} 4 & 4 & 0 \\ -1 & 0 & \cos(2) \end{bmatrix},$ $v_4 = v_2^2 v_2^2 v_1^3$	
$M_5 = \begin{bmatrix} -4 & -4 & 0 \\ -1 & 0 & 1 \end{bmatrix},$ $v_5 = v_1^1 v_1^2 v_2^3$	$M_6 = \begin{bmatrix} 4 & -4 & 0 \\ -1 & 0 & 1 \end{bmatrix},$ $v_6 = v_2^2 v_1^2 v_2^3$	
$M_7 = \begin{bmatrix} -4 & 4 & 0 \\ -1 & 0 & 1 \end{bmatrix},$ $v_7 = v_1^1 v_2^2 v_2^3$	$M_8 = \begin{bmatrix} 4 & 4 & 0 \\ -1 & 0 & 1 \end{bmatrix}.$ $v_8 = v_2^2 v_2^2 v_2^3$	

Under Assumption 5.3, with  $\bar{\mathcal{S}}$  a chosen convex set such that  $\mathcal{S} \subseteq \bar{\mathcal{S}}$  where (5.30) holds, the following lemma is important to rewrite the mismatch  $\Delta F(s)$  in a convex representation.

**Lemma 5.1.** *Consider a convex set  $\bar{\mathcal{S}}$ . Let  $M(s)$ , be a matrix that can be represented in a polytopic form*

$$M(s) = \sum_{i=1}^m v_i(s) M_i, \quad v(s) \in \Upsilon_m, \quad (5.38)$$

for  $s \in \bar{\mathcal{S}}$ , where  $M_i$  are known vertices. Take

$$\epsilon_i(s, e_s) = \int_0^1 v_i(s - \tau e_s) d\tau \quad (5.39)$$

for  $i = 1, 2, \dots, m$ , then, it follows that

$$\int_0^1 M(s - \tau e_s) d\tau = \sum_{i=1}^m \epsilon_i(s, e_s) M_i, \quad (5.40)$$

and  $\epsilon(s, e_s)$  belongs to the unit simplex (i.e.,  $\epsilon(s, e_s) \in \Upsilon_m$ ).

*Proof.* It follows from the polytopic representation (5.38), by integrating both sides, that

$$\begin{aligned} \int_0^1 M(s - \tau e_s) d\tau &= \int_0^1 \left( \sum_{i=1}^m v_i(s - \tau e_s) M_i \right) d\tau = \sum_{i=1}^m \int_0^1 v_i(s - \tau e_s) d\tau M_i \\ &= \sum_{i=1}^m \epsilon_i(s, e_s) M_i. \end{aligned} \quad (5.41)$$

It remains to prove that  $\epsilon(s, e_s) \in \Upsilon_m$ . To this end it is required to prove that  $\epsilon_l(s, e_s) \geq 0$  for  $l = 1, \dots, m$  and that  $\sum_{i=1}^m \epsilon_i(s, e_s) = 1$ .

1. Proof that  $\epsilon_l(s, e_s) \geq 0$ : Since  $\bar{\mathcal{S}}$  is a convex set, then  $(s - \tau e)$ , which is the line segment from  $s$  to  $s_k$ , also belongs to  $\bar{\mathcal{S}}$ . Since  $v(s) \in \Upsilon_m$  (belongs to a unity simplex) for any  $s \in \bar{\mathcal{S}}$ , then  $v_l(s - \tau e_s) \geq 0$ , which implies that

$$\int_0^1 v_l(s - \tau e_s) d\tau \geq 0. \quad (5.42)$$

2. Proof that  $\sum_{i=1}^m \epsilon_l(s, e_s) = 1$ : Since  $\xi(v) \in \Upsilon_m$ , then it follows that

$$\sum_{i=1}^m v_l(s - \tau e_s) = 1. \quad (5.43)$$

Integrating both sides of (5.43) for  $\tau \in [0, 1]$ , one has

$$\begin{aligned} \int_0^1 \sum_{i=1}^m v_l(s - \tau e_s) d\tau &= \int_0^1 1 d\tau \\ \sum_{i=1}^m \int_0^1 v_l(s - \tau e_s) d\tau &= \tau \Big|_0^1 \\ \sum_{i=1}^m \epsilon_l(s, e_s) &= 1. \end{aligned} \quad (5.44)$$

concluding the proof □

**Remark 5.5.** Notice that, for SISO systems, Lemma 5.1 is equivalent to the mean value theorem.

Applying Lemma 5.1 to  $\Delta F(s)$  under Assumption 5.3, it follows that

$$\Delta F(s) = M(\epsilon)e_s = \sum_{i=1}^m \epsilon_i(s, e_s) M_i e_s \quad (5.45)$$

with  $\epsilon(s, e_s) \in \Upsilon_m$ , allowing us to write (5.28) as

$$\dot{z} = (A + BK)z - BKe_z + BM(\epsilon)e_s + B\Delta G(s)u_k, \quad (5.46)$$

moreover, by decomposing  $M(\epsilon) = [M_\eta(\epsilon), M_z(\epsilon)]$ , we can rewrite (5.46) as

$$\dot{z} = (A + BK)z + B(M_z(\epsilon) - K)e_z + BM_\eta(\epsilon)e_\eta + B\Delta G(s)u_k. \quad (5.47)$$

with  $e_\eta = \eta - \eta_k$ . Note that in (5.47) the errors  $e_z$  and  $e_\eta$  are decoupled. As will be shown later, this property allows us to define a proper event triggering condition that can compensate for the effect of  $e_\eta$  caused by the internal dynamics.

### 5.3.2 Event-triggering mechanism

To compensate for both  $e_z$  and  $e_\eta$  and the mismatch  $\Delta G(s)u_k$ , the following event-triggering mechanism is proposed

$$\begin{aligned} t_0 &= 0 \\ t_{k+1} &= \inf\{t > t_k : \Gamma_0(s, e_s) > 0\} \end{aligned} \quad (5.48)$$

with

$$\Gamma_0(s, e_s) = -z^T R_1 z - \bar{\theta} \eta^T \eta + e_z^T Q_1 e_z + \gamma e_\eta^T e_\eta + u_k^T \Delta G(s)^T Q_2 \Delta G(s) u_k \quad (5.49)$$

where  $Q_1$ ,  $Q_2$ ,  $R_1$  are positive definite matrices of appropriate dimensions and  $\gamma$ ,  $\bar{\theta}$  positive scalars to be designed.

### 5.3.3 Problem statement

We consider the following event-triggered control problem.

**Problem 5.1.** Considering the nonlinear MIMO system (5.1), design an event-triggered control law (5.24) and event-triggering mechanism (5.48) such that the closed-loop system (5.47) is asymptotically stable.

The following lemma is required for the proof of the main theorems presented in Section 5.4.

**Lemma 5.2** (Converse Theorem (KHALIL, 2002)). *Consider the internal dynamics  $\dot{\eta} = f_0(\eta, z)$  in (5.23). If the zero dynamics  $f_0(\eta, 0)$  is exponentially stable, then there is a continuously differentiable Lyapunov function  $V_\eta(\eta)$  and positive scalars  $a_1$  and  $a_2$  such that the following conditions hold:*

$$\frac{\partial V_\eta}{\partial \eta} f_0(\eta, 0) \leq -a_1 \|\eta\|^2 \quad (5.50)$$

$$\left\| \frac{\partial V_\eta}{\partial \eta} \right\| \leq a_2 \|\eta\| \quad (5.51)$$

in some neighborhood of  $\eta = 0$ .

## 5.4 Results

First we introduce the theorem for event-triggered control design for the general case of partial feedback linearization. Then conditions that ensure the existence of a lower bound for IET are established. Finally, particular cases of fully feedback linearization and constant  $\gamma(x)$  are discussed.

### 5.4.1 General case: Partial feedback linearization

The following theorem presents sufficient conditions to ensure the asymptotic stability of system (5.29).

**Theorem 5.1.** *Let  $\mathcal{E}$  and  $\mathcal{Z}$  be compact neighborhoods of  $\eta = 0$  and  $z = 0$ , respectively, with  $\mathcal{E} \times \mathcal{Z} \subseteq \mathcal{S}$ . Consider system (5.23), where  $f_0(\eta, 0)$  is exponentially stable for all*

$\eta \in \mathcal{E}$ . If there exist a positive definite function  $V_z(z)$  for system (5.23), and a positive scalar  $\bar{\rho}$  such that

$$\dot{V}_z(z) - \Gamma_1(s, e_s) < -\bar{\rho}z^T z, \quad (5.52)$$

holds for all  $s \in \mathcal{E} \times \mathcal{Z}$ , where  $\Gamma_1 = \Gamma_0 + \bar{\theta}\eta^T \eta$ , with  $\Gamma_0$  defined in (5.49), or equivalently,

$$\Gamma_1(s, e_s) = -z^T R_1 z + e_z^T Q_1 e_z + \gamma e_\eta^T e_\eta + u_k^T \Delta G(s)^T Q_2 \Delta G(s) u_k, \quad (5.53)$$

then the closed-loop system (5.29) is asymptotically stable under control law (5.24) and event-triggering mechanism (5.48), where

$$\bar{\theta} = \frac{a_1 \theta}{\sigma} \quad (5.54)$$

$$\sigma > \frac{a_2^2 L_f^2}{4a_1(1-\theta)\bar{\rho}}, \quad (5.55)$$

with  $\theta$  a positive scalar in the range  $(0, 1)$ , and  $L_f$  being a Lipschitz constant for  $f_0(\eta, \cdot)$ .

*Proof.* For simplicity of notation, throughout this proof, we will write simply  $V_\eta$ ,  $V_z$ ,  $\Gamma_0$  and  $\Gamma_1$  when no confusion can arise. Let us define  $V_s = V(\eta, z) = V_\eta + \sigma V_z$ , where the Lyapunov function  $V_\eta$  satisfies the conditions from Lemma 5.2. Taking the time derivative of  $V_s$  yields

$$\dot{V}_s = \frac{\partial V_\eta}{\partial \eta} f_0(\eta, z) + \sigma \dot{V}_z \quad (5.56)$$

$$= \frac{\partial V_\eta}{\partial \eta} f_0(\eta, 0) + \frac{\partial V_\eta}{\partial \eta} (f_0(\eta, z) - f_0(\eta, 0)) + \sigma \dot{V}_z \quad (5.57)$$

$$\leq -a_1 \|\eta\|^2 + L_f a_2 \|\eta\| \|z\| + \sigma \dot{V}_z \quad (5.58)$$

where (5.58) is attained from conditions (5.50), (5.51) and Lipschitz condition.

It follows from (5.58), the definitions of  $\Gamma_0$  in (5.49) and  $\Gamma_1$  in (5.53), and  $\bar{\theta}$  in (5.54) that

$$\begin{aligned} \dot{V}_s - \sigma \Gamma_0 &\leq -a_1 \|\eta\|^2 + L_f a_2 \|\eta\| \|z\| + \sigma \dot{V}_z - \sigma \Gamma_0 \\ &= -a_1 \|\eta\|^2 + L_f a_2 \|\eta\| \|z\| + \sigma \bar{\theta} \eta^T \eta + \sigma (\dot{V}_z - \Gamma_1) \\ &< -a_1 \left(1 - \frac{\sigma \bar{\theta}}{a_1}\right) \|\eta\|^2 + L_f a_2 \|\eta\| \|z\| - \sigma \bar{\rho} \|z\|^2 \\ &= -a_1(1-\theta) \|\eta\|^2 + L_f a_2 \|\eta\| \|z\| - \sigma \bar{\rho} \|z\|^2 \end{aligned} \quad (5.59)$$

with  $\theta$  defined in (5.54). Completing the squares on the right-hand side of (5.59), it follows that

$$\dot{V}_s - \sigma \Gamma_0 < - \left( \sqrt{a_1(1-\theta)} \|\eta\| - \sqrt{\sigma \bar{\rho}} \|z\| \right)^2 - \left( 2\sqrt{a_1(1-\theta)} \sqrt{\sigma \bar{\rho}} - L_f a_2 \right) \|\eta\| \|z\| \quad (5.60)$$

Choosing  $\sigma$  such in (5.55), we have  $2\sqrt{a_1(1-\theta)} \sqrt{\sigma \bar{\rho}} - L_f a_2 > 0$ . Combining with (5.60) we conclude that

$$\dot{V}(\eta, z) - \sigma \Gamma_0 < 0. \quad (5.61)$$

Since condition (5.61) holds for all  $(\eta, z) \in \mathcal{E} \times \mathcal{Z}$ , it follows from (5.61) that  $\dot{V}(\eta, z) < 0$  whenever  $\Gamma_0 < 0$ . The proof is concluded.  $\square$

Based on the results in Theorem 5.1, the next theorem provides an LMI-based optimization problem to design the parameters  $K$  in (5.24), and  $Q_1, Q_2, R_2, \gamma$  from event-triggering mechanism (5.48).

**Theorem 5.2.** *Consider the partially feedback linearized dynamics (5.23), where  $f_0(\eta, 0)$  is exponentially stable, and the event-triggered controller (5.24). For given positive scalars  $\delta, \rho$  and vertices  $M_i = [M_{\eta,i}, M_{z,i}]$  of  $J_F(\cdot)$  as defined in (5.38), if there exist a matrix  $Y$ , positive definite matrices  $P, \bar{Q}_1, Q_2$  and  $\bar{R}_1$  of appropriate dimensions, and a positive scalar  $\gamma$ , solutions to the optimization problem*

$$\min \text{Tr}(\bar{Q}_1) + \text{Tr}(Q_2) \quad (5.62)$$

s.t.

$$\begin{bmatrix} \text{He}\{AP + BY\} + \bar{R}_1 + \rho P & B(M_{z,i}P - Y) & B & BM_{\eta,i} \\ * & -\bar{Q}_1 & 0 & 0 \\ * & * & -Q_2 & 0 \\ * & * & * & -\gamma I \end{bmatrix} \prec 0, \quad (5.63)$$

$$\bar{R}_1 - \delta I \succ 0, \quad (5.64)$$

for  $i = 1, \dots, m$  then the closed-loop system (5.29) is asymptotically stable under the event-triggered control law (5.24) and feedback gain  $K = YP^{-1}$ , i.e., condition (5.52) is satisfied with

$$V_z(z) = z^T P^{-1} z, \quad Q_1 = P^{-1} \bar{Q}_1 P^{-1}, \quad R_1 = P^{-1} \bar{R}_1 P^{-1}. \quad (5.65)$$

*Proof.* Let us choose a Lyapunov function  $V_z(z) = z^T P^{-1} z$ , where  $P$  is a positive definite matrix. From the closed-loop equation (5.47), the condition (5.52) (i.e.,  $\dot{V}_z - \Gamma_1 < 0$ ) and the definition of  $\Gamma_1(s, e_s)$  in (5.53), it follows that

$$\begin{aligned} \dot{V}_z(z) - \Gamma_1(s, e_s) &= ((A + BK)z - (M_z(\epsilon) - K)e_z + BM_\eta(\epsilon)e_\eta + B\Delta G(s)u_k)^T P^{-1} z \\ &\quad + z^T P^{-1} ((A + BK)z - (M_z(\epsilon) - K)e_z + BM_\eta(\epsilon)e_\eta + B\Delta G(s)u_k) \\ &\quad + z^T R_1 z - e_z^T Q_1 e_z - \gamma e_\eta^T e_\eta - (\Delta G(s)u_k)^T Q_2 (\Delta G(s)u_k) < -\bar{\rho} z^T z \end{aligned} \quad (5.66)$$

for  $s \neq 0$ . Notice that making  $\dot{V}_z(z) - \Gamma_1(s, e_s) < -\rho z^T P^{-1} z^T$  implies in condition (5.52) with  $\bar{\rho} = \rho \lambda_{\min}(P^{-1})$ . Moreover, following LMI condition

$$\begin{bmatrix} \text{He}(P^{-1}(A + BK)) + R_1 + \rho P^{-1} & P^{-1} B M_z(\epsilon) - P^{-1} B K & P^{-1} B & P^{-1} B M_\eta(\epsilon) \\ * & -Q_1 & 0 & 0 \\ * & * & -Q_2 & 0 \\ * & * & * & -\gamma I \end{bmatrix} \prec 0. \quad (5.67)$$

is sufficient to ensure  $\dot{V}_z(z) - \Gamma_1(s, e_s) < -\rho z^T P^{-1} z^T$ . Multiplying (5.67) on the right and on the left by  $\text{diag}(P, P, I, I)$  leads to

$$\begin{bmatrix} \text{He}((A + BK)P) + PR_1P + \rho P & BM_z(\epsilon)P - BKP & BP & BM_\eta(\epsilon) \\ * & -PQ_1P & 0 & 0 \\ * & * & -Q_2 & 0 \\ * & * & * & -\gamma I \end{bmatrix} \prec 0 \quad (5.68)$$

Hence, by defining  $Y = KP$ ,  $\bar{Q}_1 = PQ_1P$ ,  $\bar{R}_1 = PR_1P$  and from the convex property of the polytopic representation of  $M_z(z)$  and  $M_\eta(\eta)$ , it is sufficient that

$$\begin{bmatrix} \text{He}(AP + BY) + \bar{R}_1 + \bar{\rho}P & BM_{z,i}P - BY & BP & BM_{\eta,i} \\ * & -\bar{Q}_1 & 0 & 0 \\ * & * & -Q_2 & 0 \\ * & * & * & -\gamma I \end{bmatrix} \prec 0 \quad (5.69)$$

for all  $i = 1, \dots, m$  to ensure (5.68).

The proof is then concluded.  $\square$

**Remark 5.6.** Condition (5.63) and the selected cost function  $\text{Tr}(\bar{Q}_1) + \text{Tr}(\bar{Q}_2)$  in (5.62) are used for IET maximization. Looking at the event triggering condition (5.49), to maximize the inter event time, the magnitude of  $R_1$  should be large whereas the magnitudes of  $Q_1$  and  $Q_2$  should be small.

#### 5.4.2 Particular cases: Full feedback linearization

The case of full feedback linearization can be seen as a particular case of partial feedback linearization where  $f_0(\eta, z) = 0$  in (5.23) and system relative degree  $r = n_x$ . Then, system (5.23) reduces to (5.19) and the closed-loop system (5.47) is reduced to

$$\dot{z} = (A + BK)z - BKe_z + BM_z(\epsilon)e_z + B\Delta G(z)u_k. \quad (5.70)$$

For system (5.70),  $e_\eta$  and  $\eta$  are not required for the event-triggering mechanism, which can be redefined as

$$t_{k+1} = \inf\{t > t_k : -z^T R_1 z + e_z^T Q_1 e_z + u_k^T \Delta G(s)^T Q_2 \Delta G(s) u_k > 0\}. \quad (5.71)$$

From the results of Theorem 5.1 and Theorem 5.2, the following corollary provides sufficient conditions to guarantee the asymptotic stability of system (5.70).

**Corollary 5.1.** *Consider the fully feedback linearized dynamics (5.19), and the event-triggered control law (5.24) with triggering condition (5.71). For given positive scalars  $\delta$ ,  $\rho$  and matrices  $M_i = M_{z,i}$  of  $J_F(\cdot)$  as in (5.31), if there exist a matrix  $Y$ , positive matrices  $W$ ,  $\bar{Q}_1$ ,  $Q_2$  and  $\bar{R}_1$  of appropriate dimensions, solution to the optimization problem*

$$\min \text{Tr}(\bar{Q}_1) + \text{Tr}(Q_2) \quad (5.72)$$

such that (5.64) and

$$\begin{bmatrix} \text{He}\{AP + BY\} + \bar{R}_1 + \rho P & B(M_{z,i}P - Y) & B \\ * & -\bar{Q}_1 & 0 \\ * & * & -Q_2 \end{bmatrix} \prec 0 \quad (5.73)$$

for  $i = 1, \dots, m$  then the closed-loop system (5.70) is asymptotically stable under the event-triggering mechanism (5.71) with  $Q_1 = P^{-1}\bar{Q}_1P^{-1}$ ,  $R_1 = P^{-1}\bar{R}_1P^{-1}$ . Moreover, the feedback gain is defined as  $K = YP^{-1}$ .

Further assuming that  $\gamma(x)$  is constant, then the fully feedback linearized dynamics (5.19) reduces to

$$\dot{z} = (A + BK)z - BKe_z + BM_z(\epsilon)e_z. \quad (5.74)$$

Moreover, the event-triggering mechanism corresponding to system (5.74) is defined as

$$t_{k+1} = \inf\{t > t_k : -z^T R_1 z + e_z^T Q_1 e_z > 0\}. \quad (5.75)$$

Therefore, the following result can be derived from Corollary 5.1 to guarantee the asymptotic stability of system (5.74).

**Corollary 5.2.** Consider the fully feedback linearized dynamics (5.19), with  $\gamma(x)$  constant, and the event-triggered controller (5.24). For given positive scalar  $\delta$ ,  $\rho$  and vertices  $M_i = M_{z,i}$  of  $J_F(\cdot)$  as in (5.31), if there exist a matrix  $Y$  and positive matrices  $W$ ,  $\bar{Q}_1$  and  $\bar{R}_1$  of appropriate dimensions, solution to the optimization problem.

$$\min \text{Tr}(\bar{Q}_1) \quad (5.76)$$

such that (5.64) and

$$\begin{bmatrix} \text{He}(AP + BY) + \bar{R}_1 + \rho P & B(M_{z,i}P - Y) \\ * & -\bar{Q}_1 \end{bmatrix} \prec 0, \quad i = 1, \dots, m \quad (5.77)$$

$$(5.78)$$

for  $i = 1, \dots, m$  then the closed-loop system (5.74) is asymptotically stable under the event-triggering mechanism (5.75) with  $Q_1 = P^{-1}\bar{Q}_1P^{-1}$ ,  $R_1 = P^{-1}\bar{R}_1P^{-1}$ . Moreover, the feedback gain is defined as  $K = YP^{-1}$ .

**Remark 5.7.** Minimizing the IETs via LMI-based optimization may lead to a feedback gain  $K$  with an excessively large magnitude. To prevent this numerical issue, an additional LMI constraint can be included in the optimization problems

$$\begin{bmatrix} \kappa^2 I & Y \\ * & P \end{bmatrix} \succ 0 \quad (5.79)$$



for some given  $\kappa > 0$ . Indeed, by Schur's complement (Lemma 2.10, Section 2.7), condition (5.79) is equivalent to

$$YP^{-1}Y^T - \kappa^2 I \prec 0. \quad (5.80)$$

Substituting  $Y = KP$ , it follows from inequality (5.80) that

$$KPK^T \prec \kappa^2 I \quad (5.81)$$

which leads to

$$\|K\| < \frac{\kappa}{\sqrt{\|P\|}} \quad (5.82)$$

Hence, LMI (5.79) guarantees an upper bound on the feedback gain magnitude.

### 5.4.3 Existence of a lower bound for the inter-event time (IET)

The design conditions in Theorem 5.1 guarantee asymptotic stability of the closed-loop system (5.29) under event-triggering mechanism (5.48). However, those conditions do not ensure the absence of Zeno behavior. Therefore, the following theorem provides sufficient conditions to guarantee a minimum positive inter-event time.

**Theorem 5.3.** *If the linearized system (5.23) is stabilizable by control law (5.24) with event triggering condition (5.48) and  $\gamma(x)$  and  $\alpha(x)$  are Lipschitz for all  $x \in \mathcal{X}$  then there is a positive lower bound for IET.*

*Proof.* First, since system (5.29) is assumed to be stable under controller (5.24) and event-triggering mechanism (5.48), then states are bounded. Additionally, since  $\mathcal{X}$  is compact, then  $T(x)$  and its inverse  $T^{-1}(s)$  verify the Lipschitz property on  $\mathcal{X}$  and  $\mathcal{S}$ , respectively. Hence  $\gamma(T^{-1}(s)) = G(s)$  and  $\alpha(T^{-1}(s)) = F(s)$  are Lipschitz on compact sets and  $u = u(x)$  is bounded.

From the event-triggering mechanism (5.48) and the definition of  $\Gamma_0(s, e_s)$  in (5.49), we have that  $\Gamma_0(s, e_s) < 0$  which implies

$$e_z^T Q_1 e_z + \gamma e_\eta^T e_\eta + u_k^T \Delta G(s)^T Q_2 \Delta G(s) u_k < z^T R_1 z + \bar{\theta} \eta^T \eta \quad (5.83)$$

Then, considering the left hand side of (5.83) we can define an upper bound as

$$\begin{aligned} & e_z^T Q_1 e_z + \gamma e_\eta^T e_\eta + u_k^T \Delta G(s)^T Q_2 \Delta G(s) u_k \\ & \leq \|e_z^T Q_1 e_z + \gamma e_\eta^T e_\eta + u_k^T \Delta G(s)^T Q_2 \Delta G(s) u_k\| \\ & \leq \|e_z^T Q_1 e_z\| + \|\gamma e_\eta^T e_\eta\| + \|u_k^T \Delta G(s)^T Q_2 \Delta G(s) u_k\| \\ & \leq \lambda_{\max}(Q_1) \|e_z\|^2 + \gamma \|e_\eta\|^2 + u_{\sup}^2 L_G^2 \lambda_{\max}(Q_2) \|e_s\|^2 \end{aligned} \quad (5.84)$$

where  $L_G$  is the Lipschitz constant for  $G(s)$  (i.e.,  $L_G$  is a constant such that  $\|G(s_k) - G(s)\| \leq L_G \|s - s_k\|$ ), and  $u_{\sup} = \sup_{x_k \in \mathcal{X}} \{\|u(x_k)\|\}$ . Notice that  $\|u(x_k)\|$  is bounded since

the closed-loop system is stable, and the solutions, between events, belong to a compact set. Moreover, since  $e_s = \text{col}\{e_z, e_\eta\}$ , note that  $\|e_s\|^2 = \|e_z\|^2 + \|e_\eta\|^2 \geq \|e_z\|^2$ , hence  $\|e_s\| \leq \|e_z\|$  and  $\|e_s\| \leq \|e_\eta\|$ ; therefore, from (5.84), it follows that

$$\begin{aligned} & e_z^T Q_1 e_z + \gamma e_\eta^T e_\eta + u_k^T \Delta G(s)^T Q_2 \Delta G(s) u_k \\ & \leq \lambda_{\max}(Q_1) \|e_s\|^2 + \gamma \|e_s\|^2 + u_{\text{sup}}^2 L_G^2 \lambda_{\max}(Q_2) \|e_s\|^2 \\ & = \sigma_1 \|e_s\|^2 \end{aligned} \quad (5.85)$$

with  $\sigma_1 = \lambda_{\max}(Q_1) + u_{\text{sup}}^2 L_G^2 \lambda_{\max}(Q_2) + \gamma$ . Performing a similar procedure to the right hand side of (5.83), we can define a lower bound as

$$z^T R_1 z + \bar{\theta} \eta^T \eta \geq \lambda_{\min}(R_1) \|z\|^2 + \bar{\theta} \|\eta\|^2 \geq \sigma_2 (\|z\|^2 + \|\eta\|^2) = \sigma_2 \|s\|^2 \quad (5.86)$$

where  $\sigma_2 = \min\{\lambda_{\min}(R_1), \bar{\theta}\}$ . From (5.85) and (5.86) a new event-triggering mechanism is defined as

$$t_{k+1} = \inf\{t > t_k : \|e_s\| - \sigma_s \|s\| > 0\} \quad (5.87)$$

with  $\sigma_s = \sqrt{\sigma_2/\sigma_1}$ . Note that condition (5.87) is more conservative than (5.48), i.e., it takes less time to be fulfilled than (5.48) (shorter inter event time). This condition is used to prove the existence of a lower bound for IET. Since this condition takes less time to trigger, a lower bound for it is also a lower bound for (5.48). Thus, taking the time derivative of the error  $e_z = z - z_k$ , for the time interval between events, it follows that  $\dot{e}_z = \dot{z}$ , which, from (5.29), give us

$$\begin{aligned} \dot{e}_z &= (A + BK)z - BK e_z + B[\Delta F(s) + \Delta G(s)u_k] \\ &= (A + BK)z_k + A e_z + B[\Delta F(s) + \Delta G(s)u_k] \\ &= \begin{bmatrix} 0 & A + BK \end{bmatrix} s_k + \begin{bmatrix} 0 & A \end{bmatrix} e_s + B[\Delta F(s) + \Delta G(s)u_k] \end{aligned} \quad (5.88)$$

By considering the norm of  $e_z$  it follows from (5.88) that

$$\begin{aligned} \|\dot{e}_z\| &= \left\| \begin{bmatrix} 0 & A + BK \end{bmatrix} s_k + \begin{bmatrix} 0 & A \end{bmatrix} e_s + B[\Delta F(s) + \Delta G(s)u_k] \right\| \\ &\leq \left\| \begin{bmatrix} 0 & A + BK \end{bmatrix} s_k \right\| + \left\| \begin{bmatrix} 0 & A \end{bmatrix} e_s \right\| + \|B\Delta F(s)\| + \|B\Delta G(s)u_k\| \\ &\leq \|A + BK\| \|s_k\| + \|A\| \|e_s\| + \|B\| L_F \|e_s\| + \|B\| L_G u_{\text{sup}} \|e_s\| \\ &= L_k \|s_k\| + L_z \|e_s\| \end{aligned} \quad (5.89)$$

with  $L_k = \|A + BK\|$ ,  $L_z = \|A\| + \|B\|(L_F + L_G u_{\text{sup}})$  and  $L_F$  is the Lipschitz constant for  $F(s)$  (i.e.,  $L_F$  is a constant such that  $\|F(s) - F(s_k)\| \leq L_F \|s - s_k\|$ ). Following similar steps for  $e_\eta = \eta - \eta_k$ , leads to  $\dot{e}_\eta = \dot{\eta} = f_0(\eta, z)$ , and

$$\|\dot{e}_\eta\| \leq L_{f_0} \|s\| \leq L_{f_0} \|s_k\| + L_{f_0} \|e_s\|, \quad (5.90)$$

where  $L_{f_0}$  is the Lipschitz constant for  $f_0(\eta, z)$ . Combining (5.89) and (5.90), an upper bound for the time derivative of  $e_s = s - s_k$  can be defined as

$$\|\dot{e}_s\| \leq \|\dot{e}_z\| + \|\dot{e}_\eta\| \leq L_s \|s_k\| + L_e \|e_s\| \quad (5.91)$$

with  $L_s = L_{f_0} + L_k$  and  $L_e = L_{f_0} + L_z$ . From the fundamental theorem of calculus, one has  $e_s = \int_{t_k}^t \dot{e}_s d\tau$ . Then, it follows from condition (5.91) that

$$\begin{aligned} \|e_s\| &\leq \int_{t_k}^t \|\dot{e}_s\| d\tau \\ &\leq \int_{t_k}^t L_s \|s_k\| d\tau + \int_{t_k}^t L_e \|e_s\| d\tau \\ &\leq (t - t_k) L_s \|s_k\| + \int_{t_k}^t L_e \|e_s\| d\tau \end{aligned} \quad (5.92)$$

Applying the Grönwall inequality (Lemma 2.3.2, Section 2.2) to (5.92) yields

$$\begin{aligned} \|e_s\| &\leq (t - t_k) L_s e^{L_e(t-t_k)} \|s_k\| \\ &= (t - t_k) L_s e^{L_e(t-t_k)} \|s - e_s\| \\ &\leq (t - t_k) L_s e^{L_e(t-t_k)} (\|s\| + \|e_s\|) \end{aligned} \quad (5.93)$$

From the event-triggering mechanism (5.87), we have that between events  $\|e_s\| \leq \sigma_s \|s\|$ . Then, until a new event happens, there is a positive constant  $\sigma_l > \sigma_s$  such that  $\|e_s\| \leq \sigma_l \|s\|$ . Therefore, from (5.93), between events, the following inequality holds:

$$\|e_s\| \leq L_s (t - t_k) e^{L_e(t-t_k)} (1 + \sigma_l) \|s\| \quad (5.94)$$

To estimate a lower bound for the time between events, two cases can be addressed.

**Case 1:**  $(t - t_k) L_e \geq 1$ . This implies that  $(t - t_k) \geq 1/L_e > 0$ , in other words, there is a positive lower bound for IET.

**Case 2:**  $(t - t_k) L_e < 1$ . Using the inequality  $e^x < 1/(1 - x)$  for all  $x < 1$ , it follows from (5.94) that

$$\|e_s\| \leq L_s (1 + \sigma_l) \frac{(t - t_k)}{1 - L_e(t - t_k)} \|s\| \quad (5.95)$$

A lower bound for the inter event time can be found by determining the minimum time  $\Delta t = t_{k+1} - t_k$  such that the right hand side of (5.95) equals to  $\sigma_s \|s\|$ , thus

$$L_s (1 + \sigma_l) \frac{\Delta t}{1 - L_e \Delta t} \|s\| = \sigma_s \|s\| \quad (5.96)$$

From equation (5.96) follows that

$$\Delta t = \sigma_s \frac{\sigma_s}{L_e \sigma_s + L_s (1 + \sigma_l)} > 0 \quad (5.97)$$

which guarantees that there is a positive lower bound for the interval between events.

The proof can be now concluded. □

## 5.5 Examples

This section provides numerical examples to illustrate the effectiveness of the proposed event-triggered control design. All related optimization problems are solved using YALMIP toolbox (LÖFBERG, 2004) with MOSEK solver (APS, 2019). For all examples, we assume that  $x \in \mathcal{X}$  with a predefined compact set  $\mathcal{X}$  to compute the vertices of  $J_F(\cdot)$  for its polytopic representation (5.31). Moreover, for comparison purposes, all simulations corresponding to the results in (XU *et al.*, 2020) are performed using the design parameters reported in their work.

**Example 5.1.** Consider the nonlinear MIMO system

$$\begin{cases} \dot{x}_1 = x_2 \\ \dot{x}_2 = x_1^2 + x_2^2 + u_1 + x_2 u_2 \\ \dot{x}_3 = -x_1 + \sin(x_3) + u_2 \\ y_1 = x_1 \\ y_2 = x_2 \end{cases} \quad (5.98)$$

where  $-2 \leq x_i \leq 2$ , for  $i = 1, 2, 3$ . Note that this nonlinear system is fully feedback linearizable, i.e., there is no internal dynamics. The transformation is given by  $T(x) = x$ . Hence, we can obtain

$$F(z) = \begin{bmatrix} z_1^2 + z_2^2 \\ -z_1 + \sin(z_3) \end{bmatrix} \quad G(z) = \begin{bmatrix} 1 & z_2 \\ 0 & 1 \end{bmatrix}. \quad (5.99)$$

The polytopic representation of the Jacobian matrix  $J_F(\cdot)$  and was derived in the steps of the illustrative example. The control law (5.24) and the event-triggering condition (5.71) are designed using Corollary 5.1 with  $\delta = 1$  and  $\rho = 1.5$ . The corresponding solution is given by

$$\begin{aligned} P &= \begin{bmatrix} 0.85 & 0.32 & -0.01 \\ 0.32 & 0.31 & 0.02 \\ -0.01 & 0.02 & 1.0 \end{bmatrix}, \quad Q_1 = \begin{bmatrix} 6.49 & 4.68 & -0.66 \\ 4.68 & 5.13 & 0.34 \\ -0.66 & 0.34 & 5.66 \end{bmatrix}, \quad K = \begin{bmatrix} -15.26 & 0.23 \\ -13.92 & 0.06 \\ -2.34 & -5.25 \end{bmatrix}^T \\ R_1 &= \begin{bmatrix} 0.83 & 0.37 & -0.01 \\ 0.37 & 0.20 & 0.02 \\ -0.01 & 0.02 & 0.1 \end{bmatrix}, \quad Q_2 = \begin{bmatrix} 0.99 & 0.01 \\ 0.01 & 0.94 \end{bmatrix}, \end{aligned} \quad (5.100)$$

The response of the closed-loop system corresponding to the initial condition  $x(0) = [-1, 1, 1]^T$  is shown in Figure 5.1. Observe that the trajectories converge to the origin with reasonable magnitudes of the control inputs.

Figure 5.2 shows the IETs, where the stems positions on the  $x$ -axis indicate the triggering time, and their amplitudes correspond to the elapsed time  $\Delta t$  since the last event.

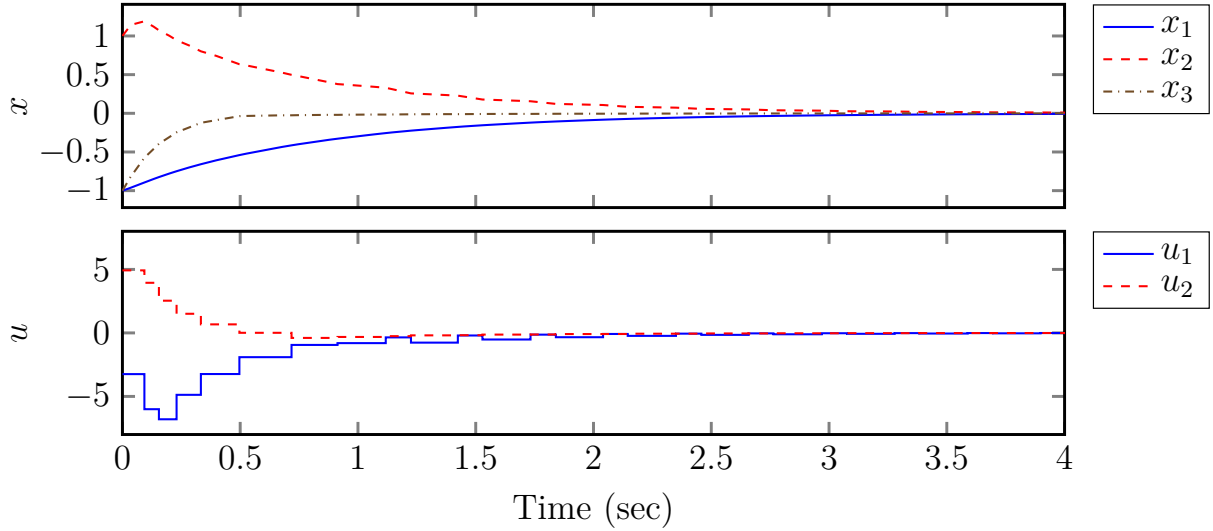

Figure 5.1 – Time response and control inputs applied to the closed-loop system (5.98) with the control design in Corollary 5.1.

To better evaluate the number of events, during simulations, the same experiment was repeated 1000 times, starting from random initial conditions. Over a ten-second simulation duration, the average number of events was about 70.89.

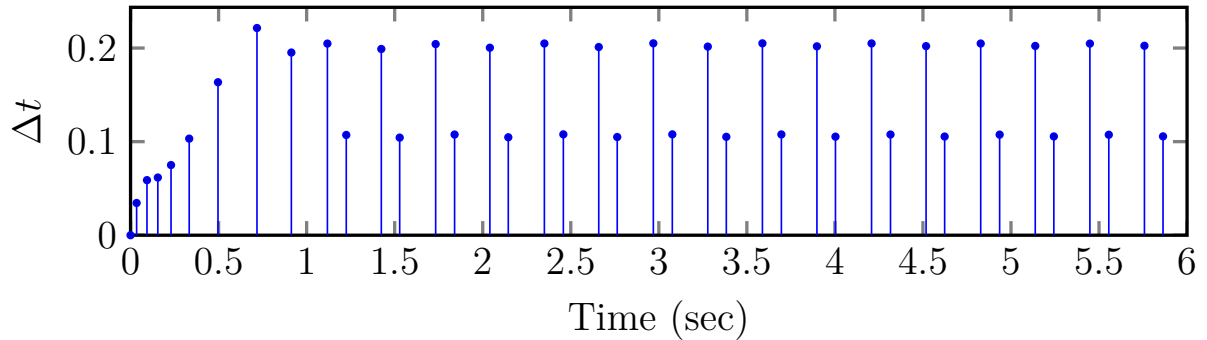

Figure 5.2 – Inter event times for system (5.98) with the control law (5.24) and the event-triggering condition (5.71) designed from Corollary 5.1.

**Example 5.2.** Consider the following pendulum system borrowed from (KHALIL, 2002)

$$\begin{cases} \dot{x}_1 = x_2 \\ \dot{x}_2 = -10 \left( \sin(x_1 + \pi/4) - 1/\sqrt{2} \right) - 10u \\ y = x_1 \end{cases} \quad (5.101)$$

where  $x_1$  is the angular position,  $x_2$  is the angular velocity,  $u$  is the applied torque, and  $-\pi \leq x_1 \leq \pi$  and  $-5 \leq x_2 \leq 5$ . The transformation is defined as  $T(x) = x$ , and the

nonlinearities and Jacobian matrix are deduced as

$$\begin{aligned} F(z) &= -10 \left( \sin(z_1 + \pi/4) - 1/\sqrt{2} \right), \quad G(z) = -10, \\ J_F(z) &= \begin{bmatrix} -10 \cos(z_1 + \pi/4) \\ 0 \end{bmatrix} \end{aligned} \quad (5.102)$$

Both control law (5.24) and the event-triggering condition (5.75) are co-designed using Corollary (5.2) with  $\delta = 0.2$  and  $\rho = 0$ . The corresponding control solution is given by

$$\begin{aligned} Q_1 &= \begin{bmatrix} 4.83 & 1.82 \\ 1.82 & 0.68 \end{bmatrix}, \quad R_1 = \begin{bmatrix} 0.17 & 0.06 \\ 0.06 & 0.02 \end{bmatrix}, \\ K &= \begin{bmatrix} -7.60 & -5.52 \end{bmatrix}, \end{aligned} \quad (5.103)$$

and it is compared with the results in (XU *et al.*, 2020). Figure 5.3 presents the closed-loop responses and the control signals of system (5.101) for initial condition  $x(0) = [\pi, 0]^T$ . The trajectories relative to the proposed approach converge faster and more smoothly to the origin. For the control signals, they might indicate that both approaches have similar control efforts. However, when evaluating the number of events and IET, Figure 5.4, it is clear that the proposed control design leads to fewer events than the approach in (XU *et al.*, 2020). This can be verified by checking the zoomed area in Figure 5.4, which shows a high number of events in a short time period.

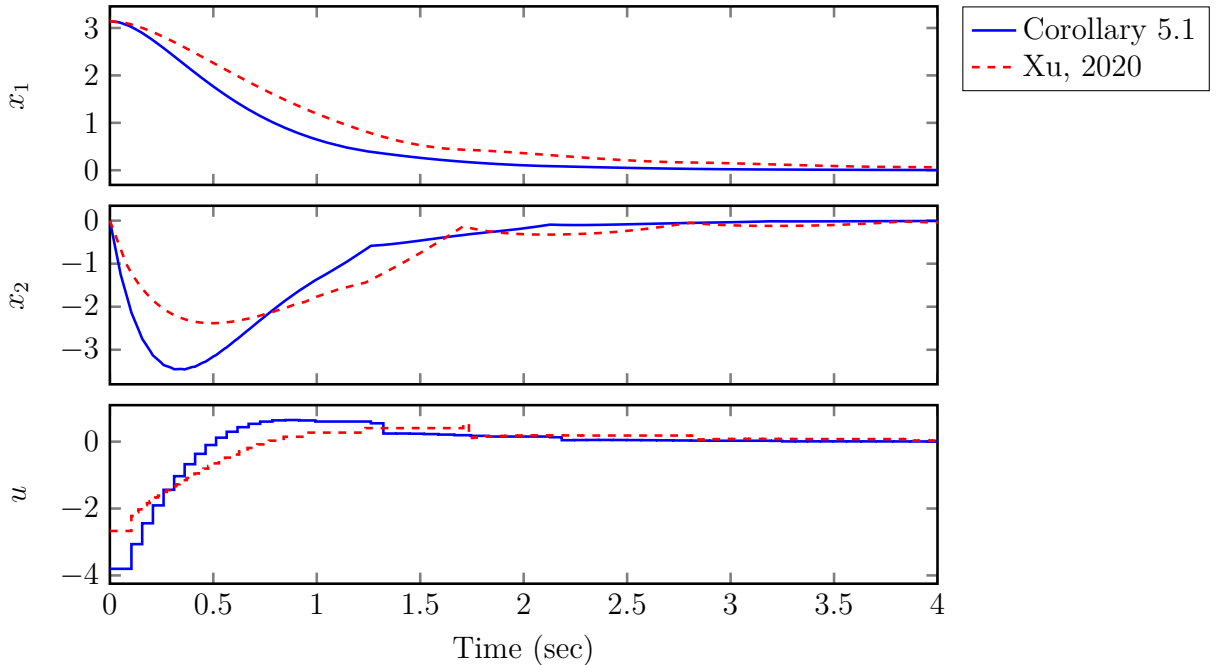

Figure 5.3 – Comparison of time responses and control signals applied to the closed-loop system (5.101) between the control design from Corollary 5.2 and the approach in (XU *et al.*, 2020).

For a better comparison in terms of the number of events, 1000 numerical simulations with both control approaches were performed for 1000 times starting from random initial

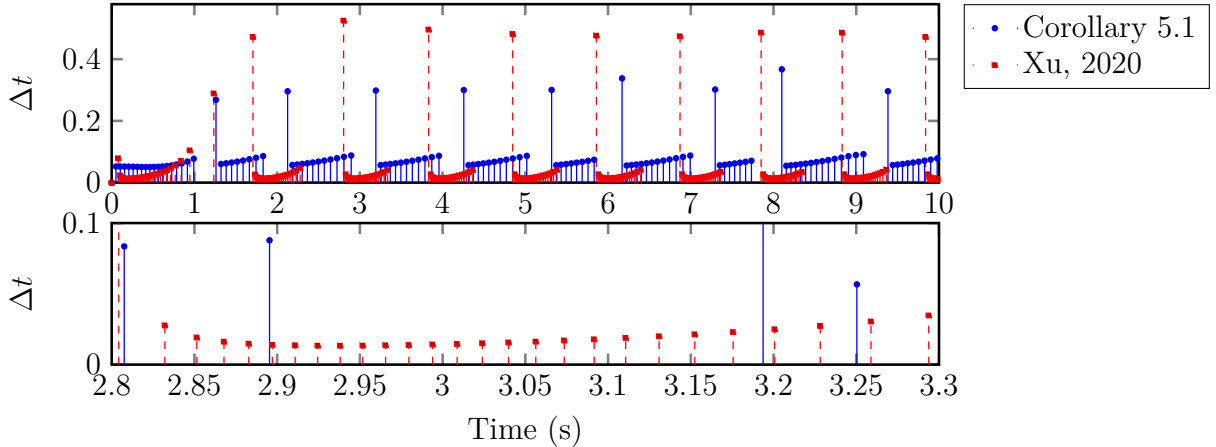

Figure 5.4 – Comparison of IETs obtained with the closed-loop system (5.101) between the control design from Corollary 5.2 and the approach in (XU *et al.*, 2020).

conditions. The event-triggered controller designed with Corollary 5.2 leads to 119.35 events on average, while the control approach in (XU *et al.*, 2020) leads to 276.69 events.

**Example 5.3.** We consider the following nonlinear system adapted from (XU *et al.*, 2020):

$$\begin{cases} \dot{x}_1 = x_1^3 + x_2 \\ \dot{x}_2 = -3x_1^2x_2 + 10u \\ y = x_1, \quad x \in \mathcal{X} \end{cases} \quad (5.104)$$

where  $\mathcal{X} = \{x \in \mathbb{R}^2 : |x_i| \leq 1.5, \quad i = 1, 2\}$ . Note that (5.104) is fully feedback linearizable. Differentiating the output  $y$ , the transformation can be defined as  $z_1 = x_1$  and  $z_2 = x_1^3 + x_2$ . Then, we can obtain

$$F(z) = 3z_1^5, \quad G(z) = 10, \quad J_F(z) = \begin{bmatrix} 15z_1^4 \\ 0 \end{bmatrix}. \quad (5.105)$$

Solving the design conditions in Corollary 5.2 with  $\delta = 0.2$  and  $\rho = 1$ , the following control solution is attained:

$$\begin{aligned} Q_1 &= \begin{bmatrix} 51.75 & 8.39 \\ 8.39 & 2.48 \end{bmatrix}, \quad R_1 = \begin{bmatrix} 0.197 & 0.025 \\ 0.025 & 0.009 \end{bmatrix}, \\ K &= [-13.91 \quad -15.32]. \end{aligned} \quad (5.106)$$

To evaluate the importance of an explicit consideration of the nonlinearity mismatches in the event-triggered control design, system (5.104) is simulated, starting from different initial conditions using the controllers designed from Corollary 5.2 and the approach in (XU *et al.*, 2020) with the same design parameters reported therein. In Figure 5.5 we compare the initial conditions that lead to stable behavior of the closed-loop system (5.104) for both event-triggered controllers. Remark that the proposed controller can

ensure the asymptotic stability for the system (5.104) starting from any initial condition inside  $\mathcal{X}$ . However, without taking into account the nonlinearity mismatches, the controller proposed by (XU *et al.*, 2020) cannot ensure the stability for many initial conditions even with its feedback linearization being valid globally.

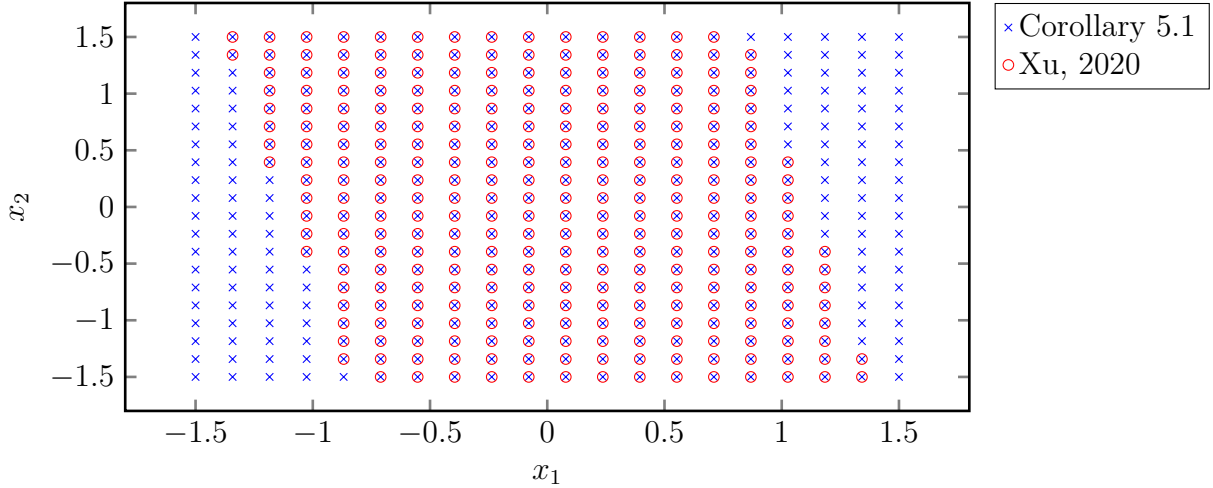

Figure 5.5 – Comparison of stable initial conditions for system (5.104) between the control design from Corollary 5.2 and the approach in (XU *et al.*, 2020).

For further illustration, we consider the initial condition  $x(0) = [-1.1, -0.1]^T$ . The corresponding closed-loop response obtained with both control methods are presented in Figure 5.6. The proposed approach provides much smoother state convergence and smaller control input signal magnitude. From the inter event times in Figure 5.7 we can see that the proposed approach yields an almost periodic triggering behavior. However, the approach in (XU *et al.*, 2020) can have a significant number of events for some intervals as shown in the corresponding zoom of Figure 5.7. Performing 1000 simulations with random initial conditions, on average the control result in (XU *et al.*, 2020) yields 354.22 events, whereas the proposed approach yields 164.19 events in a 10 seconds simulation.

**Example 5.4.** Consider the nonlinear system taken from (XU *et al.*, 2020)

$$\begin{cases} \dot{x}_1 = -x_1 + \frac{2 + x_3^2}{1 + x_3^2}u \\ \dot{x}_2 = x_3 \\ \dot{x}_3 = x_1x_3 + u \\ y = x_2 \end{cases} \quad (5.107)$$

where  $|x_i| \leq 3$  for  $i = 1, 2, 3$ . Note that system (5.107) is partially feedback linearizable with a relative degree  $r = 2$ . Following the same procedure in (XU *et al.*, 2020), we define



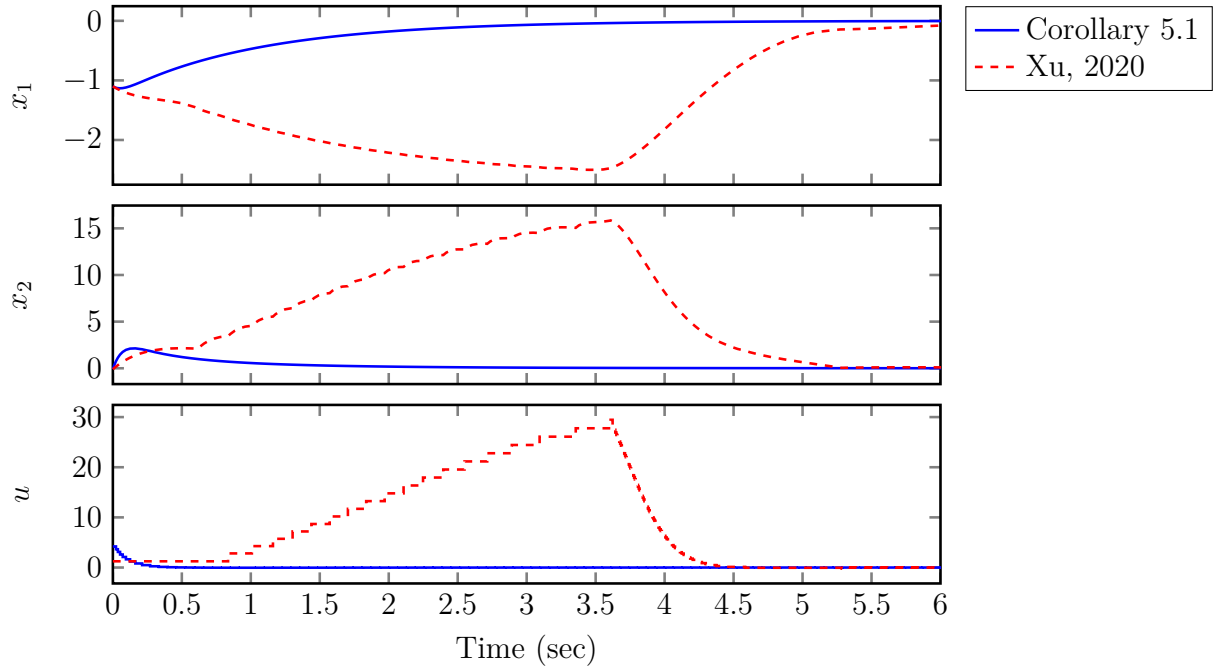

Figure 5.6 – Comparison of trajectories and control input signals applied to system (5.104) between the control design from Corollary 5.2 and the approach in (XU *et al.*, 2020).

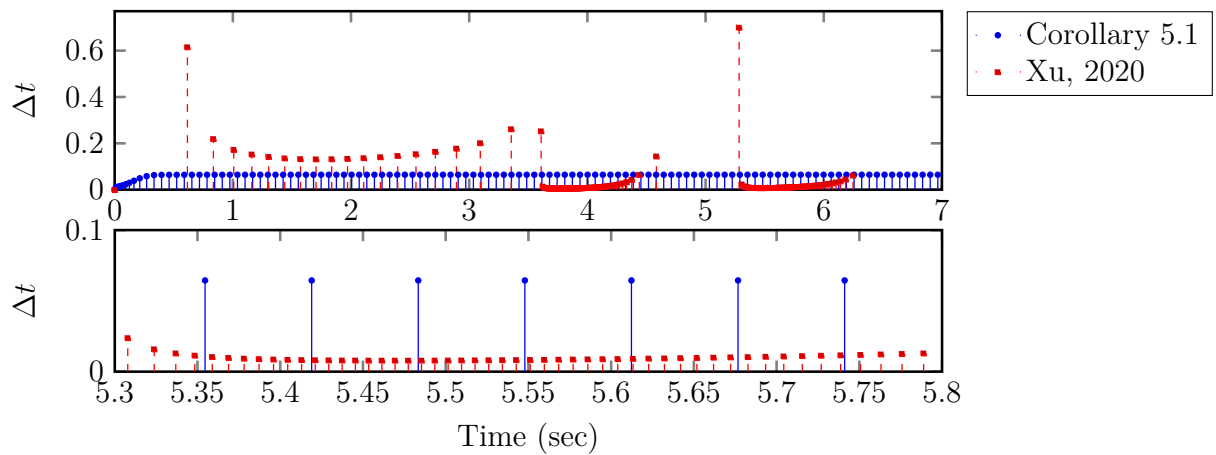

Figure 5.7 – Comparison of IETs obtained with system (5.104) between the control design from Corollary 5.2 and the approach in (XU *et al.*, 2020).

the transformation as

$$\begin{bmatrix} z_1 \\ z_2 \\ \eta \end{bmatrix} = T(x) = \begin{bmatrix} x_2 \\ x_3 \\ -x_1 + x_3 + \tan^{-1}(x_3) \end{bmatrix}, \quad (5.108)$$

which leads to the following transformed system:

$$\begin{cases} \dot{z}_1 = z_2 \\ \dot{z}_2 = \left(-\eta + z_2 + \tan^{-1}(z_2)\right) z_2 + u \\ \dot{\eta} = \left(-\eta + z_2 + \tan^{-1}(z_2)\right) \left(1 + \frac{2 + z_2^2}{1 + z_2^2} z_2\right) \end{cases} \quad (5.109)$$

Note that if  $z = \text{col}\{z_1, z_2\} = 0$ , then the zero dynamics in (5.109) becomes  $\dot{\eta} = -\eta$ . Since the zero dynamics is exponentially stable, Theorem 5.1 can be applied for the event-triggered control design of system (5.109). With the transformation (5.108), we can also define

$$\begin{aligned} F(z) &= \left(-\eta + z_2 + \tan^{-1}(z_2)\right) z_2, \quad G(z) = 1 \\ J_F(z) &= \begin{bmatrix} 0 \\ -\eta + z_2 + \tan^{-1}(z_2) + \left(1 + \frac{1}{1 - z_2^2}\right) z_2 \\ -z_2 \end{bmatrix} \end{aligned} \quad (5.110)$$

From the zero dynamics, selecting  $V_\eta = \eta^T \eta$ , the constants from Lemma 5.2 can be determined as  $a_1 = 1$  and  $a_2 = 1$ . A Lipschitz constant for  $f_0(\cdot, z)$  can be computed as approximately  $L_f = 12$ . Moreover, the event-trigger parameter is selected from (5.54) as  $\bar{\theta} = 0.0002$ . Solving the optimization problem in Theorem 5.2 with  $[\delta, \rho, \gamma] = [1, 1.5, 1]$ , the following feedback gain is obtained:

$$K^* = \begin{bmatrix} -19.7164 & -19.8374 \end{bmatrix} \quad (5.111)$$

The resulting gain  $K^*$  is large, which may lead to some numerical issues, *e.g.*, a large magnitude of control input. Hence, we redesign the feedback gain by including the additional constraint (5.79) with  $\kappa = 10$  to limit the magnitude of the feedback gain, as explained in Remark 5.7. Then, the following control results are obtained:

$$\begin{aligned} Q_1 &= \begin{bmatrix} 11.24 & 10.15 \\ 10.15 & 13.74 \end{bmatrix}, \quad R_1 = \begin{bmatrix} 0.77 & 0.41 \\ 0.41 & 0.25 \end{bmatrix}, \\ K &= \begin{bmatrix} -6.61 & -5.96 \end{bmatrix}. \end{aligned} \quad (5.112)$$

Note that the additional constraint (5.79) significantly reduces the feedback gain magnitude, yet achieving a decent control performance as shown in Figure 5.8. Observe also that the approach in (XU *et al.*, 2020) provides a similar closed-loop behavior. However, concerning the inter event times, we can see from Figure 5.9 that the proposed approach triggers fewer times than the control result from (XU *et al.*, 2020). This is corroborated by performing, over 1000 simulations with random initial conditions, for both designed controllers. On average the approach in (XU *et al.*, 2020) leads to 341.33 triggered events, while the new proposed approach leads to 229.85 events.

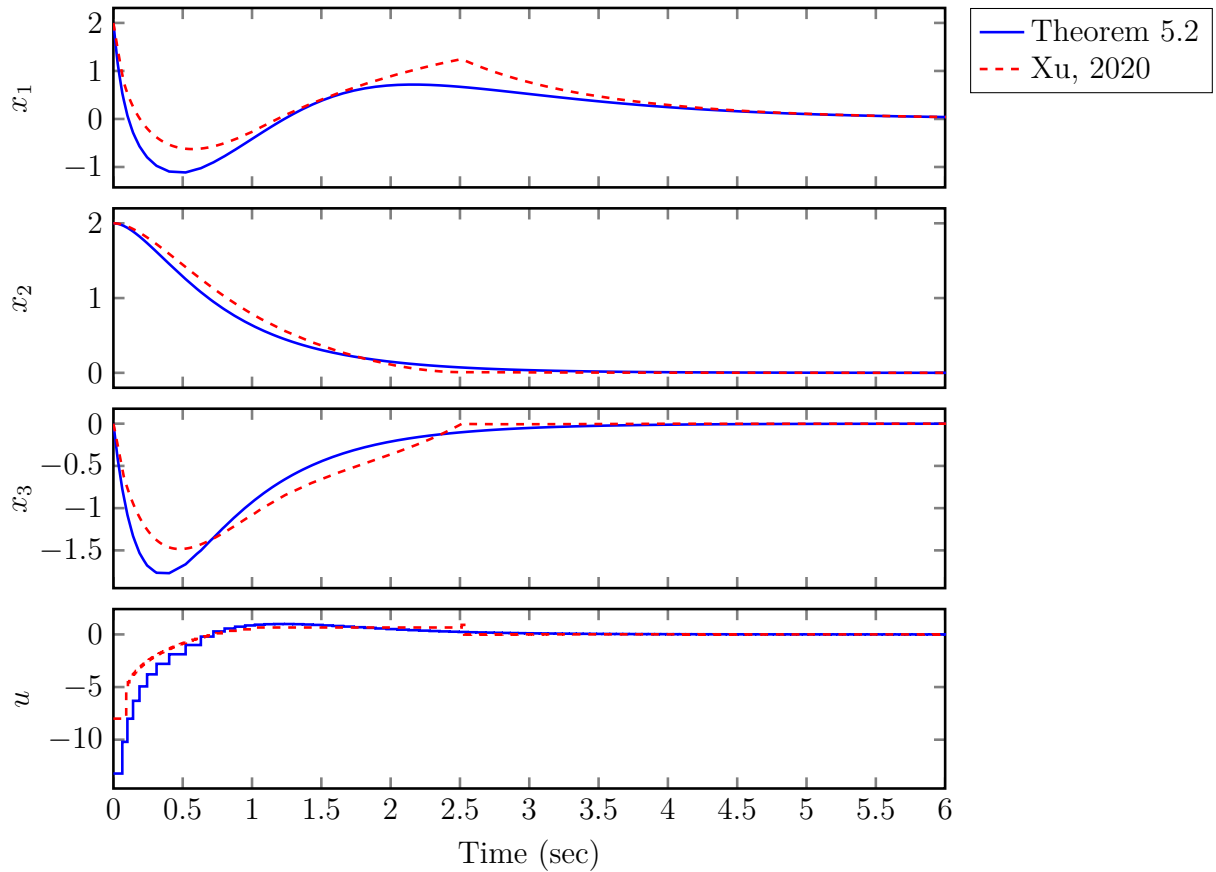

Figure 5.8 – Comparison of time responses and control input applied to system (5.107) between the control design from Theorem 5.2 and the approach in (XU *et al.*, 2020).

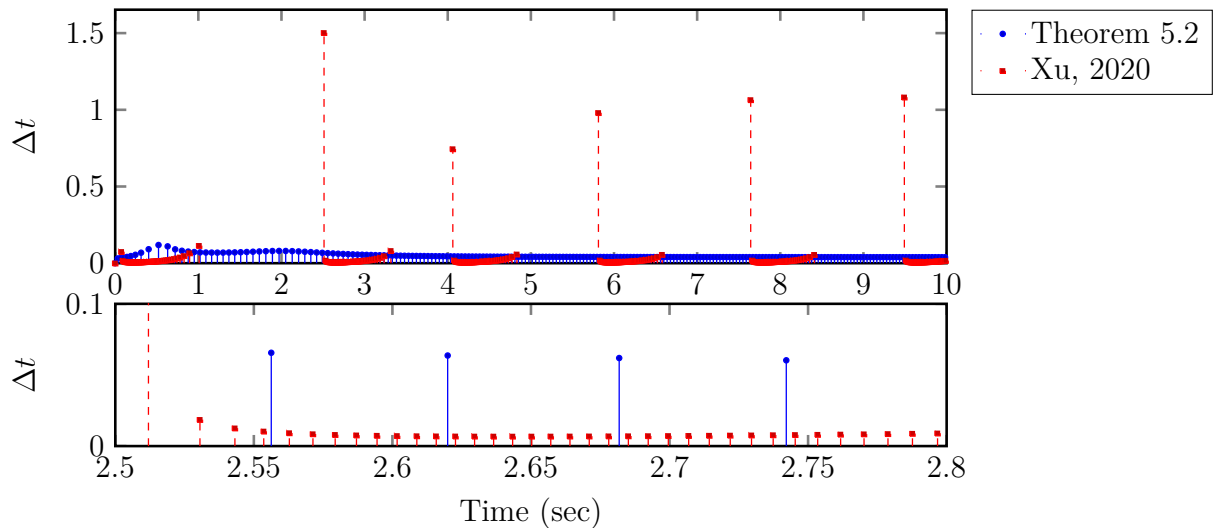

Figure 5.9 – Comparison of IETs obtained with system (5.107) between the control design from Theorem 5.2 and the approach in (XU *et al.*, 2020).

## 5.6 Conclusion

Using the feedback linearization approach, an event-triggered control design has been proposed for nonlinear MIMO systems. Sufficient conditions are provided to co-design the event-triggering conditions and the feedback controllers for both cases of full feedback linearization and partial feedback linearization with exponentially stable zero dynamics. By Lyapunov stability theory, the event-triggered control co-design is reformulated as optimization problems under LMI constraints. Moreover, using a polytopic approach and the fundamental theorem of calculus, some nonlinear mismatch terms can be explicitly incorporated to LMI-based design conditions, instead of being included in the event-triggering conditions, to reduce the number of control events. In particular, under some assumptions on Lipschitzian properties of the system nonlinearities, the proof for the existence of a lower bound for inter event time is given. The performance superiority of the proposed control approach over the related literature, mainly in terms of reducing the number of triggered events for the feedback controllers, is illustrated via several numerical examples.

## 6 Conclusion and perspectives

In this thesis the problem of designing event-triggering control laws for nonlinear systems has been addressed, focusing on vehicle platoon applications.

Chapter 3 has addressed the problem of control designing for longitudinal platoons equipped with cooperative adaptive cruise control. In this chapter the vehicles model has been assumed as uncertain, resulting in mismatches in the feedback linearization, which, as illustrated via simulation, can affect vehicles safety distance. A disturbance observer compensation has been proposed to estimate the combined effect of uncertainties and exogenous inputs. The estimated disturbance has been incorporated into the feedback linearizing control law and it shows to effectively compensate for the disturbances, thus resulting in acceptable safe distance error.

To account for the uncertainties and the disturbance compensations in the designing conditions an extension to  $\mathcal{L}_2$  string stability conditions have been proposed in Chapter 3. Considering two procedures to model the vehicles interactions, design conditions have been derived to ensure both individual and string stability in the presence of uncertainties. Throughout simulation, the two models have been compared with both being able to achieve a platoon formation with safe distance even when starting from a platoon without correct positioning. In Chapter 3 we show that an important feature of the proposed conditions is scalability. Taking advantage of the vehicle communication topology and the feedback linearization procedure, designing conditions have been achieved, which are independent of the number of vehicles.

Chapter 4 has focused on the problem of efficient communication. Considering the models derived in Chapter 3 an event triggered communication has been introduced. To ensure Zeno free behavior a minimum waiting time has been enforced between consecutive transmission and a switching approach has been introduced for model the system under event triggered communication. A dynamic switching mechanism has been proposed and designing conditions have been attained considering scenarios with and without communication delays. Simulations have illustrated that, under the scenarios in study, the proposed method is able to improve communication efficiency compared with other methodologies in the literature.

In Chapter 5 the feedback linearization procedure utilized in Chapter 3 and Chapter 4 has been detailed, however, considering an event-based linearization procedure. In the previous chapter, signals necessary for feedback linearization were assumed to be measured continuously. In Chapter 5 the feedback linearization procedure has been detailed assuming that the signals necessary for the linearization procedures are updated according to a event condition. Assuming that feedback linearization is possible, designing condi-

ons for both controller and event-triggering mechanism have been proposed for multiple input multiple output nonlinear systems. Examples have been provided to illustrate the effectiveness of the method, comparing against other existing methodologies.

The results achieved in this thesis are promising for longitudinal vehicle platooning. The proposed disturbance compensation can handle the effects of uncertainty and ensure safe distance between vehicles. Moreover, the proposed designing conditions account for uncertainties in string stability analysis while ensuring scalability of the conditions unlike most related methods in literature. The method can also reduce communication while maintaining performance utilizing the proposed ETM even in the presence of delays.

Although the method is effective, important considerations are required before real implementation. Some of them are still challenging from a theoretical point-of-view (saturation with feedback linearization, reconfiguration of the platoon. . . ); others are important steps before real application (saturation, noise, measurements, denial of service. . . ). Some of these aspects are shortly described in the next section.

## 6.1 Research perspectives

From a theoretical point of view, many works propose solutions to saturation of the control input for LPV systems, generally adding LMI constraints to the initial problem. Nevertheless, few works address the saturation problem for feedback linearization.

### Saturation issue

To illustrate the issue, consider again the platooning problem. In this work, even in a scenario free of disturbance, it was assumed that the vehicles have unsaturated signals; they can achieve any speed required and produce any torque without limitations. Including saturations for the signals can be challenging. For example, if they are introduced on the control input, the signal required for linearization might not be achievable. Moreover, when adding uncertainties, noise. . . the problem is still open. Let us consider an input saturation in the feedback linearization scheme of vehicle  $\Sigma_i$ , Figure 6.1.

With the saturation the vehicles dynamics is described by:

$$\begin{aligned} \dot{p}_i &= v_i \\ \dot{v}_i &= \frac{1}{\mathbf{W}_i} \left( \mathbf{R}_{h,i} T_i - \mathbf{m}_i \mathbf{g} F_{r,i} - \mathbf{B}_i v_i - \mathbf{C}_i v_i^2 \right) \\ \dot{T}_i &= -\frac{1}{\rho_i} T_i + \frac{1}{\rho_i} \text{sat}(u_{e,i}) \end{aligned} \quad (6.1)$$

where  $\text{sat}(\cdot)$  denotes the saturation. The following tests illustrate the challenges that can appear due to saturation.

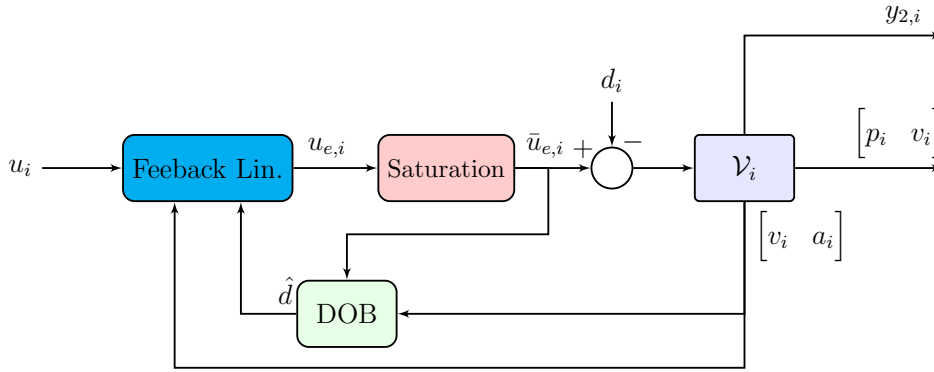

Figure 6.1 – Feedback linearization loop with DOB compensation and control input saturation.

### Test 1 - Saturation without uncertainty

Consider an example with one vehicle following the leader without uncertainties and a saturation, Figure 6.1, on the control input of  $\Sigma_1$ . The platoon configuration is set as  $\mathbb{J} = 0, 2$  with based values given in Table 6.1. Moreover, for this test, the DOB is removed. The saturation has been fixed to 75% of the maximum torque. The test corresponds to an acceleration and a braking, Figure 6.2 top left, the result without saturation is in black (dotted). Figure 6.2 shows the velocity (top left), the distance policy error (top right) along with the torque applied to the vehicle (bottom). As can be noticed even in this ideal scenario, the saturation affects the tracking performance, leading to larger values of error (up to 5 meters) and a velocity overshoot.

Table 6.1 – Nominal values for the vehicle parameters ( $\Sigma_i$  columns) and respective values used for simulation ( $\tilde{\Sigma}_i$ ).

Vehicle	$r$	$m$	$h_w$	$J_r$	$J_e$	$R_g$	$B$	$C$	$\rho$
$\Sigma_0^b$		1724	0.28	0.75	0.14	0.10	7.35	0.05	0.05
$\tilde{\Sigma}_0^b$		1724	0.25	1.05	0.14	0.13	8.09	0.06	0.08
$\Sigma_2^b$		2930	0.41	1.57	0.27	0.20	11.02	0.08	0.08
$\tilde{\Sigma}_2^b$	2.5	2637	0.33	1.26	0.40	0.30	8.82	0.05	0.06

### Test 2 - Saturation with uncertainty and DOB compensation

When uncertainties are considered and disturbance compensation is introduced, the effects of saturation can be detrimental. With DOB compensation, the estimated disturbance is added to the linearizing input:

$$u_{e,i} = \text{sat} \left( \frac{1}{b_i} \left( -\frac{1}{\rho_d} a_i - f_i(v_i, a_i) + \frac{1}{\rho_d} u_i \right) + \frac{1}{b_i} \hat{d}_i \right) \quad (6.2)$$

which can make the input saturate faster. Moreover, the saturation also affects the DOB dynamics, which is given by:

$$\begin{aligned}\dot{\omega}_i &= \frac{\partial L_i(a_i)}{\partial a_i} (f_i(v_i, a_i) + b_i \text{sat}(u_{e,i}) - \hat{d}_i) \\ \hat{d}_i &= \omega_i - L_i(a_i).\end{aligned}\tag{6.3}$$

For illustration let us consider a scenario with the same platoon configuration as in Test 1, including uncertainties and disturbances. Figure 3 shows the velocity (top left), distance policy error (top right), the torque applied to the vehicle (bottom left) and disturbance estimation (bottom right). Indeed, in this scenario, the saturation affects the disturbance estimation that makes the results worse. The distance policy error is higher (up to 10 meters) and the velocity has a larger overshoot.

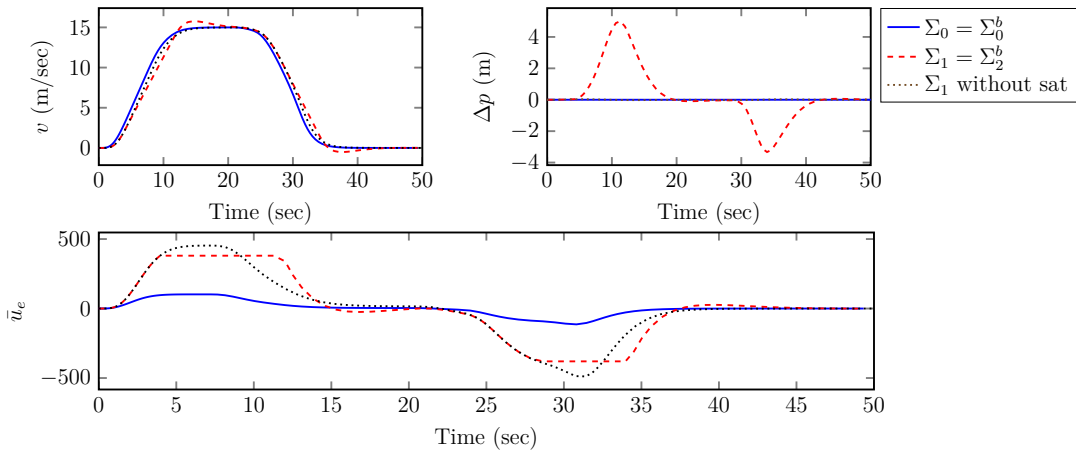

Figure 6.2 – Test 1: Platoon  $\mathbb{J} = \{0, 2\}$ . Velocity (top left), distance policy error (top right) and torque input (bottom) for nominal case with saturation.

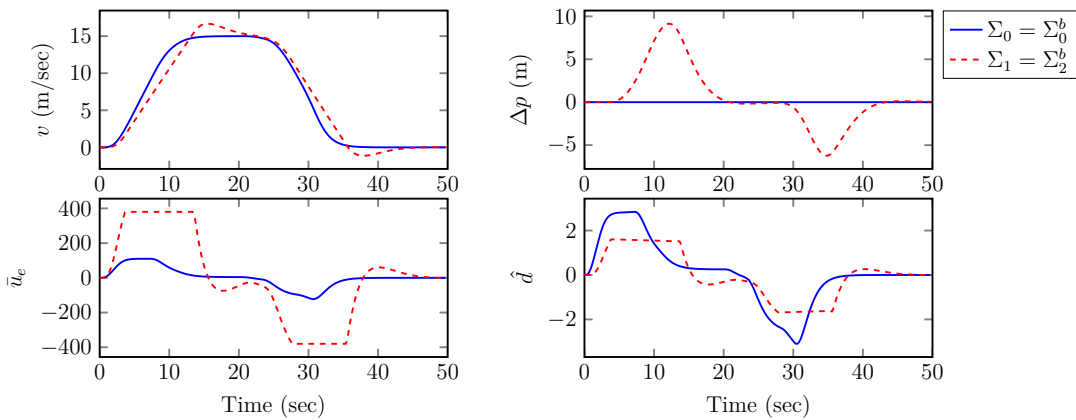

Figure 6.3 – Test 2: Platoon  $\mathbb{J} = \{0, 2\}$ . Velocity (top left), distance policy error (top right), torque input (bottom) and disturbance estimation (bottom right) for the uncertain case with saturation.



A straightforward option to tackle this issue is to design the controller without considering the saturation and verifying via simulation that the control law will not saturate. This strategy cannot be used safely, especially because for emergency situations, fast actions will be required that may force the control input to saturate. Alternatively, a safe solution must include the saturation into the nonlinear systems equations and provide designing conditions and appropriate solutions. However, this approach is not trivial due to the feedback linearization procedure as the signal required for linearization might not be achievable.

Of course, many other challenges can be considered, amongst them, problems regarding communication quality are crucial.

## Communication quality

Communication was assumed to be affected only by delays, however other phenomena like faults, attacks, or denial of service can occur. Many works already address those aspects under various methodologies (PEIXOTO *et al.*, 2023; PESSIM *et al.*, 2021; WANG *et al.*, 2022b; MA *et al.*, 2020). A part of the adaptation can be, at first sight, straightforward, for example if the faults do not affect the feedback linearization (WANG *et al.*, 2022b; MA *et al.*, 2020), even though, the effects need to be evaluated theoretically and in practice. On the contrary, the problem is not trivial.

There are also a lot of improvements that can be thought of for the application of platooning, especially if we consider reconfiguration and communications topology.

## Platoon reconfiguration

In platooning, vehicles can leave the platoon formation because of technical problems or because it is addressed for those vehicles to leave the formation. This is a particular case of platoon reconfiguration, where the other vehicles need to compensate for the vehicles leaving the formation. This situation must be considered. For example, considering the scenario described in Figure 6.4, with one leader and 4 followers. At some moment, vehicle 1 and vehicle 2 leave the formation and a gap remains between vehicle 3 and the leader. One problem that can occur during the reconfiguration is that the sensor will lose range (i.e., vehicle 3 cannot measure its distance from the leader).

To handle this class of problems, assumptions about communication must be set. For example, in the scenario, Figure 6.4, we can assume that when vehicle 1 and vehicle 2 leave the platoon they stop communication. One supplementary assumption has to be set for the leader. If we take the assumption that the leader is able to communicate with vehicle 3, then one approach is to predefine the maximum range for the sensor. Therefore, we can consider the vehicles leave as a “saturation” problem. In this example, during the time that vehicle 3 is not able to measure the distance to the leader, the distance is set as

its maximum. If the communication with the leader is lost, vehicle 3 has to become the new leader.

These aspects are strongly related to the topology of the platoon.

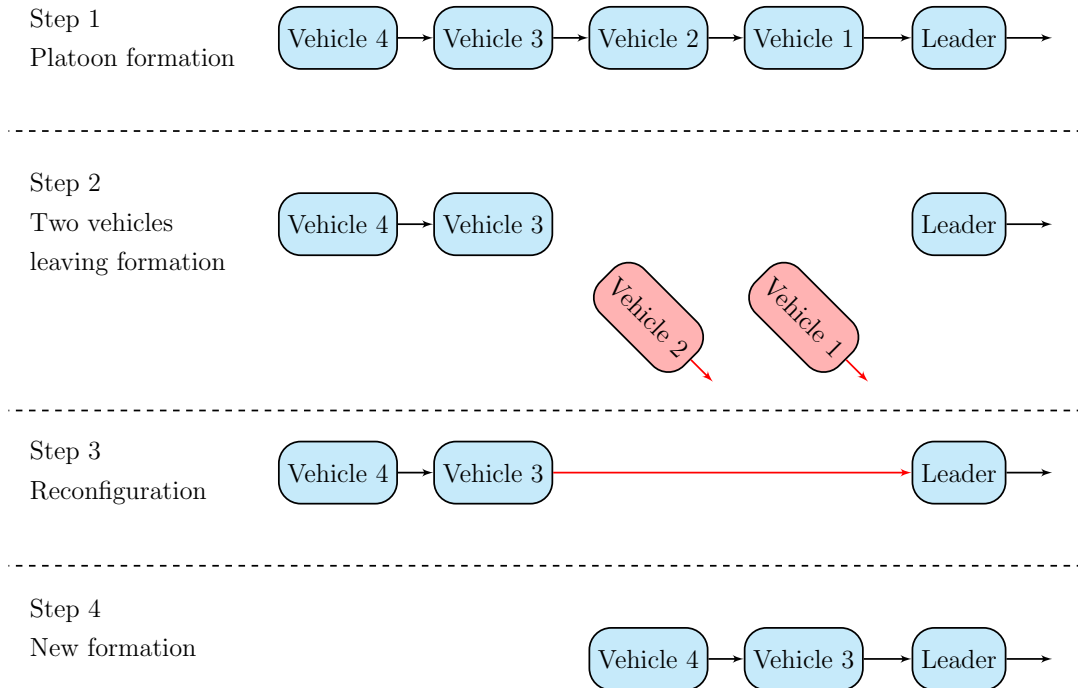

Figure 6.4 – Vehicle platoon reconfiguration with two vehicles leaving formation.

## Different topologies

The main topology considered in this work is the predecessor follower topology, where communication only occurs between adjacent vehicles and information only flows from vehicle  $i$  to vehicle  $i + 1$ . We took advantage of this topology specification to achieve design conditions that do not depend on the number of vehicles (scalability). For other topologies, adaptations are necessary especially if scalability is desired. In Figure 6.5 we show a topology of two predecessor followers, with bidirectional communication. In this case it is necessary to account for the interaction between 2 vehicles and the effects of the bidirectional communication.

Moreover, it is assumed that vehicle  $i$  only measures  $\hat{p}_i$  and  $\Delta v_i$  from vehicle  $i - 1$ . In Figure 6.5, indicated by the red arrows, we consider a case where the vehicle  $i$  can also measure  $\hat{p}_{i+1}$  and  $\Delta v_{i+1}$ . This approach can be useful, for example in platoon reconfiguration where one or more vehicles are not able to follow the formation. This topology can also allow platoon formation to adjust not only according to the leader reference, but according to both the leader and the follower(s). For example, if the vehicle  $i$  is not able to follow vehicle  $i - 1$  (for example, because of a slowest acceleration) vehicle  $i$  can decelerate. Therefore, an issue will be how to design the control strategy of vehicle  $i$

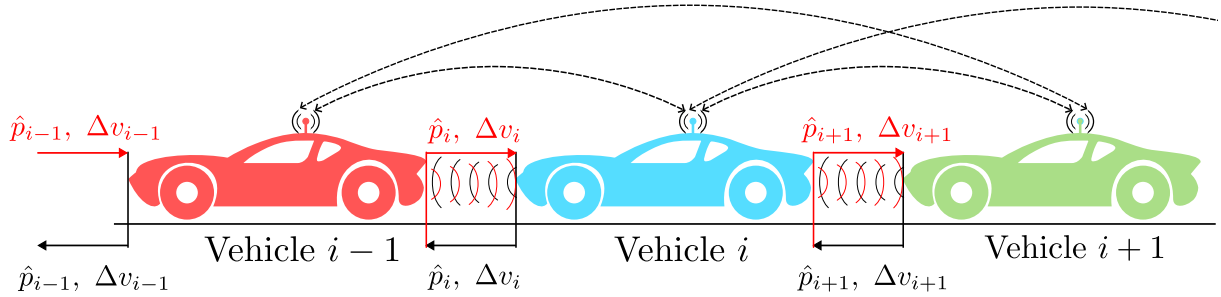

Figure 6.5 – Vehicle platoon with bidirectional communication and two predecessor follower topology.

as a tradeoff between the desired distance policy between vehicles  $i - 1$ , vehicles  $i$  and vehicles  $i + 1$ , keeping good performances and safety.

Regarding the platoon problem, other aspects can interfere with the platoon performance: road conditions, weather conditions... can affect the vehicles behavior and consequently the platoon.

## Environment adjustments

In rainy situations, foggy, and specially ice roads, additional care is needed. Foggy can affect sensors while rain and especially ice roads affect tire adherence. A possible approach to account for these changes in the environment is to adjust the distance policy according to the scenario. In the distance policy:

$$\Delta p_{d,i} = r_i + hv_i \quad (6.4)$$

the standstill distance  $r_i$  and the constant time distance  $h$ , can be chosen as time varying variables, that change according to the environment conditions. The design of the controller(s), must take into account these changes. Methodologies such as LPV and/or switching systems can be thought to have controllers that appropriately change according to those conditions.

This work only considered longitudinal motion. Including lateral motion is crucial for completeness of the platoon problem.

## Longitudinal and Lateral

A challenging aspect for platooning is combining both the longitudinal and lateral motions. Few works in literature consider string stability analysis with lateral dynamics (MAHFOUZ *et al.*, 2023). Lateral motion introduces more challenges as lateral velocity is not measured and there are additional disturbances (LI *et al.*, 2020; LI *et al.*, 2019; MAHFOUZ *et al.*, 2023; NGUYEN *et al.*, 2023). The disturbance compensation proposed cannot be adapted directly for the lateral case as it requires lateral speed measurement.

An alternative is to design an output-based disturbance observer or utilize an observer to estimate the necessary states for the DOB.

Moreover, feedback linearization can be applied for the longitudinal dynamics, but not for the lateral one. Although some nonlinearities can be canceled, full linearization (via feedback linearization) is not possible. In this case the problem can be addressed using an LPV-modeling of the system. Although, ensuring string stability can be challenging when combining with lateral dynamics.

# References

- ABDELRAHIM, M.; POSTOYAN, R.; DAAFOUZ, J.; NESIC, D. Stabilization of nonlinear systems using event-triggered output feedback controllers. *IEEE Transactions on Automatic Control*, Institute of Electrical and Electronics Engineers (IEEE), v. 61, n. 9, p. 2682–2687, sep 2016.
- ABDELRAHIM, M.; POSTOYAN, R.; DAAFOUZ, J.; NEŠIĆ, D. Robust event-triggered output feedback controllers for nonlinear systems. *Automatica*, Elsevier BV, v. 75, p. 96–108, jan 2017.
- APS, M. *The MOSEK optimization toolbox for MATLAB manual. Version 9.0*. [S.l.], 2019. Disponível em: <<http://docs.mosek.com/9.0/toolbox/index.html>>.
- ASADI, B.; VAHIDI, A. Predictive cruise control: Utilizing upcoming traffic signal information for improving fuel economy and reducing trip time. *IEEE Transactions on Control Systems Technology*, Institute of Electrical and Electronics Engineers (IEEE), v. 19, n. 3, p. 707–714, maio 2011. ISSN 1558-0865.
- BAGHERI, M.; NASERADINMOUSAVI, P.; KRSTIĆ, M. Feedback linearization based predictor for time delay control of a high-DOF robot manipulator. *Automatica*, Elsevier BV, v. 108, p. 108485, oct 2019.
- BAI, T.; JOHANSSON, A.; JOHANSSON, K. H.; MÅRTENSSON, J. Large-scale multi-fleet platoon coordination: A dynamic programming approach. *IEEE Trans. Intell. Transp. Syst.*, Institute of Electrical and Electronics Engineers (IEEE), v. 24, n. 12, p. 4427–4442, 2023.
- BELLMAN, R. The stability of solutions of linear differential equations. *Duke Mathematical Journal*, Duke University Press, v. 10, n. 4, dec 1943.
- BIAN, Y.; ZHENG, Y.; REN, W.; LI, S.-E.; WANG, J.; LI, K. Reducing time headway for platooning of connected vehicles via V2V communication. *Transp. Res. Part C Emerg. Technol.*, Elsevier, v. 102, p. 87–105, 2019.
- BORGERS, D. P.; HEEMELS, W. P. M. H. Event-separation properties of event-triggered control systems. *IEEE Transactions on Automatic Control*, Institute of Electrical and Electronics Engineers (IEEE), v. 59, n. 10, p. 2644–2656, out. 2014.
- BOYD, S.; El Ghaoui, L.; FERON, E.; BALAKRISHNAN, V. *Linear Matrix Inequalities in System and Control Theory*. Philadelphia, PA: SIAM, 1994. v. 15. ISBN 0-89871-334-X.
- CARNEVALE, D.; TEEL, A. R.; NESIC, D. A Lyapunov proof of an improved maximum allowable transfer interval for networked control systems. *IEEE Transactions on Automatic Control*, Institute of Electrical and Electronics Engineers (IEEE), v. 52, n. 5, p. 892–897, may 2007.
- CHANG, P.-F.; CHEN, C.-C.; CHANG, J.-R. Observer-based feedback linearization control of multi-input multi-output nonlinear system and application to double rotor system. *Advances in Mechanical Engineering*, SAGE Publications, v. 11, n. 4, p. 168781401984546, apr 2019.

- CHEN, J.; WEI, H.; ZHANG, H.; SHI, Y. Asynchronous self-triggered stochastic distributed MPC for cooperative vehicle platooning over vehicular ad-hoc networks. *IEEE Trans. Veh. Technol.*, v. 72, n. 11, p. 14061–14073, 2023.
- CHEN, Z.; NIU, B.; ZHAO, X.; ZHANG, L.; XU, N. Model-based adaptive event-triggered control of nonlinear continuous-time systems. *Applied Mathematics and Computation*, Elsevier BV, v. 408, p. 126330, nov 2021.
- DARBHA, S.; KONDURI, S.; PAGILLA, P. R. Benefits of V2V communication for autonomous and connected vehicles. *IEEE Transactions on Intelligent Transportation Systems*, Institute of Electrical and Electronics Engineers (IEEE), v. 20, n. 5, p. 1954–1963, maio 2019.
- DEY, K. C.; YAN, L.; WANG, X.; WANG, Y.; SHEN, H.; CHOWDHURY, M.; YU, L.; QIU, C.; SOUNDARARAJ, V. A review of communication, driver characteristics, and controls aspects of cooperative adaptive cruise control (CACC). *IEEE Transactions on Intelligent Transportation Systems*, Institute of Electrical and Electronics Engineers (IEEE), v. 17, n. 2, p. 491–509, fev. 2016.
- DOLK, V.; PLOEG, J.; HEEMELS, M. Event-triggered control for string-stable vehicle platooning. *IEEE Trans. Intell. Transp. Syst.*, v. 18, n. 12, p. 3486–3500, 2017.
- DONKERS, M. C. F.; HEEMELS, W. P. M. H. Output-based event-triggered control with guaranteed  $\mathcal{L}_\infty$ -gain and improved and decentralized event-triggering. *IEEE Transactions on Automatic Control*, Institute of Electrical and Electronics Engineers (IEEE), v. 57, n. 6, p. 1362–1376, jun 2012.
- FENG, S.; ZHANG, Y.; LI, S. E.; CAO, Z.; LIU, H. X.; LI, L. String stability for vehicular platoon control: Definitions and analysis methods. *Annu. Rev. Control.*, Elsevier BV, v. 47, p. 81–97, 2019.
- FRIDMAN, E. Tutorial on Lyapunov-based methods for time-delay systems. *European Journal of Control*, Elsevier BV, v. 20, n. 6, p. 271–283, nov 2014.
- GAO, F.; LI, S. E.; ZHENG, Y.; KUM, D. Robust control of heterogeneous vehicular platoon with uncertain dynamics and communication delay. *IET Intell. Transp. Syst.*, Institution of Engineering and Technology (IET), v. 10, n. 7, p. 503–513, set. 2016.
- GAO, H.; SONG, Y.; WEN, C. Event-triggered adaptive neural network controller for uncertain nonlinear system. *Information Sciences*, Elsevier BV, v. 506, p. 148–160, jan 2020.
- GE, X.; HAN, Q.; ZHANG, X.; DING, D. Communication resource-efficient vehicle platooning control with various spacing policies. *IEEE/CAA Journal of Automatica Sinica*, Institute of Electrical and Electronics Engineers (IEEE), v. 11, n. 2, p. 362–376, fev. 2024.
- GE, X.; HAN, Q.-L.; DING, L.; WANG, Y.-L.; ZHANG, X.-M. Dynamic event-triggered distributed coordination control and its applications: A survey of trends and techniques. *IEEE Transactions on Systems, Man, and Cybernetics: Systems*, Institute of Electrical and Electronics Engineers (IEEE), v. 50, n. 9, p. 3112–3125, set. 2020. ISSN 2168-2232.
- GIRARD, A. Dynamic triggering mechanisms for event-triggered control. *IEEE Trans. Autom. Control*, v. 60, n. 7, p. 1992–1997, 2015.

- GOEBEL, R.; SANFELICE, R. G.; TEEL, A. R. Hybrid dynamical systems. *IEEE Control Systems*, Institute of Electrical and Electronics Engineers (IEEE), v. 29, n. 2, p. 28–93, apr 2009.
- GU, K.; KHARITONOV, V.; CHEN, J. *Stability of time-delay systems*. [S.l.]: Birkhäuser Boston, 2003.
- GU, K.; NICULESCU, S.-I. Survey on recent results in the stability and control of time-delay systems\*. *Journal of Dynamic Systems, Measurement, and Control*, ASME International, v. 125, n. 2, p. 158–165, jun 2003.
- GUANETTI, J.; KIM, Y.; BORRELLI, F. Control of connected and automated vehicles: State of the art and future challenges. *Annu. Rev. Control.*, Elsevier BV, v. 45, p. 18–40, 2018. ISSN 1367-5788.
- GUO, X.; WANG, J.; LIAO, F.; TEO, R. Distributed adaptive integrated-sliding-mode controller synthesis for string stability of vehicle platoons. *IEEE Trans. Intell. Transp. Syst.*, Institute of Electrical and Electronics Engineers (IEEE), v. 17, n. 9, p. 2419–2429, 2016.
- HEEMELS, W. P. M. H.; DONKERS, M. C. F.; TEEL, A. R. Periodic event-triggered control based on state feedback. In: *IEEE Conference on Decision and Control and European Control Conference*. Orlando, USA: IEEE, 2011.
- HEEMELS, W. P. M. H.; JOHANSSON, K. H.; TABUADA, P. An introduction to event-triggered and self-triggered control. In: *2012 IEEE 51st IEEE Conference on Decision and Control (CDC)*. Maui, USA: IEEE, 2012.
- HUANG, C.; KARIMI, H. Non-fragile  $\mathcal{H}_\infty$  control for LPV-based CACC systems subject to denial-of-service attacks. *IET Control. Theory Appl.*, Institution of Engineering and Technology (IET), v. 15, n. 9, p. 1246–1256, 2021.
- ISIDORI, A. *Nonlinear control systems*. 3. ed. [S.l.]: Springer London, 1995.
- JIA, D.; LU, K.; WANG, J.; ZHANG, X.; SHEN, X. A survey on platoon-based vehicular cyber-physical systems. *IEEE Commun. Surv. Tutor.*, Institute of Electrical and Electronics Engineers (IEEE), v. 18, n. 1, p. 263–284, 2016.
- JOHANSSON, A.; BAI, T.; JOHANSSON, K. H.; MÅRTENSSON, J. Platoon cooperation across carriers: From system architecture to coordination. *IEEE Intell. Transp. Syst. Mag.*, Institute of Electrical and Electronics Engineers (IEEE), v. 15, n. 3, p. 132–144, 2023.
- JU, Z.; ZHANG, H.; LI, X.; CHEN, X.; HAN, J.; YANG, M. A survey on attack detection and resilience for connected and automated vehicles: From vehicle dynamics and control perspective. *IEEE Trans. Intell. Veh.*, v. 7, n. 4, p. 815–837, 2022.
- JU, Z.; ZHANG, H.; TAN, Y. Distributed stochastic MPC for heterogeneous vehicle platoons subject to modeling uncertainties. *IEEE Intell. Transp. Syst. Mag.*, v. 14, n. 2, p. 25–40, 2022.
- KHALIL, K. *Nonlinear Systems*. [S.l.]: Prentice Hall, 2002.

- LESCH, V.; BREITBACH, M.; SEGATA, M.; BECKER, C.; KOUNEV, S.; KRUPITZER, C. An overview on approaches for coordination of platoons. *IEEE Transactions on Intelligent Transportation Systems*, Institute of Electrical and Electronics Engineers (IEEE), v. 23, n. 8, p. 10049–10065, ago. 2022.
- LI, H.; CHEN, Z.; FU, B.; WU, Z.; JI, X.; SUN, M. Event-triggered vehicle platoon control under random communication noises. *IEEE Access*, v. 9, p. 51722–51733, 2021.
- LI, L.; NOVEL, B. d’Andrea; THOREL, S. New online estimation algorithm of lateral tire-road coefficients based on inertial navigation system. In: *2019 IEEE Intelligent Transportation Systems Conference (ITSC)*. [S.l.]: IEEE, 2019.
- LI, L.; NOVEL, B. d’Andréa; QUADRAT, A. Longitudinal and lateral control for four wheel steering vehicles. *IFAC-PapersOnLine*, Elsevier BV, v. 53, n. 2, p. 15713–15718, 2020. ISSN 2405-8963.
- LI, Z.; HU, B.; LI, M.; LUO, G. String stability analysis for vehicle platooning under unreliable communication links with event-triggered strategy. *IEEE Trans. Veh. Technol.*, v. 68, n. 3, p. 2152–2164, 2019.
- LIN, Y.-C.; NGUYEN, H. L. T. Adaptive neuro-fuzzy predictor-based control for cooperative adaptive cruise control system. *IEEE Transactions on Intelligent Transportation Systems*, Institute of Electrical and Electronics Engineers (IEEE), v. 21, n. 3, p. 1054–1063, mar. 2020. ISSN 1558-0016.
- LINSENMYER, S.; DIMAROGONAS, D. V. Event-triggered control for vehicle platooning. In: *2015 American Control Conference (ACC)*. Chicago, USA: IEEE, 2015.
- LIU, K.; SELIVANOV, A.; FRIDMAN, E. Survey on time-delay approach to networked control. *Annual Reviews in Control*, Elsevier BV, v. 48, p. 57–79, nov. 2019.
- LIU, X.; GOLDSMITH, A.; MAHAL, S.; HEDRICK, J. Effects of communication delay on string stability in vehicle platoons. In: *ITSC 2001. 2001 IEEE Intelligent Transportation Systems. Proceedings (Cat. No.01TH8585)*. [S.l.]: IEEE, 2001. (ITSC-01).
- LÖFBERG, J. YALMIP : A toolbox for modeling and optimization in MATLAB. In: *In Proceedings of the CACSD Conference*. Taipei, Taiwan: [s.n.], 2004.
- LUO, Q.; NGUYEN, A.-T.; FLEMING, J.; ZHANG, H. Unknown input observer based approach for distributed tube-based model predictive control of heterogeneous vehicle platoons. *IEEE Trans. Veh. Technol.*, v. 70, n. 4, p. 2930–2944, 2021.
- MA, F.; WANG, J.; ZHU, S.; GELBAL, S. Y.; YANG, Y.; AKSUN-GUVENC, B.; GUVENC, L. Distributed control of cooperative vehicular platoon with nonideal communication condition. *IEEE Transactions on Vehicular Technology*, Institute of Electrical and Electronics Engineers (IEEE), v. 69, n. 8, p. 8207–8220, ago. 2020. ISSN 1939-9359.
- MAHFOUZ, D.; SHEHATA, O.; MORGAN, E. Development and evaluation of a unified integrated platoon control system architecture. *IEEE Trans. Intell. Transp. Syst.*, Institute of Electrical and Electronics Engineers (IEEE), v. 24, n. 6, p. 5685–5704, 2023.
- MAITY, D.; BARAS, J. S. Event based control for control affine nonlinear systems: A Lyapunov function based approach. In: *2015 54th IEEE Conference on Decision and Control (CDC)*. Osaka, Japan: IEEE, 2015.



- MENHOUR, L.; NOVEL, B. d'Andrea; FLIESS, M.; GRUYER, D.; MOUNIER, H. An efficient model-free setting for longitudinal and lateral vehicle control: Validation through the interconnected pro-sivic/rtrmaps prototyping platform. *IEEE Transactions on Intelligent Transportation Systems*, Institute of Electrical and Electronics Engineers (IEEE), v. 19, n. 2, p. 461–475, fev. 2018. ISSN 1558-0016.
- MILANES, V.; SHLADOVER, S. E.; SPRING, J.; NOWAKOWSKI, C.; KAWAZOE, H.; NAKAMURA, M. Cooperative adaptive cruise control in real traffic situations. *IEEE Transactions on Intelligent Transportation Systems*, Institute of Electrical and Electronics Engineers (IEEE), v. 15, n. 1, p. 296–305, fev. 2014.
- MOREIRA, L. G.; GROFF, L. B.; SILVA, J. M. G. da. Event-triggered state-feedback control for continuous-time plants subject to input saturation. *Journal of Control, Automation and Electrical Systems*, Springer Science and Business Media LLC, v. 27, n. 5, p. 473–484, aug 2016.
- MOSER, D.; SCHMIED, R.; WASCHL, H.; RE, L. del. Flexible spacing adaptive cruise control using stochastic model predictive control. *IEEE Transactions on Control Systems Technology*, Institute of Electrical and Electronics Engineers (IEEE), v. 26, n. 1, p. 114–127, jan. 2018. ISSN 1558-0865.
- NARANJO, J.; GONZALEZ, C.; REVIEJO, J.; GARCIA, R.; PEDRO, T. de. Adaptive fuzzy control for inter-vehicle gap keeping. *IEEE Transactions on Intelligent Transportation Systems*, Institute of Electrical and Electronics Engineers (IEEE), v. 4, n. 3, p. 132–142, set. 2003. ISSN 1524-9050.
- NGUYEN, C. M.; NGUYEN, A.-T.; DELPRAT, S. Neural-network-based fuzzy observer with data-driven uncertainty identification for vehicle dynamics estimation under extreme driving conditions: Theory and experimental results. *IEEE Transactions on Vehicular Technology*, Institute of Electrical and Electronics Engineers (IEEE), v. 72, n. 7, p. 8686–8696, jul. 2023. ISSN 1939-9359.
- NIELSEN, C.; FULFORD, C.; MAGGIORE, M. Path following using transverse feedback linearization: Application to a maglev positioning system. *Automatica*, Elsevier BV, v. 46, n. 3, p. 585–590, mar 2010.
- NUNEN, E. van; REINDERS, J.; SEMSAR-KAZEROONI, E.; WOUW, N. van de. String stable model predictive cooperative adaptive cruise control for heterogeneous platoons. *IEEE Trans. Intell. Veh.*, v. 4, n. 2, p. 186–196, 2019.
- OHTAKE, H.; TANAKA, K.; WANG, H. O. Fuzzy modeling via sector nonlinearity concept. *Integrated Computer-Aided Engineering*, IOS Press, v. 10, n. 4, p. 333–341, set. 2003.
- OLIVEIRA, M. C. de; SKELTON, R. E. Stability tests for constrained linear systems. In: \_\_\_\_\_. *Lecture Notes in Control and Information Sciences*. [S.l.]: Springer London, 2001. p. 241–257. ISBN 9781846285769.
- ONCU, S.; PLOEG, J.; WOUW, N. van de; NIJMEIJER, H. Cooperative adaptive cruise control: Network-aware analysis of string stability. *IEEE Trans. Intell. Transp. Syst.*, Institute of Electrical and Electronics Engineers (IEEE), v. 15, n. 4, p. 1527–1537, 2014.

- PACHPATTE, B. G. *Inequalities for differential and integral equations*. [S.l.]: Elsevier Science & Technology Books, 1997. ISBN 9780080534640.
- PALIOTTA, C.; LEFEBER, E.; PETTERSEN, E. E.; PINTO, J.; COSTA, M.; SOUSA, J. T. F. B. Trajectory tracking and path following for underactuated marine vehicles. *IEEE Transactions on Control Systems Technology*, Institute of Electrical and Electronics Engineers (IEEE), v. 27, n. 4, p. 1423–1437, jul 2019.
- PANANURAK, W.; THANOK, S.; PARNICHKUN, M. Adaptive cruise control for an intelligent vehicle. In: *2008 IEEE International Conference on Robotics and Biomimetics*. [S.l.]: IEEE, 2009.
- PEIXOTO, M. L. C.; COUTINHO, P. H. S.; BESSA, I.; PESSIM, P. S. P.; PALHARES, R. M. Event-triggered control of Takagi-Sugeno fuzzy systems under deception attacks. *International Journal of Robust and Nonlinear Control*, Wiley, v. 33, n. 13, p. 7471–7487, maio 2023. ISSN 1099-1239.
- PENG, C.; LI, F. A survey on recent advances in event-triggered communication and control. *Inf. Sci.*, v. 457–458, p. 113–125, 2018.
- PESSIM, P. S.; PEIXOTO, M. L.; PALHARES, R. M.; LACERDA, M. J. Static output-feedback control for cyber-physical LPV systems under DoS attacks. *Information Sciences*, Elsevier BV, v. 563, p. 241–255, jul. 2021. ISSN 0020-0255.
- PLOEG, J.; SCHEEPERS, B.; van Nunen, E.; van de Wouw, N.; NIJMEIJER, H. Design and experimental evaluation of perative adaptive cruise control. In: *14th Int. IEEE Conf. Intell. Transp. Syst.* Washington, DC, USA: [s.n.], 2011. p. 260–265. ISBN 978-1-4577-2197-7 978-1-4577-2198-4 978-1-4577-2196-0.
- PLOEG, J.; van de Wouw, N.; NIJMEIJER, H.  $\mathcal{L}_p$  string stability of cascaded systems: Application to vehicle platooning. *IEEE Trans. Control Syst. Technol.*, v. 22, n. 2, p. 786–793, 2014.
- POLACK, P.; NOVEL, B. d’Andréa; FLIESS, M.; FORTELLE, A. de L.; MENHOUR, L. Finite-time stabilization of longitudinal control for autonomous vehicles via a model-free approach \* \*this work was supported by the international chair mines paris-tech - peugeot-citroën - safran - valeo on ground vehicle automation and the anr project 15 ce23 0007 (project finite4sos). *IFAC-PapersOnLine*, Elsevier BV, v. 50, n. 1, p. 12533–12538, jul. 2017. ISSN 2405-8963.
- PROTTER, M. H.; MORREY, C. B. *Intermediate Calculus*. [S.l.]: Springer New York, 1985. ISSN 0172-6056. ISBN 9781461210863.
- RAJAMANI, R. *Vehicle Dynamics and Control*. Boston, MA: Springer US, 2012.
- SAHOO, A.; XU, H.; JAGANNATHAN, S. Neural network-based event-triggered state feedback control of nonlinear continuous-time systems. *IEEE Transactions on Neural Networks and Learning Systems*, Institute of Electrical and Electronics Engineers (IEEE), v. 27, n. 3, p. 497–509, mar 2016.
- SAMII, A.; BEKIARIS-LIBERIS, N. Simultaneous compensation of actuation and communication delays for heterogeneous platoons via predictor-feedback CACC with integral action. *IEEE Trans. Intell. Veh.*, p. 1–13, 2024.

- SAWANT, J.; CHASKAR, U.; GINOYA, D. Robust control of cooperative adaptive cruise control in the absence of information about preceding vehicle acceleration. *IEEE Transactions on Intelligent Transportation Systems*, Institute of Electrical and Electronics Engineers (IEEE), v. 22, n. 9, p. 5589–5598, set. 2021. ISSN 1558-0016.
- SELIVANOV, A.; FRIDMAN, E. Event-triggered  $\mathcal{H}_\infty$  control: A switching approach. *IEEE Trans. Autom. Control*, v. 61, n. 10, p. 3221–3226, 2016.
- SEPULCHRE, R.; PALEY, D. A.; LEONARD, N. R. Stabilization of planar collective motion: All-to-all communication. *IEEE Transactions on Automatic Control*, Institute of Electrical and Electronics Engineers (IEEE), v. 52, n. 5, p. 811–824, may 2007.
- SEURET, A.; GOUAISBAUT, F. Stability of linear systems with time-varying delays using Bessel–Legendre inequalities. *IEEE Transactions on Automatic Control*, Institute of Electrical and Electronics Engineers (IEEE), v. 63, n. 1, p. 225–232, jan. 2018.
- SONTAG, E. D.; WANG, Y. New characterizations of input-to-state stability. *IEEE Transactions on Automatic Control*, Institute of Electrical and Electronics Engineers (IEEE), v. 41, n. 9, p. 1283–1294, set. 1996.
- STÖCKER, C.; LUNZE, J. Event-based control of input-output linearizable systems. *IFAC Proceedings Volumes*, Elsevier BV, v. 44, n. 1, p. 10062–10067, jan 2011.
- SU, Y.; YANG, X.; SHI, P.; WEN, G.; XU, Z. Consensus-based vehicle platoon control under periodic event-triggered strategy. *IEEE Trans. Syst., Man, Cybern.: Syst.*, Institute of Electrical and Electronics Engineers (IEEE), v. 54, n. 1, p. 533–542, 2024. ISSN 2168-2232.
- SWAROOP, D.; HEDRICK, K.; CHIEN, C.; IOANNOU, P. A comparison of spacing and headway control laws for automatically controlled vehicles. *Veh. Syst. Dyn.*, Taylor & Francis, v. 23, n. 1, p. 597–625, 1994.
- TABUADA, P. Event-triggered real-time scheduling of stabilizing control tasks. *IEEE Trans. Autom. Control*, v. 52, n. 9, p. 1680–1685, 2007.
- TANAKA, K.; WANG, H. O. *Fuzzy control systems design and analysis: A linear matrix inequality approach*. [S.l.]: John Wiley & Sons, Inc., 2001.
- TOULOTTE, P. F.; DELPRAT, S.; GUERRA, T. M.; BOONAERT, J. Vehicle spacing control using robust fuzzy control with pole placement in LMI region. *Engineering Applications of Artificial Intelligence*, Elsevier BV, v. 21, n. 5, p. 756–768, ago. 2008.
- UMLAUFT, J.; HIRCHE, S. Feedback linearization based on gaussian processes with event-triggered online learning. *IEEE Transactions on Automatic Control*, Institute of Electrical and Electronics Engineers (IEEE), v. 65, n. 10, p. 4154–4169, oct 2020.
- VILCA, J.; ADOUANE, L.; MEZOUAR, Y. A novel safe and flexible control strategy based on target reaching for the navigation of urban vehicles. *Robotics and Autonomous Systems*, Elsevier BV, v. 70, p. 215–226, ago. 2015. ISSN 0921-8890.
- WANG, B.; LUO, Y.; ZHONG, Z.; LI, K. Robust non-fragile fault tolerant control for ensuring the safety of the intended functionality of cooperative adaptive cruise control. *IEEE Trans. Intell. Transp. Syst.*, v. 23, n. 10, p. 18746–18760, 2022.

- WANG, J.; MA, F.; YANG, Y.; NIE, J.; AKSUN-GUVENC, B.; GUVENC, L. Adaptive event-triggered platoon control under unreliable communication links. *IEEE Trans. Intell. Transp. Syst.*, Institute of Electrical and Electronics Engineers (IEEE), v. 23, n. 3, p. 1924–1935, 2022.
- WANG, L.; HU, M.; BIAN, Y.; GUO, G.; LI, S.; CHEN, B.; ZHONG, Z. Periodic event-triggered fault detection for safe platooning control of intelligent and connected vehicles. *IEEE Trans. Veh. Technol.*, p. 1–14, 2023.
- WANG, Z.; WU, G.; BARTH, M. J. A review on cooperative adaptive cruise control (CACC) systems: Architectures, controls, and applications. In: *2018 21st International Conference on Intelligent Transportation Systems (ITSC)*. Maui, USA: IEEE, 2018.
- WEAVER, N. *Lipschitz algebras*. [S.l.]: WORLD SCIENTIFIC, 1999.
- WEI, Y.; LIYUAN, W.; GE, G. Event-triggered platoon control of vehicles with time-varying delay and probabilistic faults. *Mech. Syst. Signal Process.*, Elsevier BV, v. 87, p. 96–117, 2017.
- WU, G.; CHEN, G.; ZHANG, H.; HUANG, G. Fully distributed event-triggered vehicular platooning with actuator uncertainties. *IEEE Trans. Veh. Technol.*, Institute of Electrical and Electronics Engineers (IEEE), v. 70, n. 7, p. 6601–6612, 2021.
- WU, Z.; SUN, J.; HONG, S. RBFNN-based adaptive event-triggered control for heterogeneous vehicle platoon consensus. *IEEE Trans. Intell. Transp. Syst.*, v. 23, n. 10, p. 18761–18773, 2022.
- XIAO, L.; GAO, F. Practical string stability of platoon of adaptive cruise control vehicles. *IEEE Transactions on Intelligent Transportation Systems*, Institute of Electrical and Electronics Engineers (IEEE), v. 12, n. 4, p. 1184–1194, dez. 2011. ISSN 1524-9050.
- XIAO, S.; GE, X.; HAN, Q.-L.; ZHANG, Y. Dynamic event-triggered platooning control of automated vehicles under random communication topologies and various spacing policies. *IEEE Trans. Cybern.*, Institute of Electrical and Electronics Engineers (IEEE), v. 52, n. 11, p. 11477–11490, 2022.
- XU, B.; LIU, X.; WANG, H.; ZHOU, Y. Event-triggered control for nonlinear systems via feedback linearisation. *International Journal of Control*, Informa UK Limited, v. 94, n. 10, p. 2679–2689, feb 2020.
- YAN, S.; SHEN, M.; NGUANG, S. K.; ZHANG, G.; ZHANG, L. A distributed delay method for event-triggered control of T-S fuzzy networked systems with transmission delay. *IEEE Transactions on Fuzzy Systems*, Institute of Electrical and Electronics Engineers (IEEE), v. 27, n. 10, p. 1963–1973, oct 2019.
- YU, L.; WANG, R. Researches on adaptive cruise control system: A state of the art review. *Proceedings of the Institution of Mechanical Engineers, Part D: Journal of Automobile Engineering*, SAGE Publications, v. 236, n. 2–3, p. 211–240, maio 2021.
- ZHANG, H.; LIU, J.; WANG, Z.; YAN, H.; ZHANG, C. Distributed adaptive event-triggered control and stability analysis for vehicular platoon. *IEEE Transactions on Intelligent Transportation Systems*, Institute of Electrical and Electronics Engineers (IEEE), v. 22, n. 3, p. 1627–1638, mar. 2021.

---

ZHENG, Y.; LI, S.; WANG, J.; CAO, D.; LI, K. Stability and scalability of homogeneous vehicular platoon: Study on the influence of information flow topologies. *IEEE Trans. Intell. Transp. Syst.*, Institute of Electrical and Electronics Engineers (IEEE), v. 17, n. 1, p. 14–26, 2016.

ZHU, Y.; HE, H.; ZHAO, P. LMI-based synthesis of string-stable controller for cooperative adaptive cruise control. *IEEE Trans. Intell. Transp. Syst.*, v. 21, n. 11, p. 4516–4525, 2020.



Thèse de doctorat

Pour obtenir le grade de Docteur de  
l'UNIVERSIDADE FEDERAL DE MINAS GERAIS Graduate Program in  
Electrical Engineering et de l'UNIVERSITÉ POLYTECHNIQUE  
HAUTS-DE-FRANCE et de l'INSA HAUTS-DE-FRANCE

Spécialité: **Automatique, Productique**

**Rafael NASCIMENTO SILVA**

**École doctorale:** PPGEE – Programa de Pós-Graduação em Engenharia Elétrica UFMG  
Doctoral School Polytechnique Hauts-de-France (ED PHF n°635)  
**Unité de recherche:** Laboratoire d'Automatique, de Mécanique et d'Informatique Industrielles  
et Humaines (LAMIH - UMR CNRS 8201)  
Laboratório de Detecção de Falhas, Controle, Otimização e Modelagem (DIFCOM)

## Commande événementielle pour les systèmes non linéaires: Application au convoi de véhicules (Résumé Substantiel)

<b>Jury:</b>	D'ANDRÉA-NOVEL, Brigitte	Professeure, Universités Mines ParisTech
<b>Rapporteurs:</b>	ADOUANE, Lounis	Professeur, Université de Technologie de Compiègne
	DÓREA, Carlos	Professeur, Universidade Federal do Rio Grande do Norte
<b>Examineurs:</b>	D'ANDRÉA-NOVEL, Brigitte	Professeure, Universités Mines ParisTech
	DEAECTO, Grace	Maîtresse de conférences, Universidade Estadual de Campinas
<b>Directeurs de thèse :</b>	FREZZATO, Luciano	Professeur Adjoint, Universidade Federal de Minas Gerais
	GUERRA, Thierry Marie	Professeur, Université Polytechnique Hauts de France
<b>Co-encadrant:</b>	NGUYEN, Anh-Tu	Maître de conférences, Université Polytechnique Hauts de France
	SOUZA, Fernando	Maître de conférences, Universidade Federal de Minas Gerais

Valenciennes  
2024

*Special thanks to my family*

# Acknowledgements

Firstly, I want to thank my family, especially my parents Jaime Marques and Maria Oliveira, for all opportunities they gave me, for education, trust, and the for always been by my side, regardless of distance.

I thank the professors Fernando, Luciano, Anh-Tu and Guerra for their excellent orientation, for their patience and for knowledge share; These factors helped me on the way to become a better researcher.

I thank all the professors of the Postgraduate Program in Electrical Engineering (PP-GEE) whose knowledge contributed to this work, in addition to the aid in the research process that underlies the same. And I thank UPHF for the support.

I thank all my friends and colleagues of D!Fcom and LAMIH, friends and teachers of IFBA Campus Vitória da Conquista. Special thanks to all my friends of many years, who were by my side and supported me in the difficulties that occurred during this time.

This work was supported by the French Ministry of Higher Education and Research, by the CNRS, by the Hauts-de-France region (Allocation de recherche 2020 de la région Hauts-de-France Convention 20003875), by the Coordination for the Improvement of Higher Education Personnel - Brazil (CAPES) through the Academic Excellence Program (PROEX), by the project InSAC (National Institute of Science and Technology for Cooperative Autonomous Systems Applied to Security and Environment) under the grants CNPq (Conselho Nacional de Desenvolvimento Científico e Tecnológico) 465755/2014-3 and 88887.513093/2020-00, Fundação de Amparo à Pesquisa do Estado de Minas Gerais (FAPEMIG), and São Paulo Research Foundation (FAPESP) 2014/50851-0, and also by the grants CNPq: 312034/2020-2, FAPEMIG: APQ-00543-217 and APQ-00630-23, and Universidade Federal de Minas Gerais.





*Special thanks to my family*

# Résumé

Cette thèse aborde la mise en œuvre d'une commande événementielle pour les systèmes non linéaires avec une application au convoi non homogène de véhicules. La commande linéarisante est appliquée pour homogénéiser le convoi. Néanmoins, elle a des limitations en présence d'incertitudes paramétriques et de perturbations exogènes non mesurées. Pour résoudre ce problème, nous proposons d'utiliser un observateur de perturbations (DOB : disturbance observer) qui estime une perturbation "virtuelle", représentant les effets à la fois des incertitudes paramétriques et des signaux externes non mesurés. Cette estimation est directement intégrée dans la loi de commande linéarisante pour compenser les incertitudes. En tenant compte des effets de compensation, la stabilité individuelle de chaque véhicule et la stabilité du convoi de véhicules est formulée à partir d'un sous-système interconnecté. Ce dernier représente l'interaction entre deux véhicules consécutifs qui échangent directement des informations. Grâce à cette formulation, la stabilité individuelle et en convoi non homogène peut être étudiée en utilisant une analyse de stabilité  $\mathcal{L}_2$  d'un seul sous-système interconnecté, assurant la scalabilité des conditions de stabilité proposées. En considérant une transmission basée sur les événements pour réduire le taux de communication, des conditions suffisantes de stabilité sont proposées. Elles utilisent la théorie de Lyapunov et dans le cas de retards, des fonctionnelles de Lyapunov-Krasovskii. Pour éviter le phénomène de Zenon, un délai minimum entre les transmissions consécutives est imposé. Pour tenir compte du délai imposé, le sous-système interconnecté est réécrit sous forme d'un système à commutation basé sur les intervalles pendant lesquels le mécanisme de déclenchement est actif. En tant qu'extension des méthodes ETC pour les applications autour des convois de véhicules, une méthode de co-design pour les systèmes non linéaires est également proposée à partir d'une technique de commande linéarisante. Les conditions de synthèse à la fois pour le contrôleur et le mécanisme de déclenchement d'événements sont reformulées sous forme d'un problème d'optimisation écrit à l'aide de contraintes d'inégalité matricielle linéaire. Des simulations et des comparaisons sont présentées pour chaque partie du mémoire.

Mots clés : Systèmes Non Linéaires ; Commande En Réseau ; Commande Événementielle ; Convoi Du Véhicule ; Observateur Des Perturbations.

# Sommaire

<b>Sommaire</b> . . . . .	<b>6</b>
<b>1 Introduction</b> . . . . .	<b>7</b>
1.1 Objectif et contributions . . . . .	11
1.2 Organisation . . . . .	12
1.2.1 Publications personnelles liées au projet de doctorat . . . . .	13
<b>2 Aspects fondamentaux sur le platooning et le contrôle déclenché par événement</b> . . . . .	<b>15</b>
2.1 Introduction . . . . .	15
2.2 Conclusion . . . . .	15
<b>3 ACC coopératif avec communication continue</b> . . . . .	<b>17</b>
3.1 Introduction . . . . .	17
3.2 Conclusion . . . . .	17
<b>4 Platoon CACC avec communication déclenchée par événement</b> . . . . .	<b>19</b>
4.1 Introduction . . . . .	19
4.2 Conclusion . . . . .	19
<b>5 Linéarisation par rétroaction ETC</b> . . . . .	<b>21</b>
5.1 Introduction . . . . .	21
5.2 Conclusion . . . . .	23
<b>6 Conclusion et perspectives</b> . . . . .	<b>24</b>
6.1 Perspectives de recherche . . . . .	25
<b>Bibliographie</b> . . . . .	<b>28</b>

# 1 Introduction

Les embouteillages et les accidents sont devenus plus fréquents à mesure que la population augmente, entraînant des problèmes tels que des retards de transport, des embouteillages et une consommation accrue de carburant. Dans ce contexte, la coordination de haut niveau des convois, ainsi que le contrôle des convois au niveau physique, ont été considérés comme une solution prometteuse. Grâce au convoiage, les véhicules peuvent voyager en formation linéaire, en maintenant des distances courtes contrôlées et une vitesse en fonction d'une stratégie/politique prédéfinie et de contraintes de sécurité, un exploit souvent irréalisable par les humains seuls. Cette réduction de distance facilite la réduction de la traînée aérodynamique, diminuant ainsi la consommation de carburant. De plus, avec un espacement optimisé, le flux de trafic s'améliore, évitant ainsi les congestions.

Ces aspects motivent l'étude des véhicules équipés de systèmes de régulation adaptative de la vitesse (*adaptive cruiser control* — ACC). Dans cette configuration, un leader est suivi par  $N$  véhicules suiveurs en formation linéaire. Les véhicules sont équipés de capteurs pouvant mesurer la distance entre eux et le véhicule qui les précède. Les distances mesurées sont comparées à une politique de distance prédéfinie pour garantir une distance de sécurité entre les véhicules.

Pour le contrôle du convoi, deux propriétés principales sont d'une importance fondamentale. L'une est la stabilité individuelle, qui fait référence à la capacité de chaque véhicule dans le convoi à atteindre et à maintenir la politique de distance souhaitée. L'autre propriété est la stabilité en chaîne, qui garantit que les petites perturbations ne sont pas amplifiées dans tout le convoi. Alors que la stabilité individuelle assure la formation du convoi, la stabilité en chaîne garantit que les perturbations rapides affectant le leader ou d'autres véhicules n'entraîneront pas de changements excessifs dans la formation, par exemple, en évitant les freinages soudains.

Alors que la stabilité individuelle peut être définie en tenant compte de la théorie classique du contrôle ou du sens de Lyapunov, la stabilité en chaîne présente de nombreuses définitions mathématiques et a été analysée sous différents cadres dans la littérature. Parmi ces approches, les principales sont l'analyse dans le domaine fréquentiel (en termes de norme  $\mathcal{H}_\infty$ ) et les méthodes dans le domaine temporel (en termes de normes  $\mathcal{L}_p$ ). L'approche dans le domaine temporel repose sur l'évaluation de la norme  $\mathcal{L}_p$  entre l'entrée du leader ou les perturbations et la sortie du dernier véhicule dans le convoi. Cela peut également être étudié en évaluant la norme  $\mathcal{L}_p$  entre l'entrée et la sortie des sous-systèmes qui composent la chaîne.

## Linéarisation par rétroaction des convois de véhicules avec incertitudes

L'homogénéité et la linéarité du convoi sont des hypothèses courantes employées pour simplifier l'analyse de la stabilité individuelle et en chaîne. Bien que cette hypothèse puisse être réalisée grâce à des techniques de linéarisation par retour d'état, la procédure nécessite une connaissance précise des paramètres du véhicule. Les incertitudes paramétriques et les variables externes non mesurées peuvent provoquer des décalages, entraînant des systèmes de convoi non homogènes. Pour surmonter ces problèmes, il est proposé un observateur robuste basé sur un intermédiaire pour estimer conjointement les défauts des capteurs et des actionneurs ainsi que les perturbations correspondantes, dont les effets peuvent être compensés via une méthode de contrôle robuste tolérante aux pannes non fragiles. Une autre méthode utilise un observateur proportionnel à intégrale multiple pour estimer simultanément l'état et une perturbation globale, laquelle est compensée par un schéma de contrôle prédictif basé sur un tube. Alternativement, une technique de filtrage est considérée pour atténuer les effets des perturbations, tandis que d'autres travaux explorent des conditions de stabilité en chaîne de type Lyapunov avec des perturbations. Ces travaux évaluent la stabilité en chaîne en se basant sur la dynamique globale du convoi, décrivant la relation entre l'entrée du leader et la sortie du dernier véhicule. Dans ce cas, chaque fois que de nouveaux véhicules sont ajoutés au convoi, les conditions d'analyse de stabilité doivent être réévaluées. De plus, à mesure que le nombre de véhicules dans le convoi augmente, davantage de variables de décision et de contraintes sont impliquées dans l'analyse de la stabilité, ce qui peut accroître la complexité de la solution du problème. Ces facteurs peuvent compromettre la scalabilité de l'application.

## Communication sans fil et contrôle déclenché par événement

Assurer la stabilité individuelle et en chaîne tout en minimisant la distance entre les véhicules peut être un objectif contradictoire, car une distance plus courte peut compromettre la stabilité. Comme certaines applications pratiques l'ont démontré, ce problème peut être atténué en incorporant des dispositifs de communication dans les véhicules et en permettant le partage d'informations au sein du convoi, ce qui peut améliorer la performance du convoi et, théoriquement, permettre des politiques de distance plus courtes sans compromettre la sécurité. Cette inclusion de la communication dans les systèmes ACC est connue sous le nom de CACC (cooperative ACC). Dans le cadre du CACC, la communication joue un rôle important, et différentes topologies de flux peuvent être distinguées selon les véhicules capables de partager des informations. Un autre élément fondamental de la communication est sa qualité et son mécanisme. La qualité de la communication fait référence aux problèmes qui peuvent survenir lors de la communication. Certains travaux dans la littérature considèrent une communication parfaite ; cependant, des phénomènes tels que des pertes de paquets, des dénis de service, des attaques et des

retards de communication peuvent compromettre la stabilité individuelle et, surtout, la stabilité en chaîne.

Le mécanisme de communication spécifie comment la communication est établie entre les véhicules. La plupart des méthodes de contrôle de convoi de véhicules reposent sur une communication périodique, qui peut être supposée continue avec une transmission rapide, entraînant une consommation élevée de bande passante et d'énergie. Alternativement, le contrôle déclenché par événements (*event-triggered control* — ETC) rend la communication plus efficace en transmettant les informations en fonction d'un critère spécifié. Cependant, l'efficacité de la communication peut compromettre les performances. Lors de l'application de l'ETC aux systèmes CACC, minimiser les exigences de communication tout en maintenant la stabilité, même en présence de retards, est fondamental.

Les schémas de contrôle déclenchés par événements varient selon leurs mécanismes de déclenchement d'événements (*event-triggering mechanisms* — ETM). Les ETM statiques impliquent des paramètres qui ne changent pas au fil du temps. Les ETM adaptatifs ou dynamiques considèrent des paramètres qui changent selon des conditions de déclenchement adaptatives ou dynamiques, visant à réduire les événements transmis. Dans la conception de l'ETC, deux approches peuvent être distinguées, à savoir l'approche par émulation et l'approche de co-conception. L'approche par émulation consiste en une procédure en deux étapes où le contrôleur est d'abord conçu en supposant une communication continue, puis l'ETM est conçu en fonction du contrôleur souhaité. Dans l'approche de co-conception, à la fois le contrôleur et l'ETM sont conçus conjointement dans le cadre du même problème d'optimisation. L'approche de co-conception offre plus de flexibilité puisqu'elle permet d'incorporer à la fois les performances de contrôle et l'efficacité de la communication comme contraintes ou fonctions de coût. De plus, la stabilité individuelle et en chaîne peut être évaluée directement à partir du problème de conception basé sur l'optimisation.

Lors de la conception de contrôleurs déclenchés par événements, il est essentiel d'éviter le comportement de Zeno, qui est le phénomène d'un nombre infini d'événements (transmissions) dans un intervalle de temps fini, c'est-à-dire que le temps entre les événements converge vers zéro. De nombreux travaux concernant l'ETC dérivent leurs mécanismes des conditions classiques proposées, où un comportement exempt de Zeno peut être assuré avec des hypothèses mineures. Cependant, en présence d'incertitudes et de perturbations, ces ETM ne peuvent plus garantir une borne inférieure positive pour le temps entre événements (*inter-event time* — IET) afin de prévenir le comportement de Zeno. Par conséquent, des investigations substantielles sont nécessaires pour assurer un temps minimum entre les événements dans ces scénarios. Pour assurer un comportement exempt de Zeno pour les systèmes dynamiques avec perturbations, un temps d'attente minimum peut être imposé, de sorte que la condition de déclenchement ne soit évaluée qu'après l'écoulement d'un intervalle de temps spécifié. Alternativement, la condition de déclenchement peut

être vérifiée périodiquement au lieu de continuellement. Cela aboutit à un ETC périodique, où le comportement de Zeno est évité, car le temps entre événements est limité par la période d'échantillonnage.

Combiner la qualité de la communication avec les mécanismes de communication et les incertitudes du système rend le problème de contrôle de convoi plus complexe. Les conditions de conception doivent tenir compte à la fois des retards induits par le réseau et de la communication déclenchée par événements tout en assurant un comportement exempt de Zeno en présence d'incertitudes et de perturbations. De plus, il est crucial de s'assurer que les informations arrivent dans le bon ordre, en évitant le réarrangement des paquets. Cela impose des contraintes supplémentaires sur les délais de transmission et le temps minimum entre les transmissions.

Dans la littérature, un mécanisme statique déclenché par événements (ETM) a été proposé, tandis qu'un ETM adaptatif a été employé ; cependant, les deux ont été développés dans des scénarios sans perturbation. Un temps d'attente minimum a été imposé pour assurer un comportement exempt de Zeno. De plus, des ETM dynamiques ont été développés pour réduire davantage le nombre d'événements de déclenchement. Cependant, le contrôle déclenché par événements (event-triggered control — ETC) est conçu selon une approche en deux étapes (émulation), ce qui peut entraîner des conditions de conception plus conservatrices. Le travail n'a pris en compte que les retards de réseau sans considérer les incertitudes. Basé sur la discrétisation du système de convoi, un autre schéma ETC en temps discret a été proposé, qui prend en compte des liaisons de communication peu fiables. En raison de la discrétisation et de la nature de l'échantillonnage de cette approche de co-conception, le comportement de Zeno peut être naturellement évité. Cependant, cette approche exige que tous les véhicules échantillonnent l'information en même temps, ce qui n'est pas réaliste, même avec la même fréquence d'échantillonnage.

En tenant compte des perturbations externes, des approches ETC efficaces ont été proposées pour le CACC coopératif, en considérant le contrôle périodique déclenché par événements. Ces approches permettent d'éviter le comportement de Zeno, car le temps entre événements est limité par le temps d'échantillonnage. Un mécanisme ETM entièrement distribué a été développé pour le contrôle distribué de convois de véhicules avec une entrée non nulle du véhicule leader et des incertitudes de l'actionneur tout en assurant un comportement exempt de Zeno. Les travaux ont considéré des ETM statiques, tandis que l'ETM est adaptatif, ce qui peut réduire considérablement le nombre d'événements de transmission. De plus, plusieurs topologies de communication ont été considérées, tandis que le travail se concentre sur la topologie prédécesseur-suiveur (*predecessor-follower* — PF). Tous les travaux mentionnés ont évalué la stabilité individuelle et en chaîne en tenant compte de la dynamique combinée de tous les véhicules du convoi, du leader au dernier véhicule, ce qui peut entraîner des problèmes de scalabilité. Comme cela a été montré, la spécificité de la topologie PF peut être exploitée pour réduire le problème d'analyse à un

sous-ensemble de véhicules, facilitant ainsi la scalabilité du convoi.

## 1.1 Objectif et contributions

L'objectif principal de cette thèse est de concevoir des contrôleurs stables en chaîne pour des convois de véhicules CACC coopératifs soumis à des incertitudes dans le cadre d'une communication déclenchée par événements. Pour traiter la question des incertitudes dans le contrôle de convoi, nous proposons une technique de compensation basée sur un observateur de perturbations qui combine la linéarisation par retour d'état avec la compensation des perturbations. Les décalages causés par des incertitudes paramétriques et les effets des perturbations exogènes sont modélisés comme un signal de perturbation virtuel unique, qui est estimé et compensé à l'aide d'un observateur de perturbations (*disturbance observer* — DOB). L'estimation des perturbations basée sur le DOB est directement intégrée dans la loi de contrôle par retour d'état. Pour traiter l'impact de l'erreur d'estimation des perturbations, nous proposons une extension des conditions de stabilité de la norme  $\mathcal{L}_2$  pour évaluer la stabilité en chaîne. Plus précisément, la stabilité classique en chaîne peut être assurée en présence d'incertitudes significatives grâce à une compensation efficace des perturbations.

Pour accroître l'efficacité de la communication, nous proposons des contrôleurs dynamiques déclenchés par événements pour les convois CACC, qui assurent à la fois la stabilité individuelle des véhicules et la stabilité en chaîne  $\mathcal{L}_2$  du convoi. Nous définissons des sous-systèmes interconnectés qui modélisent l'interaction entre des véhicules consécutifs, de sorte qu'en évaluant la stabilité  $\mathcal{L}_2$  d'un seul sous-système, la stabilité individuelle et la stabilité en chaîne  $\mathcal{L}_2$  peuvent être assurées pour le convoi, indépendamment du nombre de véhicules, facilitant ainsi l'évolutivité du convoi. Pour éviter le comportement de Zeno, un temps d'attente minimum est imposé entre les transmissions consécutives. En tenant compte du délai de transmission et du temps d'attente imposé, nous définissons un contrôle déclenché par événements (ETC) commuté et modélisons le système en conséquence comme commuté. En fonction de cette commutation, ainsi que d'un choix approprié de fonctionnelles de Lyapunov-Krasovskii (LKF), à la fois le contrôleur et le mécanisme de déclenchement d'événements (ETM) peuvent être conçus dans un seul problème d'optimisation soumis à des contraintes de type inégalité matricielle linéaire (*linear matrix inequality* — LMI). De plus, nous employons des techniques de relaxation appropriées pour obtenir des conditions moins conservatrices. En outre, en tenant compte de la technique de linéarisation par retour d'état utilisée dans le convoi de véhicules, nous proposons des conditions de co-conception pour le contrôle déclenché par événements de systèmes linéarisables par retour d'état, en supposant que les états nécessaires à la procédure de linéarisation par retour d'état sont mis à jour en fonction des conditions de déclenchement d'événements. Plus précisément, les principales contributions de ce docto-



rat peuvent être résumées comme suit.

- Un schéma de compensation des perturbations basé sur un observateur de perturbations (DOB) est proposé pour le contrôle par linéarisation par retour d'état de pelotons non homogènes, avec des extensions appropriées à l'analyse de la stabilité en chaîne pour prendre en compte l'erreur d'estimation des perturbations.
- Un mécanisme dynamique de déclenchement d'événements commuté est proposé pour assurer la stabilité en chaîne du peloton soumis à des délais induits par le réseau, tout en minimisant le nombre de transmissions et en évitant le comportement de Zeno.
- Des conditions de co-conception pour le contrôle à déclenchement d'événements sont proposées pour les systèmes non linéaires en considérant une loi de contrôle par linéarisation par retour d'état, où les états utilisés pour la linéarisation par retour d'état sont mis à jour selon une condition de déclenchement d'événements.

## 1.2 Organisation

Ce manuscrit de doctorat est organisé comme suit.

Dans le Chapitre 2, nous introduisons le problème de contrôle des pelotons, discutons des résultats concernant le contrôle déclenché par événements, et présentons les propriétés utilisées pour prouver l'absence de comportement de Zeno. Ensuite, une introduction succincte à l'approche de la non-linéarité sectorielle et aux systèmes avec retard est fournie, avec une brève explication de l'analyse de stabilité utilisant les contraintes LMI.

Dans le Chapitre 3, nous abordons le problème de la conception du contrôle pour les pelotons de véhicules à régulateur de vitesse adaptatif coopératif, en supposant une communication continue. En tenant compte des paramètres incertains du modèle de véhicule, nous proposons une linéarisation par retour d'état couplée à une compensation par observateur de perturbations pour traiter les effets des incertitudes. Diverses approches pour modéliser l'interaction des véhicules sont présentées et proposées, ainsi que des conditions d'analyse de la stabilité en chaîne qui tiennent compte de la compensation des incertitudes. Des simulations sont fournies pour valider la compensation DOB, et les performances du peloton sont évaluées.

Dans le Chapitre 4, la communication est supposée être basée sur des événements, et des contrôleurs déclenchés par événements sont conçus pour assurer une communication efficace entre les véhicules. Nous proposons un contrôle déclenché par événements dynamique avec un temps d'attente minimal imposé et un modèle commuté du problème pour tenir compte de ce temps imposé. Des conditions de conception sont proposées pour

des scénarios avec et sans retard, et des exemples numériques sont fournis pour valider l'approche proposée.

Dans le Chapitre 5, des contrôleurs déclenchés par événements sont proposés pour une classe de systèmes MIMO non linéaires linéarisables par retour d'état. Dans cette approche, des décalages entre les non-linéarités surgissent du processus d'échantillonnage-insertion propre au contrôleur déclenché par événements. Avec certaines hypothèses, ces décalages sont explicitement intégrés dans la conception des conditions du contrôleur et du mécanisme de déclenchement par événements. Des exemples numériques sont fournis pour valider l'approche proposée, et les résultats sont comparés avec d'autres travaux dans la littérature.

Enfin, dans le Chapitre 6, nous présentons les remarques conclusives de ce travail de doctorat et proposons des perspectives futures pour cette recherche.

### 1.2.1 Publications personnelles liées au projet de doctorat

Les Chapitres 3 et 4 traitent principalement du contrôle déclenché par événements pour les pelotons CACC non homogènes utilisant la compensation des incertitudes basée sur l'observateur de perturbations (DOB). Les matériaux de ces chapitres sont présentés dans la publication et la soumission suivantes.

- SILVA, R.; NGUYEN, A.; GUERRA, T.-M.; SOUZA, F.; FREZZATTO, L. Switched dynamic event-triggered control for string stability of nonhomogeneous vehicle platoons with uncertainty compensation. *IEEE Transactions on Intelligent Vehicles*, doi: 10.1109/TIV.2024.3385575, p. 1–15, 2024.
- SILVA, R.; NGUYEN, A.; GUERRA, T.-M.; SOUZA, F.; FREZZATTO, L. Dynamic event-triggered CACC co-design for heterogeneous vehicular platoons under uncertainties and network delays, *IEEE Transactions on Intelligent Transportation Systems (Submitted)*, 2024.

The results of feedback linearization with event-triggered control in Chapter 5 pertain to the following submission.

- SILVA, R. N.; SOUZA, F. O.; NGUYEN, A.; GUERRA, T.; FREZZATTO, L. Event-triggered control co-design for MIMO systems via feedback linearization with tolerated nonlinearity mismatches, *IEEE Transactions on Automatic Control (Third revision)*, 2022.

À part les résultats présentés dans ce travail, le résultat suivant a été publié et présenté lors d'une conférence.

- 
- SILVA, R. N.; FREZZATTO, L.; SOUZA, F. O.; CAMPOS, V. C. S. Event-triggered control of TS fuzzy systems with guaranteed membership function mismatch. *IFAC-PapersOnLine*, Elsevier BV, v. 54, n. 4, p. 74–79, out. 2021.

## 2 Aspects fondamentaux sur le platooning et le contrôle déclenché par événement

### 2.1 Introduction

Étant donné que le manuscrit est lié d'une part au Contrôle à Événements Déclenchés (ETC) et d'autre part au platooning, ce premier chapitre décrira certaines bases et aspects techniques utiles pour les deux sujets. Certaines préliminaires mathématiques et notations utilisées tout au long du travail sont résumées dans la première section. La deuxième section rappelle les principaux défis du contrôle pour le platooning, y compris la stabilité individuelle et la stabilité de chaîne. Comme une partie de la communication sera considérée comme déclenchée par un événement, la section trois présente les principaux principes de la stabilité de l'ETC, y compris les conditions de stabilité entrée-état. Comme d'habitude dans ce domaine, le comportement dit de Zeno doit être évité ; la section trois indique également comment déterminer une borne inférieure positive des temps inter-événements. Les systèmes utilisés dans cette thèse sont généralement non linéaires et, excepté pour la pure linéarisation par rétroaction, la manière de traiter leur analyse de stabilité et/ou leur stabilisation nécessitera une description polytopique. Un rapide rappel d'une telle représentation est fait dans la section quatre. Comme la communication peut également être retardée, la section cinq fournit quelques outils classiques pour la stabilité des systèmes à temps de retard, en particulier l'utilisation de fonctionnelles de Lyapunov-Krasovskii. Enfin, tout au long de la thèse, afin de dériver des résultats, nous utilisons le cadre des contraintes d'inégalités matricielles linéaires (LMI). Par conséquent, certaines définitions et lemmes techniques utiles concluent le chapitre.

### 2.2 Conclusion

Ce chapitre a donné un aperçu des principaux sujets abordés dans notre travail. Les problèmes liés au platooning, en tenant compte de la communication entre les véhicules, ont été décrits. En particulier, il est important non seulement d'assurer la stabilité individuelle des véhicules, mais aussi d'assurer la stabilité de chaîne, afin d'éviter des comportements inappropriés. Lorsque la communication a lieu, nous la considérons comme déclenchée par un événement, d'où la nécessité de certains outils et propriétés mathématiques supplémentaires qui sont également décrits. Enfin, des aspects techniques plus détaillés ont également été présentés, concernant la description polytopique de modèles non linéaires, la stabilité des systèmes à temps de retard, en particulier la fonctionnelle de Lyapunov-Krasovskii, et enfin les outils d'optimisation utiles pour dériver des condi-

tions de stabilité/stabilisation. Le prochain chapitre commencera par le ACC classique sans communication, et nous démontrerons comment dériver des conditions de stabilité individuelle et de chaîne pour un platoon.

## 3 ACC coopératif avec communication continue

### 3.1 Introduction

Dans ce chapitre, nous abordons le problème de contrôle du régulateur de vitesse adaptatif coopératif (ACC) longitudinal avec communication continue entre les véhicules. La formation du convoi est constituée de  $N$  véhicules et d'un leader. L'objectif est que les  $N$  véhicules suivent le leader tout en maintenant une distance de sécurité entre eux. Au début de ce chapitre, nous expliquons le problème de convoi d'intérêt, la politique de distance respectueuse qui sera utilisée pour garantir une distance de sécurité et nous présentons le modèle longitudinal du véhicule. Comme discuté dans le chapitre précédent, Section ??, en pratique, les paramètres des véhicules ne sont pas connus avec précision, ce qui entraîne des incertitudes dans le modèle. En raison de ces incertitudes, l'approche classique de linéarisation par rétroaction ne peut pas être appliquée directement. Pour compenser ces incertitudes, nous proposons un observateur de perturbation pour estimer l'effet global causé par les incertitudes et les entrées exogènes possibles. Ensuite, l'approche de linéarisation par rétroaction est combinée avec une compensation basée sur la perturbation pour garantir une dynamique linéaire et homogène. Après la linéarisation, nous étudions la stabilité individuelle et la stabilité en chaîne du convoi. À cette fin, un modèle décrivant l'interaction entre deux véhicules, le véhicule  $i - 1$  et le véhicule  $i$  (immédiatement derrière), est présenté. À partir de cette modélisation, la loi de contrôle et le signal qui sera transmis d'un véhicule à un autre sont définis. En tenant compte de ce modèle, pour évaluer la stabilité individuelle et la stabilité en chaîne, nous proposons une extension des conditions de stabilité en norme  $\mathcal{L}_2$ , tenant compte des effets de la compensation de perturbation. En introduisant un filtre couramment utilisé pour l'ACC coopératif avec des politiques de distance non constantes, un modèle alternatif pour l'interaction entre les véhicules est dérivé, et des conditions de conception pour ce modèle sont présentées. Enfin, des simulations sont réalisées pour évaluer l'efficacité de la compensation des perturbations et la performance du convoi en tenant compte de chaque modèle d'interaction entre les véhicules.

### 3.2 Conclusion

Considérant la communication de contrôle entre les véhicules dans la topologie de flux prédécesseur-successeur, des conditions de stabilité en chaîne  $\mathcal{L}_2$  étendues ont été proposées pour les convois soumis à des incertitudes. Pour compenser efficacement les

incertitudes du système de convoi, considérées comme une perturbation virtuelle, une estimation d'incertitude basée sur un observateur de perturbation (DOB) est incluse dans la loi de contrôle de linéarisation par rétroaction. En conséquence, la stabilité en chaîne et la stabilité des véhicules individuels peuvent être évaluées de manière similaire aux conditions de conception classiques de l'ACC coopératif. De plus, des conditions suffisantes de LMI sont présentées pour garantir la stabilité  $\mathcal{L}_2$  entre les systèmes de véhicules  $\Sigma_i$  et  $\Sigma_{i-1}$  en tenant compte de différents modèles d'interaction entre les véhicules. À travers des simulations et des comparaisons, nous illustrons que la compensation basée sur le DOB proposée peut gérer efficacement les incertitudes du système et comment chaque modèle peut conduire à des performances différentes dans le système de convoi.

## 4 Platoon CACC avec communication déclenchée par événement

### 4.1 Introduction

Le contrôle de croisière adaptatif coopératif diffère du contrôle de croisière adaptatif en introduisant un système de communication permettant aux véhicules de partager des informations. Le partage d'informations peut améliorer les performances du convoi et permettre des politiques de distance plus courtes sans compromettre la sécurité. L'introduction de la communication nécessite de prendre en compte les délais possibles et l'utilisation efficace du réseau. Dans ce chapitre, le sujet principal est le mécanisme de communication entre les véhicules dans l'ACC coopératif. Pour améliorer l'efficacité de la communication, un mécanisme de communication déclenché par événement est envisagé. Étant donné que les modèles de système sont supposés être affectés par des incertitudes, afin d'éviter le comportement de Zeno, un temps d'attente minimum est imposé dans le mécanisme de déclenchement d'événement. En raison des délais de temps, les informations transmises ne sont reçues qu'après un intervalle de temps. En tenant compte du temps imposé et des délais, les intervalles de transmission et de réception sont divisés en sous-intervalles, et la dynamique linéarisée du véhicule est modélisée comme un système commutatif qui change selon chaque intervalle de temps. Le contrôle déclenché par événement est conçu en considérant ce modèle de système commutatif, et un mécanisme d'événement dynamique est proposé pour réduire le nombre d'événements. Pour garantir la stabilité individuelle et en chaîne, comme proposé dans le chapitre précédent Section ??, des conditions de conception sont dérivées pour les cas avec et sans délai. Les deux conditions sont formulées comme un problème d'optimisation soumis à des contraintes LMI. Enfin, des simulations sont effectuées pour évaluer l'efficacité du contrôleur et du mécanisme d'événement conçus.

### 4.2 Conclusion

Considering the control communication between vehicles in the predecessor-follower flow topology, a switched dynamic ETC method has been proposed for heterogeneous platoons. To counteract the uncertainties within the platooning system, a DOB-based uncertainty estimation is incorporated into the feedback linearization control law. The communication between vehicles is established based on a dynamic event-triggering condition with a minimum time to ensure Zeno-free behavior accounting for the transmission delays. For platooning control design, we model the system with dynamic ETC as a



switching interconnected system, representing the interaction between adjacent vehicles. Subsequently, using a Lyapunov-Krasovskii functional time delay relaxation technique, sufficient LMI conditions are derived to ensure  $\mathcal{L}_2$  stability between consecutive vehicles, as well as  $\mathcal{L}_2$  string stability. Through simulations and comparisons, we demonstrate that the proposed DOB-based event-triggered platooning control method can ensure string stability despite the modeling uncertainties. Furthermore, the dynamic switched ETC can significantly reduce the amount of communication compared to other ETM conditions.

## 5 Linéarisation par rétroaction ETC

### 5.1 Introduction

Comme exploré dans le Chapitre 3 et le Chapitre 4, la linéarisation par retour d'état est une technique de contrôle utile qui peut être appliquée à plusieurs domaines tels que, les manipulateurs robotisés (BAGHERI *et al.*, 2019), le mouvement collectif plan de (SEPULCHRE *et al.*, 2007), les véhicules marins (PALIOTTA *et al.*, 2019), le système de positionnement maglev (NIELSEN *et al.*, 2010) et les doubles rotors (CHANG *et al.*, 2019).

Pour l'approche classique de linéarisation par retour d'état, la mesure d'état et la loi de contrôle doivent être mises à jour en continu (KHALIL, 2002; ISIDORI, 1995). Par exemple, dans l'application de convoi des chapitres précédents, les états nécessaires au calcul de la loi de contrôle linéarisante étaient supposés être disponibles en temps réel. Cependant, il peut se produire que les informations utilisées pour calculer la loi de contrôle par linéarisation par retour d'état proviennent d'un processus d'échantillonnage (GOEBEL *et al.*, 2009). Étant donné que l'action de contrôle est calculée avec des signaux échantillonnés, les non-linéarités du système ne peuvent plus être parfaitement annulées via la linéarisation par retour d'état entre les échantillons. Cela donne lieu à la présence de termes de désaccord non linéaires dans l'expression du système en boucle fermée, menant à un nouveau défi pour la conception du contrôle (MAITY; BARAS, 2015; STÖCKER; LUNZE, 2011).

Dans le contexte du contrôle déclenché par événement via la linéarisation par retour d'état, le même phénomène se produit, en raison de la nature d'échantillonnage et de maintien des conditions de déclenchement d'événements. De plus, la condition de déclenchement d'événements doit être conçue en même temps que le gain de retour d'état pour garantir la stabilité en boucle fermée. Les auteurs de (STÖCKER; LUNZE, 2011) traitent un problème de linéarisation par retour d'état basé sur des événements, où un modèle de référence est considéré pour calculer la loi de contrôle et la condition de déclenchement d'événements. En particulier, le signal de contrôle est continuellement calculé en temps réel à l'aide d'un modèle de référence, et l'état du système est mis à jour chaque fois que la condition de déclenchement d'événements est vérifiée. Sur la base d'une fonction de Lyapunov, à la fois le contrôleur et la condition de déclenchement d'événements sont proposés pour des systèmes non linéaires affines dans (MAITY; BARAS, 2015). Lorsque la plante contrôlée n'est pas complètement connue, les non-linéarités inconnues du système ont été approximées à l'aide de réseaux de neurones (SAHOO *et al.*, 2016; GAO *et al.*, 2020; CHEN *et al.*, 2021) ou d'un processus d'apprentissage gaussien en ligne (UMLAUFT;

HIRCHE, 2020) pour la conception de contrôle basée sur des événements. Des conditions de déclenchement d'événements à la fois statiques et dynamiques sont considérées pour les résultats de contrôle dans (XU *et al.*, 2020). Cependant, les désaccords non linéaires, causés par l'utilisation de mesures d'état échantillonnées pour le calcul de lois de contrôle non linéaires, ne sont pas pris en compte dans les approches de contrôle déclenchées par événement précédentes. Cela peut conduire à l'instabilité des systèmes en boucle fermée, comme l'illustre ce chapitre.

Motivés par les problèmes théoriques et pratiques ci-dessus, nous proposons des conditions pour co-concevoir des contrôleurs de linéarisation par retour d'état et des mécanismes déclenchés par événement pour des systèmes MIMO non linéaires. Basées sur la théorie de la stabilité de Lyapunov, les conditions de conception, pour garantir la stabilité asymptotique en boucle fermée tout en minimisant le temps entre événements (IET), sont reformulées comme des problèmes d'optimisation sous des contraintes d'inégalité matricielle linéaire (LMI). Les cas de linéarisation par retour d'état *complet* et *partiel* sont considérés pour la conception de contrôle déclenchée par événement. En particulier, en appliquant le théorème fondamental du calcul et une approche polytopique, certains désaccords non linéaires entre non-linéarités continues et échantillonnées sont *explicitement* pris en compte dans la conception de contrôle basée sur LMI au lieu d'être incorporés dans les conditions de déclenchement d'événements, permettant d'extrapoler les conditions à d'autres mécanismes de déclenchement. De plus, sous certaines hypothèses sur les propriétés de Lipschitz des non-linéarités du système, le mécanisme déclenché par événement peut garantir un comportement sans Zeno (DONKERS; HEEMELS, 2012) en boucle fermée.

Les principales contributions présentées dans ce chapitre peuvent être résumées comme suit.

- Nous proposons des conditions suffisantes pour co-concevoir des contrôleurs de retour d'état et des mécanismes déclenchés par événement pour des systèmes MIMO linéarisables par retour d'état.
- Les désaccords entre non-linéarités continues et échantillonnées sont explicitement considérés dans la co-conception pour prévenir l'instabilité. Les conditions de co-conception sont reformulées comme des problèmes d'optimisation basés sur LMI pour minimiser l'IET.
- Une borne inférieure pour l'IET peut être garantie pour les systèmes avec des non-linéarités de Lipschitz pour éviter le comportement de Zeno.

## 5.2 Conclusion

En utilisant l'approche de linéarisation par retour d'état, une conception de contrôle déclenché par événement a été proposée pour des systèmes MIMO non linéaires. Des conditions suffisantes sont fournies pour co-concevoir les conditions de déclenchement d'événements et les contrôleurs de retour d'état pour les deux cas de linéarisation par retour d'état complète et partielle avec des dynamiques nulles exponentiellement stables. Par la théorie de la stabilité de Lyapunov, la co-conception du contrôle déclenché par événement est reformulée en tant que problèmes d'optimisation sous des contraintes d'inégalité matricielle linéaire (LMI). De plus, en utilisant une approche polytopique et le théorème fondamental du calcul, certains termes de désaccord non linéaires peuvent être explicitement incorporés dans les conditions de conception basées sur LMI, au lieu d'être inclus dans les conditions de déclenchement d'événements, afin de réduire le nombre d'événements de contrôle. En particulier, sous certaines hypothèses sur les propriétés de Lipschitz des non-linéarités du système, la preuve de l'existence d'une borne inférieure pour le temps entre événements est fournie. La supériorité en termes de performance de l'approche de contrôle proposée par rapport à la littérature connexe, principalement en termes de réduction du nombre d'événements déclenchés pour les contrôleurs de retour d'état, est illustrée par plusieurs exemples numériques.

## 6 Conclusion et perspectives

Dans cette thèse, le problème de la conception de lois de contrôle déclenchées par événement pour des systèmes non linéaires a été abordé, en se concentrant sur des applications de platoons de véhicules.

Le chapitre 3 a traité du problème de la conception de contrôles pour des platoons longitudinaux équipés de contrôle de croisière adaptatif coopératif. Dans ce chapitre, le modèle des véhicules a été considéré comme incertain, entraînant des désaccords dans la linéarisation par retour d'état, ce qui, comme l'illustre la simulation, peut affecter la distance de sécurité des véhicules. Une compensation par observateur de perturbations a été proposée pour estimer l'effet combiné des incertitudes et des entrées exogènes. La perturbation estimée a été intégrée dans la loi de contrôle de linéarisation par retour d'état et elle montre qu'elle compense efficacement les perturbations, aboutissant ainsi à une erreur de distance de sécurité acceptable.

Pour tenir compte des incertitudes et des compensations de perturbations dans les conditions de conception, une extension des conditions de stabilité en chaîne  $\mathcal{L}_2$  a été proposée dans le chapitre 3. En considérant deux procédures pour modéliser les interactions entre véhicules, des conditions de conception ont été dérivées pour garantir à la fois la stabilité individuelle et la stabilité en chaîne en présence d'incertitudes. Tout au long de la simulation, les deux modèles ont été comparés, chacun étant capable d'atteindre une formation de platoon avec une distance de sécurité même en partant d'un platoon sans positionnement correct. Dans le chapitre 3, nous montrons qu'une caractéristique importante des conditions proposées est leur évolutivité. Tirant parti de la topologie de communication des véhicules et de la procédure de linéarisation par retour d'état, des conditions de conception ont été atteintes, indépendantes du nombre de véhicules.

Le chapitre 4 s'est concentré sur le problème de la communication efficace. En considérant les modèles dérivés dans le chapitre 3, une communication déclenchée par événement a été introduite. Pour garantir un comportement sans Zeno, un temps d'attente minimum a été imposé entre les transmissions consécutives et une approche par commutation a été introduite pour modéliser le système sous communication déclenchée par événement. Un mécanisme de commutation dynamique a été proposé et des conditions de conception ont été atteintes en considérant des scénarios avec et sans délais de communication. Les simulations ont illustré que, dans les scénarios étudiés, la méthode proposée est capable d'améliorer l'efficacité de la communication par rapport à d'autres méthodologies dans la littérature.

Dans le chapitre 5, la procédure de linéarisation par retour d'état utilisée dans les chapitres 3 et 4 a été détaillée, en considérant cependant une procédure de linéarisation basée

sur des événements. Dans le chapitre précédent, les signaux nécessaires à la linéarisation par retour d'état étaient supposés mesurés en continu. Dans le chapitre 5, la procédure de linéarisation par retour d'état a été détaillée en supposant que les signaux nécessaires aux procédures de linéarisation sont mis à jour en fonction d'une condition d'événement. En supposant que la linéarisation par retour d'état est possible, des conditions de conception pour le contrôleur et le mécanisme déclenché par événement ont été proposées pour des systèmes non linéaires à entrées multiples et sorties multiples. Des exemples ont été fournis pour illustrer l'efficacité de la méthode, en la comparant à d'autres méthodologies existantes.

Les résultats obtenus dans cette thèse sont prometteurs pour le platoon longitudinal de véhicules. La compensation des perturbations proposée peut gérer les effets de l'incertitude et garantir une distance de sécurité entre les véhicules. De plus, les conditions de conception proposées tiennent compte des incertitudes dans l'analyse de la stabilité en chaîne tout en assurant l'évolutivité des conditions, contrairement à la plupart des méthodes connexes dans la littérature. La méthode peut également réduire la communication tout en maintenant la performance en utilisant le mécanisme ET proposé même en présence de délais.

Bien que la méthode soit efficace, des considérations importantes sont nécessaires avant une mise en œuvre réelle. Certaines d'entre elles restent encore un défi d'un point de vue théorique (saturation avec la linéarisation par retour d'état, reconfiguration du platoon. . . ); d'autres sont des étapes importantes avant une application réelle (saturation, bruit, mesures, déni de service. . . ). Certains de ces aspects sont brièvement décrits dans la section suivante.

## 6.1 Perspectives de recherche

D'un point de vue théorique, de nombreux travaux proposent des solutions à la saturation de l'entrée de contrôle pour des systèmes LPV, ajoutant généralement des contraintes LMI au problème initial. Néanmoins, peu de travaux abordent le problème de saturation pour la linéarisation par retour d'état.

### Qualité de la communication

On a supposé que la communication était affectée uniquement par des délais, cependant, d'autres phénomènes tels que des pannes, des attaques ou des dénis de service peuvent se produire. De nombreux travaux abordent déjà ces aspects sous diverses méthodologies (PEIXOTO *et al.*, 2023; PESSIM *et al.*, 2021; WANG *et al.*, 2022; MA *et al.*, 2020). Une partie de l'adaptation peut sembler, à première vue, simple, par exemple si les pannes n'affectent pas la linéarisation par retour d'état (WANG *et al.*, 2022; MA *et al.*,

2020), même si les effets doivent être évalués théoriquement et en pratique. Au contraire, le problème n'est pas trivial.

Il existe également de nombreuses améliorations qui peuvent être envisagées pour l'application du platooning, notamment si nous considérons la reconfiguration et la topologie des communications.

## Reconfiguration du platoon

Dans le cadre du platooning, les véhicules peuvent quitter la formation du platoon en raison de problèmes techniques ou parce qu'il est prévu que ces véhicules quittent la formation. Il s'agit d'un cas particulier de reconfiguration du platoon, où les autres véhicules doivent compenser le départ des véhicules de la formation. Cette situation doit être prise en compte.

## Différentes topologies

La topologie principale considérée dans ce travail est la topologie prédécesseur-successeur, où la communication n'a lieu qu'entre les véhicules adjacents et l'information ne circule que du véhicule  $i$  au véhicule  $i + 1$ . Nous avons tiré parti de cette spécification de topologie pour obtenir des conditions de conception qui ne dépendent pas du nombre de véhicules (scalabilité). Pour d'autres topologies, des adaptations sont nécessaires, surtout si la scalabilité est souhaitée.

## Ajustements environnementaux

Dans des situations de pluie, de brouillard, et surtout sur des routes verglacées, une attention particulière est nécessaire. Le brouillard peut affecter les capteurs, tandis que la pluie et surtout les routes verglacées affectent l'adhérence des pneus. Une approche possible pour tenir compte de ces changements dans l'environnement est d'ajuster la politique de distance en fonction du scénario.

## Longitudinal et Latéral

Un aspect difficile du platooning est la combinaison des mouvements longitudinaux et latéraux. Peu de travaux dans la littérature considèrent l'analyse de la stabilité de chaîne avec des dynamiques latérales (MAHFOUZ *et al.*, 2023). Le mouvement latéral introduit plus de défis, car la vitesse latérale n'est pas mesurée et il y a des perturbations supplémentaires (LI *et al.*, 2020; LI *et al.*, 2019; MAHFOUZ *et al.*, 2023; NGUYEN *et al.*, 2023). La compensation des perturbations proposée ne peut pas être adaptée directement au cas latéral car elle nécessite la mesure de la vitesse latérale. Une alternative consiste

à concevoir un observateur de perturbation basé sur la sortie ou à utiliser un observateur pour estimer les états nécessaires pour le DOB.

De plus, la linéarisation par rétroaction peut être appliquée pour les dynamiques longitudinales, mais pas pour les dynamiques latérales. Bien que certaines non-linéarités puissent être annulées, la linéarisation complète (via la linéarisation par rétroaction) n'est pas possible. Dans ce cas, le problème peut être abordé en utilisant une modélisation LPV du système. Cependant, assurer la stabilité de chaîne peut être difficile lorsqu'on la combine avec des dynamiques latérales.



# Bibliographie

BAGHERI, M.; NASERADINMOUSAVI, P.; KRSTIĆ, M. Feedback linearization based predictor for time delay control of a high-DOF robot manipulator. *Automatica*, Elsevier BV, v. 108, p. 108485, oct 2019.

CHANG, P.-F.; CHEN, C.-C.; CHANG, J.-R. Observer-based feedback linearization control of multi-input multi-output nonlinear system and application to double rotor system. *Advances in Mechanical Engineering*, SAGE Publications, v. 11, n. 4, p. 168781401984546, apr 2019.

CHEN, Z.; NIU, B.; ZHAO, X.; ZHANG, L.; XU, N. Model-based adaptive event-triggered control of nonlinear continuous-time systems. *Applied Mathematics and Computation*, Elsevier BV, v. 408, p. 126330, nov 2021.

DONKERS, M. C. F.; HEEMELS, W. P. M. H. Output-based event-triggered control with guaranteed  $\mathcal{L}_\infty$ -gain and improved and decentralized event-triggering. *IEEE Transactions on Automatic Control*, Institute of Electrical and Electronics Engineers (IEEE), v. 57, n. 6, p. 1362–1376, jun 2012.

GAO, H.; SONG, Y.; WEN, C. Event-triggered adaptive neural network controller for uncertain nonlinear system. *Information Sciences*, Elsevier BV, v. 506, p. 148–160, jan 2020.

GOEBEL, R.; SANFELICE, R. G.; TEEL, A. R. Hybrid dynamical systems. *IEEE Control Systems*, Institute of Electrical and Electronics Engineers (IEEE), v. 29, n. 2, p. 28–93, apr 2009.

ISIDORI, A. *Nonlinear control systems*. 3. ed. [S.l.]: Springer London, 1995.

KHALIL, K. *Nonlinear Systems*. [S.l.]: Prentice Hall, 2002.

LI, L.; NOVEL, B. d'Andrea; THOREL, S. New online estimation algorithm of lateral tire-road coefficients based on inertial navigation system. In: *2019 IEEE Intelligent Transportation Systems Conference (ITSC)*. [S.l.]: IEEE, 2019.

LI, L.; NOVEL, B. d'Andréa; QUADRAT, A. Longitudinal and lateral control for four wheel steering vehicles. *IFAC-PapersOnLine*, Elsevier BV, v. 53, n. 2, p. 15713–15718, 2020. ISSN 2405-8963.

MA, F.; WANG, J.; ZHU, S.; GELBAL, S. Y.; YANG, Y.; AKSUN-GUVENC, B.; GUVENC, L. Distributed control of cooperative vehicular platoon with nonideal communication condition. *IEEE Transactions on Vehicular Technology*, Institute of Electrical and Electronics Engineers (IEEE), v. 69, n. 8, p. 8207–8220, ago. 2020. ISSN 1939-9359.

MAHFOUZ, D.; SHEHATA, O.; MORGAN, E. Development and evaluation of a unified integrated platoon control system architecture. *IEEE Trans. Intell. Transp. Syst.*, Institute of Electrical and Electronics Engineers (IEEE), v. 24, n. 6, p. 5685–5704, 2023.

- MAITY, D.; BARAS, J. S. Event based control for control affine nonlinear systems: A Lyapunov function based approach. In: *2015 54th IEEE Conference on Decision and Control (CDC)*. Osaka, Japan: IEEE, 2015.
- NGUYEN, C. M.; NGUYEN, A.-T.; DELPRAT, S. Neural-network-based fuzzy observer with data-driven uncertainty identification for vehicle dynamics estimation under extreme driving conditions: Theory and experimental results. *IEEE Transactions on Vehicular Technology*, Institute of Electrical and Electronics Engineers (IEEE), v. 72, n. 7, p. 8686–8696, jul. 2023. ISSN 1939-9359.
- NIELSEN, C.; FULFORD, C.; MAGGIORE, M. Path following using transverse feedback linearization: Application to a maglev positioning system. *Automatica*, Elsevier BV, v. 46, n. 3, p. 585–590, mar 2010.
- PALIOTTA, C.; LEFEBER, E.; PETTERSEN, E. E.; PINTO, J.; COSTA, M.; SOUSA, J. T. F. B. Trajectory tracking and path following for underactuated marine vehicles. *IEEE Transactions on Control Systems Technology*, Institute of Electrical and Electronics Engineers (IEEE), v. 27, n. 4, p. 1423–1437, jul 2019.
- PEIXOTO, M. L. C.; COUTINHO, P. H. S.; BESSA, I.; PESSIM, P. S. P.; PALHARES, R. M. Event-triggered control of Takagi-Sugeno fuzzy systems under deception attacks. *International Journal of Robust and Nonlinear Control*, Wiley, v. 33, n. 13, p. 7471–7487, maio 2023. ISSN 1099-1239.
- PESSIM, P. S.; PEIXOTO, M. L.; PALHARES, R. M.; LACERDA, M. J. Static output-feedback control for cyber-physical LPV systems under DoS attacks. *Information Sciences*, Elsevier BV, v. 563, p. 241–255, jul. 2021. ISSN 0020-0255.
- SAHOO, A.; XU, H.; JAGANNATHAN, S. Neural network-based event-triggered state feedback control of nonlinear continuous-time systems. *IEEE Transactions on Neural Networks and Learning Systems*, Institute of Electrical and Electronics Engineers (IEEE), v. 27, n. 3, p. 497–509, mar 2016.
- SEPULCHRE, R.; PALEY, D. A.; LEONARD, N. R. Stabilization of planar collective motion: All-to-all communication. *IEEE Transactions on Automatic Control*, Institute of Electrical and Electronics Engineers (IEEE), v. 52, n. 5, p. 811–824, may 2007.
- STÖCKER, C.; LUNZE, J. Event-based control of input-output linearizable systems. *IFAC Proceedings Volumes*, Elsevier BV, v. 44, n. 1, p. 10062–10067, jan 2011.
- UMLAUFT, J.; HIRCHE, S. Feedback linearization based on gaussian processes with event-triggered online learning. *IEEE Transactions on Automatic Control*, Institute of Electrical and Electronics Engineers (IEEE), v. 65, n. 10, p. 4154–4169, oct 2020.
- WANG, J.; MA, F.; YANG, Y.; NIE, J.; AKSUN-GUVENC, B.; GUVENC, L. Adaptive event-triggered platoon control under unreliable communication links. *IEEE Trans. Intell. Transp. Syst.*, Institute of Electrical and Electronics Engineers (IEEE), v. 23, n. 3, p. 1924–1935, 2022.
- XU, B.; LIU, X.; WANG, H.; ZHOU, Y. Event-triggered control for nonlinear systems via feedback linearisation. *International Journal of Control*, Informa UK Limited, v. 94, n. 10, p. 2679–2689, feb 2020.