



HAL
open science

Application of geodesic currents to the geometry of surfaces

Marie Trin

► **To cite this version:**

Marie Trin. Application of geodesic currents to the geometry of surfaces. Mathematics [math]. Université de Rennes, 2024. English. NNT : 2024URENS025 . tel-04733090

HAL Id: tel-04733090

<https://theses.hal.science/tel-04733090v1>

Submitted on 11 Oct 2024

HAL is a multi-disciplinary open access archive for the deposit and dissemination of scientific research documents, whether they are published or not. The documents may come from teaching and research institutions in France or abroad, or from public or private research centers.

L'archive ouverte pluridisciplinaire **HAL**, est destinée au dépôt et à la diffusion de documents scientifiques de niveau recherche, publiés ou non, émanant des établissements d'enseignement et de recherche français ou étrangers, des laboratoires publics ou privés.

THÈSE DE DOCTORAT DE

L'UNIVERSITÉ DE RENNES

ÉCOLE DOCTORALE N° 601

*Mathématiques, Télécommunications, Informatique, Signal, Systèmes,
Électronique*

Spécialité : Mathématiques et leurs Interactions

Par

Marie TRIN

Application des courants géodésiques à la géométrie des surfaces

Thèse présentée et soutenue à Rennes, le 10 Juin 2024

Unité de recherche : Institut de Recherche Mathématiques de Rennes

Rapporteurs avant soutenance :

Bram PETRI Maître de conférences, Sorbonne Université
Jean-Marc SCHLENKER Professeur, Université du Luxembourg

Composition du Jury :

Président : Vincent GUIARDEL Professeur des Universités, Université de Rennes

Examineurs : Viveka ERLANDSSON Associate Professor, University of Bristol
Bram PETRI Maître de conférences, Sorbonne Université
Jean-Marc SCHLENKER Professeur, Université du Luxembourg
Jing TAO Professor, University of Oklahoma

Dir. de thèse : Juan SOUTO Directeur de Recherche, Université de Rennes

À ma mère,



REMERCIEMENTS

Mes premiers remerciements vont naturellement à mon directeur de thèse, Juan Souto. On ne mesure pas au début de notre thèse l'importance que le choix de notre sujet et de notre direction vont avoir sur notre avenir, je ne pourrais jamais assez te remercier de m'avoir proposé d'encadrer ma thèse! Je te suis tellement reconnaissante d'avoir su trouver un sujet qui m'a passionné durant ces trois années et qui m'a profondément convaincue de me lancer dans l'aventure de la recherche. Merci d'avoir été si disponible et patient (on ne peut pas compter les heures que tu as passé à m'expliquer et re-expliquer des notions ou lire et relire mes articles), merci aussi pour tes conseils, tes suggestions et surtout pour m'avoir donné confiance en moi. Je tiens aussi à te remercier pour les qualités humaines dont tu as fait preuve, tu as toujours été bienveillant et attentif : ces trois années n'auraient jamais pu aussi bien se dérouler sans cela. Et enfin, merci pour ton humour et ta bonne humeur. *¡Muchas gracias por todo!*

J'exprime ma gratitude à Bram Petri et Jean-Marc Schlenker qui ont rapporté cette thèse et m'ont chaleureusement accueillie et longuement écoutée lors de mes visites à Jussieux et Luxembourg, ainsi qu'à Viveka Erlandsson, Vincent Guirardel et Jing Tao qui ont accepté de faire partie de mon jury.

Je remercie le centre Henri Lebesgue et la Région Bretagne pour leurs financements.

I would also like to thank all the researchers with whom I have had the opportunity to discuss my work over the last years. Thank you to Francis Bonahon, François Labourie, Cyril Lecuire, Chris Leininger, Mingkun Liu, Didac Martinez-Granado, Yair Minsky, Anne Parreau, Hugo Parlier, Beatrice Pozzetti (especially for suggesting the method in section 2.5), Kasra Rafi, Ramanujan Santharoubane, Dylan Thurston, Alain Valette, Franco Vargas Pallete and Abdul Zalloum.

Enfin, je témoigne toute ma reconnaissance aux membres des équipes de théorie ergodique et géométrie analytique. J'ai une pensée particulière pour Anna qui a régulièrement partagé avec moi les récoltes de son jardin, Juliette et Françoise dont la joie de vivre est toujours communicative, Benoît que j'ai eu le plaisir de compter parmi les membres de mon CSI et Max avec qui j'ai adoré enseigner.

Ce manuscrit est avant tout une thèse de mathématiques et comme vous le savez certainement, on ne fait pas des mathématiques seule. J'aimerais donc remercier les personnes avec qui j'ai eu le plaisir de voyager dans le monde merveilleux des mathématiques.

Commençons par les enseignant.es qui ont alimenté mon amour des mathématiques et m'ont encouragée et poussée vers la voie de la recherche. Merci à M. Lallemand et M. Rocq pour vos cours, votre passion et pour votre investissement dans l'atelier MATH.en.JEANS. Merci à M. Moulier et M. Blanc de m'avoir aidée et éclairée dans mes choix d'orientation. J'aimerais aussi remercier les professeur.es qui ont rendu mes années de prépa moins dures. Merci à Mme Cruvelier qui fut une professeure de physique exceptionnelle de part ses cours mais aussi son humanité, sa gentillesse et sa bienveillance, merci d'avoir veillé sur nous durant cette difficile première année. Merci aussi à M. Favennec pour ses enseignements et ses précieux conseils.

La géomètre que je suis aujourd'hui tient à exprimer toute sa gratitude à Vincent Pécastaing qui m'a initié à la géométrie lors d'un atelier MATH.en.JEANS en 2014. Merci d'avoir pris le temps, à quelques mois de ta soutenance de thèse, d'affronter la ligne Paris-Clermont-Aurillac de la SNCF pour venir faire découvrir les mathématiques à de jeunes lycéen.nes. Mon initiation à la géométrie s'est poursuivie, entre autres, grâce à Michael Heusener et Joan Porti que je remercie chaleureusement de m'avoir encadré.

I had the great opportunity to make some research visits during my PhD, I am grateful to Viveka Erlandsson, Chris Leininger, Mingkun Liu, Hugo Parlier and Franco Vargas-Palette for giving me these opportunities. I also get the chance to took part in the WiGGD 2023 workshop : I am so grateful to the organizers, it was an amazing experience. I also want to thank Johanna Mangahas who led my group at this event. Thank you for your patience and your gentleness. Sahana, Marissa, Alice, it is a pleasure to work with you, thank you for all the knowledge you share with me for two years now.

J'ai une pensée pour tou.tes les (post)-doctorants que j'ai l'habitude de croiser en conférence et avec qui j'ai toujours plaisir à échanger, je pense notamment à Andrea, Clarence, David, Irene, Mingkun et Tommaso mais aussi à Didac que je remercie tout particulièrement pour son aide dans la rédaction de mes dossiers de candidature, et Magali dont la curiosité nous permet à tous.tes d'être de meilleur.es mathématicien.nes. Merci également à toutes les personnes qui ont eu la gentillesse de m'accueillir pour quelques nuits lors de mes nombreux déplacements : Abdul, Erwan, Cassandra et Joseph (depuis chez qui j'écris ces quelques lignes), Lucien, Titouan, et la colloc de Montrouge, merci pour votre hospitalité!

Toutes ces années n'auraient pas été les mêmes sans toutes ces personnes rencontrées grâce aux maths et qui sont aujourd'hui des ami.es précieux.ses.

Merci tout d'abord à la bande de l'agreg d'avoir rendue cette année fun malgré le travail et le covid, je garde un joyeux souvenir de nos parties de code-names sur les tableaux du bâtiment 32B et des parties de tarot inter-leçon, j'espère que nous aurons de nouveau l'occasion d'être des *Voyagheux.ses* ensemble. J'aimerais remercier tout particulièrement Gaspard, Clémentine et Gurvan, les *Power Rangers* de l'agreg, pour les débriefs d'examen, les brain-storming de leçons au phare, les ciné-raclette pas très ciné et plus galette que raclette, merci pour votre soutien indéfectible.

Je tiens à remercier mes collègues (post)-doctorant.es à l'IRMAR. Je pense notamment aux habitués du Pampers, les Antoine, Axel, Epiphane, Gibran, Jérôme, Lucien, Louis, Méwen, Raoul, Rémi, Sergio, Théo, Titouan et bien entendu Xabi. Matilde, merci beaucoup de m'avoir tenu compagnie au milieu de cette bande de mecs et de m'avoir accompagnée à la piscine le mercredi midi. Milan et Mattia, la première édition des journées des doctorant.es fût une réussite, merci beaucoup de m'avoir embarquée avec vous dans cette aventure! Merci beaucoup aux analystes, statisticien.nes et probabilistes pour leur accueil chaleureux et les parties de jeux entre midi et deux, Anaïs, Antoine, François, les Hugo, Jeanne, Ketsia, Nathan, Rita et bien entendu le bureau 232. Un merci tout particulier à Yoann et Pierre pour leur aide inestimable avec latex et linux! Merci à Alice et Emeline, mes *mâles-cuites*. Merci d'être les amies que vous êtes, merci pour votre présence, votre soutien et vos conseils avisés. Merci enfin à mes co-bureaux! Qu'auraient été ces trois années sans vous : Marc et Adrien, vous êtes officiellement mes deux ulmites préférés; Thibault, tu es une personne formidable et le meilleur des petits frères de thèse; Louis et Nicolas, je ne comprends pas grand chose à vos maths mais je suis heureuse d'avoir fait ce petit bout de chemin avec vous. Je mesure la chance que j'ai d'avoir pu passer mes journées entourée de gens aussi gentils, passionnés et brillants, merci d'avoir cassé et réparé les maths avec moi.

Merci beaucoup à Yago pour ses relectures attentives et sa compagnie lors de mon séjour à Toronto. Je suis très heureuse de te compter parmi mes amis.

Yann et Gurvan, comment vous remercier assez? Ces remerciements commencent déjà à être un peu long et il me faudrait des pages entières pour vous témoigner toute ma gratitude. Vous savez à quel point je suis reconnaissante que ma route ait rencontrée la votre et qu'elle la suive depuis plusieurs années maintenant. Merci au second concours de nous avoir réunis.

Et oui, il n'y a que les imbéciles qui ne changent pas d'avis.

Vous aurez sûrement remarqué les jolies lettrines qui ornent ce manuscrit. Merci aux doctorant.es de Grenoble avec qui cette idée a germé et à Myriam Reeve grâce à qui elle s'est concrétisée. Merci d'avoir mis de ton temps et de ton talent au service de ce manuscrit.

J'aimerais aussi remercier les membres de l'IRMAR avec qui je ne travaille pas forcément mais dont la présence a rythmé mes journées. Merci tout d'abord au personnel administratif et technique sans qui l'IRMAR ne tournerait pas très rond. Merci tout particulièrement à Aude, Caroline, Marie-Aude, Eric, Nelly et Sandra qui m'ont tellement aidé ces trois dernières années. Merci aussi aux agentes d'entretien qui font de nos locaux un endroit agréable. Merci aux chercheurs.euses qui ne sont pas de mon équipe mais que j'ai toujours plaisir à côtoyer, Adrien, Delphine, Ioana, Léo, Louise, Matthieu, Miguel, Nathalie, Rozenn, Valérie et tous.les autres.

Je voudrais aussi remercier toute l'équipe de l'IUT avec qui j'ai eu la chance de travailler pendant deux semestres. Ce fût un plaisir d'être votre collègue pour quelques temps, merci en particulier à Virginie pour sa confiance.

Vincent, merci pour tout l'amour, le soutien et la bienveillance que tu m'as apporté ces 9 dernières années. Merci d'être à mes côtés et de m'accompagner dans toutes mes aventures.

J'embrasse enfin ma famille qui m'encourage et me soutient dans tous mes projets. Merci à mes parents de m'avoir appris à toujours poursuivre mes rêves! Merci à ma sœur d'être ma meilleure amie depuis 25 ans maintenant. Merci à toutes les femmes de ma famille qui sont ou ont été des femmes fortes et déterminées, merci à vous toutes d'être, chacune à votre manière et d'où que vous soyez, un modèle pour moi. Cathie, Claire, Claudie, Coco, Delph, Mamies, Mémé, je pense fort à vous, et enfin Maman, merci pour tout, merci d'avoir rendu tout cela possible.

T ABLE DES MATIÈRES

Résumé en Français	17
Introduction	17
Compactification de Thurston de l'espace de Teichmüller	19
Comptage des arcs pour les surfaces à bord	23
Ouvertures	26
Introduction	31
Thurston compactification of Teichmüller spaces	32
Counting arcs on surfaces with boundary	34
Perspectives	36
Notations	41
1 Background	45
1.1 (Hyperbolic) Surfaces	45
1.1.1 Topological surfaces	45
1.1.2 Hyperbolic structures on surfaces	46
1.2 Curves on surfaces	46
1.2.1 Definitions	46
1.2.2 Intersection number	47
1.2.3 Self intersections, lengths and cusps	48
1.3 Mapping class groups	53
1.3.1 Definitions	53
1.3.2 Classification of mapping classes	54
1.3.3 Dehn-twists	54
1.4 Measured laminations	55
1.4.1 From laminations to measured laminations	55
1.4.2 Action of the mapping class group	58
1.5 Geodesic currents	59
1.5.1 Definition	59

1.5.2	Curves and measured laminations as currents	60
1.5.3	Intersection form for geodesic currents	62
1.5.4	Measures of complexity	63
1.5.5	Geodesic currents in non-compact surfaces	64
2	Thurston compactification via geodesic currents	67
2.1	Teichmüller space	67
2.1.1	Definition	67
2.1.2	Length function and Thurston compactification	68
2.1.3	Teichmüller classes as geodesic currents and Bonahon’s strategy	68
2.2	Preliminaries	69
2.2.1	From non-compact to compact	70
2.2.2	Cusps neighborhoods and intersection number	72
2.3	Construction of controled sequences of random geodesics	74
2.3.1	Sequences of random geodesics	74
2.3.2	Cutting process	76
2.3.3	Construction of controled sequences of random geodesics	78
2.4	Proof of Thurston’s compactification	83
2.5	Another way to recover continuity	86
3	Counting arcs of the same type	89
3.1	Background	89
3.1.1	Counting problems	89
3.1.2	Arcs on surfaces	90
3.1.3	Doubling the surface	91
3.2	Counting problems with a bound on the intersection number	93
3.3	Proof of the main theorem	96
3.4	Application to counting problems	103
3.4.1	Counting bounded arcs	103
3.4.2	Counting bi-infinite arcs	104
3.4.3	Counting arcs on orbifolds	107
4	Perspectives	111
4.1	Perspectives for counting problems	111
4.1.1	Counting orbits of certain cyclic subgroups	111

4.1.2	Analog for arcs	119
4.1.3	A step towards more general results	120
4.2	Counting problems from the geometric and measured points of view	122
4.2.1	The special cases of Dehn-twists and pseudo-Anosov	122
4.2.2	Geometric interpretation of measures convergence results	125
4.3	From counting results to asymptotics on curves	126

Bibliographie

129

Introduction

Dans ce manuscrit on s'intéresse à deux problèmes de géométrie des surfaces.

- La compactification de Thurston de l'espace de Teichmüller
- Les problèmes de comptage sur les surfaces hyperboliques

L'objectif est de traiter ces problèmes sous le prisme des courants géodésiques.

L'espace des courants géodésiques sur une surface de type fini et de caractéristique d'Euler négative est une complétion de l'ensemble des multicourbes à poids de cette surface. Cette notion a été introduite en 1986 [Bon1] par Bonahon notamment dans le but d'étudier les bouts des 3-varités. Cette notion s'est depuis révélée fructueuse dans l'étude des structures hyperboliques, plates ou à courbure négative sur les surfaces [Bon2 ; BL ; CFF ; DLR ; HP ; Ota], pour l'étude des courbes sur les surfaces [ES3 ; Erl ; RS ; EPS], et plus récemment pour l'étude des variétés de caractères [MZ ; Bur+2 ; Bur+1].

Le premier point qui nous intéresse est la preuve de Bonahon [Bon2] de la compactification de Thurston de l'espace de Teichmüller. Il utilise le fait que l'espace de Teichmüller peut être réalisé comme un sous-espace de l'ensemble des courants géodésiques afin d'établir la compactification de Thurston dans cet espace pour les surfaces fermées. Dans le Chapitre 2, on se place dans le cadre de surfaces non compactes d'aire finie où la compactification de Thurston est valable mais où la preuve de Bonahon ne s'applique pas. On construit alors les éléments nécessaires pour appliquer la preuve de Bonahon dans ce contexte. L'idée consiste à approcher les éléments de l'espace de Teichmüller par des suites de courbes (des suites de géodésiques aléatoires) dont le comportement dans les cusps est contrôlé afin d'adapter la preuve de Bonahon au cas des surfaces non-compactes d'aire finie. Ce chapitre repose sur le résultat technique suivant qui est extrait du Théorème 2.15.

Théorème. *Pour toute structure hyperbolique X sur une surface de type analytique fini S de caractéristique d'Euler $\chi(S)$ négative, il existe une suite $(\gamma_N^{(X)})_{N \in \mathbb{N}}$ de géodésiques*

aléatoires telle que :

$$\lim_{N \rightarrow \infty} i \left(\frac{\gamma_N^{(X)}}{\ell_X(\gamma_N^{(X)})}, \frac{\gamma_N^{(X)}}{\ell_X(\gamma_N^{(X)})} \right) = \frac{1}{\pi^2 |\chi(S)|}.$$

Le deuxième problème traité dans ce manuscrit est le comptage d'arcs sur les surfaces à bord. Considérons Γ un sous-groupe d'indice fini du mapping class group d'une surface de type fini compacte Σ de genre g et à r composantes de bord. D'après des résultats de Mirzakhani [Mir1 ; Mir2] ensuite généralisés par Erlandsson-Souto [ES3], on sait que pour toute mesure de complexité F pour les courbes (typiquement une fonction longueur) le nombre d'éléments de complexité au plus L dans une orbite donnée de l'action de Γ sur les courbes de Σ croît comme $L^{6g-6+2r}$. Si l'on considère maintenant des arcs entre bords de la surface plutôt que des courbes, on dispose de résultats de Bell [Bel2] similaire à ceux de Mirzakhani. Ses résultats sont généralisés dans le Chapitre 3. On montre que les arcs peuvent être des courants géodésiques et que les familles de mesures de comptage associées à l'orbite d'un arc convergent.

Théorème 3.13. *Si Σ est une surface compacte, connexe, orientée à bords et de caractéristique d'Euler négative et qu'elle n'est pas une paire de pantalons alors, pour tout multiarc à poids $\alpha_0 \in \mathcal{A}_m(\Sigma)$, et tout sous-groupe d'indice fini Γ de $\text{Map}(\Sigma)$, il existe $\mathfrak{c}_{g,r}^\Gamma(\alpha_0) > 0$ telle que*

$$\frac{1}{L^{6g-6+2r}} \sum_{\alpha \in \Gamma \cdot \alpha_0} \delta_{\frac{1}{L} \widehat{\alpha}} \xrightarrow{L \rightarrow \infty} \mathfrak{c}_{g,r}^\Gamma(\alpha_0) \cdot \widehat{\mathfrak{m}}_{Thu}^\Sigma.$$

Ici, $\widehat{\mathfrak{m}}_{Thu}^\Sigma$ est une mesure de Radon sur $\mathcal{C}(D\Sigma)$ et la convergence a lieu pour la topologie faible* sur les mesures de Radon sur $\mathcal{C}(D\Sigma)$.

On introduit ensuite une notion de mesure de complexité pour les arcs qui nous permet d'obtenir un théorème de comptage général pour les arcs d'un même type.

Le Chapitre 4 se concentre sur le comptage dans les orbites de sous-groupes monogènes générés par un élément pseudo-Anosov ou un twist de Dehn. On montre que la croissance du nombre d'éléments de complexité au plus L dans une orbite donnée est alors respectivement logarithmique et linéaire en L . Ces premiers résultats nous permettent d'aboutir à des conjectures et des pistes de travail pour traiter des cas plus généraux de sous-groupes d'indice infini. D'une manière générale, on développe dans ce chapitre les différentes questions qu'ouvre ce manuscrit.

Compactification de Thurston de l'espace de Teichmüller pour les surfaces non-compactes

L'espace de Teichmüller $\mathcal{T}(S)$ d'une surface S de type fini sans bord et de caractéristique d'Euler $\chi(S)$ négative est l'ensemble des classes d'isotopie des métriques riemanniennes (complètes et de volume fini) de courbure constante -1 sur S . Cet espace est non compact et admet de nombreuses compactifications. On s'intéresse ici à celle donnée par Thurston pour laquelle le bord de l'espace de Teichmüller est l'ensemble $\mathbb{P}_+\mathcal{ML}(S)$ des laminations projectives mesurées de S . Le point de départ de la compactification de Thurston est le plongement de $\mathcal{T}(S)$ dans l'ensemble $\mathbb{P}_+(\mathbb{R}_{\geq 0}^{\mathcal{C}(S)}) = \mathbb{R}_{>0} \setminus \mathbb{R}_{\geq 0}^{\mathcal{C}(S)}$ des classes projectives de fonctions à valeurs positives sur les courbes de S :

$$\begin{aligned} \ell &: \mathcal{T}(S) &\rightarrow &\mathbb{P}_+(\mathbb{R}_{\geq 0}^{\mathcal{C}(S)}) \\ X &\mapsto &\mathbb{R}_{>0}\ell_X(\cdot). \end{aligned}$$

Ici, si X est une structure hyperbolique sur S , on note ℓ_X la fonction longueur associée sur $\mathcal{C}(S)$. L'ensemble des courbes $\mathcal{C}(S)$ est l'ensemble des classes d'homotopie libre de chemin fermés primitifs essentiels sur S . La compactification de Thurston consiste à montrer que l'image de ℓ est localement compacte et que le bord de $\mathcal{T}(S)$ dans $\mathbb{P}_+(\mathbb{R}_{\geq 0}^{\mathcal{C}(S)})$ s'identifie à $\mathbb{P}_+\mathcal{ML}(S)$.

Théorème (Compactification de Thurston). *Si S est une surface de type analytique fini et de caractéristique d'Euler négative, alors les points d'accumulation de $\mathcal{T}(S)$ dans $\mathbb{P}_+(\mathbb{R}_{\geq 0}^{\mathcal{C}(S)})$ sont les classes projectives de fonctions de la forme $\gamma \mapsto \mathbb{R}_{>0}i(\lambda, \gamma)$ où $\lambda \in \mathcal{ML}(S)$ est une lamination mesurée sur S .*

La preuve de Thurston est exposée dans [FLP], des versions utilisant les arbres réels sont aussi données par Morgan-Shalen [MS], Bestvina [Bes] ou Paulin [Pau1]. Un aperçu des différentes méthodes de compactification est aussi donné dans [Pau2] ou [Ohs]. On s'intéressera ici à une méthode particulièrement efficace, pour les surfaces fermées, due à Bonahon [Bon2]. Exposons brièvement sa preuve. Tout d'abord, rappelons qu'un courant géodésique est une mesure de Radon $\pi_1(S)$ -invariante sur l'ensemble des géodésiques du revêtement universel de S , Bonahon plonge alors l'espace de Teichmüller dans l'ensemble des courants géodésiques sur S : à chaque élément $X \in \mathcal{T}(S)$ de l'espace de Teichmüller l'auteur associe un courant $L_X \in \mathcal{C}(S)$ appelé courant de Liouville. Pour chaque $X \in \mathcal{T}(S)$

le courant de Liouville satisfait deux propriétés particulières :

$$i(L_X, \gamma) = \ell_X(\gamma) \quad \text{pour toute courbe } \gamma, \text{ et} \quad (\text{I})$$

$$i(L_X, L_X) = \pi^2 |\chi(S)|. \quad (\text{II})$$

Ici, $i : \mathcal{C}(S) \times \mathcal{C}(S) \rightarrow \mathbb{R}_{\geq 0}$ est la forme d'intersection, une forme bilinéaire continue qui étend le nombre d'intersections usuel entre les courbes, l'existence d'une telle extension découle de la compacité de S . De plus, l'espace $\mathcal{C}(S)$ étant localement compact et $\mathbb{P}_+ \mathcal{C}(S)$ compact, toute suite $(X_n)_{n \in \mathbb{N}}$ d'éléments dans l'espace de Teichmüller admet une sous-suite, disons la suite entière, qui converge projectivement vers un courant non-nul μ . Plus précisément, il existe une suite $(\varepsilon_n)_{n \in \mathbb{N}}$ de réels strictement positifs telle que $\lim_{n \rightarrow \infty} \varepsilon_n L_{X_n} = \mu$. La continuité de la forme d'intersection et la propriété (I) assurent que la suite $(\ell_{X_n})_{n \in \mathbb{N}}$ des fonctions longueur converge projectivement vers $i(\mu, \cdot)$ et que $(\varepsilon_n)_{n \in \mathbb{N}}$ tend vers 0 dès lors que $(X_n)_{n \in \mathbb{N}}$ ne converge pas dans $\mathcal{T}(S)$. Sachant que $\varepsilon_n \xrightarrow[n \rightarrow \infty]{} 0$, la propriété (II) assure que $i(\mu, \mu) = 0$, et donc que μ est une lamination mesurée.

Soulignons que l'argument de Bonahon, malgré sa simplicité, ne s'applique qu'aux surfaces fermées. Nous reviendrons plus loin sur cette spécificité et sur les obstacles à une extension directe de son argument au cas non fermé. Récemment, Bonahon et Šarić ont donné une autre preuve de ce théorème en utilisant les courants géodésiques pour les surfaces de type infini. Il est intéressant de noter que le fait de travailler dans un contexte aussi général implique la perte de la simplicité de la première preuve de Bonahon.

Notre but dans ce manuscrit est d'adapter l'argument original de Bonahon afin de pouvoir traiter des surfaces non compactes de type fini.

Examinons les difficultés qui empêchent l'extension de la preuve de Bonahon au cas non compact. La forme d'intersection, en particulier sa continuité, est la clef de voûte de la preuve originale de Bonahon. Cependant, la continuité échoue lorsque la surface n'est pas compacte, même si elle a une aire finie. Cette obstruction est détaillée dans l'exemple 2.6. Nous allons donc changer de point de vue pour bénéficier de la continuité de i . Pour ce faire, deux possibilités s'offrent à nous : se restreindre à un compact de S où travailler dans une surface compacte. Dans le Chapitre 2 le choix est fait de travailler dans une surface compacte (la dernière section explique comment les mêmes arguments s'appliquent grâce à la restriction à un compact de S). Nous considérons donc les courants sur Σ au lieu de S , où Σ est une surface hyperbolique compacte à bords géodésiques dont l'intérieur est homéomorphe à S , c'est-à-dire $S = \Sigma \setminus \partial\Sigma$.

Le deuxième ingrédient clef de la preuve de Bonahon est l'existence du courant de Liouville mais, comme nous le verrons, lorsque l'on travaille avec des courants sur Σ , le ce dernier n'est plus défini. Notons qu'en travaillant dans un compact de S , le courant de Liouville pose lui aussi problème dans la mesure où les géodésiques de son support ne se projettent pas toutes dans ce compact.

Proposition 2.7. *Soit Σ une surface hyperbolique compacte à bord géodésique non vide et X une structure hyperbolique sur $S = \Sigma \setminus \partial\Sigma$. Il n'existe pas de courant L_X sur Σ qui satisfasse $i(L_X, \gamma) = \ell_X(\gamma)$ pour toute courbe $\gamma \in \mathfrak{C}(\Sigma)$.*

L'objectif est alors de remplacer les courants de Liouville par des suites de courants bien définis dans Σ . Pour ce faire, on utilise des suites de géodésiques aléatoires, c'est à dire des suites de géodésiques fermées, primitives et essentielles, telles que les mesures de probabilités associées sur le tangent unitaire convergent vers la mesure de Liouville pour la topologie faible*. On choisira de telles suites de sorte à ce qu'elles satisfassent (I) et (II) de manière asymptotique :

$$\lim_{n \rightarrow \infty} i\left(\frac{\gamma_n}{\ell_X(\gamma_n)}, \gamma\right) = \frac{\ell_X(\gamma)}{\pi^2 |\chi(S)|} \quad \text{pour toute courbe } \gamma, \quad (\text{III})$$

$$\lim_{n \rightarrow \infty} i\left(\frac{\gamma_n}{\ell_X(\gamma_n)}, \frac{\gamma_n}{\ell_X(\gamma_n)}\right) = \frac{1}{\pi^2 |\chi(S)|}. \quad (\text{IV})$$

Comme souligné dans [ES3], toute suite de géodésiques aléatoires $(\gamma_n)_{n \in \mathbb{N}}$ satisfait la propriété (III). De plus, si la surface est compacte, alors (IV) est assurée pour toute suite de géodésiques aléatoires. Cependant, pour une surface non compacte, des suites arbitraires de géodésiques aléatoires ne satisfont pas nécessairement (IV), on pourra se référer à l'exemple 2.12 ci-dessous. Ainsi une grande partie du chapitre 2 sera consacrée à la construction de suites de géodésiques aléatoires satisfaisant cette propriété pour les surfaces non compactes.

La stratégie de construction de telles suites repose sur le fait que seules les excursions dans les cusps peuvent empêcher (IV). Ainsi, on construit les suites souhaitées à partir de suites de géodésiques aléatoires quelconques dont on contrôle les excursions dans les voisinages des cusps : pour tout n , on demande à ce que γ_n atteigne au plus la profondeur c_n dans chaque cusp.

Théorème. *Pour toute structure hyperbolique X sur une surface S de type analytique fini de caractéristique d'Euler $\chi(S)$ négative, il existe une suite $(\gamma_N^{(X)})_{N \in \mathbb{N}}$ de géodésiques*

aléatoires telle que :

$$\lim_{n \rightarrow \infty} i \left(\frac{\gamma_N^{(X)}}{\ell_X(\gamma_N^{(X)})}, \frac{\gamma_N^{(X)}}{\ell_X(\gamma_N^{(X)})} \right) = \frac{1}{\pi^2 |\chi(S)|}.$$

Le théorème ci-dessus est extrait d'un résultat plus technique, le Théorème 2.15. Le principal contenu additionnel de ce théorème est de garantir l'indépendance des taux de convergence dans (III) et (IV) de la structure X et le contrôle du comportement des suites de géodésiques aléatoires dans les voisinages des cusps. Ces deux éléments sont clés dans l'extension de la preuve de la compactification de Thurston pour les surfaces non compactes. On résume les éléments essentiels de cette preuve ci-dessous.

Soit une suite $(X_k)_{k \in \mathbb{N}}$ d'éléments de $\mathcal{T}(S)$ où S est une surface de type analytique fini. On suppose que cette suite sort de tout compact de l'espace de Teichmüller et que la suite des fonctions longueur associée $(\ell_k)_{k \in \mathbb{N}}$ converge simplement vers une fonction F dans $\mathbb{P}_+(\mathbb{R}_{\geq 0}^{\mathcal{C}(S)})$. On veut montrer que F est de la forme $\mathbb{R}_{>0} i(\lambda, \cdot)$ où $\lambda \in \mathcal{ML}(S)$.

$$\varepsilon^1 \frac{\ell_{X_1}(\cdot)}{\pi^2 |\chi|} \quad \varepsilon^2 \frac{\ell_{X_2}(\cdot)}{\pi^2 |\chi|} \quad \dots \quad \varepsilon^k \frac{\ell_{X_k}(\cdot)}{\pi^2 |\chi|} \quad \dots \quad \longrightarrow \quad F \in \mathbb{R}_{\geq 0}^{\mathcal{C}(S)}$$

En utilisant pour chaque structure hyperbolique X_k une suite de géodésiques aléatoires $(\gamma_n^{(k)})_{n \in \mathbb{N}}$ issue du Théorème 2.15, on approche (pour la convergence simple) les fonctions longueur par des nombres d'intersection avec des courbes à poids.

$$\begin{array}{ccccccccc} \varepsilon^1 \frac{\ell_{X_1}(\cdot)}{\pi^2 |\chi|} & \varepsilon^2 \frac{\ell_{X_2}(\cdot)}{\pi^2 |\chi|} & \dots & \varepsilon^k \frac{\ell_{X_k}(\cdot)}{\pi^2 |\chi|} & \dots & \longrightarrow & F \in \mathbb{R}_{\geq 0}^{\mathcal{C}(S)} & & \\ \uparrow & \uparrow & \dots & \uparrow & \dots & & & & \\ \vdots & \vdots & \dots & \vdots & \dots & & & & \\ \varepsilon^1 i(\bar{\gamma}_n^{(1)}, \cdot) & \varepsilon^2 i(\bar{\gamma}_n^{(2)}, \cdot) & \dots & \varepsilon^k i(\bar{\gamma}_n^{(k)}, \cdot) & \dots & & & & \\ \vdots & \vdots & \dots & \vdots & \dots & & & & \\ \varepsilon^1 i(\bar{\gamma}_2^{(1)}, \cdot) & \varepsilon^2 i(\bar{\gamma}_2^{(2)}, \cdot) & \dots & \varepsilon^k i(\bar{\gamma}_2^{(k)}, \cdot) & \dots & & & & \\ \varepsilon^1 i(\bar{\gamma}_1^{(1)}, \cdot) & \varepsilon^2 i(\bar{\gamma}_1^{(2)}, \cdot) & \dots & \varepsilon^k i(\bar{\gamma}_1^{(k)}, \cdot) & \dots & & & & \end{array}$$

En considérant les $\bar{\gamma}_n^{(k)}$ comme des courbes à poids de Σ et donc comme des courants de Σ , la compacité de $\mathbb{P}_+\mathcal{C}(\Sigma)$ nous assure que chaque suite $(\bar{\gamma}_n^{(k)})_{k \in \mathbb{N}}$ tend (à extraction près), projectivement, vers un courant μ_n . Par ailleurs, la continuité du nombre d'intersections sur Σ assure la convergence simple des $(i(\bar{\gamma}_n^{(k)}, \cdot))_{k \in \mathbb{N}}$. Les constantes issues de la projectivisation peuvent être ajustées de sorte à préserver l'approximation des fonctions longueur.

$$\begin{array}{ccccccc}
\delta^1 \frac{\ell_{X_1}(\cdot)}{\pi^2 |\chi|} & \delta^2 \frac{\ell_{X_2}(\cdot)}{\pi^2 |\chi|} & \cdots & \delta^k \frac{\ell_{X_k}(\cdot)}{\pi^2 |\chi|} & \cdots & \longrightarrow & F \in \mathbb{R}_{\geq 0}^{\mathfrak{C}(S)} \\
\uparrow & \uparrow & \cdots & \uparrow & \cdots & & \uparrow ? \\
\vdots & \vdots & \cdots & \vdots & \cdots & & \vdots \\
\delta_n^1 i(\bar{\gamma}_n^{(1)}, \cdot) & \delta_n^2 i(\bar{\gamma}_n^{(2)}, \cdot) & \cdots & \delta_n^k i(\bar{\gamma}_n^{(k)}, \cdot) & \cdots & \longrightarrow & i(\mu_n, \cdot) \quad \mu_n \in \mathfrak{C}(\Sigma) \\
\vdots & \vdots & \cdots & \vdots & \cdots & \vdots & \vdots \\
\delta_2^1 i(\bar{\gamma}_2^{(1)}, \cdot) & \delta_2^2 i(\bar{\gamma}_2^{(2)}, \cdot) & \cdots & \delta_2^k i(\bar{\gamma}_2^{(k)}, \cdot) & \cdots & \longrightarrow & i(\mu_2, \cdot) \quad \mu_2 \in \mathfrak{C}(\Sigma) \\
\delta_1^1 i(\bar{\gamma}_1^{(1)}, \cdot) & \delta_1^2 i(\bar{\gamma}_1^{(2)}, \cdot) & \cdots & \delta_1^k i(\bar{\gamma}_1^{(k)}, \cdot) & \cdots & \longrightarrow & i(\mu_1, \cdot) \quad \mu_1 \in \mathfrak{C}(\Sigma)
\end{array}$$

Le contrôle du comportement des suites de géodésiques aléatoires dans les voisinages des cusps nous permet de prouver que pour chaque n le courant μ_n est une lamination mesurée de S . Enfin, l'uniformité en k dans l'approximation des fonctions longueur permet de conclure que $i(\mu_n, \cdot) \rightarrow F$ et que F est le nombre d'intersections avec une lamination mesurée.

Comptage des arcs pour les surfaces à bord

Le mapping class group $\text{Map}(\Sigma)$ d'une surface compacte connexe orientée Σ de genre g et à r composantes de bord agit sur les multicourbes à poids $\mathfrak{C}_m(\Sigma)$ de cette surface. La question du comptage des éléments dans une orbite donnée de cette action a été étudiée par Mirzakhani, d'abord pour les courbes simples [Mir1] puis pour les multicourbes en général [Mir2]. Elle montre que pour toute structure hyperbolique X sur Σ et toute multicourbe $\gamma_0 \in \mathfrak{C}_m(\Sigma)$, si Γ est un sous groupe d'indice fini de $\text{Map}(\Sigma)$ alors il existe une constante $\mathfrak{c}_{g,r}^\Gamma(\gamma_0) > 0$ telle que

$$\lim_{L \rightarrow \infty} \frac{\#\{\gamma \in \Gamma \cdot \gamma_0 \mid \ell_X(\gamma) \leq L\}}{L^{6g-6+2r}} = \mathfrak{c}_{g,r}^\Gamma(\gamma_0) \cdot \mathfrak{m}_{Thu}^\Sigma(\{\ell_X(\cdot) \leq 1\}),$$

où $\mathfrak{m}_{Thu}^\Sigma$ est la mesure de Thurston sur les laminations mesurées de Σ .

Ces résultats ont été étendus par Erlandsson-Souto [ES3] en une version plus générale, où la fonction longueur peut être remplacée par d'autres notions de complexité pour les courbes de Σ . Cela s'applique par exemple à la longueur pour n'importe quelle métrique riemannienne de courbure négative sur Σ ou son intérieur [ES1], le nombre d'intersections avec une courbe ou un courant remplissant [ES1][RS], la longueur de mot [Erl], la longueur de translation pour certaines actions de $\pi_1(\Sigma)$ sur un espace métrique [EPS] ou encore la longueur extrémale [MT1].

Maintenant, si Σ est de bord non-vide on peut s'intéresser à l'action du mapping class group sur les multiarcs à poids de Σ . On appelle arc un chemin entre deux bords de la surface. Dans ce contexte, Bell [Bel2] obtient des résultats semblables à ceux de Mirzakhani. Si X est une structure hyperbolique sur Σ et α_0 un multiarc à poids alors il existe $\mathfrak{c}_{g,r}^{\text{Map}(\Sigma)}(\alpha_0)$ telle que

$$\lim_{L \rightarrow \infty} \frac{\#\{\alpha \in \text{Map}(\Sigma) \cdot \alpha_0 \mid \ell_X(\gamma) \leq L\}}{L^{6g-6+2r}} = \mathfrak{c}_{g,r}^{\text{Map}}(\alpha_0) \cdot \mathfrak{m}_{\text{Thu}}^\Sigma(\{\ell_X(\cdot) \leq 1\}), \quad (\text{V})$$

où la longueur d'un arc est la longueur pour X de l'unique arc géodésique homotope à α et orthogonal au bord de Σ . Le but principal du Chapitre 3 est d'obtenir une version générale de (V) dans laquelle la longueur peut être remplacée par d'autres notions de complexité pour les arcs. Pour ce faire, on montrera un résultat de convergence pour des familles de mesures construites à partir de ces arcs. En effet, les résultats de Erlandsson-Souto portant sur la généralisation des résultats de Mirzakhani reposent sur la convergence de familles de mesures de comptage vers la mesure de Thurston dans l'espace des mesures sur les courants géodésiques de Σ . Dans ce cadre, un élément clef est que les multicourbes à poids peuvent être vues comme des courants sur Σ . Dans le but de voir les arcs de Σ comme des courants géodésiques on travaillera dans la surface correspondant au doublement $D\Sigma$ de Σ .

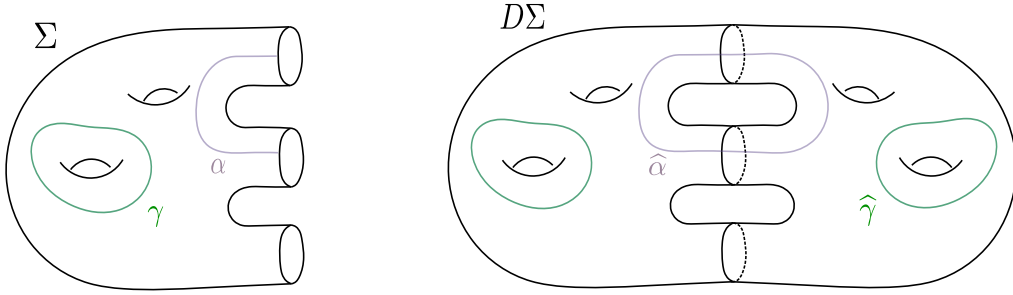

FIGURE 1 – De Σ à $D\Sigma$

Dans ce contexte, si i^+ et i^- correspondent aux deux plongements canoniques de Σ dans $D\Sigma$ alors on a le processus de doublement suivant :

$$\begin{aligned} \hat{\cdot} &: \mathcal{C}(\Sigma) \hookrightarrow \mathcal{C}(D\Sigma) \\ \mu &\mapsto i^+(\mu) + i^-(\mu). \end{aligned}$$

$$\begin{aligned} \hat{\cdot} &: \mathcal{A}_m(\Sigma) \hookrightarrow \mathfrak{C}_m(D\Sigma) \hookrightarrow \mathcal{C}(D\Sigma) \\ \alpha &\mapsto \hat{\alpha} \mapsto \hat{\alpha}. \end{aligned}$$

Nous sommes ainsi dans la possibilité d'associer à chaque multiarc α_0 et tout sous-groupe d'indice fini Γ de $\text{Map}(\Sigma)$ la famille de mesures de Radon sur $\mathcal{C}(D\Sigma)$ suivante :

$$\nu_{\alpha_0, L}^\Gamma = \frac{1}{L^{6g-6+2r}} \sum_{\alpha \in \Gamma \cdot \alpha_0} \delta_{\frac{1}{L}\hat{\alpha}}.$$

Le chapitre 3 consiste à prouver la convergence de cette famille quand L tend vers l'infini et à identifier sa limite.

Théorème 3.13. *Si Σ est une surface compacte, connexe, orientée à bords et de caractéristique d'Euler négative et que Σ n'est pas une paire de pantalon alors, pour tout multiarc à poids $\alpha_0 \in \mathcal{A}_m(\Sigma)$, et tout sous-groupe Γ d'indice fini de $\text{Map}(\Sigma)$, il existe $\mathbf{c}_{g,r}^\Gamma(\alpha_0) > 0$ telle que*

$$\lim_{L \rightarrow \infty} \nu_{\alpha_0, L}^\Gamma = \mathbf{c}_{g,r}^\Gamma(\alpha_0) \cdot \hat{\mathbf{m}}_{Thu}^\Sigma.$$

Ici, $\hat{\mathbf{m}}_{Thu}^\Sigma$ est une mesure de Radon sur $\mathcal{C}(D\Sigma)$ et la convergence a lieu pour la topologie faible* sur les mesures de Radon sur $\mathcal{C}(D\Sigma)$.

Remarque. *Dans le théorème ci-dessus la mesure $\hat{\mathbf{m}}_{Thu}^\Sigma$ est une mesure sur $\mathcal{C}(D\Sigma)$ obtenue à partir de la mesure de Thurston sur $\mathcal{ML}(\Sigma)$, plus de détails sur sa construction sont donnés dans la Section 3.1.*

La preuve de ce théorème repose sur une stratégie similaire à celle utilisée par [RS]. Les étapes essentielles de la preuve sont les suivantes.

- On commence par prouver une version de (V) pour laquelle la mesure de complexité des arcs est donnée par le nombre d'intersections avec une courbe remplissante, Théorème 3.7.
- On montre ensuite que toute sous suite $(\nu_{\alpha_0, L_n}^\Gamma)_{n \in \mathbb{N}}$ de $(\nu_{\alpha_0, L}^\Gamma)_{L > 0}$ avec $L_n \rightarrow \infty$ admet au moins une valeur d'adhérence en utilisant le Théorème 3.7.
- On s'assure ensuite que les points d'accumulation de $(\nu_{\alpha_0, L}^\Gamma)_{L > 0}$ sont supportés par $\widehat{\mathcal{ML}}(\Sigma)$. Cette étape repose elle aussi sur l'utilisation du Théorème 3.7.
- On prouve alors que ces points d'accumulation sont des multiples de $\hat{\mathbf{m}}_{Thu}^\Sigma$ à l'aide de la classification des mesures ergodiques pour l'action de $\text{Map}(\Sigma)$ sur $\mathcal{ML}(\Sigma)$ issue de [LM] ou [Ham].
- On conclut en montrant que ces éléments sont tous le même multiple de $\hat{\mathbf{m}}_{Thu}^\Sigma$.

On déduit de ce théorème une version générale du théorème de comptage de Bell pour les arcs : la fonction longueur peut être remplacée par des fonctions particulières sur $\mathcal{A}_m(\Sigma)$. On dira qu'une fonction $F \in \mathbb{R}_{\geq 0}^{\mathcal{A}_m(\Sigma)}$ est une mesure de complexité pour les

arcs s'il existe une fonction continue et homogène \widehat{F} sur $\mathcal{C}(D\Sigma)$, qui soit positive sur les courants symétriques ne donnant pas de poids à $\partial\Sigma$, et une fonction continue et homogène F sur $\mathcal{C}(\Sigma)$ telles que :

- $\forall \alpha \in \mathcal{A}_m(\Sigma), \quad \widehat{F}(\widehat{\alpha}) = 2F(\alpha),$
- $\forall \mu \in \mathcal{C}(\Sigma), \quad \widehat{F}(\widehat{\mu}) = 2F(\mu).$

Corollaire 3.16. *Soit Σ et Γ comme dans le Théorème 3.13. Pour tout multiarc à poids $\alpha_0 \in \mathcal{A}_m(\Sigma)$ et toute mesure de complexité sur les arcs F ,*

$$\lim_{L \rightarrow \infty} \frac{\#\{\alpha \in \Gamma \cdot \alpha_0 \mid F(\alpha) \leq L\}}{L^{6g-6+2r}} = \mathfrak{c}_{g,r}^\Gamma(\alpha_0) \cdot \mathfrak{m}_{Thu}^\Sigma(\{F(\cdot) \leq 1\}).$$

Par exemple, la fonction F peut être une fonction longueur ou un nombre d'intersections avec une courbe ou un courant remplissant de Σ .

On terminera le Chapitre 3 avec une adaptation des résultats ci-dessus au cas des orbifolds et leur application au comptage des arcs bi-infinis dans les surfaces à cusps pour des notions adaptées de longueur.

Corollaire 3.21. *Soit S une surface non-compacte de type analytique fini avec $r > 0$ cusps qui ne soit pas un pantalon. Pour toute structure hyperbolique X sur S , si α_0 est un multiarc à poids bi-infini et Γ un sous-groupe d'indice fini de $\text{Map}(S)$ alors*

$$\lim_{L \rightarrow \infty} \frac{\#\{\alpha \in \Gamma \cdot \alpha_0 \mid \bar{\ell}_X(\alpha) \leq L\}}{L^{6g-6+2r}} = \mathfrak{c}_{g,r}^\Gamma(\gamma_0) \cdot \mathfrak{m}_{Thu}^S(\{\ell_X(\cdot) \leq 1\}).$$

Ouvertures

Vers d'autres résultats de comptage

Les résultats de comptage du Chapitre 3 ainsi que les résultats de comptage de Mirzakhani ou Erlandsson-Souto sont valables si l'on considère l'action du mapping class group de la surface ou de l'un de ses sous-groupes d'indice fini. Qu'en est-il pour les orbites de sous-groupes d'indice infini ?

Question 1. *Soit Z une surface de type fini et γ_0 une multicourbe de Z . Pour Γ un sous-groupe de $\text{Map}(Z)$ et pour une mesure de complexité F fixée posons*

$$\Delta_{\gamma_0}^\Gamma(L) := \{\gamma \in \Gamma \cdot \gamma_0 \mid F(\gamma) \leq L\}.$$

Comment $\#\Delta_{\gamma_0}^\Gamma(L)$ croît-il quand L tend vers l'infini ? ■

Pour Γ d'indice fini, ce cardinal grandit comme $L^{6g-6+2n}$. D'après le Chapitre 3, si γ_0 est une courbe symétrique de $D\Sigma$ et $\Gamma = \text{Map}(\Sigma) < \text{Map}(D\Sigma)$, alors la croissance est de la forme $L^{6g(\Sigma)-6+2n(\Sigma)}$ (alors que $g(D\Sigma) = 2g(\Sigma) + n(\Sigma) - 1$ donc $6g(D\Sigma) - 6 = 12g(\Sigma) - 12 + 6n(\Sigma)$). On montre dans le Chapitre 4 que pour Γ monogène généré par un élément pseudo-Anosov ou un twist de Dehn la croissance de $\Delta_{\gamma_0}^\Gamma(L)$ est, respectivement, logarithmique et linéaire en L .

Théorèmes 4.4, 4.7, 4.9. Soit Z une surface de type fini, F une mesure de complexité pour les courbes de Z et $\gamma_0 \in \mathfrak{C}_m(Z)$ une multicourbe à poids. Si $\Phi \in \text{Map}(Z)$ est un élément pseudo-Anosov de $\text{Map}(Z)$ de facteur de dilatation λ et α une courbe simple telle que $i(\gamma_0, \alpha) \neq 0$, alors

$$\lim_{L \rightarrow \infty} \frac{\#\{\gamma \in \langle \Phi \rangle \cdot \gamma_0 \mid F(\gamma) \leq L\}}{\log(L)} = \frac{2}{\log(\lambda)}, \quad (\text{VI})$$

$$\lim_{L \rightarrow \infty} \frac{\#\{\gamma \in \langle T_\alpha \rangle \cdot \gamma_0 \mid F(\gamma) \leq L\}}{L} = \frac{2}{i(\alpha, \gamma_0)F(\alpha)}. \quad (\text{VII})$$

Dans la première section du dernier chapitre de ce manuscrit on développe ces deux exemples et on soulève des pistes de réflexions permettant d'allier ces résultats et ceux du Chapitre 3 pour aboutir à la conjecture suivante :

Conjecture. Soit S une surface de type fini fermée, soit Γ un sous-groupe de $\text{Map}(S)$ et X une structure hyperbolique sur S . Il existe $m, n > 0$ et un nombre fini d'entiers positifs $k_1, \dots, k_m, \delta_1, \dots, \delta_n$ tels que, si le centre $C(\Gamma)$ de Γ est d'ordre infini dans $\text{Map}(S)$ alors pour toute multicourbe γ_0 de S , il existe des entiers i_1, \dots, i_l et j_1, \dots, j_k et une constante C tels que

$$\frac{\#\{\gamma \in C(\Gamma) \cdot \gamma_0 \mid \ell_X(\gamma) \leq L\}}{\log(L)^{\delta_{j_1} + \dots + \delta_{j_k}} L^{k_{i_1} + \dots + k_{i_l}}} \xrightarrow{L \rightarrow \infty} C.$$

Points de vue géométrique et mesuré sur les problèmes de comptage

Comme souligné par le Chapitre 3 l'étude de mesures de comptage est un outil très efficace pour traiter les problèmes de comptage comme celui soulevé par la Question 1. Cette première question entraîne donc naturellement une deuxième question.

Question 2. Soit Z une surface de type fini et γ_0 une multicourbe fixée de Z . Pour tout sous-groupe Γ de $\text{Map}(Z)$, posons

$$m_{\gamma_0, L}^\Gamma := \sum_{\gamma \in \Gamma \cdot \gamma_0} \delta_{\frac{1}{L}\gamma} \quad \text{une mesure de Radon sur } \mathcal{C}(Z).$$

Existe-t-il une fonction P_Γ telle que $\frac{m_{\gamma_0, L}^\Gamma}{P_\Gamma(L)}$ converge vers une mesure non-nulle quand L tend vers l'infini ? ■

Pour un sous-groupe (d'indice infini) quelconque il semble compliqué de pouvoir identifier la mesure limite, même lorsque l'on dispose de résultats de comptage. Cependant on dispose d'exemples concrets pour lesquels cette mesure est explicite :

- Dans $D\Sigma$, pour γ_0 symétrique et $\Gamma = \text{Map}(\Sigma)$ on sait que pour $P_\Gamma(L) = L^{6g(\Sigma)-6+2r(\Sigma)}$ on obtient comme mesure limite un multiple de $\widehat{\mathfrak{m}}_{Thu}^\Sigma$,
- Dans une surface fermée S , pour γ_0 une courbe quelconque et Γ généré par un twist de Dehn le long de α telle que $i(\alpha, \gamma_0) \neq 0$ alors, pour $P_\Gamma(L) = L$ on obtient comme mesure limite un multiple de la mesure de Lebesgue sur $\{t\alpha | t \geq 0\}$,
- Dans le même contexte, si Γ est généré par un pseudo-Anosov alors pour $P_\Gamma(L) = \log(L)$, la mesure limite est une masse de Dirac en 0.

Ces interprétations des théorèmes de comptage en termes de convergence de mesures nous informe sur les objets sur lesquels s'accumule l'orbite d'une courbe pour l'action de Γ . L'orbite renormalisée d'une courbe sous l'action de $\text{Map}(\Sigma)$ s'accumule sur $\mathcal{ML}(\Sigma)$. De la même manière l'orbite d'une courbe par un twist de Dehn s'accumule sur la courbe le long de laquelle on effectue le twist. La question de la convergence des mesures de comptage est donc associée à la question suivante.

Question 3. Sur quel espace l'orbite de γ_0 sous l'action de Γ s'accumule-t-elle dans $\mathbb{P}_+\mathcal{ML}$? ■

On peut citer des cas particuliers pour lesquels cette question pourrait être traitée. Par exemple, si $\Gamma < \text{Map}$ est tel que $\Gamma \backslash S$ est un orbifold, sur quoi s'accumulent les orbites de $C(\Gamma)$?

D'une manière générale, il semble pertinent d'approcher les problèmes précédents à travers les propriétés géométriques des sous-groupes qui nous intéressent.

Résultats asymptotiques pour les courbes

Les différents résultats de comptage sur les courbes nous donnent des outils pour étudier les proportions d'apparition de chaque type de courbe. En effet, si γ_0 et γ_1 sont deux courbes d'une surface hyperbolique X , alors

$$\frac{\#\{\gamma \in \text{Map} \cdot \gamma_0 \mid \ell_X(\gamma) \leq L\}}{\#\{\gamma \in \text{Map} \cdot \gamma_1 \mid \ell_X(\gamma) \leq L\}} \xrightarrow{L \rightarrow \infty} \frac{\mathfrak{c}_{g,r}^{\text{Map}}(\gamma_0)}{\mathfrak{c}_{g,r}^{\text{Map}}(\gamma_1)}.$$

Si $k \geq 0$ est fixé, on peut poser $\mathfrak{c}_{g,r}(\iota \leq k) = \sum_{\iota\gamma_0, \gamma_0 \leq k} \mathfrak{c}_{g,r}^{\text{Map}}(\gamma_0)$ et si γ_0 a au plus k auto-intersections on peut s'intéresser à la quantité suivante :

$$\frac{\mathfrak{c}_{g,r}^{\text{Map}}(\gamma_0)}{\mathfrak{c}_{g,r}(\iota \leq k)} = \lim_{L \rightarrow \infty} \frac{\#\{\gamma \in \text{Map} \cdot \gamma_0 \mid \ell_X(\gamma) \leq L\}}{\#\{\gamma \mid \ell_X(\gamma) \leq L, \iota(\gamma, \gamma) \leq k\}}.$$

En étudiant la constante $\mathfrak{c}_{g,r}^{\text{Map}}$ dans le cas de courbes simples, Delecroix-Goujard-Zograf-Zorich [Del+] ont prouvé que, en grand genre, la plupart des courbes simples sont non-séparantes. La question se pose alors pour des courbes admettant des intersections.

Question 4. *Peut-on exprimer de manière tangible la constante $\mathfrak{c}_{g,r}^{\text{Map}}$ pour une courbe quelconque ? Qu'en apprend-on sur le comportement des courbes en grand genre ?* ■

Les questions ci-dessus font entre autre partie d'un travail en cours avec M.Liu, K.Rafi et J.Souto.



INTRODUCTION

This thesis is dedicated to the study of two aspects of geometry of surfaces:

- The Thurston compactification of Teichmüller space,
- Counting problems on surfaces.

Our goal is to treat these problems through the lens of geodesic currents. The set of geodesic currents of a finite type surface with negative Euler characteristic is a completion of the set of weighted multicurves. Bonahon introduced this notion in 1986 [Bon1], mainly to study the ends of 3-manifolds. This notion has since proved fruitful in the study of hyperbolic, flat or negatively curved structures on surfaces [Bon2; BL; CFF; DLR; HP], for the study of curves on surfaces [ES3; Erl; RS; EPS], and more recently for the study of character varieties [Bur+2; Bur+1; MZ].

Let us describe the organization and the contributions of this manuscript. The first chapter is dedicated to the introduction of the necessary background and notations and also contains some useful computations of hyperbolic geometry. The second chapter is based on [Tri1]. In this chapter we extend Bonahon's proof of the compactification of Teichmüller space to the case of non-compact finite type surfaces. To do so, a large amount of the chapter is dedicated to the construction of "random" sequences of geodesics whose behavior into the cusps is controlled. The third and fourth chapters are dedicated to counting problems on surfaces. In the third chapter we prove that arcs on surfaces can be seen as geodesic currents and that the arc-counting problem can be interpreted in terms of convergence of families of measures. The key point of this chapter is that the counting measures for arcs approximate the same measure as the counting measures for curves. In the last chapter we explain and explore different questions raised by this document.

The following sections formulate the problems of interest and highlights the main contributions.

Thurston compactification of Teichmüller spaces for non-compact surfaces

The Teichmüller space $\mathcal{T}(S)$ of a surface S of finite type, with no boundary and of negative Euler characteristic $\chi(S)$, is the space of isotopy classes of (complete and finite volume) Riemannian metrics on S of constant curvature -1 . Teichmüller space is not compact but Thurston showed in [Thu] how it can be compactified by the space $\mathbb{P}_+\mathcal{ML}(S)$ of projective measured laminations on S . The starting point of Thurston's compactification is the embedding of $\mathcal{T}(S)$ into the space $\mathbb{P}_+(\mathbb{R}_{\geq 0}^{\mathfrak{C}(S)}) = \mathbb{R}_{>0} \setminus \mathbb{R}_{\geq 0}^{\mathfrak{C}(S)}$ of projective functions on the curves of S :

$$\begin{aligned} \ell &: \mathcal{T}(S) \rightarrow \mathbb{P}_+(\mathbb{R}_{\geq 0}^{\mathfrak{C}(S)}) \\ X &\mapsto \mathbb{R}_{>0} \ell_X(\cdot). \end{aligned}$$

Here ℓ_X is the length function associated to the hyperbolic structure X on S and $\mathfrak{C}(S)$ is the set of free homotopy classes of essential closed curves of S . Thurston proved that the image of ℓ is locally compact and identified the boundary of $\mathcal{T}(S)$ in $\mathbb{P}_+(\mathbb{R}_{\geq 0}^{\mathfrak{C}(S)})$ with $\mathbb{P}_+\mathcal{ML}(S)$.

Theorem (Thurston compactification). *If S is a finite analytic type surface with negative Euler characteristic, then the accumulation points of $\mathcal{T}(S)$ in $\mathbb{P}_+(\mathbb{R}_{\geq 0}^{\mathfrak{C}(S)})$ are the projective classes of functions $\gamma \mapsto i(\lambda, \gamma)$ where $\lambda \in \mathcal{ML}(S)$ is a measured lamination on S .*

Thurston's original proof is explained in [FLP]. Alternative proofs using real-trees are given by Morgan–Shalen [MS], Bestvina [Bes] or Paulin [Pau1]. An overview of the different compactification methods is available in [Pau2] or [Ohs]. A compactification for the set of flat-structures and using geodesic currents is done in [DLR], note that this article is interested in both compact and non-compact surfaces. Here, we will be mostly interested in a very elegant argument, for closed surfaces, due to Bonahon [Bon2]. Let us sketch the proof. Recall that geodesic currents are $\pi_1(S)$ -invariant Radon measures on the set of bi-infinite geodesics of the universal cover of S . Bonahon embeds $\mathcal{T}(S)$ into the space $\mathcal{C}(S)$ of geodesic currents of S , sending each element $X \in \mathcal{T}(S)$ of the Teichmüller space to the associated Liouville current $L_X \in \mathcal{C}(S)$. The Liouville current satisfies two important properties:

$$i(L_X, \gamma) = \ell_X(\gamma) \quad \text{for every curve } \gamma, \text{ and} \tag{I}$$

$$i(L_X, L_X) = \pi^2 |\chi(S)|. \tag{II}$$

Here, $i : \mathcal{C}(S) \times \mathcal{C}(S) \rightarrow \mathbb{R}_+$ is the intersection form, a continuous bilinear map extending the usual geometric intersection number between curves. The space $\mathbb{P}_+\mathcal{C}(S)$ being compact each sequence $(X_n)_{n \in \mathbb{N}}$ in Teichmüller space admits a subsequence, say the whole sequence, which projectively converges to a non-zero current μ , meaning that there are positive real numbers ε_n such that $\lim_{n \rightarrow \infty} \varepsilon_n L_{X_n} = \mu$. The continuity of i and property (I) ensure that the length functions $\ell_{X_n}(\cdot)$ converge projectively to $i(\mu, \cdot)$. Moreover, ε_n tends to zero unless X_n converges in $\mathcal{T}(S)$. Knowing that $\varepsilon_n \xrightarrow{n \rightarrow \infty} 0$, property (II) ensures that $i(\mu, \mu) = 0$, meaning that μ is a measured lamination, as we needed to prove.

We stress that Bonahon's argument, with all its simplicity, only applies to closed surfaces. We will come back later to this specificity and to the obstructions to a direct extension of his argument. Recently, Bonahon and Šarić have given another proof of this theorem using geodesic currents. The arguments in [BŠ] are geared to infinite type surfaces and it is worth noticing that working in such a general context implies the loss of the simplicity of Bonahon's original proof.

Our goal here is to adapt Bonahon's original argument to be able to deal with non-compact surfaces of finite analytic type.

Let us look at the difficulties that prevent the extension of Bonahon's proof to the non-compact case. The intersection form, especially its continuity, is the key ingredient of Bonahon's original proof. However, continuity fails when the surface is not compact, even if it has finite area (see [Sas] or Example 2.6 below). We will therefore change our point of view to allow us to benefit from the continuity of i . We will consider currents on Σ instead of S , where Σ is a compact hyperbolic surface with geodesic boundary whose interior is homeomorphic to S , that is $S = \Sigma \setminus \partial\Sigma$. The second key ingredient of Bonahon's proof is the existence of the Liouville current but, as we will see, when working with currents on Σ , no Liouville current exists anymore.

Proposition 2.7. *Let Σ be a compact hyperbolic surface with non-empty boundary and X a hyperbolic structure on $S = \Sigma \setminus \partial\Sigma$. There is no current L_X on Σ which satisfies $i(L_X, \gamma) = \ell_X(\gamma)$ for every essential closed curve $\gamma \in \mathcal{C}(\Sigma)$.*

In order to recover a version of properties (I) and (II), we will, for every hyperbolic structure X on S , replace the Liouville current L_X by specific sequences of random geodesics $(\gamma_n^{(X)})_{n \in \mathbb{N}}$, that is sequences of essential closed geodesics whose associated probability measures in T^1X converge to the Liouville measure with respect to the weak* topology. They will be chosen to satisfy (I) and (II) asymptotically, that is:

$$\lim_{n \rightarrow \infty} i \left(\frac{\gamma_n}{\ell_X(\gamma_n)}, \gamma \right) = \frac{\ell_X(\gamma)}{\pi^2 |\chi(S)|} \quad \text{for all essential closed curve } \gamma, \quad (\text{III})$$

$$\lim_{n \rightarrow \infty} i \left(\frac{\gamma_n}{\ell_X(\gamma_n)}, \frac{\gamma_n}{\ell_X(\gamma_n)} \right) = \frac{1}{\pi^2 |\chi(S)|}. \quad (\text{IV})$$

As discussed in [ES3], any sequence of random geodesics $(\gamma_n)_{n \in \mathbb{N}}$ satisfies (III). Moreover, if the surface is compact then (IV) is ensured for every sequence of random geodesics. However, for a non-compact surface, arbitrary sequences of random geodesics do not necessarily satisfy (IV), see Example 2.12 below. Indeed, a large part of Chapter 2 will be devoted to the construction of sequences of random geodesics satisfying this property for non-compact surfaces.

Theorem. *For every complete and finite area hyperbolic structure X on a finite analytic type surface S of negative Euler characteristic $\chi(S)$, there is a sequence $(\gamma_N^{(X)})_{n \in \mathbb{N}}$ of random geodesics such that:*

$$\lim_{n \rightarrow \infty} i \left(\frac{\gamma_N^{(X)}}{\ell_X(\gamma_N^{(X)})}, \frac{\gamma_N^{(X)}}{\ell_X(\gamma_N^{(X)})} \right) = \frac{1}{\pi^2 |\chi(S)|}.$$

The Theorem above is actually part of a more technical result, Theorem 2.15. The main additional content of Theorem 2.15 is to ensure that the convergence rates in (III) and (IV) hold with no dependence on the structure X . This uniformity will be important to achieve the proof of Thurston's compactification. Moreover, the proof of the theorem also ensures that we can control the behavior of sequences of random geodesics into the cusp's neighborhoods.

Counting arcs on surfaces with boundary

The mapping class group $\text{Map}(\Sigma)$ of a connected oriented surface Σ with genus g and r boundary components acts on the set of weighted multicurves $\mathfrak{C}_m(\Sigma)$. The question of counting the elements in a given orbit has been studied by M. Mirzakhani for simple curves [Mir1] and later for general curves [Mir2]. She proved that for any complete finite area hyperbolic metric X on Σ , any weighted multicurve $\gamma_0 \in \mathfrak{C}_m(\Sigma)$ and any finite index subgroup Γ of $\text{Map}(\Sigma)$, there is a constant $\mathfrak{c}_{g,r}^\Gamma(\gamma_0)$ such that

$$\lim_{L \rightarrow \infty} \frac{\#\{\gamma \in \Gamma \cdot \gamma_0 \mid \ell_X(\gamma) \leq L\}}{L^{6g-6+2r}} = \mathfrak{c}_{g,r}^\Gamma(\gamma_0) \cdot \mathfrak{m}_{Thu}^\Sigma(\{\ell_X(\cdot) \leq 1\}),$$

where \mathbf{m}_{Thu}^Σ is the Thurston measure on the space $\mathcal{ML}(\Sigma)$ of measured geodesic laminations of Σ .

Erlandsson-Souto [ES3] have extended this theorem into a general version where the hyperbolic length function can be replaced by other notions of complexity for the curves of S . This applies for example to the length for any Riemannian metric on Σ or its interior [ES1], the intersection number with a filling curve or current [ES1][RS], the word length for a finite generating set [Erl], or the translation length in $\pi_1(\Sigma)$ when acting on a sufficiently nice metric space [EPS], to name a few.

Now, if Σ is a compact connected oriented surface with non-empty boundary, then one can consider the action of the mapping class group on the set $\mathcal{A}_m(\Sigma)$ of weighted multiarcs, where an arc is a free homotopy class of paths whose endpoints belong to the boundary of Σ . Note that arcs are not necessarily embedded. In this setting, Bell [Bel2] proved a result close to Mirzakhani's: if X is a complete hyperbolic metric with geodesic boundary on Σ then for every weighted multiarc α_0 there is a constant $\mathbf{c}_{g,r}^{\text{Map}}(\alpha_0)$ such that

$$\lim_{L \rightarrow \infty} \frac{\#\{\alpha \in \text{Map}(\Sigma) \cdot \alpha_0 \mid \ell_X(\gamma) \leq L\}}{L^{6g-6+2r}} = \mathbf{c}_{g,r}^{\text{Map}}(\alpha_0) \cdot \mathbf{m}_{Thu}^\Sigma(\{\ell_X(\cdot) \leq 1\}), \quad (\text{V})$$

where the length of an arc α is the length of the unique geodesic arc homotopic to α which is orthogonal to the geodesic boundary, and the length of a weighted multiarc is the weighted sum of the lengths of its components. The main goal of Chapter 3 is to obtain a general version of eq. (V) by proving a convergence result for a certain family of counting measures. Indeed, the Erlandsson-Souto generalization of Mirzakhani's results already relies on the convergence of certain measures on the space of geodesic currents. Here it is key that curves can be seen as currents. To see arcs as currents, we will work in the doubled surface $D\Sigma$ of Σ . Denoting by $\hat{\alpha}$ the curve in $D\Sigma$ corresponding to the doubling of an arc α of Σ , we are able to define for any weighted multiarc α_0 and for any finite index subgroup Γ of $\text{Map}(\Sigma)$ the Radon measures

$$\nu_{\alpha_0,L}^\Gamma = \frac{1}{L^{6g-6+2r}} \sum_{\alpha \in \Gamma \cdot \alpha_0} \delta_{\frac{1}{L}\hat{\alpha}} \quad (0.0.1)$$

on the space $\mathcal{C}(D\Sigma)$ of geodesic currents of $D\Sigma$. We prove that this family of measures converges when L tends to infinity. The following is our main theorem.

Theorem 3.13. *If Σ is a compact connected oriented surface of genus g with $r > 0$ boundary components and negative Euler characteristic which is not a pair of pants, then*

for every weighted multiarc $\alpha_0 \in \mathcal{A}_m(\Sigma)$, and every finite index subgroup Γ of $\text{Map}(\Sigma)$, there is $\mathbf{c}_{g,r}^\Gamma(\alpha_0) > 0$ such that

$$\lim_{L \rightarrow \infty} \nu_{\alpha_0, L}^\Gamma = \mathbf{c}_{g,r}^\Gamma(\alpha_0) \cdot \widehat{\mathbf{m}}_{Thu}^\Sigma.$$

Here $\widehat{\mathbf{m}}_{Thu}^\Sigma$ is a Radon measure on $\mathcal{C}(D\Sigma)$ and the convergence occurs with respect to the weak* topology on the set of Radon measures on $\mathcal{C}(D\Sigma)$.

Remark. In Theorem 3.13, the measure $\widehat{\mathbf{m}}_{Thu}^\Sigma$ is a specific measure on $\mathcal{C}(D\Sigma)$ obtained from the Thurston measure on the space $\mathcal{ML}(\Sigma)$ of measured laminations on Σ , see Section 2.2 for details.

We will get from Theorem 3.13 a rather general counting theorem for arcs. We will count arcs with bounded complexity where the complexity of an arc is given by functions on $\mathcal{A}_m(\Sigma)$. We will say that such a function F is a **measure of complexity for arcs** if there exist a continuous and homogeneous function \widehat{F} on $\mathcal{C}(D\Sigma)$, positive on $\mathcal{C}^\sigma(D\Sigma) \cap \{\mu(\partial\Sigma) = 0\}$, and a continuous and homogeneous function, also called F , on $\mathcal{C}(\Sigma)$ such that:

- $\forall \alpha \in \mathcal{A}_m(\Sigma), \quad \widehat{F}(\widehat{\alpha}) = 2F(\alpha),$
- $\forall \mu \in \mathcal{C}(\Sigma), \quad \widehat{F}(\widehat{\mu}) = 2F(\mu).$

Corollary 3.16. Let Σ and Γ be as in Theorem 3.13. For any weighted multiarc $\alpha_0 \in \mathcal{A}_m(\Sigma)$ and any measure of complexity for arcs F we have

$$\lim_{L \rightarrow \infty} \frac{\#\{\alpha \in \Gamma \cdot \alpha_0 \mid F(\alpha) \leq L\}}{L^{6g-6+2r}} = \mathbf{c}_{g,r}^\Gamma(\alpha_0) \cdot \widehat{\mathbf{m}}_{Thu}^\Sigma(\{F(\cdot) \leq 1\}).$$

For example, F can be the length function for any negatively curved Riemannian metric with geodesic boundary on Σ or the intersection number with a filling curve or current of Σ .

Perspectives

The different perspectives associated to this manuscript are mainly related to counting problems on surfaces. We develop in the last chapter the questions below and their answers for some special cases. We also raise some ideas for their resolution.

The results of Chapter 3 as well as Erlandsson-Souto's or Mirzakhani's results apply for both the mapping class group and its finite index subgroups. This remark raises a first natural question:

Question 1. *Let Z be a finite type surface and γ_0 a weighted multicurve of Z . For Γ a subgroup of $\text{Map}(Z)$ and F a measure of complexity for curves let us define*

$$\Delta_{\gamma_0}^{\Gamma}(L) = \{\gamma \in \Gamma \cdot \gamma_0 \mid F(\gamma) \leq L\}.$$

How does $\#\Delta_{\gamma_0}^{\Gamma}(L)$ grow when L goes to infinity? ■

We develop in Section 4.2 the answer to this question for Γ generated by a Dehn-twist or a pseudo-Anosov mapping class. We also explain how the results from Chapter 3 could be used to answer this question in a more general context.

Theorem 4.4, 4.7, 4.9. *Let Z be a finite type surface, F a measure of complexity for the curves of Z and $\gamma_0 \in \mathfrak{C}_m(Z)$ a weighted multicurve. If $\Phi \in \text{Map}(Z)$ is a pseudo-Anosov of $\text{Map}(Z)$ with stretch factor λ and α a simple curve such that $i(\gamma_0, \alpha) \neq 0$, then*

$$\lim_{L \rightarrow \infty} \frac{\#\{\gamma \in \langle \Phi \rangle \cdot \gamma_0 \mid F(\gamma) \leq L\}}{\log(L)} = \frac{2}{\log(\lambda)}, \quad (\text{VI})$$

$$\lim_{L \rightarrow \infty} \frac{\#\{\gamma \in \langle T_{\alpha} \rangle \cdot \gamma_0 \mid F(\gamma) \leq L\}}{L} = \frac{2}{i(\alpha, \gamma_0)F(\alpha)}. \quad (\text{VII})$$

As emphasized in Chapter 3, the study of counting measures plays a key role in the resolution of counting problems on surfaces. Hence, a natural problem associated to Question 1 is the study of the counting measures associated to $\Delta_{\gamma_0}^{\Gamma}(L)$.

Question 2. *Let Z be a finite type surface and γ_0 a weighted multicurve. For Γ a subgroup of $\text{Map}(Z)$ let us define*

$$m_{\gamma_0, L}^{\Gamma} := \sum_{\gamma \in \Gamma \cdot \gamma_0} \delta_{\frac{1}{L}\gamma} \quad \text{a Radon measure over } \mathcal{C}(Z).$$

Is there a function P_{Γ} such that $\frac{m_{\gamma_0, L}^{\Gamma}}{P_{\Gamma}(L)}$ converges to a non-zero measure when L goes to infinity? ■

In the same way as we will investigate Question 1 for cyclic subgroups generated by a pseudo-Anosov or a Dehn-twist we will identify P_Γ and the limit measure in these two special cases:

- If Γ is generated by a Dehn-twist along a curve α then $P_\Gamma(L) = L$ and the limit measure is a multiple of the Lebesgue measure on $\{t\alpha | t \geq 0\}$,
- If Γ is generated by a pseudo-Anosov then $P_\Gamma(L) = \log(L)$ and the limit is a Dirac mass at 0.

The fact that counting measures over full orbits of arcs or curves tend to a multiple of a Thurston measure traduces the fact that the given rescaled orbits accumulate on the set of measured laminations. So, Question 2 induces a new question.

Question 3. *On which subset of $\mathbb{P}_+\mathcal{ML}$ does the orbit of γ_0 under the action of Γ accumulate ?* ■

Finally the last question we raise in this manuscript is about the constant $\mathfrak{c}_{g,r}^\Gamma(\gamma_0)$ which appears in the different counting results. Indeed, the ratio of the number of elements of type γ_1 and γ_2 for two curves of different type is given by the ratio of $\mathfrak{c}(\gamma_1)$ and $\mathfrak{c}(\gamma_2)$.

Question 4. *Can $\mathfrak{c}_{g,r}^{\text{Map}}$ be expressed for any curve in a computable way? What do we learn from it about the asymptotic behavior of curves?* ■

Hyperbolic plane	\mathbb{H}^2	
Finite analytic type surface	S	p.45
Compact surface with boundary	Σ	p.45
Boundary of Σ	$\partial\Sigma$	
Double of Σ	$D\Sigma$	p.91
Doubling operator from Σ to $D\Sigma$	$\hat{\cdot}$	p.92
Natural involution of $D\Sigma$	σ	p.91
Finite type surface	Z	p.45
Genus of Z	$g(Z)$	p.45
Mapping class group of Z	$\text{Map}(Z)$	p.53
Fundamental group of Z	$\pi_1(Z)$	
Universal cover of Z	\tilde{Z}	
A lift of a geodesic γ in \tilde{Z}	$\tilde{\gamma}$	
Total lift of γ to \tilde{Z}	$\tilde{\tilde{\gamma}}$	
Euler characteristic of Z	$\chi(Z)$	p.46
Hyperbolic structure on Z	X	p.46
Volume of K with respect to the metric X	$\text{vol}_X(K)$	
Compact core of X bounded by the horocycles of length k	X^k	p.48
Complementary in X of X^k	\mathcal{B}^k	p.48
Teichmüller space of Z	$\mathcal{T}(Z)$	p.67
Set of weighted multicurves of Z	$\mathfrak{C}_m(Z)$	p.47
Length of the (multi)curve γ with respect to X	$\ell_X(\gamma)$	p.47
Compact length associated to X on a surface with cusps	$\bar{\ell}_X(\cdot)$	p.105
Set of weighted multiarcs of Σ	$\mathcal{A}_m(\Sigma)$	p.90
Set of integral weighted simple multicurves of Z	$\mathcal{ML}_{\mathbb{Z}}(Z)$	p.58
Set of measured laminations of Z	$\mathcal{ML}(Z)$	p.56
Set of projective measured laminations of Z	$\mathbb{P}_+\mathcal{ML}(Z)$	p.57

Set of (geodesic currents) of Σ	$\mathcal{C}(\Sigma)$	p.60
Set of internal currents of Σ	$\mathcal{C}_0(\Sigma)$	p.60
Set of internal currents of Σ with support projecting into K	$\mathcal{C}_K(\Sigma)$	p.60
Set of projective currents of Z	$\mathbb{P}_+\mathcal{C}(Z)$	p.60
Thurston measure on $\mathcal{ML}(Z)$ or $\mathcal{C}(Z)$	\mathfrak{m}_{Thu}^Z	p.58
Intersection form/number	$i(\cdot, \cdot)$	p.62
Peripheral self intersection number of γ	$i_{per}(\gamma, \gamma)$	p.52
Unit tangent bundle of X	T^1X	
Liouville measure associated to X	\mathcal{L}_X	p.69
Liouville current associated to X	L_X	p.69
Cardinal of the set A	$\#A$	



BACKGROUND

We begin by recalling the necessary definitions and properties of geometry of surfaces, and also introduce the notations we will follow throughout the document.

1.1 (Hyperbolic) Surfaces

1.1.1 Topological surfaces

In this manuscript we are interested in the study of orientable surfaces, where a **surface** is a connected 2-dimensionnal smooth manifold. We dispose of a classification of surfaces that will allow us to consider surfaces up to homeomorphism.

Theorem (Classification Theorem for compact surfaces). *Every compact connected orientable surface Σ is, up to homeomorphism, a connected sum of a sphere with $g(\Sigma) < \infty$ tori to which are removed $b(\Sigma) < \infty$ open disks with disjoint closure. The quantity g is called the **genus** of Σ and b is the number of boundary components.*

A **finite type** surface Z is a compact connected and orientable surface minus a finite number $r(Z)$ of points called **punctures**. We will no more specify it but all the surfaces we will work with are of finite type. We will also sometimes consider **finite analytic type** surfaces which are surfaces that can be seen as the interior of compact surfaces: they are finite type surfaces with $b = 0$. If also $r = 0$ then the surface is said to be **closed**. Regarding this elements, the Classification Theorem extends in the following way:

Theorem. *A finite type surface Z is, up to homeomorphism, uniquely determined by $g(Z)$, $b(Z)$ and $r(Z)$.*

In terms of notation, we will refer by S to finite analytic type surfaces and by Σ to compact surfaces with boundary. The notation Z refers to a general finite type surface.

More than surfaces we will be interested in surfaces which admit hyperbolic structures, for that considerations the **Euler characteristic** is a decisive object. Recall that the Euler

characteristic $\chi(Z)$ of a finite type surface Z is given by

$$\chi(Z) = 2 - 2g(Z) - (b(Z) + r(Z)). \quad (1.1.1)$$

Remark 1.1. *From now on we will only consider surfaces with either punctures or boundary components, we will denote by r the number of ends of the surface, be they boundary components or punctures.*

1.1.2 Hyperbolic structures on surfaces

For Z a finite type surface, a **hyperbolic structure** X on Z is, equivalently,

1. an atlas on Z with charts on \mathbb{H}^2 (or on $\mathbb{H}_+^2 = \{x + iy \in \mathbb{H}^2 \mid y \geq 0\}$ if Z has boundary) such that the transition maps are orientation preserving isometries of \mathbb{H}^2 (resp. \mathbb{H}_+^2) and the induced metric is complete,
2. a metric d on Z such that the metric space (Z, d) is complete and locally isometric to \mathbb{H}^2 (resp. \mathbb{H}_+^2),
3. a complete Riemannian structure ρ on Z with totally geodesic boundary and constant curvature -1 ,
4. an homeomorphism $h : Z \rightarrow \Gamma \backslash \mathcal{Z}$ where \mathcal{Z} is (a convex domain with geodesic boundary of) \mathbb{H}^2 and Γ a torsion free discrete subgroup of orientation preserving isometries of \mathcal{Z} with a free, properly discontinuous and finite covolume action on \mathcal{Z} .

The third point together with Gauss-Bonnet Theorem ensure that a finite type surface Z with Euler characteristic can admit hyperbolic structures. Regarding the third point, if we lift the hyperbolic structure to the universal cover \tilde{Z} then it is isometric to \mathcal{Z} and the subgroup Γ identifies with the fundamental group of the surface. Hence, the parabolic isometries in Γ generate the **cusps** in X around the punctures of Z . We will talk indistinctly of cusps or punctures now.

1.2 Curves on surfaces

1.2.1 Definitions

Definition 1.2. *Let Z be a finite type surface and γ an unoriented closed loop in Z . The loop γ is **essential** if it is non-nullhomotopic and homotopic neither to a puncture nor*

to a boundary component.

Such a loop can be seen as an element of $\pi_1(Z)$, a loop is primitive if it cannot be written as the power of another loop in $\pi_1(Z)$.

A **curve** in Z is a free homotopy class of essential closed and primitive loops in Z and $\mathfrak{C}(Z)$ is the set of all curves of Z . A **weighted multicurve** is a formal finite sum of distinct curves with positive weights and the set of all weighted multicurves is $\mathfrak{C}_m(Z)$.

If a hyperbolic structure X is fixed on Z then each curve $\gamma \in \mathfrak{C}(Z)$ admits a unique geodesic representative γ_* , hence, the set of curves can be seen as the set of essential primitive closed geodesic in X . This property allows to define the **length function** on curves.

Definition 1.3. For a hyperbolic structure X on Z and γ a curve, the **length** $\ell_X(\gamma)$ of γ with respect to X is the path length of γ_* . The length function extends naturally on $\mathfrak{C}_m(Z)$ by linearity.

Note that the length of a curve γ can also be seen as the shortest path length among the representatives of γ for the metric associated to X on Z .

1.2.2 Intersection number

Definition 1.4. For γ_1 and γ_2 two curves of a surface Z , the (geometric) **intersection number** between γ_1 and γ_2 is defined by

$$i(\gamma_1, \gamma_2) = \min_{\substack{\alpha_1 \in \gamma_1 \\ \alpha_2 \in \gamma_2}} |\alpha_1 \cap \alpha_2|$$

Where, if α and β are parametrized over $\mathbb{S}^1 = [0, 1] / \sim$ then

$$|\alpha_1 \cap \alpha_2| = \#\{(t, t') \in [0, 1]^2 \mid \alpha(t) = \beta(t')\}.$$

The definition extends to weighted multicurves by bilinearity.

For example, in Figure 1.1, $i(\gamma_1, \gamma_2) = 1$, $i(\gamma_1, \gamma_1) = 2$ and $i(\gamma_2, \gamma_2) = 0$.

Note that the intersection number is purely topological, meaning that it does not depend on the Riemannian structure on the surface, however, when such a structure is fixed, the minimum is reached by the geodesic representatives of the curves.

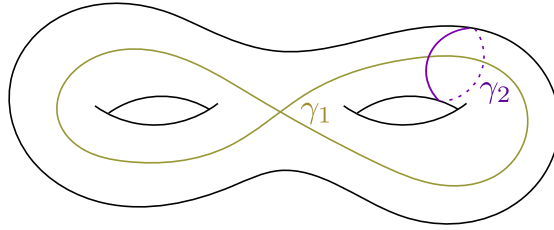

Figure 1.1 – Examples for intersection number

Remark 1.5. For the self intersection number (ie. the intersection number between a curve and itself) the following convention also exists:

$$\iota(\gamma, \gamma) = \min_{\alpha \in \gamma} \#\{\{t \neq t'\} \in [0, 1] \mid \alpha(t) = \alpha(t')\}.$$

The definition of $\iota(\cdot, \cdot)$ is a more natural way to define the self intersection of a curve but to fit with the extensions of the notion of intersection that will follow we will not use it, except for intermediate computations. Note that $i(\gamma, \gamma) = 2\iota(\gamma, \gamma)$.

Definition 1.6. A multicurve $\gamma \in \mathfrak{C}_m(Z)$ is **simple** if $i(\gamma, \gamma) = 0$.

A multicurve γ is **filling** if it has positive intersection number with every curve or, equivalently, if it cuts the surface into disks, punctured disks and annuli (where any annulus has a boundary which is a boundary component of the surface).

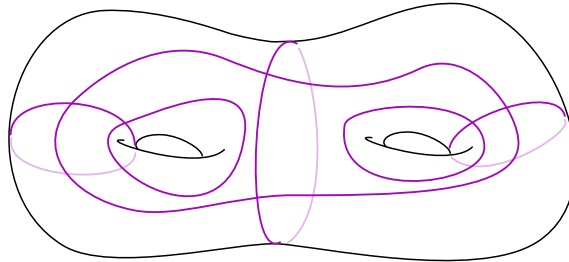

Figure 1.2 – A filling multi-curve

1.2.3 Self intersections, lengths and cusps

In non-compact surfaces the behaviour of the curves into cus neighborhoods is fixed. Hence, the length and the self intersection number are closely related.

We consider a finite analytic type surface S with $r(S) < \infty$ punctures. If X is a hyperbolic structure on S then we denote by H_k^i the embedded horosphere of length $1/k$

around the i -th cusp. The horosphere H_k^i bounds the horoball B_k^i of area $1/k$. We will refer to H_k^i and B_k^i as the horosphere and horoball of depth k , the horoballs will also be called **cuspidal neighborhoods**. We also set X^k the compact core of X bounded by the horospheres H_k^i and \mathcal{B}^k its complement:

$$X^k = X \setminus \bigcup_i B_k^i, \quad \mathcal{B}^k = \bigcup_i B_k^i.$$

There is a direct link between the number of times a curve turns around a cusp and the depth the associated geodesic reaches [BPT, Prop. 3.4]. It follows that every curve that goes deep into a cusp has a large self-intersection number. The next paragraphs aim to explore this link. More precisely, we compute the dependence between the length of a cuspidal excursion and its number of self-intersections

Definition 1.7. *Let X be a finite analytic type hyperbolic surface (with cusps). For γ a complete geodesic in X and C_i the i -th cusps, a **cuspidal excursion in the horoball at depth k** around C_i is a sub-arc I of γ included in B_k^i and with end points along H_k^i . The **depth reached by this excursion** is*

$$\inf\{k \geq 1 \mid I \cap B_k^i = \emptyset\}.$$

More clearly, the depth reached by a cuspidal excursion represents the smallest horosphere encountered by that excursion.

Remark 1.8. *Note that the computations in the paragraphs below correspond to the definition of intersection given in Remark 1.5.*

Self intersection in the horoball of depth 1

Let us focus on a given cusp C_∞ of X , identify \widetilde{X} with \mathbb{H}^2 such that $\{z \in \mathbb{C} \mid \Im(z) > 1\} = \mathbb{H}_{>1}$ identifies with the universal cover of the neighborhood $B_\infty^k = H$ of C_∞ meaning that if $T : z \mapsto z + 1$ then $B_\infty^k \cong T \setminus \mathbb{H}_{>k}$.

If I is an excursion between depth 1 and R around C_∞ , then it can be lifted to an arc based on $\mathbb{H}_{=1}$, noted J , coming from a circle centered in 0 and of (euclidean) radius $R > 1$. Denote by $a(J)$ and $b(J)$ the roots of the lifted segments J . By the way, the self intersection number $\iota(I, I)$ of I in H is the number of lifts of I in $\mathbb{H}_{>1}$ which intersect J . See fig. 1.3 for precisions.

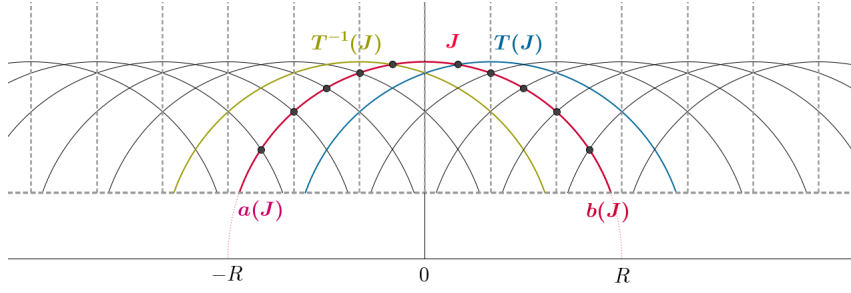

Figure 1.3 – Computation of the intersection number of a cusp excursion

The lifts of I in $\mathbb{H}_{>1}$ are the $T^n(J)$ for $n \in \mathbb{Z}^*$. If we note $D = d_E(a(J), b(J))$ the Euclidean distance between $a(J)$ and $b(J)$, then for n an integer, $T^n(J)$ intersects J if and only if $|n| < D$. Since $2R - 2 \leq D \leq 2R$ and $\iota(\gamma, \gamma) = \#\{n \in \mathbb{Z}^* \mid |n| < D\}$,

$$4R - 4 \leq \iota(\gamma, \gamma) \leq 4R.$$

Since J joins the horospheres of depth 1 and R its length is at least twice the length of the shortest path δ between these two horospheres: δ is the segment $[i, iR]$ in \mathbb{H} and its length is $\log(R)$.

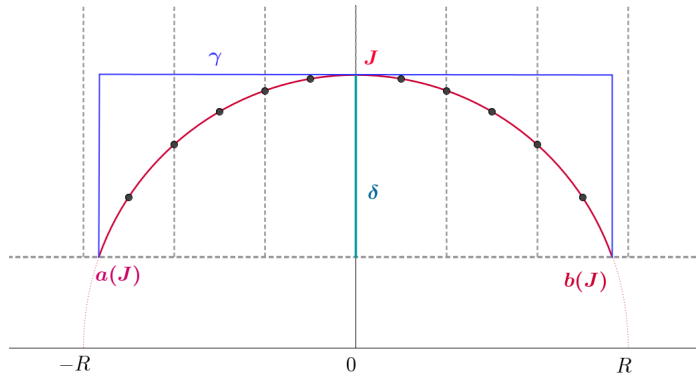

Figure 1.4 – Computation of the length of a cusp excursion

Moreover, J is a geodesic path between $a(J)$ and $b(J)$ so its length is at most the length of the path γ where γ goes from $a(J)$ to the horosphere of depth R , follows the horosphere until the abscissae of $b(J)$ and joins $b(J)$ by a straight line. The length of such a path is at most $2\log(R) + 2$. As a consequence: $2\log(R) \leq \ell_{\mathbb{H}}(J) = \ell_X(I) \leq 2\log(R) + 2$.

It follows that $e^{\ell_X(I)/2-1} \leq R \leq e^{\ell_X(I)/2}$ and thus

$$\frac{4}{e}e^{\ell_X(I)/2} - 4 \leq \iota(I, I) \leq 4e^{\ell_X(I)/2}.$$

Self intersection in the horoball of depth k

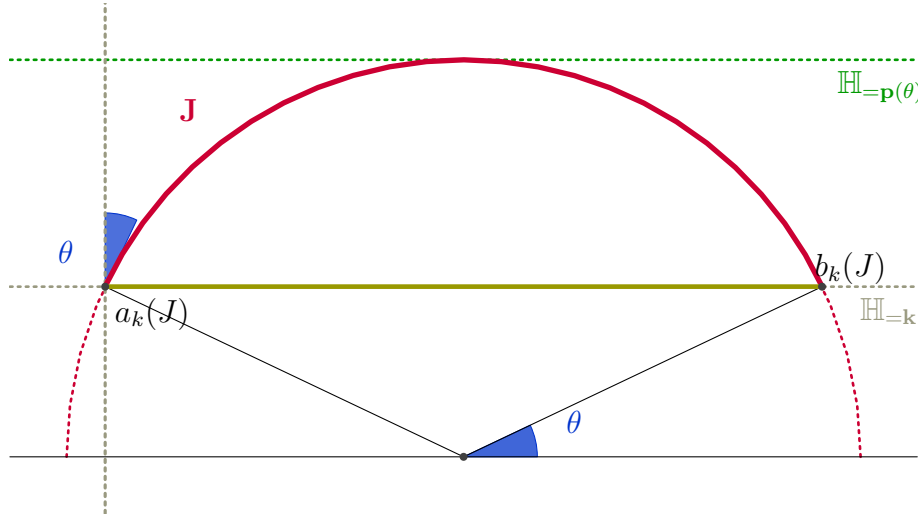

Figure 1.5 – Computation of the intersection number into the cusps

Now study a geodesic excursion I which enters the horoball of depth k with angle θ . Consider some lift J of I , θ is the angle between J and the vertical line at $a_k(J)$ (notation constant with the previous ones), this angle is between 0 and $\pi/2$. We will denote by $p(\theta)$ the depth reached by J (equivalently by I).

The arc J admits $C : t \in [\theta, \pi - \theta] \mapsto p(\theta)e^{it}$ as a parametrization, let us compute the length of the excursion:

$$\begin{aligned} \ell_{\mathbb{H}}(J) &= \int_{\theta}^{\pi-\theta} \frac{|C'(t)|}{\Im(C(t))} dt \\ &= \int_{\theta}^{\pi-\theta} \frac{p(\theta)}{p(\theta) \sin(t)} dt \\ &= \ln \left(\frac{|\tan(\frac{\pi-\theta}{2})|}{|\tan(\frac{\theta}{2})|} \right) \\ &= \ln \left(\frac{1}{\tan^2(\frac{\theta}{2})} \right) \\ &= 2 \ln \left(\frac{1}{\sin(\theta)} + \cotan(\theta) \right). \end{aligned}$$

Considering that $k = p(\theta) \sin(\theta)$ we obtain

$$\ell_S(I) = 2 \ln \left(\frac{1}{\sin(\theta)} + \cotan(\theta) \right) \text{ and } e^{\ell_X(I)/2} = \frac{p(\theta)}{k} + \cotan(\theta).$$

Using the same reasoning as in the previous case, we obtain

$$2d_E(a_k(J), b_k(J)) - 2 \leq \iota(I, I) \leq 2d_E(a_k(J), b_k(J))$$

and it is clear that the Euclidean distance $d_E(a_k(J), b_k(J))$ between $a_k(J)$ and $b_k(J)$ is $2 \cos(\theta)p(\theta) = 2k \cotan(\theta)$ so

$$4k \left(e^{\ell_X(I)/2} - \frac{p(\theta)}{k} \right) - 2 \leq \iota(I, I) \leq 4k \left(e^{\ell_X(I)/2} - \frac{p(\theta)}{k} \right).$$

Now, if θ is small then $\sin(\theta) \sim \theta$ and so $\ell_X(I) \sim 2 \ln(\frac{2}{\theta})$, $\iota(I, I) \sim 4\frac{k}{\theta} \sim 4p(\theta)$.

Peripheral self-intersection number

A natural tool to explicit the behaviour of cusps excursions is introduced in [ES3, Def. 2.6]: the **peripheral self-intersection number**. The peripheral self-intersection number $i_{per}(\gamma, \gamma)$ of a geodesic γ tells us how much each excursion of the curve into a cusp intersects itself. That notion also allows to focus on curves turning around boundary components for compact surfaces.

Definition 1.9. *Let X be a hyperbolic surface (compact or not) and recall that a peripheral subgroup of $\pi_1(X)$ is nothing other than a cyclic subgroup generated by a non-essential closed curve. The **peripheral self-intersection number** $i_{per}(\gamma, \gamma)$ of a geodesic γ is the supremum over all maximal peripheral subgroups $G \subset \pi_1(X)$ of the maximal number of times that the image of a lift $\tilde{\gamma}$ of γ under $\tilde{X} \rightarrow G \backslash \tilde{X}$ meets itself transversely. The definition extends to multicurves by taking the maximum over the components.*

An important point regarding the peripheral self-intersection number is that it is a topological invariant, in particular, for a given topological surface, the peripheral intersection number of a curve does not depend on the hyperbolic structure. Also, if γ is a closed curve in a compact surface Σ then its peripheral self-intersection number is the same in Σ and $\overset{\circ}{\Sigma}$.

For non-compact finite analytic type surfaces it follows from the previous sections that the peripheral self-intersection number is linked to the depth reached by the excursions of the geodesic we are interested in.

Lemma 1.10. *Let X be a non-compact finite type hyperbolic surface with no boundary, and γ a geodesic in X . For all $k \geq 1$, the cusp excursions of γ are of depth at most k if and only if $i_{per}(\gamma, \gamma) \leq 4k$.*

This lemma is a direct consequence of the computations above but an independant proof for the case of curves is given in the next chapter where this lemma appears as Lemma 2.9.

If we consider now only closed geodesics then Theorem 1.10 can be generalized as follow.

Proposition 1.11. *([ES3, Lemma 2.8]) Let X be a finite type hyperbolic surface, for every $N \geq 0$ there is a compact subsurface K_N of X which contains all the closed geodesics with peripheral self-intersection number less than N .*

Remark 1.12. *It is clear that the peripheral self-intersection number of a geodesic γ is bounded by its self-intersection number $\iota(\gamma, \gamma)$, hence, all the geodesics with less than N self intersections are included in K_N .*

1.3 Mapping class groups

1.3.1 Definitions

In a finite type orientable surface of negative Euler characteristic Z homotopy and isotopy (with respect to the boundary) between homeomorphisms correspond. Moreover, every homeomorphism is isotopic to a diffeomorphism. So, we will talk indifferently of homotopy and isotopy or homeomorphism and diffeomorphism. Hence, the **mapping class group** of a finite analytic type orientable surface S is defined by

$$\begin{aligned} \text{Map}(S) &= \text{Homeo}^+(S) / \text{Homeo}_0(S) \\ &= \text{Homeo}(S) / \text{homotopy} \\ &= \text{Diffeo}^+(S) / \text{Diffeo}_0(S) \\ &= \text{Diffeo}(S) / \text{isotopy}. \end{aligned}$$

If we consider now Σ a surface with boundary then its mapping class group is defined as the mapping class group of its interior $\overset{\circ}{\Sigma}$. For surfaces with boundary or punctures one can ask the boundary components or punctures to be fixed, passing from a definition to another is equivalent to taking a finite index subgroup.

Since curves are defined up to free homotopy the mapping class group naturally acts on the set of curves, a part of this manuscript is dedicated to counting problems in the orbits of this action.

Definition 1.13. *Two (weighted multi)curves are said to be **of the same type** if they are in the same orbit for $\text{Map} \curvearrowright \mathfrak{C}_m$.*

To study elements of the same type we will regularly use the stability of the intersection number through this action.

Proposition 1.14. *For all $\gamma_1, \gamma_2 \in \mathfrak{C}_m(Z)$ and $\Phi \in \text{Map}(Z)$*

$$i(\gamma_1, \gamma_2) = i(\Phi \cdot \gamma_1, \Phi \cdot \gamma_2).$$

1.3.2 Classification of mapping classes

Mapping classes are classified into three non-exclusive categories. This classification is known as the Nielsen-Thurston classification.

The first type of elements are the **periodic elements**. They are the one with finite order in $\text{Map}(Z)$. One can think of the hyperelliptic involution or "rotations".

The second kind of elements are the **reducible mapping classes**, some mapping classes can be both periodic and reducible. A mapping class is said to be reducible if it fixes a simple multicurve. Hence, the main example of reducible mapping classes are the Dehn twists along simple multicurves, we give more details about that maps in the next subsection.

Mapping classes which are neither periodic nor reducible are called **pseudo-Anosov**.

1.3.3 Dehn-twists

An important class of reducible mapping classes are the **Dehn-twists**. Given a simple curve α the Dehn-twist along γ consists in cutting an annuli around α , twisting this annuli and gluing back its boundary. See fig. 1.6.

Theorem 1.15. *The mapping class group is generated by finitely many Dehn-twists.*

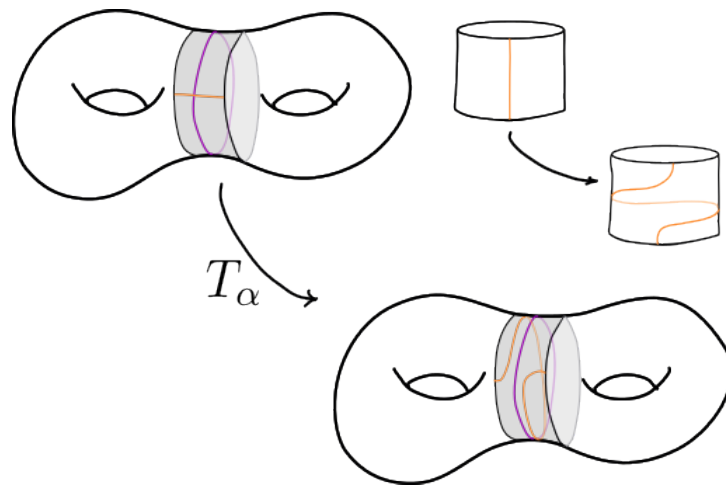

Figure 1.6 – Dehn-twist along α

1.4 Measured laminations

Heuristic

The space of measured lamination is a completion of the set of weighted simple multicurves

1.4.1 From laminations to measured laminations

Definition 1.16. A (geodesic) **lamination** Λ on a finite type hyperbolic surface X is a compact subset of the interior of X foliated by disjoint simple complete geodesics.

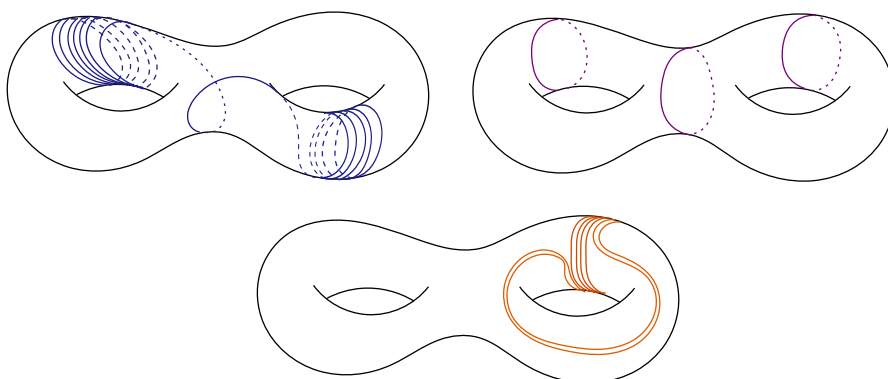

Figure 1.7 – Examples of laminations

Remark 1.17. *The fact that laminations are included in a compact of the interior of X avoids laminations to spiral around boundary components or to contain boundary leaves in compact surfaces and to go from cusps to cusps in the non-compact case.*

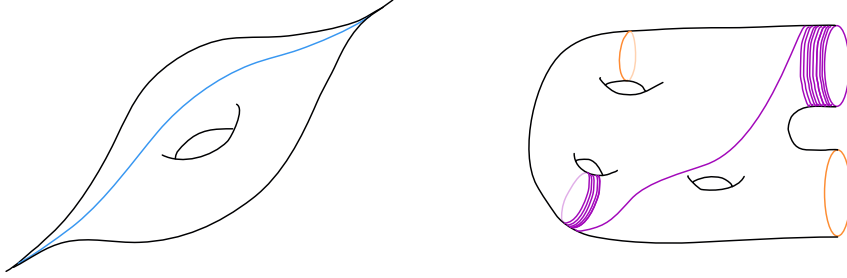

Figure 1.8 – Non-example of laminations

Proposition 1.18. *There is a fixed compact K of the interior of X such that the support of every lamination is included in K .*

Proof. This result is a direct consequence of the results for the peripheral self-intersection number of geodesics page 53 □

The foliation of a lamination by geodesics is unique and the geodesics of the foliation are the **leaves** of the lamination. The leaves can be either closed geodesics or bi-infinite ones. Simple-multicurves are example of laminations with only closed leaves (second example in fig. 1.7). By taking infinite geodesics that accumulate along closed geodesics, we can build laminations with both infinite and closed leaves (first example in fig. 1.7). There also exists laminations with infinitely many bi-infinite geodesics, see [Bon3] for an example of construction.

Definition 1.19. *A **measured lamination** is a lamination Λ endowed with a family of positive Radon measures $\{\lambda_\tau | \tau \text{ smooth arc transverse to the leaves of } \Lambda\}$ which satisfy the following properties:*

- if τ' is a subarc of τ then $\lambda_{\tau'} = \lambda_\tau|_{\tau'}$,
- if $\tau = h_1$ is homotopic to $\tau' = h_0$ through transverse arcs and following the leaves of the lamination then $\lambda_{\tau'} = (h_1)_*(\lambda_\tau)$.

The λ_τ are called **transverse measures** and they are supported by $\tau \cap \Lambda$.

Passing through the universal cover one can see that the set of measured lamination is independant from the hyperbolic structure when a topological surface is fixed. Hence, if

Z is a finite type surface we can talk about $\mathcal{ML}(Z)$ the **set of measured laminations of Z** .

Requiring transverse measures to be Radon measures means that the closed leaves of a measured lamination must be isolated. It implies that all laminations can not be endowed with transverse measures to be seen as measured laminations: typically, lamination with leaves accumulating on closed geodesics cannot be measured. An important example of measured laminations are the weighted simple multicurves which corresponding laminations are the simple multicurves: the measure of an arc is the number of intersections with the leaves counted with weights.

The set of measured laminations is in fact a topological space in which the weighted simple multicurves are dense, as a consequence, the notion of intersection extends to measured laminations.

Theorem 1.20. *If Z is a finite type surface the set of weighted simple multicurves is dense in $\mathcal{ML}(Z)$ and the intersection number extends to a continuous bilinear function*

$$i : \mathcal{ML}(Z) \times \mathcal{ML}(Z) \rightarrow \mathbb{R}_{\geq 0}.$$

A filling curve is a curve which fills the surface meaning that it meets every other curves, in fact, it is enough to meet every simple curves. Hence, we can define an analog of filling curves for measured laminations. An **ending measured lamination** is a measured lamination which has positive intersection with every simple curve. Equivalently, it means that the complementary regions of the interior of Σ are ideal, maybe once punctured, polygons.

Remark 1.21. *Since laminations are supported in the interior of the surface, the space of measured laminations of a finite topological type surface with r cusps is the same as the one of a compact surface with same genus and r boundary components. Moreover, we have defined the mapping class group of a surface with boundary as the one of its interior, so we can restrict ourselves to the compact setting.*

Proposition 1.22. *Let Σ be a compact surface of genus g with r boundary components, $\mathcal{ML}(\Sigma)$ is a piecewise linear space of dimension $6g - 6 + 2r$ and $\mathbb{P}_+ \mathcal{ML}(\Sigma) = \mathcal{ML}(\Sigma) / \mathbb{R}_{>0}$ is a sphere of dimension $6g - 7 + 2r$.*

1.4.2 Action of the mapping class group

The mapping class group naturally acts on measured laminations and this action will play a key role in Chapters 3 and 4.

The Thurston measure

The action of $\text{Map}(\Sigma)$ on $\mathcal{ML}(\Sigma)$ induces dynamical questions, the first of all being to identify the stable and ergodic measures for this action. Here, we are interested in a natural invariant measure on $\mathcal{ML}(\Sigma)$: the **Thurston measure**. If we consider the set of measured laminations endowed with its piecewise linear structure then the Thurston measure corresponds to the Lebesgue measure. This measure is known to be ergodic from works of Masur [Mas] but is defined up to a constant. Let us fix a normalization [MT2; Ara]. In the same way as the Lebesgue measure can be approximated by rescaling counting measures on the integers we fix the renormalization of the Thurston measure such that it can be seen as the limit of rescaled counting measures on the "integer points" of $\mathcal{ML}(\Sigma)$.

Proposition 1.23. *Denote by $\mathcal{ML}_{\mathbb{Z}}(\Sigma)$ the set of **integral weighted simple multicurves**, the Thurston measure on $\mathcal{ML}(\Sigma)$ is given by*

$$\mathbf{m}_{Thu}^{\Sigma} := \lim_{L \rightarrow \infty} \frac{1}{L^{6g-6+2r}} \sum_{\gamma \in \mathcal{ML}_{\mathbb{Z}}(\Sigma)} \delta_{\frac{1}{L}\gamma},$$

The locally finite $\text{Map}(\Sigma)$ -invariant measures on $\mathcal{ML}(\Sigma)$ have been totally classified independently by Lindenstrauss-Mirzakhani [LM] and Hamenstädt [Ham]. It appears that the Thurston measure is special among the ergodic measures since it is the only one which only gives weight to the ending measured laminations. A direct consequence of [LM, Theorem 7.1] is the following characterization.

Theorem (Lindenstrauss-Mirzakhani). *Let μ be a locally finite $\text{Map}(\Sigma)$ -invariant measure on $\mathcal{ML}(\Sigma)$. If for all simple closed curve γ of Σ*

$$\mu(\{\lambda \in \mathcal{ML}(\Sigma) | i(\lambda, \gamma) = 0\}) = 0, \tag{1.4.1}$$

then μ is a multiple of the Thurston measure $\mathbf{m}_{Thu}^{\Sigma}$.

Pseudo-Anosov elements

Measured laminations also play a key role in the study of pseudo-anosov mapping classes.

Theorem 1.24. *If Φ is a pseudo-Anosov then there exist two (up to normalization) measured laminations Λ^a, Λ^r and a **stretch factor** $\lambda > 1$ such that $\Phi \cdot \Lambda^a = \lambda \Lambda^a$ and $\Phi \cdot \Lambda^r = \frac{1}{\lambda} \Lambda^r$.*

The measured laminations Λ^a and Λ^r are the **attracting and repelling measured laminations** of the pseudo-Anosov, they are both ending measured laminations.

Remark 1.25. *Note that the attracting and repelling measured laminations are defined up to a multiplicative factor.*

Theorem 1.26. *If Φ is a pseudo-Anosov mapping class of a finite analytic type surface S then Φ acts on $\mathbb{P}_+ \mathcal{ML}(S)$ with a north-south dynamic with attractive point the class of Λ^a and repelling point the class of Λ^r .*

1.5 Geodesic currents

Geodesic currents are the common thread of this thesis. They allow to put under the same umbrella simple curves, non-simple curves, measured laminations and other geometric objects. They will be one of our main tool in this manuscript. For more information on currents we refer to [Bon1], [Bon2], [AL] and, [ES3, Chap. 3]

Heuristic

The space of geodesic currents is a completion of the set of weighted multicurves

1.5.1 Definition

There exist different equivalent definitions of geodesic currents, in this document we will mainly use the following one and focus on compact surfaces. In that section, Σ is a compact surface (with maybe no-boundary).

Definition 1.27. Let Σ be a compact finite type surface and $\tilde{\Sigma}$ its universal cover. A **geodesic currents** is a $\pi_1(\Sigma)$ -invariant Radon measure on the set of bi-infinite and unoriented geodesics of $\tilde{\Sigma}$. The set of all geodesic currents is denoted by $\mathcal{C}(\Sigma)$.

Remark 1.28. Since the definition involves geodesics it needs an underlying hyperbolic structure on Σ . However, if we have two distinct metrics on Σ then there is a π_1 -equivariant bijective correspondence between the associated sets of geodesics in the universal cover, hence, the definition of the set of geodesic currents is independant of the chosen hyperbolic structure.

We give now an equivalent definition which will be useful to build the so called Liouville currents in Chapter 2.

Proposition 1.29. [ES3, Exercise 3.1][Bon2] The set of geodesic currents is in bijection with the set of flip and (geodesic-)flow invariant Radon measures on $T_\infty^1 \Sigma$. Where $T_\infty^1 \Sigma$ is the subset of the unit tangent bundle of Σ made of vector tangent to bi-infinite geodesics of Σ .

The set of geodesic currents is a set of Radon measures so we endow it with the weak* topology. It is then Hausdorff, metrizable, second countable and has the Heine-Borel property. It is also locally compact and, in particular, the space $\mathbb{P}_+ \mathcal{C}(\Sigma) = \mathcal{C}(\Sigma) - \{0\} / \mathbb{R}_{>0}$ is a compact space. One can also define geodesic currents for cusped surfaces but some of the above properties are then lost, in particular the local compactity. The last part of this chapter is dedicated to this case.

We will at some point be interested in some specific subsets of $\mathcal{C}(\Sigma)$. The set $\mathcal{C}_0(\Sigma)$ of **internal currents** which is the set of currents which give no weight to the boundary components of Σ , and for K a compact of $\tilde{\Sigma}$, the set $\mathcal{C}_K(\Sigma)$ of currents whose supports project into K . Note that for all compact K the space $\mathcal{C}_K(\Sigma)$ is locally compact and $\mathbb{P}_+ \mathcal{C}_K(\Sigma)$ is compact.

1.5.2 Curves and measured laminations as currents

The introduction of the notion of geodesic currents has been motivated by the study of non-simple multicurves on surfaces: we want to see the set of geodesic currents as a completion of the set of weighted multicurves.

Curves as geodesic currents

A curve γ of Σ lifts to $\tilde{\Sigma}$ into a π_1 invariant discrete subset $\tilde{\gamma}$ of the set of bi-infinite unoriented geodesics of $\tilde{\Sigma}$. Hence, the counting measure on $\tilde{\gamma}$ is a geodesic current. We will also denote by γ the geodesic current associated to the curve.

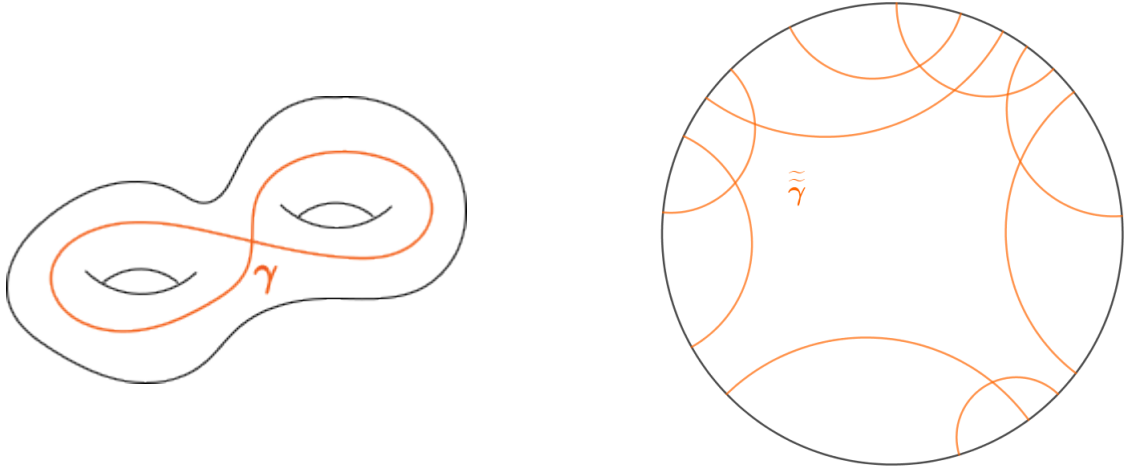

Figure 1.9 – Total lift of a curve to the universal cover

Theorem 1.30. *If Σ is a compact finite type surface then $\mathfrak{C}_m(\Sigma)$ is a dense subset of $\mathcal{C}(\Sigma)$.*

Measured laminations

Since measured laminations are a completion of the set of simple weighted multicurves, it is natural to want them to be geodesic currents.

Consider Σ a compact finite type surface and fix, temporarily, a hyperbolic metric on it. To see measured laminations as geodesic currents we have to understand the topology of the set of bi-infinite unoriented geodesics of the universal cover: indeed, to define a Radon measure is enough to define the measure of a basis of open sets. A geodesic is uniquely determined by its end points, hence, the set of unoriented bi-infinite geodesics is in bijection with $\partial_\infty \tilde{\Sigma} \times \partial_\infty \tilde{\Sigma} - \Delta / (a, b) \sim (b, a)$.

The universal cover of Σ identify with (a convex domain of) \mathbb{H}^2 and then $\partial_\infty \tilde{\Sigma}$ with (a subset of) \mathbb{S}^1 . Hence, an open basis for the infinite geodesics of $\tilde{\Sigma}$ is given by the set of geodesics with one endpoint in $I \cap \partial_\infty \tilde{\Sigma}$ and another one in $J \cap \partial_\infty \tilde{\Sigma}$ where I and J are two non-overlapping open intervals of \mathbb{S}^1 .

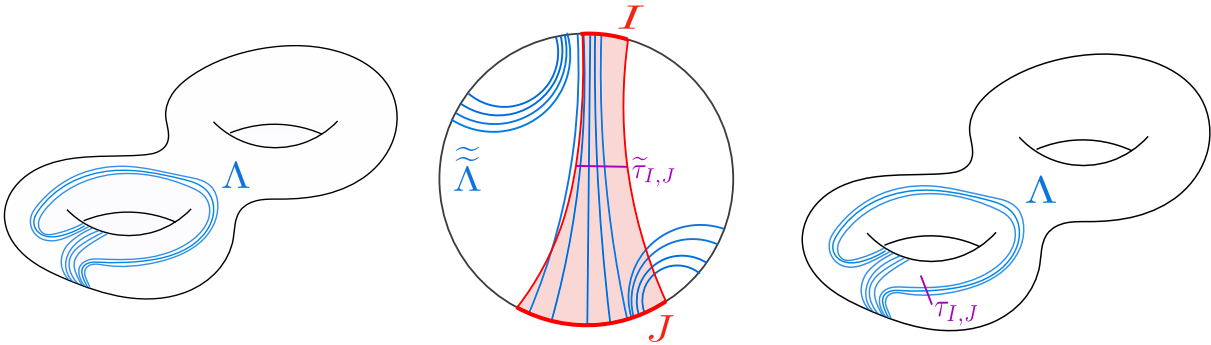

Figure 1.10 – Build a current from a measured lamination

Fixe a measured lamination Λ , it lifts to a π_1 invariant set of geodesics of the universal cover. Given an open set of geodesics $U_{I,J}$ determined by the intervals I and J there exists an arc $\tilde{\tau}_{I,J}$ in the universal cover that crosses all the geodesics of the open sets and no lifts of leaves of Λ which are not part of this open set. This arc descends to a transverse arc $\tau_{I,J}$ by projection to the surface. To see Λ as a gedsic currents we take $\Lambda(U_{I,J}) = \lambda_{\tau_{I,J}}(\tau_{I,J})$, this is well defined by properties of the transverse measures and π_1 -invariant by definition of the covering map.

Remark 1.31. *It follows from Theorem 1.18 that measured laminations are internal currents, in particular there is a compact K such that $\mathcal{ML}(\Sigma) \subset \mathcal{C}_K(\Sigma)$.*

1.5.3 Intersection form for geodesic currents

In the same way as the intersection number extends from simple multicurves to measured laminations we expect it to extend to geodesic currents.

Theorem 1.32. *If Σ is a compact finite type surface then the intersection number between curves extends to a countinuous and bilinear form called the **intersection form**:*

$$i : \mathcal{C}(\Sigma) \times \mathcal{C}(\Sigma) \rightarrow \mathbb{R}_{\geq 0}.$$

The mapping class group, which acts on curves and measured laminations, also acts on geodesic currents and preserves the intersection form.

We saw in the last section that measured laminations have zero self intersection. In fact, they are characterized by this property.

Property 1.33. $\mathcal{ML}(\Sigma) = \{\mu \in \mathcal{C}_0(\Sigma) | i(\mu, \mu) = 0\}$.

Measured laminations are exactly the geodesic currents which have no self-intersection and which give no weight to the boundary. Since measured laminations will play a special role in the following chapters this characterization will be a key element later on.

If Σ has some boundary components then the currents supported by the boundary can also be characterised in terms of intersection number.

Property 1.34. *Let μ be a geodesic current of a compact finite type surface Σ , the support of μ project into $\partial\Sigma$ if and only if $i(\mu, \nu) = 0$ for every geodesic current ν .*

1.5.4 Measures of complexity

In the part of this thesis which is dedicated to counting problems we will be interested in measuring the complexity of curves.

Definition 1.35. *A function $F : \mathfrak{C}_m(\Sigma) \rightarrow \mathbb{R}_{\geq 0}$ is a **measure of complexity** (for curves) if it admits a positive, continuous and homogeneous extension on $\mathfrak{C}_K(\Sigma)$ for every compact subset K of the interior of Σ .*

Theorem 1.36. *([ES3, Corollary 3.8]) For any two measures of complexity F_1 and F_2 and any compact K there is a constant $C_K \geq 1$ such that*

$$\frac{1}{C_K} F_1(\cdot) \leq F_2(\cdot) \leq C_K F_1(\cdot)$$

on $\mathfrak{C}_K(\Sigma)$.

One can refer to [MT1] for some criterion ensuring the extension of a functional on curves to continuous and homogeneous function on currents.

Length functions

Theorem 1.37. *([Bon2]) Let Σ be a compact finite type surface and X be a hyperbolic structure with geodesic boundary on Σ , the length function $\ell_X : \mathfrak{C}_m(\Sigma) \rightarrow \mathbb{R}_{\geq 0}$ for curves extends to a positive, linear and continuous function on geodesic currents.*

In particular, the length is a measure of complexity for curves. The hyperbolic length is not the only notion of length which extends to currents, here is a list of some other examples:

- The geodesic length for a hyperbolic metric [Bon1], for a negatively curved metric [Ota], for a non-positively curved metric [CFF], or for a non-positively curved Euclidean coned metric [BL], for example
- The word length in the fundamental group [Erl]
- The stable length [EPS]
- The extremal length [MT1]

Filling currents

Some of the functions mentioned above, especially the length functions for Riemannian structures, can be written as the intersection with a specific current.

Definition 1.38. *A **filling current** is a current whose intersection number with every internal current is positive.*

Theorem 1.39. *The intersection number with a filling current is a measure of complexity for curves.*

The notion of filling currents allow to recover some of the examples of measure of complexity mentioned above but also allow to introduce some new ones. In particular, filling curves are filling currents and as a consequence the intersection number with a filling curve is a measure of complexity for curves. Note that ending laminations are not filling currents (it is why we use the word ending and not filling to characterize them).

1.5.5 Geodesic currents in non-compact surfaces

Most of this manuscript focus on currents for compact surfaces. However, an alternative proof of the main result of Chapter 2 and some results of Chapter 3 require currents on non-compact surfaces so we introduce here the basic notions needed. One can refer to [Bur+2] for more informations about currents on cusped surfaces.

Consider a finite analytic surface S and define the set of geodesic currents on S in the same way as for compact surfaces. The reason why we do not work within this framework is that $\mathcal{C}(S)$ is no longer locally compact and the intersection is no longer continuous.

As exposed in section 1.2.3, curves behave in a particular way into the cusps, this feature prevents the intersection from extending continuously to geodesic currents in cusped surfaces.

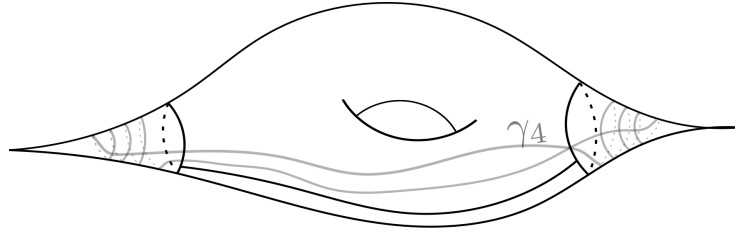

Figure 1.11 – Obstruction to the continuity of i

Example 1.40 (Discontinuity of the intersection form in the non-compact case). *Take a hyperbolic surface with at least two cusps, fix an embedded horocycle around each of them, and a simple geodesic arc between those curves which meets them orthogonally. Note that this arc is part of a cusps-to-cusps geodesic arc γ . Consider a sequence of closed curves $(\gamma_n)_{n \in \mathbb{N}}$, where γ_n is the geodesic homotopic to the closed curve which runs the geodesic arc mentioned above, turns n times around the first cusp following the fixed horocycle, goes back along the geodesic arc and turns n times around the second cusp as in fig. 2.1. The self-intersection number of such a sequence tends to infinity when n goes to infinity. On the other hand, it approaches the current 2γ which has 0 self-intersection number (the current associated to a cusp-to-cusp geodesic is defined in the same way as the one for a closed geodesic).*

See [Sas, Prop. 5.1] for a more detailed discussion on that obstruction to a continuous extension of the intersection number on the space of currents for non-compact surfaces. That paper also treat the problem of the non-denseness of curves in the space of currents in the non-compact case.

Even if we lost a lot of properties when considering currents on non-closed surfaces one can focus on compactly supported currents to recover them.

Theorem 1.41. ([Bur+2, Prop 2.6]) *Let S be finite analytic type surface and K a compact of its interior. The space $\mathcal{C}_K(S)$ is locally compact and $\mathbb{P}_+\mathcal{C}_K(S)$ is compact. Moreover, the intersection form $i : \mathcal{C}(S) \times \mathcal{C}_K(S) \rightarrow \mathbb{R}_{\geq 0}$ is bilinear and continuous.*

In the last section of Chapter 2, we will see how the results of this chapter can be proved in a non-compact surface using the previous theorem.



THURSTON

COMPACTIFICATION VIA

GEODESIC CURRENTS

Sections 2, 3 and 4 of this chapter are extracted from [Tri1]

In 1988, Bonahon gave a construction of Thurston compactification of Teichmüller space using geodesic currents. His argument only applies in the case of closed surfaces, and there are good reasons for that. In this chapter, we present a variant which applies to surfaces of finite area and to do so we prove a control theorem for sequences of random geodesics. Note that this theorem may be of independent interest, especially when the surface is non-compact.

2.1 Teichmüller space

2.1.1 Definition

Given a finite analytic type surface S its Teichmüller space is the set of all marked hyperbolic structures on S up to isotopy, or equivalently of hyperbolic metrics on S up to orientation preserving isometries homotopic to identity or, equivalently, up to the action by push-forward of $\text{Diffeo}_0(S)$. In the following we will denote by X the hyperbolic structures on surfaces as well as the associated Teichmüller class.

Definition 2.1. *The **Teichmüller space** of a finite analytic type surface S of negative Euler characteristic is defined by*

$$\begin{aligned} \mathcal{T}(S) &= \{(Y, \phi) \text{ marked hyperbolic structure on } S\} / \sim_{\mathcal{T}} \\ &= \{\rho \text{ hyperbolic metric on } S\} / \text{orientation preserving isometry homotopic to id} \\ &= \{\rho \text{ hyperbolic metric on } S\} / \text{Diffeo}_0(S) \end{aligned}$$

where $(Y, \phi) \sim_{\mathcal{T}} (Y', \phi')$ if $\phi' \circ \phi^{-1}$ is homotopic to an isometry.

The Teichmüller space can be endowed with a topology, we will not describe it here, but one can refer to [FM1] for more details. However, let us give some insight of this topology.

Theorem 2.2. *The Teichmüller space is homeomorphic to an open ball of dimension $6g - 6 + 2r$.*

The question of the compactification of this ball has been treated from various points of view. An overview of the different compactification methods is available in [Pau2] or [Ohs]. This chapter is interested in the one given by Thurston.

2.1.2 Length function and Thurston compactification

The length function play a key role in Thurston's compactification of Teichmüller space but also in the understanding of this space.

Theorem 2.3. *The length function $\ell : \mathcal{T}(S) \hookrightarrow \mathbb{R}_{\geq 0}^{\mathfrak{e}(S)}$ is a well defined embedding.*

Two Teichmüller classes cannot have all curves of the same length but neither can two length functions ℓ_{X_1} and ℓ_{X_2} be multiple one of the other when X_1 and X_2 represent to different Teichmüller classes. Hence, the above embedding extends to an embedding of $\mathcal{T}(S)$ into $\mathbb{P}_+ \mathbb{R}_{\geq 0}^{\mathfrak{e}(S)}$.

Theorem (Thurston's compactification). *If S is a finite analytic type surface with negative Euler characteristic, then the accumulation points of $\mathcal{T}(S)$ in $\mathbb{P}_+(\mathbb{R}_{\geq 0}^{\mathfrak{e}(S)})$ are the projective classes of functions $\gamma \mapsto i(\lambda, \gamma)$ where $\lambda \in \mathcal{ML}(S)$ is a measured lamination on S . More precisely, $\mathcal{T}(S) \cup \mathbb{P}_+ \mathcal{ML}(S)$ is a compact ball of dimension $6g - 6 + 2r$.*

In the same way as the mapping class group acts on \mathcal{ML} or on the set of geodesic currents it also acts on Teichmüller space. The Thurston compactification is of particular interest since this action extends to the Thurston boundary and corresponds to the usual action of the mapping class group on $\mathbb{P}_+ \mathcal{ML}(S)$.

2.1.3 Teichmüller classes as geodesic currents and Bonahon's strategy

A proof of the Thurston compactification is given in [FLP] but we are here interested in a version given by Bonahon in [Bon2]. His proof is based on the embedding of Teichmüller space into the set of geodesic currents.

Given a hyperbolic structure X on a finite analytic type surface S one can consider the **Liouville measure** \mathcal{L}_X in the unit tangent bundle T^1X (this measure can be seen either as locally $d_{vol_X} \wedge d\theta$ or as coming from the Haar measure on $PSL_2(\mathbb{R})$). This measure is flip (*ie.* time reversal) and flow invariant and is then a geodesic current by Proposition 1.29, we will denote by L_X the associated Liouville current.

Theorem 2.4. [Bon2] *The map*

$$\begin{array}{ccc} L & : & \mathcal{T}(S) \hookrightarrow \mathcal{C}(S) \\ [X] & \mapsto & L_X \end{array} \quad \text{is a well defined embedding.}$$

Bonahon's arguments rely on two main properties of the Liouville current.

Proposition 2.5. *Let X be an element in $\mathcal{T}(S)$,*

$$\forall \gamma \in \mathcal{C}(S), i(\gamma, L_X) = \ell_X(\gamma), \quad (2.1.1)$$

$$\text{If } S \text{ is closed, } i(L_X, L_X) = \pi^2 |\chi(S)|. \quad (2.1.2)$$

Let us now focus on the case of a closed surface S . In the same way as the length function induces an embedding into $\mathbb{P}_+ \mathbb{R}_{\geq 0}^{\mathcal{C}(S)}$, eq. (2.1.2) ensures that the function which associates to a Teichmüller class the associated Liouville current is an embedding into $\mathbb{P}_+ \mathcal{C}(S)$. Hence Bonahon's version of the Thurston compactification can be expressed in the following way.

Theorem. [Bon2] *Let S be a closed surface of negative Euler characteristic, the accumulation points of $\mathcal{T}(S)$ in $\mathbb{P}_+ \mathcal{C}(S)$ are the elements of $\mathbb{P}_+ \mathcal{ML}(S)$ and $\mathcal{T}(S) \cup \mathbb{P}_+ \mathcal{ML}(S)$ is a compact subspace of $\mathbb{P}_+ \mathcal{C}(S)$.*

The key steps of the proof of this theorem are mentioned in the introduction and together with eq. (2.1.1) and eq. (2.1.2) the continuity of the intersection form is primordial. However, we do not dispose of this continuity when S is non-compact, hence Bonahon's proof does not apply in this case. The end of this chapter is dedicated to the construction of an alternative proof in this case.

2.2 Preliminaries

In order to recover continuity of the intersection form one has two possibilities : working in a compact surface or considering currents of $\mathcal{C}_K(S)$ rather than $\mathcal{C}(S)$. In both of these cases we do not dispose of the Liouville current anymore. This chapter focuses on the first

option but the same technical results allow to consider the second one. An overview of it is described in the last section of this chapter.

2.2.1 From non-compact to compact

In the following S is a non-compact finite type surface. Let also Σ be a compact hyperbolic surface with geodesic boundary whose interior is homeomorphic to S . We fix a homeomorphism between S and $\Sigma \setminus \partial\Sigma$. This homeomorphism immediately induces a correspondance between the essential closed curves of S and the ones of Σ , that is

$$\mathfrak{C}(S) = \mathfrak{C}(\Sigma). \tag{2.2.1}$$

The homeomorphism $S = \Sigma \setminus \partial\Sigma$ also gives an identification between measured laminations of S and the ones of Σ :

$$\mathcal{ML}(S) = \mathcal{ML}(\Sigma) = \{\mu \in \mathcal{C}_0(\Sigma) \mid i(\mu, \mu) = 0\}. \tag{2.2.2}$$

The identifications (2.2.1) and (2.2.2) will allow us to work on Σ rather than on S .

The main reason why we want to work in Σ rather than in S is the lack of continuity of the intersection form on currents of S . Let us recall why this continuity is impossible in S .

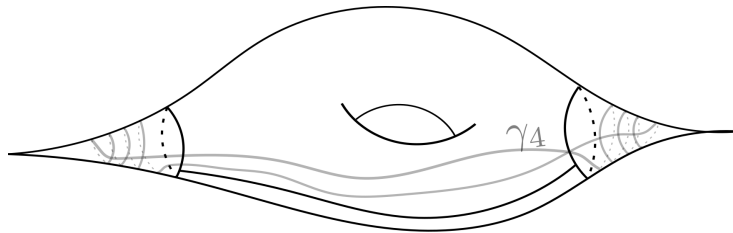

Figure 2.1 – Obstruction to the continuity of i

Example 2.6 (Discontinuity of the intersection form in the non-compact case). *Take a hyperbolic surface with at least two cusps, fix an embedded horocycle around each of them, and a simple geodesic arc between those curves which meet them orthogonally. Note that this arc is part of a cusps-to-cusps geodesic arc γ . Consider a sequence of closed curves $(\gamma_n)_{n \in \mathbb{N}}$, where γ_n is the geodesic homotopic to the closed curve which runs the geodesic arc mentioned above, turns n times around the first cusp following the fixed horocycle,*

goes back along the geodesic arc and turns n times around the second cusp as in fig. 2.1. The self-intersection number of such a sequence tends to infinity. On the other hand, it approaches the current 2γ which has 0 self-intersection number (where the current associated to a cusp to cusp geodesic is defined in the same way as the one for curves).

See [Sas, Prop. 5.1] for a more detailed discussion on that obstruction to a continuous extension of the intersection number on the space of currents for non-compact surfaces.

Working with the currents of the compact surface Σ instead of the currents on $S = \Sigma \setminus \partial\Sigma$ allows to recover continuity. However it raises a new problem: we won't be able to consider the Liouville current anymore.

Proposition 2.7. *Let Σ be a compact hyperbolic surface with non-empty boundary and X a hyperbolic structure on $S = \Sigma \setminus \partial\Sigma$. There is no current L_X on Σ which satisfies $i(L_X, \gamma) = \ell_X(\gamma)$ for every essential closed curve $\gamma \in \mathfrak{C}(\Sigma)$.*

Proof. If γ is a closed geodesic and μ a weighted multicurve of Σ then

$$i(\gamma, \mu) = \min \left\{ \#(\gamma' \cap \mu), \begin{array}{l} \gamma' \text{ piecewise geodesic homotopic to } \gamma \\ \text{in } \mu\text{-general position} \end{array} \right\}, \quad (2.2.3)$$

where a piecewise geodesic homotopic to γ is in μ -general position if the set of geodesics passing through the corners has vanishing μ measure.

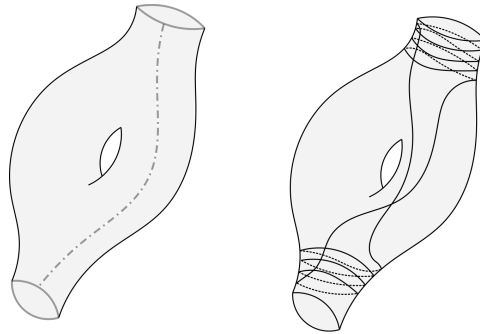

Figure 2.2 – Obstruction to the existence of the Liouville current

Now, consider b_1 and b_2 two boundary components of Σ , maybe the same, and γ a non-trivial geodesic arc joining them. For every k , we define γ_k as the unique closed geodesic homotopic to the piecewise geodesic which follows γ , turns k times around b_1 , follows back γ and turns k times around b_2 . We obtain from eq. (2.2.3) that for any weighted

multicurve μ ,

$$i(\gamma_k, \mu) \leq k\sharp(b_1 \cap \mu) + k\sharp(b_2 \cap \mu) + 2\sharp(\gamma \cap \mu) = 2\sharp(\gamma \cap \mu).$$

We want to extend the previous inequality for μ a current, to do so we need a well-defined notion of intersection with γ . For this purpose we can embed Σ into the closed doubled surface $D\Sigma$, for more details about how to pass from Σ to $D\Sigma$ the reader can refer to the next chapter. Hence, $\mathcal{C}(\Sigma)$ is a subset of $\mathcal{C}(D\Sigma)$, the double $\hat{\gamma}$ of γ is a curve and in $\mathcal{C}(D\Sigma)$ we have

$$i(\gamma_k, \mu) \leq 2i(\hat{\gamma}, \mu), \tag{2.2.4}$$

for any μ weighted multicurve of Σ . Moreover, the weighted multicurves are dense in $\mathcal{C}(\Sigma)$ and the intersection number is continuous in $\mathcal{C}(D\Sigma)$ so eq. (2.2.4) induces that

$$\forall \nu \in \mathcal{C}(\Sigma), \quad i(\gamma_k, \nu) \leq 2i(\hat{\gamma}, \nu) < \infty. \tag{2.2.5}$$

However, $\lim_{k \rightarrow \infty} \ell_X(\gamma_k) = \infty$ for any hyperbolic structure X on S , so eq. (2.2.5) prevents any intersection with a fixed current to produce the length. \square

Section 2.3 is dedicated to built sequences of currents which are going to play the role of the Liouville current. To do so, we need to recall some facts about the behavior of curves into cusps neighborhood.

2.2.2 Cusps neighborhoods and intersection number

Everything in the next section relies on a good understanding of the behaviour of geodesics in cusps. More precisely, if X is a hyperbolic structure on S then we denote by H_k^i the embedded horosphere of length $1/k$ around the i -th cusp. The horosphere H_k^i bounds the horoball B_k^i of area $1/k$. We will refer to H_k^i and B_k^i as the horosphere and horoball of depth k . We also set X^k the compact core of X bounded by the horospheres H_k^i and \mathcal{B}^k its complement:

$$X^k = X \setminus \bigcup_i B_k^i, \quad \mathcal{B}^k = \bigcup_i B_k^i.$$

There is a direct link between the number of times a curve turns around a cusp and the depth it reaches [BPT, Prop. 3.4]. It follows that every curve that goes deep into a cusp has a large self-intersection number. To make this link more clear we recall a notion introduced in [ES3, Def. 2.6]: the *peripheral self-intersection number*.

Definition 2.8. *Let Z be a hyperbolic surface (compact or not) and recall that a peripheral subgroup of $\pi_1(Z)$ is nothing other than a cyclic subgroup generated by a non-essential closed curve. The **peripheral self-intersection number** $i_{per}(\gamma, \gamma)$ of $\gamma \in \mathfrak{C}(Z)$ is the supremum over all maximal peripheral subgroups $G \subset \pi_1(Z)$ of the maximal number of times that the image of a lift $\tilde{\gamma}$ of γ under $\tilde{Z} \rightarrow G \backslash \tilde{Z}$ meets itself transversely.*

The peripheral self-intersection number is a topological invariant. It is thus independent of the metric on S , or more specifically, whether one considers the curves on S or on Σ . Moreover, for every compact subset K of $Z \setminus \partial Z$ there is an upper bound for the peripheral self-intersection number of the closed geodesics contained in K . Conversely, for every $N > 0$ there is a compact subset K_N of $Z \setminus \partial Z$ that contains all the geodesics γ with $i_{per}(\gamma, \gamma) \leq N$ [ES3, Lem. 2.7]. In the absence of boundary, one can easily quantify this property.

Lemma 2.9. *Let X be a non-compact finite type hyperbolic surface with no boundary, and γ be an essential closed curve on X , this curve has support on X^k if and only if $i_{per}(\gamma, \gamma) \leq 4k$.*

Proof. If we think of the curves of $\pi_1(X)$ as deck transformations then a peripheral subgroup of $\pi_1(X)$ is a subgroup generated by a parabolic element. Let's study a given cusp C_i , we can assume that the correspondence between \tilde{X} and \mathbb{H}^2 is such that an associated maximal parabolic element is $z \mapsto z+1$. In that case, H_k^i lifts to the horizontal line $\{\Im(z) = k\}$ and if γ is a closed geodesic of X then the number of times that the image of a lift $\tilde{\gamma}$ under $\tilde{X} \rightarrow \langle z \mapsto z+1 \rangle \backslash \tilde{X}$ meets itself transversely is $\#\{n \in \mathbb{Z} \setminus \{0\} \mid \tilde{\gamma} \cap (\tilde{\gamma} + n) \neq \emptyset\}$. However, γ stays in X^k around C_i , if and only if its lifts stay below the line $\{\Im(z) = k\}$, if and only if its lifts are half circles of radius at most k . Such a geodesic of \mathbb{H}^2 meets at most $4k$ translations of itself ($n = \pm 1, \pm 2, \dots, \pm 2k$). The same process applies for every cusps and then to every maximal parabolic subgroup and we obtain the lemma. \square

2.3 Construction of controled sequences of random geodesics

In this section we prove that for all non-compact hyperbolic surfaces of finite volume with no boundary there are sequences $(\gamma_n)_{n \in \mathbb{N}}$ of closed geodesics satisfying (2.1.2) and (2.1.1) asymptotically:

$$\lim_{n \rightarrow \infty} i \left(\frac{\gamma_n}{\ell_X(\gamma_n)}, \gamma \right) = \frac{\ell_X(\gamma)}{\pi^2 |\chi(S)|} \quad \text{for all essential closed curve } \gamma, \quad (2.3.1)$$

$$\lim_{n \rightarrow \infty} i \left(\frac{\gamma_n}{\ell_X(\gamma_n)}, \frac{\gamma_n}{\ell_X(\gamma_n)} \right) = \frac{1}{\pi^2 |\chi(S)|}. \quad (2.3.2)$$

2.3.1 Sequences of random geodesics

As we saw in Proposition 2.7, the Liouville current does not exist anymore in our setting. However, for every (complete and finite area) hyperbolic structure X on S the Liouville measure on T^1X still exists. Recall that the **Liouville measure** \mathcal{L}_X is the measure on the unit tangent bundle T^1X , obtained by pushing forward the Haar measure on $\mathrm{PSL}_2(\mathbb{R})$ and normalized so that $\mathcal{L}_X(T^1X) = 2\pi \mathrm{vol}_X(S) = 4\pi^2 |\chi(S)|$. We are going to consider geodesics approximating the Liouville measure in the following sense.

Definition 2.10. *A sequence $(\gamma_n)_{n \in \mathbb{N}}$ of essential closed geodesics on X is a **sequence of random geodesics** if the associated probability measures converge to \mathcal{L}_X with respect to the weak-* topology, meaning that:*

$$\int_{T^1X} f \frac{d\gamma_n}{\ell_X(\gamma_n)} \xrightarrow{n \rightarrow +\infty} \int_{T^1X} f \frac{d\mathcal{L}_X}{4\pi^2 |\chi(S)|},$$

for every $f \in C_c^0(T^1X)$ continuous and compactly supported function on T^1X .

Remark 2.11. *We will generally use the notation $\bar{\gamma}$ for the renormalisation $\frac{\gamma}{\ell_X(\gamma)}$.*

The Birkhoff ergodic theorem, together with the ergodicity of the geodesic flow, implies the existence of such sequences of geodesics. We refer to [ES3, Chap. 2] for some facts about sequences of random geodesics that we will use here.

The construction of the Liouville measure ensures that for a compact subsurface K of X we have $\mathcal{L}_X(T^1K) = 2\pi \mathrm{vol}_X(K)$. Then, if the boundary of K is smooth, the Port-

manteau Theorem implies that for every sequence of random geodesics $(\gamma_n)_{n \in \mathbb{N}}$ we have

$$\frac{\ell_X(\gamma_n \cap K)}{\ell_X(\gamma_n)} \xrightarrow{n \rightarrow +\infty} \frac{\text{vol}_X(K)}{2\pi|\chi(S)|}.$$

Applying this property to our compact core X^k we have

$$\frac{\ell_X(\gamma_n \cap X^k)}{\ell_X(\gamma_n)} \xrightarrow{n \rightarrow +\infty} \frac{\text{vol}_X(X^k)}{2\pi|\chi(S)|}, \quad (2.3.3)$$

and hence,

$$\frac{\ell_X(\gamma_n \cap \mathcal{B}^k)}{\ell_X(\gamma_n)} \xrightarrow{n \rightarrow +\infty} \frac{\text{vol}_X(\mathcal{B}^k)}{2\pi|\chi(S)|}. \quad (2.3.4)$$

What is much more surprising is that sequences of random geodesics can also be used to compute lengths. More concretely, we have

$$\frac{i(\gamma_n, I)}{\ell_X(\gamma_n)} \xrightarrow{n \rightarrow +\infty} \frac{\ell_X(I)}{\pi^2|\chi(S)|}, \quad (2.3.5)$$

for every compact geodesic segment I in X . This property is basically due to Bonahon [Bon2, Prop. 14], we also refer the reader to [ES3, Prop. 2.4] for details. A direct consequence of (2.3.5) is that we can use random geodesics $(\gamma_n)_{n \in \mathbb{N}}$ to compute the length of any essential geodesic $\gamma \in \mathfrak{C}(S)$:

$$\frac{i(\gamma_n, \gamma)}{\ell_X(\gamma_n)} \xrightarrow{n \rightarrow +\infty} \frac{\ell_X(\gamma)}{\pi^2|\chi(S)|}. \quad (2.3.6)$$

Note that in this equation the curve γ is fixed. Meaning that a priori, equation (2.3.6) does not say anything about $i(\gamma_n, \gamma_n)$. However, for compact sets (2.3.5) holds uniformly. As a consequence, cutting the geodesics γ_n into geodesic segments we have

$$i\left(\frac{\gamma_n}{\ell_X(\gamma_n)}, \frac{\gamma_n|_K}{\ell_X(\gamma_n|_K)}\right) \xrightarrow{n \rightarrow +\infty} \frac{1}{\pi^2|\chi|}. \quad (2.3.7)$$

for K any fixed compact subsurface of X .

All those considerations about sequences of random geodesics apply to compact surfaces, hence, if S were compact, applying (2.3.7) to $K = S$, then we would immediately have that every sequence of random geodesics satisfies (2.3.2). However, that is not necessarily true in general.

Example 2.12. First, note that an excursion of length ℓ into some \mathcal{B}_i^k has between $ke^{\ell/2} - 2$ and $4ke^{\ell/2}$ self-intersections. Consider now a sequence of random geodesics $(\gamma_n)_{n \in \mathbb{N}}$. Add to γ_n an excursion of length $6 \log(\ell_X(\gamma_n))$ at depth $k_n \xrightarrow{n \rightarrow \infty} \infty$ and pull it tight into a new geodesic γ'_n . If we add the excursions in a well-chosen way (for example, gluing it at the deepest point of an excursion) then the $(\gamma'_n)_{n \in \mathbb{N}}$ are still random geodesics and

$$\frac{i(\gamma'_n, \gamma'_n)}{\ell_X(\gamma'_n)^2} \approx \frac{i(\gamma_n, \gamma_n) + k_n \ell_X(\gamma_n)^3}{(\ell_X(\gamma_n) + 6 \log(\ell_X(\gamma_n)))^2} \underset{+\infty}{\approx} \frac{i(\gamma_n, \gamma_n)}{\ell_X(\gamma_n)^2} + k_n \ell_X(\gamma_n) \xrightarrow{n \rightarrow \infty} \infty.$$

One can also refer to the arguments in Lemma 2.14 below to prove that such sequences of random geodesics exist.

In [Lal1] or [Lal2, Cor. 11.2], Lalley gives a construction of random geodesics that justifies the use of the term "random": if for all n the geodesic γ_n is randomly chosen among the geodesics of length at most n then $(\gamma_n)_{n \in \mathbb{N}}$ is a sequence of random geodesics with probability 1. Hence, we wonder which proportion of sequences of random geodesics satisfies (2.3.2). This problem might be linked to the study of the length of cusp excursions for random geodesics, see for example [Haa], [Pol] or [Sul] and the references therein.

Anyway, the above example makes clear that to obtain (2.3.2) in the non-compact case we have to control the excursions of the sequences of random geodesics into cusps neighborhoods. We will do it through the cutting process described below.

2.3.2 Cutting process

Suppose that X is a fixed complete and finite area hyperbolic structure for S . Recall that X^t denotes the compact core of X bounded by the horospheres of length $1/t$ around the cusps of S and that $\mathcal{B}^t = X \setminus X^t$ is its complement. Given two parameters $k \in \mathbb{N}$ and $0 < \theta < \pi/4$, and a curve γ we want to cut the excursions of γ in \mathcal{B}^k in order to prevent γ from leaving $X^{k/\sin(\theta)}$. To do so, we will study γ through its lifts in the universal cover \tilde{X} of X . We focus here on a given cusp but we apply the same construction around each cusps of X . For $t \geq 1$ we denote by H_t the horosphere of depth t around this cusp and B_t the horoball it bounds. Since X is a hyperbolic surface endowed with a complete hyperbolic metric, its universal cover identifies with \mathbb{H}^2 , and we can suppose that the parabolic element associated to the cusp we are interested in is $z \mapsto z + 1$. With this normalization H_t lifts to the horizontal line $\{\Im(z) = t\}$ and we have that if a curve enters H_t with some angle $\alpha \in [0, \pi/2)$ then it reaches the horosphere $H_{k/\sin(\alpha)}$ (we measure the non-oriented

angle with the normal to the horosphere). We want to cut γ in order to replace its long excursions into B_k (ie. the ones which cross $H_{k/\sin(\theta)}$) by short ones (excursions staying between $H_{k/\sin(2\theta)}$ and $H_{k/\sin(\theta)}$). To make it explicit we make a description of the process on the universal cover.

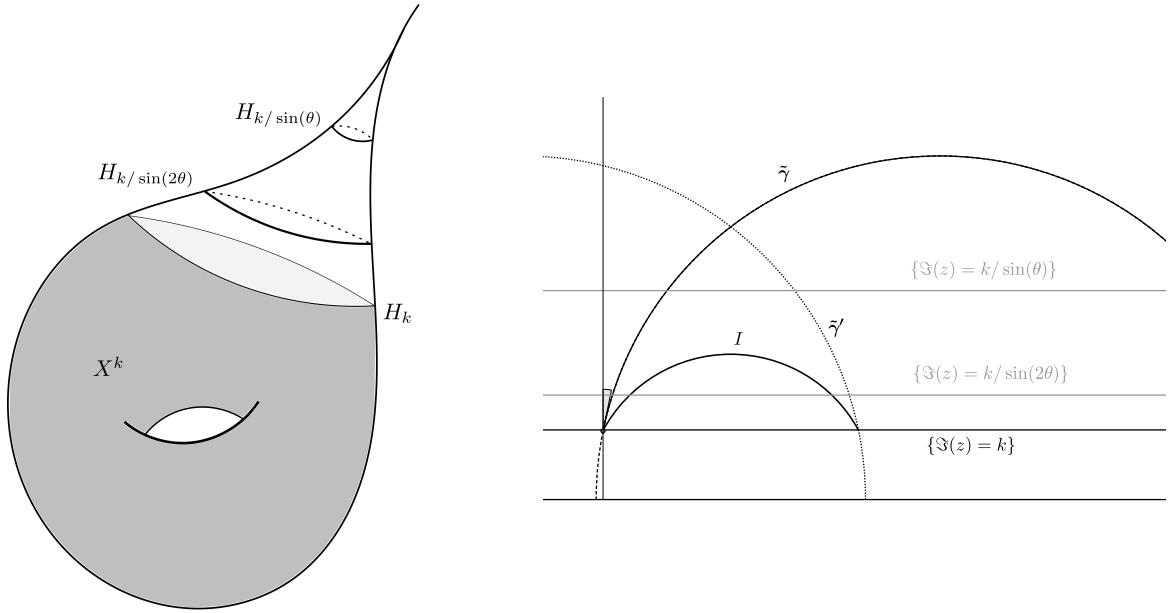

Figure 2.3 – Cutting process

If γ makes excursions in B_k we are going to modify γ explaining the process on a fixed lift $\tilde{\gamma}$ which makes an excursion in the horoball $\{\Im(z) > k\}$ bounded by $\{\Im(z) = k\}$ but the same process applies to all lifts of B_k . First, if $\tilde{\gamma}$ enters with an angle greater than θ then we don't change it. On the other hand, if it enters with an angle smaller than θ then we replace this arc by a geodesic arc I which enters with angle between θ and 2θ and whose exit point coincides with the exit point of a different lift $\tilde{\gamma}'$ of γ (see fig. 2.3). This is always possible as long as $2k \cotan(\theta) - 2k \cotan(2\theta) \geq 1$. If we apply the same process to all the excursions of γ around every cusp then γ is replaced by a closed piecewise geodesic γ' .

Now, pulling γ' tight we obtain a closed geodesic γ^* : we refer to γ^* as the **geodesic obtained by cutting process of parameters k and θ from γ** . Note that if θ is small then γ' and γ^* have basically the same length, more precisely, they can be mapped one to each other through a homotopy with small displacement and without disturbing too much the lengths. For the lengths, it is easy to see that there is some $e_\theta \xrightarrow{\theta \rightarrow 0} 0$, independent

from X , such that for every $k \geq 1$ and θ small

$$\ell_X(\gamma') \leq (1 + e_\theta)\ell_X(\gamma^*). \quad (2.3.8)$$

Here $\ell_X(\gamma')$ refer to the arc length of γ' , we will use again this abuse of notation but its meaning is clear from the context.

2.3.3 Construction of controled sequences of random geodesics

Lemma 2.13. *There is some $\theta_0 > 0$ such that if $(\gamma_n)_{n \in \mathbb{N}}$ is a sequence of random geodesics on X and $(\gamma_n^*)_{n \in \mathbb{N}}$ is obtained from the γ_n applying the cutting process of parameters $k > 1$ and $\theta < \theta_0$ then there is $\mu_n \xrightarrow{n \rightarrow \infty} 0$ such that*

$$1 \leq \frac{\ell_X(\gamma_n)}{\ell_X(\gamma_n^*)} \leq (1 + \mu_n) \frac{\text{vol}_X(S)}{\text{vol}_X(X^k)} (1 + e_\theta),$$

for every n . Here, e_θ is as in (2.3.8).

Proof. We use the same notation as in the description of the cutting process, and, as above, we denote by $\ell_X(\gamma'_n)$ the arc length of the piecewise geodesics.

We take θ_0 small enough such that (2.3.8) occurs. The γ_n being random geodesics, (2.3.3) ensures that we can find a sequence $\mu_n \xrightarrow{n \rightarrow \infty} 0$ such that $\frac{\ell_X(\gamma_n)}{\ell_X(\gamma_n|_{X^k})} = (1 + \mu_n) \frac{\text{vol}_X(S)}{\text{vol}_X(X^k)}$. The construction of γ'_n ensures that $\gamma_n|_{X^k} = \gamma'_n|_{X^k}$, thus $\frac{\ell_X(\gamma_n|_{X^k})}{\ell_X(\gamma'_n)} \leq 1$ and if $\theta < \theta_0$ then $\frac{\ell_X(\gamma'_n)}{\ell_X(\gamma_n^*)} \leq (1 + e_\theta)$. The upper bound follows from those three inequalities.

Now, γ_n and γ'_n coincide on X^k but γ'_n has shorter excursions than γ_n in \mathcal{B}^k , hence, $\frac{\ell_X(\gamma_n)}{\ell_X(\gamma'_n)} \geq 1$. The geodesic γ_n^* is the unique geodesic representative of the free homotopy class of γ'_n which proves that $\frac{\ell_X(\gamma'_n)}{\ell_X(\gamma_n^*)} \geq 1$ and the lower bound follows. \square

Lemma 2.14. *Let $(\gamma_n)_{n \in \mathbb{N}}$ be a sequence of random geodesics. If $(\gamma_n^*)_{n \in \mathbb{N}}$ is obtained from $(\gamma_n)_{n \in \mathbb{N}}$ applying the cutting processes of parameters $k_n \xrightarrow{n \rightarrow \infty} \infty$ and $\theta_n \xrightarrow{n \rightarrow \infty} 0$, then $(\gamma_n^*)_{n \in \mathbb{N}}$ is a sequence of random geodesics.*

Proof. In this proof, we denote by $\tilde{\gamma}$ the canonical lift of a geodesic γ to the unit tangent bundle of X .

Let $f \in C_c^0(T^1X)$ be a continuous and compactly supported function on T^1X , there is K a compact core of X such that $\text{Supp}(f) \subset T^1K$. Since $k_n \xrightarrow{n \rightarrow \infty} \infty$ then there is $n_0 \in \mathbb{N}$ such that for all $n \geq n_0$, $\gamma_n|_K = \gamma'_n|_K$. The homotopy between γ'_n and

γ_n^* induces that the arcs of $\gamma_{n|K}$ are freely homotopic to geodesic arcs of γ_n^* . Such a homotopy induces a projection from $\gamma_{n|K}$ to γ_n^* and lifts to $\Psi_n : \tilde{\gamma}_{n|K} \rightarrow \tilde{\gamma}_n^*$, which is a homeomorphism on its image. The homotopy can be chosen to have low displacement, that is $d(p, \Psi_n(p)) \leq \varepsilon_n \xrightarrow{n \rightarrow \infty} 0$ for every $p \in \tilde{\gamma}_{n|K}$, and not to distort too much the lengths. Moreover, we can find $\varphi_n : [0, \ell_X(\gamma_{n|K})] \rightarrow \mathbb{R}_+$ a piecewise smooth reparametrization of $[0, \ell_X(\gamma_{n|K})]$ such that for all $t \in [0, \ell_X(\gamma_{n|K})]$, $\Psi_n(\tilde{\gamma}_{n|K}(t)) = \tilde{\gamma}_n^*(\varphi_n(t))$. The homotopy between γ_n' and γ_n^* does not distort too much the lengths, hence, we have some $\delta_n \xrightarrow{n \rightarrow \infty} 0$ such that $1 - \delta_n \leq \varphi_n' \leq 1 + \delta_n$ where it is defined.

Fix some $\mu > 0$. A compactly supported continuous function is uniformly continuous, thus, there is $\varepsilon_\mu > 0$ such that if $d(p, q) \leq \varepsilon_\mu$ then $|f(p) - f(q)| \leq \mu$. We can suppose that for every $n \geq n_0$, $\varepsilon_n \leq \varepsilon_\mu$. We have

$$\int_{T^1 X} f d\gamma_n^* = \int_0^{\ell_X(\Psi_n(\gamma_{n|K}))} f \circ \tilde{\gamma}_n^*(t) dt = \int_0^{\ell_X(\gamma_{n|K})} f \circ \tilde{\gamma}_n^*(\varphi_n(s)) \varphi_n'(s) ds,$$

it follows that

$$\begin{aligned} (1 - \delta_n) \int_0^{\ell_X(\gamma_{n|K})} f(\Psi_n(\tilde{\gamma}_{n|K}(s))) ds &\leq \int_{T^1 X} f d\gamma_n^* \\ &\leq (1 + \delta_n) \int_0^{\ell_X(\gamma_{n|K})} f(\Psi_n(\tilde{\gamma}_{n|K}(s))) ds \\ \Rightarrow (1 - \delta_n) \left(\int_{\mathbb{R}^1 X} f d\gamma_n - \mu \ell_X(\gamma_{n|K}) \right) &\leq \int_{T^1 X} f d\gamma_n^* \\ &\leq (1 + \delta_n) \left(\int_{\mathbb{R}^1 X} f d\gamma_n + \mu \ell_X(\gamma_{n|K}) \right) \\ \Rightarrow (1 - \delta_n) \frac{\ell_X(\gamma_n)}{\ell_X(\gamma_n^*)} \left(\int_{\mathbb{R}^1 X} f d\bar{\gamma}_n - \mu \right) &\leq \int_{T^1 X} f d\bar{\gamma}_n^* \\ &\leq (1 + \delta_n) \frac{\ell_X(\gamma_n)}{\ell_X(\gamma_n^*)} \left(\int_{\mathbb{R}^1 X} f d\bar{\gamma}_n + \mu \right) \end{aligned}$$

Adapting the proof of Lemma 2.13 we have $\frac{\ell_X(\gamma_n)}{\ell_X(\gamma_n^*)} \xrightarrow{n \rightarrow \infty} 1$, and passing to the limit in n we obtain

$$\begin{aligned} \int_{T^1 X} f \frac{d\mathcal{L}_X}{4\pi^2 |\chi(S)|} - \mu &\leq \liminf_n \int_{T^1 X} f d\bar{\gamma}_n^* \\ &\leq \overline{\lim}_n \int_{T^1 X} f d\bar{\gamma}_n^* \leq \int_{T^1 X} f \frac{d\mathcal{L}_X}{4\pi^2 |\chi(S)|} + \mu. \end{aligned}$$

This is true for all μ , hence, $\lim_{n \rightarrow \infty} \int_{T^1 X} f d\bar{\gamma}_n^* = \int_{T^1 X} f \frac{d\mathcal{L}_X}{4\pi^2 |\chi(S)|}$ and we have proved that $(\gamma_n^*)_{n \in \mathbb{N}}$ is a sequence of random geodesics. \square

Now, for every hyperbolic structure X on S , we will be able to build sequences $(\gamma_n^{(X)})_{n \in \mathbb{N}}$ of random geodesics satisfying (2.3.2). Moreover, we will build them in such a way that neither the converging rates in (2.3.2) and (2.3.6), nor the peripheral self-intersection numbers $i_{per}(\gamma_n^{(X)}, \gamma_n^{(X)})$ depend on X .

Theorem 2.15. *For every complete and finite area hyperbolic structure X on a finite analytic type surface of negative Euler characteristic S , there is a sequence $(\gamma_n^{(X)})_{n \in \mathbb{N}}$ of random geodesics such that :*

$$\lim_{n \rightarrow \infty} i \left(\frac{\gamma_n^{(X)}}{\ell_X(\gamma_n^{(X)})}, \frac{\gamma_n^{(X)}}{\ell_X(\gamma_n^{(X)})} \right) = \frac{1}{\pi^2 |\chi(S)|}.$$

More precisely, they can be chosen such that

1. $i(\bar{\gamma}_n^{(X)}, \bar{\gamma}_n^{(X)}) \leq \frac{1}{\pi^2 |\chi(S)|} \left(1 + \frac{1}{n} \right), \forall n \in \mathbb{N}$,
2. $\forall \alpha \in \mathfrak{C}(S), \exists n_\alpha \in \mathbb{N} : \left| i(\bar{\gamma}_n^{(X)}, \alpha) \left(\frac{\ell_X(\alpha)}{\pi^2 |\chi(S)|} \right)^{-1} - 1 \right| \leq \frac{3}{n}, \forall n \geq n_\alpha$,
3. $i_{per}(\gamma_n^{(X)}, \gamma_n^{(X)}) \leq C_n, \forall n \in \mathbb{N}$,

where C_n and n_α do not depend on X .

Proof. To obtain the desired sequence $(\gamma_n^{(X)})_{n \in \mathbb{N}}$ we start with an arbitrary sequence of random geodesics $(\gamma_n)_{n \in \mathbb{N}}$. For every p we set $k_p = e^{p/2}$ and $\theta_p = e^{-p/2}$, if we apply the cutting process with parameters k_p and θ_p to the sequence $(\gamma_n)_{n \in \mathbb{N}}$ then we obtain a sequence $(\tilde{\gamma}_n^p)_{n \in \mathbb{N}}$ of piecewise geodesics and by pulling it tight a sequence $(\gamma_n^p)_{n \in \mathbb{N}}$ of geodesics. We will chose the $(\gamma_n^{(X)})_{n \in \mathbb{N}}$ among the γ_n^p .

First, study the self-intersection number of those γ_n^p . As γ_n^p is the geodesic representative of $\tilde{\gamma}_n^p$, its self-intersection number is lower than the number of self-intersections of $\tilde{\gamma}_n^p$. To count it, we divide X into two parts, the compact core X^k and its complement \mathcal{B}^k . On X^k , the geodesic arcs $\tilde{\gamma}_n^p|_{X^k}$ and $\gamma_n^p|_{X^k}$ are identical so $\tilde{\gamma}_n^p$ has $i(\gamma_n^p|_{X^k}, \gamma_n^p|_{X^k})$ self-intersections. On the complement, we count the self-intersections of $\tilde{\gamma}_n^p$ considering its different excursions in \mathcal{B}^k :

$$i(\gamma_n^p, \gamma_n^p) \leq i(\gamma_n^p|_{X^k}, \gamma_n^p|_{X^k}) + \sum_{I, J \text{ excursions in } \mathcal{B}^k} i(I, J).$$

We can distinguish two types of pairs (I, J) : the ones where at least one of the excursions stays in $\mathcal{B}^k \cap X^{k/\sin(2\theta)}$, and the ones where both I and J reach $\mathcal{B}^{k/\sin(2\theta)}$. In the first case, I and J meet at most as many times as the corresponding excursions of γ_n and then:

$$i(\gamma_n^p, \gamma_n^p) \leq i(\gamma_n \cap X^{k/\sin(2\theta)}, \gamma_n) + \sum_{\substack{I, J \text{ excursions in } \mathcal{B}^k \\ \text{which reach } \mathcal{B}^{k/\sin(2\theta)}}} i(I, J).$$

Moreover, an excursion of $\tilde{\gamma}_n^p$ in \mathcal{B}^k which reaches $\mathcal{B}^{k/\sin(2\theta)}$ has a length of at least $\ln(1/\theta)$, a lower bound for the length of the geodesic arc which enters with angle 2θ . It follows that there is at most $\frac{\ell_X(\gamma_n \cap \mathcal{B}^k)}{\ln(1/\theta)}$ such excursions. Also, the intersection number of two excursions reaching $\mathcal{B}^{k/\sin(2\theta)}$ is at most $4k/\theta$, the self-intersection number of the excursion which enters with angle θ . All in all,

$$i(\gamma_n^p, \gamma_n^p) \leq i(\gamma_n \cap X^{k/2\theta}, \gamma_n) + \left(\frac{\ell_X(\gamma_n \cap \mathcal{B}^k)}{\ln(1/\theta)} \right)^2 \frac{4k}{\theta}.$$

Applying equations (2.3.7) and (2.3.4) we have

$$i(\gamma_n \cap X^{k/2\theta}, \gamma_n) = (1 + \varepsilon_n^p) \frac{\ell_X(\gamma_n) \ell_X(\gamma_n \cap X^{k/2\theta})}{\pi^2 |\chi|} \text{ and}$$

$$\ell_X(\gamma_n \cap \mathcal{B}^k) = (1 + \delta_n^p) \frac{\ell_X(\gamma_n) C}{2\pi |\chi| k} \text{ where } C \text{ is the number of cusps of } S,$$

where $\varepsilon_n^p \xrightarrow{n \rightarrow \infty} 0$ and $\delta_n^p \xrightarrow{n \rightarrow \infty} 0$ depend on X . As a consequence,

$$i(\gamma_n^p, \gamma_n^p) \leq (1 + \varepsilon_n^p) \frac{\ell_X(\gamma_n)^2}{\pi^2 |\chi|} + \left((1 + \delta_n^p) \frac{C \ell_X(\gamma_n)}{2\pi |\chi| \cdot k \cdot \ln(1/\theta)} \right)^2 \frac{4k}{\theta}$$

and we obtain an upper bound for the self-intersection number of the normalized curves:

$$i\left(\frac{\gamma_n^p}{\ell_X(\gamma_n^p)}, \frac{\gamma_n^p}{\ell_X(\gamma_n^p)}\right) \leq \frac{1}{\pi^2 |\chi|} \left((1 + \varepsilon_n^p) + (1 + \delta_n^p)^2 \frac{C^2 4}{|\chi| p^2} \right) \left(\frac{\ell_X(\gamma_n)}{\ell_X(\gamma_n^p)} \right)^2. \quad (2.3.9)$$

We next study the intersection number of the γ_n^p with closed curves. The set $\mathfrak{C}(S)$ is infinite and can be enumerated with $\mathfrak{C}(S) = \{\alpha_q | q \in \mathbb{N}\}$ in such a way that $i_{per}(\alpha_q, \alpha_q) \leq 4q$ for every q . This enumeration is fixed whatever the structure X . Recall that for every p we have $k = k_p = e^{p/2}$ and $\theta = \theta_p = e^{-p/2}$. Hence, when p is big enough, for $q \leq p$ the

curve α_q is included in $X^q \subset X^k$. However in X^k we have $i(\gamma_n, \cdot) = i(\gamma_n^p, \cdot)$ thus

$$i(\bar{\gamma}_n^p, \alpha_q) = \frac{\ell_X(\gamma_n)}{\ell_X(\gamma_n^p)} i(\bar{\gamma}_n, \alpha_q). \quad (2.3.10)$$

Now, applying Lemma 2.13, for every p there is $\mu_n^p \xrightarrow{n \rightarrow \infty} 0$, depending on X , such that

$$1 \leq \frac{\ell_X(\gamma_n)}{\ell_X(\gamma_n^p)} \leq (1 + \mu_n^p) \frac{\text{vol}_X(S)}{\text{vol}_X(X^k)} (1 + e_p). \quad (2.3.11)$$

with $e_p = e_{e^{-p/2}}$ with the notation of (2.3.8).

Therefore, there are m_p large enough such that $\varepsilon_{m_p}^p, \delta_{m_p}^p, \mu_{m_p}^p \leq \frac{1}{p}$ for every p , and $\left| \frac{i(\bar{\gamma}_{m_p}, \alpha_q)}{\ell_X(\alpha_q)/\pi^2|\chi|} - 1 \right| \leq \frac{1}{p}$ for every $q \leq p$. Thus (2.3.11) and (2.3.9) give us

$$1 \leq \frac{\ell_X(\gamma_{m_p})}{\ell_X(\gamma_{m_p}^p)} \leq \frac{\text{vol}_X(S)}{\text{vol}_X(X^k)} \left(1 + \frac{1}{p}\right) (1 + e_p) \xrightarrow{p \rightarrow \infty} 1, \quad (2.3.12)$$

$$i(\bar{\gamma}_{m_p}^p, \bar{\gamma}_{m_p}^p) \leq \frac{1}{\pi^2|\chi|} \left(1 + \left(1 + \frac{1}{p}\right) \frac{4C^2}{p^2|\chi|}\right) \frac{\text{vol}_X(S)}{\text{vol}_X(X^k)} \left(1 + \frac{1}{p}\right)^2 (1 + e_p) \xrightarrow{p \rightarrow \infty} \frac{1}{\pi^2|\chi|}. \quad (2.3.13)$$

The terms on the right in inequalities (2.3.12) and (2.3.13) do not depend on X anymore so, for N an integer there is p_N , independent from X and with $p_N > p_{N-1}$, such that $1 \leq \frac{\ell_X(\gamma_{p_N})}{\ell_X(\gamma_{m_{p_N}}^{p_N})} \leq 1 + \frac{1}{N}$ and $i(\bar{\gamma}_{m_{p_N}}^{p_N}, \bar{\gamma}_{m_{p_N}}^{p_N}) \leq \frac{1}{\pi^2|\chi|} \left(1 + \frac{1}{N}\right)$. As a consequence, we can take $\gamma_N^{(X)} = \gamma_{m_{p_N}}^{p_N}$.

The previous constructions ensure that $i(\bar{\gamma}_N^{(X)}, \bar{\gamma}_N^{(X)}) \leq \frac{1}{\pi^2|\chi|} \left(1 + \frac{1}{N}\right)$, and we have proved (1) in the statement of the theorem.

Applying Proposition 2.9 we have $i_{\text{per}}(\gamma_N^{(X)}, \gamma_N^{(X)}) \leq 4e^{p_N}$ where p_N does not depend on X , which gives us the third point.

At last, (2.3.10) and the choice of p_N and m_p induces that

$$1 - \frac{3}{N} \leq \left(1 - \frac{1}{N}\right) \leq \frac{i(\bar{\gamma}_N^{(X)}, \alpha_q)}{\ell_X(\alpha_q)/\pi^2|\chi|} \leq \left(1 + \frac{1}{N}\right)^2 \leq 1 + \frac{3}{N}, \quad \forall q \leq N,$$

hence, we obtain the second point with $n_\alpha = q$ when $\alpha = \alpha_q$.

Moreover, up to passing to a subsequence, the $(\gamma_N^{(X)})_{N \in \mathbb{N}}$ are built from the sequence $(\gamma_N)_{N \in \mathbb{N}}$ of random geodesics through cutting processes of parameters $k_N = e^{pN/2} \xrightarrow{N \rightarrow \infty} \infty$ and $\theta_N = e^{-pN/2} \xrightarrow{N \rightarrow \infty} 0$. As a consequence, Lemma 2.14 ensures that we have built a sequence of random geodesics. At last, for K a compact subsurface of X we have

$$i\left(\bar{\gamma}_N^{(X)}, \frac{\gamma_{N|K}^{(X)}}{\ell_X(\gamma_{N|K}^{(X)})}\right) \leq i(\bar{\gamma}_N^{(X)}, \bar{\gamma}_N^{(X)}) \leq \frac{1}{\pi^2|\chi|}\left(1 + \frac{1}{N}\right),$$

and if we pass to the limit, using (2.3.7), we obtain that

$$\lim_{N \rightarrow \infty} i(\bar{\gamma}_N^{(X)}, \bar{\gamma}_N^{(X)}) = \frac{1}{\pi^2|\chi|}.$$

□

2.4 Proof of Thurston's compactification

Armed with Theorem 2.15, we are now able to prove Thurston's compactification. As we already mentioned in the introduction, the starting point of this compactification is the embedding of $\mathcal{T}(S)$ and $\mathbb{P}_+\mathcal{ML}(S)$ into the space $\mathbb{P}_+(\mathbb{R}_{\geq 0}^{\mathfrak{e}(S)})$:

$$\begin{aligned} \ell &: \mathcal{T}(S) &\rightarrow \mathbb{P}_+(\mathbb{R}_{\geq 0}^{\mathfrak{e}(S)}) \\ &X &\mapsto \mathbb{R}_{>0}\ell_X(\cdot), \\ \iota &: \mathbb{P}_+\mathcal{ML}(S) &\rightarrow \mathbb{P}_+(\mathbb{R}_{\geq 0}^{\mathfrak{e}(S)}) \\ &\lambda &\mapsto \mathbb{R}_{>0}i(\lambda, \cdot). \end{aligned}$$

The image of $\mathcal{T}(S)$ in $\mathbb{P}_+(\mathbb{R}_{\geq 0}^{\mathfrak{e}(S)})$ is included into a compact set (use eq. (2.4.1) for instance), thus, the closure $\bar{\mathcal{T}}(S)$ of $\mathcal{T}(S)$ is compact. The boundary of this set is given by the following theorem.

Theorem (Thurston's compactification). *If S is a finite analytic type surface with negative Euler characteristic then the accumulation points of $\mathcal{T}(S)$ in $\mathbb{P}_+(\mathbb{R}_{\geq 0}^{\mathfrak{e}(S)})$ are the projective classes of functions $\gamma \mapsto i(\lambda, \gamma)$ where $\lambda \in \mathcal{ML}(S)$ is a measured lamination on S .*

Our arguments apply to the compact case, but for the sake of concreteness we will focus on non-compact surfaces.

Let $X_k \in \mathcal{T}(S)$ be a sequence which converges in $\mathbb{P}_+(\mathbb{R}_{\geq 0}^{\mathfrak{C}(S)})$ and leaves all compact sets of $\mathcal{T}(S)$, meaning that there are a non-zero element F of $\mathbb{R}_{\geq 0}^{\mathfrak{C}(S)}$ and a sequence $(\varepsilon_k)_{k \in \mathbb{N}}$ of positive real numbers such that $\lim_{k \rightarrow \infty} \varepsilon_k \ell_k(\cdot) = F$ pointwise (we have written ℓ_k for ℓ_{X_k}). We will prove that F is given by taking the intersection number with a suitable measured lamination.

Fix a filling curve β on S , that is a closed curve such that the connected components of $S \setminus \beta$ are balls and annular neighborhoods of the cusps. Such a curve gives us a bound on the length of every curve $\gamma \in \mathfrak{C}(S)$, namely,

$$\ell_X(\gamma) \leq \ell_X(\beta) i(\gamma, \beta) (1 + i(\gamma, \gamma)) \quad (2.4.1)$$

for every hyperbolic structure X [SV, Lem. 2.1]. Since $F = \lim_{k \rightarrow \infty} \varepsilon_k \ell_k(\cdot)$ is non-zero, there is $\gamma \in \mathfrak{C}(S)$ with $F(\gamma) \neq 0$. We obtain from (2.4.1) that $0 < F(\gamma) \leq F(\beta) (1 + i(\gamma, \gamma)) i(\gamma, \beta)$ and hence that $F(\beta) \neq 0$. Since we are only interested in convergence in $\mathbb{P}_+(\mathbb{R}_{\geq 0}^{\mathfrak{C}(S)})$, we can assume that $F(\beta) = 1$, meaning that

$$\lim_{k \rightarrow \infty} \delta^k \frac{\ell_k(\cdot)}{\pi^2 |\chi|} = F,$$

where $\delta^k = \frac{\pi^2 |\chi|}{\ell_k(\beta)}$.

We will now prove that F is of the form $i(\mu, \cdot)$ where μ is a measured lamination on S .

Applying Theorem 2.15 to each X_k , we obtain some sequences of essential closed geodesics $(\gamma_n^{(k)})_{n \in \mathbb{N}} = (\gamma_n^{(X_k)})_{n \in \mathbb{N}}$ with $\lim_{n \rightarrow \infty} i(\gamma_n^{(k)} / \ell_k(\gamma_n^{(k)}), \cdot) = \ell_k(\cdot) / \pi^2 |\chi|$. As all along, let Σ be a compact complete hyperbolic surface with boundary whose interior is homeomorphic to S and let's identify $\mathfrak{C}(S)$ with $\mathfrak{C}(\Sigma)$. In particular, we can consider the weighted curves $\bar{\gamma}_n^{(k)} = \gamma_n^{(k)} / \ell_k(\gamma_n^{(k)})$ as currents of Σ . The space $\mathbb{P}_+ \mathfrak{C}(\Sigma)$ being compact each $(\bar{\gamma}_n^{(k)})_{k \in \mathbb{N}}$ projectively converges to a non-zero current $\mu_n \in \mathfrak{C}(\Sigma)$.

We first want to show that the μ_n are measured laminations. Consider the sequence $(\bar{\gamma}_n^{(k)})_{k \in \mathbb{N}}$ for n fixed, there are some $\varepsilon_n^k > 0$ such that $\varepsilon_n^k \bar{\gamma}_n^{(k)}$ tends to μ_n up to a subsequence in k . So, by diagonal extraction we can suppose that $\varepsilon_n^k \bar{\gamma}_n^{(k)} \xrightarrow[k \rightarrow \infty]{} \mu_n$ for every n . What we have to show is that $\lim_{k \rightarrow \infty} \varepsilon_n^k = 0$ for every n . The sequence $(X_k)_{k \in \mathbb{N}}$ leaves every compact set of $\mathcal{T}(S)$ so there is a simple closed curve α such that $\lim_{k \rightarrow \infty} \ell_k(\alpha) = \infty$. Recall that to prove Theorem 2.15 we have enumerated $\mathfrak{C}(S) = \{\alpha_n | n \in \mathbb{N}\}$ such that $i_{per}(\alpha_n, \alpha_n) \leq 4n$, since α is a simple curve we can suppose that $\alpha = \alpha_1$. The $\gamma_n^{(k)}$ come from Theorem 2.15

thus $\left| i(\bar{\gamma}_n^{(k)}, \alpha) \left(\frac{\ell_k(\alpha)}{\pi^2 |\chi|} \right)^{-1} - 1 \right| \leq \frac{3}{n}$ whatever k and n . By hypothesis $\ell_k(\alpha) \xrightarrow[k \rightarrow \infty]{} \infty$ and we can suppose, up to a shift in n , that for every n , $\left| i(\bar{\gamma}_n^{(k)}, \alpha) \left(\frac{\ell_k(\alpha)}{\pi^2 |\chi|} \right)^{-1} - 1 \right| < \frac{1}{2}$. As a consequence $i(\bar{\gamma}_n^{(k)}, \alpha) \xrightarrow[k \rightarrow \infty]{} \infty$. However, $\infty > i(\mu_n, \alpha) = \lim_{k \rightarrow \infty} \varepsilon_n^k i(\bar{\gamma}_n^{(k)}, \alpha)$ thus $\varepsilon_n^k \xrightarrow[k \rightarrow \infty]{} 0$ for every n , moreover $i(\bar{\gamma}_n^{(k)}, \bar{\gamma}_n^{(k)})$ is bounded independently from k and n , hence, $i(\mu_n, \mu_n) = \lim_{k \rightarrow \infty} (\varepsilon_n^k)^2 i(\bar{\gamma}_n^{(k)}, \bar{\gamma}_n^{(k)}) = 0$. Moreover, by construction, $i_{per}(\gamma_n^{(k)}, \gamma_n^{(k)}) \leq C_n$ for every k and n , as mentioned earlier (or in [ES3, Lem. 2.7]) it ensures that for n fixed the $\gamma_n^{(k)}$ are all included in the same compact subsurface of $\Sigma \setminus \partial\Sigma$. It follows that μ_n is supported on a compact set of $\Sigma \setminus \partial\Sigma$ and by (2.2.2) they are measured laminations.

Recall that β is a filling curve of S , as a consequence, $i(\mu_n, \beta) \neq 0$ and hence, we can suppose that $i(\mu_n, \beta) = 1$ for every n and we obtain

$$\lim_{k \rightarrow \infty} \delta_n^k \bar{\gamma}_n^{(k)} = \mu_n \text{ in } \mathcal{C}(\Sigma), \quad (2.4.2)$$

where $\delta_n^k = \frac{1}{i(\beta, \bar{\gamma}_n^{(k)})}$ is well-defined.

To sum up, we have the following convergence diagram, where all the convergences are pointwise.

$$\begin{array}{ccccccc} \delta_1^1 \frac{\ell_{X_1}(\cdot)}{\pi^2 |\chi|} & \delta_2^2 \frac{\ell_{X_2}(\cdot)}{\pi^2 |\chi|} & \cdots & \delta^k \frac{\ell_{X_k}(\cdot)}{\pi^2 |\chi|} & \cdots & \longrightarrow & F \in \mathbb{R}_+^{\mathcal{C}(S)} \\ \uparrow & \uparrow & \cdots & \uparrow & \cdots & & \uparrow ? \\ \vdots & \vdots & \cdots & \vdots & \cdots & & \vdots \\ \delta_n^1 i(\bar{\gamma}_n^{(1)}, \cdot) & \delta_n^2 i(\bar{\gamma}_n^{(2)}, \cdot) & \cdots & \delta_n^k i(\bar{\gamma}_n^{(k)}, \cdot) & \cdots & \longrightarrow & i(\mu_n, \cdot) \\ \vdots & \vdots & \cdots & \vdots & \cdots & \vdots & \vdots \\ \delta_2^1 i(\bar{\gamma}_2^{(1)}, \cdot) & \delta_2^2 i(\bar{\gamma}_2^{(2)}, \cdot) & \cdots & \delta_2^k i(\bar{\gamma}_2^{(k)}, \cdot) & \cdots & \longrightarrow & i(\mu_2, \cdot) \\ \delta_1^1 i(\bar{\gamma}_1^{(1)}, \cdot) & \delta_1^2 i(\bar{\gamma}_1^{(2)}, \cdot) & \cdots & \delta_1^k i(\bar{\gamma}_1^{(k)}, \cdot) & \cdots & \longrightarrow & i(\mu_1, \cdot) \end{array}$$

We want F to be the pointwise limit of $(i(\mu_n, \cdot))_{n \in \mathbb{N}}$. To prove it, it is sufficient to show that the convergence $\delta_n^k i(\bar{\gamma}_n^{(k)}, \gamma) \xrightarrow[n \rightarrow \infty]{} \delta^k \frac{\ell_k(\gamma)}{\pi^2 |\chi|}$ is uniform in k when $\gamma \in \mathcal{C}(S)$ is fixed.

If $\gamma \in \mathcal{C}(S)$ is fixed then Theorem 2.15 ensures that

$$\left| \frac{\delta_n^k}{\delta^k} - 1 \right| \leq \varepsilon_n \text{ and } \left| i(\bar{\gamma}_n^{(k)}, \gamma) \left(\frac{\ell_k(\gamma)}{\pi^2 |\chi|} \right)^{-1} - 1 \right| \leq \varepsilon_n$$

for every k and for n large enough (n_γ and n_β do not depend on k) with $\varepsilon_n \xrightarrow[n \rightarrow \infty]{} 0$. Moreover, fixing γ we know that $\delta^k \frac{\ell_k(\gamma)}{\pi^2 |\chi|} \xrightarrow[k \rightarrow \infty]{} F(\gamma)$ hence the sequence $(\delta^k \frac{\ell_k(\gamma)}{\pi^2 |\chi|})_{k \in \mathbb{N}}$ is

bounded by some d_γ and we obtain

$$\left| \delta_n^k i(\bar{\gamma}_n^{(k)}, \gamma) - \delta^k \frac{\ell_k(\gamma)}{\pi^2 |\chi|} \right| \leq v_n d_\gamma \xrightarrow{n \rightarrow \infty} 0.$$

Hence, the convergence holds uniformly in k , and $\lim_{n \rightarrow \infty} \lim_{k \rightarrow \infty} \delta_n^k i(\bar{\gamma}_n^{(k)}, \gamma) = \lim_{k \rightarrow \infty} \lim_{n \rightarrow \infty} \delta_n^k i(\bar{\gamma}_n^{(k)}, \gamma)$, which implies that $F(\gamma) = \lim_{n \rightarrow \infty} i(\mu_n, \gamma)$. Moreover, $\mathcal{ML}(S)$ is a closed subset of $\mathbb{R}_{\geq 0}^{\mathfrak{C}(S)}$ hence $F(\cdot) = \lim_{n \rightarrow \infty} i(\mu_n, \cdot)$ is of the form $F(\cdot) = i(\mu, \cdot)$ where $\mu \in \mathcal{ML}(S)$, which was what we needed to prove. \square

2.5 Another way to recover continuity

All the arguments above can be recovered in $\mathfrak{C}(S)$ using Theorem 1.41. Let us sketch quickly the arguments.

Let $(X_k)_{k \in \mathbb{N}}$ be a sequence in $\mathcal{T}(S)$ and assume that the associated sequence of length functions $(\ell_k)_{k \in \mathbb{N}}$ converges pointwise to F in $\mathbb{P}_+(\mathbb{R}_{\geq 0}^{\mathfrak{C}(S)})$. We want to show that F is the intersection number with a measured lamination.

$$\varepsilon^1 \frac{\ell_{X_1}(\cdot)}{\pi^2 |\chi|} \quad \varepsilon^2 \frac{\ell_{X_2}(\cdot)}{\pi^2 |\chi|} \quad \dots \quad \varepsilon^k \frac{\ell_{X_k}(\cdot)}{\pi^2 |\chi|} \quad \dots \quad \longrightarrow \quad F \in \mathbb{R}_{\geq 0}^{\mathfrak{C}(S)}$$

For each k , use Theorem 2.15 to approximate, pointwise, the lengths by intersection numbers with sequences of random geodesics $(\gamma_n^{(k)})_{n \in \mathbb{N}}$.

$$\begin{array}{ccccccc} \varepsilon^1 \frac{\ell_{X_1}(\cdot)}{\pi^2 |\chi|} & \varepsilon^2 \frac{\ell_{X_2}(\cdot)}{\pi^2 |\chi|} & \dots & \varepsilon^k \frac{\ell_{X_k}(\cdot)}{\pi^2 |\chi|} & \dots & \longrightarrow & F \in \mathbb{R}_{\geq 0}^{\mathfrak{C}(S)} \\ \uparrow & \uparrow & \dots & \uparrow & \dots & & \\ \vdots & \vdots & \dots & \vdots & \dots & & \\ \varepsilon^1 i(\bar{\gamma}_n^{(1)}, \cdot) & \varepsilon^2 i(\bar{\gamma}_n^{(2)}, \cdot) & \dots & \varepsilon^k i(\bar{\gamma}_n^{(k)}, \cdot) & \dots & & \\ \vdots & \vdots & \dots & \vdots & \dots & & \\ \varepsilon^1 i(\bar{\gamma}_2^{(1)}, \cdot) & \varepsilon^2 i(\bar{\gamma}_2^{(2)}, \cdot) & \dots & \varepsilon^k i(\bar{\gamma}_2^{(k)}, \cdot) & \dots & & \\ \varepsilon^1 i(\bar{\gamma}_1^{(1)}, \cdot) & \varepsilon^2 i(\bar{\gamma}_1^{(2)}, \cdot) & \dots & \varepsilon^k i(\bar{\gamma}_1^{(k)}, \cdot) & \dots & & \end{array}$$

For all $n \in \mathbb{N}$ the sequence $(\bar{\gamma}_n^{(k)})_{k \in \mathbb{N}}$ is a sequence in some $\mathfrak{C}_{K_n}(S)$ by the third point of Theorem 2.15, hence Theorem 1.41 ensures that $(\bar{\gamma}_n^{(k)})_{k \in \mathbb{N}}$ converges projectively (up to extraction) to some current $\mu_n \in \mathfrak{C}_{K_n}(S)$ and the continuity of the intersection number over $\mathfrak{C}_{K_n}(S)$ ensures that we have convergence of the intersection functions.

$$\begin{array}{ccccccc}
\delta^1 \frac{\ell_{X_1}(\cdot)}{\pi^2 |\mathcal{X}|} & \delta^2 \frac{\ell_{X_2}(\cdot)}{\pi^2 |\mathcal{X}|} & \cdots & \delta^k \frac{\ell_{X_k}(\cdot)}{\pi^2 |\mathcal{X}|} & \cdots & \longrightarrow & F \in \mathbb{R}_{\geq 0}^{\mathcal{C}(S)} \\
\uparrow & \uparrow & \cdots & \uparrow & \cdots & & \uparrow ? \\
\vdots & \vdots & \cdots & \vdots & \cdots & & \vdots \\
\delta_n^1 i(\bar{\gamma}_n^{(1)}, \cdot) & \delta_n^2 i(\bar{\gamma}_n^{(2)}, \cdot) & \cdots & \delta_n^k i(\bar{\gamma}_n^{(k)}, \cdot) & \cdots & \longrightarrow & i(\mu_n, \cdot) \quad \mu_n \in \mathcal{C}_{K_n}(S) \\
\vdots & \vdots & \cdots & \vdots & \cdots & \vdots & \vdots \\
\delta_2^1 i(\bar{\gamma}_2^{(1)}, \cdot) & \delta_2^2 i(\bar{\gamma}_2^{(2)}, \cdot) & \cdots & \delta_2^k i(\bar{\gamma}_2^{(k)}, \cdot) & \cdots & \longrightarrow & i(\mu_2, \cdot) \quad \mu_2 \in \mathcal{C}_{K_2}(S) \\
\delta_1^1 i(\bar{\gamma}_1^{(1)}, \cdot) & \delta_1^2 i(\bar{\gamma}_1^{(2)}, \cdot) & \cdots & \delta_1^k i(\bar{\gamma}_1^{(k)}, \cdot) & \cdots & \longrightarrow & i(\mu_1, \cdot) \quad \mu_1 \in \mathcal{C}_{K_1}(S)
\end{array}$$

The same process as previously allow to conclude.

Remark 2.16. *Note that this is a very brief summary of what could be done to work directly in the non-compact case. Therefore, the same technical details as in the proof in the previous section must be provided.*



COUNTING ARCS OF THE SAME TYPE

This chapter is based on [Tri2].

In this chapter, we prove a general counting result for arcs of the same type in compact surfaces. We also apply our results to count cusp-to-cusp arcs in cusped surfaces and arcs in orbifolds with boundary. These theorems are derived from a result that ensures the convergence of certain measures on the space of geodesic currents.

3.1 Background

In this section, we describe some background on counting problems, arcs and geodesic currents.

In the following, Σ is a compact connected oriented surface with $r > 0$ boundary components and genus g such that $2 - 2g - r < 0$ and $(g, r) \neq (0, 3)$.

3.1.1 Counting problems

The initial counting problem from which derives this chapter is the following. Given a weighted-multicurve γ_0 of Σ and F a notion of complexity for curves, how does the number of curves of type γ_0 and complexity at most L grow when L goes to infinity? One can also define the type for the action of any finite index subgroup Γ of the mapping class group. Then, we are interested in the growth of the following set:

$$\{\gamma \in \Gamma \cdot \gamma_0 \mid F(\gamma) \leq L\}$$

When the measure of complexity is a length function for a hyperbolic metric this problem is known as Mirzakhani's curves counting. She proved [Mir1; Mir2] that for any complete finite area hyperbolic metric X on Σ , any weighted multicurve $\gamma_0 \in \mathfrak{C}_m(\Sigma)$ and

any finite index subgroup Γ of $\text{Map}(\Sigma)$ there is a constant $\mathbf{c}_{g,r}^\Gamma(\gamma_0)$ such that

$$\lim_{L \rightarrow \infty} \frac{\#\{\gamma \in \Gamma \cdot \gamma_0 \mid \ell_X(\gamma) \leq L\}}{L^{6g-6+2r}} = \mathbf{c}_{g,r}^\Gamma(\gamma_0) \cdot \mathbf{m}_{Thu}^\Sigma(\{\ell_X(\cdot) \leq 1\}), \quad (3.1.1)$$

where \mathbf{m}_{Thu}^Σ is the Thurston measure on the measured geodesic laminations of Σ . The same result has been obtained by Erlandsson-Souto [ES3] for any notion of complexity for curves using the following principal. To study the cardinal of a given set one can study the counting measure associated to this set. This strategy is also the one used in [Mir1] for simple curves. The analog of eq. (3.1.1) in terms of measures is the following:

$$\lim_{L \rightarrow \infty} \frac{1}{L^{6g-6+2r}} \sum_{\gamma \in \Gamma \cdot \gamma_0} \delta_{\frac{1}{L}\gamma} = \mathbf{c}_{g,r}^\Gamma(\gamma_0) \cdot \mathbf{m}_{Thu}^\Sigma \quad (3.1.2)$$

where the convergence occurs for the weak* topology in the set of Radon measures on $\mathcal{C}(\Sigma)$. Hence, one can recover eq. (3.1.1) for a measure of complexity for curves F by applying eq. (3.1.2) to $\{\mu \in \mathcal{C}(\Sigma) \mid F(\mu) \leq 1\}$.

If we consider now arcs rather than curves (we define the notion of arcs in more detail in the next subsection) Bell [Bel2; Bell] proved an analog of eq. (3.1.1) where the complexity is the length function for arcs of the same type rather than curves. This chapter answer the following question:

Question

Can the counting problems for arcs be expressed in terms of convergence of counting measures on geodesic currents ?

3.1.2 Arcs on surfaces

For technical reasons we need to fix a orientation in the surface and the notion of arcs is defined taking into account this specificity.

Definition 3.1. *An arc α in Σ is a free homotopy class of non-trivial oriented segments based on boundary components and we identify two arcs which differ by changing the orientation. A **weighted multiarc** α is a finite sum of arcs with positive weights.*

We will denote by $\mathcal{A}(\Sigma)$ the set of arcs and $\mathcal{A}_m(\Sigma)$ the set of weighted multiarcs.

Property 3.2. *For any hyperbolic structure X on Σ , each arc α admits a unique orthogeodesic representative α_* .*

Hence, in the same way as we define the length function for curves we dispose of a notion of length for arcs:

$$\begin{aligned} \ell_X : \mathcal{A}(\Sigma) &\rightarrow \mathbb{R}_{\geq 0} \\ \alpha &\mapsto \ell_X(\alpha_*). \end{aligned}$$

The intersection number between arcs or arc and curve is also defined in the same way as for curves and we also have an action of the mapping class group on arcs which preserves the intersection number.

Definition 3.3. *Two arcs are said to be **of the same type** if they are in the same mapping class group orbit.*

3.1.3 Doubling the surface

In order to obtain a version of eq. (3.1.2) for arcs we need to be able to see arcs as geodesic currents. However, achieving this interpretation using the same approach as for curves is not feasible. This is why we will work on the doubled surface $D\Sigma$. The surface $D\Sigma$ is the closed oriented surface of genus $g(D\Sigma) = 2g + r - 1$ corresponding to the doubling of Σ . In that setting, the arcs of Σ will represent a specific subset of the symmetric curves of $D\Sigma$.

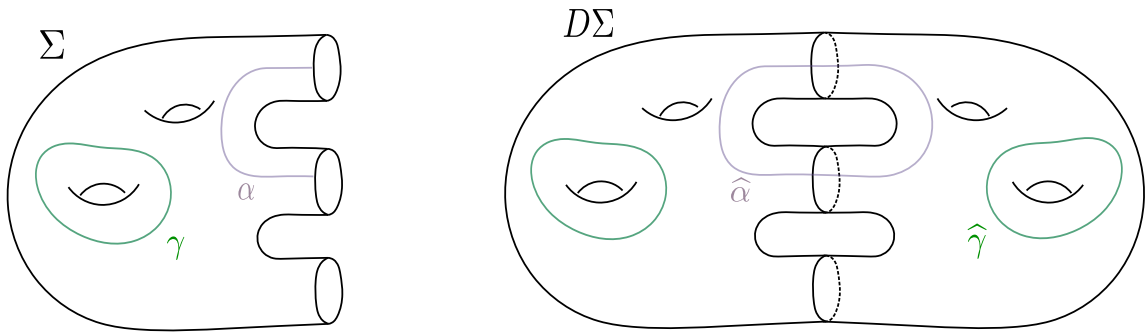

Figure 3.1 – From Σ to $D\Sigma$

We can embed two copies of Σ into $D\Sigma$ such that they cover $D\Sigma$ and meet pointwise along their boundary components. We will denote by Σ^+ and Σ^- these two copies, i^+ and i^- the associated embeddings, and $\sigma : D\Sigma \mapsto D\Sigma$ the involution that exchanges

Σ^+ and Σ^- (it is an orientation reversing map which is the identity when restricted to the boundary of Σ). The embeddings i^+ and i^- naturally extend to embeddings from the geodesic currents of Σ to the geodesic currents of $D\Sigma$; hence, for an element μ in $\mathcal{C}(\Sigma)$ we will denote by $\hat{\mu}$ its doubled version:

$$\begin{aligned} \hat{\cdot} : \mathcal{C}(\Sigma) &\hookrightarrow \mathcal{C}(D\Sigma) \\ \mu &\mapsto i^+(\mu) + i^-(\mu). \end{aligned} \tag{3.1.3}$$

To obtain Theorem 3.13, we need to see the Thurston measure as a Radon measure on $\mathcal{C}(D\Sigma)$. To do so, we pushforward the measure through the hat operator to obtain a measure \hat{m}_{Thu}^Σ in $\mathcal{C}(D\Sigma)$ supported by $\widehat{\mathcal{ML}}(\Sigma)$.

We remark that the elements in the image of the hat operator are fixed by the involution σ . More generally, we call the elements fixed by σ **symmetric** and denote by $\mathfrak{C}^\sigma(D\Sigma)$ the symmetric curves of $D\Sigma$ and $\mathcal{ML}^\sigma(D\Sigma)$ the symmetric measured laminations. We also note that the set of symmetric measured laminations is larger than the image $\widehat{\mathcal{ML}}(\Sigma)$ of $\mathcal{ML}(\Sigma)$ by the hat operator, for example, the embedded boundary components of Σ are symmetric but are not represented by elements in the image of $\mathcal{ML}(\Sigma)$ by the hat operator. We record the following characterization of $\widehat{\mathcal{ML}}(\Sigma)$ in $\mathcal{ML}^\sigma(D\Sigma)$ for later reference.

Proposition 3.4. *A symmetric measured lamination $\Lambda \in \mathcal{ML}^\sigma(D\Sigma)$ is an element of $\widehat{\mathcal{ML}}(\Sigma)$ if and only if*

1. Λ does not have connected components of $\partial\Sigma$ as leaves,
2. $i(\Lambda, \partial\Sigma) = 0$, where $i(\cdot, \cdot)$ is the intersection form between currents. □

At last, for any (multi)arc $\alpha \in \mathcal{A}(\Sigma)$ its two copies $i^+(\alpha)$ and $i^-(\alpha)$ into $D\Sigma$ meet at their endpoints and their union forms a symmetric (multi)curve of $D\Sigma$. We will denote by $\hat{\alpha}$ that curve: it is not an image by the above hat operator but this notation is consistent with the one for curves or measured lamination as their image through $\hat{\cdot}$ are the union of their two copies (see fig. 3.1). The curves of $D\Sigma$ are geodesic currents of $D\Sigma$, so, the doubling process implies that we are now able to see arcs as geodesic currents.

$$\begin{aligned} \hat{\cdot} : \mathcal{A}_m(\Sigma) &\hookrightarrow \mathfrak{C}_m^\sigma(D\Sigma) \hookrightarrow \mathcal{C}(D\Sigma) \\ \alpha &\mapsto \hat{\alpha} \mapsto \hat{\alpha}. \end{aligned} \tag{3.1.4}$$

3.2 Counting problems with a bound on the intersection number

Our next goal is to prove solve a particular counting problems for arcs we will use as a base for the proof of our main theorem. We want to show that we can count arcs when we measure their complexity using the intersection number with a filling curve of Σ . Our argument is inspired by those of Bell [Bel2; Bell]. Bell's approach consists in associating to each arc α the curve $\gamma_\alpha = \alpha^{-1} \cdot a_2 \cdot \alpha \cdot a_1$, where a_2 and a_1 are the boundary components at the end and begining of α — whatever the chosen orientation for α , the associated curve is the same. It turns out that α and γ_α are closely related and we will be able to extend the counting results for γ_α to results for α .

The above construction of γ_α for a given curve induces a map from the set of weighted multiarcs to the set of weighted multicurves of Σ :

$$\begin{aligned} I &: \mathcal{A}_m(\Sigma) &\rightarrow & \mathfrak{C}_m(\Sigma) \\ & \sum \varepsilon_i \alpha_i &\mapsto & \sum \varepsilon_i \gamma_{\alpha_i}. \end{aligned}$$

The first point to notice about the map I is that it is equivariant with respect to the mapping class group, meaning that for any $\phi \in \text{Map}(\Sigma)$ and $\alpha \in \mathcal{A}_m(\Sigma)$

$$\phi \cdot I(\alpha) = I(\phi \cdot \alpha).$$

Secondly, we can prove that α and $I(\alpha)$ are nearby in the sense that they intersect curves essentially in the same way.

Lemma 3.5. *For any $\alpha \in \mathcal{A}_m(\Sigma)$ there is $d_\alpha \in \mathbb{N}$ such that if $\mu \in \mathfrak{C}_m(\Sigma)$ is a weighted-multicurve then*

$$|i(I(\alpha), \mu) - 2i(\alpha, \mu)| \leq d_\alpha i(\mu, \mu) \tag{3.2.1}$$

where $i(\cdot, \cdot)$ is the geometric intersection number. Moreover, $\alpha \mapsto d_\alpha$ is invariant under the action of the mapping class group on $\mathcal{A}_m(\Sigma)$.

Proof. For any arc $\alpha \in \mathcal{A}(\Sigma)$ there is an immersion, unique up to homotopy, that sends a pair of pants P into Σ in such a way that the image of the boundary components are a_1 , a_2 and $I(\alpha)$, and such that α is the image of the unique simple arc between the preimage of a_1 and a_2 .

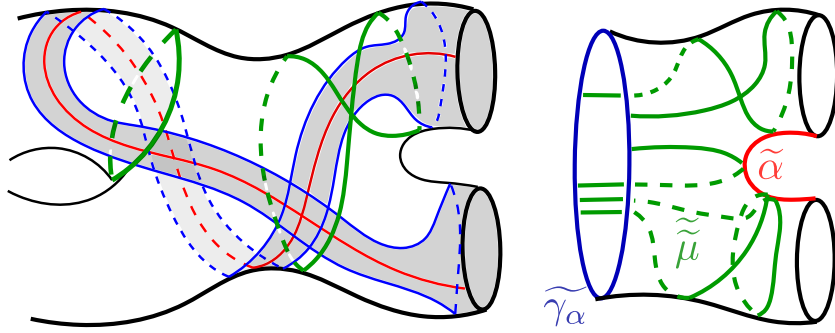

Figure 3.2 – Immersed and embedded pair of pants

Let H be the subgroup of $\pi_1(\Sigma)$ given by the image of $\pi_1(P)$ under the immersion. The group H is the free group of rank 2 and the pair of pants lifts homeomorphically to $\tilde{\Sigma}/H$ as a compact subsurface. Surface groups being LERF [Sco], there is a finite index subgroup K of $\pi_1(\Sigma)$ containing H such that P is embedded into $\tilde{\Sigma}/K$. This means that there is a cover of Σ , of degree $d_\alpha < \infty$, in which some well chosen lifts \tilde{a}_1 , \tilde{a}_2 , and $\tilde{I}(\tilde{\alpha})$ of a_1 , a_2 , and $I(\alpha)$ are the three boundary components of an embedded pair of pants and such that the unique simple arc between \tilde{a}_1 and \tilde{a}_2 is a lift $\tilde{\alpha}$ of α (see fig. 3.2). If μ is a weighted multicurve of Σ we denote by $\tilde{\mu}$ its preimage inside this cover.

In that setting, then there is a lift $\tilde{I}(\tilde{\alpha})$ of $I(\alpha)$ equal to $I(\tilde{\alpha})$. So, in the previous cover we have the following relations between intersection numbers:

1. $i(I(\alpha), \mu) \leq 2i(\alpha, \mu)$ by construction of $I(\alpha)$,
2. $i(I(\tilde{\alpha}), \tilde{\mu}) = i(I(\alpha), \mu)$, $i(\tilde{\alpha}, \tilde{\mu}) = i(\alpha, \mu)$ and $i(\tilde{\mu}, \tilde{\mu}) = d_\alpha \cdot i(\mu, \mu)$ by definition of a covering map.

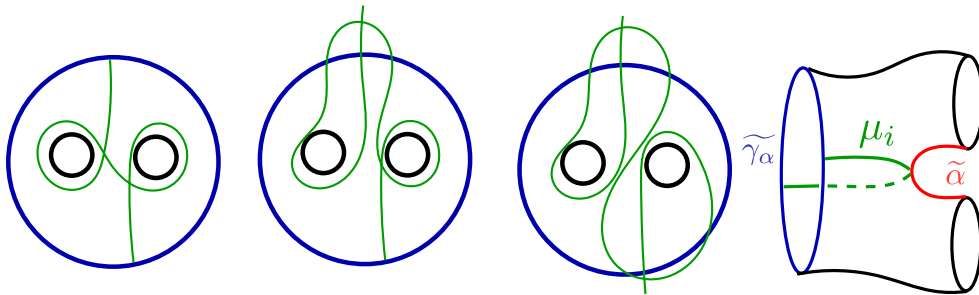

Figure 3.3 – Pulling the intersections out of the pair of pants

By pulling outside of the pair of pants bounded by \tilde{a}_1, \tilde{a}_2 and $I(\tilde{\alpha}) = \tilde{\gamma}_\alpha$ the self intersections of $\tilde{\mu}$ we obtain a curve μ' such that the arcs of $\mu' \cap P$ are all of the type μ_i

described in fig. 3.3 *ie*. An intersection with $\tilde{\alpha}$ corresponds to exactly two intersections with $\tilde{\gamma}_\alpha$. The operation of pulling an intersection outside of P does change the number of intersection with $\tilde{\alpha}$ but adds two intersections with $\tilde{\gamma}_\alpha$. Hence, we have the following inequalities.

$$i(\tilde{\alpha}, \tilde{\mu}) = i(\tilde{\alpha}, \mu') = \frac{1}{2}i(I(\tilde{\alpha}), \mu') \leq \frac{1}{2}(i(I(\tilde{\alpha}), \tilde{\mu}) + 2\iota(\tilde{\mu}, \tilde{\mu}))$$

All in all, it occurs that

$$0 \leq 2 \cdot i(\alpha, \mu) - i(I(\alpha), \mu) = 2i(\tilde{\alpha}, \tilde{\mu}) - i(I(\tilde{\alpha}), \tilde{\mu}) \leq 2\iota(\tilde{\mu}, \tilde{\mu}) = d_\alpha \cdot i(\mu, \mu), \quad (3.2.2)$$

and eq. (3.2.1) follows for α .

Moreover, since any mapping class ϕ induces a isomorphism $\phi_* : \pi_1(\Sigma) \rightarrow \pi_1(\Sigma)$ we can choose d_α to be the same for every arc in a given orbit. We have proved the lemma for arcs and the triangle inequality gives the results for weighted multiarcs. \square

Let Γ be a subgroup of $\text{Map}(\Sigma)$, we can consider the restriction of I to the orbit of a given weighted multiarc α_0 under the action of Γ :

$$\begin{aligned} I_{|\Gamma \cdot \alpha_0} & : \Gamma \cdot \alpha_0 & \rightarrow & \Gamma \cdot I(\alpha_0) \\ & \alpha & \mapsto & I(\alpha), \end{aligned}$$

equivariance under $\text{Map}(\Sigma)$ and Lemma 3.5 imply that this map is finite-to-one.

Proposition 3.6. *For all $\alpha_0 \in \mathcal{A}_m(\Sigma)$ and for any subgroup Γ of $\text{Map}(\Sigma)$, the map $I_{|\Gamma \cdot \alpha_0}$ is well defined and $k_{\alpha_0}^\Gamma$ -to-1 for some $k_{\alpha_0}^\Gamma \in \mathbb{N}$ which depends only on the Γ -type of α_0 . \square*

We are now able to count arcs with respect to the intersection number with a curve. More precisely, we will count with respect to the intersection number with a *filling multicurve* – a curve that divides the surface into disks and annuli – A filling curve must be taken in order to ensure that the limit obtained is finite as well as the intermediate sets we count..

Theorem 3.7. *If Σ is a compact connected oriented surface with non-empty boundary and negative Euler characteristic which is not a pair of pants, and Γ is any finite index subgroup of $\text{Map}(\Sigma)$, then for any weighted multiarc α_0 on Σ and for any $\mu \in \mathfrak{C}_m(\Sigma)$ filling multicurve we have*

$$\lim_{L \rightarrow \infty} \frac{\#\{\alpha \in \Gamma \cdot \alpha_0 \mid i(\mu, \alpha) \leq L\}}{L^{6g-6+2r}} = \mathfrak{c}_{g,r}^\Gamma(\alpha_0) \cdot \mathfrak{m}_{Thu}^\Sigma(\{i(\mu, \cdot) \leq 1\}).$$

Here, $\mathbf{c}_{g,r}^\Gamma(\alpha_0)$ is a constant fixed by the type of α_0 , the group Γ and the topology of Σ .

Proof. The intersection number with a filling multicurve is a measure of complexity for curves, hence [ES3, Theo. 9.1] or [ES3, Ex. 9.1] ensure that there exists $\mathbf{c}_{g,r}^\Gamma(I(\alpha_0)) > 0$ such that

$$\lim_{L \rightarrow \infty} \frac{\#\{\gamma \in \Gamma \cdot I(\alpha_0) | i(\mu, \gamma) \leq L\}}{L^{6g-6+2r}} = \mathbf{c}_{g,r}^\Gamma(I(\alpha_0)) \cdot \mathbf{m}_{Thu}^\Sigma(\{i(\mu, \cdot) \leq 1\}). \quad (3.2.3)$$

Hence, by Lemma 3.5 and eq. (3.2.3) we have

$$\begin{aligned} & \limsup_L \frac{\#\{\alpha \in \Gamma \cdot \alpha_0 | i(\alpha, \mu) \leq L\}}{L^{6g-6+2r}} \\ & \leq k_{\alpha_0}^\Gamma \cdot \limsup_L \frac{\#\{\gamma \in \Gamma \cdot I(\alpha_0) | i(\mu, \gamma) \leq 2L + 2d_{\alpha_0} i(\mu, \mu)\}}{L^{6g-6+2r}} \\ & = k_{\alpha_0}^\Gamma \cdot 2^{6g-6+2r} \cdot \limsup_L \frac{\#\{\gamma \in \Gamma \cdot I(\alpha_0) | i(\mu, \gamma) \leq 2L + 2d_{\alpha_0} i(\mu, \mu)\}}{(2L + 2d_{\alpha_0} i(\mu, \mu))^{6g-6+2r}} \left(1 + \frac{d_{\alpha_0} i(\mu, \mu)}{L}\right)^{6g-6+2r} \\ & = k_{\alpha_0}^\Gamma \cdot 2^{6g-6+2r} \cdot \mathbf{c}_{g,r}^\Gamma(I(\alpha_0)) \cdot \mathbf{m}_{Thu}^\Sigma(\{i(\mu, \cdot) \leq 1\}), \end{aligned}$$

where $k_{\alpha_0}^\Gamma$ comes from Proposition 3.6. With the same computations

$$\liminf_L \frac{\#\{\alpha \in \Gamma \cdot \alpha_0 | i(\alpha, \mu) \leq L\}}{L^{6g-6+2r}} \geq k_{\alpha_0}^\Gamma \cdot 2^{6g-6+2r} \cdot \mathbf{c}_{g,r}^\Gamma(I(\alpha_0)) \cdot \mathbf{m}_{Thu}^\Sigma(\{i(\mu, \cdot) \leq 1\}),$$

and we obtain Theorem 3.7 with $\mathbf{c}_{g,r}^\Gamma(\alpha_0) = k_{\alpha_0}^\Gamma \cdot 2^{6g-6+2r} \cdot \mathbf{c}_{g,r}^\Gamma(I(\alpha_0))$. \square

3.3 Proof of the main theorem

In this section, Σ is still a compact connected oriented surface, with genus g , and $r > 0$ boundary components, with negative Euler characteristic and such that $(g, r) \neq (0, 3)$. For technical reasons, Σ is endowed with a hyperbolic structure with geodesic boundary. Note that it induces a hyperbolic structure on $D\Sigma$. In the following, we fix a weighted multiarc $\alpha_0 \in \mathcal{A}_m(\Sigma)$ and a finite index subgroup Γ of $\text{Map}(\Sigma)$. The doubling process allows us to see α_0 as a current (see eq. (3.1.4)) and to define a family $(\nu_{\alpha_0, L}^\Gamma)_{L>0}$ of Radon measures on $\mathcal{C}(D\Sigma)$ from α_0 by

$$\nu_{\alpha_0, L}^\Gamma = \frac{1}{L^{6g-6+2r}} \sum_{\alpha \in \Gamma \cdot \alpha_0} \delta_{\frac{1}{L}\hat{\alpha}} \quad \forall L > 0. \quad (3.3.1)$$

The strategy to prove Theorem 3.13 is the following. We will prove that $(\nu_{\alpha_0, L}^\Gamma)_{L>0}$ has accumulation points and that they are all supported by $\widehat{\mathcal{ML}}(\Sigma)$. Afterwards, we will use the characterisation of $\text{Map}(\Sigma)$ -invariant measures on measured geodesic laminations [LM; Ham] to show that these accumulation points are all multiples of the pushforward by the hat operator of the Thurston measure on Σ . We will conclude proving that they are all the same multiple of $\widehat{\mathbf{m}}_{Thu}^\Sigma$. Note that at each step Theorem 3.7 will play a key role.

Proposition 3.8. *The set $(\nu_{\alpha_0, L}^\Gamma)_{L>0}$ is precompact, meaning that for every $(L_n)_{n \in \mathbb{N}} \in \mathbb{R}_+^{\mathbb{N}}$ with $L_n \rightarrow \infty$, there is a Radon measure $\widehat{\mathbf{m}}$ on $\mathcal{C}(D\Sigma)$ and subsequence L_{n_i} such that*

$$\lim_{i \rightarrow \infty} \nu_{\alpha_0, L_{n_i}}^\Gamma = \widehat{\mathbf{m}}.$$

Proof. The $\nu_{\alpha_0, L_n}^\Gamma$ are measures with support in $\mathcal{C}(D\Sigma)$ which is locally compact [Bon2]. Hence the set of Radon measures on $\mathcal{C}(D\Sigma)$ has the Heine-Borel property: to show that each sequence has a convergent subsequence it suffices to show that $\{\nu_{\alpha_0, L_n}^\Gamma\}$ is bounded, that is to show that for every continuous and compactly supported function f on $\mathcal{C}(D\Sigma)$, $\limsup_n \int f d\nu_{\alpha_0, L_n}^\Gamma < \infty$.

Fix a continuous and compactly supported function f on $\mathcal{C}(D\Sigma)$. As f has compact support, $|f|$ is bounded by some $b > 0$ and there is some $D > 0$ such that $i(\mu, \widehat{\delta}_0) \leq 2D$ for every μ in the support of f , where δ_0 is a fixed filling curve of Σ . Hence

$$\begin{aligned} \int |f| d\nu_{\alpha_0, L_n}^\Gamma &\leq b \cdot \nu_{\alpha_0, L_n}^\Gamma(\text{Supp}(f)) \\ &\leq b \cdot \nu_{\alpha_0, L_n}^\Gamma(\{\mu \in \mathcal{C}(D\Sigma) | i(\mu, \widehat{\delta}_0) \leq 2D\}). \end{aligned} \quad (3.3.2)$$

Moreover, we have

$$\begin{aligned} \nu_{\alpha_0, L_n}^\Gamma(\{\mu \in \mathcal{C}(D\Sigma) | i(\mu, \widehat{\delta}_0) \leq 2D\}) &= \frac{\#\{\alpha \in \Gamma \cdot \alpha_0 | i(\widehat{\alpha}, \widehat{\delta}_0) \leq 2DL_n\}}{L_n^{6g-6+2r}} \\ &= \frac{\#\{\alpha \in \Gamma \cdot \alpha_0 | i(\alpha, \delta_0) \leq DL_n\}}{L_n^{6g-6+2r}}. \end{aligned}$$

Hence, Theorem 3.7 ensures that

$$\nu_{\alpha_0, L_n}^\Gamma(\{\mu \in \mathcal{C}(D\Sigma) | i(\mu, \widehat{\delta}_0) \leq 2D\}) \xrightarrow{n \rightarrow \infty} D^{6g-6+2r} \cdot \mathbf{c}_{g,r}^\Gamma(I(\alpha_0)) \cdot \mathbf{m}_{Thu}^\Sigma(i(\delta_0, \cdot) \leq 1),$$

which together with eq. (3.3.2) ensures that $\limsup_n \int f d\nu_{\alpha_0, L_n}^\Gamma < \infty$. That concludes the

proof. □

We now want to show that every $\widehat{\mathbf{m}}$ as above is supported by $\widehat{\mathcal{ML}}(\Sigma)$ (meaning that its complement has 0 measure). In some sense, this justifies the notation $\widehat{\mathbf{m}}$.

Proposition 3.9. *The measure $\widehat{\mathbf{m}}$ in Proposition 3.8 is supported by $\widehat{\mathcal{ML}}(\Sigma)$.*

Proof. In light of Proposition 3.4, to show that $\widehat{\mathbf{m}}$ has support in $\widehat{\mathcal{ML}}(\Sigma)$ there are three points to prove. We need to prove that $\widehat{\mathbf{m}}$ is supported by symmetric measured laminations — the fact that the elements of the support are symmetric comes from the construction of the $\nu_{\alpha_0, L_n}^\Gamma$ so we just need to show that they are measured laminations. The second point to prove is that they do not cross the image of $\partial\Sigma$ in $D\Sigma$. Finally, we need to argue that they do not have connected components of $\partial\Sigma$ as leaves.

Regarding this last point, note that if we assume that the support of $\widehat{\mathbf{m}}$ is made of symmetric measured laminations then the elements in the support of $\nu_{\alpha_0, L}^\Gamma$ are all orthogonal to $\partial\Sigma$ so those in the support of $\widehat{\mathbf{m}}$ are all transversal to $\partial\Sigma$.

Let us now show the first two points. We know that $\widehat{\mathbf{m}}$ has support in the symmetric currents so, to show that it is supported by $\mathcal{ML}^\sigma(D\Sigma)$ it suffices to show that for every $R > 0$,

$$\int_{\{\mu \in \mathcal{C}(D\Sigma) \mid i(\mu, \Delta_0) \leq R\}} i(\mu, \mu) d\widehat{\mathbf{m}} = 0$$

where Δ_0 is a filling multicurve of $D\Sigma$. We can assume that Δ_0 decomposes into $\widehat{\delta}_0$ — where $\widehat{\delta}_0$ is a filling curve of Σ — and a multicurve s of $D\Sigma$ that completes $\widehat{\delta}_0$ to a filling multicurve of $D\Sigma$.

For every $L > 0$ we have

$$\begin{aligned} \int_{\{\mu \in \mathcal{C}(D\Sigma) \mid i(\mu, \Delta_0) \leq R\}} i(\mu, \mu) d\nu_{\alpha_0, L}^\Gamma &= \frac{1}{L^{6g-6+2r}} \sum_{\substack{\alpha \in \Gamma \cdot \alpha_0 \\ i(\widehat{\alpha}, \Delta_0) \leq LR}} i\left(\frac{\widehat{\alpha}}{L}, \frac{\widehat{\alpha}}{L}\right) \\ &\leq \frac{1}{L^{6g-6+2r}} \sum_{\substack{\alpha \in \Gamma \cdot \alpha_0 \\ i(\widehat{\alpha}, \widehat{\delta}_0) \leq LR}} i\left(\frac{\widehat{\alpha}}{L}, \frac{\widehat{\alpha}}{L}\right) \\ &= \frac{1}{L^{6g-6+2r}} \sum_{\substack{\alpha \in \Gamma \cdot \alpha_0 \\ i(\alpha, \delta_0) \leq LR/2}} 2 \frac{i(\alpha, \alpha)}{L^2} \\ &= \left(\frac{R}{2}\right)^{6g-6+2r} \frac{2i(\alpha_0, \alpha_0) \#\{\alpha \in \Gamma \cdot \alpha_0 \mid i(\alpha, \delta_0) \leq \frac{LR}{2}\}}{L^2 \left(\frac{LR}{2}\right)^{6g-6+2r}} \\ &\xrightarrow{L \rightarrow \infty} \left(\frac{R}{2}\right)^{6g-6+2r} \cdot 0 \cdot \mathbf{c}_{g,r}^\Gamma(\alpha_0) \cdot \mathbf{m}_{Thu}^\Sigma(\{i(\cdot, \delta_0) \leq 1\}) \end{aligned} \tag{3.3.3}$$

However, there is some $L_n \xrightarrow[n \rightarrow \infty]{} \infty$ such that $\nu_{\alpha_0, L_n}^\Gamma \xrightarrow[n \rightarrow \infty]{} \widehat{\mathbf{m}}$. Hence, eq. (3.3.3) ensures that

$$\int_{\{\mu \in \mathcal{C}(D\Sigma) \mid i(\mu, \Delta_0) \leq R\}} i(\mu, \mu) d\widehat{\mathbf{m}} = 0,$$

meaning that the elements of the support of $\widehat{\mathbf{m}}$ have no self intersection: they are measured laminations of $D\Sigma$ (see Theorem 1.33).

A similar computation allows us to obtain that for every $R > 0$,

$$\int_{\{\mu \in \mathcal{C}(D\Sigma) \mid i(\mu, \Delta_0) \leq R\}} i(\mu, \partial\Sigma) d\widehat{\mathbf{m}} = 0.$$

Hence the measured laminations in the support of $\widehat{\mathbf{m}}$ do not cross the boundary of Σ and that concludes the proof. \square

Corollary 3.10. *Any measure $\widehat{\mathbf{m}}$ as in Proposition 3.8 arises as the pushforward by the hat operator of a measure \mathbf{m} in $\mathcal{ML}(\Sigma)$ defined by*

$$\forall U \subset \mathcal{ML}(\Sigma), \quad \mathbf{m}(U) := \widehat{\mathbf{m}}(\{\widehat{\lambda} \mid \lambda \in U\}). \quad (3.3.4)$$

\square

As in [RS], to show that the limit element is a multiple of the pulled-back Thurston measure we will use the following theorem which comes from [LM].

Theorem (Lindenstrauss-Mirzakhani). *Let μ be a locally finite $\text{Map}(\Sigma)$ -invariant measure on $\mathcal{ML}(\Sigma)$. If for all simple closed curve γ of Σ*

$$\mu(\{\lambda \in \mathcal{ML}(\Sigma) \mid i(\lambda, \gamma) = 0\}) = 0, \quad (1.4.1)$$

then μ is a multiple of the Thurston measure \mathbf{m}_{Thu}^Σ . \square

It is certainly known to experts that this theorem is also true for a Γ -invariant measure where Γ is a finite index subgroup of $\text{Map}(\Sigma)$. Still, let us give a proof.

Lemma 3.11. *Let Γ be a finite index subgroup of $\text{Map}(\Sigma)$. If μ is a locally finite Γ -invariant measure on $\mathcal{ML}(\Sigma)$ such that*

$$\mu(\{\lambda \in \mathcal{ML}(\Sigma) \mid i(\lambda, \gamma) = 0\}) = 0 \quad (1.4.1)$$

for every simple closed curve γ of Σ , then μ is a multiple of the Thurston measure \mathbf{m}_{Thu}^Σ .

Proof. Since every finite index subgroup Γ of $\text{Map}(\Sigma)$ admits a finite index subgroup which is normal in $\text{Map}(\Sigma)$, we can suppose that Γ is normal to begin with.

As the subgroup Γ is finite index, we can choose finitely many elements ϕ_1, \dots, ϕ_s of $\text{Map}(\Sigma)$ such that every element $\varphi \in \text{Map}(\Sigma)$ can be uniquely written as $\varphi = g \circ \phi_i$ with $g \in \Gamma$. If μ is a measure as in the statement then we define

$$\tilde{\mu} := \sum_{i=1}^s \phi_{i*} \mu.$$

Since Γ is normal and μ is Γ -invariant, the definition is independent of the choice of the ϕ_i .

Now, for $\psi \in \text{Map}(\Sigma)$, $[\phi] \in \text{Map}(\Sigma)/\Gamma \mapsto [\psi \circ \phi] \in \text{Map}(\Sigma)/\Gamma$ is well-defined and bijective so $\psi_* \tilde{\mu} = \sum_{i=1}^s \psi_* \phi_{i*} \mu = \sum_{i=1}^s (\psi \circ \phi_i)_* \mu = \tilde{\mu}$ and $\tilde{\mu}$ is a $\text{Map}(\Sigma)$ -invariant locally finite measure on $\mathcal{ML}(\Sigma)$.

Moreover, if γ is a simple curve in Σ then

$$\begin{aligned} \tilde{\mu}(\{\lambda \in \mathcal{ML}(\Sigma) | i(\lambda, \gamma) = 0\}) &= \sum_{i=1}^s \phi_{i*} \mu(\{\lambda \in \mathcal{ML}(\Sigma) | i(\lambda, \gamma) = 0\}) \\ &= \sum_{i=1}^s \mu(\{\lambda \in \mathcal{ML}(\Sigma) | i(\phi_i^{-1} \lambda, \gamma) = 0\}) \\ &= \sum_{i=1}^s \mu(\{\lambda \in \mathcal{ML}(\Sigma) | i(\lambda, \phi_i \gamma) = 0\}). \end{aligned}$$

As a consequence, $\tilde{\mu}$ satisfies (1.4.1) as soon as μ does, and is therefore a multiple of the Thurston measure by Lindenstrauss-Mirzakhani Theorem.

Moreover, we can suppose that $\phi_1 = Id_\Sigma$ hence $\mu = \phi_{1*} \mu$ is absolutely continuous with respect to $\tilde{\mu}$ and to \mathbf{m}_{Thu}^Σ . However, the Thurston measure is Γ -ergodic [Mas] so μ is a positive multiple of \mathbf{m}_{Thu}^Σ . \square

Lemma 3.12. *If $\hat{\mathbf{m}}$ is as in Proposition 3.8 then the associated measure \mathbf{m} (see Corollary 3.10) on $\mathcal{ML}(\Sigma)$ satisfies eq. (1.4.1).*

Proof. Let γ be a simple curve of Σ , we want to show that $\mathbf{m}(\{\lambda \in \mathcal{ML}(\Sigma) | i(\lambda, \gamma) = 0\}) = 0$. By inner regularity it suffices to show that for every $R > 0$,

$$\mathbf{m}(\{\lambda \in \mathcal{ML}(\Sigma) | i(\lambda, \gamma) < \varepsilon, i(\lambda, \delta_0) < R\}) \xrightarrow{\varepsilon \rightarrow 0} 0 \quad (3.3.5)$$

where δ_0 is a filling curve of Σ .

Moreover, if L_n is such that $\nu_{\alpha_0, L_n}^\Gamma \xrightarrow{n \rightarrow \infty} \widehat{\mathbf{m}}$ then the Portmanteau Theorem ensures that

$$\begin{aligned} \mathbf{m}(\{\lambda \in \mathcal{ML}(\Sigma) | i(\lambda, \gamma) < \varepsilon, i(\lambda, \delta_0) < R\}) &= \widehat{\mathbf{m}}(\{\widehat{\lambda} \in \widehat{\mathcal{ML}}(\Sigma) | i(\lambda, \gamma) < \varepsilon, i(\lambda, \delta_0) < R\}) \\ &= \widehat{\mathbf{m}}(\{\mu \in \mathcal{C}(D\Sigma) | i(\mu, \gamma) < 2\varepsilon, i(\mu, \delta_0) < 2R\}) \\ &\leq \liminf_n \nu_{\alpha_0, L_n}^\Gamma(\{\mu \in \mathcal{C}(D\Sigma) | i(\mu, \gamma) < 2\varepsilon, i(\mu, \delta_0) < 2R\}). \end{aligned}$$

Recall that by Proposition 3.6 $I_{\Gamma \cdot \alpha_0} : \alpha \in \Gamma \cdot \alpha_0 \mapsto I(\alpha) \in \Gamma \cdot I(\alpha_0)$ is $k_{\alpha_0}^\Gamma$ -to-1, and that $|i(I(\alpha), \delta) - 2i(\alpha, \delta)| \leq d_{\alpha_0} i(\delta, \delta) = C_\delta$ for every $\alpha \in \Gamma \cdot \alpha_0$ and $\delta \in \mathfrak{C}_m(\Sigma)$ by Lemma 3.5, and $i(I(\alpha), \cdot) \leq 2i(\alpha, \cdot)$ by construction. Hence,

$$\begin{aligned} \nu_{\alpha_0, L_n}^\Gamma(\{\mu \in \mathcal{C}(D\Sigma) | i(\mu, \gamma) < 2\varepsilon, i(\mu, \delta_0) < 2R\}) &= \frac{\#\{\alpha \in \Gamma \cdot \alpha_0 | i(\alpha, \gamma) < \varepsilon L_n, i(\alpha, \delta_0) < R L_n\}}{L_n^{6g-6+2r}} \\ &\leq \frac{\#\{\alpha \in \Gamma \cdot \alpha_0 | i(I(\alpha), \gamma) < 2\varepsilon L_n, i(I(\alpha), \delta_0) \leq 2R L_n + C_{\delta_0}\}}{L_n^{6g-6+2r}} \\ &\leq k_{\alpha_0}^\Gamma \cdot \frac{\#\{\tau \in \Gamma \cdot I(\alpha_0) | i(\tau, \gamma) < 2\varepsilon L_n\}}{L_n^{6g-6+2r}} \\ &\leq k_{\alpha_0}^\Gamma \cdot \nu_{I(\alpha_0), L_n}^\Gamma(\{\lambda | i(\lambda, \gamma) \leq 2\varepsilon\}), \end{aligned}$$

where $\nu_{\gamma_0, L_n}^\Gamma = \frac{1}{L_n^{6g-6+2r}} \sum_{\gamma \in \Gamma \cdot \gamma_0} \delta_{\frac{1}{L_n} \gamma}$ when $\gamma_0 \in \mathfrak{C}_m(\Sigma)$. We get from [ES3, Theo. 8.1 or Ex. 8.3] that $(\nu_{I(\alpha_0), L_n}^\Gamma)_{n \in \mathbb{N}}$ converges and then

$$\begin{aligned} \liminf_n \nu_{\alpha_0, L_n}^\Gamma(\{\mu \in \mathcal{C}(D\Sigma) | i(\mu, \gamma) < 2\varepsilon, i(\mu, \delta_0) < 2R\}) &\leq k_{\alpha_0}^\Gamma \cdot \liminf_n \nu_{I(\alpha_0), L_n}^\Gamma(\{\lambda | i(\lambda, \gamma) \leq 2\varepsilon\}) \\ &\leq k_{\alpha_0}^\Gamma \cdot \limsup_n \nu_{I(\alpha_0), L_n}^\Gamma(\{\lambda | i(\lambda, \gamma) \leq 2\varepsilon\}) \\ &\leq k_{\alpha_0}^\Gamma \cdot \mathbf{c}_{g,r}^\Gamma(I(\alpha_0)) \cdot \mathbf{m}_{Thu}^\Sigma(\{\lambda \in \mathcal{ML}(\Sigma) | i(\lambda, \gamma) \leq 2\varepsilon\}). \end{aligned}$$

All in all,

$$\mathbf{m}(\{\lambda \in \mathcal{ML}(\Sigma) | i(\lambda, \gamma) < \varepsilon, i(\lambda, \delta_0) < R\}) \leq C \cdot \mathbf{m}_{Thu}^\Sigma(\{\lambda \in \mathcal{ML}(\Sigma) | i(\lambda, \gamma) \leq 2\varepsilon\})$$

and the characterisation of the Thurston measure proves eq. (3.3.5). \square

We are now able to prove our main theorem:

Theorem 3.13. *If Σ is a compact connected oriented surface with non-empty boundary*

and negative Euler characteristic which is not a pair of pants, then for every weighted multiarc $\alpha_0 \in \mathcal{A}_m(\Sigma)$, and every finite index subgroup Γ of $\text{Map}(\Sigma)$, there is $\mathbf{c}_{g,r}^\Gamma(\alpha_0) > 0$ such that

$$\lim_{L \rightarrow \infty} \nu_{\alpha_0, L}^\Gamma = \mathbf{c}_{g,r}^\Gamma(\alpha_0) \cdot \widehat{\mathbf{m}}_{Thu}^\Sigma,$$

and the convergence occurs with respect to the weak* topology on the set of Radon measures on $\mathcal{C}(D\Sigma)$.

Remark 3.14. The constant $\mathbf{c}_{g,r}^\Gamma(\alpha_0)$ is the same as in Theorem 3.7.

Proof. First of all, consider $\widehat{\mathbf{m}}$ given by $\widehat{\mathbf{m}} = \lim_{n \rightarrow \infty} \nu_{\alpha_0, L_n}^\Gamma$ for some sequence $(L_n)_{n \in \mathbb{N}}$. Lemma 3.12 together with Lemma 3.11 ensures that the associated measure \mathbf{m} on $\mathcal{ML}(\Sigma)$ is a multiple of the Thurston measure on Σ and hence $\widehat{\mathbf{m}} = c((L_n)_n) \cdot \widehat{\mathbf{m}}_{Thu}^\Sigma$ where $c((L_n)_n) > 0$ depends, a priori, on the sequence $(L_n)_{n \in \mathbb{N}}$.

Let δ_0 be a filling curve of Σ , the function $i(\delta_0, \cdot)$ is continuous, homogenous and positive on $\mathcal{C}(\Sigma)$ hence $\mathbf{m}_{Thu}^\Sigma(\{i(\delta_0, \cdot) = 1\}) = 0$. However, $\mathbf{m}_{Thu}^\Sigma(\{\lambda \in \mathcal{ML}(\Sigma) | i(\delta_0, \lambda) = 1\}) = \widehat{\mathbf{m}}_{Thu}^\Sigma(\{\widehat{\lambda} \in \widehat{\mathcal{ML}}(\Sigma) | i(i^+(\delta_0), \widehat{\lambda}) = 1\}) = \widehat{\mathbf{m}}_{Thu}^\Sigma(\{\partial\widehat{\lambda} \in \widehat{\mathcal{ML}}(\Sigma) | i(i^+(\delta_0), \widehat{\lambda}) \leq 1\})$ and $\mathcal{C}(D\Sigma)$ is locally compact so by Portmanteau Theorem and Theorem 3.7 we obtain the two following results

$$\begin{aligned} \nu_{\alpha_0, L_n}^\Gamma(\{\mu \in \mathcal{C}(D\Sigma) | i(i^+(\delta_0), \mu) \leq 1\}) &\xrightarrow{n \rightarrow \infty} c((L_n)_n) \cdot \widehat{\mathbf{m}}_{Thu}^\Sigma(\{\widehat{\lambda} \in \widehat{\mathcal{ML}}(\Sigma) | i(i^+(\delta_0), \widehat{\lambda}) \leq 1\}) \\ &= c((L_n)_n) \cdot \mathbf{m}_{Thu}^\Sigma(\{\lambda \in \mathcal{ML}(\Sigma) | i(\delta_0, \lambda) \leq 1\}) \\ &= c((L_n)_n) \cdot \mathbf{m}_{Thu}^\Sigma(\{i(\delta_0, \cdot) \leq 1\}), \\ \nu_{\alpha_0, L_n}^\Gamma(\{\mu \in \mathcal{C}(D\Sigma) | i(i^+(\delta_0), \mu) \leq 1\}) &= \frac{1}{L_n^{6g-6+2r}} \#\{\alpha \in \Gamma \cdot \alpha_0 | i(i^+(\delta_0), \widehat{\alpha}) \leq L_n\} \\ &= \frac{\#\{\alpha \in \Gamma \cdot \alpha_0 | i(\delta_0, \alpha) \leq L_n\}}{L_n^{6g-6+2r}} \\ &\xrightarrow{n \rightarrow \infty} \mathbf{c}_{g,r}^\Gamma(\alpha_0) \cdot \mathbf{m}_{Thu}^\Sigma(\{i(\delta_0, \cdot) \leq 1\}). \end{aligned}$$

Hence, $c((L_n)_n) = \mathbf{c}_{g,r}^\Gamma(\alpha_0)$ does not depend on the sequence $(L_n)_{n \in \mathbb{N}}$ and whatever the sequence $L_n \xrightarrow{n \rightarrow \infty} \infty$, up to passing to a subsequence n_i ,

$$\lim_{i \rightarrow \infty} \nu_{\alpha_0, L_{n_i}}^\Gamma = \mathbf{c}_{g,r}^\Gamma(\alpha_0) \cdot \widehat{\mathbf{m}}_{Thu}^\Sigma.$$

Since the previous convergence holds for any $L_n \xrightarrow{n \rightarrow \infty} \infty$, $\lim_{L \rightarrow \infty} \nu_{\alpha_0, L}^\Gamma = \mathbf{c}_{g,r}^\Gamma(\alpha_0) \cdot \widehat{\mathbf{m}}_{Thu}^\Sigma$. \square

3.4 Application to counting problems

Armed with Theorem 3.13 we are now able to focus on counting problems. In this section we are interested in counting the elements in the orbit of a given arc for the action of a finite index subgroup of the mapping class group.

3.4.1 Counting bounded arcs

For F a function on arcs we want to count $\#\{\alpha \in \Gamma \cdot \alpha_0 | F(\alpha) \leq L\}$ using Theorem 3.13. To do so, we have to be able to extend F to the currents of $D\Sigma$.

The more natural examples for F are

- the length function for any Riemannian metric with geodesic boundary on Σ ,
- the intersection number with a filling curve δ_0 of Σ ,
- the intersection number with a filling current μ_0 of Σ ,

in those cases, the extension on $\mathcal{C}(D\Sigma)$ is naturally given by

- the length function associated to the corresponding metric on $D\Sigma$,
- the intersection number with $\widehat{\delta}_0$,
- the intersection number with $\widehat{\mu}_0$.

To give a general context to these examples we introduce the notion of extension to currents for functions on arcs.

Definition 3.15. *A function F on $\mathcal{A}_m(\Sigma)$ is a **measure of complexity for arcs** if there exist a continuous and homogeneous function \widehat{F} on $\mathcal{C}(D\Sigma)$, which is positive on the space of symmetric currents which give no weight to $\partial\Sigma$, and a continuous and homogeneous function, also called F , on $\mathcal{C}(\Sigma)$ such that:*

- $\forall \alpha \in \mathcal{A}_m(\Sigma), \quad \widehat{F}(\widehat{\alpha}) = 2F(\alpha),$
- $\forall \mu \in \mathcal{C}(\Sigma), \quad \widehat{F}(\widehat{\mu}) = 2F(\mu).$

Now, the same process as in the proof of [ES3, Theo 9.1] allows us to obtain the following Corollary.

Corollary 3.16. *Let Σ and Γ be as in Theorem 3.13. For any weighted multiarc $\alpha_0 \in \mathcal{A}_m(\Sigma)$ and any measure of complexity for arcs F*

$$\lim_{L \rightarrow \infty} \frac{\#\{\alpha \in \Gamma \cdot \alpha_0 | F(\alpha) \leq L\}}{L^{6g-6+2r}} = \mathbf{c}_{g,r}^\Gamma(\alpha_0) \cdot \mathbf{m}_{Thu}^\Sigma(\{F(\cdot) \leq 1\}).$$

Proof. First of all, since \widehat{F} is continuous on $\mathcal{C}(D\Sigma)$,

$$\partial\{\mu \in \mathcal{C}(D\Sigma) | \widehat{F}(\mu) \leq 2\} \subset \{\mu \in \mathcal{C}(D\Sigma) | \widehat{F}(\mu) = 2\}$$

and as F is continuous and homogeneous on $\mathcal{C}(\Sigma)$

$$\begin{aligned} \widehat{\mathbf{m}}_{Thu}^\Sigma(\{\mu \in \mathcal{C}(D\Sigma) | \widehat{F}(\mu) = 2\}) &= \widehat{\mathbf{m}}_{Thu}^\Sigma(\{\widehat{\lambda} \in \widehat{\mathcal{ML}}(\Sigma) | \widehat{F}(\widehat{\lambda}) = 2\}) \\ &= \mathbf{m}_{Thu}^\Sigma(\{\lambda \in \mathcal{ML}(\Sigma) | \widehat{F}(\widehat{\lambda}) = 2\}) \\ &= \mathbf{m}_{Thu}^\Sigma(\{\lambda \in \mathcal{ML}(\Sigma) | F(\lambda) = 1\}) \\ &= \mathbf{m}_{Thu}^\Sigma(\{\mu \in \mathcal{C}_K(\Sigma) | F(\mu) = 1\}) \\ &= 0. \end{aligned} \tag{3.4.1}$$

As a consequence, using the local compactness of $\mathcal{C}(D\Sigma)$ and the Portmanteau Theorem and Theorem 3.13 we obtain that

$$\begin{aligned} \nu_{\alpha_0, L}^\Gamma(\{\mu \in \mathcal{C}(D\Sigma) | \widehat{F}(\mu) \leq 2\}) &\xrightarrow{L \rightarrow \infty} \mathbf{c}_{g,r}^\Gamma(\alpha_0) \cdot \widehat{\mathbf{m}}_{Thu}^\Sigma(\{\mu \in \mathcal{C}(D\Sigma) | \widehat{F}(\mu) \leq 2\}) \\ &= \mathbf{c}_{g,r}^\Gamma(\alpha_0) \cdot \mathbf{m}_{Thu}^\Sigma(\{\lambda \in \mathcal{ML}(\Sigma) | F(\lambda) \leq 1\}). \end{aligned} \tag{3.4.2}$$

Moreover, since \widehat{F} is homogeneous we deduce that

$$\frac{\#\{\alpha \in \Gamma \cdot \alpha_0 | F(\alpha) \leq L\}}{L^{6g-6+2r}} = \frac{\#\{\alpha \in \Gamma \cdot \alpha_0 | \widehat{F}(\widehat{\alpha}) \leq 2L\}}{L^{6g-6+2r}} = \nu_{\alpha_0, L}^\Gamma(\{\mu \in \mathcal{C}(D\Sigma) | \widehat{F}(\mu) \leq 2\}),$$

and eq. (3.4.2) concludes the proof.

The condition of positivity on F ensures that all the spaces we count are finite as well as the limit. □

3.4.2 Counting bi-infinite arcs

We work now on a non-compact surface S of finite type. More concretely, S has finite genus, finitely many punctures and empty boundary. A **bi-infinite arc** of S is a path between two punctures, we will also call them "arcs" when the context is clear. If X is a fixed finite area hyperbolic structure on S and α_0 a bi-infinite arc between two cusps of S we want to determine

$$\#\{\alpha \in \text{Map}(S) \cdot \alpha_0 | \ell_X(\alpha) \leq L\}.$$

To do so, we first have to choose a way to define $\ell_X(\alpha)$. Indeed, with the natural notion of length every bi-infinite arc has infinite length.

In a non-compact surface one can define the **peripheral self-intersection number** $i_{per}(\gamma, \gamma)$ of a geodesic γ . This number tells us how much each excursion of the geodesic into a cusp intersects itself (see [ES3, Def. 2.6] for details on the peripheral self-intersection number). The number of self intersections of an excursion being in direct link with the depth reached by this excursion into a cusp [BPT], knowing the peripheral self-intersection of a bi-infinite arc we know exactly the maximal depth reached by any finite excursion (it is an excursion that does not leave all compact subsets of the surface) into a cusp's neighborhood.

Remark 3.17. *For a weighted multiarc, we define the peripheral self-intersection number as the maximal peripheral self-intersection number of its components.*

Let us recall the following lemma.

Lemma 3.18. *Let S be a finite type surface with negative Euler characteristic, no boundary components and finitely many cusps. If γ is a bi-infinite arc of S with $i_{per}(\gamma, \gamma) > 0$ then the finite excursions of γ stay in the compact core of S bounded by the horospheres of length $1/k$ if and only if $i_{per}(\gamma, \gamma) \leq 4k$.*

Since the peripheral self-intersection number is stable through the action of $\text{Map}(S)$ we have a natural way to associate a finite length to each infinite arc and that definition will be relevant if we want to count the elements in a given orbit of the mapping class group.

Remark 3.19. *We need the notion of length we will define for bi-infinite arcs to be compatible with the length of the measured laminations of the surface. To do so, note that for any hyperbolic metric X on S the support of every $\lambda \in \mathcal{ML}(S)$ is included in X^1 , the compact core of X bounded by the horospheres of length 1.*

Definition 3.20. *Let S be a finite type surface with negative Euler characteristic, no boundary and finitely many cusps. For a fixed hyperbolic structure, we define the **compact length** of a bi-infinite arc α of S by*

$$\bar{\ell}_X(\alpha) := \begin{cases} \ell_X(\gamma \cap X^{i_{per}(\alpha, \alpha)/4}) & \text{if } i_{per}(\alpha, \alpha)/4 > 1 \\ \ell_X(\gamma \cap X^1) & \text{otherwise.} \end{cases}$$

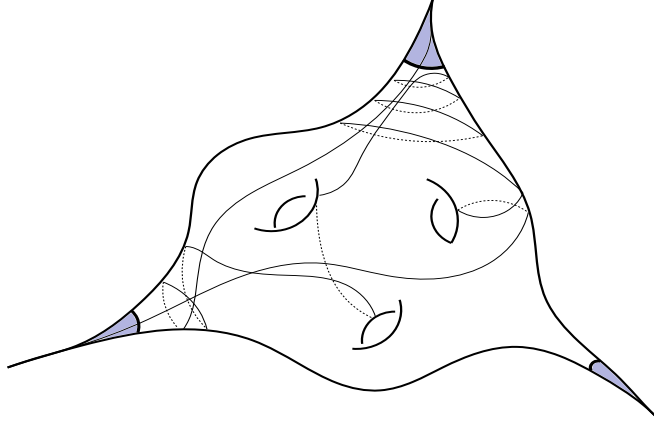

Figure 3.4 – How to compute $\bar{\ell}$.

Where for any $k \geq 1$, X^k is the compact core of X bounded by the embedded horospheres of length $1/k$.

Theorem 3.21. *Let S be a connected oriented surface with $r > 0$ punctures and negative Euler characteristic but not a pair of pants. For any hyperbolic structure X on S , if α_0 is a weighted bi-infinite multiarc and Γ is a finite index subgroup of $\text{Map}(S)$ then*

$$\lim_{L \rightarrow \infty} \frac{\#\{\alpha \in \Gamma \cdot \alpha_0 \mid \bar{\ell}_X(\alpha) \leq L\}}{L^{6g-6+2r}} = \mathbf{c}_{g,r}^\Gamma(\gamma_0) \cdot \mathbf{m}_{Thu}^S(\{\ell_X(\cdot) \leq 1\}).$$

Proof. If S has genus g and r cusps then we call Σ the compact surface of genus g with r boundary components. From now on X is a fixed hyperbolic structure on S and we want to construct a metric on Σ from X .

Fix the bi-infinite multiarc α_0 , there is $k > 0$ such that $\bar{\ell}_X(\alpha) := \ell_X(\gamma \cap X^k)$. If we cut S along the embedded horospheres of length $1/k$ then we obtain a $CAT(-1)$ metric structure on $\tilde{\Sigma}$ (see [BH, Ex. 1.16 p168]) for which the horosphere boundaries are geodesic, hence the associated gluing metric on $D\Sigma$ given by the corresponding length function $\ell_{D\Sigma}$ is also $CAT(-1)$ (see [BH, Theo. 11.1 p347]) on $\widetilde{D\Sigma}$.

In a $CAT(-1)$ space the length and the stable length coincide hence the length of curves $\ell_{D\Sigma}$ coming from X is equal to the stable length for the action $\pi_1(D\Sigma) \curvearrowright \widetilde{D\Sigma}$. However, the stable length for any discrete and cocompact isometric action of a torsion-free hyperbolic group on a geodesic metric space extends to a continuous, positive and homogeneous function on currents (see [EPS, Theo. 1.5]). Hence, Corollary 3.16 applied with $F = \bar{\ell}_X$ which extends to $\ell_{D\Sigma}$ and for the measured laminations the different notions of length coincide which concludes the proof. \square

Remark 3.22. *There are many ways to decide how to truncate an infinite arc in order to define its length. See for example [Bel2] or [Par] for other ways to do so. For example, ℓ_X^t is the length function on infinite arcs such that the length of a cusps-to-cusps arc is the length of this arc between the first time it enters X^t and the last time it leaves it. The advantage of this definition is that it does not depend on the chosen arc and is more visual in the universal cover (fig. 3.5 shows how to see ℓ_X^t in the universal cover).*

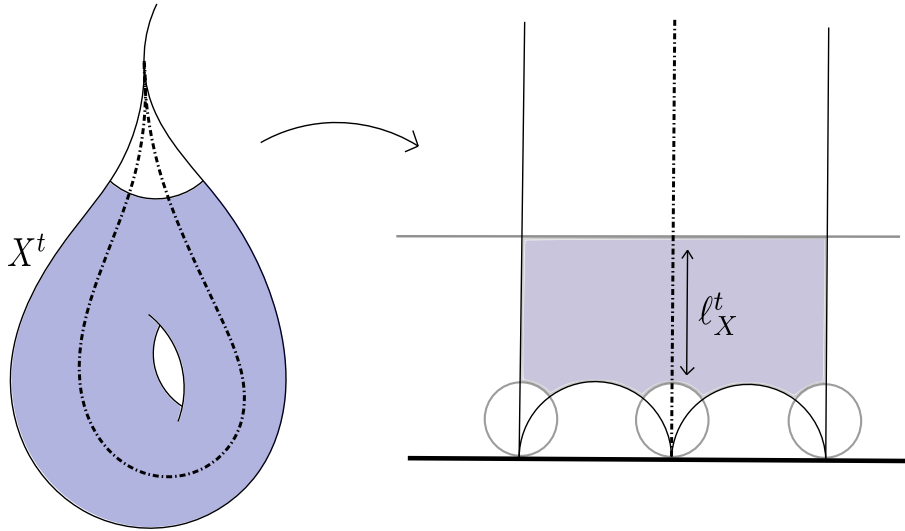

Figure 3.5 – How to compute ℓ_X^t

This notion of length differs from $\bar{\ell}_X$ by a constant hence as an immediate corollary of Theorem 3.21 we have that for all $t \geq 1$ and any infinite weighted multiarc α_0

$$\lim_{L \rightarrow \infty} \frac{\#\{\alpha \in \text{Map}(\Sigma) \cdot \alpha_0 \mid \ell_X^t(\alpha) \leq L\}}{L^{6g-6+2r}} = \mathbf{c}_{g,r}^\Gamma(\alpha_0) \cdot \mathbf{m}_{Thu}^S(\{\ell_X(\cdot) \leq 1\}). \quad (3.4.3)$$

3.4.3 Counting arcs on orbifolds

We now work on a compact orientable orbifold O rather than on Σ or S . We denote by g its genus and r the number of boundary components and singularities, assuming that it has non-empty boundary. As for surfaces, we will assume that $(g, r) \neq (0, 3)$ and an arc is free homotopy class of boundary to boundary paths.

One can define $\mathcal{C}^{or}(O)$ the set of geodesic currents for O , and a notion of Thurston measure in $\mathcal{C}^{or}(O)$ (see [ES2]). In the line of the known results for curves it is shown in [ES2] that for every $\gamma_0 \in \mathfrak{C}_m(O)$ and Γ finite index subgroup of $\text{Map}^{or}(O)$ there is a

positive constant $\mathbf{c}_{g,r}^\Gamma(\gamma_0)$ such that

$$\lim_{L \rightarrow \infty} \frac{1}{L^{6g-6+2r}} \sum_{\gamma \in \Gamma \cdot \gamma_0} \delta_{\frac{1}{L}\gamma} = \mathbf{c}_{g,r}^\Gamma(\gamma_0) \cdot \mathbf{m}_{Thu}^O, \quad (3.4.4)$$

where the convergence occurs with respect to the weak* topology on the set of Radon measures on the set of geodesic currents of O . As a consequence, for every measure of complexity for curves on $\mathcal{C}^{or}(O)$,

$$\lim_{L \rightarrow \infty} \frac{\#\{\gamma \in \Gamma \cdot \gamma_0 \mid F(\gamma) \leq L\}}{L^{6g-6+2r}} = \mathbf{c}_{g,r}^\Gamma(\gamma_0) \cdot \mathbf{m}_{Thu}^O(\{F(\cdot) \leq 1\}). \quad (3.4.5)$$

This naturally raises the question of applying the results of this paper to the case of orbifolds with boundary components:

1. Fuchsian groups are LERF [Sco] so Lemma 3.5 is still true,
2. eq. (3.4.5) ensures that we still have Theorem 3.7 for orbifolds,
3. for a compact orbifold the set of geodesic currents is still locally compact [ES2, Section 4.1] so with the same proof as in the case of surfaces, Proposition 3.8 happens in the orbifold case,
4. the same characterization of measured laminations as for surfaces holds for orbifolds what ensures that Proposition 3.9 is still true,
5. the Thurston measure on O can be seen as the pushforward for some application of the Thurston measure on the surface associated to O [ES2, Lem. 4.1], which ensures that Lindenstrauss-Mirzakhani characterisation of the Thurston measure and Lemma 3.11 are true for orbifolds,
6. finally, eq. (3.4.4) implies that we are able to prove Lemma 3.12 for O .

All the constructions of this paper apply in the orbifold case which gives us a version of Theorem 3.13 and Corollary 3.16 for orbifolds.

Theorem 3.23. *If O is a compact, connected, oriented orbifold with non-empty boundary such that $(g, r) \neq (0, 3)$, and Γ is a finite index subgroup of $\text{Map}^{or}(O)$ then for every $\alpha_0 \in \mathcal{A}_m(O)$ weighted multiarc*

$$\lim_{L \rightarrow \infty} \nu_{\alpha_0, L}^\Gamma = \mathbf{c}_{g,r}^\Gamma(\alpha_0) \cdot \widehat{\mathbf{m}}_{Thu}^O.$$

The convergence occurs with respect to the weak* topology on the set of Radon measures on $\mathcal{C}^{or}(DO)$ and $\mathfrak{c}_{g,r}^\Gamma(\alpha_0)$ is a constant coming from Theorem 3.7 and [ES2].

Corollary 3.24. *With the same conditions as above, for any function measure of complexity F on $\mathcal{A}_m(O)$*

$$\lim_{L \rightarrow \infty} \frac{\#\{\alpha \in \Gamma \cdot \alpha_0 \mid F(\alpha) \leq L\}}{L^{6g-6+2r}} = \mathfrak{c}_{g,r}^\Gamma(\alpha_0) \cdot \mathfrak{m}_{Thu}^O(\{F(\cdot) \leq 1\}).$$

Here, the notion of measure of complexity is the same as in Corollary 3.16.



4.1 Perspectives for counting problems

In this section we investigate the counting of elements in the orbits of subgroups of the mapping class group. More specifically, we address the following question:

Question 4.1. *Given Γ a subgroup of $\text{Map}(Z)$, $\gamma_0 \in \mathfrak{C}_m(Z)$ and F a measure of complexity for curves. Let us define*

$$\Delta_{\gamma_0}^{\Gamma}(L) = \{\gamma \in \Gamma \cdot \gamma_0 \mid F(\gamma) \leq L\}. \quad (4.1.1)$$

How does $\#\Delta_{\gamma_0}^{\Gamma}(L)$ grow when L goes to infinity? ■

Note that Mirzakhani and Erlandsson-Souto have answered this question for finite-index subgroups, see eq. (3.1.1). Consequently, we focus here on infinite-index subgroups of the mapping class group, in which cases we expect the counting results to depend strongly on the choice of the group. For example, we develop below examples of subgroups generated by a single Dehn-twist or a single pseudo-Anosov, in these cases the growth rates are linear and logarithmic in L respectively.

4.1.1 Counting orbits of certain cyclic subgroups

The first infinite-index subgroups of the mapping class group we can think of are the cyclic subgroups. In this section, we study cyclic subgroups generated by a pseudo-Anosov or a Dehn-twist. As well as being fundamental examples of mapping classes, they give us a glimpse of the kind of behavior we will encounter when working with infinite-index subgroups: we can expect to obtain a (discrete) spectrum of possibilities between logarithmic and polynomial asymptotics.

Dehn twists

We work in a finite type surface (maybe with punctures or boundary components) Z and are interested in the action of a Dehn-twist T_α along a simple curve α on the weighted multicurves of Z . A first point to work on, is the way this action changes the lengths.

Lemma 4.2. *Let α be a simple curve and β a weighted multicurve of a finite type surface Z . For every hyperbolic structure X on Z $\lim_{n \rightarrow \pm\infty} \frac{\ell_X(T_\alpha^n \beta)}{|n|} = i(\alpha, \beta) \ell_X(\alpha)$.*

Proof. If β is a curve with $i(\alpha, \beta) = 0$ then $T_\alpha^n \beta = \beta$ for all n and the result follows. Otherwise, computations in the hyperbolic plane allow to show that the length of the twisted β is closer and closer to $ni(\alpha, \beta)$ times the length of α when β is a curve. It passes to weighted multicurves by linearity.

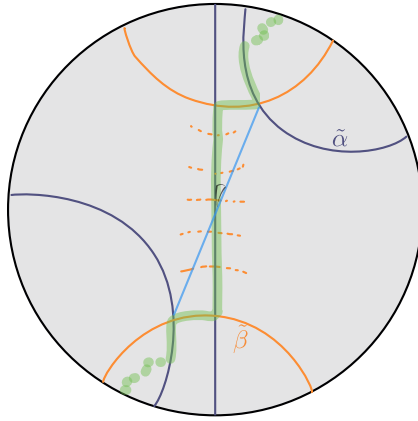

Figure 4.1 – Computations in the universal cover

□

Knowing how this action deforms lengths, we can study, from the point of view of currents, the orbit of a curve under this action, which will allow us to easily obtain counting results for the orbits.

Lemma 4.3. *Let α be a simple curve and β a weighted multicurve such that $i(\alpha, \beta) > 0$,*

$$\lim_{n \rightarrow \pm\infty} \frac{T_\alpha^n \beta}{|n|} = i(\alpha, \beta) \alpha \quad \text{in } \mathcal{C}_K(Z). \quad (4.1.2)$$

for K the compact core of Z determined par $i_{\text{per}}(\beta, \beta)$ (see Theorem 1.11) or a compact of Z containing it.

Proof. Let K be a compact subsurface as defined above. Theorem 1.11 ensures that all the elements in $\langle T_\alpha \rangle \cdot \beta$ and α are, as currents, elements of $\mathcal{C}_K(Z)$. This space is metrizable, so, we will show that $\left(\frac{T_\alpha^n \beta}{n}\right)_{n \in \mathbb{N}}$ is bounded and has only one accumulation point which is $i(\alpha, \beta)\alpha$.

Given a hyperbolic structure X on Z the length function $\ell_X : \mathcal{C}_K(Z) \rightarrow \mathbb{R}_{\geq 0}$ is continuous from a locally compact space to a Hausdorff space, hence, it is proper. However, for all $n \in \mathbb{N}$, $\ell_X(T_\alpha^n \beta) \leq \ell_X(\beta) + ni(\alpha, \beta)\ell_X(\alpha)$ hence $\ell_X\left(\frac{T_\alpha^n \beta}{n}\right)$ is bounded regardless of n what ensures that $\left(\frac{T_\alpha^n \beta}{n}\right)_{n \in \mathbb{N}}$ is bounded in $\mathcal{C}_K(Z)$.

Consider now $\mu \in \mathcal{C}_K(Z)$ an accumulation point of $\left(\frac{T_\alpha^n \beta}{n}\right)_{n \in \mathbb{N}}$. There is $m_n \xrightarrow{n \rightarrow \infty} \infty$ such that

$$\lim_{n \rightarrow \infty} \frac{T_\alpha^{m_n} \beta}{m_n} = \mu.$$

Recall that $i : \mathcal{C}_K \times \mathcal{C} \rightarrow \mathbb{R}_+$ is continuous, the

$$i\left(\frac{T_\alpha^{m_n} \beta}{m_n}, \frac{T_\alpha^{m_n} \beta}{m_n}\right) = \frac{i(\beta, \beta)}{m_n^2} \xrightarrow{n \rightarrow \infty} 0$$

hence $i(\mu, \mu) = 0$ and μ is a measured lamination (it has zero self intersection and is an element of $\mathcal{C}_K(Z)$ which is a subset of the internal currents).

Now, for any curve γ in Z if $i(\gamma, \alpha) = 0$ then

$$i\left(\frac{T_\alpha^{m_n} \beta}{m_n}, \gamma\right) \leq \frac{i(\beta, \gamma) + m_n i(\alpha, \beta) i(\alpha, \gamma)}{m_n} \xrightarrow{n \rightarrow \infty} 0,$$

and then $i(\mu, \gamma) = 0$. As a consequence, the only possible leaf for μ is α and $\mu = c \cdot \alpha$ for some $c > 0$. Lemma 4.2 and the continuity of the length function in $\mathcal{C}_K(Z)$ ensure that $c = i(\alpha, \beta)$, what concludes the proof. \square

Theorem 4.4. *Let Z be a finite type surface and $\alpha \in \mathcal{C}(Z)$ a simple curve, we denote by T_α the associated Dehn-twist. For any measure of complexity for curves F , and for all weighted multicurve $\gamma_0 \in \mathcal{C}_m(Z)$ such that $i(\gamma_0, \alpha) \neq 0$*

$$\lim_{L \rightarrow \infty} \frac{\#\{\gamma \in \langle T_\alpha \rangle \cdot \gamma_0 \mid F(\gamma) \leq L\}}{L} = \frac{2}{i(\alpha, \gamma_0)F(\alpha)}. \quad (4.1.3)$$

Proof. In all the proof, α , F and γ_0 are fixed, we are interested in the cardinal of $\Delta_{\gamma_0}^{<T_\alpha>}(L)$ where the complexity of the curves is given by F . We fix K the compact core of Z given by $i_{per}(\gamma_0, \gamma_0)$, all the elements in $\langle T_\alpha \rangle \cdot \gamma_0$ are currents of $\mathcal{C}_K(Z)$.

By continuity and homogeneity of F over $\mathcal{C}_K(Z)$ together with Lemma 4.3

$$F(T_\alpha^n \gamma_0) \underset{n \rightarrow \pm\infty}{\sim} |n| i(\alpha, \gamma_0) F(\alpha).$$

Equivalently we have

$$\exists \varepsilon_n \xrightarrow{n \rightarrow \infty} 0 : \quad \forall n \in \mathbb{N} \quad F(T_\alpha^n \cdot \gamma_0) = (1 + \varepsilon_n) n i(\alpha, \gamma_0) F(\alpha) \quad (4.1.4)$$

$$\exists \mu_n \xrightarrow{n \rightarrow \infty} 0 : \quad \forall n \in \mathbb{N} \quad F(T_\alpha^{-n} \cdot \gamma_0) = (1 + \mu_n) n i(\alpha, \gamma_0) F(\alpha). \quad (4.1.5)$$

There is $\delta_n \xrightarrow{n \rightarrow \infty} 0$ and $\nu_n \xrightarrow{n \rightarrow \infty} 0$ such that $1/(1+\varepsilon_n) = 1-\delta_n$ and $1/(1+\mu_n) = 1-\nu_n$. Now, we can decompose $\Delta_{\gamma_0}^{<T_\alpha>}(L)$ as follow:

$$\begin{aligned} \#\Delta_{\gamma_0}^{<T_\alpha>}(L) &= \#\{\gamma \in \langle T_\alpha \rangle \cdot \gamma_0 \mid F(\gamma) \leq L\} \\ &= \#\{n \geq 0 \mid (1 + \varepsilon_n) n i(\alpha, \gamma_0) F(\alpha) \leq L\} \\ &\quad + \#\{n > 0 \mid (1 + \mu_n) n i(\alpha, \gamma_0) F(\alpha) \leq L\} \\ &= \#\left\{0 \leq n \mid n \leq (1 - \delta_n) \frac{L}{i(\alpha, \gamma_0) F(\alpha)}\right\} \\ &\quad + \#\left\{0 < n \mid n \leq (1 - \nu_n) \frac{L}{i(\alpha, \gamma_0) F(\alpha)}\right\}. \end{aligned}$$

Now, for any $\varepsilon > 0$, there is $n_\varepsilon > 0$ such that for all $n \geq n_\varepsilon$, $\delta_n, \nu_n \in [-\varepsilon, \varepsilon]$ and we have

$$\begin{aligned} \#\Delta_{\gamma_0}^{<T_\alpha>}(L) &= \#\left\{0 \leq n \leq n_\varepsilon \mid n \leq (1 - \delta_n) \frac{L}{i(\alpha, \gamma_0) F(\alpha)}\right\} \\ &\quad + \#\left\{0 < n \leq n_\varepsilon \mid n \leq (1 - \nu_n) \frac{L}{i(\alpha, \gamma_0) F(\alpha)}\right\} \\ &\quad + \#\left\{n_\varepsilon \leq n \mid n \leq (1 - \delta_n) \frac{L}{i(\alpha, \gamma_0) F(\alpha)}\right\} \\ &\quad + \#\left\{n_\varepsilon \leq n \mid n \leq (1 - \nu_n) \frac{L}{i(\alpha, \gamma_0) F(\alpha)}\right\} \end{aligned}$$

what ensures that for all $\varepsilon > 0$

$$(1 - \varepsilon) \frac{2}{i(\alpha, \gamma_0)F(\alpha)} + \frac{-2n_\varepsilon}{L} \leq \frac{\#\Delta_{\gamma_0}^{\langle T_\alpha \rangle}(L)}{L} \leq (1 + \varepsilon) \frac{2}{i(\alpha, \gamma_0)F(\alpha)} + \frac{3}{L}.$$

When L goes to infinity we have

$$(1 - \varepsilon) \frac{2}{i(\alpha, \gamma_0)F(\alpha)} \leq \varliminf_{L \rightarrow \infty} \frac{\#\Delta_{\gamma_0}^{\langle T_\alpha \rangle}(L)}{L} \leq \varlimsup_{L \rightarrow \infty} \frac{\#\Delta_{\gamma_0}^{\langle T_\alpha \rangle}(L)}{L} \leq (1 + \varepsilon) \frac{2}{i(\alpha, \gamma_0)F(\alpha)},$$

letting ε tend to 0 we obtain that $\lim_{L \rightarrow \infty} \frac{\#\Delta_{\gamma_0}^{\langle T_\alpha \rangle}(L)}{L} = \frac{2}{i(\alpha, \gamma_0)F(\alpha)}$. \square

Pseudo-Anosov mapping classes

While the growth of the orbits of the mapping class group is polynomial and that of orbits of a Dehn-twist is linear, we show here that the growth is logarithmic for orbits of a pseudo-Anosov element.

We are interested in studying the action of a pseudo-Anosov mapping class on curves. Let us fix a finite type surface Z and a pseudo-Anosov mapping class Φ . We denote by Λ^a and Λ^r the attracting and repelling measured laminations.

Lemma 4.5. *Let S be a finite analytic type surface and Φ a pseudo-Anosov mapping class, Λ^a and Λ^r its attracting and repelling measured laminations and $\lambda > 1$ its stretch factor. For every hyperbolic structure X on S and any multicurve $\alpha \in \mathfrak{C}_m(\Sigma)$*

$$\lim_{n \rightarrow \infty} \frac{\ell_X(\Phi^n \cdot \alpha)}{\lambda^n} = \frac{i(\Lambda^r, \alpha) \ell_X(\Lambda^a)}{i(\Lambda^r, \Lambda^a)}. \quad (4.1.6)$$

Proof. All along the proof, Φ , α and X are fixed. Let K be a compact subsurface such that both α and $\mathcal{ML}(S)$ are in $\mathfrak{C}_K(S)$. Recall that L_X is the Liouville current associated to X when seen as an element in $\mathcal{T}(S)$ and that the intersection number with L_X is the length function.

For a finite analytic type surface the action of a pseudo-Anosov element on $\mathcal{T}(S) \cup \mathbb{P}_+ \mathcal{ML}(S)$ has a north-south dynamic with Λ^a as an attractive point and Λ^r as repelling point. As a consequence, there is $(\varepsilon_n)_{n \in \mathbb{N}}$ such that $\lim_{n \rightarrow \infty} \varepsilon_n \Phi^{-n} L_X = \Lambda^r$ and then

$$\lim_{n \rightarrow \infty} \varepsilon_n \ell_X(\Phi^n \cdot) = i(\Lambda^r, \cdot)$$

in $\mathcal{C}_K(S)$ by continuity of the intersection number. Recall also that for all $n \in \mathbb{Z}$, $\Phi^n \Lambda^a = \lambda^n \Lambda^a$, so, the result is immediat

$$\begin{aligned} \frac{\ell_X(\Phi^n \alpha)}{\lambda^n} &= \frac{i(L_X, \Phi^n \alpha) i(L_X, \Lambda^a)}{i(L_X, \Phi^n \Lambda^a)} \\ &= \frac{i(\varepsilon_n \Phi^{-n} L_X, \alpha) i(L_X, \Lambda^a)}{i(\varepsilon_n \Phi^{-n} L_X, \Lambda^a)} \\ &\xrightarrow{n \rightarrow \infty} \frac{i(\Lambda^r, \alpha) \ell_X(\Lambda^a)}{i(\Lambda^r, \Lambda^a)}. \end{aligned}$$

Note that the attracting and repelling laminations are only defined up to multiplicative factor but this choice has no incidence here. □

Based on this result, we can easily obtain a counting result for finite analytic type surfaces with a length function as measure of complexity.

Theorem 4.6. *Let S be a finite analytic type surface and $\Phi \in \text{Map}(S)$ be a pseudo-Anosov mapping class. Given a hyperbolic structure X on S , for all weighted multicurve $\gamma_0 \in \mathfrak{C}_m(S)$*

$$\lim_{L \rightarrow \infty} \frac{\#\{\gamma \in \langle \Phi \rangle \cdot \gamma_0 \mid \ell_X(\gamma) \leq L\}}{\log(L)} = \frac{2}{\log(\lambda)}. \quad (4.1.7)$$

Proof. In all the proof, Φ , δ_0 and X are fixed, we are interested in the cardinal of $\Delta_{\gamma_0}^{\langle \Phi \rangle}(L)$ where the complexity of the curves is given by $\ell_X(\cdot)$.

For γ a curve we will use the following notations:

$$c^+(\gamma) = \frac{i(\Lambda^r, \gamma) \ell_X(\Lambda^a)}{i(\Lambda^r, \Lambda^a)}, \quad c^-(\gamma) = \frac{i(\Lambda^a, \gamma) \ell_X(\Lambda^r)}{i(\Lambda^a, \Lambda^r)}.$$

Applying Lemma 4.5 to Φ and Φ^{-1} we obtain

$$\lim_{n \rightarrow \infty} \frac{\ell_x(\Phi^n \gamma_0)}{\lambda^n} = c^+(\gamma_0), \quad \lim_{n \rightarrow \infty} \frac{\ell_X(\Phi^{-n} \gamma_0)}{\lambda^n} = c^-(\gamma_0).$$

Equivalently we have

$$\exists \varepsilon_n \xrightarrow{n \rightarrow \infty} 0 : \quad \forall n \in \mathbb{N} \quad \ell_X(\Phi^n \cdot \gamma_0) = (1 + \varepsilon_n) \cdot \lambda^n \cdot c^+(\gamma_0) \quad (4.1.8)$$

$$\exists \mu_n \xrightarrow{n \rightarrow \infty} 0 : \quad \forall n \in \mathbb{N} \quad \ell_X(\Phi^{-n} \cdot \gamma_0) = (1 + \mu_n) \cdot \lambda^n \cdot c^-(\gamma_0). \quad (4.1.9)$$

Hence, if we notice that $\{\gamma \in \langle \Phi \rangle \cdot \gamma_0\} = \{\Phi^n \cdot \gamma_0 | n \in \mathbb{Z}\}$ then

$$\begin{aligned} \#\Delta_{\gamma_0}^{\langle \Phi \rangle}(L) &= \#\{n \geq 0 | (1 + \varepsilon_n) \cdot \lambda^n \cdot c^+(\gamma_0) \leq L\} \\ &\quad + \#\{n > 0 | (1 + \mu_n) \cdot \lambda^n \cdot c^-(\gamma_0) \leq L\} \\ &= \#\left\{0 \leq n | n \leq \frac{\log(L/c^+(\gamma_0)) - \log(1 + \varepsilon_n)}{\log(\lambda)}\right\} \\ &\quad + \#\left\{0 < n | n \leq \frac{\log(L/c^-(\gamma_0)) - \log(1 + \mu_n)}{\log(\lambda)}\right\}. \end{aligned}$$

Now, eq. (4.1.8) and (4.1.9) ensure that there exists $n_0 > 0$ such that for all $n \geq n_0$, we have $\varepsilon_n, \mu_n \in [\frac{1}{\sqrt{\lambda}} - 1; \sqrt{\lambda} - 1]$, equivalently

$$\forall n \geq n_0, \quad -\frac{1}{2} \leq \frac{\log(1 + \varepsilon_n)}{\log(\lambda)}, \frac{\log(1 + \mu_n)}{\log(\lambda)} \leq \frac{1}{2}.$$

This gives us the following decomposition of $\#\Delta_{\gamma_0}^{\langle \phi \rangle}(L)$:

$$\begin{aligned} \#\Delta_{\gamma_0}^{\langle \phi \rangle}(L) &= \#\{0 \leq n < n_0 | (1 + \varepsilon_n) \cdot \lambda^n \cdot c^+(\gamma_0) \leq L\} \\ &\quad + \#\{0 < n < n_0 | (1 + \mu_n) \cdot \lambda^n \cdot c^-(\gamma_0) \leq L\} \\ &\quad + \#\left\{n_0 \leq n | n \leq \frac{\log(L/c^+(\gamma_0)) - \log(1 + \varepsilon_n)}{\log(\lambda)}\right\} \\ &\quad + \#\left\{n_0 \leq n | n \leq \frac{\log(L/c^-(\gamma_0)) - \log(1 + \mu_n)}{\log(\lambda)}\right\} \end{aligned}$$

from which we deduce that

$$\begin{aligned} \#\Delta_{\gamma_0}^{\langle \phi \rangle}(L) &\geq \frac{2 \log(L) - \log(c^s(\gamma_0)c^u(\delta_0)) - \log(c^u(\gamma_0)c^s(\delta_0))}{\log(\lambda)} - 2n_0 \\ \#\Delta_{\gamma_0}^{\langle \phi \rangle}(L) &\leq 4 + \frac{2 \log(L) - \log(c^s(\gamma_0)c^u(\delta_0)) - \log(c^u(\gamma_0)c^s(\delta_0))}{\log(\lambda)}, \end{aligned}$$

what allows us to conclude:

$$\lim_{L \rightarrow \infty} \frac{\#\Delta_{\gamma_0}^{\langle \phi \rangle}(L)}{\log(L)} = \frac{2}{\log(\lambda)}. \quad (4.1.10)$$

□

Corollary 4.7. *Let S be a finite topological type surface, for any measure of complexity*

$F : \mathcal{C}(S) \rightarrow \mathbb{R}_{\geq 0}$ and for any $\Phi \in \text{Map}(S)$ pseudo-Anosov mapping class if $\gamma_0 \in \mathfrak{C}_m(S)$ is a weighted multicurve then

$$\lim_{L \rightarrow \infty} \frac{\#\{\gamma \in \langle \Phi \rangle \cdot \gamma_0 \mid F(\gamma) \leq L\}}{\log(L)} = \frac{2}{\log(\lambda)}. \quad (4.1.11)$$

Proof. In addition to Φ , F and γ_0 let us fix a hyperbolic structure X on S .

The intersection number is stable under the action of $\text{Map}(S)$, in particular all the curves in the orbit $\langle \Phi \rangle \cdot \gamma_0$ has the same number of self intersection and by Theorem 1.11 they are all included in the same compact K_0 of X . Now, F and ℓ_X being two measures of complexity, Theorem 1.36 ensures that there exists $C \geq 1$ such that

$$\frac{1}{C} \ell_X(\cdot) \leq F(\cdot) \leq C \ell_X(\cdot),$$

in $\mathcal{C}_K(S)$.

Hence, for every $L > 0$

$$\{\gamma \in \langle \phi \rangle \cdot \gamma_0 \mid \ell_X(\gamma) \leq \frac{L}{C}\} \subseteq \{\gamma \in \langle \phi \rangle \cdot \gamma_0 \mid F(\gamma) \leq L\} \subseteq \{\gamma \in \langle \phi \rangle \cdot \gamma_0 \mid \ell_X(\gamma) \leq CL\}.$$

However, Theorem 4.6 ensures that

$$\begin{aligned} \#\{\gamma \in \langle \phi \rangle \cdot \gamma_0 \mid \ell_X(\gamma) \leq L/C\} &\underset{L \rightarrow \infty}{\sim} 2 \frac{\log(L) - \log(C)}{\log(\lambda)} \\ \#\{\gamma \in \langle \phi \rangle \cdot \gamma_0 \mid \ell_X(\gamma) \leq CL\} &\underset{L \rightarrow \infty}{\sim} 2 \frac{\log(L) + \log(C)}{\log(\lambda)}, \end{aligned}$$

what concludes the proof. □

Remark 4.8. *Remark that the use of Theorem 1.36 to pass from a counting for a given measure of complexity to the counting for another measure of complexity is made possible by the logarithmic growth. We can not hope to use the same process for polynomial growth.*

Corollary 4.9. *Let Σ be a finite type surface with boundary, for any measure of complexity $F : \mathcal{C}(\Sigma) \rightarrow \mathbb{R}_{\geq 0}$ and for any $\Phi \in \text{Map}(\Sigma)$ a pseudo-Anosov mapping class if $\gamma_0 \in \mathfrak{C}_m(\Sigma)$ is a weighted multicurve then*

$$\lim_{L \rightarrow \infty} \frac{\#\{\gamma \in \langle \Phi \rangle \cdot \gamma_0 \mid F(\gamma) \leq L\}}{\log(L)} = \frac{2}{\log(\lambda)}. \quad (4.1.12)$$

Proof. We know [ES3, Theorem 3.9] that the length for a hyperbolic metric in the interior of Σ is a measure of complexity for curves in Σ . Moreover, the mapping class group of Σ is defined as the one of its interior. Hence, Corollary 4.9 ensures that we dispose of eq. (4.1.12) for F a hyperbolic length function in the interior of Σ . Now, the same process as above allows us to pass to a general measure of complexity. \square

4.1.2 Analog for arcs

Here we briefly explain how the techniques developed in Chapter 3 can be used to obtain versions of Theorem 4.4 and Corollary 4.9 for arcs.

Let Σ be a compact and finite type surface with non-empty boundary, we use here the same notations as in Chapter 3.

For Dehn-twists

For α a simple curve of Σ , if we use the same arguments as mentioned previously we can show that $\lim_{n \rightarrow \pm\infty} \frac{T_{\hat{\alpha}}^n \hat{\beta}}{|n|} = i(\alpha, \beta) \hat{\alpha}$ in $\mathcal{C}(D\Sigma)$ and then, with the same proof as for Theorem 4.4, we obtain the following counting result.

Theorem 4.10. *Let Σ be a finite type surface compact with boundary and $\alpha \in \mathcal{C}(\Sigma)$ a simple curve, we denote by T_α the associated Dehn-twist. For any measure of complexity for arcs F , and for all weighted multiarc $\beta_0 \in \mathfrak{C}_m(Z)$ such that $i(\beta_0, \alpha) \neq 0$*

$$\lim_{L \rightarrow \infty} \frac{\#\{\beta \in \langle T_\alpha \rangle \cdot \beta_0 \mid F(\beta) \leq L\}}{L} = \frac{2}{i(\alpha, \beta_0)F(\alpha)}. \quad (4.1.13)$$

For pseudo-Anosov

In the case of a group generated by a pseudo-Anosov we will use the same strategy as in [Bel2] we already used for Theorem 3.7. First of all, since pseudo-Anosov mapping classes fix no curves, whatever the weighted-multiarc $\alpha_0 \in \mathcal{A}_m(\Sigma)$ the constant $k_{\alpha_0}^\Gamma$ is equal to 1 when Γ is generated by a pseudo-Anosov, see Proposition 3.6. Hence, using Lemma 3.5 or Bell's equivalent for length functions [Bel1, Lemma 2.2.1] we obtain a counting result for arcs in the pseudo-Anosov case.

Theorem 4.11. *Let Σ be a finite type surface with boundary, denote by F a hyperbolic length function or the intersection number with a filling curve. For any $\Phi \in \text{Map}(\Sigma)$*

pseudo-Anosov mapping class, if $\alpha_0 \in \mathfrak{C}_m(\Sigma)$ is a weighted multiarc then

$$\lim_{L \rightarrow \infty} \frac{\#\{\alpha \in \langle \Phi \rangle \cdot \alpha_0 \mid F(\alpha) \leq L\}}{\log(L)} = \frac{2}{\log(\lambda)}. \quad (4.1.14)$$

Remark 4.12. *This results also allow to affirm that we have the same asymptotic when working with a partial pseudo-Anosov (pseudo-Anosov of an embeded subsurface).*

4.1.3 A step towards more general results

We expect the counting results for infinite-index subgroups to depend strongly on the choice of the group. In addition, we think that the geometric origin of the group may help us solve the associated counting problem. For a first study, let us focus on "algebraically defined" subgroups, i.e. centralizers of groups or elements.

To do so, we dispose of an analog of the Nielson-Turston classification of mapping classes for the subgroups of the mapping class group.

Definition 4.13. *Let Σ be a compact finite type surface. A subgroup Γ of $\text{Map}(\Sigma)$ is said to be*

- **Reducible** if it fixes a simple multicurve,
- **Irreducible** if it fixes no simple curve.

Knowing this classification, the subgroups of the mapping class group can be studied through the way they decompose the surface, in the line of [Iva] or [BLM]. Indeed, the reducible or irreducible characters pass to the centralizer. To go further, we need more information about irreducible subgroups.

Theorem 4.14. *([Iva, Theorem 2]) Let Γ be an infinite irreducible subgroup of $\text{Map}(\Sigma)$. Either Γ has a finite index infinite cyclic subgroup generated by a pseudo-Anosov or it contains two independant pseudo-Anosov (ie they generate a free group).*

Hence, the counting results for centralizers of infinite irreducible subgroups are the following.

- If Γ contains to independant pseudo-Anosovs then its centralizer is trivial.
- Otherwise, the centralizer also contains a finite index subgroup generated by a pseudo-Anosov. However, passing to a finite index subgroup does not change the asymptotic behavior of the counting then we have a logarithmic growth.

Let us now focus on a reducible subgroup Γ of a compact and finite type surface Σ . For a first approach assume that the subgroup we are interested in contains no finite order element. In that case, there is a simple curve C of Σ such that the action of Γ on each component of $\Sigma - C$ is either trivial or infinite irreducible and all the curves of C are fixed. Hence, the action of the centralizer of Γ will be given by the following elements:

- Denh-twists along the components of C ,
- Action by the mapping class group of a subsurface on the components where the action of Γ is trivial,
- Action by, up to finite index, a cyclic subgroup generated by a pseudo-Anosov on the parts where Γ acts as a pseudo-Anosov,
- The action of the centralizer will be trivial on the components where Γ acts by, at least, two independent pseudo-Anosovs.

Moreover, we dispose of counting results for arcs in each of the cases described above: by both Bell [Bell] and Chapter 3 for the second item and by the previous section for the others. Now, for a given multicurve of Σ , cutting the surface along C we obtain a family of multiarcs and gluing them back together we have the following conjecture.

Conjecture. *Let Σ be a compact surface of finite type equipped with a hyperbolic structure X . Let Γ be a subgroup of $\text{Map}(\Sigma)$ with infinite index centralizer $C(\Gamma)$. There exist $m, n > 0$ and positive integers $k_1, \dots, k_m, \delta_1, \dots, \delta_n$ such that for every weighted multicurve γ_0 of S , there is $i_1, \dots, i_l, j_1, \dots, j_k$ and a constant $\mathfrak{c}(\gamma_0)$ such that*

$$\frac{\#\{\gamma \in C(\Gamma) \cdot \gamma_0 \mid \ell_X(\gamma) \leq L\}}{\log(L)^{\delta_{j_1} + \dots + \delta_{j_k}} L^{k_{i_1} + \dots + k_{i_l}}} \xrightarrow{L \rightarrow \infty} \mathfrak{c}(\gamma_0).$$

Remark 4.15. *Note that this result may apply for general abelian subgroups since they decompose in the same way as centralizers of reducible groups [Iva; BLM].*

We mentioned earlier the existence of free groups generated by independent pseudo-Anosovs, it is evident that Question 4.1 for such groups can not be treated using the strategy above. However, Schottky subgroups or more generally convex cocompact subgroups of the mapping class group [FM2] are subgroups of interest for which it should be interesting to consider Question 4.1.

4.2 Counting problems from the geometric and measured points of view

As we have seen throughout Chapter 3, the problem of counting elements of a given type is closely linked to the study of certain counting measures. Consequently, the question raised in the previous section is strongly related to the following one:

Question 4.16. *Given Γ an infinite index subgroup of $\text{Map}(Z)$ and $\gamma_0 \in \mathfrak{C}_m(Z)$, is there a function $P_\Gamma : \mathbb{R}_+ \rightarrow \mathbb{R}_+$ such that ν_{L, γ_0}^Γ tends to a non-zero Radon measure over $\mathfrak{C}(Z)$?*

$$\nu_{\gamma_0, L}^\Gamma = \frac{1}{P_\Gamma(L)} \sum_{\gamma \in \Gamma \gamma_0} \delta_{\frac{1}{L}\gamma} \quad (4.2.1)$$

■

Following the same strategy as for the counting results we develop below the cases of subgroups generated by a Dehn-twist or a pseudo-Anosov mapping class. We hope these two first examples, together with Theorem 3.13, to be useful to deal with the case of abelian subgroups of the mapping class group. In all generality, it is not clear to what extent we will be able to get a positive answer to Question 4.16 whatever the subgroup.

4.2.1 The special cases of Dehn-twists and pseudo-Anosov

Bearing in mind the idea raised before of using surgery processes to deal with reducible subgroups, we deal here with the cases where Γ is generated by a Pseudo-Anosov or a Dehn-twist.

Theorem 4.17. *Let Σ be a compact finite type surface and α a simple curve of Σ . For any weighted multicurve γ_0 such that $i(\alpha, \gamma_0) \neq 0$*

$$\lim_{L \rightarrow \infty} \frac{1}{L} \sum_{\gamma \in \langle T_\alpha \rangle \gamma_0} \delta_{\frac{1}{L}\gamma} = \frac{2}{i(\alpha, \gamma_0)} \text{Leb}_\alpha.$$

Where Leb_α is the Lebesgue measure over $\{t\alpha \mid t \geq 0\}$ and the convergence occurs for the weak* topology.

Proof. Let us fix a hyperbolic structure X on Σ and denote by Γ the subgroup of $\text{Map}(\Sigma)$ generated by T_α .

We will follow the same steps of proof as in Section 3.3.

1. The family $(\nu_{\gamma_0, L}^\Gamma)_{L>0}$ is precompact,
2. The support of every accumulation point is included in $\mathcal{ML}(\Sigma)$,
3. All the measured laminations of the support have a unique leaf which is α ,
4. We identify the limit thanks to the previous counting results.

Exactly the same arguments as in the proof of Proposition 3.8, but based on Theorem 4.4 instead of Theorem 2.15 give us the precompactity.

With the same modifications, the same arguments as in the proof of Proposition 3.9 allow to conclude that every accumulation point \mathbf{m} of $(\nu_{\gamma_0, L}^\Gamma)_{L>0}$ has its support included in $\mathcal{ML}(\Sigma)$.

To identify the elements in the support let us use the following fact.

Fact. Let α be a simple curve and Λ a measured lamination. If for all curve γ with $i(\alpha, \gamma) = 0$ we also have $i(\Lambda, \gamma) = 0$ then Λ is a multiple of α .

Let \mathbf{m} be an accumulation point of $(\nu_{\gamma_0, L}^\Gamma)_{L>0}$: $\mathbf{m} = \lim_{n \rightarrow \infty} \nu_{\gamma_0, L_n}^\Gamma$ where $L_n \xrightarrow[n \rightarrow \infty]{} \infty$. Let δ be a curve of Σ such that $i(\gamma, \alpha) = 0$. We need to show that for every $R > 0$, $\int_{\{\mu \in \mathcal{C}(\Sigma) | \ell_X(\mu) \leq R\}} i(\mu, \delta) d\mathbf{m} = 0$. Using the fact that γ is a fixed point of $\langle T_\alpha \rangle$ and Theorem 4.4 we have

$$\begin{aligned}
\int_{\{\mu \in \mathcal{C}(\Sigma) | \ell_X(\mu) \leq R\}} i(\mu, \gamma) d\nu_{\gamma_0, L_n}^\Gamma &= \frac{1}{L_n} \sum_{\substack{\gamma \in \Gamma \cdot \gamma_0 \\ \ell_X(\gamma) \leq RL_n}} \frac{i(\gamma, \delta)}{L_n} && (4.2.2) \\
&= \frac{1}{L_n} \sum_{\substack{\gamma \in \Gamma \cdot \gamma_0 \\ \ell_X(\gamma) \leq L_n R}} \frac{i(\gamma_0, \delta)}{L_n} \\
&= \frac{Ri(\gamma_0, \delta) \#\{\gamma \in \Gamma \cdot \gamma_0 | \ell_X(\gamma) \leq RL_n\}}{L_n RL_n} \\
&\xrightarrow[n \rightarrow \infty]{} 0 \cdot \frac{2}{i(\gamma_0, \alpha)\ell_X(\alpha)}.
\end{aligned}$$

Hence, for every Λ in the support of \mathbf{m} , $i(\Lambda, \delta) = 0$ and \mathbf{m} is supported by $\{t\alpha | t \geq 0\} = \mathbb{R}_{\geq 0}\alpha$.

The support of \mathbf{m} identify with the real line, for every $0 \leq a \leq b$ let us consider,

$$[a, b]_\alpha = \{t\alpha | a \leq t \leq b\} = \mathbb{R}_+\alpha \cap \{\mu \in \mathcal{C}(\Sigma) | a\ell_X(\alpha) \leq \ell_X(\mu) \leq \ell_X(\alpha)b\},$$

and use constant notations for open intervals.

For every $0 \leq a < b$ we have,

$$\begin{aligned}
\nu_{\gamma_0, L_n}^\Gamma \{ \mu \in \mathcal{C}(\Sigma) \mid a\ell_X(\alpha) < \ell_X(\mu) < b\ell_X(\alpha) \} & \quad (4.2.3) \\
&= \frac{\#\{\gamma \in \Gamma \cdot \gamma_0 \mid \ell_X(\gamma) < L_n b\ell_X(\alpha)\}}{L_n} - \frac{\#\{\gamma \in \Gamma \cdot \gamma_0 \mid \ell_X(\gamma) \leq L_n a\ell_X(\alpha)\}}{L_n} \\
&\leq \frac{\#\{\gamma \in \Gamma \cdot \gamma_0 \mid \ell_X(\gamma) \leq L_n b\ell_X(\alpha)\}}{L_n} - \frac{\#\{\gamma \in \Gamma \cdot \gamma_0 \mid \ell_X(\gamma) \leq L_n a\ell_X(\alpha)\}}{L_n} \\
&\xrightarrow{n \rightarrow \infty} \frac{2(b-a)}{i(\alpha, \gamma_0)} \quad \text{via Theorem 4.4}
\end{aligned}$$

$$\begin{aligned}
\nu_{\gamma_0, L_n}^\Gamma \{ \mu \in \mathcal{C}(\Sigma) \mid a\ell_X(\alpha) \leq \ell_X(\mu) \leq b\ell_X(\alpha) \} & \quad (4.2.4) \\
&= \frac{\#\{\gamma \in \Gamma \cdot \gamma_0 \mid \ell_X(\gamma) \leq L_n b\ell_X(\alpha)\}}{L_n} - \frac{\#\{\gamma \in \Gamma \cdot \gamma_0 \mid \ell_X(\gamma) < L_n a\ell_X(\alpha)\}}{L_n} \\
&\geq \frac{\#\{\gamma \in \Gamma \cdot \gamma_0 \mid \ell_X(\gamma) \leq L_n b\ell_X(\alpha)\}}{L_n} - \frac{\#\{\gamma \in \Gamma \cdot \gamma_0 \mid \ell_X(\gamma) \leq L_n a\ell_X(\alpha)\}}{L_n} \\
&\xrightarrow{n \rightarrow \infty} \frac{2(b-a)}{i(\alpha, \gamma_0)} \quad \text{via Theorem 4.4}
\end{aligned}$$

We want to show that there is a constant $c((L_n)_{n \in \mathbb{N}})$ such that \mathbf{m} is equal to $c((L_n)_{n \in \mathbb{N}})$ times the Lebesgue measure Leb_α over $\mathbb{R}_{\geq 0}\alpha$. Equivalently, we need to show that for every $a \leq b$ non-negative $\mathbf{m}([a, b]_\alpha) = c((L_n)_{n \in \mathbb{N}})(b - a)$.

First of all, for any $a \geq 0$, by inner regularity of Radon measures we have $\mathbf{m}(\{a\}) = \inf_{\varepsilon > 0} \mathbf{m}((a - \varepsilon, a + \varepsilon)_\alpha)$. Moreover, \mathbf{m} being the weak* limit of $(\nu_{\gamma_0, L_n})_{n \in \mathbb{N}}$ the Portmanteau theorem ensures that

$$\begin{aligned}
\mathbf{m}((a - \varepsilon, a + \varepsilon)_\alpha) &\leq \liminf_n \nu_{\gamma_0, L_n}(\{ \mu \in \mathcal{C}(\Sigma) \mid (a - \varepsilon)\ell_X(\alpha) < \ell_X(\mu) < (a + \varepsilon)\ell_X(\alpha) \}) \\
&\leq \frac{4\varepsilon}{i(\alpha, \gamma_0)} \quad \text{by eq. (4.2.3)}.
\end{aligned}$$

Hence $\mathbf{m}(\{a\}) = 0$ and for every $0 \leq a < b$, $\mathbf{m}([a, b]_\alpha) = \mathbf{m}((a, b)_\alpha)$. Still by the Portmanteau theorem we have

$$\begin{aligned}
\mathbf{m}((a, b)_\alpha) &\leq \liminf_n \nu_{\gamma_0, L_n}^\Gamma \{ \mu \in \mathcal{C}(\Sigma) \mid a\ell_X(\alpha) < \ell_X(\mu) < b\ell_X(\alpha) \} \\
&\leq \frac{2}{i(\alpha, \gamma_0)}(b - a) \quad \text{by eq. (4.2.3)},
\end{aligned}$$

$$\begin{aligned} \mathbf{m}([a, b]_\alpha) &\geq \limsup_n \nu_{\gamma_0, L_n}^\Gamma \{ \mu \in \mathcal{C}(\Sigma) \mid a\ell_X(\alpha) \leq \ell_X(\mu) \leq b\ell_X(\alpha) \} \\ &\geq \frac{2}{i(\alpha, \gamma_0)}(b - a) \quad \text{by eq. (4.2.4),} \end{aligned}$$

what ensures that $\mathbf{m} = \frac{2}{i(\alpha, \gamma_0)} Leb_\alpha$. This equality being true for every accumulation point we have

$$\lim_{L \rightarrow \infty} \frac{1}{L} \sum_{\gamma \in \langle T_\alpha \rangle_{>\gamma_0}} \delta_{\frac{1}{L}\gamma} = \frac{2}{i(\alpha, \gamma_0)} Leb_\alpha.$$

□

Remark 4.18. *If we want to consider a surface of finite type with punctures, then the same proof applies when working in a certain $\mathcal{C}_K(S)$ rather than in the entire space of geodesic currents.*

Theorem 4.19. *Let Σ be a compact finite type surface and Φ a pseudo-Anosov of Σ . For every weighted multicurve γ_0 of Σ*

$$\lim_{L \rightarrow \infty} \frac{1}{\log(L)} \sum_{\gamma \in \langle \Phi \rangle_{>\gamma_0}} \delta_{\frac{1}{L}\gamma} = \frac{2}{\log(\lambda)} \delta_0,$$

where δ_0 is the Dirac mass in 0 and the convergence occurs for the weak* topology for measures on $\mathcal{C}(\Sigma)$.

Proof. The proof follows the same strategy as for the previous theorem. The fact that the limit measure is a Dirac mass follows from the independence of the counting results with the chosen measure of complexity. □

Hence, if the action of a given subgroup of the mapping class group decomposed into Dehn-twists, pseudo-Anosov and full mapping class groups of subsurfaces one can expect to obtain at the limit a combination of Lebesgue measures, Dirac mass and Thurston measures of subsurfaces. Especially, it seems that Question 4.16 can be answered positively for every abelian subgroups of the mapping class group.

4.2.2 Geometric interpretation of measures convergence results

The weak* convergence of measures informs us about the behavior of the associated supports. Indeed, if $\nu_L \xrightarrow[L \rightarrow \infty]{weak^*} \nu$ then $\text{Supp}(\nu) \subset \liminf_L \text{Supp}(\nu_L)$. In particular, the inter-

pretation of the counting results in terms of convergence of measures gives us information about the accumulation points of the rescaled orbits.

If we consider Erlandsson-Souto's measures convergence results then we have the following inclusion:

$$\text{Supp}(\mathfrak{m}_{Thu}^\Sigma) \subset \{\mu \in \mathcal{C}(\Sigma) \mid \forall \mu \in U \text{ open, } \exists L_U : \forall L \geq L_U, \frac{1}{L} \text{Map} \cdot \gamma_0 \cap U \neq \emptyset\} \quad (4.2.5)$$

meaning that the rescaled orbits $\{\frac{1}{L} \text{Map} \cdot \gamma_0\}_{L>0}$ accumulate on the ending measured laminations. Then, the identification of the limit measure in Question 4.16 is closely related to the identification of its support and then to the answer to the following question.

Question 4.20. *For $\Gamma < \text{Map}$ and γ_0 a weighted multicurve, where does $\Gamma \cdot \gamma_0$ accumulates in $\mathbb{P}_+ \mathcal{ML}$?* ■

The answer to this question should also be related to the study of the limit sets of subgroups of mapping class group done in [MP] or [KL] for example.

4.3 From counting results to asymptotics on curves

The questions raised in this section are part of an ongoing project with M.Liu, K.Rafi and J.Souto

The different counting results on curves give us some tools to study the asymptotic behavior of curves. Indeed, given two types of curves γ_1 and γ_2 on a hyperbolic surface of finite type X

$$\frac{\#\{\gamma \in \text{Map} \cdot \gamma_0 \mid \ell_X(\gamma) \leq L\}}{\#\{\gamma \in \text{Map} \cdot \gamma_1 \mid \ell_X(\gamma) \leq L\}} \xrightarrow{L \rightarrow \infty} \frac{\mathfrak{c}_{g,r}^{\text{Map}}(\gamma_0)}{\mathfrak{c}_{g,r}^{\text{Map}}(\gamma_1)}.$$

So, for a given surface, if we are able to calculate $\mathfrak{c}_{g,r}^{\text{Map}}$ then we may be able to say which type of curve is most likely. For example, focussing on the case of simple curves, Delecroix-Goujard-Zograf-Zorich [Del+] showed that in large genus, almost every simple curves are non-separating and Mirzakhani [Mir1] showed that in the closed genus 2 surface there is 48 times more non-separating than separating simple curves.

The constant $\mathfrak{c}_{g,r}^{\text{Map}}(\cdot)$ is the same as in eq. (3.1.1) according to Mirzakhani or Erlandsson-Souto, this constant can be divided into two parts: $\mathfrak{c}_{g,r}^{\text{Map}}(\cdot) = \frac{c(\cdot)}{\mathfrak{b}_{g,r}}$. Hence, the part we are

exactly interested in is $c(\cdot)$. If γ is a simple weighted multicurve then Mirzakhani gave an expression of $c(\gamma_0)$ in terms of some integrals over moduli space [Mir1], it is this expression which is used in [Del+]. For general curves Rafi-Souto [ES3, Chapter 11] expressed it in terms of the Thurston measure. Since the integrals over moduli space can be computed, it is natural to wonder if $c(\cdot)$ can be expressed for general curves in the same way as for simple curves and if results in the line of [Del+] exist for non-simple curves.

Question 4.21. *Can $c(\gamma)$ be expressed for general multicurves in the same terms as for simple curves? Can we deduce asymptotic results for the curves?* ■

BIBLIOGRAPHY

- [AL] J. Aramayona and C. Leininger. « Hyperbolic Structures on Surfaces and Geodesic Currents ». In: *Algorithmic and Geometric Topics Around Free Groups and Automorphisms*. Ed. by J. González-Meneses, M. Lustig, and E. Ventura. Birkhäuser, 2017, page(s): 111–149.
- [Ara] F. Arana-Herrera. *Normalizations of Thurston measure on the space of measured geodesic laminations*. URL: <https://terpconnect.umd.edu/~farana/normalization.pdf>.
- [Bel1] N. Bell. « Arcs on hyperbolic surfaces: a view towards counting ». PhD thesis. Bristol University, 2022.
- [Bel2] N. Bell. « Counting arcs on hyperbolic surfaces ». In: *Groups Geom. Dyn.* **17** (2023), page(s): 459–478.
- [Bes] M. Bestvina. « \mathbb{R} -trees in topology, geometry and group theory ». In: *Handbook of geometric topology* (2001), page(s): 55–91.
- [BH] M. R. Bridson and A. Haefliger. *Metric spaces of Non-positive curvature*. Vol. 319. Grundlehren der mathematischen Wissenschaften. Springer Berlin, Heidelberg, 1999.
- [BL] A. Bankovic and C. J. Leininger. « Marked-length-spectral rigidity for flat metrics ». In: *Trans. Amer. Math. Soc.* **370.3** (2018), page(s): 1867–1884.
- [BLM] J. S. Birman, A. Lubotzky, and J. McCarthy. « Abelian and solvable subgroups of the mapping class groups ». In: *Duke Math. J.* **50.4** (1983), page(s): 1107–1120.
- [Bon1] F. Bonahon. « Bouts des Variétés Hyperboliques de Dimension 3 ». In: *Annals of Mathematics* **124.1** (1986), page(s): 71–158.
- [Bon2] F. Bonahon. « The geometry of Teichmüller space via geodesic currents ». In: *Invent. Math.* **92** (1988), page(s): 139–162.
- [Bon3] F. Bonahon. « Geodesic laminations on surfaces ». In: *Laminations and Foliations in Dynamics, Geometry and Topology*. 2001.

- [BPT] A. Basmajian, H. Parlier, and S. Tan. *Prime orthogeodesics, concave cores and families of identities on hyperbolic surfaces*. 2020.
- [BŠ] F. Bonahon and D. Šarić. « A Thurston boundary for infinite-dimensional Teichmüller spaces ». *In: Mathematische Annalen* (2021), page(s): 1119–1167.
- [Bur+1] M. Burger, A. Iozzi, A. Parreau, and B. Pozzetti. *Positive crossratios, barycenters, trees and applications to maximal representations*. 2021.
- [Bur+2] M. Burger, A. Iozzi, A. Parreau, and M. B. Pozzetti. « Currents, systoles, and compactifications of character varieties ». *In: Proc. Lond. Math. Soc. (3)* **123.6** (2021), page(s): 565–596.
- [CFF] C. Croke, A. Fathi, and J. Feldman. « The marked length-spectrum of a surface of nonpositive curvature ». *In: Topology* **31.4** (1992), page(s): 847–855.
- [Del+] V. Delecroix, É. Goujard, P. Zograf, and A. Zorich. « Masur-Veech volumes, frequencies of simple closed geodesics, and intersection numbers of moduli spaces of curves ». *In: Duke Math. J.* **170.12** (2021), page(s): 2633–2718.
- [DLR] M. Duchin, C. J. Leininger, and K. Rafi. « Length spectra and degeneration of flat metrics ». *In: Invent. Math.* **182.2** (2010), page(s): 231–277.
- [EPS] V. Erlandsson, H. Parlier, and J. Souto. « Counting curves and the stable length of currents ». *In: J. Eur. Math. Soc.* **22** (2020), page(s): 1675–1702.
- [Erl] V. Erlandsson. « A remark on the word length in surface groups ». *In: Trans. Amer. Math. Soc.* **372** (2019), page(s): 441–455.
- [ES1] V. Erlandsson and J. Souto. « Counting curves in hyperbolic surfaces ». *In: Geom. Funct. Anal.* **26** (2016), page(s): 729–777.
- [ES2] V. Erlandsson and J. Souto. « Counting curves on orbifolds ». *In: Trans. London Math. Soc.* **9** (2022), page(s): 56–85.
- [ES3] V. Erlandsson and J. Souto. *Mirzakhani’s curve counting and geodesic currents*. Vol. 345. Progress in Mathematics. Birkhäuser, 2022.
- [FLP] A. Fathi, F. Laudenbach, and V. Poénaru. *Travaux de Thurston sur les surfaces*. Astérisque. Vol. 66-67. Séminaire d’Orsay. SMF, 1979. URL: http://www.numdam.org/item/AST_1979__66-67__1_0/.
- [FM1] B. Farb and D. Margalit. *A primer on mapping class groups*. Princeton University Press, 2011.

- [FM2] B. Farb and L. Mosher. « The geometry of surface-by-free groups ». *In: Geom. Funct. Anal.* **12.5** (2002), page(s): 915–963.
- [Haa] A. Haas. « Geodesic cusp excursions and metric Diophantine approximation ». *In: Math. Res. Lett.* **16** (2009), page(s): 67–85.
- [Ham] U. Hamenstädt. « Invariant Radon measures on measured lamination space ». *In: Invent. Math.* **176.2** (2009), page(s): 223–273.
- [HP] S. Hersensky and F. Paulin. « On the rigidity of discrete isometry groups of negatively curved spaces ». *In: Comment. Math. Helv.* **72.3** (1997), page(s): 349–388.
- [Iva] N. V. Ivanov. *Subgroups of Teichmüller Modular Group*. Vol. 115. Translations of Mathematical Monographs. AMS, 1991.
- [KL] A. Kent and C. J. Leininger. « Subgroups of mapping class groups from the geometrical viewpoint ». *In: In the tradition of Ahlfors-Bers. IV*. Vol. 432. Contemp. Math. Amer. Math. Soc., Providence, RI, 2007, page(s): 119–141.
- [Lal1] S. P. Lalley. « Distribution of Periodic Orbits of Symbolic and Axiom A flows ». *In: Advances in applied mathematics* **8** (1987), page(s): 154–193.
- [Lal2] S. P. Lalley. « Renewal theorems in symbolic dynamics, with applications to geodesic flows, noneuclidean tessellations and their fractal limits ». *In: Acta Mathematica* **163** (1989), page(s): 1–55.
- [LM] E. Lindenstrauss and M. Mirzakhani. « Ergodic theory of the space of measured laminations ». *In: Int. Math. Res. Not.* **4** (2008).
- [Mas] H. Masur. « Ergodic Actions of the Mapping Class Group ». *In: Proc. Amer. Math. Soc.* **94** (1985), page(s): 455–459.
- [Mir1] M. Mirzakhani. « Growth of the number of simple closed geodesics on hyperbolic surfaces ». *In: Ann. of Math* **168** (2008), page(s): 97–125.
- [Mir2] M. Mirzakhani. « Counting mapping class group orbits on hyperbolic surfaces ». *In: arXiv:1601.03342* (2016).
- [MP] J. McCarthy and A. Papadopoulos. « Dynamics on Thurston’s sphere of projective measured foliations ». *In: Comment. Math. Helv.* **64.1** (1989), page(s): 133–166.

- [MS] J. W. Morgan and P. B. Shalen. « Valuations, Trees, and Degenerations of Hyperbolic Structures ». *In: Annals of Mathematics* **120** (1984), page(s): 401–476.
- [MT1] D. Martínez-Granado and D. P. Thurston. « From curves to currents ». *In: Forum Math. Sigma* **9** (2021), page(s): Paper No. e77, 52.
- [MT2] L. Monin and V. Telpukhovskiy. « On normalizations of Thurston measure on the space of measured laminations ». *In: Topology Appl.* **267** (2019).
- [MZ] G. Martone and T. Zhang. « Positively ratioed representations ». *In: Comment. Math. Helv.* **94.2** (2019), page(s): 273–345.
- [Ohs] K. Ohshika. « Compactifications of Teichmüller spaces ». *In: Handbook of Teichmüller Theory*. Vol. iv. European Mathematical Society, 2014.
- [Ota] J-P. Otal. « Le spectre marqué des longueurs des surfaces à courbure négative ». *In: Ann. of Math.* **131.1** (1990), page(s): 151–162.
- [Par] H. Parlier. « Geodesic and orthogeodesic identities on hyperbolic surfaces ». *In: arXiv:2004.09078* (2020).
- [Pau1] F. Paulin. « Topologie de Gromov équivariante, structures hyperboliques et arbres réels ». *In: Inventiones mathematicae* (1988), page(s): 53–80.
- [Pau2] F. Paulin. « Sur la compactification de Thurston de l’espace de Teichmüller ». *In: Géométries à courbure négative ou nulle, groupes discrets et rigidités*. Soc. Math. France, 2009, page(s): 421–423.
- [Pol] M. Pollicott. « Limiting distributions for geodesics excursions on the modular surface ». *In: Contemp. Math.* **484** (2009), page(s): 177–185.
- [RS] K. Rafi and J. Souto. « Geodesic currents and counting problems ». *In: Geom. Funct. Anal.* **29** (2019), page(s): 871–889.
- [Sas] D. Sasaki. « Currents on cusped hyperbolic surfaces and denseness property ». *In: Groups Geom. Dyn.* **16.3** (2022), page(s): 1077–1117.
- [Sco] P. Scott. « Subgroups of surface groups are almost geometric ». *In: J. London Math. Soc.* **17** (1978), page(s): 555–565.
- [Sul] D. Sullivan. « Disjoint spheres, approximation by imaginary quadratic numbers, and the logarithm law for geodesics ». *In: Acta Mathematica* **149** (1982), page(s): 215–237.

- [SV] J. Souto and H. Vo. « Deciding when two curves are of the same type ». *In: arXiv:2012.09792* (2020).
- [Thu] W. P. Thurston. « On the geometry and dynamics of diffeomorphisms of surfaces ». *In: Bulletin of the american mathematical society* (1988), page(s): 417–431.
- [Tri1] M. Trin. « Thurston’s compactification via geodesic currents: the case of non-compact finite area surfaces ». *In: To be published in Annales de l’Institut Fourier* (2022).
- [Tri2] M. Trin. « Counting arcs of the same type ». *In: arXiv:2306.07573* (2023).

Titre : Application des courants géodésiques à la géométrie des surfaces

Mot clés : Surfaces hyperboliques, courants géodésiques, problèmes de comptage, espace de Teichmüller

Résumé : Soit Z une surface de type fini et de caractéristique d'Euler strictement négative. Un courant géodésique sur Z est une mesure de Radon stable par $\pi_1(Z)$ sur les géodésiques non-orientées et bi-infinies du revêtement universel de Z . Cette notion a été introduite par F. Bonahon en 1986 et a depuis eu de nombreuses applications à l'étude de la géométrie des surfaces. On s'intéresse ici à deux applications de cette notion : l'étude de la compactification de l'espace de Teichmüller et les problèmes de comptage de courbes.

Le premier chapitre de ce manuscrit est dédié aux définitions et propriétés fondamentales nécessaires. Le chapitre 2 traite de la compactification de Thurston de l'espace de

Teichmüller, en particulier, on prouve que la méthode de Bonahon par les courants géodésiques peut être adaptée aux surfaces non-compactes d'aire finie. Ce chapitre démontre aussi des résultats sur les suites de géodésiques aléatoires. Les deux chapitres suivants sont dédiés à des problèmes de comptage de géodésiques. Dans le chapitre 3 on montre que l'on peut compter les arcs d'une surface à bords à l'aide de familles convergentes de mesures sur les courants géodésiques. Puis, le chapitre 4 est dédié aux différentes ouvertures qu'offre ce manuscrit. La principale étant le comptage des orbites pour l'action des sous-groupes du mapping class group sur les courbes.

Title: Application of geodesic currents to geometry of surfaces

Keywords: Hyperbolic surfaces, geodesic currents, counting problems, Teichmüller space

Abstract: Let Z be a finite surface with negative Euler characteristic. A geodesic current on Z is a Radon measure stable through $\pi_1(Z)$ on the set of bi-infinite unoriented geodesics of the universal cover of Z . This notion has been introduced by F. Bonahon in 1986 and has since proven to be a fertile concept in the study of geometry of surfaces. In this thesis we are interested in two main applications of geodesic currents: the compactification of Teichmüller space and counting problems in surfaces.

The first chapter is dedicated to the necessary definitions and properties. Chapter 2 deals with Thurston compactification of Te-

ichmüller space. Especially, we will prove that the method developed by Bonahon using geodesic currents can be extended for non-compact surfaces of finite area. This chapter also contains some results about sequences of random geodesics. The last two chapters focus on counting problems. In chapter 3 we prove that arcs in surfaces with boundary can be counted thanks to families of measures on geodesic currents. Hence, chapter 4 is dedicated to the different perspectives associated to this manuscript. The main one being to count elements in the orbits for the action of subgroups of mapping class groups on curves.