



HAL
open science

Global Molecular Characterization of Extended-Spectrum β -lactamases and carbapenemases in Enterobacterales

Christine Lascols

► **To cite this version:**

Christine Lascols. Global Molecular Characterization of Extended-Spectrum β -lactamases and carbapenemases in Enterobacterales. Bacteriology. Université Paris-Saclay, 2024. English. NNT : 2024UPASQ010 . tel-04738725

HAL Id: tel-04738725

<https://theses.hal.science/tel-04738725v1>

Submitted on 15 Oct 2024

HAL is a multi-disciplinary open access archive for the deposit and dissemination of scientific research documents, whether they are published or not. The documents may come from teaching and research institutions in France or abroad, or from public or private research centers.

L'archive ouverte pluridisciplinaire **HAL**, est destinée au dépôt et à la diffusion de documents scientifiques de niveau recherche, publiés ou non, émanant des établissements d'enseignement et de recherche français ou étrangers, des laboratoires publics ou privés.

Global Molecular Characterization of Extended-Spectrum β -lactamases and Carbapenemases in *Enterobacterales*

*Caractérisation moléculaire des β -lactamases à spectre étendu
et carbapénémases chez les Enterobacterales dans le monde entier*

Thèse de doctorat de l'Université Paris-Saclay

École doctorale n° 569,
Innovation Thérapeutique : du Fondamental à l'Appliqué
Spécialité de doctorat : Microbiologie
Graduate school : Santé et médicaments ; Référent : Faculté de pharmacie

Thèse préparée dans l'unité de recherche
Institute for Integrative Biology of the Cell (I2BC) (Université Paris-Saclay, CEA, CNRS)
Sous la direction de **Florence DOUCET-POPULAIRE**, Professeure

Thèse soutenue à Paris-Saclay, le 22 mars 2024, par

Christine LASCOLS

Composition du Jury

Membres du jury avec voix délibérative

Emmanuelle CAMBAU

Pr, Université Paris Cité

Présidente

Laurence ARMAND-LEFEVRE

Pr, Université Paris-Cité

Rapporteur

Richard BONNET

Pr, Université de Clermont-Ferrand

Rapporteur

Jean-Winoc DECOUSSER

Pr, Université Paris-Est Créteil

Examineur

Gilles ZAMBARDI

bioMérieux (privé)

Examineur

Pierre-Edouard SAINT-ANTONIN

Novartis (privé)

Examineur

SUMMARY (ENGLISH)

Title: Global Molecular Epidemiology of Extended Spectrum β -lactamases and Carbapenemases in *Enterobacterales*.

Keywords: Antimicrobial resistance; ESBL/carbapenemase, epidemiology, *Klebsiella pneumoniae*, Nanopore sequencing.

Abstract: Antimicrobial resistance is one of the top 10 threats to public health worldwide. β -lactams, highly effective drugs with low toxicity, are the most commonly used class of antibiotics. The vicious circle in *Enterobacterales*, set in motion by the introduction of new β -lactams leading to more β -lactamases, is inevitable. Chronologically, it started with the global spread of various enzymes such as extended-spectrum- β -lactamases (ESBLs) in the 80-90s and later carbapenemases. Multidrug-resistant (MDR) pathogens that cause hospital-acquired infections often carry multiple β -lactamases and resistance to other antimicrobials. This is of great concern today as there are few, if any, drugs left as a last resort. The emergence of new concerning β -lactamases emphasizes the need for more global studies based on molecular epidemiology.

Our work focused on investigating the current epidemiology of β -lactamases at the time of the emergence of the New Delhi metallo- β -lactamase (NDM-1 MBL) in 2009, and better understand the molecular characteristics of MDR plasmids. To this end, we characterized ESBLs and carbapenemases in a worldwide collection of clinical *Enterobacterales* isolates from 2008/2009, and MDR plasmids in a collection from 2013 of clinical *K. pneumoniae* isolates from Pakistan, an endemic region of NDM-1.

Overall, we demonstrated that CTX-M was most frequently identified as an ESBL in our collection across all species and in all regions worldwide, consistent with the CTX-M pandemic. A large majority of *E. coli* (91.8%) and *K. pneumoniae* (65.6%) carried *bla*_{CTX-M} alone or in combination with other ESBL genes such as *bla*_{SHV/TEM} (1.8%). Today, CTX-M-type enzymes are still the most prevalent ESBL-types, with CTX-M-15 dominating worldwide, as shown by our study, in which 67% of CTX-M producers possessed *bla*_{CTX-M-15}. Similarly, in *Enterobacterales* the most commonly identified carbapenemase was NDM-1 (50%), followed by KPC (35%) except in *K. pneumoniae* isolates where KPC was most prevalent (43%). We reported the first NDM-1 MBL from Mauritius, illustrating the spread of NDM-1 in Africa. For each β -lactamase type, the following variants were most frequently identified: CTX-M-15, SHV-12, TEM-52, KPC-2, and NDM-1.

Three novel gene variants, and STs such as *bla*_{SHV-129}, *bla*_{KPC-11} and *bla*_{VIM-33} and ST571, ST572 and ST903, respectively, were identified. These results illustrate the constant and unstoppable evolution of β -lactamases which will have an impact on the future development of new drugs. In a key pathogen such as *K. pneumoniae*, three important STs were identified: ST11, ST147, and ST258, which were associated with different enzymes and countries (e.g., ST258 - KPC/SHV-12, Greece). This result suggests that our studies detected the known high-risk clones, which are key factors for the spread of carbapenemases, at an early stage. Finally, examination of MDR plasmids revealed that all clinical isolates of *K. pneumoniae* tested harbored multiple plasmids including ESBL and NDM-1, plasmids that carry numerous antimicrobial genes and, in some cases, have molecular rearrangements. New technologies such as real-time sequencing, which was used in our recent study, can help to rapidly identify, and understand the molecular mechanisms associated with the successful spread of specific clones or plasmids.

Overall, our studies have shown that global molecular epidemiology is constantly evolving in many parts of the world. The emergence and spread of different enzymes either as high-risk clones or via the spread of plasmids is becoming increasingly effective, and warrants more aggressive strategies, including systematic global molecular studies. Our findings suggest that today's innovative real-time sequencing technology, as part of a multi-pronged approach involving microbiologists, epidemiologists, and clinicians, can help inform and strengthen infection control measures to combat AMR by 2050.

RESUME (FRANCAIS)

Titre : Epidémiologie moléculaire mondiale des β -lactamases à spectre étendu et des carbapénémases chez les *Enterobacterales* dans le monde entier.

Mots clés : Résistance aux antibiotiques ; BLSE/carbapénémase, épidémiologie, *Klebsiella pneumoniae*, séquençage Nanopore.

Résumé : La résistance aux antibiotiques est un l'une des dix menaces principales de santé publique dans le monde entier. Les β -lactamines, antibiotiques très efficaces et peu toxiques, sont les plus utilisés. Chez les *Enterobacterales*, le cercle vicieux, enclenché par l'introduction de nouvelles β -lactamines conduisant à davantage de β -lactamases, est inévitable. La diffusion mondiale de ces enzymes a commencé par les β -lactamases à spectre étendu (BLSE) dans les années 80-90 et plus tard les carbapénémases. Les agents pathogènes multirésistants (MDR) sont souvent porteurs de plusieurs β -lactamases et gènes de résistance. Comme il ne reste que peu d'antibiotiques, en dernier recours, voire aucun, cela souligne la nécessité de faire plus d'études d'épidémiologie moléculaire mondiale.

Nos travaux se sont concentrés sur l'étude de l'épidémiologie des β -lactamases au moment de l'émergence de la métallo- β -lactamase (MBL) de New Delhi (NDM-1) en 2009, et afin de mieux comprendre les caractéristiques moléculaires des plasmides MDR. Nous avons caractérisé les BLSE/carbapénémases de souches cliniques d'*Enterobacterales* isolées dans le monde entier en 2008/2009, et les plasmides MDR provenant de souches cliniques de *K. pneumoniae* isolées en 2013 au Pakistan, une région endémique de NDM-1.

Nous avons démontré que les CTX-M étaient le plus souvent identifiées, toutes espèces confondues et dans toutes les régions du monde, ce qui a confirmé que la pandémie de CTX-M était toujours présente. Une grande majorité d'*E. coli* (91,8 %) et de *K. pneumoniae* (65,6 %) étaient porteuses de *bla*_{CTX-M} seul ou en combinaison avec *bla*_{SHV/TEM} (1,8 %). Aujourd'hui, les CTX-M sont toujours les plus répandues, avec CTX-M-15 qui prédomine dans le monde, comme dans notre étude, où 67% des souches possédaient *bla*_{CTX-M-15}. Chez les *Enterobacterales*, la carbapénémase la plus fréquemment identifiée était NDM-1 (50%), puis KPC (35%), mais chez *K. pneumoniae*, KPC était la plus répandue (43%).

Nous avons identifié la première MBL NDM-1 isolée à l'île Maurice, ce qui mis à en évidence la dissémination de NDM-1 en Afrique. Pour chaque type de β -lactamase, les variants suivants ont été les plus fréquemment identifiés : CTX-M-15, SHV-12, TEM-52, KPC-2 et NDM-1. Trois nouveaux variants (*bla*_{SHV-129}, *bla*_{KPC-11}, *bla*_{VIM-33}) et STs (ST571, ST572, ST903), ont été identifiés. Ce qui illustre une évolution constante et inévitable des β -lactamases, qui impactera le développement de nouveaux antibiotiques. Chez *K. pneumoniae*, agent pathogène clé, trois STs majeurs : ST11, ST147 et ST258, associés à des enzymes et pays différents (ex : ST258-KPC/SHV-12, Grèce), ont été identifiés. Nos études ont détecté à un stade précoce, des clones connus aujourd'hui pour être à haut risque dans la dissémination des carbapénémases. Enfin, l'étude des plasmides MDR a montré que toutes les souches de *K. pneumoniae* contenaient plusieurs plasmides (BLSE/NDM-1) porteurs de nombreux gènes de résistance avec des réarrangements moléculaires. De nouvelles technologies, comme le séquençage en temps réel, peuvent aider à identifier et à comprendre rapidement les mécanismes moléculaires associés à la dissémination efficace de clones ou de plasmides spécifiques.

Nos études ont montré que l'épidémiologie moléculaire mondiale est en constante évolution dans le monde. L'émergence de différentes enzymes qui se propagent, soit sous forme de clones à haut risque, soit par la dissémination de plasmides, devient plus efficace. De nouvelles stratégies plus agressives, comprenant des études moléculaires mondiales, sont donc justifiées. Nos résultats suggèrent aussi que dans le cadre d'une approche à plusieurs volets impliquant des microbiologistes, des épidémiologistes et des cliniciens, le séquençage en temps réel d'aujourd'hui, peut aider à éclairer et à renforcer les mesures de contrôle des infections pour diminuer la résistance aux antibiotiques d'ici 2050.

Acknowledgements

Many thanks to the members of the ED569 "Innovation Thérapeutique, du fondamental à l'Appliqué at the Doctoral School of the Paris-Saclay University

I would like to express my sincere gratitude to **Professor Sandrine Onger** (ED569 PhD School, current Director), **Professor Christian Poüs** (ED569 PhD School, former Director) and **Professor Imad Kansau** (ED569 PhD School, Head of the Department of Microbiology and Anti-Infectives), for approving my enrolment in the VAE program at the Paris-Saclay University and making this PhD journey possible for me!

Furthermore, this endeavor would not have been possible without **Ms. Audrey Antoine**, who was always helpful and supportive for all administrative steps. She always answered my numerous questions promptly. Many thanks for that!

A big thank you to all the committee members,

I would like to sincerely thank all committee members for agreeing to evaluate my work on this committee.

A big thank you to **Professor Emmanuelle Cambau** for chairing this committee and for providing her expertise,

A special thank you to **Professor Laurence Armand-Lefevre** and **Professor Richard Bonnet** for their interest in reviewing this dissertation, their valuable feedback and for making my dissertation even more attractive,

Many thanks to **Professor Jean-Winoc Decousser** for his willingness to review this thesis and for his valuable contribution,

I am also grateful to **Dr. Gilles Zambardi** and **Dr. Pierre-Edouard Saint-Antonin**, for agreeing to review this thesis. Their professional experience is a great help in evaluating not only the quality of this thesis but also my professional career,

I, also, cannot thank my thesis director, **Professor Doucet Populaire**, enough! I must say that I could not have embarked on this journey without her invaluable feedback, knowledge, guidance, and support all along the way. Her strong support of my own ideas and confidence in my abilities was an asset that I greatly appreciated. Completing a PhD through the VAE program while holding down a full-time job can be a difficult and draining experience, but I am proud to say that my experience was intellectually exciting and fun!

Thank you to all the great people I have met throughout my career,

I would like to express my deepest appreciation to the following people, without whom I would not have been able to embark on this journey, and without whom I would not have been able to pursue my PhD!

- Thank you to **the IHMA team**. Thank you to **Robert Badal, Jack, Brian, and Aaron Johnson**, and **Meredith Hackel**, for allowing me to pursue and lead several research projects on MDR pathogens from around the world while working on your team. A big thank you to **Kasia, Cathy**, both **Mary** and **Char** for their support. It was a great experience!
- A special thank you to **Professor Robert Bonomo**, a wonderful and knowledgeable researcher who taught me all about β -lactamases! It was a great pleasure to work with him on several projects. He was also the one who inspired me to do my PhD!
- Many thanks to **Professor Johann Pitout** and **Gisele Peirano** for the wonderful collaboration. I have learned so much about β -lactamases from both. Thank you so much! It was such a great adventure!
- A big thank you to **Professor Pierre Bogaerts** for his valuable guidance on writing a PhD thesis, and his feedback on this important topic of β -lactamases.
- Many thanks to **Professor Patrice Nordmann** and **Dr. Laurent Poirel** for a fruitful collaboration.
- A special thank you to **Professor Claude-James Soussy** and **Annick Allary** for supporting me at every step of the way in my career and for getting me excited about antimicrobial resistance!
- Many thanks to **the CDC BioDefense Research and Development (BDRD) team**. I sincerely thank **Linda Weigel** and **David Sue** for allowing me to continue working on CREs and giving me the opportunity to lead the research project in collaboration with Pakistan, the FDA, and UVA. A special thank you to **Blake Cherney**, for providing his valuable expertise on Nanopore sequencing, and many thanks to the rest of the team, **Pierre Michel, Thip Kongphet-Tran, Julia Bugrysheva, Amy Gargis, Heather McLaughlin** for supporting and believing in me! Go team!
- Thank you to **the CDC Bacterial Meningitis Laboratory (BML) Team**. A Special Thank You to **Marietou Faye Paye**, and **Alicia Feagins** for helping me complete this project, and to the current BML team for their support.

Many thanks to my family, friends, and neighbors,

Yes, it has been a long and difficult road, so a big thank you to my parents, my brother, my friends, and my neighbors who believed in me and kindly supported me during these long years. Thank you all for allowing me to persevere to the finish line despite all challenges! I really appreciated that!

Lat but not least, a special thank you my friends, Annick, Cedric, Manu, Antoine, Bernard, Déria, Catherine, Diane, Maria, Nancy, Radka, Magda, Justine, Peggy, Kelly, Dave, Phil, just to name a few!

Remerciements

Un grand merci aux membres de l'Ecole Doctorale ED569 « Innovation Thérapeutique, du fondamental à l'Appliqué » de l'Université Paris-Saclay

Je tiens à remercier sincèrement **Professeur Christian Poüs** (Directeur de Ecole doctorale ED569) et **Professeur Imad Kansau** (Ecole doctorale ED569, Chef de Pole, Microbiologie) d'avoir cru en moi, d'avoir validé mon inscription en VAE à l'Université Paris-Saclay, et d'avoir rendu possible ce parcours de VAE doctorale ! De plus, un grand merci **Mme Audrey Antoine** sans qui cela n'aurait pas été possible. Elle a toujours été là pour m'aider pour toutes les démarches administratives.

Un grand merci à tous les membres du jury,

Je tiens à remercier sincèrement tous les membres du jury d'avoir accepté d'évaluer mon travail au sein de ce jury. Un grand merci au **Professeur Emmanuelle Cambau** d'avoir accepté de présider ce jury et pour son expertise,

Un merci tout particulier au **Professeur Laurence Armand-Lefevre** et au **Professeur Richard Bonnet** pour l'intérêt qu'ils ont porté à la relecture de cette thèse, leurs précieux retours et pour avoir amélioré ma thèse,

Un grand merci au **Professeur Jean-Winoc Decousser** pour sa volonté de relire cette thèse et pour sa précieuse contribution,

Je remercie également vivement **Dr Gilles Zambardi** et **Dr Pierre-Edouard Saint-Antonin**, d'avoir accepté de relire cette thèse. Leur expérience professionnelle permettra d'évaluer non seulement la qualité de cette thèse mais aussi mon parcours professionnel.

Je ne remercierai jamais assez ma directrice de thèse, **Professeur Doucet Populaire** ! Je dois dire que je n'aurais pas pu me continuer cette aventure sans son avis, ses connaissances, ses conseils et son soutien tout au long du processus. Elle a su me soutenir dans mes propres idées et sa confiance en mes capacités a été un atout que j'ai grandement apprécié. Terminer un doctorat dans le cadre du programme VAE tout en travaillant à temps plein peut être une expérience difficile et épuisante, mais je suis fière de dire que mon expérience a été intellectuellement passionnante et amusante !

Merci à toutes les personnes formidables que j'ai rencontrées tout au long de ma carrière,

Je tiens à exprimer ma plus profonde gratitude aux personnes suivantes, sans qui je n'aurais pas pu me lancer dans cette aventure, et sans qui je n'aurais pas pu obtenir mon doctorat !

- **Merci à l'équipe de l'IHMA**

Je tiens vivement à remercier **Robert Badal, Jack, Brian, Aaron Johnson et Meredith Hackel**, de m'avoir permis de poursuivre et de diriger plusieurs projets de recherche sur les agents pathogènes MDR du monde entier tout en travaillant dans votre équipe à l'IHMA. Un grand merci à **Kasia, Cathy, Mary** et **Char** pour leur soutien. C'était une super expérience !

- Un grand merci au **Professeur Robert Bonomo**, un chercheur passionnant et extraordinaire qui m'a tout appris sur les β -lactamases ! Ce fut un grand plaisir de travailler avec lui sur plusieurs projets. C'est aussi lui qui m'a donné envie de me lancer dans un doctorat !
- Un grand merci au **Professeur Johann Pitout** et au **Dr Gisele Peirano** pour cette merveilleuse collaboration. J'ai beaucoup appris sur les β -lactamases. Merci beaucoup ! C'était une belle aventure !

- Un grand merci au **Professeur Pierre Bogaerts** pour ses précieux conseils sur la rédaction d'une thèse de doctorat, ses encouragements, et pour avoir partagé ses connaissances sur ce sujet important des β -lactamases.
- Un grand merci au **Professeur Patrice Nordmann** et au **Dr Laurent Poirel** pour cette collaboration fructueuse.
- Un grand merci au **Professeur Claude-James Soussy** et **Annick Allary** pour m'avoir soutenue à chaque étape de ma carrière et de m'avoir transmis cette passion pour la résistance aux antibiotiques !
- Un grand merci à **l'équipe de recherche et développement du bioterrorisme (BDRD) du CDC.**

Je remercie sincèrement **Linda Weigel et David Sue** de m'avoir permis de continuer à travailler sur les CRE et de m'avoir donné l'opportunité de diriger le projet de recherche en collaboration avec nos partenaires extérieurs au Pakistan, à la FDA et à l'UVA. Un grand merci à **Blake Cherney**, pour sa précieuse expertise sur le séquençage Nanopore, et un grand merci au reste de l'équipe, **Pierre Michel, Thip Kongphet-Tran, Julia Bugrysheva, Amy Gargis, Heather McLaughlin** pour leurs encouragements ! « Go team ! »

- Merci à **l'équipe du laboratoire de Méningite Bactérienne du CDC (BML).**

Un grand merci au Dr Marietou Faye Paye et Dr Alicia Feagins pour m'avoir aidée à mener à bien ce projet grâce à leurs encouragements, ainsi qu'à l'équipe actuelle de BML pour leur soutien.

Un grand merci à ma famille, à mes amis et à mes voisins,

Oui, la route a été longue et difficile, alors un grand merci à mes parents, mon frère, mes amis et mes voisins qui ont cru en moi et m'ont soutenu pendant ces longues années. Merci à tous de m'avoir permis de persévérer jusqu'à la ligne d'arrivée malgré tous les défis ! Je suis vraiment très reconnaissante !

Un grand merci à mes amis, **Annick, Cédric, Manu, Antoine, Bernard, Déria, Catherine, Audrey, Blandine, Diane, Maria, Nancy, Radka, Magda, Justine, Peggy, Kelly, Dave, Phil, Marie-Jo, Monique, Jean-Marie...** pour n'en citer que quelques-uns !

Synthèse (en français)

La résistance aux antibiotiques a été reconnue par les organisations de santé publique comme l'Organisation mondiale de la santé (OMS) et le Centers for Control Disease and Prevention (CDC) comme l'une des dix menaces principales de santé publique au niveau mondial. Selon des estimations récentes datant de 2019, 1,27 millions de décès ont été directement attribués à des infections causées par des bactéries résistantes aux antibiotiques dans le monde entier. Il est estimé que jusqu'à 10 millions de décès pourraient survenir chaque année d'ici 2050 ! Les carbapénèmes qui sont des antibiotiques puissants utilisés pour traiter des infections difficiles à Gram-négatif font partie de la grande famille des β -lactamines. Cette famille d'antibiotiques s'avère très efficace contre les germes multirésistants et en particulier contre ceux qui produisent des β -lactamases à spectre étendu ou BLSE. Comme les carbapénèmes sont souvent le traitement de recours pour ce type de germes, leur utilisation à grande échelle a facilité l'émergence de germes résistants par la production d'enzymes appelées carbapénémases qui ont la propriété d'hydrolyser cette classe d'antibiotiques. Ce cercle vicieux n'est pas une nouveauté et reste inévitable : plus un antibiotique est prescrit, plus il y a de risques d'émergence de nouvelles enzymes. Chez les *Enterobacterales*, l'introduction de la pénicilline dans les années 1940 et de toutes les nouvelles β -lactamines jusqu'à ce jour, a conduit à une augmentation du nombre de β -lactamases. La diffusion mondiale de ces enzymes a commencé par les β -lactamases à spectre étendu (BLSE) dans les années 80-90 et plus tard à partir des années 2000, ce fut le tour des carbapénémases. Il y a tout d'abord eu l'émergence d'une carbapénémase de type sérine en 1996 appelée « *Klebsiella pneumoniae* carbapenemase » ou KPC puis plus de 10 ans plus tard, en 2009, l'émergence d'une nouvelle métallo- β -lactamase appelée NDM-1. Par conséquent, les *Enterobacterales* résistantes aux carbapénèmes (CRE) ont été classées comme menace « urgente » de santé publique et les BLSE comme menace « grave » de santé publique par le CDC. Les agents pathogènes multirésistants (MDR) sont souvent porteurs de plusieurs β -lactamases et de nombreux gènes de résistance. Comme il ne reste que peu d'antibiotiques, en dernier recours, voire aucun, cela souligne la nécessité de faire plus d'études d'épidémiologie moléculaire mondiales. Dans les années 2010, il y avait peu d'études de surveillance moléculaire à grande échelle sur l'épidémiologie des souches productrices de BLSE et de carbapénémases dans le monde entier.

Nos travaux de recherche, visant à combler un manque de données épidémiologiques moléculaires au niveau mondial dans les années 2010 au moment de l'émergence de la nouvelle métallo- β -lactamase (MBL) de New Delhi (NDM-1), se sont concentrés sur l'étude de l'épidémiologie moléculaire des β -lactamases afin de mieux comprendre les caractéristiques moléculaires des plasmides de multirésistance disséminés par ces souches productrices de ce type d'enzymes. Le premier objectif de notre projet de recherche était de déterminer la répartition mondiale des souches productrices de BLSE et de carbapénémases afin d'établir un « snapshot » de l'épidémiologie de ces enzymes à ce moment-là. Le deuxième objectif était d'étudier certains plasmides de multirésistance identifiés dans des souches productrices de NDM-1 et OXA-48-like isolées au Pakistan afin de mieux comprendre la dissémination de ces gènes. Enfin, le dernier objectif était de caractériser le fonds génétique des souches de *K. pneumoniae* productrices de carbapénémases. Pour ce travail de recherche, réalisé en partie il y a plus de 10 ans, ces souches productrices de BLSE et/ou carbapénémases ont été caractérisées par la méthode conventionnelle de PCR/séquençage Sanger mais précédée d'une étape de pré-sélection pour cibler et identifier les gènes d'intérêt codant pour des BLSE et/ou carbapénémases. Cette pré-sélection

a été réalisée à l'aide d'un kit moléculaire de « DNA microarray », relativement récent à cette époque, qui a grandement facilité la réalisation de cette étude et a permis de réduire le temps de rendu des résultats. Ce qui s'est avéré être un avantage pour ce projet de recherche à partir d'une collection de plus de 1,000 souches productrices de β LSSE. En ce qui concerne le séquençage des plasmides de multirésistance, une méthode hybride combinant le séquençage Illumina et Nanopore dans le but d'obtenir une séquence complète de chaque plasmide de notre collection de *K. pneumoniae* productrices de carbapénèmases NDM-1 et OXA-48-like provenant du Pakistan et isolées en 2013.

Une collection de plus de 1,000 souches d'*Enterobacterales* β LSSE+, isolées en 2008-2009 sélectionnées à partir du projet de suivi de la sensibilité aux antibiotiques à l'échelle mondiale appelé « *Surveillance Monitoring of Antimicrobial Resistance Trend (SMART)* » a été utilisé pour étudier la distribution des β LSSE dans le monde. Nos résultats ont montré que 85% des souches productrices de β LSSE étaient de type CTX-M contre seulement 14% de type SHV et moins de 1% de type TEM. Parmi cette majorité de CTX-M, le variant le plus courant était CTX-M-15 aussi bien chez *E. coli* (67%), que chez *K. pneumoniae* (69%). Les enzymes CTX-M-15 étaient les β LSSEs les plus courantes dans notre collection de 2008-2009, contrairement aux années 1990, où les β LSSEs les plus courantes étaient les β LSSE de type SHV. Ce qui montre que les CTX-M-15 se sont imposées comme les β LSSE qui sont les plus prédominantes à l'échelle mondiale et ont remplacé les β LSSEs de type SHV. Ce qui est encore le cas aujourd'hui comme cela a été démontré par *Castanheira et al* (AAC, 2021). Il faut noter qu'à cette époque, notre étude portant sur l'épidémiologie moléculaire mondiale des β LSSEs était l'une des premières études à grande échelle permettant de faire le point sur le statut des souches productrices de β LSSE à l'échelle mondiale.

L'épidémiologie des carbapénèmases a été évaluée dans une collection de plus de 200 souches non sensibles à l'ertapénème. Nous avons démontré que 28% des souches possédaient au moins un gène de carbapénémase et, que 50% de ces souches étaient productrices de NDM-1, suivi de 35% qui étaient productrices de KPC. Il y avait aussi 11% de souches productrices de VIM et 5% productrices d'OXA-48. Dans cette collection, NDM-1 était la carbapénémase la plus fréquemment identifiée. Comme les carbapénèmes sont utilisés très souvent pour le traitement de la plupart des infections à β LSSE, la résistance aux carbapénèmes, due à la présence de carbapénèmases, a commencé à augmenter dans les années 2000. La dissémination mondiale de ces enzymes était importante au moment de nos études en particulier à cause de l'émergence et dissémination de KPC puis de l'émergence de la nouvelle métallo- β -lactamase NDM-1 en 2009. Dans notre étude, KPC a été identifiée dans des régions dont on savait déjà qu'elles étaient endémiques pour KPC. KPC-2 a été identifiée en Grèce, aux États-Unis et en Colombie. KPC-3 était principalement présente aux États-Unis et en Israël et un nouveau variant KPC-11, qui a émergé en Grèce, a été identifié dans cette étude.

Pour NDM-1, notre travail de recherche a confirmé que NDM-1 émergeait de l'Inde, et a également mis en évidence la dissémination de NDM-1 sur un autre continent par l'identification de la première souche d'*Enterobacterales* productrice de NDM-1 à l'île Maurice : il s'agissait d'une souche d'*E. coli* ST131 qui a été nommée avec mes initiales CL. Cette souche contenait en plus du plasmide NDM-1, un autre plasmide avec CTX-M-15 et ces deux plasmides portaient de nombreux gènes de résistance. Le groupe d'incompatibilité (IncC/A) du plasmide NDM-1 et sa taille (120kb) étaient identiques au plasmide identifié dans certaines souches productrices de NDM-1 au Kenya. Ce qui indique que ces plasmides étaient certainement très similaires et potentiellement liés. Des souches productrices d'IMP

et de VIM ont aussi été identifiées en Europe du Sud, en Australie et aux Philippines mais à moins grande échelle que KPC et NDM-1. En ce qui concerne les souches productrices d'OXA-48-like qui étaient principalement identifiées en Europe, nos études ont permis de mettre en évidence que ces souches avaient traversé l'océan grâce à l'identification des deux premières souches productrices d'OXA-48-like aux États-Unis. Dans une autre étude comprenant une collection de *K. pneumoniae* productrices de carbapénémases, nous avons identifié 12% de souches productrices de carbapénémases de type OXA-48. Deux variants ont été spécifiquement identifiés dans un seul pays, l'Inde pour OXA-181 et l'Argentine pour OXA-163. OXA-48 a été identifiée en Argentine ou en Turquie et notre étude a démontré que les 2 premières souches productrices d'OXA-48 étaient arrivées aux États-Unis. La répartition des souches productrices de carbapénémase par pays montre que cette répartition varie selon le type de carbapénémase. Toutes les souches productrices de NDM-1 et d'OXA-48 ont été isolées en Inde alors que les souches productrices de KPC ont été principalement identifiées en Grèce mais aussi aux États-Unis, en Colombie et en Israël. Cependant une grande majorité des souches productrices de VIM venaient d'Italie, mais aussi d'autres pays d'Europe comme l'Espagne ou la Turquie.

Il a été observé que dans notre collection de souches d'*Enterobacteriales* non-sensibles à l'ertapénème, la plupart des souches produisaient plusieurs β -lactamases (83%) avec une majorité de souches produisant trois enzymes telles que NDM/ β LSE/AmpC (36%), suivie de deux enzymes telles que KPC/ β LSE (20%) et NDM/ β LSE (18%). De la même manière, dans notre collection de *K. pneumoniae* isolée en 2013 au Pakistan, la plupart des souches contenaient deux ou trois plasmides différents, avec un plasmide avec NDM-1, un plasmide avec CTX-M-15, avec en plus une longue liste de gènes de résistance sur ces deux plasmides, et parfois un plasmide avec OXA-48. Une comparaison des plasmides identifiés a permis de mettre en évidence que la séquence complète de chaque plasmide de résistance n'avait jamais été décrite auparavant même si certaines régions étaient identiques. Par exemple, les plasmides pMS84 et pBL13802 présentaient à la fois des régions similaires avec deux plasmides connus mais aussi des régions différentes contenant des insertions de séquences mettant en évidence des événements de recombinaison génétiques entre plasmides. De même, dans notre collection, les plasmides pBL849 et pBL12125/456 portaient les mêmes modules A&B mais un groupe d'incompatibilité différent et ne portaient pas le même module N mettant en évidence des variations génétiques autour du gène bla_{NDM-1} , cependant leur profil de sensibilité aux antibiotiques était identique. Le séquençage des plasmides a démontré que malgré certaines similitudes concernant le profil de résistance aux antibiotiques, la structure de ces deux plasmides était très différente, mais aussi que plusieurs événements de recombinaison génétique s'étaient produits. Cependant, les plasmides pBU19801 et pBA3783 partageaient exactement les mêmes modules, le même groupe d'incompatibilité et le même profil de sensibilité aux antibiotiques mais la présence d'une séquence d'insertion tronquée (ISEc15) sur le plasmide pBA3783 suggérait que ces deux souches ont peut-être partagé auparavant le même plasmide avant que certains événements de recombinaison génétique ne se produisent. En ce qui concerne les groupes d'incompatibilité, les plasmides portant OXA-48 étaient associés à IncL mais ces groupes étaient plus variés pour les plasmides NDM-1 et β LSE. Le groupe d'incompatibilité IncC était le plus fréquent pour les plasmides NDM-1 alors que pour les plasmides β LSE, le groupe d'incompatibilité IncFIB était le plus courant. Pour les plasmides NDM-1, cette observation est cohérente avec les caractéristiques du gène bla_{NDM-1} qui a la propriété de se propager sur des plasmides différents. Pour ce qui est du fonds génétique des souches de *K. pneumoniae* de notre collection du Pakistan, trois principaux ST ont été identifiés : KpST258, KpST147 et KpST11. KpST258 était le plus fréquent avec 35%

des souches de *K. pneumoniae*, et était associée avec KPC et SHV-12. Ces souches étaient isolées en Grèce, en Israël, à Porto Rico et aux États-Unis. Cependant, KpST147 était associée à plus de carbapénèmases telles que VIM, NDM-1, OXA-48-like ainsi que CTX-M-15. Ces souches étaient identifiées en Grèce, en Italie et en Inde. KpST11 était également associée à NDM-1, OXA-48-like et à CTX-M-15 mais à l'exception de l'Inde, ces souches étaient présentes dans d'autres pays que KpST147 tels que l'Argentine et la Turquie.

Nos études ont mis en évidence la complexité et la diversité du patrimoine génétique des souches d'*Enterobacteriales* productrices de carbapénèmases isolées il y a plus de 10 ans. Certaines souches possédaient jusqu'à six β -lactamases différentes, et au moins 15 gènes conférant la résistance à au moins huit classes d'antibiotiques différentes. Il est clair aujourd'hui que les germes multirésistants sont souvent porteurs d'un ou plusieurs plasmides de résistance, mais dans les années 2010, ces résultats concernant la complexité et diversité du contexte génétique des souches productrices de carbapénèmases étaient plutôt une nouveauté qui s'est confirmée dans les années suivantes. Aujourd'hui, les événements de réarrangements génétiques peuvent être mis facilement en évidence grâce au séquençage Nanopore, et cela permettra de faciliter l'étude de la dissémination de ces gènes de résistance entre plasmides. La surveillance de ces souches productrices de carbapénèmases est essentielle à la fois à des fins épidémiologiques pour suivre l'évolution des carbapénèmases connues et/ou identifier les nouveaux variants mais aussi pour faciliter et guider le choix thérapeutique pour les patients. Dans les années 2010, KpST11 s'était déjà imposée en tant que clone international associé à NDM, KPC et CTX-M-15 mais nos résultats ont montré que ce ST pouvait également être associé à OXA-48-like. Les KpST147 et KpST258 ont été également identifiées partout dans le monde à cette époque, mais nos résultats ont montré que ces ST étaient également importés dans des pays tels que Porto Rico, l'Italie et l'Argentine. Aujourd'hui, ces trois STs (ST11, ST147 et ST258) constituent toujours un problème de santé publique et la liste de ces clones à haut risque s'est allongée. En effet, KpST307 qui avait déjà été identifiée chez une souche de *K. pneumoniae* produisant NDM-1 dans notre collection au Pakistan, semble être un problème émergent aujourd'hui. Notre étude a donc permis d'identifier à un stade précoce certains de ces clones à haut risque, ce qui souligne l'importance et la nécessité de telles études de surveillance moléculaire à l'échelle mondiale. Il faut également souligner que notre travail de recherche a été grandement facilité par les progrès techniques au cours des deux dernières décennies dans le domaine du séquençage. La caractérisation des mécanismes de résistance qui se faisait principalement par recherche spécifique de gènes de résistance il y a 20 ans, a été remplacée aujourd'hui par le séquençage du génome entier.

Notre projet de recherche dans son ensemble a démontré qu'au cours des deux dernières décennies, l'épidémiologie des BLSE et des carbapénèmases reste complexe et continue d'évoluer rapidement et a confirmé l'émergence de clones à haut risque et de plasmides différents disséminant les gènes de résistance aux antibiotiques. Ces observations sont préoccupantes, mais les anticiper en les identifiant tôt grâce à des études de surveillance moléculaire à l'échelle mondiale en utilisant le séquençage Nanopore pour faciliter la mise en œuvre de ce type d'études, reste une approche encourageante. À titre de perspective, il serait intéressant de mettre en œuvre davantage d'études de surveillance moléculaire à l'échelle mondiale pour aider à identifier et à suivre les clones internationaux à haut risque et les plasmides de résistance. Les données obtenues lors de ces études pourraient aider à mettre en place des programmes locaux de surveillance moléculaire en temps réel qui faciliteraient la mise en œuvre de mesures de contrôle des infections plus strictes en cas d'épidémies. Une approche à

trois volets, comprenant des études de surveillance moléculaire, une détection en temps réel et des mesures strictes de contrôle des infections, pourrait aider à mieux surveiller ces agents pathogènes multirésistants et pourraient faciliter le traitement des patients. Il faut espérer que cette approche pourrait aider à limiter l'impact de la résistance aux antibiotiques et à réduire le nombre de décès prévus d'ici 2050.

Table of Contents

List of Figures and Tables

List of Abbreviations

CHAPTER I: MY CAREER GROWTH PATH -----	1
A-INTRODUCTION -----	1
B-EDUCATION PATH-----	2
1-Initial Education-----	2
2-Continuing Education-----	2
C-RETROSPECTIVE FEEDBACK ON MY PROFESSIONAL AND PERSONAL DEVELOPMENT-----	3
1-Bacteriology-Virology-Hygiene Department/Henri Mondor Hospital (Créteil, France) (1997-2009)-----	3
2-International Health Associates, Inc. (IHMA, Inc), Chicago, USA (2009-2013) -----	6
3-Centers for Diseases Control and Prevention (CDC), Atlanta, USA (2013-to date) -----	8
3.1-Division of Healthcare Quality and Promotion (DHQP)/Clinical and Environmental Microbiology Branch (CEMB)/Antimicrobial Resistance Characterization Laboratory (ARCL) (2013-2014) -----	8
3.2-Division of Preparedness and Emerging Infections (DPEI)/Laboratory Preparedness and Response Branch (LPRB)/Biodefense Research and Development Laboratory (BDRD) (2014-2020) -----	8
3.3-Division of Bacterial Diseases (DBD)/ Meningitis Vaccine Preventable Diseases Branch (MVPDB)/Bacterial Meningitis Laboratory (BML) (2020-to date)-----	9
CHAPTER II : INTRODUCTION -----	13
A-HISTORY OF ANTIBIOTICS -----	13
B-IMPORTANCE OF β -LACTAMS -----	14
1-Mechanisms of action of β -lactams-----	15
2-Molecular Targets of β -lactams-----	17
3-History, structure, and spectrum of action of β -lactams-----	18
3.1- β -lactams and β -lactamase inhibitors (BLIs) -----	23
3.2- Novel Carbapenemase Inhibitors in Development -----	27
C-ANTIMICROBIAL RESISTANCE TO β -LACTAMS -----	28
1-Mechanisms of Antimicrobial Resistance to β -lactams-----	28
1.1-Intrinsic resistance -----	30
1.2-Acquired resistance -----	31

<i>2-β-lactams and Enterobacterales</i> -----	35
2.1-β-lactamases: the most important mechanism of resistance in Enterobacterales -----	36
2.1.1-Extended Spectrum β-lactamases (ESBL _s)-----	38
2.1.2-AMPc β-lactamases (class C)-----	39
2.1.3-Carbapenemases-----	40
D-LABORATORY DETECTION OF β-LACTAMASES -----	43
1-Culture-based methods -----	43
1.1-Antimicrobial Susceptibility Testing-----	43
1.2-Phenotypic Tests for detection of β-lactamase-producing Enterobacterales-----	45
1.2.1-Detection of ESBL _s -----	45
1.2.2-Detection of carbapenemases-----	46
2-Molecular methods-----	50
2.1-Rapid Molecular Tests for detection of carbapenemase-producing Enterobacterales -----	51
2.1.1-Xpert Carba-R (Cepheid) -----	51
2.1.2-Check-Direct CPE or ESBL or MDR (CheckPoints) -----	51
2.2-Molecular Sequencing for characterization of carbapenemase-producing Enterobacterales -----	52
2.2.1-Short-read sequencing (Illumina) -----	52
2.2.2-Long-read sequencing (PacBio Bioscience and Oxford Nanopore) -----	53
E- HISTORY AND WORLDWIDE MOLECULAR EPIDEMIOLOGY OF ESBL _s AND CARBAPENEMASES-----	56
1-History -----	56
2-Epidemiology-----	57
2.1-Worldwide-----	57
2.2-Europe-----	58
2.3-France -----	59
2.4 United States-----	61
CHAPTER III: OBJECTIVES -----	64
CHAPTER IV: RESEARCH CONTRIBUTIONS -----	67
CHAPTER V: PUBLICATION #1 -----	70
USING NUCLEIC ACID MICROARRAYS TO PERFORM MOLECULAR EPIDEMIOLOGY AND DETECT NOVEL β-LACTAMASES: A SNAPSHOT OF ESBLs THROUGHOUT THE WORLD -----	70

CHAPTER VI: PUBLICATION #2 -----	81
<i>INCREASING PREVALENCE AND DISSEMINATION OF NDM-1 METALLO-β-LACTAMASE IN INDIA: DATA FROM SMART STUDY (2009)</i> -----	81
CHAPTER VII: PUBLICATION #3 -----	89
NDM-1-PRODUCING KLEBSIELLA PNEUMONIAE IN MAURITIUS -----	89
CHAPTER VIII: PUBLICATION #4 -----	93
SURVEILLANCE AND MOLECULAR EPIDEMIOLOGY OF KLEBSIELLA PNEUMONIAE ISOLATES THAT PRODUCE CARBAPENEMASES: FIRST REPORT OF OXA-48-LIKE ENZYMES IN NORTH AMERICA -----	93
CHAPTER IX: PUBLICATION #5 -----	102
INVESTIGATION OF MULTIDRUG-RESISTANT PLASMIDS FROM CARBAPENEMASE-PRODUCING KLEBSIELLA PNEUMONIAE CLINICAL ISOLATES FROM PAKISTAN -----	102
CHAPTER X: DISCUSSION AND PERSPECTIVES -----	119
REFERENCES -----	131
APPENDICES -----	149
ADDITIONAL PUBLICATIONS RELATED TO ANTIMICROBIAL RESISTANCE-----	149
FROM 2011 TO 2014.-----	149
ADDITIONAL PUBLICATIONS RELATED TO ANTIMICROBIAL RESISTANCE-----	151
FROM 2015 TO DATE. -----	151
ADDITIONAL PUBLICATIONS RELATED TO OTHER TOPICS-----	152
FROM 2016 TO DATE. -----	152

List of Figures and Tables

Figures

<i>Figure 1. Structure of Cell Wall of Gram-Negative Bacteria</i>	16
<i>Figure 2. Synthesis of Peptidoglycans</i>	16
<i>Figure 3. General Structure of Penicillins</i>	23
<i>Figure 4. Antibiotic Targets and Mechanisms of Resistance</i>	28
<i>Figure 5. Acquired Mechanisms of Resistance to Antibiotics</i>	32
<i>Figure 6. Integron Structure</i>	33
<i>Figure 7. Acquisition of Gene Cassettes</i>	33
<i>Figure 8. Tn3 Transposon Structure</i>	34
<i>Figure 9. Combination Disk Test</i>	45
<i>Figure 10. Double Disk Synergy Test</i>	46
<i>Figure 11. Modified Hodge Test</i>	47
<i>Figure 12. In Vitro Hydrolysis of Imipenem</i>	47
<i>Figure 13. mCIM and eCIM Tests</i>	48
<i>Figure 14. CORIS Bioconcept Resist-3 O.K.N</i>	49
<i>Figure 15. CORIS BioConcept Resist-5 O.K.N.V.I</i>	50
<i>Figure 16. NG-TesT CARBA 5</i>	50
<i>Figure 17. Illumina Sequencing Technology</i>	53
<i>Figure 18. PACBIO Sequencing Technology</i>	53
<i>Figure 19. MinION Long-Read Sequencing Technology</i>	54
<i>Figure 20. Global Distribution of CPEs by Country and Region</i>	58
<i>Figure 21. Epidemiological Situation of CPEs in European Countries, July 2018</i>	59
<i>Figure 22. Epidemiological Situation of CPEs in France, 2021.</i>	60
<i>Figure 23. Epidemiological Situation of CPEs in France, 2021.</i>	60
<i>Figure 24. Repartition of NDM Variants in France from 2016 to 2020</i>	61
<i>Figure 25. Repartition of Carbapenemases in the United States from 2019 to 2021.</i>	61

Figure 26. Distribution of carbapenemases by species in the United States – 2017-2018 62

Figure 27. Distribution of carbapenemases by species in the United States - 2022 62

Tables

Table 1. Classification of β -lactams 19

Table 2. Classification of new β -lactams and BLI combinations 20

Table 3. Classification of β -lactamases 37

List of Abbreviations

A

AMC.....Amoxicillin-clavulanate
AMP.....Ampicillin
AMR.....Antimicrobial resistance
AMX.....Amoxicillin
ARGs.....Antimicrobial Resistance Genes
ASP.....Antimicrobial susceptibility profile
AST.....Antimicrobial susceptibility testing
AVI.....Avibactam

B

BLIs.....B-lactamase inhibitors
BMD.....Broth microdilution
BPR.....Ceftobiprole

C

C/T.....Ceftolozane/tazobactam
C1G.....1st generation cephalosporins
C2G.....2nd generation cephalosporins
C3G.....3rd generation cephalosporins
C4G.....4th generation cephalosporins
C5G.....5th generation cephalosporins
CARB.....Carbenicillin
Case.....Cephalosporinase
CAZ.....Ceftazidime
CDC.....Centers for Disease Control and Prevention
CDT.....Combination disk test
CEF.....Cefamandole
CFCefalotin
CFZ.....Cefazolin
CHDL.....Carbapenem hydrolyzing B-lactamases
CIM.....Carbapenem inactivation method
CLA.....Clavulanic acid or clavulanate
CLSI.....Clinical Laboratory Standards Institute
CMY.....Cephameycins
CNR.....French National Reference Center for
Antimicrobial Resistance
CPEs.....Carbapenemase-producing Enterobacteriales
CPO.....Cefpirome
CPT.....Ceftaroline
CRO.....Ceftriaxone
CTT.....Cefotetan
CTX.....Cefotaxime

CTX-M-1.....Cefotaximase Munich-1
CZA.....Ceftazidime/avibactam

D

D-Ala-D-Ala.....D-Alanine D-Alanine
DBO.....Diazabicyclooctanone
DD.....Disk diffusion
DDST.....Double synergy disk test
DNA.....Deoxyribonucleic acid
DOR.....Doripenem
DPA.....Dipliconic acid

E

ECDC.....European Centre for Disease Prevention
ESBL.....Extended-spectrum β -lactamase
ETP.....Ertapenem
EUCAST.....European Committee of Antimicrobial
Susceptibility Testing

F

FDC.....Cefiderocol
FEP.....Cefepime
FOX.....Cefoxitin, Cefoxitin

G

GlcNAc or NAG.....N-acetylglucosamine
GNB.....Gram-negative bacteria
GPB.....Gram-positive bacteria

H

HAIs.....Hospital-acquired infections
HGT.....Horizontal Gene Transfer
HMW.....High molecular weight

I

IAI.....Intra-abdominal infection
ICU.....Intensive care units
IMP.....Imipenemase
IPM.....Imipenem
IR-.....Inverted repeats
I-R.....Imipenem/cilastatin/relabactam

IRT.....*Inhibitor-resistant TEM*
IS-.....*Insertion sequences*
IVD.....*In vitro diagnostics*

K

KPC.....*K. pneumoniae carbapenemase*

L

LAT.....*Latamoxef*
LMW.....*Low molecular weight*
LPS.....*Lipopolysaccharides*
LRS.....*Long read sequencing*

M

mCIM...*Modified carbapenemase inactivation method*
MDR.....*Multidrug resistant*
MEM.....*Meropenem*
MGEs.....*Mobile Genetic Elements*
MHT.....*Modified Hodge Test*
MIC.....*Minimal inhibitory concentration*
MLST.....*Multilocus Sequence Typing*
MOX.....*Moxalactam*
MRR.....*Multiresistance region*
MurNAc or NAM.....*N-acetylmuramic acid*
MVB.....*Meropenem/vaborbactam*

N

NCBI...*National Center for Biotechnology Information*
NDM.....*New Delhi metallo-B-lactamase*
NGS.....*Next-generation sequencing*
NRL.....*National Reference Laboratory*

O

OXA.....*Oxacillinase*

P

PBP.....*Penicillin-binding protein*
PCR.....*Polymerase chain reaction*
PDR.....*Pandrug resistant*

PEN.....*Penicillin G*
PG.....*Peptidoglycan*
PIP.....*Piperacillin*

Q

QMS.....*Quality management system*

R

REL.....*Relabactam*
RNA.....*Ribonucleotide acid*
RUO.....*Research use only*

S

SAM.....*Ampicillin-sulbactam*
SBS.....*Sequencing by synthesis*
SHV.....*Sulphydryl Variable*
SMRT.....*Single Molecule Real-Time Sequencing*

T

TE-.....*Transposable elements*
TEM.....*Temoinera*
TIC.....*Ticarcillin*
TIM.....*Ticarcillin-clavulanate*
TSB.....*Trypticase Soy Broth*
TZP.....*Piperacillin-tazobactam*

U

UTI.....*Urinary tract infection*

V

VIM.....*Veron integron metallo-B-lactamase*

W

WHO.....*World Health Organization*

X

XDR.....*Extensively resistant*

The background of the page features a faint, light-colored image of several hands of different skin tones reaching out to hold a globe. The hands are positioned around the globe, with fingers spread, symbolizing global unity and support. The overall tone is soft and positive.

CHAPTER I: MY CAREER GROWTH PATH

A-INTRODUCTION

Years ago, I began my career in the world of academic research as a laboratory technician. In 27 years, I have gradually evolved professionally from a technician to a recognized researcher. My professional development has taken place in several major stages and in different environments and countries. Today, I would like this rather atypical career path and the professional development acquired through experience to be recognized by an official doctorate within the framework of the Validation of Acquired Professional Experience (VAE) procedure.

At school, education through traditional teaching and practice were always separate for me. In college, where theory prevailed, I thought that this educational path was not a good option for me, but 27 years later, I realize that I have educated myself by combining theory and practice in research ("formation par la recherche"). This career path was partially recognized when I did my master's degree in molecular *and Cellular Biology* with a specialization in *Microbiology* in 2008. In the continuity of this master's degree, I would now like to expand my career by obtaining a PhD in Microbiology from the doctoral school: "*Therapeutic Innovation: from foundation to application*" («*Innovation Thérapeutique: du fondamentale à l'appliqué*») at the University of Paris-Saclay.

A year after moving to the United States, I started working with a very renowned professor in the field of β -lactam resistance, Professor Robert Bonomo. He was recognized in 2016 by the *European Society of Clinical Microbiology and Infection Diseases (ESCMID)* with an Award of Excellence for all his contributions. When I met him in person during our collaboration at a conference in 2010, he advised me to enroll in a PhD program at his college in Cleveland and that he would be honored if I worked in his lab. At first, I found this idea appealing, but going back to school for at least 5 years was not a good option for me. I would have had to "relearn" everything I had already learned and practiced during my career, but also interrupt my career to become a PhD student.

Having worked in the United States for more than 15 years, I have also realized that diplomas and titles do matter in the US! They are more important than work experience in this country and you need a PhD to get promoted. The recognition of my professional experience through an official doctorate under the Validation of Acquired Professional Experience (VAE) will allow me to recognize my professional evolution from technician to recognized and experienced researcher, but also to complete my educational path and eventually to continue my career to respond to new opportunities.

1-INITIAL EDUCATION

I grew up in the mountains of Auvergne in the south of France, not far from the town of Roquefort-sur-Soulzon where the famous blue cheese “Roquefort” is produced. I grew up with the strong and delicious taste of this cheese, which can be found in many local recipes. In my biology class, I was surprised to discover that a mold called *Penicillium roqueforti* gives Roquefort its distinctive and unique flavor. From that day on, I was fascinated by the world of microbiology. I always asked myself: “How can bacteria be vital and at the same time threaten human life?”. Since then, I wanted to learn more about these wonderful creatures!

My interest in biology goes back to my school days and prompted me to apply to the Blaise-Pascal College for a two-year general college diploma in Biology-Physiology (“DEUG B – Sciences de la Nature et de la Vie (SNV)”). Since I was more interested in the hands-on side, I transferred to a school that offered a two-year program in applied medical and research biology with a focus on Biological and Biochemical Analyzes and Molecular Biology (“DUT Biologie Appliquée– option Analyses Biologiques et Biochimiques”) in a school of Sciences and Technology. This program was a wonderful experience for me and a turning point in my educational path. I did very well and came fourth out of 40 students. I enjoyed microbiology and molecular biology so much that I applied to the Lycée Saint-Louis for a one-year program in molecular biology/cell culture/electromicroscopy/anatomopathology, which confirmed my desire to pursue a career as a microbiologist.

When I started looking for a job, I knew I wanted to work in a field related to microbiology and molecular biology. I was lucky enough to find a wonderful opportunity to join a research team working on antimicrobial resistance (AMR) in a microbiology research laboratory at Henri Mondor Hospital in Créteil, France.

2-CONTINUING EDUCATION

To further my education and improve my microbiology knowledge, I went back to school from 2006 to 2008 while working in the research lab at Henri Mondor Hospital to earn a master’s degree in molecular and Cellular Biology with a specialization in microbiology, which I received through an official evaluation of my work experience. I obtained this diploma as part of a professional experience validation program (“Validation des acquis d’Expérience Professionnelle (VAE)”) at the Pierre and Marie Curie University (UPMC) (former Paris 6 University).

Several years of extensive traditional training in the Biological Sciences (“Sciences de la Nature et de la Vie”), including a specialization in Molecular Biology and Microbiology, followed by 27 years of research experience studying mechanisms of bacterial antimicrobial resistance and public health experience, inspired me to take on the ultimate challenge and earn a PhD in Microbiology.

C-RETROSPECTIVE FEEDBACK ON MY PROFESSIONAL AND PERSONAL DEVELOPMENT

When I was studying Natural and Life Sciences (SNV) at the University of Clermont-Ferrand as part of the DEUG, I realized that long years of school were not a good option for me. So, I decided to take a more technical path to obtain a technology diploma in Medical Biology in 2 years, namely the “DUT Biologie Appliquée”. This degree allowed me to acquire both the basic knowledge of biology and the methods used in medical biology. I also identified my favorite disciplines that interested me the most: bacteriology and molecular biology. This has been confirmed, as I am now an experienced researcher in the field of molecular microbiology.

1-BACTERIOLOGY-VIROLOGY-HYGIENE DEPARTMENT/HENRI MONDOR HOSPITAL (CRÉTEIL, FRANCE) (1997-2009)

I started my career in 1997 as a laboratory technician in the Bacteriology-Virology-Hygiene Research Laboratory at Henri Mondor Hospital. I directly represented the technician/laboratory manager in charge of this laboratory, so my duties were never those of a junior technician. This allowed me to quickly take on many responsibilities in this lab and develop quickly through a combination of self-study, literature research, conferences, on-the-job and college training. My main responsibilities were to manage the lab, supervise and mentor students, and participate in the production of knowledge by progressively working on different scientific projects under the guidance of several scientists/academic instructors.

I worked under the supervision of the head of department, who quickly allowed me to work independently due to my motivation and his limited availability. He was a renowned expert in the world of antibiotics and taught me everything I needed to know on the subject. Initially, I learned the common techniques for antimicrobial susceptibility testing (AST). These projects, which were supported by the pharmaceutical industry in the pre-market phase of new antibiotics, often had very tight deadlines that required excellent organizational skills. Therefore, I quickly made changes and improvements to the methods commonly used in the laboratory to increase productivity. In this way, I learned to work effectively in an environment that could sometimes be stressful due to pressure from our pharmaceutical industry clients.

In 2000, I was involved in a project led by a researcher on *Helicobacter pylori*. This project, which involved the development of molecular tests for the detection of this pathogen in gastric biopsies, was particularly interesting because I had to familiarize myself with this bacterium which was unknown to me. I familiarized myself with the standard methods used to study this difficult-to-cultivate bacterium. Due to these difficult culture conditions, the diagnosis of *Helicobacter pylori* remained difficult. I was very interested in working with this scientist, who believed that the development of a new molecular test could be of great benefit to public health. The goal of this project was to develop and optimize a real-time PCR test for the direct detection of *Helicobacter pylori* from gastric biopsies. Through this experience, I was able to better recognize how to use my knowledge to initiate and conduct a research project. This project led to the development of the first real-time PCR method for the rapid detection of *Helicobacter pylori* in gastric biopsies, combined with the identification of AMR. We were the first laboratory to report AST results within 2 days to clinicians in the gastroenterology department. Shortly after the publication of this paper, this method was implemented in our hospital's clinical laboratory and significantly improved the diagnosis of this pathogen and patient outcome. This project was my first experience as a scientific author and led to my first publication as a lead author in the *Journal of Clinical Microbiology* in 2003. Participating in a project to develop a new molecular diagnostic technique to improve patient outcome opened my eyes to the importance of a researcher's work. I understood that my ability to always combine my technical expertise with background information could answer problematic questions related to the treatment of patients. This was also an important advantage for my professional development. Overall, I was more interested in research when it was applied in the clinical world.

Working, under the supervision of a researcher whose specialty was quinolone resistance also helped my professional development. I learned that the mechanisms responsible for resistance to quinolones are usually due to chromosomal mutations in enzymes involved in DNA replication: DNA gyrase and topoisomerase IV. However, a new gene called quinolone resistance (*qnr*), which is transmitted by a plasmid, was only identified in 1998. It was a great opportunity for me to work on this new plasmid resistance, which at that time was a new discovery in the world of quinolone resistance. This research topic made me want to learn more about this new plasmid resistance. I asked myself questions about this brand-new topic, and I got involved in this new research direction. It was a great opportunity to make myself known in the research world by publishing several scientific articles (7 articles from 2006 to 2009). Since it was a novel mechanism of resistance, I introduced new molecular assays to detect and study this new mechanism to answer questions such as "Does this quinolone plasmid-mediated resistance exist at Henri Mondor Hospital? "If so, how frequent was it?"

Since I started working on the *qnr* plasmid-mediated mechanism, which was associated with β -lactamases, enzymes responsible for resistance to β -lactams, my expertise on both topics has greatly expanded. This research experience also gave me the opportunity to feel the emotions that researchers can go through. I understood how a researcher feels when making important discoveries, and how competition can drive researchers in the dissemination of scientific information. My motivation and ability to work quickly, which are great traits for a researcher, were great assets for both performance in the lab and my professional development.

Due to the many ongoing projects in our research department, our lab took on more trainees every year (DUT, Masters, PhD students). I quickly learned how to put together training sessions to teach the students all the tricks of microbiology and molecular methods and to supervise them in writing their internship report and preparing for the oral defense. As I was used to working alone, I learned to share my knowledge, delegate, guide, and mentor these young researchers in our lab. These mentoring/coaching activities helped me to develop new training skills through research, and evaluation of scientific work (scientific strategies, internship reports and publications). I also participated in preparing hands-on bacteriology sessions for third year medical students, which was a good experience for learning teaching skills.

Over the years, I have developed a strategy of continuous learning by engaging in numerous projects where I have collaborated with several scientists/academic teachers with different expertise and backgrounds. This strategy has helped me to gain knowledge about AMR, as well as the common AST methods, and the molecular methods used for detecting genes involved in AMR. Based on my literature review and experience, I then took the initiative to propose new techniques and procedures to analyze and present the results to improve the scientific production of the laboratory. Little by little, I proposed new lines of research that led to new projects that I managed from A to Z and that resulted in publications such as the project on the accumulation of quinolone resistance mechanisms in the same bacterium, and the plasmid transfer of *qnr* between bacteria of different species.

Working in research teams has played an important role in my professional development. When I was a technician, these researchers taught me many skills to understand research methods, how to ask questions as a scientist and, above all, how to answer them. I learned little by little from each of them.

During these 12 years in France, I understood that coordinating scientific research projects requires constant learning of new skills. In this teaching setting, I learned to make assumptions, define new projects, develop experimental designs, and update standard operating procedures (SOPs) and protocols according to our research objectives. I also learned to analyze and present data and results in

different ways, to evaluate these research results according to the questions raised by writing scientific articles and/or presenting posters at international conferences. The interaction with the many researchers I worked with, experts in different fields, was very fruitful and allowed me to combine techniques and theory very quickly and advance research by producing new scientific data in different areas at the same time. I understood what research really is!

Working closely with the pharmaceutical industry in this lab allowed me to experience a similar work culture to industry, in terms of productivity, and funding. I also had more opportunities to present our work at different national or international conferences every year.

2-INTERNATIONAL HEALTH ASSOCIATES, INC. (IHMA, INC), CHICAGO, USA (2009-2013)

Since 2009, my research career in the United States has taken the next step. I was hired as a molecular microbiologist in Chicago at a small company, *International Health Management and Associates, Inc. (IHMA, Inc.)*, which conducts microbiology studies on new antibiotics in development and of AMR surveillance on a global scale on behalf of pharmaceutical companies such as Merck, Pfizer, Astra-Zeneca... etc.

My first task was to set up a molecular biology laboratory in this company, using my knowledge and experience in laboratory management and my adaptability to implement my research activities. I immediately understood that research in a private company was very different from research in France. But all the skills I had acquired in a laboratory working with pharmaceutical industry in France helped me to adapt successfully as a researcher in the United States. I moved to a very different environment and became a more independent and faster researcher, able to work in an environment where competition between colleagues and pressure from clients was very noticeable.

On a scientific level, my first task as a researcher was to add a research axis to a microbiology project, namely the "*Study for Monitoring Antimicrobial Resistance Trends (SMART)*", which had been launched in 2002 to investigate molecular mechanisms related to resistance. Testing and confirming the scientific feasibility of this project to characterize β -lactamases of a large collection of clinical bacterial isolates in a very short period prompted me to look for a faster and more efficient method than the traditional methods for the detection of antimicrobial resistance genes (ARGs) and characterization by Sanger sequencing. I suggested using a brand new "DNA microarray" technology that had just been evaluated by another research group. This project was one of the world's largest molecular epidemiology-based studies on β -lactamases. It also forced me to learn to work at a much faster pace

than in French public research. Indeed, we were commissioned by several pharmaceutical companies with very tight deadlines, sometimes accompanied by urgent requests for results.

As I was the only expert in the field of molecular biology, I no longer had colleagues to talk to and I had to make all the decisions about the project myself. This improved my ability to work alone and made it easy for me to answer questions completely independently. This experience gave me the opportunity to apply and implement all the skills I had learned in France in a different environment. It was a very rewarding experience and one of the most important factors in my career as I learned to work as an isolated researcher rather than as part of a team.

Research in industry has confronted me with another facet of research, where the productivity of the laboratory is no longer focused on scientific discovery but only on profit. This type of research and its routine aspect in a rather stressful environment did not appeal to me. Nevertheless, I enjoyed the first years of setting up the laboratory, and all the scientific projects that I was responsible for. The success of this molecular biology project led to contracts for more than 5 years with other companies in the pharmaceutical industry, which resulted in more revenue and the growth of my company. This professional context allowed me to create new action, and experimental plans and to write my articles, alone instead of in a team as I had done in France. This allowed me to increase my scientific production (12 articles and 26 posters in 4 years). However, as a researcher should not work alone, I initiated collaborations with renowned experts in the field of AMR and β -lactamases such as Prof. Robert Bonomo in the United States, Prof. Johann Pitout in Canada, and Dr. Patrice Nordmann in France to facilitate our scientific production. This strategy has doubled the company's production of scientific papers. One of my projects was accepted for an oral presentation at the *Interscience Conference of Antimicrobial Agents and Chemotherapy (ICAAC)* in San Francisco in 2012. For the first time, I had the opportunity to present my research on the new global scourge of multidrug-resistant (MDR) bacteria. In doing so, I described new information on the global spread of *bla*_{OXA-48} carbapenemase-producing strains. These collaborations have fostered opportunities such as participating in peer-review of scientific articles in my field for specific journals (e.g., *Journal of Clinical Microbiology*) and attending meetings of a group of clinical microbiologists from Chicago.

3-CENTERS FOR DISEASES CONTROL AND PREVENTION (CDC), ATLANTA, USA (2013-TO DATE)

3.1-DIVISION OF HEALTHCARE QUALITY AND PROMOTION (DHQP)/CLINICAL AND ENVIRONMENTAL MICROBIOLOGY BRANCH (CEMB)/ANTIMICROBIAL RESISTANCE CHARACTERIZATION LABORATORY (ARCL) (2013-2014)

In 2013, I moved into public health and worked at the Centers for Diseases Control and Prevention (CDC) in Atlanta (GA) in a laboratory that specializes in characterizing mechanisms of resistance (Antimicrobial Resistance Characterization Laboratory, ARCL). I was able to fully utilize all the skills and knowledge I had recently acquired in industry to set up and coordinate the project I was leading. This project was very similar to the project I had already coordinated in Chicago: it involved studying the antimicrobial susceptibility of a large collection of bacterial isolates from five hospitals in the United States. The goal of the study was to better understand the transmission of AMR, which is widely studied in Europe but much less so in the United States. Therefore, this study, which asked the question: *What is the status of AMR in the United States?* was therefore extremely interesting. The execution of this project was simple and quick, as I used the same technology as for the research work conducted in Chicago. The results were presented at the *European Conference of Clinical Microbiology and Infectious Diseases (ECCMID)* in April 2015.

When I started, quality management in CDC laboratories was a highly regulated discipline that included the controlled and documented maintenance of equipment (refrigerators, freezers, incubators, instruments... etc.), the regulation and monitoring of controlled documents (protocols and procedures, laboratory notebooks... etc.). This management system called "Quality Management System (QMS)" was new to me, so I had to learn it myself, write all the protocols in a specific and standardized format and learn to comply with all the regulations of this system in a short time, being very methodical and organized. This experience allowed me to develop in a completely different environment from my previous experiences.

3.2-DIVISION OF PREPAREDNESS AND EMERGING INFECTIONS (DPEI)/LABORATORY PREPAREDNESS AND RESPONSE BRANCH (LPRB)/BIODEFENSE RESEARCH AND DEVELOPMENT LABORATORY (BDRD) (2014-2020)

In December 2014, I joined the CDC's Biodefense Research and Development Laboratory (BDRD), whose research topic was the development of new rapid tests to determine the antimicrobial susceptibility (AST) of bioterrorism agents. Working on this topic allowed me to further expand my knowledge in the field of AMR, but this time with a focus on bacterial pathogens I had never dealt with before such as *Bacillus anthracis*, *Yersinia pestis*, *Burkholderia pseudomallei*, and *Francisella tularensis*.

The scientific supervision allowed me to work on these new bacterial pathogens, familiarize myself with my first project, and specialize even more in biothreat agents that pose a greater danger to public health. Working on these pathogens, required me to work in a context where biosafety measures are more drastic. I was able to use all the knowledge and skills I had acquired in my previous work within QMS.

In the first few months, I worked in pairs on the project of one of the researchers in this laboratory and was thus able to get used to this new lab. Although in this lab, there was complete autonomy in this for each project, there was also real teamwork, which in my case was a factor of professional development and an important step in my career. This first project, on a rapid AST instrument, BacterioScan, was presented at the *Interscience Conference on Antimicrobial Agents and Chemotherapy (ICAAC)* in San Diego in September 2015, and published in the "*Journal of Clinical Microbiology (JCM)*" in April 2016. What allowed me to continue to grow in this lab was the great dynamic in this team. Everyone in the team had different backgrounds and skills, and I was the only expert in AMR. In this environment, I was able to share my knowledge and educate myself in this new field. As a team, we published many more projects on *B. anthracis* AST, penicillin resistance, AST rapid tests, and rapid detection of *B. pseudomallei* in urine. The diversity of projects in this group allowed me to develop a variety of new skills such as multitasking, proactivity and teamwork. At the same time, I was assigned to lead another project on carbapenem resistance in clinical isolates of *Klebsiella pneumoniae* from Pakistan. In total, I published 13 articles in this group over 5 years including one as first author.

3.3-DIVISION OF BACTERIAL DISEASES (DBD)/ MENINGITIS VACCINE PREVENTABLE DISEASES BRANCH (MVPDB)/BACTERIAL MENINGITIS LABORATORY (BML) (2020-TO DATE)

In 2020, I was presented with a great opportunity to move to a new position that focuses more on education and knowledge transfer in the field of bacterial meningitis diagnostics in Africa. Although I enjoyed my role as a researcher in the BDRD at the CDC, I accepted this offer because I felt that at this stage of my career, it was time to share my knowledge, and promoting public health in Africa appealed to me. In January 2020, I joined the International Unit of the Bacterial Meningitis Laboratory Team which consisted of two people responsible for international activities to strengthen laboratory capacity for the diagnosis of bacterial meningitis in 10 African countries: Benin, Burkina Faso, Chad, Ghana, Guinea, Mali, Niger, Nigeria, Ethiopia, and Togo. As I am bilingual, I was appointed as the person in charge of four French-speaking countries: Benin, Chad, Guinea, and Togo. As I already had extensive experience in training students, interns, technicians, and PhD students, I had not imagined that the learning curve would be so challenging, but I quickly understood that training activities in developing countries require

much more preparation and planning. On top of that, I joined the team just before the COVID-19 pandemic started and only had two to three months to familiarize myself with this new role on-site before switching to 100% remote work. Also, barely a year later, I found myself in a position where I had to learn quickly and apply what I had learned on my own, as all my colleagues from the International Unit had moved on to new roles. In the end, I was solely responsible for all international activities and collaboration with our ten countries for almost a year. This experience allowed me to quickly acquire new skills related to international work and at the same time introduce new processes to facilitate our activities.

My main task was to provide technical support and on-site training in Africa to the network's reference laboratories in each country. This task required frequent international travel but was impacted by the COVID-19 pandemic, and our unit had to figure out how to continue our activities in this remote working environment. I quickly suggested to the whole team to think about virtual training and training videos. So, we started developing virtual training via the Zoom platform. This type of training was met with great response and participation. As for the training videos, it took me several attempts to convince my manager, but my persistence paid off. These online videos can now be used in so many ways. For example, they could be used by trainees as post-training material, but also by trainers from the National Reference Laboratory (NRL) members either for new employees or as shared materials before on-site training sessions at other labs to facilitate learning during in-person training sessions. I am very proud of these online training materials as we have often received great feedback from our African partners who use them regularly. Being an experienced researcher often means sharing your knowledge with your peers or in academic teaching. In my case, teaching has recently been added to my activities when I became CDC laboratory advisor for African countries in this Bacterial Meningitis Laboratory.

However, virtual training and video training were not the solution in all cases. During an outbreak caused by *Neisseria meningitidis* W (*N. meningitidis* W) in the Democratic Republic of Congo (DRC) in 2021, I faced challenges. I was confident that since the DRC had benefited from on-site training a few years ago, our virtual training tools would be sufficient and that a refresher training could help them to confirm this *N. meningitidis* W outbreak by PCR in their laboratory. Despite all my efforts, it did not work out, and the samples were sent to the Pasteur Institute in Paris for confirmation. We therefore scheduled an on-site PCR training for April 2022. When I was on site, I quickly realized that the team that had previously been trained by the CDC was no longer there and that this new team needed to be trained from scratch to resume PCR laboratory activities. I stayed at the DRC NRL in Kinshasa for three weeks to ensure that each team member would be able to quickly obtain and report PCR results in the event of an outbreak. This field experience, where I was deployed alone, also allowed me to get to know

and understand the needs of the laboratory. Building, developing, and maintaining a strong relationship with each laboratory is a key factor in strengthening laboratory capacity. Today, DRC's NRL is fully equipped to confirm the diagnosis of bacterial meningitis, but we are here to support them when needed. Although my responsibilities now focus on mentoring/coaching activities and knowledge transfer, I can also continue to work on scientific publications for research projects on molecular characterization of bacterial strains involved in meningitis outbreaks in Africa as part of our collaborative projects with partner countries.

In the United States, my research experience in industry was very different from my public research experience in France. I therefore had to adapt very quickly and familiarize myself with this new mindset. For 27 years, my research topic has always been AMR, either in relation to specific classes of antibiotics (e.g., β -lactams) or to the type of bacteria studied (e.g., *Enterobacteriales*, bioterrorism pathogens, and meningitis pathogens). My interest in AMR, my thirst for knowledge, and my passion for research, quickly led me not only to participate in research projects, but also to propose, carry out and coordinate projects to disseminate our knowledge in this field. This has made me question myself and look for answers and information for all the different projects. I have also recently acquired new skills through my international teaching activities, such as intercultural communication, collaboration, networking skills, adaptive thinking, emotional intelligence, and resilience.

Overall, my experiences in France in university/clinical research settings in a teaching hospital and in the United States in industry and public health have provided me with advanced skills and improved my knowledge over the years to become a robust researcher able to work in completely different environments. This expertise and my various skills have been recognized through numerous articles published in peer-reviewed journals and by receiving a Green Card in the "Scientist of Exceptional Ability" category in 2012. To date, I have published a total of 50 articles, more than half of which (n=27) have been published since my arrival in the United States in 2009. My public health expertise has also been recognized through my work at the CDC in the areas of AMR, bioterrorism research, and building laboratory capacity for bacterial meningitis diagnosis in developing countries. In each of these experiences, my professional development occurred in two simultaneous phases: learning and mastering numerous and diverse technologies and skills in conjunction with a different articulation between technique, theory, and knowledge production in each laboratory. To validate my unusual career path, rich in diverse experiences, I would like my unique skills to be recognized through this doctoral degree.

A grayscale, high-magnification microscopic image of biological cells, likely bacteria or yeast, showing various shapes and internal structures. The cells are arranged in a somewhat circular pattern, with some appearing as individual units and others as small clusters. The lighting is soft, highlighting the textures of the cell walls and membranes.

CHAPTER II : INTRODUCTION

CHAPTER II : INTRODUCTION

A-HISTORY OF ANTIBIOTICS

Microorganisms were first observed by Antony Van Leeuwenhoek (1632–1723) with a microscope that he developed himself but were already known before that. Marcus Terentius Varro (116 BC-27 BC), a Roman scholar and writer, defined them as “*certain minute creatures that cannot be seen by the eyes and cause serious diseases.*” Girolamo Fracastoro (1478-1553), an Italian physician, called them “*seed-like entities that could transmit infection*”. However, none of these claims were taken seriously until the observation of microorganisms with microscopes became possible. The phenomena that turn grapes into wine and milk into cheese, and the reasons why food spoils were a complete mystery until Van Leeuwenhoek, Lazzaro Pallanzani (1729-1799), and Pasteur (1822-1895) showed that living organisms can grow in broth in the presence of air but are killed when boiled [1]. Pasteur founded the “germ theory”, which was directed against the theory of “spontaneous generation” [2]. Later, Robert Koch (1843-1910) declared that microbes can cause disease.

Joseph Lister (1827-1912) was the first surgeon to believe in Pasteur’s findings on asepsis [1], which had a major influence on wound treatment [3]. He adopted and followed Pasteur’s techniques and procedures [2] to create a sterile environment for patients. His new principles changed surgical practices in the late 1800s and significantly decreased the mortality rate due to infection. Lister is known as the “*father of antiseptic surgery.*” During World War I, at a time of the “pre-antibiotic area” when antibiotics were not yet available, the only treatments available to fight infection were mild antiseptics that were not effective enough to treat the severity of soldiers’ infected wounds. The increased mortality rate due to infected wounds from tetanus (*Clostridium tetani*) or gas gangrene (*Clostridium perfringens*) highlighted the importance of curing infectious diseases but also preventing the spread of infection. World War I played a major role in better understanding the treatment of infections [4].

The discovery of penicillin in 1928 by the Scottish biologist and pharmacologist, Alexander Fleming (1881-1955) [5] changed the world of modern medicine and saved the lives of millions of soldiers during World War II. He also gave the starting signal for the development of the most powerful class of antibiotics: the β -lactams [6]. However, Fleming’s warnings about the importance of controlled and cautious use of penicillin to limit resistance, were an understatement.

Fleming quoted in the New York Times:

"The greatest possibility of evil in self-medication is the use of too small doses so that instead of clearing up infection the microbes are educated to resist penicillin and a host of penicillin-fast organisms is bred out which can be passed to other individuals and from them to others until they reach someone who gets a septicemia or pneumonia which penicillin cannot save."

-New York Times, 26 June 1945-

Unfortunately, as penicillin was used extensively during World War II, the first isolate of *Staphylococcus aureus* resistant to penicillin was isolated in 1942, only 14 years after the discovery of penicillin [6]. This should have been a warning for the continued use of antibiotics but unfortunately, the same path has been repeated time and time again due to the overuse of antibiotics both in the treatment of patients and in livestock. This problem is even greater in resource-limited countries where antibiotics are available over the counter. This uncontrolled use of antibiotics has now given rise to some highly resistant isolates, known as "super bugs", which in some cases can become resistant to all available antibiotics. Three categories of level of resistance have been defined as follows [7]:

- 1) Multidrug Resistant: resistant to at least one agent in three or more antibiotics classes,
- 2) Extensively Resistant (XDR): resistant to at least one agent in all but two or fewer antibiotic classes
- 3) Pandrug Resistant (PDR) resistant to all classes of antibiotics

In some cases, the treatment of severe infections caused by *Enterobacteriales* has become one of the greatest challenges for physicians, clinicians, and hospitals. This group of bacteria has become resistant to the largest and most used class of antibiotics in the clinical settings, the β -lactams. We are now living in a time that may lead us into periods where untreatable infections could occur on a large scale. Our world would experience dramatic situations like in the "pre-antibiotic era."

B-IMPORTANCE OF β -LACTAMS

Antimicrobials (or antimicrobial agents) are substances of natural (e.g., penicillin), semi-synthetic (e.g., amoxicillin, methicillin), or synthetic (e.g., sulfonamides, quinolones) origin that can kill or inhibit microorganisms without harming the host. Antibacterial agents are substances of various origins that kill bacteria whereas antibiotics are substances that are naturally produced by a microorganism to kill other microorganisms (e.g., penicillin). Although not all antimicrobials are

antibiotics, the word "antibiotic" has now become synonymous with "antibacterial or antimicrobial agent". In this dissertation, the terms "antibiotics" or "antimicrobials" or "antimicrobial agents" are used.

Antimicrobials can be divided into two important categories: bactericidal and bacteriostatic agents. Bactericidal antimicrobials kill bacteria while bacteriostatic antimicrobials prevent their growth. Aminoglycosides, β -lactams, fluoroquinolones, glycopeptides, lipopeptides, nitroimidazoles and nitrofurans are bactericidal antimicrobials while glycyglycines, macrolides, sulfonamides, and oxazolidinones are bacteriostatic antimicrobials. However, it has been shown that this classification is not relevant in clinical practice for some infections such as abdominal infections, skin and soft tissue infections, and pneumonia [8]. Since the 1930s, several families of antimicrobials have been discovered and introduced into medicine:

- Sulfonamides (1930s),
- β -lactams and aminoglycosides (1940s),
- Chloramphenicol and tetracyclines (1950s),
- Glycopeptides and streptogramins (1960s),
- Quinolones (1970s),
- Oxazolidinones (1980s),
- Lipopeptides (1990s).

The largest and most prescribed antimicrobial family for the control of infections caused by *Enterobacteriales* today are the β -lactams due to their diversity, low toxicity to the host, and bactericidal activity.

1-MECHANISMS OF ACTION OF β -LACTAMS

The Gram-negative cell wall is involved in various processes to protect bacteria from the environment, and to selectively control the entry/exit of nutrients/compounds for bacterial survival. This wall consists of three different layers:

- 1) a cell membrane (or inner cell membrane),
- 2) a peptidoglycan (PG)
- 3) an outer cell membrane

Both membranes consist of a lipid bilayer with some embedded lipoproteins, but the outer membrane is less permeable and contains some lipopolysaccharides (LPS) and porins. The LPS act as endotoxins, and the porins are channels involved in the passive diffusion of certain molecules/nutrients.

The PG layer is located in the periplasmic space between the two membranes (Figure 1). It is a rigid structure that surrounds the cell membrane, determines, and maintains the shape of the bacterium, and provides protection from the environment.

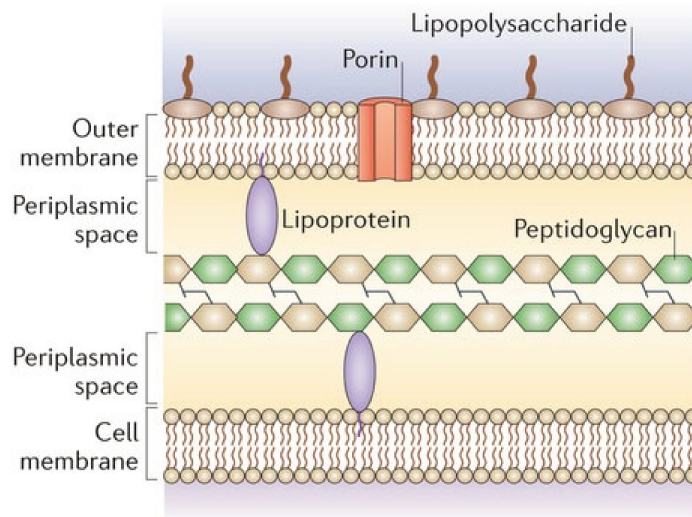

FIGURE 1. STRUCTURE OF CELL WALL OF GRAM-NEGATIVE BACTERIA FROM BROWN ET AL, NATURE REVIEWS MICROBIOLOGY (2015) [9]

The PG is a polymer consisting of strands of alternating sugars: N-acetylglucosamine (GlcNAc or NAG) and N-acetylmuramic acid (MurNAc or NAM) cross-linked by short amino-acid bridges to a terminal D-Alanine-D-Alanine (D-Ala-D-Ala) dipeptide (Figure 2).

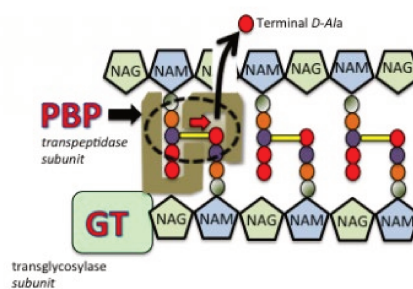

FIGURE 2. SYNTHESIS OF PEPTIDOGLYCANS FROM BROWN ET AL, NATURE REVIEWS MICROBIOLOGY (2015) [9]

Transpeptidases and transglycosylases are proteins that catalyze reactions leading to polymerization of the glycan strand (transglycosylation) and cross-linking between glycan chains (transpeptidation) via short peptide chains resulting in cleavage of one of the terminal D-Ala peptides [10]. After synthesis, the PG layer is located in the periplasmic space. This structure forms a “mesh-like” or “net-like” layer that acts as a protective lattice over the cell membrane and forms the cell wall. The

main function of the cell wall is to provide structural shape and rigidity to the bacterial cells and to provide mechanical strength to resist osmotic challenges and protect them from any environmental stress [11].

Transpeptidases and transglycosylases have been named penicillin-binding proteins (PBPs) due to their ability to bind to β -lactams, as penicillin G (PEN) and its derivatives have a structural similarity to the D-Ala-D-Ala dipeptide of nascent PG (NAM pentapeptides) [12].

2-MOLECULAR TARGETS OF β -LACTAMS

β -lactam antibiotics are bactericidal agents that can interfere with cell wall synthesis by binding to PBPs and preventing these enzymes from polymerizing the PG layer.

PBPs represent a large group of proteins that have been categorized into two classes according to their molecular classes and functions: the low molecular weight (LMW) class, which has mainly a carboxypeptidase activity, and the high molecular weight (HMW) class, which has a transpeptidase and/or transglycosylase activity. The HMW class has been divided into two subclasses: bifunctional (transpeptidase and transglycosylase) (class A), and monofunctional (transglycosylase) (class B) enzymes [13]. The late stages of PG synthesis are carried out by HMW-PBPs, whereas LMW-PBPs are mainly involved in the maintenance, remodeling and recycling of PG [14]. In general, bacteria require at least one HMW-PBP from each class to survive, while removal of LMW-PBPs is not lethal to bacteria [15].

The essential PBPs of classes A and B, identified in Gram-negative bacteria (GNB) are bifunctional (PBPs 1a and 1b) and monofunctional (PBPs 2 and 3) respectively [16]. Each bacterial species has its own set of PBPs [13]. To synthesize its PG cell wall, *Escherichia coli* possesses and maintains 12 PBPs, including 5 HMWs and 7 LMWs. Of the 5 HMWs, three are class A PBPs (PBP1a, PBP1b, PBP1c) and two are class B (PBP2 and 3). PBP1a and 1b are the most important transpeptidase transglycosylases. As mentioned above, the structure of β -lactams is similar to the D-Ala-D-Ala component of NAM-pentapeptides, the main components of PG. During the PG synthesis process in the presence of β -lactams (e.g., penicillin), PBPs mistakenly use β -lactam molecules instead of NAM-pentapeptides as "building substrates". This error leads to acylation of PBPs and prevents PBPs from catalyzing transpeptidation reactions, resulting in a disruption of cell wall synthesis. Inhibition of one or more of these PBPs by β -lactams causes the cell wall to lose its impermeability, leading to lethal cell lysis.

3-HISTORY, STRUCTURE, AND SPECTRUM OF ACTION OF β -LACTAMS

β -lactams are a large family of antibiotics that includes penicillins (penams), cephalosporins (cephems), monobactams, and carbapenems. β -lactamase inhibitors (BLIs) are molecules that have only a limited antibiotic effect themselves but inhibit β -lactamases in the presence of β -lactams. (Figure 1). Most of the β -lactams used today are “old” β -lactam drugs that were developed during the “golden age” of antibiotics from 1928 to the 1990s (Table 1). Pharmaceutical companies have stopped or significantly reduced their research and development efforts for new drugs because the return on investment was too low compared to other drugs. Only a few β -lactam antibiotics have been introduced in the last 10 years. These were combinations of β -lactams and BLIs combinations: Ceftolozane/tazobactam (C/T) (Cubist Pharmaceuticals, 2014) and Ceftazidime/avibactam (CZA) (2015, Actavis Pharma). Since the 2010s, interest in the development of new antibiotics has increased due to the alarming rise in MDR pathogens. Numerous new “start-up” companies have emerged with new approaches to reverse this current pre-penicillin era have arisen. As a result, more than five new β -lactams and BLIs have been approved from 2017-2019: Cephalosporins (Cefiderocol (FDC) 2019), BLIs (relabactam, vaborbactam) and β -lactams/BLIs (Meropenem/vaborbactam (MVB) (2017), Imipenem/cilastatin/relabactam (I-R) (2019)). To date, numerous new BLIs and β -lactam/BLIs combinations are in development (Phase 3) (Table 2).

TABLE 1. CLASSIFICATION OF β -LACTAMS

FAMILY	ANTIMICROBIAL CATEGORY	ANTIMICROBIAL AGENTS	COMBINATIONS
PENICILLINS	Penicillins G and V	Penicillin G (benzylpenicillin) ¹ ; Penicillin V	
	Penicillins M	Oxacillin ¹ ; Cloxacillin ¹	
	Penicillins A	<u>Ampicillin²</u> ; <u>Amoxicillin²</u>	<u>Ampicillin + sulbactam³</u> ; <u>Amoxicillin + clavulanic acid³</u>
	Amidinopenicillin	<u>Mecillinam²</u>	
	Carboxypenicillins	<u>Ticarcillin²</u> ; <u>Temocillin²</u>	<u>Ticarcillin + clavulanic acid³</u>
	Ureidopenicillins	<u>Piperacillin²</u>	<u>Piperacillin + tazobactam³</u>
CEPHALOSPORINS	First generation (C1G)	Cefalotin (CF), Cefazolin (CFZ); <u>Cefadroxil</u> ; <u>Cefalexin</u>	
	Second generation (C2G)	Cefoxitin (FOX) ; Cefotetan (CTT) ; Cefamandole (CEF) ; <u>Cefuroxime</u>	
	Third generation (C3G)	<u>Cefotaxime (CTX)</u> ; <u>Ceftazidime (CAZ)</u> ; <u>Ceftriaxone (CRO)</u>	<u>Ceftazidime + avibactam³</u>
	Fourth generation (C4G)	<u>Cefepime (FEP)</u> ; Cefpirome (CPO)	
	Fifth generation (C5G)	<u>Ceftobiprole (BPR)</u> ; <u>Ceftaroline (CPT)</u> ; <u>Ceftolozane</u>	<u>Ceftolozane + tazobactam (C/T)³</u>
	Other	<u>Cefiderocol (FDC)</u>	
MONOBACTAMS		<u>Aztreonam (ATM)</u>	
CARBAPENEMS		<u>Imipenem (IPM)</u> ; <u>meropenem (MEM)</u> , <u>ertapenem (ETP)</u> , <u>doripenem (DOR)</u>	<u>Imipenem + relebactam (I-R)³</u> <u>Meropenem + vaborbactam (MVB)³</u>

¹Narrow spectrum penicillins; ²Extended spectrum penicillins; ³ β -lactams inhibitors; Antibiotics included in 2023 CASFM v1.0 for are underlined.

TABLE 2. CLASSIFICATION OF NEW β -LACTAMS AND BLI COMBINATIONS

FAMILY	ANTIMICROBIAL CATEGORY	ANTIMICROBIAL AGENTS	COMBINATIONS
CEPHALOSPORINS	Third generation (C3G)	-	Cefpodoxime/ETX0282 (Phase I) Ceftibuten/VNRX-71 (Phase I)
	Fourth generation (C4G)	-	Cefepime/zidebactam Cefepime/nacubactam Cefepime/enmezobactam (Phase III) Cefepime/taniborbactam Cefepime/zidebactam (Phase I)
MONOBACTAMS	Monobactams	-	Aztreonam/avibactam (XXX) Aztreonam/nacubactam (XXX)
CARBAPENEMS	Carbapenems	Benapenem (Phase III)	Meropenem/nacubactam (Phase III)) Ertapenem/zidebactam (Phase I) Imipenem/XNW4107 (Phase I)
OTHER	Undisclosed	-	QPX7728/QPX2014 (Phase I) QPX7728/QPX2015 (Phase I)
	BLI	-	Durlobactam/sulobactam (Phase III) ARX-1796

¹Narrow spectrum penicillins; ²Extended spectrum penicillins; ³ β -lactams inhibitors.

The development of the β -lactams has been constant since the discovery of penicillin. This family includes a large number of classes as each new class has been developed to either extend its spectrum of activity or to address specific resistance mechanisms identified following the introduction of a new antimicrobial agent [17].

The introduction of penicillin G in the 1940s greatly improved the prognosis of *S. aureus* infections, but penicillinase-producing *S. aureus* isolates were quickly identified [18]. Methicillin was introduced in the 1960s to control penicillin-resistant (PEN-R) *S. aureus* isolates until the first methicillin-resistant *S. aureus* (MRSA) was discovered (1961). The first penicillins G and M showed a narrow spectrum of activity against Gram-positive cocci (staphylococci, and streptococci), some Gram-positive bacilli (e.g., *Listeria*, *Clostridium*, *Bacillus anthracis*) and some Gram-negative cocci such as *Neisseria meningitidis* but not against Gram-negative bacilli.

Later, aminopenicillins (penicillins A) (ampicillin, (AMP) and amoxicillin, (AMX) were introduced with a broader spectrum that included a large family of GNB: *Enterobacterales* (*Proteus*, *Salmonella* and *E. coli*). However, intrinsic resistance was observed in *Klebsiella* spp., *Citrobacter* spp., *Enterobacter* spp., *Providencia* spp., *Morganella* spp., *Hafnia* spp., *Yersinia* spp., *P. vulgaris/penneri*, *Kluyvera* spp. (Table 3). Carboxypenicillins (carbenicillin (CARB) and ticarcillin (TIC) also showed increased efficacy against GNB, especially *P. aeruginosa*. Finally, ureidopenicillins (piperacillin (PIP)) were further developed to broaden the spectrum of activity, including activity against AMP-resistant (AMP-R) GNB including *P. aeruginosa* [19].

For cephalosporins, the development from first to third generation (C1G to C3G) has been from activity against GPC to activity against GNB. However, some specific species are intrinsically resistant to C1G, such as *Enterobacter* spp., *Klebsiella aerogenes*, *Citrobacter freundii* complex, *Serratia marcescens*, *Providencia* spp., *Morganella* spp., *Hafnia* spp., *Yersinia* spp., *Proteus vulgaris/penneri*, and *Kluyvera* spp. The fourth generation (C4G) aimed at curbing the emergence of cephalosporinase-producing GNB pathogens, while the fifth generation (C5G) in turn has balanced activity against Gram-negative bacilli and cocci including methicillin-resistant *S. aureus* [20]

TABLE 3. INTRINSIC RESISTANCE TO β -LACTAMS IN CLINICALLY RELEVANT ENTEROBACTERIALES.

ADAPTED FROM CA-SFM v1.0.

	Group 0/1	Group 2	Group 3	Group 4	Group 5	Group 6
	<i>Salmonella</i> spp., <i>Proteus mirabilis</i> / <i>Escherichia coli</i> , <i>Shigella</i> spp.	<i>Klebsiella</i> spp., <i>Citrobacter koseri</i>	<i>Enterobacter</i> spp., <i>Klebsiella aerogenes</i> , <i>Citrobacter freundii</i> complex, <i>S. marcescens</i> , <i>Providencia</i> spp., <i>Morganella</i> spp., <i>Hafnia</i> spp.	<i>Yersinia</i> spp.	<i>Proteus vulgaris</i> , <i>Proteus penneri</i>	<i>Kluyvera</i> spp.
Aminopenicillins	S	R	R	R	R	R
Amoxicillin + clav.	S	S	R	R	S	R
Ticarcillin, Piperacillin	S	R	S	R	S	R
Cefalotin (C1G)	S	S	R	R	R	R
Cephameycins (cefoxitin)	S	S	R ¹	R	S	R
Cefuroxime (C2G)	S	S	S ²	S	R	R

¹except *M. morgannii*, *P. rettgeri* ; ²except *M. morgannii*, *S. marcescens* and *P. vulgaris*.

3.1- β -LACTAMS AND β -LACTAMASE INHIBITORS (BLIs)

a) Penicillins

The structure of penicillin consists of a fused β -lactam ring and thiazolidine ring (Figure 3). The core structure, i.e., the β -lactam ring, is common to all β -lactam drugs. The β -lactam and thiazolidine rings are 4- and 5-membered systems, respectively. Both rings form a bicyclic system called penam, and an amide and a carboxylic acid group are also present. Most variations are limited to the side chain (R) of the amide group but in some cases the carboxylic acid has been modified.

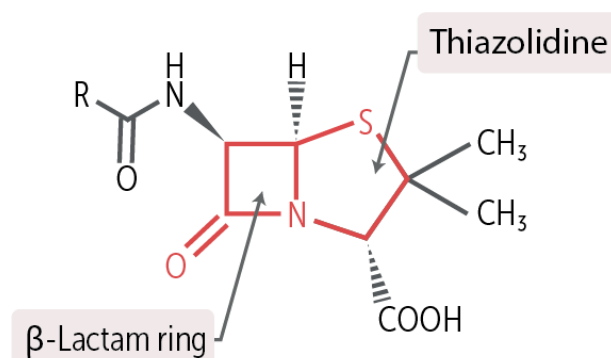

FIGURE 3. GENERAL STRUCTURE OF PENICILLINS

Penicillin G is the natural penicillin, that was discovered in 1928 from the *Penicillium fungus*, and is also known as benzylpenicillin. Penicillin G was used as a precursor to produce other semi-synthetic penicillins (aminopenicillins (A), carboxypenicillins, ureidopenicillins and penicillins M).

b) Cephalosporins

In contrast to penicillins, it took years of research for cephalosporins to bring the first clinically useful active substance to market. Cephalosporin C, a weak antibiotic that is effective against some penicillin-resistant (PEN-R) isolates, was first isolated from the original *Cephalosporium acremonium*. Cephalosporins are divided into 4 major classes, referred to as "generations", based on their chronological evolution and antimicrobial spectrum [21].

The first generation of cephalosporins (C1G, cephalotin), introduced in the 1960s, had a similar spectrum of activity to penicillins A and M and was mainly active against Gram-positive bacteria (GBP) (GPB) (e.g., penicillinase-producing *S. aureus*). The second generation cephalosporins (C2G, cefuroxime), which were introduced in the 1970s, have a similar spectrum to C1G and increased antimicrobial activity against GNB (*Haemophilus influenzae*, *Klebsiella*). The third generation cephalosporins (C3G, cefotaxime, ceftazidime) had the broadest spectrum of the cephalosporins with increased activity against GNB. The

fourth generation cephalosporins (C4G, cefepime) inhibited a broad spectrum of GPB and GNB. Finally, the fifth generation cephalosporins (C5G, e.g., ceftobiprole or ceftolozane) were the only β -lactams that were active against severe infections caused by GNB and Gram-positive cocci such as MRSA, PEN-R *S. pneumoniae*, *P. aeruginosa* and enterococci (Table 2).

The molecular structure of ceftolozane/tazobactam is similar to that of ceftazidime, but with a modified side chain at the C3 position, which is responsible for the strong antimicrobial activity against *P. aeruginosa* [22]. Ceftolozane/tazobactam, has been shown to be a potent antipseudomonal antimicrobial agent due to four important properties: 1) reduced affinity for AmpC β -lactamases of *P. aeruginosa*, 2) high affinity for PBP3 of *P. aeruginosa*, 3) it is not a substrate for MexAB/OprM efflux pumps, and 4) it does not penetrate cells through OprD porins [23]. *In vitro* experiments have also shown that multiple mutations altering AmpC β -lactamases are required to confer resistance to ceftolozane/tazobactam [24]. This confirms that ceftolozane/tazobactam could be a good candidate for the treatment of severe *P. aeruginosa* infections. Ceftolozane/tazobactam was approved by the FDA in 2014 for complicated UTIs and intra-abdominal infections (IAIs).

Finally, cefiderocol, a siderophore cephalosporin with a unique mechanism of entry into bacterial cells compared to other cephalosporins, was approved by the FDA in 2019 for the treatment of complicated UTIs including pyelonephritis, and in 2020 for the treatment of hospital-acquired infections (HAIs) and ventilator-associated bacterial pneumonia. Its molecular structure contains a catechol moiety at the side chain of the C3 position, and this molecule, like other cephalosporins, binds specifically to PBP3 [25]. In contrast to other cephalosporins, one of the most important features of this new type of cephalosporin is that cefiderocol utilizes the receptor-mediated bacterial iron transport system to cross the outer membrane of GNB. Cefiderocol can form a chelating system with iron, which leads to active transport of the drug into the bacterial cells [26].

c) Monobactams

Monobactams are naturally occurring antibiotics with a unique β -lactam structure isolated from the fermentation of unusual microorganisms called *Chromobacterium* spp. Aztreonam, the only agent in this class approved for therapeutic use, has been chemically modified. It is a fully synthetic parenteral antibiotic that is effective against almost all GNB including aerobic enteric bacteria and *P. aeruginosa* (Table 2) [21].

d) Carbapenems

The carbapenems, which are active against a wide range of GPB and GNB, including most β -lactamase-producers (Table 2). The β -lactam antibiotic thienamycin, isolated from *Streptomyces cattlea* in 1976, was an extremely potent antibiotic that formed the origin of today's most potent class of antibiotics: the carbapenems. It also had an important β -lactamase inhibitory effect. Thienamycin was never commercialized due to the self-inactivation of the molecule, but the replacement of the amine with a less nucleophilic imino functionality led to the "famous" imipenem [21]. Since then, several carbapenems have been derived from imipenem, namely meropenem, doripenem, ertapenem, faropenem, biapenem and tebipenem. However, biapenem and tebipenem are only approved in Japan. Faropenem, biapenem and tebipenem are not approved in the USA.

Carbapenems are known as broad-spectrum antibiotics and are divided into 2 groups. Group 1 carbapenems (e.g., ertapenem) are defined as broad-spectrum antimicrobials active on ESBL-positive *E. coli* with limited activity against non-fermentative GNB. Group 2 carbapenems (e.g., imipenem and meropenem) also have a broad-spectrum of activity but cover non-fermentative GNB better, making them particularly useful for the treatment of nosocomial infections.

e) β -lactamase-inhibitors (BLIs)

β -lactamases can inactivate β -lactams by cleaving the β -lactam ring. Once β -lactamases recognize the β -lactam molecules, the enzymes bind to the active site by forming an unstable covalent bond that causes cleavage of the β -lactam ring. This covalent bond is later cleaved, releasing the degraded β -lactam molecule. Therefore, the enzyme can continue and degrade further β -lactam molecules.

BLIs are co-administered together with β -lactams to prevent the development of resistance by inhibiting serine β -lactamases. BLIs have been designed to act in two different ways: i) They become "substrates" that bind either reversibly or with high-affinity to the active site of most β -lactamases by forming an irreversible interaction known as an "acyl-enzyme", that prevents the enzymes from binding and destroying β -lactams, ii) They serve as "suicide inhibitors" that permanently inactivate the enzyme through secondary chemical reactions in the active site [27].

The discovery of BLIs was motivated in the 1970s by the emergence of common and transmissible penicillinases. Clavulanic acid (or clavulanate) (CLA) a clavam subclass, was the first BLI introduced in 1984. In combination with amoxicillin, amoxicillin-clavulanate (AMC), proved to be effective against staphylococcal penicillinases, and even against the plasmid-encoded penicillinases of

intestinal bacteria. Many other inhibitors such as penicillanic acid sulfones were synthesized but only two with a similar spectrum of activity to clavulanic acid were available on the market: sulbactam (1986) and tazobactam (1993).

After a “gap” of more than 20 years in the development of BLI since the introduction of tazobactam (TZB) in 1993, new mutated β -lactamases, and carbapenemase-producing isolates emerged that hydrolyze β -lactam/BLIs combinations. The increase in enzymes such as inhibitor-resistant TEM (IRT) (IRT, 35 variants), complex mutants of TEM (CMT, 9 variants), and inhibitor-resistant SHV (Sulphydryl Variable) (5 variants) was of concern [27]. Therefore, pharmaceutical companies have focused on the development of a unique class of reversible inhibitors that were developed in the 2010s. This class includes the non- β -lactam inhibitors (avibactam (AVI), relebactam (REL)) and the boronic acid β -lactamase inhibitor (vaborbactam (VAB)). Three inhibitors have been approved by the FDA: avibactam (2015), vaborbactam (2017), and relebactam (2019) [28].

In contrast to clavulanate, sulbactam and tazobactam, are bridged diazabicyclooctanone (DBO) molecules that utilize a unique inhibition mechanism due to the lack of a β -lactam ring. Avibactam, the first DBO introduced to the market, has a broader spectrum than previous inhibitors, as class A β -lactamases, including *K. pneumoniae* carbapenemase (KPC), AmpC β -lactamases (AmpC) and some class D β -lactamases can be inhibited by this new inhibitor [29]. This dissertation covers in detail those enzymes later. This inhibitor was originally developed to solve the problem of dissemination of class A (ESBLs) and AmpC β -lactamases. It was later found that it can also inhibit KPC carbapenemases [30]. Relebactam is thought to have a similar spectrum to avibactam but has been found to be less inhibitory to bacterial isolates overexpressing AmpC and/or OXA-48 and OXA-51-producers [31]. Compared to avibactam, nacubactam has shown two other interesting properties: increased antibacterial activity against *Enterobacteriales* through PBP2 and enhanced activity against β -lactam agents [32]. The other type of inhibitor, which belongs to the boronate family, is vaborbactam. It has good inhibitory activity against KPC-producers and can lower MICs of meropenem in clinical isolates with a combination of porin loss and efflux systems. In addition, vaborbactam appears to utilize the OmpK35 and OmpK36 porins for entry into *K. pneumoniae* cells, with OmpK36 playing an important role. Finally, the AcrAB-TolC efflux systems had minimal effects on the activity of vaborbactam [33].

Each BLI must be combined with a β -lactam (penicillins or cephalosporins). Both components β -lactam/ β -lactamase-inhibitor (BL/BLI) act synergistically against β -lactamase-producing bacterial populations as BLIs on their own have very little effect on PBPs. Sulbactam (SUL) was combined with ampicillin (SAM) and tazobactam (TZB) with piperacillin (TZP) [27, 28]. In total, there are four “first

generation" BL/BLIs that were introduced in the 1980s and are currently commercially available for clinical use: AMC, ticarcillin-clavulanate (TIM), SAM, and TZP [28]. However, the first generation of BL/BLIs is only able to hydrolyze class A β -lactamases, while they have no effect on other classes. The "second generation" of BL/BLI currently commercially available for clinical use are: ceftolozane-tazobactam (C/T) (2014), ceftazidime-avibactam (CZA) (2015), meropenem-vaborbactam (MVB) (2017) and imipenem/cilastatin-relebactam (I-R) (2019).

3.2- NOVEL CARBAPENEMASE INHIBITORS IN DEVELOPMENT

The combination of aztreonam with avibactam (aztreonam/avibactam) which restores the activity of aztreonam against MDR pathogens that co-produce metallo- β -lactamases MBLs and ESBLs is still under investigation but may soon be a much-needed effective treatment option against MDR Gram-negative pathogens [34].

Among the newly developed BLIs from the DBO class, there are five next-generation BLIs, namely nacubactam, zidebactam, enmetzobactam, taniborbactam, and durlobactam, [35] which have been tested *in vitro* in combination with BL [36] and in Phase 3 clinical trials. Nacubactam (formerly RG6080/OP0595), zidebactam (formerly WCK5107) and durlobactam (formerly ETX2514) belong to the new generation of DBOs that efficiently inhibit most class A and C β -lactamases and even class D in the case of zidebactam and durlobactam. This new generation of DBOs are "double acting inhibitors", that inhibit β -lactamases and have an antimicrobial effect due to their high affinity for Gram-negative PBP2. Cefepime/zidebactam (WCK5222) sulbactam/durlobactam, cefepime, aztreonam or meropenem/nacubactam are BL/BLI or BLI/BLI combinations that could soon be available for clinical use (Phase 3 clinical trial).

Taniborbactam (formerly VNRX-5133) is a boronic acid-derivative like vaborbactam that inhibits class A and C β -lactamases and has excellent inhibitory activity on the MBLs (NDM- and -VIM-types, but not IMP-type). This inhibitor, the first to be active against all classes of β -lactamases including MBLs, is currently being developed and evaluated for use in combination with cefepime. Enmetzobactam (formerly AAI101, derivative of tazobactam, is a penicillin-based sulfone β -lactam-inhibitor that has excellent activity against class A β -lactamases of *Enterobacteriales* isolates. This inhibitor has also been developed for use in combination with cefepime [37-39]. In addition, other DBO/BLIs such as ETX-1317 (Entasis Therapeutics) [40], WCK-4234 (Wockhardt, India) [41] and GT-055 (or LCB18-055, LegoChem Biosciences, Korea) [42] are currently being developed for use in combination with cefpodoxime, meropenem and GT-1 antibiotics, respectively. Also, two further boronate inhibitors ledaborbactam (formerly VNRX-7145) [43] and xeruborbactam (formerly QPX-7728) [44] are being developed for use

in combination with a third-generation cephalosporin (ceftibuten/ledaborbactam) and a potent carbapenem (meropenem/xeruborbactam) respectively. Both BL/BLI combinations showed excellent activity against ESBL- and carbapenemase-producing *Enterobacterales* (CPEs with the latter being the most potent BL/BLI combination active against CRE including KPCs and MBL carbapenemases) [45-47].

Finally, three other carbapenems, namely sulopenem (CP-70,429), tebipenem and benapenem are under investigation [39, 48] and could be promising antimicrobial agents against *Enterobacterales*.

C-ANTIMICROBIAL RESISTANCE TO β -LACTAMS

1-MECHANISMS OF ANTIMICROBIAL RESISTANCE TO β -LACTAMS

Antibiotics or antimicrobial agents target bacterial physiological or biochemical reactions that are important for bacterial growth and survival. To be active against bacterial cells, an antimicrobial agent must 1) be able to penetrate the bacterial cell, 2) have a specific molecular target, 3) be able to remain in sufficient concentration near the target, and not be degraded or expelled by the bacteria before reaching the target, and 4) finally, be able to bind efficiently to the target. There are five main targets of antibiotics: the bacterial cell wall, the bacterial cell membrane, DNA and RNA synthesis, protein synthesis and folic acid metabolism (Figure 4).

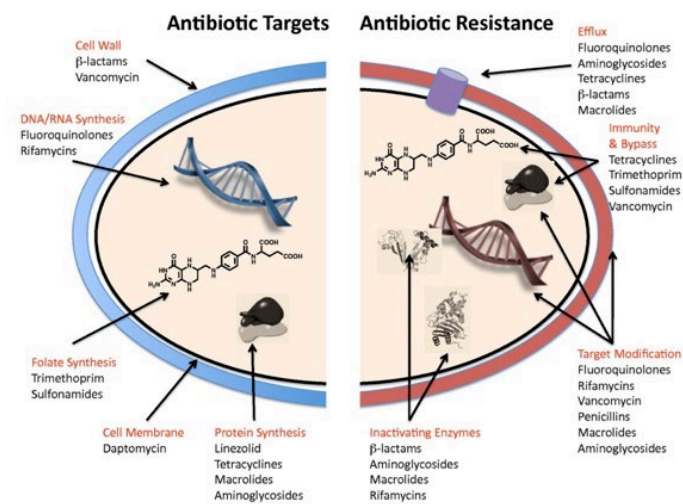

FIGURE 4. ANTIBIOTIC TARGETS AND MECHANISMS OF RESISTANCE FROM WRIGHT, BIOMED CENTRAL (2009) [49]

Antimicrobial resistance or AMR is the ability of microorganisms to resist the action of antimicrobial agents. Each microorganism can adapt to its environment so that, it can develop survival strategies and some sophisticated self-defense mechanisms in the presence of antibiotics.

Antibiotics can disrupt and/or interrupt some essential steps in the mechanism of action of drugs so that they are no longer effective. In this case, the bacteria become resistant to the drug.

There are four main mechanisms used by GNB to overcome β -lactams.

- 1) Enzyme-mediated resistance through the production of β -lactamase enzymes. When antibiotics enter the bacterial cell, these enzymes hydrolyze the β -lactams in the periplasmic space and prevent them from reaching their target (PBP).
- 2) Changes at the dynamic site of PBPs. Antibiotics penetrate the bacterial cell but are unable to recognize their targets due to structural changes in the PBPs.
- 3) Decreased expression or loss of outer membrane proteins (OMPs). By reducing the number of porins on their membrane, bacteria can prevent antibiotics from entering the periplasmic space. In *K. pneumoniae*, the loss of OmpK35/36 porins is associated with carbapenem resistance in some bacterial isolates [50]. Imipenem resistance may be due to the loss of OprD in *P. aeruginosa*, which controls the passage of imipenem across the outer membrane [51].
- 4) Up-regulation of efflux systems. These efflux pumps can expel a wide range of antibiotics from bacterial cells and prevent the drugs from becoming active. Overexpression of efflux pumps can lead to carbapenem resistance in *P. aeruginosa* [52].

Resistance to β -lactams in *Enterobacterales* is usually due to the bacterial production of β -lactamases, which inactivate these drugs. This important mechanism in *Enterobacterales* will be the focus of this dissertation. However, it is important to point out that there are two other important pathogens that are also considered a threat by the World Health Organization (WHO) and the Centers for Disease Control and Prevention (CDC) (*P. aeruginosa* and *Acinetobacter* spp.). Resistance of *P. aeruginosa* to β -lactams may also be related to β -lactamases, e.g., the presence of derepressed AmpC β -lactamases [53, 54] or the acquisition of β -lactam-hydrolyzing enzymes (e.g., PSE, PER, OXA, IMP, VIM), including MBLs. However, other important mechanisms are either up-regulation of efflux systems (e.g., MexAB-OprM) [55] or mutation-induced impermeability (e.g., the loss of the porin OprD), which confers resistance to carbapenems [56]. In *Acinetobacter* spp., several β -lactamases (ESBLs, OXAs, MBLs) have been identified that confer resistance to β -lactams including carbapenems, but a reduction in the expression of OMPs and an upregulation of efflux pumps can also be observed [57].

One of the most common mechanisms that CREs use for resistance to carbapenems is the production of enzymes called carbapenemases. These enzymes, which hydrolyze carbapenems can prevent cell death. The overexpression of AmpC β -lactamases in conjunction with the loss of porins can

also lead to carbapenem resistance [58]. The production of carbapenemases is often associated with other resistance factors that complicate patient treatment, and in some cases lead to treatment failures in the clinic. The dissemination of CPEs is a serious public health concern as they often co-produce additional genes for class A, B, and D β -lactamases [59] and also genes conferring resistance to other classes of antibiotics (e.g., aminoglycosides, cotrimoxazole, fluoroquinolones, tetracycline, chloramphenicol).

The biggest challenge in terms of AMR in the past has been GPB with the emergence of methicillin-resistant *S. aureus* (MRSA) or vancomycin-resistant *Enterococci* years ago. This type of resistance now appears to be under control and has declined over the last decade [60]. However, the spread of plasmid-mediated MDR against antimicrobials in GNB, which is becoming a daily challenge in hospitals and especially in intensive care units (ICU), is now a much greater challenge. *Enterobacterales* and non-fermenting GNB such as *A. baumannii*, *P. aeruginosa* and *S. maltophilia* are responsible for most multidrug resistance problems in this group of bacteria.

1.1-INTRINSIC RESISTANCE

Bacteria can be naturally resistant to certain antibiotics due to certain inherent structural or functional characteristics. This type of resistance is genetically encoded and is expressed by all bacterial isolates of the species in question. All *Enterobacterales*, except for *Salmonella* spp., and *Proteus mirabilis* (group 0), produce intrinsic, chromosomally encoded β -lactamases that are involved in natural protection against β -lactams. *E. coli*, *Shigella* spp. (group 1), produce a chromosomal AmpC β -lactamase gene which is not or weakly expressed. *Klebsiella* spp. (except *K. aerogenes*), and *Citrobacter koseri* (group 2) produce low levels of penicillinases, which confer resistance to ampicillin and ticarcillin/piperacillin, but those pathogens remain susceptible to BLI. *Enterobacter* spp., *K. aerogenes*, *C. freundii* complex, *Providencia* spp., *Morganella* spp., *Hafnia* spp. (group 3) produce a small amount of inducible AmpC β -lactamases that are not inhibited by BLIs and confer resistance to ampicillin, amoxicillin-clavulanate, and C1G. *Yersinia* spp. (group 4) produce both a penicillinase and an AmpC β -lactamase that confer resistance to ampicillin, amoxicillin-clavulanate, ticarcillin, and C1G. *P. vulgaris* and *P. penneri* (group 5) produce a chromosomal class A β -lactamase (cefuroxime) which confers resistance to ampicillin, C1G and C2G (cefuroxime). Lastly, *Kluyvera* spp. is the only species capable of producing a chromosomal ESBL that confers resistance to most penicillins as well as C1G, and C2G (group 6) (Table 3).

1.2-ACQUIRED RESISTANCE

Bacteria can also acquire additional resistance, either through chromosomal mutations or through horizontal gene transfer (HGT) of resistance genes. HGT or the exchange of genetic material between “neighboring” bacteria is one of the most efficient mechanisms for the transfer of resistance genes in a bacterial population. In contrast to intrinsic resistance, these acquired genetic changes only occur in selected isolates of a particular species or group of microorganisms. For example, resistance to carbapenems in *K. pneumoniae* is an acquired mechanism. This resistance is primarily due to a carbapenemase encoded by the *bla_{KPC}* gene acquired from certain isolates. This *bla_{KPC}* gene was first described in the United States in 2001, but the first KPC-producer was isolated in 1996 [61]. KPC is the best example of the rapid spread of clonally acquired resistance, as KPC-producing isolates have spread worldwide, and have become endemic in some areas [62]. Controlling the spread of carbapenemase-producers is nowadays very difficult, but still feasible if new strategies are introduced to better treat patients infected with MDR pathogens [63]. The acquisition of genes required for the development of all these different resistance mechanisms is strongly favored by a variety of bacterial mobile genetic elements (MGEs).

Bacterial MGEs can be divided into two main groups: elements that can migrate from one bacterial cell to another (resistance plasmids, conjugative resistance transposons), and those that can migrate from one DNA element to another in the same cell. These include resistance transposons, gene cassettes, and ISCR-mediated gene transfer systems [64]. Many of the antibiotic resistance genes are carried by transfer systems such as plasmids, integrons, or transposons, which serve as vectors for the transfer of resistance. Bacteria can acquire foreign genetic material by incorporating free DNA segments into their chromosome (transformation), or when they are infected by bacteriophages (transduction), or by conjugative plasmids (conjugation) (Figure 5). Transposable elements (TE-) include insertion sequences (IS-) (e.g., IS26 (NDM-1) composite conjugative transposons (e.g., Tn4401 (KPC), Tn1999 (OXA-48)). Integrons can also be part of a mobile element such as conjugative plasmids or even transposons (e.g., class 1 integrons, NDM-1).

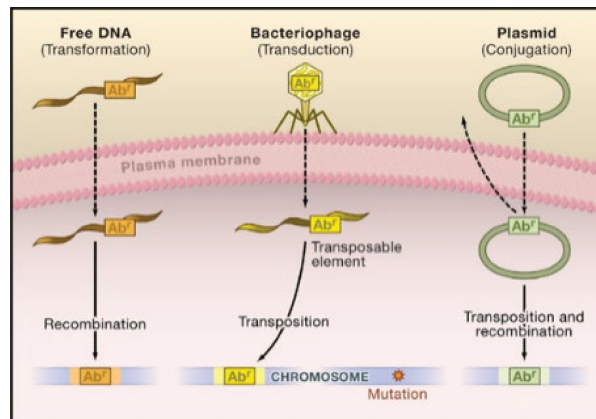

FIGURE 5. ACQUIRED MECHANISMS OF RESISTANCE TO ANTIBIOTICS
 FROM ALEKSHUN ET AL, MOLECULAR MECHANISMS OF ANTIBACTERIAL RESISTANCE. CELL (2007) [65]

ARGs can be transferred either by DNA replication between bacterial parent cells and daughter cells (vertical transmission) or by exchange between bacterial cells (horizontal transmission). Plasmids, integrons and transposons play an important role in the horizontal transmission of ARGs.

a) *Plasmids*

Plasmids are small circular double-stranded DNA molecules. They exist independently of the chromosome of the bacterial cell host and have systems that ensure their auto-replication and control their copy number and stable inheritance during the cell division process. They are not linked to the essential functions of the bacterial host but carry additional genes that may be useful for survival in certain environmental situations (e.g., resistance genes to combat antibiotics). Most plasmids can be transferred from a donor cell to a recipient cell by conjugation and are therefore referred to as conjugative plasmids. Depending on their conjugation efficiency, plasmids are often responsible for the successful transfer of a variety of ARGs. Bacterial cells can carry either one or multiple plasmids harboring many ARGs that confer resistance to different classes of antibiotics simultaneously (e.g., MDR pathogens). Plasmids can be classified according to the incompatibility group system developed by Carattoli et al [66]. Plasmids are vectors for genetic elements such as integrons and transposons. This type of horizontal transmission is the main cause of the spread of resistance genes from the environment into the community and into hospitals.

b) Integrans

Integrans are genetic elements involved in the uptake and expression of exogenous genes. As plasmids, they are best known for their role in the spread of resistance gene cassettes [67]. All integrans share three essential core features: 1) *intl*, a gene encoding an integrase (IntI), *attI*, an integrin-associated recombination site, and an integrin-associated promoter, *Pc*. The integrin integrase catalyzes recombination between incoming gene cassettes and *attI*. After recombination, the gene cassettes can be expressed thanks to the promoter *Pc* [68] (Figure 6).

Integrans can be divided into three major classes based on the phylogeny of their integrase genes: 1) Group found in Proteobacteria from freshwater and soil environments (class 1 and class 3). Most resistance integrans belong to class 1 integrans; 2) Group found in Gammaproteobacterial from marine environments (class 2); 3) Integrans whose integrase genes are in reverse position compared to the previous groups.



FIGURE 6. INTEGRON STRUCTURE
FROM GILLINS ET AL, MICROBIOL MOL BIO (2014) [68]

Gene cassettes containing a recombination site called *attC* (or 59 bp) are integrated by site-specific recombination between *attI* and *attC*. Multiple gene cassettes can be sequentially inserted into the integrin recombination site to generate impressive resistance gene arrays (Figure 7).

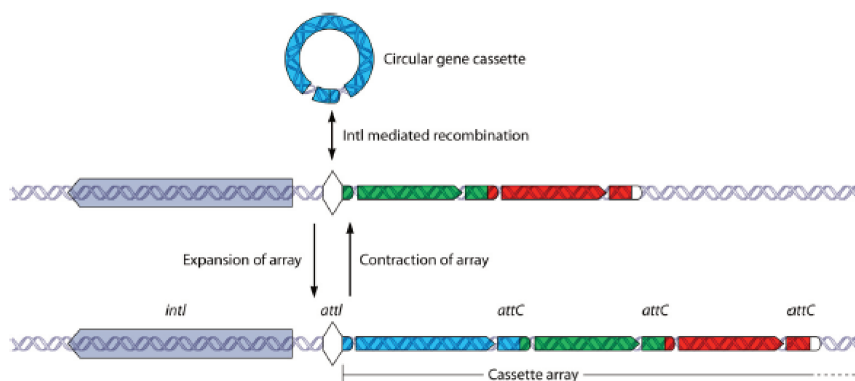

FIGURE 7. ACQUISITION OF GENE CASSETTES
FROM GILLINS ET AL, MICROBIOL MOL BIO (2014) [68]

c) Transposons

Transposons or TEs also known as “jumping genes” are DNA sequences that can move or “jump” from one location in the genome to another (e.g., from a chromosome to a plasmid or vice-versa). Bacterial transposons, known as composite transposons, usually carry one or more functional genes (e.g., ARGs) surrounded by inverted repeats (IR-). Bacterial resistance transposons belong to the Tn family. These complex transposons are often found on plasmids of *Enterobacteriales*. As an example, the Tn3 transposon is shown in Figure 8.

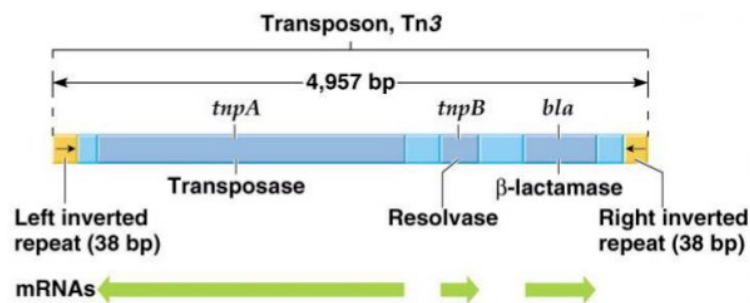

FIGURE 8. TN3 TRANSPOSON STRUCTURE
FROM PETER J RUSSEL, GENETICS, CHAPTER 7
DNA MUTATION, DNA REPAIR AND TRANSPOSABLE ELEMENTS [69]

Widespread resistance has arisen through the acquisition of pre-existing antimicrobial determinants from the environment or other sources and through mobile dissemination due to selection pressure. The acquisition or spread of resistance genes to β-lactams is largely due to HGT, more specifically to the action of MGEs. MGEs comprise two different types of DNA elements that can promote intracellular (type 1) or intercellular DNA mobility (type 2). Mobile elements such as IS, gene cassette arrays/integrans, and transposons (type 1) can transfer genes between DNA molecules within the same cell (e.g., from chromosome to plasmid). Conjugative plasmids and integrative conjugative elements (ICEs) can transfer genes between cells (type 2).

Biological gene transfer processes that lead to successful uptake of ARGs are rare and difficult to monitor. However, subsequent uptake by other microorganisms and dissemination in the community or in healthcare settings appear to be more efficient and can be monitored by molecular surveillance studies. A better understanding of how different gene cassette arrays move from environmental bacteria and between bacteria of different species would be very helpful in tracking the spread of ARGs.

The source of a captured ARG can in some cases be determined when the same mobile DNA element is associated with that specific ARG on plasmids, while it is absent on the chromosome of certain species. For example, plasmid-borne AmpC genes such as *bla*_{CMY-2-like}, *bla*_{DHA-1}, and *bla*_{FOX} have been identified on the chromosomes of *C. freundii*, *M. morgani*, and *Aeromonas caviae* [70-72]. The most common ESBL gene, *bla*_{CTX-M}, which is found worldwide, was captured by *ISEcp1* from the chromosome of *Kluyvera* spp. and transferred to a plasmid [73]. However, even when a specific MGE such as a *Tn3*-like transposon has been associated with *bla*_{TEM}, the source of this gene remains unknown. Another example of environmental acquisition of ARGs is *bla*_{OXA-48}, whose origin is the chromosome of *Shewanella* spp., and was transferred to a successful plasmid by *IS1999*, which spread worldwide [74]. *bla*_{NDM-1} appears to have been captured from a precursor gene by *ISCR27* and then fused to the *AphA6/ISAbA125* promoter region in *Acinetobacter* [75]. Subsequently, several different MGEs were involved in its transfer to multiresistance regions (MRRs) on different plasmids in *Enterobacterales* [76]. In contrast to *bla*_{CTX-M-15}, which is associated with the same *IncF* plasmid and MRRs (*IS26/Tn2*) and/or clonal spread of *E. coli* ST131 [77], *bla*_{NDM-1} is present in a broader and variable genetic context, and in numerous species, requiring more attention and in-depth analysis of each whole-genome sequence to closely monitor its spread. The success of *bla*_{KPC} has been linked to *Tn4401*, but especially to the clonal spread of *K. pneumoniae* ST258.

2-β-LACTAMS AND ENTEROBACTERALES

Enterobacterales is a large family of GNB that are part of the normal human intestinal flora, and rarely cause infections in healthy people. This family includes many different species such as: *E. coli*, *Citrobacter* spp., *Enterobacter* spp., *H. alvei*, *Klebsiella* spp.; *M. morgani*, *S. marcescens*, *Proteus* spp., *Providencia* spp., *Salmonella* spp., and *Shigella* spp. However, in hospitals or long-term care facilities, *Enterobacterales* can cause infections in various areas: urinary or respiratory tract, intravenous catheters, wounds, burns, or bloodstream. They often occur in immunocompromised patients who are unable to fight the infection or in ICU patients in critical conditions [78]. These HAIs are referred to as nosocomial infections, in contrast to CAIs when they occur outside the hospital.

With few exceptions, the main antibiotic families used to treat infections caused by *Enterobacterales* are β-lactams, fluoroquinolones, aminoglycosides, and cotrimoxazole with β-lactams remaining the most effective and commonly used. Unfortunately, the treatment of severe nosocomial infections is complicated by the emergence and spread of resistance in *Enterobacterales*. The increasing resistance of common Gram-negative pathogens such as *E. coli*, *Klebsiella* spp., *E. cloacae*, and other

Enterobacterales to broad-spectrum β -lactam antibiotics is a serious and growing problem in healthcare [79].

2.1- β -LACTAMASES: THE MOST IMPORTANT MECHANISM OF RESISTANCE IN *ENTEROBACTEREALES*

β -lactamases inactivate β -lactams by interacting with the amide group (-CONH-) of the β -lactam ring. This interaction leads to hydrolysis of the β -lactam ring and inactivates the active substance, whereby benzylpenicillin is converted into benzyl penicilloic acid, an inactive substance.

The diversity and large number of β -lactamases have led to two different classification systems: molecular and functional. The molecular classification is based on the amino-acid sequence and divides the β -lactamases into 4 classes: A, B, C and D enzymes according to the Ambler scheme [80, 81]. The functional classification according to the Bush-Medeiros-Jacoby system [82], which is based on the functional properties (isoelectric focusing, hydrolysis and inhibition profile) of the enzymes, has recently been updated. Class A, C, and D enzymes require a serine element for hydrolysis of β -lactams, whereas class B enzymes use divalent zinc ions for the hydrolysis of the substrate.

The Bush-Medeiros classification has defined three main groups of enzymes based on their substrate and inhibitor profiles. Group 1 includes cephalosporinases that are not well inhibited by clavulanic acid (e.g., AmpC β -lactamases, class C). Group 2 includes penicillinases, cephalosporinases and broad-spectrum β -lactamases (e.g., ESBLs or carbapenemases, class A), which are usually inhibited by β -lactamase inhibitors directed at the active site. Group 3 comprises enzymes that hydrolyze penicillins, cephalosporins and carbapenems (e.g., MBLs, class B), but are poorly inhibited by all β -lactam containing inhibitors. The most clinically relevant β -lactamases that are of great importance today (highlighted in bold in Table 3) are: extended spectrum β -lactamases (ESBLs) (Group 2be, class A), carbapenemases (Group 2f, class A) (e.g., KPC) including metallo- β -lactamases (MBL) (Group 3, class B) (e.g., NDM), some oxacillinases (OXA) (e.g., OXA-48-like) (Group 2d, class D) and AmpC β -lactamases (Group 1, class C) [83].

TABLE 3. CLASSIFICATION OF β -LACTAMASES

Ambler Class	Bush Classification	Enzyme Name	Preferred Substrates	Inhibited By	Representative Enzymes
A (Ser)	2a	Penicillinases (narrow)	Pen.	Clav.	Penicillinases (staphylococci)
	2b	Penicillinases (broad)	Pen., Cephalo.	Clav.	TEM-1, SHV-1, SHV-2
	2be	ESBLs	Cephalo., Mono.	Clav.	TEM, SHV, CTX-M
	2br	Inhibitor Resistant TEM (IRT)	Pen.	Clav. (+/-)	TEM-30 to TEM-36, TRC-1
	2c	Carbenicillinases	Pen., Carb.	Clav.	PSE-1, PSE-3, PSE-4
	2e	Cefuroximases	Cephalo.	Clav.	FEC-12f
	2f	Serine carbapenemases	Cephalo., Carba.	Avi.	KPC, SME-1
B (Zn)	3	MBL	Most BL	EDTA, DPA	NDM, VIM, IMP
C (Ser)	1	Cephalosporinases	Cephalo.	-	AmpC
D (Ser)	2d	Oxacillinases	Oxa., Cloxa.	Clav (+/-)	OXA-48-like

Pen.: penicillins; Cephalo.: cephalosporins, M: Monobactams, Oxa: oxacillin; Cloxa: cloxacillin; Clav.: clavulanic acid

Adapted from Bush et al, Updated Functional Classification of β -lactamases (2010) [84]

2.1.1-EXTENDED SPECTRUM β -LACTAMASES (ESBLs)

The nomenclature of β -lactamases is inconsistent: for TEM the name of the patient (Temoneira) from which the clinical isolate was identified was given, while for SHV the chemical properties of the enzyme were given (Sulphydryl Variable). Resistance to penicillins, but not to the oxyimino-cephalosporins was caused by β -lactamases of type TEM-1 and SHV-1. These enzymes were therefore considered narrow-spectrum β -lactamases. In 1988, Jarlier et al. used the term “extended broad-spectrum β -lactamases” for those enzymes that had the property of hydrolyzing a larger number of drugs other than the narrow-spectrum TEM-1 and SHV-1 enzymes [85]. Molecular characterization of these enzymes revealed that point mutations in the active site region in the parental SHV and TEM-type enzymes (e.g., TEM-1, and SHV-1), were the basis for this remarkable resistance [86, 87].

This new group of enzymes, which exhibit an extended broad spectrum of activity against cephalosporins, have been termed “extended-spectrum β -lactamases or ESBLs”. ESBLs are a group of enzymes with the ability to hydrolyze and cause resistance to penicillins (e.g., ampicillin and piperacillin), all generations of cephalosporins (C1G to C4G), and monobactams (aztreonam), but not to cephamycins (e.g., cefoxitin) or carbapenems [88]. ESBLs belong to class A of the Ambler classification and to group 2be in the Bush-Medeiros-Jacoby system (Table 3). ESBLs were defined as part of group 2 as enzymes that can be inhibited by inhibitors such as clavulanic acid, sulbactam, and tazobactam. This property enabled the development of phenotypic *in vitro* assays for the detection of ESBLs.

The three most important ESBL-types known today are SHV-, TEM- and CTX-M β -lactamases. To date, more than 650 enzymes have been identified worldwide, including more than 200 of the SHV-type, more than 200 of the TEM-type, and more than 250 CTX-M alleles. In the last 20 years, the ESBL types have become increasingly important, especially the CTX-M enzymes. Genes encoding β -lactamases in GNB are a fascinating example of multifocal and multidirectional evolution, with ESBLs being one of the most spectacular “achievements”. The updated list of new variants was available on the [Lahey Clinic website](#) previously handled by Karen Bush and George Jacoby. Since 2015, this database has been taken over by the National Center for Biotechnology Information (NCBI), and discoveries of new alleles are submitted to NCBI via the [Pathogen Isolates platform](#). All submitted data are available via the [NCBI Reference Catalog Gene](#).

2.1.1.1-TEM-type ESBLs

TEM-1 was first isolated in 1965 by Datta et al [89] in a clinical isolate of *E. coli*. TEM-1 can hydrolyze penicillins and C1G but has no effect on oxyimino-cephalosporins. The first TEM-type enzyme with extended activity on cephalosporins was TEM-3 [90]. The following amino-substitutions in

TEM-1 at residues 104 (E104K), 164 (R164S/H/C), 238 (G238S/A) and 240 (E240K) appear to be particularly important in altering the spectrum of the enzyme [91, 92]. As of 03/20/2024, 202 TEM variants are listed in the NCBI Reference Gene Catalog [here](#): TEM-1 to TEM-251.

2.1.1.2-SHV-type ESBLs

SHV-1 was first described in 1972 under the name Pit-2 by Pitton et al [93] and had the same substrate and inhibitor profiles as TEM-1. SHV-type ESBLs, which evolved from the chromosomal SHV-1 enzyme of *K. pneumoniae*, have migrated into other species such as *E. coli*, *Enterobacter cloacae* and others [94]. Variation occurs exclusively in the form of amino-acid substitutions [95] Most SHV-1-derived ESBLs carry a substitution at position 238 (G238S) which is often paired with a second mutation at position 240 (E240K). Conversion of an enzyme that is not an ESBL SHV to an ESBL is almost always caused by a G238S substitution, while further broadening of the spectrum, and increased activity of the enzyme can be achieved by an E240K substitution [96, 97]. Although many other substitutions have been reported, SHV family sites 179, 238 and 240 are the most important for the acquisition of ESBL activity [91, 96]. As of 03/20/2024, 199 SHV variants are listed in the NCBI Reference Gene Catalog [here](#): SHV-1 to SHV-243.

2.1.2.3-CTX-M-type ESBLs

The CTX-M-type enzymes are all considered to be ESBL enzymes. The bla_{CTX-M} genes are thought to have emerged from several mobilization events of the homologue in the genus *Kluyvera* [98, 99]. They possess intrinsic ESBL activity and are categorized into five subgroups named CTX-M-1, CTX-M-2, CTX-M-8, CTX-M-9, and CTX-M-25 [98]. CTX-M enzymes are now being discovered all over the world and are the most common β -lactamases found in clinical isolates. Over the past decade, the spread of CTX-M-producing isolates has been dramatic and they are considered the primary ESBL producers invariably associated with CAIs [100]. As of 03/20/2023, 254 CTX-M variants are listed in the NCBI Reference Gene Catalog [here](#): CTX-M-1 to CTX-M-270.

2.1.2-AMPC β -LACTAMASES (CLASS C)

The first β -lactamase described in the literature was identified in *Bacillus (Escherichia) coli* and is now known as the chromosomal cephalosporinase AmpC from *E. coli*. AmpC has been identified as a structural gene on the chromosome of certain *Enterobacterales* such as *Enterobacter* spp., *C. freundii*, *S. marcescens*, *Providencia* spp. but was often expressed at low levels. However, the expression of AmpC can be induced in response to the action of β -lactams. Penicillins (benzylpenicillin, amoxicillin, ampicillin)

and cephalosporins (cephalothin, cefazolin) are strong inducers and good substrates. However, some cephalosporins (cefotaxime, ceftriaxone, ceftazidime, cefuroxime), piperacillin, and aztreonam are weak inducers and substrates but can be hydrolyzed if the enzyme is overproduced. This overexpression of AmpC β -lactamases, caused by AmpD mutation in certain isolates (mostly *E. cloacae*), is a problem for therapy. Several studies have shown that patients infected with such isolates and treated with cephalosporins develop reduced susceptibility to cephalosporins and increased production of AmpC β -lactamases [101, 102].

Plasmid-mediated AmpC genes have been identified since 1988 [103], and have been frequently detected in *Enterobacterales* that lack (*Klebsiella* spp., *P. mirabilis*, *Salmonella* spp.) or have low expression of chromosomal AmpC β -lactamases (*E. coli*, *Shigella* spp.). Their names are either derived from the resistance produced: CMY (cephamycins), FOX (cefoxitin), MOX (moxalactam), LAT (latamoxef), or by type: ACT (AmpC type), ACC (Ambler Class C), or by site of discovery: MIR (Miriam Hospital, Providence), DHA (Dhahran Hospital, Saudi Arabia), or by patient name: BIL (Bilal) [104]. Like derepressed or hyperproduced chromosomal AmpC β -lactamases, plasmid-mediated AmpC β -lactamases also confer resistance to a broad spectrum of β -lactams such as penicillins, oxy-imino β -cephalosporins (cefotaxime, ceftazidime, ceftriaxone) and sometimes aztreonam.

Most strains with AmpC β -lactamases have been isolated from patients after a few days of hospitalization, but also from long-term or outpatient facilities. Risk factors for such infections include long hospital stays, ICUs, catheters, or prior antibiotic treatment with cephalosporins [105].

2.1.3-CARBAPENEMASES

Carbapenemases, which catalyze the hydrolysis of carbapenems, the most potent β -lactams, are of concern, and pose a major public health problem. With few exceptions (e.g., colistin, tigecycline), most carbapenemase-producers exhibit a high level of resistance to all antibiotics. They are active against oxyimino-cephalosporins, cephamycins and carbapenems. Carbapenemases belong to three different classes: KPCs (class A), MBLs (class B), and oxacillinases (OXA-48-like) (class D).

2.1.3.1-Klebsiella Pneumoniae Carbapenemases (KPCs) (Group2, class A)

The KPC-enzyme, which is a carbapenemase conferring resistance to extended-spectrum cephalosporins and carbapenems, represent a major clinical challenge [106]. The first description of KPC-1 dates to 1996 from the USA. The revised KPC-1 sequence was identical to KPC-2, so the KPC-1 sequence is no longer valid [61]. As of 03/20/2024, 194 KPC variants are listed in the NCBI Reference Gene Catalog [here](#) : KPC-2 to KPC-208. KPC-2 and KPC-3 are widespread and correspond to the most

common carbapenemases identified in *Enterobacteriales* worldwide. KPC-producing bacteria were first reported in the USA [61, 107-109] and later worldwide: China [110], Israel [111], Greece [112], Brazil [113] but they are still rare in Northern and Western Europe. Detection of these bacteria may remain difficult as some KPC-producing isolates are susceptible to carbapenems [107, 114].

2.1.3.2-Metallo- β -lactamases (Group 3, class B)

Metallo- β -lactamases (MBLs) belong to group 3 (Bush classification) and class B (Ambler class). They have three distinct functional properties: 1) They have a broad substrate spectrum and can catalyze the hydrolysis of most β -lactams, including carbapenems but not monobactams (aztreonam); 2) As a class B enzyme, they are not affected by inhibitors such as clavulanic acid, sulbactam or tazobactam; 3) Since zinc ions are critical for MBL activity, EDTA, or dipicolonic acid (DPA) zinc chelators, can inhibit these enzymes *in vitro*. This property has been used to develop laboratory tests for the rapid detection of these enzymes.

MBLs, which were discovered over 40 years ago, were not previously considered a problem for antibiotic therapy as they were found in chromosomally encoded, non-pathogenic bacteria. IMP-1 was the first carbapenemase as a source of acquired resistance to carbapenemase isolated in a *S. marcescens* isolate in 1991 [115]. As of 03/20/2024, 98 IMP variants are listed [here](#) in the NCBI Reference Gene Catalog : IMP-1 to IMP-102. VIM-1 was reported in 1997 from a *P. aeruginosa* isolate in Italy [116]. As of 03/20/2024, 84 VIM variants are listed [here](#) in the NCBI Reference Gene Catalog: VIM-1 to VIM-85. Although IMP- and VIM-type MBLs began to spread in Gram-negative pathogens such as *Enterobacteriales*, *Pseudomonas*, and *Acinetobacter* after 2000, they remained a minor threat because outbreaks were small, temporary, and confined to specific regions.

The first NDM-1 producing clinical isolate of *K. pneumoniae* was identified in 2009. The emergence and rapid spread of the NDM-1 MBL, discovered in a Swedish patient. who had traveled to India and stayed in a hospital during his trip, was considered an urgent threat and attracted the interest of clinicians and researchers as a public health problem [117]. As of 03/20/2024, 60 NDM variants are listed in the NCBI Reference Gene Catalog [here](#) : NDM-1 through NDM-61. The rapid spread of these genes on plasmids and integrons makes MBLs an important source of AMR: the structure and mode of action of MBLs have been extensively studied [118-120], which has facilitated the development of new inhibitors to combat these alarming enzymes [120-122]. Years ago, the pharmaceutical industry succeeded in developing new NDM-1 inhibitors [123, 124] that would be able to “revitalize” carbapenems. Today, these molecules are in Phase 3 clinical trials, and will hopefully soon be approved by the FDA and commercially available.

2.1.3.3-OXA-β-lactamases (Group 2d, class D)

The OXA-β-lactamases were the first β-lactamases identified but went unnoticed for many years because they were rare, and essentially penicillinases that, unlike class A β-lactamases, can hydrolyze oxacillin. Because of this unique property, they were named OXA (or oxacillinases). This class of enzymes was designated as group 2b in the Bush functional classification [82]. As of 03/20/2024, 1,182 OXA variants are listed [here](#) in the NCBI Reference Gene Catalog : OXA-1 to OXA-1213.

The OXA-β-lactamases were first identified in *A. baumannii* isolates resistant to carbapenems as plasmid-mediated β-lactamases (OXA-23, OXA-40, and OXA-58) together with a chromosomal type (OXA-51-like). Another group of plasmid-borne OXA β-lactamases was found in *P. aeruginosa*, which were initially referred to as PSE until a close relationship with oxacillinases was demonstrated: PSE-2 was renamed OXA-10 [125]. OXA-10 is considered by the [Lahey Clinic](#) to be the progenitor of the OXA β-lactamases.

Class D carbapenemases represent a further extension of their spectrum of activity to the antibiotics of last resort, the carbapenems. Class D Carbapenem Hydrolyzing β-lactamases (CHDLs), are enzymes that are of clinical importance due to their ability to hydrolyze carbapenems. They have been described predominantly in non-fermenters Gram-negative pathogens such as *A. baumannii* and *P. aeruginosa*, except for OXA-48-like. OXA-48-like is the only oxacillinase with carbapenemase activity identified in *Enterobacterales* including *Citrobacter* and *E. coli* [126]. OXA-48-like confers high resistance to penicillins (except piperacillin), particularly oxacillin and cloxacillin, but has attenuated activity against carbapenems and no activity against extended-spectrum cephalosporins and aztreonam, except avibactam [127]. In 2001, the first OXA-48-producing *K. pneumoniae* was isolated from a UTI sample of a Turkish patient [128]. Subsequently, OXA-48-like enzyme was detected worldwide and associated with outbreaks [126]. The *bla*_{OXA-48} gene is usually carried on a 62-kb plasmid, which contributes to its dissemination and is associated with IS1999, which is the driver for mobilization and expression of this gene [74].

To date, OXA-48-like type carbapenemases include the following enzymes: OXA-48, OXA-162, OXA-181, OXA-204, OXA-232, OXA-244, OXA-245, OXA-247, OXA-436, OXA-484 and OXA-519. OXA-48, OXA-181, OXA-232, OXA-204, OXA-162, and OXA-244 are the frequently identified enzymes among the carbapenemases of the OXA-48-like type [129].

D-LABORATORY DETECTION OF β -LACTAMASES

The emergence and steady increase of bacterial infections caused by ESBL- and carbapenemase-producers has always been a cause for concern due to limited therapeutic options. Of particular concern, however, is the emergence of CPEs developing resistance to the last resort treatment for severe bacterial infections. In addition, the presence of multiple β -lactamases in MDR pathogens often makes detection difficult. Since the presence of carbapenemases in *Enterobacterales* causing illness in hospitalized patients is considered an emergency in infection control, clinical microbiology laboratories must be able to rapidly detect such enzymes in *Enterobacterales*.

1-CULTURE-BASED METHODS

The combat against MDR isolates starts with the identification and determination of an antimicrobial susceptibility profile (ASP) for each isolate. For all types of samples, the primary role of a microbiology laboratory is to help clinicians identify the pathogens of various infectious diseases in that sample and determine their ASPs to guide patient treatment. This ASP determine which antibiotics can be used for treatment of patients. In the case of MDR pathogens, it is crucial to identify the “last resort” antibiotics that can still be used by physicians to treat these infections.

1.1-ANTIMICROBIAL SUSCEPTIBILITY TESTING

Antimicrobial Susceptibility Testing or AST determines either 1) the Minimal Inhibitory Concentration (MIC, $\mu\text{g}/\text{mL}$) or 2) the diameter of the zone of inhibition (mm) of a particular antibiotic for each isolate tested. The MIC represents the lowest concentration of the drug that inhibits the growth of the tested isolate in broth medium. The diameter of the growth inhibition zone (mm) around a disk impregnated with the antibiotic of interest on an agar medium is proportional to the activity of the drug against the isolate tested.

Before 2019, regardless of whether a MIC ($\mu\text{g}/\text{mL}$) or a zone diameter (mm) was measured in the clinical laboratory, microbiologists interpreted these results using some threshold concentrations or diameters called “breakpoints” established by the Clinical Laboratory Standards Institute (CLSI) or the European Committee of Antimicrobial Susceptibility Testing (EUCAST) to classify isolates into 3 different categories: Susceptible (S), Intermediate (I), or Resistant (R). The clinician received a report of the antimicrobial susceptibility profile classifying isolates in three different categories susceptible (S), intermediate (I) or resistant (R) indicating which antimicrobials are effective on the isolates collected in

that sample. In 2019, EUCAST decided to change the definitions of the SIR categories for susceptibility tests as described below.

A microorganism is categorized as:

- **S (Susceptible -standard dosing regimen)**

When there is a high likelihood of therapeutic success using a standard dosing regimen.

- **I (Susceptible – increased exposure)**

When there is a high likelihood therapeutic of therapeutic success because exposure to the agent is increased by adjusting the dosing regimen or by its concentration at the site of infection.

- **R (Resistant)**

When there is a high likelihood of therapeutic failure even when the exposure is increased.

In 2020, the CLSI defined a susceptible-dose-dependent (SDD) category for certain organisms and drug combinations. MICs reported in this category indicate that treatment success is likely with increased drug exposure.

The gold standard method for AST recommended by CLSI and EUCAST is the AST broth microdilution (BMD) method, which is used to determine the MIC of a particular antibiotic. In the US, pre-made in-house or commercialized drug panels from MicroScan (Siemens), or Trek Diagnostics (Thermo Scientific) can be used. MICs can also be determined by an agar-based method using commercial Etest strips impregnated with a concentration gradient of antibiotics. This method is more suitable for testing a small number of antibiotics and can be used as a confirmatory test in any routine microbiology laboratory. However, both methods are time-consuming and are mostly used by specialized research laboratories or reference laboratories but can also be useful for confirmatory results. Disk diffusion (DD) using paper disks impregnated with fixed concentrations of antimicrobial agents can also be used to determine ASPs.

The CLSI and EUCAST breakpoints for many β -lactams were updated/lowered in 2010 to allow better detection of *Enterobacterales* that produce carbapenemases. The CLSI does recommend confirmatory phenotypic tests but each microbiology laboratory in each medical center must decide whether to perform ESBL testing, and which test, if any, is preferred. One of the biggest challenges in the fight against AMR is to accurately detect resistance and treat patients accordingly. In the United States, most clinical microbiology laboratories use automated AST systems, which are rapid culture-based methods, for rapid identification of pathogens and determination of AST results, such as VITEK2 (BioMérieux), BD Phoenix (Becton-Dickinson). AST panels or disks are used by reference laboratories for confirmatory testing. In Europe, DD is the most used method for AST, including automated systems for incubation and reading (e.g., SIRSCAN).

1.2-PHENOTYPIC TESTS FOR DETECTION OF β -LACTAMASE-PRODUCING ENTEROBACTERIALES

1.2.1-DETECTION OF ESBL_s

Laboratory screening for ESBLs can be performed using BMD or DD methods as recommended by CLSI and EUCAST. The growth-inhibition zones around the following antimicrobial agents are measured: CPO or CTX or CAZ or CRO or ATM. MICs for these same agents can also be determined. The results are then interpreted according to CLSI or EUCAST rules [130, 131]. The use of more than one agent for screening improves the sensitivity of detection. A positive screening test indicates diameters or MICs below/above the CLSI or EUCAST thresholds (e.g., CAZ, ≤ 22 mm or MIC ≥ 2 $\mu\text{g/mL}$). If suspected ESBL-producers are detected and can be subjected to the following confirmatory tests recommended by CLSI, either by BMD or DD, also called combination disk test (CDT).

The BMD tests antimicrobial agents alone (CTX, CAZ or FEP) and in combination of CLA (CTX+CLA, CAZ+CLA or FEP+CLA). A positive result for ESBL is confirmed if the MIC of the agent alone is ≥ 3 times 2-fold concentrations higher than the MIC of agent combined with CLA (e.g., CAZ, 8 $\mu\text{g/mL}$; CAZ+CLA, 1 $\mu\text{g/mL}$).

For CDT, cephalosporins disks are used in combination with CLA (e.g., CTX+CLA, CAZ+CLA. or FEP+CLA) and cephalosporins alone (CTX, CAZ, FEP). The growth-inhibition zones around both disks are measured and interpreted as follows. It is a positive result for ESBL if the diameter of the inhibition zone around the disk with CLA is ≥ 5 mm larger than around the disk without CLA (e.g., CAZ, 16 mm; CAZ+CLA, 21 mm) (Figure 9).

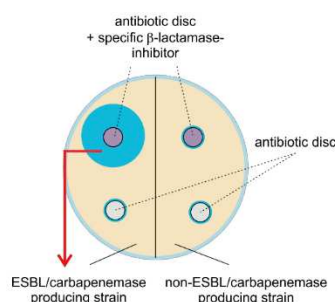

FIGURE 9. COMBINATION DISK TEST
FROM NOSTER ET AL, ANTIBIOTICS, 2021 [132]

Another test, the Double Disk Synergy Test (DDST), is the first test developed specifically for the detection of ESBL production in *Enterobacterales* [85]. Like for the CDT, this test is also performed with

disks with and without clavulanate (30 µg), which are arranged at a distance of 30 mm from each other. The test is considered positive if a reduced susceptibility to one of the two cephalosporins is accompanied by a significant increase in inhibition zone of this cephalosporin in front of the CLA combination disk. This leads to results in a characteristic “champagne cork” shape (Figure 10). This test was developed to differentiate between cephalosporinase- and ESBL-producers.

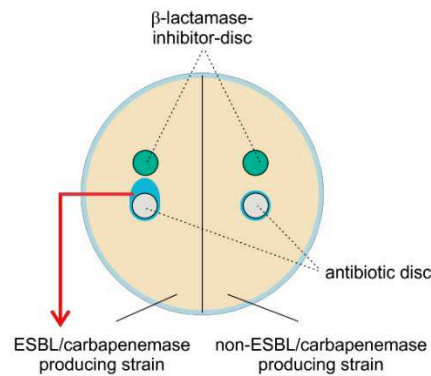

FIGURE 10. DOUBLE DISK SYNERGY TEST
FROM NOSTER ET AL, ANTIBIOTICS, 2021 [132]

1.2.2-DETECTION OF CARBAPENEMASES

In the United States, the conventional phenotypic test, recommended by the CLSI in 2009, for the detection of CPEs was the Modified Hodge Test (MHT). Carbapenemase production is detected with the MHT when the test isolate produces a carbapenemase and allows growth of a carbapenemase-susceptible control strain (*E. coli* ATCC 25922) towards the carbapenem disk. Positive test results produce a cloverleaf-like indentation (Figure 11). The test has good sensitivity for VIM-, IMP-, and OXA-48-like type enzymes, but its performance in detecting NDM enzymes is lower. Due to this low specificity for the detection of NDM-producers, the test was removed from the CLSI guidelines in early 2018. Several commercial phenotypic tests have been developed for the rapid and simple detection of CPEs including disk or Etest-based methods such as MastDiscs ID inhibitor combination disks, Rosco Diagnostica Neo-Sensitabs KPC or the Etest MBL confirmation kit. Numerous new phenotypic tests have been developed for detection of CPEs such as Carba NP, CIM/mCIM, BYG Carba, NG-Test Carba 5, but only the two methods recommended by CLSI that are suitable for clinical microbiology laboratories are mentioned in this dissertation [133].

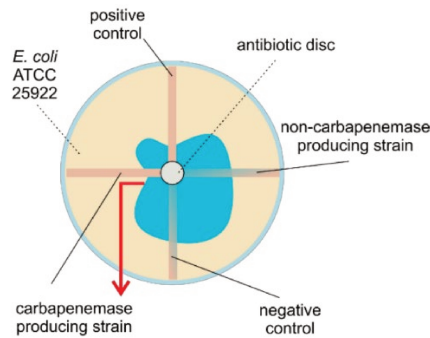
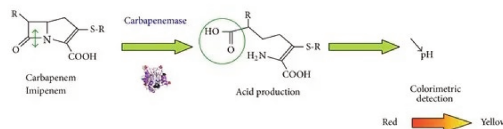

FIGURE 11. MODIFIED HODGE TEST
FROM NOSTER ET AL, ANTIBIOTICS, 2021 [132]

1.2.1-CARBA NP

Colorimetric assays have been developed for the detection of CPEs. These assays are based on the enzymatic hydrolysis of the β -lactam ring of the antibiotic, which leads to a pH change, and thus to a color change of a pH indicator (from red to yellow) (Figure 12). Nordmann, Poirel and Dortet were the first to develop a colorimetric assay, Carba NP, for the rapid detection of carbapenemases in *Enterobacteriales* [134].



(a)

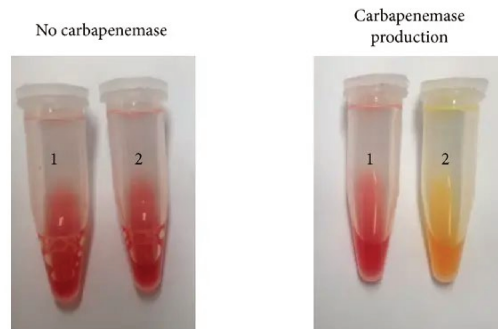

- (1) Revealing solution
(internal negative control)
(2) Revealing solution + imipenem

(b)

FIGURE 12. IN VITRO HYDROLYSIS OF IMIPENEM
FROM DORTET ET AL, BIOMED RESEARCH INTERNATIONAL (2014) [135]

These tests, characterized by excellent sensitivity and specificity, hold great promise as screening tools to 1) accelerate the identification of CPEs, and 2) facilitate the choice of molecular tests.

Routine clinical laboratories would be able to accurately detect most carbapenemases within one workday [136]. Once strains have been found to have reduced susceptibility, Carba NP should be performed to detect the presence of CPEs, followed by some molecular testing for epidemiology purposes [137]. The CLSI has incorporated this standardized Carba NP method in its guidelines since 2016 [138].

1.2.2-CIM AND mCIM METHODS

Another method was developed in 2015 by van der Zwaluw K et al. It is called Carbapenem Inactivation Method (CIM). It consists of placing a meropenem disk in an aqueous bacterial suspension for 2 hours, and then applying this disk to a Mueller-Hinton agar plate inoculated with a susceptible *E. coli* ATCC 25922 for at least 6 hours or overnight. If the test organism produces a carbapenemase, the meropenem on the disk will be degraded. The presence of an inhibition zone around the disk indicates that the antibiotic is still active and has not been inactivated by a carbapenemase and is negative. In contrast, if no inhibition zone is present, the antibiotic has been inactivated by the carbapenemase, and is positive [139] (Figure 13). Due to the lower sensitivity reported in some studies for some OXA-48-like producers, a modified Carbapenem Inactivation Method (mCIM) was later developed and validated by Pierce et al, a CLSI working group. The water was replaced by Trypticase Soy Broth (TSB), and the incubation time was extended to 4 hours instead of 2 hours [140]. MHT was replaced by the mCIM, which is the method recommended by CLSI for the detection of carbapenemase-producers. Recently, an agar-based mCIM was developed by Byun et al., in which meropenem disks are placed on a lawn of the microorganism test instead of a Trypticase Soy Broth (TSB) [141].

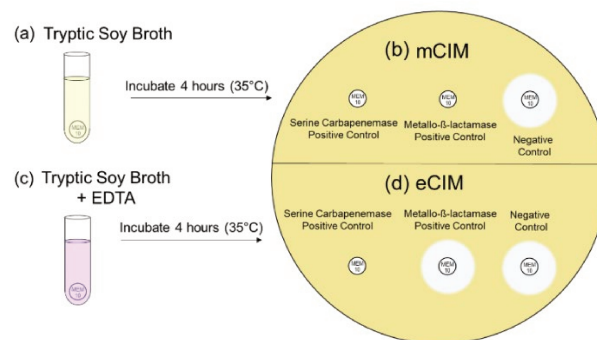

FIGURE 13. MCIM AND ECIM TESTS
FROM ASM ARTICLES, KENNETH SMITH
OPENING THE BLACK BOX OF PHENOTYPIC CARBAPENEMASE DETECTION (2019) [142]

1.2.3-LATERAL FLOW IMMUNOASSAYS

Over the last decade, lateral flow assays based on mouse monoclonal antibodies have been developed for the rapid and simple detection of carbapenemases. Several groups have shown that this technology is a powerful tool (100% sensitivity and specificity) and provides results from bacterial colonies within 15 min [143-147]. In the last five years, new multiplex lateral flow assays for the rapid detection of NDM, KPC, OXA and VIM carbapenemases have become commercially available: CORIS BioConcept: RESIST-3 O.K.N. (OXA-48, KPC, NDM), RESIST-4 O.K.N.V (OXA-48, KPC, NDM, VIM). These assays have been evaluated and shown to be powerful tools (99-100% sensitivity and specificity) suitable for microbiology clinical laboratories to detect the most common carbapenemases without the need for expensive molecular testing (Figure 14).

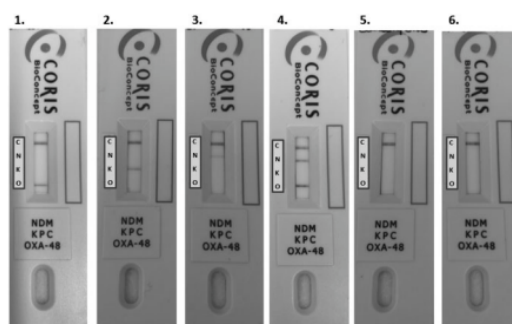

FIGURE 14. CORIS BIOCONCEPT RESIST-3 O.K.N
FROM GLUPZYNSKI ET AL, J ANTIMICROB CHEMOTHER (2017) [148]

One of the latest commercially available multiplex lateral flow immunochromatographic assay tests is the CORIS BioConcept: RESIST-5 O.K.N.V.I assay (OXA, KPC, NDM, VIM, IMP), which consists of two lateral flow cassettes: one for VIM and IMP (type I cassette) and the other for KPC, NDM and OXA (type II cassette) (Figure 15). This test is a rapid, user-friendly, and suitable diagnostic tool for clinical microbiology laboratories with excellent performance in detecting the five targeted carbapenemase genes [149-152]. This rapid immunochromatographic test could be used to improve patient care and accelerate the implementation of infection control measures in hospitals.



FIGURE 15. CORIS BIOCONCEPT RESIST-5 O.K.N.V.I.
FROM HONG ET AL, ANTIBIOTICS (2021) [152]

Another test called NG-Test Carba 5 (NG Biotech) is commercially available for detection of the five most important carbapenemases: KPC, OXA, VIM, IMP, and NDM. This test consists of a single cassette with all the 5 carbapenemases (KOVIN) (Figure 16). The sensitivity and specificity for this test is excellent and has shown good results for detection of OXA-48-producers [153] but can miss some IMP variants in some instances [154].

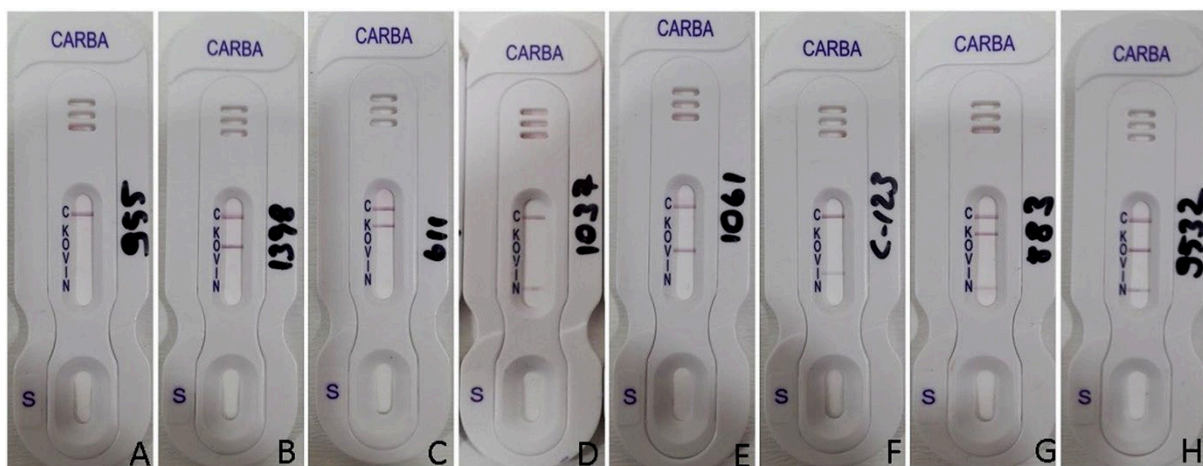

FIGURE 16. NG-TEST CARBA 5
FROM HOPKINS ET AL, J. ANTIMICROB. CHEMOTHER. (2018) [153]

2-MOLECULAR METHODS

Twenty years ago, the gold standard molecular method for detecting ARGs such as ESBLs was conventional PCR or multiplex PCR, followed by Sanger sequencing to fully characterize each gene. Later, technologies evolved, and most molecular platforms relied on multiplex real-time PCR or DNA microarrays. Since 2015, we have seen a revolution in the "Sample-To-Results" in diagnostic molecular testing from sample to result with the introduction of convenient laboratory tests that do not require a trained microbiologist. Due to the numerous genes involved in β -lactam resistance, several new

molecular test kits have been developed in the last 20 years using either DNA microarrays or real-time multiplex PCR, including some that can be used directly from specimen.

Reducing the time-to-result by just a few hours will improve patient outcome. The other major advantage of some of those commercial kits is that they are fully automated from sample to result including extraction, polymerase chain reaction (PCR) or DNA microarray or hybridization, and do not require trained microbiologists.

2.1-RAPID MOLECULAR TESTS FOR DETECTION OF CARBAPENEMASE-PRODUCING ENTEROBACTERIALES

2.1.1-XPRT CARBA-R (CEPHEID)

Xpert Carba-R is a rapid, convenient, and user-friendly diagnostic test for detection of CPEs by multiplex real-time PCR for the 5 most identified carbapenemase genes: KPC, NDM, IMP-1-like, VIM, and OXA-48. The time to result is less than one hour including one minute of hands-on time. This assay has 100% accuracy in identifying carbapenemase genes in GNB [155].

2.1.2-CHECK-DIRECT CPE OR ESBL OR MDR (CHECKPOINTS)

CheckPoints (Wageningen, the Netherlands) is a supplier that offers two types of commercial kits based on DNA microarray technology for the detection of ESBLs and carbapenemases, which have been available since 2009. This technology is based on the specific molecular detection of DNA target sequences and subsequent amplification by universal primers, followed by the recognition of the DNA target by a specific probe. This probe is paired with a unique ZIP code that corresponds to a unique position on the array.

The first set of kits, available in several versions, Check-ESBL or Check-KPC or Check-MDR (CT101, CT102, CT103XL) has been developed for the identification of the most common ESBLs (SHV, TEM, CTX-M), AmpC β -lactamases and carbapenemases (e.g., KPC). For example, the Check-MDR CT103XL kit can detect 6 AmpC genes (CMY-I/MOX, ACC, DHA, ACT/MIR, CMY-II, FOX), 5 carbapenemase genes/groups (KPC, NDM, VIM, IMP, OXA-48-like), genes coding for 5 CTX-M groups (CTX-M-1, -2, -8, -9, and -25), as well as the wild-type *bla*_{SHV} and *bla*_{TEM} and distinguish them from ESBLs. Later, a second series of kits based on real-time multiplex PCR assays was developed. These kits can be used directly from rectal swabs or cultures to detect the most clinically relevant ARGs of CPEs: KPC, OXA-48, NDM, VIM (Check-Direct CPE) or ESBLs genes: SHV-, TEM-, CTX-M (Check-Direct ESBL). Today, the *Check-Direct ESBL Screen for BD MAXTM*, a qualitative IVD test for the rapid detection of ESBLs of

Enterobacteriales from rectal swabs, is available in Europe for in vitro diagnostics (IVD) use and in the US for Research Use Only (RUO). This test is suitable for use in combination with DB Max for DNA extraction.

2.2-MOLECULAR SEQUENCING FOR CHARACTERIZATION OF CARBAPENEMASE-PRODUCING ENTEROBACTERIALES

The field of DNA sequencing has changed rapidly with the advent of massively parallel high-throughput sequencing technologies known as Next-Generation Sequencing (NGS). NGS platforms enable the parallel sequencing of millions of DNA fragments, known as “reads”, resulting in a large dataset of raw sequences. Bioinformatics is the science that assembles all this raw data and puts it in the right order to reconstruct the original DNA fragment. All these new high-throughput sequencing methods have replaced Sanger sequencing, which was the reference method for sequencing for decades. Microbiologists in research laboratories have used Sanger to identify the most common variants of ESBL-type genes (e.g.: *bla*_{SHV-12}, *bla*_{CTX-M-15...}etc.), carbapenemase-type genes (KPC, NDM, VIM, IMP, OXA-48) or to perform strain typing such as Multilocus Sequence Typing (MLST).

Today, we moved from PCR-Sanger sequencing to NGS, which is designed to sequence whole genomes of bacteria and not just individual genes. The first available NGS technology, namely 454 (Roche) pyrosequencing, was the first large-scale sequencing technology based on the use of the first next-generation sequencer, which was discontinued in 2013. The three NGS technologies currently used are Illumina, PacBio, and Nanopore sequencing, which are described below.

2.1.1-SHORT-READ SEQUENCING (ILLUMINA)

Short-read sequencing or Illumina sequencing is based on the principle of sequencing by synthesis. In short, genomic DNA is fragmented and labeled at both ends with adapters. The barcoded and labeled DNA fragments are loaded onto a flow cell (A), where one end of each DNA fragment is complementary to the oligonucleotide fixed on the surface of the flow cell, the other end hybridizes with the adjacent complementary oligonucleotide (B), then bridge amplification is initiated. After several amplification cycles, millions of dense clusters of duplex DNAs are generated in each lane of the flow cell. Finally, each labeled dNTP is added to the complementary DNA fragment and read with the laser to generate millions of DNA sequences (Figure 17). NGS short-read sequencing has revolutionized sequencing. However, this approach quickly reached its limits when it came to identifying structural variants and sequencing repetitive regions commonly found in bacterial isolates in clinical microbiology.

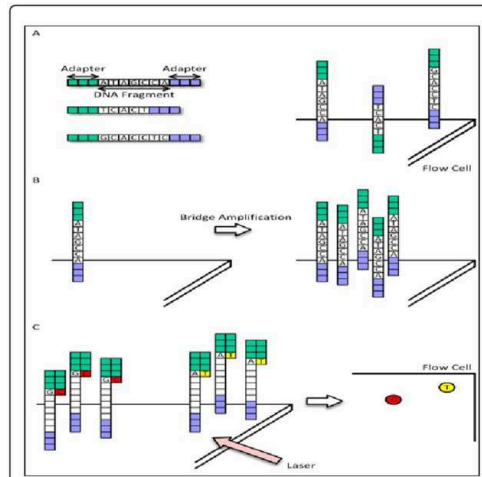

FIGURE 17. ILLUMINA SEQUENCING TECHNOLOGY

FROM KCHOUK ET AL, GENERATIONS OF SEQUENCING TECHNOLOGIES: FROM FIRST TO NEXT (2017) [156]

2.1.2-LONG-READ SEQUENCING (PACBIO BIOSCIENCE AND OXFORD NANOPORE)

Long-read sequencing (LRS) is a sequencing method that allows much longer DNA fragments to be sequenced than traditional short-read sequencing methods. While short reads can detect most genetic variations (e.g., ARGs), LRS allows the detection of complex structural variations (e.g., plasmids) that may have been missed by short reads.

2.1.2.1-PACIFIC BIOSYSTEMS OR PACBIO

Single-Molecule Real-Time Sequencing (SMRT) sequencing, developed by Pacific Biosystems, is a third-generation sequencing technology. It is based on sequencing by synthesis (SBS) of a single DNA template with hairpin loop adapters on both sides (5' and 3' ends), making the template circular. Sequencing is performed in a special nanophotonic visualization chamber called zero-mode-waveguide, in which only a single nucleotide incorporated by the $\phi 29$ DNA polymerase at the bottom of the chamber can be detected (Figure 18). PacBio relies on SBS and photometry to detect fluorescently labeled dNTPs.

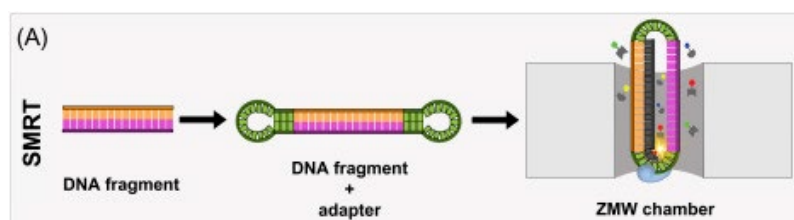

FIGURE 18. PACBIO SEQUENCING TECHNOLOGY
FROM PAVLOVIC ET AL, MI, 2020 [157]

2.1.2.2-OXFORD NANOPORE TECHNOLOGIES (ONT)

Nanopore sequencing is the fourth-generation sequencing technology that enables the sequencing of long DNA fragments without the need for amplification or chemical labeling of the sample. Nanopore sequencing is a newer innovative method in which DNA single strands (A) labeled with adapters are passed through a tiny protein channel (nanopore) (B) embedded in an electrically resistant membrane. As the DNA molecule passes through the pore, it alters the ion current, which is used to determine bases changes and generate the sequence (C) (Figure 18). This method is relatively inexpensive and generates extremely long reads in real-time. However, one of the main disadvantages is the limited sequencing accuracy (5-15% sequencing error) compared to Illumina sequencing (<0.01%).

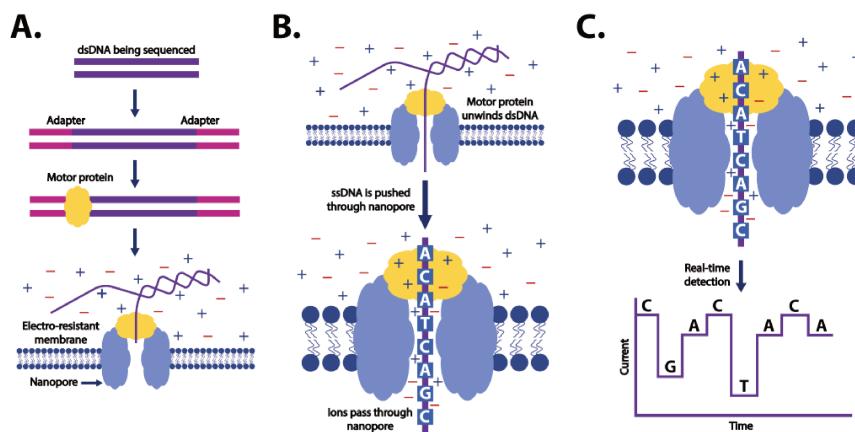

FIGURE 19. MINION LONG-READ SEQUENCING TECHNOLOGY FROM PAVLOVIC ET AL, MICROBIOMICS, 2020 [157]

Today, the explosion of bacterial whole-genome sequences obtained by NGS and published in public databases such as [NCBI Pathogen Detection](#) can help improve molecular surveillance studies. Large-scale sequencing of plasmids and/or whole genomes is becoming easier and less expensive. Several studies have analyzed MGEs and MRRs in detail to better understand their role in plasmid-mediated resistance. Analysis of AMR gene transfer requires accurate identification of AMR determinants in combination with comprehensive analysis of 1 and 2 MGE types. However, the presence of multiple plasmids and complex resistance regions in MDR pathogens poses a challenge for molecular analysis of MGEs. While long-read sequencing is increasingly used, many plasmid sequences originate from short reads that may not capture the entire sequence. The presence of multiple copies of the same element (e.g., IS), can lead to inaccurate assemblies. A thorough analysis of all MGEs identified in the different plasmids, including a comparative analysis with previously described plasmids, can shed light

on the genetic events that take place between DNA elements or bacteria to acquire specific AMR genes, as well as the modalities and networks of transmission. However, the added value of long-read sequencing lies in the complete sequencing of plasmids and the localization of ARGs in the context of AMR dissemination assessment. Another challenge associated with the resistant genomic profiles is dealing with nomenclature issues and inconsistencies in the numerous publicly available NGS AMR tools/databases. The flexibility of some NGS AMR analysis tools originally developed for the identification of ARGs may allow the identification of MGEs defined by a predefined user database, including MGEs of special interest. Due to biases in the selection of isolates studied, the methods used, and the number of sequences deposited, it can still be difficult to detect meaningful patterns in previous and currently available information. Some available sequences are often poorly or incompletely analyzed and lack important information. It is hoped that studying gene cassette arrays in whole genome sequences rather than each individual AMR determinant, as is currently done, may provide more important information on this question.

Since the introduction of a variety of novel NGS methods for short reads (Illumina) or long reads (PacBio and Nanopore), which are constantly evolving, the characterization of AMR has become easier in many ways. NGS strategies have expanded the ability of microbiologists to identify, track and characterize emerging or new resistance mechanisms. The whole-genome sequences of a given isolate obtained by NGS provides its complete molecular resistance profile, but also important information on virulence, molecular typing, etc. This is truly a wealth of information that will be very useful for epidemiological surveillance studies and, in combination with antimicrobial susceptibility data, can improve patient outcome.

1-HISTORY

The first description of β -lactamases was made not long after penicillin came onto the market for therapeutic use. The first bacterial enzyme reported by Abraham et al [158] in 1940 to be “*an enzyme able to destroy penicillin*” was AmpC β -lactamase from *E. coli* [104]. The first narrow-spectrum β -lactamases (class A) were discovered in 1965 (TEM-1) and 1972 (SHV-1). Subsequently, in 1983, two clinical isolates of *K. pneumoniae* and *S. marcescens* harboring the first acquired ESBL were identified in Germany as SHV-2, a derivative of SHV-1 [159]. These new enzymes evolved from non-ESBL β -lactamases (SHV- or TEM-type narrow-spectrum β -lactamases) to ESBLs through the acquisition of amino-acid substitutions that alter the substrate specificity. These modifications were responsible for the hydrolysis of oxyimino-cephalosporins, thus leading to resistance to these antimicrobials. These ESBLs were initially found sporadically in *E. coli* and *K. pneumoniae*, but outbreaks were increasingly reported in the USA in the 1990s. [160, 161]. Two years later, a β -lactamase resistant to cefotaxime emerged and caused a nosocomial outbreak in France [162], and many more cases occurred in the USA [163-165]. Later, in the 80s, when cephalosporins were on the market, new enzymes capable of hydrolyzing 3rd generation cephalosporins emerged, such as AmpC-type β -lactamases (also called cephalosporinases) [103, 166]. The β -lactamases of the CTX-M-group are a different group of ESBLs than the SHV- and TEM-type ESBLs. CTX-Ms were originally described as a new family in Germany in 1989 with the identification of CTX-M-1, which stands for cefotaximase-Munich-1. In the 1990s, these enzymes were increasingly reported, and in the 2000s, they overtook the SHV/TEM ESBLs as the most frequently identified group of ESBLs.

When ESBLs emerged, they posed a serious clinical problem because they showed good activity against most β -lactams: broad-spectrum penicillins, cephalosporins and monobactams, and the last drugs that were effective against such pathogens were carbapenems. Then the so-called “ β -lactamase cycle” repeated itself: new enzymes capable of hydrolyzing carbapenems emerged in the 1990s: the worrisome carbapenemases, resistant to most β -lactams, were born [58]. Chronologically, the first carbapenemase identified as a source of acquired resistance to carbapenems was IMP-1 isolated in 1991, followed by KPC in 1996, VIM-1 in 1997 and NDM-1 in 2009. The first KPC-type carbapenemase (KPC-1, later renamed KPC-2), first reported in the United States in 1996 [61, 167], spread worldwide in the 2000s, initially to Israel [168, 169], Greece [170, 171], Colombia [172], Puerto Rico [173] and the United States [174]. KPC-producers were associated with Greece, the USA and Israel, but were endemic in North America (USA), Latin America (Colombia, Brazil, Argentina), Europe (Italy, Greece, Poland) and

Asia (China) at that time [62]. The (then) novel NDM-1 carbapenemase, which was identified in 2009, quickly became endemic [175]. In the 2010s, HAIs or CAIs associated with KPC and NDM carbapenemases emerged and spread worldwide, as did other VIM-, IMP-, and OXA-48-like carbapenemases but more sporadically [176].

OXA-48, the first OXA carbapenemase discovered in *K. pneumoniae* in Turkey in 2001 [128], is of great concern because it is difficult to detect, leading to treatment failure in patients, and because it is spreading worldwide. Since its first description, several nosocomial outbreaks have occurred initially in Turkey and later in many parts of the world, including Mediterranean region, Europe, Asia, Africa, and the Americas [177]. Currently, *bla*_{OXA-48}-producing *Enterobacterales* are distributed worldwide and there are reports from all parts of the world [177].

2-EPIDEMIOLOGY

2.1-WORLDWIDE

Years ago, the prevalence of carbapenemase genes such as *bla*_{KPC}, *bla*_{NDM}, *bla*_{OXA-48-like}, *bla*_{VIM} and *bla*_{IMP} in *Enterobacterales* found around the world varied by country, region and by type of carbapenemases (Figure 20). The global spread of KPC-producing pathogens is one of the most successful pandemics of MDR pathogens in the history of AMR. This spread was facilitated by a successful high-risk clone, *K. pneumoniae* ST258, and KPC carbapenemases are now endemic on all continents: North America (USA, Puerto Rico), Latin-America (Colombia, Brazil, Argentina), Asia (Israel, China), Europe (Greece, Italy) and sporadically in many other regions. NDM carbapenemases, originally discovered in 2009 in a Swedish patient treated in an Indian hospital, are now endemic in India and surrounding regions such as Pakistan, Bangladesh, and China, but are also spreading sporadically around the world. Other carbapenemases spread endemically in more restricted regions: VIM (Europe: Greece), IMP (Asia: Japan, Taiwan) and OXA (Europe: Turkey, and Africa: Morocco) (Figure 19).

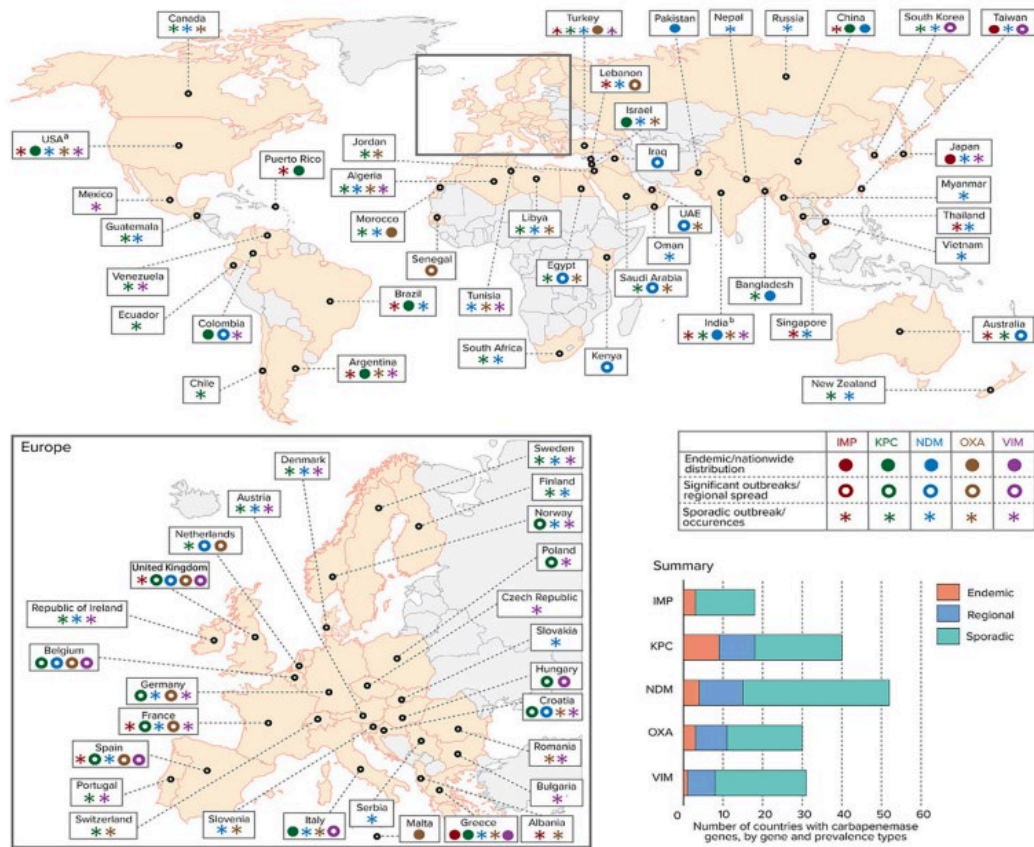

FIGURE 20. GLOBAL DISTRIBUTION OF CPES BY COUNTRY AND REGION FROM LOGAN AND WEINSTEIN, JOURNAL OF INFECTIOUS DISEASES, 2017 [178]

2.2-EUROPE

In 2017, the European Centre for Disease Prevention and Control (ECDC) conducted a survey as part of the "European Survey of Carbapenemase-Producing *Enterobacteriales* (EuSCAPE)" project, to determine the current epidemiological situation. This survey identified three countries (Italy, Greece, and Turkey) reporting endemic situations and many countries with regional or interregional distribution (Figure 20). The distribution by carbapenemase type was not available. However, a protocol for genome-based surveillance of CRE in Europe was established and updated in 2018, which should provide up-to-date molecular epidemiological data in the future.

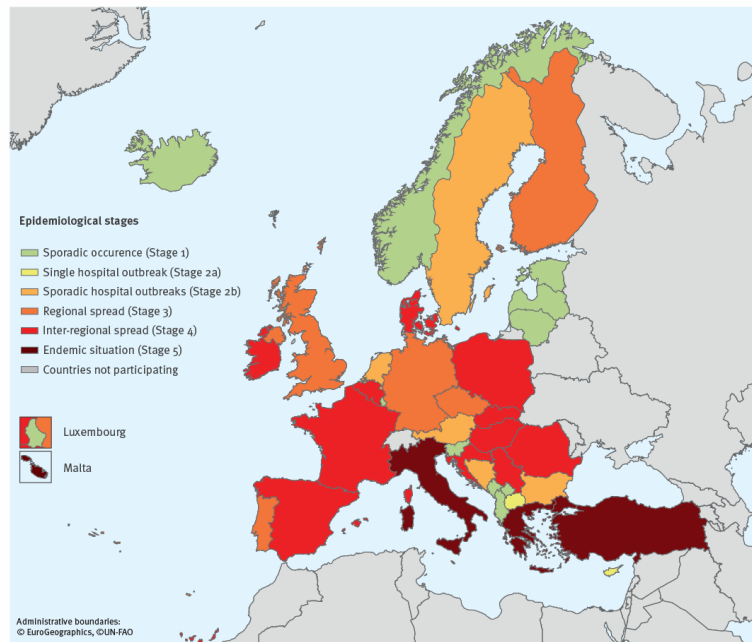

FIGURE 21. EPIDEMIOLOGICAL SITUATION OF CPES IN EUROPEAN COUNTRIES, JULY 2018
FROM BROLUND ET AL, EUROSURVEILLANCE, 2019 [179]

2.3-FRANCE

The summary report of the 2017-2021 activities published by the French National Reference Center for Antimicrobial Resistance (NRC) available [here](#) provides insights into the evolution of β -lactamases and carbapenemases in France.

Some take away messages from each NRC are:

+National Reference Center "*Enterobacterales*: resistance to C3G and colistin" (CHU Clermont-Ferrand)

- CPE-negative ESBLs or Cephalosporinase (Case)-producing *Enterobacterales* isolates.
 - Acquisition of ESBLs, plasmid-mediated Case and hyperproduction of chromosomal Case in combination with impermeability issues were the most common resistance mechanisms detected in CPE-negative *Enterobacterales* isolates.
 - The most common STs identified in *E. coli* isolates were ST131 and ST88.
 - The most common STs identified in *K. pneumoniae* isolates were ST307 and ST45.

+National Reference Center “*Enterobacterales*: resistance to carbapenems” (CHU Bicêtre)

- CPE-positive *Enterobacterales* isolates.
 - 74.2% of the isolates received in 2021 were carbapenemase-positive.
 - Most CPEs identified in France were *K. pneumoniae* (29%), *E. coli* (24%), *E. cloacae* (18%), and *C. freundii* (17%).
 - The most widespread regions in France for CPEs were Ile-de-France, Nord Pas-de Calais, and PACA (Figure 21).

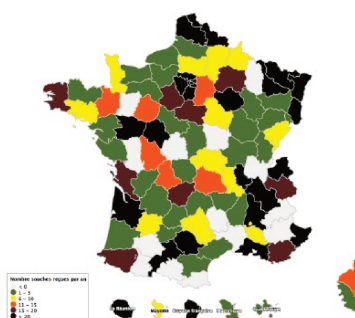

FIGURE 22. EPIDEMIOLOGICAL SITUATION OF CPES IN FRANCE, 2021.

FROM FRENCH NRC REPORT (2017-2021)

- While the most common carbapenemase in France was OXA-48-like (64.6%), a slight decrease was observed from 2017 (75.2%) to 2021 (64.6%) while MBLs increased over the same period for NDM and VIM-producers (e.g., NDM – 2017 (14.5%) to 2021 (21%); VIM – 2017 (5.3%) to 2021 (7.9%)).
- The OXA-244 variant is increasing since 2017.

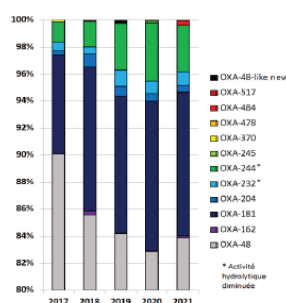

FIGURE 23. EPIDEMIOLOGICAL SITUATION OF CPES IN FRANCE, 2021.

FROM FRENCH NRC REPORT (2017-2021)

- NDM is the second type of carbapenemase identified in France since 2013. The most prevalent NDM variant is NDM-5 since 2014. (Figure 22).

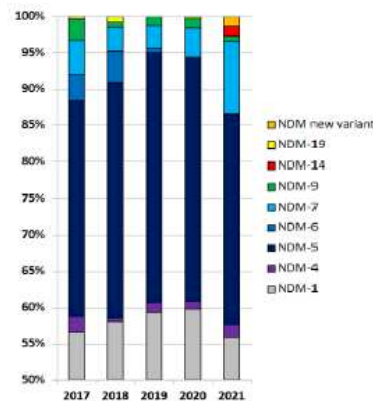

FIGURE 24. REPARTITION OF NDM VARIANTS IN FRANCE FROM 2016 TO 2020
FROM FRENCH CNR REPORT (2017-2021)

2.4 UNITED STATES

Since the mid-2010s, the most common carbapenemase identified in the United States (US) has been KPC, according to a CDC study that examined a collection of CRE isolates (n=421) from eight US hospitals from 2011-2015. The most common CRE identified in this collection was *K. pneumoniae* (63%), with ST258 being the most common ST. Most CRE harbored a carbapenemase (CPE, 73%), with KPC predominating (97%). However, there has been a marked change in the epidemiology of CPE in US medical centers: the number of KPC producers is decreasing (73.8% in 2019 to 57.1% in 2021) while the number of MBLs such as NDM (3.8% in 2019 to 20.4% in 2022) and OXA-48-like producers (1.3% in 2019 to 8.2% in 2022) is increasing (Figure 20).

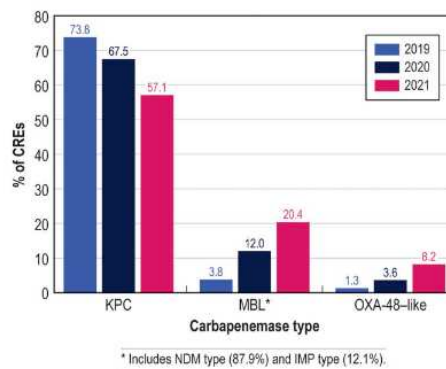

FIGURE 25. REPARTITION OF CARBAPENEMASES IN THE UNITED STATES FROM 2019 TO 2021.

The CDC’s AMR data available on the Antimicrobial Resistance & Patient Safety Portal (<https://arpsp.cdc.gov/profile/arln/cre>), shows the same pattern. For example, 92.3% and 32% of KPC were identified among *K. pneumoniae* in 2017-2018 and 2022, respectively. However, 4.8% and 28.3% of NDM were identified among *K. pneumoniae* in 2017-2018 and 2022, respectively (Figures 24 and 25).

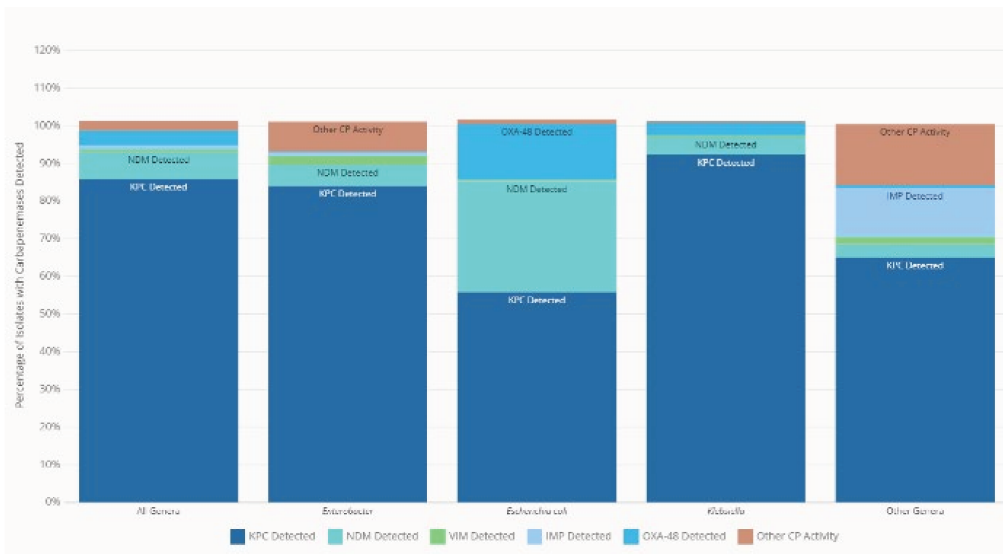

FIGURE 26. DISTRIBUTION OF CARBAPENEMASES BY SPECIES IN THE UNITED STATES – 2017-2018
FROM CDC ANTIMICROBIAL RESISTANCE & PATIENT SAFETY PORTAL

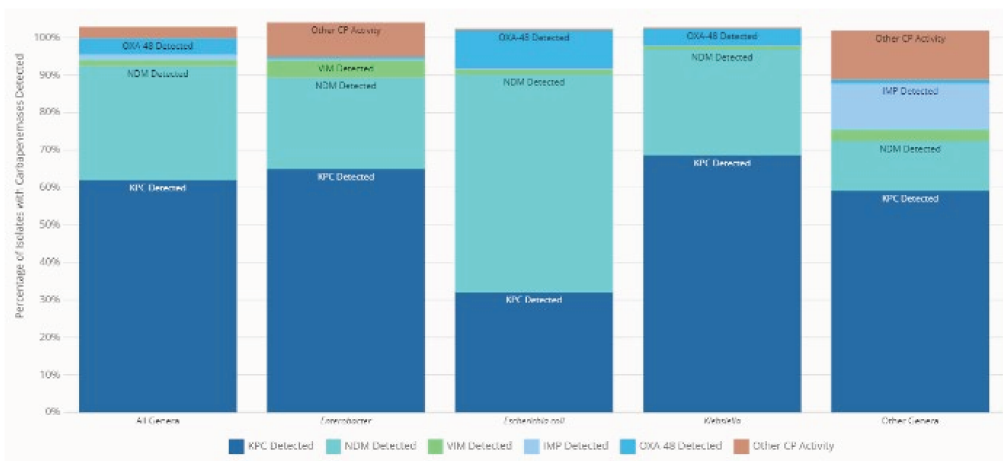
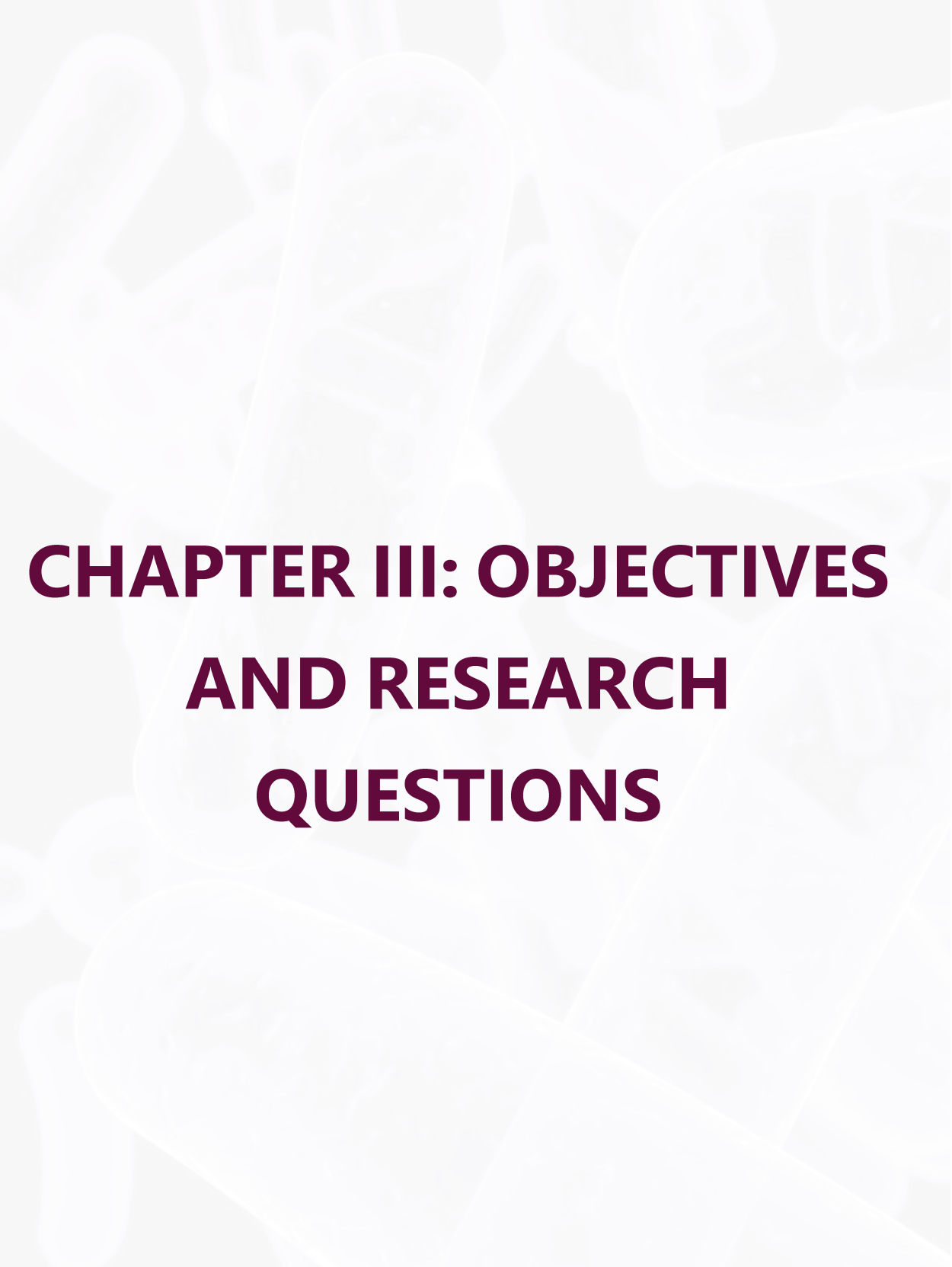

FIGURE 27. DISTRIBUTION OF CARBAPENEMASES BY SPECIES IN THE UNITED STATES - 2022
FROM CDC ANTIMICROBIAL RESISTANCE & PATIENT SAFETY PORTAL

The background of the page features a faint, light-colored image of several hands of different skin tones reaching out to hold a globe. The hands are positioned around the globe, with fingers spread, symbolizing global unity and research. The text is centered over this background.

CHAPTER III: OBJECTIVES AND RESEARCH QUESTIONS

Antibiotic-resistant infections are widespread in the United States and around the world. More than 2.8 million people were infected with resistant bacteria, and more than 35,000 people died from these infections in 2019 in the United States [181]. The rapid emergence of resistant bacteria threatens the effectiveness of antibiotics, which have saved millions of lives since their introduction into modern medicine. Since the introduction of penicillin in 1928, the overuse of antibiotics has led to widespread resistance in humans and animals [182]. Bacteria have always been able to adapt to any environmental stress and have developed new sophisticated mechanisms to survive and be resistant to antibiotics. Strategies to combat this AMR crisis [183] remain critical to continue saving lives [184]. Prevention works as data from 2019 CDC report shows (18% fewer deaths from AR overall since 2013 report, and 28% in hospitals) [181, 185].

β -lactam antimicrobials have been used extensively for more than 70 years to treat bacterial infections. The evolution of the structure and spectrum of activity of the numerous β -lactam molecules developed since the 1940s has not prevented the emergence of resistance. The prolonged exposure of bacterial isolates to a variety of potent β -lactams has led to a constant production of β -lactamases. Resistance to β -lactams is one of the most extraordinary resistance mechanisms characterized by a constantly and increasingly evolving factor through point mutations of β -lactamases: the prominent ESBLs.

Carbapenems are the most effective β -lactams active against ESBL-producing *Enterobacterales*. This class has often been used as a “last resort” in patients suspected of having severe infections caused by drug-resistant pathogens (e.g., ESBLs). The emergence of KPCs in the 1990s was therefore a worrying problem for clinicians as they had limited drug treatment available. Highly transmissible and difficult-to-treat MDR pathogens (ESBLs/CPEs) have caused several outbreaks in different parts of the world involving hospitals and long-term care facilities [186]. Today, the situation is worrying because MDR pathogens cause serious illnesses that can lead to death.

Many major health organizations recognized this health problem as a concern a decade ago. The Centers for Disease Control and Prevention (CDC) published a report listing the top 18 drug-resistant threats to the United States by level of concern. Three categories were defined: Urgent, Serious and Concerning. The WHO recognized AMR as “a global security threat that requires action across all sectors of government and society.”[187]. ESBLs, which can cause resistance to all β -lactams except cephamycins and carbapenems, have been categorized as a “Serious Threat” in the United States. CREs

are a group of bacteria that have become resistant to almost all available antibiotics. This group of alarming pathogens is categorized as an *"Urgent Threat"* in the United States, and the CDC provides guidance to help clinicians manage this public health problem with the *"Facility Guidance for Control of Carbapenem-resistant Enterobacterales and update CRE Toolkit"* [181]. We are now facing an alarming situation as the incidence and prevalence of MDR clinical isolates such as carbapenem-resistant GNB, including CPEs, are increasing worldwide, as stated by the WHO. Therefore, some global WHO guidelines have been published to prevent and control the spread of these alarming microorganisms. [187, 188].

β -lactam-resistant Gram-negative pathogens use different mechanisms to inhibit the action of carbapenems: 1) prevention of carbapenems from reaching their target (impermeability), 2) active ejection of carbapenems from the cell after their entry (efflux systems), or 3) enzyme-mediated resistance (β -lactamases including carbapenemases) [189]. The latter is the most common mechanism with dynamic and continuous production of new enzymes resistant to carbapenems (e.g., NDM-1, VIM, OXA-48, etc.).

In the last two decades, the detection and identification of ESBLs/CREs isolates has increased worldwide. New rapid molecular technologies and NGS are available to track the occurrence of all clinically relevant β -lactamases, including carbapenemases. Combined action plans that include rapid laboratory detection, adapted infection control procedures and enhanced molecular surveillance are now critical to address this worrying and overwhelming public health problem. Improving laboratory detection of these enzymes remains critical for better management of infection control procedures to limit their spread in hospitals. Due to the limited development of new antimicrobial agents and especially because all new molecules re-induce resistance, it is time to focus more on prevention measures by combining rapid diagnosis with molecular epidemiology-based studies that would serve to prevent transmission and track emerging or new mechanisms. Faster new technologies such as Nanopore sequencing are critical for epidemiology purposes. However, combating such drug-resistant clinical isolates requires teamwork and ongoing collaboration between microbiologists, bioinformaticians, epidemiologists, physicians, and infection control practitioners.

A background image showing a microscopic view of various cells, likely from a tissue sample, rendered in a light, semi-transparent style. The cells are irregular in shape and some show internal structures like nuclei.

CHAPTER IV: RESEARCH CONTRIBUTIONS

CHAPTER IV: RESEARCH CONTRIBUTIONS

The first research study presented here was designed to improve the feasibility of molecular surveillance studies and to gain insights into the evolution of the molecular epidemiology of prominent β -lactamases (Chapter V).

The Merck-sponsored SMART study, for which a large collection of worldwide bacterial isolates from IAIs were recruited each year, was an ongoing surveillance study to monitor the development of worldwide resistance trends. At the beginning of this research project in early 2009, ESBLs, including new variants, were constantly identified all over the world, while the occurrence of KPCs was limited to the United States, Israel, and some European countries (e.g., Greece). Therefore, characterizing the global distribution of ESBLs/KPCs in a large collection of *Enterobacterales* isolated from IAIs and from different parts of the world was of great importance to obtain new information on the molecular epidemiology of β -lactamases and to gain insight into the distribution of these alarming MDR *Enterobacterales* throughout the world. Within the same project, it was important for us to evaluate a new commercial molecular assay for faster molecular characterization of β -lactamases and pathogens to provide clinical laboratories with user-friendly molecular tools and to identify/confirm the most common variants of β -lactamases in the MDR population.

Later, when the new NDM-1 metallo- β -lactamase was first described, we characterized CREs from the SMART program isolated in 2008-2009. We used the same molecular tools as in the first study, described in Chapter V, to determine the global distribution status of this new emerging NDM-1 enzyme and to characterize the molecular background associated with each common carbapenem resistance gene (Chapters VI and VII).

Then, the increase of all types of carbapenemase-producers among the *Enterobacterales* prompted us to investigate their characteristics in a key nosocomial pathogen such as *K. pneumoniae* to determine the worldwide frequency and geographic distribution of carbapenemase genes in key pathogens and to identify associated resistance or ST-types in carbapenemase-producers (Chapter VIII).

Finally, when Nanopore technologies offered a portable device (MinION) capable of long-read real-time sequencing, we used this opportunity to fully characterize MDR plasmids in a small collection of NDM-1 and/or OXA-48 *K. pneumoniae*-producers from Pakistan (Chapter IX).

My contributions to these research studies included all tasks from planning to publication such as designing, planning, executing, and performing all experiments, recording, and analyzing data, and writing manuscripts. All co-authors were involved in reviewing the manuscripts. The project that led to the letter to the editor, was a collaboration with Prof. Nordmann and Dr. Poirel from France, originally

initiated by the identification of the first NDM-1 *K. pneumoniae* producer in Mauritius in our laboratory. And finally, I initiated the Nanopore project as part of a larger research project in collaboration with the FDA and University of Virginia at the Centers for Disease Control and Prevention (CDC).

All five manuscripts presented here in Chapters V through IX published in 4 different peer-reviewed journals in 2011-2012, and 2023 are listed below:

1. Journal of Clinical Microbiology (February 8, 2012),
2. Journal of Antimicrobial Chemotherapy (June 14, 2011),
3. Antimicrobial Agents and Chemotherapy (October 17, 2011)
4. Antimicrobial Agents and Chemotherapy (October 7, 2012)

and the last manuscript was published in:

5. Frontiers in Microbiology (June 28, 2023)

CHAPTER V: PUBLICATION #1

Using Nucleic Acid Microarrays to Perform Molecular Epidemiology and Detect Novel β -lactamases: a Snapshot of ESBLs throughout the World

Christine Lascols, Meredith Hackel, Andrea M. Hujer, Steven H. Marshall, Sam K. Bouchillon, Daryl J. Hoban, Stephen P. Hawser, Robert E. Badal and Robert A. Bonomo.

J Clin Microbiol. 2012 May;50(5):1632-9. doi: 10.1128/JCM.06115-11. Epub 2012 Feb 8.

PMID: 22322349 PMCID: PMC3347121 DOI: 10.1128/JCM.06115-11

USING NUCLEIC ACID MICROARRAYS TO PERFORM MOLECULAR EPIDEMIOLOGY AND DETECT NOVEL β -LACTAMASES: A SNAPSHOT OF ESBLs THROUGHOUT THE WORLD

AMR among *Enterobacterales* is a cause for concern as therapeutic options become scarce. The emergence of new β -lactamases that can degrade broad-spectrum cephalosporins and/or carbapenems such as ESBLs or carbapenemases is of great concern. These enzymes are usually detected phenotypically in the laboratory, but molecular characterization of such enzymes has rarely been performed in routine laboratories, but usually only in a reference laboratory.

We felt that investigating the molecular characteristics of a collection of *Enterobacterales* from around the world was warranted and that this study would provide a better understanding of the global and current epidemiology of ESBLs and carbapenemases. As these analyzes assess the potential impact of highly resistant GNB on treatment and infection control, they would be useful to molecular epidemiologists and clinicians and could hopefully help develop new strategies to combat resistant pathogens.

Since our laboratory had received a large collection of *Enterobacterales* (*E. coli*, *Klebsiella*, *P. mirabilis*) from 5 continents and 35 countries as part as the global SMART AMR surveillance program, our study aimed to genetically characterize a subset of ESBL-positive clinical isolates detected phenotypically to create a comprehensive database, determine the epidemiological trends for each enzyme type by country or continent, and assess whether new variants were emerging.

The SMART program, which has been monitoring the evolution of AMR trends in clinical isolates from IAls from 35 countries from the following 5 regions: Asia, Europe, Latin & North America, the Middle East, and South-Pacific since 2002, was initiated in 2009 with the molecular characterization of all ESBLs and carbapenemases identified in collected clinical *Enterobacterales* isolates. It was one of the very few programs that provided molecular epidemiology data on a large global collection of clinical *Enterobacterales* isolates. This study was one of the few molecular studies analyzing a large number of clinical isolates from in 35 countries from seven regions of the world. In our collection of clinical *Enterobacterales* isolates (n=1,093), including predominantly *E. coli* (n=730, 67%) and *K. pneumoniae* (n=340, 31%) isolates from IAls, CTX-M was the most frequently identified as an ESBL, while SHV-ESBL and TEM-SHV were rare. CTX-M, and especially the CTX-M-1 group were more frequently found in *E. coli* (92%/71%) than in *K. pneumoniae* (58%/47%), respectively. This study revealed a changed epidemiology, highlighting the CTX-M pandemic that began in the 2000s (10 years prior to this study).

At that time, SHV-ESBL was the predominant ESBL genotype, and CTX-M was an emerging ESBL enzyme [190, 191]. Ten years later, our study confirmed that CTX-M had overtaken SHV-ESBL to become the predominant ESBL type (82% for CTX-M vs 15% for ESBL-SHV). Unpublished data by Castanheira et al. from a collection of 2,059 clinical *Enterobacteriales* isolates from the SENTRY Antimicrobial Surveillance Program, a program like the SMART program, showed that 92.5% carried CTX-M-encoding genes (70% for the CTX-M-1 group) and only 8.6% ESBL-SHV-encoding genes [192].

Molecular characterization has long been performed using PCR-sequencing which can be time-consuming for a large collection. We decided to use the commercial Check-KPC ESBL DNA microarray for the detection of clinically relevant β -lactamases (TEM, SHV, CTX-M and KPC) followed by targeted PCR-sequencing. In this study, our work showed that the global epidemiology of ESBLs and KPCs is evolving and changing. The distribution of CTX-M and SHV was significantly different between *E. coli* and *K. pneumoniae*: CTX-M group 1 was more prevalent in *E. coli* in all regions while SHV was prevalent in *K. pneumoniae* in North America. Multienzyme producers were mainly found in Asia and Latin America. Finally, the most frequently identified ESBL genes were *bla*_{CTX-M-15}, *bla*_{CTX-M-14}, and *bla*_{SHV-12}, and two new genes, *bla*_{SHV-129} and *bla*_{KPC-11}, were identified. Our work has also shown that the Check-Points microarray technology in combination with targeted PCR-Sanger sequencing is a rapid molecular assay (3.5 days/72 isolates) that can be used for the detection and characterization of ESBL and KPC genes in large collections of ESBL- and KPC-producers. The agreement between the results obtained by Check-Points and with sequencing was good, with some minor discrepancies between the two methods.

Overall, our study, one of the few large molecular epidemiological studies on a diverse worldwide collection of *Enterobacteriales*, has revealed the current snapshot of ESBLs/KPC around the world and identified new variants of both ESBL and KPC genes.

Using Nucleic Acid Microarrays To Perform Molecular Epidemiology and Detect Novel β -Lactamases: a Snapshot of Extended-Spectrum β -Lactamases throughout the World

Christine Lascols,^a Meredith Hackel,^a Andrea M. Hujer,^d Steven H. Marshall,^c Sam K. Bouchillon,^a Daryl J. Hoban,^a Stephen P. Hawser,^b Robert E. Badal,^a and Robert A. Bonomo^{c,d,e,f}

International Health Management Associates, Schaumburg, Illinois, USA^a; IHMA Europe Sàrl, Epalinges, Switzerland^b; Research Service, Louis Stokes Cleveland Department of Veterans Affairs Medical Center, Cleveland, Ohio, USA^c; and Departments of Medicine,^d Pharmacology,^e and Molecular Biology and Microbiology,^f Case Western Reserve University School of Medicine, Cleveland, Ohio, USA

The worldwide dissemination of extended-spectrum- β -lactamase (ESBL)- and carbapenemase-producing *Enterobacteriaceae* is a major concern in both hospital and community settings. Rapid identification of these resistant pathogens and the genetic determinants they possess is needed to assist in clinical practice and epidemiological studies. A collection of *Escherichia coli*, *Klebsiella pneumoniae*, *Klebsiella oxytoca*, and *Proteus mirabilis* isolates, including phenotypically ESBL-positive ($n = 1,093$) and ESBL-negative isolates ($n = 59$), obtained in 2008–2009 from a longitudinal surveillance study (SMART) was examined using an *in vitro* nucleic acid-based microarray. This approach was used to detect and identify bla_{ESBL} (bla_{SHV} , bla_{TEM} , and bla_{CTX-M} genes of groups 1, 2, 9, and 8/25) and bla_{KPC} genes and was combined with selective PCR amplification and DNA sequencing for complete characterization of the bla_{ESBL} and bla_{KPC} genes. Of the 1,093 phenotypically ESBL-positive isolates, 1,041 were identified as possessing at least one bla_{ESBL} gene (95.2% concordance), and 59 phenotypically ESBL-negative isolates, used as negative controls, were negative. Several ESBL variants of bla_{TEM} ($n = 5$), bla_{SHV} ($n = 11$), bla_{CTX-M} ($n = 19$), and bla_{KPC} ($n = 3$) were detected. A new bla_{SHV} variant, $bla_{SHV-129}$, and a new bla_{KPC} variant, bla_{KPC-11} , were also identified. The most common bla genes found in this study were $bla_{CTX-M-15}$, $bla_{CTX-M-14}$, and bla_{SHV-12} . Using nucleic acid microarrays, we obtained a “molecular snapshot” of bla_{ESBL} genes in a current global population; we report that CTX-M-15 is still the dominant ESBL and provide the first report of the new β -lactamase variants $bla_{SHV-129}$ and bla_{KPC-11} .

Resistance to extended-spectrum penicillins and cephalosporins among Gram-negative pathogens such as the *Enterobacteriaceae* is a serious and growing health care threat (31). Commonly, extended-spectrum β -lactamases (ESBLs) are responsible for this phenotype and are increasingly being reported among these microorganisms (26). As these multidrug-resistant ESBL-producing isolates are now often treated with carbapenems, carbapenemases, such as KPC, are also an emerging problem.

Single- and multiple-amino-acid substitutions around the active site in the parental narrow-spectrum TEM- and SHV-type enzymes (i.e., TEM-1 and -2 and SHV-1 and -11) are the basis of ESBL-mediated resistance. To date, more than 190 TEM-type and 140 SHV-type β -lactamases have been identified worldwide (www.lahey.org/Studies). During the last 10 years, other ESBL types have gained importance, especially the CTX-M enzymes. The CTX-M family is clustered in five subgroups, designated CTX-M-1, CTX-M-2, CTX-M-8, CTX-M-9, and CTX-M-25 (5). CTX-M enzymes are currently the most prevalent β -lactamases found in *Escherichia coli* clinical isolates worldwide (6).

The KPC-type β -lactamases, which confer resistance to extended-spectrum cephalosporins, β -lactam- β -lactamase inhibitor combinations, and carbapenems, present one of the most significant challenges to date (23, 25). Eleven variants have been reported on the Lahey Clinic website thus far. KPC-2 and KPC-3 are widespread and are the most frequently identified carbapenemases in *Enterobacteriaceae*. KPC-producing bacteria were identified first in the United States and subsequently on almost every continent (2, 9, 22, 23, 29, 30, 39). Detection of these enzymes remains difficult because the MICs of carbapenems for some

bla_{KPC} -producing isolates at times remain in the susceptible range, especially when automated systems are used. Furthermore, the presence of multiple β -lactamases often renders isolates resistant to β -lactam- β -lactamase inhibitor combinations, and the presence of AmpC enzymes may produce a negative confirmatory test for ESBL production, even if a bla_{KPC} gene is present (15).

As a result of widespread dissemination of ESBLs and carbapenemases, numerous detection strategies have been developed for identification of ESBL- and KPC-producing microorganisms. Many researchers have found that standard phenotypic tests may fail, yielding unacceptable numbers of false-negative results (12, 17, 33). The lowering of clinical breakpoints has improved the sensitivity of phenotypic tests; nevertheless, it is prudent to remain cautious, since some isolates that give test results in the susceptible range may result in to clinical failure when part of an infection (11, 34). PCR followed by DNA sequencing (PCR-sequencing) is still the most widely used molecular technique for characterization of ESBLs; however, these methods remain time-consuming. Pyrose-

Received 13 October 2011 Returned for modification 8 November 2011
Accepted 2 February 2012

Published ahead of print 8 February 2012

Address correspondence to Christine Lascols, clascols@ihmainc.com.

Supplemental material for this article may be found at <http://jcm.asm.org/>.

Copyright © 2012, American Society for Microbiology. All Rights Reserved.

doi:10.1128/JCM.06115-11



FIG 1 Worldwide distribution of the 1,093 clinical isolates tested.

quencing and microarray technologies are promising genotyping systems which overcome these constraints (13, 14).

Few large-scale studies that examine the global distribution of ESBLs and carbapenemases present in clinical isolates are reported in the literature (27). These analyses provide a unique opportunity for molecular epidemiologists and clinicians to assess the potential impact of highly resistant Gram-negative pathogens on treatment and infection control strategies. The objective of this study was to characterize a major collection of 1,093 Gram-negative organisms with an ESBL phenotype from geographically diverse locations (Africa, Asia, Europe, Latin America, the Middle East, North America, and the South Pacific). All strains were collected in 2008–2009 through the Study for Monitoring Antimicrobial Resistance Trends (SMART), an ongoing global longitudinal surveillance study that has been monitoring the susceptibility of Gram-negative aerobic pathogens from intra-abdominal infections since 2002. To achieve our goals, we used a nucleic acid based-microarray technology (Check-KPC ESBL) and PCR-sequencing. To date, this microarray has performed with a sensitivity and specificity between 95 and 100% (8, 10, 21, 28).

MATERIALS AND METHODS

Bacterial strains. *Enterobacteriaceae* isolates (2008–2009) were collected through the SMART program. Phenotypic ESBL testing was done by broth microdilution according to CLSI guidelines, with a ≥ 3 -doubling-dilution decrease in the MIC of ceftazidime or cefotaxime in the presence of clavulanic acid compared to the antibiotics alone (7). The disk diffusion confirmation test, using both cefotaxime and ceftazidime alone (30 μg) and in combination with clavulanate disks (30/10 μg), was performed for verification of the ESBL phenotype (7). In this collection, 1,093 isolates with ESBL-producing phenotypes were tested. In addition, 59 non-ESBL-producing isolates, including *Escherichia coli* ATCC 25922, were used as negative controls. Eight *Escherichia coli* or *Klebsiella pneumoniae* strains, representing the ESBLs targeted by the Check-Points method (*bla*_{SHV-12}, *bla*_{TEM-52}, *bla*_{CTX-M-1}, *bla*_{CTX-M-2}, *bla*_{CTX-M-9}, *bla*_{CTX-M-8}, *bla*_{CTX-M-25} and *bla*_{KPC-2}), were used as positive controls.

The 1,093 ESBL-positive isolates included *Escherichia coli* ($n = 730$; 66.8%), *Klebsiella pneumoniae* ($n = 340$; 31.1%), *Klebsiella oxytoca* ($n = 12$; 1.1%), and *Proteus mirabilis* ($n = 11$; 1%). Isolates were collected from intra-abdominal infections in 35 countries from seven regions: Africa

($n = 7$; 0.6%), Asia ($n = 416$, 38%), Europe ($n = 300$; 27.5%), Latin America ($n = 229$; 21%), the Middle East ($n = 23$; 2.1%), North America ($n = 66$; 6%), and the South Pacific ($n = 52$; 4.8%) (Fig. 1).

DNA isolation. Whole-genomic DNA was extracted from overnight colonies grown on blood agar (Remel, Lenexa, KS) using a QIAamp DNA Mini kit and a QIAcube instrument (Qiagen, Valencia, CA) according to the manufacturer's instructions.

Nucleic acid-based microarray. The Check-KPC ESBL microarray was performed according to the manufacturer's instructions (Check-Points) as previously described (8, 10, 21).

Amplification and DNA sequencing of the ESBL and KPC genes. PCR was performed on the *bla*_{ESBL} and *bla*_{KPC} genes identified by microarray on an ABI 9700 thermocycler (Applied Biosystems, Carlsbad, CA). *bla* genes of the TEM, SHV, CTX-M, and KPC types were amplified as previously described (18, 24, 32, 36, 39). PCR was carried out with a Fast Cycling PCR kit (Qiagen, Valencia, CA). Purification of the PCR products was performed using Exo-SAP-IT (USB, Cleveland, OH). PCR-amplified fragments were sequenced using an ABI 3730XL DNA analyzer (Applied Biosystems). Nucleotide sequences were analyzed with SeqScape v. 7.0 (Applied Biosystems) and compared to sequences available at the National Center for Biotechnology Information website (www.ncbi.nlm.nih.gov).

Statistical analysis. Fisher's exact test (two-tailed) was used to evaluate differences in *bla*_{CTX-M}, *bla*_{SHV}, and *bla*_{TEM} carriage rates between *E. coli* and *K. pneumoniae* isolates. A *P* value of ≤ 0.05 was considered statistically significant.

Nucleotide sequence accession numbers. The complete sequences of the novel *bla*_{SHV} and *bla*_{KPC} β -lactamase genes have been deposited in the GenBank database under the accession numbers GU827715 (*bla*_{SHV-129}) and HM066995 (*bla*_{KPC-11}).

RESULTS

Detection and identification of *bla*_{ESBL} genes of the TEM, SHV, and CTX-M types. Of the 1,093 isolates from diverse regions that possessed an ESBL phenotype, 1,041 were positive using the microarray for *bla*_{ESBL} and/or *bla*_{KPC} genes. All the *bla*_{SHV}, *bla*_{TEM}, and *bla*_{CTX-M}-type ESBLs detected by the array were positive by PCR. For all the remaining isolates ($n = 52$; 4.8%), which were negative by this method, the microarray images were analyzed visually and were suspected to be positive because of the presence of a weak signal. Indeed, they were positive for *bla*_{CTX-M-1} ($n = 50$), *bla*_{TEM-11} ($n = 1$), and *bla*_{SHV-12} ($n = 1$) by PCR-sequencing. Of

TABLE 1 Correlation between the microarray results and the sequencing results for the 1,093 clinical isolates tested

β-Lactamase genotype based on microarray results (<i>n</i> = 1,093 ^a)	No. (%) of isolates with concordant results (<i>n</i> = 1,030, 94.2%)	Sequencing results	
		β-Lactamase genes	Non-ESBL β-lactamase genes (<i>n</i> = 11)
SHV (<i>n</i> = 133 ^a)	126 (94.7)	SHV-2, -2A, -5, -7, -12, -45, -55, -102, -129	SHV-1, -11 ^b (<i>n</i> = 6)
TEM (<i>n</i> = 8 ^a)	7 (87.5)	TEM-11, -12, -26, -52, -92	
CTX-M-1 group (<i>n</i> = 698 ^a)	648 (92.8)	CTX-M-1, -3, -12, -15, -22, -28, -30, -55, -61, -79	
CTX-M-2 group (<i>n</i> = 31)	31 (100)	CTX-M-2	
CTX-M-9 group (<i>n</i> = 147)	147 (100)	CTX-M-9, -14, -24, -27, -65	
CTX-M-8/25 group (<i>n</i> = 3)	3 (100)	CTX-M-8, -39	
SHV, -CTX-M-1 group (<i>n</i> = 21)	20 (95.2)	SHV-12 + CTX-M-3, -15, -28, -79	
		SHV-7 + CTX-M-15	
		SHV-2 + CTX-M-79	
		SHV-2A + CTX-M-15	
		SHV-5 + CTX-M-15	
		SHV-31 + CTX-M-15	
		SHV-55 + CTX-M-15	
		SHV-120 + CTX-M-15	
		CTX-M-15	SHV-28 ^b (<i>n</i> = 1)
SHV, -CTX-M-2 group (<i>n</i> = 2)	2 (100)	SHV-12 + CTX-M-2	
SHV, -CTX-M-9 group (<i>n</i> = 5)	5 (100)	SHV-12 + CTX-M-9	
		SHV-12 + CTX-M-14	
		SHV-5 + CTX-M-9	
SHV, -CTX-M-8/25 group (<i>n</i> = 1)	0 (0)	CTX-M-8	SHV-11 ^b (<i>n</i> = 1)
TEM, -CTX-M-1 group (<i>n</i> = 5)	4 (80)	TEM-52 + CTX-M-15	
		TEM-52 + CTX-M-28	
		CTX-M-61	TEM-1 ^b (<i>n</i> = 1)
TEM, -CTX-M-9 group (<i>n</i> = 1)	0 (0)	CTX-M-14	TEM-1 ^b (<i>n</i> = 1)
CTX-M-1 + 9 groups (<i>n</i> = 7)	7 (100)	CTX-M-15 + CTX-M-14	
		CTX-M-79 + CTX-M-14	
CTX-M-2 + 8/25 groups (<i>n</i> = 1)	1 (100)	CTX-M-2 + CTX-M-8	
SHV, -TEM, -CTX-M-1 group (<i>n</i> = 2)	1 (50)	SHV-12 + TEM-52 + CTX-M-15	SHV-1 ^b + TEM-1 ^b (<i>n</i> = 1)
		CTX-M-15	
SHV KPC (<i>n</i> = 18)	18 (100)	SHV-12 + KPC-2, -3, -11	
		SHV-5 + KPC-2	
SHV, -CTX-M-1 group, -KPC (<i>n</i> = 1)	1 (100)	SHV-12 + CTX-M-32 + KPC-2	
KPC (<i>n</i> = 9)	9 (100)	KPC-2, -3	

^a Including the weak signals not detected by the microarray.

^b The sequences showed none of the mutations conferring the ESBL phenotype, only the non-ESBL genes *bla*_{SHV-1} and *bla*_{SHV-11}.

the 1,041 isolates with a positive microarray result, 9 were *bla*_{ESBL} negative but *bla*_{KPC} positive.

We were able to compare only the positive results obtained by the microarray (*n* = 1,041) with the sequencing results, since the PCR amplifications were not performed on those with negative results, unless a weak signal was observed. Positive microarray results were highly comparable (94.2% concordance) to those of PCR-sequencing of the entire genes for isolates harboring one or more than one ESBL gene. The sequencing failed to detect a *bla*_{ESBL} gene and detected *bla*_{SHV-1}, *bla*_{SHV-11}, or *bla*_{TEM-1} in phenotypically *bla*_{SHV} and *bla*_{TEM} ESBL-positive isolates, respectively (*n* = 11) (Table 1).

There were also some minor discrepancies between the mutations detected by the microarray and by sequencing for *bla*_{SHV} and *bla*_{TEM} genes (Table 2). Among the *bla*_{SHV}- and *bla*_{TEM}-possessing

isolates, our results were discordant for 27 *bla*_{SHV} isolates (15%) and one *bla*_{TEM} isolate (6%). The mutations detected by the microarray were either not interpretable (*n* = 9) or misinterpreted by the software (*n* = 19) (Table 2).

A particular shortcoming of the microarray system was the failure to detect the *bla*_{CTX-M-1} genes in 50 isolates, representing 4.6% of the 1,093 *bla*_{ESBL}-positive isolates. This had already been observed in previous studies (21, 28). We minimized this specific shortcoming by carefully checking the microarray visually and confirming by PCR-sequencing any weak signals not interpreted as positive by the software. However, when detected by the microarray, the *bla*_{CTX-M} genes were always in accordance with the group detected, as verified by sequencing. Furthermore, the CTX-M-1 probe has recently been improved and the software updated, which should minimize or eliminate this problem in the future (4).

TABLE 2 Minor discrepancies between the mutations detected by the microarray and by sequencing in 28 *bla*_{ESBL}-positive isolates^a

Species (no. of isolates)	No. of isolates (n = 28)	Mutations detected by microarray	β-Lactamase gene sequencing results	Comments
<i>E. coli</i> (7) and <i>K. pneumoniae</i> (2)	9	Noninterpretable	SHV12 (L35Q, G238S , E240K)	Smear signals on microarray
<i>K. pneumoniae</i> (17)	11	238G, 240E, E240K	SHV12 (L35Q, G238S , E240K)	Weak signal for G238S on microarray
	5	238G, 240E, E240K	SHV5 (G238S , E240K)	
	1	238G, 240E, E240K	SHV55 (Y7F, G238S , E240K)	
<i>K. pneumoniae</i> (1)	1	238G, G238A , 240E	SHV28 (Y7F)	Background signal for G238A on microarray
<i>E. coli</i> (1)	1	104E, E104K , 164R, 238G	TEM52 (E104K , M182T, G238S)	Weak signal for G238S on microarray

^a Boldface indicates mutations involved in the ESBL phenotype.

Detection and identification of *bla*_{KPC}. All of the 28 *bla*_{KPC}-possessing isolates detected by microarray were positive for *bla*_{KPC} genes by PCR, including 9 ESBL-negative isolates which had originally been phenotypically characterized as ESBL positive. The 28 isolates were typed as *bla*_{KPC-2} (n = 16; 57%), *bla*_{KPC-3} (n = 8; 29%), and a new variant, *bla*_{KPC-11} (n = 4; 14%) (GenBank accession number [HM066995](#)). *bla*_{KPC-3} differs from *bla*_{KPC-2} by a single amino acid substitution (H272Y), and *bla*_{KPC-11} also differs from *bla*_{KPC-2} by a single amino acid substitution, but at position 103 (P103L). The *bla*_{KPC-11} isolates were collected from peritoneal fluids or gastrointestinal specimens from four different patients hospitalized in the same department (Surgery General) in Greece in 2009.

Worldwide distribution of ESBL enzymes. The 1,093 *bla*_{ESBL} and/or *bla*_{KPC}-positive isolates were collected from 5 regions (Table 3) and 35 countries (Fig. 1). The CTX-M-1 group was the most frequent in all regions (65.4% to 100%) in *E. coli* isolates. In *K. pneumoniae* isolates, the CTX-M-1 group was also the most common (40% to 75%), except in North America, where the SHV type predominates (59%). Of the *E. coli* isolates possessing multiple ESBL enzymes, most were isolated in Latin America (40%) and Asia (35%). The distribution observed for *K. pneumoniae* isolates possessing multiple ESBL enzymes was quite similar: predominantly Asia (35%) and Latin America (31%). The CTX-M-1 group was also the most common group present in *K. oxytoca* and *P. mirabilis* (Table 3).

The distribution by species (Table 3) shows that 93.6% (n = 683) of *E. coli* carry *bla*_{CTX-M} genes, either alone (91.8%) or in combination with other genes, such as *bla*_{SHV} or *bla*_{TEM} (1.8%). Furthermore, 65.6% (n = 223) of *K. pneumoniae* isolates also carry *bla*_{CTX-M} genes, either alone (58.2%) or in combination with other genes, such as *bla*_{SHV} and/or *bla*_{TEM} (7.1%) and *bla*_{KPC} genes (5.6%). However, 37.6% (n = 128) of *K. pneumoniae* ESBL producers carry a SHV-type *bla*_{ESBL} gene, while only 7.1% of *E. coli* (n = 52) ESBL producers carry this type. Overall, the distribution of *bla*_{CTX-M} and *bla*_{SHV} genes was significantly different between *E. coli* and *K. pneumoniae* (Fisher's exact test, *P* < 0.0001). Finally, there was no significant difference for *bla*_{TEM} genes: 1.1% of *E. coli* and 2% of *K. pneumoniae* isolates were *bla*_{TEM} positive (Fisher's exact test, *P* = 0.2634). Overall, among the *bla*_{CTX-M}-possessing isolates, 67% possessed *bla*_{CTX-M-15}, with these isolates being predominantly *E. coli* (73.8%) and *K. pneumoniae* isolates (24.7%). Also, 14% possessed *bla*_{CTX-M-14}, predominantly *E. coli* isolates (86.5%). *bla*_{SHV-12} was identified in 60% of *bla*_{SHV} ESBL-carrying isolates, and 19% carried *bla*_{SHV-5}, predominantly *K. pneumoniae*

isolates (see Fig. S1 in the supplemental material). In Table 4, the diversity and complexity of ESBL enzyme variants are summarized.

It is important to note that our scheme, microarray plus PCR-sequencing, was able to fully characterize 72 isolates in 3.5 days, compared to the 6 days required by the conventional method, and reduced the number of PCR-sequencing reactions required. As an example, for a *K. pneumoniae* isolate positive for *bla*_{CTX-M-15} by microarray, the CTX-M-1 group PCR was the only PCR performed. If the conventional method had been used, PCRs for the SHV, TEM, and CTX-M (CTX-M-1, CTX-M-2, CTX-M-9, CTX-M-8, and CTX-M-25) groups would have been performed. This means that a single PCR-sequencing reaction instead of seven reactions was required.

While the 1,093 phenotypically ESBL-positive isolates were being characterized, a novel *bla*_{SHV} gene was detected in an *E. coli* isolate: *bla*_{SHV-129}. This isolate was collected from an abscess specimen from a patient hospitalized in Italy in 2008. The substitutions detected by the microarray in this gene were G238S and E240K. Indeed, the *bla*_{SHV-129} gene encodes five amino acid substitutions (L35Q, G238S, E240K, R275L, and N276D). Three of these substitutions (L35Q, R275L, and N276D) were determined only by sequencing, since they are not included in the microarray system, while G238S and E240K were confirmed by sequencing.

DISCUSSION

Detection of ESBL-mediated and carbapenem resistance in Gram-negative bacilli is necessary for directed therapy, improving clinical outcomes, and limiting the spread of these multidrug-resistant organisms (6). The heterogeneous nature of resistance among ESBL- and KPC-producing isolates makes detection more complicated if it is based on susceptibility testing alone (23, 33). These difficulties may delay appropriate patient treatment, as well as response to an outbreak. In our study, we addressed the current status of ESBLs and KPCs in Gram-negative bacteria.

Current status of ESBLs. As stated above, few studies have been performed examining the molecular epidemiology of large numbers of clinical isolates possessing an ESBL phenotype. A previous analysis examining *K. pneumoniae* isolates was among the first to give a snapshot of the SHV and TEM sequence variability of ESBLs found in bloodstream isolates from patients on different continents at a single point in time (1996 to 1997) (27). This was a necessary first step in the quest to understand how the genotypes of these complex antibiotic resistance phenotypes emerge in the clinical setting. A major finding at that time was that SHV-type

TABLE 3 Worldwide distribution of *bla*_{ESBL/KPC} genes by species for the 1,093 clinical isolates tested

Species (no. of isolates) and ESBL type	No. (%) of isolates from region							Total
	Africa	Asia	Europe	Latin America	Middle East	North America	South Pacific	
<i>E. coli</i> (730)								
SHV		4 (1.3)	23 (11.1)	12 (8.1)		1 (4.8)	2 (7.7)	42
TEM		2 (0.6)	2 (0.9)	1 (0.7)				5
CTX-M-1 group	3 (100)	225 (72.6)	142 (68.3)	110 (73.8)	10 (76.9)	14 (66.6)	17 (65.4)	521
CTX-M-2 group			2 (0.9)	9 (6)				11
CTX-M-9 group		72 (23.2)	36 (17.3)	7 (4.7)	2 (15.4)	6 (28.6)	6 (23.1)	129
CTX-M-8/25 group				2 (1.3)				2
CTX-M-1 + 9 groups		3 (1)	1 (0.5)	2 (1.3)				6
CTX-M-2 + 8/25 groups				1 (0.7)				1
SHV + CTX-M-1 group		3 (1)		1 (0.7)	1 (7.7)			5
SHV + CTX-M-2 group				2 (1.3)				2
SHV + CTX-M-9 group		1 (0.3)		1 (0.7)			1 (3.8)	3
TEM + CTX-M-1 group			1 (0.5)	1 (0.7)				2
TEM + CTX-M-9 group			1 (0.5)					1
Species total	3	310	208	149	13	21	26	730
<i>K. pneumoniae</i> (340)								
SHV	1 (25)	15 (15.3)	31 (36)	9 (12.5)		26 (59)	6 (23.1)	88
TEM		1 (1)		1 (1.4)				2
CTX-M-1 group	3 (75)	62 (63.3)	35 (40.7)	32 (44.4)	4 (40)	8 (18.2)	17 (65.4)	161
CTX-M-2 group				20 (27.7)		1 (2.3)		21
CTX-M-9 group		11 (11.2)	3 (3.5)					14
CTX-M-8/25 group					1 (10)			1
CTX-M-1 + 9 groups			1 (1.2)					1
SHV + CTX-M-1 group		6 (6.1)	2 (2.3)	3 (4.2)	1 (10)	1 (2.3)	2 (7.7)	15
SHV + CTX-M-9 group		3 (3.1)						3
SHV + CTX-M-8/25 group				1 (1.4)				1
TEM + CTX-M-1 group				3 (4.2)				3
SHV + TEM + CTX-M-1 group				1 (1.4)			1 (3.8)	2
SHV + KPC			13 (15.1)		1 (10)	4 (9.1)		18
SHV + CTX-M-1 + KPC			1 (1.2)					1
KPC				2 (2.8)	3 (30)	4 (9.1)		9
Species total	4	98	86	72	10	44	26	340
<i>Klebsiella oxytoca</i> (12)								
SHV			2 (50)			1 (100)		3
CTX-M-1 group		3 (60)	2 (50)	2 (100)				7
CTX-M-9 group		2 (40)						2
Species total		5	4	2		1		12
<i>Proteus mirabilis</i> (11)								
TEM			1 (50)					1
CTX-M-1 group		2 (66.7)	1 (50)	6 (100)				9
CTX-M-9 group		1 (33.3)						1
Species total		3	2	6				11
Total	7	416	300	229	23	66	52	1,093

ESBLs were by far the most dominant ESBL type and that *bla*_{CTX-M} was an emerging resistance determinant of significant importance. At the time of that study, it was speculated that the types of β -lactamases produced by *K. pneumoniae* may also be evolving.

Our large-scale survey reports that the molecular epidemiology of ESBLs in *E. coli*, *K. pneumoniae*, *K. oxytoca*, and *P. mirabilis* is evolving, as was the status of *K. pneumoniae* ESBL-producing organisms from 1996–1997. We found that *E. coli* is the most common pathogen harboring ESBLs and that *bla*_{CTX-M-15}

*bla*_{CTX-M-14a} and *bla*_{SHV-12} are the most common ESBLs detected. We also found strains with novel ESBL genotypes. Among the 1,093 isolates identified that were ESBLs by phenotype, we identified one novel *bla*_{SHV} gene (SHV-129) and one novel *bla*_{KPC} gene (KPC-11). Although there are no molecular or epidemiological benchmarks against which to readily compare this rate of novel gene discovery, we believe this represents a high frequency of emergence; a rate of one novel ESBL/KPC *bla* gene in 500 ESBL-positive strains is troubling. As noted previously, analysis of the plasmid background and genetic context of these strains

TABLE 4 Distribution of *bla*_{ESBL/KPC} genes among the 1,093 clinical isolates collected worldwide

Species (no. of isolates)	Type of ESBL or KPC (no. [%] of isolates)				
	TEM	SHV	CTX-M	Mixed ESBLs	KPCs (\pm ESBLs)
<i>E. coli</i> (730)	TEM-52 (3 [0.4])	SHV-12 (32 [4.4])	CTX-M-15 (451 [61.8])	SHV-12 + CTX-M-15 (4 [0.5])	
	TEM-12 (1 [0.1])	SHV-5 (5 [0.7])	CTX-M-14 (101 [13.8])	SHV-12 + CTX-M-2 (2 [0.3])	
	TEM-11 (1 [0.1])	SHV-2 (2 [0.3])	CTX-M-61 (23 [3.1])	SHV-12 + CTX-M-79 (1 [0.1])	
		SHV-2A (1 [0.1])	CTX-M-2 (11 [1.5])	SHV-12 + CTX-M-9 (1 [0.1])	
		SHV-102 (1 [0.1])	CTX-M-79 (10 [1.4])	SHV-5 + CTX-M-14 (1 [0.1])	
		SHV-129 ^b (1 [0.1])	CTX-M-27 (10 [1.4])	SHV-7 + CTX-M-15 (1 [0.1])	
			CTX-M-3 (8 [1.1])	TEM-52 + CTX-M-15 (1 [0.1])	
			CTX-M-9 (8 [1.1])	TEM ^a + CTX-M-14 (1 [0.1])	
			CTX-M-24 (8 [1.1])	TEM ^a + CTX-M-61 (1 [0.1])	
			CTX-M-28 (8 [1.1])	CTX-M79 + CTX-M14 (3 [0.4])	
			CTX-M-55 (7 [0.9])	CTX-M15 + CTX-M14 (3 [0.4])	
			CTX-M-1 (6 [0.8])	CTX-M-2 + CTX-M-8 (1 [0.1])	
			CTX-M-22 (6 [0.8])		
			CTX-M-8 (2 [0.3])		
			CTX-M-65 (2 [0.3])		
			CTX-M-12 (1 [0.1])		
			CTX-M-30 (1 [0.1])		
<i>K. pneumoniae</i> (340)	TEM-12 (1 [0.3])	SHV-12 (41 [12])	CTX-M-15 (137 [40.3])	SHV-12 + CTXM-15 (3 [0.9])	KPC-2 (3 [0.9])
	TEM-26 (1 [0.3])	SHV-5 (22 [6.5])	CTX-M-2 (20 [5.9])	SHV-12 + CTX-M-9 (2 [0.6])	KPC-3 (6 [1.8])
		SHV-2 (8 [2.3])	CTX-M-14 (13 [3.8])	SHV-12 + CTX-M-28 (1 [0.3])	SHV-12 + KPC-2 (12 [3.5])
		SHV-2A (5 [1.5])	CTX-M-28 (7 [2])	SHV-12 + CTX-M-3 (1 [0.3])	SHV-12 + KPC-3 (2 [0.6])
		SHV-55 (4 [1.2])	CTX-M-3 (6 [1.7])	SHV-12 + TEM-52 + CTX-M-15 (1 [0.3])	SHV-12 + KPC-11 (4 [1.2])
		SHV-45 (1 [0.3])	CTX-M-22 (3 [0.9])	SHV-5 + CTX-M-15 (4 [1.2])	SHV-12 + CTX-M-32 + KPC-2 (1 [0.3])
		SHV-7 (1 [0.3])	CTX-M-55 (3 [0.9])	SHV-5 + CTX-M-9 (1 [0.3])	
		SHV ^a (6 [1.8])	CTX-M-61 (2 [0.6])	SHV-2 + CTX-M-79 (1 [0.3])	
			CTX-M-9 (1 [0.3])	SHV-2A + CTX-M-15 (1 [0.3])	
			CTX-M-12 (1 [0.3])	SHV-28 + CTX-M-15 (1 [0.3])	
			CTX-M-27 (1 [0.3])	SHV-31 + CTX-M-15 (1 [0.3])	
			CTX-M-30 (1 [0.3])	SHV-55 + CTX-M-15 (1 [0.3])	
			CTX-M-39 (1 [0.3])	SHV-120 + CTX-M-15 (1 [0.3])	
			CTX-M-79 (1 [0.3])	TEM-52 + CTX-M-15 (2 [0.6])	
				TEM-52 + CTX-M-28 (1 [0.3])	
				CTX-M-15 + CTX-M-14 (1 [0.3])	
				SHV ^a +TEM ^a +CTX-M-15 (1 [0.3])	
			SHV ^a +CTX-M-8 (1 [0.3])		
<i>K. oxytoca</i> (12)		SHV-5 (1 [8.3])	CTX-M-14 (2 [16.6])		
		SHV-7 (1 [8.3])	CTX-M-15 (4 [33.3])		
		SHV-12 (1 [8.3])	CTX-M-22 (1 [8.3])		
			CTX-M-30 (2 [16.6])		
<i>P. mirabilis</i> (11)	TEM-92 (1 [9.1])		CTX-M-3 (1 [9.1])		
			CTX-M-14 (1 [9.1])		
			CTX-M-15 (5 [45.5])		
			CTX-M-22 (1 [9.1])		
			CTX-M-28 (1 [9.1])		
			CTX-M-61 (1 [9.1])		

^a Unsuccessful sequencing of the ESBL gene.

^b New variant reported in this study.

may provide the keys to understanding why these phenotypes are becoming so prevalent.

Impact of rapid testing with microarrays. During the last 20 years, alternative molecular strategies for ESBL determination have been proposed (1, 19, 16). More recently, new technologies, such as real-time PCR, pyrosequencing, and denaturing high-per-

formance liquid chromatography (dHPLC) (3, 13, 38), have been employed, but they still remain unsuitable for the clinical laboratory. Conventional PCR remains the most convenient and cost-effective method to confirm phenotypic results for routine laboratories. However, large-scale epidemiological studies can become time-consuming and expensive when the classical

PCR-sequencing method is used. Fast and accurate methods are crucial for monitoring the constantly changing epidemiology of β -lactamases.

The nucleic acid-based microarray combined with PCR-sequencing was able to confirm the presence of a bla_{ESBL} gene, differentiate bla_{ESBL} from $bla_{non-ESBL}$ genes, and precisely identify the ESBL genotype. Also, by indicating the presence of $bla_{non-ESBL}$ and bla_{ESBL} and the mutations involved, microarrays facilitate the sequencing analysis of the double peaks in bla_{ESBL} -carrying *K. pneumoniae* or *E. coli* isolates harboring a non-ESBL gene (bla_{SHV-1} or bla_{TEM-1} , respectively) along with ESBL genes.

The discrepancies observed between the two methods were due either to the microarray probe or software or to sequencing issues. These data support the previous observation that DNA sequencing of PCR amplification products in certain isolates fails to accurately detect all ESBL genes (10, 21). However, a worrisome issue already observed by Platteel et al. was the detection of the $bla_{CTX-M-1}$ -positive isolates, since this is the most prevalent group worldwide (28). Fortunately, this issue seems to have been resolved in all Check-Points kits; as an example, Bogaerts et al. reported 100% specificity and sensitivity of the Check-Points ESBL/AmpC/KPC/NDM-1 (Check-MDR CT101) kit for the bla_{CTX-M} genes (4).

Conclusions. Microarray combined with PCR-sequencing appears to be an efficient strategy for examining quickly the molecular epidemiology of resistance genes, especially where large collections of isolates require characterization. Nevertheless, we must caution that for TEM and SHV β -lactamases, new variants may not be detected by microarrays, since oligonucleotide probes do not cover all TEM- and SHV-type β -lactamases (8). However, the flexibility of this system is an important advantage, since new primers and probes can be included depending on current molecular epidemiology (4, 20). The promising results obtained in previous evaluation studies (8, 10, 21, 28, 35) were confirmed in our large survey and emphasize the performance of the microarray as a reliable tool to guide PCR-sequencing.

We close with the following observation: worldwide epidemiological surveillance studies examining ESBL and carbapenemase genes are essential not only to monitor the dissemination of these enzymes but also to monitor the emergence of new variants that may spread globally (e.g., SHV-129, KPC-11, CTX-M-15, or NDM-1). The analysis summarized herein gives an important assessment of the current state of ESBLs throughout the world. Nucleic acid microarrays performed on a large number of clinical isolates demonstrate an application used in combination with PCR-sequencing for complete characterization of β -lactamase genes in epidemiological studies. Furthermore, the flexibility of the system has been extended to other important genes, such as bla_{AmpC} and bla_{MBLs} , including bla_{NDM-1} (4, 20, 37). We note that the molecular background of ESBL-producing pathogens found within the past 5 years has grown significantly in complexity (27). Studies are required to measure how the emerging ESBL problem is impacting the delivery of care.

ACKNOWLEDGMENTS

The Study for Monitoring Antimicrobial Resistance Trends is funded by Merck Research Laboratories, Inc. R.A.B. is funded by The Veterans Affairs Merit Review Program, the National Institutes of Health (RO1AI063517-07, RO1AI072219-05), and VISN 10 Geriatric Research Education and Clinical Center (GRECC).

We thank Johann Pitout (University of Calgary, Calgary, Canada) for providing control strains, and Check-Points for the technical and helpful support. We gratefully acknowledge contributions from the current participants in the SMART program.

We have no conflict of interest to declare.

REFERENCES

1. Arlet G, et al. 1995. Molecular characterisation by PCR-restriction fragment length polymorphism of TEM β -lactamases. *FEMS Microbiol. Lett.* 134:203–208.
2. Babouee B, et al. 2011. Emergence of four cases of KPC-2 and KPC-3-carrying *Klebsiella pneumoniae* introduced to Switzerland, 2009–10. *Euro Surveill.* 16:19817.
3. Birkett CI, et al. 2007. Real-time TaqMan PCR for rapid detection and typing of genes encoding CTX-M extended-spectrum β -lactamases. *J. Med. Microbiol.* 56:52–55.
4. Bogaerts P, et al. 2011. Multicenter evaluation of a new DNA microarray for rapid detection of clinically relevant bla genes from β -lactam-resistant gram-negative bacteria. *Antimicrob. Agents Chemother.* 55:4457–4460.
5. Bonnet R. 2004. Growing group of extended-spectrum β -lactamases: the CTX-M enzymes. *Antimicrob. Agents Chemother.* 48:1–14.
6. Canton R, Coque TM. 2006. The CTX-M β -lactamase pandemic. *Curr. Opin. Microbiol.* 9:466–475.
7. CLSI. 2009. Methods for dilution antimicrobial susceptibility tests for bacteria that grow aerobically, approved standard, 8th ed. Document M07–A8. Clinical Laboratory Standards Institute, Wayne, PA.
8. Cohen SJ, et al. 2010. Rapid detection of TEM, SHV and CTX-M extended-spectrum β -lactamases in *Enterobacteriaceae* using ligation-mediated amplification with microarray analysis. *J. Antimicrob. Chemother.* 65:1377–1381.
9. Endimiani A, et al. 2009. Emergence of bla_{KPC} -containing *Klebsiella pneumoniae* in a long-term acute care hospital: a new challenge to our healthcare system. *J. Antimicrob. Chemother.* 64:1102–1110.
10. Endimiani A, et al. 2010. Evaluation of a commercial microarray system for detection of SHV-, TEM-, CTX-M-, and KPC-type β -lactamase genes in Gram-negative isolates. *J. Clin. Microbiol.* 48:2618–2622.
11. Endimiani A, et al. 2010. Evaluation of updated interpretative criteria for categorizing *Klebsiella pneumoniae* with reduced carbapenem susceptibility. *J. Clin. Microbiol.* 48:4417–4425.
12. Hope R, et al. 2007. Efficacy of practised screening methods for detection of cephalosporin-resistant *Enterobacteriaceae*. *J. Antimicrob. Chemother.* 59:110–113.
13. Jones CH, et al. 2009. Pyrosequencing using the single-nucleotide polymorphism protocol for rapid determination of TEM- and SHV-type extended-spectrum β -lactamases in clinical isolates and identification of the novel β -lactamase genes bla_{SHV-48} , $bla_{SHV-105}$, and $bla_{TEM-155}$. *Antimicrob. Agents Chemother.* 53:977–986.
14. Leinberger DM, et al. 2010. Integrated detection of extended-spectrum- β -lactam resistance by DNA microarray-based genotyping of TEM, SHV, and CTX-M genes. *J. Clin. Microbiol.* 48:460–471.
15. Lomaestro BM, Tobin EH, Shang W, Gootz T. 2006. The spread of *Klebsiella pneumoniae* carbapenemase-producing *K. pneumoniae* to upstate New York. *Clin. Infect. Dis.* 43:e26–e28.
16. Mabilat C, Courvalin P. 1990. Development of “oligotyping” for characterization and molecular epidemiology of TEM β -lactamases in members of the family *Enterobacteriaceae*. *Antimicrob. Agents Chemother.* 34:2210–2216.
17. Miriagou V, et al. 2010. Acquired carbapenemases in Gram-negative bacterial pathogens: detection and surveillance issues. *Clin. Microbiol. Infect.* 16:112–122.
18. Mulvey MR, et al. 2004. Ambler class A extended-spectrum β -lactamase-producing *Escherichia coli* and *Klebsiella* spp. in Canadian hospitals. *Antimicrob. Agents Chemother.* 48:1204–1214.
19. M’Zali FH, Heritage J, Gascoyne-Binzi DM, Snelling AM, Hawkey PM. 1998. PCR single strand conformational polymorphism can be used to detect the gene encoding SHV-7 extended-spectrum β -lactamase and to identify different SHV genes within the same strain. *J. Antimicrob. Chemother.* 41:123–125.
20. Naas T, Cuzon G, Bogaerts P, Glupczynski Y, Nordmann P. 2011. Evaluation of a DNA microarray (Check-MDR CT102) for rapid detection of TEM, SHV, and CTX-M extended-spectrum β -lactamases and of

- KPC, OXA-48, VIM, IMP, and NDM-1 carbapenemases. *J. Clin. Microbiol.* 49:1608–1613.
21. Naas T, Cuzon G, Truong H, Bernabeu S, Nordmann P. 2010. Evaluation of a DNA microarray, the Check-Points ESBL/KPC array, for rapid detection of TEM, SHV, and CTX-M extended-spectrum β -lactamases and KPC carbapenemases. *Antimicrob. Agents Chemother.* 54:3086–3092.
 22. Navon-Venezia S, et al. 2009. First report on a hyperepidemic clone of KPC-3-producing *Klebsiella pneumoniae* in Israel genetically related to a strain causing outbreaks in the United States. *Antimicrob. Agents Chemother.* 53:818–820.
 23. Nordmann P, Cuzon G, Naas T. 2009. The real threat of *Klebsiella pneumoniae* carbapenemase-producing bacteria. *Lancet Infect. Dis.* 9:228–236.
 24. Nuesch-Inderbinen MT, Hachler H, Kayser FH. 1996. Detection of genes coding for extended-spectrum SHV β -lactamases in clinical isolates by a molecular genetic method, and comparison with the E test. *Eur. J. Clin. Microbiol. Infect. Dis.* 15:398–402.
 25. Papp-Wallace KM, et al. 2010. Inhibitor resistance in the KPC-2 β -lactamase, a preeminent property of this class A β -lactamase. *Antimicrob. Agents Chemother.* 54:890–897.
 26. Paterson DL, Bonomo RA. 2005. Extended-spectrum β -lactamases: a clinical update. *Clin. Microbiol. Rev.* 18:657–686.
 27. Paterson DL, et al. 2003. Extended-spectrum β -lactamases in *Klebsiella pneumoniae* bloodstream isolates from seven countries: dominance and widespread prevalence of SHV- and CTX-M-type β -lactamases. *Antimicrob. Agents Chemother.* 47:3554–3560.
 28. Platteel TN, et al. 2011. Evaluation of a commercial microarray as a confirmation test for the presence of extended-spectrum β -lactamases in isolates from the routine clinical setting. *Clin. Microbiol. Infect.* 17:1435–1438.
 29. Pournaras S, et al. 2009. Clonal spread of KPC-2 carbapenemase-producing *Klebsiella pneumoniae* strains in Greece. *J. Antimicrob. Chemother.* 64:348–352.
 30. Qi Y, et al. 2011. ST11, the dominant clone of KPC-producing *Klebsiella pneumoniae* in China. *J. Antimicrob. Chemother.* 66:307–312.
 31. Schwaber MJ, Carmeli Y. 2007. Mortality and delay in effective therapy associated with extended-spectrum β -lactamase production in *Enterobacteriaceae* bacteraemia: a systematic review and meta-analysis. *J. Antimicrob. Chemother.* 60:913–920.
 32. Speldooren V, Heym B, Labia R, Nicolas-Chanoine MH. 1998. Discriminatory detection of inhibitor-resistant β -lactamases in *Escherichia coli* by single-strand conformation polymorphism-PCR. *Antimicrob. Agents Chemother.* 42:879–884.
 33. Tenover FC, Mohammed MJ, Gorton TS, Dembek ZF. 1999. Detection and reporting of organisms producing extended-spectrum β -lactamases: survey of laboratories in Connecticut. *J. Clin. Microbiol.* 37:4065–4070.
 34. Wang P, et al. 2011. Susceptibility of extended-spectrum-beta-lactamase-producing *Enterobacteriaceae* according to the new CLSI breakpoints. *J. Clin. Microbiol.* 49:3127–3131.
 35. Willemsen I, et al. 2011. New diagnostic microarray (Check-KPC ESBL) for detection and identification of extended-spectrum β -lactamases in highly resistant *Enterobacteriaceae*. *J. Clin. Microbiol.* 49:2985–2987.
 36. Woodford N, Fagan EJ, Ellington MJ. 2006. Multiplex PCR for rapid detection of genes encoding CTX-M extended-spectrum β -lactamases. *J. Antimicrob. Chemother.* 57:154–155.
 37. Woodford N, Warner M, Pike R, Zhang J. 2011. Evaluation of a commercial microarray to detect carbapenemase-producing *Enterobacteriaceae*. *J. Antimicrob. Chemother.* 66:2887–2888.
 38. Xu L, Evans J, Ling T, Nye K, Hawkey P. 2007. Rapid genotyping of CTX-M extended-spectrum β -lactamases by denaturing high-performance liquid chromatography. *Antimicrob. Agents Chemother.* 51:1446–1454.
 39. Yigit H, et al. 2001. Novel carbapenem-hydrolyzing β -lactamase, KPC-1, from a carbapenem-resistant strain of *Klebsiella pneumoniae*. *Antimicrob. Agents Chemother.* 45:1151–1161.

CHAPTER VI: PUBLICATION #2

Increasing prevalence and dissemination of NDM-1 metallo- β -lactamase in India: data from the SMART study (2009)

Christine Lascols, Meredith Hackel, Steven H Marshall, Andrea M Hujer, Sam Bouchillon, Robert Badal, Daryl Hoban, Robert A Bonomo.

J Antimicrob Chemother. 2011 Sep;66(9):1992-7. doi: 10.1093/jac/dkr240. Epub 2011 Jun 14. PMID: 21676902 PMCID: PMC3153502 DOI: 10.1093/jac/dkr240.

INCREASING PREVALENCE AND DISSEMINATION OF NDM-1 METALLO- β -LACTAMASE IN INDIA: DATA FROM SMART STUDY (2009)

The emergence and rapid spread of the new NDM-1 MBL, which confers resistance to the most potent antimicrobial agents, the carbapenems, has severely compromised treatment options for serious infections. Investigation of the presence of carbapenemases in our global collection of CREs collected under the SMART program in 2009, the year NDM-1 was first described was warranted. A collection of 235 ertapenem non-susceptible isolates of *Enterobacteriales* isolated from IAIs was examined for phenotypic and genotypic profiles, and for strain relatedness.

As the first identified NDM-1-producing *K. pneumoniae* isolate was collected in Sweden but was associated with India, we expected a high prevalence of NDM-1 in our collection from India. More than ¼ of the clinical *Enterobacteriales* isolates in this collection carried at least one carbapenemase gene, often in associated with different ESBL and/or AmpC backgrounds and in different species. It was confirmed that these ertapenem non-susceptible strains were clonally related and harbored different combinations of β -lactamases. It was worrying to show that these isolates had exhibited a MDR profile that included all β -lactams, aminoglycosides, and fluoroquinolones but most isolates remained susceptible to colistin and tigecycline and sometimes to both drugs.

Fifteen and three different STs were identified in the NDM-1- and KPC-producers, respectively. ST-147 was most common among NDM-1 producers while ST-258 was most common among KPC-producers. Two new ST571 and ST572 were described for the first time in NDM-1-producers, confirming the diversity of NDM-1 isolates. Other common carbapenemases such as KPC were also identified, including a new KPC-11 variant present in two isolates.

This study provided important surveillance data on the timing of the emergence of the new NDM-1 carbapenemase. These MDR pathogens, which can produce multiple β -lactamases, are a challenge and pose a major public health problem.

Increasing prevalence and dissemination of NDM-1 metallo- β -lactamase in India: data from the SMART study (2009)

Christine Lascols^{1*}, Meredith Hackel¹, Steven H. Marshall², Andrea M. Hujer³, Sam Bouchillon¹, Robert Badal¹, Daryl Hoban¹ and Robert A. Bonomo²⁻⁵

¹International Health Management Associates, Inc., Schaumburg, IL 60173, USA; ²Research Service, Louis Stokes Cleveland Department of Veterans Affairs Medical Center, Cleveland, OH 44106, USA; ³Department of Medicine, Case Western Reserve University School of Medicine, Cleveland, OH 44106, USA; ⁴Pharmacology, Case Western Reserve University School of Medicine, Cleveland, OH 44106, USA; ⁵Molecular Biology and Microbiology, Case Western Reserve University School of Medicine, Cleveland, OH 44106, USA

*Corresponding author. Tel: +1-847-303-5003; Fax: +1-847-303-5601; E-mail: clascols@ihmainc.com

Received 19 April 2011; returned 11 May 2011; revised 16 May 2011; accepted 17 May 2011

Objectives: To investigate the β -lactamase background of ertapenem non-susceptible isolates for the presence of the most commonly detected carbapenemase genes, *bla*_{KPC}, *bla*_{OXA-48} and *bla*_{VIM}, and the newly described *bla*_{NDM-1}.

Methods: Two hundred and thirty-five ertapenem-non-susceptible (MIC \geq 0.5 mg/L) isolates of Enterobacteriaceae from the worldwide Study for Monitoring Antimicrobial Resistance Trends (SMART) 2009 programme were screened using a multiplex PCR for the presence of *bla*_{KPC}, *bla*_{OXA-48}, *bla*_{VIM} and *bla*_{NDM-1} genes. Extended-spectrum β -lactamase (ESBL) and AmpC genes (*bla*_{ESBL} and *bla*_{AmpC}) were identified using the Check-MDR CT101 microarray. DNA sequencing was performed to identify the *bla*_{ESBL}, *bla*_{KPC} and *bla*_{NDM-1} genes. Molecular typing was also performed to genetically characterize these isolates.

Results: Sixty-six isolates (28%) had a carbapenemase gene, with *bla*_{NDM-1} identified in 33 isolates including 2 isolates carrying both *bla*_{NDM-1} and *bla*_{OXA-48}; other carbapenemase genes found included *bla*_{KPC} ($n=23$), *bla*_{VIM} ($n=7$) and *bla*_{OXA-48} ($n=3$). All *bla*_{NDM-1}-carrying isolates were from patients in India and comprised five different species. With the exception of one isolate carrying only *bla*_{NDM-1}, all *bla*_{NDM-1} carbapenemase-possessing isolates carried additional β -lactamases in various combinations: *bla*_{ESBL} and *bla*_{AmpC} ($n=18$); *bla*_{ESBL} ($n=10$); *bla*_{ESBL}, *bla*_{AmpC} and *bla*_{OXA-48} ($n=2$); and *bla*_{AmpC} ($n=2$). Except for *bla*_{OXA-48}-carrying isolates, novel multilocus sequence types or enterobacterial repetitive intergenic consensus PCR patterns were observed along with clonal dissemination within and among sites.

Conclusions: A range of carbapenemase genes, associated with diverse ESBLs and/or AmpC backgrounds, were found among Enterobacteriaceae isolated during the study. Many of these ertapenem non-susceptible strains were clonally related and carried various combinations of β -lactamases.

Keywords: carbapenemases, Enterobacteriaceae, microarray analysis

Introduction

Carbapenems are often the most effective antibiotics used against multidrug-resistant (MDR) Enterobacteriaceae. For many years these potent β -lactams were highly effective against bacteria that exhibited resistance to extended-spectrum cephalosporins (e.g. ceftazidime and cefepime), including extended-spectrum β -lactamase (ESBL) and AmpC producers.¹ However, as carbapenemases began to emerge worldwide, the effectiveness of this 'last-line' antibiotic class was challenged.² The first major test for carbapenem antibiotics came with the

sporadic reports of metallo- β -lactamases found in *Aeromonas* spp., *Stenotrophomonas maltophilia* and *Pseudomonas* spp.³ Metallo- β -lactamases were also discovered in *Bacteroides fragilis* and *Bacillus* spp., but these resistant phenotypes were uncommon.^{4,5} A greater challenge arose from the widespread dissemination of serine carbapenemases of the KPC family.⁶⁻¹⁰ KPC β -lactamases are currently found in numerous genera of bacteria and have spread worldwide. Unfortunately, the recently reported metallo- β -lactamase NDM-1 (New Delhi metallo- β -lactamase) is now emerging as a new mechanism by which bacteria manifest resistance to carbapenems.¹¹ The rapid

spread of NDM-1 is causing major concern in the clinical microbiology community.^{12–14} The impact of these resistance determinants on the outcome of patients with hospital- and community-acquired infections needs to be monitored very closely.

To halt the spread of carbapenem resistance, rapid detection methods are needed. As infection control and therapeutic decisions need to be implemented quickly (in many cases <48 h after admission to hospital), there is a pressing need to rapidly detect these determinants. Presently, the most common carbapenemases reported in Enterobacteriaceae include KPC, OXA-48 and the VIM metallo- β -lactamase.¹⁵ Increasing vigilance is also required to detect the NDM-1 metallo- β -lactamase, especially as the genetic backgrounds of strains harbouring this *bla* gene tend to be complex.

In this study, we examined a collection of ertapenem non-susceptible Enterobacteriaceae isolates from five continents obtained as part of the Study for Monitoring Antimicrobial Resistance Trends (SMART) using molecular methods for rapid and accurate detection of β -lactamase genes. Our results highlight the complexity and diversity of the genetic background of these highly resistant isolates and point to the important role microarray testing plays in defining the molecular basis of these isolates.

Materials and methods

Bacterial isolates

Two hundred and thirty-five isolates of Enterobacteriaceae from intra-abdominal infections collected as part of the SMART study were selected by their reduced susceptibility to ertapenem according to the updated CLSI breakpoints (MICs ≥ 0.5 mg/L).^{16,17} All isolates were non-duplicates from 2009 and originated from a variety of intra-abdominal infections. Isolates were collected from Europe (28%, 20 sites), Asia (28%, 27 sites), North America (21%, 20 sites), Latin America (13%, 12 sites), the South Pacific (7%, 6 sites) and the Middle East (3%, 2 sites). A large proportion of isolates from Asia originated from India (68%, 8 sites).

Susceptibility testing

MICs were determined using dehydrated broth microdilution MicroScan panels (Siemens Healthcare Diagnostics, IL, USA) or in-house panels (colistin) following 2010 CLSI and manufacturer's guidelines. Susceptibility data were interpreted using CLSI guidelines¹⁶ or European Committee for Antimicrobial Susceptibility Testing (EUCAST) breakpoints (colistin) and FDA breakpoints (tigecycline) where CLSI breakpoints are not defined.

Molecular detection

Whole genomic DNA was extracted using the QIAamp DNA Mini Kit and the QIAcube instrument (Qiagen, Valencia, CA, USA) from overnight colonies grown on agar (Remel, Lenexa, KS, USA). We designed a multiplex PCR for the rapid detection of *bla*_{KPC}, *bla*_{OXA-48}, *bla*_{VIM} and *bla*_{NDM-1} genes. Primers used have been described previously except those for *bla*_{NDM-1}, which were designed in this study: NDM-1f 5'-CCGTATGATGATTGCGGCG-3' and NDM-1r 5'-GCCCAATATTATGCACCCGG-3' (779 bp expected fragment).^{18,19} *Klebsiella pneumoniae* NCTC 13443 was used as a positive control strain for *bla*_{NDM-1}. Total DNA was subjected to multiplex PCR using the Multiplex PCR kit (Qiagen, Valencia, CA, USA) following the manufacturer's instructions. Amplicons were visualized in a 2% agarose gel containing ethidium bromide.

Carbapenemase producers were further characterized using a microarray assay (Check-MDR CT101; Check-Points, The Netherlands)²⁰ for detection of additional β -lactamases, *bla*_{ESBL} (*bla*_{TEM}, *bla*_{SHV} and *bla*_{CTX-M}) and *bla*_{AmpC} (*bla*_{CMY}, *bla*_{DHA}, *bla*_{FOX}, *bla*_{MOX}, *bla*_{ACC}, *bla*_{MIR} and *bla*_{ACT}) genes, and to confirm the presence of *bla*_{KPC} and *bla*_{NDM-1}. The *bla*_{ESBL}, *bla*_{KPC}, *bla*_{VIM} and *bla*_{NDM-1} genes were PCR-amplified and sequenced to compare them with the sequences available in the NCBI database (www.ncbi.nlm.nih.gov).

Multilocus sequence typing (MLST) was performed on carbapenemase-positive isolates of *K. pneumoniae* and *Escherichia coli* and analysed according to the Institut Pasteur MLST Databases web site (http://www.pasteur.fr/recherche/genopole/PF8/mlst). Whole DNA from *Citrobacter freundii*, *Enterobacter cloacae* and *Serratia marcescens* was analysed by enterobacterial repetitive intergenic consensus (ERIC)-PCR (ERIC-2 primer) and random amplification of polymorphic DNA (RAPD) (1254 and 1281 primers).²¹ Fingerprints were compared visually and patterns differing by at least one amplification band were classified as different.

Results and discussion

Of the 235 isolates tested, 66 (28%) carried at least one carbapenemase gene, the most common being *bla*_{NDM-1} (50%), *bla*_{KPC} (34.8%), *bla*_{VIM} (10.6%) and *bla*_{OXA-48} (4.6%). Two isolates (3%) contained both *bla*_{NDM-1} and *bla*_{OXA-48}. Notably, all the *bla*_{NDM-1}-positive isolates were from India and comprised five different genera and species, namely *K. pneumoniae*, *E. coli*, *E. cloacae*, *Providencia rettgeri* and *Morganella morganii*. These findings corroborate the results of recent epidemiological studies performed in India during 2010 in which different genera carrying the *bla*_{NDM-1} gene were reported.^{22,23} The *bla*_{NDM-1} gene has also been described in *Acinetobacter baumannii*.^{24,25} All of our sequences were identical to the *bla*_{NDM-1} gene sequence deposited in the NCBI database (FN396876).¹¹ However, a new variant of this gene was recently described in *A. baumannii*, *bla*_{NDM-2}.²⁶

In addition to showing resistance to β -lactams, all isolates harbouring the *bla*_{NDM-1} gene were highly resistant to most other antibiotic classes, including aminoglycosides and fluoroquinolones. Of the 33 *bla*_{NDM-1}-harbouring isolates, 72.7% and 69.7% remained susceptible to colistin and tigecycline, respectively (Table 1). However, three *bla*_{NDM-1}-producing strains (9.1%) were non-susceptible to both colistin and tigecycline and included one *M. morganii* that exhibited intrinsic resistance and two *K. pneumoniae* isolates. Overall, only 51.5% of the tested isolates remained susceptible to both colistin and tigecycline. These resistance patterns present a significant clinical challenge.

Different combinations of ESBLs and AmpC were observed in *bla*_{NDM-1}-possessing strains (Table 1). Most expressed *bla*_{ESBL} and *bla*_{AmpC} (18); *bla*_{CTX-M-15} and *bla*_{CMY-2} (9); *bla*_{CTX-M-15} and *bla*_{ACT/MIR} (3); *bla*_{CTX-M-15} and *bla*_{DHA} (4); *bla*_{SHV-2A} along with *bla*_{CTX-M-15} and *bla*_{DHA} (1); and *bla*_{CTX-M-15} along with *bla*_{DHA} and *bla*_{CMY-2} (1). The remaining strains possessed the following: only *bla*_{ESBL} (10); *bla*_{CTX-M-15} (8); *bla*_{SHV-12} along with *bla*_{CTX-M-15} (2); or other combinations, namely *bla*_{CTX-M-15}, *bla*_{ACT/MIR} and *bla*_{OXA-48} (2) or *bla*_{CMY-2} and *bla*_{DHA} (1) or only *bla*_{DHA} (1). Remarkably, one *bla*_{ESBL}- and *bla*_{AmpC}-negative *E. coli* isolate harboured *bla*_{NDM-1}.

Molecular typing of the 18 *K. pneumoniae* *bla*_{NDM-1}-positive isolates resulted in 10 different sequence types (STs), including two new ones designated ST571 and ST572, respectively. ST571 was characterized by the presence of four new alleles of *mdh*, *phoE*, *rpoB* and *tonB* (designated 79, 108, 55 and 142,

Table 1. Characteristics of 33 *bla*_{NDM-1}-positive isolates from India, showing genetic clustering, MICs and β -lactamase genes present

Isolate	Molecular type	Hospital	Antibiotic susceptibility (mg/L)													β -Lactamase gene
			TZP	CTX	CAZ	FEP	ETP	IPM	AMK	CIP	COL ^a	TGC ^b	ESBL	Am		
<i>K. pneumoniae</i> Cm1.62	ST147	1	>64	>128	>128	>32	>4	>8	>32	>2	1	0.5	CTX-M-15	CMV-2		
<i>K. pneumoniae</i> Cm1.63	ST147	1	>64	>128	>128	>32	>4	>8	>32	>2	1	0.5	CTX-M-15	CMV-2		
<i>K. pneumoniae</i> Pd1.49	ST147	5	>64	>128	>128	>32	>4	>8	>32	>2	1	8	CTX-M-15	—		
<i>K. pneumoniae</i> Pd1.50	ST147	5	>64	>128	>128	>32	>4	>8	>32	>2	2	8	CTX-M-15	—		
<i>K. pneumoniae</i> Pd1.51	ST147	5	>64	>128	>128	>32	>4	>8	>32	>2	2	8	CTX-M-15	—		
<i>K. pneumoniae</i> Pd1.52	ST147	5	>64	>128	>128	>32	>4	>8	>32	>2	2	8	CTX-M-15	—		
<i>K. pneumoniae</i> Pd1.53	ST147	5	>64	>128	>128	>32	>4	>8	>32	>2	1	8	CTX-M-15	—		
<i>K. pneumoniae</i> Pd1.54	ST147	5	>64	>128	>128	>32	>4	>8	>32	>2	2	8	CTX-M-15	—		
<i>K. pneumoniae</i> Pd1.55	ST147	5	>64	>128	>128	>32	>4	>8	>32	>2	1	8	CTX-M-15	—		
<i>K. pneumoniae</i> Pd1.48	ST231	5	>64	>128	>128	>32	>4	>8	>32	>2	4	8	SHV-12, CTX-M-15	—		
<i>K. pneumoniae</i> Ch7.14	ST11	4	>64	>128	>128	>32	>4	>8	>32	>2	1	0.25	—	DHA		
<i>K. pneumoniae</i> Ch7.16	ST101	4	>64	>128	>128	>32	>4	>8	>32	>2	1	0.5	CTX-M-15	DHA		
<i>K. pneumoniae</i> Ch7.15	ST340	4	>64	>128	>128	>32	>4	>8	>32	>2	1	0.25	SHV-2A, CTX-M15	DHA		
<i>K. pneumoniae</i> Ch1.41	ST391	4	>64	>128	>128	>32	>4	>8	>32	>2	4	0.25	CTX-M-15	DHA		
<i>K. pneumoniae</i> Ch1.42	ST571	4	>64	>128	>128	>32	>4	>8	>32	>2	4	1	SHV-12, CTX-M-15	—		
<i>K. pneumoniae</i> Ah1.44	ST14	3	>64	>128	>128	>32	>4	>8	>32	>2	4	4	CTX-M-15	CMV-2		
<i>K. pneumoniae</i> Sc1.47	ST20	6	>64	>128	>128	>32	>4	>8	>32	>2	4	0.5	CTX-M-15	DHA		
<i>K. pneumoniae</i> Co01.37	ST572	7	>64	>128	>128	>32	>4	>8	>32	>2	1	2	CTX-M-15	—		
<i>E. coli</i> Ah8.71	ST88	3	>64	>128	>128	>32	>4	>8	>32	>2	1	0.25	CTX-M-15	CMV-2		
<i>E. coli</i> Ah8.73	ST88	3	>64	>128	>128	>32	>4	>8	>32	>2	1	0.25	CTX-M-15	CMV-2		
<i>E. coli</i> Ah8.74	ST88	3	>64	>128	>128	>32	>4	>8	>32	>2	1	0.25	CTX-M-15	—		
<i>E. coli</i> Ah8.75	ST471	3	>64	>128	>128	>32	>4	>8	>32	>2	1	0.25	CTX-M-15	CMV-2		
<i>E. coli</i> Ch8.72	ST88	4	>64	>128	>128	>32	>4	>8	>32	>2	1	0.25	CTX-M-15	CMV-2		
<i>E. coli</i> Ch8.70	ST2	4	>64	>128	>128	>32	>4	>8	>32	>2	1	0.25	CTX-M-15	CMV-2		
<i>E. coli</i> Ch8.68	ST44	4	>64	>128	>128	>32	>4	>8	>32	>2	2	0.12	CTX-M-15	CMV-2		
<i>E. coli</i> Ch8.69	ST501	4	>64	>128	>128	>32	>4	>8	>32	>2	2	0.12	CTX-M-15	CMV-2		
<i>E. cloacae</i> Pd6.31	A ^c	5	>64	>128	>128	>32	>4	>8	>32	>2	1	1	CTX-M-15	ACT/M		
<i>E. cloacae</i> Pd6.32	A ^c	5	>64	>128	>128	>32	>4	>8	>32	>2	2	1	CTX-M-15	ACT/M		
<i>E. cloacae</i> Cm6.45	no	1	>64	>128	>128	>32	>4	>8	>32	>2	4	0.5	CTX-M-15	ACT/M		
<i>E. cloacae</i> Gh6.43	no	2	>64	>128	>128	>32	>4	>4	>32	>2	4	0.5	CTX-M-15	ACT/M		
<i>E. cloacae</i> Ch01.28	no	4	>64	>128	>128	>32	>4	>8	>32	>2	1	0.5	CTX-M-15	ACT/M		
<i>P. rettgeri</i> Ch01.27	ND	4	>64	>128	>128	>32	>4	>8	>32	>2	4	2	—	CMV-2		
<i>M. morgani</i> SC01.39	ND	6	>64	>128	>128	>32	>4	>8	>32	>2	>8	16	CTX-M-15	DHA		

TZP, piperacillin/tazobactam; CTX, cefotaxime; CAZ, ceftazidime; FEP, cefepime; ETP, ertapenem; IPM, imipenem; AMK, amikacin; CIP, ciprofloxacin; COL_a, colistin clonal relationship; ND, not determined.

CLST breakpoints used where available.

^aColistin: susceptible ≤ 2 mg/L; resistant ≥ 4 mg/L (EUCAST).

^bTigecycline: susceptible ≤ 2 mg/L; intermediate = 4 mg/L; resistant ≥ 8 mg/L (FDA).

^cBy ERIC-PCR and RAPD molecular typing.

Isolate	Molecular type	Country	Hospital	Antibiotic susceptibility (mg/L)											β-Lact	
				TZP	CTX	CAZ	FEP	ETP	IPM	AMK	CIP	COL ^a	TGc ^b	KPC	ESBL	A
K. pneumoniae Hh6.56	ST258	Greece	8	>64	>128	>128	>32	>4	>8	32	>2	>8	1	KPC-11	SHV-12	—
K. pneumoniae Hh6.57	ST258	Greece	8	>64	>128	>128	>32	>4	>8	>32	>2	>8	1	KPC-2	SHV-12	—
K. pneumoniae Hh6.58	ST258	Greece	8	>64	>128	>128	>32	>4	8	32	>2	>8	1	KPC-11	SHV-12	—
K. pneumoniae Hh7.26	ST258	Greece	8	>64	>128	>128	>32	>4	>8	32	>2	>8	1	KPC-2	SHV-12	—
K. pneumoniae Hh7.09	ST17	Greece	8	>64	>128	16	>32	>4	>8	16	>2	8	1	KPC-2	—	—
K. pneumoniae M56.62	ST258	USA	9	>64	>128	>128	>32	>4	8	32	>2	8	1	KPC-3	SHV-12	—
K. pneumoniae M56.63	ST258	USA	9	>64	>128	>128	>32	>4	>8	32	>2	8	1	KPC-2	SHV-12	—
K. pneumoniae M57.23	ST258	USA	9	>64	>128	64	>32	>4	8	32	>2	8	4	KPC-2	—	—
K. pneumoniae M57.23	ST258	USA	9	>64	>128	>128	>32	>4	8	32	>2	8	4	KPC-2	—	—
K. pneumoniae M56.67	ST258	USA	11	>64	>128	>128	>32	>4	8	32	>2	4	0.5	KPC-3	CTX-M-14	—
K. pneumoniae M56.68	ST258	USA	11	>64	>128	>128	>32	>4	4	32	>2	4	0.5	KPC-3	CTX-M-14	—
K. pneumoniae M56.68	ST258	USA	11	>64	>128	>128	>32	>4	4	32	>2	8	0.5	KPC-3	CTX-M-14	—
K. pneumoniae Sm1.38	ST258	Israel	12	>64	>128	>128	>32	>4	>8	>32	>2	>8	0.5	KPC-3	—	—
K. pneumoniae Sm7.04	ST258	Israel	12	>64	>128	>128	>32	>4	>8	>32	>2	8	1	KPC-3	—	—
K. pneumoniae Sm1.39	ST512	Israel	12	>64	>128	>128	>32	>4	>8	>32	>2	4	2	KPC-3	—	—
K. pneumoniae Cl6.54	ST258	USA	15	>64	128	>128	32	>4	4	32	>2	8	1	KPC-3	SHV-12	—
K. pneumoniae Rm1.34	ST258	Israel	10	>64	>128	>128	>32	>4	>8	>32	>2	1	1	KPC-3	—	—
K. pneumoniae Rm8.33	ST512	Israel	10	>64	>128	>128	>32	>4	>8	32	>2	4	1	KPC-3	—	—
K. pneumoniae P7.51	ST418	USA	16	>64	128	64	32	>4	8	>32	>2	8	1	KPC-2	—	—
S. marcescens Cu8.19	B ^c	Colombia	13	>64	>128	16	>32	>4	>8	>32	>2	>8	0.5	KPC-2	—	—
S. marcescens Cu8.20	B ^c	Colombia	13	>64	>128	64	>32	>4	>8	>32	>2	>8	0.5	KPC-2	—	—
E. cloacae Ms4.67	no	USA	9	>64	>128	>128	>32	>4	8	8	>2	4	2	KPC-3	—	AC
E. cloacae Tj6.05	no	USA	14	>64	128	64	>32	2	8	16	>2	4	1	KPC-3	—	AC
C. freundii Um8.42	ND	USA	17	>64	>128	>128	>32	>4	>8	32	>2	4	0.12	KPC-3	SHV-12	CN

Table 2. Characteristics of 23 bla_{KPC}-positive isolates, showing genetic clustering, MICs and β-lactamase genes present

TZP, piperacillin/tazobactam; CTX, ceftoxime; CAZ, ceftazidime; FEP, cefepime; ETP, ertapenem; IPM, imipenem; AMK, amikacin; CIP, ciprofloxacin; COL_a, colistin clonal relationship; ND, not determined.
 CLSI breakpoints used where available.
^aColistin: susceptible ≤2 mg/L; resistant ≥4 mg/L (EUCAST).
^bTigecycline: susceptible ≤2 mg/L; intermediate =4 mg/L; resistant ≥8 mg/L (FDA).
^cBy ERIC-PCR and RAPD molecular typing.

respectively) while ST572 had a novel variant of *tonB* (new allele 143). Nine of the 18 *K. pneumoniae* (from two different hospitals) were identified as ST147, the remainder (obtained from four different hospitals) being identified as ST11, ST14, ST20, ST101, ST231, ST340 and ST391 (Table 1).

The eight *E. coli* isolates that were positive for *bla*_{NDM-1} comprised five different STs, including one new type designated ST501, which was characterized by lack of amplification for *uidA*. Four isolates were identified as ST88 and the remainder as ST2, ST44 and ST471. Interestingly, the *E. coli* isolate carrying no additional β-lactamase genes was identified as ST88 while two other ST88 isolates from the same hospital carried *bla*_{CTX-M-15} and *bla*_{CMY-2}. Two *E. cloacae* from the same hospital were clonally related (cluster A by ERIC-PCR and RAPD typing), but no clonal relationship was observed for the remaining isolates.

The 23 isolates that contained *bla*_{KPC} were highly resistant to most other antibiotic classes, including aminoglycosides, fluoroquinolones and colistin. Tigecycline was the only antibiotic active against KPC producers (95.7% susceptibility) (Table 2). The *bla*_{KPC} variants found in this study were those reported most commonly worldwide, namely *bla*_{KPC-3} (*n*=13), *bla*_{KPC-2} (*n*=8) and a new allele *bla*_{KPC-11} (*n*=2) described in a previous study (C. Lascols, M. Hackel, S. H. Marshall, A. M. Hujer, D. Hoban, S. Hawser, R. Badal and R. A. Bonomo, unpublished results) (GenBank accession number HM066995). Some of the *K. pneumoniae* isolates additionally harboured *bla*_{ESBL}, namely *bla*_{SHV-12} (*n*=7) or *bla*_{CTX-M-14} (*n*=3). One *C. freundii* isolate harboured *bla*_{SHV-12} along with *bla*_{CMY-2} and two *E. cloacae* harboured *bla*_{ACT/MIR} (Table 2).

The *bla*_{KPC}-positive isolates, which were from seven hospitals, comprised four different STs. Fourteen of the 18 isolates tested belonged to ST258, which is the most common clone observed among *K. pneumoniae*. ST258, which was found in six different hospitals in three countries (Israel, Greece and the USA) carried *bla*_{KPC-3} (*n*=8), *bla*_{KPC-2} (*n*=4) or *bla*_{KPC-11} (*n*=2). Two *S. marcescens* isolates from the same hospital in Colombia were genetically related (cluster B by ERIC-PCR and RAPD typing) and the remaining isolates were of genetically different origins (Table 2).

Seven *bla*_{VIM}-containing isolates were identified, comprising three *E. cloacae* isolates carrying a *bla*_{AmpC} (*bla*_{ACT/MIR}) and one *K. pneumoniae* and two *C. freundii* isolates associated with either an ESBL (*bla*_{SHV-12}) or an AmpC (*bla*_{CMY-2}), respectively, and one *K. pneumoniae* isolate harbouring both *bla*_{SHV-31} and *bla*_{DHA} (Table 3). The only antibiotic active against *bla*_{VIM}-harbouring (*n*=7) and *bla*_{OXA-48}-harbouring (*n*=3) isolates remained tigecycline, with 85.7% and 100% susceptibility, respectively, at the FDA susceptibility breakpoint of ≤2 mg/L. Isolates carrying *bla*_{OXA-48} were always associated with *bla*_{CTX-M-15}, and in two cases were additionally associated with *bla*_{NDM-1}. All *bla*_{VIM}-containing isolates possessed a *bla*_{VIM-1}-like gene except for one *E. cloacae* isolate that carried a *bla*_{VIM-5}-like gene. Two *C. freundii* *bla*_{VIM}-possessing isolates demonstrated identical ERIC-PCR and RAPD profiles (cluster C) and were detected in the same hospital emergency room (Italy). The three *K. pneumoniae* *bla*_{OXA-48}-possessing strains belonged to multilocus STs ST43, ST147 and ST258, and there was no genetic link among these isolates.

The diversity, in these *bla*_{NDM-1}-containing isolates, of both the β-lactamase genes and the range of genera and species is consistent with the findings of Kumarasamy et al. and Walsh et al. who showed carriage of *bla*_{NDM} on distinct plasmids.^{23,27}

Table 3. Characteristics of *bla*_{VIM} and *bla*_{OXA-48}-positive isolates, showing genetic clustering, MICs and β-lactamase genes present

Isolate	Molecular type	Country	Hospital	TZP	CTX	CAZ	FEP	ETP	IPM	AMK	CIP	COL ^a	TG ^b	Antibiotic susceptibility (mg/L)					β-Lactamases									
														KPC	ESBL	AmpC	VIM-like	OXA-48	KPC	ESBL	AmpC	VIM-like	OXA-48					
<i>K. pneumoniae</i> Ud1.35	ST147	Italy	18	>64	32	>128	16	1	4	>4	>2	1	0.5	—	—	—	—	—	—	—	—	—	—	—	—	—	VIM-1	—
<i>K. pneumoniae</i> Hh7.10	ST147	Greece	8	>64	>128	>128	>32	>4	>8	32	>2	8	1	—	—	—	—	—	—	—	—	—	—	—	—	—	VIM-1	—
<i>E. cloacae</i> Cp4.65	no	USA	20	>64	>128	>128	>32	>4	8	16	>2	4	2	—	—	—	—	—	—	—	—	—	—	—	—	—	VIM-1	—
<i>E. cloacae</i> Hr5.55	no	Spain	21	>64	>128	>128	>32	>4	8	>4	>2	4	2	—	—	—	—	—	—	—	—	—	—	—	—	—	VIM-1	—
<i>E. cloacae</i> Chs6.27	no	Turkey	22	>64	>128	>128	8	>4	4	16	>2	4	8	—	—	—	—	—	—	—	—	—	—	—	—	—	VIM-5	—
<i>C. freundii</i> Ud8.35	C ^c	Italy	18	>64	128	>128	>32	2	4	>4	>2	4	0.12	—	—	—	—	—	—	—	—	—	—	—	—	—	VIM-1	—
<i>C. freundii</i> Ud8.36	C ^c	Italy	18	>64	128	>128	32	2	4	>4	>2	4	0.12	—	—	—	—	—	—	—	—	—	—	—	—	—	VIM-1	—
<i>K. pneumoniae</i> Ma6.64	ST258	India	7	>64	>128	>128	>32	>4	1	>4	>2	8	1	—	—	—	—	—	—	—	—	—	—	—	—	—	OXA-48	—
<i>K. pneumoniae</i> Ma6.65	ST147	India	19	>64	>128	>128	>32	>4	8	32	>2	4	2	—	—	—	—	—	—	—	—	—	—	—	—	—	OXA-48	—
<i>K. pneumoniae</i> Ca6.70	ST43	India	19	>64	>128	>128	>32	>4	8	32	>2	4	2	—	—	—	—	—	—	—	—	—	—	—	—	—	OXA-48	—

TZP, piperacillin/tazobactam; CTX, cefotaxime; CAZ, ceftazidime; FEP, ertapenem; ETP, ertapenem; IPM, imipenem; AMK, amikacin; CIP, ciprofloxacin; COL, colistin; TGC, tigecycline; no, no clonal relationship.

^aColistin: susceptible ≤2 mg/L; resistant ≥4 mg/L (EUCAST).

^bTigecycline: susceptible ≤2 mg/L; intermediate =4 mg/L; resistant ≥8 mg/L (FDA).

^cBy ERIC-PCR and RAPD molecular typing.

Conclusions

Pathogens that produce carbapenemases along with an ESBL or AmpC β -lactamases are particularly challenging for clinicians and are a major threat worldwide. This is an alarming public health concern since carbapenemase-containing isolates are highly resistant to most antibiotic classes, even including colistin and tigecycline in some *bla*_{NDM-1}-containing isolates. Unfortunately, new and effective antibiotics are currently still not available. Moreover, the widespread dissemination of the new NDM-1 metallo- β -lactamase requires particular attention as the genetic background demonstrates extreme mobility and versatility. Carbapenemases are becoming a worrisome global problem, and molecular epidemiological studies will be important in determining, tracking and better understanding the dissemination of these plasmid-mediated enzymes.

Acknowledgements

We would like to thank Dr Johann Pitout for providing control strains. We would also like to thank the Genotyping of Pathogens and Public Health platform (Institut Pasteur, Paris) for coding MLST alleles and profiles.

Funding

The Study for Monitoring Antimicrobial Resistance Trends is funded by Merck Research Laboratories, Inc. R. A. B. is funded by the Merit Review Program of the Department of Veterans Affairs, the National Institutes of Health (RO1AI063517-07, RO1AI072219-05) and VISN 10 GRECC.

Transparency declarations

None to declare.

References

- Paterson DL, Bonomo RA. Extended-spectrum β -lactamases: a clinical update. *Clin Microbiol Rev* 2005; **18**: 657–86.
- Deshpande P, Rodrigues C, Shetty A *et al*. New Delhi metallo- β -lactamase (NDM-1) in Enterobacteriaceae: treatment options with carbapenems compromised. *J Assoc Physicians India* 2010; **58**: 147–9.
- Bush K. Metallo- β -lactamases: a class apart. *Clin Infect Dis* 1998; **27** Suppl 1: S48–53.
- Rasmussen BA, Bush K. Carbapenem-hydrolyzing β -lactamases. *Antimicrob Agents Chemother* 1997; **41**: 223–32.
- Rasmussen BA, Bush K, Tally FP. Antimicrobial resistance in anaerobes. *Clin Infect Dis* 1997; **24** Suppl 1: S110–20.
- Bush K. Alarming β -lactamase-mediated resistance in multidrug-resistant Enterobacteriaceae. *Curr Opin Microbiol* 2010; **13**: 558–64.
- Cuzon G, Naas T, Nordmann P. [KPC carbapenemases: what is at stake in clinical microbiology?]. *Pathol Biol (Paris)* 2010; **58**: 39–45.
- Endimiani A, Depasquale JM, Forero S *et al*. Emergence of *bla*_{KPC}-containing *Klebsiella pneumoniae* in a long-term acute care hospital: a new challenge to our healthcare system. *J Antimicrob Chemother* 2009; **64**: 1102–10.
- Hirsch EB, Tam VH. Detection and treatment options for *Klebsiella pneumoniae* carbapenemases (KPCs): an emerging cause of multidrug-resistant infection. *J Antimicrob Chemother* 2010; **65**: 1119–25.
- Walsh TR. Emerging carbapenemases: a global perspective. *Int J Antimicrob Agents* 2010; **36** Suppl 3: S8–14.
- Yong D, Toleman MA, Giske CG *et al*. Characterization of a new metallo- β -lactamase gene, *bla*_{NDM-1}, and a novel erythromycin esterase gene carried on a unique genetic structure in *Klebsiella pneumoniae* sequence type 14 from India. *Antimicrob Agents Chemother* 2009; **53**: 5046–54.
- Bonomo RA. New Delhi metallo- β -lactamase and multidrug resistance: a global SOS? *Clin Infect Dis* 2011; **52**: 485–7.
- Moellering RC Jr. NDM-1—a cause for worldwide concern. *N Engl J Med* 2010; **363**: 2377–9.
- Walsh TR, Toleman MA. The new medical challenge: why NDM-1? Why Indian? *Expert Rev Anti Infect Ther* 2011; **9**: 137–41.
- Nordmann P, Carrer A. [Carbapenemases in Enterobacteriaceae]. *Arch Pediatr* 2010; **17** Suppl 4: S154–62.
- Clinical and Laboratory Standards Institute. *Performance Standards for Antimicrobial Susceptibility Testing: Twentieth Informational Supplement M100-S20-U*. CLSI, Wayne, PA, USA, 2010.
- Endimiani A, Perez F, Bajaksouzian S *et al*. Evaluation of updated interpretative criteria for categorizing *Klebsiella pneumoniae* with reduced carbapenem susceptibility. *J Clin Microbiol* 2010; **48**: 4417–25.
- Dallenne C, Da Costa A, Decre D *et al*. Development of a set of multiplex PCR assays for the detection of genes encoding important β -lactamases in Enterobacteriaceae. *J Antimicrob Chemother* 2010; **65**: 490–5.
- Yigit H, Queenan AM, Anderson GJ *et al*. Novel carbapenem-hydrolyzing β -lactamase, KPC-1, from a carbapenem-resistant strain of *Klebsiella pneumoniae*. *Antimicrob Agents Chemother* 2001; **45**: 1151–61.
- Cohen Stuart J, Dierikx C, Al Naiemi N *et al*. Rapid detection of TEM, SHV and CTX-M extended-spectrum β -lactamases in Enterobacteriaceae using ligation-mediated amplification with microarray analysis. *J Antimicrob Chemother* 2010; **65**: 1377–81.
- Cambau E, Lascols C, Sougakoff W *et al*. Occurrence of *qnrA*-positive clinical isolates in French teaching hospitals during 2002–2005. *Clin Microbiol Infect* 2006; **12**: 1013–20.
- Castanheira M, Deshpande LM, Mathai D *et al*. Early dissemination of NDM-1- and OXA-181-producing Enterobacteriaceae in Indian hospitals: report from the SENTRY Antimicrobial Surveillance Program, 2006–2007. *Antimicrob Agents Chemother* 2010; **55**: 1274–8.
- Kumarasamy KK, Toleman MA, Walsh TR *et al*. Emergence of a new antibiotic resistance mechanism in India, Pakistan, and the UK: a molecular, biological, and epidemiological study. *Lancet Infect Dis* 2010; **10**: 597–602.
- Chen Y, Zhou Z, Jiang Y *et al*. Emergence of NDM-1-producing *Acinetobacter baumannii* in China. *J Antimicrob Chemother* 2011; **66**: 1255–9.
- Karthikeyan K, Thirunarayan MA, Krishnan P. Coexistence of *bla*_{OXA-23} with *bla*_{NDM-1} and *armA* in clinical isolates of *Acinetobacter baumannii* from India. *J Antimicrob Chemother* 2010; **65**: 2253–4.
- Kaase M, Nordmann P, Wichelhaus TA *et al*. NDM-2 carbapenemase in *Acinetobacter baumannii* from Egypt. *J Antimicrob Chemother* 2011; **66**: 1260–2.
- Walsh TR, Weeks J, Livermore DM *et al*. Dissemination of NDM-1 positive bacteria in the New Delhi environment and its implications for human health: an environmental point prevalence study. *Lancet Infect Dis* 2011; **11**: 355–62.

CHAPTER VII: PUBLICATION #3

NDM-1-producing *Klebsiella pneumoniae* in Mauritius.

Laurent Poirel, **Christine Lascols**, Sandrine Bernabeu, Patrice Nordmann.

Case Reports Antimicrob Agents Chemother. 2012 Jan;56(1):598-9. doi: 10.1128/AAC.05639-11.

Epub 2011 Oct 17.

PMID: 22006002 PMCID: PMC3256058 DOI: 10.1128/AAC.05639-11

NDM-1-PRODUCING *KLEBSIELLA PNEUMONIAE* IN MAURITIUS

In 2009, the novel NDM-1 MBL, originally identified in a Swedish patient transferred from India, had already begun to spread to many different countries and continents. This letter to the editor describes for the first time an NDM-1-positive clinical isolate identified in Mauritius in 2009. This NDM-positive clinical isolate, named after me (*K. pneumoniae* CL), the original identifier, was collected from a urinary tract infection (UTI) in a 39-year-old male patient admitted to the surgical ward of Victoria Hospital in Mauritius. AST revealed a MDR clinical isolate that was resistant to all β -lactams, including carbapenems, and most other antimicrobial agents except colistin and tigecycline. This clinical isolate of *K. pneumoniae* was identified as ST231. In some of our earlier work, a clinical isolate of *K. pneumoniae* with ST131 was also identified in India. We hypothesized that these two ST131 clinical isolates may be related which would confirm the current global trends where clinical isolates from India were rapidly spreading to many parts of the world.

Molecular analysis revealed that this *K. pneumoniae* harbored the *bla*_{NDM-1} carbapenemase gene, and the *bla*_{CTX-M-15} β -lactamase on two different plasmids of 120 kb and 160 kb in length, respectively. Additional β -lactamases *bla*_{CMY-6}, *bla*_{OXA-1}, *bla*_{SHV-28}, and *bla*_{TEM-1} as well as the *rmtC* gene were also identified. The *bla*_{CMY-6} and *rmtC* genes were located on the 120 kb IncA/C NDM-1 plasmid. A similar plasmid with the same AMR determinants isolated in Kenya may be related to our plasmid but long-read sequencing would be required to confirm this hypothesis.

Overall, this study confirmed that the prevalence of NDM-1 β -lactamase continues to increase in the African subcontinent and is spreading to different countries, especially in Mauritius, as NDM-1 producers have already been detected in other countries of this continent (e.g.: Kenya).

NDM-1-Producing *Klebsiella pneumoniae* in Mauritius

The carbapenemase NDM-1 initially identified in *Escherichia* and *Klebsiella pneumoniae* in Sweden from a patient transferred from India (15) has been now identified in many enterobacterial species and isolates from patients mainly in the United Kingdom, India, and Pakistan (6) but also from many different countries in Europe, Asia, Africa, and North America (10). Most of these reports indicated a link with the Indian subcontinent, corresponding to either hospital or community acquisitions. Balkan countries have been also recently considered an additional reservoir for NDM producers (8).

Here we report an isolate from a 39-year-old male patient who was admitted to the surgery department of the Victoria Hospital, city of Quatre Bornes, Mauritius, in 2009. Urine samples grew a multidrug-resistant *K. pneumoniae* strain, and susceptibility testing performed and interpreted according to the updated CLSI guidelines (3) showed that it was resistant to all β -lactams, including carbapenems, to all aminoglycosides, and to fluoroquinolones, nitrofurantoin, chloramphenicol, and trimethoprim-sulfamethoxazole. It was susceptible only to tigecycline and colistin (MICs of 0.5 $\mu\text{g}/\text{ml}$ for both). According to phenotypic test results (synergy between aztreonam and clavulanate), *K. pneumoniae* CL produced an extended-spectrum β -lactamase (ESBL). Metallo- β -lactamase (MBL) detection performed by using the Etest combining imipenem and EDTA (AB bioMérieux, Solna, Sweden) gave a positive result. MICs of imipenem, ertapenem, doripenem, and meropenem determined by Etest for *K. pneumoniae* isolate CL were, respectively, 4, 12, 3, and 4 $\mu\text{g}/\text{ml}$. According to the CLSI updated guidelines (3), the isolate could therefore be considered resistant to those molecules, except for having intermediate susceptibility to doripenem. Unfortunately no information was available on the treatment and outcome of this patient.

PCR, sequencing, and plasmid analysis revealed that *K. pneumoniae* CL harbored the $bla_{\text{NDM-1}}$ carbapenemase gene (9), in addition to the ESBL gene $bla_{\text{CTX-M-15}}$, both of which were located on different plasmids (120 and 160 kb in size, respectively) (13). Screening for additional β -lactamase genes (13) and for 16S RNA methylase genes as reported previously (1) showed that *K. pneumoniae* CL was coharboring the $bla_{\text{CMY-6}}$, $bla_{\text{OXA-1}}$, $bla_{\text{SHV-28}}$, and $bla_{\text{TEM-1}}$ genes (a total of five β -lactamase genes) and the *rmtC* gene, encoding high-level resistance to all aminoglycosides. Mating-out assays performed as described previously (14) allowed us to obtain an *E. coli* transconjugant expressing NDM-1, exhibiting resistance to all β -lactams, although remaining susceptible to aztreonam and with reduced susceptibility to carbapenems (MICs of 3, 1, and 0.75 $\mu\text{g}/\text{ml}$ for imipenem, ertapenem, and meropenem, respectively), as well as to all sulfonamides and all aminoglycosides. This transconjugant harbored a single 120-kb plasmid that was of the IncA/C type, as identified by PCR-based replicon typing (2), and that carried the $bla_{\text{CMY-6}}$ and *rmtC* genes in addition to $bla_{\text{NDM-1}}$. Interestingly, the same resistance determinants had been identified on an IncA/C type and 120-kb plasmid from *K. pneumoniae* in Kenya (14), suggesting that both plasmids could be related.

Multilocus sequence typing was performed as described previously (4), and the results were analyzed by eBURST (<http://pubmlst.org>).

The results showed that isolate CL belonged to the ST231 sequence type that corresponds to the ST of one NDM-1-positive *K. pneumoniae* isolate recently identified from India (7), but not to that of the NDM-1-producing *K. pneumoniae* isolates from Kenya (14). Nevertheless, it does not correspond to the most common STs identified from NDM-1-positive *K. pneumoniae*, which are ST14 and ST147 (7, 11, 13). It may be speculated that isolate CL would have a link with India, considering the geographical and cultural links between the two countries, the Indian diaspora being quite numerous in Mauritius. Corresponding medical authorities in Mauritius therefore have to be alerted about the threat of such multidrug-resistant strains and should implement adequate measures in order to control their spread. This study further underlines the occurrence of NDM-1 producers in countries from the African continent, after the recent identifications made in Kenya (14), Egypt (5), and Morocco (12).

ACKNOWLEDGMENT

This work was funded by the INSERM U914, France.

REFERENCES

- Berçot B, Poirel L, Nordmann P. 12 October 2011, posting date. Updated multiplex PCR for detection of 16S rRNA methylases; high prevalence among NDM-1 producers. *Diagn. Microbiol. Infect. Dis.* [Epub ahead of print.] doi:10.1016/j.diagmicrobio.2011.08.016.
- Carattoli A, et al. 2005. Identification of plasmids by PCR-based replicon typing. *J. Microbiol. Methods* 63:219–228.
- Clinical Laboratory Standards Institute. 2011. Performance standards for antimicrobial susceptibility testing: 21st informational supplement. CLSI M100-S21. Clinical and Laboratory Standards Institute, Wayne, PA.
- Diancourt L, Passet V, Verhoef J, Grimont PA, Brisse S. 2005. Multilocus sequence typing of *Klebsiella pneumoniae* nosocomial isolates. *J. Clin. Microbiol.* 43:4178–4182.
- Kaase M, et al. 2011. NDM-2 carbapenemase in *Acinetobacter baumannii* from Egypt. *J. Antimicrob. Chemother.* 66:1260–1262.
- Kumarasamy KK, et al. 2010. Emergence of a new antibiotic resistance mechanism in India, Pakistan, and the UK: a molecular, biological, and epidemiological study. *Lancet Infect. Dis.* 10:597–602.
- Lascols C, et al. 2011. Increasing prevalence and dissemination of NDM-1 metallo- β -lactamase in India: data from the SMART study (2009). *J. Antimicrob. Chemother.* 66:1992–1997.
- Livermore DM, Walsh TR, Toleman M, Woodford N. 2011. Balkan NDM-1: escape or transplant? *Lancet Infect. Dis.* 11:164.
- Nordmann P, Poirel L, Carrère A, Toleman MA, Walsh TR. How to detect NDM-1 producers. *J. Clin. Microbiol.* 49:718–721.
- Nordmann P, Poirel L, Toleman MA, Walsh TR. 2011. Does broad spectrum β -lactam resistance due to NDM-1 herald the end of the antibiotic era for treatment of infections caused by Gram-negative bacteria? *J. Antimicrob. Chemother.* 66:689–692.
- Poirel L, Al Maskari Z, Al Rashdi F, Bernabeu S, Nordmann P. 2011. NDM-1-producing *Klebsiella pneumoniae* isolated in the Sultanate of Oman. *J. Antimicrob. Chemother.* 66:304–306.
- Poirel L, Benouda A, Hays C, Nordmann P. 19 September 2011. Emergence of NDM-1-producing *Klebsiella pneumoniae* in Morocco. *J.*

Published ahead of print 17 October 2011

Address correspondence to Patrice Nordmann, nordmann.patrice@bct.aphp.fr.

Copyright © 2012, American Society for Microbiology. All Rights Reserved.

doi:10.1128/AAC.05639-11

- Antimicrob. Chemother. [Epub ahead of print.] doi:10.1093/jac/dkr384.
13. **Poirel L, Dortet L, Bernabeu S, Nordmann P.** 2011. Genetic features of *bla*_{NDM-1}-positive *Enterobacteriaceae*. *Antimicrob. Agents Chemother.* 55: 5403–5407.
14. **Poirel L, Revathi G, Bernabeu S, Nordmann P.** 2011. Detection of NDM-1-producing *Klebsiella pneumoniae* in Kenya. *Antimicrob. Agents Chemother.* 55:934–936.
15. **Yong D, et al.** 2009. Characterization of a new metallo- β -lactamase gene, *bla*_{NDM-1}, and a novel erythromycin esterase gene carried on a unique genetic structure in *Klebsiella pneumoniae* sequence type 14 from India. *Antimicrob. Agents Chemother.* 53:5046–5054.

Laurent Poirel

INSERM U914 Emerging Resistance to Antibiotics
Hôpital de Bicêtre
Kremlin-Bicêtre, France

Christine Lascols

International Health Management Associates, Inc.
Schaumburg, Illinois, USA

Sandrine Bernabeu**Patrice Nordmann**

Service de Bactériologie-Virologie
INSERM U914 Emerging Resistance to Antibiotics
Hôpital de Bicêtre, Assistance Publique/Hôpitaux de Paris
Faculté de Médecine et Université Paris-Sud
Kremlin-Bicêtre, France



CHAPTER VIII: PUBLICATION #4

Surveillance and molecular epidemiology of *Klebsiella pneumoniae* isolates that produce carbapenemases: first report of OXA-48-like enzymes in North America

Christine Lascols, Gisele Peirano, Meredith Hackel, Kevin B Laupland, Johann DD Pitout

Antimicrob Agents Chemother. 2013 Jan;57(1):130-6. doi: 10.1128/AAC.01686-12. Epub 2012 Oct 15.
PMID: 23070171 PMCID: PMC3535978 DOI: 10.1128/AAC.01686-12

SURVEILLANCE AND MOLECULAR EPIDEMIOLOGY OF *KLEBSIELLA PNEUMONIAE* ISOLATES THAT PRODUCE CARBAPENEMASES: FIRST REPORT OF OXA-48-LIKE ENZYMES IN NORTH AMERICA

It was noteworthy that a high proportion of the *Enterobacteriales* in this collection were clinical isolates of *K. pneumoniae*, as this species is one of the most commonly collected pathogens in HAIs. This study focused on the molecular characterization of carbapenemase-producing *K. pneumoniae* isolated in 2008-2009, at the time of the emergence of NDM-1, as part of the ongoing SMART surveillance program.

The most common enzymes identified in this study were KPC, NDM, VIM, IMP, and OXA-48-producers including several different known variants: KPC-2, KPC-3, NDM-1, VIM-1, VIM-5, VIM-27, IMP-26 but also two new variants (at this time): KPC-11 and VIM-33.

Many different ESBLs and/or AmpC β -lactamases were identified: SHV-2, -5, -12, -31; CTX-M-3, -14, -15; and CMY-2, DHA-1. As with most carbapenemase producers, the only two antimicrobials that were effective were colistin and tigecycline. Other ARGs were also detected: *aac6'-Ib-cr*, *aac6'-Ib-cr+qnrB*, *qnrA*, *B* and *S*, *armA*, *armA+rmtC*, *rmtC*, and *B*. Three large clusters A (ST11), B (ST147) and C (ST258) comprising more than 10 isolates, as well as other "smaller" clusters were identified. In addition, a novel ST type, ST-903, was identified in an IMP-26-positive clinical isolate from the Philippines. Four and three different pulsotypes A, B, C, and A, B, C, D, were observed in clusters ST11 and ST258, and ST147 clusters, respectively. ST11 was mainly associated with NDM-1, OXA-48-like and CTX-M-15 mainly in India, Argentina, and Turkey. ST147 was associated with VIM, NDM-1, and CTX-M-15, in India, Greece, and Italy. ST258 was associated with KPC and SHV-12 in Greece, the USA, Israel, and Puerto Rico. Another important finding of our study was that we identified the first two OXA-48-positive isolates in the USA, suggesting that OXA-48 had arrived on the North American continent.

This unique study of carbapenemase-producing clinical isolates of *K. pneumoniae* from 2008-2009, collected in more than 35 countries around the world, provided up-to-date information related on the specific characteristics of these resistant pathogens as well as on the status of their global distribution. Our results confirmed the current worldwide geographic distribution of each type of carbapenemase-producer at that time. KPC-producers were associated with the USA, Greece, and Israel, while NDM-1-producers were associated only with India, VIM-producers with Greece, and OXA-48-producers with Turkey.

This global study, which included resource-limited countries, provided important information such as 1) the current epidemiology of specific resistance mechanisms; 2) the ability to track the spread of emerging resistance mechanisms from the endemic areas to other countries, and 3) insights regarding the spread of specific STs. This study emphasizes the importance of global molecular AMR surveillance for gathering “real-time” information on the current state of the rapidly changing epidemiology worldwide and also enables rapid identification of emerging variants, which can strengthen infection control measures.

Surveillance and Molecular Epidemiology of *Klebsiella pneumoniae* Isolates That Produce Carbapenemases: First Report of OXA-48-Like Enzymes in North America

Christine Lascols,^a Gisele Peirano,^{b,c} Meredith Hackel,^a Kevin B. Laupland,^{b,c,e,f} Johann D. D. Pitout^{b,c,d}

International Health Management Associates Inc., Schaumburg, Illinois, USA^a; Division of Microbiology, Calgary Laboratory Services^b; Departments of Pathology and Laboratory Medicine^c; Microbiology, Immunology, and Infectious Diseases^d; Medicine^e; Critical Care Medicine,^f University of Calgary, Calgary, Alberta, Canada

A study was designed to characterize nonrepeat isolates of carbapenemase-producing *K. pneumoniae* obtained from the SMART worldwide surveillance program during 2008 and 2009. Characterization was done by PCR and sequencing for *bla*_{VIM}, *bla*_{IMP}, *bla*_{NDM}, *bla*_{OXA}, *bla*_{KPC}, and plasmid-mediated quinolone resistance and virulence factors (VFs). Genetic relatedness was determined with pulsed-field gel electrophoresis (PFGE) using XbaI and multilocus sequence typing. A total of 110 isolates were included; 47 possess genes that encode *K. pneumoniae* carbapenemases (KPCs), 26 NDMs, 19 VIMs, 13 OXA-48-like, and 5 imipenems (IMPs). We identified 3 different major sequence types (STs) among 65% of the isolates (i.e., ST11 [*n* = 11], ST147 [*n* = 23], and ST258 [*n* = 38]). ST11 and ST147, producing OXA-48-like and NDMs, were found in Argentina, Turkey, Greece, Italy, and India; ST258, producing KPCs, was present in the United States, Israel, Greece, and Puerto Rico. The major STs consisted of up to 4 different pulsotypes, and each pulsotype had a specific geographical distribution. A new ST, named ST903, with *bla*_{IMP-26} was identified in the Philippines, while two *bla*_{OXA-48}-positive isolates were detected in the United States. There were no significant differences in the distribution of the VFs between the isolates; all were positive for *fimH*, *mrkD*, *wabG*, and *ureA*. This is the first report of OXA-48-like enzymes in North America. Our study highlights the importance of surveillance programs using molecular techniques as powerful tools to identify the importance of international sequence types.

The *Enterobacteriaceae*, most notably *Escherichia coli* and *Klebsiella pneumoniae*, are among the most important causes of serious hospital-acquired and community onset bacterial infections in humans (1). Since β-lactam antibiotics are a major drug class used to treat serious community onset or hospital-acquired infections caused by *Enterobacteriaceae*, resistance to these agents will continue to challenge clinical therapeutic choices. Of special concern is the development of resistance to the carbapenems, since these agents are often the last line of effective therapy available for the treatment of infections caused by multiresistant *Enterobacteriaceae* (2).

Most important within the *Enterobacteriaceae* is the increasing recognition of isolates that produce carbapenemases, which cause resistance to the carbapenems. They include the class A (*K. pneumoniae* carbapenemase [KPC] types), the class B (metallo-β-lactamases [MBLs] [i.e., VIM, imipenem [IPM], and NDM types]), and the class D (e.g., OXA-48-like enzymes) oxacillinases (3).

Multilocus sequence typing (MLST), which uses sequence variation in a number of housekeeping genes to define sequence types (STs), or clones, is an excellent tool for evolutionary studies to show common-ancestry lineages among bacteria (4). It has led to the definition of major sequence types and the recognition of successful widespread international antimicrobial-resistant sequence types, such as *E. coli* ST101, which produces NDMs (5); *E. coli* ST131, which produces various extended-spectrum β-lactamases (ESBLs) (6); and *K. pneumoniae* ST258, which produces KPCs (7).

Several worldwide surveillance studies have shown the emergence of *Enterobacteriaceae* that produce carbapenemases, especially KPCs in the United States and NDMs in the Indian subcontinent (8–10). However, limited information is available about the molecular epidemiology of carbapenemase-producing *Enterobac-*

teriaceae from different parts of the world. A study was designed to characterize nonrepeat isolates of carbapenemase-producing *K. pneumoniae* obtained from the SMART worldwide surveillance program during 2008 and 2009.

MATERIALS AND METHODS

Bacterial isolates. One hundred and ten nonduplicate isolates of *K. pneumoniae* from intra-abdominal infections collected as part of the SMART surveillance program during 2008 and 2009 were included in this study (11). Isolates were obtained from Europe (20 sites), Asia (27 sites), North America (20 sites), Latin America (12 sites), the South Pacific (6 sites), and the Middle East (2 sites).

Antimicrobial susceptibility testing. MICs of ampicillin-sulbactam (SAM), piperacillin-tazobactam (TZP), cefoxitin (FOX), cefotaxime (CTX), ceftriaxone (CRO), ceftazidime (CAZ), cefepime (FEP), ertapenem (ERT), IPM, amikacin (AMK), ciprofloxacin (CIP), tigecycline (TIG), and colistin (COL) were determined using dehydrated broth microdilution MicroScan panels (Siemens Healthcare Diagnostics, IL) or in-house panels (COL) following 2012 CLSI and manufacturers' guidelines (12). Throughout this study, results were interpreted using 2012 CLSI breakpoints for broth dilution (12). The European Committee for Antimicrobial Susceptibility Testing (EUCAST) breakpoint was used for COL, and the FDA breakpoint was used for TIG.

Received 14 August 2012 Returned for modification 7 October 2012

Accepted 9 October 2012

Published ahead of print 15 October 2012

Address correspondence to Johann D. D. Pitout, johann.pitout@cls.ab.ca.

C.L. and G.P. contributed equally to the study.

Copyright © 2013, American Society for Microbiology. All Rights Reserved.

doi:10.1128/AAC.01686-12

β -Lactamase gene identification. KPC, OXA-48-like, VIM, IMP, and NDM-carbapenemases were identified using PCR amplification and sequencing as described previously (10). A microarray assay (Check-MDR CT101; Check-Points, The Netherlands) was also used to detect additional β -lactamases, as described previously (10).

Plasmid-mediated quinolone resistance (PMQR) determinants. The amplification of the *qnrA*, *qnrS*, and *qnrB* genes was undertaken in all isolates with multiplex PCR (13). *aac(6')-Ib* and *qepA* were amplified in separate PCRs using primers and conditions previously described (14, 15). The variant *aac(6')-Ib-cr* was further identified by digestion with *BstF5I* (New England BioLabs, Ipswich, MA).

16S rRNA methylation. The amplification of genes encoding 16 RNA methylases was determined using a multiplex PCR described by Doi and Arakawa (16).

Virulence factors in *K. pneumoniae*. PCR as described by Brisse et al. was used to determine the presence of virulence genes that have previously been associated with virulence in *K. pneumoniae* (17). They included the following: *uge* (encoding UDP galacturonate 4-epimerase), *wabG* (involved in the biosynthesis of the outer core lipopolysaccharide), *ureA* (related to the urease operon), *magA* (mucoviscosity-associated gene A), *mrkD* (type 3 fimbrial adhesion), *allS* (activator of the allantoin regulon), *kfuBC* (iron uptake system), *rpmA* (regulator of mucoid phenotype), and *fimH* (fimbrial gene encoding type 1 fimbrial adhesion).

PFGE. The genetic relatedness of the ESBL-producing *K. pneumoniae* isolates was examined by pulsed-field gel electrophoresis (PFGE) following the extraction of genomic DNA and digestion with *XbaI* using the standardized *E. coli* (O157:H7) protocol established by the Centers for Disease Control and Prevention, Atlanta, GA (18). The subsequent PFGE analyses were performed on a Chef Mapper apparatus (Bio-Rad Laboratories, Hercules, CA). PFGE banding patterns were analyzed with BioNumerics software (Applied Maths, Kortrijk, Belgium), and the relatedness was calculated by the unweighted-pair group method using average linkages (UPGMA) algorithm, with similarity of bands calculated using the Dice coefficient. Cluster designation was based on the criteria of Tenover et al. (19).

MLST. MLST was performed using seven conserved housekeeping genes (*gapA*, *infB*, *mdh*, *pgi*, *phoE*, *rpoB*, and *tonB*) (20). A detailed protocol of the MLST procedure, including allelic type and ST assignment methods, is available in MLST databases from the Pasteur Institute, Paris, France (<http://www.pasteur.fr/recherche/genopole/PF8/mlst/Kpneumoniae.html>). New alleles and STs were submitted to the MLST website and were approved. The eBURST V3 algorithm (<http://eburst.mlst.net/>) was used to demonstrate phylogenetic relationships among closely related STs. Those STs that differed from the ancestor at one of the seven MLST alleles were defined as single-locus variants (SLVs), while STs that differed at two of the seven MLST alleles were defined as double-locus variants (DLVs). Clonal complexes (CCs) were defined as groups of STs that are related to each other by SLV level. For the purpose of this study, we included major sequence types only if 10 or more isolates belonged to that specific sequence type.

Statistical methods. Data were analyzed using Stata 11.2 (StataCorp, College Station, TX). Fishers' exact and χ^2 tests were used for comparing categorical variables among two and multiple groups, respectively. *P* values of less than 0.05 were deemed to represent statistical significance.

Nucleotide sequence accession number. The sequence of VIM-33 was submitted to GenBank under accession number JX258134.

RESULTS

Bacterial isolates, β -lactamases, susceptibilities, PMQR, and RNA methylases. A total of 110 *K. pneumoniae* isolates that produce carbapenemases were included in this study: 47 that produce KPCs (i.e., KPC-2 [*n* = 23], KPC-3 [*n* = 18], and KPC-11 [*n* = 6]), 26 that produce NDM-1, 19 that produce VIMs (i.e., VIM-1 [*n* = 16], VIM-5 [*n* = 1], VIM-27 [*n* = 1], and VIM-33 [*n* = 1]),

TABLE 1 Numbers of *K. pneumoniae* isolates that produce different carbapenemases^a

Carbapenemase	Country of isolation
KPC types (<i>n</i> = 47)	
KPC-2 (<i>n</i> = 23)	Greece (<i>n</i> = 14), USA (<i>n</i> = 7), Israel (<i>n</i> = 1), Puerto Rico (<i>n</i> = 1)
KPC-3 (<i>n</i> = 18)	USA (<i>n</i> = 9), Israel (<i>n</i> = 8), Columbia (<i>n</i> = 1)
KPC-11 (<i>n</i> = 6)	Greece (<i>n</i> = 6)
NDM-1 (<i>n</i> = 26)	India (<i>n</i> = 26)
OXA-48-like (<i>n</i> = 13)	
OXA-48 (<i>n</i> = 6)	Turkey (<i>n</i> = 3), Argentina (<i>n</i> = 1), USA (<i>n</i> = 2)
OXA-163 (<i>n</i> = 2)	Argentina (<i>n</i> = 2)
OXA-181 (<i>n</i> = 5)	India (<i>n</i> = 5)
VIM types (<i>n</i> = 19)	
VIM-1 (<i>n</i> = 16)	Greece (<i>n</i> = 13), Spain (<i>n</i> = 2), Italy (<i>n</i> = 1)
VIM-5 (<i>n</i> = 1)	Greece (<i>n</i> = 1)
VIM-27 (<i>n</i> = 1)	Turkey (<i>n</i> = 1)
VIM-33 (<i>n</i> = 1)	Greece (<i>n</i> = 1)
IMP-26 (<i>n</i> = 5)	Australia (<i>n</i> = 2), Philippines (<i>n</i> = 3)

^a *n*, no. of isolates.

13 that produce OXA-48-like (i.e., OXA-48 [*n* = 6], OXA-163 [*n* = 2], and OXA-181 [*n* = 5]), and 5 that produce IMP-26 (Table 1). Some of the isolates also produced ESBLs (SHV-2, -5, -12, and -31; CTX-M-3, -14 and -15) and plasmid-mediated Ampc β -lactamases (CMY-2 and DHA-1) (Table 2 shows details).

All the isolates included in this study were nonsusceptible (NS) (i.e., either intermediate or resistant) to SAM, FOX, CTX, CRO, ERT, IPM, or CIP, and 97% were NS to TZP and FEP, 95% to AMK, 32% to COL, and 15% to TIG.

Eight (7%) of the *K. pneumoniae* isolates that produced carbapenemases were positive for *aac(6')-Ib-cr*, 23 (21%) for *aac(6')-Ib-cr* with *qnrB*, 1 (1%) for *aac(6')-Ib-cr* with *qnrS*, 5 (5%) for *qnrB*, 4 (4%) for *qnrA*, and 1 (1%) for *qnrS* (Table 3). All the isolates were negative for *qepA*.

Twenty (18%) of the *K. pneumoniae* isolates that produced carbapenemases were positive for *armaA*, 2 (2%) for *armaA* with *rmtB*, 5 (5%) for *rmtC*, and 2 (2%) for *rmtB* (Table 3).

Virulence factors. All 110 isolates tested positive for *fimH*, *wabG*, and urea; 108 (98%) were positive for *mrkD*, 105 (95%) for *uge*, 11 (10%) for *kfuB*, and 7 (6%) for *alls*. All the isolates were negative for *magA*, *rpmA*, and aerobactin (Table 3).

Pulsed-field gel electrophoresis. PFGE identified 3 major clusters (with more than 10 isolates per cluster) of *K. pneumoniae* among 72 isolates, which were designated clusters A (*n* = 11), B (*n* = 23), and C (*n* = 38). Ten minor clusters (with less than 10 isolates per cluster) were also identified: clusters D (*n* = 2), E (*n* = 2), F (*n* = 2), G (*n* = 4), H (*n* = 2), I (*n* = 2), J (*n* = 3), K (*n* = 2), L (*n* = 4), and M (*n* = 2). The isolates that belonged to clusters A to M had >80% similar PFGE profiles among the isolates of each cluster. Interestingly, isolates that belonged to clusters A, H, I, and L exhibited >60% similarity of PFGE profiles to cluster C, and this suggested that they were related to cluster C. The remaining isolates (*n* = 13) were not clonally related, i.e., exhibited <60% similar PFGE profiles and did not show patterns similar to those from clusters A to M.

TABLE 2 Sequence types of *Klebsiella pneumoniae* that produce carbapenemases

Sequence type	Carbapenemase	ESBL or AmpC	Country of isolation
ST11 (<i>n</i> = 11)			
Pulsotype 11A (<i>n</i> = 3)	OXA-48	CTX-M-15	Turkey, Argentina
Pulsotype 11B (<i>n</i> = 3)	NDM-1	CTX-M-15, DHA-1	India
Pulsotype 11C (<i>n</i> = 2)	OXA-163		Argentina
Pulsotype 11D (<i>n</i> = 3)	NDM-1	CTX-M-15	India
ST147 (<i>n</i> = 23)			
Pulsotype 147A (<i>n</i> = 9)	NDM-1	CTX-M-15, CMY-2	India
Pulsotype 147B (<i>n</i> = 2)	OXA-181	CTX-M-15	India
Pulsotype 147C (<i>n</i> = 12)	VIM-1, -27, 33	SHV-12, -31, DHA-1	Greece, Italy
ST258 (<i>n</i> = 38)			
Pulsotype 258A (<i>n</i> = 7)	KPC-3	SHV-12, CTX-M-14	USA, Israel
Pulsotype 258B (<i>n</i> = 6)	KPC-3		USA, Israel
Pulsotype 258C (<i>n</i> = 20)	KPC-2, -11	SHV-12	Greece, Israel
Pulsotype 258D (<i>n</i> = 5)	KPC-2	SHV-12	USA, Puerto Rico
ST1 (<i>n</i> = 2)	VIM-1		Spain
ST14 (<i>n</i> = 2)	NDM-1	CTX-M-15, CMY-2	India
ST15 (<i>n</i> = 2)	OXA-48, -181	CTX-M-15	USA, India
ST17 (<i>n</i> = 4)	KPC-2, VIM-1, OXA-48		Greece, Turkey
ST340 (<i>n</i> = 2)	NDM-1	SHV-2, CTX-M-15	India
ST418 (<i>n</i> = 2)	KPC-2		USA
ST43 (<i>n</i> = 3)	OXA-181, VIM-5	SHV-2, CTX-M-15, CTX-M-3	India, Turkey
ST478 (<i>n</i> = 2)	IMP-26	CTX-M-15	Australia
ST512 (<i>n</i> = 4)	KPC-3		Israel, Columbia
ST626 (<i>n</i> = 2)	IMP-26		Philippines
Other STs (<i>n</i> = 13) ^a	NDM-1, VIM-1, OXA-48, KPC-2, -3, and IMP-26	CTX-M-15, SHV-5, DHA-1, CMY-2,	India, Greece, USA, Philippines

^a Including ST101, ST20, ST231, ST271, ST278, ST29, ST336, ST34, ST391, ST437, ST572, ST676, and ST903; most of them (*n* = 9) were NDM-1 producers, with CTX-M-15 from India.

MLST. MLST identified the “major” clusters as follows: cluster A, ST11; B, ST147; and C, ST258. The “minor” clusters belonged to the following sequence types: cluster D, ST1; E, ST14; F, ST15; G, ST17; H, ST340; I, ST418; J, ST43; K, ST478; L, ST512; and M, ST626. ST11, ST340, ST418, and ST512 are SLVs of ST258 and explained the similarity of PFGE patterns between these sequence types. The remaining 13 isolates were identified as ST101, ST20, ST231, ST271, ST278, ST29, ST336, ST34, ST391, ST437, ST572, ST676, and ST903 (Table 2). ST903, isolated in the Philippines, was described for the first time in this study with a novel allele (i.e., *phoE151*). ST903, with *bla*_{IMP-26}, was positive for *armA*, *rmtB*, and *qnrB*. The eBURST analysis of ST903 showed that it is not associated with any clonal complex.

ST11 and ST258 each consisted of 4 different pulsotypes, and ST147 consisted of 3 pulsotypes (i.e., there were >90% similar PFGE profiles among the isolates of each pulsotype). The geographical distribution and the presence of ESBL and AmpC β-lactamases of the different major sequence types ST11, ST147, and ST258, with their respective pulsotypes, are shown in Table 2. It was interesting that the isolates within each pulsotype produced similar carbapenemases and ESBLs and had the same geographical distribution (e.g., isolates that belonged to pulsotype 147A produced NDM-1 with CTX-M-15 and were present in India, while isolates that belonged to pulsotype 147D produced VIMs with SHV-12 and were mostly present in Greece).

ST11 produced NDM-1, OXA-48-like, and CTX-M-15; was present in India, Argentina, and Turkey; and was often positive

for *aac(6′)-Ib-cr* (Table 3). ST147 mostly produced VIMs, NDM-1, and CTX-M-15; was present in India, Greece, and Italy; and was often positive for *aac(6′)-Ib-cr* with *qnrB* and *armA* (Table 3). ST258 produced KPC and SHV-12; was present in Greece, the United States, Israel, and Puerto Rico (1 isolate); and was not associated with PMQR determinants or 16S RNA methylases (Table 3). There were no significant differences in the presence of virulence factors between ST11, ST147, ST258, and the other sequence types (Table 3). Over half of ST258 isolates (53%) were NS to COL, while 35% of ST147 isolates were NS to TIG.

Some interesting geographical distributions were also noted among the minor sequence types. ST1 with VIM-1 was present in Spain; ST14 with KPC-2, VIM-1, and OXA-48 in Greece and Turkey; ST43 with OXA-181 and VIM-5 in India and Turkey; ST478 with IMP-26 in Australia; and ST512 with KPC-2 in Israel and Columbia (Table 2).

DISCUSSION

The pandemics caused by CTX-M-, KPC-, and NDM-producing *Enterobacteriaceae* between 2000 and 2010 highlighted the desperate need for global antimicrobial resistance surveillance systems, especially in resource-limited countries, where novel resistance mechanisms are more likely to emerge (21). These surveillance systems would help to determine the scope of antimicrobial resistance in resource-limited countries, while molecular characterization would ensure the early recognition of

TABLE 3 Characteristics of *K. pneumoniae* sequence types ST11, ST147, and ST258 and other STs that produce carbapenemases

Characteristic	No. (%) with characteristic:				P value
	ST11 (n = 11)	ST147 (n = 23)	ST258 (n = 38)	Other STs (n = 38)	
Carbapenemase					<0.001
NDM	6 (55)	9 (39)	0	11 (29)	
KPC	0	0	38 (100)	9 (24)	
OXA-48-like	5 (45)	2 (9)	0	6 (16)	
VIM	0	12 (52)	0	7 (18)	
IMP	0	0	0	5 (13)	
ESBL					<0.001
CTX-M-15	5 (45)	11 (48)	0	16 (42)	
CTX-M-14	0	0	3 (8)	0	
Other CTX-Ms	0	0	0	1 (3)	
SHV-12	0	4 (17)	26 (68)	2 (5)	
Other SHVs	0	1 (4)	0	5 (13)	
AmpC					0.233
DHA-1	1 (1)	1 (4)	0	1 (3)	
CMY-2	0	2 (9)	0	1 (3)	
Country of origin					<0.001
India	6 (55)	11 (48)	0	14 (37)	
Philippines	0	0	0	3 (8)	
Australia	0	0	0	2 (5)	
USA	0	0	13 (34)	5 (13)	
Puerto Rico	0	0	1 (3)	0	
Columbia	0	0	0	1 (3)	
Argentina	3 (27)	0	0	0	
Spain	0	0	0	2 (5)	
Greece	0	11 (48)	18 (47)	6 (16)	
Italy	0	1 (4)	0	0	
Turkey	2 (18)	0	0	2 (5)	
Israel	0	0	6 (16)	3 (8)	
Antimicrobial susceptibility					<0.001
Col NS	1 (1)	3 (13)	20 (53)	9 (24)	
Tig NS	2 (18)	8 (35)	2 (5)	5 (13)	
PMQR determinants					0.016
<i>aac(6')-Ib-cr</i>	5 (45)	0	0	3 (8)	
<i>aac(6')-Ib-cr</i> with <i>qnrB</i>	1 (1)	11 (48)	0	11 (29)	
<i>aac(6')-Ib-cr</i> with <i>qnrS</i>	0	0	0	1 (3)	
<i>qnrB</i>	2 (18)	0	0	3 (8)	
<i>qnrA</i>	0	1 (4)	0	3 (8)	
<i>qnrS</i>	0	0	0	1 (3)	
16S RNA methylases					0.014
<i>armA</i>	3 (27)	7 (30)	0	10 (26)	
<i>armA</i> with <i>rmtB</i>	0	0	0	2 (5)	
<i>rmtC</i>	0	4 (17)	0	1 (3)	
<i>rmtB</i>	0	0	1 (3)	1 (3)	
Virulence factors					0.022
<i>uge</i>	9 (82)	23 (100)	38 (100)	37 (97)	
<i>wabG</i>	11 (100)	23 (100)	38 (100)	38 (100)	
<i>urea</i>	11 (100)	23 (100)	38 (100)	38 (100)	
<i>magA</i>	0	0	0	0	
<i>mrkD</i>	11 (100)	23 (100)	38 (100)	36 (95)	0.468
<i>alls</i>	0	2 (9)	0	5 (13)	0.084
<i>kfuBC</i>	0	0	0	11 (29)	<0.001
<i>rpmA</i>	0	0	0	0	
<i>fimH</i>	11 (100)	23 (100)	38 (100)	38 (100)	
Aerobactin	0	0	0	0	

novel resistance mechanisms, including the worldwide emergence of certain successful international clones or sequence types (21). Studies that combine surveillance with molecular characterization would also help with the development of rapid techniques to detect novel or emerging resistance mechanisms in travelers returning from areas of endemicity. This would ensure the appropriate implementation of infection control measures and help to curb the worldwide spread of antibiotic resistance.

The SMART program is one of the few worldwide surveillance systems that has a wide representation of microbiology laboratories among resource-limited countries. The program started in 2002 to monitor antimicrobial resistance trends among isolates from intra-abdominal-infection isolates obtained from Asia, Latin America, the South Pacific, and the Middle East. The molecular characterization of the SMART isolates started in 2008. We believe this surveillance program provides a unique opportunity to study the significance and importance of certain sequence types with their respective pulsotypes among *K. pneumoniae* that produce carbapenemases.

Infections with KPC-, VIM-, OXA-48-like-, and NDM-producing *Enterobacteriaceae* have most often been associated with visiting and being hospitalized in areas of endemicity, such as the United States, Greece, and Israel for KPCs; Greece for VIMs; Turkey for OXA-48-like; and the Indian subcontinent for NDMs (21). The results from our study support this notion (Table 1); KPC-producing isolates were mostly found in Greece, the United States, and Israel; NDM-1 producers in India; VIM producers in Greece; and IMP producers in Australia and the Philippines, while *K. pneumoniae* with OXA-48-like β -lactamases were present in India (OXA-181), Turkey (OXA-48), Argentina (OXA-163), and, surprisingly, the United States. To our knowledge, this is the first description of OXA-48-like β -lactamases from the North American continent. The 2 isolates from the United States were obtained during 2009; produced OXA-48 and CTX-M-15; belonged to ST15 and ST336, respectively; and were positive for *aac(6')-Ib-cr* with *qnrB*.

KPC-producing bacteria are endemic in certain parts of the world, and intercontinental dissemination of ST258 has contributed to the worldwide spread of KPC-producing *K. pneumoniae* (7). Of the 47 KPC-producing isolates included in our study, 38 (81%) belonged to ST258, which consisted of 4 different pulsotypes; pulsotypes 258A and 258B with KPC-3 were found in the United States and Israel, pulsotype 258C with KPC-2 and -11 was limited to Greece, while pulsotype 258D with KPC-2 was present in the United States and Puerto Rico (Table 2). A highly epidemic clone of KPC-3-producing *K. pneumoniae* emerged in Israel during 2006, causing several nosocomial outbreaks with high mortality among patients, and was most likely introduced into Israel via travelers from the United States during the early to middle part of 2000 to 2010 (22). The fact that pulsotypes 258A and 258B with KPC-3 were present in the United States and Israel (but absent in KPC isolates from Greece) suggests that there is still intercountry transfer of patients colonized or infected with KPC-3-producing *K. pneumoniae*. In 2008, 32 patients presented with infections due to KPC-producing *K. pneumoniae* in a Colombian hospital; the index case was a medical tourist who traveled from Israel to undergo a liver transplantation (23). We identified ST512, an SLV of ST258, in isolates from Israel and Columbia (Table 2), again supporting the notion that KPC-producing *K. pneumoniae* can travel

with travelers and can easily be introduced into a country or region.

K. pneumoniae isolates that produce VIMs were first reported during 2002 from patients admitted to intensive care units (ICUs) of three teaching hospitals located in Athens, Greece (24). *K. pneumoniae* with VIM-1 is endemic in certain hospitals in Greece, and nosocomial infections caused by these bacteria constitute a major public health problem for the Mediterranean country (25). VIM-27, a single-point variant of VIM-1, has been described in *K. pneumoniae* ST147 recovered from hospitals in Greece (26). Of the 19 VIM-producing isolates included in our study, 12 (63%) belonged to ST147, which consisted of 3 different pulsotypes: pulsotypes 147A with NDM-1 and 147B with OXA-181 were found in India, while pulsotype 147C with VIM-1, -27, and -33 was limited to Greece and Italy (Table 2). VIM-33, first described in this study, is a point mutant variant of VIM-1 and was present in Greece. Interestingly, the 2 VIM-1-producing isolates from Spain belonged to a different sequence type, namely, ST1.

The majority of the patients from North America, Europe, and Australia infected with NDM-producing bacteria were previously hospitalized in the Indian subcontinent (27). All the NDM-1-producing *K. pneumoniae* isolates ($n = 26$) from this study were isolated from sites in India; interestingly, 9 (35%) belonged to ST147 and 6 (23%) to ST11 (i.e., over 50% of NDM-producing *K. pneumoniae* isolates from India belonged to either ST11 or ST147). It is therefore possible that clonal spread of NDM-1 among *K. pneumoniae* isolates in India could be more significant than previously believed.

We identified 3 different major sequence types, namely, ST11, ST147, and ST258, among the majority of isolates (65%) identified during 2008 and 2009. ST11 is a truly international sequence type and has been associated with NDMs (28, 29), KPC (30–32), and CTX-M-15 (33). Our results show that this sequence type also has the ability to produce OXA-48-like enzymes from isolates found in Argentina and Turkey (Table 3). ST147 has only recently been described in Greece (26) and has been associated with VIMs and KPCs in that country (34). This sequence type is also associated with NDMs from Canada (35) and the United Kingdom (28) and VIMs from Scandinavia (36). ST147 in our study was associated with VIMs, NDMs, and OXA-48-like enzymes from *K. pneumoniae* isolates in India, Greece, and Italy (Table 3). These sequence types, especially ST147 and ST258, pose important new public health threats in countries such as the United States, Israel, Greece, and India. Our results also show that these major sequence types are possibly being imported into countries such as Puerto Rico, Columbia, Italy, and Argentina.

A study by Johnson and colleagues investigating a different successful international sequence type, *E. coli* ST131, showed that the unique combination of antimicrobial resistance and certain virulence factors most likely give ST131 a competitive advantage over other isolates of *E. coli*, promoting its clonal expansion and dominance over less virulent and/or more susceptible *E. coli* clones (37). We investigated the susceptibilities and virulence factors of ST11, ST147, and ST258 and compared the results to those for other sequence types identified in this study (Table 3). ST258 was significantly more resistant to colistin, but we failed to identify certain virulence factors that might have been responsible for the international success of ST258 (Table 3).

ST11, ST147, and ST258 are major drug-resistant pathogens among *K. pneumoniae* strains that produce carbapenemases in

different parts of the world. We urgently need well-designed epidemiological and molecular studies to understand the dynamics of transmission, risk factors, and reservoirs for *K. pneumoniae* ST11, ST147, and ST258. This will provide insight into the emergence and spread of these multiresistant sequence types that will hopefully lead to information essential for preventing infections and the spread of these bacteria.

ACKNOWLEDGMENTS

J.D.D.P. and K.B.L. previously received research funds from Merck, Pfizer, and Astra Zeneca.

This work was supported by a research grant from Calgary Laboratory Services (number 73-6350).

REFERENCES

- Paterson DL. 2006. Resistance in gram-negative bacteria: Enterobacteriaceae. *Am. J. Infect. Control* 34:S20–S28, S64–S73.
- Livermore DM, Woodford N. 2006. The beta-lactamase threat in Enterobacteriaceae, *Pseudomonas* and *Acinetobacter*. *Trends Microbiol.* 14:413–420.
- Kalpo J, Al Naiemi N, Poirel L, Nordmann P. 2011. Detection of an Ambler class D OXA-48-type beta-lactamase in a *Klebsiella pneumoniae* strain in The Netherlands. *J. Med. Microbiol.* 60:677–678.
- Sullivan CB, Diggle MA, Clarke SC. 2005. Multilocus sequence typing: data analysis in clinical microbiology and public health. *Mol. Biotechnol.* 29:245–254.
- Mushtaq S, Irfan S, Sarma JB, Doumith M, Pike R, Pitout J, Livermore DM, Woodford N. 2011. Phylogenetic diversity of *Escherichia coli* strains producing NDM-type carbapenemases. *J. Antimicrob. Chemother.* 66:2002–2005.
- Peirano G, Pitout JD. 2010. Molecular epidemiology of *Escherichia coli* producing CTX-M beta-lactamases: the worldwide emergence of clone ST131 O25:H4. *Int. J. Antimicrob. Agents* 35:316–321.
- Nordmann P, Cuzon G, Naas T. 2009. The real threat of *Klebsiella pneumoniae* carbapenemase-producing bacteria. *Lancet Infect. Dis.* 9:228–236.
- Castanheira M, Deshpande LM, Mathai D, Bell JM, Jones RN, Mendes RE. 2011. Early dissemination of NDM-1- and OXA-181-producing Enterobacteriaceae in Indian hospitals: report from the SENTRY Antimicrobial Surveillance Program, 2006–2007. *Antimicrob. Agents Chemother.* 55:1274–1278.
- Castanheira M, Mendes RE, Woosley LN, Jones RN. 2011. Trends in carbapenemase-producing *Escherichia coli* and *Klebsiella* spp. from Europe and the Americas: report from the SENTRY antimicrobial surveillance programme (2007–09). *J. Antimicrob. Chemother.* 66:1409–1411.
- Lascols C, Hackel M, Marshall SH, Hujer AM, Bouchillon S, Badal R, Hoban D, Bonomo RA. 2011. Increasing prevalence and dissemination of NDM-1 metallo-beta-lactamase in India: data from the SMART study (2009). *J. Antimicrob. Chemother.* 66:1992–1997.
- Hawser SP, Bouchillon SK, Lascols C, Hackel M, Hoban DJ, Badal RE, Woodford N, Livermore DM. 2011. Susceptibility of *Klebsiella pneumoniae* isolates from intra-abdominal infections and molecular characterization of ertapenem-resistant isolates. *Antimicrob. Agents Chemother.* 55:3917–3921.
- Clinical and Laboratory Standards Institute. 2012. Performance standards for antimicrobial susceptibility testing: 22nd informational supplement. M100-S22. CLSI, Wayne, PA.
- Robicsek A, Strahilevitz J, Sahn DF, Jacoby GA, Hooper DC. 2006. qnr prevalence in ceftazidime-resistant Enterobacteriaceae isolates from the United States. *Antimicrob. Agents Chemother.* 50:2872–2874.
- Park CH, Robicsek A, Jacoby GA, Sahn D, Hooper DC. 2006. Prevalence in the United States of aac(6′)-Ib-cr encoding a ciprofloxacin-modifying enzyme. *Antimicrob. Agents Chemother.* 50:3953–3955.
- Yamane K, Wachino J, Suzuki S, Arakawa Y. 2008. Plasmid-mediated qepA gene among *Escherichia coli* clinical isolates from Japan. *Antimicrob. Agents Chemother.* 52:1564–1566.
- Doi Y, Arakawa Y. 2007. 16S ribosomal RNA methylation: emerging resistance mechanism against aminoglycosides. *Clin. Infect. Dis.* 45:88–94.
- Brise S, Fevre C, Passet V, Issenhuth-Jeanjean S, Tournibize R, Diancourt L, Grimont P. 2009. Virulent clones of *Klebsiella pneumoniae*: identification and evolutionary scenario based on genomic and phenotypic characterization. *PLoS One* 4:e4982. doi:10.1371/journal.pone.0004982.
- Hunter SB, Vauterin P, Lambert-Fair MA, Van Duyn MS, Kubota K, Graves L, Wrigley D, Barrett T, Ribot E. 2005. Establishment of a universal size standard strain for use with the PulseNet standardized pulsed-field gel electrophoresis protocols: converting the national databases to the new size standard. *J. Clin. Microbiol.* 43:1045–1050.
- Tenover FC, Arbeit RD, Goering RV, Mickelsen PA, Murray BE, Persing DH, Swaminathan B. 1995. Interpreting chromosomal DNA restriction patterns produced by pulsed-field gel electrophoresis: criteria for bacterial strain typing. *J. Clin. Microbiol.* 33:2233–2239.
- Diancourt L, Passet V, Verhoef J, Grimont PA, Brisse S. 2005. Multilocus sequence typing of *Klebsiella pneumoniae* nosocomial isolates. *J. Clin. Microbiol.* 43:4178–4182.
- Van der Bij AK, Pitout JD. 2012. The role of international travel in the worldwide spread of multiresistant Enterobacteriaceae. *J. Antimicrob. Chemother.* 67:2090–2100.
- Navon-Venezia S, Leavitt A, Schwaber MJ, Rasheed JK, Srinivasan A, Patel JB, Carmeli Y. 2009. First report on a hyperepidemic clone of KPC-3-producing *Klebsiella pneumoniae* in Israel genetically related to a strain causing outbreaks in the United States. *Antimicrob. Agents Chemother.* 53:818–820.
- Lopez JA, Correa A, Navon-Venezia S, Correa AL, Torres JA, Briceno DF, Montealegre MC, Quinn JP, Carmeli Y, Villegas MV. 2011. Intercontinental spread from Israel to Colombia of a KPC-3-producing *Klebsiella pneumoniae* strain. *Clin. Microbiol. Infect.* 17:52–56.
- Giakkoupi P, Xanthaki A, Kanelopoulou M, Vlahaki A, Miriagou V, Kontou S, Papafragas E, Malamou-Lada H, Tzouveleki LS, Legakis NJ, Vatopoulos AC. 2003. VIM-1 Metallo-beta-lactamase-producing *Klebsiella pneumoniae* strains in Greek hospitals. *J. Clin. Microbiol.* 41:3893–3896.
- Vatopoulos A. 2008. High rates of metallo-beta-lactamase-producing *Klebsiella pneumoniae* in Greece—a review of the current evidence. *Euro Surveill.* 13:pii:8023.
- Papagiannitsis CC, Kotsakis SD, Petinaki E, Vatopoulos AC, Tzelepi E, Miriagou V, Tzouveleki LS. 2011. Characterization of metallo-beta-lactamase VIM-27, an A57S mutant of VIM-1 associated with *Klebsiella pneumoniae* ST147. *Antimicrob. Agents Chemother.* 55:3570–3572.
- Nordmann P, Poirel L, Walsh TR, Livermore DM. 2011. The emerging NDM carbapenemases. *Trends Microbiol.* 19:588–595.
- Giske CG, Froding I, Hasan CM, Turlej-Rogacka A, Toleman M, Livermore D, Woodford N, Walsh TR. 2012. Diverse sequence types of *Klebsiella pneumoniae* contribute to the dissemination of blaNDM-1 in India, Sweden, and the United Kingdom. *Antimicrob. Agents Chemother.* 56:2735–2738.
- Williamson DA, Sidjabat HE, Freeman JT, Roberts SA, Silvey A, Woodhouse R, Mowat E, Dyet K, Paterson DL, Blackmore T, Burns A, Heffernan H. 2012. Identification and molecular characterisation of New Delhi metallo-beta-lactamase-1 (NDM-1)- and NDM-6-producing Enterobacteriaceae from New Zealand hospitals. *Int. J. Antimicrob. Agents* 39:529–533.
- Balm MN, Ngan G, Jureen R, Lin RT, Teo J. 2012. Molecular characterization of newly emerged blaKPC-2-producing *Klebsiella pneumoniae* in Singapore. *J. Clin. Microbiol.* 50:475–476.
- Baraniak A, Grabowska A, Izdebski R, Fiett J, Herda M, Bojarska K, Zabicka D, Kania-Pudlo M, Mlynarczyk G, Zak-Pulawska Z, Hryniewicz W, Gniadkowski M. 2011. Molecular characteristics of KPC-producing Enterobacteriaceae at the early stage of their dissemination in Poland, 2008–2009. *Antimicrob. Agents Chemother.* 55:5493–5499.
- Qi Y, Wei Z, Ji S, Du X, Shen P, Yu Y. 2011. ST11, the dominant clone of KPC-producing *Klebsiella pneumoniae* in China. *J. Antimicrob. Chemother.* 66:307–312.
- Damjanova I, Toth A, Paszti J, Hajbel-Vekony G, Jakab M, Berta J, Milch H, Fuzi M. 2008. Expansion and countrywide dissemination of ST11, ST15 and ST147 ciprofloxacin-resistant CTX-M-15-type beta-lactamase-producing *Klebsiella pneumoniae* epidemic clones in Hungary in 2005—the new ‘MRSAs’? *J. Antimicrob. Chemother.* 62:978–985.
- Giakkoupi P, Papagiannitsis CC, Miriagou V, Pappa O, Polemis M, Tryfinopoulou K, Tzouveleki LS, Vatopoulos AC. 2011. An update of

- the evolving epidemic of blaKPC-2-carrying *Klebsiella pneumoniae* in Greece (2009–10). *J. Antimicrob. Chemother.* 66:1510–1513.
35. Peirano G, Pillai DR, Pitondo-Silva A, Richardson D, Pitout JD. 2011. The characteristics of NDM-producing *Klebsiella pneumoniae* from Canada. *Diagn. Microbiol. Infect. Dis.* 71:106–109.
36. Samuelsen O, Toleman MA, Hasseltvedt V, Fuursted K, Leegaard TM, Walsh TR, Sundsfjord A, Giske CG. 2011. Molecular characterization of VIM-producing *Klebsiella pneumoniae* from Scandinavia reveals genetic relatedness with international clonal complexes encoding transferable multidrug resistance. *Clin. Microbiol. Infect.* 17:1811–1816.
37. Johnson JR, Johnston B, Clabots C, Kuskowski MA, Castanheira M. 2010. *Escherichia coli* sequence type ST131 as the major cause of serious multidrug-resistant *E. coli* infections in the United States. *Clin. Infect. Dis.* 51:286–294.

CHAPTER IX: PUBLICATION #5

Investigation of multidrug-resistant plasmids from carbapenemase-producing *Klebsiella pneumoniae* clinical isolates from Pakistan

Christine Lascols, Blake Cherney, Andrew B Conley, Lavanya Rishishwar, Matthew A Crawford, Stephen A Morse, Debra J Fisher, Kevin Anderson, David R Hodge, Segaran P Pillai, Molly A Hughes, Erum Khan, David Sue

Front Microbiol. 2023 Jun 29 ; 14 :1192097. doi : 10.3389/fmicb.2023.1192097. eCollection 2023.

PMID: 37455731 PMCID: PMC10340517 DOI: 10.3389/fmicb.2023.1192097

INVESTIGATION OF MULTIDRUG-RESISTANT PLASMIDS FROM CARBAPENEMASE-PRODUCING KLEBSIELLA PNEUMONIAE CLINICAL ISOLATES FROM PAKISTAN

Today, more than 10 years after the emergence of NDM-1 carbapenemase, molecular epidemiology and molecular methods have evolved. Due to its technical nature, NGS technology which can provide a “complete” dataset or genomic profile for a given sample or bacterial isolate has replaced Sanger sequencing. The same dataset can be analyzed using specific bioinformatics techniques to answer different questions. The aim of this study was to investigate MDR plasmids from a collection of carbapenemase-producing clinical isolates from Pakistan. For the complete characterization of these MDR plasmids identified in 10 carbapenemase-producing clinical isolates of *K. pneumoniae*, an approach combining two sequencing-based methods such as short-read (Illumina) and long-read sequencing (Nanopore) was used. Using the ResFinder platform, genome-based AMR and AST profiles were generated with this approach and compared to BMD-based AST phenotypes. Conjugation experiments confirmed the presence of AMR determinants located on *bla*_{NDM-1} plasmids.

Overall, all clinical isolates of *K. pneumoniae* harbored multiple plasmids: *bla*_{NDM-1}, *bla*_{ESBL}, or *bla*_{OXA-48} plasmids. Both *bla*_{NDM-1} and *bla*_{ESBL} plasmids carried genes conferring resistance to β -lactams (e.g.: *bla*_{NDM-1} or *bla*_{OXA-10} or *bla*_{CTX-M-15}). *bla*_{NDM-1} plasmids carried genes conferring resistance to aminoglycosides (e.g., *armA*) and chloramphenicol, while *bla*_{ESBL} plasmids carried sulfamethoxazole and tetracycline determinants. Two isolate pairs (BL12125/BL12456 and BL8800/BABL2880) shared the same plasmids and were confirmed to be related. NGS identified genetic rearrangements in non-AMR regions of three isolates (BL849, BL12125/456) with the same AMR profiles. The genome-based predicted AST phenotypes correlated well with the AMR profile and conventional AST phenotypes, but detection of a gene conferring resistance did not always result in a resistant phenotype due to possible genetic rearrangements in some isolates. NGS approaches using Nanopore technology provide a wealth of valuable real-time information that can be used as part of an AMR action plan to guide patient treatment, detect outbreaks, and improve infection control measures.



OPEN ACCESS

EDITED BY

Isabel Henriques,
University of Coimbra, Portugal

REVIEWED BY

João Pedro Rueda Furlan,
University of São Paulo, Brazil
Nadezhda Fursova,
State Research Center for Applied Microbiology
and Biotechnology, Russia

*CORRESPONDENCE

Christine Lascols
✉ clascols@cdc.gov

RECEIVED 22 March 2023

ACCEPTED 05 June 2023

PUBLISHED 29 June 2023

CITATION

Lascols C, Cherney B, Conley AB, Rishishwar L, Crawford MA, Morse SA, Fisher DJ, Anderson K, Hodge DR, Pillai SP, Hughes MA, Khan E and Sue D (2023) Investigation of multidrug-resistant plasmids from carbapenemase-producing *Klebsiella pneumoniae* clinical isolates from Pakistan.
Front. Microbiol. 14:1192097.
doi: 10.3389/fmicb.2023.1192097

COPYRIGHT

© 2023 Lascols, Cherney, Conley, Rishishwar, Crawford, Morse, Fisher, Anderson, Hodge, Pillai, Hughes, Khan and Sue. This is an open-access article distributed under the terms of the [Creative Commons Attribution License \(CC BY\)](https://creativecommons.org/licenses/by/4.0/). The use, distribution or reproduction in other forums is permitted, provided the original author(s) and the copyright owner(s) are credited and that the original publication in this journal is cited, in accordance with accepted academic practice. No use, distribution or reproduction is permitted which does not comply with these terms.

Investigation of multidrug-resistant plasmids from carbapenemase-producing *Klebsiella pneumoniae* clinical isolates from Pakistan

Christine Lascols^{1*}, Blake Cherney¹, Andrew B. Conley², Lavanya Rishishwar², Matthew A. Crawford³, Stephen A. Morse², Debra J. Fisher³, Kevin Anderson⁴, David R. Hodge⁴, Segaran P. Pillai⁵, Molly A. Hughes³, Erum Khan⁶ and David Sue¹

¹National Center for Emerging and Zoonotic Infectious Diseases Centers for Disease Control and Prevention, Atlanta, GA, United States, ²IHRC, Inc., Atlanta, GA, United States, ³Division of Infectious Diseases and International Health, Department of Medicine, University of Virginia, Charlottesville, VA, United States, ⁴Science and Technology Directorate, U.S. Department of Homeland Security, Washington, DC, United States, ⁵Office of the Commissioner, U.S. Food and Drug Administration, Silver Spring, MD, United States, ⁶Department of Pathology and Laboratory Medicine, Aga Khan University, Karachi, Pakistan

Objectives: The study aim was to investigate multidrug-resistant (MDR) plasmids from a collection of 10 carbapenemase-producing *Klebsiella pneumoniae* clinical isolates identified within the same healthcare institution in Pakistan. Full characterization of the MDR plasmids including structure, typing characteristics, and AMR content as well as determination of their plasmid-based antimicrobial susceptibility profiles were carried out.

Methods: Plasmids were isolated from 10 clinical isolates of *Klebsiella pneumoniae*, and from a corresponding set of *Escherichia coli* transconjugants, then sequenced using Nanopore/Illumina technology to generate plasmid hybrid assemblies. Full characterization of MDR plasmids, including determination of next generation sequencing (NGS)-based AMR profiles, plasmid incompatibility groups, and types, was carried out. The structure of MDR plasmids was analyzed using the Galileo AMR platform. For *E. coli* transconjugants, the NGS-based AMR profiles were compared to NGS-predicted AMR phenotypes and conventional broth microdilution (BMD) antimicrobial susceptibility testing (AST) results.

Results: All carbapenemase-producing *K. pneumoniae* isolates (carrying either *bla*_{NDM-1}, or/and *bla*_{OXA-48}) carried multiple AMR plasmids encoding 34 antimicrobial resistance genes (ARGs) conferring resistance to antimicrobials from 6 different classes. The plasmid incompatibility groups and types identified were: IncC (types 1 and 3), IncFIA (type 26) IncFIB, IncFII (types K1, K2, K7, and K9), IncHI1B, and IncL. None of the *bla*_{NDM-1} and *bla*_{ESBL}-plasmids identified in this study were previously described. Most *bla*_{NDM-1}-plasmids shared identical AMR regions suggesting potential genetic material/plasmid exchange between *K. pneumoniae* isolates of this collection. The majority of NGS-based AMR profiles from the *E. coli* transconjugants correlated well with both NGS-based predicted and conventional AST results.

Conclusion: This study highlights the complexity and diversity of the plasmid-based genetic background of carbapenemase-producing clinical isolates from

Pakistan. This study emphasizes the need for characterization of MDR plasmids to determine their complete molecular background and monitor AMR through plasmid transmission between multi-resistant bacterial pathogens.

KEYWORDS

Klebsiella pneumoniae, AMR determinants, MDR plasmids, nanopore hybrid assemblies, AMR data analysis

Introduction

Bacterial infections caused by multidrug resistant (MDR) pathogens represent a major public health threat that jeopardizes antimicrobial therapy and its fundamental role in modern medicine (World Health Organization, 2014; CDC Report, 2019). The transfer of antimicrobial resistance (AMR) genes between bacteria of the same or different species often occurs via mobile genetic elements (MGE), such as plasmids, during horizontal gene transfer (HGT). Strategies to combat AMR include rapidly identifying MDR pathogens, elucidating disease transmission pathways for community-acquired and nosocomial infections and implementing effective prevention and infection control measures.

The continued emergence and global spread of ESBLs and carbapenemases among MDR pathogens responsible for life-threatening infections are alarming (Castanheira et al., 2019). ESBL- and carbapenemase-producing bacteria often carry additional AMR determinants that confer resistance to other classes of antimicrobials (Mączczyńska et al., 2023). The 2018 isolation of a *Klebsiella* (*K.*) *pneumoniae* strain in the United States that was resistant to all currently available antibiotics, highlights the challenges of treating infections caused by “pan-resistant pathogens” (de Man et al., 2018).

High fidelity NGS data are critical for accurate plasmid characterization and the identification of ARG variants necessary to predict AMR profiles with high concordance to phenotypic AST results in bacteria (Neuert et al., 2018; Yee and Simner, 2022). The portable MinION (Oxford Nanopore Technologies; ONT) long-read sequencer addresses the limitations observed with many NGS technologies for plasmid sequencing (e.g.; abundance of repetitive elements), and offers a potential solution in real-time and at a much lower cost (e.g., ~\$2K for a start-up kit) for reconstructing MGEs (e.g.; plasmids) and facilitating the identification of ARGs while also helping to track plasmid dissemination and the spread of AMR (Brown et al., 2023).

Since most ARGs are located on plasmids and transmitted to other microorganisms through HGT, long-read plasmid sequencing is essential for characterizing mechanisms of resistance, and understanding the basis of plasmid dissemination, and for tracking MDR pathogens during epidemiological surveillance studies in hospital and community settings (Hendriksen et al., 2019; Hadjadj et al., 2022; Valcek et al., 2022; Yang et al., 2022). Plasmid sequence data from the original strain is used as starting material, and the plasmid of interest can then be transferred to a well-characterized bacterial strain [e.g., *Escherichia* (*E.*) *coli* J53] for further comprehensive analysis. Although this approach requires additional laboratory work, there are potential benefits. Following transformation of a host strain, the plasmid-mediated contributions to AMR

transmission are clarified since the chromosome of the original strain is absent. Also, transferring a single plasmid allows the study of the direct phenotypic effects from the ARGs located on that specific plasmid.

Since the first identification of NDM-positive clinical *Enterobacteriaceae* isolates in a patient from Sweden who visited India in 2009, NDM has quickly spread worldwide due to its location on MGEs, and continuous surveillance and characterization of MGEs in regions around India where NDM originated such as Pakistan is essential for implementing control measures in hospitals and community.

The collection of 10 carbapenemase-producing (i.e., NDM- and/or OXA-48) MDR *K. pneumoniae* clinical isolates from Pakistan described in our previously published study (Lomonaco et al., 2018) was randomly selected with at least resistance to one carbapenem. Multiple STs were identified: ST11 ($n=3$), ST14 ($n=3$), ST15 ($n=1$), ST101 ($n=2$), and ST307 ($n=1$), and identical AMR content was observed for some isolates with the same ST. The aim of the current research was to further investigate and fully characterize MDR plasmids to identify potential transmission of the same plasmids or plasmids rearrangements, between *K. pneumoniae* clinical isolates in this same hospital in Pakistan. Unlike our first study using Illumina sequencing which is not suitable for plasmids, ONT (long-read sequencing) was combined with Illumina (short-read sequencing) to generate long hybrid assemblies and successfully resolve MDR plasmids. We characterized the bla_{NDM-1} and bla_{OXA-48} plasmids and identified the genetic origin of AMR for 10 MDR *K. pneumoniae* isolates using free publicly available software tools. Using these hybrid assemblies, we: (1) determined plasmid incompatibility groups and types, (2) determined NGS-based resistance profiles and compared with NGS- and AST-phenotypes from *E. coli* transconjugants (3) fully characterized the genetic structure of bla_{NDM-1} and bla_{OXA-48} plasmids. This study aimed to determine genetic relatedness and transferability of AMR plasmids within this collection of clinical isolates to help monitor AMR transmission in hospitals, which constitute an important healthcare problem.

Materials and methods

Bacterial isolates

Ten MDR *K. pneumoniae* isolates, isolated from patients in 2013 and identified as carbapenemase-positive harboring either bla_{NDM-1} ($n=5$), bla_{OXA-48} ($n=3$), or both ($n=2$), were obtained from the Clinical Microbiology Laboratory at the Department of Pathology and Laboratory Medicine, Aga Khan University Hospital, Karachi,

Pakistan. The 10 *K. pneumoniae* isolates were recently described in our previous work: BL849 (CFSAN044563), BU19801 (CFSAN044564), MS84 (CFSAN044565), BL12125 (CFSAN044566), BL12456 (CFSAN044568), BA3783 (CFSAN044569), BL13802 (CFSAN044570), BA2664 (CFSAN044571), BL8800 (CFSAN044572), and BA2880 (CFSAN044573). BL12125 (CFSAN044566), BL12456 (CFSAN044568) including two pairs of isolates closely related to each other and sharing the same AMR profile: BL12125 (CFSAN044566), and BL12456 (CFSAN044568) belonging to ST14, and BL8800 (CFSAN044572), and BA2880 (CFSAN044573) belonging to ST101, and isolated from 2 specimens (blood and catheter) on the same patient (Lomonaco et al., 2018).

Transfer experiments

*bla*_{NDM-1} or *bla*_{OXA-48} plasmids from the above 10 *K. pneumoniae* isolates were transferred to an *E. coli* J53 recipient strain. Conjugal transfer of carbapenem resistance between the *K. pneumoniae* isolates and *E. coli* J53, an azide-resistant recipient strain susceptible to all antibiotics, was performed as previously described (Lascols et al., 2008). Briefly, all isolates were grown to logarithmic phase in Brain Heart Infusion broth (BHI; ThermoFisher Scientific, MA, USA), and 2 ml of the donor and the recipient strain suspensions were mixed in flasks and incubated at 37°C for 40 min without shaking. Transconjugant selection was performed on Mueller-Hinton (ThermoFisher Scientific, MA, USA) plates containing sodium azide (100 µg/ml; ThermoFisher Scientific, MA, USA) and cefotaxime (16 µg/ml) or ticarcillin (100 µg/ml; TOKU-E, WA, USA) for transfer of *bla*_{NDM-1} and/or *bla*_{OXA-48} plasmids, respectively. Plates were incubated at 37°C and inspected at 24 and 48 h for bacterial growth.

Antimicrobial susceptibility testing

Nine *E. coli* transconjugants were obtained: Ec_pBU19801_NDM, Ec_pMS84_NDM, Ec_pBL12125_NDM, Ec_pBL12456_NDM, Ec_pBA3783_NDM, Ec_pBL13802_NDM&OXA-48, Ec_pBA2664_OXA-48, Ec_pBL8800_OXA-48, and Ec_pBA2880_OXA-48. AST was carried out according to Clinical and Laboratory Standards Institute (CLSI) guidelines (CLSI, 2018; CLSI, 2023) and results interpreted using CLSI and European Committee on Antimicrobial Susceptibility Testing (EUCAST) breakpoints (EUCAST, 2023) for the above *E. coli* transconjugants.

DNA extraction

Different DNA extraction methods were used for total genomic and plasmid DNA purification. Total genomic DNA was extracted using the QIAGEN DNA Mini Kit (QIAGEN, Valencia, CA, USA) per the manufacturer's instructions from a 10 µl loopful of cells harvested from isolated colonies grown overnight.

Plasmid DNA was extracted from 100 ml overnight culture using the QIAGEN Plasmid Midi Kit (QIAGEN, Valencia, CA, USA) per the manufacturer's instructions. For the *K. pneumoniae* isolates, the QIAGEN low-copy plasmid protocol was modified: the volumes of P1, P2, and P3 buffers were doubled (8 ml instead of 4 ml). DNA

concentrations and purity were measured using a Qubit 3.0 fluorometer (ThermoFisher Scientific, MA, USA) with a dsDNA Broad Range Assay Kit and Nanodrop (ThermoFisher Scientific, MA, USA), respectively. DNA quality was assessed by measuring absorbency ratios at 260 nm/280 nm and at 260 nm/230 nm to ensure that the manufacturer's recommended ratios of 1.8 and 2.0–2.2, respectively, were met prior to sequencing library preparation.

Illumina MiSeq library preparation and sequencing

Libraries for Illumina MiSeq sequencing were prepared from total genomic DNA of each original isolate, and each *E. coli* transconjugant using the Nextera XT library prep kit (Illumina, San Diego, CA, USA), following the manufacturer's instructions. DNA libraries were sequenced on a MiSeq instrument using 2×250 bp paired-end MiSeq Reagent Kit v2 (Illumina, San Diego, CA, USA) chemistry.

Multiplexed nanopore library preparation and sequencing

MinION sequencing libraries were prepared from plasmid DNA preparations from both *K. pneumoniae* isolates and *E. coli* transconjugants. The SQK-RBK004 rapid barcoding kit was used according to the manufacturer's protocol (Oxford Nanopore Technologies (ONT), Oxford, UK). The constructed library was loaded into a R9.4 (FLO-MIN106) Flow Cell on a MinION device and run with the High Accuracy BaseCaller script of MinKNOW1.5.12 for 72 h. The long reads sequencing data were stored on the MinIT, and accessible in real-time during the run.

Generation of assembly sequences

Whole genome *de novo* assemblies obtained from SPAdes Genome Assembler (Bankevich et al., 2012) were used for analyses. Plasmid *de novo* assemblies were obtained from four genome assemblers: Miniasm, WTDBG2, Canu, and Flye (Koren et al., 2017; Kolmogorov et al., 2019; Ruan and Li, 2020). Assemblers were run with default parameters, resulting in a genome size of 5.4 M as expected for *K. pneumoniae* isolates. Hybrid assemblies from raw MinION reads were generated first by aligning MiSeq reads to the corresponding *de novo* assembly using minimap2 (Li, 2018). These alignments and *de novo* assembly were used as input to the Pilon utility, generating the error-corrected, hybrid assembly (Walker et al., 2014). All plasmid sequences for *K. pneumoniae* isolates were uploaded to the publicly available NCBI BioProject PRJNA946140.

NGS-based prediction of antimicrobial resistance and plasmid and replicon-type analysis

Once NGS data are generated, AMR analysis tools were used for fully characterizing the AMR gene content and determining the plasmid types. Some software tools (e.g., ResFinder/PlasmidFinder/

pMLST) rely on regular updates and curation (Bortolaia et al., 2020; Carattoli and Hasman, 2020) to accurately identify known and newly emerged ARGs/plasmid types across diverse bacterial species. To generate a comprehensive genotypic AMR profile from long-read sequences, and perform plasmid-typing, three publicly available web-based tools developed by the Center for Genomic Epidemiology (CGE): ResFinder, PlasmidFinder and pMLST were used.

ResFinder 4.0¹ was used to independently identify acquired AMR determinants and determine NGS-based predicted phenotypes (Bortolaia et al., 2020). Full-length AMR determinants sharing more than 98% similarity and 100% coverage with the genes of interest found in the ResFinder databases were considered “present,” and included in the organism’s NGS-based AMR profile. In case of discrepant findings, the presence/absence of an AMR gene was determined manually by conducting BLAST analysis. Each gene’s presence was interpreted as either resistant (R) or not resistant (NR) by ResFinder 4.0. All NGS-predicted phenotypes were compared with conventional BMD results for *E. coli* transconjugants.

Plasmid incompatibility (Inc) groups were assessed using PlasmidFinder 2.0² from CGE with default settings. Briefly, PlasmidFinder uses a curated database of known plasmid replicons for identifying plasmid incompatibility groups in *Enterobacteriaceae* whole genome sequences (Carattoli and Hasman, 2020). The software assigns plasmids for identification of lineages and suggests possible reference plasmids for additional analysis.

pMLST analysis was carried out with pMLST 2.0,³ which is a web-based tool for bacterial typing of MDR *Enterobacteriaceae* for rapid detection of known plasmid types (Carattoli and Hasman, 2020).

Those web-based tools (ResFinder4.0, PlasmidFinder2.0 and pMLST2.0) were used for determining AMR profiles, plasmid Inc. groups and types for each long-read sequence from the *K. pneumoniae* isolates and their corresponding *E. coli* transconjugants.

Comparative analysis of plasmid structure in *E. coli* transconjugants.

The analysis of the structure of the *bla*_{NDM-1} plasmids transferred to *E. coli* was performed using an intuitive interface for rapid annotation of plasmid sequences that does not require bioinformatics expertise and provide detailed easy-to understand diagrams (Partridge and Tsafnat, 2018).

Results

All NDM-producers carried at least two MDR plasmids, one with *bla*_{NDM-1} and one carrying one or more genes encoding other β-lactamases, either a non-ESBL (*bla*_{TEM-1B}) and/or an ESBL (*bla*_{CTX-M-15}); except isolate MS84, which did not carry any *bla*_{ESBL}-plasmid (Table 1). All OXA-48-producers carried two to three plasmids, one with *bla*_{OXA-48}, one with *bla*_{TEM-1B}, and/or an additional plasmid containing ARGs such as those encoding aminoglycoside and/

or rifampicin resistance (Table 1). Plasmids were transferred to *E. coli* J53 via conjugation to isolate *bla*_{NDM-1}- and *bla*_{OXA-48}-plasmids for sequencing and analysis. Overall, a total of nine *E. coli* transconjugants harboring either *bla*_{NDM-1} (*n* = 6) or *bla*_{OXA-48} (*n* = 3) plasmids were obtained from the 10 *K. pneumoniae* isolates. No transconjugant was obtained for BL849. For the two *bla*_{NDM-1/OXA-48} positive isolates (BA3783 and BL13802): only *bla*_{NDM-1}-plasmid was successfully transferred from BA3783, while both *bla*_{NDM-1} and *bla*_{OXA-48}-plasmids were successfully transferred from BL13802 (Table 1).

Comparison of assembly tools for generating hybrid plasmid assemblies

Multiple assemblers can be used for whole genome DNA assembly, but we assessed which assembler would perform best on plasmids by comparing the most common assemblers: Miniasm, WTDBG2, Canu, and Flye. Overall, six PacBio plasmid sequences were used for reference: three originating from BL12456 (BL12456_pNDM, BL12456_pESBL; Table 1), and a non-AMR plasmid, and three plasmids from MS84 (MS84_pNDM; Table 1), and two non-AMR plasmids. Canu could not accurately assemble any of the six plasmid sequences. WTDBG2 correctly assembled four plasmid sequences, and Miniasm assembled five out of six plasmid sequences. Flye accurately assembled all six plasmid sequences, thus being the assembler that produced the most accurate and reliable hybrid assemblies. Therefore, Flye was used to generate assemblies for our collection of isolates (Figure 1). This finding is consistent with a new pipeline WeFaceNano for complete ONT sequence assembly and detection of AMR in plasmids (Heikema et al., 2021).

Distribution and identification of plasmid-encoded AMR determinants by antimicrobial classes using ResFinder

ResFinder identified a total of 34 plasmid-mediated AMR determinants from hybrid assemblies of the 10 MDR *K. pneumoniae* isolates. Out of the 34 plasmid-mediated AMR determinants identified, the frequencies by antimicrobial agent classes were: β-lactams (23%, *n* = 8); aminoglycosides (35%, *n* = 12; trimethoprim and macrolides, 9% each, *n* = 3); 6% (fluoroquinolones, sulfamethoxazole, chloramphenicol, 6% each, *n* = 2). For tetracycline and rifampicin, the frequency was 3% for each (*n* = 1; Supplementary Figure S1). Excluding the 2 pairs of similar *K. pneumoniae* isolates, *bla*_{NDM-1}, *bla*_{ESBL}, and *bla*_{OXA-48}-plasmids were identified in 6, 6 and 4 out of a total of 8 *K. pneumoniae* isolates, respectively. Single *bla*_{NDM-1} and *bla*_{OXA-48}-plasmids were identified in two *K. pneumoniae* isolates (BA3783 and BL13802).

A total of eight different β-lactamase genes, encoding enzymes belonging to four classes, were identified: *bla*_{NDM-1}, *bla*_{OXA-10}, *bla*_{CMY-6} and *bla*_{CMY-16} on NDM plasmids; *bla*_{CTX-M-15}, *bla*_{OXA-1}, and *bla*_{TEM-1B} on *bla*_{ESBL}-plasmids, and *bla*_{OXA-48}-plasmids (Table 2). A total of 12 different plasmid-associated aminoglycoside resistance genes were identified: *aac*(6′)-Ib, *aph*(3′)-Ib, *aph*(6)-Id, *aadA1/A2*; *aph*(3′)-VIb, *rmtC/F*, and *armA* on *bla*_{NDM-1}-plasmids, and *aac*(3)-IIa/d, *aac*(6′)-Ib-cr, *aph*(3′)-Ia, *aph*(3′)-Ib, and *aph*6-Id on *bla*_{ESBL}-plasmids (Table 2). A total of two plasmid-mediated *qnr* genes were identified

1 <https://cge.cbs.dtu.dk/services/ResFinder/>

2 <https://cge.food.dtu.dk/services/PlasmidFinder/>

3 <https://cge.food.dtu.dk/services/pMLST/>

TABLE 1 List of MDR plasmids identified from Nanopore hybrid plasmid assemblies from 10 MDR *K. pneumoniae* clinical isolates and their respective *E. coli* transconjugants.

Isolate name	Plasmid name	Size (kb)	Plasmid replicon/Type	Plasmid typing
BL849	pBL849_NDM	277	IncFIB(pNDM-Mar); IncHI1B (pNDM-MAR)	-
	pBL849_ESBL	89	IncFIB(pQil)	-
BU19801	pBU19801_NDM	116	IncFIB(pQil); IncFII(K)	FIIK_2
	pBU19801_ESBL	181	IncFIB(K)*; IncFII(K)	FIIK_7
	<i>Ec_pBU19801_NDM</i>	116	IncFIB(pQil); IncFII(K)	FIIK_2
MS84	pMS84_NDM	142	IncC	ST1
	<i>Ec_pMS84_NDM</i>	142	IncC	ST1
BL12125	pBL12125_NDM	177	IncC	ST3
	pBL12125_ESBL	128	IncFII(K); repB(R1701)	-
	<i>Ec_pBL12125_NDM</i>	177	IncC	ST3
BL12456	pBL12456_NDM	177	IncC	ST3
	pBL12456_ESBL	128	IncFII(K); repB(R1701)	-
	<i>Ec_pBL12456_NDM</i>	177	IncC	ST3
BA3783	pBA3783_NDM	116	IncFIB(pQil); IncFII(K)	FIIK_2
	pBA3783_ESBL	135	FIA(pBK30683)	FIA_26
	<i>Ec_pBA3783_NDM + OXA-48</i>	116	IncFIB(pQil); IncFII(K)	FIIK_2
		62	IncL	-
BL13802	pBL13802_NDM	130	IncFII(pKPX1)	FIIK_1
	pBL13802_ESBL	135	IncFIB(K)	-
	pBL13802_OXA-48	62	IncL	-
	<i>Ec_pBL13802_NDM</i>	130	IncFII(pKPX1)	FIIK_1
	<i>Ec_pBL13802_OXA-48</i>	62	IncL	-
BA2664	pBA2664_OXA-48	62	IncL	-
	pBA2664_AAC	69	IncC	ST1
	<i>Ec_pBA2664_OXA-48</i>	62	IncL	-
BL8800	pBL8800_OXA-48	62	IncL	-
	pBL8800_ESBL	114	IncFIB(K); IncFII(pKP91)	FIIK_9
	pBL8800_AAC	121	IncFII(pKPX1)	-
	<i>Ec_pBL8800_OXA-48</i>	62	IncL	-
BABL2880	pBABL2880_OXA-48	62	IncL	-
	pBABL2880_ESBL	114	IncFIB(K)*; IncFII(pKP91)	FIIK_9
	pBABL2880_AAC	121	IncFII(pKPX1)	-
	<i>Ec_pBABL2880_OXA-48</i>	62	IncL	-

The *E. coli* transconjugants (italics) harboring bla_{NDM-1}-plasmid ($n = 6$), bla_{OXA-48}-plasmid ($n = 3$) or both plasmids ($n = 1$) are highlighted in blue, green and brown, respectively.

in four *K. pneumoniae* isolates (*qnrB1*, $n = 3$; *qnrS1*, $n = 1$) on bla_{ESBL}-plasmids and *aac(6)-Ib-cr* was identified in 6 *K. pneumoniae* isolates on bla_{ESBL}-plasmids as well. Three variants of the *dfrA* gene (*dfrA1*, *dfrA12*, and *dfrA14*), which confer resistance to trimethoprim, and two variants of the *sul* gene (*sul1* and *sul2*), that confer resistance to sulfamethoxazole, were detected on bla_{ESBL}-plasmids. In five *K. pneumoniae* isolates, *dfrA* and *sul* genes were found together on bla_{ESBL}-plasmids: *dfrA1/sul1*, *dfrA14/sul2*, *dfrA14/sul1/sul2*, and *dfrA12/sul1*, but *sul1* alone was also identified on the bla_{NDM-1}-plasmid

in six *K. pneumoniae* isolates. The tetracycline resistance determinant *tetA* was identified on bla_{ESBL}-plasmids from two *K. pneumoniae* isolates; a third *K. pneumoniae* isolate possessed a *tetA* gene with 99.92% similarity to the reference sequence (Genbank accession number: AJ517790) on bla_{ESBL}-plasmid. The *arr2* gene conferring resistance to rifampicin, was identified on bla_{NDM-1}-plasmids in six *K. pneumoniae* isolates. Macrolide resistance conferred by determinants such as *mphE* and *msrE* genes were identified on bla_{NDM-1}-plasmids in three and four *K. pneumoniae* isolates,

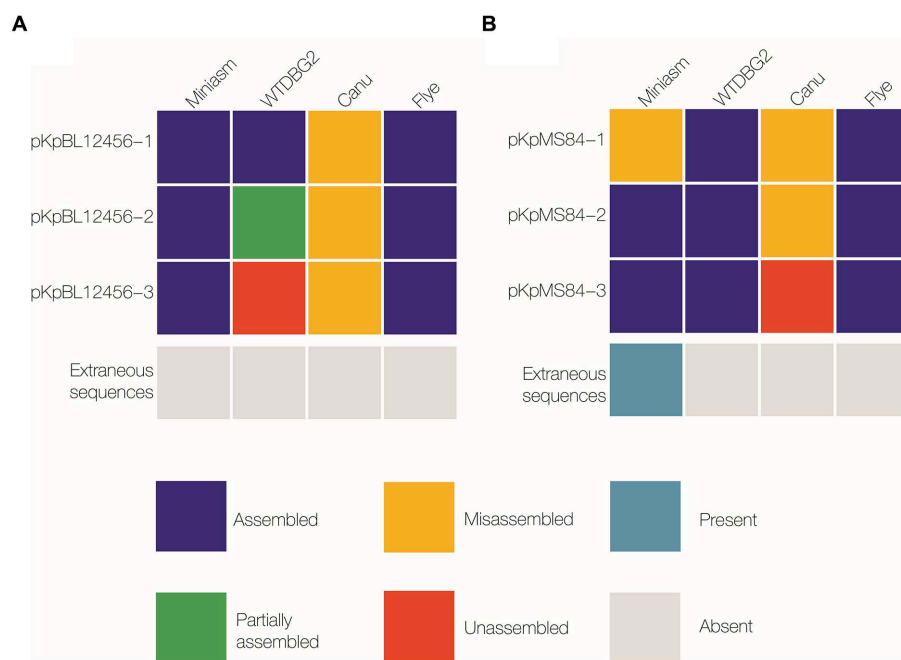

FIGURE 1

Comparison of plasmid-sequence assembly by Miniasm, WTDBG2, Canu, and Flye. Three plasmids were isolated from each of two *K. pneumoniae* strains: BL12456 (pKpBL12456-1, -2 and -3; **A**), and MS84 (pKpMS84-1, -2 and -3; **B**). Assembled was considered a complete sequence with the same nucleotide order as the reference sequence (navy); partially assembled represented a sequence that was assembled, but not as a single contig (green); misassembled included a sequence that was assembled, but the bases were in a different order than the reference sequence, or a sequence assembled multiple times resulting in an incomplete assembly (yellow); unassembled refers to a sequence that was not present in the reference assembly (orange).

respectively. *mphA* was identified on *bla*_{ESBL}-plasmid in one *K. pneumoniae* isolate. For chloramphenicol, *cmlA5* was identified on *bla*_{NDM-1}-plasmids of two *K. pneumoniae* isolates. ESBL plasmids carried a *catB4* gene, which was subsequently found to be a truncated *catB3* gene in six *K. pneumoniae* isolates, and *catA1* was present in one *K. pneumoniae* isolate (data not shown).

Analysis of NGS-based genotypic AMR profiles and phenotypes from plasmids

NGS-based AMR profiles were generated from the hybrid assemblies obtained from plasmid preps from both the original *K. pneumoniae* isolates, and the *E. coli* transconjugants. The plasmids isolated from *K. pneumoniae* isolates are noted with a p in front of the isolate designation (e.g., pMS84) while the plasmids isolated from the *E. coli* transconjugants are noted with Ec before the isolate name (e.g., Ec_pMS84_NDM). The presence of both *bla*_{NDM-1} or *bla*_{OXA-48} and *bla*_{ESBL} plasmids in the original *K. pneumoniae* isolates could not explain the contribution of each plasmid in NGS-based AMR profiles, while the NGS-based AMR profiles obtained from *E. coli* transconjugants gave insights on the contribution of ARGs present on *bla*_{NDM-1} or *bla*_{OXA-48} plasmids. All detected ARGs, NGS-predicted AST results for *K. pneumoniae* isolates, and *E. coli* transconjugants, and AST results for *E. coli* transconjugants are summarized in [Supplementary Table S2](#) (β -lactams), [Supplementary Table S3](#) (aminoglycosides), [Supplementary Table S4](#)

(fluoroquinolones), and [Supplementary Table S5](#) (trimethoprim/sulfamethoxazole, tetracyclines, and chloramphenicol).

Resistance to β -lactams

All five *K. pneumoniae* isolates (BL849, BU19801, MS84, BL12125/456) carrying *bla*_{NDM-1} were resistant to all classes of β -lactam antimicrobials. Among these isolates, three (BL849, BL12125, and BL12456) carried up to five β -lactamase genes: one *bla*_{CTX-M-15} ESBL gene, one *bla*_{OXA-1} along with *bla*_{TEM-1B} on the *bla*_{ESBL}-plasmid, and *bla*_{OXA-10} on the *bla*_{NDM-1}-plasmid, including two isolates that were found to carry the *bla*_{CMY-16} AmpC β -lactamase gene on the *bla*_{NDM-1}-plasmid. BU19801 carried three β -lactamase genes (*bla*_{CTX-M-15}, *bla*_{OXA-1}, and *bla*_{TEM-1B}) on the *bla*_{ESBL}-plasmid while MS84 carried in addition to *bla*_{NDM-1} only one gene variant of AmpC β -lactamase (*bla*_{CMY-6}) on the *bla*_{NDM-1}-plasmid. Since most β -lactamase genes were located on the *bla*_{ESBL}-plasmid, when *bla*_{NDM-1} was transferred by itself, the *E. coli* transconjugants were susceptible to aztreonam which agrees with the definition of NDM-1 producers except for BL12125 and BL12456. When additional β -lactamase genes were transferred, such as *bla*_{CMY-16} and *bla*_{OXA-1} (BL12125 and BL12456), the *E. coli* transconjugant isolates were resistant to all β -lactams tested by both the NGS-based approach and confirmed by BMD.

For most *bla*_{NDM-1}-positive *E. coli* transconjugants, the NGS-based AMR profiles were in concordance with conventional AST results, and consistent with the characteristics of NDM-1 producers [example: NDM-1 producers hydrolyze all β -lactams except aztreonam (ATM)]. However, the absence of *bla*_{CTX-M-15} was interpreted by ResFinder as

TABLE 2 Antimicrobial resistance determinants identified from Nanopore hybrid plasmid assemblies from 10 MDR *K. pneumoniae* clinical isolates.

	pBL849_NDM	pBL849_ESBL	pBU19801_NDM	pBU19801_ESBL	pMS84_NDM	pBL12125/BL12456_NDM	pBL12125/BL12456_ESBL	pBA3783_NDM	pBA3783_ESBL	pBA3783_OXA-48	pBL13802_NDM	pBL13802_ESBL	pBL13802_OXA-48	pBA2664_OXA-48	pBA2664_AAC	pBL8800/BABL2880_OXA-48	pBL8800/BABL2880_ESBL	pBL8800/BABL2880_AAC	
β-LACTAMS																			
<i>bla</i> _{CMY-6/16}					6 ¹	16													
<i>bla</i> _{CTX-M-15}		x		x			x		x			x							
<i>bla</i> _{NDM-1}	x		x		x	x		x			x								
<i>bla</i> _{OXA-1/10/48}	10	1		1		10	1		1	48			48	48		48		1	
<i>bla</i> _{SHV-1,-11,-28}																			
<i>bla</i> _{TEM-1B}		x		x			x											x	
AMINOGLYCOSIDES																			
<i>aac(3)-lia</i>		x		x			x					x			d			a	
<i>aac(6)-Ib3</i>			x		x			x							x				
<i>aac(6)-Ib-cr</i>		x		x			x		x			x						x	x
<i>aacA4</i>																			
<i>aadA1/A2</i>	A1					A1						A2							
<i>aph(3')-Ia</i>												x							
<i>aph(3'')-VIb = aphA6</i>	x																		
<i>aph(3'')-Ib = strA</i>		x	x	x			x	x										x	
<i>aph(6)-Id = strB</i>		x	x	x			x	x											
<i>armA</i>	x		x					x											
<i>rmtC/F</i>					C						F								F
FLUOROQUINOLONES																			
<i>qnrB1/S1</i>		S1					B1		B1										
TMP/SXT																			
<i>dfpA1/12/14</i>		1		14			14		14			A12							
<i>sul1/2</i>	1	1	1	2	1	1	2	1				1			1			2	
TETRACYCLINES																			
<i>tetA</i>		x					x												
CHLORAMPHENICOL																			
<i>catA1</i>		A1																	
<i>cmlA1</i>	x					x													
MACROLIDES																			
<i>mphA/E</i>			E			E		E				A							
<i>msrE</i>	x		x			x		x											
RIFAMPICIN																			
<i>arr2</i>	x					x					x								x
<i>Number of ARGs</i>	9	12	9	9	6	9	11	9	5	1	4	7	1	1	3	1	6	3	

¹An “x” indicates the presence of a gene as determined by ResFinder 4.0.

²The number indicates the variant identified for that gene (e.g., 10 refers to blaOXA-10).

³The ARGs identified on blaNDM-1-, blaESBL-, and blaOXA-48-plasmids are highlighted in pink, blue, or green, respectively. The ARGs identified at 95–99.9% are highlighted in light pink, blue or green.

⁴A dark pink or blue cell or allele designation indicates 100% identity. A threshold of 98% identity along with a full gene length were used to determine the presence of a gene.

not resistant to ceftriaxone (CRO) and ATM for five *bla*_{NDM-1}-positive (Ec_pBU19801_NDM, Ec_pMS84_NDM, Ec_pBL12125/456_NDM, Ec_pBA3783_NDM, and Ec_pBL13802_NDM) and two *bla*_{OXA-48}-positive *E. coli* transconjugants (Ec_pBA2664_OXA-48, Ec_pBL8800/pBABL2880_OXA-48) respectively, and one *K. pneumoniae* isolate (MS84). MICs for CRO and ATM were $\geq 32 \mu\text{g/ml}$ for those *K. pneumoniae/E. coli* isolates which is interpreted as resistant ($\geq 4 \mu\text{g/ml}$) by CLSI (2023), therefore those NGS-based results did not match BMD results (Supplementary Table S1).

Among the three *bla*_{OXA-48}-positive *K. pneumoniae* isolates, two (BL8800 and BA2880) carried both *bla*_{TEM-1} and *bla*_{OXA-1} located on a *bla*_{ESBL}-plasmid and were resistant to penicillins [ampicillin (AMP), amoxicillin-clavulanic acid (AMC), ampicillin-sulbactam (SAM), piperacillin-tazobactam (TZP)], cephalosporins [cefazolin (CZ), cefotaxime (CTX), ceftazidime (CAZ), CRO, cefepime (FEP)], and ATM and yet were susceptible to doripenem (DOR), meropenem (MEM) and non-susceptible to imipenem (IMP). One *K. pneumoniae* isolate (BA2664) did not carry any *bla*_{ESBL}-plasmid and was resistant to all β -lactams except CAZ and ATM.

The three *E. coli* transconjugant isolates that carried the *bla*_{OXA-48} plasmid were also resistant to the first generation of β -lactams, but not to the more recent generations of cephalosporins (FOX, CTX, CAZ, CRO, and FEP) and carbapenems (IPM, MEM, ERT) except DOR. This susceptibility profile is consistent with the observation that OXA-48 producers hydrolyze carbapenems at a low level (Poirel et al., 2012). However, in two instances (Ec_pBL8800/BABL2880_OXA-48), the presence of *bla*_{OXA-48} was interpreted by ResFinder as resistant for IPM and MER, which does not agree with MICs for IPM and MEM of 1 and 2 $\mu\text{g/ml}$ (susceptible), respectively (Supplementary Table S1).

Resistance to aminoglycosides

A total of 11 different genes responsible for high-level aminoglycoside resistance: (i) N-acetyltransferases (AAC): *aac(3)-IIa*, *aac(6')-Ib-cr*; (ii) aminoglycoside-O-nucleotidyltransferases (ANT): *aadA1*, and *aadA2*; (iii) aminoglycoside-O-phosphotransferases (APH): *aph(3')-Ia*, *aph(3'')-Ib*, *aph(6)-Id*, *aph(3')-VIIb*; $n=4$; and (iv) 16S rRNA methylases (*armA*, *rmtC* or *rmtF*) were identified in *E. coli* transconjugants (Supplementary Table S2). All of the *E. coli* transconjugants carrying *bla*_{NDM-1}-plasmids were resistant to AMK (MIC > 64 $\mu\text{g/ml}$), GM (MIC > 16 $\mu\text{g/ml}$), and TOB (MIC > 16 $\mu\text{g/ml}$) by ResFinder and confirmed by BMD.

Out of the six *bla*_{NDM-1}-positive *E. coli* transconjugants, each of the *bla*_{NDM-1}-plasmids carried at least one AMR gene conferring resistance to amikacin (AMK), gentamicin (GM) and tobramycin (TOB). Four carried *aac(6')-Ib-cr* either solely ($n=2$) or with *armA* ($n=2$), *rmtC* ($n=1$), or *rmtF* ($n=1$). In addition to all the ARGs identified on the NDM plasmids, most *K. pneumoniae* isolates harbored additional ARGs conferring resistance to aminoglycosides such as *aac3-IIa* on the *bla*_{ESBL}-plasmids except MS84 and BA3783. Ec_pBA2664_OXA-48 did not carry any aminoglycoside resistance gene except *aac3-IIId* located on a non-*bla*_{ESBL}-plasmid but was called resistant by ResFinder, which did not agree with MICs of susceptible of 8 $\mu\text{g/ml}$.

Other ARGs conferring resistance to STR (not tested by BMD) such as *aadA2* and *aph(3')-Ia* were identified on the *bla*_{ESBL}-plasmid (pBL13802) of a single *K. pneumoniae* isolate. The *aph(3'')-Ib* gene also called *strA* was identified on four *bla*_{ESBL}-plasmids (pBL849_ESBL, pBU19801_ESBL, pBL12125/456_ESBL and pBL8800/BABL2880_ESBL) and two *bla*_{NDM-1}-plasmid (pBU19801_NDM and

pBA3783_NDM). *aph(6)-Id* also called *strB* was identified on the same above plasmids except for pBL8800/BABL2880_NDM for which *aph(6)-Id* was missing. Two *E. coli* transconjugants carried *aadA1* and two carried both *aph(3'')-Ib* and *aph(6)-Id*.

Resistance to fluoroquinolones

All nine *E. coli* transconjugants that were susceptible to CIP (MICs $\leq 0.25 \mu\text{g/ml}$) did not carry any *aac(6')-Ib-cr*, *qnrB*, or *qnrS*. However, ResFinder identified a truncated version of *aac(6')-Ib-cr*-EF636461 (519 bp) in 4/9 *E. coli* transconjugants (Supplementary Table S3) which were categorized as resistant. This observation suggests that this truncated *aac(6')-Ib-cr* may not confer resistance to fluoroquinolones and should be removed from the ResFinder database until confirmation.

Resistance to trimethoprim-sulfamethoxazole (cotrimoxazole), tetracyclines, and chloramphenicol

Modified dihydrofolate reductase (DHFR) and dihydropteroate synthetase (DHPS), enzymes encoded by *dfr* and *sul*, respectively, are involved in resistance to cotrimoxazole (SXT; trimethoprim + sulfamethoxazole; Ramirez and Tolmasky, 2010). The five *E. coli* transconjugants carrying *bla*_{NDM-1}-plasmid that harbored *sulI* without any *dfr* genes likely explained their susceptibility to SXT. The absence of the *dfr/sul* genes on *bla*_{NDM-1}-plasmid for four *E. coli* transconjugants was consistent with the observed susceptibility to SXT. However, Resfinder does not propose any interpretation categorization for SXT susceptibilities. The absence of the *tetA* gene on *bla*_{NDM-1}-plasmid was consistent with the observed susceptibility to TET by AST. Two *E. coli* transconjugants, carrying *cmlA5* on the *bla*_{NDM-1} plasmid, were susceptible to CHL (MIC = 8 $\mu\text{g/ml}$) but categorized as resistant to CHL by Resfinder (Supplementary Table S4).

Structure of MDR plasmids identified in MDR *Klebsiella pneumoniae* clinical isolates

The structures of each plasmid transferred *via* conjugation and identified in *E. coli* transconjugants were consistent with the plasmids identified in the *K. pneumoniae* study isolates (100% similarity). The *bla*_{NDM-1}-plasmid was the only plasmid that was transferred for BA3783 while both *bla*_{NDM-1} and *bla*_{OXA-48}-plasmids were transferred for BL13802. Lastly, no transconjugant was obtained for BL849. The incompatibility groups identified for (1) *bla*_{NDM-1}, (2) *bla*_{ESBL}, and (3) *bla*_{OXA-48}-plasmids were: (1) IncFIB, IncHI1B, IncFII, and IncC; (2) IncFIB; and IncFII; and (3) IncL, respectively. The pMLST types identified were IncC11 and IncC3 ($n=2$), IncFII2 and IncFIII among *bla*_{NDM-1}-plasmids and were IncFIIK7, IncFIIK9, and IncFIIA26 among *bla*_{ESBL}-plasmids (Table 1).

NDM-producers ($n=7$): BL849, BU19801, MS84, BL12125, BL12456, BA3783, BL13802

Among the seven *bla*_{NDM-1}-positive *K. pneumoniae* isolates, the number of AMR determinants encoded on *bla*_{NDM-1} and *bla*_{ESBL}-plasmids varied from 4 to 10, and 7–12 genes, respectively. Whole-plasmid hybrid sequencing identified seven *bla*_{NDM-1}-plasmids of various sizes ranging from 117 to 277 kb: pBL849_NDM (277 kb), pBU19801_NDM (181 kb), pMS84_NDM (142 kb), pBL12125_NDM

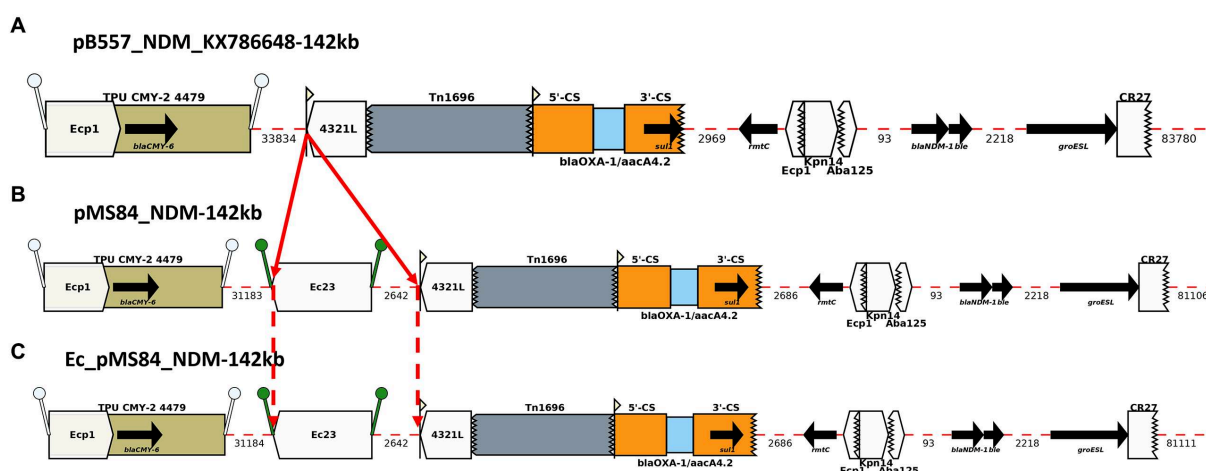

FIGURE 2
 Annotation Diagram of (A) pB557-NDM_KX786648, (B) MS84_pNDM, and (C) Ec_MS84_pNDM using Galileo AMR platform. Gaps >50 (base pairs) bp are indicated by dashed red lines and the length in bp is given. Gene features (e.g., *bla_{CMY-6}*, *sul1*, *rmtC*, *bla_{NDM-1}*) are shown by arrows; gene cassettes (e.g., *bla_{OXA-1/aacA4.2}*) by pale blue boxes; the CS of integrons as orange boxes; and IS (e.g., ISEc23) as white block arrows labeled with the IS number/name and the pointed end indicating IR_R. Unit transposons (e.g., Tn1696) are shown as boxes of different colors and their IR are shown as flags, with the flat side at the outer boundary of the transposon. Truncated features (e.g., Tn1696) are shown with a jagged edge on the truncated side(s). Direct repeats flanking ISs are shown as 'lollipops' of the same color ISEc1 (white) and ISEc23 (green). Here, an ISEc23 has been inserted in MS84_pNDM and Ec_MS84_pNDM compared to pB557-NDM-KX786648.

and pBL12456_NDM (177 kb), pBA3783_NDM (117 kb), and pBL13802_NDM (130 kb). Among the seven *bla_{NDM-1}*-plasmids, IncC was the most common incompatibility group identified (*n* = 3), followed by IncFIB (*n* = 2), IncFII (*n* = 1), and IncFIB/IncHI1B (*n* = 1; Table 1).

BLAST analysis of the complete nucleotide sequences of MDR plasmids identified in this study found zero exact matches to previously reported MDR plasmids for five *K. pneumoniae* isolates: pBL849_NDM, pBU19801_NDM, pBL12125/456_NDM and pBA3783_NDM. However, pMS84_NDM and pBL13802_NDM each shared high similarity with two plasmids previously described, pB557-NDM-KX786648 (142 kb) and pKX-1-NDM-AP012055 (250 kb), respectively (Figures 2, 3).

pMS84_NDM shared 100% identity with pB557-NDM_KX786648 (GenBank accession number: KX786648), a *bla_{NDM-1}*-plasmid isolated from an *Enterobacter cloacae* clinical isolate in China in 2016. An ISEc23 (5 kb) was inserted downstream the ISEc1/*bla_{CMY-6}* module and upstream of a Tn1696 transposon in pMS84_NDM (Figure 2). The ARGs identified on this *bla_{NDM-1}*-plasmid were: *bla_{CMY-6}*, *sul1*, *rmtC*, and *bla_{NDM-1}*.

pBL13802_NDM was identical to part of the 250-kb total sequence (99.98% similarity) of plasmid pKPX-1-NDM-AP012055 (Genbank accession number: AP012055), a plasmid isolated from *K. pneumoniae* strain KPX-1, obtained from a Taiwanese patient with a hospitalization history in New Delhi (Huang et al., 2013). pBL13802_NDM lacked a 120-kb region from pKPX-1 plasmid. pBL13802_NDM contained a 22-kb AMR region, also found in pKPX-1-AP012055, composed of several gene cassettes, such as *catB3*, *aac(6)-Ib*, *aacA4* and *arr2*, as well as a region containing *bla_{NDM-1}* (Figure 3).

BLAST analysis identified regions/AMR modules that were present in several of the study plasmids: Modules A-D and N0-N3.

The AMR modules identified in this study are illustrated in Figures 4, 5, respectively. Module A is composed of a complete gene cassette of 5 ARGs: 3'-CS-[*arr2/cmlA5/bla_{OXA-10/aadA1/sul1}*]-5'-CS. Module B has *armA*, *msrE*-like, and *mphE* (2 copies) genes, along with multiple insertion sequences (IS; ISEc28, ISEc29, and ISKpn21). Module C contains two ARGs: a truncated *aac(6)-Ib-cr* and *sul1*. Module D is composed of ISKpn25 along with two *strA/strB* ARGs (Figure 4).

Module N0 here is composed of *bla_{NDM-1}*, *ble_{MBL}*, and *gro_{ESL}* which is consistent with the backbone of a truncated ΔTn125 transposon previously described in multiple *bla_{NDM-1}*-plasmids (Dong et al., 2019). Prior studies showed that IS*Aba125* mobilized "en bloc" both *bla_{NDM-1}* and bleomycin *ble_{MBL}* genes which originated from the same progenitor (Poirel et al., 2011). *bla_{NDM-1}* is mainly and widely spread by an IS*Aba125*-bounded composite transposon Tn125 (Poirel et al., 2012). Module N1 is a section downstream of Module N with multiple truncated IS (ISCr27/ISCRp4/IS3000) along with a complete sequence of IS3000 and IS26. Module N2 is composed of Module N except *gro_{ESL}* is flanked upstream of IS*Aba125* by a set of three ARGs (e.g., *bla_{OXA-10}*, *aadA1*, and *sul1*). Lastly, Module N3 is very similar with Module N1 with an addition of IS5 upstream of IS*Aba125* (Figure 5).

Among the seven *bla_{NDM-1}*-positive *K. pneumoniae*: pBL849_NDM and pBL12125/456_NDM, shared modules A and B and some variations of module N (N1, BL849 and N2, BL12125/456) while pBU19801_NDM and pBA3783_NDM, shared the exact same modules: B, C, D and N3 (Figure 6).

pBL849_NDM, and pBL12125/456_NDM shared a common set of seven ARGs (Table 2) including *arr-2*, *cmlA5*, *aadA1*, *sul1* as part of Module A, and *armA*, *msrE*, and *mphE* (2 copies for pBL849_NDM) as part of Module B. Also, pBL849_NDM and pBL12125/456_NDM carried different genes or IS around *bla_{NDM-1}* (Module N1 for pBL849_NDM and Module N2 for pBL12125/456_NDM; Figure 6).

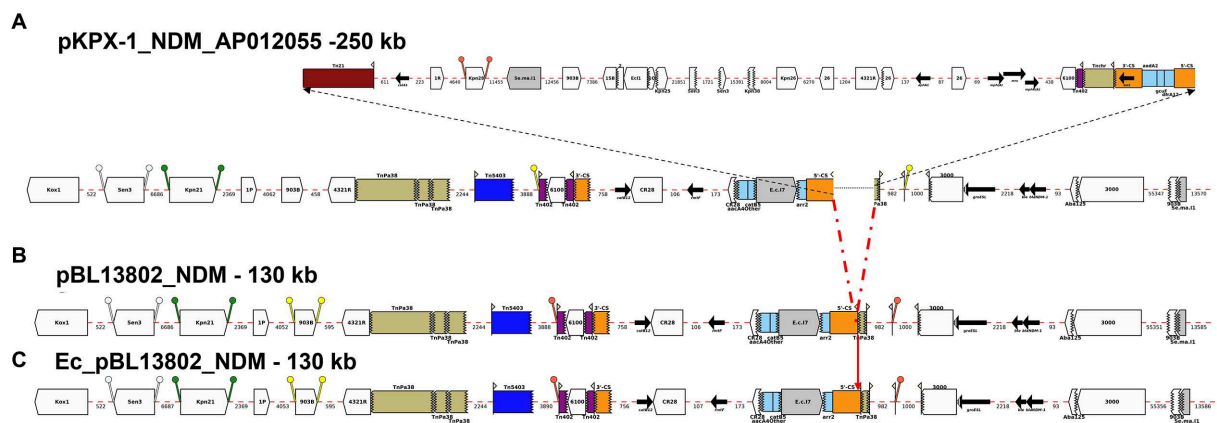

FIGURE 3
 Annotation Diagram of (A) pKPX-1-NDM_AP012055, (B) BL13802_pNDM, and (C) Ec_BL13802_pNDM using Galileo AMR platform. Gaps >50 (base pairs) bp are indicated by dashed red lines and the length in bp is given. Genes features (e.g., *catB12*, *rmtF*, *bla_{NDM-1}*) are shown by arrows; gene cassettes (*catB3/aacA4/arr2*) by pale blue boxes; the CS of integrons as orange boxes; and IS (e.g., *IS3000*) as white block arrows labelled with the IS number/name and the pointed end indicating IR_R. Unit transposons are shown as boxes of different colors (e.g., Tn5403, blue, Tn40, dark purple) and their IR are shown as flags, with the flat side at the outer boundary of the transposon. Truncated features (e.g., 3'-CS) are shown with a jagged edge on the truncated side(s). Direct repeats flanking ISs are shown as 'lollipops' of the same color IS*kpn21* (green) and IS903B (yellow). Here, a 46-kb region containing *aacA4*, *catB3*, and *arr2* cassettes is found in pKPX-1-A012055 upstream of *bla_{NDM-1}* both in BL13802_pNDM, and Ec_BL13802_pNDM.

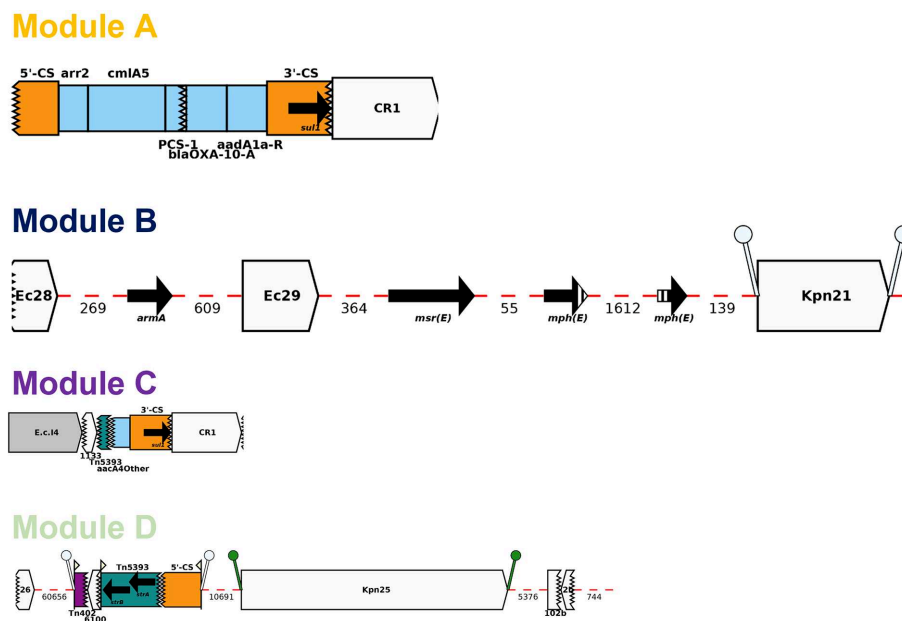

FIGURE 4
 Representation of AMR modules A-D described in this study using Galileo AMR platform.

pBU19801_NDM and pBA3783_NDM shared a common set of eight ARGs (Table 2) including truncated-*aac(6')-Ib-cr* and *sul1* (Module C); *armA*, *msrE*, and *mphE* (Module B), and *aph(3'')-Ib* (or *strA*), *aph(6)-Id* (or *strB*; Module D) along with Module N3 (Figure 6). pBL12125/456 had the same AMR profiles for both *bla_{NDM-1}*-10 ARGs) and *bla_{ESBL}*-11 ARGs) plasmids. pBL12125/456_NDM also contained *bla_{CMY-16}*-like downstream of module B which was not present in pBL849_NDM. Conversely, pBL849_NDM also contained an additional AMR gene,

aph(3'')-Vib (=aph6) upstream of Module N1 which was not present in pBL12125_NDM and pBL12456_NDM (Table 2; Figure 6).

Module A was shared by pBL849_NDM, pBL12125/456_NDM (*n*=3) while module B was shared by pBL849_NDM, pBL12125/456_NDM, pBU19801_NDM, and pBA3783_NDM (*n*=5). Modules C and D were shared by pBU19801_NDM and pBA3783_NDM (*n*=2). Module N0 was shared by all five *K. pneumoniae* NDM-1 producers including modifications for pBL849_NDM (Module N1)

pBL12125_NDM and pBL12456_NDM (Module N2), and pBU19801_NDM and pBA3783_NDM (Module N3; Figure 6).

OXA-48-producers (n =5): BA3783, BL13802, BA2664, BL8800, and BA2880

All OXA-48 producers shared the same *bla*_{OXA-48}-plasmid, which does not carry additional ARGs (Figure 7). All five *bla*_{OXA-48}-plasmids were positive for IncL. BLAST analyses of the plasmid sequence

revealed high similarity (99.99%) between the current 62-kb *bla*_{OXA-48}-plasmid and pRJ-119-2, first *bla*_{OXA-48}-positive plasmid isolated in China in 2016 (Figure 6). Tn1999, also named Tn1999.1, consists of two copies of the insertion sequence IS1999 surrounding *bla*_{OXA-48}: one copy inserted 26bp upstream of *bla*_{OXA-48} and another copy downstream of *bla*_{OXA-48}. In our sequences, the insertion of IS1999 into IS1999 upstream of *bla*_{OXA-48} indicates the presence of a Tn1999.2 variant (Giani et al., 2012; Figure 7).

ESBL-plasmids: BL849, BU19801, MS84, BL12125, BL12456, BA3783, BL13802, BL8800, and BA2880

Among the 10 *bla*_{NDM-1} and/or *bla*_{OXA-48}-positive *K. pneumoniae* isolates, eight *bla*_{ESBL}-plasmids were characterized by hybrid sequencing. *K. pneumoniae* isolates pMS84 and pBA2664 did not carry *bla*_{ESBL}-plasmids. Among the eight *bla*_{ESBL}-plasmids, IncFIB was the most common incompatibility group identified with 100% identity (n =2) followed by IncFII (n =1). As far as incompatibility groups with an identity >96%, the IncFIB/IncFII combination was the most common (n =3), followed by IncFII (n =1) and FIA (n =1; Table 1).

Five *bla*_{ESBL}-plasmids identified in this study were highly comparable to some regions of previously described *bla*_{ESBL}-plasmids. However, none of the prior *bla*_{ESBL}-plasmids shared the exact same sequence structure with the *bla*_{ESBL}-plasmids described herein. Also, 3/8 *bla*_{ESBL}-plasmids shared identity in a region that did not contain ARGs: BU19801_pESBL (99.97%, a 180-kb region of *K. pneumoniae* E16KP0258 chromosome, Genbank accession number: CP052272), BL8800/BABL2880_pESBL (99.98%, a 75-kb region of *K. pneumoniae*69 p69-1, Genbank accession number: CP025457; data not shown).

pBL849_ESBL (89 kb) was highly similar to some sections of the p4_1_2.2 plasmid from *K. pneumoniae* strain 4/1-2 (99.98%, 96 kb,

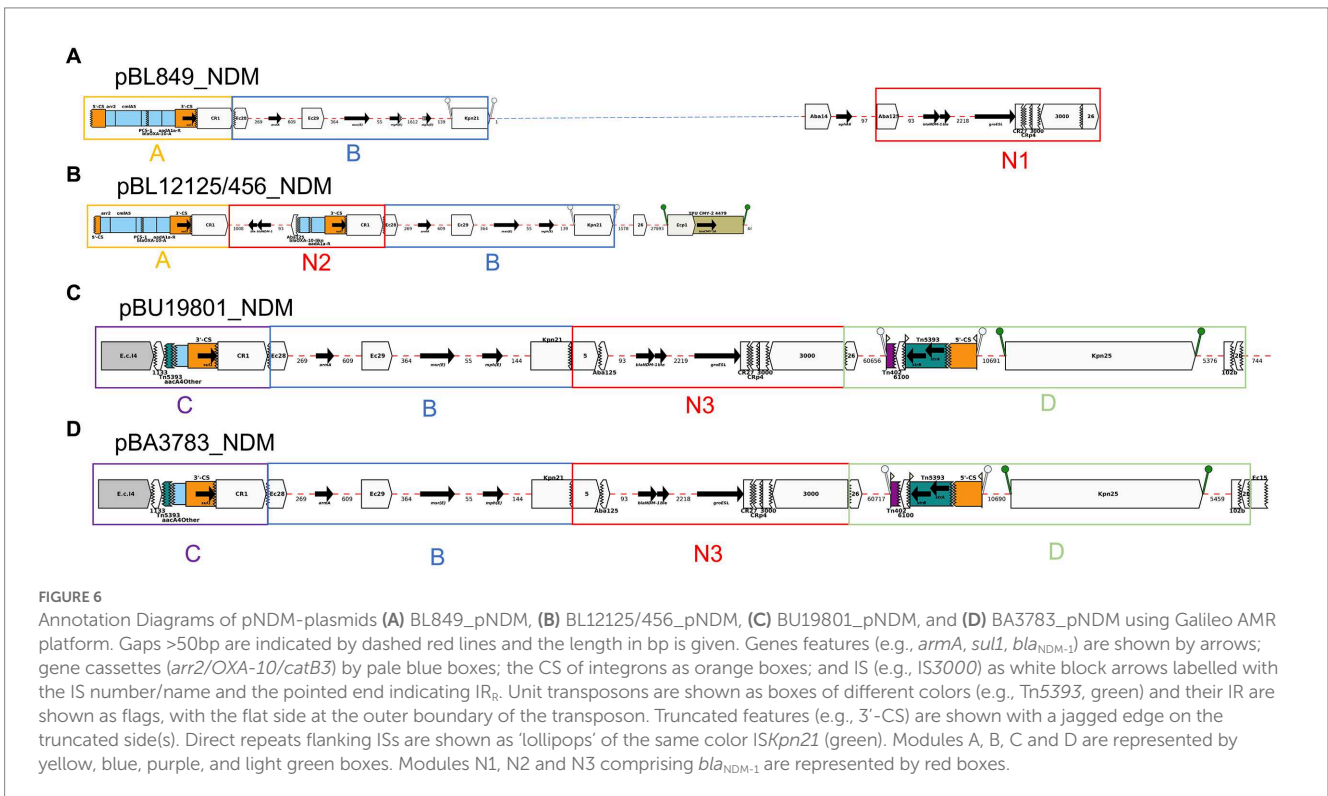
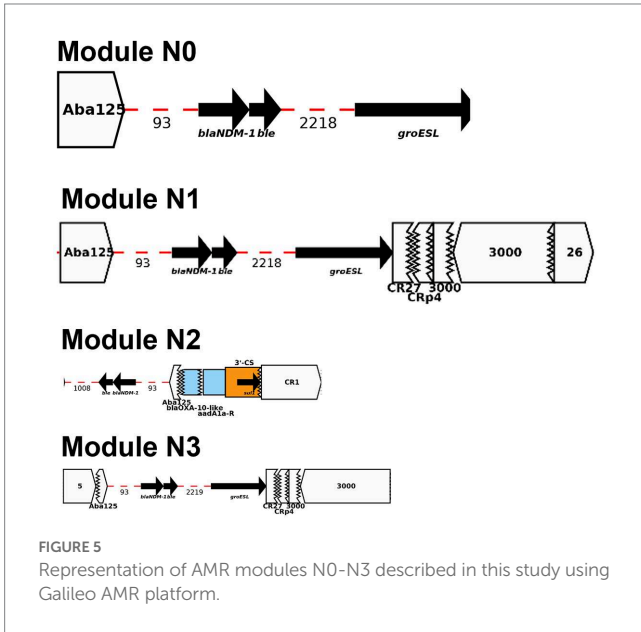

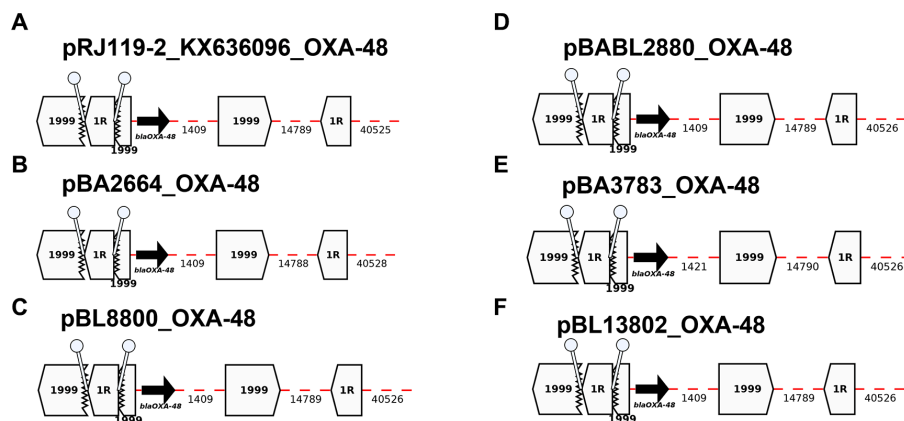

FIGURE 7

Annotation Diagrams of OXA-48-plasmids (A) pRJ119-1-OXA-48_KX636096, (B) pBA2664-NDM, (C) pBL8800_OXA-48, (D) pBABL2880_OXA-48, (E) pBA3783-OXA-48, and (F) pBL13802_OXA-48 using Galileo AMR platform. Gaps >50bp are indicated by dashed red lines and the length in bp is given. Genes features (i.e., bla_{OXA-48}) are shown by arrows, and IS (e.g., IS1999, IS1) as white block arrows labelled with the IS number/name and the pointed end indicating IR_R. Truncated features (e.g., IS1999) are shown with a jagged edge on the truncated side(s). Direct repeats flanking ISs are shown as 'lollipops' of the same color IS1R (white). Here, the bla_{OXA-48} module found in all isolates are the same and identical to the module identified in pRJ119-2_KX636096.

Genbank accession number: CP023841), isolated in Sweden in 2018 including evidence of rearrangements between regions. pBL12125_ESBL and pBL12456_ESBL (127 kb) were both comparable at 99.95% to part of pG747, a 151 kb plasmid isolated from the *K. pneumoniae* strain G747 in Maryland (USA) in 2018 (Genbank accession number: CP034137). pBA3783_ESBL (135 kb) was highly comparable (99.97%) to part of the p2K157 plasmid (157 kb) isolated from the *K. pneumoniae* strain KP69 (Genbank accession number: CP054291). pBL13802_ESBL (189 kb) was almost identical (99.99%) to part of a 180-kb plasmid that was present in a *K. pneumoniae* strain named *K. pneumoniae*_Goe_588-1 (Genbank accession number: CP018693), which was isolated in Germany in 2016. Also, pBL12125/456_ESBL, pBU19801_ESBL and pBL849_ESBL shared a common set of 7 ARGs including *aph(3'')-Ib* (or *strA*), *aph(6)-Id* (or *strB*), bla_{TEM-1B} , $bla_{CTX-M-15}$, bla_{OXA-1} and *aac(6)-Ib-cr* (data not shown).

Discussion

Understanding the evolution and spread of MDR bacteria is essential to countering the serious global threat posed by these organisms. The presence of ARGs on mobile genetic elements, strongly increases the risk of transferring resistance between different bacterial genera, including among those established in hospital environments. The development of novel sequencing methods and user-friendly web-based tools that fully characterize plasmids found in MDR pathogens is crucial for detecting and tracking the spread of AMR determinants across communities and preventing outbreaks.

Here, we characterized the plasmid structure in a collection of bla_{NDM-1} and bla_{OXA-48} -harboring MDR *K. pneumoniae* isolated in Karachi, Pakistan using a hybrid NGS approach combining Nanopore long-read sequencing data with Illumina short-reads data. We also isolated bla_{NDM-1} -plasmids of interest *via* conjugation to study correlation between plasmid-targeted AMR profiles and their associated susceptibility profiles. The genotypic AMR profiles of the

E. coli transconjugants harboring only bla_{NDM-1} -plasmids highlights the impact of bla_{NDM-1} and ARGs present on that same plasmid and co-transferred.

Several different types of plasmids associated with the *Enterobacteriaceae* have been reported to harbor bla_{NDM} , including IncA/C, IncFII subtypes, IncH types, IncL/M, IncN and IncX (Ho et al., 2012; Partridge and Iredell, 2012; Carattoli, 2013). The variety of incompatibility groups and pMLST identified in our plasmids collection (IncC (types 1 and 3), IncFIA (type 26) IncFIB, IncFII (types K1, K2, K7, K9), IncHI1B, and IncL) are consistent with this observation.

All seven bla_{NDM-1} -plasmids identified in our study were unique, however plasmids from isolates BL12125/BL12456 harbored the same IncC3 plasmid. As discussed previously (Lomonaco et al., 2018), BL12125 and BL12456 were identified as related strains ST14 sharing the same AMR profile, the same AST phenotype, and the same plasmid incompatibility group and plasmid type (IncC3). In both cases, bla_{NDM-1} is surrounded by a duplication of a set of ARGs (bla_{OXA-10} , *aadA1*, and *sul1* including two copies of *ISCR1*) suggesting insertion events. A common IncL bla_{OXA-48} -plasmid was also found to be shared by isolates BL8800/BA2880. Long read sequencing confirmed that the plasmids identified in BL12125 and BL12456 are identical. Additionally, BL8800 and BA2880 were found to carry the same bla_{ESBL} -plasmid (IncFIIK9; 6 ARGs) and IncL bla_{OXA-48} -plasmid, suggesting again that these 2 pairs of isolates are equivalent but obtained from different sites of infection in a single patient as previously reported by Lomonaco et al. (2018).

The bla_{NDM-1} -plasmids isolated from BU19801 (ST307; IncFIIK2) and BA3783 (ST14, IncFIIK2) were 100% identical except for the insertion of a 746-bp truncated *ISEc15* region on pBA3783_NDM, suggesting that the genetic rearrangements did not impact AMR profiles. However, both isolates BU19801 and BA3783 do share the same plasmid incompatibility group and type (IncFIIK2), AMR profiles, and AST phenotypes which strongly suggests that those two *K. pneumoniae* isolates may have previously shared the exact same plasmid.

Long-read technology has significantly enhanced the usefulness of NGS data to accurately predict AMR profiles, detect the presence of similar plasmids in different isolates, and identify genetic rearrangement events. For instance, pBL849 [IncFIB(pNDM-Mar)/IncHI1B(pNDM-MAR), pBL12125/456 (IncC3)] shared 3 AMR modules that lead to the same AMR profiles but carried both different non-AMR regions and incompatibility groups. This observation suggests that their respective plasmids are different.

pMS84_NDM and pBL13802_NDM were similar to two *bla*_{NDM-1}-plasmids described previously. pMS84_NDM, which was IncC1-positive, shared 100% identity with an IncA/C2 *bla*_{NDM-1}-plasmid (GenBank accession number: C050164) isolated from a *K. pneumoniae* strain from Hong-Kong in 2020. The ISEc23 element found in pMS84_NDM suggests that their respective plasmids are related. pBL13802_NDM, which was IncFII(pKPX1)/type 1-positive, shared 99.98% identity with the pKPX-1 plasmid identified from a *K. pneumoniae* clinical isolate obtained from a rectal swab in Taiwan in 2016 (Huang et al., 2013). BL13802_pNDM and pKPX-1, shared a ~130-kb region comprising a stretch of AMR determinants, but a 121-kb region neighboring *bla*_{NDM-1}, and filled with a succession of IS elements, was missing from pBL13802_NDM. The KPX strain originated from a Taiwanese patient with a hospitalization history in New Delhi (Huang et al., 2013), which may suggest that those two plasmids are also related.

The *bla*_{OXA-48}-plasmids (IncL) identified in this study were identical to the pRJ119-2 plasmid reported in 2020 as the first *bla*_{OXA-48}-plasmid in China (Genbank accession number: KX636096). Finally, while some large AMR regions have been reported, all *bla*_{ESBL}-plasmids identified in this study have not been previously described. The AMR features were observed in multiple rearrangements which underscores the complexity of molecular background and importance of mobility of ARGs via horizontal transfer.

All *bla*_{NDM-1}-positive *E. coli* transconjugants were resistant to most β -lactams, and all aminoglycosides while these transconjugants were susceptible to CIP, SXT, TET, and CHL. All *E. coli* transconjugants were susceptible to ATM as expected for NDM producers except for Ec_BL12125/456 due to the presence of *bla*_{OXA-10} on the *bla*_{NDM-1}-plasmid. All *bla*_{OXA-48}-positive *E. coli* transconjugants were resistant to ampicillin, β -lactams/ β -lactamase inhibitor combinations (AMC, TZP, and SAM), but susceptible to fluoroquinolones, other β -lactams and aminoglycosides.

Overall, the NGS/RF-phenotypes-based approach performed well in comparison with BMD for *E. coli* transconjugants except for a few instances: CRO, ATM, and CHL. The potential hydrolysis of CRO (MIC >32 μ g/ml) by the NDM enzyme was apparently not accounted for by ResFinder. The OXA-48 enzyme, which is not a particularly efficient carbapenemase often referred to “phantom menace” or “hidden threat” (Poirel et al., 2012; Bakthavatchalam et al., 2016) is difficult to detect and often missed by routine diagnostics was detected by ResFinder both genotypically and phenotypically. Both *K. pneumoniae* isolates harboring the *cmlA5* gene (BL12125/456) were classified as susceptible by ResFinder and BMD. In both study isolates, two important components of the class 1 integron described by Revathi et al. (2013) were altered: (1) truncated integrase (*intI1*) and (2) absence of the Pc promoter for the *cmlA5* gene cassette. This finding suggests that *cmlA5* may not be expressed in this integron. Lastly, all *E. coli* transconjugants carrying *qnrB/S* or *aac(6)-Ib-cr* were susceptible to fluoroquinolones (CIP), which implies that the

high-level fluoroquinolone resistance phenotypes observed in our previous study (Lomonaco et al., 2018) are most likely due to chromosomal mutations on genes encoding DNA gyrase and topoisomerases IV, respectively.

It has been well-established that genetic-based screening approaches informed by high-quality sequencing data have potential to be useful to rapidly detect the most common and well-described mechanisms of resistance which correlate with phenotypes for the major classes of antimicrobials. However, the current bioinformatics landscape lacks a standardized and well-curated database with expert-defined rules for AMR gene inclusion/exclusion (e.g., truncated genes). Moreover, our findings reiterate that the presence/detection of ARGs does not necessarily yield a resistant phenotype, as observed for *qnrB1*, *aac(6)-Ib-cr* and *cmlA5*.

In this study, bacterial conjugation provided additional information on phenotypes of targeted plasmids but one of the limitations is that plasmids over ~200 kb may be difficult to transfer (e.g., BL249, 277 kb). This study did not aim to investigate the transfer of plasmids between isolates, since this collection did not include all carbapenemase-positive *Enterobacteriaceae* samples from the same period. However, this study highlights how comprehensive characterization of AMR plasmids may offer insights to rapidly respond to outbreaks and help early implementation of effective infection controls procedures.

The use of ONT/Illumina sequencing is crucial for accurate and complete plasmid characterization in research laboratories, but ONT sequencing could also provide preliminary results within healthcare institutions to inform and fortify infection control measures while waiting for AST results that would confirm expression of the ARGs detected by NGS. Nanopore offers a specific workflow for plasmids that has the potential to identify pathogens, AMR determinants, and plasmid classification and/or structural features within minutes (Tamma et al., 2019; Neal-McKinney et al., 2021).

Further comprehensive plasmid analysis including a hybrid approach can be performed for epidemiologic purposes. Real-time sequencing approaches could enable MDR plasmid characterization and analysis as new isolates are collected. To maximize impact, the data could be used to build a curated AMR-based plasmid database, that combines AMR profiles and metadata. Overall, such a resource would provide scientists and clinicians a powerful infection control surveillance system that tracks plasmid-based AMR transmission in real time.

This study highlights the complexity and diversity of molecular background of pathogens that produce carbapenemases along with ESBL or AmpC β -lactamases, which are challenging for clinicians. The spread of plasmid-mediated AMR determinants between pathogens emerging as MDR bacteria is a major threat worldwide, and rapid tracking of such pathogens is warranted. This study emphasizes the value of rapid, real-time sequencing of AMR plasmids to predict NGS-based AST profiles, and to provide insights on their dissemination especially during outbreaks.

Data availability statement

The datasets presented in this study can be found in online repositories. The names of the repository/repositories and accession number(s) can be found in the article/Supplementary material.

Author contributions

CL, MC, MH, EK, KA, DH, SP, and DS contributed to conception and design of the study. CL, BC, DE, and MC performed all lab experiments. AC and LR performed the bioinformatics data analysis. CL wrote the first draft of the manuscript. All authors contributed to the article and approved the submitted version.

Funding

This project was supported by the Department of Homeland Security through an interagency agreement HSHQPM-14-X-00116 with the Centers for Disease Control and Prevention. MC and MH received additional support from the U.S. National Institutes of Health grants R21 AI139947 and R01 AI150941. The findings and conclusions in this report are those of the authors and do not necessarily represent the views or official positions of the Department of Health and Human Services, Centers for Disease Control and Prevention, U.S. Food and Drug Administration and the Department of Homeland Security. The use of trade names is for identification only and does not imply endorsement.

Acknowledgments

The authors thank Linda Weigel for spearheading this project with external CDC collaborators, and Sara Lomonaco for her valuable scientific input for this project. A special thank you to David Lonsway

References

- Bakthavatchalam, Y. D., Anandan, S., and Veeraraghavan, B. (2016). Laboratory detection and clinical implication of oxacillinase-48 like Carbapenemase: the hidden threat. *J. Global Infect. Dis.* 8, 41–50. doi: 10.4103/0974-777X.176149
- Bankevich, A., Nurk, S., Antipov, D., Gurevich, A. A., Dvorkin, M., Kulikov, A. S., et al. (2012). SPAdes: a new genome assembly algorithm and its applications to single-cell sequencing. *J. Comput. Biol.* 19, 455–477. doi: 10.1089/cmb.2012.0021
- Bortolaia, V., Kaas, R. S., Ruppe, E., Roberts, M. C., Schwarz, S., Cattoir, V., et al. (2020). ResFinder 4.0 for predictions of phenotypes from genotypes. *J. Antimicrob. Chemother.* 75, 3491–3500. doi: 10.1093/jac/dkaa345
- Brown, S. D., Dreolini, L., Wilson, J. F., Balasundaram, M., and Holt, R. A. (2023). Complete sequence verification of plasmid DNA using the Oxford Nanopore Technologies' MinION device. *BMC Bioinform.* 24:116. doi: 10.1186/s12859-023-05226-y
- Carattoli, A. (2013). Plasmids and the spread of resistance. *Int. J. Med. Microbiol.* 303, 298–304. doi: 10.1016/j.ijmm.2013.02.001
- Carattoli, A., and Hasman, H. (2020). PlasmidFinder and in Silico pMLST: identification and typing of plasmid replicons in whole-genome sequencing (WGS). *Methods Mol. Biol.* 2075, 285–294. doi: 10.1007/978-1-4939-9877-7_20
- Castanheira, M., Deshpande, L. M., Mendes, R. E., Canton, R., Sader, H. S., and Jones, R. N. (2019). Variations in the occurrence of resistance phenotypes and Carbapenemase genes among Enterobacteriaceae isolates in 20 years of the SENTRY antimicrobial surveillance program. *Open Forum Infect. Dis.* 6, S23–S33. doi: 10.1093/ofid/ofy347
- CDC Report (2019). Antibiotic resistance threats in the United States.
- CLSI (2018). Methods for dilution antimicrobial susceptibility tests for Bacteria that grow aerobically; Approved Standards—11th Edition. CLSI standard M07, Wayne, PA. Clinical and Laboratory Standards Institute.
- CLSI (2023). Performance standards for antimicrobial susceptibility testing, 33rd Edition. CLSI Supplement M100, Clinical and Laboratory Standards Institute.
- de Man, T. J. B., Lutgring, J. D., Lonsway, D. R., Anderson, K. F., Kiehlauch, J. A., Chen, L., et al. (2018). Genomic analysis of a Pan-resistant isolate of *Klebsiella pneumoniae*, United States 2016. *MBio* 9, 1–7. doi: 10.1128/mBio.00440-18
- Dong, D., Li, M., Liu, Z., Feng, J., Jia, N., Zhao, H., et al. (2019). Characterization of a NDM-1- encoding plasmid pHFK418-NDM from a clinical *Proteus mirabilis* isolate

and his team from the Division of Healthcare Quality Promotion at the Centers for Disease Control and Prevention for providing the antibiotic panels for BMD. We also thank Tom de Man for his appreciated assistance in bioinformatics.

Conflict of interest

The authors declare that the research was conducted in the absence of any commercial or financial relationships that could be construed as a potential conflict of interest.

Publisher's note

All claims expressed in this article are solely those of the authors and do not necessarily represent those of their affiliated organizations, or those of the publisher, the editors and the reviewers. Any product that may be evaluated in this article, or claim that may be made by its manufacturer, is not guaranteed or endorsed by the publisher.

Supplementary material

The Supplementary material for this article can be found online at: <https://www.frontiersin.org/articles/10.3389/fmicb.2023.1192097/full#supplementary-material>

harboring two novel transposons, Tn6624 and Tn6625. *Front. Microbiol.* 10:2030. doi: 10.3389/fmicb.2019.02030

EUCAST (2023). Breakpoint tables for interpretation of MICs and zone diameters, version 13. Available at: http://www.eucast.org/clinical_breakpoints/ (Accessed January 02, 2023).

Giani, T., Conte, V., di Pilato, V., Aschbacher, R., Weber, C., Larcher, C., et al. (2012). *Escherichia coli* from Italy producing OXA-48 carbapenemase encoded by a novel Tn1999 transposon derivative. *Antimicrob. Agents Chemother.* 56, 2211–2213. doi: 10.1128/AAC.00035-12

Hadjadj, L., Cassir, N., Saïdani, N., Hoffman, C., Brouqui, P., Astoul, P., et al. (2022). Outbreak of carbapenem-resistant enterobacteria in a thoracic-oncology unit through clonal and plasmid-mediated transmission of the bla (OXA-48) gene in southern France. *Front. Cell. Infect. Microbiol.* 12:1048516. doi: 10.3389/fcimb.2022.1048516

Heikema, A. P., Jansen, R., Hiltmann, S. D., Hays, J. P., and Stubbs, A. P. (2021). WeFaceNano: a user-friendly pipeline for complete ONT sequence assembly and detection of antibiotic resistance in multi-plasmid bacterial isolates. *BMC Microbiol.* 21:171. doi: 10.1186/s12866-021-02225-y

Hendriksen, R. S., Bortolaia, V., Tate, H., Tyson, G. H., Aarestrup, F. M., and McDermott, P. F. (2019). Using genomics to track global antimicrobial resistance. *Front. Public Health* 7:242. doi: 10.3389/fpubh.2019.00242

Ho, P. L., Li, Z., Lo, W. U., Cheung, Y. Y., Lin, C. H., Sham, P. C., et al. (2012). Identification and characterization of a novel incompatibility group X3 plasmid carrying bla NDM-1 in Enterobacteriaceae isolates with epidemiological links to multiple geographical areas in China. *Emerg. Microbes Infect.* 1:e39. doi: 10.1038/emi.2012.37

Huang, T. W., Chen, T. L., Chen, Y. T., Lauderdale, T. L., Liao, T. L., Lee, Y. T., et al. (2013). Copy number change of the NDM-1 sequence in a multidrug-resistant *Klebsiella pneumoniae* clinical isolate. *PLoS One* 8:e62774. doi: 10.1371/journal.pone.0062774

Kolmogorov, M., Yuan, J., Lin, Y., and Pevzner, P. A. (2019). Assembly of long, error-prone reads using repeat graphs. *Nat. Biotechnol.* 37, 540–546. doi: 10.1038/s41587-019-0072-8

Koren, S., Walenz, B. P., Berlin, K., Miller, J. R., Bergman, N. H., and Phillippy, A. M. (2017). Canu: scalable and accurate long-read assembly via adaptive k-mer weighting and repeat separation. *Genome Res.* 27, 722–736. doi: 10.1101/gr.215087.116

- Lascols, C., Podglajen, I., Verdet, C., Gautier, V., Gutmann, L., Soussy, C. J., et al. (2008). A plasmid-borne *Shewanella algae* gene, qnrA3, and its possible transfer in vivo between *Kluyvera ascorbata* and *Klebsiella pneumoniae*. *J. Bacteriol.* 190, 5217–5223. doi: 10.1128/JB.00243-08
- Li, H. (2018). Minimap2: pairwise alignment for nucleotide sequences. *Bioinformatics* 34, 3094–3100. doi: 10.1093/bioinformatics/bty191
- Lomonaco, S., Crawford, M. A., Lascols, C., Timme, R. E., Anderson, K., Hodge, D. R., et al. (2018). Resistome of carbapenem- and colistin-resistant *Klebsiella pneumoniae* clinical isolates. *PLoS One* 13:e0198526. doi: 10.1371/journal.pone.0198526
- Mączyńska, B., Frej-Mądrzak, M., Sarowska, J., Woronowicz, K., Choroszy-Król, I., and Jama-Kmieciak, A. (2023). Evolution of antibiotic resistance in *Escherichia coli* and *Klebsiella pneumoniae* clinical isolates in a multi-profile hospital over 5 years (2017–2021). *J. Clin. Med.* 12, 1–7. doi: 10.3390/jcm12062414
- Neal-McKinney, J. M., Liu, K. C., Lock, C. M., Wu, W. H., and Hu, J. (2021). Comparison of MiSeq, MinION, and hybrid genome sequencing for analysis of *Campylobacter jejuni*. *Sci. Rep.* 11:5676. doi: 10.1038/s41598-021-84956-6
- Neuert, S., Nair, S., Day, M. R., Doumith, M., Ashton, P. M., Mellor, K. C., et al. (2018). Prediction of phenotypic antimicrobial resistance profiles from whole genome sequences of non-typhoidal *Salmonella enterica*. *Front. Microbiol.* 9:592. doi: 10.3389/fmicb.2018.00592
- Partridge, S. R., and Iredell, J. R. (2012). Genetic contexts of blaNDM-1. *Antimicrob. Agents Chemother.* 56, 6065–6067. doi: 10.1128/AAC.00117-12
- Partridge, S. R., and Tsafnat, G. (2018). Automated annotation of mobile antibiotic resistance in gram-negative bacteria: the multiple antibiotic resistance annotator (MARA) and database. *J. Antimicrob. Chemother.* 73, 883–890. doi: 10.1093/jac/dkx513
- Poirel, L., Bonnin, R. A., Boulanger, A., Schrenzel, J., Kaase, M., and Nordmann, P. (2012). Tn125-related acquisition of blaNDM-like genes in *Acinetobacter baumannii*. *Antimicrob. Agents Chemother.* 56, 1087–1089. doi: 10.1128/AAC.05620-11
- Poirel, L., Dortet, L., Bernabeu, S., and Nordmann, P. (2011). Genetic features of blaNDM-1-positive Enterobacteriaceae. *Antimicrob. Agents Chemother.* 55, 5403–5407. doi: 10.1128/AAC.00585-11
- Poirel, L., Potron, A., and Nordmann, P. (2012). OXA-48-like carbapenemases: the phantom menace. *J. Antimicrob. Chemother.* 67, 1597–1606. doi: 10.1093/jac/dks121
- Ramirez, M. S., and Tolmasky, M. E. (2010). Aminoglycoside modifying enzymes. *Drug Resist. Updat.* 13, 151–171. doi: 10.1016/j.drug.2010.08.003
- Revathi, G., Siu, L. K., Lu, P. L., and Huang, L. Y. (2013). First report of NDM-1-producing *Acinetobacter baumannii* in East Africa. *Int. J. Infect. Dis.* 17, e1255–e1258. doi: 10.1016/j.ijid.2013.07.016
- Ruan, J., and Li, H. (2020). Fast and accurate long-read assembly with wtdbg2. *Nat. Methods* 17, 155–158. doi: 10.1038/s41592-019-0669-3
- Tamma, P. D., Fan, Y., Bergman, Y., Perlea, G., Kazmi, A. Q., Lewis, S., et al. (2019). Applying rapid whole-genome sequencing to predict phenotypic antimicrobial susceptibility testing results among Carbapenem-resistant *Klebsiella pneumoniae* clinical isolates. *Antimicrob. Agents Chemother.* 63, 1–12. doi: 10.1128/AAC.01923-18
- Valcek, A., Nesporova, K., Whiteway, C., de Pooter, T., de Coster, W., Strazisar, M., et al. (2022). Genomic analysis of a strain collection containing multidrug-, extensively drug-, Pandrug-, and Carbapenem-resistant modern clinical isolates of *Acinetobacter baumannii*. *Antimicrob. Agents Chemother.* 66:e0089222. doi: 10.1128/aac.00892-22
- Walker, B. J., Abeel, T., Shea, T., Priest, M., Abouelliel, A., Sakthikumar, S., et al. (2014). Pilon: an integrated tool for comprehensive microbial variant detection and genome assembly improvement. *PLoS One* 9:e112963. doi: 10.1371/journal.pone.0112963
- World Health Organization (2014). Antimicrobial resistance: global report on surveillance.
- Yang, M., Xu, G., Ruan, Z., and Wang, Y. (2022). Genomic characterization of a multidrug-resistant *Escherichia coli* isolate co-carrying Bla (NDM-5) and Bla (CTX-M-14) genes recovered from a pediatric patient in China. *Infect. Drug Resist.* 15, 6405–6412. doi: 10.2147/IDR.S388797
- Yee, R., and Simner, P. J. (2022). Next-generation sequencing approaches to predicting antimicrobial susceptibility testing results. *Clin. Lab. Med.* 42, 557–572. doi: 10.1016/j.cl.2022.09.011

The background of the page features a faint, light-colored image of several hands of different skin tones reaching out to hold a globe. The hands are positioned around the globe, with fingers spread, symbolizing global unity and shared responsibility. The overall tone is soft and positive.

CHAPTER X: DISCUSSION AND PERSPECTIVES

CHAPTER X: DISCUSSION AND PERSPECTIVES

Antimicrobial resistance is a topic that requires constant review, as the numerous studies published regularly can update or redefine our view of this recurring problem. β -lactam resistance and β -lactamases, are undoubtedly the most studied topics in this field. β -lactams, the most commonly used antibiotics worldwide, have also led to an increasing number of resistant clinical isolates due to their permanent selective power, which leads to an extraordinary diversification of the mechanisms of resistance. The rise of pathogenic MDR bacteria responsible for healthcare-associated and/or community-acquired infections represents a persistent global public health threat [193]. As carbapenem-resistant bacterial infections are associated with higher mortality rates and prolonged hospitalizations leading to high healthcare costs, combating the spread of CREs remains critical [194].

Due to the dramatic increase in the number of β -lactamases, GNB have become increasingly resistant to most β -lactams. For ESBL-producing *Enterobacterales*, 197,400 cases (26,000 in 2013) and 9,100 deaths (610 in 2013) were reported by the CDC in the United States in 2019. For CREs, 13,100 cases (9,300 in 2013) and 1,100 deaths (610 in 2013) were reported in the United States in 2019 [195, 196]. The emergence and global spread of microorganisms with acquired carbapenemases is of great concern worldwide. ESBL and carbapenemase-producers often carry multiple plasmid-borne genes that confer resistance to other classes of antimicrobial agents, making patient treatment problematic.

Due to the ability of MGEs to efficiently spread ARGs between bacteria inside and outside hospitals, in the environment, or other sources, tracking global spread is difficult and complex. The evolution of β -lactamases towards resistance, induced by antimicrobial use in humans and food-animals, is one of the most extraordinary pathways described in antimicrobial resistance.

The main objective of this thesis project was to investigate the global evolution of β -lactamases over the last 15 years. To this end, we aimed to answer the following questions:

1. How has the global epidemiology of ESBLs and carbapenemases evolved since the 2010s when NDM-1 emerged in India, until today?
2. What were the molecular characteristics of carbapenemase-resistant *K. pneumoniae* (CRKP) in the 2010s? How have they evolved today?
3. What were the characteristics of MDR plasmids in NDM-1-producing CRKP in endemic parts of the world?

With the widespread use of gene sequencing, many hundreds of unique β -lactamase gene variants (SHV, TEM, CTX-M, KPC, NDM, IMP, VIM...) have been identified since the first β -lactamase was

described in the 1940s [192]. Regarding ESBLs, ESBL SHV and TEM are now rare, while CTX-M-15 has increased over time in most regions, except in some regions of Asia and Spain, where CTX-M-14 dominated, and in South America where CTX-M-2 is most common [197].

Our first study, which included worldwide clinical *Enterobacterales* isolates from 2008-2009, provided new insights into the status of ESBLs and KPCs in Gram negative bacteria. We found that *E. coli* was the most common pathogen harboring ESBLs, and that CTX-M group 1 was the most common ESBL group in all species and in all seven regions with *bla*_{CTX-M-15} being the most common CTX-M worldwide followed by *bla*_{CTX-M-14}. A much lower proportion of SHV ESBLs was observed, with *bla*_{SHV-12} being the most common SHV, followed by *bla*_{SHV-5} and *bla*_{SHV-2}. This study highlighted a change in the epidemiology of ESBLs: SHV ESBLs were no longer the predominant ESBL-type, as observed in the 1990s [190], and the CTX-M pandemic, that began in the 2000s, was not yet over. Today, as noted in numerous reports from around the world [192, 198-201], CTX-M enzymes are still the most prevalent ESBL-type identified in most regions of the world, with *bla*_{CTX-M-15} commonly referred to the most common variant worldwide. In the 2013 collection from Pakistan, 9/10 *K. pneumoniae* isolates were ESBL-positive including 9/9 *bla*_{CTX-M-15}-positive.

As carbapenem resistance began to increase worldwide, the attention of microbiologists, clinicians and researchers turned to carbapenemases such as KPC and NDM enzymes which were among the most worrisome carbapenemases emerging and spreading worldwide at an alarming rate in the 2010s. The KPC variants reported in our studies in 2009 were those most frequently reported worldwide at that time (KPC-2 and KPC-3). In the second study, KPC-producers from our 2008-2009 collection were mainly isolated in Greece, and the United States, but also in Israel, Colombia, and Puerto Rico, which was consistent with previous reports [202]. NDM, was the most frequently reported carbapenemase in our 2008-2009 ertapenem non-susceptible *Enterobacterales* collection from the SMART program, and this enzyme was identified in India. The global spread of this enzyme to the African subcontinent was evidenced by our first report of an NDM-1 producing *K. pneumoniae* collected from a urinary tract infection (UTI) in a 39 year-old male patient admitted in hospital in Mauritius in 2009, after the first report in that continent in Kenya [203].

Carbapenemases do not all behave the same way. Even though the KPC and NDM enzymes successfully disseminated in *Enterobacterales*, this was not the case for the VIM and IMP enzymes. In our study, a small proportion of VIM- and IMP-producers were identified in 2008-2009 in various European countries (e.g., Greece, Italy, Spain) and in Australia/Philippines, respectively. This observation

highlights the low prevalence and spread worldwide of VIM and IMP enzymes, which emerged in Southern Europe, Australia, and the Philippines, respectively [204, 205].

Besides the MBLs, another carbapenemase that spread worldwide was the OXA-48 class D carbapenemase. In our 2008-2009 collection, OXA-48-producers were found in India, Turkey, and Argentina. We also identified the first two *bla*_{OXA-48}-positive *K. pneumoniae* isolates in the United States, suggesting that the OXA-48 enzyme, originally reported in Europe in 2001 entered the North American continent from Europe or North Africa [128].

The diversity and mobilization of these new β -lactamases lead to alarming clinical *Enterobacteriales* isolates carrying multiple enzymes, which complicates the detection and molecular analysis of such pathogens. Some reports from different countries have described clinical isolates carrying multiple types of broad-spectrum β -lactamases activity. For example, clinical isolates carrying two to four different types of broad-spectrum β -lactamases were reported from China [206]. Similarly, in the SENTRY program collection conducted in the USA in 2012, a large majority of clinical isolates carried multiple β -lactamases [199, 200]. This phenomenon was not new, but laboratory detection of multiple enzymes was not as easily accessible years ago as today.

Twenty years ago, Paterson et al. had already observed a higher rate of *K. pneumoniae* isolates producing multiple β -lactamase enzymes in Latin America, South Africa, Europe, and the United States [88]. Our study supported this notion and showed that some study clinical isolates carried at least two ESBL β -lactamase-types, especially in *K. pneumoniae* and *E. coli*. The coexistence of multiple β -lactamase enzymes was even more frequent (>60%) in carbapenemase-producers than in ESBL-producers. In our first study, pretty much any combination of β -lactamases was observed including either two to three ESBLs (SHV+CTX-M, CTX-M-1+9, TEM+CTX-M, TEM+SHV+CTX-M), or one to two ESBLs in combination with a KPC (SHV+KPC, SHV+CTX-M+KPC).

It was also noteworthy that the clinical isolates with the highest number of β -lactamases were isolated in Asia and Latin America. The most common combinations were ESBL_{SHV+CTX-M} as well as other combinations with a lower proportion such as double CTX-Ms or ESBL_{TEM+CTX-M} or ESBL_{SHV+TEM+CTX-M}. China is the second largest consumer of antibiotics in the world [207], and Latin America is challenging when it comes to implementing antimicrobial stewardship [208]. These observations suggest that pathogens carrying multiple ESBL enzymes may be more prevalent in resource-limited countries in warm climates where unsafe water, poor sanitation and poor hygiene are common along with the

overuse of antimicrobial drugs without prescription [209]. This higher frequency of clinical isolates carrying multiple enzymes may correlate with a higher rate of mobilization of ESBL genes between bacteria by successful plasmids or MGEs in certain areas where antibiotics are overused.

In the 2013 collection from Pakistan, most of the MDR *K. pneumoniae* clinical isolates examined carried at least four ARGs such as NDM+SHV+CTX-M+OXA (6/9). The MDR pathogens that produce multiple β -lactamases can be challenging and pose a serious public health problem when limited therapeutic options are available. Nowadays, more threatening pathogens are on the rise, as shown by *K. pneumoniae* strains carrying multiple plasmids with two to three carbapenemase genes, such as NDM-1, KPC and OXA-48, which represent a major clinical problem (e.g., Russia) [210].

Our extensive molecular surveillance studies, which included over 1,000 MDR pathogens collected in 2008-2009 as part of the SMART program, identified three novel genes: an ESBL SHV gene (*bla*_{SHV-129}), a KPC-type carbapenemase (*bla*_{KPC-11}) and a VIM-type carbapenemase (*bla*_{VIM-33}). The *bla*_{SHV-129} gene was collected in 2008 from an Italian patient infected with *E. coli*, and the *bla*_{KPC-11} gene was found in four clinical isolates collected in Greece in 2009. Except for *bla*_{VIM-33}, these novel *bla*_{SHV-129}, and *bla*_{KPC-11} enzymes were further investigated in subsequent publications. Wrinkler et al suggested that SHV-129 evolved from SHV-5, probably due to the increased use of cefepime [211]. The new KPC-11 variant, which was identified in our study, was further investigated by Mehta et al. It was found that KPC-11, an evolved version of KPC-2, showed no change in the resistance levels to ceftazidime or carbapenems [212]. Both examples illustrate that mutations do not always lead to increased resistance to antimicrobial agents (e.g., KPC-11).

Although it may be difficult to assess the frequency of generation of new variants among β -lactamases, the finding of three new variants in over 1,000 clinical isolates is an alarming result. We identified KPC-11 in 2010, and 14 years later, 184 variants have been described which corresponds to an average of 12 new variants per year. In contrast, 60 variants have been described for NDM, which corresponds to an average of 4 new variants per year. The emergence of new variants is a constant adaptation phenomenon in MDR pathogens to generate more efficient β -lactamases that are active against overused antibiotics (e.g., cephalosporins and carbapenems). The acquisition of mutations has been frequently observed in class A β -lactamases such as TEM/SHV and CTX-M β -lactamases [213]. This phenomenon varies by ARG but may be more pronounced in endemic regions (e.g., Greece) or resource-limited countries (Philippines) where antibiotics are readily available and widely overused in humans and animals.

Twenty years ago, molecular studies used conventional PCR-Sanger sequencing as the method of choice to identify point-mutations in ESBLs and carbapenemases to fully characterize these enzymes. In the 2010s, very little data was available on the molecular epidemiology of ESBL- and CPEs on large scale. Ongoing molecular surveillance and AMR programs such as the SMART program were rare. Our study was the first large-scale molecular surveillance study in which the commercial DNA microarray kit developed by CheckPoints (Netherlands, Wageningen), first evaluated in 2010 [214], was used and detected as a valuable tool for the molecular epidemiology of clinically relevant β -lactamases. In combination with targeted PCR-sequencing, this nucleic acid-based microarray was able to confirm the presence of ESBL or non-ESBL genes and identify the ESBL/carbapenemase genotype. This study has shown that this commercial kit could be used as part of a targeted method suitable for microbiology laboratories equipped for molecular biology to perform local molecular surveillance studies.

Today, molecular tests targeting specific genes, such as PCR or DNA microarrays, which were used in our studies 15 years ago, are being replaced by NGS technology. NGS provides genome sequences from whole DNA or plasmids for comprehensive profiling of MDR pathogens. NGS technology has evolved and the introduction of real-time sequencing such as Nanopore technology developed by Oxford Nanopore Technologies (ONG) has revolutionized molecular testing [215]. The development of real-time sequencing has the potential to identify ARGs, STs, and plasmid replicon types to improve our knowledge of the spread of MDR pathogens [216]. For example, the correlation between carbapenemase-type, ST, virulence, and multidrug resistance could be useful information to improve the screening of hospitalized patients infected with life-threatening bacteria and assist physicians in treatment selection. The development of novel sequencing methods and user-friendly web-based tools that fully characterize ARGs and plasmids detected in MDR pathogens is a valuable tool for detecting and tracking the spread of ARGs, and MGEs (e.g., integrons, transposons) in hospitals or communities and limiting outbreaks. Our initial study stated, "*The plasmid background and genetic context of these strains may provide the keys to understanding why these phenotypes are becoming so prevalent.*"

Several reports have indicated that certain strain types such as *K. pneumoniae* ST258 or ST147 play an important role in the worldwide dissemination of ESBL- and/or CPEs. [166, 217]. When we investigated this question in our collection, 15 different STs were identified among NDM-producers with ST147 being the most abundant while only 4 STs were identified among KPC-producers, with ST258 being the most abundant. Moreover, the few VIM-producers described in our study were associated with ST147 as previously reported [204], while IMP-producers were associated with several STs (ST478, ST626, ST903 (novel)). However, when we focused on the CRKPs from the SMART program, three major

clusters A (ST11), B (ST147), and C (ST258) were identified with ST258 (34%) being the most common, followed by ST147 (21%) and ST11 (10%).

ST258 has been associated with KPC/SHV-12 in Greece, the USA, Israel, and Puerto Rico. This clone has previously been found to be associated with KPC-2 and KPC-3 [218]. Our study confirmed that ST258 is a high-risk clone largely responsible for the global spread of KPC pathogens. This ST258 high-risk clone, which is still endemic among CRKPs today, is a global concern [219, 220].

K. pneumoniae ST11 has been associated with NDM-1, OXA-48-like and CTX-M-15 particularly in India, Argentina, and Turkey. *K. pneumoniae* ST11, closely related to *K. pneumoniae* ST258 (single locus variant (*tonB*)), is prevalent in KPC-producing clinical isolates in China and Latin America [62, 221]. It has also been associated with NDM-1 [222, 223]. To our knowledge, Voulgari et al reported the first *K. pneumoniae* ST11 producing *bla*_{OXA-48} in Greece in 2013 [224]. This suggests that the *K. pneumoniae* ST11 positive for *bla*_{OXA-48} originally identified in our study in Turkey and Argentina may be related to the *K. pneumoniae* ST11 discovered one year later in Greece. In 2015, *K. pneumoniae* ST11 was also found in association with *bla*_{OXA-48} in Spain [225]. Today, *K. pneumoniae* clonal complex 258 (CC258) is the predominant CRKP strain worldwide, comprising 43 ST members. *K. pneumoniae* ST11 and ST258 are still represented worldwide alongside *K. pneumoniae* ST340, ST437 and ST512, which are the most predominant members of CC258. It is noteworthy that *K. pneumoniae* ST340 (NDM, India) and *K. pneumoniae* ST512 (KPC, Israel), were already identified in our study 15 years ago. *K. pneumoniae* ST340 was reported in Argentina and Brazil [226, 227] and *K. pneumoniae* ST512 in Israel, Italy and Colombia [228-230]. *K. pneumoniae* ST11 is more common in Latin America and Asia, while *K. pneumoniae* ST258 is more common in North America and some European countries [231].

K. pneumoniae ST147, originally identified in Hungary and Spain in 2008/2009 [232, 233], is another high-risk clone. It was associated with CTX-M-15, and later in Greece in 2011 with VIM and KPC [234]. The same results were described in our study, as *K. pneumoniae* ST147 was associated with VIM/SHV-12 or OXA-181/CTX-M-15 and was mainly isolated in India, Greece, and Italy. To our knowledge, the association of ST147 with OXA-181 was first described in our study. This clone was later identified in association with NDM-1 in Canada [235] and Europe (UK and Finland) [222, 236] and, more importantly, in a pan-resistant *K. pneumoniae* isolate in the United Arab Emirates [237], which evolved by acquiring a higher level of resistance and emerged in Pakistan [238]. ST147 has also recently been linked to both OXA-181 and NDM-5 [239]. Today, *K. pneumoniae* ST147 has established itself as a successful AMR high-risk clone among *K. pneumoniae* populations [240].

The global distribution of successful ST types has evolved and changed over the last two decades. A systematic review in 30 countries showed that the three most common lineages identified in CRKP causing neonatal infections were ST17, ST11 and ST15 [241]. The same successful clones and others were labeled as “global problem clones” including MDR clones such as clonal groups (CG): CG15, 20, 29, 37, 147, 10, 258 and 307 and hypervirulent clones such as CG23, 25, 65, 66, 86 and 380 [242]. In a large genomic surveillance study in China, 30 different CGs were identified, with CG11 being the predominant clonal group [243]. *K. pneumoniae* ST307 was identified in our 2013 collection and has been known since the 2010s but it is now emerging as a potential AMR high-risk clone. This clone is associated with the most common ESBLs/carbapenemase enzymes such as CTX-M-15, KPC-2, NDM-1, OXA-48, OXA-181, and VIM-1, and has spread worldwide except in Antarctica [240]. Recent reports have shown that this *K. pneumoniae* ST307 clone is increasing among CRKP over time, and even displacing the well-known predominant clone such as ST258 in certain regions (Italy, Colombia) [244, 245]. This emerging clone is extremely worrying due to its ability to acquire resistance determinants through plasmid plasticity and to evolve into resistance to BLIs and carbapenems [246]. This *K. pneumoniae* ST307 was identified in clinical MDR isolates from Pakistan in 2013.

In our second study, three new STs were reported for the first time: *K. pneumoniae* ST571 and *K. pneumoniae* ST572 (India), and *K. pneumoniae* ST903 (Philippines) among NDM-1 and IMP-producers, respectively. This observation highlighted that the spread of NDM-producers was not limited to the clonal spread of *K. pneumoniae* ST147, and *K. pneumoniae* ST11. This was a new finding, in the 2010s, as it was a completely different mechanism than the clonal spread of KPC. A few years later (2012), *K. pneumoniae* ST571 was reported in a Chinese patient who had never traveled outside of China. The ~300 kb NDM-1 plasmid carried an additional ARG (IMP-4), which may indicate that the acquisition of IMP-4 occurred through further recombination events [247]. Similarly, *K. pneumoniae* ST572 carrying NDM-1 on a ~70kb plasmid as well as CTX-M-15 was reported in Saudi Arabia in 2015 from a UTI from a 50-year-old male patient [248]. However, no other reports of *K. pneumoniae* ST903 were found in the literature. Both examples confirm that dissemination and mobilization of ARGs and/or plasmids can occur through dissemination of the same ST-type and/or plasmid recombination events.

At the time of our fourth study, there were few studies that provided information on the relationship between ST and carbapenemase-type and ARGs, which is now of great importance in tracking these MDR pathogens and providing guidelines for clinical management. For example, reports from China identified a link between ST and resistance profile: *K. pneumoniae* ST11 exhibited resistance to quinolones and AG, while other *K. pneumoniae* STs (ST76, ST25) were susceptible [206].

Additional resistance to other antibiotic families is common in microorganisms producing carbapenemases or in MDR pathogens. Thus, ARGs conferring non-susceptibility or resistance to quinolones (*aac6'-Ib-cr*, *aac6'-Ib-cr+qnrB*, *qnrA*, *B*, and *S*), aminoglycosides (*armA*, *armA+rmtC*, *rmtC*, *B*), cotrimoxazole (*dfr/sul*), tetracycline (*tetA*), chloramphenicol (*cmlA*) were identified in our collection from Pakistan. Resistance genotypes obtained via NGS are commonly used to study resistance of MDR pathogens, but it is important to continue to perform AST for confirmation. Despite the presence of *cmlA5*, both *K. pneumoniae* clinical isolates were susceptible to chloramphenicol (CHL). Further integron analysis revealed that the *intI1* integrase gene was truncated and the Pc promoter was absent suggesting that *cmlA5* may not be expressed [249]. These results emphasize that analysis of NGS data alone can lead to inaccurate resistance profiles and highlight the importance of phenotypic data. However, NGS-based resistance profiles in combination with AST results may provide useful information on MGE-mediated resistance for tracking resistance and plasmids in healthcare settings.

The virulence factors (*rpmA*, *magA*, and aerobactin), which were not identified in our collection, are important virulence factors associated with hypermucoviscous *K. pneumoniae* isolates [250]. In contrast to Zhao et al. who found a correlation between ST and virulence traits in hypermucoviscous *K. pneumoniae* isolates, no significant differences between virulence factors of an ST type were detected in our study, which may indicate that hypermucoviscous *K. pneumoniae* isolates were not included in our study isolates [251].

The genomics of *K. pneumoniae*, recognized as the most common nosocomial pathogen worldwide, and CRKP as a critical public threat, has attracted the interest of microbiologists from all over the world. Today, NGS enables the comparison of whole genomes of large collections of *K. pneumoniae* clinical isolates. These studies have provided insights into the pathogen's population structure, its evolutionary path, its spread, and the way it causes disease. General trends in the populations showed that the presence of virulence plasmids would negatively affect the presence of acquired MDR plasmids. The current data suggest that both populations can be divided into two distinct clonal groups: "AMR global clones" and "hypervirulent clones" as previously mentioned [252]. However, CG25, an initially hypervirulent strain, is continues to evolve, and a second hypervirulent and multi-resistant cluster has been identified in China, which is an alarming finding and a greater threat to the public [243].

To understand antimicrobial multiresistance to β -lactams in *Enterobacterales*, the source of ARGs, pathways and genetic events leading to resistance, including mutations and/or HGT need to be determined. The diversity of clinical *Enterobacterales* isolates carrying carbapenemases identified in our study supports the notion that HGT is an important factor in their global spread. The successful spread

of a particular ARG may be influenced by many factors, including the MGEs responsible for its capture, the plasmids in which it has been identified, and the clonal spread of particular STs. Twenty years ago, these questions were not easy to answer but today molecular techniques have evolved and NGS can provide a wealth of information. For example, Arcari et al have demonstrated the extraordinary ability of the new high-risk clone ST307 to evolve and acquire resistance through genome plasticity to the two most commonly used classes of antibiotics: carbapenems and BLIs [246].

The dissemination of certain ARGs such as *bla*_{NDM-1} required more attention and a thorough analysis of each whole-genome sequence to accurately track their spread, as they occurred in a broader and variable genetic context, and in numerous species. In our recent manuscript, the distribution of incompatibility groups identified in the study NDM plasmids was highly variable (IncC, IncFIB, IncFII and IncHI1B), but was consistent with the findings of other reports that the *bla*_{NDM-1} gene had been identified on at least 20 different incompatibility groups, including those described in our study [158]. For the *bla*_{OXA-48} gene, the most common incompatibility group is IncL/M, which is consistent with our findings (IncL). These observations confirm that the epidemiology of circulating MDR plasmids varies by carbapenemase-type and is as important as the type of strains. These findings underscore the importance of ongoing genomic surveillance studies that characterize both the strains and plasmids involved.

Molecular analysis of the NDM-1 and OXA-48-positive plasmids revealed that all seven *bla*_{NDM-1} plasmids were unique, but we hypothesized that some type of recombination/insertion events may have occurred. First, it was shown that plasmids from two related MDR NDM-1-positive clinical *K. pneumoniae* isolates (BL12125/BL12456, ST14) from our collection shared the same AMR profile and AST phenotype and harbored the same IncC3 plasmid. Both plasmids harbored an *arr2-cmlA5-bla*_{OXA-10-aadA1} gene cassette array followed by *qacEdelta1-sul1*, as well as two copies of *ISCR1* surrounding *bla*_{NDM-1}, indicating potential recombination/insertion events on the plasmid.

Second, the *bla*_{NDM-1} plasmid collected from BU19801 (ST307, IncFIK2) coexisted with a *bla*_{CTX-M15} plasmid (IncFIK7). The same *bla*_{CTX-M15} plasmid (IncFIK7) was previously detected in Pakistan in a carbapenem-susceptible *K. pneumoniae* ST307 [253] suggesting that the *bla*_{NDM-1} plasmid may have been acquired downstream of *bla*_{CTX-M15}. It is worth noting that *K. pneumoniae* ST307, which is associated with several ARGs, is now emerging worldwide as an AMR high-risk global clone [246]. The two *K. pneumoniae* isolates BU19801 and BA3783 shared the same plasmid incompatibility group and plasmid type (IncFIK2), the same AMR profile and AST phenotypes, and harbored the same plasmid except for the insertion of a truncated *ISEc15*. This finding suggests that both *K. pneumoniae* isolates may have

shared the same plasmid at some point in the past. This highlights the importance of characterizing both the clones and the plasmids to better understand the spread of plasmid-mediated ARGs between pathogens that emerge as MDR.

Over the past two decades, the emergence and increase in the global prevalence of ESBLs and CPEs, including KPC and NDM CPEs, along with the description of diverse and multiple enzymes in a single MDR isolate, has led to greater interest in molecular surveillance studies for epidemiological purposes. It is well established that molecular global surveillance is very effective in providing a global, up-to-date status of the endemic distribution of ESBLs/carbapenemases as well as insights into clonality, especially in resource-limited countries where data are limited.

However, there are very few studies today that provides global data. Adequate surveillance programs that provide global data from all countries, including low- and middle-income countries (LMICs), are urgently needed. Early identification of new β -lactamase gene variants and new STs in endemic regions and countries where new mechanisms are emerging, is crucial to better track their spread. The molecular epidemiology of ESBLs and carbapenemases is complex and constantly evolving. Many reports over the past decades have shown that molecular epidemiology is useful in monitoring MDR pathogens and adapting infection control measures in healthcare settings. For example, a comprehensive genome-based study elucidated the rapid spread of VIM-producing pathogens in Poland by identifying several successful clonal *E. hormaechei* lineages (ST89, ST90 and ST121) that are spreading nationwide [254].

A deep understanding and knowledge of circulating local/international strains (STs), high-risk clones and hypervirulent strains together with associated resistance patterns (e.g., NDM-1, KPC...etc) is of utmost importance for epidemiological purposes. An additional layer of knowledge on the role, and identification of transmission of MGEs with these resistance patterns seems to be the future research direction of the new generation of microbiologists/bioinformaticians [254]. From a clinical perspective, implementation of local genomic surveillance programs using NGS has proven to be important epidemiological information that healthcare providers should be aware of to improve infection control strategies and patient outcomes. Today, as we move towards an era of successful hypervirulent and multiresistant clones causing HAIs, genomic surveillance studies in healthcare are a must. Further research that provides insights into the characterization of MGEs and answers to questions about the origin of these genes is critical to limiting the spread of bacterial resistance in the nosocomial settings. Genomic surveillance studies using real-time sequencing as new isolates are collected could have a

positive impact on surveillance and allow a better understanding and identification of circulating clones causing severe infections.

AMR is a natural survival process that cannot be stopped. It is a part of nature! However, there is hope that we can keep it under control if the fight against AMR becomes a three-pronged approach involving researchers, clinicians, microbiologists from universities, hospitals and public health institutions, and infection control specialists.

First, systematic molecular surveillance studies are critical to determine the current prevalence of all known β -lactamases that are already spreading but also to identify, track and better understand emerging resistance mechanisms. All this information can help guide the implementation of stringent infection control measures in the endemic areas. Up-to-date information on the current variants spreading in each area should be easily accessible. This can be achieved by building a user-friendly real-time public database containing a comprehensive description of the global epidemiology of all mechanisms of resistance maintained by clinical microbiologists from around the world. Secondly, prevention should be a priority in all hospitals. Screening of high-risk patients (travelers, transfers from another hospital) using rapid molecular tests should be performed to limit the spread of MDR pathogens and outbreaks. Thirdly, the use of antimicrobials could be improved by rapid molecular detection of CPEs in hospitals, which would facilitate the choice of treatment. Finally, the development of new antibiotics or other alternatives should be a continuous process to try to win the race and stay one step ahead of potential new mechanisms of resistance. The gap in antimicrobial development over the last 20 years may have favored the emergence of "superbugs".

Overall, the impact of these alarming healthcare-associated pathogens could be limited if interventions and collaboration between infection control, clinical microbiology, and research teams were implemented. Current advances in molecular characterization, which provides a wealth of information, may be useful in developing more effective infection control measures. Although the costs are still high, the introduction of NGS in clinical microbiology laboratories, or at least in reference laboratories, should facilitate the control of the spread of CPEs. A powerful surveillance system with systematic molecular studies, with all data available in a public user-friendly database could provide insights into the spread of these pathogens and guide scientists and clinicians to improve patient care.

Tracking MDR pathogens for better patient care is the most common strategy to combat antimicrobial resistance, but this does not address the root cause of antibiotic overuse. Ultimately, the use of antibiotics in humans and food-producing animals should be limited by incorporating possible alternative substances to treat and prevent diseases. Combating MDR pathogens is a recurring

challenge that can be addressed with a multi-pronged strategy. The combination of precise antibiotic use, rapid detection/characterization of MDR pathogens in the clinical setting, and improved infection control measures may help limit the global spread of AMR and prevent the estimated 10 million deaths by 2050.

REFERENCES

1. **Schlich T.** Asepsis and bacteriology: a realignment of surgery and laboratory science. *Med Hist* 2012;56(3):308-334.
2. **Toledo-Pereyra LH.** Louis Pasteur surgical revolution. *J Invest Surg* 2009;22(2):82-87.
3. **Cameron HC.** Lord Lister and the Evolution of Wound Treatment during the Last Forty Years: Being the James Watson Lectures Delivered at the Faculty of Physicians and Surgeons of Glasgow in February, 1906. *Br Med J* 1907;1(2414):789-803.
4. **Manring MM, Hawk A, Calhoun JH, Andersen RC.** Treatment of war wounds: a historical review. *Clin Orthop Relat Res* 2009;467(8):2168-2191.
5. **Tan SY, Tatsumura Y.** Alexander Fleming (1881-1955): Discoverer of penicillin. *Singapore Med J* 2015;56(7):366-367.
6. **Lobanovska M, Pilla G.** Penicillin's Discovery and Antibiotic Resistance: Lessons for the Future? *Yale J Biol Med* 2017;90(1):135-145.
7. **Magiorakos AP, Srinivasan A, Carey RB, Carmeli Y, Falagas ME et al.** Multidrug-resistant, extensively drug-resistant and pandrug-resistant bacteria: an international expert proposal for interim standard definitions for acquired resistance. *Clin Microbiol Infect* 2012;18(3):268-281.
8. **Nemeth J, Oesch G, Kuster SP.** Bacteriostatic versus bactericidal antibiotics for patients with serious bacterial infections: systematic review and meta-analysis. *J Antimicrob Chemother* 2015;70(2):382-395.
9. **Brown L, Wolf JM, Prados-Rosales R, Casadevall A.** Through the wall: extracellular vesicles in Gram-positive bacteria, mycobacteria and fungi. *Nat Rev Microbiol* 2015;13(10):620-630.
10. **Bouhss A, Trunkfield AE, Bugg TD, Mengin-Lecreulx D.** The biosynthesis of peptidoglycan lipid-linked intermediates. *FEMS Microbiol Rev* 2008;32(2):208-233.
11. **Vollmer W, Blanot D, de Pedro MA.** Peptidoglycan structure and architecture. *FEMS Microbiol Rev* 2008;32(2):149-167.
12. **Peters K, Kannan S, Rao VA, Biboy J, Vollmer D et al.** The Redundancy of Peptidoglycan Carboxypeptidases Ensures Robust Cell Shape Maintenance in *Escherichia coli*. *mBio* 2016;7(3).
13. **Sauvage E, Kerff F, Terrak M, Ayala JA, Charlier P.** The penicillin-binding proteins: structure and role in peptidoglycan biosynthesis. *FEMS Microbiol Rev* 2008;32(2):234-258.
14. **Sauvage E, Terrak M.** Glycosyltransferases and Transpeptidases/Penicillin-Binding Proteins: Valuable Targets for New Antibacterials. *Antibiotics (Basel)* 2016;5(1).
15. **Denome SA, Elf PK, Henderson TA, Nelson DE, Young KD.** *Escherichia coli* mutants lacking all possible combinations of eight penicillin binding proteins: viability, characteristics, and implications for peptidoglycan synthesis. *J Bacteriol* 1999;181(13):3981-3993.
16. **Cho H, Uehara T, Bernhardt TG.** Beta-lactam antibiotics induce a lethal malfunctioning of the bacterial cell wall synthesis machinery. *Cell* 2014;159(6):1300-1311.

17. **Essack SY.** The development of beta-lactam antibiotics in response to the evolution of beta-lactamases. *Pharm Res* 2001;18(10):1391-1399.
18. **Chambers HF, Deleo FR.** Waves of resistance: Staphylococcus aureus in the antibiotic era. *Nat Rev Microbiol* 2009;7(9):629-641.
19. **Bush LM, Johnson CC.** Ureidopenicillins and beta-lactam/beta-lactamase inhibitor combinations. *Infect Dis Clin North Am* 2000;14(2):409-433, ix.
20. **Harrison CJ, Bratcher D.** Cephalosporins: a review. *Pediatr Rev* 2008;29(8):264-267; quiz 273.
21. **Asbel LE, Levison ME.** Cephalosporins, carbapenems, and monobactams. *Infect Dis Clin North Am* 2000;14(2):435-447, ix.
22. **Cho JC, Fiorenza MA, Estrada SJ.** Ceftolozane/Tazobactam: A Novel Cephalosporin/beta-Lactamase Inhibitor Combination. *Pharmacotherapy* 2015;35(7):701-715.
23. **Skalweit MJ.** Profile of ceftolozane/tazobactam and its potential in the treatment of complicated intra-abdominal infections. *Drug Des Devel Ther* 2015;9:2919-2925.
24. **Cabot G, Bruchmann S, Mulet X, Zamorano L, Moya B et al.** Pseudomonas aeruginosa ceftolozane-tazobactam resistance development requires multiple mutations leading to overexpression and structural modification of AmpC. *Antimicrob Agents Chemother* 2014;58(6):3091-3099.
25. **Ito A, Sato T, Ota M, Takemura M, Nishikawa T et al.** In Vitro Antibacterial Properties of Cefiderocol, a Novel Siderophore Cephalosporin, against Gram-Negative Bacteria. *Antimicrob Agents Chemother* 2018;62(1).
26. **Ito A, Nishikawa T, Matsumoto S, Yoshizawa H, Sato T et al.** Siderophore Cephalosporin Cefiderocol Utilizes Ferric Iron Transporter Systems for Antibacterial Activity against Pseudomonas aeruginosa. *Antimicrob Agents Chemother* 2016;60(12):7396-7401.
27. **Drawz SM, Bonomo RA.** Three decades of beta-lactamase inhibitors. *Clin Microbiol Rev* 2010;23(1):160-201.
28. **Bush K, Bradford PA.** beta-Lactams and beta-Lactamase Inhibitors: An Overview. *Cold Spring Harb Perspect Med* 2016;6(8).
29. **Ehmann DE, Jahic H, Ross PL, Gu RF, Hu J et al.** Kinetics of avibactam inhibition against Class A, C, and D beta-lactamases. *J Biol Chem* 2013;288(39):27960-27971.
30. **Stachyra T, Levasseur P, Pechereau MC, Girard AM, Claudon M et al.** In vitro activity of the {beta}-lactamase inhibitor NXL104 against KPC-2 carbapenemase and Enterobacteriaceae expressing KPC carbapenemases. *J Antimicrob Chemother* 2009;64(2):326-329.
31. **Lapuebla A, Abdallah M, Olafisoye O, Cortes C, Urban C et al.** Activity of Imipenem with Relebactam against Gram-Negative Pathogens from New York City. *Antimicrob Agents Chemother* 2015;59(8):5029-5031.
32. **Morinaka A, Tsutsumi Y, Yamada M, Suzuki K, Watanabe T et al.** OP0595, a new diazabicyclooctane: mode of action as a serine beta-lactamase inhibitor, antibiotic and beta-lactam 'enhancer'. *J Antimicrob Chemother* 2015;70(10):2779-2786.

33. **Lomovskaya O, Sun D, Rubio-Aparicio D, Nelson K, Tsivkovski R et al.** Vaborbactam: Spectrum of Beta-Lactamase Inhibition and Impact of Resistance Mechanisms on Activity in Enterobacteriaceae. *Antimicrob Agents Chemother* 2017;61(11).
34. **Rossolini GM, Stone G, Kantecki M, Arhin FF.** In vitro activity of aztreonam/avibactam against isolates of Enterobacterales collected globally from ATLAS in 2019. *J Glob Antimicrob Resist* 2022;30:214-221.
35. **Vazquez-Ucha JC, Arca-Suarez J, Bou G, Beceiro A.** New Carbapenemase Inhibitors: Clearing the Way for the beta-Lactams. *Int J Mol Sci* 2020;21(23).
36. **Le Terrier C, Nordmann P, Freret C, Seigneur M, Poirel L.** Impact of Acquired Broad Spectrum beta-Lactamases on Susceptibility to Novel Combinations Made of beta-Lactams (Aztreonam, Cefepime, Meropenem, and Imipenem) and Novel beta-Lactamase Inhibitors in *Escherichia coli* and *Pseudomonas aeruginosa*. *Antimicrob Agents Chemother* 2023;67(7):e0033923.
37. **Papp-Wallace KM, Bethel CR, Caillon J, Barnes MD, Potel G et al.** Beyond Piperacillin-Tazobactam: Cefepime and AAI101 as a Potent beta-Lactam-beta-Lactamase Inhibitor Combination. *Antimicrob Agents Chemother* 2019;63(5).
38. **Morrissey I, Magnet S, Hawser S, Shapiro S, Knechtle P.** In Vitro Activity of Cefepime-Enmetazobactam against Gram-Negative Isolates Collected from U.S. and European Hospitals during 2014-2015. *Antimicrob Agents Chemother* 2019;63(7).
39. **Karvouniaris M, Almyroudi MP, Abdul-Aziz MH, Blot S, Paramythiotou E et al.** Novel Antimicrobial Agents for Gram-Negative Pathogens. *Antibiotics (Basel)* 2023;12(4).
40. **Miller AA, Shapiro AB, McLeod SM, Carter NM, Moussa SH et al.** In Vitro Characterization of ETX1317, a Broad-Spectrum beta-Lactamase Inhibitor That Restores and Enhances beta-Lactam Activity against Multi-Drug-Resistant Enterobacterales, Including Carbapenem-Resistant Strains. *ACS Infect Dis* 2020;6(6):1389-1397.
41. **Iregui A, Khan Z, Landman D, Quale J.** Activity of Meropenem with a Novel Broader-Spectrum beta-Lactamase Inhibitor, WCK 4234, against Gram-Negative Pathogens Endemic to New York City. *Antimicrob Agents Chemother* 2019;64(1).
42. **Halasohoris SA, Scarff JM, Pysz LM, Lembirik S, Lemmon MM et al.** In vitro and in vivo activity of GT-1, a novel siderophore cephalosporin, and GT-055, a broad-spectrum beta-lactamase inhibitor, against biothreat and ESKAPE pathogens. *J Antibiot (Tokyo)* 2021;74(12):884-892.
43. **Mendes RE, Rhomberg PR, Watters AA, Castanheira M.** In vitro activity of the orally bioavailable ceftibuten/VNRX-7145 (VNRX-5236 etzadroxil) combination against a challenge set of Enterobacterales pathogens carrying molecularly characterized beta-lactamase genes. *J Antimicrob Chemother* 2022;77(3):689-694.
44. **Saral Sariyer A.** Three new inhibitors of class A beta-lactamases evaluated by molecular docking and dynamics simulations methods: relebactam, enmetazobactam, and QPX7728. *J Mol Model* 2022;28(4):76.
45. **Karlowsky JA, Wise MG, Hackel MA, Pevear DC, Moeck G, Sahn DF.** Ceftibuten-Ledaborbactam Activity against Multidrug-Resistant and Extended-Spectrum-beta-Lactamase-Positive Clinical Isolates of Enterobacterales from a 2018-2020 Global Surveillance Collection. *Antimicrob Agents Chemother* 2022;66(11):e0093422.

46. **Giacobbe DR, Bassetti M.** Innovative beta-lactam/beta-lactamase inhibitor combinations for carbapenem-resistant Gram-negative bacteria. *Future Microbiol* 2022;17:393-396.
47. **Lomovskaya O, Castanheira M, Lindley J, Rubio-Aparicio D, Nelson K et al.** In vitro potency of xeruborbactam in combination with multiple beta-lactam antibiotics in comparison with other beta-lactam/beta-lactamase inhibitor (BLI) combinations against carbapenem-resistant and extended-spectrum beta-lactamase-producing Enterobacterales. *Antimicrob Agents Chemother* 2023;67(11):e0044023.
48. **Maher JM, Huband MD, Blankers CG, Puttagunta S, Aronin SI, Castanheira M.** In vitro activity of sulopenem and comparator agents against Enterobacterales and anaerobic clinical isolates collected during the SENTRY Antimicrobial Surveillance Program. *J Antimicrob Chemother* 2023;78(6):1406-1414.
49. **Wright GD.** Q&A: Antibiotic resistance: where does it come from and what can we do about it? *BMC Biol* 2010;8:123.
50. **Tsai YK, Fung CP, Lin JC, Chen JH, Chang FY et al.** Klebsiella pneumoniae outer membrane porins OmpK35 and OmpK36 play roles in both antimicrobial resistance and virulence. *Antimicrob Agents Chemother* 2011;55(4):1485-1493.
51. **Lister PD, Wolter DJ, Hanson ND.** Antibacterial-resistant Pseudomonas aeruginosa: clinical impact and complex regulation of chromosomally encoded resistance mechanisms. *Clin Microbiol Rev* 2009;22(4):582-610.
52. **Meletis G, Exindari M, Vavatsi N, Sofianou D, Diza E.** Mechanisms responsible for the emergence of carbapenem resistance in Pseudomonas aeruginosa. *Hippokratia* 2012;16(4):303-307.
53. **Livermore DM.** Multiple mechanisms of antimicrobial resistance in Pseudomonas aeruginosa: our worst nightmare? *Clin Infect Dis* 2002;34(5):634-640.
54. **Moya B, Dotsch A, Juan C, Blazquez J, Zamorano L et al.** Beta-lactam resistance response triggered by inactivation of a nonessential penicillin-binding protein. *PLoS Pathog* 2009;5(3):e1000353.
55. **Poole K.** Multidrug efflux pumps and antimicrobial resistance in Pseudomonas aeruginosa and related organisms. *J Mol Microbiol Biotechnol* 2001;3(2):255-264.
56. **Pirnay JP, De Vos D, Mossialos D, Vanderkelen A, Cornelis P, Zizi M.** Analysis of the Pseudomonas aeruginosa oprD gene from clinical and environmental isolates. *Environ Microbiol* 2002;4(12):872-882.
57. **Bonomo RA, Szabo D.** Mechanisms of multidrug resistance in Acinetobacter species and Pseudomonas aeruginosa. *Clin Infect Dis* 2006;43 Suppl 2:S49-56.
58. **Nordmann P, Dortet L, Poirel L.** Carbapenem resistance in Enterobacteriaceae: here is the storm! *Trends Mol Med* 2012;18(5):263-272.
59. **Nordmann P.** Carbapenemase-producing Enterobacteriaceae: overview of a major public health challenge. *Med Mal Infect* 2014;44(2):51-56.
60. **Khatib R, Sharma M, Iyer S, Fakhri MG, Obeid KM et al.** Decreasing incidence of Staphylococcus aureus bacteremia over 9 years: greatest decline in community-associated methicillin-susceptible and hospital-acquired methicillin-resistant isolates. *Am J Infect Control* 2013;41(3):210-213.

61. **Yigit H, Queenan AM, Anderson GJ, Domenech-Sanchez A, Biddle JW et al.** Novel carbapenem-hydrolyzing beta-lactamase, KPC-1, from a carbapenem-resistant strain of *Klebsiella pneumoniae*. *Antimicrob Agents Chemother* 2001;45(4):1151-1161.
62. **Munoz-Price LS, Poirel L, Bonomo RA, Schwaber MJ, Daikos GL et al.** Clinical epidemiology of the global expansion of *Klebsiella pneumoniae* carbapenemases. *Lancet Infect Dis* 2013;13(9):785-796.
63. **Nordmann P, Poirel L.** The difficult-to-control spread of carbapenemase producers among Enterobacteriaceae worldwide. *Clin Microbiol Infect* 2014;20(9):821-830.
64. **Bennett PM.** Plasmid encoded antibiotic resistance: acquisition and transfer of antibiotic resistance genes in bacteria. *Br J Pharmacol* 2008;153 Suppl 1:S347-357.
65. **Alekshun MN, Levy SB.** Molecular mechanisms of antibacterial multidrug resistance. *Cell* 2007;128(6):1037-1050.
66. **Carattoli A, Bertini A, Villa L, Falbo V, Hopkins KL, Threlfall EJ.** Identification of plasmids by PCR-based replicon typing. *J Microbiol Methods* 2005;63(3):219-228.
67. **Cambray G, Guerout AM, Mazel D.** Integrons. *Annu Rev Genet* 2010;44:141-166.
68. **Gillings MR.** Integrons: past, present, and future. *Microbiol Mol Biol Rev* 2014;78(2):257-277.
69. **Russell PG.** *GENETICS* 1997.
70. **Barlow M, Hall BG.** Origin and evolution of the AmpC beta-lactamases of *Citrobacter freundii*. *Antimicrob Agents Chemother* 2002;46(5):1190-1198.
71. **Fosse T, Giraud-Morin C, Madinier I, Labia R.** Sequence analysis and biochemical characterisation of chromosomal CAV-1 (*Aeromonas caviae*), the parental cephalosporinase of plasmid-mediated AmpC 'FOX' cluster. *FEMS Microbiol Lett* 2003;222(1):93-98.
72. **Verdet C, Arlet G, Barnaud G, Lagrange PH, Philippon A.** A novel integron in *Salmonella enterica* serovar Enteritidis, carrying the bla(DHA-1) gene and its regulator gene ampR, originated from *Morganella morganii*. *Antimicrob Agents Chemother* 2000;44(1):222-225.
73. **Lartigue MF, Poirel L, Aubert D, Nordmann P.** In vitro analysis of ISEcp1B-mediated mobilization of naturally occurring beta-lactamase gene blaCTX-M of *Kluyvera ascorbata*. *Antimicrob Agents Chemother* 2006;50(4):1282-1286.
74. **Aubert D, Naas T, Heritier C, Poirel L, Nordmann P.** Functional characterization of IS1999, an IS4 family element involved in mobilization and expression of beta-lactam resistance genes. *J Bacteriol* 2006;188(18):6506-6514.
75. **Toleman MA, Spencer J, Jones L, Walsh TR.** blaNDM-1 is a chimera likely constructed in *Acinetobacter baumannii*. *Antimicrob Agents Chemother* 2012;56(5):2773-2776.
76. **Partridge SR, Iredell JR.** Genetic contexts of blaNDM-1. *Antimicrob Agents Chemother* 2012;56(11):6065-6067; author reply 6071.
77. **Partridge SR, Zong Z, Iredell JR.** Recombination in IS26 and Tn2 in the evolution of multiresistance regions carrying blaCTX-M-15 on conjugative IncF plasmids from *Escherichia coli*. *Antimicrob Agents Chemother* 2011;55(11):4971-4978.

78. **Ritchie DJ, Alexander BT, Finnegan PM.** New antimicrobial agents for use in the intensive care unit. *Infect Dis Clin North Am* 2009;23(3):665-681.
79. **Melzer M, Petersen I.** Mortality following bacteraemic infection caused by extended spectrum beta-lactamase (ESBL) producing *E. coli* compared to non-ESBL producing *E. coli*. *J Infect* 2007;55(3):254-259.
80. **Ambler RP.** The structure of beta-lactamases. *Philos Trans R Soc Lond B Biol Sci* 1980;289(1036):321-331.
81. **Ambler RP, Coulson AF, Frere JM, Ghuysen JM, Joris B et al.** A standard numbering scheme for the class A beta-lactamases. *Biochem J* 1991;276 (Pt 1):269-270.
82. **Bush K, Jacoby GA, Medeiros AA.** A functional classification scheme for beta-lactamases and its correlation with molecular structure. *Antimicrob Agents Chemother* 1995;39(6):1211-1233.
83. **Bush K.** Bench-to-bedside review: The role of beta-lactamases in antibiotic-resistant Gram-negative infections. *Crit Care* 2010;14(3):224.
84. **Bush K, Jacoby GA.** Updated functional classification of beta-lactamases. *Antimicrob Agents Chemother* 2010;54(3):969-976.
85. **Jarlier V, Nicolas MH, Fournier G, Philippon A.** Extended broad-spectrum beta-lactamases conferring transferable resistance to newer beta-lactam agents in Enterobacteriaceae: hospital prevalence and susceptibility patterns. *Rev Infect Dis* 1988;10(4):867-878.
86. **Jacoby GA, Medeiros AA.** More extended-spectrum beta-lactamases. *Antimicrob Agents Chemother* 1991;35(9):1697-1704.
87. **Philippon A, Labia R, Jacoby G.** Extended-spectrum beta-lactamases. *Antimicrob Agents Chemother* 1989;33(8):1131-1136.
88. **Paterson DL, Bonomo RA.** Extended-spectrum beta-lactamases: a clinical update. *Clin Microbiol Rev* 2005;18(4):657-686.
89. **Datta N, Kontomichalou P.** Penicillinase synthesis controlled by infectious R factors in Enterobacteriaceae. *Nature* 1965;208(5007):239-241.
90. **Sougakoff W, Petit A, Goussard S, Sirot D, Bure A, Courvalin P.** Characterization of the plasmid genes blaT-4 and blaT-5 which encode the broad-spectrum beta-lactamases TEM-4 and TEM-5 in enterobacteriaceae. *Gene* 1989;78(2):339-348.
91. **Gniadkowski M.** Evolution of extended-spectrum beta-lactamases by mutation. *Clin Microbiol Infect* 2008;14 Suppl 1:11-32.
92. **Perez F, Endimiani A, Hujer KM, Bonomo RA.** The continuing challenge of ESBLs. *Curr Opin Pharmacol* 2007;7(5):459-469.
93. **Pitton JS.** Mechanisms of bacterial resistance to antibiotics. *Ergeb Physiol* 1972;65:15-93.
94. **Bradford PA.** Extended-spectrum beta-lactamases in the 21st century: characterization, epidemiology, and detection of this important resistance threat. *Clin Microbiol Rev* 2001;14(4):933-951, table of contents.
95. **Pitout JD, Thomson KS, Hanson ND, Ehrhardt AF, Moland ES, Sanders CC.** beta-Lactamases responsible for resistance to expanded-spectrum cephalosporins in

- Klebsiella pneumoniae, Escherichia coli, and Proteus mirabilis isolates recovered in South Africa. *Antimicrob Agents Chemother* 1998;42(6):1350-1354.
96. **Huletsky A, Knox JR, Levesque RC.** Role of Ser-238 and Lys-240 in the hydrolysis of third-generation cephalosporins by SHV-type beta-lactamases probed by site-directed mutagenesis and three-dimensional modeling. *J Biol Chem* 1993;268(5):3690-3697.
97. **Jacoby GA.** Genetics of extended-spectrum beta-lactamases. *Eur J Clin Microbiol Infect Dis* 1994;13 Suppl 1:S2-11.
98. **Bonnet R.** Growing group of extended-spectrum beta-lactamases: the CTX-M enzymes. *Antimicrob Agents Chemother* 2004;48(1):1-14.
99. **Humeniuk C, Arlet G, Gautier V, Grimont P, Labia R, Philippon A.** Beta-lactamases of *Kluyvera ascorbata*, probable progenitors of some plasmid-encoded CTX-M types. *Antimicrob Agents Chemother* 2002;46(9):3045-3049.
100. **Rossolini GM, D'Andrea MM, Mugnaioli C.** The spread of CTX-M-type extended-spectrum beta-lactamases. *Clin Microbiol Infect* 2008;14 Suppl 1:33-41.
101. **Chow JW, Fine MJ, Shlaes DM, Quinn JP, Hooper DC et al.** Enterobacter bacteremia: clinical features and emergence of antibiotic resistance during therapy. *Ann Intern Med* 1991;115(8):585-590.
102. **Choi SH, Lee JE, Park SJ, Choi SH, Lee SO et al.** Emergence of antibiotic resistance during therapy for infections caused by Enterobacteriaceae producing AmpC beta-lactamase: implications for antibiotic use. *Antimicrob Agents Chemother* 2008;52(3):995-1000.
103. **Philippon A, Arlet G, Jacoby GA.** Plasmid-determined AmpC-type beta-lactamases. *Antimicrob Agents Chemother* 2002;46(1):1-11.
104. **Jacoby GA.** AmpC beta-lactamases. *Clin Microbiol Rev* 2009;22(1):161-182, Table of Contents.
105. **Pai H, Kang CI, Byeon JH, Lee KD, Park WB et al.** Epidemiology and clinical features of bloodstream infections caused by AmpC-type-beta-lactamase-producing *Klebsiella pneumoniae*. *Antimicrob Agents Chemother* 2004;48(10):3720-3728.
106. **Nordmann P, Cuzon G, Naas T.** The real threat of *Klebsiella pneumoniae* carbapenemase-producing bacteria. *Lancet Infect Dis* 2009;9(4):228-236.
107. **Bratu S, Tolaney P, Karumudi U, Quale J, Mooty M et al.** Carbapenemase-producing *Klebsiella pneumoniae* in Brooklyn, NY: molecular epidemiology and in vitro activity of polymyxin B and other agents. *J Antimicrob Chemother* 2005;56(1):128-132.
108. **Deshpande LM, Rhomberg PR, Sader HS, Jones RN.** Emergence of serine carbapenemases (KPC and SME) among clinical strains of Enterobacteriaceae isolated in the United States Medical Centers: report from the MYSTIC Program (1999-2005). *Diagn Microbiol Infect Dis* 2006;56(4):367-372.
109. **Endimiani A, Hujer AM, Perez F, Bethel CR, Hujer KM et al.** Characterization of blaKPC-containing *Klebsiella pneumoniae* isolates detected in different institutions in the Eastern USA. *J Antimicrob Chemother* 2009;63(3):427-437.
110. **Cai JC, Zhou HW, Zhang R, Chen GX.** Emergence of *Serratia marcescens*, *Klebsiella pneumoniae*, and *Escherichia coli* Isolates possessing the plasmid-mediated

carbapenem-hydrolyzing beta-lactamase KPC-2 in intensive care units of a Chinese hospital. *Antimicrob Agents Chemother* 2008;52(6):2014-2018.

111. **Leavitt A, Navon-Venezia S, Chmelnitsky I, Schwaber MJ, Carmeli Y.** Emergence of KPC-2 and KPC-3 in carbapenem-resistant *Klebsiella pneumoniae* strains in an Israeli hospital. *Antimicrob Agents Chemother* 2007;51(8):3026-3029.
112. **Tsakris A, Kristo I, Poulou A, Markou F, Ikonomidis A, Pournaras S.** First occurrence of KPC-2-possessing *Klebsiella pneumoniae* in a Greek hospital and recommendation for detection with boronic acid disc tests. *J Antimicrob Chemother* 2008;62(6):1257-1260.
113. **Peirano G, Seki LM, Val Passos VL, Pinto MC, Guerra LR, Asensi MD.** Carbapenem-hydrolyzing beta-lactamase KPC-2 in *Klebsiella pneumoniae* isolated in Rio de Janeiro, Brazil. *J Antimicrob Chemother* 2009;63(2):265-268.
114. **Lomaestro BM, Tobin EH, Shang W, Gootz T.** The spread of *Klebsiella pneumoniae* carbapenemase-producing *K. pneumoniae* to upstate New York. *Clin Infect Dis* 2006;43(3):e26-28.
115. **Osano E, Arakawa Y, Wacharotayankun R, Ohta M, Horii T et al.** Molecular characterization of an enterobacterial metallo beta-lactamase found in a clinical isolate of *Serratia marcescens* that shows imipenem resistance. *Antimicrob Agents Chemother* 1994;38(1):71-78.
116. **Lauretti L, Riccio ML, Mazzariol A, Cornaglia G, Amicosante G et al.** Cloning and characterization of blaVIM, a new integron-borne metallo-beta-lactamase gene from a *Pseudomonas aeruginosa* clinical isolate. *Antimicrob Agents Chemother* 1999;43(7):1584-1590.
117. **Yong D, Toleman MA, Giske CG, Cho HS, Sundman K et al.** Characterization of a new metallo-beta-lactamase gene, bla(NDM-1), and a novel erythromycin esterase gene carried on a unique genetic structure in *Klebsiella pneumoniae* sequence type 14 from India. *Antimicrob Agents Chemother* 2009;53(12):5046-5054.
118. **Feng H, Liu X, Wang S, Fleming J, Wang DC, Liu W.** The mechanism of NDM-1-catalyzed carbapenem hydrolysis is distinct from that of penicillin or cephalosporin hydrolysis. *Nat Commun* 2017;8(1):2242.
119. **Groundwater PW, Xu S, Lai F, Varadi L, Tan J et al.** New Delhi metallo-beta-lactamase-1: structure, inhibitors and detection of producers. *Future Med Chem* 2016;8(9):993-1012.
120. **Khan AU, Maryam L, Zarrilli R.** Structure, Genetics and Worldwide Spread of New Delhi Metallo-beta-lactamase (NDM): a threat to public health. *BMC Microbiol* 2017;17(1):101.
121. **Bergstrom A, Katko A, Adkins Z, Hill J, Cheng Z et al.** Probing the Interaction of Aspergillomarasmine A with Metallo-beta-lactamases NDM-1, VIM-2, and IMP-7. *ACS Infect Dis* 2018;4(2):135-145.
122. **Christopeit T, Leiros HK.** Fragment-based discovery of inhibitor scaffolds targeting the metallo-beta-lactamases NDM-1 and VIM-2. *Bioorg Med Chem Lett* 2016;26(8):1973-1977.

123. **Cain R, Brem J, Zollman D, McDonough MA, Johnson RM et al.** In Silico Fragment-Based Design Identifies Subfamily B1 Metallo-beta-lactamase Inhibitors. *J Med Chem* 2018;61(3):1255-1260.
124. **Djoko KY, Achard MES, Phan MD, Lo AW, Miraula M et al.** Copper Ions and Coordination Complexes as Novel Carbapenem Adjuvants. *Antimicrob Agents Chemother* 2018;62(2).
125. **Hall LM, Livermore DM, Gur D, Akova M, Akalin HE.** OXA-11, an extended-spectrum variant of OXA-10 (PSE-2) beta-lactamase from *Pseudomonas aeruginosa*. *Antimicrob Agents Chemother* 1993;37(8):1637-1644.
126. **Poirel L, Potron A, Nordmann P.** OXA-48-like carbapenemases: the phantom menace. *J Antimicrob Chemother* 2012;67(7):1597-1606.
127. **Sader HS, Dale GE, Rhomberg PR, Flamm RK.** Antimicrobial Activity of Murepavadin Tested against Clinical Isolates of *Pseudomonas aeruginosa* from the United States, Europe, and China. *Antimicrob Agents Chemother* 2018;62(7).
128. **Poirel L, Heritier C, Tolun V, Nordmann P.** Emergence of oxacillinase-mediated resistance to imipenem in *Klebsiella pneumoniae*. *Antimicrob Agents Chemother* 2004;48(1):15-22.
129. **Pitout JDD, Peirano G, Kock MM, Strydom KA, Matsumura Y.** The Global Ascendency of OXA-48-Type Carbapenemases. *Clin Microbiol Rev* 2019;33(1).
130. **CLSI.** Performance Standards for Antimicrobial Susceptibility Testing, 33rd Edition. CLSI Supplement M100, Clinical and Laboratory Standards Institute. 2023.
131. **EUCAST.** Breakpoint tables for interpretation of MICs and zone diameters, version 13, 02 January 2023) http://www.eucast.org/clinical_breakpoints/. 2023.
132. **Noster J, Thelen P, Hamprecht A.** Detection of Multidrug-Resistant Enterobacterales-From ESBLs to Carbapenemases. *Antibiotics (Basel)* 2021;10(9).
133. **Caliskan-Aydogan O, Alocilja EC.** A Review of Carbapenem Resistance in Enterobacterales and Its Detection Techniques. *Microorganisms* 2023;11(6).
134. **Nordmann P, Poirel L, Dortet L.** Rapid detection of carbapenemase-producing Enterobacteriaceae. *Emerg Infect Dis* 2012;18(9):1503-1507.
135. **Dortet L, Poirel L, Nordmann P.** Worldwide dissemination of the NDM-type carbapenemases in Gram-negative bacteria. *Biomed Res Int* 2014;2014:249856.
136. **Dortet L, Brechard L, Cuzon G, Poirel L, Nordmann P.** Strategy for rapid detection of carbapenemase-producing Enterobacteriaceae. *Antimicrob Agents Chemother* 2014;58(4):2441-2445.
137. **Nordmann P, Poirel L.** Strategies for identification of carbapenemase-producing Enterobacteriaceae. *J Antimicrob Chemother* 2013;68(3):487-489.
138. **CLSI.** Clinical Laboratory Standards Institute. 2018. Methods for Dilution Antimicrobial Susceptibility Tests for Bacteria That Grow Aerobically; Approved Standards—11th Edition. CLSI document M07-A10, Wayne, PA. 2018.
139. **van der Zwaluw K, de Haan A, Pluister GN, Bootsma HJ, de Neeling AJ, Schouls LM.** The carbapenem inactivation method (CIM), a simple and low-cost alternative for the Carba NP test to assess phenotypic carbapenemase activity in gram-negative rods. *PLoS One* 2015;10(3):e0123690.

140. **Pierce VM, Simner PJ, Lonsway DR, Roe-Carpenter DE, Johnson JK et al.** Modified Carbapenem Inactivation Method for Phenotypic Detection of Carbapenemase Production among Enterobacteriaceae. *J Clin Microbiol* 2017;55(8):2321-2333.
141. **Byun JH, Seo Y, Kim D, Kim M, Lee H et al.** An agar plate-based modified carbapenem inactivation method (p-mCIM) for detection of carbapenemase-producing Enterobacteriaceae. *J Microbiol Methods* 2019:105781.
142. **Smith K.** Opening the Black Box of Phenotypic Carbapenemase Detection.
143. **Dortet L, Jousset A, Sainte-Rose V, Cuzon G, Naas T.** Prospective evaluation of the OXA-48 K-SeT assay, an immunochromatographic test for the rapid detection of OXA-48-type carbapenemases. *J Antimicrob Chemother* 2016;71(7):1834-1840.
144. **Glupczynski Y, Evrard S, Ote I, Mertens P, Huang TD et al.** Evaluation of two new commercial immunochromatographic assays for the rapid detection of OXA-48 and KPC carbapenemases from cultured bacteria. *J Antimicrob Chemother* 2016;71(5):1217-1222.
145. **Meunier D, Vickers A, Pike R, Hill RL, Woodford N, Hopkins KL.** Evaluation of the K-SeT R.E.S.I.S.T. immunochromatographic assay for the rapid detection of KPC and OXA-48-like carbapenemases. *J Antimicrob Chemother* 2016;71(8):2357-2359.
146. **Pasteran F, Denorme L, Ote I, Gomez S, De Belder D et al.** Rapid Identification of OXA-48 and OXA-163 Subfamilies in Carbapenem-Resistant Gram-Negative Bacilli with a Novel Immunochromatographic Lateral Flow Assay. *J Clin Microbiol* 2016;54(11):2832-2836.
147. **Wareham DW, Shah R, Betts JW, Phee LM, Momin MH.** Evaluation of an Immunochromatographic Lateral Flow Assay (OXA-48 K-SeT) for Rapid Detection of OXA-48-Like Carbapenemases in Enterobacteriaceae. *J Clin Microbiol* 2016;54(2):471-473.
148. **Glupczynski Y, Jousset A, Evrard S, Bonnin RA, Huang TD et al.** Prospective evaluation of the OKN K-SeT assay, a new multiplex immunochromatographic test for the rapid detection of OXA-48-like, KPC and NDM carbapenemases. *J Antimicrob Chemother* 2017;72(7):1955-1960.
149. **Bianco G, Boattini M, van Asten SAV, Iannaccone M, Zanotto E et al.** RESIST-5 O.O.K.N.V. and NG-Test Carba 5 assays for the rapid detection of carbapenemase-producing Enterobacteriales from positive blood cultures: a comparative study. *J Hosp Infect* 2020;105(2):162-166.
150. **El Kettani A, Maaloum F, Nzoyikorera N, Khalis M, Katfy K et al.** Evaluation of the Performances of the Rapid Test RESIST-5 O.O.K.N.V Used for the Detection of Carbapenemases-Producing Enterobacteriales. *Antibiotics (Basel)* 2021;10(8).
151. **Han R, Guo Y, Peng M, Shi Q, Wu S et al.** Evaluation of the Immunochromatographic NG-Test Carba 5, RESIST-5 O.O.K.N.V., and IMP K-SeT for Rapid Detection of KPC-, NDM-, IMP-, VIM-type, and OXA-48-like Carbapenemase Among Enterobacteriales. *Front Microbiol* 2020;11:609856.
152. **Hong J, Kang D, Kim D.** Performance Evaluation of the Newly Developed In Vitro Rapid Diagnostic Test for Detecting OXA-48-Like, KPC-, NDM-, VIM- and IMP-Type Carbapenemases: The RESIST-5 O.O.K.N.V.I. Multiplex Lateral Flow Assay. *Antibiotics (Basel)* 2021;10(4).

153. **Gelmez GA, Can B, Hasdemir U, Soyletir G.** Evaluation of two commercial methods for rapid detection of the carbapenemase-producing *Klebsiella pneumoniae*. *J Microbiol Methods* 2020;178:106084.
154. **Hopkins KL, Meunier D, Naas T, Volland H, Woodford N.** Evaluation of the NG-Test CARBA 5 multiplex immunochromatographic assay for the detection of KPC, OXA-48-like, NDM, VIM and IMP carbapenemases. *J Antimicrob Chemother* 2018;73(12):3523-3526.
155. **Li HH, He ZJ, Xie LM, Zhang JS, Xie TA et al.** Evaluation of Xpert Carba-R Assay for the Detection of Carbapenemase Genes in Gram-Negative Bacteria. *Biomed Res Int* 2021;2021:6614812.
156. **M. K.** Generations of Sequencing Technologies: From First to Next Generation. doi: 10.4172/0974-8369.1000395.
157. **S P.** NEXT-GENERATION SEQUENCING: THE ENABLER AND THE WAY AHEAD. *Microbiomics* 2017.
158. **Abraham EP, Chain E.** An enzyme from bacteria able to destroy penicillin. 1940. *Rev Infect Dis* 1988;10(4):677-678.
159. **Knothe H, Shah P, Krcmery V, Antal M, Mitsuhashi S.** Transferable resistance to cefotaxime, cefoxitin, cefamandole and cefuroxime in clinical isolates of *Klebsiella pneumoniae* and *Serratia marcescens*. *Infection* 1983;11(6):315-317.
160. **Quale JM, Landman D, Bradford PA, Visalli M, Ravishankar J et al.** Molecular epidemiology of a citywide outbreak of extended-spectrum beta-lactamase-producing *Klebsiella pneumoniae* infection. *Clin Infect Dis* 2002;35(7):834-841.
161. **Wiener J, Quinn JP, Bradford PA, Goering RV, Nathan C et al.** Multiple antibiotic-resistant *Klebsiella* and *Escherichia coli* in nursing homes. *JAMA* 1999;281(6):517-523.
162. **Sirot D, Sirot J, Labia R, Morand A, Courvalin P et al.** Transferable resistance to third-generation cephalosporins in clinical isolates of *Klebsiella pneumoniae*: identification of CTX-1, a novel beta-lactamase. *J Antimicrob Chemother* 1987;20(3):323-334.
163. **Bradford PA, Cherubin CE, Idemyor V, Rasmussen BA, Bush K.** Multiply resistant *Klebsiella pneumoniae* strains from two Chicago hospitals: identification of the extended-spectrum TEM-12 and TEM-10 ceftazidime-hydrolyzing beta-lactamases in a single isolate. *Antimicrob Agents Chemother* 1994;38(4):761-766.
164. **Rice LB, Willey SH, Papanicolaou GA, Medeiros AA, Eliopoulos GM et al.** Outbreak of ceftazidime resistance caused by extended-spectrum beta-lactamases at a Massachusetts chronic-care facility. *Antimicrob Agents Chemother* 1990;34(11):2193-2199.
165. **Urban C, Meyer KS, Mariano N, Rahal JJ, Flamm R et al.** Identification of TEM-26 beta-lactamase responsible for a major outbreak of ceftazidime-resistant *Klebsiella pneumoniae*. *Antimicrob Agents Chemother* 1994;38(2):392-395.
166. **Pitout JD, Laupland KB.** Extended-spectrum beta-lactamase-producing Enterobacteriaceae: an emerging public-health concern. *Lancet Infect Dis* 2008;8(3):159-166.
167. **Smith Moland E, Hanson ND, Herrera VL, Black JA, Lockhart TJ et al.** Plasmid-mediated, carbapenem-hydrolysing beta-lactamase, KPC-2, in *Klebsiella pneumoniae* isolates. *J Antimicrob Chemother* 2003;51(3):711-714.

168. **Leavitt A, Carmeli Y, Chmelnitsky I, Goren MG, Ofek I, Navon-Venezia S.** Molecular epidemiology, sequence types, and plasmid analyses of KPC-producing *Klebsiella pneumoniae* strains in Israel. *Antimicrob Agents Chemother* 2010;54(7):3002-3006.
169. **Navon-Venezia S, Leavitt A, Schwaber MJ, Rasheed JK, Srinivasan A et al.** First report on a hyperepidemic clone of KPC-3-producing *Klebsiella pneumoniae* in Israel genetically related to a strain causing outbreaks in the United States. *Antimicrob Agents Chemother* 2009;53(2):818-820.
170. **Kontopoulou K, Protonotariou E, Vasilakos K, Kriti M, Koteli A et al.** Hospital outbreak caused by *Klebsiella pneumoniae* producing KPC-2 beta-lactamase resistant to colistin. *J Hosp Infect* 2010;76(1):70-73.
171. **Mavroidi A, Miriagou V, Malli E, Stefos A, Dalekos GN et al.** Emergence of *Escherichia coli* sequence type 410 (ST410) with KPC-2 beta-lactamase. *Int J Antimicrob Agents* 2012;39(3):247-250.
172. **Cuzon G, Naas T, Correa A, Quinn JP, Villegas MV, Nordmann P.** Dissemination of the KPC-2 carbapenemase in non-*Klebsiella pneumoniae* enterobacterial isolates from Colombia. *Int J Antimicrob Agents* 2013;42(1):59-62.
173. **Gregory CJ, Llata E, Stine N, Gould C, Santiago LM et al.** Outbreak of carbapenem-resistant *Klebsiella pneumoniae* in Puerto Rico associated with a novel carbapenemase variant. *Infect Control Hosp Epidemiol* 2010;31(5):476-484.
174. **Kitchel B, Rasheed JK, Patel JB, Srinivasan A, Navon-Venezia S et al.** Molecular epidemiology of KPC-producing *Klebsiella pneumoniae* isolates in the United States: clonal expansion of multilocus sequence type 258. *Antimicrob Agents Chemother* 2009;53(8):3365-3370.
175. **Kumarasamy KK, Toleman MA, Walsh TR, Bagaria J, Butt F et al.** Emergence of a new antibiotic resistance mechanism in India, Pakistan, and the UK: a molecular, biological, and epidemiological study. *Lancet Infect Dis* 2010;10(9):597-602.
176. **Doi Y, Paterson DL.** Carbapenemase-producing Enterobacteriaceae. *Semin Respir Crit Care Med* 2015;36(1):74-84.
177. **Mairi A, Pantel A, Sotto A, Lavigne JP, Touati A.** OXA-48-like carbapenemases producing Enterobacteriaceae in different niches. *Eur J Clin Microbiol Infect Dis* 2018;37(4):587-604.
178. **Logan LK, Weinstein RA.** The Epidemiology of Carbapenem-Resistant Enterobacteriaceae: The Impact and Evolution of a Global Menace. *J Infect Dis* 2017;215(suppl_1):S28-S36.
179. **Brolund A, Lagerqvist N, Byfors S, Struelens MJ, Monnet DL et al.** Worsening epidemiological situation of carbapenemase-producing Enterobacteriaceae in Europe, assessment by national experts from 37 countries, July 2018. *Euro Surveill* 2019;24(9).
180. **Sader HS, Mendes RE, Carvalhaes CG, Kimbrough JH, Castanheira M.** Changing Epidemiology of Carbapenemases Among Carbapenem-Resistant Enterobacterales From United States Hospitals and the Activity of Aztreonam-Avibactam Against Contemporary Enterobacterales (2019-2021). *Open Forum Infect Dis* 2023;10(2):ofad046.
181. CDC. CDC 2019 Report. Antibiotic Resistance Threats in the United States.2019.

182. **zur Wiesch PA, Kouyos R, Engelstadter J, Regoes RR, Bonhoeffer S.** Population biological principles of drug-resistance evolution in infectious diseases. *Lancet Infect Dis* 2011;11(3):236-247.
183. **Ventola CL.** The antibiotic resistance crisis: part 1: causes and threats. *P T* 2015;40(4):277-283.
184. **Infectious Diseases Society of A, Spellberg B, Blaser M, Guidos RJ, Boucher HW et al.** Combating antimicrobial resistance: policy recommendations to save lives. *Clin Infect Dis* 2011;52 Suppl 5:S397-428.
185. CDC. CDC 2013 Report. Antibiotic Resistance Threats in the United States.2013.
186. **Chen HY, Jean SS, Lee YL, Lu MC, Ko WC et al.** Carbapenem-Resistant Enterobacteriales in Long-Term Care Facilities: A Global and Narrative Review. *Front Cell Infect Microbiol* 2021;11:601968.
187. WHO. Global antimicrobial resistance and use surveillance system (GLASS) report.2022.
188. World Health Organization. Antimicrobial resistance: global report on surveillance.2014.
189. **Meletis G.** Carbapenem resistance: overview of the problem and future perspectives. *Ther Adv Infect Dis* 2016;3(1):15-21.
190. **Paterson DL, Hujer KM, Hujer AM, Yeiser B, Bonomo MD et al.** Extended-spectrum beta-lactamases in *Klebsiella pneumoniae* bloodstream isolates from seven countries: dominance and widespread prevalence of SHV- and CTX-M-type beta-lactamases. *Antimicrob Agents Chemother* 2003;47(11):3554-3560.
191. **Canton R, Coque TM.** The CTX-M beta-lactamase pandemic. *Curr Opin Microbiol* 2006;9(5):466-475.
192. **Castanheira M, Simner PJ, Bradford PA.** Extended-spectrum beta-lactamases: an update on their characteristics, epidemiology and detection. *JAC Antimicrob Resist* 2021;3(3):dlab092.
193. **Avershina E, Shapovalova V, Shipulin G.** Fighting Antibiotic Resistance in Hospital-Acquired Infections: Current State and Emerging Technologies in Disease Prevention, Diagnostics and Therapy. *Front Microbiol* 2021;12:707330.
194. **Otter JA, Burgess P, Davies F, Mookerjee S, Singleton J et al.** Counting the cost of an outbreak of carbapenemase-producing Enterobacteriaceae: an economic evaluation from a hospital perspective. *Clin Microbiol Infect* 2017;23(3):188-196.
195. CDC Report. Antibiotic Resistance Threats in the United States.2013.
196. CDC Report. Antibiotic Resistance Threats in the United States.2019.
197. **Bevan ER, Jones AM, Hawkey PM.** Global epidemiology of CTX-M beta-lactamases: temporal and geographical shifts in genotype. *J Antimicrob Chemother* 2017;72(8):2145-2155.
198. **Bogner C MT, Wantia N, Gebhard F, Busch D, Hoffmann R.** Differences in ESBL Genes between *E. coli*, *Klebsiella* spp. and *Enterobacter Cloacae* Strains. *Int J of Clin Med Microbiol* 2016;1(106).
199. **Castanheira M, Farrell SE, Deshpande LM, Mendes RE, Jones RN.** Prevalence of beta-lactamase-encoding genes among Enterobacteriaceae bacteremia isolates collected in 26

- U.S. hospitals: report from the SENTRY Antimicrobial Surveillance Program (2010). *Antimicrob Agents Chemother* 2013;57(7):3012-3020.
200. **Castanheira M, Farrell SE, Krause KM, Jones RN, Sader HS.** Contemporary diversity of beta-lactamases among Enterobacteriaceae in the nine U.S. census regions and ceftazidime-avibactam activity tested against isolates producing the most prevalent beta-lactamase groups. *Antimicrob Agents Chemother* 2014;58(2):833-838.
201. **Doi Y, Iovleva A, Bonomo RA.** The ecology of extended-spectrum beta-lactamases (ESBLs) in the developed world. *J Travel Med* 2017;24(suppl_1):S44-S51.
202. **Tesfa T, Mitiku H, Edae M, Assefa N.** Prevalence and incidence of carbapenem-resistant *K. pneumoniae* colonization: systematic review and meta-analysis. *Syst Rev* 2022;11(1):240.
203. **Poirel L, Revathi G, Bernabeu S, Nordmann P.** Detection of NDM-1-producing *Klebsiella pneumoniae* in Kenya. *Antimicrob Agents Chemother* 2011;55(2):934-936.
204. **Hasan CM, Turlej-Rogacka A, Vatopoulos AC, Giakkoupi P, Maatallah M, Giske CG.** Dissemination of blaVIM in Greece at the peak of the epidemic of 2005-2006: clonal expansion of *Klebsiella pneumoniae* clonal complex 147. *Clin Microbiol Infect* 2014;20(1):34-37.
205. **Matsumura Y, Peirano G, Bradford PA, Motyl MR, DeVinney R, Pitout JDD.** Genomic characterization of IMP and VIM carbapenemase-encoding transferable plasmids of Enterobacteriaceae. *J Antimicrob Chemother* 2018;73(11):3034-3038.
206. **Zhang X, Chen D, Xu G, Huang W, Wang X.** Molecular epidemiology and drug resistant mechanism in carbapenem-resistant *Klebsiella pneumoniae* isolated from pediatric patients in Shanghai, China. *PLoS One* 2018;13(3):e0194000.
207. **Ding G, Vinturache A, Lu M.** Addressing inappropriate antibiotic prescribing in China. *CMAJ* 2019;191(6):E149-E150.
208. **Fabre V, Cosgrove SE, Secaira C, Tapia Torrez JC, Lessa FC et al.** Antimicrobial stewardship in Latin America: Past, present, and future. *Antimicrob Steward Healthc Epidemiol* 2022;2(1):e68.
209. **WHO.** Worldwide country situation analysis: response to antimicrobial resistance. 2015.
210. **Kuzina ES, Kislichkina AA, Sizova AA, Skryabin YP, Novikova TS et al.** High-Molecular-Weight Plasmids Carrying Carbapenemase Genes bla(NDM-1), bla(KPC-2), and bla(OXA-48) Coexisting in Clinical *Klebsiella pneumoniae* Strains of ST39. *Microorganisms* 2023;11(2).
211. **Winkler ML, Bonomo RA.** SHV-129: A Gateway to Global Suppressors in the SHV beta-Lactamase Family? *Mol Biol Evol* 2016;33(2):429-441.
212. **Mehta SC, Rice K, Palzkill T.** Natural Variants of the KPC-2 Carbapenemase have Evolved Increased Catalytic Efficiency for Ceftazidime Hydrolysis at the Cost of Enzyme Stability. *PLoS Pathog* 2015;11(6):e1004949.
213. **Wang X, Minasov G, Shoichet BK.** Evolution of an antibiotic resistance enzyme constrained by stability and activity trade-offs. *J Mol Biol* 2002;320(1):85-95.
214. **Cohen Stuart J, Dierikx C, Al Naiemi N, Karczmarek A, Van Hoek AH et al.** Rapid detection of TEM, SHV and CTX-M extended-spectrum beta-lactamases in

- Enterobacteriaceae using ligation-mediated amplification with microarray analysis. *J Antimicrob Chemother* 2010;65(7):1377-1381.
215. **Ciuffreda L, Rodriguez-Perez H, Flores C.** Nanopore sequencing and its application to the study of microbial communities. *Comput Struct Biotechnol J* 2021;19:1497-1511.
216. **Greig DR, Dallman TJ, Hopkins KL, Jenkins C.** MinION nanopore sequencing identifies the position and structure of bacterial antibiotic resistance determinants in a multidrug-resistant strain of enteroaggregative *Escherichia coli*. *Microb Genom* 2018;4(10).
217. **Peirano G, van der Bij AK, Gregson DB, Pitout JD.** Molecular epidemiology over an 11-year period (2000 to 2010) of extended-spectrum beta-lactamase-producing *Escherichia coli* causing bacteremia in a centralized Canadian region. *J Clin Microbiol* 2012;50(2):294-299.
218. **Deleo FR, Chen L, Porcella SF, Martens CA, Kobayashi SD et al.** Molecular dissection of the evolution of carbapenem-resistant multilocus sequence type 258 *Klebsiella pneumoniae*. *Proc Natl Acad Sci U S A* 2014;111(13):4988-4993.
219. **Chen L, Mathema B, Chavda KD, DeLeo FR, Bonomo RA, Kreiswirth BN.** Carbapenemase-producing *Klebsiella pneumoniae*: molecular and genetic decoding. *Trends Microbiol* 2014;22(12):686-696.
220. **Pitout JD, Nordmann P, Poirel L.** Carbapenemase-Producing *Klebsiella pneumoniae*, a Key Pathogen Set for Global Nosocomial Dominance. *Antimicrob Agents Chemother* 2015;59(10):5873-5884.
221. **Yang J, Ye L, Guo L, Zhao Q, Chen R et al.** A nosocomial outbreak of KPC-2-producing *Klebsiella pneumoniae* in a Chinese hospital: dissemination of ST11 and emergence of ST37, ST392 and ST395. *Clin Microbiol Infect* 2013;19(11):E509-515.
222. **Giske CG, Froding I, Hasan CM, Turlej-Rogacka A, Toleman M et al.** Diverse sequence types of *Klebsiella pneumoniae* contribute to the dissemination of blaNDM-1 in India, Sweden, and the United Kingdom. *Antimicrob Agents Chemother* 2012;56(5):2735-2738.
223. **Williamson DA, Sidjabat HE, Freeman JT, Roberts SA, Silvey A et al.** Identification and molecular characterisation of New Delhi metallo-beta-lactamase-1 (NDM-1)- and NDM-6-producing Enterobacteriaceae from New Zealand hospitals. *Int J Antimicrob Agents* 2012;39(6):529-533.
224. **Voulgari E, Zarkotou O, Ranellou K, Karageorgopoulos DE, Vriioni G et al.** Outbreak of OXA-48 carbapenemase-producing *Klebsiella pneumoniae* in Greece involving an ST11 clone. *J Antimicrob Chemother* 2013;68(1):84-88.
225. **Oteo J, Ortega A, Bartolome R, Bou G, Conejo C et al.** Prospective multicenter study of carbapenemase-producing Enterobacteriaceae from 83 hospitals in Spain reveals high in vitro susceptibility to colistin and meropenem. *Antimicrob Agents Chemother* 2015;59(6):3406-3412.
226. **Borghi M, Pereira MF, Schuenck RP.** The Presence of Virulent and Multidrug-Resistant Clones of Carbapenem-Resistant *Klebsiella pneumoniae* in Southeastern Brazil. *Curr Microbiol* 2023;80(9):286.
227. **de Oliveira EM, Beltrao EMB, Pimentel MIS, Lopes ACS.** Occurrence of high-risk clones of *Klebsiella pneumoniae* ST11, ST340, and ST855 carrying the blaKPC-2, blaNDM-

- 1, blaNDM-5, and blaNDM-7 genes from colonized and infected patients in Brazil. *J Appl Microbiol* 2023;134(11).
228. **Errico G, Del Grosso M, Pagnotta M, Marra M, Carollo M et al.** Whole-Genome Sequencing and Molecular Analysis of Ceftazidime-Avibactam-Resistant KPC-Producing *Klebsiella pneumoniae* from Intestinal Colonization in Elderly Patients. *Antibiotics (Basel)* 2023;12(8).
229. **Ocampo AM, Chen L, Cienfuegos AV, Roncancio G, Chavda KD et al.** A Two-Year Surveillance in Five Colombian Tertiary Care Hospitals Reveals High Frequency of Non-CG258 Clones of Carbapenem-Resistant *Klebsiella pneumoniae* with Distinct Clinical Characteristics. *Antimicrob Agents Chemother* 2016;60(1):332-342.
230. **Lalaoui R, Bakour S, Livnat K, Assous MV, Diene SM, Rolain JM.** Spread of Carbapenem and Colistin-Resistant *Klebsiella pneumoniae* ST512 Clinical Isolates in Israel: A Cause for Vigilance. *Microb Drug Resist* 2019;25(1):63-71.
231. **Zhao Y, Liao Y, Zhang N, Liu S, Zhang J et al.** Four Types of ST11 Novel Mutations From Increasing Carbapenem-Resistant *Klebsiella pneumoniae* in Guangdong, 2016-2020. *Front Microbiol* 2021;12:702941.
232. **Coelho A, Mirelis B, Alonso-Tarres C, Nieves Larrosa M, Miro E et al.** Detection of three stable genetic clones of CTX-M-15-producing *Klebsiella pneumoniae* in the Barcelona metropolitan area, Spain. *J Antimicrob Chemother* 2009;64(4):862-864.
233. **Damjanova I, Toth A, Paszti J, Hajbel-Vekony G, Jakab M et al.** Expansion and countrywide dissemination of ST11, ST15 and ST147 ciprofloxacin-resistant CTX-M-15-type beta-lactamase-producing *Klebsiella pneumoniae* epidemic clones in Hungary in 2005--the new 'MRSA's'? *J Antimicrob Chemother* 2008;62(5):978-985.
234. **Papagiannitsis CC, Kotsakis SD, Petinaki E, Vatopoulos AC, Tzelepi E et al.** Characterization of metallo-beta-lactamase VIM-27, an A57S mutant of VIM-1 associated with *Klebsiella pneumoniae* ST147. *Antimicrob Agents Chemother* 2011;55(7):3570-3572.
235. **Peirano G, Ahmed-Bentley J, Fuller J, Rubin JE, Pitout JD.** Travel-related carbapenemase-producing Gram-negative bacteria in Alberta, Canada: the first 3 years. *J Clin Microbiol* 2014;52(5):1575-1581.
236. **Osterblad M, Kirveskari J, Hakanen AJ, Tissari P, Vaara M, Jalava J.** Carbapenemase-producing Enterobacteriaceae in Finland: the first years (2008-11). *J Antimicrob Chemother* 2012;67(12):2860-2864.
237. **Sonnevend A, Ghazawi A, Hashmey R, Haidermota A, Girgis S et al.** Multihospital Occurrence of Pan-Resistant *Klebsiella pneumoniae* Sequence Type 147 with an ISEcp1-Directed blaOXA-181 Insertion in the mgrB Gene in the United Arab Emirates. *Antimicrob Agents Chemother* 2017;61(7).
238. **Nahid F, Zahra R, Sandegren L.** A blaOXA-181-harboring multi-resistant ST147 *Klebsiella pneumoniae* isolate from Pakistan that represent an intermediate stage towards pan-drug resistance. *PLoS One* 2017;12(12):e0189438.
239. **Rojas LJ, Hujer AM, Rudin SD, Wright MS, Domitrovic TN et al.** NDM-5 and OXA-181 Beta-Lactamases, a Significant Threat Continues To Spread in the Americas. *Antimicrob Agents Chemother* 2017;61(7).

240. **Peirano G, Chen L, Kreiswirth BN, Pitout JDD.** Emerging Antimicrobial-Resistant High-Risk *Klebsiella pneumoniae* Clones ST307 and ST147. *Antimicrob Agents Chemother* 2020;64(10).
241. **Hu Y, Yang Y, Feng Y, Fang Q, Wang C et al.** Prevalence and clonal diversity of carbapenem-resistant *Klebsiella pneumoniae* causing neonatal infections: A systematic review of 128 articles across 30 countries. *PLoS Med* 2023;20(6):e1004233.
242. **Wyres KL, Lam MMC, Holt KE.** Population genomics of *Klebsiella pneumoniae*. *Nat Rev Microbiol* 2020;18(6):344-359.
243. **Pei N, Li Y, Liu C, Jian Z, Liang T et al.** Large-Scale Genomic Epidemiology of *Klebsiella pneumoniae* Identified Clone Divergence with Hypervirulent Plus Antimicrobial-Resistant Characteristics Causing Within-Ward Strain Transmissions. *Microbiol Spectr* 2022;10(2):e0269821.
244. **Giddins MJ, Macesic N, Annavajhala MK, Stump S, Khan S et al.** Successive Emergence of Ceftazidime-Avibactam Resistance through Distinct Genomic Adaptations in bla(KPC-2)-Harboring *Klebsiella pneumoniae* Sequence Type 307 Isolates. *Antimicrob Agents Chemother* 2018;62(3).
245. **Villa L, Feudi C, Fortini D, Iacono M, Bonura C et al.** Complete Genome Sequence of KPC-3- and CTX-M-15-Producing *Klebsiella pneumoniae* Sequence Type 307. *Genome Announc* 2016;4(2).
246. **Arcari G, Polani R, Santilli S, Capitani V, Sacco F et al.** Multiplicity of bla(KPC) Genes and pKpQIL Plasmid Plasticity in the Development of Ceftazidime-Avibactam and Meropenem Coresistance in *Klebsiella pneumoniae* Sequence Type 307. *Antimicrob Agents Chemother* 2023:e0036823.
247. **Chen Z, Wang Y, Tian L, Zhu X, Li L et al.** First report in China of Enterobacteriaceae clinical isolates coharboring blaNDM-1 and blaIMP-4 drug resistance genes. *Microb Drug Resist* 2015;21(2):167-170.
248. **Al-Agamy MH, El-Mahdy TS, Radwan HH, Poirel L.** Cooccurrence of NDM-1, ESBL, RmtC, AAC(6)-Ib, and QnrB in Clonally Related *Klebsiella pneumoniae* Isolates Together with Coexistence of CMY-4 and AAC(6)-Ib in *Enterobacter cloacae* Isolates from Saudi Arabia. *Biomed Res Int* 2019;2019:6736897.
249. **Revathi G, Siu LK, Lu PL, Huang LY.** First report of NDM-1-producing *Acinetobacter baumannii* in East Africa. *Int J Infect Dis* 2013;17(12):e1255-1258.
250. **Chiang TT, Yang YS, Yeh KM, Chiu SK, Wang NC et al.** Quantification and comparison of virulence and characteristics of different variants of carbapenemase-producing *Klebsiella pneumoniae* clinical isolates from Taiwan and the United States. *J Microbiol Immunol Infect* 2016;49(1):83-90.
251. **Zhao WH, Hu ZQ.** Epidemiology and genetics of CTX-M extended-spectrum beta-lactamases in Gram-negative bacteria. *Crit Rev Microbiol* 2013;39(1):79-101.
252. **Wyres KL, Wick RR, Judd LM, Froumine R, Tokolyi A et al.** Distinct evolutionary dynamics of horizontal gene transfer in drug resistant and virulent clones of *Klebsiella pneumoniae*. *PLoS Genet* 2019;15(4):e1008114.
253. **Habeeb MA, Haque A, Nematzadeh S, Iversen A, Giske CG.** High prevalence of 16S rRNA methylase RmtB among CTX-M extended-spectrum beta-lactamase-producing

Klebsiella pneumoniae from Islamabad, Pakistan. *Int J Antimicrob Agents* 2013;41(6):524-526.

254. **Izdebski R, Biedrzycka M, Urbanowicz P, Zabicka D, Gniadkowski M.** Genome-Based Epidemiologic Analysis of VIM/IMP Carbapenemase-Producing *Enterobacter* spp., Poland. *Emerg Infect Dis* 2023;29(8):1618-1626.

APPENDICES

ADDITIONAL PUBLICATIONS RELATED TO ANTIMICROBIAL RESISTANCE FROM 2011 TO 2014.

1. Hawser SP, Bouchillon SK, Lascols C, Hackel M, Hoban DJ, Badal RE, Cantón R.

Susceptibility of European *Escherichia coli* clinical isolates from intra-abdominal infections, extended-spectrum β -lactamase occurrence, resistance distribution, and molecular characterization of ertapenem-resistant isolates (SMART 2008-2009).

Antimicrob Agents Chemother. 2011 Aug;55(8):3917-21. doi: 10.1128/AAC.00070-11. Epub 2011 Jun 13. PMID: 21670192

2. Hawser SP, Bouchillon SK, Lascols C, Hackel M, Hoban DJ, Badal RE, Woodford N, Livermore D.

Susceptibility of *Klebsiella pneumoniae* Isolates from Intra-Abdominal Infections, and Molecular Characterization of Ertapenem-Resistant Isolates

Antimicrob Agents Chemother. 2011 Aug;55(8):3917-21. doi: 10.1128/AAC.00070-11. Epub 2011 Jun 13. PMID: 21670192

3. Hawser SP, Bouchillon SK, Hoban DJ, Badal RE, Hackel M, Lascols C, Villegas MV, Rossi F.

Low frequency of ertapenem-resistant intra-abdominal isolates of *Escherichia coli* from Latin America: susceptibility, ESBL-occurrence, and molecular characterization (SMART 2008-2009)

J Chemother. 2012 Feb;24(1):6-11. doi: 10.1179/1120009X12Z.0000000003. PMID: 22546718

4. Hoban DJ, Lascols C, Nicolle LE, Badal R, Bouchillon S, Hackel M, Hawser S.

Antimicrobial susceptibility of *Enterobacteriales*, including molecular characterization of extended-spectrum beta-lactamase-producing species, in urinary tract isolates from hospitalized patients in North America and Europe: results from the SMART study 2009-2010.

Diagn Microbiol Infect Dis. 2012 Sep ;74(1):62-7. doi: 10.1016/j.diagmicrobio.2012.05.024. Epub 2012 Jul 2. PMID: 22763019

5. Doyle D, Peirano G, Lascols C, Lloyd T, Church DL, Pitout JD.

The Laboratory Diagnosis of Enterobacteriales that produce Carbapenemases.

J Clin Microbiol. 2012 Dec ; 50(12) : 3877-80. Doi : 10.1128/JCM.02117-12. Epub 2012 Sep 19. PMID : 22993175

6. Hackel M, Lascols C, Bouchillon S, Hilton B, Morgenstern D, Purdy J.

Serotype prevalence and antibiotic resistance in *Streptococcus pneumoniae* clinical isolates among global populations.

Vaccine. 2013 Oct 1;31(42):4881-7. doi: 10.1016/j.vaccine.2013.07.054. Epub 2013 Aug 6. PMID: 23928466

7. Peirano G, Lascols C, Hackel M, Hoban DJ, Pitout JD.

Molecular epidemiology of *Enterobacterales* that produce VIMs and IMPs from the SMART surveillance program.

Diagn Microbiol Infect Dis. 2014 Mar ;78(3) :277-81. Doi : 10.1016/j.diagmicrobio.2013.11.024. Epub 2013 Dec 6. PMID: 24387958

8. Hoban D.J., Badal R., Bouchillon S., Hackel M., Kazmierczak K., Lascols C., Hawser S.

In vitro susceptibility and distribution of beta-lactamases in *Enterobacterales* causing intra-abdominal infections in North America 2010-2011.

Diagn Microbiol Infect Dis. 2014 Jul ;79(3) :367-72. doi : 10.1016/j.diagmicrobio.2014.03.026. Epub 2014 Apr 12.

PMID: 24813688

- 1. Crawford MA, Timme R, Lomonaco S, Lascols C, Fisher DJ, Sharma SK, Strain E, Allard MW, Brown EW, McFarland MA, Croley T, Hammack TS, Weigel LM, Anderson K, Hodge DR, Pillai SP, Morse SA, Khan E, Hughes MA.**

Genome Sequences of Multidrug-Resistant, Colistin-Susceptible and -Resistant Klebsiella pneumoniae Clinical Isolates from Pakistan.

Genome Announc. 2016 Dec 15;4(6): e01419-16. doi: 10.1128/genomeA.01419-16.

PMID: 27979956 Free PMC article.

- 2. Crawford MA, Fisher DJ, Leung LM, Lomonaco S, Lascols C, Cannatelli A, Giani T, Rossolini GM, Doi Y, Goodlett DR, Allard MW, Sharma SK, Khan E, Ernst RK, Hughes MA.**

CXC Chemokines Exhibit Bactericidal Activity against Multidrug-Resistant Gram-Negative Pathogens.

mBio. 2017 Nov 14;8(6): e01549-17. doi: 10.1128/mBio.01549-17.

PMID: 29138303 Free PMC article.

- 3. Lomonaco S, Crawford MA, Lascols C, Timme RE, Anderson K, Hodge DR, Fisher DJ, Pillai SP, Morse SA, Khan E, Hughes MA, Allard MW, Sharma SK.**

Resistome of carbapenem- and colistin-resistant Klebsiella pneumoniae clinical isolates.

PLoS One. 2018 Jun 8;13(6): e0198526. doi: 10.1371/journal.pone.0198526. eCollection 2018.

PMID: 29883490 Free PMC article.

- 4. Lomonaco S, Lascols C, Crawford MA, Anderson K, Hodge DR, Fisher DJ, Pillai SP, Morse SA, Khan E, Hughes MA, Allard MW, Sharma SK.**

Draft Genome Sequences of Antimicrobial-Resistant Shigella Clinical Isolates from Pakistan.

Microbiol Resour Announc. 2019 Jul 25;8(30): e00500-19. doi: 10.1128/MRA.00500-19.

PMID: 31346012 Free PMC article.

- 5. Lomonaco S, Crawford MA, Lascols C, Fisher DJ, Anderson K, Hodge DR, Pillai SP, Morse SA, Khan E, Hughes MA, Allard MW, Sharma SK.**

Draft Genome Sequences of Two Extensively Drug-Resistant Strains of Acinetobacter baumannii Isolated from Clinical Samples in Pakistan.

Microbiol Resour Announc. 2020 May 14;9(20): e00026-20. doi: 10.1128/MRA.00026-20.

PMID: 32409526 Free PMC article.

- 6. Crawford MA, Lascols C, Lomonaco S, Timme RE, Fisher DJ, Anderson K, Hodge DR, Morse SA, Pillai SP, Sharma SK, Khan E, Allard MW, Hughes MA.**

Enterobacterales draft genome sequences: 15 historical (1998-2004) and 30 contemporary (2015-2016) clinical isolates from Pakistan.

Microbiol Resour Announc. 2023 Jul 28: e0016323. doi: 10.1128/MRA.00163-23. Online ahead of print. PMID:

37504519 Free articles.

ADDITIONAL PUBLICATIONS RELATED TO OTHER RESEARCH TOPICS
FROM 2017 TO DATE.

1. Michel PA, Lascols C, Gee JE, Weigel LM, Sue D.

Rapid Filter-Based Detection and Culture of Burkholderia pseudomallei from Small Volumes of Urine.
J Clin Microbiol. 2017 Sep;55(9):2698-2707. doi: 10.1128/JCM.00764-17. Epub 2017 Jun 21.
PMID: 28637908 Free PMC article.

2. Gargis AS, McLaughlin HP, Conley AB, Lascols C, Michel PA, Gee JE, Marston CK, Kolton CB, Rodriguez-R LM, Hoffmaster AR, Weigel LM, Sue D.

Analysis of Whole-Genome Sequences for the Prediction of Penicillin Resistance and β -Lactamase Activity in Bacillus anthracis.
mSystems. 2018 Dec 11;3(6): e00154-18. doi: 10.1128/mSystems.00154-18. eCollection 2018 Nov-Dec. PMID: 30574557 Free PMC article.

3. Gargis AS, Lascols C, McLaughlin HP, Conley AB, Hoffmaster AR, Sue D.

Genome Sequences of Penicillin-Resistant Bacillus anthracis Strains.
Microbiol Resour Announc. 2019 Jan 10;8(2): e01122-18. doi: 10.1128/MRA.01122-18. eCollection 2019 Jan.
PMID: 30643874 Free PMC article.

4. McLaughlin HP, Bugrysheva JV, Conley AB, Gulvik CA, Cherney B, Kolton CB, Marston CK, Saile E, Swaney E, Lonsway D, Gargis AS, Kongphet-Tran T, Lascols C, Michel P, Villanueva J, Hoffmaster AR, Gee JE, Sue D.

Rapid Nanopore Whole-Genome Sequencing for Anthrax Emergency Preparedness.
Emerg Infect Dis. 2020 Feb;26(2):358-361. doi: 10.3201/eid2602.191351.
PMID: 31961318 Free PMC article.

5. Bugrysheva JV, Lascols C, McLaughlin HP, Gee JE, Elrod MG, Sue D.

Antimicrobial Susceptibility of Western Hemisphere Isolates of Burkholderia pseudomallei: Phenotypic and Genomic Analyses.
Microb Drug Resist. 2021 Sep;27(9):1176-1185. doi: 10.1089/mdr.2020.0362. Epub 2021 Feb 10. PMID: 33570476

6. Itsko M, Topaz N, Ousmane-Traoré S, Popoola M, Ouedraogo R, Gamougam K, Sadjji AY, Abdul-Karim A, Lascols C, Wang X.

Enhancing Meningococcal Genomic Surveillance in the Meningitis Belt Using High-Resolution Culture-Free Whole-Genome Sequencing.
J Infect Dis. 2022 Sep 4 ;226(4) :729-737. doi : 10.1093/infdis/jiac104. PMID : 35325163

7. Maxson T, Kongphet-Tran T, Mongkolrattanothai T, Travis T, Hendricks K, Parker C, McLaughlin HP, Bugrysheva J, Ambrosio F, Michel P, Cherney B, Lascols C, Sue D.

Systematic Review of In Vitro Antimicrobial Susceptibility Testing for Bacillus anthracis, 1947-2019.
Clin Infect Dis. 2022 Oct 17;75(Suppl 3): S373-S378. doi: 10.1093/cid/ciac520.
PMID: 36251548 Free PMC article.

8. Crawford MA, Lascols C, Lomonaco S, Timme RE, Fisher DJ, Anderson K, Hodge DR, Morse SA, Pillai SP, Sharma SK, Khan E, Allard MW, Hughes MA.

Enterobacterales draft genome sequences: 15 historical (1998-2004) and 30 contemporary (2015-2016) clinical isolates from Pakistan

Microbiol Resour Announc. 2023 Sep 19;12(9):e0016323. doi: 10.1128/MRA.00163-23. Epub 2023 Jul 28.

PMID: 37504519; PMCID: PMC10508161; DOI: 10.1128/MRA.00163-23