



HAL
open science

Un nouveau modèle de protection de graphes : problème de l'ensemble de rebouclement éternel

Nour Dyab

► **To cite this version:**

Nour Dyab. Un nouveau modèle de protection de graphes : problème de l'ensemble de rebouclement éternel. Computer Science [cs]. Université Claude Bernard - Lyon I, 2023. English. NNT : 2023LYO10201 . tel-04739375

HAL Id: tel-04739375

<https://theses.hal.science/tel-04739375v1>

Submitted on 16 Oct 2024

HAL is a multi-disciplinary open access archive for the deposit and dissemination of scientific research documents, whether they are published or not. The documents may come from teaching and research institutions in France or abroad, or from public or private research centers.

L'archive ouverte pluridisciplinaire **HAL**, est destinée au dépôt et à la diffusion de documents scientifiques de niveau recherche, publiés ou non, émanant des établissements d'enseignement et de recherche français ou étrangers, des laboratoires publics ou privés.



**THESE de DOCTORAT
DE L'UNIVERSITE CLAUDE BERNARD LYON 1**

Ecole Doctorale N° 512
Mathématiques et Informatique (InfoMaths)

Discipline:INFORMATIQUE

Soutenue publiquement le 24/10/2023, par:
Nour Dyab

**A New Protection Model:
The Eternal Feedback Vertex Problem**

Devant le jury composé de :

Mr. Abdallah MAKHOUL	Professor	Université de Franche-Comté	Rapporteur
Mr. Olivier TOGNI	Professeur	Université de Bourgogne	Rapporteur
Mme. Salima BENBERNOU	Professor	Université Paris Descartes	Présidente
Mme. Nora FACI	Maître de Conférences-HDR	Université Lyon 1	Examinatrice
Mme. Maidoun MORTADA	Maître de Conférences	Université Libanaise	Examinatrice
Mr. Mohammed LALOU	Maître de Conférences	Université de Bourgogne	Examinateur
Mr. Hamamache KHEDDOUCI	Professeur	Université Lyon1	Directeur de thèse

"TODAY IS A STRUGGLE. TOMORROW IS HOPE. THE FUTURE BELONGS TO US WHO KEEP TRYING."

Acknowledgment

“Let us be grateful to the people who make us happy; they are the charming gardeners who make our souls blossom.”

Marcel Proust

I am grateful for the wisdom and knowledge that God has bestowed upon me, and for the opportunities and resources that He has provided me with. His love and mercy have been a guiding force in my life, and I am humbled and grateful for His infinite blessings.

I would like to express my deepest gratitude to my thesis supervisors, *Dr. Hamamache Kheddouci*, and *Dr. Mohammed Lalou* for their guidance, support, and invaluable feedback throughout the entire research process. Their expertise and encouragement have been instrumental in shaping my ideas and approaches toward the study. *Dr. Hamamache Kheddouci*, thank you so much for allowing me to be a part of your team (GOAL TEAM), I was really excited to work alongside you and contribute to our shared goals. *Dr. Mohammed Lalou* you have been a mentor, teacher, and coach, and I finished this thesis having learned a lot. Thank you for everything. I sincerely hope that the work presented in this thesis meets the expectations of you both and all who have supported and encouraged me throughout this research project. Their guidance, feedback, and encouragement have been invaluable, and I am grateful for their contributions to my academic and professional development. It is my sincere hope that this research project reflects the level of dedication and hard work that they have invested in me. To *Dr. Remy Cazabet*, I just wanted to express my gratitude for helping me to learn Python language.

Also, I am thankful to the reporters and the members of jury, Pr. Olivier Togni, Pr. Abdallah Makhoul, Prof. Salima Benbernou, and Dr. Nora Faci for agreeing to participate in my thesis committee and for their insightful comments, feedback, and suggestions that helped me refine my research and analytical skills. And a special thanks for the special doctor Dr. Maidoun Mortada, it was indeed an honor and a pleasure to have you as a part of my thesis defense jury.

I would like to express my sincere appreciation to *Dr. Amine El-Sahili*, who allowed me to enter the research world and provided me with the necessary resources and support to carry out this project. I am extremely grateful for his trust and confidence in me, which has been a driving force throughout this academic endeavor.

Family members:

I would like to dedicate this thesis to my hero, my Dad. Throughout my life, my father has been my role model and my source of inspiration. He instilled in me the values of hard work, dedication, and perseverance, which have guided me throughout this research project. To my angel, I am grateful to my Mom. Her unwavering faith in me and her constant prayers to Allah have given me the strength and motivation to persevere during the most challenging times. They have always been there for me, providing me with the guidance and wisdom that I needed to succeed. Their sacrifices and dedication have made it possible for me to pursue my academic and professional goals, and I will always be grateful for everything he has done for me. Thank you, Dad and Mom, for being my hero and angel and for always believing in me. This thesis is a testament to the values that you have instilled in me, and I am proud to dedicate it to you.

My heartfelt thanks go to my big family (Sisters, Brothers, friends, and all who support me), for their love, support, and encouragement. Their constant motivation and belief in me have been a source of strength and inspiration throughout my academic journey. Thank you for giving me your time.

My deepest gratitude and love go to my partner, my dearest friend and supportive partner, *Hassan*. Your willingness to help me, whether it's with practical matters or emotional support, has meant the world to me. Your selflessness and genuine care have made all the difference, and I am truly grateful to have you by my side. Your love has given me strength and motivation during challenging times. Your belief in me has pushed me to strive for greatness and overcome obstacles. Your kindness and generosity have touched my heart in ways I cannot adequately put into words. I want you to know that I cherish you and your support deeply. Your assistance has not gone unnoticed, and I am forever grateful for the love and care you have bestowed upon me. Thank you, my love, for being my rock and always being there for me. Your presence in my life is a true blessing, and I am eternally grateful for your help and love.

Last but not least, I would like to extend my sincere gratitude to *Islamic Association for Guidance and Higher Education* for their generous financial support, which enabled me to carry out this research project.

Thank you all for your contributions and support towards the completion of this thesis.

Abstract

“ It always seems impossible until it is done.”

Nelson Mandela

This thesis aims to develop a model for graph protection using mobile guards, specifically focusing on the concept of eternal feedback vertex sets. The problem of protecting a graph using mobile guards has been extensively studied in the literature. This problem involves defending the vertices, as well as edges, of a graph G against any attack using defense units, called guards, stationed at the vertices of G . Our primary interest lies in protecting graphs against infinite sequences of attacks, where each attack is executed one at a time. A protection problem can be modeled by a two-player game between a defender and an attacker. In this game, the defender selects the initial configuration of guards in the first turn and must defend all vertices of G against any attack by reconfiguring the guards at each subsequent turn. On the other hand, the attacker chooses the location of each attack at each turn. An attack is considered defended if a guard can be moved to the attacked vertex via an edge. The defender wins the game if he successfully defends the graph against every sequence of attacks, while the attacker wins if he manages to breach the defense. Importantly, the sequence of attacks can be of infinite length. Variants of this problem, such as eternal dominating set [1], eternal independent set [2], and eternal covering [3] have been well explored in the literature.

In this thesis, we introduce two new variants of the graph protection problem, namely *Eternal Feedback Vertex Sets (EFVS)* and *m-Eternal Feedback Vertex Sets (m-EFVS)*. The two variants are modeled in the same way using a two-player game, with the specific condition that the set of vertices chosen by the defender to receive guards must simultaneously form a feedback vertex set and a dominating set in each turn. In other words, the *Eternal Feedback Vertex Set* on a graph can be seen as an infinite game between a defender and an attacker, where the defender chooses a set of guards F_i at each turn $i, i \geq 1$. At turn i , the attacker chooses a vertex r_i , called an attack, in $V \setminus F_{i-1}$ and the defender must defend the attack by moving to r_i a guard from a vertex v_j adjacent to r_i . The new guards configuration is $F_i = F_{i-1} \cup \{r_i\} \setminus \{v_j\}$. The sets F_i , for any $i \geq 1$, must be dominating and feedback vertex sets. In the case where the defender protects vertices by moving more than one guard, we talk about the *m-Eternal Feedback Vertex Sets*.

The organization of this thesis is as follows. We start with [Chapter 1](#) devoted to present essential definitions, commonly used notations, and initial findings that are well-established in graph theory and directly relevant to our research. The aim of this chapter is to introduce the reader to the fundamental concepts and terminology that will be utilized throughout this research document.

[Chapter 2](#) provides a brief history of the research conducted by graph theorists on protective models of graphs, specifically on the concept of *Eternal Problems*. Within this chapter, we highlight a multitude of significant findings that have motivated and inspired numerous researchers to introduce new approaches for solving complex problems.

Our primary focus in this study is to propose a new protective model that utilizes mobile guards to protect the vertices of a graph, this is what we do in [Chapter 3](#). We provide formal definitions of our new models of graph protection, namely the *Eternal Feedback vertex set* and *m-Eternal Feedback vertex set*. Both models are based on an initial selection of a feedback vertex set (*FVS*), where a vertex in *FVS* can be replaced with a neighboring vertex such that the resulting set is a *FVS* too. Then, we compare the two parameters; the eternal and m-eternal numbers, F^∞ and F_m^∞ , corresponding to the smallest eternal (m-eternal) feedback set of the graph, with known graph parameters. Consequently, we deduce some inequalities for F^∞ and F_m^∞ on cycles, complete graphs and complete bipartite graphs. Also, we provide a detailed study of both variants on grids, distance and circulant graphs.

In *Chapter 4*, and considering the class of interval graphs, we prove that the eternal feedback vertex number $F^\infty(G)$ on an interval graph G depends on the F^∞ of cliques in G . Also, we develop a linear algorithm for finding the eternal feedback vertex set on G , which utilizes a graph partitioning method as a preprocessing step, and then selects the guards from each partition independently.

In *Chapter 5*, we explore strategies for constructing an *EFVS* and determining the eternal feedback vertex number on various classes of graphs, including k -dimensional graphs, wheel graphs, and fan graphs. We also develop a linear algorithm for finding the eternal feedback vertex set in k -spiral graphs.

Finally, we conclude the thesis by providing a comprehensive summary of the presented work and highlighting intriguing open problems for further investigation.

Keyword:

Keyword: Eternal protection, guards, eternal dominating set, eternal feedback vertex set, eternal feedback vertex numbers, m-eternal feedback vertex numbers, interval graphs, k-dimension graphs, k-butterfly graphs, cliques.

Contents

Acknowledgement	i
Abstract	iii
1 Introduction into Graph Theory	2
1.1 Graphs	2
1.1.1 Foundations of Graph Theory: Key Concepts and Terminology	2
1.1.2 Classes of Graphs	4
1.1.3 Graph Problems and Parameters	10
1.2 Graph Theory Applications	14
1.3 Conclusion	16
2 Graph Protection Models Using Guards	19
2.1 Historical overview	19
2.2 Eternal Protections Models	20
2.2.1 Eternal dominating problem	20
2.2.2 Eternal Independent problem	23
2.2.3 Eternal vertex covering problem	25
2.3 Conclusion	26
3 Eternal Feedback Vertex Sets: A New Graph Protection Model Using Guards	27
3.1 Eternal Feedback Vertex Models	27
3.2 EFVS and m-EFVS on general graphs	29
3.3 EFVS and m-EFVS on particular classes of graphs	30
3.3.1 Cycles, complete graphs, and complete bipartite graphs	31
3.3.2 Distance graphs and Circulant graphs	32
3.3.3 Grids	39
3.4 Conclusion	41
4 A linear Algorithm For The Eternal Feedback Vertex Set on Interval Graphs	42
4.1 Interval Graph Clique Partition	42
4.2 Eternal feedback vertex number on interval graphs	42
4.3 Algorithm for finding EFVS on interval graphs	44
4.4 Conclusion	46
5 Exploring Strategies for Constructing Eternal Feedback Vertex Sets	48
5.1 EFVS for k-Tree graphs	48
5.2 Wheel, Helm, and Gear Graphs	51
5.3 Friendship and Fan graphs	53
5.4 Algorithm for EFVS problem on k-spiral graphs	55
5.5 Conclusion	56
6 Conclusion	57

1 Introduction into Graph Theory

"The whole universe based on the concepts of *Graph Theory*, where love is an edge that is connecting two peoples, or vertices, either directly or indirectly."

Yatin Mehndiratta

The basic concepts of graph theory can be used to deal with problems from many different subjects, such as discrete mathematics, computer science, biology, chemical compounds, etc. This introductory chapter serves to provide an overview of the terminology and concepts of graph theory, setting the foundation for the subsequent discussions in this thesis. We will present key definitions and notations that will be employed throughout this research. For further in-depth knowledge, we recommend consulting the following books [4, 5, 6, 7, 8].

1.1 Graphs

Graphs are mathematical structure consisting of a collection of objects known as vertices or nodes, connected by a set of connections known as edges. The presence of an edge between two vertices indicates a relationship or connection between them. For instance, the transport network can be represented as a graph, with stations represented as vertices and roads represented as edges.

Many definitions and concepts of graph theory have been formulated to describe the characteristics and organization of graphs. These concepts have found extensive applications across diverse disciplines, ranging from computer science and engineering to social sciences and biology.

1.1.1 Foundations of Graph Theory: Key Concepts and Terminology

Real-world entities and their interactions are often represented by graphs. Social media platforms, for instance, construct graphs by assigning nodes to users and edges to connections between them. These connections can take various forms, including friendships, following relationships, or retweets. For instance, by modeling friendship relations on Facebook as a graph, we can examine the network properties of social connections among users. In this graph representation, individual users are depicted as nodes, and friendship relations are represented as edges.

Figure 1 illustrates a graph that models the relationships among five user accounts, where nodes represent individual users, and edges connect users who are friends. For example, we can see that Alice and David are friends on Facebook, while Carla and Bob are not.

Formally, a *graph* G is a couple of two sets $V(G)$ and $E(G)$, where $V(G)$ is the set of vertices of G and $E \subseteq \{xy \mid x, y \in V(G)\}$ is the set of edges of G , and it is denoted by $G(V(G), E(G))$, and sometimes $G(V, E)$. Set $V(G)$ is often assumed to be non-empty, but $E(G)$ is allowed to be empty. The order of a graph G , denoted by $v(G)$, is the cardinality of $V(G)$, and the size of a graph G , denoted by $e(G)$, is the number of edges in G . In case there are no conditions on graph G , let n be the order of G and m be its size.

Let $e = xy \in E(G)$, x and y are called the *ends* of e , and we say that e is *incident* to x and y , and x and y are said to be *adjacent*. Two edges, $e_1, e_2 \in E(G)$, are said to be adjacent if they have a common end. A graph consisting of a single vertex is referred to as a *trivial graph*. When a graph has a finite number of vertices and edges, it is classified as a *finite graph*. Furthermore, a *simple graph* is a graph without loops, which are edges connecting a vertex to itself, and multiple edges, which are

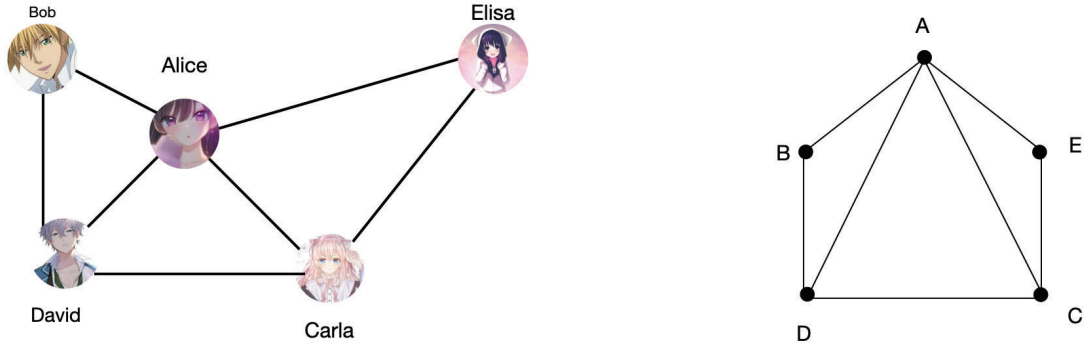

Figure 1.1: An example on friend network between the users Alice(A), Bob(B), Carla(C), David(D), and Elisa(E).

edges that connect the same pair of vertices. Throughout this thesis, all graphs are assumed finite and simple.

Let G be a graph, and x and y two vertices in G . x and y are said to be *neighbors* if they are adjacent. Denote by $N_G(x)$ the set of neighbors of x in G , and let $d_G(x)$ denote the number of neighbors of x in G and called the *degree of x* in G . That is, $d_G(x) = |N_G(x)|$. Also, we denote by $N_G[x]$ the set of closed neighbors of x in G , i.e. $N_G[x] = N_G(x) \cup \{x\}$. The *minimum degree* $\delta(G)$ of G is defined by $\delta(G) = \min\{d_G(v), v \in G\}$. Similarly, the *maximum degree* $\Delta(G)$ of G is stated as $\Delta(G) = \max\{d_G(v), v \in G\}$. A vertex x is said to be *isolated* if $d(x) = 0$. A vertex of degree $n - 1$ is called a *universal vertex*. By reference to graph G in *Figure 1.1* we have, $\Delta(G) = 4$, $\delta(G) = 2$, $N_G(A) = \{B, C, D, E\}$, $d_G(A) = 4$. Also, A is a universal vertex of G .

A graph H is said to be a *subgraph* of G if $V(H) \subseteq V(G)$ and $E(H) \subseteq E(G)$. A subgraph H of G is said to be *spanning subgraph* if $V(G) = V(H)$. It is said to be *induced subgraph* of G if $V(H) \subseteq V(G)$, $E(H) \subseteq E(G)$, and for all $x, y \in V(H)$, we have $xy \in E(G) \iff xy \in E(H)$, we write $H = G[V(H)]$ (see *Figure 1.2*). Let $S \subseteq V(G)$, we say that S is a *stable set* if every induced subgraph of S is empty. The *stability number* of G , α , is the cardinal of a maximum stable set, i.e. $\alpha(G) = \max\{|S|, S \text{ is stable in } G\}$.

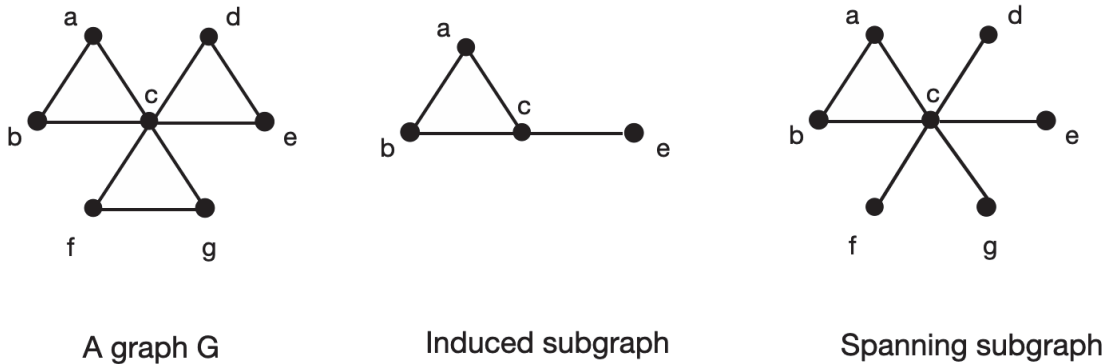

Figure 1.2: Examples of subgraphs, a graph G , an induced subgraph $G[\{a, b, c, e\}]$ and a spanning subgraph of G .

Let G be a graph, and let H be a subgraph of G . We denote by $H \cup e$ (or $H + e$), the subgraph obtained by adding edge e to H . As well, $H - e$ denotes the subgraph of G obtained from H by

removing edge e .

Given two graphs $G_1 = (V_1, E_1)$ and $G_2 = (V_2, E_2)$, the *cartesian product* of G_1 and G_2 denoted by $G_1 \times G_2$, is the graph whose vertex set is the cartesian product $V_1 \times V_2$, and where two vertices (u_1, u_2) and (v_1, v_2) are adjacent if and only if either $u_1 = v_1$ and u_2 is adjacent to v_2 in G_2 , or $u_2 = v_2$ and u_1 is adjacent to v_1 in G_1 , see *Figure 1.3*.

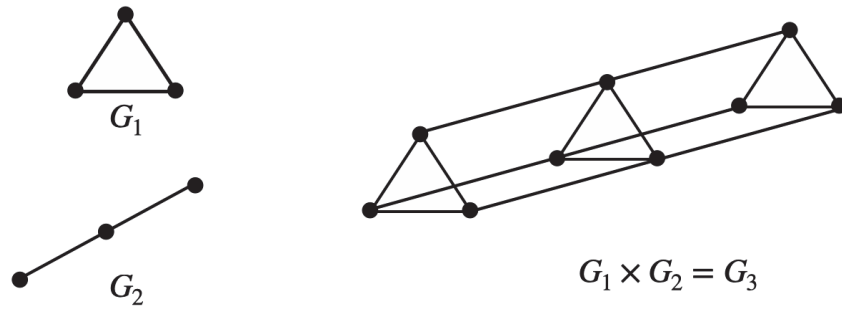

Figure 1.3: Cartesian product G_3 of two graphs, G_1 and G_2 .

1.1.2 Classes of Graphs

There are many particular classes of graphs that have been identified and studied in graph theory. Here are the definitions of the classes we are needed.

Empty graphs

A graph with no edges is called an *empty graph*; that is, G is said to be empty if $e(G) = 0$.

Regular graphs

G is said to be *regular* if all the vertices in G are of equal degree. G is said to be *k -regular* if $\forall v \in V(G)$, $d(v) = k$.

Paths

A *path* is a graph where the set of vertices can be arranged in a sequence such that only consecutive vertices are adjacent. Formally, a path of n vertices, denoted by P_n , is a graph such that $V(P_n) = \{v_1, v_2, \dots, v_n\}$ and $E(P_n) = \{v_1v_2, v_2v_3, \dots, v_{n-1}v_n\}$, and we write $P_n = v_1v_2v_3 \dots v_n$. We say that v_1 and v_n are the *ends* of P_n . An *xy -path* is a path with ends x and y . P_n is said to be *simple path* if no vertex in $V(P_n)$ appears more than once. The length $l(P_n)$ of path P_n is equal to the number of edges in P , i.e $l(P_n) = n - 1$.

Cycles

A cycle C is a graph whose edge set $E(C) = \{v_i v_{i+1} \mid 0 \leq i \leq n-1\} \cup \{v_n v_1\}$. Let C_n be a cycle with n vertices, we usually write $C = v_1 v_2 \dots v_n v_1$, denoted by C_n . The *length* $l(C_n)$ of C_n , is equal to the number of edges in C_n , i.e $l(C_n) = n$.

Figure 1.4 gives an example of an empty graph, a path, and a cycle.

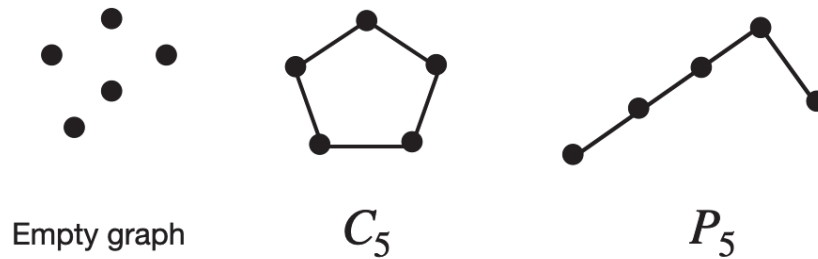

Figure 1.4: An empty graph, a path, a cycle

Connected and Disconnected Graphs

G is said to be a *connected graph* if $\forall x, y \in V(G)$, G contains an xy -path, otherwise G is said to be *disconnected*. A *connected component* of a graph G is a maximal induced subgraph of G . Disconnected graphs contain more than one connected component.

Trees and Forest

A *forest* is an acyclic graph, *i.e.* it does not contain any cycle as a subgraph. If a forest is connected then it is called a *tree*, denoted by T_n where n is the number of vertices. A vertex of degree 1 in a tree is called a *leaf*. Figure 1.5 illustrates an example of a forest, where the third tree is a *star*. A *star*, denoted S_k , is a graph of k vertices with the set of edges $E = \{v_1v_i\}$, for all $2 \leq i \leq k$.

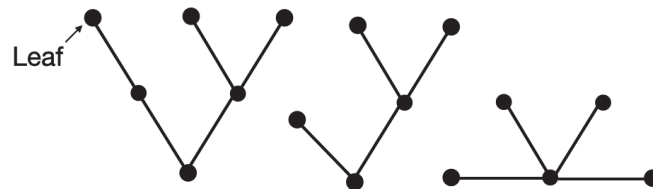

Figure 1.5: A forest of three dis-connected trees.

Complete Graphs

The *complete graph* of order n , denoted by K_n , is the graph where every pair of vertices is an edge, *i.e.* $\forall v \in V(G)$, $d_G(v) = n - 1$. A complete induced subgraph is called a *clique*.

Bipartite Graphs

A graph G is said to be *bipartite* if $V(G)$ can be partitioned into two stable sets S_1 and S_2 , *i.e.* $G[S_1]$ and $G[S_2]$ are empty. S_1 and S_2 are called *bipartition* of G , and G is usually denoted by $G(S_1, S_2, E)$.

Complete Bipartite Graphs

A bipartite graph $G = (S_1, S_2, E)$ is *complete* if there is an edge $xy \in E$ for every $x \in S_1$ and $y \in S_2$. A complete bipartite graph is denoted by $K_{n,m}$, where $|S_1| = n$ and $|S_2| = m$. Figure 1.6 gives an example of a complete graph, bipartite graph, and complete bipartite graph.

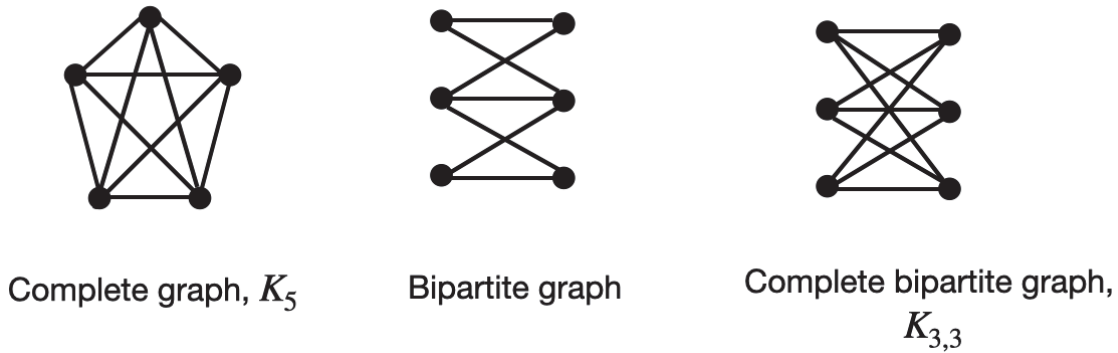

Figure 1.6: A complete graph, a bipartite graph, and a complete bipartite graph.

Chordal Graphs

A *chordal graph* is a graph in which all cycles of four vertices or more have a chord, where a chord is an edge that is not part of the cycle but connects two vertices of the cycle (see *Figure 1.7*).

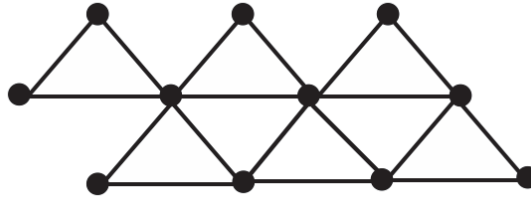

Figure 1.7: A chordal graph.

k -Sun graphs

A k -sun graph consists of $2k$ vertices, partitioned into two ordered sets, $C = \{c_1, \dots, c_k\}$ and $S = \{s_1, \dots, s_k\}$, where C induces a complete graph and each s_i is adjacent to c_i and c_{i+1} , for $i = \{1, 2, \dots, k\}$ and $c_{k+1} = c_1$.

k -Star graphs

The k -star graph, denoted by $S_{k,n-k}$, has a vertex set $V = \{v_1, \dots, v_n\}$ where $\{v_1, \dots, v_k\}$ induces a complete graph, and $N(v_i) = \{v_1, \dots, v_k\}$, for all $k+1 \leq i \leq n$.

k -Path graphs

The k -path graph, denoted by P_n^k , has a vertex set $V = \{v_1, \dots, v_n\}$ where $\{v_1, \dots, v_k\}$ induces a complete graph, and $v_i v_j \in E$, where $k+1 \leq i \leq n$ and $i-k \leq j \leq i-1$. See *Figure 1.8* for examples of k -sun, k -star, and k -path graphs, where $k = 4$.

k -Tree graphs

A k -tree, denoted T_n^k , where $n > k$, is a graph formed by starting with a $(k+1)$ -vertex complete graph and then repeatedly adding vertices in such a way that each added vertex v has exactly k neighbors

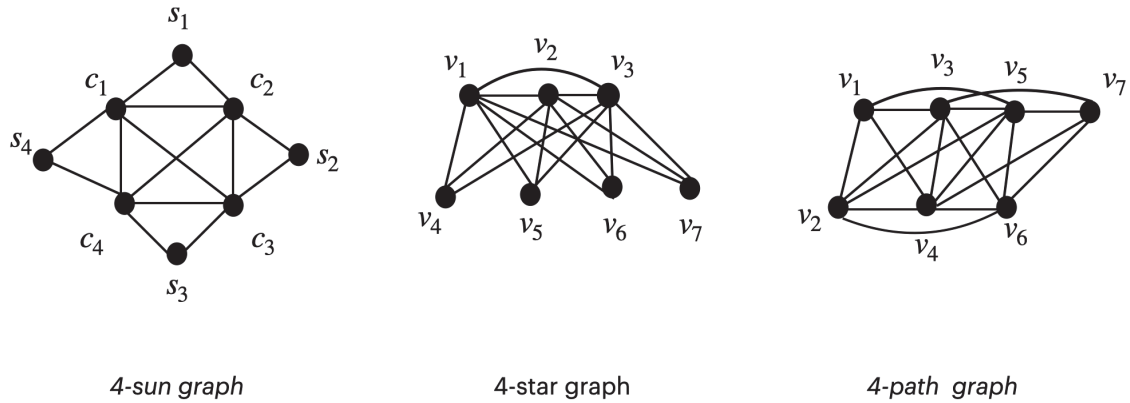

Figure 1.8: 4-Sun graph, a 4-star graph, and a 4-path graph.

U such that, together, the $k + 1$ vertices formed by v and U form a clique, see Figure 1.9.



Figure 1.9: Two k -tree graphs of different orders

k -spiral graphs

The k -spiral graph, denoted by S_n^k , has a vertex set $V = \{v_1, \dots, v_n\}$ such that, the set $\{v_1, \dots, v_{k-1}\}$ induces a complete graph, and $v_i v_j \in E$, for all $i \geq k$ and $j \leq k - 1$, and $\{v_{i-1} v_i, v_i v_{i+1}\} \in E$ for $k + 1 \leq i \leq n - 1$.

Friendship graphs

The friendship graph, denoted F_n , consists of $2n + 1$ vertices and $3n$ edges. It is constructed by joining n copies of C_3 with a common vertex, see Figure 1.10a.

Fan graphs

The fan graph, $F_{m,n}$, is defined as the graph join $\overline{K_m} + P_n$, Figure 1.10b.

Wheel Graphs

A wheel graph, W_n , is a graph constructed by connecting a single universal vertex to all vertices of a cycle of length n , C_n , see Figure 1.11a.



Figure 1.10: A friendship graph and a fan graph

Gear Graphs

A *Gear graph*, G_n , is obtained from a wheel graph, W_n , by inserting an extra vertex between each pair of adjacent vertices on the perimeter of a wheel graph, W_n , see *Figure 1.11b*.



Figure 1.11: A wheel graph and a gear graph

Helm Graphs

A *helm graph*, denoted by H_n , is a graph obtained by attaching a single edge and vertex to each vertex of the outer cycle of a wheel graph. A helm graph, H_n , consists of $2n + 1$ vertices.

Half graphs

A graph G with vertex set $V = \{a_1, \dots, a_k\} \cup \{b_1, \dots, b_k\}$ and $E = \{a_i b_j, 1 \leq i \leq j \leq k\}$, is called a *half-graph* with length k and denoted $H_{k,k}$.

Figure 1.12 illustrates the definitions of the helm and half graphs by an example for each.

Grids

The *grid* of dimensions $p \times q$, where p and q are two positive integers, is the graph $P_p \times P_q$. *Figure 1.13* shows $P_5 \times P_5$.

Distance Graphs

A graph G is a *distance graph*, denoted $P(D)$, if it is defined on a set of distances $D = \{d_1, \dots, d_k\}$, where d_i is a positive integer, and two distinct vertices $v_i, v_j \in V$ being adjacent if and only if

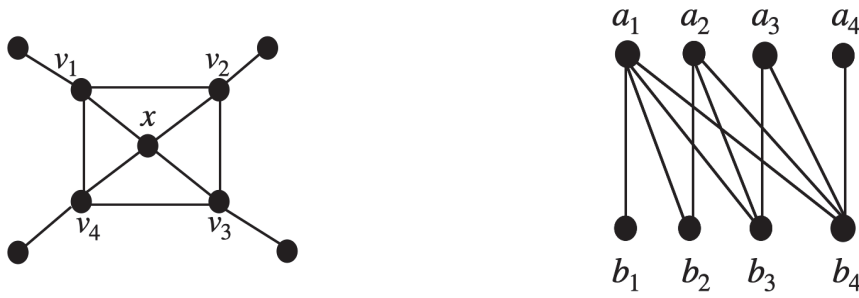

Figure 1.12: A helm graph and a half graph

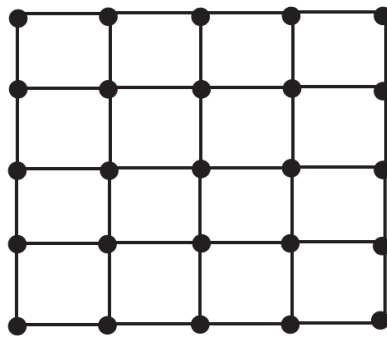

Figure 1.13: Grid of dimensions 5×5 .

$|i - j| \in D$. The finite distance graph $P_p(D)$ is the subgraph of $P(D)$ induced by vertices v_0, \dots, v_{p-1} . We omit sometimes the brackets and we write $P_p(d_1, \dots, d_k)$ instead of $P_p(\{d_1, \dots, d_k\})$.

Circulant Graphs

G is a *circulant graph*, denoted $C(D)$, if it is defined on $D = \{d_1, d_2, \dots, d_k\}$, where the set of neighbors of a given vertex v_i is $\{v_k | k = (i \pm d_j) \bmod n, j = 1, 2, \dots, k\}$, such that $1 \leq d_1 < d_2 < \dots < d_k \leq \frac{n}{2}$, p is the number of vertices. The finite circulant graph $C_p(D)$ is the subgraph of $C(D)$ induced by vertices v_0, \dots, v_{p-1} . We omit sometimes the brackets and we write $C_p(d_1, \dots, d_k)$ instead of $C_p(\{d_1, \dots, d_k\})$. We illustrate the definition of distance and circulant graphs in *Figure 1.14*.

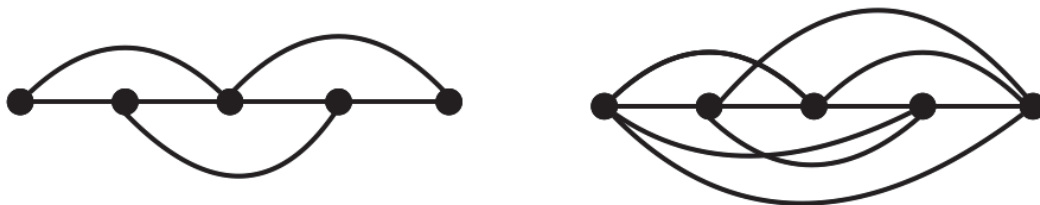

Figure 1.14: A distance graph (on the right) and a circulant graph (on the left), where $D = \{1, 2\}$ and $n = 5$.

Interval Graphs

An *interval graph* is a graph in which every vertex can be mapped into an interval in the real line. Let $\Gamma = \{I_1, I_2, \dots, I_n\}$ be a set of intervals, such that $I_i = [b_i, e_i]$, where b_i represents the beginning point and e_i represents the ending point. The interval graph G is the graph with $V = \{v_1, \dots, v_n\}$ where vertex v_i is associated with interval I_i , and v_i is adjacent to v_j in G , i.e. $v_i v_j \in E$, if and only if $I_i \cap I_j \neq \emptyset$, for all $i \neq j$ (see *Figure 1.15*).

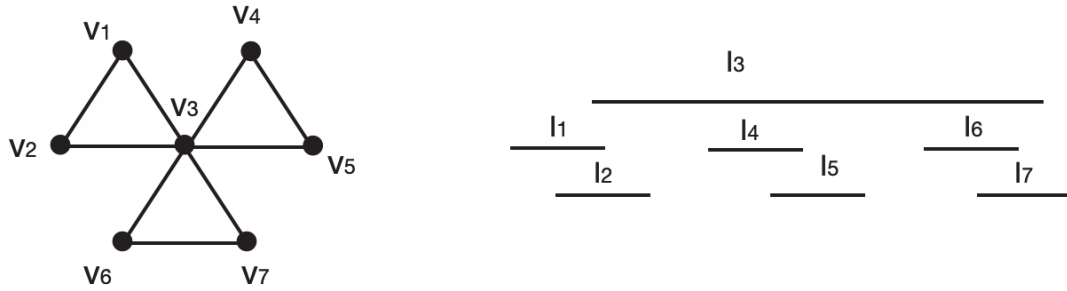

Figure 1.15: An interval graph G and its interval representation Γ .

Oriented Graphs

An *oriented graph* (or *digraph*) is a graph where vertices are connected by directed edges called *arcs*, i.e. for a digraph $D = (V(D), A(D))$, $V(D)$ is the set of vertices and $A(D) \subseteq \{(x, y) | x, y \in V(D)\}$ is the set of arcs.

The *underlying graph* of D , denoted by $G(D)$, is the graph obtained from D by ignoring the orientations of its arcs. A digraph is called *simple* if its underlying graph is so (*Figure 1.16*).

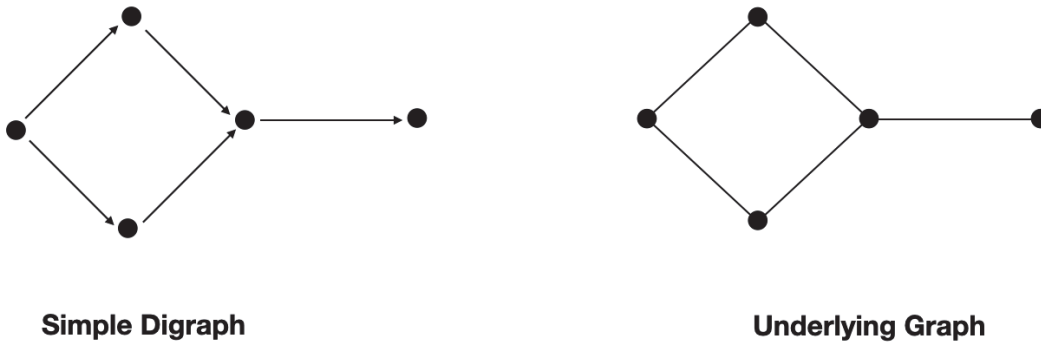

Figure 1.16: A simple digraph and its underlying graph.

1.1.3 Graph Problems and Parameters

In various domains, problems can be effectively modeled using graphs, enabling mathematical solutions. Numerous graph parameters arise from studying graphs for many decades, including maximal cliques [9], graph coloring [10], graph matching, independent set, dominating set [11], feedback vertex

set [12]. In this section, we provide an overview of these problems along with their associated applications. We take with more detail the two ones related to our research subject, namely, the dominating and feedback vertex set problems.

Maximum clique. Consider a Facebook network with users Alice (A), Bob (B), Carla (C), David (D), Emilie (E), Frank (F), George (G), and Key (K) (see Figure 1.17). One can ask for the largest possible chat group, where every pair of group members are friends on the platform. This amounts to find a clique as larger as possible in the graph representing the relationships among the users. A clique is a group of users, represented by vertices, who are all friends with each others, *i.e.* connected by edges. And a *maximum clique* is a clique containing the largest possible number of vertices.

Given a clique of a graph G , we call the *clique number*, denoted by $\omega(G)$, the order of a maximum clique in G . For further details on the maximal clique problem, refer to [9].

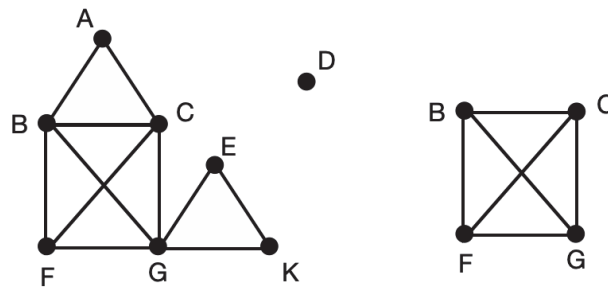

Figure 1.17: The graph G on the left represents the friendship between users, and an example of a maximum clique of G is shown on the right, resulting in $\omega(G) = 4$.

Clique covering. Consider a school with a diverse student population. In the graph, representing the school, the vertices are students, and the edges represent the friendships between them. Suppose that the school wants to organize social or friendship groups among the students. The objective is to create groups where all the students within the same group are friends with each other. The goal is to cover all the students in the school with these groups while maximizing the number of students in each group. This amounts to finding a clique covering of the graph. The goal is to find a set of cliques that covers all the students, such that no student is left without being assigned to a group, and to cover as many students as possible in each clique, ensuring that each group is cohesive and comprises a maximum number of friends. Formally, the *clique covering* is a partition $V = V_1 \cup \dots \cup V_k$ of V where each induced subgraph, $G[V_i]$, is a complete graph, for all $1 \leq i \leq k$. The *clique covering number* $\theta(G)$ is the minimum number k of partitions.

Similar to the clique covering problem, the *neo-colonization* problem is defined to be a partition $V_1 \cup \dots \cup V_k$ of G such that each V_i induces a connected graph. The weight assigned to V_i is equal to one if it induces a clique, otherwise, it is $1 + \gamma_c(G[V_i])$, where γ_c is the connected domination number. Then $\theta_c(G)$ is the minimum weight of any neo-colonization of G .

Vertex covering. A *vertex cover* of G is a set $C \subset V$ such that each edge of G is incident to a vertex in C . The minimum cardinality of a vertex cover of G is the *vertex cover number* $\tau(G)$. For more details and results on the vertex cover, the reader is referred to [13]. A real-life example of vertex covering can be seen in the context of network security or system administration, where each vertex represents a network device and each edge represents the connection between the corresponding devices. The network administrator may seek for strategically selecting a minimal set of devices to deploy monitoring sensors, ensuring comprehensive coverage of the network while minimizing the number of deployed sensors. This helps in efficient network control, such as detecting potential issues.

Graph matching. A matching in a graph is a subset of edges such that no two edges share a common vertex. A matching M of graph G is said to be maximal if no other edges of G can be added to M .

One real application of graph matching is in image recognition. For instance, suppose a database of known objects is constructed by a graph, such that each node represents a feature, and edges represent similarities between these features. The aim is to compare the graph representing the image with the known graphs in the database, which leads to find the best matching graph or subgraph that represents the object presented in the image. This can be done by comparing the structural similarity, edge weights, node attributes, or other characteristics of the graphs. Once a match is found, we can identify the object in the image based on the corresponding known graph. This application has practical uses in computer vision, pattern recognition, and object tracking, where graph matching helps in identifying and locating specific objects or patterns within images or video sequences. Graph matching has been well studied in the literature [14, 15, 16].

Graph decomposition. The graph decomposition problem consists in partitioning the graph into smaller, non-overlapping subgraphs. Different types of decomposition have been studied, including *path decomposition*, *cycle decomposition*, and *clique decomposition*. These methods can be employed to analyze transportation networks, such as road or subway systems. By decomposing the network into smaller components, it becomes easier to identify critical junctions, optimize routes, and understand the overall flow of traffic. This information can be valuable for urban planning, logistics, and traffic management.

Independent set problem. An Independent set $S \subset V$ of a graph $G = (V, E)$ is a set of vertices such that no two vertices in S are adjacent to each other. The *independence number* $\alpha(G)$ is the size of a largest independent set of G [17]. An example of the independent set is given in *Figure 1.18a* and the independent set number is illustrated in *Figure 1.18b*.

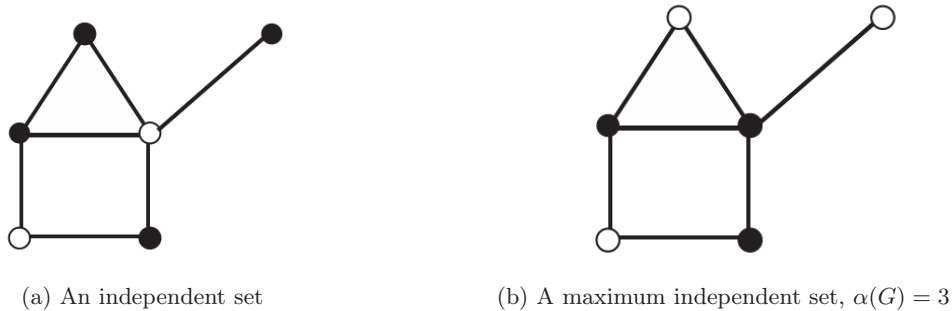

Figure 1.18: The unshaded vertices represent an independent set of G .

A real application of this parameter is the timetabling problem. The aim is to find the perfect school timetable where no student has two different classes at the same time. For that, we ask for the independent set in the graph where vertices are subjects, and two vertices are connected by an edge whenever at least one student has signed up for both subjects corresponding to the two vertices.

Dominating set Problem. The dominating problems were introduced in the early years of graph theory, with many applications in various domains, such as computer science, social sciences, physics, and biology. For instance, in network deployment, one can ask for efficiently placing the stations of internet in a city so that all the villages can benefit. As the internet station has a limited broadcasting range and a cost, we have to place as few as possible stations to reach all the villages, which leads to find a dominating set for the city graph connecting different villages. Formally, a set $S \subset V$ of vertices in a graph G is called a *dominating set* if every vertex $v \in V$ is either an element of S or is adjacent to an element of S . S is called a *minimal dominating set* if no proper subset of S is a dominating set of G . The *domination number* of a graph G , denoted by $\gamma(G)$, is the minimum cardinality of a dominating set in G (see *Figure 1.19*).

In the literature, different results have been obtained on several classes of graphs. Ore [18] proved that if G is a connected graph of order $n \geq 2$, then $\gamma(G) \leq \frac{n}{2}$. In [19], the authors gave a complete characterization of the graphs for which the equality is reached. One can easily see the relationship

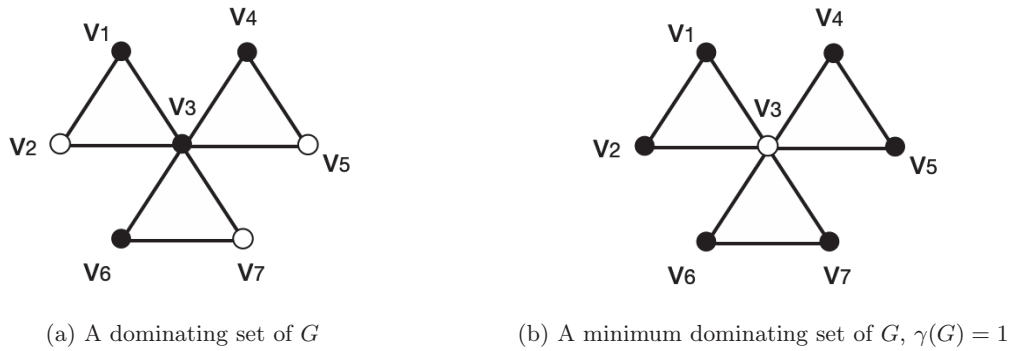

Figure 1.19: The unshaded vertices represent a dominating set of G .

between the domination number of a graph G and its independence number, stated as $\gamma(G) \leq \alpha(G)$. Indeed, let I be a maximum independent set of G , such that it contains a vertex from each incident edge *i.e.* each vertex in $V \setminus I$ has a neighbor in I . This means that a maximum independent set is dominating set. Several variants of the problem have been studied, including *total domination*, *connected domination*, and *independent dominating set*. To illustrate, let $S \subset V$ be a dominating set of G . If $G[S]$ has no isolated vertices, then S is a total dominating set, and the corresponding parameter, $\gamma_t(G)$, is the total domination number, and if $G[S]$ is connected, then S is a connected dominating set, and the corresponding parameter is the connected domination number $\gamma_c(G)$. S is said to be *independent dominating set* if it is an independent set. A thorough survey of domination sets can be found in [11].

Feedback Vertex Set Problem. Given a graph G , a *Feedback Vertex set (FVS)* is a subset of vertices $F \subset G$ such that its removal induces a forest. We denote by $F(G)$ the minimum cardinality over all FVS, *i.e.* $F(G) = \min\{|S|, S \text{ is a FVS}\}$. A *minimum feedback vertex set (MFVS)* is a FVS of cardinality $F(G)$. This problem is well-known to be NP-complete for general graphs [20]. It has received much attention in the literature, and finds a lot of applications in many domains, such as combinatorial circuit design, converter placement in optical networks, and deadlock prevention in computer systems [21, 12].

Given a graph G , if G is a path, tree or a cycle, the feedback cardinality is $F(P_n) = 0$, $F(T_n) = 0$ and $F(C_n) = 1$, respectively, for all $n \geq 1$. For a complete graph K_n , as each triplet of vertices forms a cycle, we have $F(K_n) = n - 2$, for all $n \geq 3$. For a complete bipartite graph $K_{n,m}$, such that the vertex set $V = A \cup B$, where $A = \{v_1, \dots, v_n\}$ and $B = \{u_1, \dots, u_m\}$, a cycle $v_i v_j u_k u_l$ is obtained for all $i, j, k, l \geq 1$, so $A \setminus \{v\}$ and $B \setminus \{u\}$ is an FVS of G for any $v \in A$ and $u \in B$. Therefore, $F(G) = \min\{|A| - 1, |B| - 1\}$.

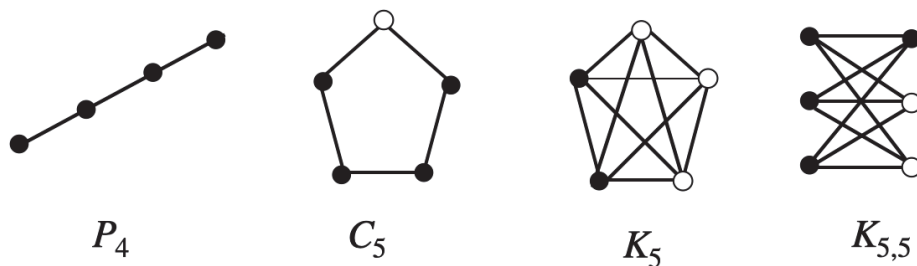

Figure 1.20: The unshaded vertices represent a feedback vertex sets of P_5 , C_5 , K_5 and $K_{3,3}$, which gives $F(P_5) = 0$, $F(C_5) = 1$, $F(K_5) = 3$ and $F(K_{3,3}) = 2$.

Considering distance and circulant graphs, we summarize, in *Table 1.1* [22], some bounds of *MFVS*. A comprehensive survey of this problem on many other classes of graphs is provided in [23].

D	$F(P_n(D))$		$F(C_n(D))$	
	Lower bound	Upper bound	Lower bound	Upper bound
$\{1, 2, 4\}$	$4\lfloor \frac{n}{8} \rfloor$	$\lceil \frac{n}{2} \rceil$	$4\lfloor \frac{n}{8} \rfloor$	$\lceil \frac{n+4}{2} \rceil$
$\{1, t\}$	$\lceil \frac{n-t}{3} \rceil$	$\lceil \frac{n-2}{3} \rceil$	$\lceil \frac{n+1}{3} \rceil$	$\lceil \frac{n+t}{3} \rceil + 1$
$\{1, s, t\}$	$\lceil \frac{2n-s-t}{5} \rceil$	$\lceil \frac{n}{2} \rceil$	$\lceil \frac{2n+1}{5} \rceil$	$\lceil \frac{n+t}{2} \rceil$
$\{1, 2, 3, \dots, t\}$	$\begin{cases} \lfloor \frac{n}{t+1} \rfloor (t-1) & \text{if } n = 0, 1 \pmod{t=1} \\ n - 2\lfloor \frac{n}{t+1} \rfloor - 2 & \text{otherwise} \end{cases}$		$n - 2\lfloor \frac{n}{t+1} \rfloor - 1$	$n - 2\lfloor \frac{n}{t+1} \rfloor$

Table 1.1: Bounds of MFVS on distance graphs and circulant graphs.

Note that the dynamic versions of the independent set problem, dominating problem, and feedback vertex set problem have been extensively studied in the context of protecting graphs with guards. These variants introduce changes to the traditional definitions, and commonly referred to as the eternal independent set, eternal dominating set, and eternal feedback vertex set, respectively. In these dynamic versions, the goal is to maintain the desired set (independent, dominating, or feedback vertex) as changes occur in the graph over time. Detailed discussions and analyses of these dynamic variants are the subjects of the next chapters.

1.2 Graph Theory Applications

“Knowledge without application is like a book that is never read.”

Christopher Crawford

Graphs are widely used and play a crucial role in various real-world applications. They provide a powerful mathematical framework to represent and analyze data in different fields, namely social science, electrical engineering, computer science [24], biology [25, 26] chemistry and physics [27, 28] (Figure 1.22). The first application is the famous *seven bridges of Königsberg* problem. It involves finding a path through the city of Königsberg that crosses each of its seven bridges exactly once and returns to the starting point. The problem was initially posed by the mathematician *Leonhard Euler* in the 18th century and is considered one of the pioneering problems in the field of graph theory. Euler approached the problem by abstracting the city and its bridges into a mathematical structure known as a graph. In this graph, each landmass is represented by a node, and each bridge is represented by an edge connecting two nodes (see Figure 1.21 [29]).

Euler’s solution proved that it is impossible to find a path that crosses each bridge exactly once and returns to the starting point if there are more than two nodes with an odd number of edges connected to them. This solution did not only solve a specific puzzle but also established fundamental principles in graph theory. It laid the foundation for the field, which has since developed into a powerful tool in various disciplines such as computer science, engineering, and many other fields.

In this section, we will explore the diverse range of real-world applications where graph theory finds practical utility.

1. Computer Science

Graph theory has many practical applications in computer science, and one of its most well-known uses is in the design of algorithms for routing data across networks. The internet can

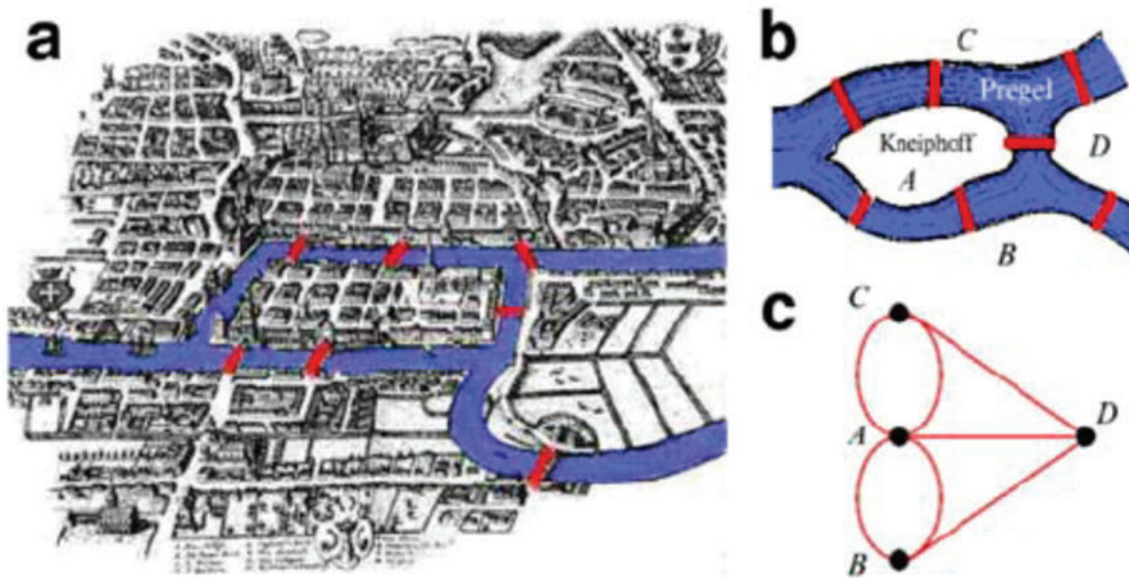

Figure 1.21: Map of Königsberg in Euler's time.

be viewed as a massive graph consisting of nodes representing individual computers and edges representing their connections. These algorithms enable traffic to flow smoothly on the internet, even in the presence of faults or congestion points. Thanks to graph theory, these algorithms tend to be more effective and efficient than those developed without taking graph theory principles into account. This is the case of *Dijkstra's Algorithm*, *Prims's Algorithm* and *Kruskal's Algorithm*.

2. Social Networks

Graph theory can be applied to social networks by representing individuals as nodes and their relationships as edges. This approach allows for analysis of the network's structure and identification of influential nodes within it. For instance, studying the spread of information or trends in social networks, graph theory can help predict how ideas, rumors, or news propagate within the network. This analysis is crucial for understanding the dynamics of information flow and its impact. A thorough survey about graph theory applications in social networks can be found in [24], see *Figure 1.23* [30].

3. Transportation

Graph theory finds many uses in transportation planning, logistics, routing, and cost analysis. It is employed to model road networks, identify efficient routes, and optimize traffic flow. In fact, it has even been used to predict and prevent traffic congestion before it happens, by analyzing two-dimensional graphs to identify potential problem areas. Other applications of graph theory in transportation planning include designing transit systems, flight schedules, forecasting regional economic growth, and developing new streets or railways.

4. Electrical Engineering

Graph theory has many other practical applications in electrical engineering, including Circuit Analysis, Power Grid Optimization, Fault Detection, Signal Processing, Control Systems, and designing circuit topologies. For the last one Some common circuit topologies include series, bridge, star, and parallel topologies, and by representing the components of a circuit as nodes and their connections as edges, graph theory can be used to analyze and optimize circuit behavior, as well as create circuits that are more reliable, efficient, and cost-effective [31]. Moreover, Graph theory can be used to analyze and process signals in electrical systems, such as audio or video

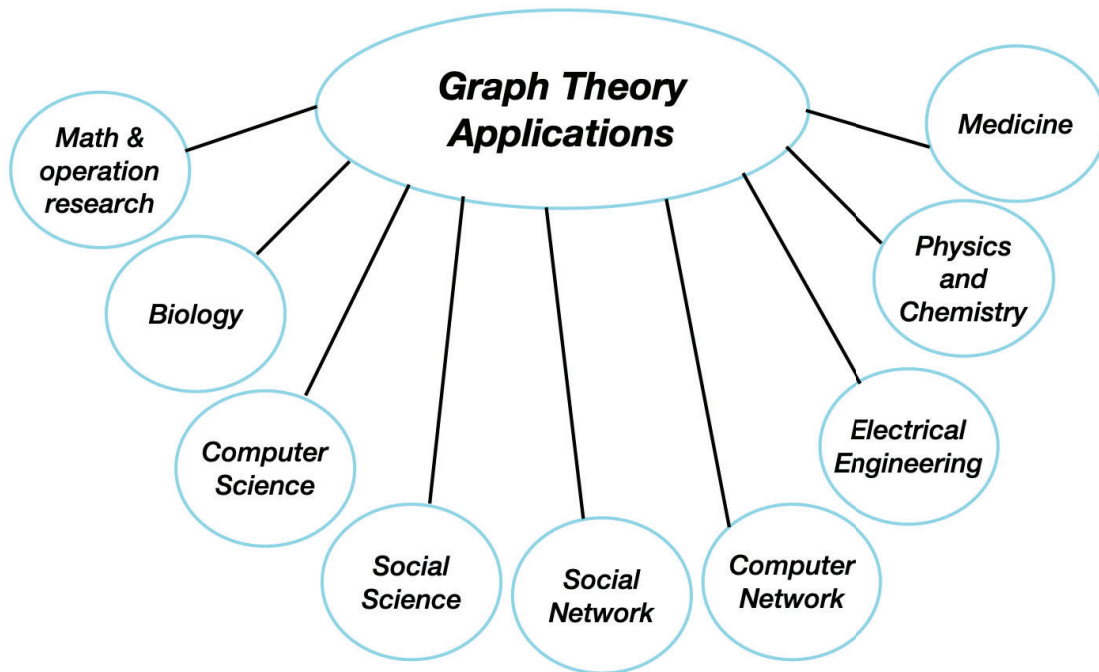

Figure 1.22: Graph Theory Applications

signals. By representing signals as graphs, it is possible to apply graph theory algorithms to filter, compress, or otherwise manipulate the signal.

5. Physics and Chemistry

Many problems in the field of physics and chemistry are solved using graph theory skills. Indeed, graph theory provides a mathematical framework to study molecular structures and properties, enabling the analysis and optimization of complex systems especially in physics. For more detailed, we invite the reader to [31, 27, 28].

6. Biology and Medicine

Biologists used graphs in transcriptional regulation networks, Metabolic networks and Protein-Protein interaction networks. Also, they are useful in characterizing drug-drug target relationships, where nodes in biological networks referred to a bimolecular such as genes, proteins, or metabolites, and edges connecting these nodes indicate functional, physical, or chemical interactions between the corresponding bimolecular. Furthermore, graph theory has numerous applications in the study of diseases, including epidemic modeling, disease network analysis, genetic analysis, and drug discovery. By using graph theory to analyze disease data, researchers can gain insights into the underlying causes of diseases and develop more effective treatments. This is the case of *Cancer heterogeneity* studied using graphs (see Figures 1.24 [32] and 1.25 [33]).

For more applications and details of biological applications of the theory of graphs [25, 26].

1.3 Conclusion

In this chapter, we introduced different basic concepts, key definitions and notations of graph theory we will use throughout the rest of the report. All the concepts are mainly about the structural properties of graphs as the graph protection problem considered in this thesis lies to the graph structure.

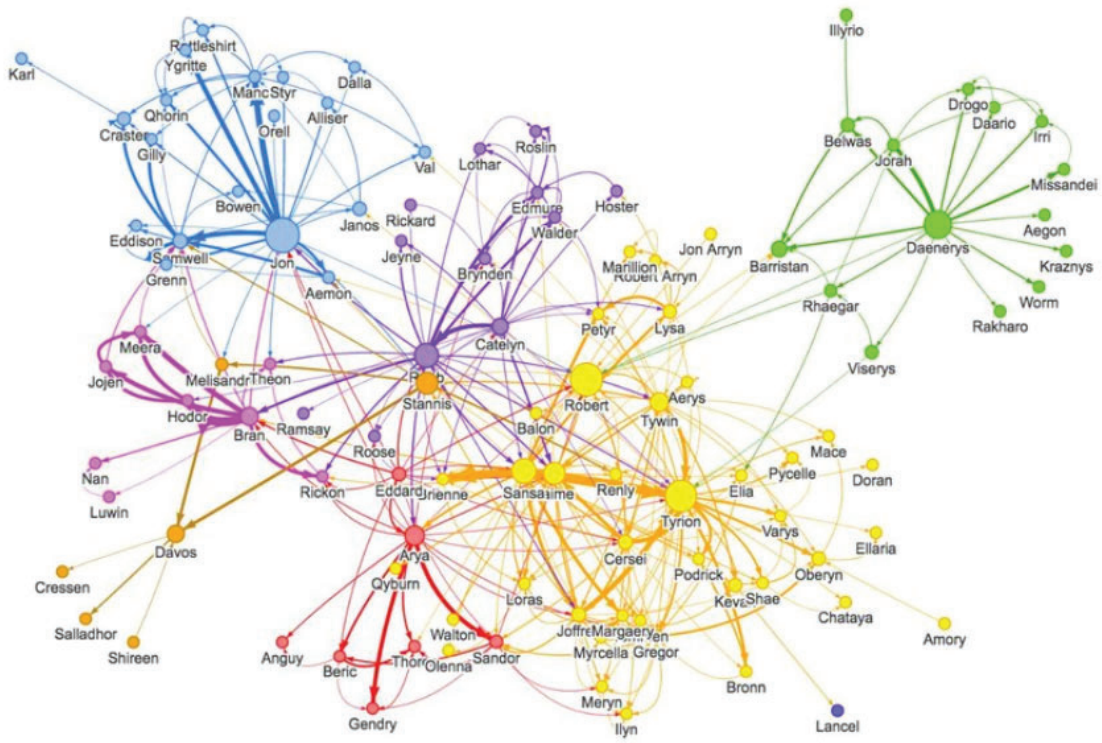

Figure 1.23: Social Networks

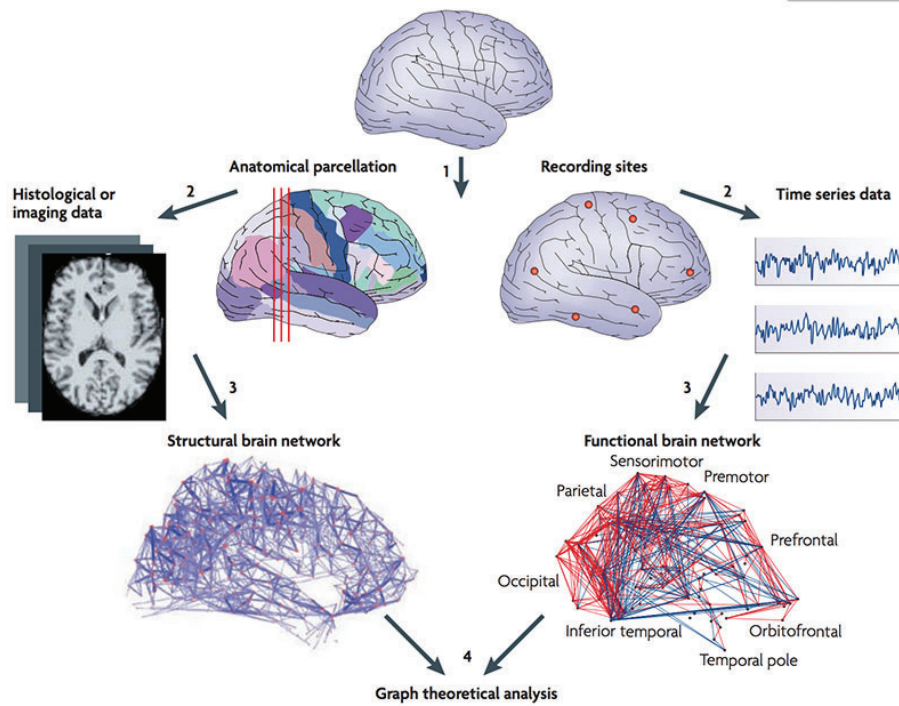

Figure 1.24: Brain Network

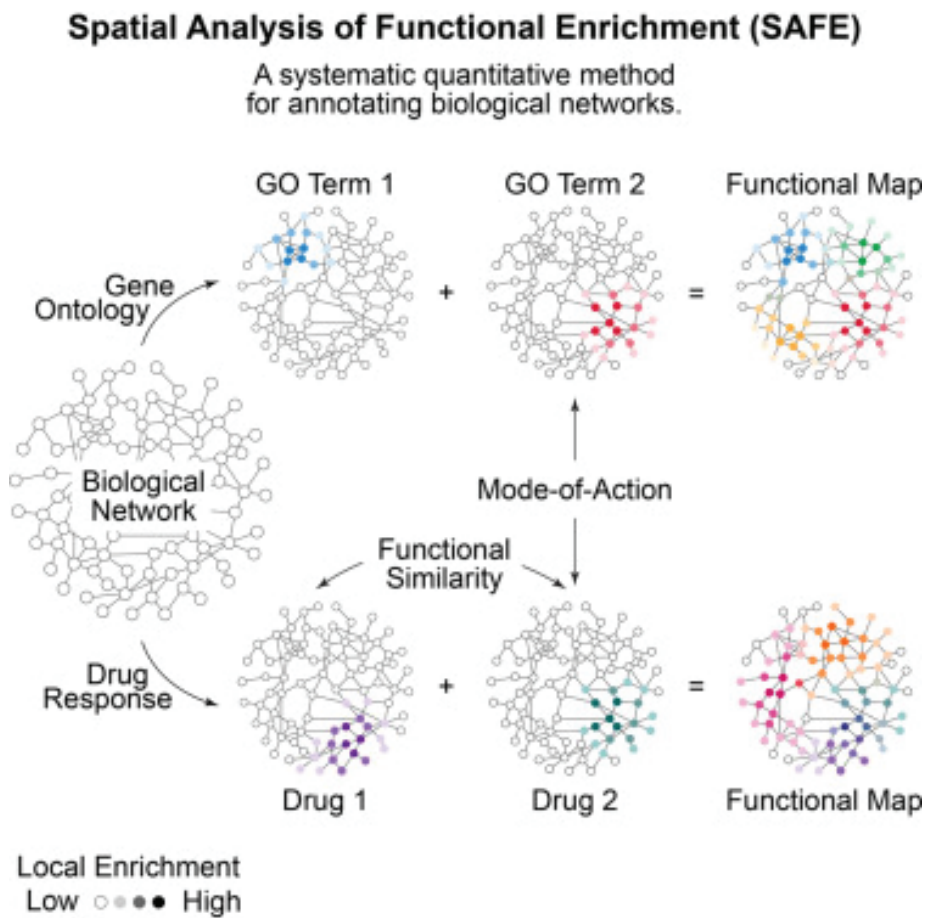

Figure 1.25: Biological Networks

2 Graph Protection Models Using Guards

“The more you know about the past, the better prepared you are for the future.”

Roosevelt

The protection of graphs using mobile guards is a well-explored problem in the research literature. This problem revolves around safeguarding both the vertices and edges of a given graph G against potential attacks. In doing so, defense units, known as guards, are strategically positioned at various vertices of G . Our primary focus lies in defending graphs against infinite sequences of attacks carried out one at a time. Several studies have delved into the protection of graphs with guards, leading to diverse formulations. Notable variants include the *Eternal Dominating set* [1], *Eternal Independent set* [2], *Eternal Vertex Cover set* [34].

In this chapter, we present a concise overview of previous models that have received significant attention. Specifically, we explore the concepts of eternal dominating sets, eternal independent sets, and eternal vertex covers, shedding light on their respective studies and contributions.

2.1 Historical overview

A protection problem can be modeled by a two-player game; defender and attacker. The defender chooses the set of vertices needed to hold the guards in the first turn, and he is required to defend vertices against any attack, on any vertex, by finding a new guard configuration at each turn. On the other hand, the attacker chooses at each turn the locations of the attack. An attack is defended if a guard moves to the attacked vertex across one edge. The defender wins the game if he can successfully defend any sequence of attacks, the attacker wins otherwise. We note that the sequence of attacks may be infinite in length. More formally, let $D_i \subset V$, where $i \geq 1$, be a collection of sets of vertices of the same cardinality, with one guard located on each vertex of D_i . The protection problem can be modeled in such away that the defender chooses the set D_i , for each iteration, that allows to avoid the attack. The defender wins the game if he dealt with infinite turns of attacks.

The study of graph protection originated in 2004 by Burger *et al.* [1], who introduced the concept of *infinite order domination*, commonly known as the *eternal dominating problem* or the *one-guard moves* model. In this model, each set D_i representing guard placement must be a dominating set, and D_{i+1} is obtained from D_i by moving only one guard to the attacked vertex from an adjacent vertex in D_i .

Following that, Goddard *et al.* [35] proposed a new variant called the *m-eternal dominating set* problem or the *many guards move model*. In this model, each D_i where $i > 1$ must be a dominating set, and D_{i+1} is obtained from D_i by allowing each guard to move to a neighboring vertex. Note that the eternal dominating problem allows only one guard move per turn (per attack), while the m-eternal dominating set model permits multiple moves per turn (per attack). Subsequently, several variations of graph protection with mobile guards were explored, predominantly focusing on the domination property. For instance, Klostermeyer *et al.* [36] introduced the *eternal total domination* model that asks for a set $D \subset V$ with the property that for each $u \in V$, there exists $x \in D$ adjacent to u , and the *eternal connected domination* model which is an eternal secure set whose induced subgraph is connected. Similarly, Klostermeyer *et al.* [37] introduced the *eternal vertex covering problem*, where each set D_i is required to be a vertex cover. The *eternal independent set problem* was first introduced by Hartnell *et al.* in 2014 [2], which encompasses two variants: the *eternal independent set problem* and the *m-eternal independent set problem*. Our work, starting in 2020, focuses on new models, namely the *eternal feedback vertex set problem* and the *m-eternal feedback set problem*, which will be

discussed in detail throughout this report.

2.2 Eternal Protections Models

In-depth surveys presenting different graph protection models and encompassing several findings are available in [38, 39]. In this section, we detail each model and present some intriguing results.

2.2.1 Eternal dominating problem

The first application of eternal domination was introduced in the 90's to investigate the military strategy of Emperor Constantine used to defend the *Roman Empire* [40]. In 2004, Burger *et al.* [1] introduced the formal variant of the *eternal domination model*, that can be modeled as a two-player, defender and attacker, game. The defender must defend all attacks of the attacker, and starts the game by choosing a set of vertices, say D_0 , with one guard on each vertex of D_0 . The attacker, at each turn i , chooses the location of the attack, while the defender is required to replace the guards on a new set of vertices, D_{i+1} , obtained from D_i . Each set D_i is required to be a dominating set. More formally, Let G be a graph, the set $EDS(G)$, for *Eternal Domination Sets of G* , is the greatest set of subsets of V such that for every subset $S \in EDS(G)$ and every $r \in V \setminus S$, there is a vertex $v \in S$ such that $vr \in E$ and $S \cup \{r\} \setminus \{v\} \in EDS(G)$.

The size of a smallest eternal dominating set of G is the *eternal domination number* denoted by $\gamma^\infty(G)$, i.e. $\gamma^\infty(G) = \min\{|S|, S \in EDS\}$. Figure 2.1 illustrates an eternal domination game between the defender and the attacker. The defender placed the guards initially on the vertices of $D_1 = \{v_3, v_5, v_6, v_8\}$. In the first turn, the attacker attacks the vertex v_1 . To avoid this attack, the defender is required to replace the guards on another set of vertices in which only one guard moves to an adjacent vertex (the others must remain in their places). We assume that the defender chooses to move the guard from v_3 to v_1 , and the new guard configuration, $D_2 = \{v_1, v_5, v_6, v_8\}$ is also a dominating set. Although, in the next turn, where v_4 is attacked, the defender remove the guard from v_5 to v_4 , and the new guard configuration, $D_3 = \{v_1, v_4, v_6, v_8\}$ is also a dominating set. Notice here, in the next turn, if the defender moves the guard from vertex v_7 to v_3 , which are also adjacent, the new guard configuration, $\{v_1, v_3, v_4, v_6\}$ is not dominating, and thus the defender will lose the game. In this example, we see that the defender can defend the graph against infinite attacks, starting from D_1 , and then he wins the game. Therefore, D_1 is an eternal dominating set of G and $\gamma^\infty(G) = 4$.

Another variant of the eternal dominating problem is the *m-eternal domination problem*¹, in which more than one guard can move, in the same turn, either to avoid the attacked or to preserve the domination property. Let us give a more formal definition of these notions. Let G be a graph and let $S_1, S_2 \subset V$ be two subsets. A multimove f from S_1 to S_2 is a one-to-one mapping from S_1 to S_2 such that for every $x \in S_1$, we have $f(x) = x$ or $(x, f(x)) \in E$. The set $MEDS(G)$ of m-eternal dominating sets of G is the greatest set of subsets of V such that for every $S \in MEDS(G)$ and every $r \in V(G) \setminus S$, there is a multimove f such that $r \in f(S)$ and $f(S) \in MEDS(G)$.

The size of the smallest m-eternal dominating set of G is the *m-eternal domination number* $\gamma_m^\infty(G)$. i.e. $\gamma_m^\infty(G) = \min\{|S|, S \in MEDS\}$.

Figure 2.2 illustrates a game played between the defender and the attacker in m-eternal domination on a graph G of 7 vertices. The defender starts the game by placing a guard on each vertex of $D_1 = \{v_3, v_5\}$. The first attack, at the first turn, is on the vertex v_1 . To avoid this attack, the defender moves the guard from vertex v_3 to vertex v_1 , and to preserve the domination property, the defender moves the guard from vertex v_5 to v_3 . Notice that, if only one guard is moved, the guard configuration, $\{v_1, v_5\}$ is not dominating and thus the attacker is the winner. Therefore, D_1 is a m-eternal dominating set and $\gamma_m^\infty(G) = 2$.

Burger *et al.* [1] observed that, for any graph G , the eternal domination number of G ; $\gamma^\infty(G)$, lies

¹Note that the m of m-eternal does not represent a parameter, but stands for multiple, as multiple guards can move at a time.

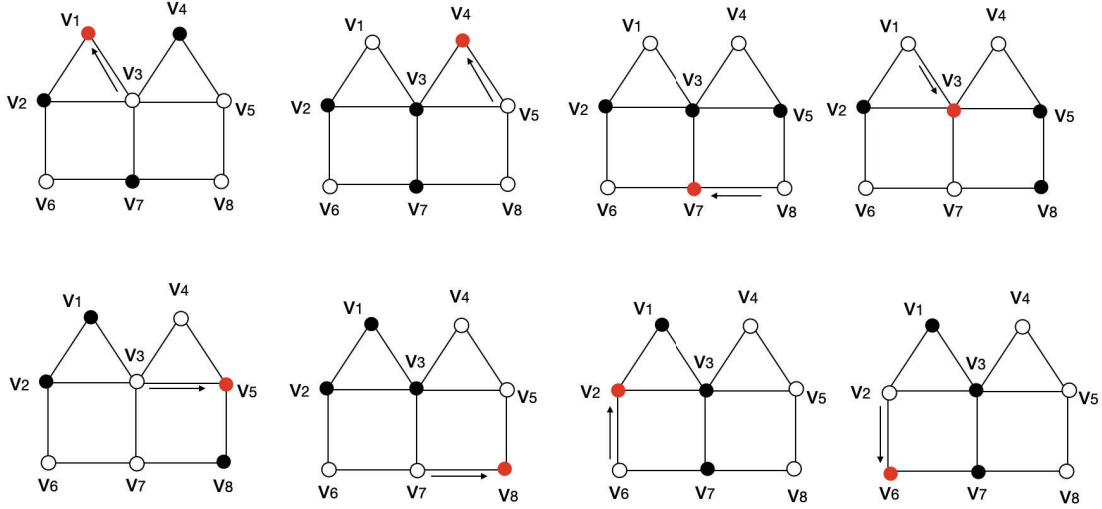

Figure 2.1: An example of eternal domination of a graph. Each unshaded vertex represents a guard, and the attacked vertex is colored red.

between its independence number and clique covering number.

Observation 1 [1] For any graph G , we have $\alpha(G) \leq \gamma^\infty(G) \leq \theta(G)$.

Also, they found the parameter values for certain simple classes of graphs, namely, paths, cycles, and products of complete graphs and paths.

Theorem 2.2.1 [1]

1. For any n , $\gamma^\infty(P_n) = \lceil \frac{n}{2} \rceil$.
2. For any n , $\gamma^\infty(C_n) = \lceil \frac{n}{2} \rceil$.
3. For any p, q , where $p \leq q$, $\gamma^\infty(k_p \times k_q) = p$.
4. For any p, q , where $p, q \geq 2$, $\gamma^\infty(P_p \times P_q) = \lceil \frac{pq}{2} \rceil$.

In 2007, Klostermeyer and MacGillivray, in [41], gave another bound for the eternal dominating number, and they proved that:

Theorem 2.2.2 [41] For any graph G , $\alpha(G) \leq \gamma^\infty(G) \leq \binom{\alpha(G) + 1}{2}$.

In 2008, Klostermeyer *et al.* [42] determined the classes of graphs for which the inequality of *Theorem 2.2.2* is tight.

For the *m-eternal dominating problem*, and according to the definitions of both parameters, $\gamma_m^\infty(G)$ and $\gamma^\infty(G)$, Goddard *et al.* [35] observed the following inequality.

Observation 2 [35] Let G be any graph, then $\gamma(G) \leq \gamma_m^\infty(G) \leq \gamma^\infty(G)$.

According to the above inequalities, *Theorem 2.2.2* and *Observation 2*, Klostermeyer *et al.* state the following inequalities.

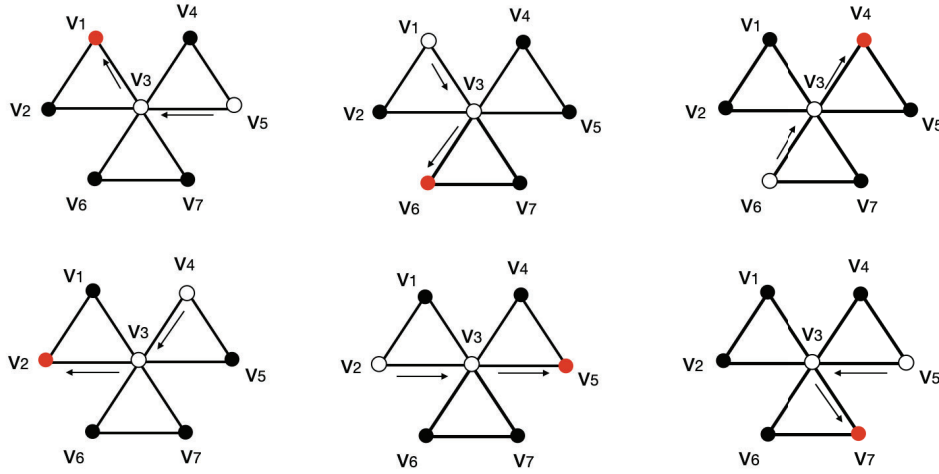

Figure 2.2: An example of m -eternal domination of a graph. Each unshaded vertex represents a guard, and the attack is colored red.

Theorem 2.2.3 [1, 35, 43]. For any graph G , where $\gamma(G)$ and $\alpha(G)$ are, respectively, the domination and independence number of G ,

$$\gamma(G) \leq \gamma_m^\infty(G) \leq \alpha(G) \leq \gamma^\infty(G) \leq \binom{\alpha(G) + 1}{2}.$$

Goddard *et al.* [35] computed the exact values of the m -eternal dominating number for some classes of graphs, namely paths, cycles, and complete graphs.

Theorem 2.2.4 [35]

1. For any n , $\gamma_m^\infty(P_n) = \lceil \frac{n}{2} \rceil$.
2. For any n , $\gamma_m^\infty(C_n) = \lceil \frac{n}{3} \rceil$.
3. For any n , $\gamma_m^\infty(K_n) = 1$.

Although they gave the following corollary.

Corollary 2.2.1 [35] For any graph G , $\gamma_m^\infty(G) \geq \frac{\text{diam}(G)+1}{2}$.

Cartesian grids $P_n \times P_m$ have been vastly studied with tight bounds existing for small grids, such as $2 \times n$, $3 \times n$, $4 \times n$, and $5 \times n$ grids [44, 45, 46].

Theorem 2.2.5 [44, 45, 46]

1. For any $n \geq 2$, $\gamma_m^\infty(P_2 \times P_n) = \lceil \frac{2n}{3} \rceil$.
2. For any $n > 1$, $\gamma_m^\infty(P_3 \times P_n) \leq n$.
3. $\gamma_m^\infty(P_3 \times P_3) = 3$.

Lamprou *et al.* [47] recently proved that $\gamma^\infty(P_n \times P_m) = \gamma(P_n \times P_m) + O(n + m)$. A thorough survey about the main results obtained for both parameters, $\gamma_m^\infty(G)$ and $\gamma^\infty(G)$, for several classes of graphs, can be found [39].

Considering oriented graphs, Began *et al.* [48] proved that computing the oriented eternal dominating number is NP-hard, and they generalized known results in graphs to digraphs. They proved the following inequalities for any digraph D .

Theorem 2.2.6 [48] For any digraph D , $\gamma(D) \leq \gamma_m^\infty(D) \leq \alpha(D) \leq \gamma^\infty(D) \leq \binom{\alpha(D) + 1}{2}$.

The solving approaches are surprisingly little considered in the literature. We can find polynomial algorithms to solve the domination protection problem on proper interval graphs [49], and general interval graphs [50].

Other variants of the eternal dominating problem have been introduced growing from the variants of the classic domination one. For instance, the eternal total domination, which considers the total domination set, and the eternal connected dominating problem version [36]. In 2017, a new variant was introduced, where a guarded vertex is attacked, this model is known as the eviction model [38]. In the eviction model, each configuration $D_i, i \geq 1$, of guards is required to be a dominating set. An attack occurs at a vertex $r_i \in D_i$ such that there exists at least one $v \in N(r_i)$ with $v \notin D_i$. The next guard configuration D_{i+1} is obtained from D_i by moving the guard from r_i to a vertex $v \in N(r_i), v \notin D_i$. That is, attacks occur at vertices with guards and we must move that guard to an unoccupied neighboring vertex.

The concept of eternal dominating sets has broad applications in many fields, including robotics, finance, and transportation. Here are some examples of application.

1. *Network security.* An eternal dominating set can be used to secure a network against attacks. The vertices in the set can represent critical network components that need to be monitored continuously to ensure that they are not compromised.
2. *Sensor networks.* In a sensor network, an eternal dominating set can be used to monitor the environment continuously. The vertices in the set can represent the sensors that need to be active at all times to collect data.
3. *Social Networks.* In social networks, an eternal dominating set can be used to identify influential nodes that have a significant impact on the spread of information or behavior in the network, even over long periods of time.

2.2.2 Eternal Independent problem

In 2014, Hartnell *et al.* [2] introduced another variant of the graph protection models, namely the *eternal independent dominating model*. They considered the protection problem where each $D_i, i \geq 1$, is an *independent dominating set*, $r_i \in V - D_i$, and D_{i+1} is obtained from D_i by replacing a number of vertices by their neighbors, r_i must be included (many guards can move in the same turn). Thus, one guard moves to the attacked vertex and the other guards move to maintain an independent dominating set. If an already occupied vertex is attacked, its guard deals with the attack without moving. The independent protection number $i^\infty(G)$ is the smallest number of guards required to protect the graph G against an arbitrary sequence of attacks.

For instance, considering cycles, a solution for the eternal independent problem consists in placing the guards on the maximal independent dominating set, and then rotating them, after each attacked, to deal with an attack on the unguarded vertices. *Figure 2.3* illustrates an example for C_5 .

Therefore, the following result has been proved in [2].

Theorem 2.2.7 [2] For any n , we have $i^\infty(C_n) = \lceil \frac{n}{3} \rceil$.

A slightly different variant, namely the *k-independent protection problem*, in which several vertices of an independent set can be attacked simultaneously and a number of guards may move, has been studied [2]. Let denote $i_k^\infty(G)$ the *k-independent protection number* which is the smallest number of guards required to protect G against an arbitrary sequence of simultaneous attacks on up to k -independent vertices, the following theorem holds.

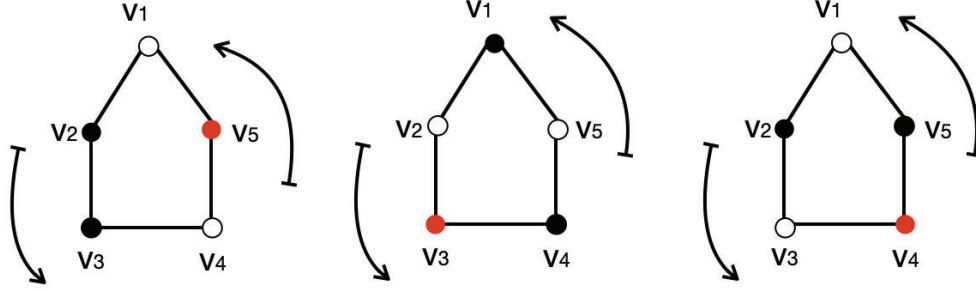

Figure 2.3: An example of eternal independent dominating of C_5 . Each unshaded vertex represents a guard, and the attacked vertex is colored red.

Theorem 2.2.8 [2] For any graph G , if $i_k^\infty(G)$ exists, then $k \leq \alpha(G)$ and $i(G) \leq i_k^\infty(G) \leq \alpha(G)$. Where, $i(G)$ is the independent domination number of G .

Caro and Klostermeyer [51] considered the variant of the eternal independent problem where D_{i+1} is obtained from D_i by moving only one guard on r_i from an adjacent vertex. We denote $\alpha^\infty(G)$ the eternal independence number which is the size of a largest eternal independent set of G .

Examples of α^∞ for some classes of graphs are $\alpha^\infty(C_4) = 1$, $\alpha^\infty(C_5) = 2$, $\alpha^\infty(k_{n,n}) = 1$, $\forall n$. As well, for *m-eternal independent set problem* examples of the *m-eternal independence number* $\alpha_m^\infty(G)$ are the following $\alpha_m^\infty(C_4) = 2$, $\alpha_m^\infty(C_5) = 2$, $\alpha_m^\infty(k_{n,n}) = n$, $\forall n$.

Similarly, the case where all the guards must move upon each attack is also introduced and known as the *Total-eternal independent set problem*. For this variant, each D_i , $i \geq 1$, is required to be an independent set, $r_i \in D_i$, and D_{i+1} is obtained from D_i by a total-switch. If the defender can win the game with the sets $\{D_i\}$, then each D_i is a total-eternal independent set. The largest cardinality of a total-eternal independent set is the total-eternal independence number of G denoted $\alpha_t^\infty(G)$.

Observation 3 [51] For any graph G , we have $\alpha_t^\infty(G) \leq \alpha_m^\infty(G)$.

The following proposition explains how a graph with a high matching and low chromatic number can lead to a large free matching and therefore a large total eternal independence number.

Proposition 1 [51] Let G be a graph with $\chi(G) = k$ and $m(G) = m$. Then

$\alpha_m^\infty(G) \geq \alpha_t^\infty(G) \geq \frac{2m}{k(k-1)}$, where $m(G)$ is the matching number and $\chi(G)$ is the chromatic number of G .

In a clique cover, no clique can contain more than one vertex from any independent set, thus $\alpha(G) \leq \theta(G)$, for all G . Then, the following inequality holds.

Observation 4 [51] For any G , $\alpha^\infty(G) \leq \theta(G)$.

In the case where G is a free-triangle graph with $\theta(G) \leq 2$ and no isolated vertices, the eternal independence number is less than the vertex cover number *i.e* $\alpha^\infty(G) < \theta(G)$. We have an equality between the two parameters, if the graph maximum matching is equal to the vertex cover number of the graph.

Theorem 2.2.9 [51] Let G be a connected graph, $\alpha^\infty(G) = \theta(G)$ if and only if $m_i(G) = \theta(G)$, where $m_i(G)$ is the size of a maximum induced matching in G .

For bipartite graphs, the eternal independent number is stated by the following theorem.

Theorem 2.2.10 [51] *Let G be a bipartite graph.*

1. $\alpha^\infty(G) = m_i(G)$
2. $\alpha_m^\infty(G) = m(G)$

2.2.3 Eternal vertex covering problem

In 2009, Klostermeyer and Mynhardt [3] introduced an eternal problem associated with the vertex covering problem, known as the *eternal vertex covering problem*. They consider infinite sequences of attacks on edges rather than vertices. Considering the two classical models of the eternal protection problem; whether one or all guards are allowed to move in each turn to defend an attack, the model that appears interesting is the one where all guards can move, *i.e.* *m-eternal vertex cover problem*. For this model, to defend an attack, a guard from an incident vertex moves across the attacked edge. More formally, each D_i , $i \geq 1$, is required to be a vertex cover, $r_i \in E$, and D_{i+1} is obtained from D_i where each guard in D_i may move to an adjacent vertex provided that one guard moves across edge r_i (we assume without loss of generality that one end-vertex of r_i is not in D_i , otherwise the two guards on the end vertices of r_i simply interchange positions). The size of the smallest eternal vertex cover of G is the m-eternal covering number denoted $\tau_m^\infty(G)$.

For example, let $C = \{v_1, v_2, \dots, v_n\}$ be a cycle, a solution consists in placing the guards on the vertices with odd index, v_1, v_3, v_5, \dots , and after an attack on any edge, the defender rotates the guards to all even numbered vertices (see *Figure 2.4*).

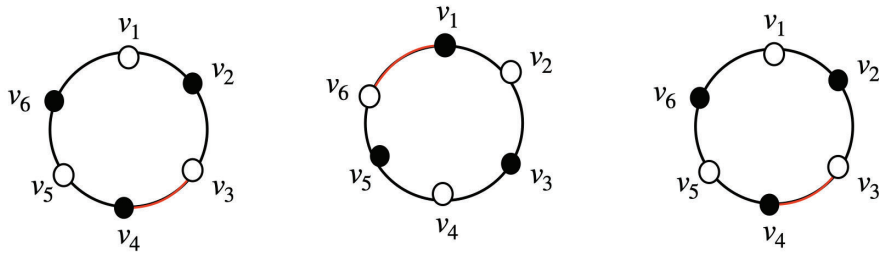

Figure 2.4: An example of m-eternal vertex covering of C_6 . Each unshaded vertex represents a guard, and the attacked edge is colored red.

For a general graph G , the m-eternal covering number $\tau_m^\infty(G)$ is bounded in terms of the vertex covering number $\tau(G)$.

Proposition 2 [3] *For any G , we have $\tau(G) \leq \tau_m^\infty(G) \leq 2\tau(G)$.*

If G has a connected vertex cover set, then the m-eternal covering number satisfies the following.

Theorem 2.2.11 [3] *Let G be any connected graph and let D be a vertex cover of G such that D is connected. Then $\tau_m^\infty(G) \leq |D| + 1$.*

In [3], the authors proved the upper and lower bounds of the m-eternal covering number on some classes of graphs. For paths, cycles, and trees, τ_m^∞ is stated as follows.

Proposition 3 [3] *Given a graph G :*

1. if $G = C_n$, then for any $n \geq 3$, $\tau_m^\infty(C_n) = \tau(C_n) = \lceil \frac{n}{2} \rceil$.

$$2. \text{ if } G = P_n, \text{ then for any } n \geq 1, \tau_m^\infty(P_n) = n - 1 = \begin{cases} 2\tau(P_n) & \text{if } n \text{ is odd} \\ 2\tau(P_n) - 1 & \text{if } n \text{ is even} \end{cases}$$

3. if $G = T$, then for any tree T , $\tau_m^\infty(T) = |V - L| + 1$, where L is the set of leaves in T .

Motivated by the question of which graphs have equal eternal vertex cover and eternal domination numbers, the authors in [52], proved that the eternal vertex cover number is greater than the eternal domination number in all graphs of minimum degree at least two.

Proposition 4 [52] *Let G be a connected graph with $\delta(G) \geq 2$. Then $\gamma_m^\infty(G) \leq \tau_m^\infty(G)$.*

For more results raised from studying the eternal covering problem, we invite the reader to [34, 53, 54].

2.3 Conclusion

We presented an overview of different protection models considered in the literature. We provided the most important findings raised from dealing with each model, and that helped us in our study of the problem. Almost all results concern mainly the eternal number computation as well as the algorithm for finding the eternal sets.

3 Eternal Feedback Vertex Sets: A New Graph Protection Model Using Guards

“Success is not the key to happiness. Happiness is the key to success. If you love what you are doing, you will be successful.”

Albert Schweitzer

Graph protection using mobile guards has garnered considerable attention in the literature. Various forms of graph protection have been explored, such as Eternal Dominating Set, Eternal Independent Set, and Eternal Vertex Cover Set (refer to *Chapter 2* for more details). In this chapter, we will introduce and analyze two new models of graph protection, namely the *Eternal Feedback Vertex Sets (EFVS)* and *m-Eternal Feedback Vertex Sets (m-EFVS)*. These models rely on an initial selection of a feedback vertex set (*FVS*), where a vertex in the *FVS* can be substituted with a neighboring vertex while still maintaining the set’s properties as an *FVS*.

3.1 Eternal Feedback Vertex Models

We recall that the graph protection problem consists in defending the vertices, as well as edges, of a graph G against any attack using defense units, called guards, stationing at the vertices of G . It can be modeled by a two-player game between a defender and an attacker. The defender chooses the set of vertices needed to hold the guards in the first turn, and must defend any attack on any vertex, by finding a new guard configuration at each turn. On the other hand, the attacker chooses at each turn the location of the attack. An attack is defended if a guard can be moved to the attacked vertex across one edge. The defender wins the game if each sequence of attacks is successfully defended, the attacker wins otherwise. We note that the sequence of attacks may be infinite in length.

In the same way as the eternal dominating problem, we introduce the *Eternal Feedback Vertex Set Problem (EFVS)* as the problem of protecting a graph using mobile guards, where the subset of vertices holding guards must be, at each turn, both a feedback and a dominating set.

In our variant, we consider the case where the attack is defended if a guard moves to the attacked vertex across only one edge. Using the two-players game model, the defender firstly chooses a set F_0 of k vertices which hold the guards. At turn i , the attacker attacks by choosing a vertex $r_i \in V \setminus F_{i-1}$, and the defender must defend the attack by moving to r_i a guard from an adjacent vertex v_i . The new guards configuration is $F_i = F_{i-1} \cup \{r_i\} \setminus \{v_i\}$. The defender wins the game if any infinite sequence of attacks is defended. The *eternal feedback vertex number*, denoted $F^\infty(G)$, is the minimum number of guards necessary for the defender to win, and the *eternal feedback vertex set* is a set that can initially be chosen by the defender in a winning strategy.

Formally, Let G be a graph. The set $EFVS(G)$, of eternal feedback vertex sets of G , is the greatest set of subsets of V such that for every subset $S \in EFVS(G)$ and every $r \in V \setminus S$, there is a vertex $v \in S$ such that $vr \in E$ and $S \cup \{r\} \setminus \{v\} \in EFVS(G)$. The size of the smallest eternal feedback set of G is the *eternal feedback vertex number* $F^\infty(G)$, i.e $F^\infty(G) = \min\{|S|, S \in EFVS\}$.

For example, we have $F^\infty(P_3) = 2$, $F^\infty(C_3) = 1$. *Figure 3.1* illustrates possible configurations on the house graph G , where $F^\infty(G) = 2$.

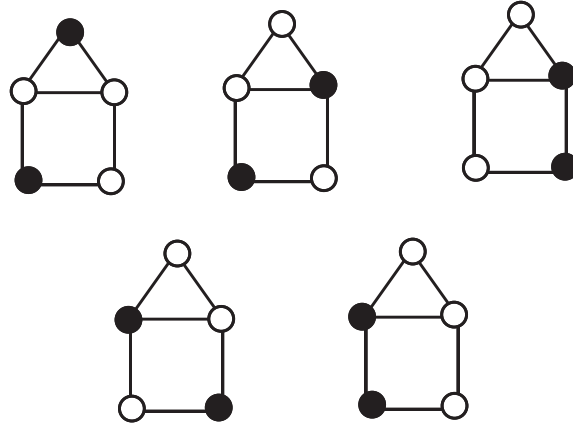

Figure 3.1: Eternal feedback vertex set on house graph (shaded vertices are guards).

Consider the cycle graph $C_6 = \{v_1, v_2, v_3, v_4, v_5, v_6\}$ (see Figure 3.2). Removing any vertex from C_6 results in a path, implying that a minimum feedback vertex set consists of only one vertex. However, the smallest dominating set of C_6 must contain at least two vertices. Consequently, we must begin the game with a minimum of two guards. As a defender, we choose two vertices to initially hold the guards, and let be $F_1 = \{v_2, v_5\}$, without loss of generality. Now, suppose that the attacker chooses vertex v_3 . In response, the defender must relocate the guard from v_2 to v_3 . However, the resulting configuration, $F_2 = \{v_3, v_5\}$, is not a dominating set (see Figure 3.2a). Consequently, with only two guards, the defender will lose the game.

To improve our chances, let us start the game with three guards. Without loss of generality, we select $F_1 = \{v_2, v_4, v_6\}$ as the initial guard configuration. In this scenario, a guard positioned on a shaded vertex can move to an unshaded neighboring vertex. As a result, the resulting guard configuration induces a dominating feedback vertex set. This is exemplified in Figure 3.2b, where the guard moves from v_2 to v_3 after an attack on v_3 .

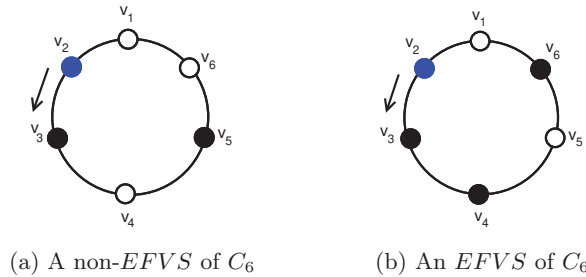

Figure 3.2: C_6 , the guards are placed on the black shaded vertices, and the blue nodes holding the guard before moving.

The *m-Eternal Feedback Vertex Problem*¹ is the variant where the defender is authorized to move several guards at a time. It is defined in the same way as the *EFVS*, except that when the attack occurs, each guard is allowed to move to a neighboring vertex through only one hop. Several guards movement can be considered either to defend the attacked vertex, or to make a better position of guards for the coming turns.

The set $MEFVS(G)$ of *m*-eternal feedback vertex sets of G is the greatest set of subsets of V such that for every $S \in MEFVS(G)$ and every $r \in V(G) \setminus S$, there is a multimove f such that $r \in f(S)$ and $f(S) \in MEFVS(G)$. The size of a smallest *m*-eternal feedback vertex set of G is the

¹Notice that the *m* in *m*-eternal does not represent a value.

m-eternal feedback vertex number $F_m^\infty(G)$; i.e $F_m^\infty(G) = \min\{|S|, S \in MEFVS\}$. Figure 3.3 shows the m-eternal feedback vertex number for C_3 , C_4 and C_5 .

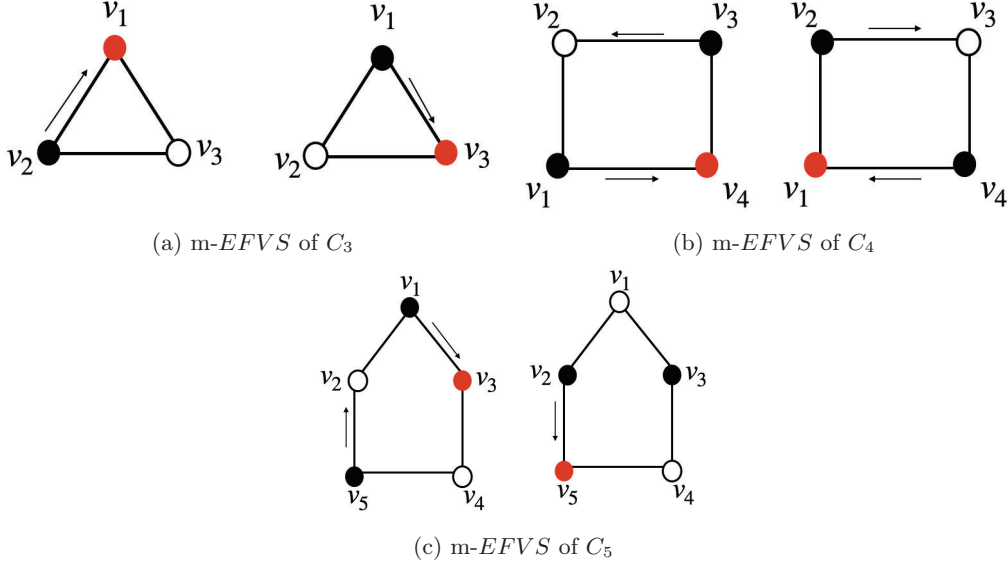

Figure 3.3: The guards are placed on the black shaded vertices, and the red vertex represent the attack.

3.2 EFVS and m-EFVS on general graphs

The comparison between the two numbers, F^∞ and F_m^∞ , in relation to known graph parameters, arises directly from the definitions of the Eternal Feedback Vertex Sets (EFVS) and m-Eternal Feedback Vertex Sets (m-EFVS).

Observation 5 *Let G be a general graph, then*

$$F^\infty(G) \geq F_m^\infty(G) \geq F(G). \tag{3.1}$$

For further illustration, suppose that $F_m^\infty(G) < F(G)$. Let F_0 be a minimum m-eternal feedback vertex set (FVS) of G such that $|F_0| < F(G)$. According to the definition of an m-EFV set, we can see that F_0 is a feedback vertex set. Thus, there exists a feedback vertex set F_0 with $|F_0| < F(G)$, which is a contradiction. Moreover, assuming that $F^\infty(G) < F_m^\infty(G)$, let F_0 be a minimum eternal FVS of G such that $|F_0| < F_m^\infty(G)$. By definition, each m-eternal FVS is an eternal FVS with multiple turns, leading to a contradiction.

Given the result comparing both the eternal domination number and m-eternal domination number of a graph G with the domination number and independent number of G :

Theorem 3.2.1 [1, 35, 41]
For any graph G , we have

$$\gamma(G) \leq \gamma_m^\infty(G) \leq \alpha(G) \leq \gamma^\infty(G) \leq \binom{\alpha(G) + 1}{2}.$$

Based on the fact that each eternal (resp. m-eternal) feedback vertex set is an eternal (resp. a m-eternal) dominating set, we can establish the following inequalities:

Theorem 3.2.2 *Let G be any graph, then $\gamma_m^\infty(G) \leq F_m^\infty(G)$ and $\gamma^\infty(G) \leq F^\infty(G)$.*

Consequently, we have the following corollary:

Corollary 3.2.1 *For any graph G , $\alpha(G) \leq \gamma^\infty(G) \leq F^\infty(G)$.*

The relation between the eternal and m-eternal feedback vertex numbers of a graph and its induced subgraphs is given by the following:

Proposition 5 *For any graph G , and any induced subgraph H of G , we have*

$$F^\infty(G) \geq F^\infty(H) \text{ and } F_m^\infty(G) \geq F_m^\infty(H).$$

PROOF:

For the first inequality, we suppose that $F^\infty(G) < F^\infty(H)$. Thus, for any eternal FVS F of G , F is not an eternal FVS of H . On the other hand, the sequence of attacks in G restricted to the induced subgraph H requires only $F^\infty(G)$ guards, which is a contradiction. The same proof is used for the second inequality. ■

It was proved in [48] that the eternal (*resp.* m-eternal) dominating number of a graph is the sum of the eternal (*resp.* m-eternal) dominating number of its components. This is trivially true also for the eternal (*resp.* m-eternal) feedback number for any graph.

Corollary 3.2.2 *Given a graph G consisting in the connected components G_1, G_2, \dots, G_i , $i > 0$, we have:*

$$F^\infty(G) = \sum_{j=1}^i F^\infty(G_j), \quad \text{and} \quad F_m^\infty(G) = \sum_{j=1}^i F_m^\infty(G_j).$$

In fact, we know that each G_i is an induced subgraph of G , and $\bigcap_{j=1}^i V(G_j) = \emptyset$, so the eternal feedback vertex number of G is greater than or equal to the sum of the eternal feedback vertex number of all the connected components, *i.e.* $F^\infty(G) \geq \sum_{j=1}^i F^\infty(G_j)$. Now, we suppose that the eternal feedback vertex number of G is greater than the sum of the eternal feedback vertex number of all the connected components, *i.e.* $F^\infty(G) > \sum_{j=1}^i F^\infty(G_j)$. As each connected component is completely

disjoint from the other, $\bigcap_{j=1}^i V(G_j) = \emptyset$, and for every $uv \in E(G)$, u and v are in the same connected component, thus there exists a connected component G_i protected by less than $F^\infty(G_i)$ guards, which is a contradiction since the EFVS for each component G_i is the minimal subset of guards needed to protect G_i .

We can use the same proof for the second equality $F_m^\infty(G) = \sum_{j=1}^i F_m^\infty(G_j)$.

3.3 EFVS and m-EFVS on particular classes of graphs

In this section, we compute F^∞ and F_m^∞ on some particular classes of graphs. First, we note that for any acyclic graph G , it is trivial to see that the feedback vertex number is equal to zero, hence finding an eternal feedback vertex set for G is equivalent to find an eternal dominating set.

According to *Theorem 2.2.1*, we have for any n , $\gamma^\infty(P_n) = F^\infty(P_n) = \lceil \frac{n}{2} \rceil$.

3.3.1 Cycles, complete graphs, and complete bipartite graphs

For cycles, complete graphs, and complete bipartite graphs, we have the following observations:

Observation 6 Given a cycle C_n and a complete graph K_n , for any $n \geq 3$, and given a complete bipartite graph $K_{n,m}$, where $V = A \cup B$, $|A| = n$ and $|B| = m$, then:

- (i) $\lfloor \frac{n}{2} \rfloor \leq F^\infty(C_n) \leq \lceil \frac{n}{2} \rceil$.
- (ii) $F_m^\infty(C_n) = \lceil \frac{n}{3} \rceil$.
- (iii) $F^\infty(K_n) = F(K_n) = n - 2$.
- (iv) $F^\infty(K_{n,m}) = n + m - 3$.
- (v) $F_m^\infty(K_{n,m}) = \max\{n, m\}$.

For cycles, removing any vertex produces a path graph, thus finding the eternal feedback vertex number is equivalent to finding the eternal domination number. *Figure 3.4* illustrates an example of the m-Eternal FVS on C_{12} , and shows that $F_m^\infty(C_{12}) = \lceil \frac{12}{3} \rceil$.

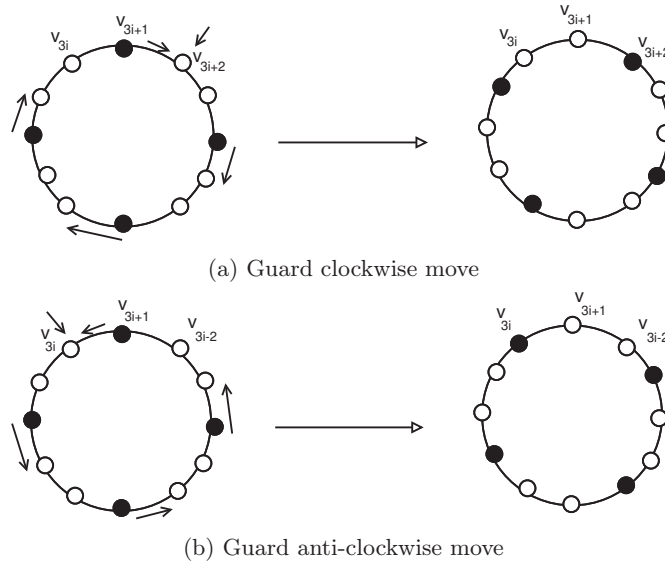

Figure 3.4: Example of m-Eternal Feedback Vertex Set on C_{12} . The guards are placed on the black shaded vertices.

In a complete graph K_n , any three vertices form a cycle, so any feedback vertex set must contain at least $n - 2$ vertices and thus both eternal and m-eternal feedback vertex numbers of a complete graph are equal to its feedback vertex number.

Now, for complete bipartite graphs where $A = \{v_1, \dots, v_n\}$ and $B = \{u_1, \dots, u_m\}$, a cycle $v_i u_k v_j u_l$ is obtained for all $i, j, k, l \geq 1$. So we can see that, at all turns, we must place the guards in such a way that if A holds less than $n - 2$ guards, then B must contain at least $m - 1$ guards. Therefore, the only way to get this is to place $n + m - 3$ guards. *Figure 3.5b* shows that if we use less than $n + m - 3$ guards to protect a complete graph, $K_{n,m}$, a cycle will be obtained.

In the case of m-Eternal FVS, all vertices of A (or B ; we select the maximum) must hold guards (see *Figure 3.6*). Note that each partition in $K_{n,m}$ is an independent set, and so no cycle is obtained by removing a set partition.

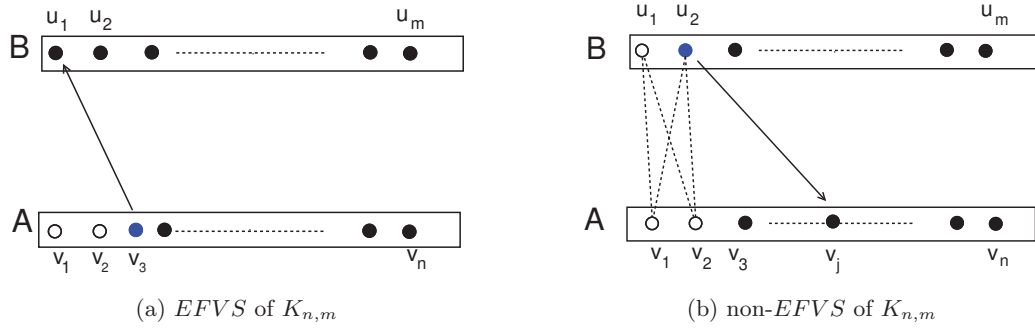

Figure 3.5: $K_{n,m}$, the guards are placed on the black shaded vertices, and the blue nodes holding the guard before moving.

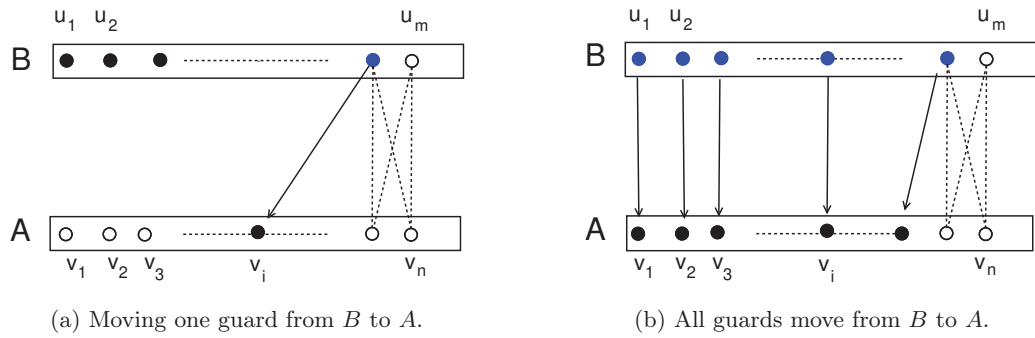

Figure 3.6: $K_{n,m}$, the guards are placed on the black shaded vertices, and blue nodes are guard positions before moving.

3.3.2 Distance graphs and Circulant graphs

Along this section, we use the bounds of the minimum feedback vertex set number, F , of different families of distance and circulant graphs, summarized in *Table 1.1 Chapter 1*.

We note that hereafter, for figures, we illustrate only edges needed to explain the proofs, and so the other edges can be easily deduced from the definition of the graph class.

Distance Graphs

Depending on the values of D , we first consider the particular case where $D = \{1, 2, 4\}$, and then the more general cases where $D = \{1, t\}$, and $D = \{1, 2, 3, \dots, t\}$, where t is a non-negative integer.

Case 1. $D = \{1, 2, 4\}$.

Let $P_n(D)$ be the distance graph of n vertices, where two distinct vertices v_i, v_j are adjacent in $P_n(D)$ if and only if $|i - j| \in \{1, 2, 4\}$.

Theorem 3.3.1 *For any integer n , we have $F^\infty(P_n(1, 2, 4)) = 5 \lfloor \frac{n}{8} \rfloor$.*

PROOF:

Let F_1 be any EFVS of a distance graph $G = P_n(1, 2, 4)$. According to *Proposition 5* in [22], there are two possible cases for F_1 :

- (i) Only two vertices over the first six are in F_1 . In this case, it is obligatory to choose vertices v_1 and v_4 , as removing them is the only possibility to get an acyclic graph. Suppose that any other vertex is attacked, without loss of generality let be v_0 . To defend v_0 , we must move the guard

either from v_1 to v_0 , or from v_4 to v_0 . In both cases, at least one cycle will be generated, such as $v_1v_2v_3$ for the first move and $v_2v_3v_4$ for the second move (see *Figure 3.7*). For illustration, if we assume that the guard moves from v_1 to v_0 , then the new guard configuration is $\{v_0, v_1\}$. According to the construction of $P_n(1, 2, 4)$, v_1 is adjacent to v_2 , v_2 is adjacent to v_3 and v_1 is adjacent to v_3 . Hence, a cycle is generated by $\{v_1, v_2, v_3\}$.



Figure 3.7: $P_6(1, 2, 4)$, guards are on black shaded vertices.

- (ii) At least three vertices over the first six are in F_1 . We arbitrary choose three non-consecutive vertices to hold guards in the first turn, considered as a minimum eternal FVS for $P_6(1, 2, 4)$. Consider now the first 12 vertices of G , and suppose that we apply the same strategy on each 6 vertices. A counter example can be occurred as follows. Without loss of generality and as we consider a game with infinite turns, let's suppose that at turn i , we have $F_i = \{v_0, v_3, v_5, v_6, v_8, v_{11}\}$, and vertex v_7 is attacked. All possible guard moves will generate at least one cycle. In fact, if the guard is moved from v_3 to v_7 , v_5 to v_7 , v_6 to v_7 , v_8 to v_7 , or v_{11} to v_7 , we get respectively cycle $v_2v_3v_4$, $v_1v_2v_4v_5$, $v_2v_4v_6$, $v_8v_9v_{10}$, or $v_9v_{10}v_{11}$ (see *Figure 3.8*).

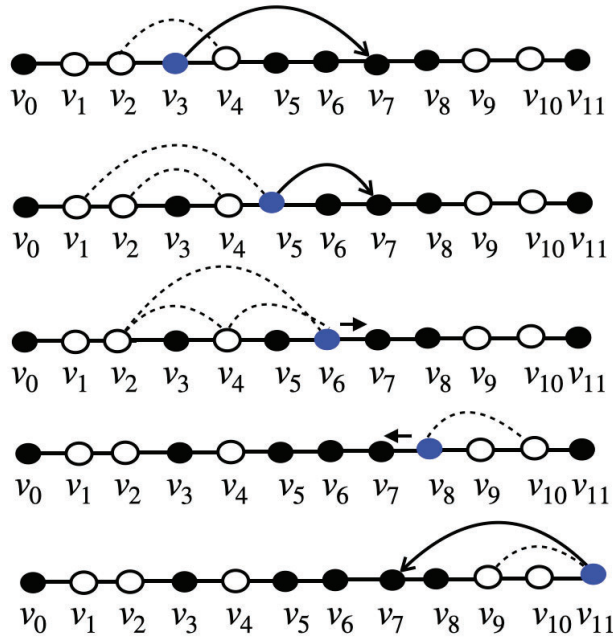

Figure 3.8: The different possible cycles generated while defending an attack on vertex v_7 of $P_{12}(1, 2, 4)$.

So, for this case, we must fix the guards on vertices v_6 and v_7 to protect them. Accordingly, we can see that in general at least 5 vertices must be selected to hold guards for each 8 vertices. Consider F_1 is obtained by any FVS of three vertices selected from the six first vertices (for each block of 8 vertices), with the addition of the two vertices v_6 and v_7 , we can see easily that the defender can avoid any attack (see *Figure 3.9*).

Knowing that we are in the eternal variant of the feedback vertex problem, we can see that this

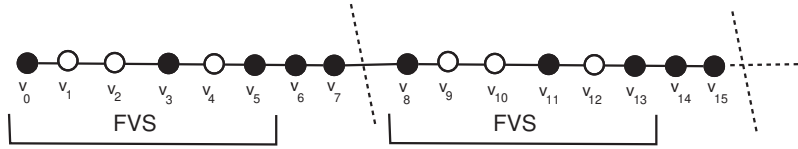

Figure 3.9: A winning configuration for $P_n(1, 2, 4)$, guards are on black shaded vertices.

example can be generalized for a large n , and thus the defender can win the game starting with 5 guards on each consecutive 8 vertices, and hence $F^\infty(P_n(D)) = 5\lfloor \frac{n}{8} \rfloor$.

We have $4\lfloor \frac{n}{8} \rfloor \leq F(G)$, thus the following corollary is true. ■

Corollary 3.3.1 For any integer n , $4\lfloor \frac{n}{8} \rfloor \leq F_m^\infty(P_n(1, 2, 4)) \leq 5\lfloor \frac{n}{8} \rfloor$.

Case 2. $D = \{1, s, t\}$.

In this case, two distinct vertices v_i, v_j from a distance graph $P_n(D)$ of n vertices, are adjacent if and only if $|i - j| \in \{1, s, t\}$, where s and t are integers.

Theorem 3.3.2 For any integers n, s and t , such that $t \leq n - 1$ and $2 \leq s < t$, let $G = P_n(D)$ be a distance graph, where $D = \{1, s, t\}$, then

$$\lceil \frac{2n - s - t}{5} \rceil \leq F^\infty(G) \leq \lceil \frac{n}{2} \rceil.$$

PROOF:

The lower bound follows from Equation (3.1) and the lower bound of feedback vertex set in the case where $D = \{1, s, t\}$ (see Table 1.1). For the upper bound, we prove that for a winning strategy, the defender can use as initial EFVS the minimum feedback set defined in [22]. Thus, similarly to the proof of Proposition 4 [22], we have two possible cases.

- (i) s or t is odd. Let $F = \{v_{2j+1}, 0 \leq j \leq \lfloor \frac{n-2}{2} \rfloor\}$. Each chord of odd length joins two vertices of different parity index, so the induced subgraph $G[V \setminus F]$, with odd indices, is either a disjoint union of paths or an independent set (if both s and t are odd). Hence F is a FVS of $\lceil \frac{n}{2} \rceil$ vertices. Figure 3.10 illustrates the case where $s = 3, t = 5$, and $n = 7$. Also, we have $\bigcap_{v_i \in F} N(v_i) = V$, thus F is a dominating set.

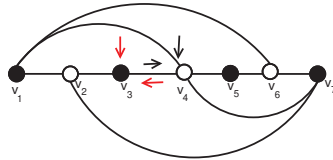

Figure 3.10: $P_7(1, 3, 5)$, Eternal feedback vertex Set shaded

Now, to prove that F is an EFVS, we consider that each vertex in F holds a guard. We have $\bigcap_{v_i \in F} N[v_i] = V$. Thus, each vertex of G either holds a guard or is adjacent to a vertex holding a guard. And so, if vertex v_{i+1} is attacked the guard must be moved from v_i to v_{i+1} , and if in a coming turn vertex v_i is attacked the guard should return from v_{i+1} to v_i . Thus, F can be applied in a winning strategy.

(ii) s and t are even. As well, we show that the FVS constructed in [22] can be an initial choice for the defender in a winning strategy. Let k be any integer such that $1 \leq k \leq \lceil \frac{n}{t} \rceil$. If k is even, let $F_k = \{v_u, u = 2j + 1 + (k - 1)t, u \leq n - 1, 0 \leq j \leq \frac{t-2}{2}\}$, otherwise, if k is odd, $F_k = \{v_u, u = 2j + (k - 1)t, u \leq n - 1, 0 \leq j \leq \frac{t-2}{2}\}$.

We have $F = \cup F_k$ is a FVS for G [22]. In fact, each chord of length s or t joins vertices of the same parity (since s and t are even), and thus $G[V \setminus F]$ results in an induced subgraph of G where all chords of length t , as well as all chords of length s between two consecutive blocks (of t vertices) are removed (note that odd and even vertices are alternately removed from blocks of t vertices). That yields an acyclic graph, knowing that the chords of length one is also removed except some that join two consecutive blocks of t vertices. *Figure 3.11* illustrates the case where $s = 2, t = 6$ and $n = 12$. We have $F = \{v_1, v_3, v_5, v_8, v_{10}, v_{12}\}$ is a FVS of $P_{12}(1, 2, 6)$. The subgraph obtained from $P_{12}(1, 2, 6)$ after removing vertices of F is a forest, since the chord of length 6, v_1v_6 , in each block of 6 vertices, and the chords of length 2, v_1v_3 , between two consecutive blocks of t vertices are removed. In addition, all chords of length one, except those joining two blocks, are also removed. We note that $|F_k| = \frac{t}{2}$ and thus, $|F| \leq \frac{n}{2}$.

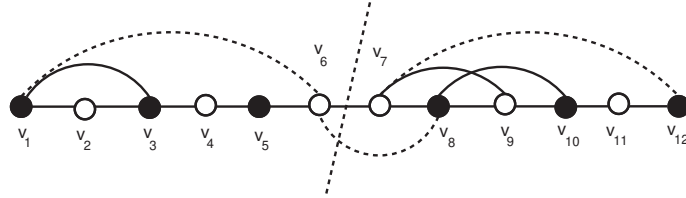

Figure 3.11: $P_{12}(1, 2, 6)$, Eternal feedback vertex set shaded.

We consider now that each vertex in F holds a guard. We have $\bigcap_{v_i \in F} N[v_i] = V$ and thus, each vertex in G can be protected by moving one guard at least. As in the previous case, we apply the same manner of moving the guards to obtain a winning strategy. ■

This inequality comes directly from the previous theorem and *Equation (3.1)*.

Corollary 3.3.2 *Let $G = P_n(n, s, t)$ for any integers n, s and t , with $t \leq n - 1$ and $2 \leq s < t$, $\lceil \frac{2n-s-t}{5} \rceil \leq F(G) \leq F_m^\infty(G) \leq F^\infty(G) \leq \lceil \frac{n}{2} \rceil$.*

Case 3. $D = \{1, t\}$.

This is the case where edges of the distance graph are constructed for each distance t , besides the unit distance.

In [44], the authors proved the following lemma.

Lemma 3.3.1 [44] *Let G be a path graph with n vertices, then $\gamma^\infty(P_n) = \lceil \frac{n}{2} \rceil$.*

Theorem 3.3.3 *For any integers n and t , such that $1 \leq t < n$, we have :*

$$F^\infty(P_n(1, t)) = \lceil \frac{n}{2} \rceil + 1.$$

PROOF:

If $t \geq n$, then $P_n(1, t)$ is a path (an acyclic graph), so we are in the case where $F(P_n(1, t)) = 0$, and $F^\infty(P_n(1, t)) = \gamma^\infty(P_n(1, t))$. For the case where $t \leq n$ and $n \geq 2t$, we have two possible cases.

(i) $n \bmod t = 0$. Depending on the parity of $\frac{n}{t}$, we have two cases.

- (a) $\frac{n}{t}$ is even. We partition the graph into $\frac{n}{t}$ blocks, namely $T_1, T_2, \dots, T_{\frac{n}{t}}$, of t vertices each. Let $V(T_i) = \{v_1^i, v_2^i, \dots, v_t^i\}$ for all $1 \leq i \leq \frac{n}{t}$. According to Lemma 3.3.1, we have $\gamma_m^\infty(P_n) = \lceil \frac{n}{2} \rceil$. Thus, $F^\infty(P_n) \geq F_m^\infty(P_n) \geq \lceil \frac{n}{2} \rceil$ (Equation 3.1). On the other hand, and as paths are a subclass of distance graphs (a distance graph $P_n(1, t)$ is a path with some extra edges), so we have $F^\infty(P_n(1, t)) \geq F^\infty(P_n) \geq \lceil \frac{n}{2} \rceil$.

First, we prove that $F^\infty(P_n(1, t)) > \lceil \frac{n}{2} \rceil$. For that, we show that any subset F of G of $\lceil \frac{n}{2} \rceil$ vertices cannot be an EFVS. Without loss of generality, let $F = \{v_i^{2k+1}, 0 \leq k \leq \frac{n}{2t}, 1 \leq l \leq t\}$ since starting with any other subset of vertices of cardinality $\lceil \frac{n}{2} \rceil$ as a guard configuration, we inevitably end up with configuration F after some number of turns (note that we consider an infinite game). In fact, for instance where $G = P_{16}(1, 4)$, we let $F_1 = \{v_1^1, v_2^1, v_3^1, v_4^1, v_3^2, v_4^2, v_3^3, v_4^3, v_3^4, v_4^4\}$. After a sequence of attacks on vertices $v_3^1, v_4^1, v_3^3, v_4^3$ found in blocks T_1 and T_3 respectively, the guards should be arranged on T_1 and T_3 (see Figure 3.12). We denote this configuration F , and we have just to prove that F , which is clearly of cardinality $\lceil \frac{n}{2} \rceil$, is not an EFVS. Assume that the defender starts the game with F , and the attacker chooses to attack vertex $v_1^{\frac{n}{t}}$. The defender has only two choices to avoid the attack, either by moving the guard from vertex $v_1^{\frac{n}{t}-1}$ to $v_1^{\frac{n}{t}}$, which results in cycle $v_1^{(n/t)-2} v_2^{(n/t)-2} \dots v_t^{(n/t)-2} v_1^{(n/t)-1}$ (see Figure 3.13); or by moving the guard from $v_t^{\frac{n}{t}-1}$ to $v_1^{\frac{n}{t}}$, which results in a non-dominating guard configuration $F' = F \setminus \{v_t^{\frac{n}{t}-1}\} \cup \{v_1^{\frac{n}{t}}\}$. Hence F is not an EFVS, and so $F^\infty(P_n(1, t)) \neq \lceil \frac{n}{2} \rceil$.

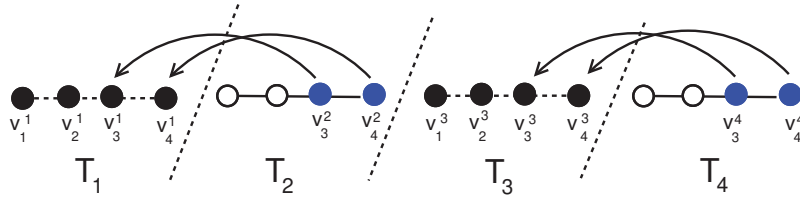

Figure 3.12: $P_{16}(1, 4)$, the guards are moved from blue vertices after an attack on the two last vertices of blocks T_1 and T_3 . Black shaded vertices are guard positions after attacks (which results in a F configuration).

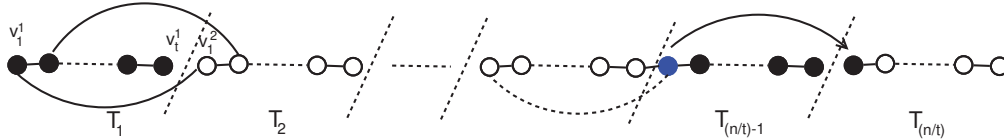

Figure 3.13: $P_n(1, t)$, the guards are on black shaded vertices.

Second, we show that $F^\infty(P_n(1, t)) = \lceil \frac{n}{2} \rceil + 1$. For that, let $F' = F \cup \{v_t^{\frac{n}{t}}\}$ be the set that holds the guards in the initial turn. We have $|F'| = |F| + 1 = \lceil \frac{n}{2} \rceil + 1$, and F' is a dominating FVS of G (since F is a dominating FVS). Starting the game with F' , the defender will win the game by applying the following strategy. Depending on the block of the attacked vertex, we have two defense strategies: (a') where $k = 1$, i.e. the attack occurs on the two first consecutive blocks, the defender can move the guard from v_1^1 to v_2^1 when v_2^1 is attacked, for all $1 \leq l \leq t$. (b') where $k \geq 2$, we deal with each attacked vertex according to its position in the block. If vertices v_l^{2k} , for $2 \leq l < t$, are attacked then the defender can move the guard from v_l^{2k-1} to v_l^{2k} . If vertices v_t^{2k} are attacked, the guard can be moved from v_1^{2k+1} to v_t^{2k} . Finally, vertices v_1^{2k} are protected by moving the guard from v_t^{2k} to v_1^{2k} . Note that all the obtained guard configurations F' are dominating FVS as $G \setminus F'$ has no chord of length t joining two consecutive blocks. Thus, fixing a guard on $v_t^{\frac{n}{t}}$

allows to deal with the non-domination encountered above (where $F^\infty(P_n(1, t)) = \lceil \frac{n}{2} \rceil$).

- (b) $\frac{n}{t}$ is odd. As above, we partition the graph into $\frac{n}{t}$ blocks, say $T_1, T_2, \dots, T_{\frac{n}{t}}$, of t vertices each. Let G' be the graph obtained from G by removing vertices of the last block $T_{\frac{n}{t}}$, where $n' = n - t$ is the number of vertices of G' . We deal with G' as follows. We have $\frac{n'}{t}$ is even, and so $F^\infty(G') = \lceil \frac{n'}{2} \rceil + 1$. For a winning strategy, we have to just choose any dominating set of cardinality $\frac{t}{2}$ for block $T_{\frac{n}{t}}$. We note that block $T_{\frac{n}{t}}$ is a path graph with t vertices, and as $F(T_{\frac{n}{t}}) = 0$ so any eternal dominating set is an EFVS. Accordingly, we have:

$$F^\infty(G) \leq F^\infty(G') + F^\infty(T_{\frac{n}{t}}) \leq \lceil \frac{n'}{2} \rceil + 1 + \frac{t}{2} \leq \lceil \frac{n}{2} \rceil + 1.$$

Now, we assume that there exists an EFVS of G with cardinal less than $\lceil \frac{n}{2} \rceil + 1$. There is at least $\lceil \frac{n'}{2} \rceil + 1$ guards for G' , so the path graph $G[T_{\frac{n}{t}}]$ will be protected by less than $\lceil \frac{t}{2} \rceil$, which leads to a contradiction, *i.e.* after some moves of the guards, we necessarily get three consecutive vertices in $T_{\frac{n}{t}}$ without guards. And hence $F^\infty(G) = \lceil \frac{n}{2} \rceil + 1$.

- (ii) $n \bmod t \neq 0$. We partition the graph into $\lceil \frac{n}{t} \rceil$ blocks, $T_1, \dots, T_{\lceil \frac{n}{t} \rceil}$, each of t vertices except the last block, $T_{\lceil \frac{n}{t} \rceil}$, contain $r < t$ vertices. Similar to case (i), we deal with two cases according to the parity of $\lceil \frac{n}{t} \rceil$.

- (a) $\lceil \frac{n}{t} \rceil$ is even. Let $G' = G \setminus T_{\lceil \frac{n}{t} \rceil}$ be the graph obtained from G by deleting the last block, and let n' be the number of vertices of G' . We use the same strategy as in case (i)(b) on graph G' , and we have $F^\infty(G') = \lceil \frac{n'}{2} \rceil + 1$. In fact, $T_{\lceil \frac{n}{t} \rceil}$ is a path graph with $r < t$ vertices, thus the last block can be defended by $\lceil \frac{r}{2} \rceil$ guards. Hence,

$$F^\infty(G) \leq F^\infty(G') + F^\infty(T_{\lceil \frac{n}{t} \rceil}) = \lceil \frac{n'}{2} \rceil + 1 + \lceil \frac{r}{2} \rceil = \lceil \frac{n}{2} \rceil + 1.$$

Now, we assume that the defender can win the game with less than $\lceil \frac{n}{2} \rceil + 1$ guards. We know that for a winning strategy, it is obligatory to have at least $\lceil \frac{n'}{2} \rceil + 1$ guards to protect G' in each turn of the game. And so the path graph $T_{\lceil \frac{n}{t} \rceil}$ is supposed to be protected by less than $\lceil \frac{r}{2} \rceil$ guards, which leads to a contradiction as this results in a non-dominating guard configuration. And hence, $F^\infty(G) = \lceil \frac{n}{2} \rceil + 1$.

- (b) $\lceil \frac{n}{t} \rceil$ is odd. Similarly, we let G' be the graph obtained from G by removing the last r vertices. We use exactly the same proof as in (ii)(a), except that in this case we deal with G' according to (i)(a).

■

We note that the proof of *Theorem 3.3.3* present as well a linear solving algorithm of the EFVS problem on $P_n(1, t)$.

Directly from [22], *Equation (3.1)* and *Theorem 3.3.3*, we get the following corollary.

Corollary 3.3.3 *For any n and t , and $G = P_n(1, t)$ we have:*

$$\begin{aligned} \lfloor \frac{n-t}{2} \rfloor \leq F_m^\infty(G) \leq \lceil \frac{n}{2} \rceil + 1, & \quad \text{if } \frac{n}{2} \leq t \leq n. \\ \lfloor \frac{n+2}{4} \rfloor \leq F_m^\infty(G) \leq \lceil \frac{n}{2} \rceil + 1, & \quad \text{if } \frac{n}{3} \leq t \leq \frac{n}{2}. \\ \lfloor \frac{n-t}{3} \rfloor \leq F_m^\infty(G) \leq \lceil \frac{n}{2} \rceil + 1, & \quad \text{if } t \geq 2 \text{ and } n \geq t. \end{aligned}$$

Case 4. $D = \{1, 2, 3, \dots, t\}$.

In this case, the graph is more dense and contains all edges established between each pair of vertices considering all possible distances less or equal than t .

Theorem 3.3.4 Let $G = P_n(1, 2, 3, \dots, t)$. For any $n \geq 5$ and $t \leq \frac{n-2}{2}$, we have:

$$F^\infty(P_n(D)) = \begin{cases} \lfloor \frac{n}{t+1} \rfloor (t-1) & n \bmod (t+1) = 0, 1, \\ n - 2\lfloor \frac{n}{t+1} \rfloor - 2 & \text{otherwise.} \end{cases}$$

PROOF:

Directly from Table 1.1 and Observation 3.1, we have:

$$F^\infty(P_n(D)) \geq F(P_n(D)) \geq \begin{cases} \lfloor \frac{n}{t+1} \rfloor (t-1) & n \bmod (t+1) = 0, 1 \\ n - 2\lfloor \frac{n}{t+1} \rfloor - 2 & \text{otherwise.} \end{cases}$$

To prove the equality it is sufficient to prove that the FVS constructed in [22] can be an initial $EFVS$ for a winning strategy. Let $G = P_n(1, 2, 3, \dots, t)$, we decompose G into q blocks of $(t+1)$ vertices each, and one block with r vertices, where $n = q(t+1) + r$, $q \geq 1$ and $0 \leq r \leq t+1$, and let v_i^s denote the i^{th} vertex in block s , for $i \geq 0$ and $s \geq 1$.

Let $F = \{v_i^s, 2 \leq i \leq t, 1 \leq s \leq q\} \cup \{v_i^s, 2 \leq i \leq r-1, 1 \leq s \leq q\}$. F is a FVS of G . In fact, the graph obtained from G after removing the vertices of F is an acyclic graph. All the chords that join the vertices of the two consecutive blocks are removed except the chord that join the vertices v_1^s and v_0^{s+1} , for all $s \geq 1$. Thus, $G[V \setminus F]$ is a path graph (see Figure 3.14).

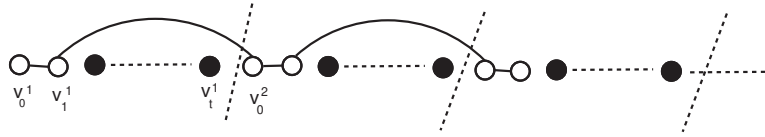

Figure 3.14: The vertices of F are shaded

Assume that each vertex of F holds a guard, we can see that the first two vertices of each block are not in F , i.e. $v_i^s \in F$ for all $i \geq 2$ and $v_i^s \notin F$ for $i = 0, 1$ (see Figure 3.14). Thus, F is a dominating set of G , and all vertices are protected by at least one guard. For instance, vertex v_1^s is protected by v_2^s and v_0^s . We suppose that the first vertex on the block is attacked, without loss of generality, let be v_0^1 , so the defender can avoid this attack with many ways, such as through moving a guard from v_t^1 to v_0^1 (no cycle is obtained) (see Figure 3.15).



Figure 3.15: $P_n(1, 2, \dots, t)$, $EFVS$ is shaded

Generalizing this model of protection to all the other blocks ensures that the new guard configurations, after each turn, is a dominating FVS , and the defender can avoid any attack. Therefore, starting with F , where $|F| = q(t-1)$ if $n \bmod (t+1) = 0, 1$, and $|F| = q(t-1) + r - 2$ otherwise, the defender wins the game, and the theorem is proved. ■

By Equation (3.1) and Theorem 3.3.4 the following corollary follows.

Corollary 3.3.4 Let $n \geq 5$ and $t \leq \frac{n-2}{2}$, then

$$F_m^\infty(P_n(D)) = \begin{cases} \lfloor \frac{n}{t+1} \rfloor (t-1) & n = 0, 1 \bmod (t+1) \\ (n-2)\lfloor \frac{n}{t+1} \rfloor - 2 & \text{otherwise.} \end{cases}$$

Circulant Graphs

In this section, we consider the class of circulant graphs, and we deal with two cases, depending on the set of distance D , namely the case when $D = \{1, s, t\}$ and when $D = \{1, t\}$, where s and t are assumed satisfies $1 < s < t \leq \frac{n}{2}$.

We first establish the relationship between both parameters, F^∞ and F_m^∞ , on distance and circulant graphs. We have, by definition, distance graphs are a subclass of circulant graphs, *i.e.* circulant graph is a distance graph with some extra edges (chords), so the following corollary holds.

Corollary 3.3.5 *For any $n \geq 1$ and any set D ,*

$$F^\infty(P_n(D)) \leq F^\infty(C_n(D)), \text{ and } F_m^\infty(P_n(D)) \leq F_m^\infty(C_n(D)).$$

For the general case, where $D = \{1, s, t\}$, the set of neighbors of a vertex v_i is $\{v_k | k = (i \pm w) \bmod n, w = 1, s, t, \text{ and } j = 1, 2, \dots, n\}$, where n is the number of vertices in the graph. The following bounds immediately follows from *Corollary 3.3.5*, *Equation (3.1)* and *Table 1.1*.

Corollary 3.3.6 *For any integers n, s and t , with $t \leq \frac{n-1}{2}$ and $2 \leq s < t$, $\lceil \frac{2n+1}{5} \rceil \leq F_m^\infty(C_n(1, s, t)) \leq F^\infty(C_n(1, s, t))$.*

For the case where $D = \{1, t\}$, the set of neighbors of a vertex v_i is $\{(i \pm w) \bmod n, w = 1, t, \text{ and } j = 1, 2, \dots, n\}$.

Theorem 3.3.5 *For any $n \geq 5$ and $t < \frac{n}{2}$, we have:*

$$F^\infty(C_n(1, t)) = \lceil \frac{n}{2} \rceil + 1.$$

PROOF:

From *Corollary 3.3.5* and *Theorem 3.3.3*, we have $F^\infty(C_n(1, t)) \geq \lceil \frac{n}{2} \rceil + 1$. To prove the equality, let $G = C_n(1, t)$, and let $H = P_{n-t}(1, t)$ be the subgraph of G induced by $\{t, t+1, \dots, n-1\}$. Directly from *Theorem 3.3.3*, we get $F^\infty(H) = \lceil \frac{n-t}{2} \rceil + 1$. On the other hand, for the cycle graph induced by the first t vertices $\{v_0, v_1, \dots, v_{t-1}\}$ of G , we can find an *EFVS* of size at most $\lceil \frac{t}{2} \rceil$. Therefore, there is an eternal feedback vertex set for $C_n(1, t)$ of size at most $(\lceil \frac{n-t}{2} \rceil + 1) + (\lceil \frac{t}{2} \rceil) = \lceil \frac{n}{2} \rceil + 1$. Hence, $F^\infty(C_n(1, t)) = \lceil \frac{n}{2} \rceil + 1$. ■

Using *Equation (3.1)* and *Theorem 3.3.5*, we obtain the following corollary.

Corollary 3.3.7 *For any $n \geq 5$ and $t < \frac{n}{2}$, $F_m^\infty(C_n(1, t)) = \lceil \frac{n}{2} \rceil + 1$.*

3.3.3 Grids

We compute F^∞ on a grid graph $G = P_n \times P_m$ obtained by the product of two paths P_n and P_m . Let assume that $n \leq m$ for all $n, m > 1$.

Theorem 3.3.6 *Let G be a grid, such that $G = P_n \times P_m$, and let $n \leq m$. $F^\infty(G)$ is computed as follows:*

$$F^\infty(G) = \begin{cases} \frac{m \times n}{2}, & \text{if } n \text{ or } m \text{ is even,} \\ \lceil \frac{m}{2} \rceil \times n, & \text{else.} \end{cases}$$

PROOF:

Let $G = P_n \times P_m$, with n rows and m columns. We label the vertices of G according to their positions, such that $v_{i,j}$ is the vertex obtained on row i and column j , where $i \leq n$ and $j \leq m$. There are two possible cases depending on the parity of n and m .

(i) *n* or *m* is even. First, let suppose that *n* and *m* are even. We assume that $F = \{v_{i,2k-1} | i, k \geq 1\}$ is the set of vertices chosen by the defender to hold the guards in the initial turn. F is a dominating feedback vertex set (we choose the vertices of each odd column), and $|F| = \frac{n \times m}{2}$. For an attack on any vertex $v_{i,j} \notin F$, say $v_{i,2k}$ where $k \geq 1$, the defender can remove a guard from the vertex $v_{i,2k-1}$ to $v_{i,2k}$, and the new guard configuration is FVS and dominating. Also, if at turn *i*, vertex $v_{i,2k-1} \notin F_i$ is attacked, then moving a guard from $v_{i,2k}$ to $v_{i,2k-1}$ ensures defending the attack. Thus, by applying this strategy, the defender will win the game.

Now, suppose that the defender starts the game with a number of guards less than $\frac{n \times m}{2}$, so using the same strategy, there is a turn *k* where the new configuration will no longer be a domination. In fact, without loss of generality let $F' = F \setminus \{v_{3,1}\}$ be the set obtained from F by deleting a vertex, say $v_{3,1}$. If $v_{2,4}$ is attacked, then if the guard moves from $v_{2,3}$ to $v_{2,4}$, so the new guard configuration is non-domination ($v_{1,3}$ is not protected by any guard), see *Figure 3.16a* for an example when $n = m = 4$. Otherwise, for $n > 4$, if the guard moves from $v_{2,5}$ to $v_{2,4}$, then as *n* is even, after a series of attacks, all possible moves lead to a non-dominating configuration. And hence we get the result that the minimal number of guards is $\frac{n \times m}{2}$.

In what follows, we generalize this result for any subset making an $EFVS$ for G . In doing so, we first show that this is true for the particular case of grids, namely $P_2 \times P_2$, and then we generalize it for $P_m \times P_2$ and $P_n \times P_m$, for any *n, m*.

For $P_2 \times P_2$, which is a cycle graph of length four, and using *Observation 6*, we have $F^\infty(P_2 \times P_2) = \frac{n}{2} = \frac{4}{2} = \frac{n \times m}{2}$. To prove that $F^\infty(P_2 \times P_m) = \frac{n \times m}{2} = m$ is true for all *m*, we proceed by induction. We assume that it is true for all *m*, and prove it for $m + 2$. Let $G = P_2 \times P_{m+2}$ be a grid graph, and assume that $F^\infty(G) < \frac{2 \times (m+2)}{2} = m + 2$. Let $G' = P_2 \times P_m$ be the subgraph induced by the first *m* columns of G , and G'' be the subgraph induced by the last two columns. We have $F^\infty(G'') = F^\infty(P_2 \times P_2) = 2$, and from the hypothesis of induction we have $F^\infty(G') = \frac{2 \times m}{2} = m$. Thus, we contradict our assumption, $F^\infty(G) < m + 2$ (note that there is a turn where the subgraph G'' will hold only one guard which is a non-dominating configuration). Therefore, we need at least $m + 2$ guards, and so $F^\infty(P_2 \times P_m) = m$.

Now, we similarly generalize the result for all *n* and *m*. By induction, we suppose that it is true for any *n* and *m*, and prove that it remains for $n' = n + 2$ and any *m*. Let $G = P_{n'} \times P_m$ be a grid graph, where $n' = n + 2$, and *n* and *m* are even. And let G_1 be the subgraph induced by the first *n* rows of G . We have $G' = P_n \times P_m$, and so $F^\infty(G') = \frac{n \times m}{2}$ (induction hypothesis). On the other hand, we have $G'' = G[V(G) \setminus V(G')]$ is $P_2 \times P_m$, and so $F^\infty(G'') = m$ (which we have already proved). So assuming that $F^\infty(P_{n'} \times P_m)$ is less than $\frac{n' \times m}{2}$ leads to a contradiction. In fact, in this case, the defender must move a guard from G' to G'' to avoid an attack which results in a non dominating guard configuration. *Figure 3.16* illustrates the case of $P_4 \times P_4$. As we can see such a graph must be defended by $\frac{4 \times 4}{2} = 8$. The same proof can be used for the case where *n* is odd and *m* is even. For the case when *n* is even and *m* is odd, we deal with this case in the same manner as the previous one, by switching between the rows and columns. We let $F = \{v_{2k-1,j} | k, j \geq 1\}$ be the set of vertices chosen by the defender in the initial turn. F is a dominating feedback vertex set, and $|F| = \frac{n \times m}{2}$ (we choose the vertices of each odd row). For an attack on any vertex $v_{2k,j}$, where $k \geq 1$, the defender can move the guard from $v_{2k-1,j}$ to $v_{2k,j}$ and the new guard configuration is dominating FVS after any turn of the game. And thus, F is an $EFVS$.

(ii) *n* and *m* are odd. We assume that the defender begin the game with $F' = \{v_{i,2k+1}, i \geq 1, k \geq 0\}$ (we choose all vertices of odd columns). F' is a dominating feedback vertex set and $|F'| = \lceil \frac{m}{2} \rceil \times n$. After any attack on vertices $v_{i,2k+2}$, the defender can move guards from $v_{i,2k+1}$ to $v_{i,2k+2}$, and the new guard configuration is dominating FVS after any turn, which is a winning strategy starting with F' . Thus, $F^\infty(G) \leq \lceil \frac{m}{2} \rceil \times n$. To prove the equality, we decompose graph G into two subgraphs, G_1 and G_2 , such that $G_1 = P_{n-1} \times P_m$ is the grid subgraph induced by the $n - 1$ rows and *m* columns, and G_2 is the path graph induced by the last row and column of G .



Figure 3.16: $P_4 \times P_4$, the guards are placed on the black shaded vertices, and blue nodes are guard positions before moving.

From case (i), we have $F^\infty(G_1) = \frac{(n-1)(m)}{2}$, (note that $(n-1)$ is even and (m) is odd), and G_2 is a path graph with m vertices, so $F^\infty(G_2) = \lceil \frac{m}{2} \rceil$. Figure 3.17 illustrate the case where $n = m = 5$, $G = P_5 \times P_5$.

This complete the proof. ■



Figure 3.17: $P_5 \times P_5$, the guards are placed on the black shaded vertices, and blue nodes are guard positions before moving.

3.4 Conclusion

In this chapter, we have introduced and examined novel models of the graph protection problem, namely the *Eternal Feedback Vertex Set* and *m-Eternal Feedback Vertex Set*. Due to their difficulty, we firstly considered them on relatively simple classes of graphs. We deduced some inequalities for F^∞ and F_m^∞ on general graphs, cycles, complete graphs, and complete bipartite graphs. Furthermore, we computed both parameters on distance graphs, circulant graphs, and grids.

4 A linear Algorithm For The Eternal Feedback Vertex Set on Interval Graphs

“Success is not the key to happiness. Happiness is the key to success. If you love what you are doing, you will be successful.”

Albert Schweitzer

The eternal feedback vertex set of a graph G is a particular case of the eternal dominating set problem, where the guard configurations are also feedback sets (in all turns) [1]. In fact, by definition an *EFVS*, besides it is a dominating set, it is also a feedback set of G .

In 2015 [50], *Barga et al.* solved the Eternal Dominating Set problem on proper interval graphs. They proved that, in this case, the optimal value of the problem equals the largest size of an independent set of the graph G , *i.e.* $\gamma^\infty(G) = \gamma_m^\infty(G) = \alpha(G)$. Later, in 2018 [49], the authors proved that the m -eternal dominating number is equal to the clique-connected cover numbers for interval graphs, *i.e.* $\gamma_m^\infty(G) = \theta(G)$, where G is an interval graph and $\theta(G)$ its clique-connected cover number.

In this chapter, we consider the eternal feedback vertex set problem on the class of interval graphs. We first determine the value of the Eternal Feedback Vertex number, $F^\infty(G)$, on this class of graph and then we develop an algorithm for computing it. For that, we adapt the graph partitioning approach presented in [49].

4.1 Interval Graph Clique Partition

Let $G = (V, E)$, where $V = \{v_1, \dots, v_n\}$, be an interval graph, and $\Gamma = \{I_1, I_2, \dots, I_n\}$ be the interval representation of G , where $I_i = [b_i, e_i]$ is a closed interval assigned to the vertex $v_i \in V$. According to the interval graph definition (refer to *Chapter 1*), we have $v_i v_j \in E$, for all $i \neq j$, if and only if $I_i \cap I_j \neq \emptyset$. These graphs have many important properties and applications in various fields. First, let state the following adapted graph partitioning approach needed for our study, and which is a slightly different method from the one presented in [49].

Let G be an interval graph, with $V = \{v_1, \dots, v_n\}$, constructed by a family of intervals $\Gamma = \{I_1, I_2, \dots, I_n\}$, by associating a vertex $v_i \in V$ to each interval I_i , for $1 \leq i \leq n$, and let $\beta(\Gamma)$ be an increasing order of interval in Γ according to their endpoints, *i.e.* $e_1 \leq e_2 \leq \dots \leq e_n$. We partition Γ on a set of subset of intervals $\Gamma_1, \Gamma_2, \dots, \Gamma_p$, each corresponding to a clique of G , as follows. We put $C_1 = I_1$, the first interval in Γ according to $\beta(\Gamma)$. We define $\Gamma_1 = C_1 \cup \{I_j \in \Gamma \mid I_j \cap C_1 \neq \emptyset\}$. Γ_1 contains, besides I_1 all intervals that intersect C_1 . Similarly, we define C_{i+1} as the first interval in $\Gamma \setminus \cup_i \Gamma_i$ according to $\beta(\Gamma)$, and so $\Gamma_{i+1} = C_{i+1} \cup \{I_j \in \Gamma \setminus \cup_i \Gamma_i \mid I_j \cap C_{i+1} \neq \emptyset\}$ (see *Figure 4.1*).

The subgraphs G_1, \dots, G_p induced by the vertices of G associated to the intervals of $\Gamma_1, \dots, \Gamma_p$ are complete graphs (cliques).

4.2 Eternal feedback vertex number on interval graphs

Before computing the EFVS number of an interval graph, let first present the following needed result.

Lemma 4.2.1 *Let $G = K_n$ be a complete graph, where $n \geq 3$. We have:*

$$F^\infty(K_n) = F(K_n) = n - 2.$$

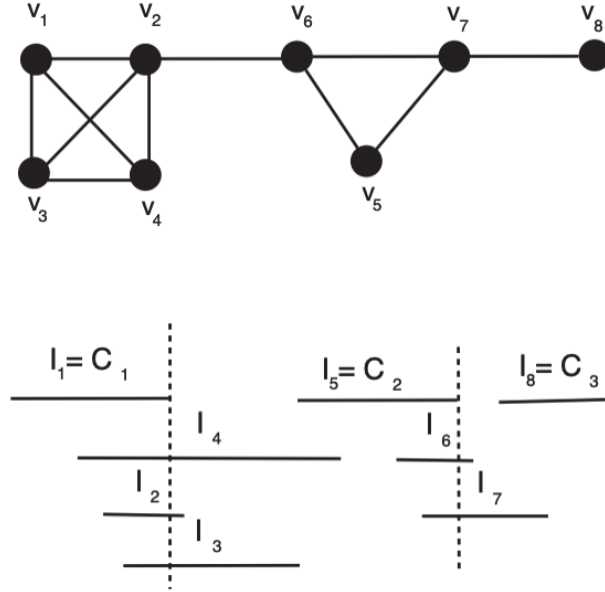

Figure 4.1: An interval graph G and its interval representation Γ . We have, $C_1 = I_1$, $C_2 = I_5$ and $C_3 = I_8$, and hence $\Gamma_1 = \{I_1, I_2, I_3, I_4\}$, $\Gamma_2 = \{I_5, I_6, I_7\}$, $\Gamma_3 = \{I_8\}$.

PROOF:

Given a complete graph K_n , where $n \geq 3$, each triplet of vertices in K_n forms a cycle, and thus we must delete at least $n-2$ vertices to get a forest. Hence, $F^\infty(K_n) \geq F(K_n) = n-2$. The graph obtained from K_n after deleting $n-2$ vertices is an edge (acyclic graph), and hence $F^\infty(K_n) = F(K_n) = n-2$.

Theorem 4.2.1 *Let G be an interval graph, and let G_1, \dots, G_p be the clique decomposition of G , then, we have:*

$$F^\infty(G) = \sum_{n_j \geq 3} n_j - 2 + \sum_{n_j \leq 2} 1$$

where n_j denotes the number of vertices of G_j , for all $j \geq 1$.

PROOF:

Let G be an interval graph constructed by a family of intervals, $\Gamma = \{I_1, I_2, \dots, I_n\}$, by associating a vertex v_i to each interval $I_i = [b_i, e_i]$, for $1 \leq i \leq n$. We partition G into p disjoint complete subgraphs, say G_1, G_2, \dots, G_p , using the method described in Section 4.1. And let denote n_j the number of vertices of G_j induced by the vertices associated to the intervals in Γ_j , for all $1 \leq j \leq p$. From Lemma 4.2.1, we have each complete subgraph G_j , where $n_j \geq 3$, can be defended by $n_j - 2$ guards, i.e. $F^\infty(G_j) = n_j - 2$ if $n_j > 3$. Otherwise, if $n_j \leq 2$, we have G_j is either an edge or an isolated vertex, and in both cases $F^\infty(G_j) = 1$. So as a defender, for a winning strategy, we can place $\sum_{n_j \geq 3} n_j - 2 + \sum_{n_j \leq 2} 1$ guards on G , and hence $F^\infty(G) \leq \sum_{n_j \geq 3} n_j - 2 + \sum_{n_j \leq 2} 1$.

Now to prove the equality, we prove that if the defender uses less than $\sum_{n_j \geq 3} n_j - 2 + \sum_{n_j \leq 2} 1$ guards, for all $1 \leq j \leq p$, he will lose the game. We assume that the defender place less than $\sum_{n_j \geq 3} n_j - 2 + \sum_{n_j \leq 2} 1$ guards on the vertices of G . One can see that, in this case, at least there is two subgraphs, say G_j and G_{j+1} , are protected by a common guard. This is the case of v_4 in Figure 4.2a. We have four possible cases according to the number of vertices of each subgraph.

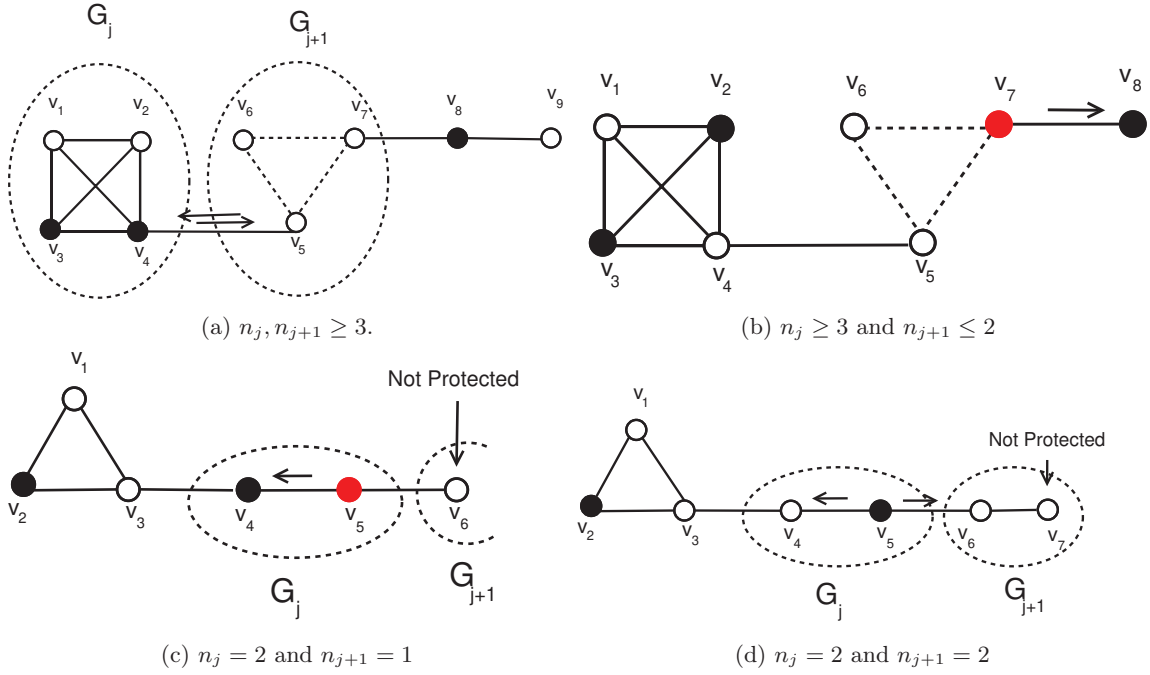

Figure 4.2: The guards are placed on the black shaded vertices, and the red nodes are the positions of guards before moving.

First, we suppose that $n_j \geq 3$ and $n_{j+1} \geq 3$, and so there is a cycle either in G_j or in G_{j+1} , which leads to a contradiction (see Figure 4.2a). If we assume that $n_j \geq 3$ and $n_{j+1} \leq 2$, which is the case of $G_j[\{v_5, v_6, v_7\}]$ and $G_{j+1}[\{v_8\}]$ of Figure 4.2b, then a cycle is obtained in G_j at the turn in which a guard must move from G_j to G_{j+1} , since G_j at this turn contains at most $n_j - 3$ guards (a contradiction with Lemma 4.2.1). Now, suppose that $n_j, n_{j+1} \leq 2$, and let start with the case where $n_j = 2$ and $n_{j+1} = 1$ (see Figure 4.2c). According to our assumption, we have the vertices of the two subgraphs, G_j and G_{j+1} , holds at most one guard, and so there is a contradiction since the subgraph induced by $G_j \cup G_{j+1}$ is a path with three vertices (at the turn where the guard is placed on the first vertex, the last vertex is not protected by any guard). Finally, in the case where $n_j = n_{j+1} = 2$, the subgraph induced by $G_j \cup G_{j+1}$ is a path with four vertices (see Figure 4.2d), and defended by at most one guard (a contradiction). Therefore, $F^\infty(G) = \sum_{n_j \geq 3} n_j - 2 + \sum_{n_j \leq 2} 1$, where n_j presents the number of vertices of G_j , for all $j \geq 1$.

4.3 Algorithm for finding EFVS on interval graphs

Given an interval graph G , a linear algorithm for finding the EFVS on G can be developed as follows (see Algorithm 1).

One can easily see that Algorithm 1 runs in $O(n)$. Also, from Lemma 4.2.1 we have the set F returned by the algorithm is an initial choice for the defender in a winning game, i.e. F is a dominating feedback set which can hold the guards in a winning strategy, and which is minimal as removing any vertex from F results in either a cycle or a non-protected vertex.

Example. Considering the interval graph G in Figure 4.3.

1. According to the decomposition mentioned in Section 4.1, we have $\Gamma_1 = \{I_1, I_2, I_3, I_4, I_5\}$, $\Gamma_2 = \{I_6, I_7\}$, $\Gamma_3 = \{I_8, I_9\}$, and $\Gamma_4 = \{I_{10}, I_{11}, I_{12}\}$. Then, $G_1 = G[\{v_1, v_2, v_3, v_4, v_5\}]$, $G_2 =$

Algorithm 1: Algorithm for the EFVS problem on interval graphs

```

1 Input: an interval graph  $G$ 
2 Output: an EFVS and the EFV number of  $G$ 
3 Partition  $G$  using the decomposition mentioned in Section 4.1, and let  $G_i = (V_i, E_i)$ ,
    $1 \leq i \leq p$  be the set of cliques, where  $V_i = \{v_1^i, \dots, v_{n_i}^i\}$ ,  $n_i$  is the number of vertices of  $G_i$ .
4  $F \leftarrow \phi$  and  $F^\infty(G) \leftarrow 0$ 
5 for  $i=1, \dots, p$  do
6   if  $n_i \geq 3$  then
7      $F \leftarrow F \cup \{v_1^i, \dots, v_{n_i-2}^i\}$ 
8      $F^\infty(G) \leftarrow F^\infty(G) + n_i - 2$ 
9   else
10     $F \leftarrow F \cup \{v_1^i\}$ 
11     $F^\infty(G) \leftarrow F^\infty(G) + 1$ 
12   end
13 end
14 return  $F$  and  $F^\infty(G)$ 

```

$G[\{v_6, v_7\}]$, $G_3 = G[\{v_8, v_9\}]$, and $G_4 = G[\{v_{10}, v_{11}, v_{12}\}]$ (see *Figure 4.4*). Hence, we have:

$$F^\infty(G) \leq 3 + 1 + 1 + 1 = 6.$$

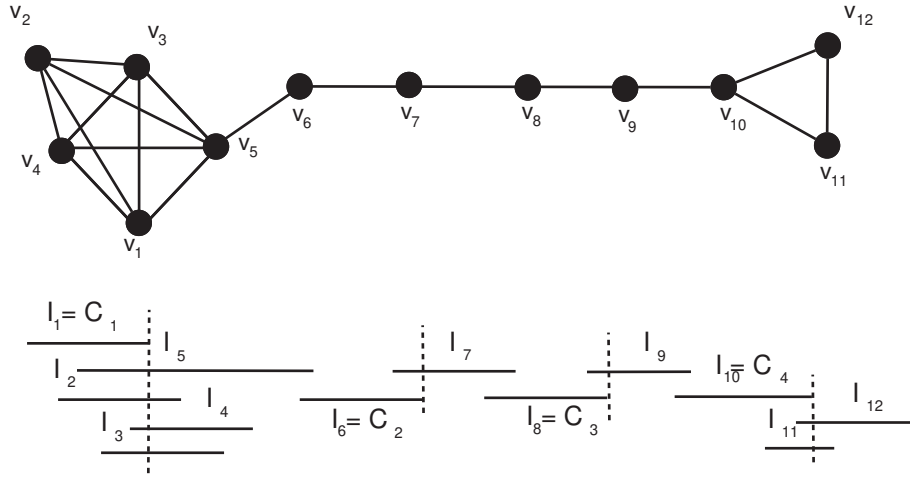

Figure 4.3: An interval model (below) of an interval graph G (above).

Now, suppose that G is protected by less than 6 guards. Without loss of generality, let $F_1 = \{v_1, v_3, v_5, v_8, v_{10}\}$ and the vertex v_6 is attacked. The only possible guard moves, from v_5 to v_6 , will generate a cycle $v_2v_4v_5$ (*Figure 4.5*).

- In *Figure 4.6*, $\Gamma_1 = \{I_1, I_2, I_3, I_4\}$, $\Gamma_2 = \{I_5, I_6, I_7, I_8\}$, and $\Gamma_3 = \{I_9, I_{10}\}$. G decomposed into three cliques (see *Figure 4.7*). Hence, we have:

$$F^\infty(G) \leq 2 + 2 + 1 = 5.$$

See *Figure 4.8a* for more illustration.

Now, suppose that G is protected by less than 5 guards. Without loss of generality, let $F_1 = \{v_1, v_3, v_6, v_8\}$ and the vertex v_{10} is attacked.

The only possible guard moves, from v_8 to v_{10} , will generate a cycle $v_7v_8v_9$ (*Figure 4.8b*).

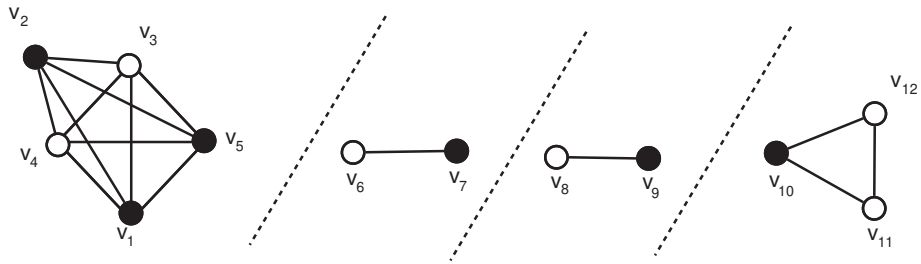

Figure 4.4: The decomposition of graph G , the guards are on the shaded vertices.

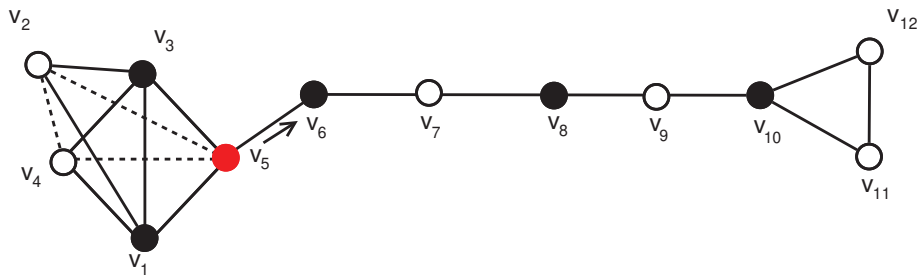

Figure 4.5: Non-EFVS of G , the guards are on the black shaded vertices and the red node present the position of guard before moving.

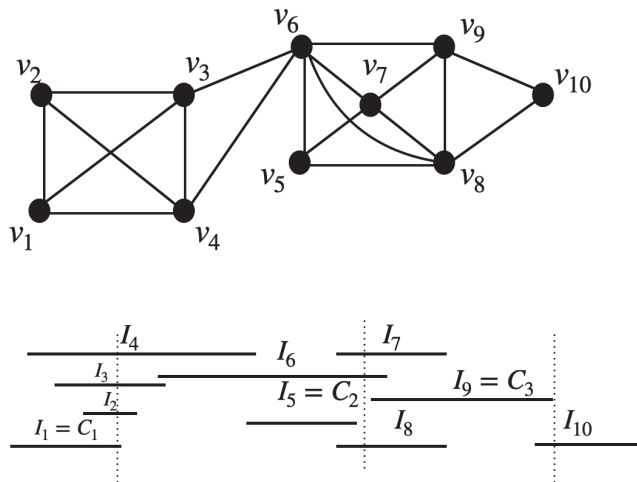

Figure 4.6: An interval model (below) of an interval graph G (above).

4.4 Conclusion

The *Eternal Feedback Vertex Set* is known to be hard even when considered on relatively simple classes of graphs. In this chapter, we developed a linear algorithm to solve it on interval graphs. The algorithm is based on a graph partitioning method as a preprocessing step, and then the set of guards is selected for each partition independently. And each sub-clique deal with its own attacks by the

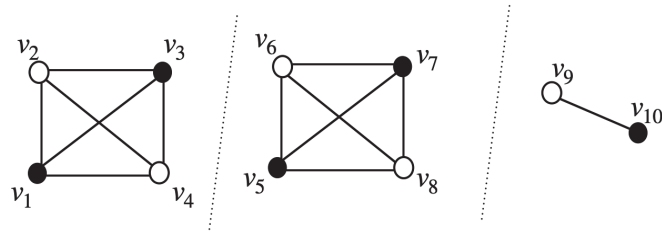

Figure 4.7: The decomposition of graph G , $G_1 = G[\{v_1, v_2, v_3, v_4\}]$, $G_2 = G[\{v_5, v_6, v_7, v_8\}]$, and $G_3 = G[\{v_9, v_{10}\}]$

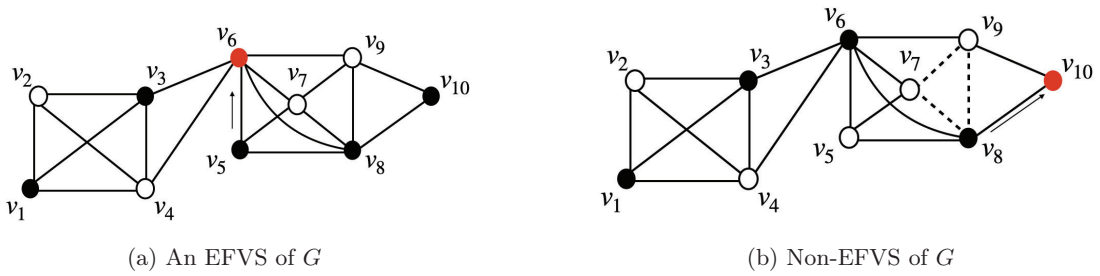

Figure 4.8: The guards are on the black shaded vertices and the red node present the position of guard before moving.

guards on its vertices. The algorithm may be generalized for the m -EFVS problem where more than one guard can move at the same turn. These variant may reduce the number of guards we should use inorder to defend all the attacked.

5 Exploring Strategies for Constructing Eternal Feedback Vertex Sets

“ Success is the result of perfection, hard work, learning from failure, loyalty, and persistence.”

Albert Schweitzer

Protecting a graph using mobile guards is a problem that has been previously studied in many models as seen in previous chapters. In this chapter, we focus on studying the techniques of defending the vertices of a graph by considering the eternal feedback vertex property. We present a suitable technique to effectively protect the vertices of k -tree graphs from infinite attacks. Additionally, we conduct a thorough study of this protective model within various specific classes of graphs including k -star, k -sun, and k -cube connected cycle graphs. Furthermore, we calculate the eternal feedback vertex number for helm graphs, wheel graphs, gear graphs, fan graphs, and friendship graphs. For the k -spiral graph, we develop a linear algorithm for identifying the eternal feedback vertex set. This algorithm provides an efficient way to determine the set of vertices that ensures the elimination of cycles within these graphs.

First, let state the following lemmas [55] we have used to establish our results.

Lemma 5.0.1 [55] *For any $n \geq 3$, $F^\infty(K_n) = F(K_n) = n - 2$.*

Lemma 5.0.2 [55] *Let G be a cycle graph with n vertices, we have:*

$$\lfloor \frac{n}{2} \rfloor \leq F^\infty(C_n) \leq \lceil \frac{n}{2} \rceil.$$

Note that in what follows, the blue and black shaded vertices in all figures hold the guards, respectively, before and after moving.

5.1 EFVS for k -Tree graphs

Recall that a k -Tree graph is constructed starting with a $(k + 1)$ vertex complete graph, and then repeatedly adding vertices in such a way that each added vertex v has exactly k neighbors U where the $k + 1$ vertices formed by v and U form a clique¹.

Let G be a k -tree graph on n vertices, $G = T_n^k$, where V is partitioned into two disjoint subsets, $C = \{v_1, v_2, \dots, v_{k+1}\}$ and S . We decompose the graph into disjoint cliques, such that $G[C]$ is the main clique and S_i is referred to the other cliques with r_i vertices denoted by $V(S_i) = \{s_1^i, \dots, s_{r_i}^i\}$ (see *Figure 5.1*).

According to the definition of k -tree graphs, it is evident that for all indices p, q, i , the neighborhood $N[S_p^i]$ of vertex S_p^i is equal to the neighborhood $N[S_q^i]$ of vertex S_q^i .

A winning *EFVS* strategy on k -tree graphs is the following. As a defender, we begin by selecting guard positions on the vertices of T_n^k . Based on *Lemma 5.0.1*, we have at each turn, $k - 1$ guards need to be placed on the vertices of C , and $r_i - 2$ guards on each S_i (in the case where $r_i \leq 2$ only one guard is needed). Thus, we ensure that the specified number of guards is sufficient to effectively defend

¹These graphs introduced in [56], have attracted considerable research as well as many applications [56, 57, 58].

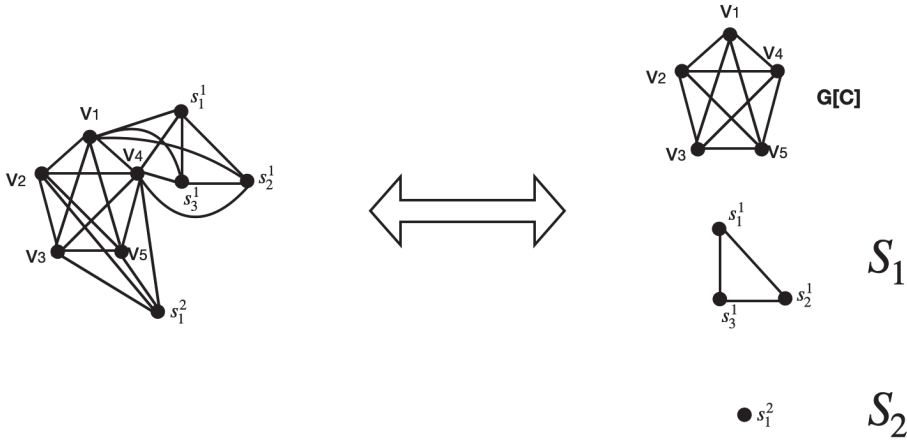

Figure 5.1: 4-tree graph decomposition, T_9^4 .

vertices against continuous attacks on individual separated cliques, while maintaining the property of dominating feedback vertex set. In the worst-case where there are no shared neighbors between the vertices of S_i and S_j in C , for all i and j , this strategy, allocates $k - 1$ guards on the vertices of $G[C]$ to protect them against any attacks, and prevent constructing a cycle within other cliques. Consequently, at any given turn t , the guard configuration will not include all the vertices in $N(S_i)$ (or $N(S_j)$), which would otherwise induce a cycle in S_i (or S_j). Thus, we must add a guard on the vertices of $G[C]$. *Figure 5.2* illustrates each step of this strategy on the graph G shown in *Figure 5.1*. It shows the possible configurations on G , where $F^\infty(G) = 5$, i.e. $F^\infty(G) = 3 + 1 + 1 = 5$. Note that G consists of three clique components; a main clique denoted $G[C]$, and two other cliques S_1 and S_2 . Also, we have $N[s_j^1] = \{s_1^1, s_2^1, s_3^1, v_1, v_4\}$ and $N[s_j^2] = \{s_1^2, v_2, v_3, v_4, v_5\}$, where both sets represent the neighborhoods of s_1^1 and s_1^2 respectively, and induce cliques.

Figure 5.3 illustrates the worst case on $G = T_{10}^4$. In this case, we have $N[s_j^1] = \{s_1^1, s_2^1, s_3^1, v_1, v_4\}$ and $N[s_j^2] = \{s_1^2, s_2^2, v_2, v_3, v_5\}$, and so no shared neighbors. Assume that $F = \{v_1, v_3, v_4, s_1^2, s_2^1\}$ is an eternal FVS of G . If v_2 is attacked, the all possible moves induce a cycle. For instance, if the guard moved from v_4 to v_2 , v_3 to v_2 , v_1 to v_2 , or s_1^2 to v_2 , we get respectively cycle $s_1^1 s_3^1 v_4$, $v_3 v_5 s_2^2$, $s_1^1 s_3^1 v_1$, or $s_1^1 v_5 s_2^2$.

Based on the aforementioned strategy, we can state that the eternal feedback vertex number of k -tree graphs satisfies the following inequality.

Theorem 5.1.1 *Let G be a k -tree graph of n vertices with decomposition into disjoint cliques of sizes $k + 1, r_1, r_2, \dots, r_p$ then $k - 1 + \sum_i \max\{1, (r_i - 2)\} \leq F^\infty(G) \leq k + 1 + \sum_i \max\{1, (r_i - 2)\}$.*

PROOF:

Consider a k -tree graph G with n vertices. The lower bound for the number of guards required can be obtained directly from *Lemma 5.0.1*. To prove the upper bound, we adopt the following strategy:

- Fix $k + 1$ guards on the vertices of the main clique.
- Allocate $r_i - 2$ guards for each subclique S_i .
- Ensure that the guards assigned to each subclique are not shared with any other subcliques.

By distributing the guards in this manner, we can defend all the vertices of the k -tree graph G by $k + 1 + \sum_i (r_i - 2)$ guards at most. ■

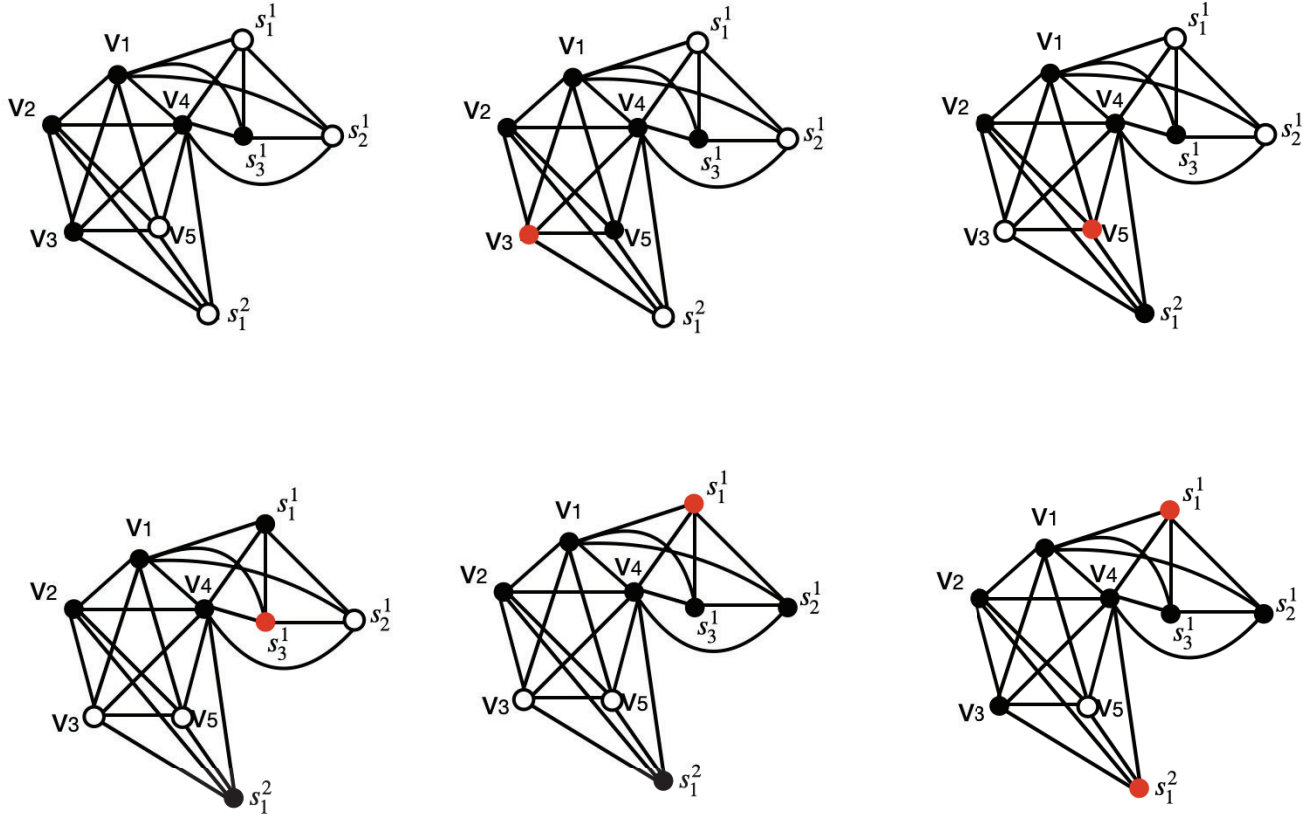

Figure 5.2: $EFVS$ for T_9^4

k-Star, k-Path and k-Sun

For k -star, k -path, and k -sun graphs we have the following observation.

Observation 7 Let G be a graph with $V = \{v_1, v_2, \dots, v_n\}$.

- (i) If G is a k -star graph, with $n > k$, then $F^\infty(G) = n - 2$.
- (ii) If G is a k -path graph, with $n > k$ vertices and $k > 3$, then $F^\infty(G) = n - 2$.
- (iii) If G is a k -sun graph, then $F^\infty(G) = n - 2$.

In fact, consider (i) a k -star graph, and according to Lemma 5.0.1, it is necessary to assign guards to $k - 1$ vertices from the set $\{v_1, \dots, v_k\}$. This ensures the protection of the central hub and its direct neighbors. Furthermore, for all vertices v_i where $k + 1 \leq i \leq n$, each vertex must have its own dedicated defense unit to safeguard it eternally (see Figure 5.4). For example, Figure 5.5 illustrates that $F^\infty(G) \geq n - 2$. For (ii) a k -path graph, let $V_1 = \{v_1, \dots, v_{k+2}\}$ and $V_i = \{v_i, \dots, v_{i+k+1}\}$, for all $i \geq 1$, a set of sequence vertices, and let F be its $EFVS$. Each V_i induces a clique, thus according to Lemma 5.0.1, F contain at least $k - 1$ vertices from each V_i . In the case where $|(F \cap V_i) \cap (F \cap V_{i-1})| = k - 1$, to defend an attack on a vertex v_i , a guard must be moved from $\{v_{i+2}, \dots, v_{i+k+1}\}$ to v_i , and hence a cycle will be obtained (See Figure 5.6).

Finally, for (iii) a k -sun graph, the set of vertices V is partitioned into two subsets, $C = \{c_1, \dots, c_k\}$ and $S = \{s_1, \dots, s_k\}$, where C induces a complete graph. According to Lemma 5.0.1, we have $F^\infty(G[C]) = k - 2$. Let $F = \{c_1, \dots, c_{k-2}\}$ be an eternal feedback vertex set of G . To defend an

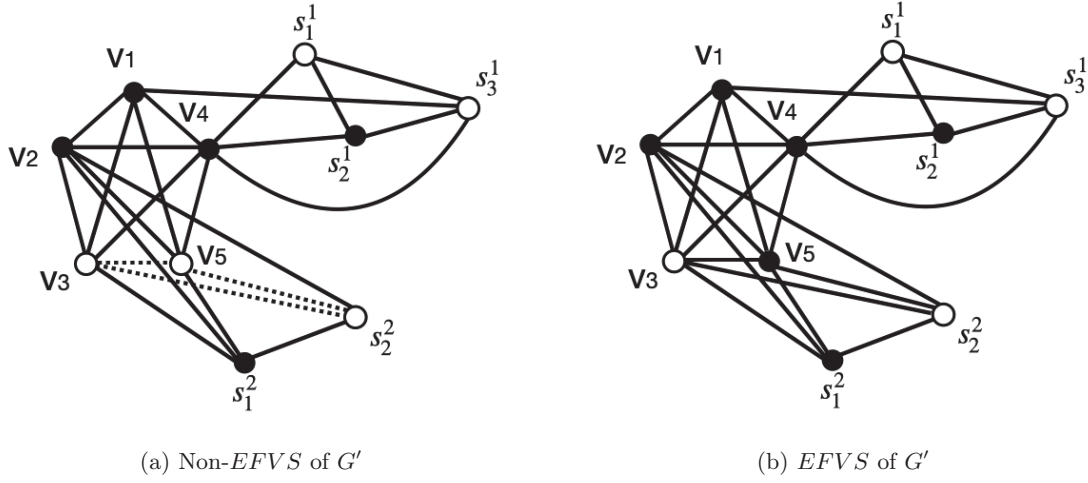

Figure 5.3: Eternal feedback problem on T_{10}^4 .

attack on s_i , a guard should be moved either from c_i to s_i or from c_{i+1} to s_i . In both cases, a cycle will be generated, which is $c_k c_{k-1} c_i$ for the first move and $c_k c_{k-1} c_{i+1}$ for the next move (see Figure 5.7a). Thus, each vertex of S can be defended only by holding a guard. Therefore, F is constructed by adding the vertices of S to k_2 vertices of C . Hence, $F^\infty(G) = n - 2$.

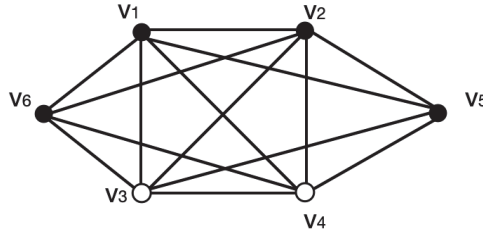

Figure 5.4: EFVS for $S_{4,2}$.

5.2 Wheel, Helm, and Gear Graphs

We remind that a wheel graph is constructed by connecting all vertices of a cycle C_n to a single universal vertex. From the definition and Lemma 5.0.2, we can easily observe that finding an eternal feedback vertex set (EFVS) of a wheel graph is equivalent to finding an EFVS of a cycle with an additional guard placed on the universal vertex to protect it (see Figure 5.8). Thus, we have the following observation.

Observation 8 *If $G = W_n$ is a wheel graph, then*

$$\lfloor \frac{n}{2} \rfloor + 1 \leq F^\infty(G) = F^\infty(C_n) + 1 \leq \lceil \frac{n}{2} \rceil + 1.$$

The gear graph is derived from a wheel graph by inserting an extra vertex between each pair of adjacent vertices. As a result, it is easy to observe that the following corollary holds.

Corollary 5.2.1 *For any n , $F^\infty(G_n) = F^\infty(C_{2n}) + 1$.*

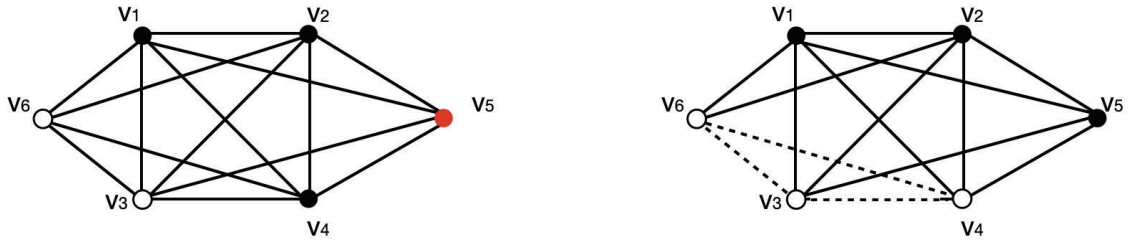

Figure 5.5: Non $EFVS$ for $S_{4,2}$.

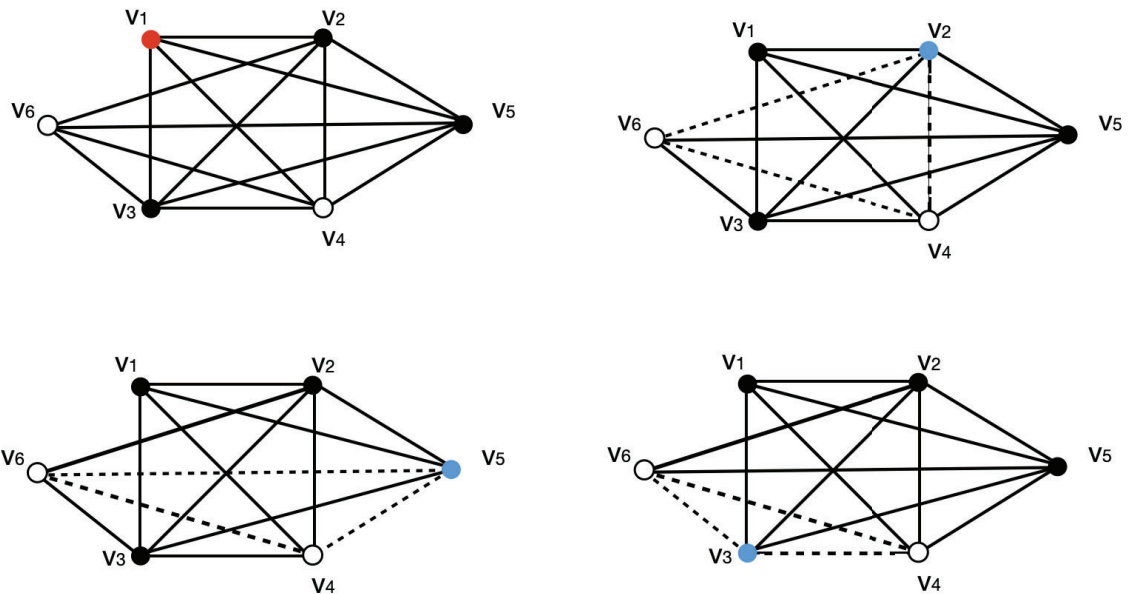

Figure 5.6: The different possible cycles generated while defending an attack on vertex v_1 of P_6^4 .

Consider a helm graph formed by adding a single edge and vertex to each vertex of the outer cycle of a wheel graph. This results in a graph with $2n + 1$ vertices. We prove that a helm graph needs exactly $n + 1$ guards to be effectively defended against any possible attack.

Theorem 5.2.1 *Let G be a helm graph, then $F^\infty(G) = n + 1$.*

PROOF: Consider a helm graph G with vertex set $V = \{x\} \cup \{v_1, \dots, v_n\} \cup \{u_1, \dots, u_n\}$, where vertices $\{x, v_1, \dots, v_n\}$ induce a wheel graph, and each vertex v_i is connected to its corresponding vertex u_i . Let $F = \{x, v_1, \dots, v_n\}$ be an eternal feedback vertex set ($EFVS$) of G . We prove the theorem through a winning strategy. Whenever a vertex u_i is attacked, we have to move a guard from vertex v_i to vertex u_i , and hence each vertex u_i is defended by a guard from its corresponding vertex v_i . It is evident that all the obtained guard configurations through the proposed strategy are both dominating and feedback vertex sets. As a result, we can confidently state that this strategy is a winning approach, allowing the defender to prevent an infinite attack by using $n + 1$ guards. To prove that F is minimal we proceed by contradiction. Suppose that there exists a set F' obtained by removing a vertex from F i.e., $F' = F \setminus \{v_i\}$. Since $F \setminus \{v_i\}$ is not a dominating set, see Figure 5.9b, it implies that $F' = \{v_1, \dots, v_n\}$. Now, if vertex x is attacked, the defender must move a guard from any vertex in F' to x . However, the resulting guard configuration, $F' \setminus \{v_i\} \cup \{x\}$, is not a dominating set, leading to a contradiction. Hence, we can conclude that F is indeed a minimum

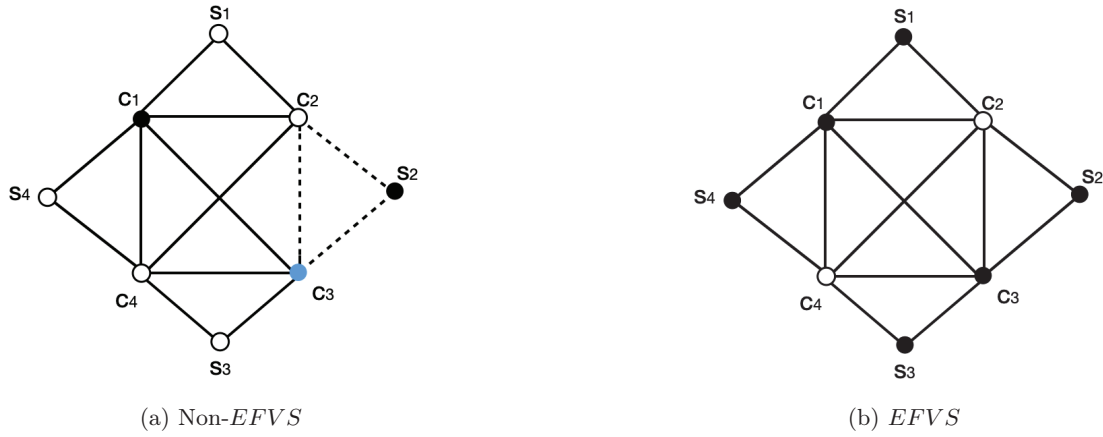

Figure 5.7: 4-sun graph

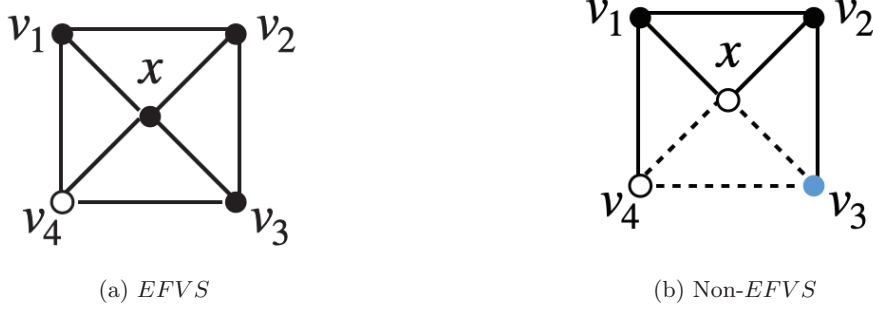

Figure 5.8: Wheel graph, the blue nodes holding the guards before moving.

eternal feedback vertex set of G , as any removal of a vertex from F would result in a non-dominating guard configuration. ■

5.3 Friendship and Fan graphs

The friendship graph is constructed by joining n copies of C_3 with a common vertex, we prove that the minimum $EFVS$ must contain n vertices.

Theorem 5.3.1 *Let G be a friendship graph, then $F^\infty(G) = n$, where $n \geq 1$.*

PROOF: Consider the friendship graph F_n , and let $V = \{x, a_1^1, a_1^2, a_2^1, a_2^2, \dots, a_n^1, a_n^2\}$, where each set $\{x, a_i^1, a_i^2\}$ forms a cycle. The eternal feedback vertex set F of F_n must include a vertex from each triplet $\{x, a_i^1, a_i^2\}$, for all i . Note that vertex x alone cannot serve as an $EFVS$ of F_n since moving the guard from x to any other vertex will result in a cycle (see Figure 5.10). Therefore, F must contain n vertices, one vertex (distinct from x) from each copy of the cycle C_3 (refer to Figure 5.11). ■

For *fan graphs*, the following inequality about the minimum $EFVS$ holds.

Theorem 5.3.2 *Let $G = F_{m,n}$ be a fan graph, where $m > 1$, then*

$$m + \lceil \frac{n}{2} \rceil - 1 \leq F^\infty(F_{m,n}) \leq m + \lceil \frac{n}{2} \rceil.$$

PROOF:

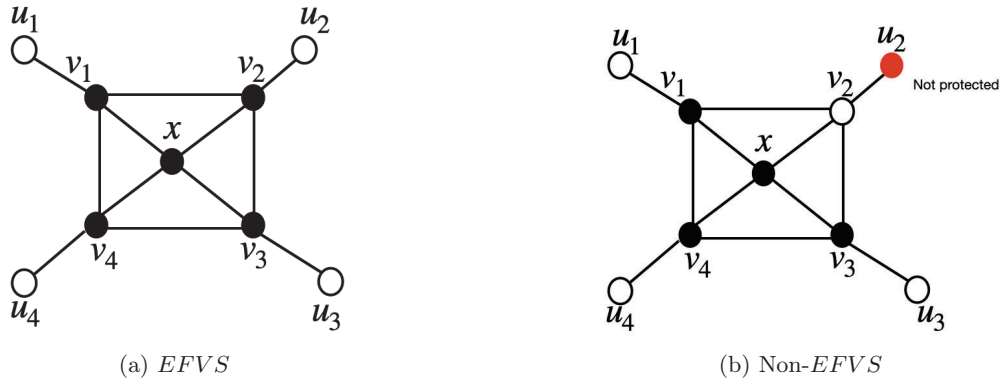

Figure 5.9: Helm graph

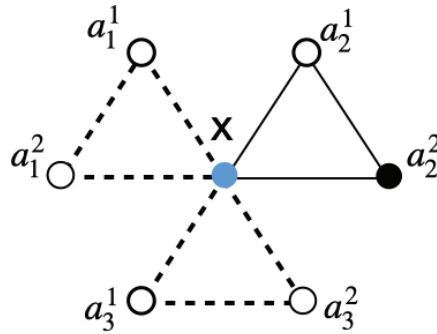

Figure 5.10: A non-EFVS of a friendship graph.

Consider a graph $F_{m,n}$, where the vertex set V is partitioned into two sets, $C = \{c_1, \dots, c_m\}$ and $S = \{s_1, \dots, s_n\}$, where C forms an empty graph, $\overline{K_m}$, and S induces a path, P_n . In this graph, C is dominating feedback vertex set. However, the defender cannot win the game starting with C because, after the first move of a guard, a cycle will be generated (see Figure 5.12). Let $F = C \cup \{s_i \mid i \text{ is odd}\}$ be an eternal feedback vertex set of $F_{m,n}$. It is evident that F is a dominating feedback vertex set of $F_{m,n}$. As a defender, we place guards on the vertices of F and apply the following strategy. No vertex in C can be attacked as it holds a guard. If vertex s_{2k} is attacked, we move the guard from s_{2k+1} to s_{2k} . This ensures the protection of all vertices in C , and hence all vertices in $F_{m,n}$. Therefore, $F^\infty(F_{m,n}) \leq m + \lceil \frac{n}{2} \rceil$. To establish the lower bound, we can consider an EFVS F' obtained from F by removing two guards. To ensure that F' does not generate a cycle, it is important to note that the two guards removed from F must belong to the same set; C or S . Now, let consider the case where $F' = F \setminus \{c_i, c_j\}$ for any i, j . If we remove a guard from s_l , for some l , to its neighboring vertex c_i , it will result in a cycle $c_j s_l s_{l+1}$. This contradicts the property of an eternal feedback vertex set. Similarly, if we assume that $F' = F \setminus \{s_i, s_j\}$, we would have at least three consecutive vertices in S without guards. Consequently, this will create a cycle (see Figure 5.13b). In both cases, removing two guards from F leads to the generation of cycles, violating the requirements of an eternal feedback vertex set. Thus, $m + \lceil \frac{n}{2} \rceil - 1 \leq F^\infty(F_{m,n})$. ■

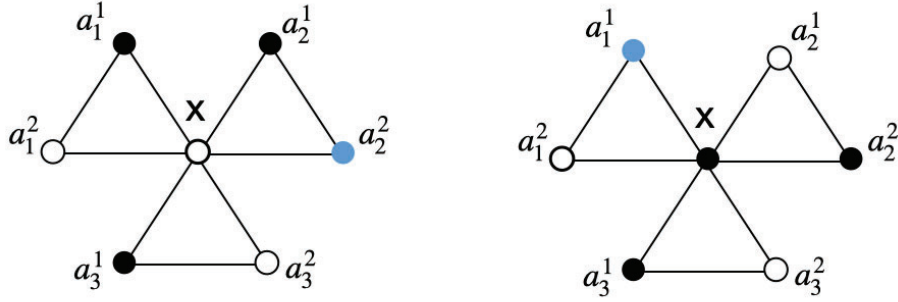

Figure 5.11: A EFVS of a friendship graph.

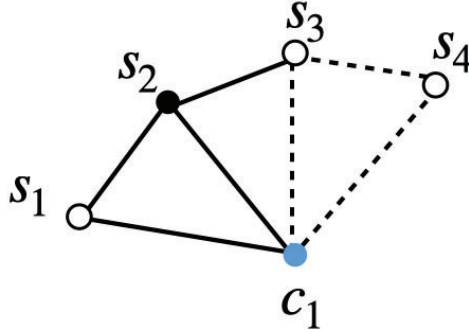

Figure 5.12: Fan Graph, $F_{1,4}$, a non-EFVS,

5.4 Algorithm for EFVS problem on k-spiral graphs

In this section, we develop a linear time algorithm for solving the Eternal Feedback Vertex problem on k -spiral graphs (see *Algorithm 2*). Note that a spiral graph is formed by a complete graph with additional vertices and edges.

Based on *Algorithm 2*, the following theorem about the EFV number on spiral graphs holds.

Theorem 5.4.1 For any $n > k$, $F^\infty(S_n^k) = k - 1 + \lceil \frac{n-k+1}{2} \rceil$.

PROOF:

Let S_n^k be a k -spiral graph with vertex set $V = \{v_1, \dots, v_n\}$, and let F be an EFVS of S_n^k . Considering the graph structure, we can place guards on the vertices of F . Since $G[v_1, \dots, v_{k-1}]$ forms a clique, at least $k - 3$ vertices from this set must hold guards. Thus, we have the triplet $\{v_{k-2}, v_{k-1}, v_i\}$ forms a cycle, and hence at least one vertex from this triplet must receive a guard. Without loss of generality, let $F = \{v_1, \dots, v_{k-2}\}$ be an EFVS of S_n^k . First, considering v_{k+1} , and as F is a dominating and feedback vertex set, any attack on this vertex would generate a cycle (for example, $F \setminus \{v_1\} \cup \{v_{k+1}\}$ is not a feedback vertex set). Now, for vertices $\{v_1, \dots, v_k\}$, we require $k - 2$ guards to protect them in each turn. For the set $\{v_{k+1}, v_{k+2}, \dots, v_n\}$, which forms a path graph with $n - k + 1$ vertices, we need $\lceil \frac{n-k+1}{2} \rceil$ guards. These guards should be placed on non-consecutive vertices to ensure an EFVS configuration. Therefore, for a winning strategy, the defender must place $k - 1 + \lceil \frac{n-k+1}{2} \rceil$ guards on the vertices of S_n^k . ■

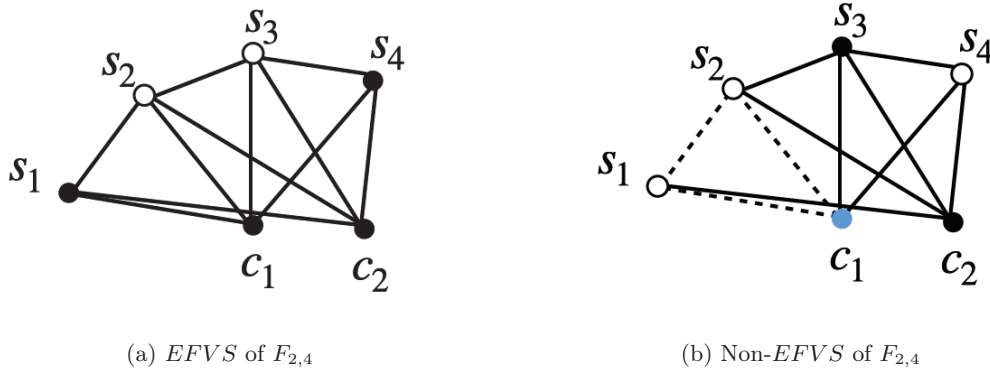
Figure 5.13: A fan graph $F_{2,4}$.

Algorithm 2: Algorithm for the *EFVS* problem on k -spiral graphs

```

1 Input: an  $k$ -spiral graph  $S_n^k$ 
2 Output: an EFVS and the EFV number of  $S_n^k$ 
3  $F \leftarrow \phi$  and  $F^\infty(S_n^k) \leftarrow 0$ 
4 for  $i=1, \dots, k-1$  do
5    $F \leftarrow F \cup \{v_i\}$ 
6    $F^\infty(S_n^k) \leftarrow F^\infty(S_n^k) + 1$ 
7 end
8 for  $i=k, \dots, n$  do
9   if  $v_i \notin F$  then
10     $F \leftarrow F \cup \{v_{i+1}\}$ 
11     $F^\infty(G) \leftarrow F^\infty(G) + 1$ 
12   end
13 end
14 return  $F$  and  $F^\infty(G)$ 

```

5.5 Conclusion

This chapter delved into the analysis of the eternal feedback vertex number for various classes of graphs, including k -tree, k -star, k -path, k -sun, friendship graphs, fan graphs, wheel graphs, gear graphs, helm graphs, and half graphs. Additionally, a linear algorithm for determining the eternal feedback vertex set on k -spiral graphs was developed. This algorithm could be used to compute the *EFV* number on chordal graph.

6 Conclusion

“The future belongs to those who believe in the beauty of their dreams”

Eleanor Roosevelt

This section serves as a comprehensive conclusion to my PhD research, focusing on the novel graph protection model called Eternal Feedback Vertex Set (*EFVS*).

In our study, we introduced the *EFVS* model, which extends existing graph protection models by incorporating the feedback vertex property. Two variants of the model were presented: the Eternal Feedback Vertex Set (*EFVS*) and m-Eternal Feedback Vertex Set (*m-EFVS*). These models involve a game between a defender and an attacker, where the defender strategically positions guards to defend the graph against attacks, such that the guard configuration must satisfy, besides the dominating property, the feedback property.

Our research primarily aimed to compute the graph parameters, namely the *EFV* and *m-EFVS* number, for various graph classes. Exact values and upper bounds were determined for these parameters, as well as inequalities were established between the two parameters and the other known graph metrics. Additionally, computations were performed on specific graph classes, leading to important results. We demonstrated that the eternal feedback vertex number and m-eternal feedback vertex number can be precisely calculated, this is the case for cycle graphs. Similar results were obtained for complete graphs and complete bipartite graphs.

Tables 6.1 and 6.2 provide a comprehensive consolidation of our research contributions, presenting a comparative analysis of the feedback number, eternal feedback number, and m-eternal feedback number within select categories of graphs.

On the other hand, we investigated the interval graphs and devised a linear algorithm for finding the eternal feedback vertex set on this class of graphs. The *EFV* number for interval graphs was explored, and a similar analysis was expanded to compute the parameter on other graph classes, including k-dimensional graphs such as k-star, k-sun, and k-tree.

Throughout the research, several open questions and directions for future study emerged. These include addressing the eternal feedback vertex problem on other graph classes, such as chordal graphs, using the already developed approaches, exploring scenarios where guards can move for more than one hop, and computing *EFV* parameters for this new variant on different classes of graphs. Another area of interest is the integration of machine learning techniques to efficiently determine the eternal set for different classes of graphs.

In conclusion, the problem of graph protection using guards presents a vast and intriguing field of study, and as a part of completing my research, I intend to expand my study to deal with more interesting related problem such as eternal critical vertices, and to encompass a broader range of variants within this domain.

	F	F^∞	F_m^∞
P_n	0	γ^∞	γ_m^∞
C_n	1	$\lfloor \frac{n}{2} \rfloor$	$\lfloor \frac{n}{3} \rfloor$
K_n	$n - 2$		
$K_{n,m}$	$\min\{n,m\} - 1$	$n+m-3$	$\max\{n,m\}$

Table 6.1: Bounds of F , F^∞ and F_m^∞ on particular classes of graphs

D	F		F^∞		F_m^∞	
	lower bound	upper bound	lower bound	upper bound	lower bound	upper bound
$\{1, 2, 4\}$	$4 \lfloor \frac{n}{8} \rfloor$	$\lceil \frac{n}{2} \rceil$	$5 \lceil \frac{n}{8} \rceil$		$4 \lfloor \frac{n}{8} \rfloor$	$5 \lceil \frac{n}{8} \rceil$
$\{1, t\}$	$\lceil \frac{n-t}{3} \rceil$	$\lceil \frac{n-2}{3} \rceil$	$\lceil \frac{n}{2} \rceil + 1$		$\lceil \frac{n-t}{3} \rceil$	$\lceil \frac{n}{2} \rceil + 1$
$\{1, s, t\}$	$\lceil \frac{2n-s-t}{5} \rceil$	$\lceil \frac{n}{2} \rceil$	$\lceil \frac{2n-s-t}{5} \rceil$	$\lceil \frac{n}{2} \rceil$	$\lceil \frac{2n-s-t}{5} \rceil$	$\lceil \frac{n}{2} \rceil$
$\{1, 2, \dots, t\}$	$\begin{cases} \lfloor \frac{n}{t+1} \rfloor (t-1) & \text{if } n = 0, 1 \pmod{t=1} \\ n - 2 \lfloor \frac{n}{t+1} \rfloor - 2 & \text{otherwise} \end{cases}$					

Table 6.2: Bounds of F , F^∞ and F_m^∞ on distance graphs

Bibliography

- [1] A. P. Burger, E. J. Cockayne, W. Grundlingh, C. M. Mynhardt, J. H. van Vuuren, W. Winterbach, Infinite order domination in graphs, *Journal of Combinatorial Mathematics and Combinatorial Computing* 50 (2004) 179–194.
- [2] B. L. Hartnell, C. M. Mynhardt, Independent protection in graphs, *Discrete Mathematics* 335 (2014) 100–109.
- [3] W. F. Klostermeyer, C. M. Mynhardt, Edge protection in graphs., *Australas. J Comb.* 45 (2009) 235–250.
- [4] C. Berge, *The theory of graphs*, Courier Corporation, 2001.
- [5] B. Bollobás, *Modern graph theory*, vol. 184 berlin (2013).
- [6] R. Diestel, A. Schrijver, P. Seymour, *Graph theory*, *Oberwolfach Reports* 4 (2) (2008) 887–944.
- [7] M. C. Golumbic, *Algorithmic graph theory and perfect graphs*, Elsevier, 2004.
- [8] O. Ore, R. J. Wilson, *Graphs and their uses*, Vol. 34, Cambridge University Press, 1990.
- [9] I. M. Bomze, M. Budinich, P. M. Pardalos, M. Pelillo, The maximum clique problem. *handbook of combinatorial optimization*, Supplement A 174 (1999).
- [10] J. Pattillo, S. Butenko, Maximum clique, maximum independent set, and graph coloring problems, *Wiley Encyclopedia of Operations Research and Management Science* (2010).
- [11] T. Haynes, Hedetniemi. st and slater pj, *fundamentals of domination in graphs* (1998).
- [12] O. Togni, Placement de convertisseurs de longueur d’onde dans les réseaux optiques, *Proc. of 2iemes Rencontres Francophones sur les Aspects Algorithmiques des Télécommunications (Algotel2000)* (2000) 35–40.
- [13] J. Chen, I. A. Kanj, W. Jia, Vertex cover: further observations and further improvements, *Journal of Algorithms* 41 (2) (2001) 280–301.
- [14] D. König, *On graphs and their application to determinant and set theory*.
- [15] T. S. Caetano, J. J. McAuley, L. Cheng, Q. V. Le, A. J. Smola, Learning graph matching, *IEEE transactions on pattern analysis and machine intelligence* 31 (6) (2009) 1048–1058.
- [16] L. Livi, A. Rizzi, The graph matching problem, *Pattern Analysis and Applications* 16 (2013) 253–283.
- [17] R. E. Tarjan, A. E. Trojanowski, Finding a maximum independent set, *SIAM Journal on Computing* 6 (3) (1977) 537–546.
- [18] O. Ore, *Theory of graphs*, Vol. 38, American Mathematical Society, 1965.
- [19] X. Baogen, E. J. Cockayne, T. W. Haynes, S. T. Hedetniemi, Z. Shangchao, Extremal graphs for inequalities involving domination parameters, *Discrete Mathematics* 216 (1-3) (2000) 1–10.
- [20] M. R. Garey, D. S. Johnson, *Computers and intractability*, Vol. 174, Freeman San Francisco, 1979.
- [21] A. Becker, D. Geiger, Approximation algorithms for the loop cutset problem, in: *Uncertainty Proceedings 1994*, Elsevier, 1994, pp. 60–68.

- [22] O. Togni, H. Kheddouci, Bounds for minimum feedback vertex sets in distance graphs and circulant graphs, *Discrete Mathematics & Theoretical Computer Science* 10 (2008).
- [23] I. M. Bomze, M. Budinich, P. M. Pardalos, M. Pelillo, Feedback set problem. handbook of combinatorial optimization, Kluwer Academic 4 (1999).
- [24] A. Majeed, I. Rauf, Graph theory: A comprehensive survey about graph theory applications in computer science and social networks, *Inventions* 5 (1) (2020) 10.
- [25] W. Gao, H. Wu, M. K. Siddiqui, A. Q. Baig, Study of biological networks using graph theory, *Saudi journal of biological sciences* 25 (6) (2018) 1212–1219.
- [26] G. A. Pavlopoulos, M. Secrier, C. N. Moschopoulos, T. G. Soldatos, S. Kossida, J. Aerts, R. Schneider, P. G. Bagos, Using graph theory to analyze biological networks, *BioData mining* 4 (1) (2011) 1–27.
- [27] A. T. Balaban, Applications of graph theory in chemistry, *Journal of chemical information and computer sciences* 25 (3) (1985) 334–343.
- [28] S. Wagner, H. Wang, Introduction to chemical graph theory, Chapman and Hall/CRC, 2018.
- [29] J. Najera, Graph theory — history overview, *Towards Data Science* (Nov 26, 2018).
- [30] M. R. Islam, N. Sultana, M. A. Moni, P. Sarkar, B. Rahman, A comprehensive survey of time series anomaly detection in online social network data, *International Journal of Computer Applications* 180 (2017) 13–22. doi:10.5120/ijca2017915989.
- [31] N. Deo, Graph theory with applications to engineering and computer science, Courier Dover Publications, 2017.
- [32] U. Lee, G. Mashour, Role of network science in the study of anesthetic state transitions, *Anesthesiology* 129 (2018) 1. doi:10.1097/ALN.0000000000002228.
- [33] A. Baryshnikova, Systematic functional annotation and visualization of biological networks, *Cell systems* 2 (6) (2016) 412–421.
- [34] W. Klostermeyer, An eternal vertex cover problem, *Journal of Combinatorial Mathematics and Combinatorial Computing* 85 (2013) 79–95.
- [35] W. Goddard, S. M. Hedetniemi, S. T. Hedetniemi, Eternal security in graphs, *Combinatorial Mathematics and Combinatorial Computing* 52 (2005) 169–180.
- [36] W. Klostermeyer, C. M. Mynhardt, Eternal total domination in graphs., *Ars Combinatorial* 107 (2012) 473–492.
- [37] W. F. Klostermeyer, C. M. Mynhardt, Edge protection in graphs., *Australasian Journal of Combinatorics* 45 (2009) 235–250.
- [38] W. F. Klostermeyer, M. Lawrence, G. MacGillivray, Dynamic dominating sets: the eviction model for eternal domination, *Combinatorial Mathematics and Combinatorial Computing*, volume=97, pages=247–269, year=2016.
- [39] W. F. Klostermeyer, C. M. Mynhardt, Protecting a graph with mobile guards, arXiv preprint arXiv:1407.5228 (2014).
- [40] J. Arquilla, H. Fredricksen, " graphing" an optimal grand strategy, *Military Operations Research* (1995) 3–17.
- [41] W. Klostermeyer, G. MacGillivray, Eternal security in graphs of fixed independence number, *Journal of Combinatorial Mathematics and Combinatorial Computing* 63 (2007) 97.

- [42] J. L. Goldwasser, W. F. Klostermeyer, Tight bounds for eternal dominating sets in graphs, *Discrete Mathematics* 308 (12) (2008) 2589–2593.
- [43] W. F. Klostermeyer, G. MacGillivray, Eternal dominating sets in graphs, *Combinatorial Mathematics and Combinatorial Computing* 68 (2009) 97–111.
- [44] J. L. Goldwasser, W. F. Klostermeyer, C. Mynhardt, Eternal protection in grid graphs, *Utilitas Mathematica* 91 (2013) 47–64.
- [45] S. Finbow, M.-E. Messinger, M. F. van Bommel, Eternal domination on $3 \times n$ grid graphs., *Australas. J Combinatorics* 61 (2015) 156–174.
- [46] C. M. van Bommel, M. F. van Bommel, Eternal domination numbers of $5 \times n$ grid graphs, *Combinatorial Mathematics and Combinatorial Computing* 97 (83) (2016) 102.
- [47] I. Lamprou, R. Martin, S. Schewe, Perpetually dominating large grids, in: *Algorithms and Complexity: 10th International Conference, CIAC 2017, Athens, Greece, May 24-26, 2017, Proceedings*, Springer, 2017, pp. 393–404.
- [48] G. Bagan, A. Joffard, H. Kheddouci, Eternal dominating sets on digraphs and orientations of graphs, *Discrete Applied Mathematics* 291 (2021) 99–115.
- [49] M. Rinemberg, F. J. Soullignac, The eternal dominating set problem for interval graphs, *Information Processing Letters* 146 (2019) 27–29.
- [50] A. Braga, C. C. de Souza, O. Lee, The eternal dominating set problem for proper interval graphs, *Information Processing Letters* 115 (6-8) (2015) 582–587.
- [51] Y. Caro, W. F. Klostermeyer, Eternal independent sets in graphs, *Theory and Applications of Graphs* 3 (1) (2016) 3.
- [52] W. F. Klostermeyer, C. M. Mynhardt, Graphs with equal eternal vertex cover and eternal domination numbers, *Discrete Mathematics* 311 (14) (2011) 1371–1379.
- [53] J. Babu, L. S. Chandran, M. Francis, V. Prabhakaran, D. Rajendraprasad, N. J. Warriar, On graphs whose eternal vertex cover number and vertex cover number coincide, *Discrete Applied Mathematics* 319 (2022) 171–182.
- [54] J. Babu, L. S. Chandran, M. Francis, V. Prabhakaran, D. Rajendraprasad, J. N. Warriar, On graphs with minimal eternal vertex cover number, in: *Algorithms and Discrete Applied Mathematics: 5th International Conference, CALDAM 2019, Kharagpur, India, February 14-16, 2019, Proceedings*, Springer, 2019, pp. 263–273.
- [55] N. Dyab, M. Lalou, H. Kheddouci, Eternal feedback vertex sets: A new graph protection model using guards., *Discussiones Mathematicae Graph Theory (Under review)* (2022).
- [56] L. W. Beineke, R. E. Pippert, The number of labeled k -dimensional trees, *Journal of Combinatorial Theory* 6 (2) (1969) 200–205.
- [57] H. Broersma, L. Xiong, K. Yoshimoto, Toughness and hamiltonicity in k -trees, *Discrete mathematics* 307 (7-8) (2007) 832–838.
- [58] J. M. Shook, B. Wei, Some properties of k -trees, *Discrete Mathematics* 310 (17-18) (2010) 2415–2425.