



**HAL**  
open science

# Homologie des T-Hypersurfaces

Jules Chenal

► **To cite this version:**

Jules Chenal. Homologie des T-Hypersurfaces. Mathématiques [math]. Université Claude Bernard - Lyon I, 2023. Français. NNT: 2023LYO10273 . tel-04791180

**HAL Id: tel-04791180**

**<https://theses.hal.science/tel-04791180v1>**

Submitted on 19 Nov 2024

**HAL** is a multi-disciplinary open access archive for the deposit and dissemination of scientific research documents, whether they are published or not. The documents may come from teaching and research institutions in France or abroad, or from public or private research centers.

L'archive ouverte pluridisciplinaire **HAL**, est destinée au dépôt et à la diffusion de documents scientifiques de niveau recherche, publiés ou non, émanant des établissements d'enseignement et de recherche français ou étrangers, des laboratoires publics ou privés.

**THESE de DOCTORAT DE  
L'UNIVERSITE CLAUDE BERNARD LYON 1**

**Ecole Doctorale 521  
InfoMaths**

**Discipline : Mathématiques**

Soutenue publiquement le 05/12/2023, par :  
**Jules Chenal**

---

**Homologie des T-Hypersurfaces**

---

Devant le jury composé de :

Itenberg, Ilia	Professeur des Universités, Sorbonne Université	Rapporteur
Mikhalkin, Grigory	Professeur Ordinaire, Université de Genève	Rapporteur
Renaudineau, Arthur	Maître de Conférence, Université de Lille	Examineur
Ressayre, Nicolas	Professeur des Universités, Université Claude Bernard Lyon 1	Examineur
Salepci, Nermin	Maître de Conférence, Université Claude Bernard Lyon 1	Examinatrice
Shaw, Kris	Professeure, Université d'Oslo	Examinatrice
Welschinger, Jean-Yves	Directeur de Recherche, CNRS	Directeur de thèse
Zimmermann, Susanna	Professeure des Universités, Université de Paris-Saclay	Présidente



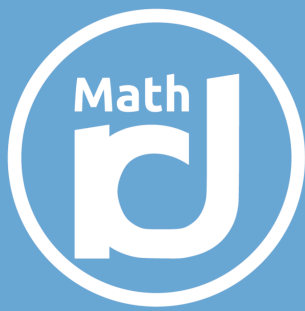

Institut  
Camille  
Jordan

Laboratoire de recherche en mathématiques Lyon/Saint-Étienne

# Homologie des T-Hypersurfaces

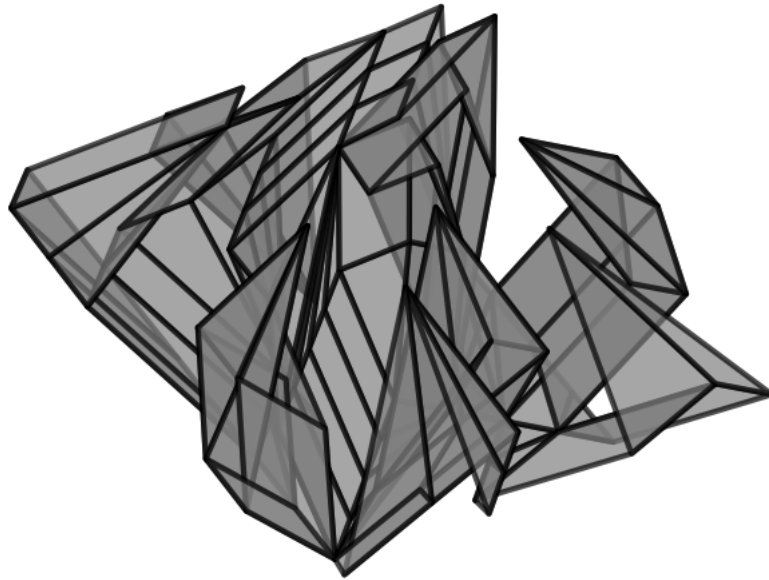

**Jules Chenal**  
Thèse de doctorat

Université Claude Bernard

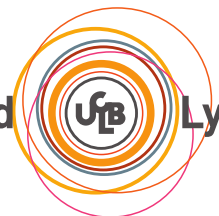

Lyon 1



# Résumé

Notre objet d'étude est la topologie, en particulier l'homologie, des T-hypersurfaces. Ces espaces topologiques construits de manière combinatoire sont une généralisation des *patchworks* combinatoires d'O. Viro. Ils sont naturellement plongés dans les lieux réels de variétés toriques et sont nés d'un besoin en hypersurfaces algébriques réelles ayant une topologie riche. En effet, dans le cas particulier des *patchworks*, les hypersurfaces affines par morceaux obtenues sont isotopes à des lieux réels d'hypersurfaces algébriques. L'espoir placé dans cette construction combinatoire est de pouvoir contrôler la topologie des hypersurfaces qui en sont issues. Les T-hypersurfaces se situent à l'intersection de la géométrie algébrique réelle, de la géométrie torique, de la géométrie des polytopes et de leurs subdivisions, et de la géométrie tropicale. Aujourd'hui l'outil le plus avancé dans l'étude de leur homologie est la suite spectrale d'A. Renaudineau et K. Shaw. Elle découle de l'action du tore algébrique unitaire sur le lieu réel d'une variété torique. Elle s'interprète aussi localement comme une suite spectrale de Kalinin. A. Renaudineau et K. Shaw calculèrent la première page de cette suite spectrale et montrèrent qu'elle correspond à l'homologie tropicale d'une hypersurface tropicale de même degré. Ce théorème leur a permis de majorer individuellement les nombres de Betti d'une T-hypersurface, raffinant ainsi l'inégalité de Smith-Thom pour les *patchworks*.

Dans un premier chapitre (rédigé en français) nous présentons le contexte dans lequel nous menons notre étude des T-hypersurfaces. Il s'agit d'un exposé introductif succinct des différentes théories qui menèrent à la définition de ces objets et au travers desquelles nous les envisageons. Il y est notamment question de topologie des variétés algébriques réelles, de géométrie torique, de géométrie projective complexe, de géométrie tropicale, et du *patchwork* de Viro.

Dans un second chapitre nous abordons la théorie des faisceaux et cofaisceaux cellulaires. Nous y portons une attention particulière à une certaine subdivision des CW-complexes que nous nommons (pseudo)-subdivision dihomologique. Elle est déjà présente dans les travaux de E. C. Zeeman et R. Forman. Il se trouve qu'elle est particulièrement adaptée à l'homologie tropicale mais offre également un cadre canonique dans lequel étudier le produit cohomologique de manière cellulaire.

Le troisième chapitre traite de l'homologie tropicale des polytopes subdivisés. Nous y généralisons le théorème de Lefschetz tropical. Afin de décrire ici nos résultats nous allons poser quelques notations. Désignons par  $P$  un polytope entier, simple, de dimension  $n$ , et muni d'une subdivision  $K$  en polytopes entiers. Soit  $X$  l'hypersurface duale à  $K$ . Nous pouvons noter que lorsque la subdivision  $K$  est

convexe, l'hypersurface  $X$  correspond à une hypersurface tropicale associée à la subdivision. Nous introduisons une nouvelle famille  $(\hat{F}_p^X)_{p \geq 0}$  de cofaisceaux cellulaires sur  $X$ . Ils sont les saturations des cofaisceaux usuels de l'homologie tropicale tels que définis par I. Itenberg, L. Katzarkov, G. Mikhalkin, et I. Zharkov. De plus, ils coïncident avec ces derniers dès que  $K$  est une triangulation primitive. Nous définissons également une mesure  $\delta(P)$  des singularités de la variété torique associée à  $P$ , et étendons le théorème de Lefschetz tropical à ces cofaisceaux moyennant quelques hypothèses sur l'anneau de coefficients.

**Theorem 3.2.14.** *Soit  $R$  un anneau dans lequel  $\delta(P)$  est inversible. Les morphismes homologiques :*

$$\hat{\iota}_{p,q} : \hat{H}_{p,q}(X; R) \rightarrow H_{p,q}(P; R),$$

*induits par les inclusions de cofaisceaux  $\hat{\iota}_p : \hat{F}_p^X \rightarrow F_p^P$  sont :*

- des isomorphismes, pour tous  $p + q < n - 1$ ;
- surjectifs, pour tous  $p + q = n - 1$ .

Dans le quatrième chapitre nous nous restreignons aux polytopes non-singuliers  $P$ , muni d'une triangulation primitive  $K$ . On désigne par  $\mathbb{R}P$  le lieu réel de la variété torique associée à  $P$ . Dans ce contexte nous donnons la définition d'une T-hypersurface  $\mathbb{R}X_\varepsilon$  associée à une distribution de signes  $\varepsilon \in C^0(K; \mathbb{F}_2)$ . Nous introduisons également la suite spectrale de Renaudineau-Shaw d'un tel objet. On la note  $(E_r^{p,q}(\mathbb{R}X_\varepsilon))_{p,q,r \geq 0}$ . Nous démontrons que cette suite spectrale est symétrique grâce à la dualité de Poincaré.

**Theorem 4.2.28** (Symétrie). *Pour tout  $r \geq 1$ , la page d'indice  $r$  de la suite spectrale de Renaudineau-Shaw calculant la cohomologie de  $\mathbb{R}X_\varepsilon$  satisfait la dualité de Poincaré. C'est à dire :*

1. *L'espace vectoriel  $E_r^{p,q}(\mathbb{R}X_\varepsilon)$  est nul dès que  $p > n - 1$  ou  $q > n - 1$  ;*
2. *L'espace vectoriel  $E_r^{n-1,n-1}(\mathbb{R}X_\varepsilon)$  est de dimension 1 ;*
3. *Le couplage bilinéaire  $\cup : E_r^{p,q}(\mathbb{R}X_\varepsilon) \otimes E_r^{n-1-p,n-1-q}(\mathbb{R}X_\varepsilon) \rightarrow E_r^{n-1,n-1}(\mathbb{R}X_\varepsilon)$  est non-dégénéré.*

*En particulier,  $E_r^{p,q}(\mathbb{R}X_\varepsilon)$  est isomorphe à  $E_r^{n-1-p,n-1-q}(\mathbb{R}X_\varepsilon)$  et  $d_r^{p,q}$  a même rang et même dimension nucléaire que  $d_r^{n-1-p+r,n-2-q}$ .*

Ensuite nous parvenons à établir un critère d'annulation de l'ensemble des différentielles de la page d'indice  $r \geq 2$  de la suite spectrale de Renaudineau-Shaw de  $\mathbb{R}X_\varepsilon$ .

**Theorem 4.2.31** (Critère d'annulation). *Soit  $r \geq 2$  un entier congru à  $n$  modulo 2. L'ensemble des différentielles de la page  $E_r(\mathbb{R}X_\varepsilon)$  s'annulent toutes si et seulement si  $i^q : H^q(\mathbb{R}P; \mathbb{F}_2) \rightarrow H^q(\mathbb{R}X_\varepsilon; \mathbb{F}_2)$  est injective lorsque  $q$  égale  $\frac{n-r}{2}$ .*

Nous en déduisons le critère de dégénérescence suivant :

**Corollary 4.2.32** (Critère de dégénérescence). *Soit  $r_0 \geq 2$  un entier congru à  $n$  modulo 2. Les différentielles  $d_r^{p,q}$  de la suite spectrale de Renaudineau-Shaw calculant la cohomologie de  $\mathbb{R}X_\varepsilon$  s'annulent pour tous  $p, q \geq 0$ , et tout  $r \geq r_0$ , si et seulement si les inclusions cohomologiques  $i^q : H^q(\mathbb{R}P; \mathbb{F}_2) \rightarrow H^q(\mathbb{R}X_\varepsilon; \mathbb{F}_2)$  sont injectives pour tout  $q \leq \frac{n-r_0}{2}$ . En particulier, toutes les différentielles  $d_r^{p,q}$  sont triviales pour tout  $r \geq 2$  si et seulement si les morphismes  $i^q : H^q(\mathbb{R}P; \mathbb{F}_2) \rightarrow H^q(\mathbb{R}X_\varepsilon; \mathbb{F}_2)$  sont injectives pour tout  $q \leq \lfloor \frac{n}{2} \rfloor - 1$ .*

Ce corollaire peut être reformulé comme une comparaison entre des quantités associées à  $\mathbb{R}X_\varepsilon$ : son «rang»  $\ell(\mathbb{R}X_\varepsilon)$  et son indice de dégénérescence  $r(\mathbb{R}X_\varepsilon)$  :

$$\begin{cases} \ell(\mathbb{R}X_\varepsilon) = \max \{ q \geq 0 \mid i^p : H^p(\mathbb{R}P; \mathbb{F}_2) \rightarrow H^p(\mathbb{R}X_\varepsilon; \mathbb{F}_2) \text{ est injectif } \forall 0 \leq p \leq q \} \\ r(\mathbb{R}X_\varepsilon) = \min \{ r \geq 0 \mid d_s^{p,q} = 0, \forall s \geq r, \forall 0 \leq p, q \leq n-1 \}, \end{cases}$$

où les  $(d_r^{p,q})_{r,p,q \geq 0}$  sont les différentielles de la suite spectrale de Renaudineau-Shaw de  $\mathbb{R}X_\varepsilon$ .

**Corollary 4.2.35.** *Nous avons les inégalités suivantes :*

$$\ell(\mathbb{R}X_\varepsilon) \geq \left\lfloor \frac{n - r(\mathbb{R}X_\varepsilon)}{2} \right\rfloor,$$

avec égalité dès que  $r(\mathbb{R}X_\varepsilon) \geq 3 + \frac{1-(-1)^n}{2}$ , et :

$$r(\mathbb{R}X_\varepsilon) \leq \max(2; n - 2\ell(\mathbb{R}X_\varepsilon) - 1),$$

avec égalité dès que  $\ell(\mathbb{R}X_\varepsilon) \leq \frac{n-5}{2}$ .

Par la proposition suivante nous pouvons conclure à la dégénérescence de la suite spectrale pour toute distribution de signes sur certaines triangulations, e.g. les triangulations de simplexes non-singulier de taille impaire (i.e. les hypersurfaces projectives de degré impair).

**Définition 4.2.36.** Soit  $Y$  une variété topologique et  $\alpha \in H^1(Y; \mathbb{F}_2)$  une classe de cohomologie. On désigne par  $\iota(\alpha)$  le minimum des entiers  $q \geq -1$  pour lesquels il existe une classe non-nulle  $\beta \in H^{q+1}(Y; \mathbb{F}_2)$  pour laquelle  $\alpha \cup \beta$  s'annule.

La classe duale de Poincaré de la classe fondamentale de  $\mathbb{R}X_\varepsilon$  dans l'homologie de  $\mathbb{R}P$  est indépendante de la distribution de signes  $\varepsilon$ , on la note  $[\omega_{\mathbb{R}X}]$ .

**Proposition 4.2.40.** *Nous avons l'inégalité suivante :*

$$\ell(\mathbb{R}X_\varepsilon) \geq \iota[\omega_{\mathbb{R}X}].$$

En particulier, il découle du corollaire 4.2.35 que si  $\iota[\omega_{\mathbb{R}X}] \geq \lfloor \frac{n}{2} \rfloor - 1$  alors toutes les différentielles de  $(E_r^{p,q}(\mathbb{R}X_\varepsilon))_{p,q \geq 0}$  s'annulent pour tout  $r \geq 2$ .



Notons  $P^n$  un simplexe non-singulier de dimension  $n$ . Sa variété torique est l'espace projectif. En toute généralité, si  $\mathbb{R}X_\varepsilon \subset \mathbb{R}P^n$  est de degré impair  $\ell(\mathbb{R}X_\varepsilon)$  égale  $n - 1$  et si  $\mathbb{R}X_\varepsilon$  est de degré pair  $\ell(\mathbb{R}X_\varepsilon)$  est inférieure à  $\lfloor \frac{n-1}{2} \rfloor$ . Nous démontrons que, pour une certaine famille de triangulations du simplexe  $P^n$ , le rang est aussi maximal en degré pair.

**Theorem 4.3.9** (Maximalité du rang). *Soit  $K$  une triangulation de Viro de  $P^n$ . Les inclusions homologiques :*

$$i_q : H_q(\mathbb{R}X_\varepsilon; \mathbb{F}_2) \rightarrow H_q(\mathbb{R}P^n; \mathbb{F}_2),$$

sont surjectives pour tout  $q \leq \lfloor \frac{n-1}{2} \rfloor$  et tout  $\varepsilon \in C^0(K; \mathbb{F}_2)$ . En d'autres termes, le rang d'une hypersurface projective obtenue comme patchwork primitif sur une triangulation de Viro est toujours maximal.

Le cinquième chapitre traite de la première page de la suite spectrale. On y calcule ses opérateurs de bord explicitement. Ces calculs nous mènent à une généralisation du théorème de B. Haas pour les T-courbes. Notre résultat caractérise les distributions de signes et les triangulations menant à une T-hypersurface ayant un nombre maximal de composantes connexes au sens de l'inégalité de Renaudineau-Shaw. A. Renaudineau et K. Shaw montrèrent la majoration suivante :

$$\dim H_0(\mathbb{R}X_\varepsilon; \mathbb{F}_2) \leq 1 + h^{n-1,0}(X),$$

où  $h^{n-1,0}(X)$  est le nombre de points entiers contenus dans l'intérieur du polytope  $P$ . Nous disons alors que  $\mathbb{R}X_\varepsilon$  a un nombre maximal de composantes connexes lorsque cette borne est atteinte. Afin d'énoncer notre résultat nous définissons la notion de  $\rho$ -uniformité d'une triangulation primitive. Il s'agit d'une propriété technique concernant les parités relatives des coordonnées des sommets de deux simplexes maximaux partageant une face de codimension 1.

**Theorem 5.3.14** (Théorème de Haas généralisé). *Soit  $P$  un polytope non-singulier de  $\mathfrak{t}^*(\mathbb{R})$  muni d'une triangulation primitive  $K$ . Pour toute distribution de signes  $\varepsilon \in C^0(K; \mathbb{F}_2)$ , la T-hypersurface  $\mathbb{R}X_\varepsilon$  a un nombre maximal de composantes connexes si et seulement si :*

1. La triangulation  $K$  est  $\rho$ -uniforme ;
2. Le rang  $\ell(\mathbb{R}X_\varepsilon)$  est au moins égal à  $\min(n - 2; 1)$  ;
3. La distribution de signes  $\varepsilon$  satisfait l'équation :

$$D^2\varepsilon = \rho \text{ dans } H_{n-1}(K; \mathcal{B}_1K; N).$$

4. Pour tout simplexe  $\sigma^{n-2}$  de  $\mathcal{B}_1K$ , non contenu dans  $\mathcal{B}_0K$ ,  $(\text{ap}(\sigma^{n-2}); \sigma^{n-2})_\varepsilon$  est nul.

Une triangulation bidimensionnelle est toujours  $\rho$ -uniforme, ainsi cette nouvelle hypothèse est automatiquement satisfaite pour les T-courbes. Cependant, ce n'est pas toujours le cas à partir de la dimension 3. On définit un nombre  $\kappa(K)$  qui mesure le défaut de  $\rho$ -uniformité de la triangulation  $K$ . Cette quantité peut être utilisée pour raffiner l'inégalité d'A. Renaudineau et K. Shaw sur le nombre de composantes connexes de  $\mathbb{R}X_\varepsilon$ .

**Proposition 5.3.24.** *Soit  $K$  une triangulation primitive d'un polytope non-singulier  $P$ . Pour toute distribution de signes  $\varepsilon \in C^0(K; \mathbb{F}_2)$ , le rang de la matrice  $M_{0,n-2}(\varepsilon)$  est toujours supérieur à  $\kappa(K)$ . Il s'en suit la majoration suivante :*

$$\dim H_0(\mathbb{R}X_\varepsilon; \mathbb{F}_2) \leq 1 + h^{n-1,0}(X) - \kappa(K).$$

Pour conclure nous utilisons nos calculs afin de déterminer la vitesse de croissance de l'espérance du nombre de composantes connexes de  $\mathbb{R}X_\varepsilon$ . On considère un polytope non-singulier  $P$  et une suite de triangulations primitives  $(K_d)_{d \geq 1}$  des dilatés  $dP$ . Ensuite, nous montrons que si  $\varepsilon$  est choisie uniformément au hasard dans  $C^0(K_d; \mathbb{F}_2)$  alors on a la proposition suivante.

**Proposition 5.3.27.** *Pour toute suite  $(K_d)_{d \geq 1}$  de triangulations primitives des dilatés  $(dP)_{d \geq 1}$ , on a :*

$$1 \geq \limsup_{d \rightarrow +\infty} \mathbb{E} \left[ \frac{b_0(\mathbb{R}X_\varepsilon(d))}{1 + h^{n-1,0}(X(d))} \right] \geq \liminf_{d \rightarrow +\infty} \mathbb{E} \left[ \frac{b_0(\mathbb{R}X_\varepsilon(d))}{1 + h^{n-1,0}(X(d))} \right] > 0.$$

On rappelle que  $h^{n-1,0}(X(d)) = \text{vol}_{\mathbb{Z}}(P)d^n + o(d^n)$ .

On en déduit que bien qu'obtenir une hypersurface avec un nombre maximal de composantes connexes puisse s'avérer impossible, le nombre de composantes reste toujours substantiel par rapport à la borne supérieure d'A. Renaudineau et K. Shaw.

\*



# Contents

<b>1</b>	<b>Introduction</b>	<b>1</b>
1.1	Géométrie Algébrique Réelle Projective . . . . .	2
1.2	Variétés Toriques Projectives . . . . .	9
1.3	Hypersurfaces et Fibrés en Droites . . . . .	17
1.4	Cohomologie des Variétés Toriques Projectives . . . . .	19
1.5	Amibes et Géométrie Tropicale . . . . .	23
1.6	Patchwork de Viro . . . . .	31
1.7	T-hypersurfaces et plan de la thèse . . . . .	36
<b>2</b>	<b>Sheaves and Cosheaves on CW-Complexes</b>	<b>38</b>
2.1	CW-Complexes . . . . .	38
2.2	Cellular Sheaves and Cosheaves . . . . .	49
2.3	Cellular Homology and Cohomology . . . . .	54
2.4	Products in Cellular Cohomology . . . . .	62
2.5	A Theorem of the Poincaré-Lefschetz Type . . . . .	68
<b>3</b>	<b>Tropical Homology of Subdivided Polytopes</b>	<b>75</b>
3.1	Hodge Theory in Tropical Toric Geometry . . . . .	75
3.2	Lefschetz Theorem for Tropical Toric Varieties . . . . .	86
3.3	Generating Family for the Tropical Homology . . . . .	100
<b>4</b>	<b>T-Hypersurfaces</b>	<b>104</b>
4.1	Construction of T-Hypersurfaces . . . . .	105
4.2	Renaudineau-Shaw Spectral Sequence . . . . .	108
4.3	Degeneracy for a Family of Triangulations . . . . .	130
<b>5</b>	<b>The First Page of the Spectral Sequence</b>	<b>140</b>
5.1	Differential Geometry of Primitive Complexes . . . . .	140
5.2	Boundaries of the First Page . . . . .	149
5.3	The First and Last Boundaries . . . . .	165
5.4	Examples and Non-Examples . . . . .	189
<b>A</b>	<b>Duality in Spectral Sequences</b>	<b>195</b>
	<b>Index</b>	<b>206</b>



# Chapter 1

## Introduction

L'objet de cette présente thèse est l'étude topologique des T-hypersurfaces des variétés toriques. Ces objets, dérivés des travaux d'O. Viro, se situent à la confluence de la géométrie algébrique réelle, de la topologie algébrique et de la géométrie tropicale. Elles sont nées de la méthode, dite de *Patchwork*, d'O. Viro qui répond à un besoin de construction d'hypersurfaces algébriques réelles ayant une topologie riche. Le point de départ dans notre étude des T-hypersurfaces est la suite spectrale<sup>1</sup> d'A. Renaudineau et K. Shaw. Cette suite spectrale calcule l'homologie à coefficients dans le corps à deux éléments d'une T-hypersurface. Sa première page est isomorphe à l'homologie tropicale<sup>2</sup> de l'hypersurface duale à la triangulation à partir de laquelle est construite la T-hypersurface. C'est d'ailleurs comme ceci qu'A. Renaudineau et K. Shaw démontrèrent leurs inégalités<sup>3</sup> sur les nombres de Betti individuels des T-hypersurfaces. Il s'agit alors pour nous d'essayer d'aller plus loin dans cette suite spectrale. La première page contient un unique complexe de chaînes non trivial. Ce complexe médian fait l'objet du cinquième chapitre de cette thèse. Seules les pages suivantes d'indice ayant la même parité que la dimension de la variété torique ambiante peuvent a priori posséder des opérateurs de bord non-triviaux. Il a été conjecturé que la suite spectrale dégénère à la deuxième page. Cette conjecture impliquerait que l'intégralité de l'information homologique de la T-hypersurface serait concentrée dans le complexe médian de sa première page. Dans le quatrième chapitre nous démontrons plusieurs résultats allant dans le sens de cette conjecture. Nous y établissons un lien entre la dégénérescence de la suite spectrale de Renaudineau-Shaw et la surjectivité d'applications induites en homologie par l'inclusion de la T-hypersurface dans sa variété torique. Le critère de dégénérescence que nous en tirons nous permet de conclure que la suite spectrale dégénère à la deuxième page dans certains cas. Par exemple, cette dégénérescence a toujours lieu à la seconde page pour les T-hypersurfaces de degré impair de l'espace projectif. Nous étendons même ce résultat aux T-hypersurfaces de degré pair construites sur certaines triangulations. Le troisième chapitre traite de l'homologie tropicale des hypersurfaces duales aux subdivisions de polytopes. Nous y établissons une généralisation du

---

<sup>1</sup>c.f. [RS23].

<sup>2</sup>c.f. [IKMZ19].

<sup>3</sup>c.f. [RS23].

théorème de Lefschetz<sup>4</sup> tropical. De cette généralisation nous déduisons une famille (quasi)-génératrice de l'homologie tropicale de l'hypersurface duale à la triangulation. Cette famille génératrice nous permet, dans le cinquième chapitre, d'insérer le complexe médian de la suite spectrale de Renaudineau-Shaw dans une suite exactes de complexes. En particulier, ceci nous permet d'en calculer les opérateurs de bord. Ces calculs nous mènent à une généralisation du théorème de B. Haas. Cette généralisation nous permet de mettre à jour une propriété géométrique que la triangulation doit nécessairement satisfaire pour pouvoir posséder une distribution de signes dont la T-hypersurface possède un nombre maximale de composantes connexes au sens des inégalités de Renaudineau-Shaw. Les triangulations satisfaisant cette propriété possèdent un classe d'homologie canonique  $\rho$  à valeurs dans un cofaisceau particulier. Trouver les distributions de signes  $\varepsilon$  dont la T-hypersurface associée a un nombre maximal de composantes connexes revient alors à déterminer les solutions d'un système différentiel discret. Ce système est constitué d'une E.D.O.  $D^2\varepsilon = \rho$  qui doit être satisfaite à « l'intérieur » de la triangulation et « d'équations au bord ». Il est intéressant de noter que toutes les triangulations bidimensionnelles satisfont notre propriété géométrique. Dans ce cas l'équation  $D^2\varepsilon = \rho$  et même bien définie sur la totalité de la triangulation. Les solutions de cette équation renforcée sont les distributions de signes quadratiques et les T-courbes associées sont précisément les courbes de Harnack simples.

Dans cette introduction nous présentons quelques points des différentes théories dans lesquelles s'inscrivent nos objets d'étude. Dans une première partie nous donnerons quelques points sur la topologie des variétés algébriques réelles. L'article *Topological Properties of Real Algebraic Varieties: Du Cote de chez Rokhlin*, par V. Kharlamov et A. Degtyarev, [DK99], donne un très large panorama de ces dernières. Nous évoquerons le théorème de Bézout ainsi que les inégalités de Harnack et Smith-Thom. Ensuite nous présenterons les variétés toriques, en insistant sur celles qui sont projectives. Puis nous introduirons la géométrie tropicale par l'intermédiaire des amibes. Enfin nous conclurons cette introduction par l'énoncé du théorème de *Patchwork* de Viro, la définition des T-hypersurfaces ainsi que le plan des chapitres suivants.

## 1.1 Géométrie Algébrique Réelle Projective

**Définition 1.1.1** (Espace projectif). Soit  $K$  un corps et  $n$  un entier naturel. L'espace projectif sur  $K$  de dimension  $n$ , noté  $\mathbb{P}^n(K)$ , est l'ensemble des droites vectorielles de l'espace  $K^{n+1}$ . En d'autres termes, il consiste en l'espace des orbites de l'action homothétique du groupe multiplicatif  $K^\times$  sur l'ensemble  $K^{n+1} \setminus \{0\}$ . Ainsi, chaque point de l'espace  $\mathbb{P}^n(K)$  est représenté par un  $(n+1)$ -uplet de nombres défini à un facteur multiplicatif non-nul près. Si  $p$  est l'image de  $(x_0, \dots, x_n) \in K^{n+1}$  dans  $\mathbb{P}^n(K)$ , on note  $p = (x_0 : \dots : x_n)$  et on dit que  $(x_0, \dots, x_n)$  sont des coordonnées homogènes de  $p$ . Lorsque  $K$  est un corps topologique, l'espace projectif  $\mathbb{P}^n(K)$  est

---

<sup>4</sup>c.f. [ARS21].

naturellement muni de la topologie quotient. Une extension de corps  $K \rightarrow L$  induit une inclusion de  $\mathbb{P}^n(K)$  dans  $\mathbb{P}^n(L)$ .

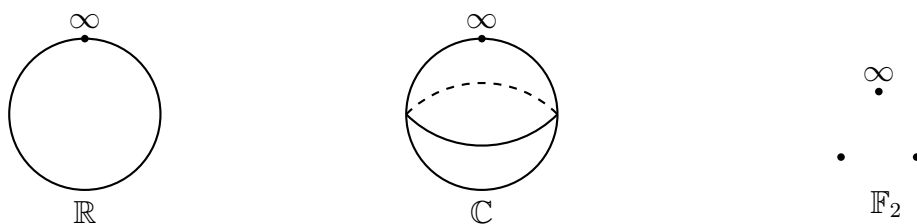

(a) La droite projective réelle. (b) La droite projective complexe (ou sphère de Riemann). (c) La droite projective du corps à deux éléments.

Figure 1.1: Les droites projectives de trois corps.

Lorsque  $n$  est au moins égal à 1, l'ensemble  $K^{n+1} \setminus \{0\}$  s'écrit toujours comme l'union disjointe des ensembles  $(K^n \times \{0\}) \setminus \{0\}$  et  $K^n \times K^\times$ , tous deux stables pour l'action de  $K^\times$ . Le quotient de  $K^n \times K^\times$  par l'action de  $K^\times$  est canoniquement en bijection avec l'espace affine  $K^n$ . Ainsi, pour tout entier naturel  $n$ , l'espace projectif de dimension  $(n + 1)$  s'écrit comme l'union disjointe de l'espace affine de dimension  $(n + 1)$  et de l'espace projectif de dimension  $n$ . Cet espace projectif de codimension 1 est traditionnellement nommé l'hyperplan à l'infini, de sorte que l'espace projectif puisse se décrire comme l'adjonction d'un hyperplan à l'infini à un espace affine. Lorsque  $K$  est le corps des réels ou des complexes, munis de leur topologie euclidienne, cette adjonction résulte en une compactification de l'espace affine. La Figure 1.1 dépeint les droites projectives associées aux corps de réels, des complexes, et au corps à deux éléments. La procédure découpant l'espace projectif en un espace affine et un hyperplan à l'infini peut être répétée. Cette répétition nous permet d'écrire, pour tout entier naturel  $n$ , la formule suivante :

$$\mathbb{P}^n(K) = K^n \amalg K^{n-1} \amalg \dots \amalg K \amalg K^0, \quad (1.1)$$

où  $K^0$  désigne un point unique. Soit  $p$  un entier naturel. Chaque sous-espace vectoriel  $V \subset K^{n+1}$  de dimension  $p + 1$  définit un sous-ensemble  $\mathbb{P}(V)$  de  $\mathbb{P}^n(K)$ , isomorphe à  $\mathbb{P}^p(K)$ . On appelle de tels sous-ensembles des *sous-espaces projectifs* de  $\mathbb{P}^n(K)$ . L'action du groupe linéaire  $\mathrm{GL}_{n+1}(K)$  sur  $K^{n+1}$  descend en une action sur l'espace projectif  $\mathbb{P}^n(K)$  dont le noyau est constitué des homothéties. Ainsi, le groupe projectif  $\mathrm{PGL}_{n+1}(K)$ , quotient de  $\mathrm{GL}_{n+1}(K)$  par  $K^\times$ , agit fidèlement sur l'espace projectif. Cette action preserve les sous-espaces projectifs de  $\mathbb{P}^n(K)$  et est même transitive sur les ensemble de sous-espaces projectifs de même dimension.

Chaque point de l'espace projectif réel  $\mathbb{P}^n(\mathbb{R})$  admet exactement deux relevés dans la sphère unité  $S^n$  de  $\mathbb{R}^{n+1}$ . Ces deux relevés sont antipodaux, et  $\mathbb{P}^n(\mathbb{R})$  se réalise comme le quotient de  $S^n$  par l'action de  $\mathbb{Z}/2\mathbb{Z}$  par l'involution antipodale  $[x \mapsto -x]$ . Cette représentation muni naturellement  $\mathbb{P}^n(\mathbb{R})$  d'une structure de variété différentielle compacte de dimension  $n$ . De plus, l'homéomorphisme  $[x \mapsto -x]$  de  $S^n$



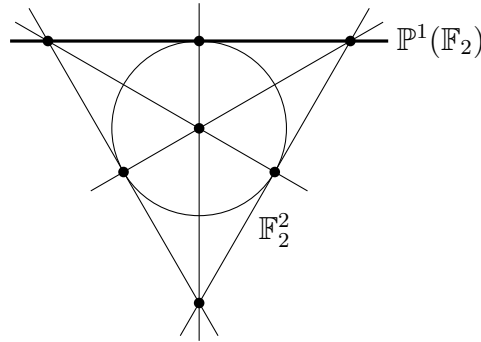

Figure 1.2: Les sept droites de  $\mathbb{P}^2(\mathbb{F}_2)$ , la droite à l'infini est en gras.

préserve l'orientation de cette dernière si et seulement si  $n$  est impair. Il en résulte que  $\mathbb{P}^n(\mathbb{R})$  est orientable si et seulement si  $n$  est impair. La projection quotient  $\pi : S^n \rightarrow \mathbb{P}^n(\mathbb{R})$  est un revêtement double et comme  $S^n$  est simplement connexe pour  $n \geq 2$ , il s'agit dans ce cas du revêtement universel de l'espace projectif réel. L'image par  $\pi$  d'un seul hémisphère de  $S^n$  suffit à recouvrir  $\mathbb{P}^n(\mathbb{R})$ . On peut ainsi voir  $\mathbb{P}^n(\mathbb{R})$  comme une boule fermée dont on a identifié les points antipodaux de son bord. On utilisera souvent cette représentation. La décomposition (1.1) appliquée à l'espace projectif réel en fournit une décomposition cellulaire. Les opérateurs de bord du complexe cellulaire associée sont tous divisibles par deux. Ainsi on en déduit que les nombres de Betti à coefficients  $\mathbb{F}_2$  de  $\mathbb{P}^n(\mathbb{R})$  valent 1 en dimensions inférieures à  $n$  et 0 sinon. On peut même montrer que l'anneau de cohomologie de  $\mathbb{P}^n(\mathbb{R})$  est isomorphe à  $\mathbb{F}_2[h] / (h^{n+1})$ , où  $h$  est la classe duale de Poincaré de l'hyperplan à l'infini. En utilisant l'action de  $\mathrm{PGL}_{n+1}(\mathbb{R})$ ,  $h$  est même la classe duale de n'importe quel hyperplan projectif.

La décomposition (1.1) permet également de montrer que l'anneau de cohomologie à coefficients entiers de  $\mathbb{P}^n(\mathbb{C})$  est isomorphe à l'anneau  $\mathbb{Z}[h] / (h^{n+1})$ , où  $h$  a dimension 2 et est la classe duale de Poincaré de n'importe quel hyperplan projectif de  $\mathbb{P}^n(\mathbb{C})$ . La conjugaison complexe, induit une involution antiholomorphe de la variété complexe  $\mathbb{P}^n(\mathbb{C})$ . Son lieu fixe est  $\mathbb{P}^n(\mathbb{R})$ .

**Courbes réelles planes.** Dans ce qui suit on se concentre sur les corps des réels et des complexes.

**Définition 1.1.2** (Polynômes Homogènes). Un polynôme  $F \in K[X, Y, Z]$  est homogène de degré  $d \in \mathbb{N}$ , si pour tout nombre  $\lambda \in K$ , le polynôme  $F(\lambda X, \lambda Y, \lambda Z)$  est égal au polynôme  $\lambda^d F(X, Y, Z)$ . Pour un tel polynôme  $F$  il existe des nombres  $f_{a,b,c} \in K$ , pour tout  $a, b, c \in \mathbb{N}$  tels que  $a + b + c = d$ , satisfaisant :

$$F = \sum_{a+b+c=d} f_{a,b,c} X^a Y^b Z^c .$$

**Définition 1.1.3** (Courbes Planes). Pour tout polynôme homogène  $F$  de  $K[X, Y, Z]$  et toute extension  $L$  de  $K$ , on définit la courbe d'équation  $F$  dans  $\mathbb{P}^2(L)$  comme étant l'ensemble des points  $p$  de  $\mathbb{P}^2(L)$  pour lesquels  $F(x, y, z)$  s'annule pour tous

choix de coordonnées homogènes  $(x : y : z)$  de  $p$ . On note cet ensemble  $C_F(L)$ . On définit la courbe associée à  $F$  comme le foncteur  $C_F : L \mapsto C_F(L)$ . On identifie ainsi la courbe au foncteur des points de son schéma.

La Figure 1.3 représente quelques courbes algébriques de  $\mathbb{P}^2(\mathbb{R})$ . On remarquera que la droite à l'infinie a pour equation  $Z = 0$ .

On définit une courbe réelle plane comme la courbe associée à un polynôme homogène réel  $F \in \mathbb{R}[X, Y, Z]$ . On dit que  $C_F$  est irréductible dès que  $F$  l'est. On dit que la courbe  $C_F$  est non-singulière lorsque  $C_F(\mathbb{C})$  est une sous-variété différentielle de  $\mathbb{P}^2(\mathbb{C})$ . Cela implique en particulier que  $C_F(\mathbb{R})$  est également une sous-variété différentielle de  $\mathbb{P}^2(\mathbb{R})$ . Ainsi  $C_F(\mathbb{R})$  est constituée d'une union disjointe de cercles plongés dans  $\mathbb{P}^2(\mathbb{R})$ . D'un point de vue homologique, le cercle peut être plongé de deux manières dans  $\mathbb{P}^2(\mathbb{R})$ . Lorsque l'image de la classe fondamentale du cercle s'annule dans l'homologie de  $\mathbb{P}^2(\mathbb{R})$ , on dit que ce cercle plongé est un oval de  $\mathbb{P}^2(\mathbb{R})$ . Dans le cas contraire on dit que le cercle est une pseudo-droite. Un oval déconnecte le plan projectif réel en deux parties, l'une d'entre elles est un disque et l'autre un ruban de Möbius. Une pseudo-droite est homologue à une droite projective et son complémentaire est connexe. C'est un disque. On dit qu'un oval  $O_1$  est contenu dans un oval  $O_2$  s'il est contenu dans la composante connexe contractile du complémentaire de  $O_2$ . Un peu d'homologie permet de montrer que si  $C_F$  est une courbe réelle non-singulière, alors  $C_F(\mathbb{R})$  est uniquement constitué d'ovals (possiblement aucun) lorsque le degré de  $F$  est pair et d'exactlyement une pseudo-droite, éventuellement accompagnée d'ovals, lorsque le degré de  $F$  est impair. Le seizième problème de Hilbert consiste en partie à caractériser les arrangements d'ovals et pseudo-droite que l'on peut obtenir à partir de courbes réelles d'un certain degré. Ou encore, en suivant la reformulation de G. Wilson<sup>5</sup>, à caractériser les ensembles ordonnés réalisables comme ensembles d'ovals de courbes réelles. L'inégalité de Harnack donne une borne supérieure optimale du nombre de composantes connexes de  $C_F(\mathbb{R})$ . La preuve d'A. Harnack repose sur le théorème de Bézout.

**Théorème de Bézout** Considérons  $F, G \in \mathbb{C}[X; Y; Z]$  deux polynômes complexes homogènes.

**Définition 1.1.4** (Nombres d'intersection. [Ful08], §3.3 Intersec. Numb. pp.36-41). On pose  $A$  le localisé de l'anneau  $\mathbb{C}[X; Y]$  en l'idéal maximal  $(X, Y)$ . Il s'agit des fractions rationnelles de  $\mathbb{C}(X; Y)$  dont le dénominateur n'appartient pas à l'idéal  $(X, Y)$ . Soit  $p$  un point de  $C_F(\mathbb{C}) \cap C_G(\mathbb{C})$  et  $g$  un élément de  $GL_3(\mathbb{C})$  qui envoie  $p$  sur  $(0 : 0 : 1)$ . Le nombre :

$$I_p(F \cap G) := \dim A \Big/ (F(g(X; Y; 1)), G(g(X; Y; 1))) \in [1; +\infty],$$

ne dépend pas du choix de  $g$ , et est fini dès que  $C_F(\mathbb{C})$  et  $C_G(\mathbb{C})$  ne possèdent pas de composante irréductible commune passant par  $p$ . On l'appelle le nombre

---

<sup>5</sup>c.f. [Wil78], p.54.

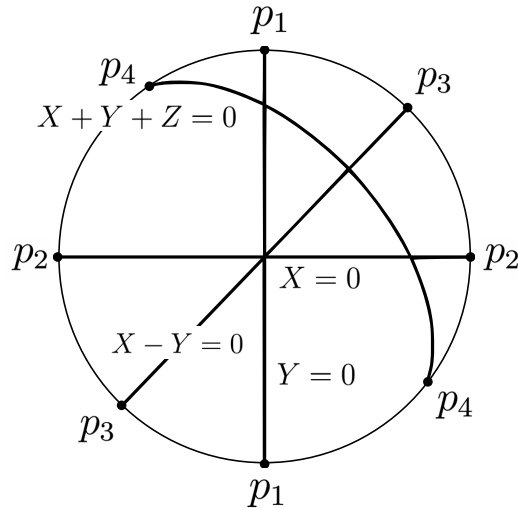

(a) Quatre droites projectives réelles.

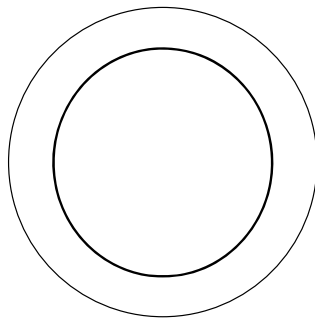

(b) La conique d'équation  $X^2 + Y^2 = Z^2$ .

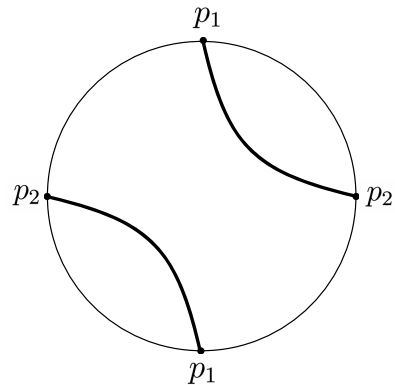

(c) La conique d'équation  $XY = \frac{1}{9}Z^2$ .

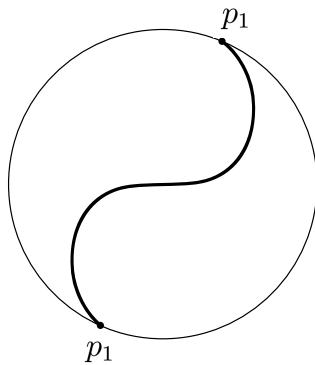

(d) La cubique d'équation  $YZ^2 = X^3$ .

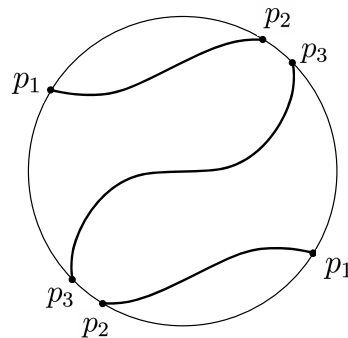

(e) La cubique d'équation  $YZ^2 = X^3 - 2XY^2 + Y^3$ .

Figure 1.3: Quelques courbes algébriques de  $\mathbb{P}^2(\mathbb{R})$ .

d'intersection de  $C_F$  et  $C_G$  en  $p$ . Il vaut 1 dès que  $C_F$  et  $C_G$  sont non-singulières et que leur lieux complexes s'intersectent transversalement en  $p$ .

**Théorème 1.1.5** (Théorème de Bézout. [Ful08], Bézout's Theorem p.57). *Pour tous polynômes homogènes complexes  $F, G \in \mathbb{C}[X; Y; Z]$ , sans facteur irréductible*

commun, l'ensemble  $C_F(\mathbb{C}) \cap C_G(\mathbb{C})$  est fini. De plus on a :

$$\sum_{p \in C_F(\mathbb{C}) \cap C_G(\mathbb{C})} I_p(P \cap Q) = \deg F \cdot \deg G.$$

En particulier on en déduit que si  $F$  et  $G$  sont à coefficients réels et ne possèdent pas de composante irréductible commune alors  $C_F(\mathbb{R}) \cap C_G(\mathbb{R})$  possède au plus  $\deg F \cdot \deg G$  éléments. Si  $G$  est de degré 1, alors  $C_G(\mathbb{R})$  est une droite projective et  $C_F(\mathbb{R})$  ne peut couper cette droite qu'en  $\deg F$  points, comptés avec multiplicité. Ce cas particulier du théorème de Bézout est un écho du fait qu'un polynôme réel non nul ne peut avoir plus de racines que son degré. Un corollaire directe du théorème de Bézout permet de proscrire certaines configurations d'ovales comme réalisables par des courbes réelles. Un nid d'une configuration d'ovales est une chaîne totalement ordonnée d'ovales. La profondeur d'un nid est le nombre d'ovales qu'il contient.

**Théorème 1.1.6** (D. Hilbert, [Wil78], Theorem 1.2 p.54). *La profondeur d'un nid d'ovales d'une courbe réelle de degré  $d$  ne peut excéder  $\lfloor \frac{d}{2} \rfloor$ . De même si une courbe réelle de degré  $d$  possède deux nids alors la somme de leurs profondeurs ne peut excéder  $\lfloor \frac{d}{2} \rfloor$ .*

**Inégalité de Harnack.** A. Harnack utilisa le théorème de Bézout de concert avec la propriété qu'il passe toujours une courbe de degré  $d \geq 1$  par  $\binom{d+2}{2} - 1$  points, afin de montrer l'inégalité suivante :

**Théorème 1.1.7** (Inégalité de Harnack. A. Harnack, [Har76]). *Une courbe réelle plane non-singulière de degré  $d$  ne peut avoir plus de  $1 + \frac{(d-1)(d-2)}{2}$  composantes connexes. De plus, cette borne est optimale. Lorsqu'une courbe réelle atteint cette borne on dit qu'elle est maximale.*

Il démontra l'optimalité en construisant par induction une suite de courbes maximales en perturbant des courbes singulières. Cette inégalité, le théorème de Bézout, ainsi que la méthode de construction par perturbations suffisent à répondre au problème de Hilbert jusqu'au degré 5. L'allure des arrangements de courbes réalisables en degré inférieur à 5 est décrite dans la Figure 1.4. Les arrangements des courbes de degré 6 et 7 ont aussi été caractérisés, cependant cette caractérisation demande des techniques plus avancées. C'est en particulier O. Viro qui classifia ces arrangements en degré 7. Pour ce faire il utilisa sa méthode de *Patchwork* que nous évoquerons plus loin.

L'espace des courbes de degré  $d$  forme un espace projectif de dimension  $\binom{d+2}{2} - 1$ , le projectivisé de l'espace vectoriel des polynômes homogènes de degré  $d$ . Dans cet espace le déterminant est l'hypersurface formée par toutes les courbes singulières. Ainsi l'espace des courbes complexes non-singulières est connexe et le premier lemme d'isotopie de Thom<sup>6</sup> nous assure que pour deux courbes non-singulières  $C_F$  et  $C_G$ , leur lieux complexes  $C_F(\mathbb{C})$  et  $C_G(\mathbb{C})$  sont homéomorphes. Ce sont des variétés

<sup>6</sup>c.f. [Tho69], Théorème 1.G.1 p.258, ou [Mat12], Proposition 11.1 p.499.

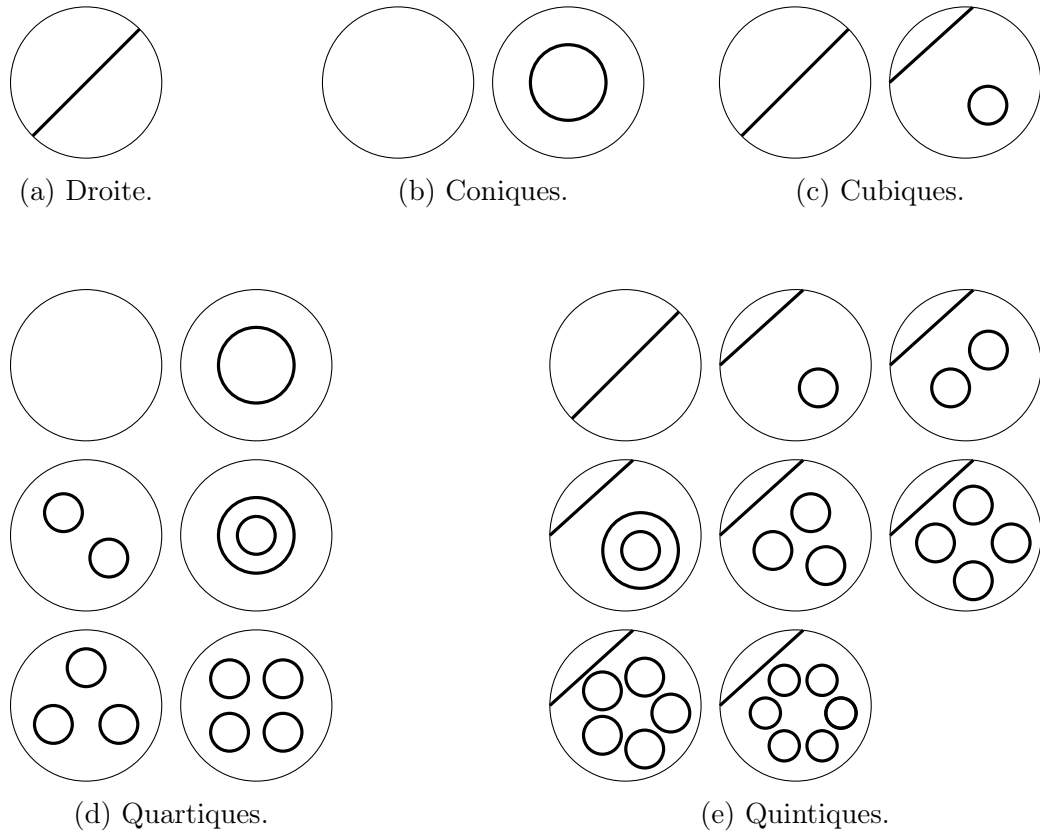

Figure 1.4: Allure des arrangements de courbes réalisables jusqu'au degré 5.

différentielles complexes de dimension 1 et donc des surfaces orientables. Leur genre  $g(C_F(\mathbb{C}))$ , la moitié de leur premier nombre de Betti, ne dépend que de leur degré et les caractérise topologiquement. La formule d'adjonction et le théorème de Riemann-Roch permettent de calculer que  $g(C_F(\mathbb{C}))$  vaut  $\frac{1}{2}(\deg F - 1)(\deg F - 2)$ . Ainsi, l'inégalité d'Harnack énonce que le nombre de composantes connexes de  $C_F(\mathbb{R})$  est inférieur à 1 plus le genre de  $C_F(\mathbb{C})$ . F. Klein donna une autre preuve<sup>7</sup> de l'inégalité de Harnack utilisant cette interprétation du nombre  $\frac{(d-1)(d-2)}{2}$ . Sa démonstration se base sur l'inclusion de  $C_F(\mathbb{R})$  dans  $C_F(\mathbb{C})$ . Dans cet ordre d'idées, l'inégalité de Smith-Thom permet de généraliser l'inégalité de Harnack aux variétés algébriques réelles de plus grande dimension.

**Inégalité de Smith-Thom.** L'inégalité de Smith-Thom est un théorème général sur la topologie des lieux fixes d'involutions.

**Théorème 1.1.8** (Inégalité de Smith-Thom. [DK99], Theorem A.1.1 et Corollary A.1.3 p.59). *Soit  $X$  la réalisation géométrique d'un complexe simplicial muni d'une involution simpliciale  $\sigma$ , on note  $F$  le lieu fixe de  $\sigma$ . Si l'homologie totale de  $X$  à coefficients dans  $\mathbb{F}_2$  est de dimension finie, on a l'inégalité suivante :*

$$\sum_{q \in \mathbb{N}} \dim H_q(F; \mathbb{F}_2) \leq \sum_{q \in \mathbb{N}} \dim H_q(X; \mathbb{F}_2),$$

<sup>7</sup>c.f. [Kle73].

et le nombre  $\sum_{q \in \mathbb{N}} \dim H_q(F; \mathbb{F}_2)$  a la même parité que  $\sum_{q \in \mathbb{N}} \dim H_q(X; \mathbb{F}_2)$ .

Lorsque  $X$  est une variété algébrique réelle projective, son lieu complexe est muni d'une involution canonique : la conjugaison complexe. Son lieu réel correspond alors au lieu fixe de cette involution et l'inégalité de Smith-Thom se réécrit sous la forme suivante :

$$\sum_{q \in \mathbb{N}} \dim H_q(X(\mathbb{R}); \mathbb{F}_2) \leq \sum_{q \in \mathbb{N}} \dim H_q(X(\mathbb{C}); \mathbb{F}_2). \quad (1.2)$$

Dans le cas des courbes non-singulières (1.2) se spécialise en l'inégalité suivante :

$$2 \dim H_0(C_F(\mathbb{R}); \mathbb{F}_2) \leq 2 + 2g(C_F(\mathbb{C})).$$

On retrouve bien l'inégalité de Harnack. Une variété  $X$  pour laquelle (1.2) est une égalité est appelée une *variété maximale* ou *M-variété*. De manière générale on dit que  $X$  est une  $(M - k)$ -variété lorsque le nombre de Betti total de son lieu complexe  $\sum_{q \in \mathbb{N}} \dim H_q(X(\mathbb{C}); \mathbb{F}_2)$  est  $2k$  unités supérieur au nombre de Betti total de son lieu réel  $\sum_{q \in \mathbb{N}} \dim H_q(X(\mathbb{R}); \mathbb{F}_2)$ .

## 1.2 Variétés Toriques Projectives

Les espaces projectifs font partie de la famille des variétés toriques, on donne ici leur définition ainsi que certaines propriétés que ces dernières satisfont.

**Définition 1.2.1.** Soit  $K$  un corps. Pour tout monoïde abélien  $(S; +)$ , on note  $K[S]$  l'algèbre associée. Cette algèbre est librement engendrée par les éléments de  $S$  en tant qu'espace vectoriel. Pour tout  $s \in S$ , on note  $x^s$  le générateur associé. La multiplication de  $K[S]$  est définie par les formules  $x^s x^{s'} = x^{s+s'}$  pour tous  $s, s' \in S$ .

**Définition 1.2.2** (Tore algébrique réel). Un tore algébrique réel est un groupe algébrique réel  $T$  isomorphe au produit  $GL_1 \times_{\mathbb{R}} \dots \times_{\mathbb{R}} GL_1$  où  $GL_1$  est le groupe  $\text{Spec}(\mathbb{R}[\mathbb{Z}])$ .

En d'autres termes un tore algébrique réel  $T$  est isomorphe à  $\text{Spec}(\mathbb{R}[\mathbb{Z}^n])$  pour un certain entier  $n \in \mathbb{N}$ , appelé *dimension* de  $T$ . Le groupe  $\mathfrak{t}(\mathbb{Z})$  des sous-groupes à un paramètre de  $T$ ,  $\text{Hom}_{\text{Grp. Alg.}}(GL_1; T)$ , est un groupe abélien libre. Son groupe dual  $\mathfrak{t}^*(\mathbb{Z}) := \text{Hom}(\mathfrak{t}(\mathbb{Z}); \mathbb{Z})$  est naturellement isomorphe à  $\text{Hom}_{\text{Grp. Alg.}}(T; GL_1)$ , le groupe des caractères de  $T$ . De plus,  $T$  est naturellement isomorphe à  $\text{Spec}(\mathbb{R}[\mathfrak{t}^*(\mathbb{Z})])$ , et  $\mathfrak{t}^*(\mathbb{Z})$  est de rang  $n$ . Si  $K$  est une extension de  $\mathbb{R}$ , le groupe des  $K$ -points de  $T$  est naturellement isomorphe à  $\text{Hom}(\mathfrak{t}^*(\mathbb{Z}); K^\times)$ . Lorsque  $K$  est le corps des réels ou des complexes,  $T(K)$  est un groupe de Lie dont l'algèbre est donnée par  $\mathfrak{t}(K) := \mathfrak{t}(\mathbb{Z}) \otimes K$ .

**Définition 1.2.3** ([KKMSD73], Lemma 1 p.5). Soit  $T$  un tore réel de dimension  $n$ . Soit  $S \subset \mathfrak{t}^*(\mathbb{Z})$  un sous-monoïde saturé<sup>8</sup>, finiment engendré, et qui engendre  $\mathfrak{t}^*(\mathbb{Z})$  en tant que groupe. Une *variété torique affine normale*  $Y$  de tore  $T$  est une variété affine de la forme  $\text{Spec}(\mathbb{R}[S])$ . Une telle variété est équipée d'une immersion ouverte

<sup>8</sup>i.e. tel que  $n\alpha \in S$  implique  $\alpha \in S$  pour tout entier  $n \in \mathbb{Z}$ .

$T \rightarrow Y$  et d'une action  $T \times_{\mathbb{R}} Y \rightarrow Y$  qui étend l'action par translations de  $T$  sur lui-même.

**Définition 1.2.4.** Une partie  $C \subset \mathfrak{t}(\mathbb{R})$  est appelée un *cône polyédral rationnel* si elle est de la forme suivante :

$$C = \left\{ \sum_{i=1}^k \lambda_i v_i : \lambda_1, \dots, \lambda_k \in \mathbb{R}_+ \right\},$$

où les  $v_i$  sont des vecteurs de  $\mathfrak{t}(\mathbb{Q})$ . On dit que  $C$  est *fortement convexe* si l'unique sous-espace vectoriel qu'il contient est l'origine  $\{0\}$ . Un *hyperplan d'appuie*  $H$  de  $C$  est un hyperplan de la forme  $\ker(\alpha)$  où  $\alpha \in \mathfrak{t}^*(\mathbb{R})$  est une forme dont la restriction à  $C$  est positive. Une *face* de  $C$  est l'intersection de ce dernier avec un hyperplan d'appuie. C'est encore un cône polyédral, il est fortement convexe si et seulement si  $C$  l'est. Le *dual*  $C^+$  de  $C$  est l'ensemble des formes  $\alpha \in \mathfrak{t}^*(\mathbb{R})$  positives sur  $C$ . C'est un cône polyédral rationnel de  $\mathfrak{t}^*(\mathbb{R})$ . Il engendre  $\mathfrak{t}^*(\mathbb{R})$  si et seulement si  $C$  est fortement convexe. De plus  $C^+ \cap \mathfrak{t}^*(\mathbb{Z})$  est un monoïde saturé et finiment engendré de  $\mathfrak{t}^*(\mathbb{Z})$ . Un tel monoïde est toujours de cette forme<sup>9</sup>.

Une variété torique affine normale  $Y$  de tore  $T$  est donc nécessairement de la forme  $Y_C := \text{Spec}(\mathbb{R}[C^+ \cap \mathfrak{t}^*(\mathbb{Z})])$ , où  $C$  est un cône polyédral rationnel fortement convexe de  $\mathfrak{t}(\mathbb{R})$ . Si  $K$  est le corps des nombres réels ou complexes,  $Y_C(K)$  est homéomorphe à l'espace des morphismes de monoïdes de  $C^+ \cap \mathfrak{t}^*(\mathbb{Z})$  dans le monoïde multiplicatif  $(K; \times)$ . Le monoïde  $C^+ \cap \mathfrak{t}^*(\mathbb{Z})$  est finiment présenté. On peut l'écrire multiplicativement comme ayant  $N \in \mathbb{N}$  générateurs  $X_1, \dots, X_N$  qui commutent et qui observant  $l \in \mathbb{N}$  relations  $\prod_{i=1}^N X_i^{a_{i,j}} = \prod_{i=1}^N X_i^{b_{i,j}}$ , où  $j$  appartient à  $\{1, \dots, l\}$  et les  $a_{i,j}, b_{i,j}$  sont des entiers naturels. Ainsi  $Y_C$  est isomorphe à la sous-variété de l'espace affine  $\mathbb{A}_{\mathbb{R}}^k$  définie par les équations polynomiales  $\prod_{i=1}^N X_j^{a_{i,j}} = \prod_{i=1}^N X_j^{b_{i,j}}$ , pour tout  $j \in \{1, \dots, l\}$ . La Figure 1.5 représente comment obtenir le plan affine comme une variété torique affine. La Figure 1.6, quant à elle, représente comment obtenir le cône quadratique  $X_3^2 = X_1 X_2$  comme une variété torique affine.

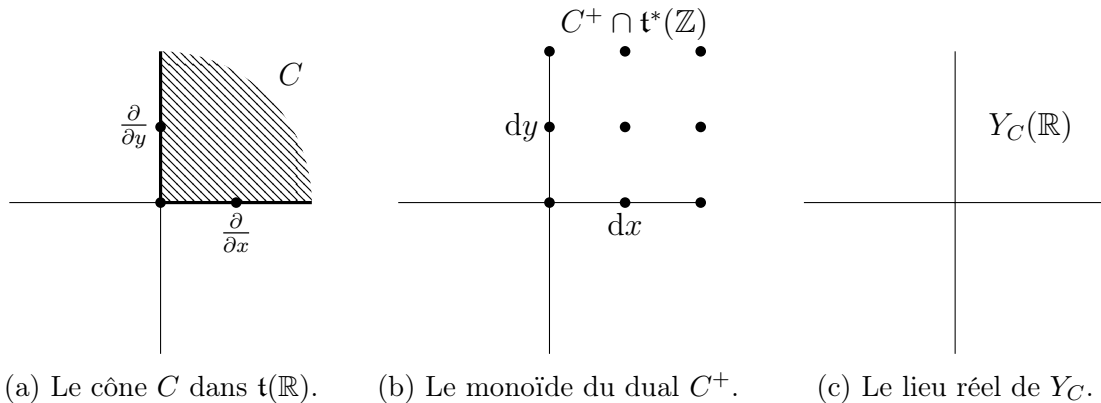

Figure 1.5: Le plan affine comme variété torique affine.

<sup>9</sup>c.f. [KKMSD73], Lemma 2 p.7.

Lorsque  $C$  est un cône tout élément  $\alpha \in C^+ \cap \mathfrak{t}^*(\mathbb{Z})$  définit une fonction régulière  $x^\alpha$  sur  $Y_C$ . Si  $x$  est un point de  $Y_C(K)$ , où  $K$  est une extension de  $\mathbb{R}$ , on note  $x^\alpha \in K$  l'image de  $x$  par  $x^\alpha$ . Ces fonctions permettent de définir le *lieu positif* de  $Y_C(K)$ . Il est noté  $Y_C(\mathbb{R}_+)$  et correspond aux points  $x$  de  $Y_C(K)$  pour lesquels les nombres  $x^\alpha$  appartiennent tous à  $\mathbb{R}_+$ , pour tout  $\alpha \in C^+ \cap \mathfrak{t}^*(\mathbb{Z})$ . Cet espace est homéomorphe à l'espace des morphismes de monoïdes de  $C^+ \cap \mathfrak{t}^*(\mathbb{Z})$  vers  $(\mathbb{R}_+; \times)$ . Si  $K$  est le corps des nombres réels ou des nombres complexes, le module  $|\cdot| : K \rightarrow \mathbb{R}_+$  est une rétraction de l'injection du monoïde  $(\mathbb{R}_+; \times)$  dans  $(K; \times)$ . Ce morphisme de monoïde induit une rétraction continue de l'inclusion de l'espace  $Y_P(\mathbb{R}_+)$  dans  $Y_C(K)$ . On la note aussi par le symbole  $|\cdot|$ .

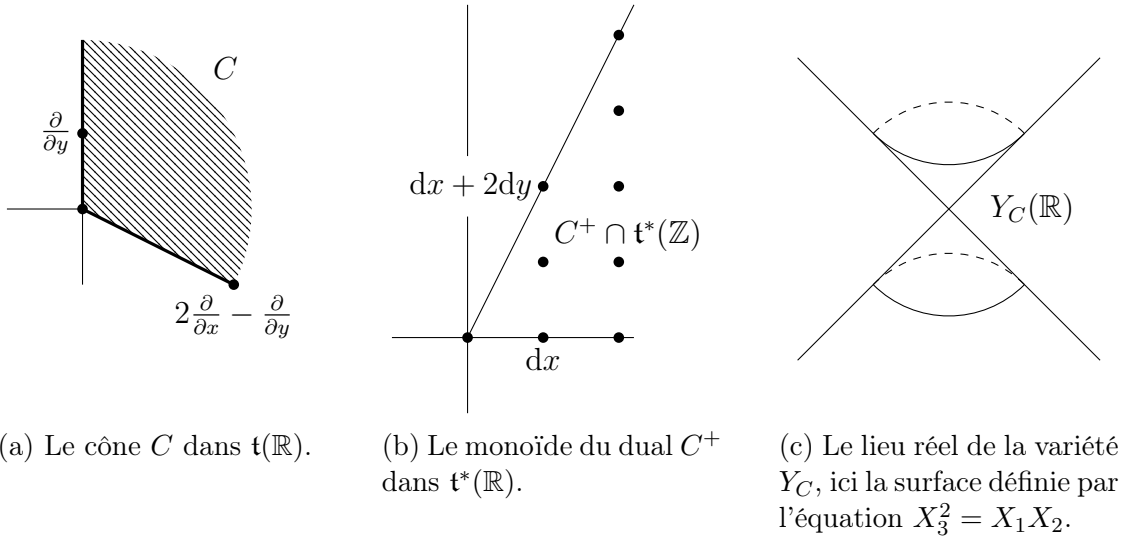

Figure 1.6: Une surface de l'espace affine réalisée comme variété torique affine.

**Définition 1.2.5.** Un cône polyhedral rationnel fortement convexe  $C$  de  $\mathfrak{t}(\mathbb{R})$  est dit *simplicial* s'il est engendré par les éléments d'une base de  $\mathfrak{t}(\mathbb{Q})$ . Si de plus ces éléments sont issus d'une base de  $\mathfrak{t}(\mathbb{Z})$  on dit que  $C$  est *non-singulier*. Un cône simplicial possède un sous-réseau distingué dans son espace tangent. Il s'agit de la somme des réseaux contenus dans ses rayons<sup>10</sup>.

**Théorème 1.2.6** ([Ful93], §2.1 Local Properties of Toric Varieties pp.28-31, et §2.2 Surfaces ; Quotient Singularities pp.31-36). *La variété torique affine  $Y_C$  est non-singulière si et seulement si  $C$  est non-singulier. Dans ce cas  $Y_C$  est isomorphe au produit d'un tore réel et d'un espace affine réel. Si  $C$  est seulement simplicial,  $Y_C \times_{\mathbb{R}} \mathbb{C}$  a une singularité quotient. Elle est le produit d'un tore complexe avec le quotient d'un espace affine  $\mathbb{A}_{\mathbb{C}}^k$  par l'action d'un groupe fini  $\Delta_C$ . Ce groupe est le quotient du réseau  $TC \cap \mathfrak{t}(\mathbb{Z})$  par son sous-réseau distingué.*

Considérons  $C$  un cône simplicial fortement convexe de dimension  $n$  et notons  $L$  le sous-réseau distingué de  $TC$ . On note  $L^*$  le réseaux dual dans  $\mathfrak{t}^*(\mathbb{R})$ . Ce dernier contient  $\mathfrak{t}^*(\mathbb{Z})$  et l'anneau  $\mathbb{C}[C^+ \cap \mathfrak{t}^*(\mathbb{Z})]$  est naturellement contenu dans

<sup>10</sup>Un rayon est un cône polyhedral fortement convexe de dimension 1.



l'anneau  $\mathbb{C}[C^+ \cap L^*]$ . Comme  $C$  est engendré par une base de  $L$ , ce dernier anneau  $\mathbb{C}[C^+ \cap L^*]$  est isomorphe à un anneau de polynômes à  $n$  indéterminées. Le groupe fini  $\Delta_C := \mathfrak{t}(\mathbb{Z})/L$  agit sur  $\mathbb{C}[C^+ \cap L^*]$  par morphisme d'algèbres de la manière suivante. Pour tout  $v \in \Delta_C$  et tout  $x^\alpha \in \mathbb{C}[C^+ \cap L^*]$ , on a :

$$v \cdot x^\alpha := e^{2i\pi\alpha(v)} x^\alpha.$$

L'anneau  $\mathbb{C}[C^+ \cap \mathfrak{t}^*(\mathbb{Z})]$  est le sous-anneaux des invariants de cette action. Ainsi,  $Y_C \times_{\mathbb{R}} \mathbb{C}$  est bien le quotient de  $\mathbb{A}_{\mathbb{C}}^n$  par l'action de  $\Delta_C$ . En général, si  $C$  est de dimension  $k < n$ ,  $Y_C \times_{\mathbb{R}} \mathbb{C}$  est un fibré trivial en tores algébriques au dessus d'un quotient d'un espace affine par le groupe  $\Delta_C$ . Si nous revenons au cas où  $C$  est de dimension maximale  $n$ . L'action de  $\Delta_C$  sur l'anneau  $\mathbb{C}[C^+ \cap L^*]$  préserve l'anneau  $\mathbb{R}[C^+ \cap L^*]$  si et seulement si  $L^*(\mathfrak{t}(\mathbb{Z}))$  est contenu dans  $\frac{1}{2}\mathbb{Z}$ . Dans ce cas  $Y_C$  est elle aussi le quotient de  $\mathbb{A}_{\mathbb{R}}^n$  par  $\Delta_C$ . L'exemple donné dans la Figure 1.6 est de cette espèce, l'application quotient envoie  $(u; v) \in \mathbb{C}^2$  sur  $(u^2; v^2; uv) \in \mathbb{C}^3$ . Il est à noter cependant que, bien que  $Y_C(\mathbb{C})$  soit toujours homéomorphe au quotient topologique de  $\mathbb{C}^n$  par  $\Delta_C$ ,  $Y_C(\mathbb{R})$  n'est en général pas le quotient de  $\mathbb{R}^n$  par  $\Delta_C$ . L'exemple de la Figure 1.6 illustre ce phénomène. Dans ce cas  $\Delta_C$  est isomorphe à  $\mathbb{Z}/2\mathbb{Z}$  et agit par multiplication par  $(-1)$  sur  $\mathbb{R}^2$ . Le quotient topologique obtenu consiste en une seule moitié de  $Y_P(\mathbb{R})$ . L'autre moitié est obtenue comme image de  $(i\mathbb{R})^2$  par l'application quotient  $\mathbb{C}^2 \rightarrow Y_C(\mathbb{C})$ . La variété  $Y_C$  est le quotient de  $\mathbb{A}_{\mathbb{R}}^n$  par  $\Delta_C$  au sens de la théorie géométrique des invariants.

En dimension 2 tous les cônes sont simpliciaux donc les singularités des surfaces toriques affines sont toujours du type quotient. À partir de la dimension 3 ça n'est plus le cas. Les singularités peuvent être plus compliquées. Si  $\mathfrak{t}(\mathbb{R})$  est l'espace  $\mathbb{R}^3$  muni de son réseau  $\mathbb{Z}^3$ , alors la variété torique cône défini par les quatre inéquations  $z \geq 0$ ,  $x+z \geq 0$ ,  $x+y \geq 0$ , et  $x+y+z \geq 0$ , correspond à l'hypersurface de  $\mathbb{A}_{\mathbb{R}}^4$  définie par l'équation  $X_1X_3 = X_2X_4$ . Il s'agit du cône affine sur l'image de  $\mathbb{P}_{\mathbb{R}}^1 \times_{\mathbb{R}} \mathbb{P}_{\mathbb{R}}^1$  par le plongement de Segre dans  $\mathbb{P}_{\mathbb{R}}^3$ .

**Définition 1.2.7.** On appelle *éventail* de  $\mathfrak{t}(\mathbb{R})$  tout ensemble non-vide  $\Sigma$  de cônes polyédraux rationnels fortement convexes satisfaisant les deux propriétés suivantes :

1. Si  $C$  est un cône de  $\Sigma$  alors chacune de ses faces est également un cône de  $\Sigma$  ;
2. Deux cônes de  $\Sigma$  s'intersectent toujours le long d'une face commune.

Un éventail dont la réunion des cônes recouvre  $\mathfrak{t}(\mathbb{R})$  est dit *complet*.

Soit  $\Sigma$  un éventail de  $\mathfrak{t}(\mathbb{R})$ . Si  $C_1 \in \Sigma$  est une face de  $C_2 \in \Sigma$  alors  $\mathbb{R}[C_2^+ \cap \mathfrak{t}(\mathbb{Z})]$  est une sous-algèbre de  $\mathbb{R}[C_1^+ \cap \mathfrak{t}(\mathbb{Z})]$ . De plus, il existe toujours<sup>11</sup>  $\alpha \in C_2^+ \cap \mathfrak{t}^*(\mathbb{Z})$  pour lequel l'algèbre  $\mathbb{R}[C_1^+ \cap \mathfrak{t}(\mathbb{Z})]$  correspond à l'algèbre  $\mathbb{R}[C_2^+ \cap \mathfrak{t}(\mathbb{Z})][x^{-\alpha}]$ . Ainsi l'application duale  $Y_{C_1} \rightarrow Y_{C_2}$  est une immersion ouverte, équivariante pour l'action de  $T$ .

---

<sup>11</sup>c.f. [Ful93], Proposition 2 p.13.

**Définition 1.2.8.** Soit  $\Sigma$  un éventail de  $\mathfrak{t}(\mathbb{R})$ . La *variété torique*  $Y_\Sigma$  est définie comme la limite inductive suivante :

$$Y_\Sigma := \lim_{C \in \Sigma} \text{ind } Y_C .$$

Comme les applications de recollements sont équivariantes,  $Y_\Sigma$  est munie d'une action de  $T$ . Lorsque  $K$  est le corps des nombres réels ou complexes, les applications induites entre les points  $K$ -rationnels préservent les points positifs, il nous est donc possible de définir le lieu positif  $Y_\Sigma(\mathbb{R}_+)$  de  $Y_\Sigma$  et la retraction  $|\cdot| : Y_\Sigma(K) \rightarrow Y_\Sigma(\mathbb{R}_+)$  de l'inclusion de  $Y_\Sigma(\mathbb{R}_+)$  dans  $Y_\Sigma(K)$ .

**Proposition 1.2.9** ([Ful93], §2.4 Compactness and Properness pp.39-42). *L'espace  $Y_\Sigma(\mathbb{C})$  est compact si et seulement si  $\Sigma$  est complet.*

**Définition 1.2.10.** Un *polytope entier* de  $\mathfrak{t}^*(\mathbb{R})$  est l'enveloppe convexe d'un nombre fini de points de  $\mathfrak{t}^*(\mathbb{Z})$ . Sa *dimension* est la dimension de l'espace affine qu'il engendre. Son espace tangent  $TP$  étant rationnel il contient un réseau  $TP(\mathbb{Z})$ . Ainsi son cotangent en contient également un, noté  $T^*P(\mathbb{Z})$ . Une *face* d'un polytope est l'intersection de ce dernier avec un hyperplan dont l'équation est de signe constant sur celui-ci. Si  $P$  est un polytope entier et  $Q$  est une face de  $P$ , noté  $Q \leq P$ , alors  $Q$  est également un polytope entier. Chacune des faces de  $P$  détermine un cône polyédral rationnel fortement convexe de son cotangent  $T^*P$  :

$$C_{P,Q} := \{v \in T^*P \mid (\alpha - \beta)(v) \geq 0, \forall (\alpha; \beta) \in P \times Q\} .$$

L'ensemble  $\Sigma_P := \{C_{P,Q} : Q \leq P\}$  est un éventail complet de  $T^*P$ . On l'appelle l'*éventail dual* de  $P$ . On dit que  $P$  est *simple* si son éventail dual est simplicial et que  $P$  est *non-singulier* si son éventail dual est non-singulier.

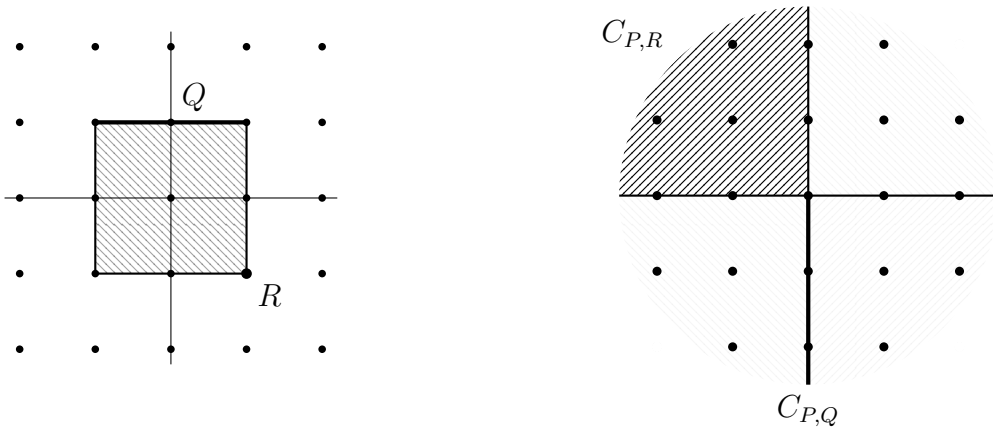

(a) Un polytope  $P$  de dimension  $\mathfrak{t}^*(\mathbb{R})$ .

(b) Son éventail dual dans  $\mathfrak{t}(\mathbb{R})$ .

Figure 1.7: Un polytope et son éventail dual.

**Définition 1.2.11.** Soit  $P$  un polytope entier de  $\mathfrak{t}^*(\mathbb{R})$  de dimension  $n$ . La *variété torique associée à  $P$*  est la variété torique de tore  $T$  associée à son éventail dual. On

la note  $Y_P$ . Pour chaque face  $Q$  de  $P$ , on note  $U_{P,Q}$  l'ouvert affine de  $Y_P$  associé au cône  $C_{P,Q}$ . On notera que l'application  $[Q \leq P \mapsto U_{P,Q}]$  est décroissante. Lorsque  $P$  est de dimension strictement inférieure à  $n$ , la variété torique de  $P$  est la variété de tore  $T_P := \text{Spec}(\mathbb{R}[TP(\mathbb{Z})])$  associée à son éventail dual. Dans ce cas le tore  $T$  agit toujours sur  $Y_P$  mais son action n'est plus fidèle. Son noyau est le sous-tore  $\text{Spec}(\mathbb{R}[\mathfrak{t}^*(\mathbb{Z})/TP(\mathbb{Z})])$ .

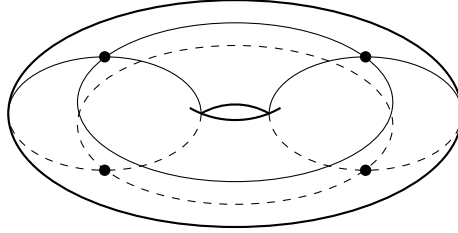

Figure 1.8: Le lieu réel de la variété torique associée au carré de la Figure 1.7 et ses diviseurs toriques.

Soit  $P$  un polytope entier et  $Q$  une face de ce dernier. Pour toute face  $R$  de  $Q$ , le cône  $C_{P,R}$  est envoyé surjectivement sur le cône  $C_{Q,R}$  par la projection  $T^*P \rightarrow T^*Q$ . Ainsi le cône  $C_{Q,R}^+ \subset TQ$  est inclus dans  $C_{P,R}^+ \subset TP$ . C'est une face propre de ce dernier. Il vérifie la propriété suivante : pour tout  $\alpha, \beta \in C_{P,R}^+$ ,  $\alpha + \beta$  appartient à  $C_{Q,R}^+$  si et seulement si  $\alpha$  et  $\beta$  y appartiennent. Ainsi, l'application qui envoie le générateur  $x^\alpha$  de  $\mathbb{R}[C_{P,R}^+ \cap TP(\mathbb{Z})]$  sur :

- le même élément si  $\alpha$  appartient à  $C_{Q,R}^+$  ;
- l'élément nul de  $\mathbb{R}[C_{Q,R}^+ \cap TP(\mathbb{Z})]$  sinon,

définie un morphisme d'algèbres surjectif. On obtient alors une immersion fermée  $U_{P,R} \rightarrow U_{Q,R}$ . Ces immersions se recollent en une immersion fermée de  $Y_Q$  dans  $Y_P$ . L'ensemble des images de ces variétés sont les *diviseurs toriques* de  $Y_P$ . Ils sont représentés dans la Figure 1.8.

**Théorème 1.2.12.** *Une variété torique est projective, i.e. se plonge dans un espace projectif, si et seulement si elle provient d'un polytope.*

En utilisant le Théorème 1.2.6 et la Définition 1.2.10. La variété torique d'un polytope  $P$  est non-singulière si et seulement si  $P$  l'est. Si  $P$  est seulement simple alors  $Y_P$  pourra avoir des singularités quotients. Plusieurs polytopes peuvent définir la même variété torique. Si  $P'$  s'écrit comme  $dP + \alpha$  avec  $d \geq 1$  entier et  $\alpha \in \mathfrak{t}^*(\mathbb{Z})$  alors  $P$  et  $P'$  auront les mêmes éventails duaux et donc des variétés toriques identiques. Si  $P'$  est obtenu en transformant  $P$  par un automorphisme de  $\mathfrak{t}^*(\mathbb{Z})$  leurs variétés toriques seront également isomorphes. On pourra utiliser l'automorphisme  $g \in \text{GL}(\mathfrak{t}^*(\mathbb{Z}))$  pour construire explicitement l'isomorphisme.

**Définition 1.2.13.** Un *simplex* de  $\mathfrak{t}^*(\mathbb{R})$  est l'enveloppe convexe de  $(k + 1)$ -points de  $\mathfrak{t}^*(\mathbb{R})$  qui engendrent un espace affine de dimension  $k$ . Lorsque ses sommets sont

tous dans  $\mathfrak{t}^*(\mathbb{Z})$  on dit que le simplexe est *entier*. Un *simplexe primitif* de  $\mathfrak{t}^*(\mathbb{Z})$  est l'enveloppe convexe de  $(k+1)$ -points entiers  $\alpha_0, \dots, \alpha_k$  de  $\mathfrak{t}^*(\mathbb{Z})$  qui engendrent un espace affine de dimension  $k$  et dont les ensembles  $B_j := \{\alpha_i - \alpha_j : i \neq j\}$  sont inclus dans des bases de  $\mathfrak{t}^*(\mathbb{Z})$  pour tout  $0 \leq j \leq k$ . Un simplexe entier  $\sigma$  de  $\mathfrak{t}^*(\mathbb{Z})$  est primitif si et seulement si les différences de ses sommets engendrent son réseau tangent  $T\sigma(\mathbb{Z})$ . Un simplexe est non-singulier si et seulement si c'est un multiple d'un simplexe primitif. On appelle la taille de ce dernier l'entier naturel par lequel il faut multiplier un simplexe primitif pour l'obtenir.

Si  $P$  est un simplexe non-singulier dont les sommets sont  $\alpha_0, \dots, \alpha_k$  on peut toujours trouver une base :

$$\frac{\partial}{\partial x_1}, \dots, \frac{\partial}{\partial x_k},$$

de  $T^*P(\mathbb{Z})$  dans laquelle son éventail dual est donné par les cônes engendrés par les ensembles de vecteurs :

$$\left\{ \frac{\partial}{\partial x_i} : i \in I \right\},$$

pour tout  $I \subset \{0, \dots, k\}$ , où :

$$\frac{\partial}{\partial x_0} := - \sum_{i=1}^k \frac{\partial}{\partial x_i}.$$

La variété  $Y_P$  est recouverte par les ouverts affines  $U_{P,\alpha_i} \cong \mathbb{A}_{\mathbb{R}}^k$ . Les ouverts  $U_{P,\alpha_i}$ ,  $0 \leq i \leq k$ , peuvent être munis de coordonnées  $x_0, \dots, x_{i-1}, x_{i+1}, \dots, x_k$ , dans lesquels les intersections  $U_{P,\alpha_i} \cap U_{P,\alpha_j}$ , pour  $i$  différent de  $j$ , correspondent à  $\{x_j \neq 0\}$  dans  $U_{P,\alpha_i}$  et à  $\{x_i \neq 0\}$  dans  $U_{P,\alpha_j}$ . De plus le changement de cartes de  $U_{P,\alpha_i}$  vers  $U_{P,\alpha_j}$  s'écrit comme suit :

$$(x_0, \dots, x_{i-1}, x_{i+1}, \dots, x_k) \mapsto \left( \frac{x_0}{x_j}, \dots, \frac{x_0}{x_{i-1}}, \frac{1}{x_j}, \frac{x_0}{x_{i+1}}, \dots, \frac{x_{j-1}}{x_j}, \frac{x_{j+1}}{x_j}, \dots, \frac{x_k}{x_j} \right).$$

Il s'agit de l'atlas par deshomogénéisation de l'espace projectif de dimension  $k$ . Ainsi  $Y_P$  est isomorphe à  $\mathbb{P}_{\mathbb{R}}^k$ .

**Définition 1.2.14.** Soit  $T$  un tore réel. Le groupe  $T(K)$  est naturellement isomorphe à  $\text{Hom}(\mathfrak{t}^*(\mathbb{Z}); K^\times)$ . Lorsque  $K$  désigne le corps des réels ou des complexes, la valeur absolue et le module permettent de définir le sous-tore unitaire. On note  $T(\pm 1)$  le sous-tore unitaire de  $T(\mathbb{R})$  et  $T(S^1)$  le sous-tore unitaire de  $T(\mathbb{C})$ . Le premier est isomorphe au groupe  $\mathfrak{t}(\mathbb{F}_2)$  et le second à  $\mathfrak{t}(\mathbb{R})/\mathfrak{t}(\mathbb{Z})$ . Le lieu positif  $Y_P(\mathbb{R}_+)$  est homéomorphe aux quotients des lieux réel et complexe de  $Y_P$  par l'action des sous-tores unitaires.

**Définition 1.2.15** (Application moment. [Ful93], §4.2 Moment map pp.81-83). Soit  $P$  un polytope entier de  $\mathfrak{t}^*(\mathbb{R})$ . L'application suivante :

$$\begin{aligned} \mu_P : Y_P(\mathbb{C}) &\longrightarrow P \\ x &\longmapsto \frac{\sum_{\alpha \in P \cap \mathfrak{t}^*(\mathbb{Z})} |x^\alpha| \alpha}{\sum_{\alpha \in P \cap \mathfrak{t}^*(\mathbb{Z})} |x^\alpha|}, \end{aligned}$$

est bien définie, continue et induit un homéomorphisme entre  $Y_P(\mathbb{R}_+)$  et  $P$ . On l'appelle l'*application moment* de  $P$ . On note  $s_P$  la section de  $\mu_P$  à valeurs dans  $Y_P(\mathbb{R}_+)$ .

**Définition 1.2.16.** Soit  $P$  un polytope entier de  $\mathfrak{t}^*(\mathbb{R})$ . On note  $NP(\mathbb{Z})$  l'ensemble des vecteurs de  $\mathfrak{t}(\mathbb{Z})$  annulés par les formes tangentés à  $P$ . Soit  $p$  un point d'un polytope entier  $P$ . On note  $\text{Sed}(p)$  le groupe  $NQ(\mathbb{Z})$  où  $Q$  est la plus petite face de  $P$  qui contient  $p$  et on l'appelle la *sédentarité* de  $p$ . Le stabilisateur de  $s_P(p)$  pour l'action de  $T(\pm 1)$  correspond à  $\text{Sed}(p) \otimes \mathbb{F}_2$ . Le stabilisateur de  $s_P(p)$  pour l'action de  $T(S^1)$  correspond, quant à lui, à  $\text{Sed}(p) \otimes \mathbb{R}/\mathbb{Z}$ .

**Définition 1.2.17.** On appelle l'application :

$$\begin{aligned} \phi_P^{\mathbb{R}} : T(\pm 1) \times P &\rightarrow Y_P(\mathbb{R}) \\ (v; p) &\mapsto v \cdot s_P(p), \end{aligned}$$

la *carte* de  $Y_P(\mathbb{R})$ .

La carte de  $Y_P(\mathbb{R})$  le représente comme le recollement de  $2^{\dim P}$  copies de  $P$ . Les deux copies,  $(v; p)$  et  $(w; p)$ , de  $p \in P$  sont collées l'une sur l'autre si et seulement si  $v - w$  appartient à  $\text{Sed}(p) \otimes \mathbb{F}_2$ . Cette application nous fournit une décomposition cellulaire régulière de  $Y_P(\mathbb{R})$ . En l'utilisant on trouve que la caractéristique d'Euler de  $Y_P(\mathbb{R})$  vaut :

$$\chi(Y_P(\mathbb{R})) = \sum_{i=0}^{\dim P} (-2)^i f_i(P),$$

où  $f_i(P)$  est le nombre de faces de dimension  $i$  de  $P$ . Les figures 1.9 et 1.10, illustrent cette construction dans les cas de deux simplexes. Dans la première on part d'un simplexe primitif et on obtient le plan projectif. Dans la seconde on part d'un simplexe dont l'un des côtés est de longueur 2. La variété obtenue s'appelle un espace projectif pondéré. Il s'agit de  $\mathbb{P}(1, 1, 2)$ .

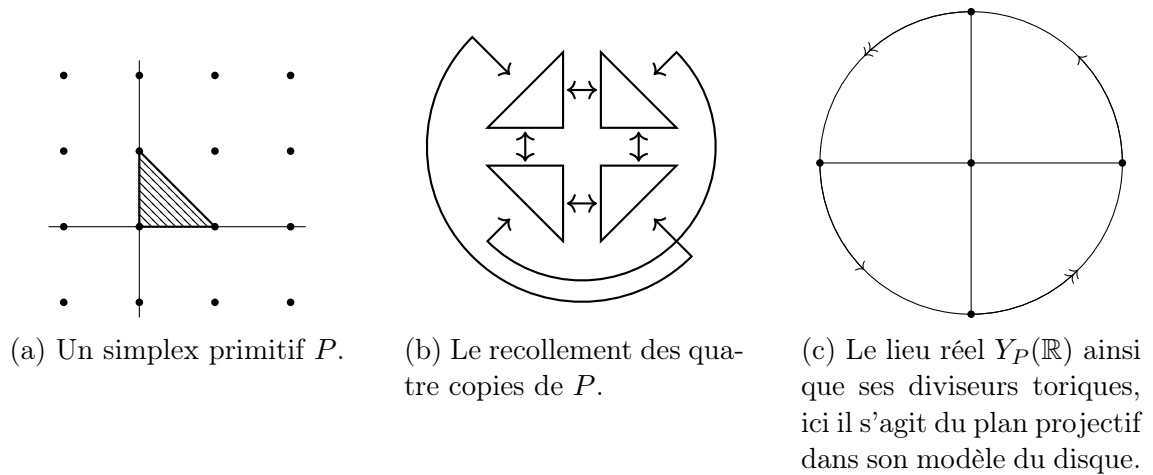

Figure 1.9: Le lieu réel du plan projectif et sa décomposition cellulaire induite par l'action du tore unitaire.

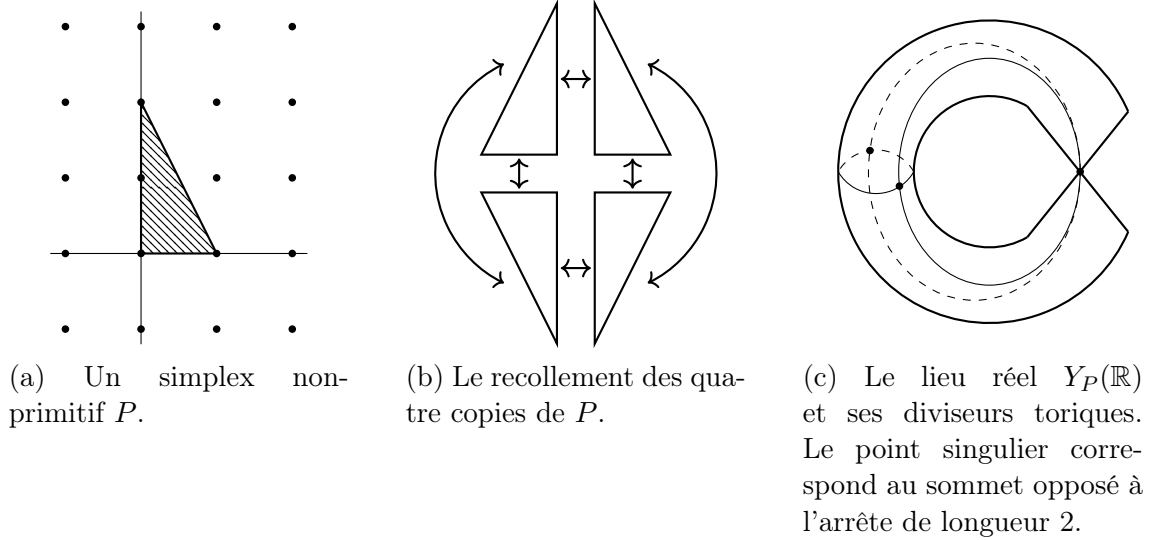

Figure 1.10: Le lieu réel du plan projectif pondéré  $\mathbb{P}(1, 1, 2)$  et sa décomposition cellulaire induite par l'action du tore unitaire.

### 1.3 Hypersurfaces et Fibrés en Droites

**Définition 1.3.1** (Morphisme de Veronese). Soit  $P$  un polytope entier de  $\mathfrak{t}^*(\mathbb{R})$ . Notons  $A$  l'ensemble des points entiers de  $P$ . L'espace vectoriel  $\mathbb{R}^A$  possède un réseau canonique  $\mathbb{Z}^A$ . Le simplexe  $S := \{(x_\alpha)_{\alpha \in A} \in \mathbb{R}_+^A \mid \sum_{\alpha \in A} x_\alpha = 1\}$  est primitif et s'envoie surjectivement sur  $P$  via la projection linéaire  $\pi : \mathbb{R}^A \rightarrow \mathfrak{t}^*(\mathbb{R})$  qui envoie le générateur associé à  $\alpha$  sur  $\alpha$ . Notons pour toute face  $Q$  de  $P$ ,  $S(Q)$  la face de  $S$  engendrée par les points entiers de  $Q$ . La projection  $\pi$  envoie le monoïde  $C_{S, S(Q)}^+ \cap TS(\mathbb{Z})$  sur  $C_{P, Q}^+ \cap TP(\mathbb{Z})$  et définit un morphisme de l'ouvert affine  $U_{S, S(Q)}$  sur l'ouvert affine  $U_{P, Q}$ . Ces morphismes se recollent et définissent le *morphisme de Veronese* de  $P$  :

$$\mathcal{V}_P : Y_P \longrightarrow \mathbb{P}_{\mathbb{R}}^A,$$

où  $\mathbb{P}_{\mathbb{R}}^A$  est l'espace projectif associé à  $S$ . Les coordonnées homogènes de  $\mathbb{P}_{\mathbb{R}}^A$  sont indexées par les éléments de  $A$  et pour toute extension  $K$  de  $\mathbb{R}$  et tout  $x \in Y_P(K)$ ,  $\mathcal{V}_P(x)$  correspond au point  $(x^\alpha)_{\alpha \in A} \in \mathbb{P}^A(K)$ . Ainsi  $Y_P$  est équipée d'un fibré en droites réel  $\mathcal{L}_P$ , tiré en arrière de  $\mathcal{O}(1)$  par  $\mathcal{V}_P$ , pour lequel  $H^0(Y_P; \mathcal{L}_P)$  est isomorphe à  $\mathbb{R}^A$ . On notera que  $H^0(Y_P; \mathcal{L}_P)$  est isomorphe à un sous-espace des fonctions régulières  $\mathcal{O}(T_P)$  du tore de  $Y_P$ . Chacune de ses sections sera notée sous la forme  $\sum_{\alpha \in P \cap \mathfrak{t}^*(\mathbb{Z})} a_\alpha x^\alpha$ . Si  $X$  est le lieu d'annulation d'une section  $F$  de  $\mathcal{L}_P$  alors l'intersection de  $X$  avec le tore de  $Y_P$  correspond au lieu d'annulation de la fonction régulière correspondante. De manière générale pour tout sommet  $\alpha$  de  $P$ , l'intersection de  $X$  avec l'ouvert affine  $U_{P, \alpha}$  correspond au lieu d'annulation de la fonction  $x^{-\alpha} F \in \mathcal{O}(U_{P, \alpha})$ .

Lorsque la variété torique projective  $Y$  correspond à la variété  $Y_P$  d'un polytope  $P$  on dit que  $P$  est un *polytope moment* de  $Y$ . Plusieurs polytopes entiers de  $\mathfrak{t}^*(\mathbb{R})$  peuvent conduire à la même variété torique. Cela arrive lorsque deux polytopes ont le même éventail dual. Se donner un polytope particulier fixe un certain fibré

en droite sur la variété. Dilater ce polytope par un facteur entier  $d \geq 1$  revient à tensoriser  $d$  fois le fibré en droites initial.

**Définition 1.3.2.** Un polytope entier  $P$  de  $\mathfrak{t}^*(\mathbb{R})$  est dit *très ample* lorsque pour chacun de ses sommets  $\alpha$  le monoïde  $C_{P,\alpha}^+ \cap TP(\mathbb{Z})$  est engendré par les différences  $\beta - \alpha$  pour tout  $\beta \in P \cap \mathfrak{t}^*(\mathbb{Z})$ .

**Proposition 1.3.3** ([CLS11], Proposition 3.1.6 p.108). *Les trois assertions suivantes sont équivalentes :*

1. *Le fibré  $\mathcal{L}_P$  est très ample;*
2. *Le polytope  $P$  est très ample;*
3. *Le morphisme de Veronese  $\mathcal{V}_P$  est un plongement.*

Lorsque le polytope  $P$  est très ample et  $K$  désigne le corps des réels ou des complexes, la variété  $Y_P(K)$  peut aussi se définir comme l'adhérence de Zariski de l'image du tore  $T_P(K)$  par le morphisme de Veronese  $\mathcal{V}_P$ .

**Proposition 1.3.4** ([CLS11], Corollary 2.2.18 p.87). *Le fibré  $\mathcal{L}_P$  est ample, i.e. il existe toujours un entier  $d \geq 1$  pour lequel  $dP$  est très ample. On peut toujours prendre  $d$  égale à  $\min(1; \dim P - 1)$ . De plus tout polytope non-singulier est très ample<sup>12</sup>.*

Toute section globale  $F$  de  $\mathcal{L}_P$  définit une hypersurface réelle  $X$  de  $Y_P$ . On dit que  $F$  est l'*équation* de  $X$ . Quand le polytope est fixé on se restreindra à ces dernières. Fixer un polytope moment d'une variété torique projective revient à fixer le degré des hypersurfaces considérées. Par exemple, un polytope moment de l'espace projectif est toujours un simplexe non-singulier. Ce dernier est de taille  $d$  si et seulement si son fibré associé est isomorphe à  $\mathcal{O}(d)$ . Une hypersurface de l'espace projectif, vu comme la variété torique d'un simplexe non-singulier de taille  $d$ , est une hypersurface de degré  $d$  au sens usuel. Considérons à présent que  $Y$  est une variété torique réelle projective non-singulière de tore  $T$  et que le polytope non-singulier  $P \subset \mathfrak{t}^*(\mathbb{R})$  est un polytope moment de  $Y$ . Soit  $X$  une hypersurface non-singulière de  $Y$  associée au polytope moment  $P$ . Le théorème d'isotopie de Thom assure que les lieux complexes de deux telles hypersurfaces sont homéomorphes. Le théorème des sections hyperplanes de Lefschetz exprime comment la topologie de  $X(\mathbb{C})$  est influencée par celle de  $Y(\mathbb{C})$ .

**Théorème 1.3.5** (Théorème des sections hyperplane de Lefschetz. [Lef50], Théorèmes p.89, [Bot59], Corollary of Theorem I p.212, [KS53], Theorem 1 p.1275, et [AN54], Theorem 2 p.270). *Soit  $Y$  une sous-variété algébrique de dimension  $n$  de  $\mathbb{P}_{\mathbb{C}}^N$  et  $X$  une section hyperplane de  $Y$ , c'est à dire l'intersection de  $Y$  avec un hyperplan de  $\mathbb{P}_{\mathbb{C}}^N$ . Si  $Y \setminus X$  est non-singulière alors :*

---

<sup>12</sup>c.f. [CLS11], Proposition 2.4.4 p.87.

1. L'application de restriction  $H^k(Y(\mathbb{C}); \mathbb{Z}) \rightarrow H^k(X(\mathbb{C}); \mathbb{Z})$  est un isomorphisme pour tout  $k < n - 1$  et injective pour  $k = n - 1$ ;
2. L'application induite par l'inclusion  $H_k(X(\mathbb{C}); \mathbb{Z}) \rightarrow H_k(Y(\mathbb{C}); \mathbb{Z})$  est un isomorphisme pour tout  $k < n - 1$  et surjective pour  $k = n - 1$ ;
3. L'application induite par l'inclusion  $\pi_k(X(\mathbb{C})) \rightarrow \pi_k(Y(\mathbb{C}))$  est un isomorphisme pour tout  $k < n - 1$  et surjective pour  $k = n - 1$ ;

Si de plus  $X$  et  $Y$  sont non-singulières et que le fibré en droites  $\mathcal{O}_Y(X)$  est ample alors l'application de restriction  $H^{p,q}(Y(\mathbb{C})) \rightarrow H^{p,q}(X(\mathbb{C}))$  est un isomorphisme pour tous  $p + q < n - 1$  et injective pour tous  $p + q = n - 1$ .

Ce théorème peut en particulier s'appliquer aux variétés toriques projectives  $Y$  et à leurs hypersurfaces  $X$  associées à des polytopes moment très amples. En effet,  $X$  est dans ce cas une section hyperplane de  $Y$  quand on la voit plongée par le morphisme de Veronese et  $\mathcal{O}_{Y \times_{\mathbb{R}} \mathbb{C}}(X \times_{\mathbb{R}} \mathbb{C})$  est isomorphe à la complexification de  $\mathcal{L}_P$ , en particulier très ample.

## 1.4 Cohomologie des Variétés Toriques Projectives

On rappelle certaines des propriétés satisfaites par la cohomologie des variétés toriques projectives non-singulières ainsi que de celles de certaines de leurs hypersurfaces. Dans un premier temps on introduit quelques notions sur les polytopes qui nous permettrons d'exprimer les nombres de Betti et de Hodge des objets considérés.

**Polytopes simples et polytopes simpliciaux.** Lorsque nous avons défini les variétés toriques nous avons introduit les polytopes simples. Nous abordons ici la notion duale, celle des polytopes simpliciaux. Nous donnons les définitions de certaines quantités inhérentes à ces objets, telles que le  $f$ -vecteur ou bien encore le  $h$ -vecteur.

**Définition 1.4.1.** Soit  $P$  un polytope de dimension  $k$  de  $\mathfrak{t}^*(\mathbb{R})$ . Le  $f$ -vecteur de  $P$  le  $(k + 1)$ -uplets d'entiers naturels  $(f_{-1}(P), \dots, f_k(P))$  dont la  $i$ -ème coordonnée,  $f_i(P)$ , est le nombre de  $i$ -faces de  $P$  pour tout  $-1 \leq i \leq k$ . Par convention  $f_{-1}(P)$  vaut 1 et correspond à la face vide de  $P$ . On note  $\mathbf{f}_P$  le polynôme  $\sum_{i=-1}^k f_i(P) X^{k-i}$ .

**Définition 1.4.2.** Soit  $P$  un polytope de  $\mathfrak{t}^*(\mathbb{R})$ . L'intérieur relatif de  $P$  est l'intérieur topologique de  $P$  vu comme sous-ensemble de l'espace affine qu'il engendre.

**Définition 1.4.3.** Soit  $P$  un polytope de  $\mathfrak{t}^*(\mathbb{R})$  et  $\alpha$  un point de son intérieur relatif. Le polaire de  $P$  relativement à  $\alpha$  est le polytope suivant de son cotangent  $T^*P$  :

$$P_\alpha^\circ := \{v \in T^*P \mid (\beta - \alpha)(v) \geq -1, \forall \beta \in P\}.$$



Ce polytope a la même dimension que  $P$ . Chaque face  $Q$  de  $P$  induit une face de  $P_\alpha^\circ$  via la formule :

$$Q_\alpha^* = \{v \in P_\alpha^\circ \mid (\beta - \alpha)(v) = -1, \forall \beta \in Q\}.$$

De plus  $Q \mapsto Q_\alpha^*$  est une bijection décroissante de l'ensemble des faces de  $P$  vers l'ensemble des faces de  $P_\alpha^\circ$ . Pour toute face  $Q$  de  $P$  on a la formule :

$$\dim Q_\alpha^* + \dim Q + 1 = \dim P.$$

Ainsi, pour tout  $-1 \leq i \leq \dim P$ ,  $f_i(P_\alpha^\circ)$  vaut  $f_{k-1-i}(P)$ , où  $k$  est la dimension de  $P$ . De manière plus concise on a la relation  $\mathbf{f}_{P_\alpha^\circ}(X) = X^{\dim P+1} \mathbf{f}_P(X^{-1})$ . D'un point de vue combinatoire, le polytope  $P_\alpha^\circ$  est unique, il correspond à l'ensemble ordonné opposé à  $P$ . On le notera souvent  $P^\circ$ , sous-entendant qu'on considère le polaire relativement à un point arbitraire de l'intérieur relatif de  $P$ .

Certaines propriétés de  $P$  peuvent directement se traduire en terme de propriétés de son polaire.

**Définition 1.4.4.** Un polytope  $P$  est *simplicial* si chacune de ses faces propres  $Q < P$  est un simplexe.

**Proposition 1.4.5.** *Un polytope est simple si et seulement si son polaire est simplicial.*

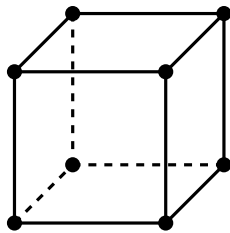

(a) Le cube est un polytope simple et non simplicial.

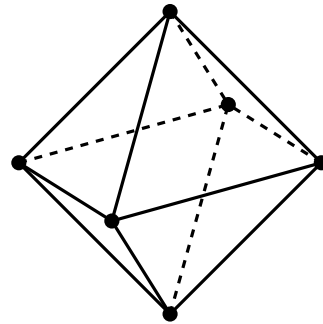

(b) L'octaèdre est un polytope simplicial et non simple.

Figure 1.11: Un polytope et son polaire.

**Définition 1.4.6.** Soit  $P$  un polytope simplicial. Un *effeuillage* du bord de  $P$  est une numérotation  $Q_0, \dots, Q_N$  de ses faces de codimension 1 telle que pour tout  $1 \leq i \leq N$ ,  $Q_i \cap \bigcup_{j=1}^{i-1} Q_j$  est une réunion non vide de faces de codimension 1 de  $Q_i$ . Pour tout  $0 \leq j \leq \dim P$ , on note  $h_j(\partial P)$  le nombre de faces  $Q_i$  dont l'intersection  $Q_i \cap \bigcup_{j=1}^{i-1} Q_j$  est la réunion de  $j$  faces de codimension 1 de  $Q_i$ . On dit que  $Q_i$  est une face d'*ordre*  $j$ .

**Théorème 1.4.7** (H. Bruggesser et P. Mani, [BM71], Corollary p.203). *Tout polytope simplicial possède un effeuillage.*

**Proposition 1.4.8.** *Les nombres  $(h_j(\partial P))_{0 \leq j \leq \dim P}$  ne dépendent pas de l'effeuillage choisi. De plus si on note  $\mathbf{h}_{\partial P}$  le polynôme  $\sum_{j=0}^{\dim P} h_j(\partial P) X^{\dim P - j}$  alors on a :*

$$\mathbf{f}_P(X) = 1 + X \mathbf{h}_{\partial P}(1 + X).$$

Le vecteur  $(h_q(\partial P))_{0 \leq q \leq \dim P}$  s'appelle le  $h$ -vecteur de  $\partial P$ .

**Théorème 1.4.9** (Relations de Dehn-Sommerville, [Som27]). *Pour tout polytope simplicial  $P$  on a :*

$$\mathbf{h}_{\partial P}(X) = X^{\dim P} \mathbf{h}_{\partial P}(X^{-1}).$$

**Définition 1.4.10.** Soit  $P$  un polytope entier simple de  $\mathfrak{t}^*(\mathbb{R})$ . Son anneau de Stanley-Reisner est le quotient  $\text{SR}(P)$  de l'algèbre  $\mathbb{Z}[X_Q : Q \leq P, \text{codim} Q = 1]$  par l'idéal engendré par les monômes  $X_{Q_1} \cdots X_{Q_k}$ , pour tout ensemble  $Q_1, \dots, Q_k$  de  $k$  faces distinctes de  $P$  dont l'intersection est vide. C'est un anneau gradué car quotient par un idéal homogène. Par convention on dit que les générateurs  $X_Q$  ont degré 2. Pour chacune des faces  $Q$  de codimension 1 de  $P$ , le monoïde  $C_{P,Q}^+ \cap T^*P(\mathbb{Z})$  est isomorphe à  $\mathbb{N}$ . Il possède un unique générateur  $v_Q$ . On note  $\mathfrak{J}(P)$  l'idéal homogène de  $\text{SR}(P)$  engendré par les polynômes  $\sum_{Q \leq P} \alpha(v_Q) X_Q$  pour tout  $\alpha \in TP(\mathbb{Z})$ .

**Cohomologie des variétés toriques projectives non-singulières.** Soit  $P$  un polytope non-singulier de  $\mathfrak{t}^*(\mathbb{R})$  de dimension  $n$ . Le lieu complexe  $Y_P(\mathbb{C})$  est une variété différentielle complexe, elle est donc canoniquement orientable et satisfait la dualité de Poincaré à coefficients entiers. On note  $[Y_P(\mathbb{C})] \in H_{2n}(Y_P(\mathbb{C}); \mathbb{Z})$  la classe fondamentale associée à l'orientation complexe. Pour toute face  $Q$  de codimension 1 de  $P$  on note  $\omega_Q \in H^2(Y_P(\mathbb{C}); \mathbb{Z})$  la classe duale de Poincaré de l'image de  $[Y_Q(\mathbb{C})]$  dans  $H_{2n-2}(Y_P(\mathbb{C}); \mathbb{Z})$ .

**Théorème 1.4.11** ([Ful93], §5.2 Cohomology of Nonsingular Varieties pp.101-108). *L'application :*

$$\begin{aligned} \text{SR}(P) &\longrightarrow \bigoplus_{q \geq 0} H^q(Y_P(\mathbb{C}); \mathbb{Z}) \\ X_Q &\longmapsto \omega_Q, \end{aligned}$$

définie un morphisme d'algèbres surjectif dont le noyau est l'idéal  $\mathfrak{J}(P)$ . De plus, l'anneau de cohomologie de  $Y_P(\mathbb{C})$  est sans torsion et, pour tout  $0 \leq q \leq n$ , le groupe  $H^{2q}(Y_P(\mathbb{C}); \mathbb{Z})$  est de rang  $h_{n-q}(\partial P^\circ)$ .

**Corollaire 1.4.12.** *Pour tout  $p, q \in \mathbb{N}$ , le groupe  $H^{p,q}(Y_P(\mathbb{C}))$  s'annule dès que  $p$  est différent de  $q$ .*

**Théorème 1.4.13** (F. Bihan et al., [BFMvH06], Theorem 1.1 p.218). *La variété  $Y_P$  est maximale au sens de l'inégalité de Smith-Thom. De plus l'anneau gradué  $\bigoplus_{0 \leq q \leq n} H^q(Y_P(\mathbb{R}); \mathbb{F}_2)$  est isomorphe à l'anneau gradué  $\bigoplus_{0 \leq q \leq n} H^{2q}(Y_P(\mathbb{C}); \mathbb{F}_2)$ .*

P. McMullen proposa une liste de propriétés<sup>13</sup> qu'un vecteur d'entiers naturels  $(h_q)_{0 \leq q \leq n}$  doit satisfaire si et seulement si l'agit du  $h$ -vecteur d'un polytope sim-

<sup>13</sup>c.f. [McM71], Conjecture p.561.

plicial. L. Billera et C. Lee démontrèrent que ces propriétés suffisent<sup>14</sup> à réaliser le vecteur d'entiers comme  $h$ -vecteur d'un polytope simplicial. C'est R. Stanley qui proposa la première preuve<sup>15</sup> de nécessité. Pour ce faire, il s'appuya en particulier sur l'interprétation du théorème 1.4.11 du  $h$ -vecteur d'un polytope simplicial et sur des résultats concernant la cohomologie des variétés complexes.

**Série d'Ehrhart et formules de Danilov-Khovanskiï.** Le théorème des sections hyperplanes de Lefschetz ainsi que la dualité Poincaré permettent de connaître presque intégralement les nombres de Hodge d'un hypersurface non-singulière d'une variété torique projective non-singulière. Les seuls nombres que nous ne pouvons pas déduire des résultats précédemment énoncés sont situés sur le niveau médian du diamant de Hodge de l'hypersurface. Ces nombres sont calculés par les formules de Danilov-Khovanskiï. Avant de pouvoir les énoncer nous avons besoin d'introduire de nouvelles quantités associées à un polytope.

**Définition 1.4.14.** Soit  $P$  un polytope entier de  $\mathfrak{t}^*(\mathbb{R})$ . On note  $\text{Eh}_P$  sa *série d'Ehrhart*. Elle est définie par la formule suivante :

$$\text{Eh}_P(t) := \sum_{q \geq 0} \text{card}(qP \cap \mathfrak{t}^*(\mathbb{Z}))t^q.$$

Par le théorème d'Ehrhart<sup>16</sup>, cette série est une fraction rationnelle qui s'écrit sous la forme suivante :

$$\text{Eh}_P(t) = \frac{\sum_{q=0}^{\dim P} h_q^*(P)t^q}{(1-t)^{\dim P+1}},$$

et permet de définir les nombres  $(h_q^*(P))_{0 \leq q \leq \dim P}$ . Le nombre  $h_0^*(P)$  vaut toujours 1 et le nombre  $h_{\dim P}^*(P)$  correspond au nombre de points entiers contenus dans l'intérieur relatif de  $P$ .

**Définition 1.4.15.** Soit  $P$  un polytope non-singulier. Une hypersurface  $X$  de  $Y_P$  associée à  $P$  est dite *non-dégénérée* si elle intersecte transversalement les diviseurs toriques de  $Y_P$ . C'est à dire que  $X \cap Y_Q$  est une hypersurface non-vide non-singulière de  $Y_Q$  pour toute face de dimension au moins 1 de  $P$  et  $X$  évite les points  $Y_\alpha$  pour tout sommet  $\alpha$  de  $P$ .

**Théorème 1.4.16** (Danilov-Khovanskiï, [DK87], §5.5 p.293). *Soit  $P$  un polytope non-singulier de dimension  $n$  et  $X$  une hypersurface non-dégénérée de  $Y_P$  associée à  $P$ . Pour tout  $p, q \in \mathbb{N}$ , on note  $h^{p,q}(X)$  la dimension de l'espace vectoriel  $H^{p,q}(X(\mathbb{C}))$ . On a alors les propriétés suivantes :*

1. Pour tous  $p, q$  distincts et dont la somme n'est pas égale à  $n - 1$ ,  $h^{p,q}(X)$  est nul;

---

<sup>14</sup>c.f. [BL81].

<sup>15</sup>c.f. [Sta80].

<sup>16</sup>c.f. [Ehr62], Théorème 1 p.616.

2. Pour tout  $p < \frac{n-1}{2}$ ,  $h^{p,p}(X)$  égale  $h^{n-1-p, n-1-p}(X)$  et ces deux nombres égalent  $h_p(\partial P^\circ)$ ;

3. Pour tous  $p, q$  distincts dont la somme égale  $n - 1$ , le nombre  $h^{p,q}(X)$  égale :

$$h^{p,q}(X) = \sum_{Q \leq P} (-1)^{n-\dim Q} h_{p+1}^*(Q).$$

4. Pour  $p = \frac{n-1}{2}$ , le nombre  $h^{p,p}(X)$  égale :

$$h^{p,p}(X) = h_p(\partial P^\circ) + \sum_{Q \leq P} (-1)^{n-\dim Q} h_{p+1}^*(Q).$$

Les formules des troisième et quatrième points s'appellent les formules de Danilov-Khovanskii.

**Théorème 1.4.17** ([Wel07], Corollary 4.13 p.195, ou [Voi02], §6.2 pp.137-155). Soit  $P$  un polytope non-singulier de dimension  $n$  et  $X$  une hypersurface non-dégénérée de  $Y_P$  associée à  $P$ . On note  $\omega_X$  la classe de  $H^2(Y_P(\mathbb{C}); \mathbb{Z})$  duale de Poincaré de l'image de la classe fondamentale de  $X(\mathbb{C})$  dans  $H_{2n-2}(Y_P(\mathbb{C}); \mathbb{Z})$ . Pour tout  $0 \leq k \leq n$ , le cup produit :

$$\omega_X^k \cup - : H^{n-k}(Y_P(\mathbb{C}); \mathbb{Q}) \rightarrow H^{n+k}(Y_P(\mathbb{C}); \mathbb{Q}),$$

est un isomorphisme.

## 1.5 Amibes et Géométrie Tropicale

**Définition 1.5.1.** Le *semi-corps tropical* est l'ensemble  $\mathbb{T} = \mathbb{R} \amalg \{-\infty\}$  muni des deux opérations suivantes :

1. L'addition tropicale  $+_{\mathbb{T}}$ , définie par la formule  $a +_{\mathbb{T}} b := \max(a, b)$ . Elle est commutative, associative, possède un élément neutre  $-\infty$ , idempotante i.e.  $a +_{\mathbb{T}} a = a$  pour tout  $a \in \mathbb{T}$ , et le seul nombre tropical à posséder un opposé est l'élément neutre  $-\infty$ ;
2. La multiplication tropicale  $\cdot_{\mathbb{T}}$ , définie par la formule  $a \cdot_{\mathbb{T}} b := a + b$ . Elle est commutative, associative, distributive par rapport à  $+_{\mathbb{T}}$ , possède un élément neutre  $0$ ,  $-\infty$  en est l'unique éléments absorbant, et chaque nombre tropicale différent de  $-\infty$  possède un inverse.

En particulier le groupe multiplicatif  $\mathbb{T}^\times$  correspond au groupe  $(\mathbb{R}; +)$  et pour tout  $n \in \mathbb{N}$ , l'espace  $\mathbb{T}^n$  est homéomorphe à  $\mathbb{R}_+^n$ .

Le semi-corps tropical peut s'interpréter comme la structure algébrique des ordres de grandeur. Pour être plus précis on note  $\Theta$  l'ensemble des classes d'équivalence de fonctions continues  $f : \mathbb{R}_+ \rightarrow \mathbb{R}_+$  pour la relation d'équivalence  $f = \theta(g)$ . La fonction  $f$  est un  $\theta(g)$  s'il existe  $A \in \mathbb{R}_+$  et deux constantes  $c_1, c_2 \in \mathbb{R}_+$  pour

lesquelles on a  $c_1g(x) \leq f(x) \leq c_2g(x)$  pour tout  $x \geq A$ . On peut montrer que l'addition et la multiplication des fonctions induisent deux opérations sur  $\Theta$ . Ce faisant, l'application qui associe à  $a \in \mathbb{T}$  la classe d'équivalence de la fonction  $[t \mapsto t^a]$  est injective et respecte les structures algébriques de  $\mathbb{T}$  et  $\Theta$ . En ce sens le nombre tropical  $a$  représente le comportement asymptotique de la fonction  $[t \mapsto t^a]$ .

**Définition 1.5.2.** Comme on construit l'anneau des polynômes d'un corps on peut construire le semi-anneau des *polynômes tropicaux*  $\mathbb{T}[W]$ . Chaque élément de  $\mathbb{T}[W]$  correspond à une combinaison linéaire formelle des puissances de l'indéterminée  $W$  :

$$F(W) = \sum_{i=0}^k a_i W^i$$

L'addition est donnée par l'addition tropicale coefficients par coefficients et la multiplication par les formules de convolution des coefficients. Le polynôme  $P$  définit une fonction polynomial, notée par le même symbol  $P : \mathbb{T} \rightarrow \mathbb{T}$ . Pour tout nombre  $w \in \mathbb{T}$  la valeur de  $P$  en  $w$  est donnée par la formule suivante :

$$F(w) = \max_{0 \leq i \leq k} (a_i + iw).$$

Les fonctions polynomiales tropicales correspondent au fonctions convexes, affines par morceaux, et à pentes entières positives.

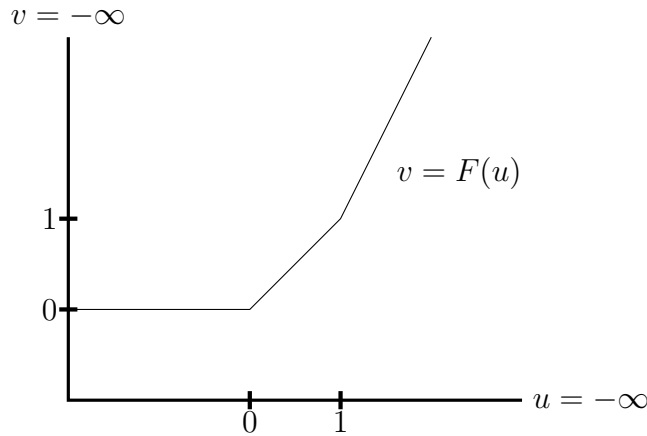

Figure 1.12: Le graphe de  $F = 0 +_{\mathbb{T}} 0W +_{\mathbb{T}} (-1)W^2$

Supposons que  $F$  est un polynôme tropical différent de  $-\infty$ . Pour tout  $t > 1$ , on peut lui associer un polynôme réel  $F_t(X) := \sum_{i=0}^k t^{a_i} X^i$ . Notons  $\text{Log}_t : \mathbb{R}_+^2 \rightarrow \mathbb{T}^2$  l'homéomorphisme qui à  $(x; y)$  associe  $(\log_t(x); \log_t(y))$ . Dans ces coordonnées, le graphe  $\Gamma_t$  de  $F_t$  restreinte à  $\mathbb{R}_+$  s'exprime comme le graphe de la fonction :

$$f_t : u \mapsto F(u) + \log_t \left( \frac{\sum_{i=0}^k t^{a_i + iu}}{t^{F(u)}} \right).$$

Pour tout  $u \in \mathbb{T}$ , le nombre  $\frac{\sum_{i=0}^k t^{a_i + iu}}{t^{F(u)}}$  est inférieur à  $k$ . Ainsi la fonction  $f_t$  converge uniformément vers  $F$  et l'image  $\text{Log}_t(\Gamma_t)$  converge au sens de la distance de Hausdorff

vers le graphe de  $F$ . D'une certaine façon un polynôme tropical représente un polynôme dont on ne se rappelle que les ordres de grandeur des coefficients. Ce phénomène de convergence s'inscrit de celui de la convergence des amibes et motivera la notion d'annulation des polynômes tropicaux en faisant le pont entre géométrie algébrique complexe et géométrie tropicale.

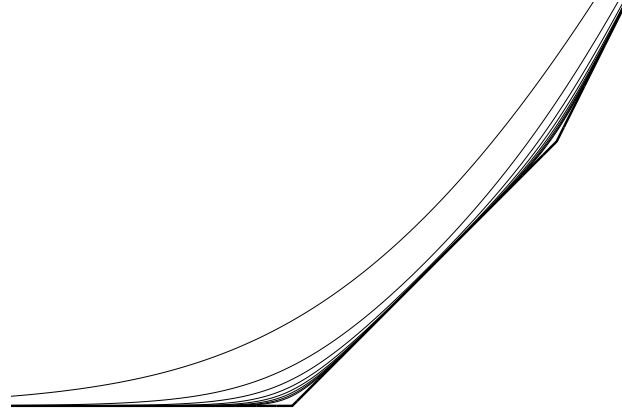

Figure 1.13: Convergence de  $\text{Log}_t(\Gamma_t)$  vers le graphe de  $F = 0 +_{\mathbb{T}} 0W +_{\mathbb{T}} (-1)W^2$ .

**Amibes.** Les amibes sont un concept antérieur à la géométrie tropicale. Un polynôme de Laurent complexe à  $n$  indéterminées est un élément de l'anneau  $\mathbb{C}[\mathbb{Z}^n]$ , c'est à dire un fonction régulière du tore complexe  $T := \text{Spec}(\mathbb{C}[\mathbb{Z}^n])$ . Le lieu complexe de ce tore est l'espace  $T(\mathbb{C}) = \text{Hom}(\mathbb{Z}^n; \mathbb{C}^\times)$ . Par extension de cette formule, on définit son *lieu tropical*  $T(\mathbb{T})$  comme étant l'espace vectoriel réel  $\text{Hom}(\mathbb{Z}^n; \mathbb{R})$  car le groupe multiplicatif  $\mathbb{T}^\times$  correspond au groupe  $(\mathbb{R}; +)$ . On pose  $t > 1$  un nombre réel. Le morphisme de groupes  $\log_t : z \in \mathbb{C}^\times \mapsto \log_t |z| \in \mathbb{R}$  induit un morphisme de groupes  $\log_t : T(\mathbb{C}) \rightarrow T(\mathbb{T})$  dont le noyau n'est autre que le tore compact  $T(S^1)$ .

**Définition 1.5.3** (I. Gelfand et al., [GKZ94], Definition 1.4 p.194). Soit  $F$  un polynôme de Laurent à  $n$  indéterminées et  $X$  l'hypersurface de  $T$  qu'il définit. L'*amibe* de  $X$  est le sous-ensemble  $\mathcal{A}_t(X)$  de  $T(\mathbb{T})$ , image par l'application  $\log_t$  du lieu complexe  $X(\mathbb{C})$  de  $X$ .

**Définition 1.5.4.** Le *polytope de Newton* de  $F$  est l'enveloppe convexe  $\text{PN}(F) \subset \mathbb{R}^n$  des points  $\alpha$  de  $\mathbb{Z}^n$  pour lesquels le coefficient du monôme  $x^\alpha$  dans  $F$  est non-nul.

**Théorème 1.5.5** (I. Gelfand et al., [GKZ94], Corollary 1.6 p.195 et Corollary 1.8 p.196, et M. Forsberg et al., [FPT00] Theorem 2.8 p.51). *Chaque composante connexe de  $\mathbb{R}^n \setminus \mathcal{A}_t(X)$  est convexe. De plus le nombre de celles-ci est au moins égale au nombre de sommets de  $\text{PN}(F)$  mais n'excède jamais le nombre de points entiers de  $\text{PN}(F)$ .*

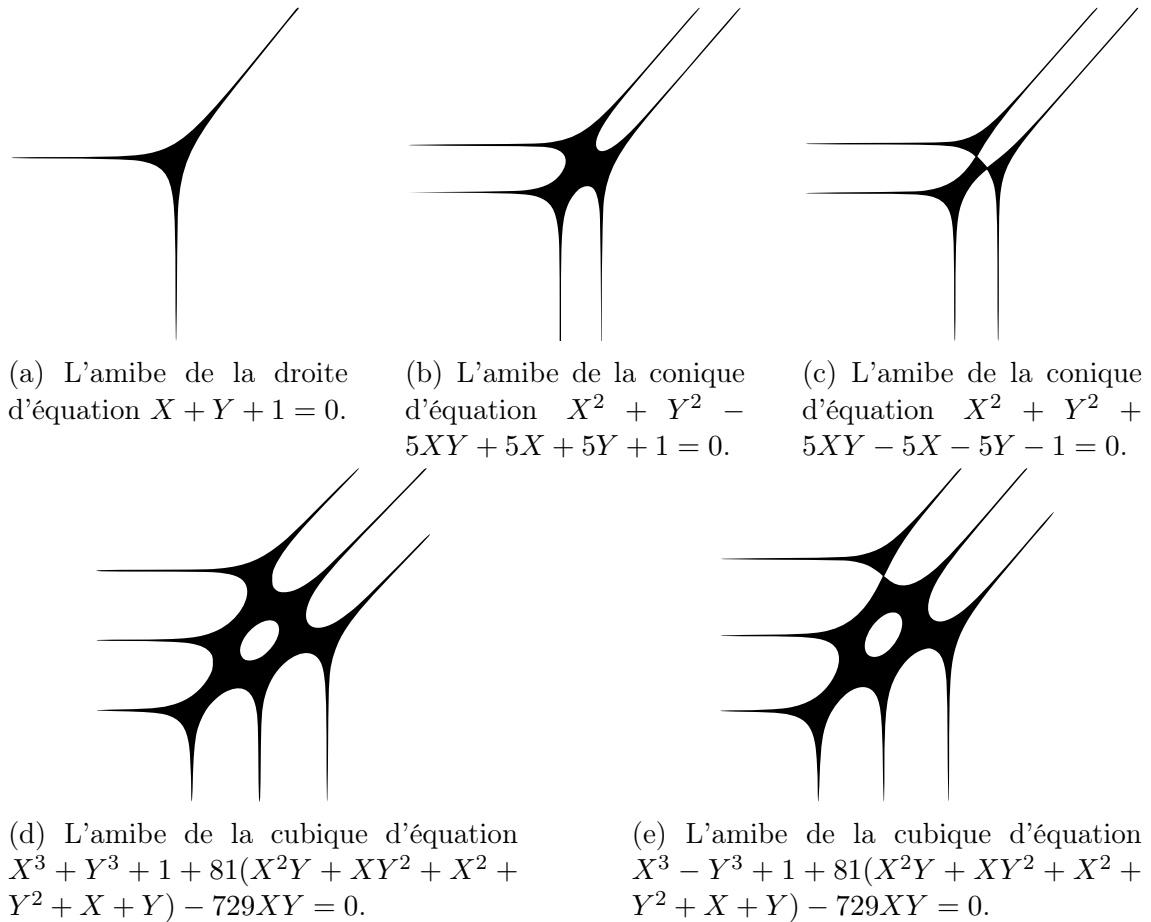

Figure 1.14: Une collection d'amibes planes.

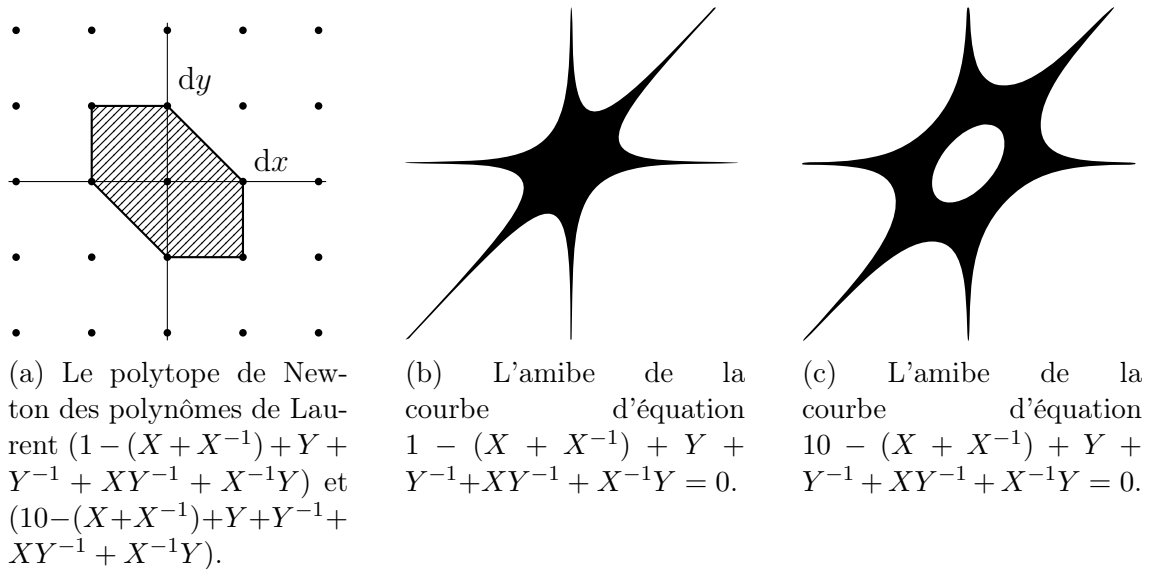

Figure 1.15: Deux amibes associées au même polytope de Newton avec un nombre de composantes complémentaires différent.

**Lieu d'annulation tropical.** Considérons à présent un polynôme de Laurent tropical  $F \in \mathbb{T}[\mathbb{Z}^n]$ . Comme dans le cas complexe, un tel polynôme est une combinaison linéaire formelle de points de  $\mathbb{Z}^n$  à coefficients dans  $\mathbb{T}$  où l'addition est définie

coefficients par coefficients et la multiplication par convolution. Un tel polynôme différent de  $-\infty$  définit une fonction continue à valeurs réels de  $T(\mathbb{T})$ . Notons  $F \neq -\infty$  de la manière suivante :

$$F := \sum_{\alpha \in A} a_{\alpha} X^{\alpha},$$

où  $A$  est un sous-ensemble fini de  $\mathbb{Z}^n$ . Si  $a_{\alpha}$  est différent de  $-\infty$  pour tout  $\alpha \in A$  on dit que  $A$  est le *support* de  $F$  et que l'enveloppe convexe de ce dernier  $\text{PN}(F)$  est son *polytope de Newton*. Si  $w$  est un élément de  $T(\mathbb{T}) = \text{Hom}(\mathbb{Z}^n; \mathbb{R})$ , son image par  $F$  est donnée par la formule suivante :

$$F(w) := \max_{\alpha \in A} (a_{\alpha} + \alpha(w)).$$

Les fonctions polynomiales tropicales du tore  $T(\mathbb{T})$  sont les fonctions convexes, affines par morceaux à pentes entières. Parallèlement on peut considérer le polynôme de Laurent complexe  $F_t \in \mathbb{C}[\mathbb{Z}^n]$ , défini de la manière suivante :

$$F_t := \sum_{\alpha \in A} t^{a_{\alpha}} X^{\alpha}.$$

On note  $X_t$  la sous-variété de  $T$  qu'il définit.

**Théorème 1.5.6** (H. Rullgård, [Rul01], Theorem 9 p.21 ou G. Mikhalkin, [Mik04], Corollary 6.4 p.1060). *La famille  $(\mathcal{A}_t(X_t))_{t>1}$  de sous-ensembles de  $T(\mathbb{T})$  converge au sens de la distance de Hausdorff vers le lieu de  $T(\mathbb{T})$  où la fonction définie par  $F$  n'est pas différentiable.*

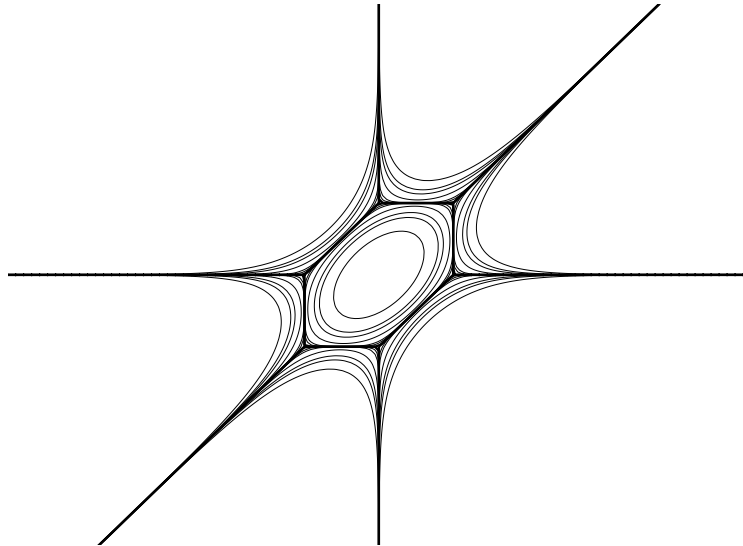

Figure 1.16: Convergence de la famille  $(\mathcal{A}_t(X_t))_{t>1}$  vers le lieu de non-différentiabilité de  $F$  (en gras).

Ce théorème motive la définition du lieu d'annulation de  $F$  comme étant ce lieu de non-différentiabilité. C'est à dire l'ensemble des  $w \in T(\mathbb{T})$  pour lesquels le maximum  $\max_{\alpha \in A} (a_{\alpha} + \alpha(w))$  est atteint pour au moins deux valeurs de  $\alpha$ . Cette



définition est aussi cohérente avec l'interprétation par ordres de grandeur que nous avons évoquée précédemment. En effet si le nombre tropical  $a_\alpha + \alpha(w)$  représente un nombre de module  $t^{a_\alpha + \alpha(w)}$  avec  $t$  très grand, alors la somme de ces nombres pour  $\alpha \in A$  ne peut s'annuler si le maximum de ces modules n'est atteint qu'une fois car les nombres dont le module n'est pas maximal sont négligeables devant les autres. En un certain sens si le nombre tropical  $w$  représente la famille des nombres complexes de module  $t^w$  avec  $t$  grand, une hypersurface tropicale  $X$  représente tout une famille d'hypersurfaces complexes. C'est une des interprétations possibles du théorème 1.5.6.

**Hypersurfaces tropicales d'une variété torique projective.** Dans le paragraphe précédent on a défini le lieu tropical du tore  $T := \text{Spec}(\mathbb{R}[\mathfrak{t}^*(\mathbb{Z})])$  comme l'espace des morphismes de monoïdes de  $\mathfrak{t}^*(\mathbb{Z})$  dans  $(\mathbb{T}; \times_{\mathbb{T}})$ , i.e.  $\text{Hom}(\mathfrak{t}^*(\mathbb{Z}); \mathbb{T}^\times)$  ou encore  $\mathfrak{t}(\mathbb{R})$ . De manière générale, on définit le *lieu tropical* d'une variété torique  $Y_\Sigma$  comme la limite inductive d'espaces topologiques suivante :

$$Y_\Sigma(\mathbb{T}) := \lim_{C \in \Sigma} \text{ind} \text{Hom}_{\text{Mon.}}(C^+ \cap \mathfrak{t}^*(\mathbb{Z}); (\mathbb{T}; \times_{\mathbb{T}})).$$

Pour tout réel  $t > 1$ , le monoïde  $(\mathbb{T}; \times_{\mathbb{T}})$  est isomorphe au monoïde  $(\mathbb{R}_+; \times)$  via l'application exponentielle de base  $t$ , cette dernière induit un homéomorphisme  $\exp_t : Y_\Sigma(\mathbb{T}) \rightarrow Y_\Sigma(\mathbb{R}_+)$ . On note  $\log_t$  l'homéomorphisme réciproque. Lorsque  $\Sigma$  est l'éventail dual d'un polytope  $P$ , l'espace  $Y_P(\mathbb{T})$  n'est encore qu'un autre avatar de l'espace topologique stratifié associé au polytope  $P$ . Il est peut-être quand même intéressant de noter que cette dernière représentation est munie d'une action de l'espace vectoriel  $\mathfrak{t}(\mathbb{R})$  correspondant au tore tropical  $T(\mathbb{T})$ . Les stabilisateurs de cette action sont des sous-espaces vectoriels. Ainsi les orbites de cette action sont naturellement des espaces affines réels. À chaque face  $Q$  de  $P$  correspond une orbite torique, c'est un espace affine de la dimension de  $Q$ , qui est envoyé sur l'intérieur relatif de  $Q$  via l'homéomorphisme  $\mu_P \circ \exp_t$ . L'espace  $Y_P(\mathbb{T})$  est une compactification de l'espace  $\mathfrak{t}(\mathbb{R})$  par ajout d'espaces affines à l'infini. Dans la figure 1.17, on a représenté le plan projectif tropical ainsi que l'adhérence des orbites de l'origine de  $\mathfrak{t}(\mathbb{R})$  pour l'action torique restreinte à certaines droites de  $\mathfrak{t}(\mathbb{R})$ .

**Définition 1.5.7.** Soit  $T$  un tore réel de dimension  $n$  et  $P$  un polytope entier de dimension  $n$  de  $\mathfrak{t}^*(\mathbb{R})$ . Une *section tropicale* de  $\mathcal{L}_P$  est un polynôme de Laurent tropical,  $F \in \mathbb{T}[\mathfrak{t}^*(\mathbb{Z})]$ , dont le support est contenu dans  $P$ . L'*hypersurface tropicale* de  $Y_P(\mathbb{T})$  définie par  $F$  est l'adhérence du lieu de non-différentiabilité de la fonction  $T(\mathbb{T}) \rightarrow \mathbb{T}$  définie par  $F$ . On dit que l'hypersurface tropicale  $X$  définie par  $F$  est *combinatoirement ample* si le polytope de Newton  $\text{PN}(F)$  de  $F$  est égal à  $P$ .

On trouvera dans La figure 1.18a un exemple de telle courbe tropicale. L'équation  $F$  d'une hypersurface tropicale  $X$  subdivise  $T(\mathbb{T})$  par ses domaines d'affinité. Chacun de ces domaines est un polyèdre. Cette subdivision est ce que l'on appelle un complexe de polyèdres. Pour rappel, un *polyèdre* de  $T(\mathbb{T})$  est l'intersection d'un nombre fini de demi-espaces. Les polytopes sont les polyèdres compacts. Un *com-*

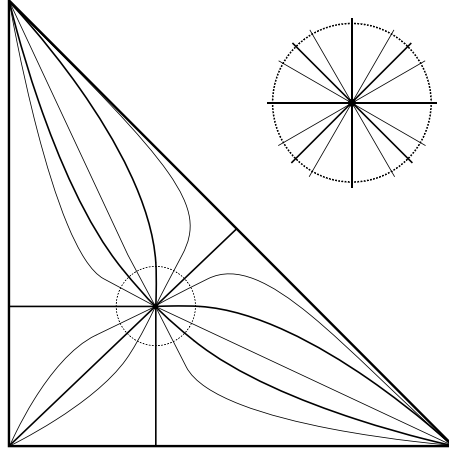

Figure 1.17: L'adhérence de certaines droites vectorielles dans le plan projectif tropical.

*plexe de polyèdres* est un ensemble de polyèdres contenant toutes les faces de ses membres et dont l'intersection de deux d'entre eux est une face de chacun. Ainsi l'intersection d'une hypersurface tropicale  $X$  avec le tore  $T(\mathbb{T})$  est par définition le squelette de codimension 1 de la subdivision de  $T(\mathbb{T})$ . C'est à dire la réunion de tous les polyèdres de dimension au plus  $(n - 1)$  de la subdivision.

**Définition 1.5.8.** Soit  $X$  une hypersurface tropicale combinatoirement ample de  $Y_P(\mathbb{T})$  d'équation  $F$  :

$$F := \sum_{\alpha \in P \cap \mathfrak{t}^*(\mathbb{Z})} a_\alpha X^\alpha.$$

On note  $K$  l'ensemble des images des faces compactes du polyèdre suivant :

$$\text{Conv}((\alpha; -a_\alpha) : \alpha \in P \cap \mathfrak{t}^*(\mathbb{Z}) \text{ tel que } a_\alpha \neq -\infty) + (\{0\} \times \mathbb{R}_+),$$

par la projection sur le premier facteur  $\mathfrak{t}^*(\mathbb{R}) \times \mathbb{R} \rightarrow \mathfrak{t}^*(\mathbb{R})$ .  $K$  est un complexe de polytopes qui subdivise  $P$ . On l'appelle la *subdivision duale* de  $F$ . Un exemple en est donné dans la figure 1.18b.

**Théorème 1.5.9** (G. Mikhalkin et J. Rau, [MR18] Theorem 2.3.7 p.44). *L'application  $\psi$  qui à un polyèdre  $D$  de  $T(\mathbb{T})$  subdivisé par  $F$  associe :*

$$\text{Conv}(\alpha \in P \cap \mathfrak{t}^*(\mathbb{Z}) \mid F|_D = (a_\alpha X^\alpha)|_D),$$

*est à valeurs dans la subdivision duale de  $F$ . C'est une bijection décroissante pour laquelle le tangent à  $\psi(D)$  est l'orthogonal du tangent à  $D$ .*

Ce théorème permet de montrer que l'hypersurface tropicale  $X$  est homéomorphe au support d'un sous-complexe de la subdivision barycentrique de la subdivision duale  $K$  de  $F$ . La subdivision barycentrique de  $K$  est donné par l'ensemble des enveloppes convexes des barycentres  $b_{e_1}, \dots, b_{e_k}$  pour toute suite croissante  $e_1 < \dots < e_k$  de polytopes de  $K$ .

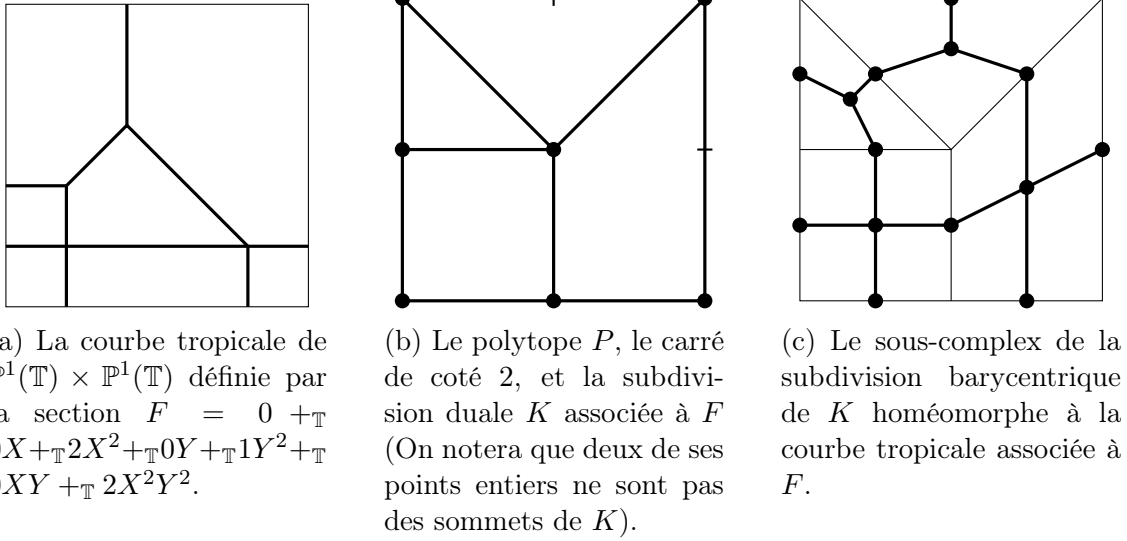

Figure 1.18: Un courbe tropicale singulière de bidegré  $(2; 2)$  dans le lieu tropical de  $\mathbb{P}^1 \times \mathbb{P}^1$ .

**Proposition 1.5.10.** *L'hypersurface combinatoirement ample  $X$  de  $Y_P(\mathbb{T})$  et d'équation  $F$  est homéomorphe à la réunion des simplexes barycentriques  $[b_{e_1}, \dots, b_{e_k}]$  associés à toutes suites croissantes  $e_1 < \dots < e_k$  de polytopes de  $K$ , pour lesquels  $e_1$  est de dimension au moins 1.*

La figure 1.18 illustre ce principe.

**Homologie tropicale.** La théorie de l'homologie tropicale<sup>17</sup>, introduite par I. Itenberg, L. Katzarkov, G. Mikhalkin, et I. Zharkov, définit une famille  $(F_p^X)_{p \geq 0}$  de faisceaux<sup>18</sup> associée à une variété tropicale  $X$ . L'idée est d'apparenter les groupes d'homologie  $(H_q(X; F_p^X))_{p, q \geq 0}$  aux duaux des groupes de Hodges d'un membre générique de la famille de variétés complexes représentée par  $X$ . Sous certaines hypothèses sur  $X$  ils montrent que les groupes  $(H_q(X; F_p^X))_{p, q \geq 0}$  sont duaux à certaines pièces graduées de la structure de Hodge mixte limite sur la cohomologie d'un membre générique de la famille de variétés représentée par  $X$ .

Lorsque  $P$  est un polytope non-singulier la famille de faisceaux duaux  $(F_P^p)_{p \geq 0}$  correspond aux images directes dérivées du faisceau constant par l'application logarithme  $\log_t |\cdot| : Y_P(\mathbb{C}) \rightarrow Y_P(\mathbb{T})$  (ou encore par l'application moment). Dans ce cas particulier les seuls groupes non-nuls sont les  $H^p(Y_P(\mathbb{T}); F_P^p)$  et la cohomologie tropicale est isomorphe à la cohomologie du lieu complexe  $Y_P(\mathbb{C})$ . Pour une hypersurface tropicale  $X$  de  $Y_P(\mathbb{T})$  il n'y a, en général, pas de manière de comparer les groupes  $(H^q(X; F_X^p))_{p, q \geq 0}$  avec des groupes de cohomologie du lieu complexe d'une hypersurface de  $Y_P$ . En revanche ces groupes de cohomologie et d'homologie tropicales d'une hypersurface vérifient la plupart des théorèmes satisfaits par la cohomologie du lieu complexe d'une hypersurface de  $Y_P$ .

<sup>17</sup>c.f. [IKMZ19].

<sup>18</sup>On peut y penser comme à un systèmes de coefficients variables.

**Théorème 1.5.11** (Sections hyperplanes de Lefschetz. C. Arnal, A. Renaudineau, et K. Shaw, [ARS21], Theorem 1.2 p.1349). *Soit  $X$  une hypersurface tropicale non-singulière et combinatoirement ample de la variété torique tropicale  $Y_P(\mathbb{T})$  non-singulière. L'inclusion  $i$  de  $X$  dans  $Y_P(\mathbb{T})$ , induit des applications en homologie  $i_{p,q} : H_q(X; F_p^X) \rightarrow H_q(Y_P(\mathbb{T}); F_p^P)$ . Ces applications sont des isomorphismes pour tout  $p + q < n - 1$  et surjectives pour tout  $p + q = n - 1$ .*

**Théorème 1.5.12** (Dualité de Poincaré, P. Jell, J. Rau, et K. Shaw, [JRS18], Theorem 5.3 p.16). *Soit  $X$  une hypersurface tropicale non-singulière et combinatoirement ample de la variété torique tropicale  $Y_P(\mathbb{T})$  non-singulière. Le cup produit en cohomologie tropicale induit une forme bilinéaire non dégénérée :*

$$H^q(X; F_X^p) \otimes_{\mathbb{Z}} H^{n-1-q}(X; F_X^{n-1-p}) \rightarrow H^{n-1}(X; F_X^{n-1}).$$

**Théorème 1.5.13** (Formules de Danilov-Khovanskiï. C. Arnal, A. Renaudineau, et K. Shaw, [ARS21], Corollary 1.6 p.1350 et Corollary 1.9 p.1351). *Soit  $X$  une hypersurface tropicale non-singulière et combinatoirement ample de la variété torique tropicale  $Y_P(\mathbb{T})$  non-singulière. Pour tout  $p, q \in \mathbb{N}$ ,  $H_q(X; F_p^X)$  est un groupe abélien libre. De plus le rang de  $H_q(X; F_p^X)$  égale la dimension de  $H^{p,q}(X(\mathbb{C}))$  où  $X(\mathbb{C})$  est une hypersurface non-dégénérée de  $Y_P(\mathbb{C})$  où  $P$  est le polytope de Newton de  $X$ .*

La proposition 1.5.10 permet de voir les faisceaux  $(F_X^p)_{p \geq 0}$  sur le sous-complexe homéomorphe à  $X$  de la subdivision duale  $K$ . On peut montrer que la donnée de la subdivision est suffisante pour définir les faisceaux  $(F_X^p)_{p \geq 0}$ . Leur définition s'étend à toutes les subdivisions de  $P$  par des polytopes entiers. Lorsqu'une subdivision de  $P$  en polytopes entiers est obtenue comme subdivision duale d'une équation  $F$  on dit qu'elle est *convexe*. E. Brugallé, L. Lop, et J.Rau montrèrent<sup>19</sup> que les trois théorèmes sus-cités sont encore vrais pour les triangulations primitives arbitraires de  $P$ . Ces trois théorèmes s'envisagent alors comme des cas particuliers de résultats portant sur la géométrie des triangulations d'un polytope plutôt que comme des théorèmes propres à la géométrie tropicale.

## 1.6 Patchwork de Viro

Soit  $T$  un tore algébrique réel de dimension  $n$ ,  $P$  un polytope entier de dimension  $n$  de  $\mathfrak{t}^*(\mathbb{R})$  et  $K$  une subdivision convexe de  $P$  en polytopes entiers. Par définition,  $K$  est obtenu par projection sur  $P$  des faces compactes d'un polyèdre  $P'$  de  $\mathfrak{t}^*(\mathbb{R}) \times \mathbb{R}$  qui satisfait  $P' + (\{0\} \times \mathbb{R}_+) = P'$ . On peut toujours supposer, sans modifier  $K$ , qu'un tel polyèdre est rationnel et même entier. Ainsi, c'est l'épigraphe d'une fonction  $\nu : P \rightarrow \mathbb{R}$  convexe, affine par morceaux et prenant des valeurs entières sur les points entiers de  $P$ .

**Définition 1.6.1.** Soit  $F = \sum_{\alpha \in P \cap \mathfrak{t}^*(\mathbb{Z})} a_{\alpha} x^{\alpha}$  une section de  $\mathcal{L}_P$ . Pour tout polytope

<sup>19</sup>c.f. [BLdMR22].

$e$  de  $K$  on note  $F^e$  la section de  $\mathcal{L}_e$  définie comme suit :

$$F^e = \sum_{\alpha \in e \cap \mathfrak{t}^*(\mathbb{Z})} a_\alpha x^\alpha.$$

La *carte* de  $F$  est la préimage  $C_P(F) \subset T(\pm 1) \times P$  par  $\phi_P^{\mathbb{R}}$  du lieu réel de l'hypersurface de  $Y_P$  définie par  $F$ .

**Théorème 1.6.2** (Patchwork. O. Viro, [Vir06] Theorem 4.3.A p.32, ou [Ris93], Théorème 4.2 p.75). *Soit  $F = \sum_{\alpha \in P \cap \mathfrak{t}^*(\mathbb{Z})} a_\alpha x^\alpha$  une section de  $\mathcal{L}_P$ . Pour tout  $t > 1$ , on note par  $F_t$  la section :*

$$F_t = \sum_{\alpha \in P \cap \mathfrak{t}^*(\mathbb{Z})} a_\alpha t^{-\nu(\alpha)} x^\alpha.$$

*Si pour tout  $e \in K$  de dimension  $n$ ,  $F^e$  est non-dégénéré alors il existe  $t_0 > 1$  tel que pour tout  $t > t_0$ , il existe un difféomorphisme stratifié de  $T(\pm 1) \times P$  qui envoie la réunion des cartes  $\bigcup_{\dim e=n} C_e(F^e)$  sur la carte  $C_P(F_t)$ . Dans ce cas on dit que l'hypersurface définie par  $F_t$  pour  $t$  grand est obtenue par patchwork des hypersurfaces d'équations  $(F^e)_{\dim e=n}$ . On dit que  $F$  est la donnée du patchwork.*

Ce théorème permet de découper et de recoller des hypersurfaces algébriques afin d'en obtenir une nouvelle. Comme exemple nous allons utiliser ce théorème pour construire une quartique plane à trois composantes connexes à partir de deux coniques et d'une courbe de bidegré (2;2) de  $\mathbb{P}^1 \times \mathbb{P}^1$ . On peut découper le triangle non-singulier de taille 4 en un carré  $C$  de taille 2 et deux triangles non-singuliers  $P_1, P_2$  de taille 2 comme indiqué dans la figure 1.20a. Cette subdivision est convexe. Dans  $C$  on considère la courbe définie par la section  $F = -1 + x^{2dx} + x^{2dy} + x^{2dx+2dy}$ . En coordonnées bihomogènes  $([x : \bar{x}]; [y : \bar{y}])$ , cette section correspond au polynôme  $x^2 y^2 + x^2 \bar{y}^2 + y^2 \bar{x}^2 - \bar{x}^2 \bar{y}^2 = (x^2 + \bar{x}^2)(y^2 + \bar{y}^2) - 2\bar{x}^2 \bar{y}^2$ . Dans  $P_1$  on considère la section  $G_1 = x^{2dx} + x^{2dx+2dy} - x^{4dx}$ , dont l'hypersurface a pour équation homogène  $z^2 + y^2 - x^2 = 0$ . Dans  $P_2$  on considère  $G_2 = x^{2dy} + x^{2dx+2dy} - x^{4dy}$ , dont l'hypersurface a pour équation homogène  $z^2 + x^2 - y^2 = 0$ . La figure 1.19 représente les lieux réels de ces courbes dans leur variétés toriques respectives ainsi que leurs cartes. Dans la figure 1.20b on procède au recollement de ces dernières. On obtient ainsi une quartique à trois composantes connexes.

**Patchwork Combinatoire.** Le patchwork combinatoire est la restriction du théorème 1.6.2 aux *triangulations primitives convexes*. Une triangulation primitive convexe d'un polytope entier  $P$  en est une subdivision convexe en polytopes dont tous les polytopes sont des simplexes primitifs. On notera qu'ici l'ensemble des sommets de ces simplexes correspond exactement à l'ensemble  $P \cap \mathfrak{t}^*(\mathbb{Z})$ . Dans ce cas les pièces du patchwork sont toutes des hyperplans projectifs et seuls les signes des coefficients des sections ont une réelle influence sur la topologie de l'hypersurface obtenue. Soit  $\sigma^n$  un simplexe primitif de dimension  $n$  de  $\mathfrak{t}^*(\mathbb{R})$ . Les sommets de ce simplexe sont, à translation près, de la forme  $0, dx_1, \dots, dx_n$ , où  $dx_1, \dots, dx_n$  est une

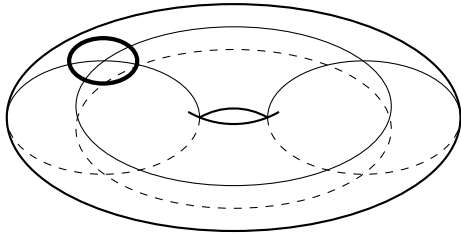

(a) Le lieu réel d'une courbe de bidegré  $(2, 2)$  d'équation  $F$  de  $\mathbb{P}^1 \times \mathbb{P}^1$ .

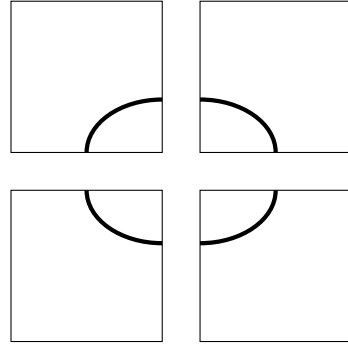

(b) La carte de  $F$ .

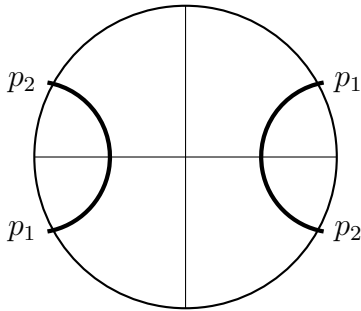

(c) Le lieu réel d'une conique d'équation  $G_1$  de  $\mathbb{P}^2$ .

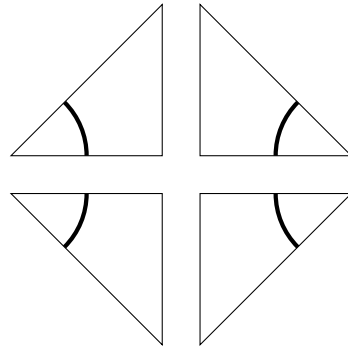

(d) La carte de  $G_1$ .

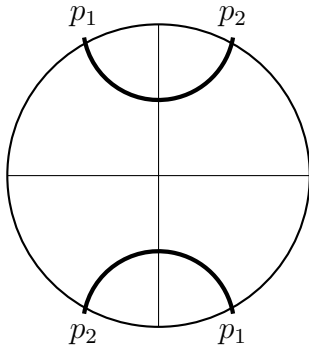

(e) Le lieu réel d'une conique d'équation  $G_2$  de  $\mathbb{P}^2$ .

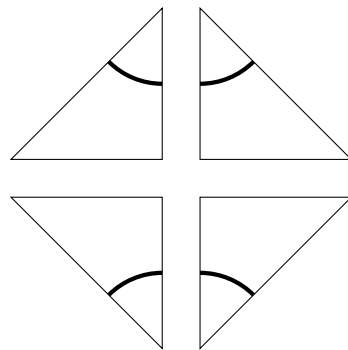

(f) La carte de  $G_2$ .

Figure 1.19: Les lieux réels et les cartes de quelques courbes.

base du réseau  $\mathfrak{t}^*(\mathbb{Z})$ . Dans ce cas l'hypersurface associée à la section  $a_0 + \sum_{i=1}^n a_i x^{d_i}$  correspond à l'hyperplan projectif  $H$  d'équation homogène  $a_0 X_0 + \sum_{i=1}^n a_i X_i = 0$ . Cette section est non-dégénérée si et seulement si aucun des coefficients  $(a_i)_{0 \leq i \leq n}$  n'est nul. De plus, le point  $x$  de  $Y_{\sigma^n}(\mathbb{R}_+)$  est envoyé par l'application moment sur le point de coordonnées barycentriques  $(\frac{x_i}{\sum_{0 \leq i \leq n} x_i})_{0 \leq i \leq n}$ . Inversement, le point  $p$  de  $\sigma^n$  de coordonnées barycentriques  $(x_i)_{0 \leq i \leq n}$  correspond au point de coordonnées homogènes  $[x_0 : \dots : x_n]$ . Donc l'image  $\mu_P(H(\mathbb{R}) \cap Y_{\sigma^n}(\mathbb{R}_+))$  correspond à l'intersection du simplex  $\sigma^n$  avec l'hyperplan affine d'équation  $a_0 X_0 + \sum_{i=1}^n a_i X_i = 0$  en coordonnées barycentriques. À isotopie près il s'agit de l'unique hyperplan séparant les points de  $\sigma^n$  de coefficient positif de ceux de coefficient négatif. Considérons à

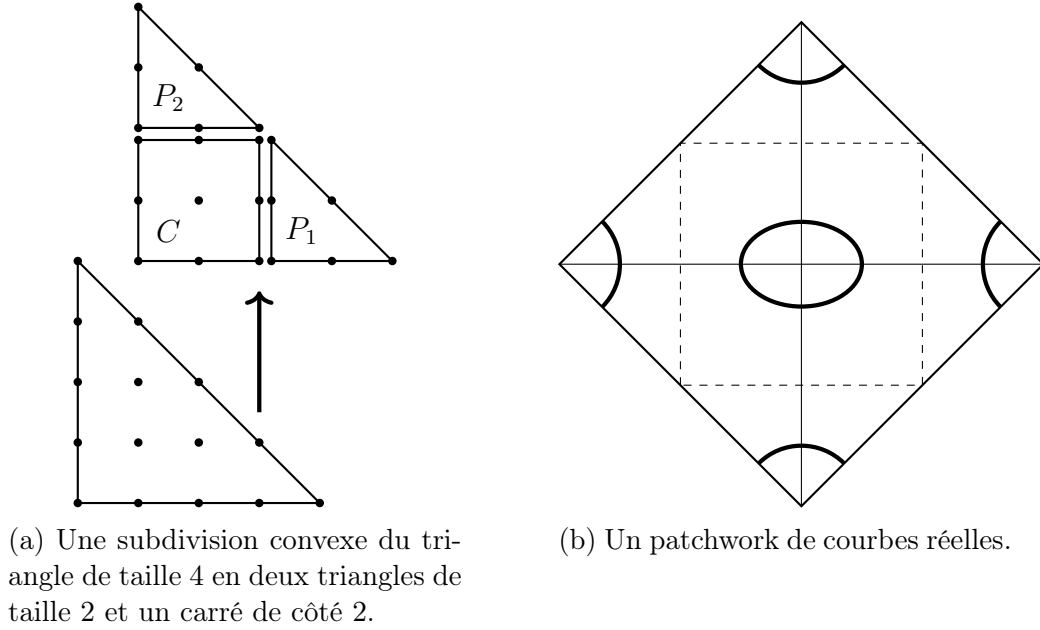

Figure 1.20: Une subdivision du triangle de taille 4 et une quartique plane obtenue comme patchwork sur cette subdivision.

présent  $v \in T(\pm 1)$ . L'image par l'application moment des points de  $H(\mathbb{R})$  contenus dans  $v \cdot Y_{\sigma^n}(\mathbb{R}_+)$  correspond à l'image des points de  $H^v(\mathbb{R}) \cap Y_{\sigma^n}(\mathbb{R}_+)$  où  $H^v$  est l'hyperplan obtenu en précomposant l'équation de  $H$  par l'action de  $v$ . Les coordonnées  $(dx_i)_{1 \leq i \leq n}$  induisent un isomorphisme entre  $T(\pm 1)$  et  $\{\pm 1\}^n$ , et la nouvelle équation obtenue est  $a_0 X_0 + \sum_{i=1}^n v_i a_i X_i = 0$ . Ainsi l'image moment des points de  $H(\mathbb{R})$  contenus dans le quadrant correspondant à  $v$  sépare les sommets de  $P$  à coordonnées positives des autres après avoir convenablement modifiés ces derniers par l'action de  $v$ . Dans la suite on utilisera l'isomorphisme de groupe suivant :

$$\begin{aligned} \mathfrak{t}(\mathbb{F}_2) &\longrightarrow T(\pm 1) = \text{Hom}(\mathfrak{t}^*(\mathbb{Z}); \{\pm 1\}) \\ v &\longmapsto [\alpha \mapsto (-1)^{\alpha(v)}], \end{aligned}$$

pour représenter les éléments du tore réel unitaire.

**Définition 1.6.3.** Soit  $P$  un polytope non-singulier de dimension  $n$  de  $\mathfrak{t}^*(\mathbb{R})$  et  $K$  une triangulation primitive convexe de  $P$ . Une *distribution de signes* sur  $K$  est une cochaîne  $\varepsilon \in C^0(K; \mathbb{F}_2)$ . C'est à dire une fonction de l'ensemble des sommets de  $K$  vers  $\mathbb{F}_2$  le corps à deux éléments. Le *patchwork combinatoire* associé à  $(K; \varepsilon)$  est l'hypersurface  $\mathbb{R}X_\varepsilon$  obtenue par patchwork à partir de la donnée  $\sum_{\alpha \in P} (-1)^{\varepsilon(\alpha)} \mathbf{x}^\alpha$ , c'est à dire l'image dans  $Y_P(\mathbb{R})$  du recollement des cartes.

Le patchwork des cartes associées à un patchwork combinatoire s'obtient simplement en observant la règle précédemment décrite dans chacun des simplexes composant  $K$ . Pour en donner un exemple supposons que  $\mathfrak{t}^*(\mathbb{Z})$  est muni d'une base, on le voit donc comme  $\mathbb{Z}^n$ . De même  $\mathfrak{t}(\mathbb{F}_2)$  est isomorphe à  $\mathbb{F}_2^n$  via la base duale et chacune des copies de  $P$  de la carte  $\phi_P^{\mathbb{R}}$  est indexée par un  $n$ -uplet de nombres de  $\mathbb{F}_2$ . On appelle ces dernières les *cadran*s de la carte. Le patchwork des cartes de  $(K; \varepsilon)$  dans

le quadrant positif  $(0, \dots, 0)$  correspond à l'hypersurface obtenue en prenant l'union pour chaque  $\sigma^n \in K$  de l'enveloppe convexe des milieux ses arêtes  $\sigma^1 \leq \sigma^n$  portant des coefficients de signes opposés, i.e. pour lesquels  $d\varepsilon(\sigma^1) = 1$ . Pour obtenir la carte totale il faut répéter cette opération  $2^n$  fois en modifiant les signes dans chaque quadrant. Dans le quadrant  $v$ , le sommet  $\alpha$  doit à présent porter le signe  $(-1)^{\varepsilon(\alpha)+\alpha(v)}$ . Passer du quadrant  $(0, \dots, 0)$  au quadrant  $v = (1, 0, \dots, 0)$  correspond à appliquer la réflexion  $[x_1 \mapsto -x_1]$ . La règle de changement de signes s'interprète alors de la manière suivante : le sommet de coordonnées entières  $(m_1, \dots, m_n)$  correspond au monôme  $x_1^{m_1} \dots x_n^{m_n}$ , donc son coefficient dans le quadrant  $v$  doit être multiplié par  $(-1)^{m_1}$ . Il suffit ensuite de répéter l'opération jusqu'à avoir visité tous les quadrants et ensuite de recoller ces derniers dans  $Y_P(\mathbb{R})$ . La figure 1.21 illustre cette procédure.

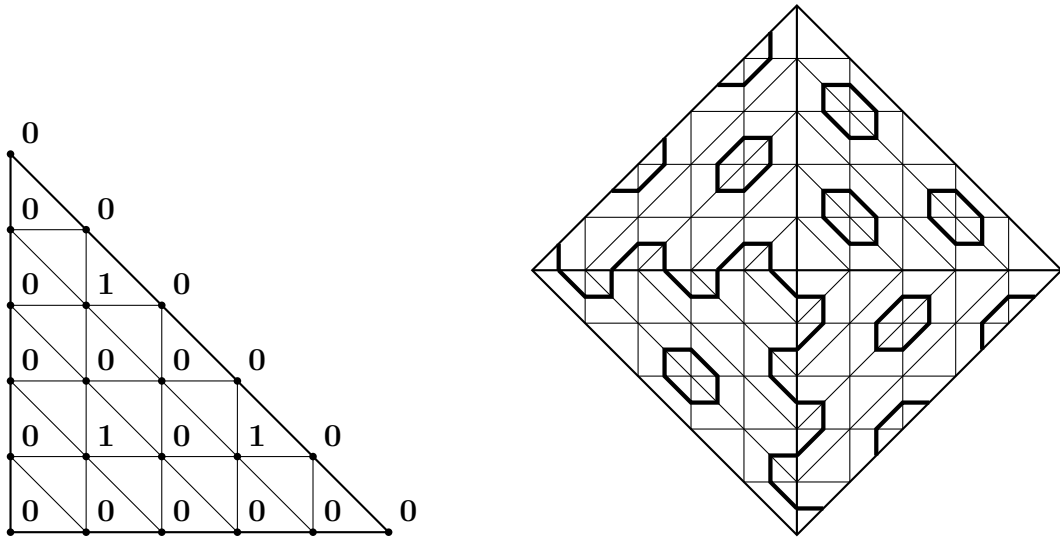

(a) Une distribution de signe sur une subdivision convexe du triangle de taille 5. (b) Le patchwork combinatoire associé.

Figure 1.21: Le patchwork combinatoire d'une quintique plane maximale.

Le théorème de Viro nous dit que ces hypersurfaces de  $Y_P(\mathbb{R})$  obtenues par recollage de polytopes sont réalisables comme lieux réels d'hypersurfaces algébriques. En particulier elles satisfont l'inégalité de Smith-Thom au sens suivant :

$$\sum_{q \geq 0} \dim H^q(\mathbb{R}X_\varepsilon; \mathbb{F}_2) \leq \sum_{q \geq 0} \dim H^q(X_t(\mathbb{C}); \mathbb{F}_2),$$

où  $X_t$  désigne l'hypersurface algébrique associée au patchwork pour  $t$  très grand. Comme  $X_t$  est non-dégénérée, ses nombres de Hodge sont calculés par les formules de Danilov-Khovanskiï et ne dépendent que du polytope  $P$ . A fortiori, il en va de même pour ses nombres de Betti. Notons ces nombres  $h^{p,q}(X)$ . L'inégalité de Smith-Thom se réécrit alors sous la forme suivante :

$$\sum_{q \geq 0} \dim H^q(\mathbb{R}X_\varepsilon; \mathbb{F}_2) \leq \sum_{p,q \geq 0} h^{p,q}(X).$$

Les patchworks combinatoires vérifient en réalité une famille d'inégalités plus forte



que cette dernière.

**Théorème 1.6.4** (A. Renaudineau et K. Shaw, [RS23], Theorem 1.4 p.3). *Soit  $\mathbb{R}X_\varepsilon$  un patchwork combinatoire de  $Y_P(\mathbb{R})$ . Pour tout  $q \geq 0$ , on a l'inégalité suivante :*

$$\dim H^q(\mathbb{R}X_\varepsilon; \mathbb{F}_2) \leq \sum_{p \geq 0} h^{p,q}(X).$$

Ces inégalités se déduisent du calcul de la cohomologie de  $\mathbb{R}X_\varepsilon$  à l'aide d'une suite spectrale dont les groupes de la première page correspondent aux groupes de cohomologie tropicale d'une hypersurface tropicale duale à  $K$ .

## 1.7 T-hypersurfaces et plan de la thèse

Considérons  $P$  un polytope non-singulier. La construction de l'hypersurface  $\mathbb{R}X_\varepsilon$  de  $Y_P(\mathbb{R})$  associée à la triangulation primitive convexe  $K$  et à la distribution de signes  $\varepsilon$  ne fait pas intervenir la convexité de  $K$ . Elle s'étend naturellement à toutes les triangulations primitives  $K$  munies d'une distribution de signes  $\varepsilon \in C^0(K; \mathbb{F}_2)$ . On appelle une telle hypersurface une *T-hypersurface* de  $Y_P(\mathbb{R})$ . À la différence des patchworks combinatoires ces hypersurfaces ne sont pas a priori réalisable par des lieux réels d'hypersurfaces algébriques. Cependant ces dernière satisfont toujours les inégalités du théorème 1.6.4 et la suite spectrale est toujours bien définie en utilisant l'extension de la définition de la cohomologie tropicale à la triangulation  $K$  non-nécessairement convexe. Même si le théorème de Viro ne s'applique pas à ces dernières elles sont semblable en beaucoup d'aspects aux patchworks combinatoires. Ainsi on mènera leur étude dans le prisme de la géométrie réelle.

Le chapitre 2 traite des complexes cellulaires réguliers, de certaines de leur subdivisions et de la cohomologie des faisceaux cellulaires (et de l'homologie de leur objets duaux). On y démontrera notamment un énoncé du type de la dualité de Poincaré-Lefschetz pour ces faisceaux.

Le chapitre 3 traite de l'homologie tropicale des subdivision polyédrale. On y introduit l'homologie tropicale d'un polytope entier  $P$  ainsi que de ses subdivisions en polytopes entiers. On y discutera l'analogie du théorème des sections hyperplanes de Lefschetz, c'est à dire la nature de certaines applications naturelles entre l'homologie tropicale d'une subdivision de  $P$  et l'homologie tropicale de  $P$ .

Dans le chapitre 4 on abordera les T-hypersurfaces. On y introduira la suite spectrale d'A. Renaudineau et K. Shaw et on montra que sa suite duale est un anneau spectral satisfaisant la dualité de Poincaré à partir de la première page. Ce résultat répond à une conjecture formulée par la plupart des personnes intéressées au domaine. Il nous permettra aussi de caractériser la dégénérescence de la suite spectrale en fonction de propriétés cohomologiques de l'inclusion de la T-hypersurface dans le lieu réel de la variété torique ambiante. Ce chapitre se concentre principalement sur l'étude des pages de rang au moins 2 de la suite spectrale.

Dans le chapitre 5, nous nous intéresserons spécifiquement à la première page de la suite spectrale d'A. Renaudineau et K. Shaw. On y calculera tous les opérateurs de bord, ce qui nous permettra d'établir une généralisation du théorème de B. Haas. Nous caractériserons l'ensemble des distributions de signes d'une triangulation pour lesquelles on a l'égalité :

$$\dim H^0(\mathbb{R}X_\varepsilon; \mathbb{F}_2) = \sum_{p \geq 0} h^{p,0}(X). \quad (1.3)$$

Cette caractérisation nous permet de dégager une propriété qu'une triangulation doit nécessairement satisfaire pour pouvoir posséder une distribution de signe  $\varepsilon$  satisfaisant (1.3). Nous répondrons partiellement à la réciproque en énonçant qu'une triangulation satisfaisant certaines propriétés supplémentaires possédera toujours une telle distribution.

# Chapter 2

## Sheaves and Cosheaves on CW-Complexes

CW-complexes were introduced by J. H. C. Whitehead in *Combinatorial homotopy. I*, [Whi49]. Their underlying topological spaces, their *supports*, form a broad family of spaces usually considered well-behaved. Some of the sheaves defined on their support are particularly adapted to their structure. They can be described by a relatively small amount of data and their cohomology can be computed with the techniques of cellular cohomology. In the following chapter we give a succinct presentation of these objects.

### 2.1 CW-Complexes

**Definition 2.1.1** (CW-complex). A *CW-complex*  $K$  is the data of a Hausdorff topological space  $|K|$ , called the *support* of  $K$ , filtered by closed subsets:

$$\emptyset = K^{(-1)} \subset K^{(0)} \subset \dots \subset K^{(k)} \subset \dots \subset |K|,$$

called the *skeleta* of  $K$  whose union covers  $|K|$ . The filtration has to satisfy the following additional properties:

1. For every  $k \geq 0$  and every connected component  $e^k$  of  $K^{(k)} \setminus K^{(k-1)}$ , called an *open  $k$ -cell*, there exists a surjective continuous map from the closed  $k$ -dimensional ball onto the closure of  $e^k$  carrying homeomorphically the open ball onto  $e^k$ . Such a map is called a *characteristic map* of the open cell  $e^k$ ;
2.  $|K|$  has the weak topology: *a subset  $A \subset |K|$  is closed if and only if its intersection  $A \cap \bar{e}^k$  with every closed cell is closed*;
3. Every skeleton  $K^{(k)}$  has the weak topology in the same sense as in point 2.

We may write  $e^k \in K$  to denote that  $e^k$  is an open  $k$ -cell of  $K$ . The *dimension* of  $K$ ,  $\dim K$ , is the smallest integer, if any, from which the filtration  $(K^{(k)})_{k \geq -1}$  is stationary. If there is none we say that the dimension of  $K$  is  $+\infty$ . A *sub-complex*  $L$

of  $K$  is determined by a closed subset  $|L|$  for which the induced filtration:

$$\emptyset = L^{(-1)} \subset L^{(0)} \subset \dots \subset L^{(k)} \subset \dots \subset |L| \text{ with } L^{(k)} := |L| \cap K^{(k)} \text{ for all } k \in \mathbb{N},$$

turns it into a CW-complex of its own right. The intersection of sub-complexes is again a sub-complex. For any subset  $A$  of  $|K|$  we set  $K(A)$  to be the smallest sub-complex containing  $A$  in its support i.e. the intersection of all sub-complexes containing  $A$  in their support.

Classical examples of CW-complexes are given by real projective spaces. They filter themselves  $\mathbb{P}^0(\mathbb{R}) \subset \mathbb{P}^1(\mathbb{R}) \subset \dots \subset \mathbb{P}^n(\mathbb{R})$  by inclusion on the first coordinates. The induced partition of  $\mathbb{P}^n(\mathbb{R})$  into open cells corresponds to a decomposition into affine spaces, one for every  $0 \leq k \leq n$ , c.f. (1.1). By extension, the inductive limit  $\mathbb{P}^\infty(\mathbb{R})$  is also a CW-complex for the induced filtration. Other examples of CW-complexes are given by complexes of polytopes. We recall their definition:

**Definition 2.1.2** (Complex of Polytopes). A *complex of polytope* of a real affine space  $E$  is a collection  $K$  of polytopes<sup>1</sup>  $E$  that contains all the faces of its members and in which two distinct polytopes intersect on a common face (which might be empty). When all the polytopes of  $E$  are simplices we may call  $E$  a *triangulation*.

Triangulations arise naturally as geometric realisations of simplicial complexes. In particular, as sub-complexes of simplices.

**Definition 2.1.3** (Simplicial Complex, [Whi39]). A *simplicial complex*  $K$  is a non-empty set endowed with an increasing filtration  $(K^{(k)})_{k \geq -1}$  such that:

1.  $K^{(-1)}$  is the set  $\{\emptyset\}$ ;
2. for all  $k \geq 1$ , every element  $\sigma^k$  of  $K^{(k)} \setminus K^{(k-1)}$  is a set of  $(k + 1)$  elements of  $K^{(0)}$ ;
3. for all  $\sigma \in K$ , every subset of  $\sigma$  belongs to  $K$ ;
4.  $K$  is the union of the sets  $(K^{(k)})_{k \geq -1}$ .

Let  $k \geq 0$  be an integer. The elements of  $K^{(k)} \setminus K^{(k-1)}$  are called the *k-simplices* of  $K$ . A 0-simplex is called a *vertex* of  $K$ , a 1-simplex an *edge*, a 2-simplex a *triangle*, and a 3-simplex a *tetrahedron*. The *geometric realisation* of  $K$ , denoted by  $|K|$ , is the union of the convex hulls of its simplices in the real vector space freely generated by its vertices.

**Definition 2.1.4.** A CW-complex is called *locally finite* if all of its points has a neighbourhood that meets only finitely many open cells.

Any *finite* (with finitely many cells) CW-complex is obviously locally finite. Among our examples,  $\mathbb{R}P^\infty$  is not locally finite for the neighbourhood of a point in the open cell  $\mathbb{R}^k$  will meet all the open cells  $\mathbb{R}^n$  for all  $n \geq k$ .

---

<sup>1</sup>a convex hull of a finite number of vertices.

**Proposition 2.1.5** (J. H. C. Whitehead. *Combinatorial homotopy. I* [Whi49], (G), pp.225-227, (M), pp.230-231.). *A CW-complex is a normal and locally contractible topological space.*

**Definition 2.1.6.** A *regular* CW-complex is one that admits for each cell a characteristic map that is a homeomorphism on the entire closed ball.

In particular, every closed cell of a regular CW-complex is homeomorphic to a closed ball. It excludes the CW-complex structure of the real projective spaces (except  $\mathbb{P}^0(\mathbb{R})$ ) given by affine spaces for every positive dimensional closed cell is a projective space (different from a closed ball). An important example of regular CW-complex is given by geometric realisations of simplicial complexes for which every closed cell is a closed simplex, hence topologically a closed ball. Likewise a polyhedral complex is necessarily a regular CW-complex.

In a general CW-complex the formula  $e_1 \leq e_2 \iff \bar{e}_1 \subset \bar{e}_2$  defines an order on the cells. When the CW-complex is regular this order shares the same properties as the inclusion of faces in a simplicial complex.

**Lemma 2.1.7** ([CF67], R.R.1, pp.229-230). *For any two open cells  $e_1, e_2$  of  $K$  a regular CW-complex,  $e_1$  meets the closure of  $e_2$  if and only if it is fully contained in it:*

$$e_1 \cap \bar{e}_2 \neq \emptyset \iff e_1 \subset \bar{e}_2.$$

Therefore, in a regular CW-complex, whenever a cell  $e_1$  meets the closure of another one  $e_2$  we have  $e_1 \leq e_2$  and we say that  $e_1$  is a *face* of  $e_2$ . If  $e_1$  is distinct from  $e_2$  we say that  $e_1$  is a *proper face* of  $e_2$  and denote it by  $e_1 < e_2$ . Furthermore, if  $e_1 \leq e_2$  or  $e_2 \leq e_1$  we say that  $e_1$  and  $e_2$  are *adjacent*.

**Lemma 2.1.8** ([CF67], Proposition 1.6, p.30). *Let  $K$  be a regular CW-complex and  $e$  be an open cell of  $K$ . The support of the sub-complex  $K(e)$  is the topological closure  $\bar{e}$  of  $e$ .*

**Lemma 2.1.9** ([CF67], Theorem 4.2, pp.231-232). *Let  $k \in \mathbb{N}$  and  $e^{k+2}$  be an open cell of  $K$  a regular CW-complex. For all faces  $e^k$  of  $e^{k+2}$  there are exactly two  $(k+1)$ -cells adjacent to both of them:*

$$\text{card}\{e^{k+1} \mid e^k < e^{k+1} < e^{k+2}\} = 2.$$

**Lemma 2.1.10** (Open Star, [CF67], Lemma 4.1, p.230). *For all cells  $e$  of a regular CW-complex  $K$  the union of all the cells having  $e$  as a face, called the open star of  $e$ , is an open subset of  $|K|$ . We may denote it by  $\text{St}(e; K)$ .*

**Definition 2.1.11.** In a locally finite regular CW-complex  $K$  the open star of a cell is a finite union of cells. Hence its closure, the *closed star* of the cell, is a finite sub-complex of  $K$ . The collection  $K - e$  of all the cells whose closure avoid  $e$  is the complement of the open star of  $e$  and is a sub-complex of  $K$ . Its underlying topological space is a deformation retract of  $|K| \setminus e$  and is the largest sub-complex of  $K$  contained in the complement  $|K| \setminus e$ . Likewise we define for all subsets  $A$  of  $|K|$ ,  $K - A$  to be the largest sub-complex of  $K$  contained in  $|K| \setminus A$ .

**Definition 2.1.12.** Let  $K$  be a simplicial complex and  $\sigma$  be a simplex of  $K$ . The *link* of  $\sigma$  in  $K$  is the sub-complex  $\text{lk}(\sigma; K)$  of the simplices of the closed star of  $\sigma$  that are disjoint from it. If  $\sigma'$  belongs to  $\text{lk}(\sigma; K)$ , the *join* of  $\sigma$  and  $\sigma'$  is the smallest simplex  $\sigma * \sigma'$  that contains both of them.

We will consider the following slight generalisation of simplicial complexes.

**Definition 2.1.13.** We say that a regular CW-complex  $K$  is a  $\Delta$ -*complex* if for all  $e \in K$ , the complex  $K(e)$  is isomorphic to a simplex.

**Definition 2.1.14** (Subdivisions). A *subdivision*  $K'$  of a CW-complex  $K$  is a CW-complex on the same support  $|K'| = |K|$  in which every cell  $e' \in K'$  is contained in a cell  $e \in K$ . Another way of saying it is that the partition of  $|K|$  into open cells of  $K'$  is finer than the partition given by  $K$ .

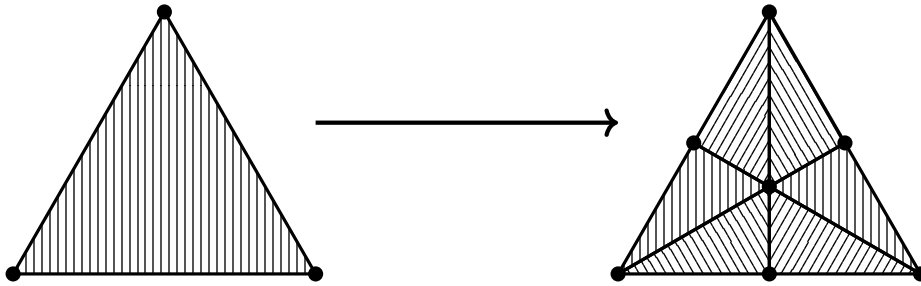

Figure 2.1: The barycentric subdivision of the triangle.

A common example of subdivisions is given by the *barycentric subdivision*  $\text{Sd } S$  of a simplicial complex  $S$ , see for instance Figure 2.1. It is described abstractly as follows: the vertices of  $\text{Sd } S$  are given by the simplices of  $S$  and the simplices of  $\text{Sd } S$  by the flags of simplices of  $S$ . More concretely a collection of simplices of  $S$ , say  $\{\sigma_0, \dots, \sigma_k\}$ , is a simplex of  $\text{Sd } S$  if and only if they can be totally ordered by adjacency i.e. there is a permutation  $\pi$  of the indices  $\{0, \dots, k\}$  such that:

$$\sigma_{\pi(0)} < \dots < \sigma_{\pi(k)}.$$

One can define an homeomorphism between the geometric realisation of  $\text{Sd } S$  and the geometric realisation of  $S$  by sending each vertex of  $\text{Sd } S$  to the barycenter of its corresponding simplex in  $S$  and extending such map by linearity. An example of such homeomorphism is depicted in Figure 2.2.

The image of the skeletal filtration of  $\text{Sd } S$  under such homeomorphism defines a subdivision of the CW-complex induced by  $S$  in the sense of the previous definition. Note that if instead we chose to send each vertex of  $\text{Sd } S$  to an arbitrary point in the open cell defined by the corresponding simplex in  $S$  (and then extending the map by linearity) we would also have defined a subdivision of  $S$ , equivalent in a combinatorial way to the previous one. We could say that the barycentric subdivision is only defined unequivocally on the abstract level. The same abstract procedure can be performed with a regular CW-complex  $K$ .

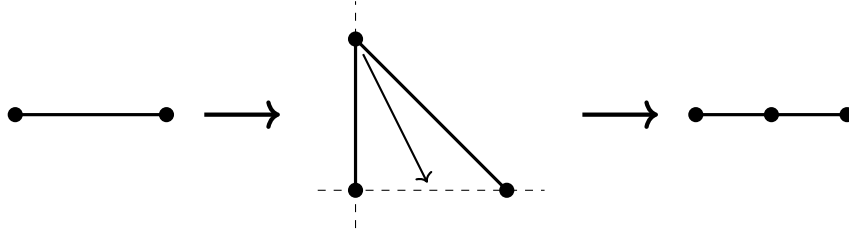

Figure 2.2: The homeomorphism from the barycentric subdivision of the segment to the initial segment.

**Definition 2.1.15.** Let  $K$  be a regular CW-complex. Its *barycentric subdivision*  $\text{Sd } K$  is defined to be the following simplicial complex:

1. Every cell of  $K$  corresponds to a vertex of  $\text{Sd } K$ ;
2. A finite set of cells of  $K$  corresponds to a simplex of  $\text{Sd } K$  if and only if it can be totally ordered by adjacency.

**Proposition 2.1.16** ([LW69], Theorem 1.7, pp.80-81). *For every regular CW-complex  $K$ , the geometric realisation of  $\text{Sd } K$  is homeomorphic to  $|K|$  in such a way that  $\text{Sd } K$  can be seen as a subdivision of  $K$ .*

This proposition allows us to see a regular CW-complex as “a simplicial complex in which the simplexes are more efficiently combined into closed cells.”<sup>2</sup> Another feature of simplicial complexes shared by regular complexes is the following one:

**Proposition 2.1.17.** *In a regular CW-complex the open stars of cells are contractible.*

*Proof.* The geometric realisation of  $\text{Sd } K$  lives in the real vector space  $V$  spanned by the cells of  $K$ . We use the same symbol to denote a cell  $e^k$  and its associated generator in  $V$ . Hence, an element of  $V$  is a formal finite linear combination of the cells of  $K$ . We endow this vector space with the norm 1:

$$\left\| \sum_{e \in K} x_e e \right\|_1 := \sum_{e \in K} |x_e|.$$

The geometric realisation  $|\text{Sd } K|$  is the union of the convex hulls of the sets of cells  $\{e^{k_0}, \dots, e^{k_n}\}$  corresponding to barycentric simplices i.e. flags of cells. It is a subset of the intersection of the unit sphere with the positive ortant:

$$V_+ := \left\{ \sum_{e \in K} x_e e \in V \mid x_e \geq 0, \forall e \in K \right\}.$$

For all flags of cells  $e^{k_0} < \dots < e^{k_n}$  let us denote here the corresponding open simplex by:

$$(e^{k_0}; \dots; e^{k_n}) := \left\{ \sum_{i=0}^n x_i e^{k_i} \mid \forall i, x_i > 0 \text{ and } \sum_{i=0}^n x_i = 1 \right\}.$$

<sup>2</sup>c.f. [LW69], p.77.

An open cell  $e^k$  of  $K$  corresponds under the homeomorphism of Proposition 2.1.16 to the union of the open barycentric simplices  $(e^{k_0}; \dots; e^{k_n})$  for which  $e^{k_n} = e^k$ . Therefore, the open star  $S$  of  $e^k$  is given by the following formula:

$$S = \bigcup_{\substack{e^{k_0} < \dots < e^{k_n} \\ e^k \leq e^{k_n}}} (e^{k_0}; \dots; e^{k_n}).$$

Now we define the family of bounded linear operators  $(\Phi_t : V \rightarrow V)_{0 \leq t \leq 1}$  by  $\Phi_t = (\text{id} - \pi) + t\pi$  where  $\pi$  is the projection to the sub-space spanned by the cells  $e^p$  that do not contain  $e^k$  parallelly to the sub-space spanned by those that contain it. Let  $U$  be the open set of  $V_+$  of vectors that have at least one coordinate indexed by a cell that contains  $e^k$  strictly positive.  $S$  equals  $|\text{Sd } K| \cap U$ . For all  $t \in [0; 1]$ , the map:

$$\begin{aligned} \Psi : [0; 1] \times U &\longrightarrow U \\ u &\longmapsto \frac{\|u\|_1}{\|\Phi_t(u)\|_1} \Phi_t(u), \end{aligned}$$

is continuous and every partial map  $\Psi(t; -)$  fixes  $S$ . The image  $\Psi(0; S)$  is the union of the open barycentric simplices  $(e^{k_0}; \dots; e^{k_n})$  for which  $e^k \leq e^{k_0}$ . Note that the restriction of every map  $\Psi(t; -)$  is constant on this set. Therefore,  $\Psi(0; S)$  is a deformation retract of  $S$ . Now this set retracts on the barycentre of  $e^k$  by simple convex interpolation  $(t; u) \in [0; 1] \times \Psi(0; S) \mapsto (1 - t)u + te^k$ . Thus  $S$  is contractible.  $\square$

When we consider the barycentric subdivision of a finite regular CW-complex we increase considerably the number of cells. There is however a less expensive procedure that builds for any regular CW-complex  $K$  a ‘‘pseudo-subdivision’’ that sits between  $K$  and  $\text{Sd } K$ . By pseudo-subdivision we mean a certain recombination of the barycentric simplices that looks a lot like a regular subdivision.

**Definition 2.1.18** (Dihomologic Pseudo-subdivision). Let  $K$  be a regular CW-complex and  $e^p \leq e^q$  be a pair of adjacent cells. We define the *dihomologic pseudo-cell* spanned by  $e^p$  and  $e^q$  to be the union of the open barycentric simplices<sup>3</sup> associated the flags  $e^{k_1} < \dots < e^{k_n}$  for which  $e^{k_1}$  is  $e^p$  and  $e^{k_n}$  is  $e^q$ . These ‘‘open’’ pseudo-cells partition the simplicial complex  $\text{Sd } K$ . We call such partition the *dihomologic pseudo-subdivision* of  $K$ . We say that the dihomologic pseudo-cell associated with the pair  $e^p \leq e^q$  has dimension  $q - p$ . Figure 2.3 illustrates this procedure on a disc.

This partition shares many properties with a regular subdivision of  $K$  but may fail to define a CW-complex structure on  $|K|$ . In full generality the closure of a dihomologic pseudo-cell might not be homeomorphic to a closed ball. However, for a broad variety of examples, this is indeed a regular subdivision of  $K$ .

**Remark 2.1.19.** We chose to use the terminology ‘‘dihomologic’’ because Zeeman’s dihomology bicomplex<sup>4</sup> would be the cellular chain complex of this pseudo-

<sup>3</sup>The open simplex on a vertex set  $v_0, \dots, v_n$  is the set  $\{\sum_{i=0}^n t_i v_i \mid \forall i, t_i > 0 \text{ and } \sum_{i=0}^n t_i = 1\}$ .

<sup>4</sup>c.f. [Zee62a, Zee62b, Zee63].



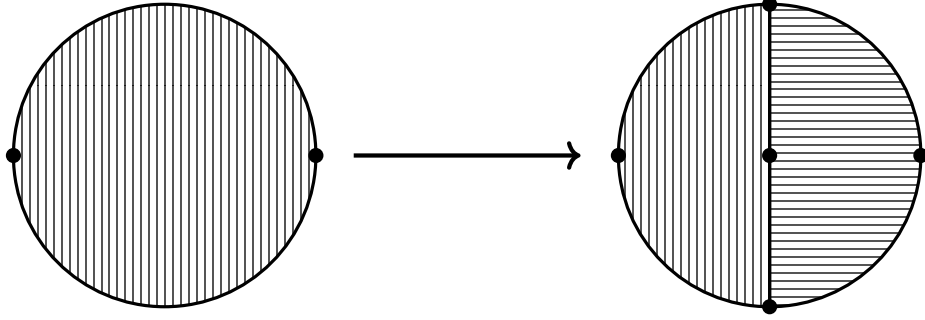

Figure 2.3: The dihomologic pseudo-subdivision of a regular CW-complex structure of the disc.

subdivision. This bicomplex was latter (dually) rediscovered by Forman in [For02] under the name of “combinatorial differential forms”.

**Proposition 2.1.20.** *Let  $e^p \leq e^q$  be a pair of adjacent cells of  $K$ . The closure of the pseudo-cell associated with  $e^p \leq e^q$ , is a pure collapsable simplicial complex of dimension  $q - p$ . Moreover, any codimension 1 simplex of the open pseudo-cell is exactly contained in two of its maximal simplices.*

*Proof.* Let  $e^p \leq e^q$  be a pair of adjacent cells. If  $e^p$  equals  $e^q$  the associated pseudo-cell is a single vertex and the statement of the proposition is true. Now suppose  $e^p$  is a proper face of  $e^q$ . The closure of the associated pseudo-cell is the union of the barycentric simplices whose flags  $e^{k_1} < \dots < e^{k_n}$  satisfy  $e^p \leq e^{k_1} < \dots < e^{k_n} \leq e^q$ . This is a sub-simplicial complex of  $\text{Sd } K$ . A maximal simplex of this closed pseudo-cell is given by a maximal chain of adjacent cells of  $K$  starting from  $e^p$  and ending at  $e^q$ . Since  $K$  is regular such chain has necessarily length  $q - p + 1$ . Hence, the closed pseudo-cell is a pure  $(q - p)$ -dimensional simplicial complex. If  $q - p = 1$ , this closed pseudo-cell corresponds to the closed barycentric edge  $e^p < e^q$ . This is a collapsable complex. If  $q - p > 1$ , the maximal simplices of the closed pseudo-cell correspond to flags  $e^p < e^{p+1} < \dots < e^{q-1} < e^q$ . They all have a codimension 2 free face, given by  $e^{p+1} < \dots < e^{q-1}$ . If we collapse all such simplices we obtain the union of the closed  $(q - p - 1)$ -simplices associated with the flags of the form  $e^p < e^{k_1} < \dots < e^{k_{q-p-2}} < e^q$ . All such simplices are now maximal and contain each a free face of codimension 2, namely  $e^{k_1} < \dots < e^{k_{q-p-2}}$ . We can recursively perform all such collapses to end up with the barycentric edge  $e^p < e^q$ . Thus the closed pseudo-cell of the pair  $e^p \leq e^q$  is collapsable. For the final part, a simplex of codimension 1 of the open pseudo-cell is given by a flag  $e^p < e^{k_1} < \dots < e^{k_{q-p-2}} < e^q$  of length  $q - p$  and has the form  $e^p < \dots < e^i < e^{i+2} < \dots < e^q$ . Since  $K$  is regular there is exactly two  $(i + 1)$ -cells between  $e^i$  and  $e^{i+1}$ , hence two  $(q - p)$ -simplices.  $\square$

**Proposition 2.1.21.** *The open pseudo-cell associated with the pair  $e^p \leq e^q$  meets the closed pseudo-cell indexed by the pair  $e^{p'} \leq e^{q'}$  if and only if it is fully contained in it. This only happens when  $e^{p'} \leq e^p \leq e^q \leq e^{q'}$ . Moreover, if  $\epsilon_0$  is an open pseudo-cell of dimension  $k$  included in a closed pseudo-cell  $\bar{\epsilon}_2$  of dimension  $k + 2$  then there is exactly two open pseudo-cells  $\epsilon_1$  of dimension  $k + 1$  such that  $\epsilon_0 \subset \bar{\epsilon}_1$  and  $\epsilon_1 \subset \bar{\epsilon}_2$ .*

*Proof.* The first part is a consequence of the definition. For the second part, we choose  $\epsilon_0$  corresponding to a pair  $e^{p+a} \leq e^{p+a+k}$  and  $\epsilon_2$  to a pair  $e^p \leq e^{p+a+k+b}$  satisfying  $e^p \leq e^{p+a} \leq e^{p+a+k} \leq e^{p+a+k+b}$ . By assumption, we have  $a + b = 2$  and three different cases can occur: one of the two numbers  $a, b$  is 2 and the other 0 or both equal 1. The two first cases are symmetric. If  $a$  equals 2, we have:

$$e^p \leq e^{p+2} \leq e^{p+2+k} \leq e^{p+2+k},$$

and the two  $(k+1)$ -pseudo-cells between  $\epsilon_0$  and  $\epsilon_1$  are those associated with the two pairs  $e^{p+1} \leq e^{p+2+k}$  with  $e^p \leq e^{p+1} \leq e^{p+2}$ . The symmetric case is similar. If both  $a$  and  $b$  equal 1 then we have:

$$e^p \leq e^{p+1} \leq e^{p+1+k} \leq e^{p+2+k},$$

and the two  $(k+1)$ -pseudo-cells between  $\epsilon_0$  and  $\epsilon_1$  are those associated with the two pairs  $e^p \leq e^{p+1+k}$  and  $e^{p+1} \leq e^{p+2+k}$ .  $\square$

In the light of this property it makes sense to talk about *adjacent* pseudo-cells as we do for cells of regular CW-complexes. As in the regular case, if  $\epsilon$  and  $\epsilon'$  are adjacent pseudo-cells with  $\epsilon \subset \bar{\epsilon}'$  we say that  $\epsilon$  is a *face* of  $\epsilon'$ . If in addition  $\epsilon \neq \epsilon'$  we say that  $\epsilon$  is a *proper face* of  $\epsilon'$ . Let  $e^p < e^q$  be a proper pair of adjacent cells of  $K$  and  $\epsilon$  denote their associated pseudo-cell. The simplicial complex supported on the closure,  $(\text{Sd } K)(\epsilon)$ , is the join of the barycentric edge  $e^p < e^q$  and a sub-complex  $A(e^p; e^q) \subset \text{Sd } K$ . This sub-complex is the collection of all the barycentric simplices indexed with the flags  $e^{k_1} < \dots < e^{k_n}$  for which  $e^p < e^{k_1}$  and  $e^{k_n} < e^q$ .

**Proposition 2.1.22.** *The support of  $A(e^p; e^q)$  is a connected  $(q-p-2)$ -dimensional homology manifold whose  $(p+1)$ -fold suspension is homeomorphic to a  $(q-1)$ -sphere.*

Let us recall the definition:

**Definition 2.1.23** (Homology Manifold). A *homology manifold* of dimension  $n \in \mathbb{N}$  is the support  $X$  of a regular, finite dimensional, locally finite CW-complex for which the graded local homology group  $(H_q(X; X \setminus \{x\}; \mathbb{Z}))_{q \geq 0}$  of every point  $x \in X$  is isomorphic to either  $(H_q(\mathbb{R}^n; \mathbb{R}^n \setminus \{0\}; \mathbb{Z}))_{q \geq 0}$  or 0. The *boundary* of  $X$ , denoted by  $\partial X$ , is the set of points  $x \in X$  for which  $(H_q(X; X \setminus \{x\}; \mathbb{Z}))_{q \geq 0}$  vanishes.

*Proof.* Let  $B$  denote the simplicial complex  $(\text{Sd } K)(\bar{e}^q \setminus e^q)$  and  $e^0 < \dots < e^p$  be a complete flag of cells of  $K$ . The simplicial complex  $A(e^p; e^q)$  is the link in  $B$  of the barycentric simplex associated with  $e^0 < \dots < e^p$ .  $B$  is a simplicially triangulated  $(q-1)$ -sphere thus in application of Proposition 1.3 p.5 from [GS80] the  $(p+1)$ -fold suspension of  $A(e^p; e^q)$  is homeomorphic to a  $(q-1)$ -sphere. The Mayer-Vietoris long exact sequence in singular homology implies that if  $\Sigma A$  is the suspension of a topological space  $A$ ,  $H_0(\Sigma A; \mathbb{Z})$  is free of rank 1,  $H_k(\Sigma A; \mathbb{Z})$  is isomorphic to  $H_{k-1}(A; \mathbb{Z})$  for all  $k \geq 2$ , and we have the following short exact sequence:

$$0 \rightarrow H_1(\Sigma A; \mathbb{Z}) \rightarrow H_0(A; \mathbb{Z}) \rightarrow \mathbb{Z} \rightarrow 0.$$

Thus  $A$  has the homology of a  $k$ -sphere if and only if the  $l$ -fold suspension  $\Sigma^l A$  has the homology of an  $(l+k)$ -sphere. Therefore, the simplicial complex  $A(e^p; e^q)$  has the integral homology of a  $(q-p-2)$ -sphere. For the remaining part of the proposition we note that if the barycentric  $n$ -simplex with indexing flag  $e^{k_0} < \dots < e^{k_n}$  belongs to  $A(e^p; e^q)$  then its link  $L$  in this complex is the join:

$$A(e^p; e^{k_0}) * A(e^{k_0}; e^{k_1}) * \dots * A(e^{k_{n-1}}; e^{k_n}) * A(e^{k_n}; e^q).$$

Hence, its  $(p+n+2)$ -fold suspension is homeomorphic to a  $(q-1)$ -sphere and  $L$  has the integral homology of a  $(q-p-n-3)$ -sphere. Now  $A(e^p; e^q)$  is a pure simplicial complex of dimension  $(q-p-2)$  in which the link of every  $n$ -dimensional simplex has the homology of a  $(q-p-n-3)$ -sphere. This is a homology manifold of dimension  $(q-p-2)$ . Indeed, if  $x$  is a point of  $|A(e^p; e^q)|$  that belongs to the relative interior of the barycentric  $n$ -simplex  $\sigma$ . And for all  $k \geq 0$ , we have by excision:

$$H_k(|A(e^p; e^q)|; |A(e^p; e^q)| \setminus \{x\}; \mathbb{Z}) = H_k(|S|; |S| \setminus \{x\}; \mathbb{Z}),$$

where  $S$  is the closed star of  $\sigma$ . Note that  $|S|$  is contractible and  $|S| \setminus \{x\}$  is non-empty so  $H_0(|S|; |S| \setminus \{x\}; \mathbb{Z})$  vanishes,  $H_k(|S|; |S| \setminus \{x\}; \mathbb{Z})$  equals  $H_{k-1}(|S| \setminus \{x\}; \mathbb{Z})$  for all  $k \geq 2$  and:

$$0 \rightarrow H_1(|S|; |S| \setminus \{x\}; \mathbb{Z}) \rightarrow H_0(|S| \setminus \{x\}; \mathbb{Z}) \rightarrow \mathbb{Z} \rightarrow 0.$$

Since  $|S|$  is homeomorphic to the topological join  $\sigma * |L|$  where  $L$  is the link of  $\sigma$ ,  $|S| \setminus \{x\}$  is homotopic to the  $n$ -fold suspension of  $|L|$ . By assumption  $|L|$  has the homology of a  $(q-p-n-3)$ -sphere so  $|S| \setminus \{x\}$  has the homology of a  $(q-p-3)$ -sphere. Combining this with the relation observed by the relative homology of  $(|S|; |S| \setminus \{x\})$  with the homology of  $|S| \setminus \{x\}$  we find that  $H_k(|A(e^p; e^q)|; |A(e^p; e^q)| \setminus \{x\}; \mathbb{Z})$  is isomorphic to  $H_k(\mathbb{R}^{q-p-2}; \mathbb{R}^{q-p-2} \setminus \{0\}; \mathbb{Z})$  for all  $k \geq 0$ . Thus  $A(e^p; e^q)$  is a compact  $(q-p-2)$ -homology manifold without boundary.  $\square$

**Remark 2.1.24.** Every link in  $A(e^p; e^q)$  is a join of  $A(e^r; e^s)$ 's.

As a direct consequence we find that:

**Proposition 2.1.25.** *The closed pseudo-cells associated with the adjacent pairs of the form  $e^0 \leq e^p$  are homeomorphic to closed balls.*

*Proof.* It follows from the previous observation that the support of this closed pseudo-cell is homeomorphic to the topological join  $[0; 1] * |A(e^0; e^p)|$  which is the cone over the suspension of  $|A(e^0; e^p)|$ . By the last proposition this suspension is a  $(p-1)$ -sphere so the closed pseudo-cell is actually a closed ball.  $\square$

Let  $\epsilon$  be a dihomologic pseudo-cell associated with a pair  $e^p \leq e^q$ . Its ‘‘boundary’’  $\bar{\epsilon} \setminus \epsilon$  is the support of the simplicial join of the union of the barycenters of  $e^p$  and  $e^q$  with  $A(e^p; e^q)$  (so the suspension of  $A(e^p; e^q)$ ). This description implies that the boundary of a dihomologic pseudo-cell is the union of its proper faces.

**Proposition 2.1.26.** *If  $K$  is not only regular but also satisfies that the induced CW-complex on every closed cell  $K(e)$  is shellable in the sense of [Bjö84] then every closed dihomologic pseudo-cell is also shellable. As a consequence, the geometric realisation of every closed pseudo-cell is actually homeomorphic to a closed ball making the dihomologic pseudo-subdivision a regular subdivision of  $K$ .*

*Proof.* Let  $e^q$  be a cell of  $K$ . From the first part of Proposition 4.4 p.12 of [Bjö84] we know that the barycentric subdivision of  $K(e^q)$  is a shellable simplicial complex. For all faces  $e^p$  of  $e^q$  we expressed the associated closed dihomologic pseudo-cell  $\bar{e}$  as the simplicial join of a closed edge with the simplicial complex  $A(e^p; e^q)$ . As in the proof of Proposition 2.1.22 we can write this complex as the link of a barycentric simplex  $\sigma$  with indexing flag  $e^0 < e^1 < \dots < e^p < e^q$  in  $\text{Sd}(K(e^q))$ . The link of  $\sigma$  is shellable by Lemma 8.7 p.237 of [Zie95]. The complex  $A(e^p; e^q)$  is a pure  $(q - p - 2)$ -dimensional shellable simplicial complex in which every codimension 1 simplex belongs to exactly two maximal simplices, hence it is homeomorphic to a sphere by Proposition 4.3 p.12 of [Bjö84]. Finally, the closed dihomologic pseudo-cell  $\bar{e}$  is the support of a shellable simplicial complex homeomorphic to a closed ball.  $\square$

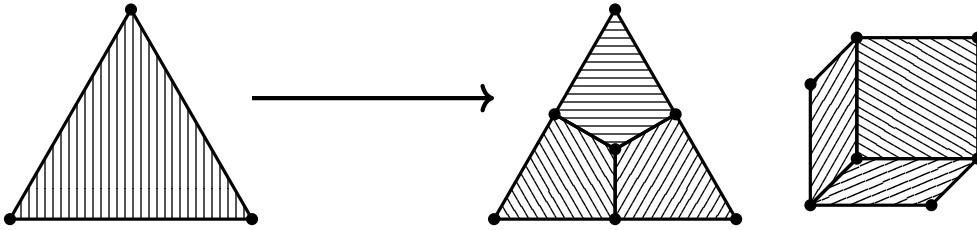

Figure 2.4: The dihomologic subdivision of the triangle.

When  $K$  is a polyhedral complex the theorem<sup>5</sup> of Bruggesser and P. Mani ensures that it satisfies the hypotheses of Proposition 2.1.26. This is especially the case when  $K$  is a simplicial complex. In this particular case the associated dihomologic subdivision even has the structure of a cubical complex, c.f. Figure 2.4. It comes from the following triangulation of the cube  $[0; 1]^n$ : order its vertex set  $\{0; 1\}^n$  with the product order<sup>6</sup> and consider the convex hulls of the flags of such vertices as the simplices of the triangulation. The triangulation of the 3-dimensional cube is illustrated in Figure 2.5. It produces a triangulation of the  $n$ -cube into  $n!$  simplices. We observe now that the ordered set of vertices of  $[0; 1]^n$  is naturally isomorphic to the lattice of subsets of a set with  $n$  elements. Moreover, if  $\sigma \leq \tau$  is a pair of adjacent simplices of relative codimension  $n$ , the lattice of intermediary simplices  $\{\sigma \leq \nu \leq \tau\}$  is the same as the lattice of faces of the link of  $\sigma$  in  $\tau$  (empty face included) i.e. the lattice of subsets of a set with  $\dim(\tau) + 1 - (\dim(\sigma) + 1) = n$  elements. For more general polyhedral complexes the shapes of the pseudo-cells can be different, as shown in Figure 2.6.

<sup>5</sup>c.f. [BM71], Corollary p.203.

<sup>6</sup> $(x_i)_{1 \leq i \leq n} \leq (y_i)_{1 \leq i \leq n}$  if and only if  $x_i \leq y_i$ , for all  $1 \leq i \leq n$ .

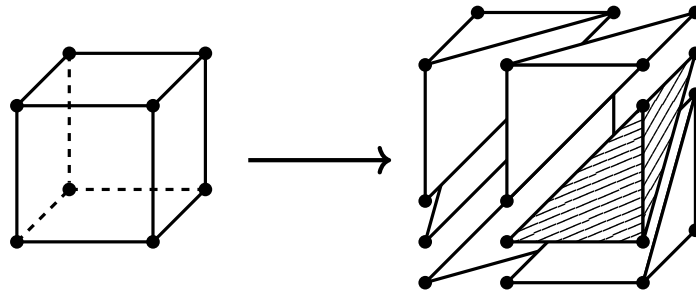

Figure 2.5: The subdivision of a cube into six tetrahedra, the convex hull of  $\{(0; 0; 0); (1; 0; 0); (1; 0; 1); (1; 1; 1)\}$  is marked.

However, even when  $K$  doesn't satisfy the hypotheses of the Proposition 2.1.26 all the 2-dimensional dihomologic pseudo-cells are squares because of Lemma 2.1.9, c.f. Figure 2.7. In low dimension the pseudo-subdivision is always regular.

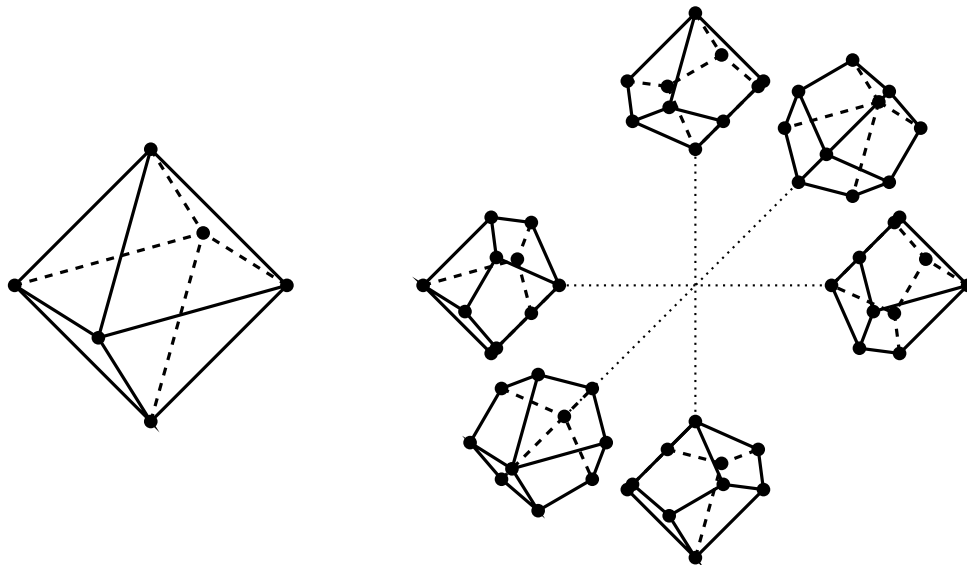

Figure 2.6: The dihomologic subdivision of an octahedron.

**Proposition 2.1.27.** *Let  $e^p \leq e^q$  be an adjacent pair of cells of  $K$ . If,  $2 \leq q - p \leq 4$ , then  $A(e^p; e^q)$  is homeomorphic to a sphere. If  $q = p + 5$ ,  $A(e^p; e^q)$  is a 3-dimensional integral homology sphere.*

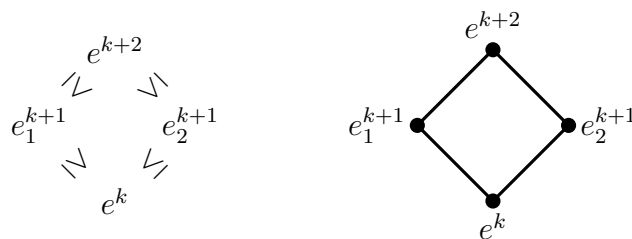

Figure 2.7: The lattice of faces and the dihomologic square associated with a pair of relative codimension 2.

*Proof.* As shown in Figure 2.7 the simplicial complex  $A(e^p; e^{p+2})$  consists of two vertices and therefore is a 0-sphere. In  $A(e^p; e^{p+3})$  the link of every simplex is either empty or a  $A(e^k; e^{k+2})$ . Thus  $A(e^p; e^{p+3})$  is actually a manifold by Proposition 1.3 p.5 of [GS80]. By Proposition 2.1.22, it is a 1-dimensional integral homology sphere, so a circle. From Remark 2.1.24, the link of every simplex of  $A(e^k; e^{k+4})$  is either empty or a join of a  $A(e^k; e^{k+2})$  with a  $A(e^k; e^{k+3})$  which we have just shown to be spheres. Therefore,  $A(e^k; e^{k+4})$  is a 2-dimensional integral homology sphere. By classification of compact orientable 2-dimensional manifolds it is homeomorphic to a 2-sphere. For the last part our previous arguments show that the  $A(e^p; e^{p+5})$ 's are 3-dimensional integral homology spheres.  $\square$

**Remark 2.1.28.** The 3-dimensional closed pseudo-cells are not only closed balls but even *trapezohedra* i.e. similar to Figure 2.8. The family of such polyhedra is indexed by an integer  $n$  at least equal to 3 for which we find “the cube”.

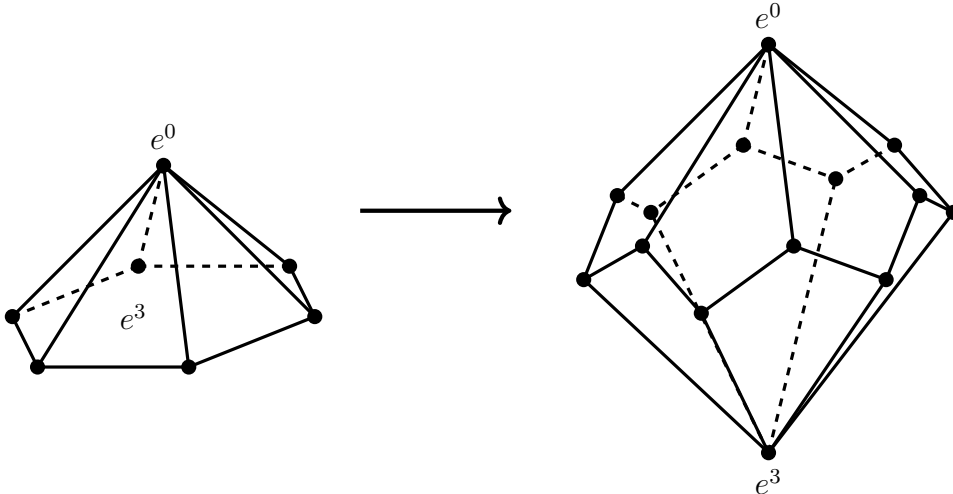

Figure 2.8: The shape of the dihomologic cell associated with the adjacent pair  $e^0 \leq e^3$ .

A direct consequence of Proposition 2.1.27 and Proposition 2.1.25 is the following proposition:

**Proposition 2.1.29.** *If  $\dim K$  is at most 5 its dihomologic pseudo-subdivision is a regular subdivision.*

## 2.2 Cellular Sheaves and Cosheaves

In this section  $K$  denotes a regular CW-complex.

**Definition 2.2.1** (Constructible Sheaves). A sheaf  $F$  on  $|K|$  is called *constructible* with respect to the CW-complex structure if its restriction to every open cell is constant.

Such sheaves are among the “simplest ones” on  $|K|$ . They are reducible to combinatorial data. The knowledge of their groups of sections above every open star as well as the restriction morphisms is enough to characterise the sheaf completely, up to isomorphism. The key fact about these sheaves is the following: for every cell  $e$  of  $K$ , if  $S$  denotes its open star and  $x \in e$  then the two following morphisms are isomorphisms<sup>7</sup>:

$$F(S) \xrightarrow{\text{rest.}} F|_e(e) \xrightarrow{\text{stalk}} F_x.$$

Since  $e$  is connected and locally connected the fact that  $F|_e(e) \rightarrow F_x$  is an isomorphism follows from the constance of  $F|_e$ . Let  $F(e)$  denote the group  $F|_e(e)$  of values of  $F|_e$ . From the previous observation we gain a “restriction map” between  $F(e^q)$  and  $F(e^p)$  for all pairs of adjacent cells  $e^q \leq e^p$ . It comes from the following commutative diagram:

$$\begin{array}{ccc} F(e^q) & \xrightarrow{\quad\quad\quad} & F(e^p) \\ \text{rest. to } F|_{e^q}(e^q) \uparrow \cong & & \cong \uparrow \text{rest. to } F|_{e^p}(e^p) \\ F(\text{St}(e^q; K)) & \xrightarrow[\text{St}(e^p; K) \subset \text{St}(e^q; K)]{\text{rest.}} & F(\text{St}(e^p; K)) \end{array}$$

**Definition 2.2.2** (Cellular Sheaf). A *cellular sheaf* on  $K$  is the data of a covariant functor:

$$F : \mathbf{Cell} K \rightarrow \mathbf{Mod}_R,$$

from the category of cells of  $K$  with arrows given by adjacency to the category of  $R$ -modules (for some commutative ring  $R$ ). We call the images of the arrows by such functor its *restriction morphisms*. For all pairs of adjacent cells  $e^p \leq e^q$  and all  $f \in F(e^p)$  we will denote by  $f|_{e^p}^{e^q}$  the image of  $f$  in  $F(e^q)$  by the restriction morphism.

A typical example of cosheaf on a topological space is the assignment to every open set its ring of continuous functions with compact support. The definition of cellular cosheaf is dual to the definition of cellular sheaves.

**Definition 2.2.3** (Cellular Cosheaf). A *cellular cosheaf* on  $K$  is the data of a contravariant functor:

$$F : (\mathbf{Cell} K)^{\text{op}} \rightarrow \mathbf{Mod}_R,$$

from the category of cells of  $K$  with arrows given by adjacency to the category of  $R$ -modules (for some commutative ring  $R$ ). We call the images of the arrows by such functor its *extension morphisms*. For all pairs of adjacent cells  $e^p \leq e^q$  and all  $f \in F(e^p)$  we will denote by  $f|_{e^p}^{e^q}$  the image of  $f$  in  $F(e^q)$  by the extension morphism.

Every functorial operation performed on Abelian groups, or more generally on modules over a given commutative ring, such as direct sums, products, tensor products, etc. can be performed as well on cellular sheaves and cosheaves by performing it group by group over every cell. Also we can construct a cosheaf from a sheaf  $F$  by

<sup>7</sup>c.f. [Kas84], Proposition 1.3 p.323.

considering for  $G$  a fixed group the contravariant functor  $e \mapsto \text{Hom}(F(e); G)$  with adjoint arrows. This construction also goes the other way around when one starts with a cosheaf.

**Definition 2.2.4** (Morphisms of Sheaves and Cosheaves). A *morphism of cellular sheaves* (or *cosheaves*)  $f : F \rightarrow F'$  is a natural transformation. Such morphism is said to be *injective* (resp. *surjective*, resp. *invertible*) if the associated morphisms  $f(e) : F(e) \rightarrow F'(e)$  are injective (resp. surjective, resp. invertible) for all cells  $e$ . The *kernel*, *image*, and *cokernel* of such morphism  $f$  are the “cell-wise” kernel, image, and cokernel. They are sheaves (or cosheaves) themselves with the induced restriction (or extension) morphisms because  $f$  is a natural transformation.

The most basic examples of such objects are given by *local system of coefficients*. We see such local systems as fibre bundles of discrete groups above  $|K|$ . Since every cell is connected and contractible the restriction of its sheaf of continuous sections to any cell is constant. Therefore, it satisfies the hypothesis of the definition and induces a cellular sheaf. It has the property that all its restriction morphisms are invertible. This is even a way to characterise such local systems. This special property also allows us to see it as a cellular cosheaf by inverting every arrow. Indeed, the commutativity conditions on the composition of such morphisms are automatically satisfied from the ones given by the cellular sheaf structure. Another family of examples is given by the *characteristic cosheaves* associated with sub-complexes:

**Definition 2.2.5.** Let  $K'$  be a sub-complex of  $K$  and  $G$  be an Abelian group (or a module over a commutative ring). We denote by  $[K'; G]$  the cellular cosheaf defined as follows:

$$e \in K \mapsto \begin{cases} G & \text{if } e \in K' \\ 0 & \text{otherwise} \end{cases} ,$$

with extension morphisms given either by the identity of  $G$  or the zero morphism whenever one of the two groups involved is trivial. If a cell belongs to  $K'$  then all of its faces belong to it too. As a consequence the commutativity conditions are satisfied for every triplet of adjacent cells gives rise to one of the following commutative diagrams:

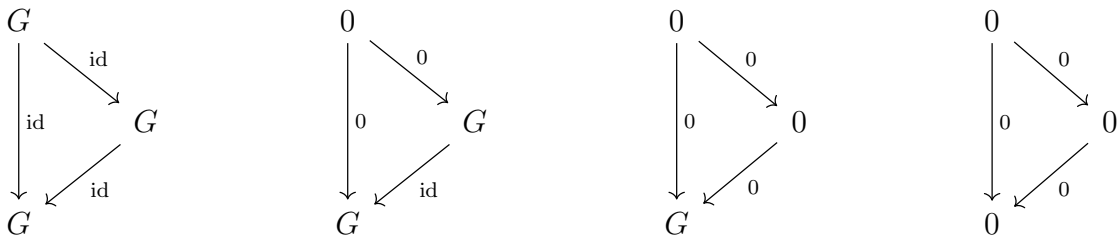

Whenever  $K''$  is a sub-complex of  $K'$  we have a natural injective morphism of cosheaves  $[K''; G] \rightarrow [K'; G]$  either given by the 0 morphism or the identity. We will denote the resulting quotient by  $[K'; K''; G]$ . Its value is  $G$  on the cells of  $K'$  not contained in  $K''$  and 0 elsewhere. A sub-family of these examples will be of



particular interest. They are the “local” cosheaves  $[K; K - e; G]$ , where  $e$  is a cell of  $K$ . Their value is  $G$  only on the cells containing  $e$ . For all cells  $e$ , the cosheaves  $[K(e); G]$  and  $[K; K - e; G]$  are the dual constructions of the elementary cellular sheaves considered by A. Shepard in his thesis [She85]. They were also considered later by J. Curry in [Cur12].

**Definition 2.2.6** (Localisation of a cellular cosheaf). Let  $F$  be a cellular cosheaf on  $K$  and  $e$  be a cell. We denote by  $F_e$  the tensor product  $F \otimes_{\mathbb{Z}} [K; K - e; \mathbb{Z}]$  and call it the *localisation* of  $F$  at  $e$ . For  $e'$  another cell, the group  $F_e(e')$  equals  $F(e')$  if  $e' \geq e$  and 0 otherwise, its extension morphisms are then appropriately given by the extension morphisms of  $F$  or 0. Moreover, the natural projection:

$$[K; K - e; \mathbb{Z}] \rightarrow [K; K - e'; \mathbb{Z}],$$

for all pairs of adjacent cells  $e \leq e'$ , induces a surjective localisation morphism  $F_e \rightarrow F_{e'}$ .

**Definition 2.2.7** (Subdivision). If  $K'$  is a subdivision of  $K$  there is a subdivision functor from the category of cellular cosheaves on  $K$  (resp. cellular sheaves) to the category of cellular cosheaves (resp. cellular sheaves) on  $K'$ . If  $F$  is a cosheaf (resp. sheaf) on  $K$  its *subdivision*  $F'$  is given for all cells  $e' \in K'$  by:

$$F'(e') := F(e),$$

where  $e$  is the only cell of  $K$  containing  $e'$ . The extension (resp. restriction) morphisms are then adequately derived from those of  $F$ . If  $e'_0 \leq e'_1$  are contained in the same cell the morphism is the identity. If they are not it is given by the morphism associated with the only pair of cells  $e_0 \leq e_1$  of  $K$  satisfying  $e'_0 \subset e_0$  and  $e'_1 \subset e_1$ .

**Definition 2.2.8** (Dihomologic Cellular Sheaves and Cosheaves). A *dihomologic cellular cosheaf* (resp. *sheaf*) on  $K$  is the data of a contravariant (resp. covariant) functor  $F$  from the category associated with the set of dihomologic pseudo-cells of  $K$  ordered by adjacency to the category of  $R$ -modules. As in the case of cellular sheaves and cosheaves, a morphism of such objects is defined to be a natural transformation of functors. The notions of injectivity, surjectivity and invertibility are also defined “cell-wise” and so are the kernels, images and cokernels.

Formally, a dihomologic cellular cosheaf consists of an assignment of a module  $F(e^p; e^q)$  to every pair of adjacent cells  $e^p \leq e^q$  and morphisms connecting them. Because of the commutativity conditions on the compositions of such morphisms it is only necessary to define them on elementary adjacency relations. By that we mean that if the dihomologic pseudo-cell of the pair  $e^p \leq e^q$  is a face of the pseudo-cell  $e^{p'} \leq e^{q'}$  then we have  $e^{p'} \leq e^p \leq e^q \leq e^{q'}$  and the commutative diagram of

extension morphisms is the following:

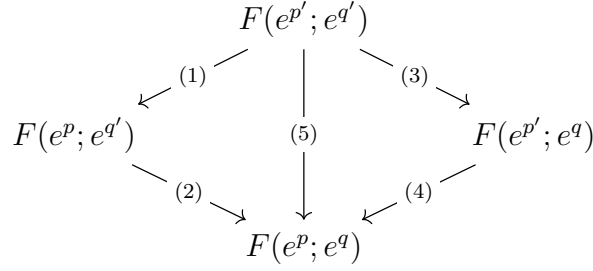

Knowing the morphism (5) only amounts to knowing the composition of (1) and (2) or (3) and (4). To describe such  $F$  completely we can only provide the groups and the extension morphisms when we “increase the first coordinate” and “decrease the second one” and verify that these satisfy the following commutative diagram:

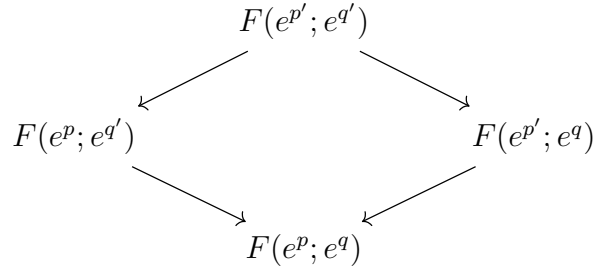

**Definition 2.2.9** (Dihomologic Subdivision of Cellular Sheaves and Cosheaves). Let  $F$  be a cellular cosheaf (resp. sheaf) on  $K$  its *dihomologic subdivision*  $F'$  is the dihomologic cellular cosheaf (resp. sheaf) that associates to every pair of adjacent cells  $e^p \leq e^q$  the module:

$$F'(e^p; e^q) := F(e^q),$$

with extension (resp. restriction) morphisms coming from those of  $F$  and illustrated in the following commutative diagram (resp. with opposite arrows) for the elementary adjacency relations  $e^{p'} \leq e^p \leq e^q \leq e^{q'}$ :

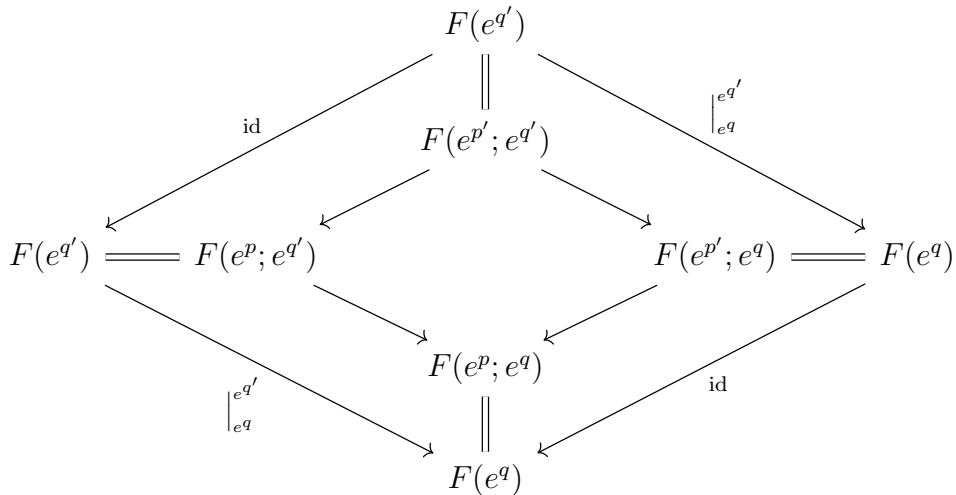

Whenever the dihomologic pseudo-subdivision of  $K$  is a regular subdivision this construction corresponds to the usual subdivision of cosheaves (resp. sheaves) of Definition 2.2.7. The open cell  $e^q$  is covered by the open dihomologic (pseudo)-cells associated with the adjacent pairs of the form  $e^p \leq e^q$ .

**Definition 2.2.10** (Localisation by fixing the first coordinate). Let  $F$  be a dihomologic cosheaf on  $K$ . For all cells  $e$  of  $K$  we define the local cellular cosheaf  $F_e$  on  $K$  by the following formula:

$$e' \in K \mapsto \begin{cases} F(e; e') & \text{if } e' \geq e \\ 0 & \text{otherwise} \end{cases},$$

with extension morphisms either 0 or given by those of  $F$ . We call it local as it is invariant by the operation of localisation at  $e$ :  $(F_e)_e = F_e$ . Moreover, if we apply this process to a dihomologic cosheaf  $F'$  obtained by subdividing a cellular cosheaf  $F$ , we recover the localisation operation previously defined. The situation is illustrated in the following commutative diagram:

$$\begin{array}{ccc} \{\text{Cosheaves of } K\} & \xrightarrow{\text{subd.}} & \{\text{Dihomologic cosheaves of } K\} \\ \text{loc. at } e \downarrow & \swarrow \text{fix. loc. at } e & \downarrow \text{loc. at } (e \leq e) \\ \{\text{Cosheaves of } K\} & \xrightarrow{\text{subd.}} & \{\text{Dihomologic cosheaves of } K\} \end{array} \quad (2.1)$$

## 2.3 Cellular Homology and Cohomology

In this section,  $K$  denotes a locally finite regular CW-complex. When one computes the homology of the CW-complex  $K$  by filtering, the singular chain complex for instance, by its skeleta, one ends up on the  $E^1$ -page of the associated spectral sequence with the cellular chain complex of  $K$ . The  $k$ -th group of this complex is given by a direct sum of free Abelian groups of rank 1, one for each  $k$ -cell. These groups, that we redefine below, are a key ingredient in cellular homology. Their two generators correspond to the two orientations of the cell.

**Definition 2.3.1** (Oriented Cells, J. Munkers, *Elements of Algebraic Topology* [Mun84], §39. pp.222-231.). Let  $e$  be a  $k$ -cell of  $K$ . An *orientation* of  $e$  is a generator of the group  $\mathbb{Z}(e) := H_k(|K|; |K| \setminus e; \mathbb{Z})$  or equivalently  $H_k(\bar{e}; \bar{e} \setminus e; \mathbb{Z})$  computed with the singular homology. We call the latter group the *group of oriented coefficients* of  $e$  and say that  $[e]$  is an *oriented  $k$ -cell* when  $[e]$  is an orientation of the  $k$ -cell  $e$ . Whenever  $e^{p-1}$  is a codimension 1 face of  $e^p$  we have a *boundary morphism*  $\mathbb{Z}(e^p) \rightarrow \mathbb{Z}(e^{p-1})$  defined by the composition:

$$\begin{aligned} H_k(\bar{e}^p; \bar{e}^p \setminus e^p) & \xrightarrow{(1)} H_{k-1}(\bar{e}^p \setminus e^p) \xrightarrow{(2)} \dots \\ \dots \xrightarrow{(2)} H_{k-1}(\bar{e}^p \setminus e^p; \bar{e}^p \setminus (e^p \cup e^{p-1})) & \xrightarrow{(3)} H_{k-1}(\bar{e}^{p-1}; \bar{e}^{p-1} \setminus e^{p-1}), \end{aligned}$$

where all four homology groups are computed with integral coefficients. The morphism (1) is the connection morphism of the homological long exact sequence associated with the pair  $(\bar{e}^p \setminus e^p) \subset \bar{e}^p$ , (2) is the reduction modulo  $\bar{e}^p \setminus (e^p \cup e^{p-1})$ , and (3) is the inverse of the excision isomorphism. The image of an orientation  $[e^p]$  under this morphism is nothing but the  $\mathbb{Z}(e^{p-1})$ -component of its boundary when seen as a relative cellular chain. It is a generator of  $\mathbb{Z}(e^{p-1})$ . The first map, the connection morphism, comes from the boundary operator of the singular homology chain complex and therefore relies on the canonical orientation of  $\mathbb{R}^n$ . For all singular simplices  $\sigma$  on  $\text{Conv}(\{0, \dots, n\})$  we have the formula:

$$\partial\sigma = \sum_{i=0}^n (-1)^i \sigma_i,$$

where  $\sigma_i$  is the restriction of  $\sigma$  to  $\text{Conv}(\{0, \dots, n\} \setminus \{i\})$ . The convention on the orientation of such restriction  $\sigma_i$  is then given by “outward pointing normal vector” as illustrated in Figure 2.9.

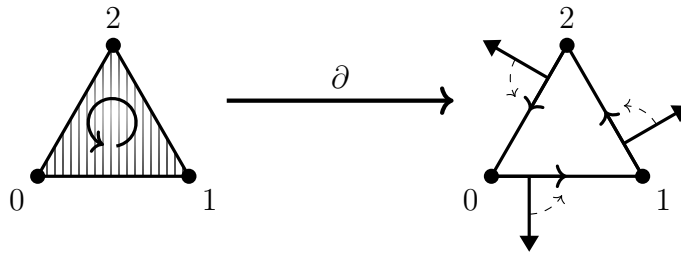

Figure 2.9: The orientation of the boundary.

These boundary morphisms satisfy the well known property that if  $e^p$  is a codimension 2 face of some cell  $e^{p+2}$  and  $e_1^{p+1}, e_2^{p+1}$  denote the two codimension 1 faces of  $e^{p+2}$  adjacent to  $e^p$  then the two compositions of boundary morphisms  $\mathbb{Z}(e^{p+2}) \rightarrow \mathbb{Z}(e_1^{p+1}) \rightarrow \mathbb{Z}(e^p)$  and  $\mathbb{Z}(e^{p+2}) \rightarrow \mathbb{Z}(e_2^{p+1}) \rightarrow \mathbb{Z}(e^p)$  are opposite of each other. In particular, composing boundary morphisms between oriented coefficients does not define a cellular cosheaf.

**Definition 2.3.2** (Dihomologic Orientations). Let  $\epsilon$  be the dihomologic pseudo-cell associated with an adjacent pair  $e^p \leq e^q$ , we define its *group of oriented coefficients* to be:

$$\mathbb{Z}(\epsilon) := \mathbb{Z}(e^p; e^q) := \text{Hom}(\mathbb{Z}(e^p); \mathbb{Z}(e^q)).$$

We call a generator of such group an *orientation* of  $\epsilon$  or a *relative orientation* of the pair  $e^p \leq e^q$  and denote such an element by the symbol  $[e^p; e^q]$ . If  $e'$  is a codimension 1 face of the pseudo-cell  $\epsilon$  we also have a *boundary morphism*  $\mathbb{Z}(\epsilon) \rightarrow \mathbb{Z}(e')$  defined by the boundary morphisms between the groups of oriented cells of  $K$  and, up to sign, by the functorial properties of the bifunctor  $\text{Hom}$ , as shown in the diagram

below.

$$\begin{array}{ccccc}
 & \mathbb{Z}(e^p; e^q) & & \mathbb{Z}(e^{p+1}) & \mathbb{Z}(e^q) \\
 (-1)^{p+1}\text{Hom}(\partial; \text{id}) \swarrow & & \searrow (-1)^p\text{Hom}(\text{id}; \partial') & \partial \downarrow & \downarrow \partial' \\
 \mathbb{Z}(e^{p+1}; e^q) & & \mathbb{Z}(e^p; e^{q-1}) & \mathbb{Z}(e^p) & \mathbb{Z}(e^{q-1})
 \end{array} \quad (2.2)$$

Note that if  $\epsilon$  is a dihomologic pseudo-cell of dimension  $k$  its closure can be expressed as the cone over a space that has the homology of a  $(k-1)$ -sphere. In that description  $\epsilon$  would correspond to the open cone. Therefore, the singular homology of  $\bar{\epsilon}$  relatively to  $\bar{\epsilon} \setminus \epsilon$  is isomorphic to the singular homology of a  $k$ -ball relatively to its boundary. Thus, we could equivalently define  $\mathbb{Z}(\epsilon)$  to be  $H_k(\bar{\epsilon}; \bar{\epsilon} \setminus \epsilon; \mathbb{Z})$  as in the case of a regular CW-complex. Indeed, Let  $e^p \leq e^q$  be an adjacent pair of cells of  $K$  indexing the pseudo-cell  $\epsilon$ . There is a canonical isomorphism between the group  $H_{q-p}(\bar{\epsilon}; \bar{\epsilon} \setminus \epsilon; \mathbb{Z})$  and  $\text{Hom}(\mathbb{Z}(e^p); \mathbb{Z}(e^q))$ . If we represent a cell  $e^p$  by a  $p$ -dimensional real vector space inside a  $q$ -dimensional vector space (representing  $e^q$ ) then the dihomologic pseudo-cell  $\epsilon$  indexed by  $e^p \leq e^q$  represents a supplementary sub-space of the former in the latter. An orientation of such supplementary space allows by wedge product to orient the  $q$ -dimensional vector space from an orientation of the  $p$ -dimensional one. The situation is explained by the cohomological bilinear cup product:

$$\cup : H^p(\bar{e}^p; \bar{e}^p \setminus e^p) \otimes H^{q-p}(\bar{\epsilon}; \bar{\epsilon} \setminus \epsilon) \rightarrow H^q(\bar{e}^q; \bar{e}^q \setminus e^q).$$

It is non-degenerate. To see it one can notice that all the spaces considered are supports of simplicial complexes so each of these groups can be computed simplicially. A generator of  $H^p(\bar{e}^p; \bar{e}^p \setminus e^p)$  is represented by the simplicial cocycle whose value is 1 on the barycentric simplex indexed by a complete flag  $e^0 < \dots < e^p$  and 0 elsewhere. Likewise, a generator of  $H^{q-p}(\bar{\epsilon}; \bar{\epsilon} \setminus \epsilon)$  is represented by the simplicial cocycle whose value is 1 on the barycentric simplex indexed by a complete flag  $e^p < \dots < e^q$  and 0 elsewhere. Their cup product is the simplicial cocycle whose value is 1 on the barycentric simplex indexed by the complete flag  $e^0 < \dots < e^p < \dots < e^q$  and 0 elsewhere. It represents a generator of  $H^q(\bar{e}^q; \bar{e}^q \setminus e^q)$ . It gives rise to an isomorphism:

$$H^{q-p}(\bar{\epsilon}; \bar{\epsilon} \setminus \epsilon) \cong \text{Hom}\left(H^p(\bar{e}^p; \bar{e}^p \setminus e^p); H^q(\bar{e}^q; \bar{e}^q \setminus e^q)\right).$$

Using the Universal Coefficient Theorem<sup>8</sup> three times this isomorphism becomes:

$$\mathbb{Z}(\epsilon) \cong \text{Hom}\left(\text{Hom}\left(\text{Hom}(\mathbb{Z}(e^p); \mathbb{Z}); \text{Hom}(\mathbb{Z}(e^q); \mathbb{Z})\right); \mathbb{Z}\right).$$

Since all the groups involved are free we can compose it with the musical isomor-

<sup>8</sup>c.f. [CE56], Theorem 3.3 p.113.

phism of the trace scalar product:

$$\mathrm{Hom}\left(\mathrm{Hom}\left(\mathrm{Hom}(\mathbb{Z}(e^p); \mathbb{Z}); \mathrm{Hom}(\mathbb{Z}(e^q); \mathbb{Z})\right); \mathbb{Z}\right) \cong \mathrm{Hom}\left(\mathrm{Hom}(\mathbb{Z}(e^q); \mathbb{Z}); \mathrm{Hom}(\mathbb{Z}(e^p); \mathbb{Z})\right),$$

and then with the transposition:

$$\mathrm{Hom}\left(\mathrm{Hom}(\mathbb{Z}(e^q); \mathbb{Z}); \mathrm{Hom}(\mathbb{Z}(e^p); \mathbb{Z})\right) \cong \mathrm{Hom}\left(\mathbb{Z}(e^p); \mathbb{Z}(e^q)\right),$$

to finally find our desired isomorphism  $\mathbb{Z}(\epsilon) \cong \mathrm{Hom}(\mathbb{Z}(e^p); \mathbb{Z}(e^q))$ . Note that the signs in the Definition 2.3.2, diagram (2.2), of the boundary morphisms between the groups of oriented coefficients of dihomologic pseudo-cells come from this description and the following relations:

$$d_1\alpha \cup \beta + (-1)^p\alpha \cup d_2\beta = 0 \text{ and } d_3(\alpha \cup \gamma) = 0 + (-1)^p\alpha \cup d_4\gamma,$$

emanating from the graded Leibniz rule and satisfied by all  $\alpha \in H^p(\bar{e}^p; \bar{e}^p \setminus e^p)$ ,  $\beta \in H^{q-p-1}(\bar{\epsilon}_1; \bar{\epsilon}_1 \setminus \epsilon_1)$  and  $\gamma \in H^{q-p-1}(\bar{\epsilon}_2; \bar{\epsilon}_2 \setminus \epsilon_2)$ . Where:

1. The adjacent dihomologic pseudo-cells  $\epsilon_1$  and  $\epsilon_2$  are respectively indexed by the pairs  $e^{p+1} \leq e^q$  and  $e^p \leq e^{q-1}$ ;
2. The morphisms  $d_1$  and  $d_3$  are respectively transpose of the orientation boundary morphisms  $\partial_1 : \mathbb{Z}(e^{p+1}) \rightarrow \mathbb{Z}(e^p)$  and  $\partial_3 : \mathbb{Z}(e^q) \rightarrow \mathbb{Z}(e^{q-1})$ ;
3. The morphism  $d_2 : H^{q-p-1}(\bar{\epsilon}_1; \bar{\epsilon}_1 \setminus \epsilon_1) \rightarrow H^{q-p}(\bar{\epsilon}_3; \bar{\epsilon}_3 \setminus \epsilon_3)$  and the morphism  $d_4 : H^{q-p-1}(\bar{\epsilon}_2; \bar{\epsilon}_2 \setminus \epsilon_2) \rightarrow H^{q-p}(\bar{\epsilon}_3; \bar{\epsilon}_3 \setminus \epsilon_3)$  are composition of connection morphism of homological long exact sequences of pairs and reduction modulo  $\bar{\epsilon}_3 \setminus \epsilon_3$  where  $\epsilon_3$  is indexed by the pair  $e^p \leq e^q$ .

If  $[e^p] \in \mathbb{Z}(e^p)$  is an orientation of  $e^p$  and  $[e^p; e^q] \in \mathbb{Z}(e^p; e^q)$  is a relative orientation, we denote by  $[e^p][e^p; e^q]$  the associated orientation of  $e^q$ . For any pair  $e^p \leq e^{p+1}$  of relative codimension 1 the inverse of the boundary morphism  $\partial : \mathbb{Z}(e^{p+1}) \rightarrow \mathbb{Z}(e^p)$  defines a canonical relative orientation. We will always denote it by the symbol  $[e^p; e^{p+1}]$  but we should emphasise that for any other positive dimensional dihomologic pseudo-cell the similar notation denotes an arbitrary orientation, possibly subject to conditions, as there are no canonical orientation for them. We can compose relative orientations in their morphism representations, we adopt the convention  $[e^p; e^q][e^q; e^r]$  to denote  $[e^q; e^r] \circ [e^p; e^q]$ . In these notations, one can write the anti-commutativity of the boundary morphisms as follows: for all adjacent pairs  $e^p \leq e^{p+2}$  of relative codimension 2 we have:

$$\sum_{e^p \leq e^{p+1} \leq e^{p+2}} [e^p; e^{p+1}][e^{p+1}; e^{p+2}] = 0.$$

**Definition 2.3.3** (Cellular Chain and Cochain Complexes). Let  $F$  be a cellular cosheaf on  $K$  and  $k \in \mathbb{N}$ . We define the group of *cellular  $k$ -chains* of  $K$  with

coefficients in  $F$  to be:

$$C_k(K; F) := \bigoplus_{\dim e=k} F(e) \otimes_{\mathbb{Z}} \mathbb{Z}(e).$$

Moreover, if  $[e]$  is an oriented  $k$ -cell of  $K$  and  $c$  is a  $k$ -chain with coefficients in  $F$  we denote by  $\langle c, [e] \rangle$  the unique element of  $F(e)$  satisfying  $c_e = \langle c, [e] \rangle \otimes [e]$ . We also define the *boundary operator*  $\partial : C_k(K; F) \rightarrow C_{k-1}(K; F)$  by the formula:

$$\partial c := \sum_{e^{k-1} < e^k} \langle c, [e^k] \rangle \Big|_{e^{k-1}}^{e^k} \otimes [e^{k-1}],$$

for all  $c \in F(e^k) \otimes_{\mathbb{Z}} \mathbb{Z}(e^k)$  with  $[e^{k-1}]$  the image of  $[e^k]$  by the boundary morphism, which can be written  $[e^{k-1}][e^{k-1}; e^k] = [e^k]$  with  $[e^{k-1}; e^k]$  the canonical relative orientation. The property of the compositions of the boundary morphisms between oriented coefficients implies directly that  $\partial^2 = 0$  and that  $(C_k(K; F); \partial)_{k \geq 0}$  is a chain complex.

Dually, when  $F$  is a cellular sheaf, the *cellular cochain complex* with coefficients in  $F$ , is defined, for all  $k \in \mathbb{N}$ , by the groups:

$$C^k(K; F) := \prod_{\dim e=k} \text{Hom}(\mathbb{Z}(e); F(e)).$$

For all  $k$ -cochains  $\alpha$  with coefficients in  $F$  and all oriented  $k$ -cells  $[e]$ ,  $\alpha[e] \in F(e)$  denotes the value of the map  $\alpha(e)$  at  $[e]$ . The *coboundary operator* or *differential*  $d : C^k(K; F) \rightarrow C^{k+1}(K; F)$  is given for all  $k$ -cochains  $\alpha$  and all oriented  $(k+1)$ -cells  $[e^{k+1}]$  by the following formula:

$$d\alpha[e^{k+1}] = \sum_{e^k < e^{k+1}} \alpha[e^k] \Big|_{e^k}^{e^{k+1}},$$

where for all  $e^k$ ,  $[e^k]$  denotes the unique orientation of  $e^k$  whose image by the boundary morphism is  $[e^{k+1}]$ , i.e.  $[e^k][e^k; e^{k+1}] = [e^{k+1}]$ .

The last cochain complex we define here is the complex of *cellular cochains with compact support*. It is a sub-complex of  $(C^k(K; F); d)_{k \geq 0}$  whose groups are given, for all  $k \in \mathbb{N}$ , by:

$$C_c^k(K; F) := \bigoplus_{\dim e=k} \text{Hom}(\mathbb{Z}(e); F(e)).$$

The image of  $C_c^k(K; F)$  under  $d$  is contained in  $C_c^{k+1}(K; F)$  only because we assumed  $K$  to be locally finite. A morphism of cosheaves or sheaves gives rise to a morphism of chain or cochain complexes, respectively. In a more categorical language, the association  $F \mapsto (C_k(K; F))_{k \geq 0}$  where  $F$  is a cosheaf and  $G \mapsto (C_{(c)}^k(K; G))_{k \geq 0}$  where  $G$  is a sheaf are all covariant functors.

**Definition 2.3.4** (Dihomologic chain and cochain complex). Let  $F$  be a dihomologic cellular cosheaf on  $K$ . We define the group of *dihomologic  $k$ -chains* of  $K$  with

coefficients in  $F$  to be:

$$\Omega_k(K; F) := \bigoplus_{\dim \epsilon = k} F(\epsilon) \otimes_{\mathbb{Z}} \mathbb{Z}(\epsilon),$$

where  $\epsilon$  runs through the set of  $k$ -dimensional dihomologic pseudo-cells of  $K$ . If  $[\epsilon]$  is an oriented  $k$ -pseudo-cell of  $K$  and  $c$  a  $k$ -chain with coefficients in  $F$  we denote by  $\langle c, [\epsilon] \rangle$  the unique element of  $F(\epsilon)$  satisfying  $c_\epsilon = \langle c, [\epsilon] \rangle \otimes [\epsilon]$ . We also define the *boundary operator*  $\partial : \Omega_k(K; F) \rightarrow \Omega_{k-1}(K; F)$  by the formula:

$$\partial c := \sum_{\epsilon^{k-1} < \epsilon^k} \langle c, [\epsilon^k] \rangle \Big|_{\epsilon^{k-1}}^{\epsilon^k} \otimes [\epsilon^{k-1}],$$

for all  $c \in F(\epsilon^k) \otimes_{\mathbb{Z}} \mathbb{Z}(\epsilon^k)$  where  $[\epsilon^{k-1}]$  is the image of  $[\epsilon^k]$  by the boundary morphism. Likewise, for all dihomologic sheaves  $F$ , the group of *dihomologic  $k$ -cochains* of  $K$  with coefficients in  $F$  is the following:

$$\Omega^k(K; F) := \prod_{\dim \epsilon = k} \text{Hom}(\mathbb{Z}(\epsilon); F(\epsilon)).$$

The *differential*  $d : \Omega^k(K; F) \rightarrow \Omega^{k+1}(K; F)$  is given for all  $k$ -cochains  $\alpha$  and all oriented  $(k+1)$ -cells  $[\epsilon^{k+1}]$  by the following formula:

$$d\alpha[\epsilon^{k+1}] = \sum_{\epsilon^k < \epsilon^{k+1}} \alpha[\epsilon^k] \Big|_{\epsilon^k}^{\epsilon^{k+1}},$$

where for all  $\epsilon^k$ ,  $[\epsilon^k]$  denotes the unique orientation of  $\epsilon^k$  whose image by the boundary morphism is  $[\epsilon^{k+1}]$ .

**Remark 2.3.5.** If the dihomologic pseudo-subdivision of  $K$  is a regular subdivision of  $K$  we find that the last definition is identical to the definition of the cellular chain complex associated with a cellular cosheaf on a CW-complex.

**Definition 2.3.6.** Let  $F$  be a cellular cosheaf (resp. a cellular sheaf). Its *homology* (resp. *cohomology*, resp. *cohomology with compact support*) is the homology of its cellular chain complex (resp. cohomology of its cellular cochain complex, resp. cohomology of cellular its cochain complex with compact support). We also define the homology (resp. cohomology) of a dihomologic cosheaf (resp. sheaf) to be the homology (resp. cohomology) of the associated chain (resp. cochain) complex.

**Example 2.3.7.** Given two sub-complexes  $K_1 \leq K_2$  of  $K$  and an Abelian group  $G$  the homology of  $[K_2; K_1; G]$  is exactly the same as the cellular homology of  $K_2$  relatively to  $K_1$  with coefficients in  $G$ .

The following propositions illustrate the usefulness of these cellular constructions:

**Proposition 2.3.8.** *If  $F$  is a sheaf of Abelian groups on  $|K|$ , constructible with respect to the skeletal filtration, then the sheaf cohomology of  $F$  is isomorphic to the cellular cohomology of the cellular sheaf associated with  $F$ .*



*Proof.* The open cover of  $|K|$  by the open stars of its vertices is a Leray cover for  $F$  and the cellular cochain complex of its associated cellular sheaf is the complex of its Čech cochains<sup>9</sup>.  $\square$

**Proposition 2.3.9.** *Whenever  $F$  is the cellular cosheaf arising from a local system of coefficients  $L$  on  $|K|$  there is a canonical isomorphism from the cellular homology of  $F$  to the singular homology of  $|K|$  with coefficients in  $L$ .*

*Proof.* The proposition follows directly from the description<sup>10</sup> of the complex of singular chains with coefficients in  $L$  and an adaptation of the classical proof relating singular homology and cellular homology.  $\square$

**Proposition 2.3.10.** *Let  $K'$  be a subdivision of  $K$  and  $F$  a cellular cosheaf on  $K$ . If  $F'$  denotes the subdivision of  $F$  we have the following injective morphism of chain complexes:*

$$\begin{aligned} C_k(K; F) &\longrightarrow C_k(K'; F') \\ c &\longmapsto \sum_{e^k \in K} \left( \sum_{\substack{e'^k \subset e^k \\ e'^k \in K'}} \langle c; [e^k] \rangle \otimes [e'^k] \right) \end{aligned}$$

*with the orientations defined as follows: if  $[e^k]$  is an orientation of  $e^k$  then  $[e'^k]$  is the image of such orientation under the isomorphism  $H_k(\bar{e}^k; \bar{e}^k \setminus e^k) \rightarrow H_k(\bar{e}'^k; \bar{e}'^k \setminus e'^k)$  inverse of the map induced by the inclusion  $(\bar{e}'^k \setminus e'^k; \bar{e}'^k) \subset (\bar{e}^k \setminus e'^k; \bar{e}^k)$ . This is a quasi-isomorphism of chain complexes.*

*Proof.* Theorem 1.5.2 p.31 of [She85] is the dual statement for cellular sheaves. Its proof can be transposed to cellular cosheaves.  $\square$

The same proposition holds for dihomologic subdivisions of cellular cosheaves on  $K$ . The specific dual case of the constant sheaf on the dihomologic subdivision is treated in Theorem 1.2 p.12 of [For02].

**Proposition 2.3.11.** *Let  $F$  be a cellular cosheaf on  $K$ . If  $F'$  denotes the dihomologic subdivision of  $F$  we have the following injective morphism of chain complexes:*

$$\begin{aligned} C_k(K; F) &\longrightarrow \Omega_k(K; F') \\ c &\longmapsto \sum_{e^0 \leq e^k} \langle c; [e^k] \rangle \otimes [e^0; e^k] \end{aligned}$$

*with the orientations defined as follows: if  $[e^k]$  is an orientation of  $e^k$  then  $[e^0; e^k]$  is the relative orientation defined by the relation  $[e^0][e^0; e^k] = [e^k]$  where  $[e^0]$  is the canonical orientation of the vertex  $e^0$  of  $K$ . This is a quasi-isomorphism of chain complexes.*

This is an adaptation of the proof given by R. Forman.

<sup>9</sup>c.f. [God58], Théorème 5.10.1 p.228.

<sup>10</sup>c.f. [Hat00], Section 3.H. Local Coefficients pp.327-337.

*Proof.* We denote by  $f$  the chain complexes morphism given in the statement of the proposition. We have natural inclusions of the dihomologic complexes associated with the restrictions of  $F'$  to the skeleta of  $K$ :

$$(\Omega_k(K^{(q)}; F'))_{k \geq 0} \subset (\Omega_k(K^{(q+1)}; F'))_{k \geq 0},$$

for all  $q \in \mathbb{N}$ . We note that for every  $k \in \mathbb{N}$ ,  $f$  maps  $C_k(K; F)$  to  $\Omega_k(K^{(k)}; F')$ . Now we consider the spectral sequence associated with this filtration:

$$E_{p,q}^r := \frac{Z_{p,q}^r + \Omega_{q-p}(K^{(q-1)}; F')}{\partial Z_{p+r-2, q+r-1}^{r-1} + \Omega_{q-p}(K^{(q-1)}; F')},$$

where  $Z_{p,q}^r$  is  $\{c \in \Omega_{q-p}(K^{(q)}; F') \mid \partial c \in \Omega_{q-p-1}(K^{(q-r)}; F')\}$ . The boundary operator  $\partial_{p,q}^r : E_{p,q}^r \rightarrow E_{p-r+1, q-r}^r$  applied to an element  $c \in E_{p,q}^r$  is given by computing  $\partial c' \in \Omega_{q-p-1}(K; F')$  for any lift  $c' \in Z_{p,q}^r$  of  $c$  and then projecting to  $E_{p-r+1, q-r}^r$ . The term  $E_{p,q}^0$  is written as follows:

$$E_{p,q}^0 = \bigoplus_{e^p \leq e^q} F'(e^p; e^q) \otimes \mathbb{Z}(e^p; e^q),$$

with  $F'(e^p; e^q)$  equal to  $F(e^q)$  by assumption. The boundary  $\partial_{p,q}^0$  acts on the element  $f \otimes [e^p; e^q] \in F'(e^p; e^q) \otimes \mathbb{Z}(e^p; e^q)$  (i.e.  $F(e^q) \otimes \mathbb{Z}(e^p; e^q)$ ) as follows:

$$\partial_{p,q}^0 f \otimes [e^p; e^q] = \sum_{e^p \leq e^{p+1} \leq e^q} f \otimes [e^{p+1}; e^q] \in \bigoplus_{e^p \leq e^{p+1} \leq e^q} F'(e^{p+1}; e^q) \otimes \mathbb{Z}(e^{p+1}; e^q),$$

where  $[e^{p+1}; e^q]$  is the image of  $[e^p; e^q]$  by  $\partial : \mathbb{Z}(e^p; e^q) \rightarrow \mathbb{Z}(e^{p+1}; e^q)$ . Remember that this morphism is given by  $(-1)^{p+1} \text{Hom}(\partial'; \text{id})$  with  $\partial' : \mathbb{Z}(e^{p+1}) \rightarrow \mathbb{Z}(e^q)$ . Therefore, if we decide to write  $[e^p; e^q]$  in the form  $\alpha \otimes [e^q]$  in  $\text{Hom}(\mathbb{Z}(e^p); \mathbb{Z}) \otimes \mathbb{Z}(e^q)$ ,  $[e^{p+1}; e^q]$  equals  $(-1)^{p+1}(\alpha \circ \partial') \otimes [e^q]$ . As a consequence the line of index  $q$  of the  $E^0$ -page of the spectral sequence splits into the direct sum of the cellular cochain complexes of the  $K(e^q)$  with coefficients in the constant cellular sheaf  $F(e^q) \otimes \mathbb{Z}(e^q)$ , and coboundary operator  $d$  twisted by  $(-1)^{p+1}$ :

$$\cdots \longrightarrow E_{p,q}^0 \xrightarrow{\partial_{p,q}^0} E_{p+1,q}^0 \longrightarrow \cdots$$

$$\bigoplus_{e^q \in K} C^p(K(e^q); F(e^q) \otimes \mathbb{Z}(e^q)) \xrightarrow{\oplus (-1)^{p+1} d} \bigoplus_{e^q \in K} C^{p+1}(K(e^q); F(e^q) \otimes \mathbb{Z}(e^q))$$

Since the support of  $K(e^q)$  is the closure of  $e^q$ , the  $E^1$ -page of the spectral sequence is concentrated on the 0-th column and satisfies:

$$E_{0,q}^1 = \bigoplus_{e^q \in K} H^0(K(e^q); F(e^q) \otimes \mathbb{Z}(e^q)).$$

Note that  $E_{0,q}^1 \subset E_{0,q}^0$  and is precisely the image of  $f$ . It defines an isomorphism between this 0-th column and  $(C_k(K; F))_{k \geq 0}$ . Thus between the homology of  $F$  and the homology of its subdivision  $F'$ . Moreover, we deduce that our filtration is adapted to the cokernel of  $f$ . The first page of the spectral sequence of the cokernel is given by the reduced cohomology of the  $K(e^q)$ 's with coefficients in the group  $F(e^q) \otimes \mathbb{Z}(e^q)$ . Since  $|K(e^q)|$  is contractible they all vanish. Thus the cokernel of  $f$  has trivial homology and  $f$  is a quasi-isomorphism.  $\square$

## 2.4 Products in Cellular Cohomology

**Cup Product.** The singular cohomology of a topological space  $X$  is always endowed with an algebra structure. This additional structure is often useful in the study of the topology of  $X$ . In this section we recall its definition and discuss its definition in cellular homology.

**Notations.** Let  $X$  denote a topological space and  $R$  be a commutative ring with unit.

**Definition 2.4.1** (Singular Cup Product). Let  $\alpha \in C^q(X; R)$  and  $\beta \in C^{q'}(X; R)$  be two singular cochains on  $X$ . The *cup product* of  $\alpha$  and  $\beta$ , denoted by  $\alpha \cup \beta$ , is the  $(q + q')$ -singular cochain on  $X$  define by the formula:

$$\alpha \cup \beta(\sigma^{q+q'}) := \alpha(\sigma_{0,\dots,q}^{q+q'})\beta(\sigma_{q,\dots,q+q'}^{q+q'}),$$

for all singular simplices  $\sigma^{q+q'}$ , where  $\sigma_{0,\dots,q}^{q+q'}$  and  $\sigma_{q,\dots,q+q'}^{q+q'}$  are the restrictions of  $\sigma^{q+q'}$  to the faces defined by the vertices  $\{0, \dots, q\}$  and  $\{q, \dots, q + q'\}$  respectively. This product satisfies the *Leibniz rule*:

$$d(\alpha \cup \beta) = d\alpha \cup \beta + (-1)^q \alpha \cup d\beta,$$

and therefore defines a product on the cohomology of  $X$ . Moreover the cohomology class of  $\alpha \cup \beta$  equals  $(-1)^{qq'}$  times the class of  $\beta \cup \alpha$ .

When  $X$  is the support of a regular CW-complex  $K$ , its cohomology is canonically isomorphic to its cellular cohomology. And its cellular cohomology is ipso facto endowed with this cup product. One might ask if this product can be computed from cellular cochains.

The canonical isomorphism can be defined as follows:

1. We endow the singular cochain complex of  $|K|$  with the following filtration:

$$F^p C^q(|K|; R) := C^q(|K|; K^{(p-1)}; R),$$

for all  $p, q \geq n$ ;

2. All the terms  $E_1^{p,q}$ , with  $p$  different from  $q$ , of the first page of the spectral sequence vanish. Thus the sequence degenerates at the second page. In addition we have an isomorphism  $\phi^q$  from  $H^q(|K|; R)$  to  $E_2^{q,q}$ , for all  $q \geq 0$ ;

3. The complex  $(E_1^{q,q}; d_1^{q,q})_{q \geq 0}$  is by definition the cellular cochain complex of  $K$ .

Unfortunately, the cup product image  $F^p C^q(|K|; R) \cup F^{p'} C^{q'}(|K|; R)$  is not a priori contained in the piece  $F^{p+p'} C^{q+q'}(|K|; R)$ . Hence, we cannot conclude that the spectral sequence is a spectral ring<sup>11</sup>. The dual spectral sequence of the dual filtration<sup>12</sup> defines an isomorphism from the singular homology of  $|K|$  to its cellular homology. It is essential to note that these isomorphisms are not associated with canonical quasi-isomorphisms, in contrast with subdivision isomorphisms for instance. However, when  $K$  is a simplicial complex there are almost canonical quasi-isomorphic injections of the cellular chain complex into the singular chain complex.

**Definition 2.4.2.** A *simplicial ordering* of the vertices of  $K$  is a partial order of its set of vertices for which any two vertices of an edge can be compared. Any such order induces a total order on the set of vertices of every simplex of  $K$ . A total order of the set of vertices of  $K$  is an example of simplicial ordering.

Let  $\geq_{so}$  be a simplicial ordering of the vertices of  $K$ . The restriction of  $\geq_{so}$  to the vertices of  $\sigma^q$  defines an isomorphism between the model simplex and  $K(\sigma^q)$ . Hence, it provides a singular simplex of  $|K|$  whose image is  $\bar{\sigma}^q$ . Which we denote by the same symbol  $\bar{\sigma}^q$ . This singular chain  $\bar{\sigma}^q$  defines a local orientation  $[\bar{\sigma}^q]$  of  $\sigma^q$ . Now we can define the following injective morphism of chain complexes:

$$\begin{aligned} \phi_q^{so} : C_q(K; R) &\longrightarrow C_q(|K|; R) \\ c &\longmapsto \sum_{\sigma^q \in K} \langle c; [\bar{\sigma}^q] \rangle \bar{\sigma}^q. \end{aligned}$$

One can show that any two such morphisms are chain homotopic to one another. Hence, they define the same morphism in homology  $\phi_q^* : H_q(K; R) \rightarrow H_q(|K|; R)$ . This is the inverse of the canonical isomorphism from  $H_q(|K|; R)$  to  $H_q(K; R)$ . The adjoint projection  $\phi_{so}^q : C^q(|K|; R) \rightarrow C^q(K; R)$  induces the canonical isomorphism  $\phi^q$  in cohomology. Definition 2.4.1 directly implies the following proposition.

**Proposition 2.4.3.** *For all simplicial orderings  $so$ , the kernel of  $(\phi_{so}^q)_{q \geq 0}$  is a two-sided ideal of the graded algebra  $(C^q(|K|; R))_{q \geq 0}$ .*

Hence, Proposition 2.4.3 endows  $(C^q(K; R))_{q \geq 0}$  with a product  $\cup_{so}$ . All these products satisfy the Leibniz rule and yield the same product in cohomology, the singular cup product. However they differ at the level of cellular cochains. Let us compute the product of  $\alpha \in C^q(K; F)$  and  $\beta \in C^{q'}(K; F)$ . For all simplices  $\sigma^{q+q'}$  of  $K$ , the simplicial ordering  $so$  induces a numbering  $v_0, \dots, v_{q+q'}$  of the vertices of  $\sigma^{q+q'}$  and at the same an orientation  $[v_0; \dots; v_{q+q'}]$ . The value of  $\alpha \cup_{so} \beta$  on  $[v_0; \dots; v_{q+q'}]$  is given by the following formula:

$$(\alpha \cup_{so} \beta) [v_0; \dots; v_{q+q'}] = \alpha[v_0; \dots; v_q] \beta[v_q; \dots; v_{q+q'}].$$

<sup>11</sup>c.f. [McC00], §2.3. Spectral sequences of algebras pp.44-46.

<sup>12</sup>c.f. Definition A.3.

When  $K$  is just a regular CW-complex one can use this construction on its barycentric subdivision. It has the advantage of being already endowed with the simplicial ordering given by the adjacency of the cells of  $K$ . Hence, when  $K$  is a simplicial complex we may avoid choosing a simplicial order by considering its barycentric subdivision instead. Nevertheless, considering the barycentric subdivision introduces a lot more cells. However, defining a canonical cellular cup product can be achieved on the dihomologic subdivision of a regular CW-complex. Doing so limits the complexity of the new complex. To give an idea of the difference between the number of cells of  $\text{Sd } K$  and the number of pseudo-cells of the dihomologic subdivision of  $K$ , there are as many edges and vertices in  $\text{Sd } K$  as there are pseudo-cells in the dihomologic pseudo-subdivision.

**Definition 2.4.4** (Dihomologic Cup Product). Let  $K$  be a regular CW-complex. The *dihomologic cup product* is the morphism:

$$\cup : \Omega^q(K; R) \otimes_R \Omega^{q'}(K; R) \rightarrow \Omega^{q+q'}(K; R),$$

defined for all  $\alpha \in \Omega^q(K; R)$ , all  $\beta \in \Omega^{q'}(K; R)$  and all oriented dihomologic pseudo-cells  $[e^p; e^{p+q+q'}]$ , by the following formula:

$$(\alpha \cup \beta)[e^p; e^{p+q+q'}] := \sum_{e^p \leq e^{p+q} \leq e^{p+q+q'}} \alpha[e^p; e^{p+q}] \beta[e^{p+q}; e^{p+q+q'}],$$

where  $[e^p; e^{p+q}]$  and  $[e^{p+q}; e^{p+q+q'}]$  are any choices of orientations satisfying the relation  $[e^p; e^{p+q}][e^{p+q}; e^{p+q+q'}] = [e^p; e^{p+q+q'}]$ .

In a regular CW-complex  $K$ , we have a natural subdivision projection from the barycentric cochain complex  $(C^q(\text{Sd } K; R))_{q \geq 0}$  to the dihomologic cochain complex  $(\Omega^q(K; R))_{q \geq 0}$ . Its composition with the subdivision projection of  $(\Omega^q(K; R))_{q \geq 0}$  onto  $(C^q(K; R))_{q \geq 0}$  corresponds to the subdivision projection of  $(C^q(\text{Sd } K; R))_{q \geq 0}$  onto  $(C^q(K; R))_{q \geq 0}$ . In other words we have the following commutative diagram:

$$\begin{array}{ccc} (C^q(\text{Sd } K; R))_{q \geq 0} & \longrightarrow & (\Omega^q(K; R))_{q \geq 0} \\ & \searrow & \downarrow \\ & & (C^q(K; R))_{q \geq 0} \end{array}$$

Proposition 2.3.10 and Proposition 2.3.11 ensure that the two projections onto  $(C^q(K; R))_{q \geq 0}$  are quasi-isomorphisms. Hence, so has to be the projection of the complex  $(C^q(\text{Sd } K; R))_{q \geq 0}$  onto  $(\Omega^q(K; R))_{q \geq 0}$ .

**Proposition 2.4.5.** *The subdivision quasi-isomorphic projection:*

$$(C^q(\text{Sd } K; R))_{q \geq 0} \rightarrow (\Omega^q(K; R))_{q \geq 0},$$

is a morphism of algebras.

*Proof.* Let  $\alpha \in C^q(\text{Sd } K; R)$  and  $\beta \in C^{q'}(\text{Sd } K; R)$  be two barycentric cochains, and  $[e^p; e^{p+q+q'}]$  be an oriented dihomologic pseudo-cell of  $K$ . Let us denote by  $\text{Sub}$  the subdivision projection. The value of  $\text{Sub}(\alpha) \cup \text{Sub}(\beta)$  is given by the following formula:

$$(\text{Sub}(\alpha) \cup \text{Sub}(\beta))[e^p; e^{p+q+q'}] = \sum_{e^p \leq e^{p+q} \leq e^{p+q+q'}} \text{Sub}(\alpha)[e^p; e^{p+q}] \text{Sub}(\beta)[e^{p+q}; e^{p+q+q'}].$$

with  $[e^p; e^{p+q}]$  and  $[e^{p+q}; e^{p+q+q'}]$  satisfying  $[e^p; e^{p+q}][e^{p+q}; e^{p+q+q'}] = [e^p; e^{p+q+q'}]$ . A  $q$ -barycentric simplex of the oriented pseudo-cell  $[e^p; e^{p+q}]$  is given by a complete flag of cells  $e^p < e^{p+1} < \dots < e^{p+q}$ . The orientation of  $[e^p; e^{p+q}]$  induces an orientation  $[e^p < e^{p+1} < \dots < e^{p+q}]_{\text{Sd } K}$  of the associated barycentric simplex. The same happens for the barycentric simplices contained in  $[e^{p+q}; e^{p+q+q'}]$ . Hence, we have:

$$\begin{aligned} (\text{Sub}(\alpha) \cup \text{Sub}(\beta))[e^p; e^{p+q+q'}] &= \sum_{e^p \leq e^{p+q} \leq e^{p+q+q'}} \left( \sum_{e^p < \dots < e^{p+q}} \alpha([e^p; \dots; e^{p+q}]_{\text{Sd } K}) \right) \\ &\quad \times \left( \sum_{e^{p+q} < \dots < e^{p+q+q'}} \beta([e^{p+q}; \dots; e^{p+q+q'}]_{\text{Sd } K}) \right) \\ &= \sum_{e^p < \dots < e^{p+q+q'}} \alpha([e^p; \dots; e^{p+q}]_{\text{Sd } K}) \\ &\quad \times \beta([e^{p+q}; \dots; e^{p+q+q'}]_{\text{Sd } K}) \\ &= \sum_{e^p < \dots < e^{p+q+q'}} (\alpha \cup \beta)([e^p; \dots; e^{p+q+q'}]_{\text{Sd } K}) \\ &= \text{Sub}(\alpha \cup \beta)[e^p; e^{p+q+q'}]. \end{aligned}$$

□

In order to reduce even more the complexity of the representatives of the cohomology classes with which we can compute the cup product without making any choices, we can define the cup product of a dihomologic cochain with a cellular cochain. This construction is highly linked to the definition of dihomologic cochains as *combinatorial differential forms*<sup>13</sup> of R. Forman. He defined combinatorial differential form as local, graded endomorphisms of the graded group  $\bigoplus_{q \geq 0} C_q(K; R)$ . With this definition in mind, the “action” of dihomologic cochains on cellular cochains is adjoint to this representation.

**Definition 2.4.6.** Let  $\alpha \in C^{q'}(K; R)$  be a cellular cochain and  $\beta \in \Omega^q(K; R)$  be a dihomologic cochain. The value of the cellular  $(q+q')$ -cochain  $\alpha \cup \beta$  on the oriented cell  $[e^{q+q'}]$  is defined by the formula:

$$(\alpha \cup \beta)[e^{q+q'}] := \sum_{e^{q'} \leq e^{q+q'}} \alpha[e^{q'}] \beta[e^{q'}; e^{q+q'}],$$

<sup>13</sup>c.f. [For02], Definition 1 p.11.

where the orientations  $[e^{q'}]$  and  $[e^{q'}; e^{q+q'}]$  satisfy the relation  $[e^{q'}][q'; e^{q+q'}] = [e^{q+q'}]$ .

**Proposition 2.4.7.** *Let  $\alpha \in \Omega^{q'}(K; R)$  and  $\beta \in \Omega^q(K; R)$  be two dihomologic cochains, and  $\text{Sub} : (\Omega^q(K; R))_{q \geq 0} \rightarrow (C^q(K; R))_{q \geq 0}$  denote the subdivision quasi-isomorphic projection. The cochain  $\text{Sub}(\alpha) \cup \beta$  equals the cochain  $\text{Sub}(\alpha \cup \beta)$ .*

*Proof.* Let  $[e^{q+q'}]$  be an oriented cell of  $K$ . By Definition 2.4.4, we have:

$$\begin{aligned} \text{Sub}(\alpha \cup \beta)[e^{q+q'}] &= \sum_{e^0 \leq e^{q+q'}} (\alpha \cup \beta)[e^0; e^{q+q'}] \\ &= \sum_{e^0 \leq e^{q+q'}} \sum_{e^0 \leq e^q \leq e^{q+q'}} \alpha[e^0; e^q] \beta[e^q; e^{q+q'}] \\ &= \sum_{e^q \leq e^{q+q'}} \left( \sum_{e^0 \leq e^q} \alpha[e^0; e^q] \right) \beta[e^q; e^{q+q'}] \\ &= \sum_{e^q \leq e^{q+q'}} \text{Sub}(\alpha)[e^q] \beta[e^q; e^{q+q'}] \\ &= (\text{Sub}(\alpha) \cup \beta)[e^{q+q'}], \end{aligned}$$

since the orientations  $[e^0; e^q]$  and  $[e^q; e^{q+q'}]$  had to satisfy  $[e^0][e^0; e^q][e^q; e^{q+q'}] = [e^{q+q'}]$  where  $[e^0]$  is the canonical orientation of the vertex  $e^0$ .  $\square$

Definition 2.4.4 can be extended to cochains with coefficients in dihomologic sheaves.

**Definition 2.4.8.** Let  $A, B, C$  be three dihomologic sheaves of  $R$ -modules on  $K$ . Let  $\mu : A \otimes_R B \rightarrow C$  be a morphism of sheaves of  $R$ -modules. For all integers  $q, q' \geq 0$ , the associated cup product:

$$\cup : \Omega^q(K; A) \otimes \Omega^{q'}(K; B) \rightarrow \Omega^{q+q'}(K; C),$$

is defined for all  $\alpha \in \Omega^q(K; A)$ ,  $\beta \in \Omega^{q'}(K; B)$ , and all oriented pseudo-cells  $[e^p, e^{p+q+q'}]$  by the following formula:

$$(\alpha \cup \beta)[e^p, e^{p+q+q'}] := \sum_{e^p \leq e^{p+q} \leq e^{p+q+q'}} \mu \left( \alpha[e^p, e^{p+q}] \otimes \beta[e^{p+q}, e^{p+q+q'}] \right),$$

where  $[e^p; e^{p+q}]$  and  $[e^{p+q}; e^{p+q+q'}]$  are any choices of orientations satisfying the relation  $[e^p; e^{p+q}][e^{p+q}; e^{p+q+q'}] = [e^p; e^{p+q+q'}]$ , and  $\alpha[e^p, e^{p+q}] \otimes \beta[e^{p+q}, e^{p+q+q'}]$  is understood as the tensor product of the image of  $\alpha[e^p, e^{p+q}]$  in  $A(e^p; e^{p+q+q'})$  and of the image of  $\beta[e^{p+q}, e^{p+q+q'}]$  in  $B(e^p; e^{p+q+q'})$  by the respective restriction morphisms of  $A$  and  $B$ . It satisfies the Leibniz rule and induces a bilinear morphism in cohomology. In particular, it defines a product when  $A, B$ , and  $C$  are all the same sheaf of algebras and  $\mu$  is its product.

**Cap Product.** On a topological space  $X$  the singular cochain complex is the algebraic dual of the singular chain complex. For infinite spaces the bidual of the

singular chain complex is always strictly bigger than itself. Nevertheless, for all singular cochains  $\alpha$ , the adjoint of the map  $-\cup\alpha$  always stabilises the singular chain complex. The induced morphism is called the *cap product*. The cellular constructions of the cup product can be carried on for the cap product.

**Remark 2.4.9.** If  $A$  is a dihomologic sheaf of  $R$ -modules on  $K$ , and  $B$  a dihomologic cosheaf of  $R$ -modules then  $\text{Hom}_R(A; B) : (e^p; e^q) \mapsto \text{Hom}_R(A(e^p; e^q); B(e^p; e^q))$  is a cosheaf of  $R$ -modules. Indeed, it is isomorphic to  $\text{Hom}_R(A; R) \otimes_R B$  and  $\text{Hom}_R(A; R)$  is a cosheaf.

**Definition 2.4.10.** Let  $A$  be a sheaf of  $R$ -modules on  $K$ , and  $B$  and  $C$  be two cosheaves of  $R$ -modules of  $K$ . Let  $\mu : B \rightarrow \text{Hom}_R(A; C)$  be a morphism of cosheaves. For all integers  $q, q' \geq 0$ , the associated cap product:

$$\cap : \Omega^q(K; A) \otimes \Omega_{q+q'}(K; B) \rightarrow \Omega_{q'}(K; C),$$

is defined for all  $\alpha \in \Omega^q(K; A)$ ,  $c \in \Omega_{q+q'}(K; B)$ , and all oriented pseudo-cells  $[e^p, e^{p+q'}]$  by the formula:

$$\langle \alpha \cap c; [e^p, e^{p+q'}] \rangle := \sum_{e^{p+q'} \leq e^{p+q+q'}} \mu \left( \langle c; [e^p, e^{p+q+q'}] \rangle \right) \left( \alpha[e^{p+q'}; e^{p+q+q'}] \right) \Big|_{e^p, e^{p+q'}}^{e^p, e^{p+q+q'}},$$

where  $[e^p; e^{p+q+q'}]$  and  $[e^{p+q'}; e^{p+q+q'}]$  are any choices of orientations satisfying the relation  $[e^p; e^{p+q'}][e^{p+q'}; e^{p+q+q'}] = [e^p; e^{p+q+q'}]$ , and  $\alpha[e^{p+q'}; e^{p+q+q'}]$  and  $\langle c; [e^p, e^{p+q+q'}] \rangle$  are understood as their respective images in  $A(e^p; e^{p+q+q'})$  and  $B(e^p; e^{p+q+q'})$  by the respective restriction/extension morphisms of  $A$  and  $B$ .

A direct computation yields the following proposition:

**Proposition 2.4.11.** *Let  $\mu^* : \text{Hom}_R(C; R) \otimes_R A \rightarrow \text{Hom}_R(B; R)$  be the adjoint of the cosheaves morphism  $\mu : B \rightarrow \text{Hom}_R(A; C)$  and  $M$  be an  $R$ -module. Let  $\cup$  be the cup product associated to  $\mu^* \otimes \text{id}_M : \text{Hom}_R(C; M) \otimes_R A \rightarrow \text{Hom}_R(B; M)$ . Then, for all  $\beta \in \Omega^q(K; A)$ ,  $c \in \Omega_{q+q'}(K; B)$ , and all  $\alpha \in \Omega^{q'}(K; \text{Hom}_R(C; M))$ , we have:*

$$\alpha(\beta \cap c) = (\alpha \cup \beta)(c) \in M.$$

*Proof.* We have:

$$\begin{aligned} \alpha(\beta \cap c) &= \sum_{e^p \leq e^{p+q'}} \alpha[e^p; e^{p+q'}] \left( \langle \beta \cap c; [e^p; e^{p+q'}] \rangle \right) \\ &= \sum_{e^p \leq e^{p+q'}} \alpha[e^p; e^{p+q'}] \left( \sum_{e^{p+q'} \leq e^{p+q+q'}} \mu \left( \langle c; [e^p, e^{p+q+q'}] \rangle \right) \left( \beta[e^{p+q'}; e^{p+q+q'}] \right) \right) \\ &= \sum_{e^p \leq e^{p+q'} \leq e^{p+q+q'}} \mu^* \left( \alpha[e^p; e^{p+q'}] \otimes \beta[e^{p+q'}; e^{p+q+q'}] \right) \left( \langle c; [e^p, e^{p+q+q'}] \rangle \right) \\ &= (\alpha \cup \beta)(c). \end{aligned}$$



□

**Proposition 2.4.12.** *The cap product satisfies the following Leibniz rule: for all  $\beta \in \Omega^q(K; A)$  and all  $c \in \Omega_{q+q'}(K; B)$ , we have:*

$$\partial(\beta \cap c) = \beta \cap \partial c + (-1)^{q'} d\beta \cap c.$$

*Proof.* Let  $I$  be an injective  $R$ -module and  $\alpha \in \Omega^{q'-1}(K; \text{Hom}_R(C; I))$  be a dihomologic cochain. By Proposition 2.4.11, we have:

$$\begin{aligned} \alpha(\partial(\beta \cap c)) &= (d\alpha)(\beta \cap c) \\ &= (d\alpha \cup \beta)(c) \\ &= (d(\alpha \cup \beta) - (-1)^{q'-1} \alpha \cup d\beta)(c) \\ &= \alpha(\beta \cap \partial c) + (-1)^{q'} \alpha(d\beta \cap c) \\ &= \alpha(\beta \cap \partial c + (-1)^{q'} d\beta \cap c). \end{aligned}$$

Hence,  $\partial(\beta \cap c)$  equals  $\beta \cap \partial c + (-1)^{q'} d\beta \cap c$  for  $\Omega^{q'-1}(K; \text{Hom}_R(C; I))$  is isomorphic to  $\text{Hom}_R(\Omega_{q'-1}(K; C); I)$ . □

The last definition we give is of the cap product of a dihomologic cochain with a cellular chain. This is exactly how R. Forman defines combinatorial differential forms.

**Definition 2.4.13.** Let  $\alpha \in \Omega^q(K; R)$  be a dihomologic cochain and  $c \in C_{q+q'}(K; R)$  be a cellular chain. The cap product  $\alpha \cap c \in C_{q'}(K; R)$  is defined for all oriented  $q$ -cells  $[e^q]$  by the following formula:

$$\langle \alpha \cap c; [e^q] \rangle := \sum_{e^{q+q'} \geq e^q} \alpha[e^q; e^{q+q'}] \langle c; [e^{q+q'}] \rangle,$$

with  $[e^q][e^q; e^{q+q'}] = [e^{q+q'}]$ . It satisfies the Leibniz rule:

$$\partial(\alpha \cap c) = \alpha \cap \partial c + (-1)^{q'} d\alpha \cap c.$$

## 2.5 A Theorem of the Poincaré-Lefschetz Type

Let  $K$  be a locally finite regular CW-complex and  $F$  be a dihomologic cosheaf on  $K$ . The chain complex  $(\Omega_k(K; F))_{k \geq 0}$  is actually the total complex of a bicomplex. The  $k$ -dimensional dihomologic pseudo-cells being represented by adjacent pairs of cells  $e^p \leq e^q$  with  $q - p = k$  their set is partitioned into sets of cells of different types. If we say that a dihomologic pseudo-cell indexed by  $e^p \leq e^q$  has type  $(p, q)$ , the set of  $k$ -dimensional dihomologic pseudo-cells is the disjoint union of the set of pseudo-cells of type  $(p, q)$  for all  $q - p = k$ . Similarly the group  $\Omega_k(K; F)$  splits into the direct sum:

$$\Omega_k(K; F) = \bigoplus_{q-p=k} \Omega_{p,q}(K; F),$$

where:

$$\Omega_{p,q}(K; F) = \bigoplus_{e^p \leq e^q} F(e^p; e^q) \otimes \mathbb{Z}(e^p; e^q),$$

for all  $p, q \in \mathbb{N}$ . A codimension 1 face of  $e^p \leq e^q$  either starts with  $e^p$  or ends with  $e^q$ . Therefore, the restriction of the boundary operator to  $\Omega_{p,q}(K; F)$  takes values in the sum  $\Omega_{p+1,q}(K; F) \oplus \Omega_{p,q-1}(K; F)$ . It splits into the sum of an operator  $\partial_1$  of bidegree  $(+1; 0)$  and an operator  $\partial_2$  of bidegree  $(0; -1)$ . With this additional structure we can consider the two canonical filtrations and associated spectral sequences. We will only study the (decreasing) horizontal filtration. That is to say the one using the index  $p$ . The filtering pieces are, for all  $l, k \in \mathbb{N}$ :

$$\Omega_k^{(l)}(K; F) := \bigoplus_{\substack{q-p=k \\ p \geq l}} \Omega_{p,q}(K; F).$$

The associated spectral sequence is given for all  $p, q \in \mathbb{Z}$  by:

$$E_{p,q}^r := \frac{Z_{p,q}^r + \Omega_{q-p}^{(p+1)}(K; F)}{\partial Z_{p-r+1, q-r+2}^{r-1} + \Omega_{q-p}^{(p+1)}(K; F)},$$

where  $Z_{p,q}^r$  stands for  $\{c \in \Omega_{q-p}^{(p)}(K; F) \mid \partial c \in \Omega_{q-p-1}^{(p+r)}(K; F)\}$ . The boundary operator  $\partial_{p,q}^r : E_{p,q}^r \rightarrow E_{p+r, q+r-1}^r$  applied to an element  $c \in E_{l,k}^r$  is given by computing  $\partial c$  in  $\Omega_{q-p-1}^{(p+r)}(K; F)$  for any lift  $c' \in Z_{p,q}^r$  of  $c$  and then projecting it to  $E_{p+r, q+r-1}^r$ .

**Proposition 2.5.1.** *If there is an  $n \in \mathbb{N}$  such that for every cell  $e$  of  $K$  the local cosheaf  $F_e$  has its homology concentrated in dimension  $n$  then the horizontal spectral sequence of  $(\Omega_k(K; F))_{k \geq 0}$  degenerates at the second page.*

*Proof.* We have:

$$E_{p,q}^0 \cong \Omega_{p,q}(K; F),$$

with  $\partial_{p,q}^0$  corresponding to the vertical component,  $\partial_2$ , of the total boundary operator,  $\partial$ , of  $(\Omega_k(K; F))_{k \geq 0}$ . The following page  $(E_{p,q}^1)_{p,q \geq 0}$  is given by the homology groups of the column complexes of the bicomplex  $(\Omega_{p,q}(K; F))_{p,q \geq 0}$ . Let  $p, q \geq 0$  be integers. Let us consider the following morphism:

$$\Phi_{p,q} : \Omega_{p,q}(K; F) \rightarrow \bigoplus_{e^p \in K} \text{Hom}(\mathbb{Z}(e^p); C_q(K; F_{e^p})),$$

for which the  $(e^p)$ -component of the image of an element  $c$  is given by the linear map:

$$[e^p] \mapsto (-1)^{\frac{p(p+1)}{2} + \frac{q(q+1)}{2}} \sum_{e^q > e^p} \langle c, [e^p; e^q] \rangle \otimes [e^q],$$

where  $[e^p; e^q]$  and  $[e^q]$  are some choices of orientations satisfying  $[e^p][e^p; e^q] = [e^q]$  (the map does not depend on such choices). For a fixed  $p \in \mathbb{N}$ , the collection  $(\Phi_{p,q})_{q \geq 0}$  is almost a chain complex isomorphism between the  $p$ -th column of the bicomplex of  $F$ -valued dihomologic chains and the direct sum over the  $p$ -cells  $e^p$  of the complexes

$\text{Hom}(\mathbb{Z}(e^p); C_q(K; F_{e^p}))_{q \geq 0}$ . We have:

$$\partial \Phi_{p,q} = (-1)^{q-p} \Phi_{p,q-1} \partial_2,$$

and  $(\Phi_{p,q})_{q \geq 0}$  still defines an isomorphism in homology. Each of the  $\Phi_{p,q}$  being individually an isomorphism is a matter of bookkeeping. On the left hand side we sum the groups  $F(e^p, e^q) \otimes \mathbb{Z}(e^p, e^q)$  over all ordered pairs of cells  $e^p < e^q$  and on the right hand side we sum the groups  $\text{Hom}(\mathbb{Z}(e^p); F(e^p, e^q) \otimes \mathbb{Z}(e^q))$  over the same index set but in a different order. The morphism  $\Phi_{p,q}$  sends bijectively each one of the former summands to one of the latter by means of the following composition:

$$\begin{aligned} F(e^p, e^q) \otimes \mathbb{Z}(e^p, e^q) & \xlongequal{\quad} F(e^p, e^q) \otimes \text{Hom}(\mathbb{Z}(e^p); \mathbb{Z}(e^q)) \xrightarrow{\pm 1} \dots \\ \dots & \xrightarrow{\pm 1} \text{Hom}(\mathbb{Z}(e^p); F(e^p, e^q) \otimes \mathbb{Z}(e^q)). \end{aligned}$$

Let  $c$  be a  $(p, q)$ -chain. On the one hand, for all  $p$ -cells  $e^p$  of  $K$ , the value of the  $(e^p)$ -component of  $\Phi_{p,q-1}(\partial_2 c)$  on an orientation  $[e^p]$  is given by the formula:

$$\Phi_{p,q-1}(\partial_2 c)[e^p] = (-1)^{\frac{p(p+1)}{2} + \frac{q(q-1)}{2}} \sum_{e^{q-1} > e^p} \left( \sum_{e^q > e^{q-1}} \langle c, [e^p; e^q] \Big|_{e^p, e^{q-1}}^{e^p, e^q} \right) \otimes [e^{q-1}],$$

where  $[e^p][e^p, e^{q-1}] = [e^{q-1}]$  and  $[e^p, e^q] = (-1)^p [e^p, e^{q-1}][e^{q-1}, e^q]$ . That is to say:

$$\Phi_{p,q-1}(\partial_2 c)[e^p] = (-1)^{\frac{p(p-1)}{2} + \frac{q(q-1)}{2}} \sum_{e^{q-1} > e^p} \left( \sum_{e^q > e^{q-1}} \langle c, [e^p; e^q] \Big|_{e^p, e^{q-1}}^{e^p, e^q} \right) \otimes [e^{q-1}],$$

where  $[e^p][e^p, e^q] = [e^{q-1}][e^{q-1}, e^q]$ . Note that we changed the equation defining the orientation which resulted in the multiplication by a factor  $(-1)^p$  in the computation of  $\Phi_{p,q-1}(\partial_2 c)[e^p]$ . It turned  $(-1)^{\frac{p(p+1)}{2}}$  into  $(-1)^{\frac{p(p-1)}{2}}$ . On the other hand, the value of the  $(e^p)$ -component of  $\partial \Phi_{p,q}(c)$  on  $[e^p]$  is the same as the boundary of  $\Phi_{p,q}(c)[e^p]$ :

$$\partial \Phi_{p,q}(c)[e^p] = (-1)^{\frac{p(p+1)}{2} + \frac{q(q+1)}{2}} \sum_{e^q > e^p} \left( \sum_{e^{q-1} < e^q} \langle c, [e^p, e^q] \Big|_{e^{q-1}}^{e^q} \otimes [e^{q-1}] \right),$$

where  $[e^p][e^p, e^q] = [e^q]$  and  $[e^{q-1}][e^{q-1}, e^q] = [e^q]$ , i.e.  $[e^p][e^p, e^q] = [e^{q-1}][e^{q-1}, e^q]$ . Note that the element  $\langle c, [e^p, e^q] \Big|_{e^{q-1}}^{e^q}$  of  $F(e^p, e^q)$  in the last formula is understood as an element of  $F_{e^p}(e^q)$ . Hence, the extension morphisms of  $F_{e^p}$  apply to it, and this is why we wrote  $\langle c, [e^p, e^q] \Big|_{e^{q-1}}^{e^q}$ . However, these extension morphisms are zero whenever  $e^{q-1}$  doesn't contain  $e^p$  and identical to those of  $F$  in the opposite case.

Therefore, we can write:

$$\begin{aligned}
 \partial\Phi_{p,q}(c)[e^p] &= (-1)^{\frac{p(p+1)}{2} + \frac{q(q+1)}{2}} \sum_{e^q > e^p} \left( \sum_{e^p < e^{q-1} < e^q} \langle c, [e^p, e^q] \rangle \Big|_{e^p, e^{q-1}}^{e^p, e^q} \otimes [e^{q-1}] \right) \\
 &= (-1)^{\frac{p(p+1)}{2} + \frac{q(q+1)}{2}} \sum_{e^{q-1} > e^p} \left( \sum_{e^q > e^{q-1}} \langle c, [e^p; e^q] \rangle \Big|_{e^p, e^{q-1}}^{e^p, e^q} \right) \otimes [e^{q-1}] \\
 &= (-1)^{q-p} \Phi_{p,q-1}(\partial_2 c)[e^p].
 \end{aligned}$$

For each  $p$ -cell, the group  $\mathbb{Z}(e^p)$  is free. The Universal Coefficient Theorem<sup>14</sup> ensures that  $E_{p,q}^1$  is isomorphic to the direct sum of the  $\text{Hom}(\mathbb{Z}(e^p); H_q(K; F_{e^p}))$ 's. By assumptions  $H_q(K; F_{e^p})$  is trivial as soon as  $q$  is not  $n$ . As a consequence all pages following  $E^1$  are concentrated on the horizontal line  $\{q = n\}$ . Since  $\partial_{p,q}^r$  has bidegree  $(r, r-1)$  the spectral sequence degenerates at the second page.  $\square$

**Definition 2.5.2.** Let  $F$  be a dihomologic cosheaf on  $K$  a regular CW-complex and  $q$  be an integer. We define the cellular sheaf  $H_q(F_*)$  as follows:

1. For all cells  $e$  of  $K$ ,  $H_q(F_*)(e)$  is the local homology group  $H_q(K; F_e)$ ;
2. Its restriction morphisms are given in homology by the localisation projections  $F_e \rightarrow F_{e'}$ , for all  $e' \leq e$ .

**Theorem 2.5.3** (Cellular Poincaré-Lefschetz Theorem). *Let  $K$  be a finite dimensional, locally finite and regular CW-complex and  $F$  be a dihomologic cosheaf satisfying the hypotheses of Proposition 2.5.1. For all integers  $k \geq 0$ ,  $H_k(K; F)$  and  $H_c^{n-k}(K; H_n(F_*))$  are canonically isomorphic. In particular  $H_k(K; F)$  vanishes for all  $k > n$ . If in addition  $K$  has dimension  $n$ , this isomorphism comes from an injective quasi-isomorphism:*

$$(C_c^{n-k}(K; H_n(F_*)))_{0 \leq k \leq n} \rightarrow (\Omega_k(K; F))_{0 \leq k \leq n}.$$

*Proof.* Let  $d$  be  $\dim K$  and consider the horizontal filtration of the homology of  $F$ :

$$0 \subset H_k(K; F)^{(d)} \subset \dots \subset H_k(K; F)^{(n-k)} \subset \dots \subset H_k(K; F)^{(0)},$$

whose graded pieces:

$$E_{d,k+d}^\infty \quad \dots \quad E_{n-k,n}^\infty \quad \dots \quad E_{0,k}^\infty,$$

vanish as soon as the second index is not  $n$ , c.f. Proposition 2.5.1. Therefore,  $H_k(K; F)$  equals  $H_k(K; F)^{(n-k)}$  which is isomorphic to  $E_{n-k,n}^2$ . Now because of the isomorphisms  $(\Phi_{p,q})_{p,q \geq 0}$  given in the proof of Proposition 2.5.1, we recognise that  $E_{p,q}^1$  is isomorphic to the group  $C_c^p(K; H_q(F_*))$ . Then it remains only to show that the boundary operator  $\partial_{p,q}^1$  of the spectral sequence is mapped to the coboundary

<sup>14</sup>c.f. [CE56], Theorem 3.3 p.113.

operator  $d$ . If  $c' \in \Omega_{p,q}(K; F)$  is a  $\partial_2$ -cycle representing an element  $c \in E_{p,q}^1$  then  $\partial_1 c'$  is a  $\partial_2$ -cycle representing  $\partial_{p,q}^1 c$ . We have:

$$\langle \partial_1 c', [e^{p+1}; e^q] \rangle = \sum_{e^p < e^{p+1}} \langle c', [e^p; e^q] \rangle \Big|_{e^{p+1}; e^q}^{e^p, e^q},$$

where  $[e^p; e^q] = (-1)^{p+1} [e^p; e^{p+1}] [e^{p+1}; e^q]$ . So the image of  $\partial_1 c'$  under  $\Phi$  satisfies:

$$\Phi_{p+1,q}(\partial_1 c')[e^{p+1}] = (-1)^{\frac{(p+2)(p+1)}{2} + \frac{q(q+1)}{2}} \sum_{e^q > e^{p+1}} \left( \sum_{e^p < e^{p+1}} \langle c', [e^p; e^q] \rangle \Big|_{e^{p+1}; e^q}^{e^p, e^q} \right) \otimes [e^q],$$

where  $[e^{p+1}][e^{p+1}; e^q] = [e^q]$  and  $[e^p; e^q] = (-1)^{p+1} [e^p; e^{p+1}] [e^{p+1}; e^q]$ . Which can be written as follows:

$$\begin{aligned} \Phi_{p+1,q}(\partial_1 c')[e^{p+1}] &= (-1)^{\frac{p(p+1)}{2} + \frac{q(q+1)}{2}} \sum_{e^p < e^{p+1}} \left( \sum_{e^q > e^{p+1}} \langle c', [e^p; e^q] \rangle \Big|_{e^{p+1}; e^q}^{e^p, e^q} \otimes [e^q] \right) \\ &= (-1)^{\frac{p(p+1)}{2} + \frac{q(q+1)}{2}} \sum_{e^p < e^{p+1}} \Psi_{e^p}^{e^{p+1}} \left( \sum_{e^q > e^p} \langle c', [e^p; e^q] \rangle \otimes [e^q] \right), \end{aligned}$$

where the orientations satisfy  $[e^{p+1}][e^{p+1}; e^q] = [e^q]$  and  $[e^p; e^q] = [e^p; e^{p+1}] [e^{p+1}; e^q]$ , and  $\Psi_{e^p}^{e^{p+1}} : C_q(K; F_{e^p}) \rightarrow C_q(K; F_{e^{p+1}})$  is the morphism associated with the cosheaf morphism  $F_{e^p} \rightarrow F_{e^{p+1}}$ . Therefore,  $\Phi_{p+1,q}(\partial_{p,q}^1 c)$  is the  $(p+1)$ -cochain with compact support that associates to an oriented cell  $[e^{p+1}]$  the sum over its codimension 1 faces of the images in  $H_q(K; F_{e^{p+1}})$  of the homology classes:

$$\left[ (-1)^{\frac{p(p+1)}{2} + \frac{q(q+1)}{2}} \sum_{e^q > e^p} \langle c', [e^p; e^q] \rangle \otimes [e^q] \right] \in H_q(K; F_{e^p}),$$

where the orientations satisfy the two relations  $[e^p; e^q] = [e^p; e^{p+1}] [e^{p+1}; e^q]$  and  $[e^p; e^q] = [e^p; e^{p+1}] [e^{p+1}; e^q]$ . Finally we check that this is precisely  $d\Phi_{p,q}(c)$  for:

$$d\Phi_{p,q}(c)[e^{p+1}] = \sum_{e^p < e^{p+1}} \Phi_{p,q}(c)[e^p],$$

with  $[e^p][e^p; e^{p+1}] = [e^{p+1}]$ , and:

$$\Phi_{p,q}(c)[e^p] = \left[ (-1)^{\frac{p(p+1)}{2} + \frac{q(q+1)}{2}} \sum_{e^q > e^p} \langle c', [e^p; e^q] \rangle \otimes [e^q] \right].$$

To prove the second part of the statement, when  $\dim K = n$ , we need to remember that  $\Phi$  provided us with an isomorphism between the chain complexes  $(E_{n-k,n}^1; \partial_{n-k,n}^1)_{0 \leq k \leq n}$  and  $(C_c^{n-k}(K; H_n(F_*)); d)_{0 \leq k \leq n}$ . Also, in the special context of spectral sequences of bicomplex we know that  $\bar{E}_{n-p,n}^1$  is the  $n$ -th homology group of the  $(n-p)$ -th column of  $(\Omega_{p,q}(K; F))_{p,q \geq 0}$ . With the dimensional assumption, this is the homology group of highest dimension and therefore a group of cycles.

We have an inclusion of  $E_{n-p,n}^1$  in  $\Omega_{n-p,n}(K; F)$  as the kernel of the vertical part of the boundary operator, namely  $\partial_2$ . With this description it is clearly an injective chain complexes morphism  $(E_{n-k,n}^1; \partial^1)_{0 \leq k \leq n} \rightarrow (\Omega_k(K; F); \partial)_{0 \leq k \leq n}$  whose cokernel inherits a bicomplex structure from  $(\Omega_{p,q}(K; F))_{p,q \geq 0}$ . By construction all the columns of this bicomplex are exact and so is its total complex. Our injective quasi-isomorphism is the composition of  $\Phi$  with the inclusion of  $(E_{n-k,n}^1; \partial_{n-k,n}^1)_{0 \leq k \leq n}$  in the total complex  $(\Omega_k(K; F); \partial)_{0 \leq k \leq n}$ .  $\square$

**Remark 2.5.4.** In the proof of Theorem 2.5.3 we did not actually use that  $c'$  was a  $\partial_2$ -cycle and have actually proved that  $\Phi$  is a bicomplex isomorphism. Indeed we have  $(\sum_{q-p=k} \Phi_{p,q}) \circ (\partial_1 + \partial_2) = (d + (-1)^{q-p} \partial) \circ (\sum_{q-p=k+1} \Phi_{p,q})$ . So if we no longer assume the vanishing hypotheses on the local homology of  $F$ , we get instead a complex of cellular sheaves  $e \mapsto (C^k(K; F_e); d)_{k \geq 0}$  whose cohomology (or hypercohomology) with compact support corresponds to the homology of  $F$ . In these words, Theorem 2.5.3 is very close to a theorem of J. Curry, which is this exact statement for dihomologic subdivisions of cellular sheaves.

A direct consequence of the last corollary is the already known Poincaré-Lefschetz theorem:

**Corollary 2.5.5.** *If  $X$  is a homology  $n$ -manifold in the sense of Definition 2.1.23 then  $H_k(X; \mathbb{Z})$  is isomorphic to  $H_c^{n-k}(X; \partial X; o_{\mathbb{Z}})$  where  $o_{\mathbb{Z}}$  is the system of local orientations defined on  $X \setminus \partial X$  by  $x \mapsto H_n(X; X - x; \mathbb{Z})$ .*

*Proof.* Let us consider the local system  $o_{\mathbb{Z}}$  on  $X \setminus \partial X$  given by  $x \mapsto H_n(X; X \setminus \{x\}; \mathbb{Z})$ . We denote by  $K$  a locally finite, regular, finite dimensional CW-complex whose support is  $X$ . By hypotheses  $H_k(K; K - e; \mathbb{Z})$  vanishes as soon as  $k$  does not equal  $n$ , for every cell  $e$  of  $K$ . By Theorem 2.5.3, we have:

$$H_k(K; \mathbb{Z}) \cong H_c^{n-k}(X; H_n(\mathbb{Z}_*)) .$$

The cellular sheaf  $H_n(\mathbb{Z}_*)$  vanishes on the boundary and corresponds to the local system  $o_{\mathbb{Z}}$  elsewhere. Hence, the corollary follows.  $\square$

An interesting corollary is a version of Serre duality for flat vector bundles over a field  $\mathbb{F}$  where  $o_{\mathbb{F}} := o_{\mathbb{Z}} \otimes \mathbb{F}$  plays the role of the canonical line bundle:

**Corollary 2.5.6.** *If  $X$  is a homology  $n$ -manifold in the sense of Definition 2.1.23 and  $E$  is a flat bundle of  $\mathbb{F}$ -vector spaces of finite rank over  $X$  then:*

$$H^k(X; E) \cong (H_c^{n-k}(X; \partial X; o_{\mathbb{F}} \otimes_{\mathbb{F}} E^*))^* .$$

*Proof.* Let  $K$  denote a locally finite, regular, finite dimensional CW-complex whose support is  $X$ . We note that  $(C^k(K; E))_{k \geq 0}$  is dual to the complex  $(C_k(K; E^*))_{k \geq 0}$ . By the Universal Coefficient Theorem<sup>15</sup>,  $H^k(X; E)$  is isomorphic to  $(H_k(X; E^*))^*$ . For all cells  $e$  of  $K$ , we define an isomorphism  $\phi_e : [K; K - e; E^*(e)] \rightarrow E_e^*$  given by

<sup>15</sup>c.f. [CE56], Theorem 3.3 p.113.

the inverses of the extension morphisms:  $E^*(e') \rightarrow E^*(e)$  for all cells  $e' \geq e$ . We have the following isomorphisms:

$$H_k(K; K - e; E^*) \cong H_k(K; K - e; E^*(e)) \cong H_k(K; K - e; \mathbb{F}) \otimes_{\mathbb{F}} E^*(e).$$

By hypotheses, these groups are all trivial as soon as  $k$  does not equal  $n$ . Hence, the dihomologic pseudo-subdivision of the cosheaf  $E^*$  satisfies the conditions of Proposition 2.5.1. Therefore, Theorem 2.5.3 applies. In addition, for all  $e^p \leq e^q$  we have the following commutative square:

$$\begin{array}{ccc} [K; K - e^p; E^*(e^p)] & \xrightarrow{\phi_{e^p}} & E_{e^p}^* \\ \downarrow & & \downarrow \text{loc. at } e^q \\ [K; K - e^q; E^*(e^q)] & \xrightarrow{\phi_{e^q}} & E_{e^q}^* \end{array}$$

where the unlabelled morphism on the left is given by the tensor product of the localisation morphism  $[K; K - e^p; \mathbb{F}] \rightarrow [K; K - e^q; \mathbb{F}]$  with the inverse of the restriction  $E^*(e^q) \rightarrow E^*(e^p)$ . It appears that the cellular sheaf  $e \mapsto H_n(K; K - e; E^*)$  is isomorphic to the tensor product  $e \mapsto H_n(K; K - e; \mathbb{F}) \otimes_{\mathbb{F}} E^*$ . By Theorem 2.5.3, we have the isomorphism:

$$H^k(X; E) \cong \left( H_c^{n-k}(X; H_n(E_*)) \right)^* \cong \left( H_c^{n-k}(X; H_n(\mathbb{F}_*) \otimes_{\mathbb{F}} E^*) \right)^*.$$

The sheaf  $H_n(\mathbb{F}_*)$  vanishes on  $\partial X$  and its restriction to  $X \setminus \partial X$  is given by the local system  $o_{\mathbb{F}}$ . Finally,  $H^k(X; E)$  is isomorphic to the dual of  $H_c^{n-k}(X; \partial X; o_{\mathbb{F}} \otimes_{\mathbb{F}} E^*)$ .  $\square$

# Chapter 3

## Tropical Homology of Subdivided Polytopes

In this chapter we present the sheaves and cosheaves of the theory of tropical homology, introduced by I. Itenberg, L. Katzarkov, G. Mikhalkin, and I. Zharkov in [IKMZ19]. We also introduce a modified version of these objects and establish a generalisation of the Lefschetz Theorem for subdivision of simple polytopes.

### 3.1 Hodge Theory in Tropical Toric Geometry

**Notations.** All the rings we consider will be assumed commutative and with a unit. This will not be the case for algebras.

1.  $\mathfrak{t}^*(\mathbb{Z})$  is a free Abelian group of finite rank  $n \in \mathbb{N}$  with dual group  $\mathfrak{t}(\mathbb{Z})$ ;
2. For all rings  $R$ ,  $\mathfrak{t}^*(R)$  (resp.  $\mathfrak{t}(R)$ ) is the associated free  $R$ -module  $\mathfrak{t}^*(\mathbb{Z}) \otimes R$  (resp.  $\mathfrak{t}(\mathbb{Z}) \otimes R$ );

**Definition 3.1.1.** A sub-space  $V$  of  $\mathfrak{t}^*(\mathbb{R})$  is called *rational*, if  $V \cap \mathfrak{t}^*(\mathbb{Z})$  is a lattice of  $V$ . When this is the case we denote by  $V(\mathbb{Z})$  the lattice  $V \cap \mathfrak{t}^*(\mathbb{Z})$  and, for every ring  $R$ , by  $V(R)$  the  $R$ -module  $V(\mathbb{Z}) \otimes R$ .

**Definition 3.1.2** (Polytope). A *polytope*  $P$  of  $\mathfrak{t}^*(\mathbb{R})$  is the convex hull of a finite number of points. Its *tangent space*  $TP$  is the vectorial direction of the affine subspace it spans. Its *dimension*  $\dim P$  is the dimension of its tangent space. When  $P$  has the same dimension  $n$  as  $\mathfrak{t}^*(\mathbb{R})$ , we say that  $P$  is *full dimensional*. We say that  $P$  is *integral* when all its vertices lie in the lattice  $\mathfrak{t}^*(\mathbb{Z})$ . The polytope  $P$  is said to be *simple* if every face  $Q$  of  $P$  of codimension  $k$  is contained in  $k$  faces of codimension 1 of  $P$ . The polytope  $P$  is *non-singular* or *smooth* if it is integral, simple, and if for all its faces  $Q$  the lattice contained in the orthogonal of its tangent space  $TQ^\perp(\mathbb{Z})$  is the sum of the groups  $TQ_{(1)}^\perp(\mathbb{Z})$  for all 1-codimensional faces  $Q_{(1)}$  containing  $Q$ .

**Definition 3.1.3** (Polyhedral subdivision). A *polyhedral subdivision*  $K$  of a polytope  $P$  is a collection of polytopes contained in  $P$  such that:



1. All the faces of a polytope of  $K$  are also polytopes of  $K$ ;
2. Any two polytopes of  $K$  intersect along a common face or the empty set;
3. The union of the polytopes of  $K$  covers  $P$ .

Such a subdivision is a complex of polytopes, hence a regular CW-complex. When  $K$  is a simplicial complex we say that  $K$  is a *triangulation* of  $P$ . We say that the polyhedral subdivision  $K$  is *integral* if all its polytopes are integral. When an integral triangulation is made of primitive simplices we say that the triangulation is *primitive* or *smooth*. If there is a piecewise affine convex function  $\nu : P \rightarrow \mathbb{R}$  whose affinity domains are exactly the maximal polytopes of  $K$ , we say that  $K$  is *convex*.

**Definition 3.1.4** (Dual Hypersurface). Let  $P$  be a polytope and  $K$  be a polyhedral subdivision of  $P$ . The dual hypersurface  $X$  of  $K$  is the sub-complex of the dihomologic subdivision of  $K$  made of all the dihomologic cells whose first indexing cell is at least 1-dimensional.

Examples of dual hypersurfaces are depicted in Figure 3.1.

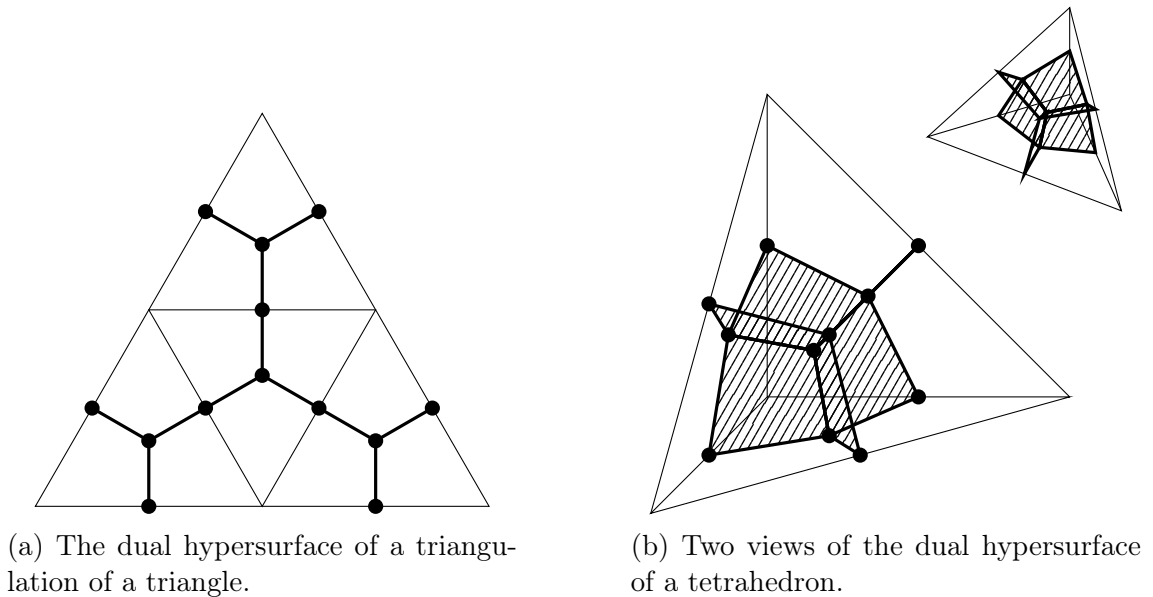

Figure 3.1: Two examples of dual hypersurfaces.

**Definition 3.1.5** (Tropical Sheaves and Cosheaves, [IKMZ19] Definition 13 p.10).

1. The first cosheaf we define is called the *sedentarity*. It represents the stabilisers of the action of the different loci of the algebraic torus of the toric variety of  $P$ . We denote it by  $\text{Sed}$ . It is defined on the CW-complex associated with the polytope  $P$ . If  $Q$  is a face of  $P$  we set:

$$\text{Sed}(Q) := TQ^\perp(\mathbb{Z}) = \{v \in \mathfrak{t}(\mathbb{Z}) \mid \alpha(v) = 0, \forall \alpha \in TQ\} \subset \mathfrak{t}(\mathbb{Z}),$$

The cosheaf  $\text{Sed}(Q)$  consists of the integral vectors orthogonal to  $TQ$ . So, whenever  $Q'$  is a face of  $Q$ ,  $\text{Sed}(Q)$  is a sub-module of  $\text{Sed}(Q')$ . The extension

morphisms are simply given by these inclusions. We denote all its subdivisions by the same symbol  $\text{Sed}$ .

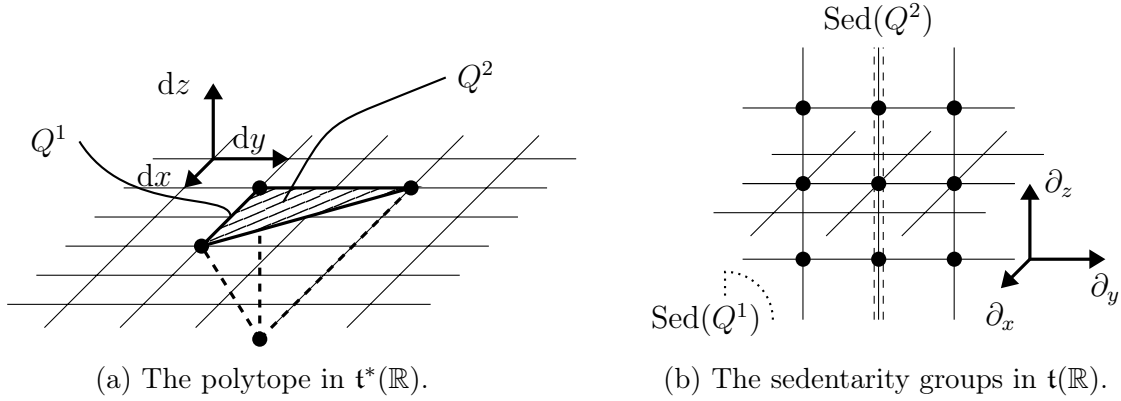

Figure 3.2: An edge  $Q^1$  of a 2-dimensional face  $Q^2$  and their respective sedentarity.

2. Let  $p \geq 0$  be an integer. The  $p$ -th *tropical cosheaf*  $F_p^P$  associated with  $P$  is defined by the formula:

$$F_p^P := \bigwedge^p \mathfrak{t}(\mathbb{Z}) / \text{Sed} .$$

We denote all its subdivisions by the same symbol  $F_p^P$ .

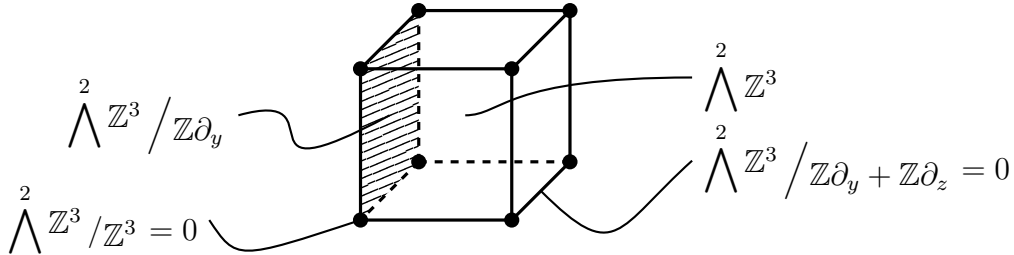

Figure 3.3: A cube and the groups associated by  $F_2^P$  to some of its faces.

3. Let  $p \geq 0$  be an integer. The  $p$ -th *tropical sheaf*  $F_p^P$  associated with  $P$  is the dual of  $F_p^P$ , i.e.  $F_p^P := \text{Hom}(F_p^P; \mathbb{Z})$ . We note that their direct sum is the exterior algebra of  $F_p^1$ , hence a sheaf of algebras.
4. Let  $p \geq 0$  be an integer. The  $p$ -th *tropical cosheaf* associated with the dual hypersurface  $X$  is denoted by  $F_p^X$ . It is a dihomologic cosheaf on  $K$ . For all pairs  $e^q < e^{q'}$  of cells of  $K$ , the group  $F_p^X(e^q; e^{q'})$  is given by the following formula:

$$F_p^X(e^q; e^{q'}) := \sum_{e^1 \leq e^q} \bigwedge^p (T e^1)^\perp(\mathbb{Z}) / \text{Sed}(e^{q'}) \subset F_p^P(e^q; e^{q'}) . \quad (3.1)$$

As pointed out in Definition 2.2.8, the extension morphisms need only be defined on elementary adjacencies. Let  $e^{q_1} \leq e^{q_2} \leq e^{q_3} \leq e^{q_4}$  be four cells of  $K$

(maybe with repetitions). The elementary extension morphisms are depicted in the following diagram:

$$\begin{array}{ccc}
 & F_p^X(e^{q_1}; e^{q_4}) & \\
 f \swarrow & & \searrow g \\
 F_p^X(e^{q_2}; e^{q_4}) & & F_p^X(e^{q_1}; e^{q_3}) \\
 h \searrow & & \swarrow t \\
 & F_p^X(e^{q_2}; e^{q_3}) &
 \end{array}$$

where:

- (a) The morphisms  $f$  and  $t$  are the inclusions coming from the definition of the groups, c.f. (3.1);
- (b) The morphisms  $g$  and  $h$  are the reductions modulo  $\text{Sed}(e^{q_3})$ . More precisely they correspond to the canonical projection:

$$\bigwedge^p (Te^1)^\perp(\mathbb{Z}) / \text{Sed}(e^{q_4}) \rightarrow \bigwedge^p (Te^1)^\perp(\mathbb{Z}) / \text{Sed}(e^{q_3}),$$

on every summand of (3.1).

By the nature of the morphisms involved the diagram is commutative. It is a sub-cosheaf of  $F_p^P$  and we denote the inclusion by  $i_p : F_p^X \rightarrow F_p^P$ . Even if it is defined on the dihomologic subdivision of  $K$  it is supported on  $X$ . The Figure 3.4 illustrates the values taken by the cosheaf  $F_1^X$  on a triangle with trivial subdivision  $K$ .

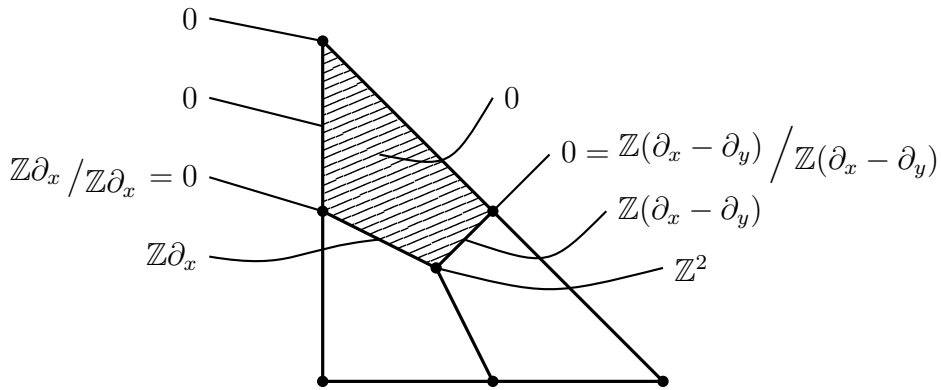

Figure 3.4: A triangle and the groups associated by  $F_1^X$  to some of its dihomologic cells.

5. Let  $p \geq 0$  be an integer. The  $p$ -th *tropical sheaf* associated with the dual hypersurface  $X$  is denoted by  $F_X^p$ . It is the dual sheaf of  $F_p^X$ , i.e.  $F_X^p := \text{Hom}(F_p^X; \mathbb{Z})$ . We denote by  $i^p : F_X^p \rightarrow F_p^X$  the adjoint morphism of  $i_p$ .

**Definition 3.1.6** (Contraction). Let  $M$  be free module of finite rank over a ring  $R$ , and  $k, l \in \mathbb{N}$  be integers. For all  $\alpha \in \bigwedge^l \text{Hom}_R(M; R)$  and  $v \in \bigwedge^{l+k} M$  the contraction  $\alpha \cdot v$  is the only element of  $\bigwedge^k M$  satisfying:

$$\beta(\alpha \cdot v) = (\beta \wedge \alpha)(v),$$

for all  $\beta \in \bigwedge^k \text{Hom}_R(M; R)$ . This construction is dual to the interior product.

**Definition 3.1.7.** Let  $P$  be an integral polytope of  $\mathfrak{t}^*(\mathbb{R})$ ,  $K$  be an integral subdivision of  $P$ , and  $p \geq 0$  be an integer. The  $p$ -th saturated tropical cosheaf is the dihomologic cosheaf  $\hat{F}_p^X$  defined for all pairs  $e^q \leq e^r$  by the following formula:

$$\hat{F}_p^X(e^q; e^r) := \left\{ v \in F_p^P(e^q; e^r) \mid \omega \cdot v = 0, \forall \omega \in \bigwedge^q Te^q(\mathbb{Z}) \right\}.$$

The contraction  $\omega \cdot v$  is well defined since  $\text{Sed}(e^r)$  is included in the orthogonal of  $Te^q(\mathbb{Z})$ . Let  $e^q \leq e^{q+1} \leq e^r$  be a triple of cells of  $K$ . There is a form  $\alpha \in \mathfrak{t}^*(\mathbb{Z})$  for which  $\omega \mapsto \alpha \wedge \omega$  is an isomorphism from  $\bigwedge^q Te^q(\mathbb{Z})$  to  $\bigwedge^{q+1} Te^{q+1}(\mathbb{Z})$ . Hence  $\hat{F}_p^X(e^{q+1}; e^r)$  is included in  $\hat{F}_p^X(e^q; e^r)$  and  $\hat{F}_p^X$  is a sub-cosheaf of the dihomologic subdivision of  $F_p^P$ . We denote by  $\hat{i}_p$  the inclusion of  $\hat{F}_p^X$  in  $F_p^P$ . A direct computation shows that  $F_p^X$  is included in  $\hat{F}_p^X$ . The  $p$ -th saturated tropical sheaf is the dual sheaf  $\hat{F}_X^p := \text{Hom}(\hat{F}_p^X; \mathbb{Z})$ . We denote by  $\hat{i}^p$  the adjoint of  $\hat{i}_p$ .

**Lemma 3.1.8.** Let  $M$  be a free Abelian group of finite rank and some linear forms  $\alpha_1, \dots, \alpha_k \in \text{Hom}(M; \mathbb{Z}) \setminus \{0\}$ . If  $\omega$  is a generator of the last exterior power of the group spanned by the  $\alpha_i$ 's then for all  $p \in \mathbb{N}$ , the quotient:

$$G := \left\{ v \in \bigwedge^p M \mid \omega \cdot v = 0 \right\} / \sum_{i=1}^k \bigwedge^p \ker(\alpha_i),$$

is a finite group.

*Proof.* We notice that for every  $1 \leq i \leq k$ , the form  $\alpha_i$  divides a non-zero multiple of  $\omega$  in the exterior algebra of  $\text{Hom}(M; \mathbb{Z})$ . It follows that all  $p$ -elements of  $\ker(\alpha_i)$  contract to 0 against  $\omega$ . We assume now that  $r \geq 1$  is the rank of the sub-group spanned by the  $\alpha_i$ 's and that  $\alpha_1 \wedge \dots \wedge \alpha_r = m\omega$  with  $m \neq 0$ . Then we have:

$$\left\{ v \in \bigwedge^p M \mid \omega \cdot v = 0 \right\} = \left\{ v \in \bigwedge^p M \mid (\alpha_1 \wedge \dots \wedge \alpha_r) \cdot v = 0 \right\}.$$

We can complete the set  $\{\alpha_1, \dots, \alpha_r\}$  with a set  $\{\beta_1, \dots, \beta_s\} \subset \text{Hom}(M; \mathbb{Z})$  into a basis of the rational vector space  $\text{Hom}(M; \mathbb{Q})$ . For all  $p$ -elements  $v \in \bigwedge^p M$ , seen as  $p$ -vectors in  $\bigwedge_{\mathbb{Q}}^p(M \otimes \mathbb{Q})$ , we have:

$$(\alpha_1 \wedge \dots \wedge \alpha_r) \cdot v = \sum_{|J|=p-r} (\alpha_1 \wedge \dots \wedge \alpha_r \wedge \beta_J)(v) f_J,$$

where  $\{e_1, \dots, e_r, f_1, \dots, f_s\}$  denotes the dual basis of  $\{\alpha_1, \dots, \alpha_r, \beta_1, \dots, \beta_s\}$ . As a consequence, we have:

$$\left\{ v \in \bigwedge^p M \mid \omega \cdot v = 0 \right\} \otimes \mathbb{Q} = \left\langle e_I \wedge f_J : |I| < r \text{ and } |I| + |J| = p \right\rangle_{\mathbb{Q}}.$$

It implies the equality of  $\ker(\alpha_i) \otimes \mathbb{Q}$ ,  $\ker(\alpha_i \otimes 1)$ , and  $\langle e_j, f_k : j \neq i \text{ and } 1 \leq k \leq s \rangle_{\mathbb{Q}}$ . Hence:

$$\left\{ v \in \bigwedge^p M \mid \omega \cdot v = 0 \right\} \otimes \mathbb{Q} = \left( \sum_{i=1}^k \bigwedge^p \ker(\alpha_i) \right) \otimes \mathbb{Q},$$

and  $G \otimes \mathbb{Q}$  vanishes. Since  $G$  is finitely generated, it is finite.  $\square$

**Proposition 3.1.9.** *Let  $P$  be an integral polytope of  $\mathfrak{t}^*(\mathbb{R})$ ,  $K$  be an integral subdivision of  $P$ , and  $p \geq 0$  be an integer. The cosheaf  $\hat{F}_p^X$  is the saturation of  $F_p^X$  in  $F_p^P$ , i.e. for all pairs  $e^q \leq e^r$ , we have:*

$$\hat{F}_p^X(e^q; e^r) = \{v \in F_p^P(e^q; e^r) \mid \exists k \in \mathbb{Z}, kv \in F_p^X(e^q; e^r)\}.$$

*It follows that  $\hat{F}_X^p$  is a sub-sheaf of  $F_X^p$  and the quotient is a cosheaf of finite Abelian groups.*

*Proof.* Let  $e^q \leq e^r$  be two cells of  $K$ . Lemma 3.1.8 implies that  $F_p^X(e^q; e^r)$  is of finite index in  $\hat{F}_p^X(e^q; e^r)$ . Hence, these two groups have same rank and same saturation. The module  $\hat{F}_p^X(e^q; e^r)$  is the kernel of a morphism between two free Abelian groups, thus it is saturated. The following short exact sequence:

$$0 \rightarrow F_p^X(e^q; e^r) \rightarrow \hat{F}_p^X(e^q; e^r) \rightarrow \hat{F}_p^X(e^q; e^r) / F_p^X(e^q; e^r) \rightarrow 0,$$

becomes:

$$0 \rightarrow \hat{F}_X^p(e^q; e^r) \rightarrow F_X^p(e^q; e^r) \rightarrow \text{Ext} \left( \hat{F}_p^X(e^q; e^r) / F_p^X(e^q; e^r); \mathbb{Z} \right) \rightarrow 0,$$

since the quotient is finite. The proposition follows.  $\square$

**Proposition 3.1.10.** *Let  $P$  be an integral polytope of  $\mathfrak{t}^*(\mathbb{R})$ ,  $K$  be an integral subdivision of  $K$ , and  $p \geq 0$  be an integer. Let us denote by  $f_p$  the inclusion of  $F_p^X$  in  $\hat{F}_p^X$ .*

We have the following commutative diagram with exact rows and exact columns:

$$\begin{array}{ccccccc}
 & & 0 & & 0 & & \\
 & & \downarrow & & \downarrow & & \\
 0 & \longrightarrow & \ker(\hat{i}^p) & \longrightarrow & \ker(i^p) & \longrightarrow & 0 \\
 & & \downarrow & & \downarrow & & \\
 0 & \longrightarrow & F_P^p & \xrightarrow{\text{id}} & F_P^p & \longrightarrow & 0 \\
 & & \downarrow \hat{i}^p & & \downarrow i^p & & \downarrow \\
 0 & \longrightarrow & \hat{F}_X^p & \xrightarrow{\text{Hom}(f_p; \mathbb{Z})} & F_X^p & \longrightarrow & \text{Ext}(\text{coker}(f_p); \mathbb{Z}) \longrightarrow 0 \\
 & & \downarrow & & \downarrow & & \downarrow \\
 & & 0 & \longrightarrow & \text{coker}(i^p) & \longrightarrow & \text{Ext}(\text{coker}(f_p); \mathbb{Z}) \longrightarrow 0 \\
 & & & & \downarrow & & \downarrow \\
 & & & & 0 & & 0
 \end{array}$$

Moreover,  $\text{coker}(i^p)$  is naturally isomorphic to  $\text{Ext}(\text{coker}(i_p); \mathbb{Z})$ .

*Proof.* This is a direct consequence of the Snake Lemma<sup>1</sup> applied to the following commutative diagram with exact rows:

$$\begin{array}{ccccccc}
 0 & \longrightarrow & F_P^p & \xrightarrow{\text{id}} & F_P^p & \longrightarrow & 0 \longrightarrow 0 \\
 & & \downarrow \hat{i}^p & & \downarrow i^p & & \downarrow \\
 0 & \longrightarrow & \hat{F}_X^p & \xrightarrow{\text{Hom}(f_p; \mathbb{Z})} & F_X^p & \longrightarrow & \text{Ext}(\text{coker}(f_p); \mathbb{Z}) \longrightarrow 0
 \end{array}$$

We should remark that  $\text{coker}(\hat{i}^p)$  vanishes for  $\hat{F}_p^X$  is saturated in  $F_p^P$ . The last assertion is a consequence of the definition of the functor  $\text{Ext}$ .  $\square$

**Proposition 3.1.11.** *The sheaf  $(\ker(i^p))_{p \geq 0}$  (which equals  $(\ker(\hat{i}^p))_{p \geq 0}$ ) is a sheaf of homogeneous ideals and  $(\hat{F}_X^p)_{p \geq 0}$  is a sheaf of graded algebras. Moreover  $(F_X^p)_{p \geq 0}$  has a unique structure of sheaf of graded algebras for which  $(i_p)_{p \geq 0}$  is a morphism of sheaves of algebras, i.e. which extends the algebra structure of  $(\hat{F}_X^p)_{p \geq 0}$ .*

*Proof.* Let  $e^q \leq e^r$  be a pair of cells of  $K$ , and  $\omega$  be a generator of  $\bigwedge^q T e^q(\mathbb{Z})$ . We have the following exact sequence:

$$0 \rightarrow \hat{F}_p^X(e^q; e^r) \rightarrow F_p^P(e^q; e^r) \xrightarrow{\omega \cdot -} F_{p-q}^P(e^q; e^r).$$

The image of the contraction  $\omega \cdot -$  is saturated for  $\omega$  is primitive. It follows that the dual sequence is exact as well. It implies that  $(\ker(i^p(e^q; e^r)))_{p \geq 0}$  is the principal ideal  $(\omega)$  in the graded algebra  $(F_p^P(e^q; e^r))_{p \geq 0}$ . Hence, the product of  $(F_p^P)_{p \geq 0}$  induces a

<sup>1</sup>c.f. [Lan93] Lemma 9.1 p.158.

product on  $(\hat{F}_p^X)_{p \geq 0}$  by Proposition 3.1.10. Since  $\mathbb{Q}$  is a divisible group we have the following short exact sequence:

$$0 \rightarrow \ker(i^p) \otimes \mathbb{Q} \rightarrow F_p^p \otimes \mathbb{Q} \rightarrow F_X^p \otimes \mathbb{Q} \rightarrow 0,$$

in particular,  $\hat{F}_X^p \otimes \mathbb{Q}$  is isomorphic to  $F_X^p \otimes \mathbb{Q}$ . Hence,  $F_X^p \otimes \mathbb{Q}$  is naturally endowed with a product. Now we will show this product preserves  $(F_X^p)_{p \geq 0}$ . Let  $\alpha \in F_X^p(e^q; e^r)$ ,  $\beta \in F_X^{p'}(e^q; e^r)$ , and  $v_1, \dots, v_{p+p'}$  be  $p+p'$  vectors of  $F_1^X(e^1; e^r)$ , where  $e^1$  is an edge of  $e^q$ . We have:

$$(\alpha \wedge \beta)(v_1 \wedge \dots \wedge v_{p+p'}) = \sum_{\substack{I \sqcup J = \{1; \dots; p+p'\} \\ |I|=p, |J|=p'}} \pm \alpha(v_I) \beta(v_J).$$

Since both  $\alpha(v_I)$  and  $\beta(v_J)$  are integers so is  $(\alpha \wedge \beta)(v_1 \wedge \dots \wedge v_{p+p'})$ . Hence, the rational product preserves  $(F_p^X)_{p \geq 0}$ . Any product on  $(F_p^X)_{p \geq 0}$  making  $(i^p)_{p \geq 0}$  a morphism of algebras induces the quotient product on  $(F_p^X \otimes \mathbb{Q})_{p \geq 0}$ . Thus corresponds to the one we defined.  $\square$

**Definition 3.1.12.** Let  $P$  be an integral polytope of  $\mathfrak{t}^*(\mathbb{R})$  and  $K$  be an integral subdivision of  $P$ . The number  $\theta(K)$  is the least common multiple of the exponents of the quotients of  $\hat{F}_p^X(e^q; e^r)$  by  $F_p^X(e^q; e^r)$ , for all integers  $p \geq 0$  and all pair of cells  $e^q \leq e^r$  of  $K$ . We recall that the exponent of an Abelian group  $M$  is the smallest, if any,  $e \in \mathbb{N}$  for which  $em$  vanishes for all  $m \in M$ .

**Definition 3.1.13** (Tropical Homology and Cohomology Groups). Let  $R$  be a commutative ring, and  $p, q \in \mathbb{N}$  be integers. The  $(p, q)$ -th *tropical homology group* of  $P$  with coefficients in  $R$  is defined as:

$$H_{p,q}(P; R) := H_q(K; F_p^P \otimes R).$$

Likewise, the  $(p, q)$ -th *tropical cohomology group* of  $P$  with coefficients in  $R$  is defined as:

$$H^{p,q}(P; R) := H^q(K; F_p^P \otimes R).$$

They form a bigraded algebra for the cup product. The  $(p, q)$ -th *tropical homology group* (resp. *saturated*) of  $X$  with coefficients in  $R$  is defined as:

$$H_{p,q}(X; R) := H_q(K; F_p^X \otimes R),$$

respectively:

$$\hat{H}_{p,q}(X; R) := H_q(K; \hat{F}_p^X \otimes R).$$

Likewise, the  $(p, q)$ -th *tropical cohomology groups* (resp. *saturated*) of  $X$  with coefficients in  $R$  is defined as:

$$H^{p,q}(X; R) := H^q(K; F_X^p \otimes R).$$

respectively:

$$\hat{H}^{p,q}(X; R) := H^q(K; \hat{F}_X^p \otimes R).$$

They form bigraded algebras for the cup product. We denote the morphisms induced in homology and cohomology by  $(i_p)_{p \geq 0}$  (resp.  $(\hat{i}_p)_{p \geq 0}$ ) and  $(i^p)_{p \geq 0}$  (resp.  $(\hat{i}^p)_{p \geq 0}$ ) by:

$$i_{p,q} : H_{p,q}(X; R) \longrightarrow H_{p,q}(P; R),$$

and:

$$i^{p,q} : H^{p,q}(P; R) \longrightarrow H^{p,q}(X; R),$$

Respectively:

$$\hat{i}_{p,q} : \hat{H}_{p,q}(X; R) \longrightarrow H_{p,q}(P; R),$$

and:

$$\hat{i}^{p,q} : H^{p,q}(P; R) \longrightarrow \hat{H}^{p,q}(X; R),$$

**Proposition 3.1.14.** *Let  $e^q \leq e^r$  be two cells of the integral subdivision  $K$  of the integral polytope  $P$ . If  $e^q$  is a primitive simplex then  $F_p^X(e^q; e^r)$  equals  $\hat{F}_p^X(e^q; e^r)$  for all integers  $p \geq 0$ .*

*Proof.* Let us choose a vertex  $\alpha$  of  $e^q$ . Since  $e^q$  is a primitive simplex, the following set  $\{\beta - \alpha : \beta \leq e^q, \beta \neq \alpha\}$  is, up to ordering, a basis of the module  $Te^q(\mathbb{Z})$ . We order this set  $\{\omega_1, \dots, \omega_p\}$  and choose elements  $\alpha_1, \dots, \alpha_{n-p} \in \mathfrak{t}^*(\mathbb{Z})$  to have a basis of  $\text{Sed}(e^r)^\perp(\mathbb{Z})$ . We can do so for  $Te^q(\mathbb{Z})$  is saturated. We denote by  $\{e_1, \dots, e_p, f_1, \dots, f_s\}$  the dual basis. We see that  $\sum_{e^1 \leq e^q} (Te^1)^\perp(\mathbb{Z}) / \text{Sed}(e^r)$  is spanned by the elements<sup>2</sup>  $e_I \wedge f_J$  for all  $I \subset \{1, \dots, p\}$  and  $J \subset \{1, \dots, n-p\}$  satisfying  $|I| + |J| = k$  and  $|I| < p$ . We can observe that  $\omega(e^q) := \omega_1 \wedge \dots \wedge \omega_p$  is a generator of  $\bigwedge^q Te^q(\mathbb{Z})$ , and that:

$$\omega(e^q) \cdot e_I \wedge f_J = \begin{cases} \pm f_J & \text{if } I = \{1, \dots, p\} \\ 0 & \text{otherwise} \end{cases}.$$

Hence,  $F_p^X(e^q; e^r)$  equals  $\ker(\omega(e^q) \cdot -)$  and the proposition follows.  $\square$

**Proposition 3.1.15.** *Let  $P$  be an integral polytope endowed with an integral subdivision  $K$ . Let  $R$  be a ring in which  $\theta(K)$  is invertible. Then  $F_p^X \otimes R$  equals  $\hat{F}_p^X \otimes R$ , for all integers  $p \geq 0$ .*

*Proof.* We have the following exact sequence of  $R$ -modules:

$$0 \rightarrow \text{Tor} \left( \hat{F}_p^X / F_p^X; R \right) \rightarrow F_p^X \otimes R \rightarrow \hat{F}_p^X \otimes R \rightarrow \hat{F}_p^X / F_p^X \otimes R \rightarrow 0.$$

Since  $\theta(K)$  is invertible in  $R$ , both  $\text{Tor} \left( \hat{F}_p^X / F_p^X; R \right)$  and  $\hat{F}_p^X / F_p^X \otimes R$  vanish.  $\square$

**Tropical Homology and Smoothness.** In this paragraph we state the properties of the tropical homology with coefficients in the field with two elements  $\mathbb{F}_2$  for

<sup>2</sup>we use the standard notation  $e_I := e_{i_1} \wedge \dots \wedge e_{i_k}$  where  $I = \{i_1 < \dots < i_k\}$ .



a smooth polytope  $P$  and a primitive triangulation  $K$ . The Universal Coefficient Theorem<sup>3</sup> allows us to derive the dual statements for the tropical cohomology.

**Theorem 3.1.16** (C. Arnal, R. Renaudineau, and K. Shaw, [ARS21] Proposition 4.1 p.1376). *The only non-trivial tropical homology groups  $(H_{p,q}(P; \mathbb{F}_2))_{p,q \geq 0}$  of the polytope  $P$  are located on the line segment  $\{p = q \text{ and } 0 \leq p \leq n\}$ . Moreover, for all  $0 \leq q \leq n$ , the dimension of the group  $H_{q,q}(P; \mathbb{F}_2)$  is the  $q$ -th  $h$ -number of the polar polytope  $P^\circ$ , that is to say:*

$$\dim H_{q,q}(P; \mathbb{F}_2) = \sum_{i=0}^q (-1)^{q-i} \binom{n-i}{q-i} f_{n-i}(P),$$

*By the Universal Coefficient Theorem the same holds for the tropical cohomology groups  $(H^{p,q}(P; \mathbb{F}_2))_{p,q \geq 0}$ . Moreover, the bigraded algebra  $(H^{p,q}(P; \mathbb{F}_2))_{p,q \geq 0}$  satisfies the Poincaré duality:*

1.  $H^{n,n}(P; \mathbb{F}_2)$  is free of rank 1;
2. The bilinear pairing  $\cup : H^{p,q}(P; \mathbb{F}_2) \otimes_{\mathbb{F}_2} H^{n-p,n-q}(P; \mathbb{F}_2) \rightarrow H^{n,n}(P; \mathbb{F}_2)$  is non-degenerate for all  $0 \leq p, q \leq n$ .

**Theorem 3.1.17** (C. Arnal, R. Renaudineau, and K. Shaw, [ARS21] Corollary 1.9 p.1351). *The only non-trivial tropical homology groups  $(H_{p,q}(X; \mathbb{F}_2))_{p,q \geq 0}$  of the dual hypersurface  $X$  are located on the line segments  $\{p = q \text{ for all } 0 \leq q \leq n-1\}$  and  $\{p + q = n-1 \text{ for all } 0 \leq q \leq n-1\}$ . Moreover, for all  $0 \leq q < \frac{n-1}{2}$ , the dimension of the group  $H_{q,q}(X; \mathbb{F}_2)$  is the  $q$ -th  $h$ -number of the polar polytope  $P^\circ$ . And for all  $p + q = n-1$ , the dimension of the group  $H_{p,q}(X; \mathbb{F}_2)$  is given by the Danilov-Khovanskiĭ formulæ<sup>4</sup>:*

1. If  $p, q$  are distinct:

$$\dim H_{p,q}(X; \mathbb{F}_2) = \sum_{Q \leq P} (-1)^{n-\dim Q} h_{p+1}^*(Q).$$

2. If  $p$  equals  $q$ :

$$\dim H_{p,p}(X; \mathbb{F}_2) = h_p(\partial P^\circ) + \sum_{Q \leq P} (-1)^{n-\dim Q} h_{p+1}^*(Q).$$

*where the numbers  $h_k^*(Q)$  are defined in Definition 1.4.14. By the Universal Coefficient Theorem the same holds for the tropical cohomology groups  $(H^{p,q}(X; \mathbb{F}_2))_{p,q \geq 0}$ . Moreover, the bigraded algebra  $(H^{p,q}(X; \mathbb{F}_2))_{p,q \geq 0}$  satisfies the Poincaré duality<sup>5</sup>:*

1.  $H^{n-1,n-1}(X; \mathbb{F}_2)$  is free of rank 1;

<sup>3</sup>c.f. [CE56] Theorem 3.3a p.114.

<sup>4</sup>c.f. [DK87] §5.5 p.293 and §5.12 pp.296-297.

<sup>5</sup>c.f. [ARS21] Corollary 1.4 p.1350 and [JRS18] Theorem 5.3 p.16.

2. The pairing  $\cup : H^{p,q}(X; \mathbb{F}_2) \otimes_{\mathbb{F}_2} H^{n-1-p, n-1-q}(X; \mathbb{F}_2) \rightarrow H^{n-1, n-1}(X; \mathbb{F}_2)$  is non-degenerate, for all  $0 \leq p, q \leq n-1$ .

C. Arnal, R. Renaudineau, and K. Shaw proved Theorem 3.1.17 for convex triangulations. Its extension<sup>6</sup> to non-convex primitive triangulations is due to E. Bruggallé, L. López de Medrano, and J. Rau. Before moving on to Lefschetz Theorem we would like to give the expressions of the fundamental classes of  $P$  and  $X$ .

**Definition 3.1.18.** Let  $[\mathfrak{t}(\mathbb{F}_2)]$  denote the generator of  $\bigwedge^n \mathfrak{t}(\mathbb{F}_2)$ . The three cycles:

$$\begin{cases} [\mathfrak{t}(\mathbb{F}_2)] \otimes [P] \in C_n(P; \mathbb{F}_2 \otimes F_n^P) \\ \sum_{\sigma^n \in K} [\mathfrak{t}(\mathbb{F}_2)] \otimes [\sigma^n] \in C_n(K; \mathbb{F}_2 \otimes F_n^P) \\ \sum_{\sigma^0 \leq \sigma^n} [\mathfrak{t}(\mathbb{F}_2)] \otimes [\sigma^0; \sigma^n] \in \Omega_n(K; \mathbb{F}_2 \otimes F_n^P) \end{cases}$$

represent the same homology class  $[P] \in H_{n,n}(P; \mathbb{F}_2)$ . It is the generator of this group. We call it the *fundamental class* of  $P$ .

**Definition 3.1.19** (P. Jell, J. Rau and K. Shaw, [JRS18], Definition 4.8 p.12). For all edges  $\sigma^1$  of  $K$ , we denote by  $[T\sigma^1(\mathbb{F}_2)^\perp]$  the generator of  $\bigwedge^{n-1} T\sigma^1(\mathbb{F}_2)^\perp$ . The chain:

$$\sum_{\sigma^1 \leq \sigma^n} [T\sigma^1(\mathbb{F}_2)^\perp] \otimes [\sigma^1; \sigma^n] \in \Omega_{n-1}(K; F_{n-1}^X),$$

is a cycle. Its homology class  $[X]$  is the generator of  $H_{n-1, n-1}(X; \mathbb{F}_2)$ . We call it the *fundamental class* of  $X$ .

Using the cap product, the cycle  $[P]$  of  $C_n(K; \mathbb{F}_2 \otimes F_n^P)$  defines a morphism of complex, given for all  $0 \leq q \leq n$  by:

$$\begin{array}{ccc} \Omega^q(K; \mathbb{F}_2 \otimes F_p^P) & \longrightarrow & C_{n-q}(K; \mathbb{F}_2 \otimes F_{n-p}^P) \\ \alpha & \longmapsto & \alpha \cap [P] \end{array},$$

It is a quasi-isomorphism by the Poincaré duality in  $P$ . Its adjoint sends the cochain  $\alpha \in C^q(K; F_p^P)$  to:

$$\alpha \cap [P] := \sum_{\sigma^q \leq \sigma^n} \alpha[\sigma^q] \cdot [\mathfrak{t}(\mathbb{F}_2)] \otimes [\sigma^q; \sigma^n].$$

**Definition 3.1.20.** Let  $\sigma^1$  be an edge of  $K$ . Since  $K$  is a primitive triangulation of  $P$ ,  $\omega(\sigma^1) := \alpha - \beta \pmod{2}$  where  $\alpha$  and  $\beta$  are the vertices of  $\sigma^1$  is the generator of  $[T\sigma^1(\mathbb{F}_2)]$ . Hence  $\omega_X : \sigma^1 \mapsto \omega(\sigma^1)$  is a cocycle of  $C^1(K; F_p^1)$  for which  $\omega_X \cap [P]$  is the image in  $\Omega_{n-1}(K; F_{n-1}^P)$  of the cycle representing the fundamental class of  $X$ . The class of  $\omega_X$  is the Poincaré dual of  $i_{n-1, n-1}[X]$  in the cohomology of  $P$ .

**Proposition 3.1.21.** *The class  $i_{n-1, n-1}[X]$  vanishes if and only if the integer lengths of the edges of  $P$  are even, i.e. the vertices of  $P$  belong, up to translation, to  $2\mathfrak{t}^*(\mathbb{Z})$ .*

<sup>6</sup>c.f. [BLdMR22] Theorem 1.4 p.5, Theorem 3.3 p.16, and Proposition 4.14 p.27

*Proof.* The class  $i_{n-1, n-1}[X]$  vanishes if and only if  $\omega_X$  is exact. However, a primitive  $\beta \in C^0(K; \mathbb{F}_2 \otimes F_P^1)$  of  $\omega_X$  has necessarily the following form:

$$\beta(\alpha) = \alpha + \alpha_0,$$

for all vertices  $\alpha$  of  $K$  and  $\alpha_0 \in \mathfrak{t}^*(\mathbb{F}_2)$ . However, as such  $\beta$  is only a cochain of  $C^0(K; \mathfrak{t}^*(\mathbb{F}_2))$ . Hence,  $\omega_X$  is exact if and only if there exists a vector  $\alpha_0 \in \mathfrak{t}^*(\mathbb{F}_2)$  such that  $\alpha + \alpha_0$  belongs to  $\text{Sed}(\alpha)^\perp \otimes \mathbb{F}_2$ , for all vertices  $\alpha$  of  $K$ . If  $\alpha$  is a vertex of  $P$ ,  $\text{Sed}(\alpha)^\perp \otimes \mathbb{F}_2$  is 0. It follows that if  $\omega_X$  is exact then, up to translation, the vertices of  $P$  belong to  $2\mathfrak{t}^*(\mathbb{Z})$ . Conversely, we assume that the vertices of  $P$  belong to  $2\mathfrak{t}^*(\mathbb{Z})$ . Let  $\alpha$  be a vertex of  $K$  and  $\alpha_0, \dots, \alpha_k$  be a sequence of vertices of  $K$  such that  $\alpha_0$  is a vertex of  $P$ ,  $\alpha_k$  is  $\alpha$ ,  $\alpha_i$  and  $\alpha_{i+1}$  are vertices of an edge of  $K$ , for all  $0 \leq i \leq k-1$ , and  $(\text{Sed}(\alpha_i; \alpha_{i+1}))_{i \geq 0}$  is increasing. We have:

$$\alpha = \alpha_0 + \sum_{i=0}^{k-1} \omega(\alpha_i; \alpha_{i+1}).$$

Since the vertices of  $P$  are even,  $\alpha_0$  vanishes in  $\mathfrak{t}^*(\mathbb{F}_2)$ . Moreover, the forms  $\omega(\alpha_i; \alpha_{i+1})$  vanish on  $\text{Sed}(\alpha_i; \alpha_{i+1}) \otimes \mathbb{F}_2$  for all  $0 \leq i \leq k-1$ , hence vanish on  $\text{Sed}(\alpha) \otimes \mathbb{F}_2$ . And then  $\omega_X$  is exact.  $\square$

**Definition 3.1.22** (Intersection Product). The *intersection product* of the class  $[c_1] \in H_{p_1, q_1}(P; \mathbb{F}_2)$  and the class  $[c_2] \in H_{p_2, q_2}(P; \mathbb{F}_2)$  is given by the formula:

$$[c_1] \cdot [c_2] = (\alpha_1 \cup \alpha_2) \cap [P] \in H_{p_1+p_2-n, q_1+q_2-n}(P; \mathbb{F}_2),$$

where  $\alpha_i \cap [P]$  equals  $[c_i]$  for all  $1 \leq i \leq 2$ . It equivalently corresponds to the class  $\alpha_1 \cap [c_2]$ . Likewise, The *intersection product* of the class  $[c_1] \in H_{p_1, q_1}(X; \mathbb{F}_2)$  and the class  $[c_2] \in H_{p_2, q_2}(X; \mathbb{F}_2)$  is given by the formula:

$$[c_1] \cdot [c_2] = (\alpha_1 \cup \alpha_2) \cap [X] \in H_{p_1+p_2-n+1, q_1+q_2-n+1}(X; \mathbb{F}_2),$$

where  $\alpha_i \cap [X]$  is  $[c_i]$  for all  $1 \leq i \leq 2$ . It also corresponds to the class  $\alpha_1 \cap [c_2]$ . We note that  $(i_{p, q})_{p, q \geq 0}$  is not a morphism of algebras.

## 3.2 Lefschetz Theorem for Tropical Toric Varieties

**Three Lemmata.** We begin the section by proving three preparatory lemmata.

**Definition 3.2.1.** Let  $V$  be an  $R$ -module,  $G \subset V$  be a finite subset, and  $p \geq 0$  be an integer. We define the complex of  $R$ -modules  $C(V; G; p) := (C_k, \partial_k)_{k \geq 0}$  as follows:

$$C_k := \bigoplus_{\substack{F \subset G \\ |F|=k}}^{p-k} \bigwedge V_F,$$

where  $V_F$  denotes the quotient of  $V$  by the sub-module spanned by  $F$ . the boundary operator  $\partial_k : C_k \rightarrow C_{k-1}$  is the sum of the following maps:

$$\begin{aligned} \bigwedge^{p-k} V_F &\longrightarrow \bigoplus_{f \in F} \bigwedge^{p-(k-1)} V_{F \setminus f} \\ v &\longmapsto \sum_{f \in F} f \wedge v. \end{aligned}$$

Because of the antisymmetry of the wedge product,  $\partial^2$  vanishes. Moreover, it is worth noticing that when  $G'$  is a subset of  $G$  the complex  $C(V; G'; p)$  is naturally a sub-complex of  $C(V; G; p)$ .

**Lemma 3.2.2.** *Let  $V$  be free  $R$ -module of finite rank and  $p \geq 0$  be an integer. If  $G$  is a linearly independent finite subset of  $V$  spanning a free summand of  $V$ , then  $C(V; G; p)$  can only have non-trivial homology in dimension 0 and this  $H_0$  is equal to the  $p$ -th exterior power of  $V_G$ . In other words:*

$$0 \leftarrow \bigwedge^p V_G \leftarrow C_0 \leftarrow \dots \leftarrow C_{|G|} \leftarrow 0,$$

is a free resolution of  $\bigwedge^p V_G$ . (The augmenting morphism is the reduction modulo the module spanned by  $G$ .)

*Proof.* By hypotheses, one can find a subset  $G' \subset V$  disjoint from  $G$  such that  $G \cup G'$  is a basis of  $V$ . Let us denote by  $g_1, \dots, g_n$  (resp.  $g'_1, \dots, g'_{n'}$ ) the elements of  $G$  (resp.  $G'$ ). Let  $F$  be the subset  $\{g_i : i \in I\} \subset G$  where  $|I|$  equals  $k$ . A basis of the  $(p - k)$ -th exterior power of  $V_F$  is given by the elements  $(g_{P \setminus I} \wedge g'_Q)$  for all  $I \subset P \subset \{1, \dots, n\}$ , and all  $Q \subset \{1, \dots, n'\}$  such that  $|P| + |Q| = p$ . Moreover, the image of the generator  $g_{P \setminus I} \wedge g'_Q$  under the boundary map is:

$$\partial g_{P \setminus I} \wedge g'_Q = \sum_{i \in I} g_i \wedge g_{P \setminus I} \wedge g'_Q \in \bigoplus_{i \in I} \bigwedge^{p-(k-1)} V_{F \setminus g_i}.$$

Therefore, if we fix  $P$  and  $Q$  with  $|P| + |Q| = p$  and see  $P$  as an abstract simplex we have an injective morphism of chain complexes from the reduced simplicial chain complex of  $P$  to  $C$  given by:

$$\begin{aligned} \tilde{C}_k(P; R) &\longrightarrow C_{k+1} \\ I &\longmapsto g_{P \setminus I} \wedge g'_Q, \end{aligned}$$

By construction,  $C$  is the direct sum of the images of these complexes, hence it can only have homology in dimension 0. Furthermore, the only summands that contribute are the ones for which  $P$  is empty : there is exactly one free summand of rank 1 for every basis element of  $\bigwedge^p V_G$ , although a very quick computation shows that  $B_0 = \langle G \rangle \wedge \bigwedge^{p-1} V$ .  $\square$

**Lemma 3.2.3** (Homology Shift). *Let  $n \geq 0$  be an integer and:*

$$0 \longrightarrow C(n) \xrightarrow{a_n} C(n-1) \xrightarrow{a_{n-1}} \cdots \xrightarrow{a_2} C(1) \xrightarrow{a_1} C(0) \longrightarrow 0, \quad (3.2)$$

*be an exact sequence of chain complexes. If  $C(i)$  is exact for all  $1 \leq i \leq n-1$ , then the homology of  $C(0)$  is the one of  $C(n)$  shifted by  $1-n$ :*

$$H(0) = H(n)[1-n].$$

*Proof.* For all  $1 \leq i \leq n$ , let  $A(i)$  denote the kernel complex of  $a_i$ . Since (3.2) is an exact sequence all the columns of the following diagram are exact:

$$\begin{array}{ccccccc}
 & & & 0 & & 0 & & 0 & & 0 \\
 & & & \downarrow & & \downarrow & & \downarrow & & \downarrow \\
 & 0 & & A(n-1) & \cdots & A(i) & \cdots & A(1) & & A(0) \\
 & \downarrow & & \downarrow & & \downarrow & & \downarrow & & \downarrow \\
 0 & \longrightarrow & C(n) & \xrightarrow{a_n} & C(n-1) & \xrightarrow{a_{n-1}} & \cdots & \xrightarrow{a_{i+1}} & C(i) & \xrightarrow{a_i} & \cdots & \xrightarrow{a_2} & C(1) & \xrightarrow{a_1} & C(0) & \longrightarrow & 0 \\
 & & \downarrow a_n & & \downarrow a_{n-1} & & \downarrow a_i & & \downarrow a_1 & & \downarrow & & \downarrow & & \downarrow & & \\
 & & A(n-1) & & A(n-2) & & \cdots & & A(i-1) & & \cdots & & A(0) & & 0 & & \\
 & & \downarrow & & \downarrow & & \downarrow & & \downarrow & & \downarrow & & \downarrow & & \downarrow & & \\
 & & 0 & & 0 & & \cdots & & 0 & & \cdots & & 0 & & 0 & & 
 \end{array}$$

By assumption,  $H(i)$  vanishes for all  $1 \leq i \leq n-1$ . Hence, by the homological long exact sequence of the  $i$ -th column  $H(A(i-1))$  equals  $H(A(i))[-1]$ . A finite recursion implies that:

$$H(0) = H(A(0)) = H(A(n-1))[1-n] = H(n)[1-n].$$

□

**Lemma 3.2.4** (Double Localisation). *Let  $F$  be a cellular cosheaf on a regular CW-complex  $K$ , and  $K'$  be a subdivision of  $K$ . If  $e$  is a cell of  $K$  and  $e'$  is a cell of  $K'$  contained in  $e$  then the local homology of  $F$  at  $e$  is identical to the local homology of the subdivision of  $F$  at  $e'$ . More precisely, if  $F'$  is the subdivision of  $F$  there is a canonical quasi-isomorphism between  $(C_k(K; F_e))_{k \geq 0}$  and  $(C_k(K'; F'_{e'}))_{k \geq 0}$ .*

*Proof.* We denote by  $(F_e)'$  the subdivision of  $F_e$ . We have the following commutative square of cellular cosheaves on  $K'$ :

$$\begin{array}{ccc}
 F' & \longrightarrow & (F')_{e'} \\
 \downarrow & & \downarrow \\
 (F_e)' & \longrightarrow & (F_e)'_{e'}
 \end{array}$$

where all four morphisms come from localisation and subdivision. The two cosheaves

on the right hand column are actually equal and the arrow is rigorously the identity between them. Indeed, every cell  $\tilde{e}'$  of  $K'$  that contains  $e'$  has to be contained in a cell  $\tilde{e}$  of  $K$  that contains  $e$ . Hence,  $(F')_{e'}(\tilde{e}')$  equals  $F(\tilde{e})$ . We have the following commutative diagram of chain complexes:

$$\begin{array}{ccc}
 & & \xrightarrow{h} (C_k(K'; (F')_{e'})_{k \geq 0}) \\
 & \nearrow & \parallel \\
 (C_k(K; F_e))_{k \geq 0} & \xrightarrow[\text{subd.}]{f} (C_k(K'; (F_e)'))_{k \geq 0} & \xrightarrow[\text{loc.}]{g} (C_k(K'; (F_e)')_{e'})_{k \geq 0}
 \end{array}$$

where  $h$  is the canonical quasi-isomorphism announced in the statement of the proposition. Since  $f$  is a subdivision morphism it is automatically a quasi-isomorphism. We only need to show that the localisation morphism  $g$  is a quasi-isomorphism. This is a surjective morphism since localisations are quotients. By definition, we have the following short exact sequence of cosheaves:

$$0 \rightarrow (F_e)' \otimes [K' - e'; \mathbb{Z}] \rightarrow (F_e)' \rightarrow (F_e)'_{e'} \rightarrow 0.$$

Hence  $g$  is a quasi-isomorphism if and only if the kernel cosheaf has trivial homology. The cosheaf  $(F_e)'$  equals  $F' \otimes [K'; K' - e; \mathbb{Z}]$  for  $K' - e$  is the subdivision of the sub-complex  $K - e$ . Consequently:

$$(F_e)' \otimes [K' - e'; \mathbb{Z}] = F' \otimes [K'; K' - e; \mathbb{Z}] \otimes [K' - e'; \mathbb{Z}] = F' \otimes [K' - e'; K' - e; \mathbb{Z}].$$

By a process similar to excision, we see that:

$$[K' - e'; K' - e; \mathbb{Z}] = [K'(e) - e'; K'(e) - e; \mathbb{Z}].$$

Indeed,  $K'(e)$  is the smallest sub-complex of  $K'$  containing  $e$  in its support and any cell not in it falls into  $K' - e$ . We note that  $[K'(e) - e'; K'(e) - e; \mathbb{Z}]$  can only be non-zero on the cells of  $K'$  contained in  $e$ . Therefore:

$$(F_e)' \otimes [K' - e'; \mathbb{Z}] = F' \otimes [K' - e'; K' - e; \mathbb{Z}] = [K'(e) - e'; K'(e) - e; F(e)].$$

Now because  $K$  is regular,  $|K'(e)|$  is a closed ball  $B$ ,  $|K'(e) - e|$  is its boundary  $\partial B$ , and  $|K'(e) - e'|$  sits somewhere between  $\partial B$  and  $B$  punctured on one point. Since the latter retracts by deformation on the former, the homology of  $[K'(e) - e'; K'(e) - e; F(e)]$  is trivial.  $\square$

**Lefschetz Theorem.** In this paragraph we discuss the tropical analogue of Lefschetz Hyperplane Section Theorem. In the context of subdivided polytopes there is no hyperplane section per se, and the statement is closer to the version of Kodaira and Spencer.

**Definition 3.2.5.** Let  $P$  be an integral simple polytope, we denote by  $\text{Sed}_{(1)}$  the

cosheaf:

$$\text{Sed}_{(1)} := \bigoplus_{\substack{Q < P \\ \text{codim} Q = 1}} [Q; \text{Sed}(Q)].$$

Let  $Q$  be a codimension 1 face of  $P$ . If  $Q'$  is a face of  $P$  the group  $[Q; \text{Sed}(Q)](Q')$  is either  $\text{Sed}(Q)$  or 0. The former only happens when  $Q'$  is a face of  $Q$ . Hence, there is a natural injective cosheaves morphism  $[Q; \text{Sed}(Q)] \rightarrow \text{Sed}$  given by inclusion. Summing all these yields a morphism of cosheaves:

$$\text{Sed}_{(1)} \rightarrow \text{Sed}.$$

It is injective for  $P$  is simple : if  $Q' < P$  has codimension  $q$  it is the intersection of exactly  $q$  faces of codimension 1 and:

$$(TQ')^\perp = \bigoplus_{\substack{Q' \leq Q < P \\ \text{codim} Q = 1}} TQ^\perp,$$

and the  $\text{Sed}(Q)$ 's are in direct sum inside  $\text{Sed}(Q')$ . For the same reason the quotient  $\Delta$  of  $\text{Sed}$  by  $\text{Sed}_{(1)}$  is a cosheaf of finite groups. We denote by  $\delta(P)$  the least common multiple of the exponents<sup>7</sup> of the groups  $\Delta(Q)$  for all  $Q \leq P$ .

**Remarks 3.2.6.** Let  $P$  be an integral simple polytopes:

1. The cosheaf of finite groups  $\Delta$  encodes the singularities of the toric variety associated with  $P$ . The set of complex points of the affine open set associated with the face  $Q \leq P$  is the quotient<sup>8</sup> of  $(\mathbb{C}^\times)^k \times \mathbb{C}^{n-k}$  by an algebraic action of the group  $\Delta(Q)$ .
2. For two adjacent faces  $Q_1 < Q_2$  of  $P$ , the Snake Lemma<sup>9</sup> implies that the following commutative diagram of exact sequences:

$$\begin{array}{ccccccccc} 0 & \longrightarrow & \text{Sed}_{(1)}(Q_2) & \longrightarrow & \text{Sed}(Q_2) & \longrightarrow & \Delta(Q_2) & \longrightarrow & 0 \\ & & \downarrow f & & \downarrow g & & \downarrow h & & \\ 0 & \longrightarrow & \text{Sed}_{(1)}(Q_1) & \longrightarrow & \text{Sed}(Q_1) & \longrightarrow & \Delta(Q_1) & \longrightarrow & 0 \end{array}$$

gives rise to the following exact sequence:

$$\underbrace{0}_{\ker(g)} \rightarrow \ker(h) \rightarrow \underbrace{\bigoplus_{\substack{Q_1 < Q < P \\ Q \neq Q_2 \\ \text{codim} Q = 1}} \text{Sed}(Q)}_{\text{coker}(f)} \rightarrow \underbrace{\text{Sed}(Q_1)/\text{Sed}(Q_2)}_{\text{coker}(g)} \rightarrow \text{coker}(h) \rightarrow 0.$$

<sup>7</sup>The exponent of a group  $G$ , with group law denoted multiplicatively, is the smallest, if any, positive integer  $e$  for which  $g^e = 1$  for all  $g \in G$ .

<sup>8</sup>c.f. [Ful93], §2.2 Surfaces; quotient singularities p.34.

<sup>9</sup>c.f. [Lan93] Lemma 9.1 p.158.

The kernel  $\ker(h)$  is a finite group and  $\operatorname{coker}(f)$  is free. Hence,  $\ker(h)$  must vanish and  $h$  be injective. As a consequence,  $\delta(P)$  is the least common multiple of the exponents of the groups  $\Delta(V)$ ,  $V$  running amongst all vertices of  $P$ .

3. Let  $R$  be a commutative ring. The classification of finite Abelian groups implies that the vanishing of both  $\Delta(V) \otimes R$  and  $\operatorname{Tor}(\Delta(V); R)$  is equivalent to the invertibility of the exponent of the group  $\Delta(V)$  in  $R$ . When  $R$  is a field this is equivalent to the coprimality of this exponent with the characteristic of  $R$ .

**Lemma 3.2.7.** *Let  $P$  be an integral simple polytope. If  $R$  is a ring in which  $\delta(P)$  is invertible then  $\operatorname{Sed}_{(1)} \otimes R$  equals  $\operatorname{Sed} \otimes R$ .*

*Proof.* Since  $P$  is simple, we have the exact sequence of cosheaves of abelian groups of Definition 3.2.5:

$$0 \rightarrow \operatorname{Sed}_{(1)} \rightarrow \operatorname{Sed} \rightarrow \Delta \rightarrow 0,$$

which is tensorised to the following exact sequence of cosheaves of  $R$ -modules:

$$0 \rightarrow \operatorname{Tor}(\Delta; R) \rightarrow \operatorname{Sed}_{(1)} \otimes R \rightarrow \operatorname{Sed} \otimes R \rightarrow \Delta \otimes R \rightarrow 0.$$

Since  $\delta(P)$  is invertible in  $R$  both  $\Delta \otimes R$  and  $\operatorname{Tor}(\Delta; R)$  vanish and  $\operatorname{Sed}_{(1)} \otimes R$  equals  $\operatorname{Sed} \otimes R$ .  $\square$

**Proposition 3.2.8.** *Let  $P$  be a simple integer polytope endowed with an integer polyhedral subdivision  $K$ . For all rings  $R$  in which  $\delta(P)$  is invertible, the images of the cosheaves  $(F_p^P \otimes R)_{p \geq 0}$  under the dihomologic subdivision of  $K$  satisfy the hypotheses of Proposition 2.5.1 i.e. for all polyhedral cells  $e \in K$  we have:*

$$H_q(K; (F_p^P \otimes R)_e) \neq 0 \Rightarrow q = n.$$

*Proof.* Let  $F$  denote one of the cosheaves  $(F_p^P)_{0 \leq p \leq n}$  on  $P$ . The polyhedral subdivision  $K$  of  $P$  first and then its dihomologic subdivision give rise to two consecutive subdivisions of cosheaves  $F \mapsto F'$  and  $F' \mapsto F''$ . For all cells  $e$  of  $K$ , the localisation process for dihomologic cosheaves consisting in “fixing the first coordinate”<sup>10</sup> applied to a subdivided cosheaf is equivalent to the localisation of the initial cosheaf<sup>11</sup>. Consequently, the cosheaf  $(F'')_e$  is the same as  $(F')_e$ . In the light of Lemma 3.2.4 on double localisation, showing that  $(F')_e$  can only have non-trivial homology in degree  $n$  for all cells  $e \in K$ , is strictly equivalent to showing that  $F_Q$  can only have non-trivial homology in degree  $n$  for all faces  $Q < P$ . By Lemma 3.2.7,  $\operatorname{Sed} \otimes R$  equals  $\operatorname{Sed}_{(1)} \otimes R$  and  $F_p^P \otimes R$  equals:

$$\bigwedge^p \mathfrak{t}(R) / (\operatorname{Sed}_{(1)} \otimes R).$$

<sup>10</sup>c.f. Definition 2.2.10.

<sup>11</sup>c.f. Diagram (2.1).



The cosheaf  $\text{Sed}_{(1)}$  can be described as follows : choose, for every codimension 1 face  $Q_{(1)}$  of  $P$ , a generator  $g_{Q_{(1)}}$  of  $\text{Sed}(Q_{(1)}) \cong \mathbb{Z}$ , and associate to all faces  $Q$  of  $P$  the set  $G(Q)$  of the  $(g_{Q_{(1)}})$ 's for which  $Q \leq Q_{(1)}$ . The association  $G : Q \mapsto G(Q)$  is a cosheaf of sets with inclusions as extension maps. In these notations,  $\text{Sed}_{(1)}$  is the cosheaf that associate to  $Q$  the sub-module of  $\mathfrak{t}(\mathbb{Z})$  spanned by  $G(Q)$  and whose extension morphisms are given by inclusions. We can consider the cosheaf of chain complexes  $Q \mapsto C(\mathfrak{t}(\mathbb{Z}); G(Q); p)$  of Definition 3.2.1. It has an augmentation morphism:

$$0 \leftarrow \bigwedge^p \mathfrak{t}(\mathbb{Z}) / \text{Sed}_{(1)} \leftarrow C(\mathfrak{t}(\mathbb{Z}); G; p) ,$$

and becomes a resolution once we tensorise every group by  $R$ . Indeed, for all  $Q$  the set  $G(Q) \otimes R$  is linearly independent in  $\mathfrak{t}(R)$ , and  $\text{Sed}_{(1)}(Q) \otimes R$ , which equals  $\text{Sed}(Q) \otimes R$ , is a free summand of  $\mathfrak{t}(R)$  since  $\mathfrak{t}(R)/(\text{Sed}(Q) \otimes R) \cong \text{Hom}(TQ_{\mathbb{Z}}; R)$  is free. Hence Lemma 3.2.2 applies. For that reason, we set  $\text{Res}_p := C(\mathfrak{t}(\mathbb{Z}); G; p) \otimes R$  and we have a resolution of cosheaves:

$$0 \leftarrow F_p^P \otimes R \leftarrow \text{Res}_p .$$

The localisation at a face  $Q$  amounts to a tensorisation by a cosheaf of free modules. Therefore, it is an exact endofunctor of the category of cellular cosheaves. To avoid confusion we will denote, from now on, the CW-complex defined by the polytope  $P$  by  $\Pi$ . Every face  $Q \leq P$  is now meant to be open. In particular,  $\Pi(Q)$  is the smallest sub-complex of  $\Pi$  containing the open face  $Q$ , that is to say the collection of the faces of  $Q$ . For all faces  $Q$ , we have the local resolution:

$$0 \leftarrow (F_p^P \otimes R)_Q \leftarrow (\text{Res}_p)_Q ,$$

and for all  $q \geq 0$ :

$$\begin{aligned} (\text{Res}_{p,q})_Q &= \bigoplus_{\substack{Q_{(q)} < P \\ \text{codim } Q_{(q)} = q}} \left[ \Pi(Q_{(q)}); \left( \bigwedge^{p-q} \mathfrak{t}(\mathbb{Z}) / \text{Sed}_{(1)}(Q_{(q)}) \right) \otimes R \right] \otimes_R [\Pi; \Pi - Q; R] \\ &= \bigoplus_{\substack{Q < Q_{(q)} < P \\ \text{codim } Q_{(q)} = q}} \left[ \Pi(Q_{(q)}); \Pi(Q_{(q)}) - Q; \left( \bigwedge^{p-q} \mathfrak{t}(\mathbb{Z}) / \text{Sed}_{(1)}(Q_{(q)}) \right) \otimes R \right] . \end{aligned}$$

If  $Q$  is a proper face of  $Q_{(q)}$  then  $|\Pi(Q_{(q)})|$ , the closure of  $Q_{(q)}$ , retracts by deformation on  $|\Pi(Q_{(q)}) - Q|$ . Thus, the cosheaf:

$$\left[ \Pi(Q_{(q)}); \Pi(Q_{(q)}) - Q; \left( \bigwedge^{p-q} \mathfrak{t}(\mathbb{Z}) / \text{Sed}_{(1)}(Q_{(q)}) \right) \otimes R \right] ,$$

has trivial homology. When  $Q_{(q)}$  equals  $Q$ , we are computing the homology of a closed  $(n - q)$ -ball relatively to its boundary. The homology is concentrated in top

dimension  $n - q$ . In application of Lemma 3.2.3, the homology of  $(F_p^P \otimes R)_Q$  is the shift by  $q$  of  $(\text{Res}_{p,q})_Q$ . Its homology is concentrated in dimension  $(n - q) + q = n$ .  $\square$

**Remark 3.2.9.** In the previous proof we have defined a resolution of the cosheaf  $F_p^P \otimes R$ , namely:

$$0 \leftarrow F_p^P \otimes R \leftarrow \text{Res}_p .$$

**Proposition 3.2.10.** *Under the same hypotheses as Proposition 3.2.8 the dihomologic cosheaves  $(\hat{F}_p^X \otimes R)_{0 \leq p \leq n-1}$  satisfy the hypotheses of Proposition 2.5.1 i.e. for all polyhedral cells  $e \in K$ :*

$$H_q \left( K; (\hat{F}_p^X \otimes R)_e \right) \neq 0 \Rightarrow q = n .$$

*Proof.* Let  $p$  be a non-negative integer. Proposition 3.2.10 follows from Proposition 3.2.8 and the fact that  $\hat{F}_p^X \otimes R$  is locally a direct summand of  $F_p^P \otimes R$ . More precisely, we will show that for all cells  $e^q$  of  $K$ , the cosheaf  $(\hat{F}_p^X \otimes R)_{e^q}$  is a direct summand of the cosheaf  $(F_p^P \otimes R)_{e^q}$ . This statement implies that the homology of the former is a direct summand of the latter. By Proposition 3.2.8, the latter can only have non-vanishing homology in dimension  $n$  and so can the former.

Let  $e^q$  be a cell of  $K$  and  $A$  denote  $(Te^q)^\perp(\mathbb{Z})$ . Now let us choose  $B$  a supplementary sub-module<sup>12</sup> of  $A$  in  $\mathfrak{t}(\mathbb{Z})$ . We consider  $A/\text{Sed}$  and  $B/\text{Sed}$  the respective images of the constant cosheaves  $[K; A]$  and  $[K; B]$  in the quotient  $\mathfrak{t}(\mathbb{Z})/\text{Sed}$ . We note that if  $e^r$  is a cell containing  $e^q$  then  $\text{Sed}(e^r) \subset A$  and the projection  $B \rightarrow B/\text{Sed}(e^r)$  is an isomorphism. Since the commutativity conditions of these projections are satisfied they induce an isomorphism of cosheaves:

$$[K; K - e^q; B] \xrightarrow{\cong} (B/\text{Sed})_{e^q} .$$

Therefore, the cosheaf  $\mathfrak{t}(\mathbb{Z})/\text{Sed}$  splits around  $e^q$  into the following direct sum:

$$\left( \mathfrak{t}(\mathbb{Z})/\text{Sed} \right)_{e^q} = \left( A/\text{Sed} \right)_{e^q} \oplus \left( B/\text{Sed} \right)_{e^q} .$$

For all  $p \geq 0$  we have the decomposition:

$$\left( \bigwedge^p \mathfrak{t}(\mathbb{Z})/\text{Sed} \right)_{e^q} = \bigoplus_{p_A + p_B = p} \left( \bigwedge^{p_A} A/\text{Sed} \right)_{e^q} \otimes \left( \bigwedge^{p_B} B/\text{Sed} \right)_{e^q} .$$

All the involved cosheaves are made of free groups. Thus the decomposition remains valid after tensorisation by  $R$ :

$$\left( \bigwedge^p \mathfrak{t}(\mathbb{Z})/\text{Sed} \right)_{e^q} \otimes R = \bigoplus_{p_A + p_B = p} \left( \bigwedge^{p_A} A/\text{Sed} \right)_{e^q} \otimes \left( \bigwedge^{p_B} B/\text{Sed} \right)_{e^q} \otimes R .$$

Definition 3.1.7 implies that if  $\omega$  is a generator of  $\bigwedge^q Te^q(\mathbb{Z})$ , the group  $\hat{F}_p^X(e^q; e^r)$ ,

<sup>12</sup>It can be done for  $(Te^q)^\perp$  is a rational sub-space of  $\mathfrak{t}(\mathbb{R})$ .

for all  $e^r \geq e^q$ , consists of the  $p$ -elements of  $\bigwedge^p \mathfrak{t}(\mathbb{Z}) / \text{Sed}(e^r)$  whose contraction against  $\omega$  vanishes. Thus the localisation  $(\hat{F}_p^X)_{e^q} \otimes R$  can be expressed as:

$$\left(\hat{F}_p^X\right)_{e^q} \otimes R = \bigoplus_{\substack{p_A + p_B = p \\ p_B < q}} \left(\bigwedge^{p_A} A / \text{Sed}\right)_{e^q} \otimes \left(\bigwedge^{p_B} B / \text{Sed}\right)_{e^q} \otimes R,$$

and is a direct summand of  $(F_p^P)_{e^q} \otimes R$ .  $\square$

**Proposition 3.2.11.** *Let  $P$  be a simple integral polytope and  $R$  be a P.I.D. in which  $\delta(P)$  is invertible. For all  $p \in \mathbb{N}$ , the only non-trivial homology group of the cosheaf  $F_p^P \otimes R$  is the  $p$ -th. Moreover, this  $R$ -module is free of rank  $h_p(\partial P^\circ)$ , the  $p$ -th  $h$ -number of the polar polytope  $P^\circ$  of  $P$ . More precisely:*

$$\text{rk}_R H_{p,p}(P; R) = \sum_{k=0}^p (-1)^{p-k} \binom{n-k}{p-k} f_{n-k}(P),$$

where  $f_k(P)$  denotes the number of  $k$ -faces of  $P$ .

*Proof.* Since  $F_p^P \otimes R$  is originally defined on the CW-structure induced by the faces of  $P$  we can compute its homology on  $\Pi$  the CW-complex induced on  $P$  by its faces. We note, on the one hand, that from the Definition 3.1.5 the groups  $F_p^P(Q)$  vanish for all faces  $Q$  of dimension  $q < p$ . Therefore,  $H_q(\Pi; F_p^P \otimes R)$  vanishes for all  $q < p$ . On the other hand, we have the resolution of Remark 3.2.9:

$$0 \leftarrow F_p^P \otimes R \leftarrow \text{Res}_p.$$

This is an acyclic<sup>13</sup> resolution<sup>14</sup>. The  $(\text{Res}_{p,q})$ 's are sums of elementary cosheaves  $[\Pi(Q); M]$  where  $Q$  is a face of  $P$  and  $M$  a free  $R$ -module. All the sub-complexes  $\Pi(Q)$  are contractible. Hence, these cosheaves only have non-trivial homology in dimension 0. The cosheaf resolution becomes a resolution of chain complexes:

$$0 \leftarrow (C_k(\Pi; F_p^P \otimes R))_{k \geq 0} \leftarrow (C_k(\Pi; \text{Res}_{p,0}))_{k \geq 0} \leftarrow (C_k(\Pi; \text{Res}_{p,1}))_{k \geq 0} \leftarrow \cdots.$$

Since the complexes  $(C_k(\Pi; \text{Res}_{p,q}))_{k \geq 0}$  are acyclic, the homology of the complex  $(C_k(\Pi; F_p^P \otimes R))_{k \geq 0}$  is isomorphic to the homology of the complex:

$$0 \leftarrow H_0(\Pi; \text{Res}_{p,0}) \leftarrow H_0(\Pi; \text{Res}_{p,1}) \leftarrow \cdots.$$

The cosheaves  $\text{Res}_{p,q}$  vanish for all  $q > p$ . Indeed, we have:

$$\text{Res}_{p,q} = \bigoplus_{\substack{Q_{(q)} < P \\ \text{codim } Q_{(q)} = q}} \left[ \Pi(Q_{(q)}); \underbrace{\left(\bigwedge^{p-q} \mathfrak{t}(\mathbb{Z}) / \text{Sed}_{(1)}(Q_{(q)})\right)}_{=0 \text{ if } q > p} \otimes R \right].$$

<sup>13</sup>A cosheaf is acyclic if it has trivial homology in dimension at least 1.

<sup>14</sup>This is even a projective resolution, c.f. [She85] in the dual setting of cellular sheaves.

Therefore, the only possibly non-trivial homology group of  $F_p^P \otimes R$  is the  $p$ -th. Using again the resolution to compute this group we see that it coincides with a group of cycles:

$$H_p(\Pi; F_p^P \otimes R) \cong \ker(\partial: H_0(\Pi; \text{Res}_{p,p}) \rightarrow H_0(\Pi; \text{Res}_{p,p-1})).$$

Hence  $H_p(\Pi; F_p^P \otimes R)$  is free and its rank equals the dimension of  $H_p(\Pi; F_p^P \otimes R_0)$  where  $R_0$  is the fraction field of  $R$ . Because  $F_p^P \otimes R_0$  can only have non-trivial homology in dimension  $p$  we have:

$$\begin{aligned} \dim_{R_0} H_p(\Pi; F_p^P \otimes R_0) &= (-1)^p \sum_{k=0}^n (-1)^k \dim_{R_0} H_0(\Pi; \text{Res}_{p,k}^{R_0}) \\ &= \sum_{k=0}^p (-1)^{p-k} \binom{n-k}{p-k} f_{n-k}(P) \\ &= h_p(\partial P^\circ), \end{aligned}$$

Where  $\text{Res}_{p,k}^{R_0}$  denotes the cosheaves  $\text{Res}_{p,k}$  defined for the ring  $R_0$ . Note that  $f_{k-1}(P^\circ)$  equals  $f_{n-k}(P)$  for all  $k$ .  $\square$

**Definition 3.2.12.** Let  $e^n$  be a cell of  $K$ . Since the closure of  $e^n$  is a full dimensional polytope of  $\mathfrak{t}^*(\mathbb{R})$  there is a canonical isomorphism  $f$  between  $\bigwedge^n \mathfrak{t}(\mathbb{Z})$  and  $\mathbb{Z}(e^n)$ . Let  $[\mathfrak{t}(\mathbb{Z})]$  be a generator of  $\bigwedge^n \mathfrak{t}(\mathbb{Z})$  and  $\sigma^n = [v_0; \dots; v_n]$  be a barycentric simplex of the closure of  $e^n$ . Since  $e^n$  is a polytope, its barycentric simplices define singular simplices of its support by convex interpolation<sup>15</sup>. We denote by  $[\mathfrak{t}(\mathbb{Z})](\sigma^n)$  the sign of the number  $(\bigwedge_{i=1}^n (v_i - v_0))[\mathfrak{t}(\mathbb{Z})] \in \mathbb{R}$ . The morphism  $f$  sends the generator  $[\mathfrak{t}(\mathbb{Z})]$  to the orientation of  $e^n$  defined by the class of the singular chain  $\sum_{\sigma^n \in \text{Sd}(K(e^n))} [\mathfrak{t}(\mathbb{Z})](\sigma^n) \sigma^n$ . We denote by  $[\mathfrak{t}(\mathbb{Z})]_{e^n}$  the image  $f[\mathfrak{t}(\mathbb{Z})]$ .

**Lemma 3.2.13.** Let  $0 \leq p \leq n$  be an integer and  $R$  be a ring in which  $\delta(P)$  is invertible. For all cells  $e^q$  of  $K$  we have an isomorphism:

$$\psi_p^R(e^q) : H_n(K; (F_p^P \otimes R)_{e^q}) \xrightarrow{\cong} \bigwedge^n \mathfrak{t}(\mathbb{Z}) \otimes \left( \bigwedge^s \text{Sed}(e^q) \wedge \bigwedge^{p-s} \mathfrak{t}(\mathbb{Z}) \right) \otimes R,$$

where  $s$  denotes the rank of  $\text{Sed}(e^q)$ . Moreover, the morphism of cellular sheaves  $j_p : H_n((\hat{F}_p^X \otimes R)_*) \rightarrow H_n((F_p^P \otimes R)_*)$  induced from the inclusion  $\hat{i}_p : \hat{F}_p^X \rightarrow F_p^P$  is injective. The image of the composition  $\psi_p^R(e^q) \circ j_p(e^q)$  is the tensor product of  $\bigwedge^n \mathfrak{t}(\mathbb{Z})$  with the kernel of the contraction against  $\omega$ , a generator of  $\bigwedge^q T e^q(R)$ , restricted to  $(\bigwedge^s \text{Sed}(e^q) \wedge \bigwedge^{p-s} \mathfrak{t}(\mathbb{Z})) \otimes R$ . In particular,  $j_p(e^q)$  is an isomorphism whenever  $q$  is greater than  $p$ .

*Proof.* Let  $e^q$  be a cell of  $K$ . Since  $K$  has dimension  $n$ , the module  $H_n(K; (F_p^P \otimes R)_{e^q})$  is the same as  $Z_n(K; (F_p^P \otimes R)_{e^q})$ . Let  $c \in C_n(K; (F_p^P \otimes R)_{e^q})$  and  $[e^{n-1}]$  be an oriented cell adjacent to  $e^q$ . If  $e^{n-1}$  does not belong to  $\partial K$ , there are two  $n$ -cells  $e_\pm^n$

<sup>15</sup>the vertex of a barycentric simplex are canonically ordered.

adjacent to  $e^{n-1}$ . In this case, we have:

$$\langle \partial c; [e^{n-1}] \rangle = \langle c; [e^{n-1}][e^{n-1}; e_+^n] \rangle + \langle c; [e^{n-1}][e^{n-1}; e_-^n] \rangle,$$

since the extension morphism  $(F_p^P \otimes R)_{e^q}(e_{\pm}^n) \rightarrow (F_p^P \otimes R)_{e^q}(e^{n-1})$  is the identity. Any two  $n$ -cells adjacent to  $e^q$  can be joined by a sequence  $e_1^n, \dots, e_k^n$ , with  $k \geq 1$ , of  $n$ -cells such that  $e_i^n$  and  $e_{i+1}^n$  are adjacent to the same cell  $e_i^{n-1} \geq e^q$ , for all  $1 \leq i \leq k-1$ . Therefore, if  $\partial c$  vanishes we can find a  $p$ -element  $v \in \bigwedge^p \mathfrak{t}(R)$  such that  $c = \sum_{e^n \geq e^q} v \otimes [\mathfrak{t}(\mathbb{Z})]_{e^n}$  where  $[\mathfrak{t}(\mathbb{Z})]$  is a choice of generator of  $\bigwedge^n \mathfrak{t}(\mathbb{Z})$ . If now  $e^{n-1}$  belongs to  $\partial K$  we have:

$$\langle \partial c; [e^{n-1}] \rangle = \pm v \left( \text{mod} \left( \text{Sed}(e^{n-1}) \wedge \bigwedge^{p-1} \mathfrak{t}(\mathbb{Z}) \right) \otimes R \right).$$

It follows that  $\partial c$  vanishes if and only if  $v$  is divisible in the exterior algebra by the generators of  $\text{Sed}(e^{n-1}) \otimes R$ , for all  $e^q \leq e^{n-1} \in \partial K$ . Since  $\delta(P)$  is invertible in  $R$ ,  $\text{Sed}(e^q) \otimes R$  is equal to  $\text{Sed}_{(1)}(e^q) \otimes R$  by Lemma 3.2.7. The latter condition is equivalent to  $v$  being divisible by the generators of  $\bigwedge^s \text{Sed}(e^q) \otimes R$ , where  $s$  denotes the dimension of  $\text{Sed}(e^q)$ . The inverse of the isomorphism  $\psi_p^R(e^q)$  is given by the following formula:

$$[\mathfrak{t}(\mathbb{Z})] \otimes v \in \bigwedge^n \mathfrak{t}(\mathbb{Z}) \otimes \left( \left( \bigwedge^s \text{Sed}(e^q) \wedge \bigwedge^{p-s} \mathfrak{t}(\mathbb{Z}) \right) \otimes R \right) \mapsto \sum_{e^n \geq e^q} v \otimes [\mathfrak{t}(\mathbb{Z})]_{e^n}. \quad (3.3)$$

The morphism  $j_p(e^q)$  is injective because  $K$  has dimension  $n$ . Since it is induced in homology by the injective morphism  $i_p$  the associated long exact sequence in homology ensures that  $j_p$  is injective. The groups  $\hat{F}_p^X(e^q; e^n)$  are all equal. Their common value is the kernel of the contraction  $\omega \cdot - : \bigwedge^p \mathfrak{t}(R) \rightarrow \bigwedge^{p-q} \mathfrak{t}(R)$ , where  $\omega$  is a generator of  $\bigwedge^q T e^q(R)$ , c.f. Definition 3.1.7. Combining this fact with the formula (3.3) we find the desired description of the image of  $\psi_p^R(e^q) \circ j_p(e^q)$ .  $\square$

**Theorem 3.2.14.** *Let  $R$  be a ring in which  $\delta(P)$  is invertible. The homological morphisms:*

$$\hat{i}_{p,q}: \hat{H}_{p,q}(X; R) \rightarrow H_{p,q}(P; R),$$

*induced by the inclusions  $\hat{i}_p: \hat{F}_p^X \rightarrow F_p^P$  are:*

- isomorphisms, for all  $p + q < n - 1$  ;
- surjective morphisms, for all  $p + q = n - 1$ .

*Proof.* In the light of Theorem 2.5.3, Proposition 3.2.8, and Proposition 3.2.10 we can write:

$$\begin{cases} H_{p,q}(P; R) \cong H_c^{n-q}(K; H_n((F_p^P \otimes R)_*)) \\ \hat{H}_{p,q}(X; R) \cong H_c^{n-q}(K; H_n((\hat{F}_p^X \otimes R)_*)) \end{cases}.$$

Since  $K$  is finite ( $P$  being compact), cohomology with compact support is the same as cohomology. Let us denote by  $G_p^P$  (resp.  $G_p^X$ ), the sheaf  $H_n((F_p^P \otimes R)_*)$  (resp.  $H_n((\hat{F}_p^X \otimes R)_*)$ ). The cosheaf inclusion  $\hat{i}_p: \hat{F}_p^X \rightarrow F_p^P$  induces a morphism of sheaves  $j_p: G_p^X \rightarrow G_p^P$ . Since  $K$  has dimension  $n$ , the long exact sequence in homology associated with:

$$0 \rightarrow \hat{F}_p^X \otimes R \xrightarrow{\hat{i}_p} F_p^P \otimes R \rightarrow \text{coker}(\hat{i}_p) \rightarrow 0,$$

implies that  $j_p$  is also injective. We have the following commutative square relating the homological and cohomological counterparts of  $\hat{i}_p$  and  $j_p$ :

$$\begin{array}{ccc} H_q(K; \hat{F}_p^X \otimes R) & \xrightarrow{\hat{i}_p} & H_q(K; F_p^P \otimes R) \\ \cong \uparrow & & \uparrow \cong \\ H^{n-q}(K; G_p^X) & \xrightarrow{j_p} & H^{n-q}(K; G_p^P) \end{array}$$

The vertical isomorphisms are induced by the quasi-isomorphisms given by the second part of Theorem 2.5.3. The commutativity is already satisfied on the level of chain and cochain complexes:

$$\begin{array}{ccc} \Omega_q(K; \hat{F}_p^X \otimes R) & \xrightarrow{\hat{i}_p} & \Omega_q(K; F_p^P \otimes R) \\ \text{q.i.} \uparrow & & \uparrow \text{q.i.} \\ \Omega_{n-q,n}(K; \hat{F}_p^X \otimes R) \cap \ker(\partial_2) & \xrightarrow[\hat{i}_p]{\text{rest.}} & \Omega_{n-q,n}(K; F_p^P \otimes R) \cap \ker(\partial_2) \\ \parallel & & \parallel \\ E_{n-q,n}^1 & & E_{n-q,n}^1 \\ \Phi \uparrow & & \uparrow \Phi \\ C^{n-q}(K; G_p^X) & \xrightarrow{j_p} & C^{n-q}(K; G_p^P) \end{array}$$

The two vertical isomorphisms in the previous diagram are the homological and cohomological counterparts of compositions of the isomorphism  $\Phi$  and the quasi-isomorphic inclusions of Proposition 2.5.1. Let  $F$  denotes either  $\hat{F}_p^X \otimes R$  or  $F_p^P \otimes R$  and  $G$  respectively designating  $G_p^X$  or  $G_p^P$ . We have:

$$\begin{aligned} \Omega_{n-q,n}(K; F) &= \bigoplus_{e^{n-q} \leq e^n} F(e^{n-q}; e^n) \otimes \mathbb{Z}(e^{n-q}; e^n), \\ \text{and } : \Omega_{n-q,n-1}(K; F) &= \bigoplus_{e^{n-q} \leq e^{n-1}} F(e^{n-q}; e^n) \otimes \mathbb{Z}(e^{n-q}; e^{n-1}). \end{aligned}$$

In this description, both these groups have a splitting indexed by the  $(n-q)$ -cells of  $K$ . Both the morphisms  $\hat{i}_p$  and  $\partial_2$  respect these splittings which explains the commutativity of the upper square of the last diagram. Also in that setting, the value  $\text{Hom}(\mathbb{Z}(e^{n-q}); G(e^{n-q}))$ , on some cell  $e^{n-q}$ , is, modulo the action of the

isomorphism  $\Phi$ , the kernel of  $\partial_2$  restricted to the  $(e^{n-q})$ -component of  $\Omega_{n-q,n}(K; F)$ . By construction,  $j_p$  is the restriction of  $i_p$  to the  $(e^{n-q})$ -component of the kernel of  $\partial_2$ , so the bottom square also commutes.

Because of Lemma 3.2.13, the morphism  $j_p(e^r): G_p^X(e^r) \rightarrow G_p^P(e^r)$  is an isomorphism for all  $r$ -cells  $e^r$  whenever  $r > p$ . This implies that the cokernel of  $j_p$  is trivial in dimension greater than  $p$ . By means of the long exact sequence induced in cohomology by the injective morphism  $j_p$ , we find that  $j_p^r: H^r(K; G_p^X) \rightarrow H^r(K; G_p^P)$  is surjective for  $r = p + 1$  and invertible for all  $r > p + 1$ . Theorem 3.2.14 follows after performing the change of variables  $r = n - q$ .  $\square$

The hypothesis on the coefficients or the choice of the cosheaves cannot be dropped in Theorem 3.2.14. The following two examples show where Theorem 3.2.14 fails for  $R = \mathbb{Z}$  when  $\delta(P) \neq 1$  or when we use  $(F_p^X)_{p \geq 0}$  instead of  $(\hat{F}_p^X)_{p \geq 0}$ .

**Examples 3.2.15.** 1. Let the triangle  $T$  be the convex hull of  $0$ ,  $dx$ , and  $2dy$  in  $\text{Hom}_{\mathbb{R}}(\mathbb{R}^2; \mathbb{R})$  endowed with the canonical lattice  $\mathbb{Z}dx + \mathbb{Z}dy$ , c.f. Figure 3.5a. We consider the unique primitive triangulation  $K$  of  $T$ , depicted in Figure 3.5a. We have  $\delta(P) = 2$  and  $\theta(K) = 1$  and the groups  $H_{p,q}(P; \mathbb{Z})$  and  $\hat{H}_{p,q}(X; \mathbb{Z})$  are given, along with some of the homological morphisms induced by inclusion, in the Figure 3.5c. In this example, the morphism  $\hat{i}_{0,1}: H_{0,1}(X; \mathbb{Z}) \rightarrow H_{0,1}(P; \mathbb{Z})$  is not surjective.

2. We consider the cube with edges of length 2 in  $\text{Hom}_{\mathbb{R}}(\mathbb{R}^3; \mathbb{R})$ , endowed with its canonical lattice  $\mathbb{Z}dx + \mathbb{Z}dy + \mathbb{Z}dz$ , and subdivided by  $K$  as in Figure 3.6a. Its associated tropical surface is singular. We have  $\delta(P) = 1$  and  $\theta(K) = 2$ . Here the map  $i_{1,1}: H_{1,1}(X; \mathbb{Z}) \rightarrow H_{1,1}(P; \mathbb{Z})$  is not surjective. Its image is  $\mathbb{Z}(e_1 + e_2) + \mathbb{Z}(e_1 - e_2) + \mathbb{Z}e_3$  where  $e_1, e_2, e_3$  is the standard basis of  $H_1(K; F_1^P)$  given by the three independent copies of  $\mathbb{P}^1$  in  $\mathbb{P}^1 \times \mathbb{P}^1 \times \mathbb{P}^1$ , the toric variety associated with the cube.

We would like to conclude this section with few remarks on the numbers  $\delta(P)$  and  $\theta(K)$ . From its definition the number  $\delta(P)$  equals 1 if and only if the toric variety associated with  $P$  is smooth. Therefore, assuming  $\delta(P) = 1$  puts us closer to the tropical Lefschetz hyperplane section theorem<sup>16</sup> of C. Arnal, A. Renaudineau and K. Shaw. However, assuming  $\delta(P) = \theta(K) = 1$  does not implies that  $X$  is smooth, i.e. that  $K$  is a primitive triangulation. Therefore, assuming both  $\delta(P)$  and  $\theta(K)$  to be 1 generalises their theorem for the cosheaves  $(F_p^X)_{p \geq 0}$ . For a general polytope  $Q$ , the number  $\theta(Q)$  seems difficult to compute. However, it seems computable for simplices. For segments it is 1. For a triangle  $T$ , a direct computation yields:

$$\theta(T) = \frac{2 \cdot \text{vol}_{\mathbb{Z}}(T) \cdot \text{GCD}\{\text{vol}_{\mathbb{Z}}(E) : E \text{ edge of } T\}}{\prod_{E \leq T} \text{vol}_{\mathbb{Z}}(E)},$$

---

<sup>16</sup>c.f. [ARS21], Theorem 1.2 p.1349.

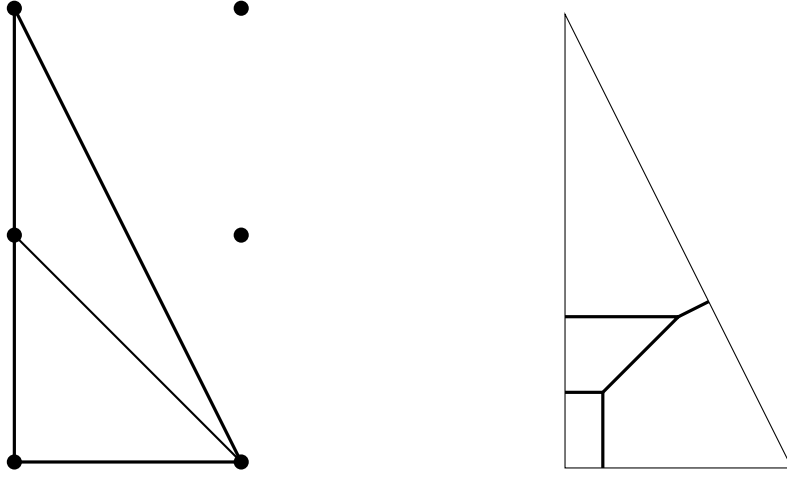

(a) The triangle  $T$  associated with the weighted projective space  $\mathbb{P}(1, 1, 2)$  and its subdivision  $K$  into two unimodular triangles.

(b) A tropical curve whose dual subdivision is  $K$ .

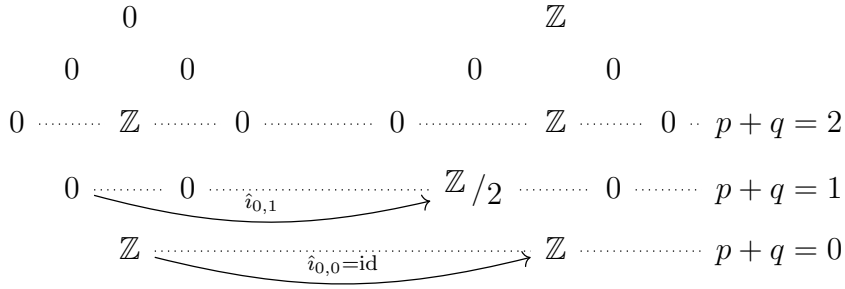

(c) The saturated Hodge diamond of the curve on the left and the Hodge diamond of  $\mathbb{P}(1, 1, 2)$  on the right. The parameter  $p$  increases in the north-east direction ( $\nearrow$ ) and  $q$  in the north-west direction ( $\nwarrow$ ).

Figure 3.5: A curve in the weighted projective plane  $\mathbb{P}(1, 1, 2)$  whose integral tropical homology does not satisfy the tropical version of the Lefschetz hyperplane section theorem.

where  $\text{vol}_{\mathbb{Z}}(Q)$  is the integral volume of  $Q$ , i.e. its Lebesgue measure in the affine sub-space it spans normalised so that a parallelogram on a basis of the induced lattice has measure 1.

Finally, we want to acknowledge that even if the Lefschetz hyperplane section theorem with rational coefficients is a consequence of the Hard Lefschetz theorem with rational coefficients it is usually not the case when one considers coefficient rings of positive characteristic. For instance a product of at least three copies of  $\mathbb{P}^1$  does not have any cohomology class over  $\mathbb{F}_2$ , the field with two elements, satisfying the Hard Lefschetz property. However the Lefschetz hyperplane theorem with coefficients in  $\mathbb{F}_2$  remains valid for any non-singular hypersurface of this product.





For all integers  $p \geq 0$ , we denote by  $C^p(K; \omega_R^*)$  the product:

$$C^p(K; \omega_R^*) := \prod_{e^p \in K} \text{Hom}(\mathbb{Z}(e^p); \omega_R^*(e^p)).$$

There is a natural projection of  $C^p(K; \bigwedge^n \mathfrak{t}(\mathbb{Z}) \otimes_{\mathbb{Z}} \bigwedge^p \mathfrak{t}(R))$  onto  $C^p(K; \omega_R^*)$ . It is the product of the projections  $\text{Hom}(\mathbb{Z}(e^p); \bigwedge^n \mathfrak{t}(\mathbb{Z}) \otimes_{\mathbb{Z}} \bigwedge^p \mathfrak{t}(R)) \rightarrow \text{Hom}(\mathbb{Z}(e^p); \omega_R^*(e^p))$  for all cells  $e^p$ . We denote by  $C^p(K; \partial K; \omega_R^*)$  the subgroup of  $C^p(K; \omega_R^*)$  made of the elements whose value is zero on the boundary of  $K$ . Since  $\bigwedge^n \mathfrak{t}(\mathbb{Z})$  is free of rank 1, if one chooses a generator  $[\mathfrak{t}(\mathbb{Z})]$  of  $\bigwedge^n \mathfrak{t}(\mathbb{Z})$ , then for all cochains  $\alpha$  in  $C^p(K; \partial K; \bigwedge^n \mathfrak{t}(\mathbb{Z}) \otimes_{\mathbb{Z}} \bigwedge^p \mathfrak{t}(R))$  there is a unique cochain  $\langle [\mathfrak{t}(\mathbb{Z})]; \alpha \rangle$  in the group  $C^p(K; \partial K; \bigwedge^p \mathfrak{t}(R))$  satisfying the relation  $\alpha[e^p] = [\mathfrak{t}(\mathbb{Z})] \otimes \langle [\mathfrak{t}(\mathbb{Z})]; \alpha \rangle[e^p]$  for all oriented cell  $[e^p]$ .

**Proposition 3.3.2.** *Let  $0 \leq p \leq n - 1$  be an integer and  $[\mathfrak{t}(\mathbb{Z})]$  be a generator of  $\bigwedge^n \mathfrak{t}(\mathbb{Z})$ , i.e. an orientation of  $\mathfrak{t}(\mathbb{Z})$ . For all  $n$ -cells  $e^n \in K$ , we denote by  $[\mathfrak{t}(\mathbb{Z})]_{e^n} \in \mathbb{Z}(e^n)$  the orientation of  $e^n$  induced by  $[\mathfrak{t}(\mathbb{Z})]$ , c.f. Definition 3.2.12. We have a well defined morphism:*

$$\begin{aligned} \bar{g}^p : C^p(K; \partial K; \bigwedge^n \mathfrak{t}(\mathbb{Z}) \otimes_{\mathbb{Z}} \bigwedge^p \mathfrak{t}(R)) &\longrightarrow \hat{H}_{p, n-1-p}(X; R) \\ \alpha &\longmapsto \left[ \sum_{e^{p+1} \leq e^n} (d\langle [\mathfrak{t}(\mathbb{Z})]; \alpha \rangle[e^{p+1}]) \otimes [e^{p+1}; e^n] \right], \end{aligned}$$

where the orientations  $[e^{p+1}]$  and  $[e^{p+1}; e^n]$  satisfy  $[e^{p+1}][e^{p+1}; e^n] = [\mathfrak{t}(\mathbb{Z})]_{e^n}$ . Moreover, it factors through the natural projection:

$$C^p \left( K; \partial K; \bigwedge^n \mathfrak{t}(\mathbb{Z}) \otimes_{\mathbb{Z}} \bigwedge^p \mathfrak{t}(R) \right) \rightarrow C^p(K; \partial K; \omega_R^*),$$

of Definition 3.3.1 into the morphism  $g^p : C^p(K; \partial K; \omega_R^*) \rightarrow \hat{H}_{p, n-1-p}(X; R)$ .

*Proof.* Let  $\alpha \in C^p(K; \partial K; \bigwedge^n \mathfrak{t}(\mathbb{Z}) \otimes_{\mathbb{Z}} \bigwedge^p \mathfrak{t}(R))$  and  $c$  denote the dihomologic chain:

$$c := \sum_{e^{p+1} \leq e^n} (d\langle [\mathfrak{t}(\mathbb{Z})]; \alpha \rangle[e^{p+1}]) \otimes [e^{p+1}; e^n],$$

where the orientations  $[e^{p+1}]$  and  $[e^{p+1}; e^n]$  satisfy  $[e^{p+1}][e^{p+1}; e^n] = [\mathfrak{t}(\mathbb{Z})]_{e^n}$ . We note that  $c$  does not depend on the choice of orientation  $[\mathfrak{t}(\mathbb{Z})]$ . Indeed,  $\langle -[\mathfrak{t}(\mathbb{Z})]; \alpha \rangle$  equals  $-\langle [\mathfrak{t}(\mathbb{Z})]; \alpha \rangle$  and  $(-[e^{p+1}])[e^{p+1}; e^n] = -[e^{p+1}; e^n]$ . The chain  $c$  belongs to the module  $\Omega_{p+1, n}(K; \hat{F}_p^X \otimes R)$  since  $\hat{F}_p^X(e^{p+1}; e^n) \otimes R$  equals  $\bigwedge^p \mathfrak{t}(R)$  for all pairs of cells  $e^p \leq e^n$ . We need to show that  $c$  is a cycle. Its boundary  $\partial c$  vanishes if and only if both  $\partial_1 c$  and  $\partial_2 c$  vanish because of its pure type  $(p+1; n)$ . Let  $[e^{p+2}; e^n]$  be an oriented dihomologic cell, we have:

$$\langle \partial_1 c; [e^{p+2}; e^n] \rangle = \sum_{e^{p+1} \leq e^{p+2}} (d\langle [\mathfrak{t}(\mathbb{Z})]; \alpha \rangle[e^{p+1}]) \Big|_{e^{p+2}, e^n}^{e^{p+1}, e^n},$$

where the orientations  $[e^{p+1}]$  satisfy  $[e^{p+1}][e^{p+1}; e^{p+2}][e^{p+2}; e^n] = [\mathbf{t}(\mathbb{Z})]_{e^n}$ . Therefore, if the orientation  $[e^{p+2}]$  satisfies  $[e^{p+2}][e^{p+2}; e^n] = [\mathbf{t}(\mathbb{Z})]_{e^n}$ , we have:

$$\langle \partial_1 c; [e^{p+2}; e^n] \rangle = \text{dd} \langle [\mathbf{t}(\mathbb{Z})]; \alpha \rangle [e^{p+2}] = 0.$$

Let  $[e^{p+1}; e^{n-1}]$  be an oriented dihomologic cell, we have:

$$\langle \partial_2 c; [e^{p+1}; e^{n-1}] \rangle = \sum_{e^{n-1} \leq e^n} \langle c; [e^{p+1}; e^n] \rangle \Big|_{e^{p+1}, e^{n-1}}^{e^{p+1}, e^n},$$

where the orientations  $[e^{p+1}; e^n]$  satisfy  $[e^{p+1}; e^n] = [e^{p+1}; e^{n-1}][e^{n-1}; e^n]$ . If  $e^{n-1}$  belongs to  $\partial K$  it has only one adjacent  $n$ -cell  $e^n$ . By construction  $\langle c; [e^{p+1}; e^n] \rangle$  is null. If on the contrary  $e^{n-1} \notin \partial K$  then it has two adjacent  $n$ -cells  $e_+^n$  and  $e_-^n$ . If we write  $[e^{p+1}]_{\pm}$  for the unique orientation satisfying  $[e^{p+1}]_{\pm}[e^{p+1}; e^{n-1}][e^{n-1}; e_{\pm}^n] = [\mathbf{t}(\mathbb{Z})]_{e_{\pm}^n}$ , then  $[e^{p+1}]_+$  and  $[e^{p+1}]_-$  are opposite of each other. Indeed the solutions  $[e^{n-1}]_{\pm}$  of  $[e^{n-1}]_{\pm}[e^{n-1}; e_{\pm}^n] = [\mathbf{t}(\mathbb{Z})]_{e_{\pm}^n}$  are opposite of each other since  $[\mathbf{t}(\mathbb{Z})]$  is a global orientation. As a consequence:

$$\langle \partial_2 c; [e^{p+1}; e^{n-1}] \rangle = \text{d} \langle [\mathbf{t}(\mathbb{Z})]; \alpha \rangle ([e^{p+1}]_+) + \text{d} \langle [\mathbf{t}(\mathbb{Z})]; \alpha \rangle ([e^{p+1}]_-) = 0.$$

To prove the last part of the proposition we further assume that  $\alpha$  projects to zero in  $C^p(K; \partial K; \omega_R^*)$ . It implies that for all pairs of cells  $e^p \leq e^n$  and all orientations  $[e^p]$  of  $e^p$ , the  $p$ -vector  $\langle [\mathbf{t}(\mathbb{Z})]; \alpha \rangle [e^p]$  belongs to  $\hat{F}_p^X(e^p; e^n)$ . As a consequence, the formula:

$$b := \sum_{e^{p+1} \leq e^n} (\langle [\mathbf{t}(\mathbb{Z})]; \alpha \rangle [e^p]) \otimes [e^{p+1}; e^n],$$

where the orientations  $[e^p]$  and  $[e^p; e^n]$  satisfy  $[e^p][e^p; e^n] = [\mathbf{t}(\mathbb{Z})]_{e^n}$ , defines an element of  $\Omega_{p,n}(K; \hat{F}_p^X)$ . One can check by direct computation that  $\partial b = c$ .  $\square$

**Lemma 3.3.3.** *Let  $0 \leq p \leq n - 1$  be an integer. We have the exact sequence of  $R$ -modules:*

$$C^p(K; \partial K; \omega_R^*) \xrightarrow{g^p} \hat{H}_{p,n-1-p}(X; R) \xrightarrow{\hat{i}_{p,n-1-p}} H_{p,n-1-p}(P; R) \longrightarrow 0.$$

*Proof.* We have the short exact sequence of cellular sheaves:

$$0 \longrightarrow H_n((\hat{F}_p^X \otimes R)_*) \xrightarrow{j_p} H_n((F_p^P \otimes R)_*) \xrightarrow{\pi_p} \text{coker}(j_p) \longrightarrow 0. \quad (3.4)$$

From Lemma 3.2.13 we know that  $\text{coker}(j_p)$  vanishes on all the cells of dimension greater than  $p$ . Since  $H_n((\hat{F}_p^X \otimes R)_*)$  and  $H_n((F_p^P \otimes R)_*)$  respectively compute the tropical homology of  $X$  and  $P$ , we find the following the exact sequence, extracted from the long exact sequence associated with (3.4):

$$H^p(K; \text{coker}(j_p)) \xrightarrow{\text{d}} \hat{H}_{p,n-1-p}(X; R) \xrightarrow{\hat{i}_{p,n-1-p}} H_{p,n-1-p}(P; R) \longrightarrow 0.$$

Let  $e^p$  be a cell of  $K$ . We have the following alternative: either  $e^p$  belongs to the boundary  $\partial K$  and  $\text{coker}(j_p)(e^p)$  is trivial or  $\text{coker}(j_p)(e^p)$  equals  $\omega_R^*(e^p)$ . From Lemma 3.2.13,  $H_n((F_p^P \otimes R)_*)(e^p)$  equals  $\bigwedge^n \mathfrak{t}(\mathbb{Z}) \otimes (\bigwedge^s \text{Sed}(e^p) \wedge \bigwedge^{p-s} \mathfrak{t}(\mathbb{Z})) \otimes R$ , and we have the exact sequence:

$$0 \rightarrow H_n((\hat{F}_p^X \otimes R)_{e^p}) \xrightarrow{j_p} \bigwedge^n \mathfrak{t}(\mathbb{Z}) \otimes \left( \bigwedge^s \text{Sed}(e^p) \wedge \bigwedge^{p-s} \mathfrak{t}(\mathbb{Z}) \right) \otimes R \xrightarrow{1 \otimes \omega} \bigwedge^n \mathfrak{t}(\mathbb{Z}) \otimes R,$$

where  $\omega$  is a generator of  $\bigwedge^p T e^p(R)$  and  $s$  is the rank of  $\text{Sed}(e^p)$ . So if  $s$  is positive, i.e.  $e^p$  belongs to  $\partial K$ , the restriction of  $\omega$  to  $(\bigwedge^s \text{Sed}(e^p) \wedge \bigwedge^{p-s} \mathfrak{t}(\mathbb{Z})) \otimes R$  vanishes and so does  $\text{coker}(j_p)(e^p)$ . If on the contrary  $s = 0$ , we find that  $\text{coker}(j_p)(e^p)$  equals  $\omega_R^*(e^p)$ . Since  $\text{coker}(j_p)$  vanishes on all cells of dimension greater than  $p$ , The cycle group  $Z^p(K; \text{coker}(j_p))$  equals  $C^p(K; \text{coker}(j_p))$  and therefore  $C^p(K; \partial K; \omega_R^*)$ . By composing the projection  $Z^p(K; \text{coker}(j_p)) \rightarrow H^p(K; \text{coker}(j_p))$  with the connecting morphism  $d$  we find the following exact sequence:

$$C^p(K; \partial K; \omega_R^*) \xrightarrow{g} \hat{H}_{p,n-1-p}(X; R) \xrightarrow{i_{p,n-1-p}} H_{p,n-1-p}(P; R) \longrightarrow 0.$$

Now we need to check that  $g$  equals  $g^p$ . Let  $\Phi$  denote the injective quasi-isomorphism of Theorem 2.5.3. We have the commutative diagram:

$$\begin{array}{ccc} C^p(K; \partial K; \omega_R^*) & \xrightarrow{d} & Z^{p+1}\left(K; H_n((\hat{F}_p^X \otimes R))\right) \\ g \downarrow & & \downarrow \Phi \\ \hat{H}_{p,n-1-p}(X; R) & \longleftarrow & Z_{n-1-p}\Omega(K; \hat{F}_p^X \otimes R) \end{array}$$

Using the description of  $\Phi$  we find that  $g$  and  $g^p$  are the same morphism.  $\square$

# Chapter 4

## T-Hypersurfaces

In this chapter we introduce T-hypersurfaces, in non-singular polytopes. We will only consider primitive triangulations  $K$  of non-singular polytope  $P$ . The T-hypersurface  $\mathbb{R}X_\varepsilon$  can be seen as a PL-smooth<sup>1</sup> lift by the moment map of the dual hypersurface  $X$  in the real locus of the toric variety associated with  $P$ . We will be interested in their cohomology with coefficients in  $\mathbb{F}_2$ , in particular, the version of I.O. Kalinin's spectral sequence<sup>2</sup> of A. Renaudineau and K. Shaw. Since we will only consider tropical homology with coefficient in  $\mathbb{F}_2$  we shall denote by  $\text{Sed}$ ,  $F_p^P$ ,  $F_p^X$ ,  $F_P^p$ , and  $F_X^p$  the tropical sheaves and cosheaves  $\text{Sed} \otimes \mathbb{F}_2$ ,  $F_p^P \otimes \mathbb{F}_2$ ,  $F_p^X \otimes \mathbb{F}_2$ ,  $F_P^p \otimes \mathbb{F}_2$ , and  $F_X^p \otimes \mathbb{F}_2$ . Since  $K$  is a primitive triangulation, we note that, in regard of Proposition 3.1.14,  $F_X^p$  and  $\hat{F}_X^p$  coincide and  $i^p : F_P^p \rightarrow F_X^p$  is surjective. We will tackle the following conjecture:

**Conjecture 1** (A. Renaudineau and K. Shaw, Conjecture 1.10, [RS23]). The spectral sequence  $(E_{p,q}^r(\mathbb{R}X_\varepsilon))_{p,q,r \in \mathbb{N}}$  degenerates at the second page.

To do so will establish a link between the degeneracy of the spectral sequence and the rank of  $\mathbb{R}X_\varepsilon$ :

**Definition 4.0.1.** The rank of  $\mathbb{R}X_\varepsilon$  is the following number:

$$\ell(\mathbb{R}X_\varepsilon) := \max\{q_0 \geq 0 \mid i^q : H^q(\mathbb{R}P; \mathbb{F}_2) \rightarrow H^q(\mathbb{R}X_\varepsilon; \mathbb{F}_2) \text{ is injective for all } q \leq q_0\}.$$

The quantity  $\ell$  was previously introduced for subsets of real projective spaces by I.O. Kalinin. “[It] is involved in many restrictions on topology of real algebraic hypersurfaces of a given degree”<sup>3</sup>. It was studied by I.O. Kalinin<sup>4</sup>, V. Nikulin<sup>5</sup>, or V. Kharlamov<sup>6</sup> for real projective hypersurfaces. Let  $V$  be a real algebraic hypersurface of the projective space  $\mathbb{P}^n$  then  $\ell(V(\mathbb{R})) = n - 1$  when  $V$  has odd degree and  $\ell(V(\mathbb{R})) \leq \lfloor \frac{n}{2} \rfloor$  if  $V$  has even degree<sup>7</sup>. The same holds for  $\ell(\mathbb{R}X_\varepsilon)$  even when the

<sup>1</sup>c.f. [BLdMR22] Proposition 4.11 p.26.

<sup>2</sup>c.f. [Kal91] or [Kal05]

<sup>3</sup>O. Viro, [Vir] p.5.

<sup>4</sup>c.f. [Kal91] and [Kal05].

<sup>5</sup>c.f. [Nik80].

<sup>6</sup>c.f. [Kha75].

<sup>7</sup>c.f. [Kha75] Remarks on the Homomorphisms  $j_*$  p.136.

triangulation  $K$  is non-convex. As a consequence we will show that the spectral sequences  $(E_{p,q}^r(\mathbb{R}X_\varepsilon))_{p,q,r \geq 0}$  and  $(E_r^{p,q}(\mathbb{R}X_\varepsilon))_{p,q,r \geq 0}$  both degenerate at the second page when  $P$  is a non-singular simplex of odd size. We will generalise this property to a broader variety of polytopes.

## 4.1 Construction of T-Hypersurfaces

**Notations.** Let  $P$  be a smooth, full dimensional, integral polytope of the  $n$ -dimensional vector space  $\mathfrak{t}^*(\mathbb{R})$  endowed with the lattice  $\mathfrak{t}^*(\mathbb{Z})$ , and  $K$  be a primitive triangulation of  $P$  with dual hypersurface  $X$ .

**Definition 4.1.1.** We denote by  $\mathbb{R}P$  the topological space obtained as the quotient of  $\mathfrak{t}(\mathbb{F}_2) \times P$  by the equivalence relation:

$$(v; x) \sim (v'; x') \text{ if and only if } x = x' \text{ and } v - v' \in \text{Sed}(x),$$

where  $\text{Sed}(x)$  denotes the space  $\{v \in \mathfrak{t}(\mathbb{Z}) \mid \alpha(v) = 0, \forall \alpha \in TQ\} \otimes \mathbb{F}_2$ ,  $Q$  being the only face of  $P$  containing  $x$  in its relative interior. This space is obtained by gluing together  $2^n$  copies of  $P$  and is naturally a regular CW-complex. Using the moment map, this space is homeomorphic to  $Y_P(\mathbb{R})$  the real locus of the toric variety associated with  $P$ . Therefore  $\mathbb{R}P$  can be thought as a CW-structure on  $Y_P(\mathbb{R})$ . We denote by  $|\cdot| : \mathbb{R}P \rightarrow P$  the projection onto  $P$ . It corresponds to the moment map. We denote by  $\mathbb{R}K$  the lift of  $K$  to a subdivision of  $\mathbb{R}P$ . It might not be a triangulation, however it is always a  $\Delta$ -complex. To distinguish the cells of  $K$  from those of  $\mathbb{R}K$  we will denote the former by the symbols  $\sigma^p$  and the latter by the symbols  $\sigma_{\mathbb{R}}^p$ . With this definition the projection  $|\cdot| : \mathbb{R}P \rightarrow P$  is automatically a cellular map and for any simplex  $\sigma^p \in K$ , the set of  $p$ -simplices of  $\mathbb{R}K$  above  $\sigma^p$  is canonically in bijection with the vector space:

$$\mathfrak{t}(\mathbb{F}_2) / \text{Sed}(\sigma^p).$$

Thus we define the argument of a simplex  $\sigma_{\mathbb{R}}^p \in \mathbb{R}K$ , denoted by  $\arg(\sigma_{\mathbb{R}}^p)$ , to be the element of  $\mathfrak{t}(\mathbb{F}_2) / \text{Sed}(\sigma^p)$  to which  $\sigma_{\mathbb{R}}^p$  corresponds. A dihomologic cube of  $\mathbb{R}K$  is indexed by a pair of simplices  $\sigma_{\mathbb{R}}^p \leq \sigma_{\mathbb{R}}^q$  and is projected by  $|\cdot|$  on the cube of  $K$  indexed by  $|\sigma_{\mathbb{R}}^p| \leq |\sigma_{\mathbb{R}}^q|$ . Reciprocally, if  $\sigma^p \leq \sigma^q$  is a pair of simplices of  $K$  its set of lifting cubes is in bijection with the vector space:

$$\mathfrak{t}(\mathbb{F}_2) / \text{Sed}(\sigma^p; \sigma^q).$$

If the cube  $\sigma_{\mathbb{R}}^p \leq \sigma_{\mathbb{R}}^q$  lifts the cube  $\sigma^p \leq \sigma^q$  we define  $\arg(\sigma_{\mathbb{R}}^p; \sigma_{\mathbb{R}}^q)$  as the element of  $\mathfrak{t}(\mathbb{F}_2) / \text{Sed}(\sigma^p; \sigma^q)$  to which it corresponds. One can show that  $\arg(\sigma_{\mathbb{R}}^p; \sigma_{\mathbb{R}}^q)$  equals  $\arg(\sigma_{\mathbb{R}}^q)$ .

**Definition 4.1.2.** (Rule of Signs Cocycle) The cellular complex  $\mathbb{R}K$  possesses a canonical 1-cocycle  $\omega_{\mathbb{R}K} \in Z^1(\mathbb{R}K; \mathbb{F}_2)$  given, for all edges  $\sigma_{\mathbb{R}}^1$ , by the following for-

mula:

$$\omega_{\mathbb{R}X}(\sigma_{\mathbb{R}}^1) := \omega(|\sigma_{\mathbb{R}}^1|)(\arg(\sigma_{\mathbb{R}}^1)).$$

The projection map  $|\cdot| : \mathbb{R}P \rightarrow P$  being cellular, it induces both a morphism chain complexes and a morphism cochain complexes respectively denoted by  $|\cdot| : (C_p(\mathbb{R}K; \mathbb{F}_2) \rightarrow C_p(K; \mathbb{F}_2))_{p \geq 0}$  and by  $|\cdot|^* : (C^p(K; \mathbb{F}_2) \rightarrow C^p(\mathbb{R}K; \mathbb{F}_2))_{p \geq 0}$  for all primitive triangulations  $K$  of  $P$ .

**Definition 4.1.3** (T-Hypersurface). Let  $\varepsilon \in C^0(K; \mathbb{F}_2)$ . We may call such cochain a *sign distribution* on  $K$ . We denote by  $\mathbb{R}X_\varepsilon$  the subcomplex of the cubical subdivision of  $\mathbb{R}K$  dual to the 1-cocycle  $d|\varepsilon|^* + \omega_{\mathbb{R}X}$ . That is to say,  $\mathbb{R}X_\varepsilon$  is the union of the closed cubes of  $\mathbb{R}K$  indexed by the pairs of simplices  $\sigma_{\mathbb{R}}^1 \leq \sigma_{\mathbb{R}}^n$  for which  $d\varepsilon(|\sigma_{\mathbb{R}}^1|) + \omega_{\mathbb{R}X}(\sigma_{\mathbb{R}}^1) = 1$ . We say that  $\mathbb{R}X_\varepsilon$  is the *T-hypersurface* constructed from the sign distribution  $\varepsilon$ . See Figure 4.1 for an example. We may say that the cohomology class  $[\omega_{\mathbb{R}X}] \in H^1(\mathbb{R}P; \mathbb{F}_2)$  is the *degree* of  $\mathbb{R}X_\varepsilon$ .

**Remark 4.1.4.** Following the terminology of O. Viro, we may call the hypersurface  $\mathbb{R}X_\varepsilon$  a primitive *patchwork* when the primitive triangulation  $K$  is convex.

**Proposition 4.1.5.**  $\mathbb{R}X_\varepsilon$  is a sub-manifold of  $\mathbb{R}P$  of codimension 1 that is Poincaré dual to the class  $[\omega_{\mathbb{R}X}] \in H^1(\mathbb{R}P; \mathbb{F}_2)$ .

*Proof.* The first part of the statement is Proposition 4.11 p.26 of [BLdMR22]. The second part is a consequence of both the definition of  $\mathbb{R}X_\varepsilon$  and of the Poincaré duality. See Theorem 67.1 p.394 of [Mun84] for instance.  $\square$

**Example 4.1.6.** In Figure 4.1 we give an example of T-curve in the compact torus  $\mathbb{P}^1(\mathbb{R}) \times \mathbb{P}^1(\mathbb{R})$  from a triangulation of the square of size 3. It is made of two connected components: one contractible, and one non-contractible whose homology class is  $(1; 1)$  in the canonical basis  $([\mathbb{P}^1(\mathbb{R}) \times \{0\}], [\{0\} \times \mathbb{P}^1(\mathbb{R})])$ .

The image of  $\mathbb{R}X_\varepsilon$  under the projection  $|\cdot| : \mathbb{R}P \rightarrow P$  does not depend on  $\varepsilon$ . It is always the dual hypersurface  $X$ . Consider a cube of  $K$  indexed by  $\sigma^p \leq \sigma^q$ . We denote by  $\text{Arg}_\varepsilon(\sigma^p; \sigma^q)$  the set of arguments  $\arg(\sigma_{\mathbb{R}}^p; \sigma_{\mathbb{R}}^q) \in \mathfrak{t}(\mathbb{F}_2) / \text{Sed}(\sigma^q; \sigma^q)$  of the lifts  $\sigma_{\mathbb{R}}^p \leq \sigma_{\mathbb{R}}^q$  of  $\sigma^p \leq \sigma^q$  belonging to  $\mathbb{R}X_\varepsilon$ . This is a cubical cosheaf of sets.

**Lemma 4.1.7.** For all pairs  $\sigma^p \leq \sigma^q$  of simplices of  $K$  the set  $\text{Arg}_\varepsilon(\sigma^p; \sigma^q)$  is the complementary sub-set in  $V = \mathfrak{t}(\mathbb{F}_2) / \text{Sed}(\sigma^q; \sigma^q)$  of an affine sub-space parallel to  $\{v \in V \mid \alpha(v) = 0, \forall \alpha \in T\sigma^p(\mathbb{F}_2)\}$ , so in particular of codimension  $p$ .

*Proof.* The set  $\text{Arg}_\varepsilon(\sigma^p; \sigma^q)$  is the set of the vectors  $v \in V$  for which there exists  $\sigma^1 \subset \sigma^p$  such that:

$$d\varepsilon(\sigma^1) + \omega(\sigma^1)(v) = 1.$$

We can see a vector  $v \in V$  as a closed 1-cocycle on  $\sigma^p$  using the following morphism:

$$\begin{aligned} z : V &\longrightarrow Z^1(\sigma^p; \mathbb{F}_2) \\ v &\longmapsto [\sigma^1 \mapsto \omega(\sigma^1)(v)]. \end{aligned}$$

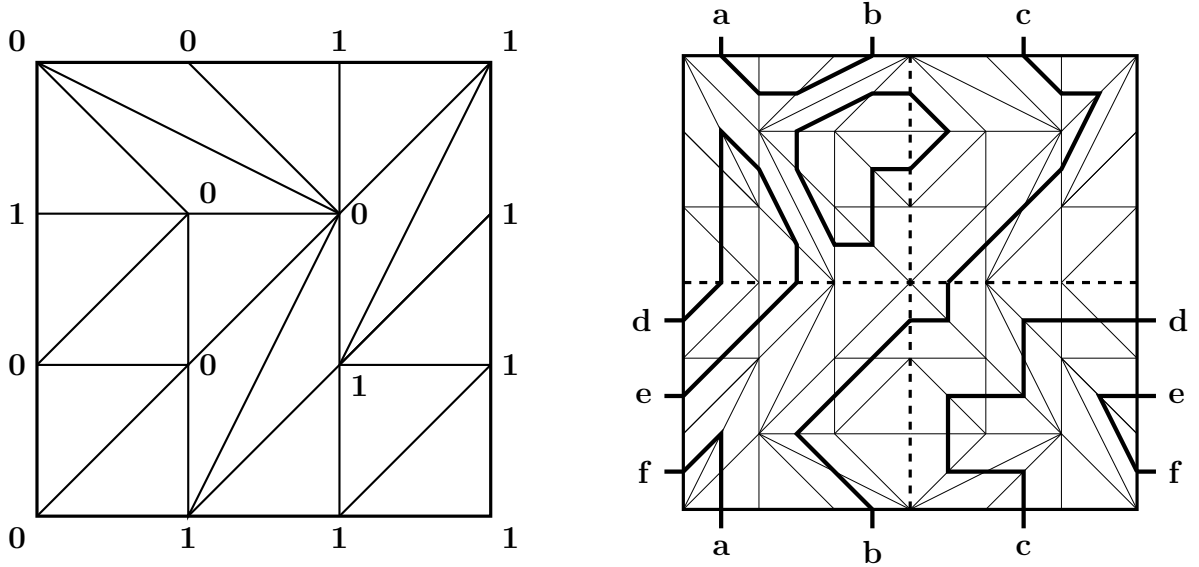

(a) The triangulation  $K$  and the signs distribution  $\varepsilon$ .

(b) the associated T-curve  $\mathbb{R}X_\varepsilon$ .

Figure 4.1: An example of T-curve in  $\mathbb{P}^1(\mathbb{R}) \times \mathbb{P}^1(\mathbb{R})$ .

From that point of view  $\text{Arg}_\varepsilon(\sigma^p; \sigma^q)$  is the set  $\{v \in V \mid z(v) \neq d\varepsilon|_{\sigma^p}\}$  and it is the complementary sub-set in  $V$  of the fiber  $z^{-1}(d\varepsilon|_{\sigma^p})$ . This fibre is an affine space parallel to the kernel of  $z$ . Since  $K$  is primitive,  $z$  is onto and its kernel has codimension  $p$ . Furthermore, the family of linear forms  $\{v \mapsto z(v)(\sigma^1) : \sigma^1 \leq \sigma^p\}$  spans  $T\sigma^p(\mathbb{F}_2)$  so the kernel of  $z$  is precisely  $\{v \in V \mid \alpha(v) = 0, \forall \alpha \in T\sigma^p(\mathbb{F}_2)\}$ .  $\square$

**Remark 4.1.8.** Let  $\sigma^1$  be an edge of  $K$ . The sets  $\text{Arg}_\varepsilon(\sigma^1; \sigma^n)$  are all identical for all  $n$ -simplices  $\sigma^n \geq \sigma^1$ . A. Renaudineau and K. Shaw denoted a member of this collection by  $\mathcal{E}$  and called it the real phase structure.

**Definition 4.1.9** (Sign Sheaves and Cosheaves). We set the notations of two cubical cosheaves and two cubical sheaves on  $K$ :

1.  $\mathcal{K}^{\mathbb{R}P}$  is the cosheaf of group algebras  $(\sigma^p; \sigma^q) \mapsto \mathbb{F}_2 [F_1^P(\sigma^p; \sigma^q)]$  (we will denote by  $x^v$  the generator associated with  $v \in F_1^P(\sigma^p; \sigma^q)$ ) and its dual, the sheaf  $\mathcal{O}_{\mathbb{R}P}$  associates the  $\mathbb{F}_2$ -algebra of functions from  $F_1^P(\sigma^p; \sigma^q)$  to  $\mathbb{F}_2$  to the pair  $(\sigma^p; \sigma^q)$ .
2. Likewise we set  $\mathcal{K}^{\mathbb{R}X_\varepsilon}$  to be the sub cubical cosheaf of  $\mathcal{K}^{\mathbb{R}P}$  that associates to  $(\sigma^p; \sigma^q)$  the sub-space of  $\mathbb{F}_2 [F_1^P(\sigma^p; \sigma^q)]$  freely generated by the elements of  $\text{Arg}_\varepsilon(\sigma^p; \sigma^q)$ . Its dual,  $\mathcal{O}_{\mathbb{R}X_\varepsilon}$ , is the quotient of  $\mathcal{O}_{\mathbb{R}P}$  that associates to  $(\sigma^p; \sigma^q)$  the algebra of functions from  $\text{Arg}_\varepsilon(\sigma^p; \sigma^q)$  to  $\mathbb{F}_2$ .
3. We denote by  $i_* : \mathcal{K}^{\mathbb{R}X_\varepsilon} \rightarrow \mathcal{K}^{\mathbb{R}P}$  the inclusion and by  $i^* : \mathcal{O}_{\mathbb{R}P} \rightarrow \mathcal{O}_{\mathbb{R}X_\varepsilon}$  the adjoint projection. The latter morphism is a morphism of sheaves of algebras.

With this definition we can recall Proposition 3.17 of [RS23] and translate it for the dual sheaves.



**Proposition 4.1.10** (Folding Isomorphisms). *There are chain complexes isomorphisms  $\Phi_{\mathbb{R}P}$  and  $\Phi_{\mathbb{R}X_\varepsilon}$  that make the following diagram commute:*

$$\begin{array}{ccc} (\Omega_q(K; \mathcal{K}^{\mathbb{R}P}))_{q \geq 0} & \xrightarrow[\cong]{\Phi_{\mathbb{R}P}} & (\Omega_q(\mathbb{R}K; \mathbb{F}_2))_{q \geq 0} \\ i_* \uparrow & & \uparrow \\ (\Omega_q(K; \mathcal{K}^{\mathbb{R}X_\varepsilon}))_{q \geq 0} & \xrightarrow[\Phi_{\mathbb{R}X_\varepsilon}]{\cong} & (C_q(\mathbb{R}X_\varepsilon; \mathbb{F}_2))_{q \geq 0} \end{array}$$

As a consequence the dual isomorphisms make the dual diagram commute:

$$\begin{array}{ccc} (\Omega^q(K; \mathcal{O}_{\mathbb{R}P}))_{q \geq 0} & \xleftarrow[\cong]{\Phi_{\mathbb{R}P}^*} & (\Omega^q(\mathbb{R}K; \mathbb{F}_2))_{q \geq 0} \\ \downarrow i^* & & \downarrow \\ (\Omega^q(K; \mathcal{O}_{\mathbb{R}X_\varepsilon}))_{q \geq 0} & \xleftarrow[\Phi_{\mathbb{R}X_\varepsilon}^*]{\cong} & (C^q(\mathbb{R}X_\varepsilon; \mathbb{F}_2))_{q \geq 0} \end{array}$$

*Proof.* The first part of the statement is Proposition 3.17 of p.19 in [RS23]. The second part is a consequence of the duality. We can however remind ourselves of the construction of  $\Phi_{\mathbb{R}P}$  ( $\Phi_{\mathbb{R}X_\varepsilon}$  is its restriction). If  $\sigma^p \leq \sigma^q$  is a cube of  $K$  and  $v \in \mathfrak{t}(\mathbb{F}_2) / \text{Sed}(\sigma^q)$  let us write  $(v; \sigma^p; \sigma^q)$  for the corresponding lift in  $\mathbb{R}K$ . The isomorphism  $\Phi_{\mathbb{R}P}$  sends the chain  $x^v \otimes (\sigma^p; \sigma^q)$  to the chain  $(v; \sigma^p; \sigma^q)$ .  $\square$

## 4.2 Renaudineau-Shaw Spectral Sequence

We recall the construction of the filtration given by A. Renaudineau and K. Shaw in [RS23] and describe the dual filtration in cohomology.

**The Augmentation Filtration in Group Algebras.** We denote respectively by  $\mathbf{Vect}_{\mathbb{F}_2}^{\mathbf{f}}$ ,  $\mathbf{Hopf}_{\mathbb{F}_2}^{\mathbf{f}}$ , and  $\mathbf{gr}\mathbf{Alg}_{\mathbb{F}_2}^{\mathbf{f}}$  the categories of finite dimensional vector spaces over  $\mathbb{F}_2$ , of finite dimensional Hopf algebras over  $\mathbb{F}_2$ , and of finite dimensional graded algebras over  $\mathbb{F}_2$ .

**Definition 4.2.1.** We denote by  $\mathbb{F}_2[-] : \mathbf{Vect}_{\mathbb{F}_2}^{\mathbf{f}} \rightarrow \mathbf{Hopf}_{\mathbb{F}_2}^{\mathbf{f}}$  the functor that associates to a finite dimensional vector space its group ring over  $\mathbb{F}_2$ . For all finite dimensional vector spaces  $V$  over  $\mathbb{F}_2$ , we denote by  $x^v \in \mathbb{F}_2[V]$  the generator associated with the vector  $v \in V$ . The generator  $x^0$  is the unit of  $\mathbb{F}_2[V]$ . Hence it equals 1. We use the notation  $\mathfrak{m}_V$  for the augmentation ideal of  $\mathbb{F}_2[V]$ . This is the kernel of the augmentation of  $\mathbb{F}_2[V]$ : the morphism of algebras  $\text{aug}_V : \mathbb{F}_2[V] \rightarrow \mathbb{F}_2$  that sends every generator  $x^v$  to 1. Note that this is the only algebra morphism  $\mathbb{F}_2[V] \rightarrow \mathbb{F}_2$ . This ideal is known<sup>8</sup> to be generated by the elements of the form  $1 + x^v$  for all  $v \in V$ . We denote by  $\text{gr} : \mathbf{Hopf}_{\mathbb{F}_2}^{\mathbf{f}} \rightarrow \mathbf{gr}\mathbf{Alg}_{\mathbb{F}_2}^{\mathbf{f}}$  the functor that associates to a Hopf algebra  $A$  the graded algebra builded from the filtration of iterated powers of its augmentation ideal. For instance if  $V$  is a finite dimensional vector space over

<sup>8</sup>c.f. [BFMvH06] Lemma 6.2 p.8 or [RS23] Lemma 4.1 p.21

$\mathbb{F}_2$  we have:

$$\mathrm{gr} \mathbb{F}_2[V] = \bigoplus_{k \geq 0} \left( \mathfrak{m}_V^k / \mathfrak{m}_V^{k+1} \right).$$

Moreover, for all  $k \in \mathbb{N}$ , we denote the functor  $V \mapsto \mathfrak{m}_V^k$  by  $\mathfrak{m}^k : \mathbf{Vect}_{\mathbb{F}_2}^{\mathbf{f}} \rightarrow \mathbf{Vect}_{\mathbb{F}_2}^{\mathbf{f}}$ . These functors are linked by natural inclusions  $\mathfrak{m}^l \rightarrow \mathfrak{m}^k$  for all  $l \geq k$ .

**Lemma 4.2.2** ([BFMvH06] Lemma 6.2 p.8, and [RS23], Lemma 4.1 p.21). *For all  $k \in \mathbb{N}$ , the ideal  $\mathfrak{m}_V^k$  is spanned, as sub-vector space, by the following elements:*

$$\sum_{w \in W} x^w,$$

where  $W$  is a sub-vector space of dimension  $k$  of  $V$ .

**Proposition 4.2.3** (F. Bihan, M. Franz, C. McCrory, and J. van Hamel, [BFMvH06] Proposition 6.3 p.8). *We denote by  $\bigwedge : \mathbf{Vect}_{\mathbb{F}_2}^{\mathbf{f}} \rightarrow \mathbf{gr}.\mathbf{Alg}_{\mathbb{F}_2}^{\mathbf{f}}$  the exterior algebra functor. There is a natural isomorphism  $\eta : \bigwedge \rightarrow \mathrm{gr} \mathbb{F}_2[-]$  defined for all finite dimensional  $\mathbb{F}_2$ -vector spaces  $V$ , and all  $k \in \mathbb{N}$ , by the formula:*

$$\begin{aligned} \eta_V^k : \bigwedge^k V &\longrightarrow \mathfrak{m}_V^k / \mathfrak{m}_V^{k+1} \\ v_1 \wedge \dots \wedge v_k &\longmapsto \prod_{i=1}^k (1 + x^{v_i}) \pmod{\mathfrak{m}_V^{k+1}}. \end{aligned}$$

This description is a special case of D. Quillen's description of graded rings associated with the augmentation filtration of a group algebras<sup>9</sup>. The proof of the special case of interest here is recalled in [RS23] under Proposition 4.3 on p.21.

**Proposition 4.2.4.** *Let  $V$  be a finite dimensional vector space over  $\mathbb{F}_2$ . For all  $v \in V$ , the graded endomorphism of  $\bigwedge V \cong \mathrm{gr} \mathbb{F}_2[V]$  induced by the multiplication by  $x^v$  is the identity.*

*Proof.* Let  $v$  be a vector of  $V$  and  $v_1, \dots, v_k \in V$  be a linearly independent family of  $V$ , we have:

$$\prod_{i=1}^k (1 + x^{v_i}) = x^v \prod_{i=1}^k (1 + x^{v_i}) + (1 + x^v) \prod_{i=1}^k (1 + x^{v_i}).$$

Hence  $\prod_{i=1}^k (1 + x^{v_i})$  and  $x^v \prod_{i=1}^k (1 + x^{v_i})$  correspond to the same element in  $\mathfrak{m}_V^k / \mathfrak{m}_V^{k+1}$ .  $\square$

**Proposition 4.2.5.** *Let  $V$  be a finite dimensional vector space over  $\mathbb{F}_2$ . For all linear sub-spaces  $W \subset V$  and all  $k \in \mathbb{N}$ , the intersection of the sub-algebra  $\mathbb{F}_2[W]$  of  $\mathbb{F}_2[V]$  with  $\mathfrak{m}_V^k$  is the ideal  $\mathfrak{m}_W^k$ .*

*Proof.* This is a consequence of the functoriality of  $\mathbb{F}_2[-]$  and the natural transformation  $\eta$  described in Proposition 4.2.3. However, we can also give a direct proof

<sup>9</sup>c.f. [Qui68].

here. Using lemma 4.1 p.21 of [RS23] we know that a generating set of  $\mathfrak{m}_V^k$  is given by the elements  $\sum_{u \in U} x^u$  where  $U$  is a  $k$ -linear sub-space of  $V$ . Now let  $H$  be a linear hyperplane of  $V$  and  $P = \sum_{i=1}^N \sum_{u \in U_i} x^u \in \mathbb{F}_2[H] \cap \mathfrak{m}_V^k$ . We want to write this element as a sum  $\sum_{i=1}^N \sum_{u \in U'_i} x^u$  where  $U'_i$  is a linear sub-space of  $H$ . Since  $P$  belongs to  $\mathbb{F}_2[H]$  we have:

$$\sum_{i=1}^N \sum_{u \in U_i \setminus H} x^u = 0.$$

Let  $v$  be the generator of a supplementary line of  $H$ . We define  $U'_i$  as follows:

1. If  $U_i \subset H$ , we set  $U'_i := U_i$ ;
2. If  $U_i \not\subset H$  and  $(U_i \cap H) \neq (v + (U_i \setminus H))$ , we set  $U'_i := (U_i \cap H) \cup (v + (U_i \setminus H))$ ;
3. Otherwise we set  $U'_i := \emptyset$ .

Note that in each case  $U'_i \subset H$  and is either a  $k$ -dimensional vector space or the empty set. Now we have:

$$\begin{aligned} \sum_{i=1}^N \sum_{u \in U_i} x^u &= \sum_{i=1}^N \sum_{u \in U_i \cap H} x^u + \sum_{i=1}^N \sum_{u \in U_i \setminus H} x^u \\ &= \sum_{i=1}^N \sum_{u \in U_i \cap H} x^u + x^v \sum_{i=1}^N \sum_{u \in U_i \setminus H} x^u \\ &= \sum_{i=1}^N \left( \sum_{u \in U_i \cap H} x^u + \sum_{u+v \in U_i \setminus H} x^u \right) \\ &= \sum_{i=1}^N \sum_{u \in U'_i} x^u. \end{aligned}$$

Thus  $\mathbb{F}_2[H] \cap \mathfrak{m}_V^k = \mathfrak{m}_H^k$ . Let  $W$  be a sub-space of codimension  $l \geq 1$  and  $H_1, \dots, H_l$  be hyperplanes that intersect along  $W$ . We have:

$$\begin{aligned} \mathbb{F}_2[W] \cap \mathfrak{m}_V^k &= \mathbb{F}_2[\cap_{i=1}^l H_i] \cap \mathbb{F}_2[\cap_{i=2}^l H_i] \cap \dots \cap \mathbb{F}_2[H_l] \cap \mathfrak{m}_V^k \\ &= \mathbb{F}_2[\cap_{i=1}^l H_i] \cap \mathbb{F}_2[\cap_{i=2}^l H_i] \cap \dots \cap \mathbb{F}_2[H_{l-1} \cap H_l] \cap \mathfrak{m}_{H_l}^k \\ &\quad \vdots \\ &= \mathbb{F}_2[\cap_{i=1}^l H_i] \cap \mathfrak{m}_{\cap_{i=2}^l H_i}^k \\ &= \mathfrak{m}_W^k, \end{aligned}$$

since  $\cap_{i=k}^l H_i$  is a hyperplane of  $\cap_{i=k+1}^l H_i$  for all  $1 \leq k \leq l$ .  $\square$

In the category of finite dimensional Hopf algebras there is a duality contravariant functor. We denote it by  $(-)^* : (\mathbf{Hopf}_{\mathbb{F}_2}^f)^{\text{op}} \rightarrow \mathbf{Hopf}_{\mathbb{F}_2}^f$ . If we only remember the vector space structure, it corresponds to the classical functor  $(-)^* = \text{Hom}_{\mathbb{F}_2}(-; \mathbb{F}_2)$ . If  $A$  is a finite dimensional Hopf algebra, the product of  $A^*$  is the adjoint of the coproduct of  $A$ , the unit of  $A^*$  is the adjoint of the counit of  $A$  and vice-versa.

**Definition 4.2.6.** We denote by  $\mathcal{O}$  the functor  $(\mathbb{F}_2[-])^* : (\mathbf{Vect}_{\mathbb{F}_2}^{\mathbf{f}})^{\text{op}} \rightarrow \mathbf{Hopf}_{\mathbb{F}_2}^{\mathbf{f}}$ . The functor  $\mathcal{O}$  is naturally isomorphic to the functor of  $\mathbb{F}_2$ -valued function algebras  $V \mapsto \{f : V \rightarrow \mathbb{F}_2\}$  with pointwise addition and multiplication. We will not describe the coalgebra structure as we will not need it further. The natural isomorphism is realised by means of a duality pairing. For all finite dimensional vector spaces  $V$ , all functions  $f \in \mathcal{O}(V)$  and all elements  $P = \sum_{v \in V} p_v x^v \in \mathbb{F}_2[V]$ , we define such pairing by:

$$\langle f ; P \rangle := \sum_{v \in V} f(v) p_v.$$

**Remark 4.2.7.** We justify the notation  $\mathcal{O}(V)$  by the known fact that, for all finite dimensional vector spaces  $V$  over a finite field  $\mathbb{F}$ , every function  $f : V \rightarrow \mathbb{F}$  is polynomial. It is only a matter of expressing the indicatrix functions as polynomials in a set of coordinates of  $V$ .

**Definition 4.2.8.** The functor  $\mathcal{O}^{(k)} : (\mathbf{Vect}_{\mathbb{F}_2}^{\mathbf{f}})^{\text{op}} \rightarrow \mathbf{Vect}_{\mathbb{F}_2}^{\mathbf{f}}$  is given, for all  $k \in \mathbb{N}$  and all finite dimensional vector spaces  $V$  over  $\mathbb{F}_2$ , by the formula<sup>10</sup>:

$$\mathcal{O}^{(k)}(V) := \text{im} \left( \left( \mathbb{F}_2[V] / \mathfrak{m}^{k+1} \right)^* \hookrightarrow \mathcal{O}(V) \right).$$

Furthermore, they are naturally included in one another  $\mathcal{O}^{(k)} \rightarrow \mathcal{O}^{(l)}$ , for all  $l \geq k$ . We denote by  $\text{gr } \mathcal{O} : (\mathbf{Vect}_{\mathbb{F}_2}^{\mathbf{f}})^{\text{op}} \rightarrow \mathbf{gr} \mathbf{Vect}_{\mathbb{F}_2}^{\mathbf{f}}$  the functor  $\bigoplus_{k \geq 0} \mathcal{O}^{(k)} / \mathcal{O}^{(k-1)}$ .

By construction and Proposition 4.2.3 we have:

**Proposition 4.2.9.** *The functor  $\text{gr } \mathcal{O}$  is naturally isomorphic to  $\Lambda(-)^*$  through  $\eta^*$ .*

Since we did not define a product on  $\text{gr } \mathcal{O}$ , we should emphasise that in Proposition 4.2.9 the two functors  $\text{gr } \mathcal{O}$  and  $\Lambda(-)^*$  are naturally isomorphic as functors to the category of graded vector spaces. However, Proposition 4.2.11 will ensure that we can endow  $\text{gr } \mathcal{O}$  with a product compatible with  $\eta^*$ .

**Lemma 4.2.10.** *For all functions  $u : \{1, \dots, l\} \rightarrow \{1, \dots, k\}$ , the number:*

$$\sum_{\beta \in \mathbb{F}_2^k} \prod_{j=1}^l \beta_{u(j)} \in \mathbb{F}_2,$$

*equals 1 if and only if  $u$  is surjective.*

*Proof.* If  $u$  is onto the only non-zero term in the sum is the one for which  $\beta_i = 1$  for all  $i$ . If on the contrary  $u$  is not surjective it misses an index  $i_0$  and we have:

$$\sum_{\beta \in \mathbb{F}_2^k} \prod_{j=1}^l \beta_{u(j)} = \sum_{\substack{\beta \in \mathbb{F}_2^k \\ \beta_{i_0}=0}} \prod_{j=1}^l \beta_{u(j)} + \sum_{\substack{\beta \in \mathbb{F}_2^k \\ \beta_{i_0}=1}} \prod_{j=1}^l \beta_{u(j)} = 0,$$

since the two terms are equals. □

<sup>10</sup>c.f. Definition A.3 or [Del71] (1.1.6) p.7.

**Proposition 4.2.11.** *The composition  $\mathcal{O}^{(k)} \otimes \mathcal{O}^{(l)} \rightarrow \mathcal{O} \otimes \mathcal{O} \rightarrow \mathcal{O}$  where the first natural transformation is given by the tensor product of the inclusions and the second is given by the product of  $\mathcal{O}$  takes values in  $\mathcal{O}^{(k+l)}$ . In other words  $\mathcal{O}^{(k)}\mathcal{O}^{(l)} \subset \mathcal{O}^{(k+l)}$ .*

*Proof.* Let  $V$  be a finite dimensional vector space over  $\mathbb{F}_2$ . We need to show that for all  $k, l \in \mathbb{N}$ , all  $f \in \mathcal{O}^{(k)}(V)$ , and all  $g \in \mathcal{O}^{(l)}(V)$ , the product  $fg$  belongs to  $\mathcal{O}^{(k+l)}(V)$ . To do so we will show that a function is an element of  $\mathcal{O}^{(k)}(V)$  if and only if it can be represented by a polynomial of degree at most  $k$  (c.f. Remark 4.2.7). The functions of  $\mathcal{O}^{(k)}(V)$  are those which vanish against elements of  $\mathfrak{m}_V^{k+1}$ . Following lemma 4.1 p.21 of [RS23], the vector space  $\mathfrak{m}_V^{k+1}$  is generated by the elements  $\sum_{v \in W} x^v$  for all linear sub-spaces  $W$  of  $V$  of dimension  $(k+1)$ . Such an element can be written as  $\prod_{i=1}^{k+1} (1 + x^{w_i})$  where  $\{w_1, \dots, w_{k+1}\}$  is a basis of  $W$ . Let us fix a set of linear coordinates  $x_1, \dots, x_n$  of  $V$ , i.e. a basis of  $V^*$ . Because of Fermat's little theorem<sup>11</sup>, a function  $f \in \mathcal{O}(V)$  can be uniquely written as follows:

$$f = \sum_{\alpha \in \{0,1\}^n} f_\alpha x^\alpha,$$

in the usual multi-index notations:  $x^\alpha := \prod_{i=1}^n x_i^{\alpha_i}$  and  $|\alpha| := \sum_{i=1}^n \alpha_i$ . For all integers  $k \geq 1$ , let us denote by  $[k]$  the integer interval  $\{1, \dots, k\}$ . Let  $\alpha \in \mathbb{F}_2^n$  with  $|\alpha| = l$  and  $W = \langle w_1, \dots, w_k \rangle$  be a  $k$ -dimensional sub-space of  $V$ . We have:

$$\begin{aligned} \left\langle x^\alpha ; \prod_{i=1}^k (1 + x^{w_i}) \right\rangle &= \sum_{w \in W} \langle x^\alpha ; x^w \rangle \\ &= \sum_{w \in W} \prod_{j=1}^n x_j(w)^{\alpha_j} \\ &= \sum_{\beta \in \mathbb{F}_2^k} \prod_{j=1}^n \left( x_j \left( \sum_{i=1}^k \beta_i w_i \right) \right)^{\alpha_j} \\ &= \sum_{\beta \in \mathbb{F}_2^k} \sum_{u: [n] \rightarrow [k]} \left( \prod_{j=1}^n \beta_{u(j)}^{\alpha_j} \right) \left( \prod_{j=1}^n (x_j(w_{u(j)}))^{\alpha_j} \right). \end{aligned}$$

Up to reordering we can assume that  $\alpha_i = 1$  if and only if  $1 \leq i \leq l$ , thus:

$$\begin{aligned} \sum_{\beta \in \mathbb{F}_2^k} \sum_{u: [n] \rightarrow [k]} \left( \prod_{j=1}^n \beta_{u(j)}^{\alpha_j} \right) \left( \prod_{j=1}^n (x_j(w_{u(j)}))^{\alpha_j} \right) &= \sum_{\beta \in \mathbb{F}_2^k} \sum_{u: [l] \rightarrow [k]} \left( \prod_{j=1}^l \beta_{u(j)} \right) \left( \prod_{j=1}^l x_j(w_{u(j)}) \right) \\ &= \sum_{u: [l] \rightarrow [k]} \left( \sum_{\beta \in \mathbb{F}_2^k} \prod_{j=1}^l \beta_{u(j)} \right) \left( \prod_{j=1}^l x_j(w_{u(j)}) \right). \end{aligned}$$

By Lemma 4.2.10, the number  $\sum_{\beta \in \mathbb{F}_2^k} \prod_{j=1}^l \beta_{u(j)}$  equals 1 if and only if  $u$  is onto.

<sup>11</sup> $a^2 = a$  for all  $a \in \mathbb{F}_2$

Therefore, the number:

$$\left\langle x^\alpha ; \prod_{i=1}^k (1 + x^{w_i}) \right\rangle,$$

vanishes whenever  $k$  is bigger than  $l$ . Thus the polynomial functions of degree at most  $k$  belong to  $\mathcal{O}^{(k)}(V)$ . If  $k$  equals  $l$ , and  $\mathfrak{S}_k$  denotes the  $k$ -th symmetric group, the number:

$$\left\langle x^\alpha ; \prod_{i=1}^k (1 + x^{w_i}) \right\rangle = \sum_{u \in \mathfrak{S}_k} \prod_{j=1}^l x_j(w_{u(j)}),$$

is the minor of the matrix of the coordinates of  $w_1, \dots, w_k$  in the dual basis of  $x_1, \dots, x_n$  with the row set selected by the multi-index  $\alpha$ . As a consequence we can find, for all polynomials of degree  $k$ , a sub-space  $W$  of dimension  $k$  such that the evaluation of  $f$ , as a linear form, against the generator of  $\mathfrak{m}_V^k$  associated with  $W$  is 1. It implies that  $\{f : \deg f = k\}$  is included in  $\mathcal{O}^{(k)}(V) \setminus \mathcal{O}^{(k-1)}(V)$  and that the two partitions of  $\mathcal{O}(V)$ , by the degree on one hand, and by the sets  $\mathcal{O}^{(k)}(V) \setminus \mathcal{O}^{(k-1)}(V)$  on the other hand, coincide.  $\square$

As a direct consequence of Proposition 4.2.11 we have:

**Proposition 4.2.12.** *The functor  $\mathcal{O}$  together with the filtration  $(\mathcal{O}^{(k)})_{k \in \mathbb{N}}$  takes values in the category of filtered finite dimensional algebras over  $\mathbb{F}_2$ , and therefore  $\text{gr } \mathcal{O}$  takes values in the category of graded algebras.*

Moreover:

**Proposition 4.2.13.** *The natural isomorphism  $\eta^* : \text{gr } \mathcal{O} \rightarrow \bigwedge(-)^*$  is compatible with the products.*

*Proof.* Let  $V$  be a finite dimensional vector space over  $\mathbb{F}_2$  and let  $k \in \mathbb{N}$ . Let us consider  $f \in \mathcal{O}^{(k)}(V)$  and express it in a system of linear coordinates  $x_1, \dots, x_n$ :

$$f = \sum_{|\alpha| \leq k} f_\alpha x^\alpha = \sum_{\substack{I \subset \{1, \dots, n\} \\ |I| \leq k}} f_I \prod_{i \in I} x_i.$$

Using Lemma 4.2.10, we find that, for all  $v_1 \wedge \dots \wedge v_k \in \bigwedge^k V$ :

$$\begin{aligned} \left\langle f \pmod{\mathcal{O}^{(k-1)}(V)} ; \eta_V^k(v_1 \wedge \dots \wedge v_k) \right\rangle &= \sum_{|I|=k} f_I \left\langle \prod_{i \in I} x_i ; \prod_{j=1}^k (1 + x^{v_j}) \right\rangle \\ &= \sum_{|I|=k} f_I \sum_{u \in \mathfrak{S}_k} \prod_{i=1}^k x_{I(i)}(v_{u(i)}) \\ &= \sum_{|I|=k} f_I \left( \bigwedge_{i \in I} x_i \right) \left( \bigwedge_{i=1}^k v_i \right), \end{aligned}$$

where  $I(i)$  is the  $i$ -th element of  $I$ . The inverse of  $(\eta_V^k)^*$  sends a wedge product of linear forms  $\alpha_1 \wedge \dots \wedge \alpha_k$  to the polynomial function  $\alpha_1 \dots \alpha_k$  modulo  $\mathcal{O}^{(k-1)}(V)$ . It respects the product structures.  $\square$

**Definition 4.2.14.** Let  $V$  be a finite dimensional vector space over  $\mathbb{F}_2$ . For all  $f \in \mathcal{O}(V)$  and all  $P = \sum_{v \in V} p_v x^v \in \mathbb{F}_2[V]$  we denote by  $f \cdot P$  the element of  $\mathbb{F}_2[V]$  defined by the formula:

$$f \cdot P := \sum_{v \in V} f(v) p_v x^v.$$

**Proposition 4.2.15.** Let  $V$  be a finite dimensional vector space over  $\mathbb{F}_2$ . For all  $f \in \mathcal{O}^{(l)}(V)$  and all  $P \in \mathfrak{m}_V^{k+l}$ ,  $f \cdot P$  belongs to  $\mathfrak{m}_V^k$ . Moreover, the induced product between the graded pieces:

$$\bigwedge^l V^* \otimes \bigwedge^{k+l} V \rightarrow \bigwedge^k V,$$

is the contraction.

*Proof.* Let  $a \in \mathcal{O}^{(1)}(V)$  be an affine function and denote its linear part by  $da$ . A straightforward computation yields for all  $P, Q \in \mathbb{F}_2[V]$ :

$$a \cdot (PQ) = (a \cdot P)Q + P(da \cdot Q).$$

Using this formula we can show, by induction, that  $a \cdot \mathfrak{m}_V^{k+1}$  is included in  $\mathfrak{m}_V^k$  for all  $k \geq 0$ . From the definition  $(fg) \cdot P$  equals  $f \cdot (g \cdot P)$  for all  $f, g \in \mathcal{O}(V)$  and all  $P \in \mathbb{F}_2[V]$ . Consequently,  $(a_1 \dots a_l) \cdot \mathfrak{m}_V^{k+l}$  is included in  $\mathfrak{m}_V^k$  for all  $a_1, \dots, a_l \in \mathcal{O}^{(1)}(V)$ . Finally, we find the following inclusions:

$$\mathcal{O}^{(l)}(V) \cdot \mathfrak{m}_V^{k+l} \subset \sum_{i=0}^l \mathfrak{m}_V^{k+l-i} \subset \mathfrak{m}_V^k.$$

The duality pairing  $\langle f; P \rangle$  of  $f \in \mathcal{O}(V)$  with  $P \in \mathbb{F}_2[V]$  can be written as  $\text{aug}_V(f \cdot P)$ . Hence, the operation  $P \mapsto f \cdot P$  is adjoint to  $g \mapsto gf$ . This remains true in the graded algebras and it is precisely the definition of the contraction.  $\square$

**Lemma 4.2.16.** Let  $V$  be a finite dimensional vector space over  $\mathbb{F}_2$  and  $A$  be an affine sub-space of  $V$  of codimension  $l$ . Let  $\chi_A$  denote the indicatrix function of  $A$ . We have the following exact sequence:

$$0 \longrightarrow \langle x^v : v \in V \setminus A \rangle \longrightarrow \mathbb{F}_2[V] \xrightarrow{\chi_A^-} \langle x^v : v \in A \rangle \longrightarrow 0. \quad (4.1)$$

Moreover, if  $\omega$  denotes the generator of  $\bigwedge^l \{\alpha \mid \alpha(v) = 0, \forall v \in TA\}$ ,  $K$  denotes  $\langle x^v : v \in V \setminus A \rangle$ , and  $o$  is a point of  $A$ , then for all  $k \in \mathbb{N}$ , we have the following

diagram with exact rows and columns:

$$\begin{array}{ccccccc}
 & & 0 & & 0 & & 0 \\
 & & \uparrow & & \uparrow & & \uparrow \\
 0 & \longrightarrow & K \cap \mathfrak{m}_V^k / K \cap \mathfrak{m}_V^{k+1} & \longrightarrow & \bigwedge^k V & \xrightarrow{\omega \cdot -} & \bigwedge^{k-l} TA \longrightarrow 0 \\
 & & \uparrow & & \uparrow & & \uparrow \\
 0 & \longrightarrow & K \cap \mathfrak{m}_V^k & \longrightarrow & \mathfrak{m}_V^k & \xrightarrow{x^o(\chi_A \cdot -)} & \mathfrak{m}_{TA}^k \longrightarrow 0 \\
 & & \uparrow & & \uparrow & & \uparrow \\
 0 & \longrightarrow & K \cap \mathfrak{m}_V^{k+1} & \longrightarrow & \mathfrak{m}_V^{k+1} & \xrightarrow{x^o(\chi_A \cdot -)} & \mathfrak{m}_{TA}^{k+1} \longrightarrow 0 \\
 & & \uparrow & & \uparrow & & \uparrow \\
 & & 0 & & 0 & & 0
 \end{array} \tag{4.2}$$

*Proof.* The space  $\mathbb{F}_2[V]$  is the direct sum of  $\langle x^v : v \in A \rangle$  and  $\langle x^v : v \in V \setminus A \rangle$ . A direct computation yields that the operation  $P \mapsto \chi_A \cdot P$  is the projection onto  $\langle x^v : v \in A \rangle$  parallel to  $\langle x^v : v \in V \setminus A \rangle$ . Therefore we have the exact sequence (4.1):

$$0 \longrightarrow \langle x^v : v \in V \setminus A \rangle \longrightarrow \mathbb{F}_2[V] \xrightarrow{\chi_A \cdot -} \langle x^v : v \in A \rangle \longrightarrow 0 .$$

Since  $A$  has codimension  $l$ , it is the intersection of  $l$  affine hyperplanes. The indicator functions of affine hyperplanes have degree 1 hence  $\chi_A$  has degree  $l$ . Following Proposition 4.2.15, the linear map  $P \mapsto \chi_A \cdot P$  has degree  $(-l)$  as a morphism of filtered vector spaces. Moreover, because of Proposition 4.2.4, choosing a point  $o \in A$  yields an isomorphism of filtered vector spaces  $P \in \mathbb{F}_2[TA] \mapsto x^o P \in \langle x^v : v \in A \rangle$ . Therefore,  $P \mapsto x^o(\chi_A \cdot P)$  is a surjective filtered morphism of degree  $(-l)$  from  $\mathbb{F}_2[V]$  onto  $\mathbb{F}_2[TA]$ . Consequently, for all  $k \in \mathbb{N}$ , we obtain, by partial use of the Snake Lemma<sup>12</sup>, the following commutative diagram with exact rows and columns:

$$\begin{array}{ccccccc}
 & & 0 & & 0 & & 0 \\
 & & \uparrow & & \uparrow & & \uparrow \\
 \bigwedge^k V & \xrightarrow{f_k} & \bigwedge^{k-l} TA & \longrightarrow & C_k & \longrightarrow & 0 \\
 \uparrow & & \uparrow & & \uparrow & & \\
 \mathfrak{m}_V^k & \xrightarrow{x^o(\chi_A \cdot -)} & \mathfrak{m}_{TA}^{k-l} & \longrightarrow & C_{(k)} & \longrightarrow & 0 \\
 \uparrow & & \uparrow & & \uparrow & & \\
 \mathfrak{m}_V^{k+1} & \xrightarrow{x^o(\chi_A \cdot -)} & \mathfrak{m}_{TA}^{k-l+1} & \longrightarrow & C_{(k+1)} & \longrightarrow & 0 \\
 \uparrow & & \uparrow & & & & \\
 0 & & 0 & & & & 
 \end{array}$$

Where  $f_k$  is induced by  $x^o(\chi_A \cdot -)$  between the  $k$ -th graded pieces and the right hand

<sup>12</sup>c.f. [Lan93] Lemma 9.1 p.158.



side column is made of the cokernels of the associated morphisms. Using Proposition 4.2.4 and Proposition 4.2.15 we find that the morphism  $f_k$  is the contraction against  $\omega$ . It is a surjective morphism and  $C_k$  vanishes. Since all the  $C_k$ 's vanish the  $C_{(k)}$ 's must vanish as well. Using now the Snake Lemma in its complete form we find the commutative diagram (4.2).  $\square$

**Proposition 4.2.17.** *Let  $V$  be a finite dimensional vector space over  $\mathbb{F}_2$  and  $A \subset V$  be an affine sub-space of codimension  $l$ . For all families  $H_1, \dots, H_l \subset V$  of affine hyperplanes that intersect along  $A$  and all  $k \in \mathbb{N}$ , we have:*

$$\langle x^v : v \in V \setminus A \rangle \cap \mathfrak{m}_V^k = \sum_{i=1}^l \langle x^v : v \in V \setminus H_i \rangle \cap \mathfrak{m}_V^k.$$

*Proof.* Let us denote by  $K$  the sub-space  $\langle x^v : v \in V \setminus A \rangle$  of  $\mathbb{F}_2[V]$ , also equal to  $\sum_{i=1}^l \langle x^v : v \in V \setminus H_i \rangle$ . It is endowed with two decreasing filtrations:

$$K_{(k)} := \langle x^v : v \in V \setminus A \rangle \cap \mathfrak{m}_V^k,$$

and:

$$K'_{(k)} := \sum_{i=1}^l \langle x^v : v \in V \setminus H_i \rangle \cap \mathfrak{m}_V^k.$$

We need to show that they coincide. Since  $K'_{(k)}$  is included in  $K_{(k)}$  for all  $k \in \mathbb{N}$ , we can only show that the induced morphisms between the graded pieces are surjective. Because of Proposition 4.2.4 and Proposition 4.2.5,  $K'_{(k)}$  is equal to  $\sum_{i=1}^l x^{o_i} \mathfrak{m}_{TH_i}^k$  where, for all  $1 \leq i \leq l$ ,  $o_i$  is a point of  $V \setminus H_i$  and  $TH_i$  is the direction of  $H_i$ . It follows that the image of  $K'_{(k)}$  in  $\bigwedge^k V$  is:

$$\sum_{i=1}^l \bigwedge^k TH_i.$$

As a consequence of the definition of the other filtration  $(K_{(i)})_{i \geq 0}$ , its associated graded vector space is embedded in the exterior algebra  $\bigwedge V$ . Moreover, if  $\omega$  is the generator of  $\bigwedge^l (V/TA)^*$  and  $k$  is a non-negative integer, we have, from Diagram (4.2) of Lemma 4.2.16, the following exact sequence:

$$0 \longrightarrow K_k \xrightarrow{c_k} \bigwedge^k V \xrightarrow{\omega \cdot -} \bigwedge^{k-l} TA \longrightarrow 0, \quad (4.3)$$

and the commutative diagram:

$$\begin{array}{ccc} K'_k & & \\ \downarrow a_k & \searrow b_k & \\ K_k & & \bigwedge^k V \\ & \nearrow c_k & \end{array}$$

Where  $a_k$  is induced from the inclusions  $(K'_{(k)} \subset K_{(k)})_{k \in \mathbb{N}}$ ,  $b_k$  is induced from  $(K'_{(k)} \subset \mathfrak{m}_V^k)_{k \in \mathbb{N}}$ , and  $c_k$  is induced from  $(K_{(k)} \subset \mathfrak{m}_V^k)_{k \in \mathbb{N}}$ . The morphism  $c_k$  is injective and using Proposition 3.1.14 with the Exact Sequence (4.3) imply that  $c_k$  and  $b_k$  have the same image, so that  $a_k$  is onto. It implies that all the inclusions  $K'_{(k)} \subset K_{(k)}$ , for all  $k \in \mathbb{N}$  are onto, hence equalities.  $\square$

### The Induced Filtrations.

**Definition 4.2.18.** In Definition 4.1.9 the cubical cosheaf  $\mathcal{K}^{\mathbb{R}P}$  and the cubical sheaf  $\mathcal{O}_{\mathbb{R}P}$  were given by the formulæ  $\mathcal{K}^{\mathbb{R}P} = \mathbb{F}_2[F_1^P]$  and  $\mathcal{O}_{\mathbb{R}P} = \mathcal{O}(F_1^P)$ . The functoriality of the filtrations of  $\mathbb{F}_2[-]$  and  $\mathcal{O}$  ensures that these cosheaf and sheaf are respectively endowed with a decreasing filtration:

$$0 \subset \mathcal{K}_{(n)}^{\mathbb{R}P} \subset \dots \subset \mathcal{K}_{(0)}^{\mathbb{R}P} = \mathcal{K}^{\mathbb{R}P},$$

and an increasing filtration:

$$0 \subset \mathcal{O}_{\mathbb{R}P}^{(0)} \subset \dots \subset \mathcal{O}_{\mathbb{R}P}^{(n)} = \mathcal{O}_{\mathbb{R}P},$$

and that the associated graded pieces satisfy, for all  $k \in \mathbb{N}$ :

$$0 \longrightarrow \mathcal{K}_{(k+1)}^{\mathbb{R}P} \longrightarrow \mathcal{K}_{(k)}^{\mathbb{R}P} \xrightarrow{\text{bv}_k^P} F_k^P \longrightarrow 0, \quad (4.4)$$

and:

$$0 \longrightarrow \mathcal{O}_{\mathbb{R}P}^{(k-1)} \longrightarrow \mathcal{O}_{\mathbb{R}P}^{(k)} \xrightarrow{\text{bv}_P^k} F_P^k \longrightarrow 0. \quad (4.5)$$

The right hand side projections  $\text{bv}_k^P$  and  $\text{bv}_P^k$  are given by the projections onto the graded pieces composed with the natural isomorphisms  $\eta$  and  $(\eta^*)^{-1}$ . We denote by:

- $(E_{p,q}^r(\mathbb{R}P))_{p,q,r \geq 0}$  the spectral sequence converging toward  $(H_q(\mathbb{R}P; \mathbb{F}_2))_{q \geq 0}$  that arises from the bounded filtration of  $\mathcal{K}_{\mathbb{R}P}$ ;
- $(E_r^{p,q}(\mathbb{R}P))_{p,q,r \geq 0}$  the dual spectral sequence converging toward  $(H^q(\mathbb{R}P; \mathbb{F}_2))_{q \geq 0}$  that arises from the bounded filtration of  $\mathcal{O}_{\mathbb{R}P}$ .

The spectral sequence  $(E_r^{p,q}(\mathbb{R}P))_{p,q,r \geq 0}$  is a spectral ring for  $\mathcal{O}_{\mathbb{R}P}$  is a sheaf of filtered algebras<sup>13</sup>.

These filtrations can be transported on  $\mathbb{R}X_\varepsilon$ :

**Definition 4.2.19.** The filtration of  $\mathcal{K}^{\mathbb{R}P}$  from Definition 4.2.18 induces a filtration of the sub-cosheaf  $\mathcal{K}^{\mathbb{R}X_\varepsilon} \subset \mathcal{K}^{\mathbb{R}P}$  by intersection. Dually, the filtration of  $\mathcal{O}_{\mathbb{R}P}$  induces a filtration of  $\mathcal{O}_{\mathbb{R}X_\varepsilon}$  by projection. With these definitions the inclusion  $i_* : \mathcal{K}^{\mathbb{R}X_\varepsilon} \rightarrow \mathcal{K}^{\mathbb{R}P}$  and the projection  $i^* : \mathcal{O}_{\mathbb{R}P} \rightarrow \mathcal{O}_{\mathbb{R}X_\varepsilon}$  are morphisms of filtered

<sup>13</sup>c.f. Proposition 4.2.12.

cosheaves and sheaves respectively. Lemma A.7 ensures that these filtrations are dual of one another. We denote by:

$$(E_{p,q}^r(\mathbb{R}X_\varepsilon))_{p,q,r \geq 0} \quad \text{and} \quad (E_r^{p,q}(\mathbb{R}X_\varepsilon))_{p,q,r \geq 0},$$

the spectral sequences respectively associated with the filtrations of  $\mathcal{K}^{\mathbb{R}X_\varepsilon}$  and of  $\mathcal{O}_{\mathbb{R}X_\varepsilon}$ . The sheaves and cosheaves morphisms  $i^*$  and  $i_*$  induce spectral sequences morphisms:

$$i_{p,q}^r : E_{p,q}^r(\mathbb{R}X_\varepsilon) \rightarrow E_{p,q}^r(\mathbb{R}P) \quad \text{and} \quad i_r^{p,q} : E_r^{p,q}(\mathbb{R}P) \rightarrow E_r^{p,q}(\mathbb{R}X_\varepsilon).$$

The multiplicative property of the filtration of  $\mathcal{O}_{\mathbb{R}P}$  is passed onto the filtration of  $\mathcal{O}_{\mathbb{R}X_\varepsilon}$  since  $i^* : \mathcal{O}_{\mathbb{R}P} \rightarrow \mathcal{O}_{\mathbb{R}X_\varepsilon}$  is a morphism of sheaves of algebras and therefore  $(E_{p,q}^r(\mathbb{R}X_\varepsilon))_{p,q,r \geq 0}$  is also a spectral ring. Furthermore, the collection  $(i_r^{p,q})_{p,q,r \geq 0}$  is a morphism of spectral rings.

The main theorem of [RS23] rests on the computation of the first page of the spectral sequence  $(E_{p,q}^r(\mathbb{R}X_\varepsilon))_{p,q,r \geq 0}$  and more specifically the graded pieces of  $\mathcal{K}^{\mathbb{R}X_\varepsilon}$ . However, we gave a different definition of the filtration of  $\mathcal{K}^{\mathbb{R}X_\varepsilon}$ . Before recalling the results of [RS23] about the spectral sequence  $(E_{p,q}^r(\mathbb{R}X_\varepsilon))_{p,q,r \geq 0}$  we should check that the two definitions coincide. Let us recall their construction.

**Definition 4.2.20** (A. Renaudineau and K. Shaw, [RS23] Definition 4.5 p.22). Let us denote by  $((\mathcal{K}_{(k)}^{\mathbb{R}X_\varepsilon})')_{k \geq 0}$  the decreasing filtration of  $\mathcal{K}^{\mathbb{R}X_\varepsilon}$  constructed as follows:

1. Let  $\sigma^1 \leq \sigma^q$  be a pair of simplices of  $K$ . The set  $\text{Arg}_\varepsilon(\sigma^1; \sigma^q)$  is a hyperplane of the vector space  $F_1^P(\sigma^1; \sigma^q) = \mathfrak{t}(\mathbb{F}_2) / \text{Sed}(\sigma^1; \sigma^q)$  (c.f. Lemma 4.1.7). Let us denote its vectorial direction by  $TA$  and chose an origin  $o \in \text{Arg}_\varepsilon(\sigma^1; \sigma^q)$ . Let  $k \in \mathbb{N}$ , and  $(\mathcal{K}_{(k)}^{\mathbb{R}X_\varepsilon})'(\sigma^1; \sigma^q)$  denote the image of the  $k$ -th power augmentation ideal  $\mathfrak{m}_{TA}^k$  by the isomorphism  $\mathbb{F}_2[TA] \rightarrow \mathcal{K}^{\mathbb{R}X_\varepsilon}(\sigma^1; \sigma^q)$  obtained from the multiplication by  $x^o$ .
2. Let  $\sigma^p \leq \sigma^q$  be a pair of simplices of  $K$  and  $k \in \mathbb{N}$ . The sub-space  $(\mathcal{K}_{(k)}^{\mathbb{R}X_\varepsilon})'(\sigma^p; \sigma^q)$  of  $\mathcal{K}^{\mathbb{R}X_\varepsilon}(\sigma^p; \sigma^q)$  is obtained as the sum:

$$(\mathcal{K}_{(k)}^{\mathbb{R}X_\varepsilon})'(\sigma^p; \sigma^q) := \sum_{\sigma^1 \leq \sigma^p} (\mathcal{K}_{(k)}^{\mathbb{R}X_\varepsilon})'(\sigma^1; \sigma^q).$$

**Proposition 4.2.21.** *Let  $\sigma^p \leq \sigma^q$  be a pair of simplices of  $K$ . For all integers  $k \geq 0$ :*

$$(\mathcal{K}_{(k)}^{\mathbb{R}X_\varepsilon})'(\sigma^p; \sigma^q) = \mathcal{K}_{(k)}^{\mathbb{R}X_\varepsilon}(\sigma^p; \sigma^q).$$

*Proof.* Let  $k \geq 0$  be an integer. From Definition 4.2.19, we have:

$$\mathcal{K}_{(k)}^{\mathbb{R}X_\varepsilon}(\sigma^p; \sigma^q) = \langle x^v : v \in \text{Arg}_\varepsilon(\sigma^p; \sigma^q) \rangle \cap \mathfrak{m}_V^k,$$

where  $V$  is  $\mathfrak{t}(\mathbb{F}_2) / \text{Sed}(\sigma^p; \sigma^q)$ . Lemma 4.1.7 ensures that  $\text{Arg}_\varepsilon(\sigma^p; \sigma^q)$  is the complementary sub-set of an affine sub-space of  $V$ . Let  $\sigma^0$  be a vertex of  $\sigma^p$ . We can

apply Proposition 4.2.17 to find that:

$$\langle x^v : v \in \text{Arg}_\varepsilon(\sigma^p; \sigma^q) \rangle \cap \mathfrak{m}_V^k = \sum_{\sigma^0 \subset \sigma^1 \subset \sigma^p} \langle x^v : v \in \text{Arg}_\varepsilon(\sigma^1; \sigma^q) \rangle \cap \mathfrak{m}_V^k.$$

Indeed, the sets  $V \setminus \text{Arg}_\varepsilon(\sigma^1; \sigma^q)$ , for all edges  $\sigma^0 \subset \sigma^1 \subset \sigma^p$ , are hyperplanes intersecting along  $V \setminus \text{Arg}_\varepsilon(\sigma^p; \sigma^q)$ . We can add the remaining  $\langle x^v : v \in \text{Arg}_\varepsilon(\sigma^1; \sigma^q) \rangle \cap \mathfrak{m}_V^k$  on both sides to find that:

$$\langle x^v : v \in \text{Arg}_\varepsilon(\sigma^p; \sigma^q) \rangle \cap \mathfrak{m}_V^k = \sum_{\sigma^1 \subset \sigma^p} \langle x^v : v \in \text{Arg}_\varepsilon(\sigma^1; \sigma^q) \rangle \cap \mathfrak{m}_V^k.$$

Because of Proposition 4.2.4 and Proposition 4.2.5, the intersection of the subspace  $\langle x^v : v \in \text{Arg}_\varepsilon(\sigma^1; \sigma^q) \rangle$  with  $\mathfrak{m}_V^k$  corresponds to  $(\mathcal{K}_{(k)}^{\mathbb{R}X_\varepsilon})'(\sigma^1; \sigma^q)$ . Using the second construction step of Definition 4.2.20 we finally find that the two filtrations coincide.  $\square$

The following proposition describes the graded pieces of the filtration of  $\mathcal{K}^{\mathbb{R}X_\varepsilon}$  and is mainly equivalent to Lemma 4.8 and Proposition 4.10 of [RS23]. However in this article, the Borel-Viro morphisms  $(\text{bv}_k^X)_{k \in \mathbb{N}}$  were not introduced as we do here since their construction relied on a different definition of the filtration, i.e. Definition 4.2.20.

**Proposition 4.2.22.** *For all integers  $k \geq 0$ , the Borel-Viro morphism  $\text{bv}_k^P$  of Definition 4.2.18 sends  $\mathcal{K}_{(k)}^{\mathbb{R}X_\varepsilon}$  onto  $F_k^X$ . We denote its restriction-corestriction by  $\text{bv}_k^X$ . As a consequence we have the following commutative diagram with exact rows:*

$$\begin{array}{ccccccc} 0 & \longrightarrow & \mathcal{K}_{(k+1)}^{\mathbb{R}P} & \longrightarrow & \mathcal{K}_{(k)}^{\mathbb{R}P} & \xrightarrow{\text{bv}_k^P} & F_k^P & \longrightarrow & 0 \\ & & \uparrow i_* & & \uparrow i_* & & \uparrow i_k & & \\ 0 & \longrightarrow & \mathcal{K}_{(k+1)}^{\mathbb{R}X_\varepsilon} & \longrightarrow & \mathcal{K}_{(k)}^{\mathbb{R}X_\varepsilon} & \xrightarrow{\text{bv}_k^X} & F_k^X & \longrightarrow & 0 \\ & & \uparrow & & \uparrow & & \uparrow & & \\ & & 0 & & 0 & & 0 & & \end{array} \quad (4.6)$$

*Proof.* Let  $\sigma^p \leq \sigma^q$  be a pair of simplices of the triangulation  $K$  and  $k \in \mathbb{N}$ . From Diagram (4.2) of Lemma 4.2.16 and Proposition 3.1.14 we derive the following com-

mutative diagram with exact rows and columns:

$$\begin{array}{ccccccc}
 & & 0 & & 0 & & 0 \\
 & & \uparrow & & \uparrow & & \uparrow \\
 0 & \longrightarrow & F_k^X(\sigma^p; \sigma^q) & \xrightarrow{i_k} & F_k^P(\sigma^p; \sigma^q) & \xrightarrow{\omega \cdot -} & \bigwedge^{k-p} TA \longrightarrow 0 \\
 & & \uparrow \text{bv}_k^X & & \uparrow \text{bv}_k^P & & \uparrow \text{bv}_k^{TA} \\
 0 & \longrightarrow & \mathcal{K}_{(k)}^{\mathbb{R}X_\varepsilon}(\sigma^p; \sigma^q) & \xrightarrow{i_*} & \mathcal{K}_{(k)}^{\mathbb{R}P}(\sigma^p; \sigma^q) & \xrightarrow{x^o(\chi_A \cdot -)} & \mathfrak{m}_{TA}^{k-p} \longrightarrow 0 \\
 & & \uparrow & & \uparrow & & \uparrow \\
 0 & \longrightarrow & \mathcal{K}_{(k+1)}^{\mathbb{R}X_\varepsilon}(\sigma^p; \sigma^q) & \xrightarrow{i_*} & \mathcal{K}_{(k+1)}^{\mathbb{R}P}(\sigma^p; \sigma^q) & \xrightarrow{x^o(\chi_A \cdot -)} & \mathfrak{m}_{TA}^{k+1-p} \longrightarrow 0 \\
 & & \uparrow & & \uparrow & & \uparrow \\
 & & 0 & & 0 & & 0
 \end{array}$$

where  $A$  is the codimension  $p$  affine sub-space of  $F_1^P(\sigma^p; \sigma^q)$  complementary to  $\text{Arg}_\varepsilon(\sigma^p; \sigma^q)$ ,  $o$  is a point of  $A$ , and  $\omega$  is the generator of  $\bigwedge^p \left( F_1^P(\sigma^p; \sigma^q) / TA \right)^*$ .  $\square$

**Remark 4.2.23.** If  $x^o \prod_{i=1}^k (1+x^{v_i})$  belongs to  $\mathcal{K}_{(k)}^{\mathbb{R}P}(\sigma^p; \sigma^q)$ , its image under  $\text{bv}_k^P(\sigma^p; \sigma^q)$  is  $\bigwedge_{i=1}^k v_i$ .

**Proposition 4.2.24.** *The Borel-Viro morphism  $\text{bv}_P^k$  of Definition 4.2.18 composed with  $i^k : F_P^k \rightarrow F_X^k$  can be factored by  $i^* : \mathcal{O}_{\mathbb{R}P}^{(k)} \rightarrow \mathcal{O}_{\mathbb{R}X_\varepsilon}^{(k)}$  and we denote this factorisation by  $\text{bv}_X^k$ . As a consequence we have the following commutative diagram with exact rows and columns:*

$$\begin{array}{ccccccc}
 0 & \longrightarrow & \mathcal{O}_{\mathbb{R}P}^{(k-1)} & \longrightarrow & \mathcal{O}_{\mathbb{R}P}^{(k)} & \xrightarrow{\text{bv}_P^k} & F_P^k \longrightarrow 0 \\
 & & \downarrow i^* & & \downarrow i^* & & \downarrow i^k \\
 0 & \longrightarrow & \mathcal{O}_{\mathbb{R}X_\varepsilon}^{(k-1)} & \longrightarrow & \mathcal{O}_{\mathbb{R}X_\varepsilon}^{(k)} & \xrightarrow{\text{bv}_X^k} & F_X^k \longrightarrow 0 \\
 & & \downarrow & & \downarrow & & \downarrow \\
 & & 0 & & 0 & & 0
 \end{array} \tag{4.7}$$

*Proof.* Let  $\sigma^p \leq \sigma^q$  be a pair of simplices of the triangulation  $K$  and  $k \in \mathbb{N}$ . By dualising Diagram (4.2) of Lemma 4.2.16 and using Proposition 3.1.14 and Proposition 3.1.10 we derive the following commutative diagram with exact rows and

columns:

$$\begin{array}{ccccccc}
 & & 0 & & 0 & & 0 \\
 & & \uparrow & & \uparrow & & \uparrow \\
 0 & \longrightarrow & \bigwedge^{k-p} (TA)^* & \xrightarrow{\omega \wedge -} & F_P^k(\sigma^p; \sigma^q) & \xrightarrow{i^k} & F_X^k(\sigma^p; \sigma^q) \longrightarrow 0 \\
 & & \text{bv}_{TA}^{k-p} \uparrow & & \text{bv}_P^k \uparrow & & \text{bv}_X^k \uparrow \\
 0 & \longrightarrow & \mathcal{O}^{(k-p)}(TA) & \xrightarrow{\text{ext}_A} & \mathcal{O}_{\mathbb{R}P}^{(k)}(\sigma^p; \sigma^q) & \xrightarrow{i^*} & \mathcal{O}_{\mathbb{R}X_\varepsilon}^{(k)}(\sigma^p; \sigma^q) \longrightarrow 0 \\
 & & \uparrow & & \uparrow & & \uparrow \\
 0 & \longrightarrow & \mathcal{O}^{(k-1-p)}(TA) & \xrightarrow{\text{ext}_A} & \mathcal{O}_{\mathbb{R}P}^{(k-1)}(\sigma^p; \sigma^q) & \xrightarrow{i^*} & \mathcal{O}_{\mathbb{R}X_\varepsilon}^{(k-1)}(\sigma^p; \sigma^q) \longrightarrow 0 \\
 & & \uparrow & & \uparrow & & \uparrow \\
 & & 0 & & 0 & & 0
 \end{array}$$

where  $A$  is the codimension  $p$  affine sub-space of  $F_1^P(\sigma^p; \sigma^q)$  defined as the complementary sub-set of  $\text{Arg}_\varepsilon(\sigma^p; \sigma^q)$ ,  $\text{ext}_A$  is the composition of the translation isomorphism  $f \in \mathcal{O}(TA) \mapsto [x \mapsto f(x + o)] \in \mathcal{O}(A)$ , for a choice of  $o \in A$ , with the extension by 0 to a map of  $\mathcal{O}(F_1^P(\sigma^p; \sigma^q))$ , and  $\omega$  is the generator of the dual of  $\bigwedge^p F_1^P(\sigma^p; \sigma^q) / TA$ .  $\square$

**Properties of the Spectral Sequences.** Theorem 3.1.16 and Theorem 3.1.17 together with Proposition 4.2.22 and Proposition 4.2.24 induce a description of the Kalinin spectral sequences.

**Theorem 4.2.25** (A. Borel and A. Haefliger, [BH61], §5.15 p.496). *The spectral sequences  $(E_{p,q}^r(\mathbb{R}P))_{p,q,r \geq 0}$  and  $(E_r^{p,q}(\mathbb{R}P))_{p,q,r \geq 0}$  degenerate at the first page (i.e.  $\partial^r$  and  $d_r$  vanish for all integers  $r \geq 1$ ). Moreover, the graded algebra  $(H^q(\mathbb{R}P; \mathbb{F}_2); \cup)_{q \geq 0}$  is isomorphic to  $(H^{q,q}(P; \mathbb{F}_2); \cup)_{q \geq 0}$ .*

**Remark 4.2.26.** The isomorphism  $H^1(\mathbb{R}P; \mathbb{F}_2) \rightarrow H^{1,1}(P; \mathbb{F}_2)$  maps the class  $[\omega_{\mathbb{R}X}]$  to the class  $[\omega_X]$ . Proposition 3.1.21 characterises when the latter vanishes.

**Theorem 4.2.27** (Structure of the Spectral Sequences of  $\mathbb{R}X_\varepsilon$ , A. Renaudineau and K. Shaw, [RS23] Lemma 6.3 p.26 and Proposition 4.12 p.24). *The first page  $(E_{p,q}^1(\mathbb{R}X_\varepsilon))_{p,q \geq 0}$  is isomorphic to the tropical homology  $(H_{p,q}(X; \mathbb{F}_2))_{p,q \geq 0}$ . Moreover for all integers  $r \geq 2$ , the only possibly non-trivial groups of the  $r$ -th page  $(E_{p,q}^r(\mathbb{R}X_\varepsilon))_{p,q \geq 0}$  are located on the line segments  $\{p = q \text{ and } 0 \leq q \leq n - 1\}$  and  $\{p + q = n - 1 \text{ and } 0 \leq q \leq n - 1\}$ . Figure 4.2 depicts the shape of such a spectral sequence. Hence, the only possibly non-trivial boundary operators  $(\partial_{p,q}^r)_{p,q \geq 0}$  are:*

$$\partial_{\frac{n-r}{2}, \frac{n-r}{2}}^r \quad \text{and} \quad \partial_{\frac{n-r}{2}-1, \frac{n+r}{2}}^r,$$

when  $r$  is congruent to  $n$  modulo 2. By duality the same holds for the dual page

$(E_r^{p,q}(\mathbb{R}X_\varepsilon))_{p,q \geq 0}$ . However, this time the possibly non-trivial differentials are:

$$d_r^{\frac{n+r}{2}, \frac{n-r}{2}-1} \quad \text{and} \quad d_r^{\frac{n+r}{2}-1, \frac{n+r}{2}-1},$$

under the same hypothesis  $r = n \pmod{2}$ .

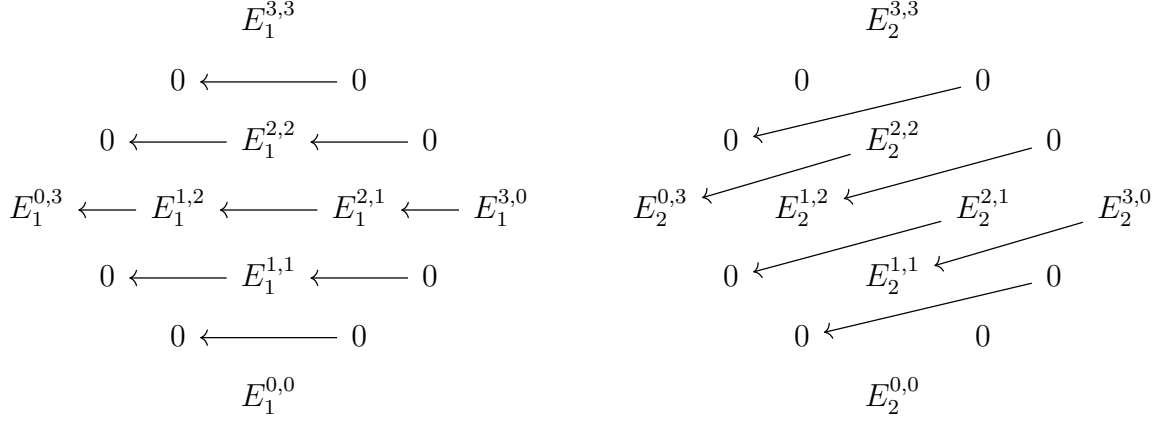

(a) The first page.

(b) The second page.

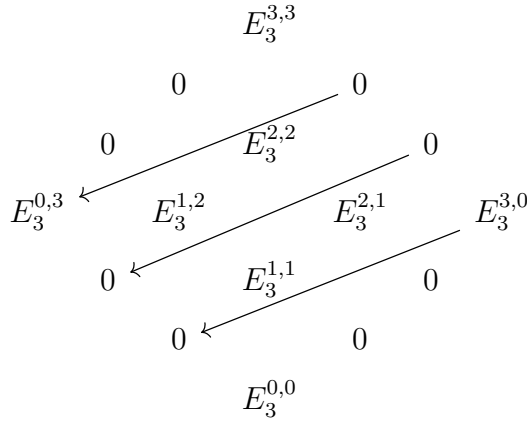

(c) The third page.

Figure 4.2: Some page of the spectral sequence of a T-hypersurface of dimension 3.

Following Theorem 4.2.27 we will say that a page of the spectral sequences of  $\mathbb{R}X_\varepsilon$  is *irrelevant* if its differentials or boundary operators are all trivial for having either a trivial source or a trivial target. The other ones, which we call the *relevant* pages are those for which  $0 \leq r \leq 1$ , or  $2 \leq r \leq n - 1$  and  $r = n \pmod{2}$ .

**Theorem 4.2.28** (Symmetry). *For all  $r \geq 1$ , the  $E_r$ -pages of the Renaudineau-Shaw spectral sequence computing the cohomology of  $\mathbb{R}X_\varepsilon$  satisfy the Poincaré duality. That is to say:*

1. The vector space  $E_r^{p,q}(\mathbb{R}X_\varepsilon)$  vanishes whenever  $p > n - 1$  or  $q > n - 1$ ;

2. The vector space  $E_r^{n-1, n-1}(\mathbb{R}X_\varepsilon)$  has dimension 1;
3. The bilinear pairing  $\cup : E_r^{p, q}(\mathbb{R}X_\varepsilon) \otimes E_r^{n-1-p, n-1-q}(\mathbb{R}X_\varepsilon) \rightarrow E_r^{n-1, n-1}(\mathbb{R}X_\varepsilon)$  is non-degenerate.

In particular,  $E_r^{p, q}(\mathbb{R}X_\varepsilon)$  is isomorphic to  $E_r^{n-1-p, n-1-q}(\mathbb{R}X_\varepsilon)$  and  $d_r^{p, q}$  has the same rank and kernel dimension as  $d_r^{n-1-p+r, n-2-q}$ .

*Proof.* By construction the first page of the spectral sequence  $(E_1^{p, q}(\mathbb{R}X_\varepsilon))_{p, q \geq 0}$  is the cohomology of the sheaf of graded algebras associated with  $\mathcal{O}_{\mathbb{R}X_\varepsilon}$ . Following Proposition 4.2.24, this sheaf is isomorphic to the sheaf of graded algebras  $\bigoplus_{k=1}^{n-1} F_X^k$ . On that account  $E_1^{p, q}(\mathbb{R}X_\varepsilon)$  is isomorphic, for all  $p, q \in \mathbb{N}$ , to the tropical cohomology group  $H^{p, q}(X; \mathbb{F}_2)$ . Furthermore, this isomorphism respects the cup product. Using Theorem 3.1.17, this page satisfies the Poincaré duality and the theorem follows from Lemma A.5.  $\square$

**Corollary 4.2.29.** *If  $\mathbb{R}X_\varepsilon$  is even dimensional, i.e.  $P$  has odd dimension, then the total Betti number of  $\mathbb{R}X_\varepsilon$  satisfies:*

$$\sum_{i=1}^{n-1} \dim H_i(\mathbb{R}X_\varepsilon; \mathbb{F}_2) = \sum_{p, q=0}^{n-1} \dim H_{p, q}(X; \mathbb{F}_2) \pmod{4}.$$

*Proof.* By the Universal Coefficient Theorem<sup>14</sup> and duality the statement of the corollary is equivalent to:

$$\sum_{i=1}^{n-1} \dim H^i(\mathbb{R}X_\varepsilon; \mathbb{F}_2) = \sum_{p, q=0}^{n-1} \dim H^{p, q}(X; \mathbb{F}_2) \pmod{4}.$$

Using the convergence of the spectral sequence  $(E_r^{p, q}(\mathbb{R}X_\varepsilon))_{p, q, r \geq 0}$  and Theorem 4.2.27 we find that:

$$\begin{aligned} \sum_{i=1}^{n-1} \dim H^i(\mathbb{R}X_\varepsilon; \mathbb{F}_2) &= \sum_{p, q=0}^{n-1} \dim E_1^{p, q}(\mathbb{R}X_\varepsilon) - \sum_{r \geq 1} \sum_{p, q=0}^{n-1} 2 \operatorname{rk} d_r^{p, q} \\ &= \sum_{p, q=0}^{n-1} \dim E_1^{p, q}(\mathbb{R}X_\varepsilon) - \underbrace{\sum_{\substack{p+q=n-1 \\ 0 \leq q \leq n-2}} 2 \operatorname{rk} d_1^{p, q}}_U \\ &\quad - \underbrace{\sum_{\substack{r \geq 2 \\ r=n(\bmod 2)}} 2(\operatorname{rk} d_r^{\frac{n+r}{2}, \frac{n-r}{2}-1} + \operatorname{rk} d_r^{\frac{n+r}{2}-1, \frac{n+r}{2}-1})}_V. \end{aligned}$$

From Theorem 4.2.28 we know that  $d_r^{\frac{n+r}{2}, \frac{n-r}{2}-1}$  and  $d_r^{\frac{n+r}{2}-1, \frac{n+r}{2}-1}$  have same rank since  $n-1-\frac{n+r}{2}+r$  equals  $\frac{n+r}{2}-1$ , and  $n-2-\frac{n-r}{2}+1$  equals  $\frac{n+r}{2}-1$ . It follows that  $V$  is divisible by 4. Using the same argument we get that the differential  $d_1^{p, q}$  has

<sup>14</sup>c.f. [CE56] Theorem 3.3a p.114.



the same rank as the differential  $d_1^{q+1,p-1}$ . Thus  $U$  is also divisible by 4 whenever  $n$  is odd. Finally we deduce Corollary 4.2.29 by remembering that  $E_1^{p,q}(\mathbb{R}X_\varepsilon)$  is isomorphic to  $H^{p,q}(X; \mathbb{F}_2)$ .  $\square$

**Remark 4.2.30.** It was pointed out to me by I. Itenberg in a conference that Corollary 4.2.29 could already be deduced from the fact that the Euler characteristic  $\chi(\mathbb{R}X_\varepsilon)$  is equal to the signature of a non-singular hypersurface  $\mathbb{C}X$  of the complex locus of the toric variety associated with  $P$  and arising from a section the ample line bundle associated with the polytope<sup>15</sup>. Indeed, because  $\mathbb{R}X_\varepsilon$  is of even dimension  $2k$  and satisfies the Poincaré duality with  $\mathbb{F}_2$ -coefficients its total Betti number is congruent to  $(-1)^k \chi(\mathbb{R}X_\varepsilon)$  modulo 4. From Lemma 2.2 p.148 of [Kha73], the signature  $\sigma(\mathbb{C}X)$  is congruent to  $(-1)^k \chi(\mathbb{C}X)$  modulo 4. Therefore, the total Betti number of  $\mathbb{R}X_\varepsilon$  is congruent to  $\chi(\mathbb{C}X)$  modulo 4. Since  $\mathbb{C}X$  only has homology in even dimensions  $\chi(\mathbb{C}X)$  equals its total Betti number.

**Theorem 4.2.31** (Vanishing Criterion). *Let  $r \geq 2$  be an integer congruent to  $n$  modulo 2. The differentials of the relevant page  $E_r(\mathbb{R}X_\varepsilon)$  are all zero if and only if  $i^q : H^q(\mathbb{R}P; \mathbb{F}_2) \rightarrow H^q(\mathbb{R}X_\varepsilon; \mathbb{F}_2)$  is injective when  $q$  equals  $\frac{n-r}{2}$ .*

*Proof.* Let  $r \geq 2$  and  $r = n \pmod{2}$ . By Theorem 4.2.27 the only possibly non-trivial differentials of the  $r$ -th page are:

$$d_r^{\frac{n+r}{2}, \frac{n-r}{2}-1} \quad \text{and} \quad d_r^{\frac{n+r}{2}-1, \frac{n+r}{2}-1}.$$

Following Theorem 4.2.28, they have the same rank so one vanishes if and only the other does. Let  $q$  be  $\frac{n-r}{2}$ , we have the commutative diagram:

$$\begin{array}{ccc} E_r^{q+r, q-1}(\mathbb{R}P) & \xrightarrow{i_r^{q+r, q-1}} & E_r^{q+r, q-1}(\mathbb{R}X_\varepsilon) \\ d_r^{q+r, q-1} \downarrow & & \downarrow d_r^{q+r, q-1} \\ E_r^{q, q}(\mathbb{R}P) & \xrightarrow{i_r^{q, q}} & E_r^{q, q}(\mathbb{R}X_\varepsilon) \end{array} \quad (4.8)$$

Using Theorem 4.2.25, Theorem 4.2.27, and Proposition 4.2.24 the commutative diagram (4.8) can be written as follows:

$$\begin{array}{ccc} 0 & \longrightarrow & E_2^{q+r, q-1}(\mathbb{R}X_\varepsilon) \\ \downarrow & & \downarrow d_r^{q+r, q-1} \\ H^{q, q}(P; \mathbb{F}_2) & \xrightarrow{i^{q, q}} & H^{q, q}(X; \mathbb{F}_2) \end{array}$$

Since  $2q = n - r < n - 1$  by assumption, the tropical Lefschetz Hyperplane Section Theorem<sup>16</sup> implies that  $i^{q, q}$  is an isomorphism. As a consequence  $d_r^{q+r, q-1}$  vanishes if and only if the map  $i_{r+1}^{q, q} : E_{r+1}^{q, q}(\mathbb{R}P) \rightarrow E_{r+1}^{q, q}(\mathbb{R}X_\varepsilon)$  is injective. Furthermore, we

<sup>15</sup>c.f. [Ber10] Theorem 2.1 p.12 and [BLdMR22] Theorem 1.3 p.4.

<sup>16</sup>c.f. [ARS21] Theorem 1.1 p.1348 and [BM71] Proposition 3.2 p.15.

have the following exact sequence:

$$0 \rightarrow E_{\infty}^{q,q}(\mathbb{R}X_{\varepsilon}) \rightarrow H^q(\mathbb{R}X_{\varepsilon}; \mathbb{F}_2) \rightarrow E_{\infty}^{n-1-q,q}(\mathbb{R}X_{\varepsilon}) \rightarrow 0.$$

Since  $E_{\infty}^{q,q}(\mathbb{R}X_{\varepsilon})$  is isomorphic to  $E_{r+1}^{q,q}(\mathbb{R}X_{\varepsilon})$ ,  $H^q(\mathbb{R}P; \mathbb{F}_2)$  is isomorphic to  $E_{r+1}^{q,q}(\mathbb{R}P)$ , and the morphism  $i^q: H^q(\mathbb{R}P; \mathbb{F}_2) \rightarrow H^q(\mathbb{R}X_{\varepsilon}; \mathbb{F}_2)$  respects the filtration, the morphism  $i_{r+1}^{q,q}$  is injective if and only if  $i^q$  is.  $\square$

From this vanishing criterion we deduce the following corollary:

**Corollary 4.2.32** (Criterion of Degeneracy). *Let  $r_0 \geq 2$  be an integer congruent to  $n$  modulo 2. The differentials  $d_r^{p,q}$  of the Renaudineau-Shaw spectral sequence computing the cohomology of  $\mathbb{R}X_{\varepsilon}$  vanish for all  $p, q \geq 0$ , and all  $r \geq r_0$ , if and only if the cohomological inclusions  $i^q: H^q(\mathbb{R}P; \mathbb{F}_2) \rightarrow H^q(\mathbb{R}X_{\varepsilon}; \mathbb{F}_2)$  are injective for all  $q \leq \frac{n-r_0}{2}$ . In particular, all the differentials  $d_r^{p,q}$  are trivial for all  $r \geq 2$  if and only if the cohomological inclusions  $i^q: H^q(\mathbb{R}P; \mathbb{F}_2) \rightarrow H^q(\mathbb{R}X_{\varepsilon}; \mathbb{F}_2)$  are injective for all  $q \leq \lfloor \frac{n}{2} \rfloor - 1$ .*

Corollary 4.2.32 can be interpreted as a comparison of two invariants of the pair  $\mathbb{R}X_{\varepsilon} \subset \mathbb{R}P$ . The first one is the following:

**Definition 4.2.33.** We define the *degeneracy index* of  $\mathbb{R}X_{\varepsilon}$  as:

$$r(\mathbb{R}X_{\varepsilon}) := \min \{ r_0 \geq 0 \mid d_r^{p,q} = 0, \forall p, q \in \mathbb{N}, \forall r \geq r_0 \}.$$

The second invariant was introduced by I.O. Kalinin for projective hypersurfaces and named the *rank* of the hypersurface by O. Viro:

**Definition 4.2.34.** The *rank* of  $\mathbb{R}X_{\varepsilon}$  is defined as:

$$\ell(\mathbb{R}X_{\varepsilon}) := \max \{ q_0 \geq 0 \mid i^q: H^q(\mathbb{R}P; \mathbb{F}_2) \rightarrow H^q(\mathbb{R}X_{\varepsilon}; \mathbb{F}_2) \text{ is injective for all } q \leq q_0 \}.$$

**Corollary 4.2.35.** *We have the inequalities:*

$$\ell(\mathbb{R}X_{\varepsilon}) \geq \left\lfloor \frac{n - r(\mathbb{R}X_{\varepsilon})}{2} \right\rfloor,$$

with equality if  $r(\mathbb{R}X_{\varepsilon}) \geq 3 + \frac{1-(-1)^n}{2}$  and:

$$r(\mathbb{R}X_{\varepsilon}) \leq \max(2; n - 2\ell(\mathbb{R}X_{\varepsilon}) - 1),$$

with equality if  $\ell(\mathbb{R}X_{\varepsilon}) \leq \frac{n-5}{2}$ .

*Proof.* In a first time we prove the first inequality. The number  $r(\mathbb{R}X_{\varepsilon})$  lies between 1 and  $n - 1$ . Assume  $r(\mathbb{R}X_{\varepsilon}) \geq 2$  and let us denote by  $R$  and  $L$  the sets:

$$\begin{cases} R := \{ 2 \leq r_0 \leq n \mid d_r^{p,q} = 0, \forall p, q \in \mathbb{N}, \forall r \geq r_0 \}, \\ L := \{ q_0 \geq 0 \mid i^q: H^q(\mathbb{R}P; \mathbb{F}_2) \rightarrow H^q(\mathbb{R}X_{\varepsilon}; \mathbb{F}_2) \text{ is injective for all } q \leq q_0 \}. \end{cases}$$

If we denote by  $f$  the map  $r \mapsto \lfloor \frac{n-r}{2} \rfloor$ , Corollary 4.2.32 implies that  $f(R)$  is a subset of  $L$ . Since  $f$  is non-increasing  $\ell(\mathbb{R}X_\varepsilon)$  is at least equal to  $f(\min R) = f(r(\mathbb{R}X_\varepsilon))$ . If  $r(\mathbb{R}X_\varepsilon) = 1$  then the hypersurface  $\mathbb{R}X_\varepsilon$  is maximal for the Smith-Thom inequality<sup>17</sup>. There are two cases depending on the parity of  $n - 1$ . If  $n - 1$  is odd then the inequality is a direct consequence of Corollary 4.2.32. If  $n - 1$  is even then we have to show that  $i^{\frac{n-1}{2}}$  is also injective. In the first page of the Renaudineau-Shaw spectral sequences we have the following commutative diagram:

$$\begin{array}{ccc} E_1^{\frac{n+1}{2}, \frac{n-3}{2}}(\mathbb{R}P) & \xrightarrow{i_1^{\frac{n+1}{2}, \frac{n-3}{2}}} & E_1^{\frac{n+1}{2}, \frac{n-3}{2}}(\mathbb{R}X_\varepsilon) \\ \downarrow d_1^{\frac{n+1}{2}, \frac{n-3}{2}} & & \downarrow d_1^{\frac{n+1}{2}, \frac{n-3}{2}} \\ E_1^{\frac{n-1}{2}, \frac{n-1}{2}}(\mathbb{R}P) & \xrightarrow{i_1^{\frac{n-1}{2}, \frac{n-1}{2}}} & E_1^{\frac{n-1}{2}, \frac{n-1}{2}}(\mathbb{R}X_\varepsilon) \end{array}$$

Using the maximality hypothesis as well as Theorem 4.2.25, Theorem 4.2.27, and Proposition 4.2.24 this commutative diagram can be written as follows:

$$\begin{array}{ccc} 0 & \longrightarrow & H^{\frac{n+1}{2}, \frac{n-3}{2}}(X; \mathbb{F}_2) \\ \downarrow & & \downarrow 0 \\ H^{\frac{n-1}{2}, \frac{n-1}{2}}(P; \mathbb{F}_2) & \xrightarrow{i^{\frac{n-1}{2}, \frac{n-1}{2}}} & H^{\frac{n-1}{2}, \frac{n-1}{2}}(X; \mathbb{F}_2) \end{array}$$

Where  $i^{\frac{n-1}{2}, \frac{n-1}{2}}$  is injective by the tropical Lefschetz Hyperplane Section Theorem<sup>18</sup>. Since  $\mathbb{R}X_\varepsilon$  is maximal  $H^{\frac{n-1}{2}}(\mathbb{R}X_\varepsilon; \mathbb{F}_2)$  is isomorphic to  $H^{\frac{n-1}{2}, \frac{n-1}{2}}(X; \mathbb{F}_2)$  and the morphism  $i^{\frac{n-1}{2}} : H^{\frac{n-1}{2}}(\mathbb{R}P; \mathbb{F}_2) \rightarrow H^{\frac{n-1}{2}}(\mathbb{R}X_\varepsilon; \mathbb{F}_2)$  is conjugated to the morphism  $i^{\frac{n-1}{2}, \frac{n-1}{2}} : H^{\frac{n-1}{2}, \frac{n-1}{2}}(P; \mathbb{F}_2) \rightarrow H^{\frac{n-1}{2}, \frac{n-1}{2}}(X; \mathbb{F}_2)$ . As a consequence  $i^{\frac{n-1}{2}}$  is also injective. If  $r(\mathbb{R}X_\varepsilon) \geq 3 + \frac{1-(-1)^n}{2}$  then the differentials of at least one relevant page are non-trivial. Then, using Corollary 4.2.32 we find that the map  $i^q$  is not injective for the corresponding index  $q$  and the equality follows. To prove the second inequality we use the converse implication of Corollary 4.2.32 to find that:

$$\begin{aligned} r(\mathbb{R}X_\varepsilon) &\leq \min \left\{ r \geq 2 \mid i^q \text{ is injective for all } q \leq \lfloor \frac{n-r}{2} \rfloor \right\} \\ &\leq \min \left\{ r \geq 2 \mid \lfloor \frac{n-r}{2} \rfloor \leq \ell(\mathbb{R}X_\varepsilon) \right\} \\ &\leq \min \left( \left\{ r \geq 2 \mid \frac{n-r}{2} \leq \ell(\mathbb{R}X_\varepsilon) \right\} \right. \\ &\quad \left. \cup \left\{ r \geq 2 \mid \lfloor \frac{n-r}{2} \rfloor \leq \ell(\mathbb{R}X_\varepsilon) < \frac{n-r}{2} \right\} \right) \\ &\leq \min \left( \left\{ \max(2; n - 2\ell(\mathbb{R}X_\varepsilon)) \right\} \right. \\ &\quad \left. \cup \left\{ r \geq 2 \mid \lfloor \frac{n-r}{2} \rfloor \leq \ell(\mathbb{R}X_\varepsilon) < \frac{n-r}{2} \right\} \right). \end{aligned}$$

<sup>17</sup>c.f. [RS23] Theorem 6.1 p.26.

<sup>18</sup>c.f. [ARS21] Theorem 1.1 p.1348 and [BM71] Proposition 3.2 p.15.

The set  $\{r \geq 2 \mid \lfloor \frac{n-r}{2} \rfloor \leq \ell(\mathbb{R}X_\varepsilon) < \frac{n-r}{2}\}$  is either empty or reduced to the singleton  $\{n - 2\ell(\mathbb{R}X_\varepsilon) - 1\}$ . The latter case only occurs when  $n - 2\ell(\mathbb{R}X_\varepsilon) - 1 \geq 2$  i.e.  $\ell(\mathbb{R}X_\varepsilon) \leq \frac{n-3}{2}$ . In that case we find  $r(\mathbb{R}X_\varepsilon) \leq n - 2\ell(\mathbb{R}X_\varepsilon) - 1$ . If on the contrary  $\ell(\mathbb{R}X_\varepsilon) \geq \frac{n-1}{2}$  then  $\max(2; n - 2\ell(\mathbb{R}X_\varepsilon)) = 2$  and  $r(\mathbb{R}X_\varepsilon) \leq 2$ . Therefore,  $r(\mathbb{R}X_\varepsilon)$  is at most equal to  $\max(2; n - 2\ell(\mathbb{R}X_\varepsilon) - 1)$ . The associated equality follows from Corollary 4.2.32 since under the assumption  $\ell(\mathbb{R}X_\varepsilon) \leq \frac{n-5}{2}$  there is at least one relevant page of index at least 2 with non-trivial differentials.  $\square$

Corollary 4.2.32 can be improved for a particular class of real toric varieties whose cohomology ring have a property related to Hard Lefschetz Theorem<sup>19</sup>:

**Definition 4.2.36.** Let  $Y$  be a topological space and  $\alpha \in H^1(Y; \mathbb{F}_2)$ . We denote by  $\iota(\alpha)$  the minimum of the integers  $q \geq -1$  for which there exists a non-zero class  $\beta \in H^{q+1}(Y; \mathbb{F}_2)$  for which  $\alpha \cup \beta$  vanishes. We denote the maximum of the  $\iota(\alpha)$ 's for all  $\alpha \in H^1(Y; \mathbb{F}_2)$  by  $\iota(Y)$ .

**Remark 4.2.37.** For any  $n$ -dimensional smooth polytope  $P$  the number  $\iota(\mathbb{R}P)$  is at most  $n - 1$ . The Hard Lefschetz Theorem might lead us to think that  $\iota(\mathbb{R}P)$  is always at least equal to  $\lfloor \frac{n}{2} \rfloor - 1$  since the cohomology ring of  $\mathbb{R}P$  with  $\mathbb{F}_2$ -coefficients is isomorphic, up to dividing the grading by 2, to the reduction modulo 2 of the integral cohomology ring of its complex locus  $\mathbb{C}P$ . However, the powers of the class of a primitive ample line bundle might be divisible by 2 from a certain rank. This phenomenon is illustrated in the fourth point of Examples 4.2.38. Nevertheless, we can deduce from the Hard Lefschetz Theorem that  $\iota(\mathbb{R}P)$  being greater than  $\lfloor \frac{n}{2} \rfloor - 1$  is a constraint on the polytope  $P$ . Since the Betti numbers of  $\mathbb{R}P$  form an unimodal sequence centered at  $\frac{n}{2}$ , if  $\iota(\mathbb{R}P) \geq \lfloor \frac{n}{2} \rfloor$  then all the  $q$ -th Betti numbers of  $\mathbb{R}P$  must be equal for all  $n - \iota(\mathbb{R}P) - 1 \leq q \leq \iota(\mathbb{R}P) + 1$ , as in the third point of Examples 4.2.38. The only polytope  $P$  satisfying  $\iota(\mathbb{R}P) = n - 1$  is the simplex.

**Examples 4.2.38.** Here we give examples of the numbers  $\iota(Y)$  when  $Y$  is the real locus of a smooth projective toric variety:

1. If  $P$  is a non-singular simplex its associated toric variety is a projective space. The cohomology ring of  $\mathbb{R}P$  is isomorphic to  $\mathbb{F}_2[h]/(h^{n+1})$  where  $n$  is the dimension of the simplex. We have  $\iota(\mathbb{R}P) = n - 1$ ;
2. If  $P$  is the product of two non-singular simplices then the cohomology ring associated with  $\mathbb{R}P$  is  $\mathbb{F}_2[h_1, h_2]/(h_1^{n_1+1}, h_2^{n_2+1})$ . If  $n_1 \leq n_2$  any class of the form  $h_2 + uh_1$ ,  $u \in \mathbb{F}_2$ , has  $\iota(h_2 + uh_1) = n_2 - 1$ , the other non-zero classes have  $\iota(h_1) = n_1 - 1$ . Therefore,  $\iota(\mathbb{R}P) = \max(n_1; n_2) - 1$ ;
3. We say that a simple integer polytope  $P$  is a *blow-up* of a simple integer polytope  $Q$  if  $P$  is obtained by chopping off one of its corner. More precisely, the corner to be chopped off must be adjacent to edges of integral length at least 2 and the chopping hyperplane must pass through integer points of these edges at equal integer distances from the corner. See Figure 4.3 for

<sup>19</sup>c.f. [Wel07] Corollary 4.13 p.195.

instance. The corner vertex of the polytope corresponds to a fixed point of the torus action on the associated toric variety. Chopping off the corner corresponds to blowing-up the fixed point. One can find a description of the normal fan on pp.40-41 of [Ful93]. The space  $\mathbb{R}P$  is the connected sum of  $\mathbb{R}Q$  with  $\mathbb{R}P^n$ . Using the Mayer-Vietoris exact sequence<sup>20</sup> we find that  $\bigoplus_{q \in \mathbb{N}} H^q(\mathbb{R}P; \mathbb{F}_2)$  is the quotient of  $(\bigoplus_{q \in \mathbb{N}} H^q(\mathbb{R}Q; \mathbb{F}_2))[x]$  by the ideal  $(x\alpha : \alpha \in \bigoplus_{q \geq 1} H^q(\mathbb{R}Q; \mathbb{F}_2)) + (x^n + [\mathbb{R}Q]^*)$  where  $[\mathbb{R}Q]^*$  is the generator of  $H^n(\mathbb{R}Q; \mathbb{F}_2)$ . Therefore, if  $\alpha \in H^1(\mathbb{R}Q; \mathbb{F}_2)$  then the class of  $P$ ,  $\alpha + x$  satisfies  $\iota(\alpha + x) = \min(\iota(\alpha); n - 2)$ . However, the class  $\alpha$ , seen as a class of  $P$ , has  $\iota$ -number equal to either 0 or  $-1$ . Since  $x$  has  $\iota$ -number equal to 0 we find that  $\iota(\mathbb{R}P) = \min(\iota(\mathbb{R}Q); n - 2)$ .

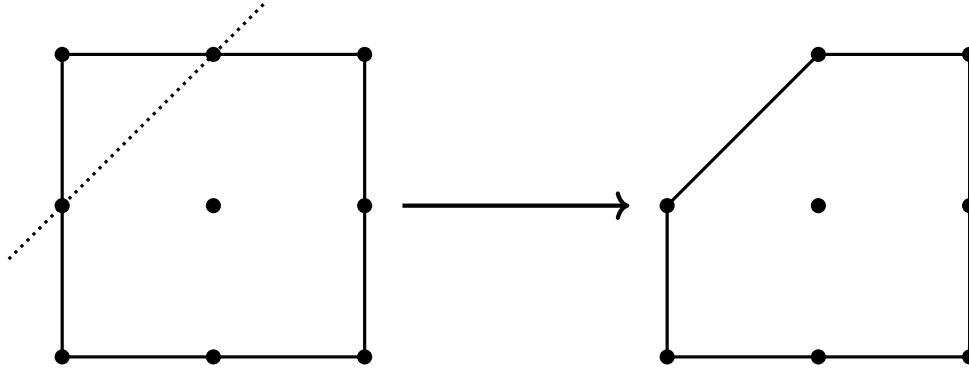

Figure 4.3: A blow-up of  $\mathbb{P}^1 \times \mathbb{P}^1$ .

4. Let  $I^n$  be the  $n$ -dimensional cube. The cohomology ring  $\bigoplus_{q \in \mathbb{N}} H^q(\mathbb{R}I^n; \mathbb{F}_2)$  is the exterior algebra  $\bigwedge H^1(\mathbb{R}I^n; \mathbb{F}_2)$  so any class of degree 1 squares to 0. Therefore,  $\iota(\mathbb{R}I^n) = 0$ .

**Corollary 4.2.39.** *Let  $r_0 \geq 2$  be an integer congruent to  $n$  modulo 2. If  $\iota(\mathbb{R}P)$  is at least  $\lfloor \frac{n}{2} \rfloor - 2$  then the differentials  $d_{p,q}^r$  of the Renaudineau-Shaw spectral sequence computing the cohomology of  $\mathbb{R}X_\varepsilon$  vanish for all  $p, q \in \mathbb{N}$ , and all  $r \geq r_0$ , if and only if the cohomological inclusion  $i^q : H^q(\mathbb{R}P; \mathbb{F}_2) \rightarrow H^q(\mathbb{R}X_\varepsilon; \mathbb{F}_2)$  is injective for  $q = \frac{n-r_0}{2}$ . In particular, all the differentials  $d_{p,q}^r$  are trivial for all  $r \geq 2$  if and only if the cohomological inclusion  $i^q : H^q(\mathbb{R}P; \mathbb{F}_2) \rightarrow H^q(\mathbb{R}X_\varepsilon; \mathbb{F}_2)$  is injective for  $q = \lfloor \frac{n}{2} \rfloor - 1$*

*Proof.* Let  $\omega$  be a class of  $P$  for which  $\iota(\omega) \geq \lfloor \frac{n}{2} \rfloor - 2$ . For all  $q \in \mathbb{N}$ , we have the following commutative diagram:

$$\begin{array}{ccc} H^q(\mathbb{R}P; \mathbb{F}_2) & \xrightarrow{i^q} & H^q(\mathbb{R}X_\varepsilon; \mathbb{F}_2) \\ \omega \cup - \downarrow & & \downarrow i^1(\omega) \cup - \\ H^{q+1}(\mathbb{R}P; \mathbb{F}_2) & \xrightarrow{i^{q+1}} & H^{q+1}(\mathbb{R}X_\varepsilon; \mathbb{F}_2) \end{array}$$

Therefore, if  $q + 1 \leq \lfloor \frac{n}{2} \rfloor - 1$  and  $i^{q+1}$  is injective then so is  $i^q$  since  $\omega \cup -$  is injective. Corollary 4.2.39 follows from Corollary 4.2.32.  $\square$

<sup>20</sup>c.f. [Mun84] Theorem 33.1 pp.186-187.

If  $P$  is a non-singular simplex of odd size and  $K$  is a convex triangulation,  $\mathbb{R}X_\varepsilon$  is isotopic to a real algebraic hypersurface of odd degree in a real projective space by Viro's Patchworking Theorem<sup>21</sup>. In this case, it is known that  $\ell(\mathbb{R}X_\varepsilon) = n - 1$ , hence all the differentials of  $(E_r^{p,q}(\mathbb{R}X_\varepsilon))_{p,q \geq 0}$  vanish for all  $r \geq 2$ . This sufficient criterion of degeneracy can be generalised to the class of polytopes satisfying  $\iota(\mathbb{R}P) \geq \lfloor \frac{n}{2} \rfloor - 1$  regardless of the convexity of the triangulation.

**Proposition 4.2.40.** *We have the inequality:*

$$\ell(\mathbb{R}X_\varepsilon) \geq \iota[\omega_{\mathbb{R}X}].$$

In particular it follows from Corollary 4.2.39 that if  $\iota[\omega_{\mathbb{R}X}] \geq \lfloor \frac{n}{2} \rfloor - 1$  then all the differentials of  $(E_r^{p,q}(\mathbb{R}X_\varepsilon))_{p,q \geq 0}$  vanish for all  $r \geq 2$ .

*Proof.* For all  $0 \leq q \leq n - 1$ , we have the following commutative diagram:

$$\begin{array}{ccc} & H^q(\mathbb{R}P; \mathbb{F}_2) & \\ & \swarrow -\cap[\mathbb{R}P] \quad \searrow i^q & \\ H_{n-q}(\mathbb{R}P; \mathbb{F}_2) & & H^q(\mathbb{R}X_\varepsilon; \mathbb{F}_2) \\ & \searrow [\omega_{\mathbb{R}X}] \cap - \quad \swarrow -\cap[\mathbb{R}X_\varepsilon] & \\ H_{n-1-q}(\mathbb{R}P; \mathbb{F}_2) & \xleftarrow{i_{n-1-q}} & H_{n-1-q}(\mathbb{R}X_\varepsilon; \mathbb{F}_2) \end{array}$$

Where  $\cap$  denotes the cap product,  $[\mathbb{R}P]$  is the generator of  $H_n(\mathbb{R}P; \mathbb{F}_2)$ , and  $[\mathbb{R}X_\varepsilon]$  is the generator of  $H_{n-1}(\mathbb{R}X_\varepsilon; \mathbb{F}_2)$ . Because both  $\mathbb{R}P$  and  $\mathbb{R}X_\varepsilon$  satisfy the Poincaré duality with  $\mathbb{F}_2$ -coefficients, both  $-\cap[\mathbb{R}P]$  and  $-\cap[\mathbb{R}X_\varepsilon]$  are isomorphisms. We also have the following commutative diagram:

$$\begin{array}{ccc} H^q(\mathbb{R}P; \mathbb{F}_2) & \xrightarrow{[\omega_{\mathbb{R}X}] \cup -} & H^{q+1}(\mathbb{R}P; \mathbb{F}_2) \\ \downarrow \cong -\cap[\mathbb{R}P] & & \cong \downarrow -\cap[\mathbb{R}P] \\ H_{n-q}(\mathbb{R}P; \mathbb{F}_2) & \xrightarrow{[\omega_{\mathbb{R}X}] \cap -} & H_{n-q-1}(\mathbb{R}P; \mathbb{F}_2) \end{array}$$

Therefore, the morphism  $i^q$  is injective for all  $q \leq \iota[\omega_{\mathbb{R}X}]$ , and  $\ell(\mathbb{R}X_\varepsilon) \geq \iota[\omega_{\mathbb{R}X}]$ .  $\square$

Combining Corollary 4.2.35 and Proposition 4.2.40 yields a generalisation in some cases of the statement “The Renaudineau-Shaw spectral sequence of a projective primitively patchworked hypersurface of odd degree degenerates at the second page”, namely the upper bound:

$$r(\mathbb{R}X_\varepsilon) \leq \max(2; n - 2\iota[\omega_{\mathbb{R}X}] - 1).$$

Therefore we can sometimes directly know if the Renaudineau-Shaw spectral sequence degenerates at the second page by only looking at the degree of  $\mathbb{R}X_\varepsilon$ , i.e.

<sup>21</sup>c.f. [Vir06] Theorem 4.3.A pp.32-33, or [Ris93] Théorème 4.2 p.75.

at the class  $[\omega_{\mathbb{R}X}]$ . In Table 4.1 and Table 4.2 below we described the the possible values of  $\iota[\omega_{\mathbb{R}X}]$  and the associated upper bound on the degeneracy index. In the first table we study the case of a product of non-singular simplices and in the second one the case of a blow-up of a non-singular simplex. Both these examples have a  $H^1$  of dimension 2. However for some polytopes, e.g. a cube of dimension at least 4, this upper bound is completely vacuous no matter the degree of the hypersurface.

$\mathbb{P}_d^n \times \mathbb{P}_{d'}^{n+m}$	$d'$ even	$d'$ odd
$d$ even	0	$n + m - 1$
$d$ odd	$n - 1$	$n + m - 1$

(a) The value of  $\iota[\omega_{\mathbb{R}X}]$  in the product of an  $n$ -projective space with an  $(n + m)$ -projective space as a function of the parity of the bidegree  $(d; d')$ .

$\mathbb{P}_d^n \times \mathbb{P}_{d'}^{n+m}$	$d'$ even	$d'$ odd
$d$ even	$\max(2; n + m - 1)$	2
$d$ odd	$\max(2; m + 1)$	2

(b) The corresponding upper bound on  $r(\mathbb{R}X_\varepsilon)$  deduced from Corollary 4.2.35 and Proposition 4.2.40.

Table 4.1: The value of  $\iota[\omega_{\mathbb{R}X}]$  as well as the corresponding upper bound on the degeneracy index of a T-hypersurface in a product of two projective spaces as functions of the bidegree.

Bl. $\mathbb{P}_d^n$	$[\mathbb{R}X_\varepsilon] \cdot E = 0$	$[\mathbb{R}X_\varepsilon] \cdot E = E^2$
$d$ even	0	0
$d$ odd	0	$n - 2$

(a) The value of  $\iota[\omega_{\mathbb{R}X}]$  in the blow-up of an  $n$ -projective space as a function of the parity of the degree  $d$  and the intersection with the exceptional divisor  $E$ .

Bl. $\mathbb{P}_d^n$	$[\mathbb{R}X_\varepsilon] \cdot E = 0$	$[\mathbb{R}X_\varepsilon] \cdot E = E^2$
$d$ even	$\max(2; n - 1)$	$\max(2; n - 1)$
$d$ odd	$\max(2; n - 1)$	2

(b) The corresponding upper bound on  $r(\mathbb{R}X_\varepsilon)$  deduced from Corollary 4.2.35 and Proposition 4.2.40.

Table 4.2: The value of  $\iota[\omega_{\mathbb{R}X}]$  as well as the corresponding upper bound on the degeneracy index of a T-hypersurface in the blow-up as a function of the degree and the intersection with the exceptional divisor.

### 4.3 Degeneracy for a Family of Triangulations

In this section we will construct a particular sequence of primitive triangulations of the non-singular simplices inspired from the triangulations on which I. Itenberg constructs<sup>22</sup> maximal surfaces of every degree. We will then show that any T-hypersurface constructed on these triangulations has degeneracy index equal to 2. To do so we will prove a stronger statement than the criterion of Corollary 4.2.39. We begin with two auxiliary propositions.

<sup>22</sup>c.f. [Ite97], §5 M-Surfaces pp.139-141.

**Proposition 4.3.1.** *Let  $K$  be a finite simplicial complex,  $\Sigma K$  its suspension and  $\varepsilon \in C^0(\Sigma K; \mathbb{F}_2)$ . We denote by  $a_+$  and  $a_-$  the two suspension apexes. If  $\varepsilon(a_+) + \varepsilon(a_-)$  equals 1 then the hypersurface  $X$  dual to  $d\varepsilon$  is isotopic to  $|K|$  relatively to  $|K| \cap X$ .*

*Proof.* The hypersurface  $X$  is the support of the subcomplex of the cubical subdivision of  $\Sigma K$  made of the cubes indexed by the pairs of simplices  $\sigma^1 \leq \sigma^n$  for which  $d\varepsilon(\sigma^1) = 1$ . The geometric realisation of  $\Sigma K$  lives in the finite dimensional real vector space freely generated by the vertices of  $\Sigma K$  and the hypersurface  $X$  is homeomorphic to the intersection of  $|\Sigma K|$  with the hyperplane of equation:

$$f := \sum_{p \in \Sigma K^{(0)}} (-1)^{\varepsilon(p)} x_p = 0,$$

where  $x_p$  is the coordinate associated with the vertex  $p$ . We can construct a homeomorphism  $G$  of  $|\Sigma K|$  that exchanges the two sets the following way:

1. Let  $\sigma \in \Sigma K$ , if the restriction  $\varepsilon|_\sigma$  is non-constant we can find a set of positive real numbers  $u(\sigma)$  indexed by the vertices of  $\sigma$  whose sum is 1 and satisfying:

$$\sum_{p \in \sigma^{(0)}} (-1)^{\varepsilon(p)} u_p(\sigma) = 0.$$

If the restriction  $\varepsilon|_\sigma$  is constant we set  $u_p(\sigma) = \frac{1}{\dim \sigma + 1}$ ;

2. We denote by  $G$  the homeomorphism of  $|\Sigma K|$ , affine on the simplices of the barycentric subdivision of  $\Sigma K$ , which sends the barycenter of every simplex  $\sigma$  to  $\sum_{p \in \sigma^{(0)}} u_p(\sigma)p$ .

This map  $G$  is simplicial by construction. Now we study the hypersurface of  $|\Sigma K|$  defined by  $f$ . It avoids the two apexes  $a_+$  and  $a_-$  so  $|\Sigma K| \cap \{f = 0\}$  equals  $(|\Sigma K| \setminus \{a_\pm\}) \cap \{f = 0\}$ . Let us consider the following homeomorphism:

$$\begin{aligned} \varphi : |K| \times ]-1; 1[ &\longrightarrow |\Sigma K| \setminus \{a_+; a_-\} \\ (p; t) &\longmapsto (1 - |t|)p + \max(0; t)a_+ - \min(0; t)a_- . \end{aligned}$$

Since  $\varepsilon(a_+) + \varepsilon(a_-)$  equals 1,  $f(\varphi(p; t))$  is equal to  $(1 - |t|)f(p) + (-1)^{\varepsilon(a_+)}t$ . If  $f(\varphi(p; t))$  vanishes and  $f(p)$  does not,  $0 < |t| < 1$ . And therefore:

$$\frac{t}{|t|} = \frac{(-1)^{\varepsilon(a_+)+1}f(p)}{|f(p)|}.$$

From which we deduce, after considering the case  $f(p) = 0$ , that  $f(\varphi(p; t))$  vanishes if and only if:

$$f(p) + (-1)^{\varepsilon(a_+)}(1 + |f(p)|)t = 0.$$

The hypersurface  $\{f = 0\}$  is the graph of the function  $u : p \mapsto (-1)^{\varepsilon(a_+)+1} \frac{f(p)}{1+|f(p)|}$  in the coordinates given by  $\varphi$ . We consider the map  $H : [0; 1] \times |K| \rightarrow |\Sigma K|$  defined



for all  $(t; p) \in [0; 1] \times |K|$  by the formula:

$$H(t; p) := G^{-1} \left( (1-t)G(p) + t\varphi \left( G(p); u(G(p)) \right) \right).$$

The map  $H(t; -)$  is an embedding for all  $0 \leq t \leq 1$  since it is conjugated to a graph embedding,  $H(0; -)$  is the inclusion of  $|K|$  in  $|\Sigma K|$ . The set  $H(1; |K|)$  is  $X$ . If  $p$  is in  $|K| \cap X$  then  $G(p)$  belongs to  $|K| \cap \{f = 0\}$ . Consequently,  $H(t; p)$  equals  $G^{-1}((1-t)G(p) + tG(p))$  which is  $p$ .  $\square$

We denote by  $B^{n+1}$  the  $(n+1)$ -dimensional Euclidean ball and by  $\pi$  the projection of  $B^{n+1}$  onto  $\mathbb{R}P^{n+1}$  by antipodal identification of the points of  $\partial B^{n+1}$ . Let  $X$  be a subset of  $\mathbb{R}P^n$ , we define  $CX \subset \mathbb{R}P^{n+1}$  as the image under  $\pi$  of the cone at the origin 0 over  $\pi^{-1}(X)$ .

**Lemma 4.3.2.** *If  $X \subset \mathbb{R}P^n$  is homeomorphic to  $\mathbb{R}P^p$  and homologous to a linear sub-space then  $CX$  is homeomorphic to  $\mathbb{R}P^{p+1}$  and homologous to a linear sub-space as well.*

*Proof.* The space  $\pi^{-1}(X)$  is a double cover of  $X$ . If it is connected and  $p > 1$   $\pi^{-1}(X) \rightarrow X$  is the universal cover of  $X$  and  $\pi^{-1}(X)$  is a sphere. If  $p = 1$  and it is connected  $\pi^{-1}(X)$  is a circle. In this case  $CX$  is homeomorphic to  $\mathbb{R}P^{p+1}$ . Now we prove that if  $X$  is homologous to a linear sub-space of  $\mathbb{R}P^n$  then  $\pi^{-1}(X)$  is connected. We have the commutative diagram of exact sequences of singular chain complexes:

$$\begin{array}{ccccccccc} 0 & \longleftarrow & C_*(\mathbb{R}P^n; \mathbb{F}_2) & \xleftarrow{\pi_*} & C_*(S^n; \mathbb{F}_2) & \xleftarrow{i} & C_*(\mathbb{R}P^n; \mathbb{F}_2) & \longleftarrow & 0 \\ & & \uparrow j_* & & \uparrow & & \uparrow j_* & & \\ 0 & \longleftarrow & C_*(X; \mathbb{F}_2) & \xleftarrow{\pi_*} & C_*(\pi^{-1}(X); \mathbb{F}_2) & \xleftarrow{i} & C_*(X; \mathbb{F}_2) & \longleftarrow & 0 \end{array}$$

where the vertical morphism are given by the corresponding inclusions of topological spaces and the morphism  $i$  sends a singular simplex  $\sigma$  to the sum of its two lifts to  $S^n$ . It yields the following commutative diagram of exact sequences:

$$\begin{array}{ccccccccc} 0 & \longleftarrow & H_0(\mathbb{R}P^n; \mathbb{F}_2) & \xleftarrow{\cong} & H_0(S^n; \mathbb{F}_2) & \xleftarrow{0} & H_0(\mathbb{R}P^n; \mathbb{F}_2) & \xleftarrow{\cong} & H_1(\mathbb{R}P^n; \mathbb{F}_2) & \longleftarrow & \dots \\ & & \uparrow \cong & & \uparrow & & \uparrow \cong & & \uparrow j_* & & \\ 0 & \longleftarrow & H_0(X; \mathbb{F}_2) & \xleftarrow{\pi_*} & H_0(\pi^{-1}(X); \mathbb{F}_2) & \xleftarrow{i} & H_0(X; \mathbb{F}_2) & \longleftarrow & H_1(X; \mathbb{F}_2) & \longleftarrow & \dots \end{array}$$

It implies in particular that  $b_0(\pi^{-1}(X); \mathbb{F}_2) = 1 + \text{rk } i = 2 - \text{rk } j_*$ . By assumption the image of the fundamental class of  $X$  in the homology of  $\mathbb{R}P^n$  is  $[\mathbb{R}P^p]$  so its intersection with  $[\mathbb{R}P^{n+1-p}]$  is the class of the line  $[\mathbb{R}P^1]$ . If  $\alpha$  is the Poincaré dual of  $[\mathbb{R}P^{n+1-p}]$ , we have  $j_*(j^*\alpha \cap [X]) = [\mathbb{R}P^{n+1-p}] \cdot [\mathbb{R}P^p] = [\mathbb{R}P^1]$ , so  $j_*$  has rank 1 and  $\pi^{-1}(X)$  is connected.

To see that  $CX$  is still homologous to a linear sub-space we can notice that we

have the following commutative square:

$$\begin{array}{ccc} H^1(\mathbb{RP}^{n+1}; \mathbb{F}_2) & \xrightarrow{\cong} & H^1(\mathbb{RP}^n; \mathbb{F}_2) \\ \downarrow & & \downarrow \cong \\ H^1(CX; \mathbb{F}_2) & \xrightarrow{\cong} & H^1(X; \mathbb{F}_2) \end{array}$$

So the generator of  $H^1(\mathbb{RP}^{n+1}; \mathbb{F}_2)$  is sent to the generator of  $H^1(CX; \mathbb{F}_2)$ . Using the structure of the cohomology rings of projective spaces, we see that the restriction morphism  $H^q(\mathbb{RP}^{n+1}; \mathbb{F}_2) \rightarrow H^q(CX; \mathbb{F}_2)$  is an isomorphism for all  $q \leq p + 1$ .  $\square$

We recall that for a simplex  $\sigma^n$  whose vertices are ordered we have a canonical triangulation of the prism  $\sigma^n \times [0; 1]$ . Its maximal simplices are the simplicial joins  $[v_0; \dots; v_i] \times \{1\} * [v_i; \dots; v_n] \times \{0\}$  where  $0 \leq i \leq n$  and  $[v_1; \dots; v_k]$  is the face of  $\sigma$  indexed by the vertices  $v_1, \dots, v_k$ . See Figure 4.4 for an example. This triangulation allows us to construct triangulations of the standards simplices inductively.

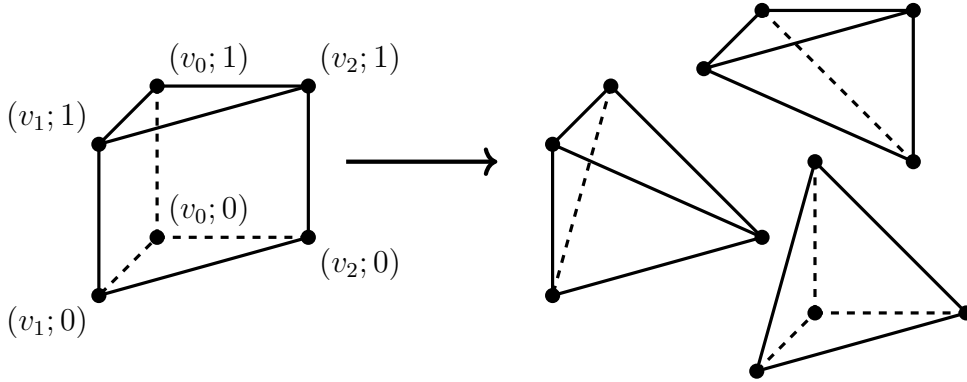

Figure 4.4: Canonical Triangulation of the Product of a Segment with a Triangle.

**Definition 4.3.3.** Let  $n, d \geq 1$  be two integers and  $P_d^n$  be the convex hull of  $\{0; de_1; \dots; de_n\} \subset \mathbb{R}^n$ . If  $K$  is a triangulation of  $P_d^n$  and  $L$  is a triangulation of  $P_{d+1}^{n-1}$  we define  $K + L$  as the unique triangulation of  $P_{d+1}^n$  for which:

1. The restriction of  $K + L$  to  $P_{d+1}^n \cap \{x_n \geq 1\}$  is the translation of  $K$ ;
2. The restriction of  $K + L$  to  $[e_n, e_n + de_1, \dots, e_n + de_i] * [(d+1)e_i, \dots, (d+1)e_{n-1}]$ , for all  $0 \leq i \leq n - 1$ , is the join of the restriction of the translation of  $K$  to  $[e_n, e_n + de_1, \dots, e_n + de_i]$  with the restriction of  $L$  to  $[(d+1)e_i, \dots, (d+1)e_{n-1}]$ .

Figure 4.5 depicts an example of such triangulation.

**Lemma 4.3.4.** Let  $P$  be a full dimensional polytope of  $\mathbb{R}^n$  endowed with a triangulation  $K$ , and  $f, g : P \rightarrow \mathbb{R}$  be two functions, affine on every simplex of  $K$ . If  $f$  is convex and, for any convex subset  $A$  of  $P$ ,  $g|_A$  is convex as soon as  $f|_A$  is affine, then there is an  $\eta > 0$  for which  $f + \eta g$  is convex.

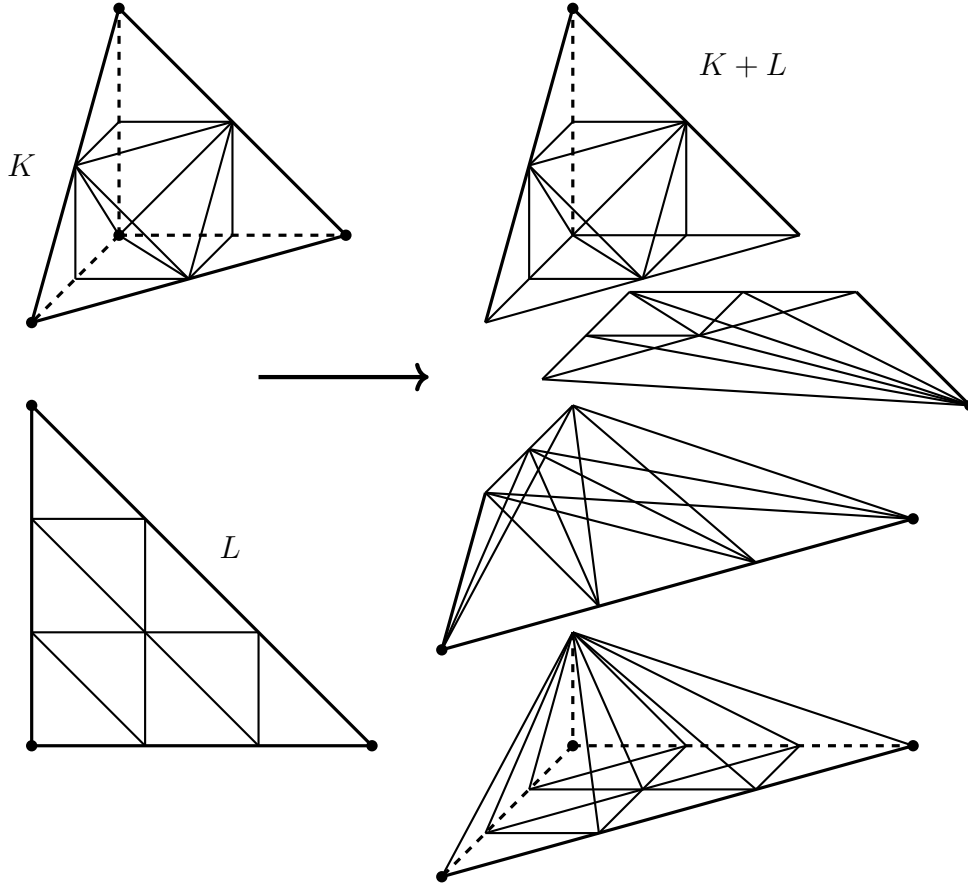
 Figure 4.5: A Triangulation  $K + L$ .

*Proof.* Let  $\sigma$  be a maximal simplex of  $K$ , for all functions  $h : P \rightarrow \mathbb{R}$  affine on every simplex of  $K$ , we denote by  $a(h; \sigma)$  the unique affine function of  $\mathbb{R}^n$  satisfying  $h|_{\sigma} = a(h; \sigma)|_{\sigma}$ . For all vertices  $v$  of  $K$  and all maximal simplices  $\sigma$  of  $K$ , we denote by  $\delta(h; v; \sigma)$  the difference  $h(v) - a(h; \sigma)(v)$ . The function  $h$  is convex if and only if:

$$h = \max_{\sigma \in K} a(h; \sigma),$$

which is itself equivalent to  $\delta(h; v; \sigma) \geq 0$  for all vertices  $v$  and maximal simplices  $\sigma$ . Moreover, if  $h$  is convex then  $\delta(h; v; \sigma)$  vanish if and only if  $v$  and  $\sigma$  belong to the same affinity component of  $h$ . Indeed, since  $h$  is convex, its affinity components are the projections of the  $n$ -dimensional faces of the epigraph of  $h$ , i.e. the sets  $\{p \in P \mid h(p) = a(h; \sigma)(p)\}$  where  $\sigma$  is a maximal simplex of  $K$ . By assumption, we have  $\delta(g; v; \sigma) \geq 0$  whenever  $\delta(f; v; \sigma) = 0$ . If  $\min\{\delta(g; v; \sigma) : v, \sigma \in K\} \geq 0$  the function  $g$  is convex and  $f + \eta g$  is convex for all  $\eta > 0$ . In the other case  $f$  cannot be affine and there is at least one couple  $(v; \sigma)$  for which  $\delta(f; v; \sigma)$  is positive, and any  $\eta$  satisfying:

$$0 < \eta \leq \frac{\min\{\delta(f; v; \sigma) > 0 : v, \sigma \in K\}}{-\min\{\delta(g; v; \sigma) : v, \sigma \in K\}},$$

yields a convex function  $f + \eta g$ , since  $\delta(f + \eta g; v; \sigma) = \delta(f; v; \sigma) + \eta \delta(g; v; \sigma) \geq 0$  for all vertices  $v$  and all maximal simplices  $\sigma$ .  $\square$

**Proposition 4.3.5.** *If both  $K$  and  $L$  are convex then so is  $K + L$ .*

*Proof.* The triangulation  $K + L$  of  $P_{d+1}^n$  is a subdivision of the first triangulation  $M$  of  $P_{d+1}^n$  made of the translation of  $P_d^n$  by  $e_n$  and the joins of the second point of Definition 4.3.3 subdividing the prism  $P_{d+1}^n \cap \{0 \leq x_n \leq 1\}$ . The triangulation  $M$  is convex. It has exactly  $(n + 1)$  maximal simplices, the interior of each is a connected component of the complement in  $P_{d+1}^n$  of a union of  $n$  affine hyperplanes. A direct computation yields their equations:  $(d + 1)(x_n - 1) + \sum_{k=i}^{n-1} x_k$ , for all  $1 \leq i \leq n - 1$ , and  $x_n = 1$ . On that account, the function:

$$\nu : x \in P_d^n \mapsto |x_n - 1| + \sum_{i=1}^{n-1} \left| (d + 1)(x_n - 1) + \sum_{k=i}^{n-1} x_k \right|,$$

certifies the convexity of  $M$ . Let  $\nu_K$  and  $\nu_L$  be two functions respectively certifying the convexity of  $K$  and  $L$ . We consider  $[\nu_K + \nu_L]$  the unique function  $P_{d+1}^n \rightarrow \mathbb{R}$  affine on every simplex of  $K + L$  whose restriction to  $P_{d+1}^n \cap \{x_n \geq 1\}$  is the translation of  $\nu_K$  by  $e_n$  and whose restriction to  $P_{d+1}^n \cap \{x_n = 0\}$  is  $\nu_L$ . In other words  $[\nu_K + \nu_L]$  is defined on the joins of the bottom prism  $P_{d+1}^n \cap \{0 \leq x_n \leq 1\}$  by the convex interpolation of  $\nu_K(- + e_n)$  and  $\nu_L$ . By construction this function is convex on the simplices of  $M$ , therefore, following Lemma 4.3.4 we can find  $\eta > 0$  small enough so that  $\nu + \eta[\nu_K + \nu_L]$  is convex. By construction, this function certifies the convexity of  $K + L$ .  $\square$

**Remark 4.3.6.** Lemma 4.3.4 and Proposition 4.3.5 are contained in [KKMSD73] pp.112-116.

**Definition 4.3.7** (Viro triangulations). The *Viro triangulations*  $(V_d^n)_{n,d \geq 1}$  of  $(P_d^n)_{n,d \geq 1}$  are defined by the following recursive procedure:  $V_1^n$  is the trivial triangulation,  $V_d^1$  is the unique primitive triangulation of the segment, and  $V_{d+1}^{n+1} = V_d^{n+1} + V_{d+1}^n$  for all  $n, d \geq 1$ . By recursion and Proposition 4.3.5,  $V_d^n$  is primitive, integral, and convex for all  $n, d \geq 1$ .

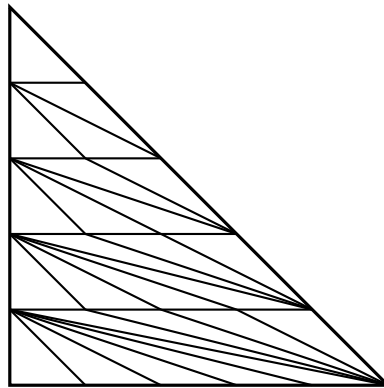

Figure 4.6: The Viro triangulation  $V_5^2$ .

**Proposition 4.3.8.** *Let  $n \geq 2$  and  $d \geq 1$ . The injective affine map:*

$$f_d^{n-1} : \mathbb{P}_d^{n-1} \rightarrow \mathbb{P}_d^n,$$

*that sends 0 to  $de_1$  and  $de_i$  to  $de_{i+1}$ , for all  $1 \leq i \leq n-1$ , is simplicial with respect to  $V_d^{n-1}$  and  $V_d^n$ .*

*Proof.* The proposition is a consequence of the recursive construction of the Viro triangulations. Let us denote  $K_d^n$  the pull-back to  $\mathbb{P}_d^n$  of  $V_d^{n+1}$  by  $f_d^n$ . By construction,  $K_{d+1}^n$  equals  $K_d^n + K_{d+1}^{n-1}$ ,  $K_1^n$  is the trivial triangulation, and  $K_d^1$  is the unique primitive triangulation of the segment. Therefore  $K_d^n$  is  $V_d^n$  for all  $d, n \geq 1$ .  $\square$

**Theorem 4.3.9** (Rank Maximality). *If  $K$  is a Viro triangulation of  $\mathbb{P}^n$  then the homological inclusion:*

$$i_q : H_q(\mathbb{R}X_\varepsilon; \mathbb{F}_2) \rightarrow H_q(\mathbb{R}\mathbb{P}^n; \mathbb{F}_2),$$

*is surjective for all  $q \leq \lfloor \frac{n-1}{2} \rfloor$  and all  $\varepsilon \in C^0(K; \mathbb{F}_2)$ . That is to say, the rank of a projective hypersurface obtained from a primitive patchwork on a Viro triangulation is always maximal.*

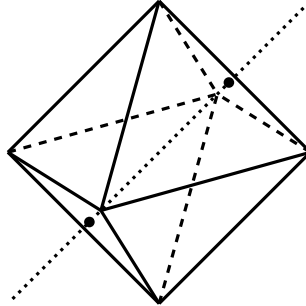
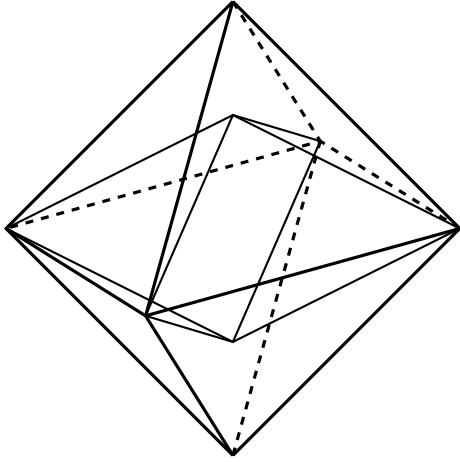

Figure 4.7: Antipodal identifications.

*Proof.* Let  $d \leq 1$  be an integer. We prove by induction on  $n \geq 0$ , that for all  $\mathbb{R}X_\varepsilon$  of dimension  $2n$  in  $\mathbb{R}\mathbb{P}_d^{2n+1}$  constructed on the Viro triangulation  $V_d^{2n+1}$ , there is a sub-space  $L_n \subset \mathbb{R}X_\varepsilon$  homeomorphic to  $\mathbb{R}\mathbb{P}^n$  and homologous in  $\mathbb{R}\mathbb{P}_d^{2n+1}$  to a linear sub-space. Since  $\mathbb{R}X_\varepsilon$  is never empty the initial statement is satisfied. Now we assume that the statement is true up to rank  $n \geq 0$ . We remember that to construct  $\mathbb{R}\mathbb{P}_d^{2n+3}$  we considered  $2^{2n+3}$  copies of  $\mathbb{P}_d^{2n+3}$  indexed by  $v \in \mathfrak{t}(\mathbb{F}_2) = \mathbb{F}_2^{2n+3}$  glued along their codimension 1 faces with the following rule : *the face  $\sigma^{2n+2} \times \{v\}$  is identified with the face  $\sigma^{2n+2} \times \{v + w_\sigma\}$  where  $w_\sigma$  is the generator of the line  $(T\sigma^{2n+2})^\perp(\mathbb{F}_2)$ .* We consider the ball  $B^{2n+3}$  obtained by performing such gluings for all the codimension 1 faces of  $\mathbb{P}_d^{2n+3}$  except the one opposite to the origin. The projection we obtain by performing the remaining gluings  $\pi : B^{2n+3} \rightarrow \mathbb{R}\mathbb{P}_d^{2n+3}$  is the usual quotient of the ball where we identify the antipodal points of its boundary, c.f. Figure 4.7. We consider the sphere  $S^{2n+1} \subset \partial B^{2n+3}$  made of the images of all the copies of the codimension 2 face of  $\mathbb{P}_d^{2n+3}$  opposite to the edge joining the

vertices 0 and  $de_{2n+3}$ . The image  $\pi(S^{2n+1})$  is the  $(2n + 1)$ -dimensional projective space associated with the codimension 2 face of  $P_d^{2n+3}$  that build  $S^{2n+1}$ .



(a) The suspension of the equatorial disc as a subcomplex in  $B^3 = \pi^{-1}(\mathbb{RP}^3)$ .

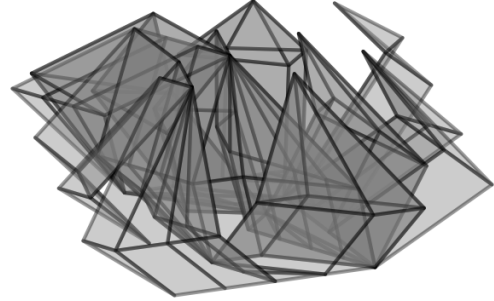

(b) A first view of the portion of  $\mathbb{R}X_\varepsilon$  located in the suspension of the equatorial ball.

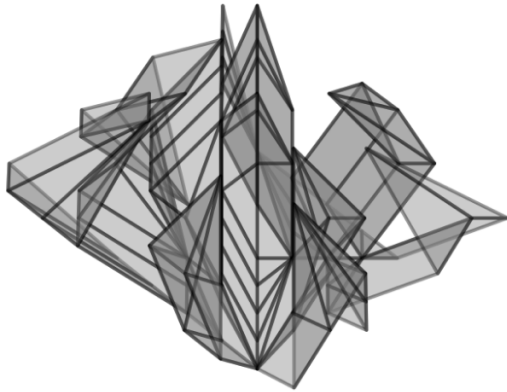

(c) A front view from a  $\frac{\pi}{4}$  angle.

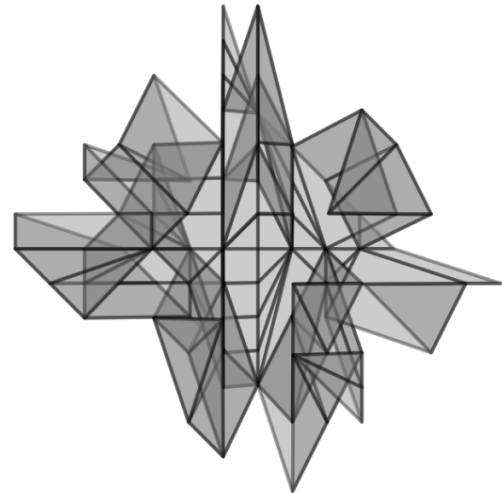

(d) A view from above.

Figure 4.8: Some portion of a T-surface  $\mathbb{R}X_\varepsilon$  constructed from a sign distribution on the Viro triangulation  $V_4^3$ .

The intersection of  $\mathbb{R}X_\varepsilon$  with this  $\mathbb{RP}_d^{2n+1}$  is, by construction, the patchwork of the restriction of  $\varepsilon$  to this codimension 2 face of  $P_d^{2n+3}$ . This face is the codimension 1 of the bottom face opposite to the origin. Since the bottom face is endowed with the Viro triangulation, Proposition 4.3.8 implies that the triangulation of the codimension 2 face is the Viro triangulation  $V_d^{2n+1}$ . Hence we can use our recursion hypothesis to find a sub-space  $L_n \subset \mathbb{R}X_\varepsilon \cap \mathbb{RP}_d^{2n+1}$  homeomorphic and homologous to  $\mathbb{RP}^n$ . Following Lemma 4.3.2 we know that  $CL_n \subset \mathbb{RP}_d^{2n+3}$  is homeomorphic and homologous to  $\mathbb{RP}^{n+1}$ . The preimage  $\pi^{-1}(CL_n)$  is located in the equatorial ball  $B^{2n+2}$  of  $B^{2n+3}$ , the one spanned by the codimension 1 face of  $P_d^{2n+3}$  opposite to the vertex  $de_{2n+3}$ . From Proposition 4.3.1 we can move the ball  $B^{2n+2}$  inside

$\pi^{-1}(\mathbb{R}X_\varepsilon)$  by isotopy relative to  $B^{2n+2} \cap \pi^{-1}(\mathbb{R}X_\varepsilon)$ . Indeed, the union of the  $(2n+3)$ -dimensional simplices of  $\mathbb{R}V_d^{2n+3}$  that have a codimension 1 face in  $B^{2n+2}$  is the suspension of the triangulation of  $B^{2n+2}$ . Moreover, the two suspension apexes are  $\pm e_{2n+3}$  which carry opposite signs by definition. The isotopy sends  $\pi^{-1}(CL_n)$  to a sub-space that projects to  $L_{n+1} \subset \mathbb{R}X_\varepsilon$  which satisfies the desired properties. The isotopy unfolding of the portion of  $\mathbb{R}X_\varepsilon$  located inside the suspension of the equatorial ball is depicted in Figure 4.9. From this we deduce that if  $\mathbb{R}X_\varepsilon$  has even dimension  $2n$  we have, for all  $q \geq 0$ , a commutative diagram:

$$\begin{array}{ccc}
 H_q(\mathbb{R}X_\varepsilon; \mathbb{F}_2) & & \\
 \uparrow & \searrow^{i_q} & \\
 & & H_q(\mathbb{R}P^{2n+1}; \mathbb{F}_2) \\
 & \nearrow_{j_q} & \\
 H_q(L_n; \mathbb{F}_2) & & 
 \end{array}$$

The map  $j_q$  is surjective for all  $0 \leq q \leq n$ , so the theorem is proven for even dimensional patchworks. For odd dimensional patchworks we can notice that the triangulation restricted to the codimension 1 face opposite to  $de_{2n+2}$  carries the Viro triangulation as well so we can apply our construction to the induced patchwork and deduce the statement.  $\square$

Combining this statement with Corollary 4.2.39 we find the following corollary:

**Corollary 4.3.10.** *The Renaudineau-Shaw spectral sequences computing the homology and the cohomology of the hypersurface  $\mathbb{R}X_\varepsilon \subset \mathbb{R}P^n$  constructed from a Viro triangulation  $K$  and a sign distribution  $\varepsilon \in C^0(K; \mathbb{F}_2)$  degenerates at the second page.*

Conjecture 1 can be rephrased as  $r(\mathbb{R}X_\varepsilon) \leq 2$  or equivalently  $\ell(\mathbb{R}X_\varepsilon) \geq \lfloor \frac{n}{2} \rfloor - 1$ . However, as in Theorem 4.3.9, we believe the stronger inequality  $\ell(\mathbb{R}X_\varepsilon) \geq \lfloor \frac{n-1}{2} \rfloor$  might even be true in full generality.

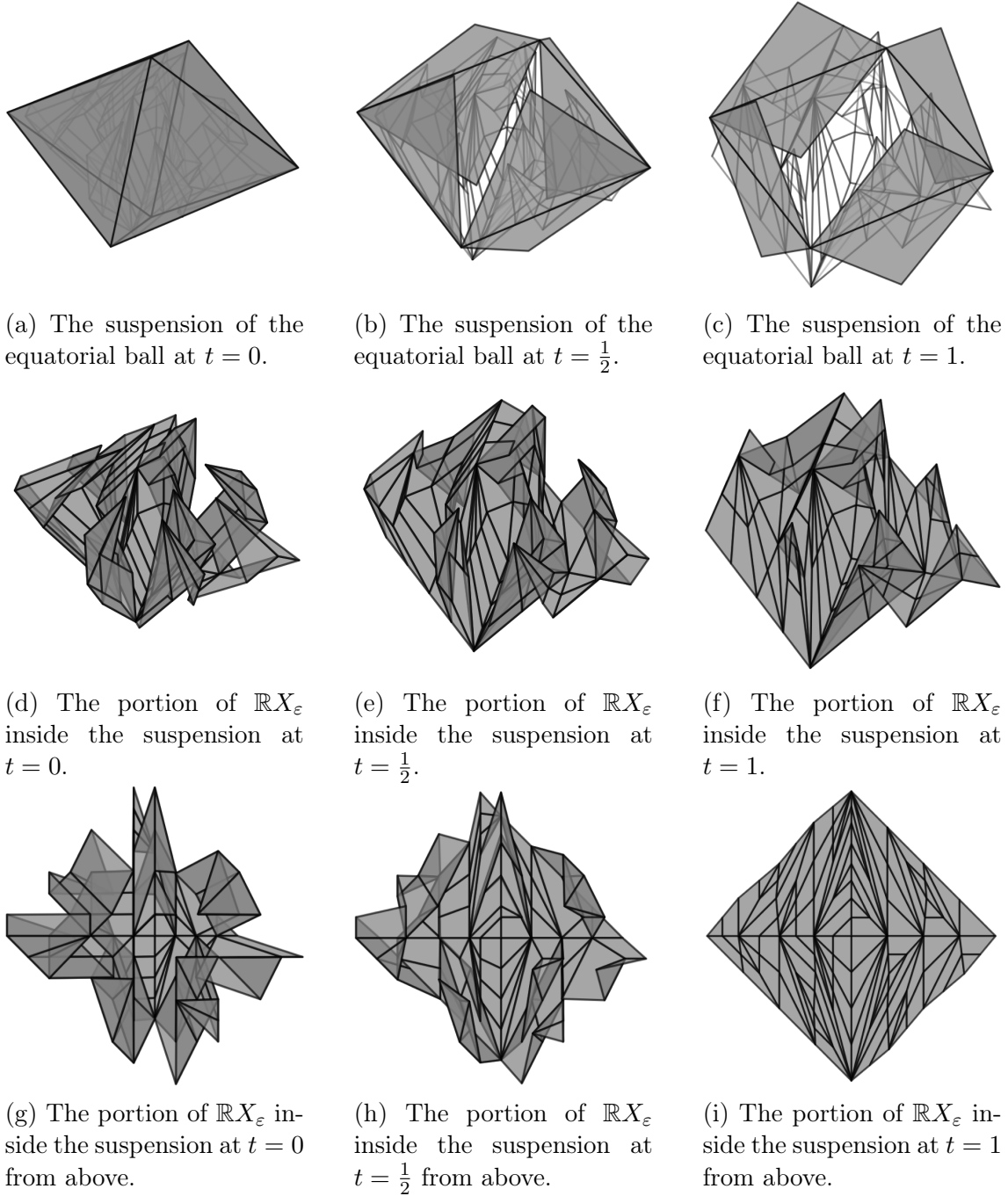

Figure 4.9: The unfolding isotopy from Proposition 4.3.1 applied to the portion of a T-surface  $\mathbb{R}X_\varepsilon$  on  $V_4^3$  located in the suspension of the equatorial ball.



# Chapter 5

## The First Page of the Spectral Sequence

### 5.1 Differential Geometry of Primitive Complexes

**Shellings.** In this paragraph we provide the definitions and basic properties of shellings of simplicial complexes.

**Definition 5.1.1.** Let  $K$  be a finite simplicial complex of dimension  $n \in \mathbb{N}$ . The polynomial  $\mathbf{f}_K$  is given by the formula:

$$\mathbf{f}_K(X) = \sum_{i=0}^{n+1} f_{i-1}(K) X^{n+1-i},$$

where  $f_i(K)$  is the number of  $i$ -simplices of  $K$ .

**Definition 5.1.2.** A *shelling* of a finite simplicial complex  $K$  of pure dimension  $n \in \mathbb{N}$ , is a numbering of its maximal simplices  $\sigma_0^n, \dots, \sigma_k^n$  such that, for all integers  $0 \leq i \leq k-1$ , the intersection of  $\sigma_{i+1}^n$  with the previous simplices  $\cup_{j \leq i} \sigma_j^n$  is a non-empty union of faces of codimension 1 of  $\sigma_{i+1}^n$ . Let  $0 \leq i \leq k$ , we call the *order* of  $\sigma_i^n$ , the number of its faces of codimension 1 that belong to the previous simplices. For all  $0 \leq j \leq n+1$ , we denote by  $h_j(K)$  the number of simplices of order  $j$  of the shelling. Moreover, we define the polynomial  $\mathbf{h}_K$  by the formula:

$$\mathbf{h}_K(X) = \sum_{j=0}^{n+1} h_j(K) X^{n+1-j}.$$

A simplicial complex that admits a shelling is called *shellable*.

The polynomial  $\mathbf{h}_K$  of a shellable simplicial complex  $K$  does not depend on the particular shelling used to compute it. This property is a corollary of the following formula.

**Proposition 5.1.3** ([Zie95], p.249). *Let  $K$  be a shellable simplicial complex. We*

have the following identity:

$$\mathbf{h}_K(X) = \mathbf{f}_K(X - 1). \quad (5.1)$$

The relation (5.1) implies that  $h_0(K)$  equals  $f_{-1}(K)$ , i.e. 1, and also that  $h_{n+1}(K)$  equals  $\mathbf{f}_K(-1)$ , i.e.  $(-1)^{n+1} + (-1)^n \chi(|K|)$  (the Euler characteristic of  $|K|$ ).

**Proposition 5.1.4** ([Bjö84], Proposition 4.3 p.12). *Let  $K$  be a shellable simplicial complex of dimension  $n$  in which every  $(n - 1)$ -simplex is contained in at most two  $n$ -simplices. Then:*

1. *If every  $(n - 1)$ -simplex is contained in exactly two  $n$ -simplices, the geometric realisation of  $K$  is homeomorphic to a sphere;*
2. *If there is a  $(n - 1)$ -simplex contained in exactly one  $n$ -simplex, the geometric realisation of  $K$  is homeomorphic to a ball.*

*In particular, in the first case  $h_{n+1}(K)$  equals 1 and in the second 0.*

**Lemma 5.1.5.** *Let  $K$  be an  $n$ -dimensional shellable simplicial complex in which every  $(n - 1)$ -simplex is contained in at most two  $n$ -simplices. Let  $\sigma_0^n, \dots, \sigma_k^n$  be a shelling of  $K$ . For all  $0 \leq i \leq k$ , we denote by  $\tau_i$  the intersection of all the codimension 1 faces of  $\sigma_i^n$  along which it intersects the previous simplices. For all  $0 \leq i \leq k$ , the star of  $\tau_i$  in  $K$  is contained in  $\cup_{j \leq i} \sigma_j^n$ . In other words, when we add the simplex  $\sigma_i^n$  we complete the star of  $\tau_i$ .*

*Proof.* Let  $0 \leq i \leq k$ . The link of  $\tau_i$  is a pure  $(n - 1 - \dim(\tau_i))$ -dimensional simplicial complex in which every simplex of codimension 1 is contained in at most two maximal simplices. The shelling of  $K$  induces a shelling of the link  $\text{lk}(\tau_i; K)$ . The proof of Lemma 8.7 p.237 of [Zie95] is directly adaptable from the case of a vertex to the case of a simplex of higher dimension. By definition of  $\tau_i$ , this shelling has a simplex of order  $n - \dim(\tau_i)$ , i.e.  $\dim \text{lk}(\tau_i; K) + 1$ . This is  $\text{lk}(\tau_i; \sigma_i^n)$ . Hence, by Proposition 5.1.4, this link must be a sphere. Thus, every simplex of codimension one of this link belongs to exactly two maximal simplices. The shelling of the link can be reversed to find another shelling of the link. This is Lemma 8.10 p.240 of [Zie95] for boundary of simplicial polytopes. However, its proof only uses the fact that every simplex of codimension one belongs to two maximal simplices, hence it is directly transposable to our case. Reversing the order changes the order of every maximal simplex by the involution  $x \mapsto \dim \text{lk}(\tau_i; K) + 1 - x$ . Therefore, the simplex of order  $\dim \text{lk}(\tau_i; K) + 1$  has to be the last for the simplex of order 0 is always the first. Therefore, when we add  $\sigma_i^n$  we complete the link of  $\tau_i$ , hence its star.  $\square$

**Differential Geometry.** Some concepts of differential geometry are adaptable to the discrete context of simplicial complexes primitively embedded in affine spaces. We give the definitions of this framework. Like in the previous chapter  $\mathfrak{t}^*(\mathbb{Z})$  denotes a free Abelian group of rank  $n$ , and for every commutative ring  $R$ ,  $\mathfrak{t}^*(R)$  denotes the associated free module  $\mathfrak{t}^*(\mathbb{Z}) \otimes_{\mathbb{Z}} R$ .  $\mathfrak{t}(\mathbb{Z})$  denotes the dual lattice of the dual

vector space  $\mathfrak{t}(\mathbb{R})$ .  $\mathbb{F}_2$  is the field with two elements. We say that a sub-vector space  $W \subset \mathfrak{t}^*(\mathbb{R})$  is rational if there exists a sub-module  $M \subset \mathfrak{t}^*(\mathbb{Z})$  satisfying  $M \otimes_{\mathbb{Z}} \mathbb{R} = W$ . In this case we denote by  $W(\mathbb{Z})$  the lattice  $W \cap \mathfrak{t}^*(\mathbb{Z})$ , and for every commutative ring  $R$ , by  $W(R)$  the free module  $W(\mathbb{Z}) \otimes_{\mathbb{Z}} R$ . We say that an affine sub-space  $A$  of  $\mathfrak{t}^*(\mathbb{R})$  is rational if its tangent space  $TA$  is.

**Definition 5.1.6.** We call a *primitive complex* in  $\mathfrak{t}^*(\mathbb{R})$ , a purely  $n$ -dimensional piecewise-affinely embedded simplicial complex  $K \subset \mathfrak{t}^*(\mathbb{R})$  whose simplices are primitive. The *boundary* of  $K$  is the sub-complex of simplices contained in exactly one maximal simplex of  $K$ . We denote it by  $\partial K$ .

**Definition 5.1.7.** Let  $K$  be primitive complex in  $\mathfrak{t}^*(\mathbb{R})$ . The  $\mathbb{F}_2$ -*normal cosheaf*  $N$  of  $K$  is defined for all simplices  $\sigma^p$  by the formula:

$$N(\sigma^p) := (T\sigma^p)^\perp(\mathbb{F}_2),$$

with extension morphisms given by inclusions. Likewise, the  $\mathbb{F}_2$ -*cotangent cosheaf*  $T^*$  of  $K$  is defined for all simplices  $\sigma^p$  by the formula:

$$T^*(\sigma^p) := T^*\sigma^p(\mathbb{F}_2),$$

with extension morphisms given by the quotient morphisms. We have the following exact sequence of cosheaves:

$$0 \rightarrow N \rightarrow [K; \mathfrak{t}(\mathbb{F}_2)] \rightarrow T^* \rightarrow 0.$$

**Definition 5.1.8.** Let  $K$  be primitive complex in  $\mathfrak{t}^*(\mathbb{R})$  and  $\sigma^p$  be a simplex of  $K$ . We denote by  $\omega(\sigma^p) \in \bigwedge^p \mathfrak{t}^*(\mathbb{F}_2)$  the generator of the line  $\bigwedge^p T\sigma^p(\mathbb{F}_2)$ . If  $\sigma^1$  is an edge of  $K$  with vertices  $\alpha$  and  $\beta$  then  $\omega(\sigma^1)$  is the reduction modulo 2 of  $\beta - \alpha$ .

**Proposition 5.1.9.** *The cochain  $[\sigma^p \mapsto \omega(\sigma^p)] \in C^p(K; \bigwedge^p \mathfrak{t}^*(\mathbb{F}_2))$  is closed.*

*Proof.* If  $p$  equals 0 then by definition  $[\sigma^0 \mapsto \omega(\sigma^0)]$  is constant to 1. It is closed. Now let  $p \geq 1$  be an integer,  $\sigma^p$  be a simplex of  $K$ , and  $\beta$  be a vertex of  $\sigma^p$ . Since  $K$  is primitive,  $\omega(\sigma^p)$  is given by the following formula:

$$\begin{aligned} \omega(\sigma^p) &= \bigwedge_{\alpha \in \text{lk}(\beta; \sigma^p)^{(0)}} (\alpha - \beta) \\ &= \bigwedge_{\alpha \in \text{lk}(\beta; \sigma^p)^{(0)}} \alpha + \sum_{\alpha \in \text{lk}(\beta; \sigma^p)^{(0)}} \beta \wedge \bigwedge_{\substack{\alpha' \in \text{lk}(\beta; \sigma^p)^{(0)} \\ \alpha' \neq \alpha}} \alpha' \\ &= \sum_{\sigma^{p-1} \leq \sigma^p} \bigwedge_{\alpha \in (\sigma^{p-1})^{(0)}} \alpha. \end{aligned}$$

If we denote by  $\lambda$  the cochain  $[\sigma^{p-1} \mapsto \bigwedge_{\alpha \in (\sigma^{p-1})^{(0)}} \alpha]$ , the cochain  $\omega$  is the differential of  $\lambda$ . Hence, it is closed.  $\square$

**Proposition 5.1.10.** *Let  $K$  be primitive complex in  $\mathfrak{t}^*(\mathbb{R})$ . For all simplices  $\sigma^p \in K$  and all vertices  $\alpha$  of  $\sigma^p$  the set  $\{\beta - \alpha : \beta \text{ vertex of } \text{lk}(\alpha; \sigma^p)\}$  is, up to ordering, a basis of  $T\sigma^p(\mathbb{Z})$ . Moreover for all  $q \in \mathbb{N}$ , the morphism:*

$$\begin{aligned} z_{\sigma^p}^q : \bigwedge^q \mathfrak{t}(\mathbb{F}_2) &\longrightarrow Z^q(\sigma^p; \mathbb{F}_2) \\ v &\longmapsto \left[ \sigma^q \mapsto (\omega(\sigma^q))(v) \right], \end{aligned}$$

*fits in the short exact sequence:*

$$0 \rightarrow N(\sigma^p) \wedge \bigwedge^{q-1} \mathfrak{t}(\mathbb{F}_2) \rightarrow \bigwedge^q \mathfrak{t}(\mathbb{F}_2) \xrightarrow{z_{\sigma^p}^q} Z^q(\sigma^p; \mathbb{F}_2) \rightarrow 0.$$

*Moreover, for all pairs  $\sigma^p \leq \sigma^r$  and all vectors  $v \in \bigwedge^q \mathfrak{t}(\mathbb{F}_2)$  the restriction of  $z_{\sigma^r}^q(v)$  to  $\sigma^p$  is  $z_{\sigma^p}^q(v)$ .*

*Proof.* The first statement is a direct consequence of Definition 1.2.13. The morphism  $z_{\sigma^0}^0$  is an isomorphism,  $z_{\sigma^0}^q$  is null for all  $q > 0$ , and  $N(\sigma^p)$  equals  $\mathfrak{t}(\mathbb{F}_2)$ . The proposition is true for  $p = 0$ . Let  $\sigma^p$  be a simplex of  $K$  of positive dimension, and  $q \geq 0$  be an integer. Proposition 5.1.9 ensures us that  $z_{\sigma^p}^q$  is well defined with  $Z^q(\sigma^p; \mathbb{F}_2)$  as target space. Let  $\beta$  be a vertex of  $\sigma^p$  and let us label  $\sigma_1^q, \dots, \sigma_k^q$ , with  $k$  being  $\binom{p}{q}$ , the  $q$ -simplices of  $\sigma^p$  that contain  $\beta$ . The first statement implies that  $\{\omega(\sigma_1^q), \dots, \omega(\sigma_k^q)\}$  is a basis of  $\bigwedge^q T\sigma^p(\mathbb{F}_2)$ . Let  $\zeta$  be a  $q$ -cocycle of  $\sigma^p$ . We define  $v$  to be the unique vector of  $\bigwedge^q \mathfrak{t}(\mathbb{F}_2) / (\bigwedge^q T\sigma^p(\mathbb{F}_2))^\perp$  satisfying:

$$\omega(\sigma_i^q)(v) = \zeta(\sigma_i^q),$$

for all  $1 \leq i \leq k$ . Let  $\sigma^q$  be a simplex of  $\sigma^p$  that does not contain  $\beta$ . The boundary of  $\beta * \sigma^q$  is made of  $\sigma^q$  and  $\sigma_{i_1}^q, \dots, \sigma_{i_{q+1}}^q$ . Since both  $\omega$  and  $\zeta$  are closed we have:

$$\begin{aligned} \omega(\sigma^q)(v) &= \sum_{j=1}^{q+1} \omega(\sigma_{i_j}^q)(v) \\ &= \sum_{j=1}^{q+1} \zeta(\sigma_{i_j}^q) \\ &= \zeta(\sigma^q). \end{aligned}$$

Hence, for any lift  $\bar{v}$  of  $v$  in  $\bigwedge^q \mathfrak{t}(\mathbb{F}_2)$ ,  $z_{\sigma^p}^q(\bar{v})$  equals  $\zeta$ , and  $z_{\sigma^p}^q$  is surjective. Moreover, the kernel of  $z_{\sigma^p}^q$  is  $(\bigwedge^q T\sigma^p(\mathbb{F}_2))^\perp$ . This vector space has codimension  $\binom{p}{q}$  and contains  $N(\sigma^p) \wedge \bigwedge^{q-1} \mathfrak{t}(\mathbb{F}_2)$ . Using a basis of  $\mathfrak{t}(\mathbb{F}_2)$  whose  $(n-p)$  first vectors belong to  $N(\sigma^p)$ , we find that the latter space has dimension  $\binom{n}{q} - \binom{p}{q}$ . Therefore, they must be equal. The last statement of the proposition is a direct consequence of the definition of  $z_{\sigma^p}^q$ .  $\square$

**Proposition 5.1.11.** *Let  $K$  be primitive complex in  $\mathfrak{t}^*(\mathbb{R})$  and  $\sigma^n$  be a maximal simplex of  $K$ . For all vertices  $\alpha$  of  $\sigma^n$ , we denote by  $e_{\sigma^n}(\alpha)$  the generator of the line  $N(\text{lk}(\alpha; \sigma^n))$ . For all vertices  $\alpha$  of  $\sigma^n$  the collection  $\{e_{\sigma^n}(\beta) : \beta \in \text{lk}(\alpha; \sigma^n)^{(0)}\}$  is the*

dual basis of the reduction modulo 2 of  $\{\beta - \alpha : \beta \in \text{lk}(\alpha; \sigma^p)^{(0)}\}$ . Moreover, we have the relation:

$$\sum_{\alpha \in (\sigma^n)^{(0)}} e_{\sigma^n}(\alpha) = 0.$$

In addition, for all simplices  $\sigma^p \leq \sigma^n$ , the set  $\{e_{\sigma^n}(\alpha) : \alpha \in \text{lk}(\sigma^p; \sigma^n)^{(0)}\}$  is a basis of the vector space  $N(\sigma^p)$ . Also, for all simplices  $\sigma^p \leq \sigma^n$ , with  $p \geq 1$ , and all vertices  $\alpha \in \sigma^n$ , the interior product  $\iota_{e_{\sigma^n}(\alpha)}\omega(\sigma^p)$  vanishes if  $\alpha$  is not a vertex of  $\sigma^p$  and equals  $\omega(\text{lk}(\alpha; \sigma^p))$  when  $\alpha$  belongs to  $\sigma^p$ .

*Proof.* Let  $\sigma^n$  be a simplex of  $K$  and  $\alpha, \beta$  be distinct vertices of  $\sigma^n$ . If  $\beta' \in \sigma^n$  is different from  $\alpha$  and  $\beta$ , then, by definition,  $(\beta' - \alpha)(e_{\sigma^n}(\beta))$  must vanish for the edge  $[\beta'; \alpha]$  belongs to  $\text{lk}(\beta; \sigma^n)$ . The number  $(\beta - \alpha)(e_{\sigma^n}(\beta))$  must be 1, for otherwise  $e_{\sigma^n}(\beta)$  would vanish. Indeed,  $\{\beta - \alpha : \beta \in \text{lk}(\alpha; \sigma^p)^{(0)}\}$  is a basis of  $\mathfrak{t}^*(\mathbb{Z})$ , hence its reduction modulo 2 is a basis of  $\mathfrak{t}^*(\mathbb{F}_2)$ . It follows that  $\{e_{\sigma^n}(\beta) : \beta \in \text{lk}(\alpha; \sigma^p)^{(0)}\}$  is the dual basis of  $\{\beta - \alpha \pmod{2} : \beta \in \text{lk}(\alpha; \sigma^p)^{(0)}\}$ . Moreover, it implies that for any two vertices  $\beta, \beta'$  of  $\sigma^n$ , we have:

$$\begin{aligned} (\beta - \beta') \left( \sum_{\alpha \in (\sigma^n)^{(0)}} e_{\sigma^n}(\alpha) \right) &= (\beta - \beta')(e_{\sigma^n}(\beta) + e_{\sigma^n}(\beta')) \\ &= 1 + 1 \\ &= 0. \end{aligned}$$

Therefore, the vector  $\sum_{\alpha \in (\sigma^n)^{(0)}} e_{\sigma^n}(\alpha)$  is 0. We also deduce that, for all  $\sigma^p \leq \sigma^n$ ,  $\{e_{\sigma^n}(\alpha) : \alpha \in \text{lk}(\sigma^p; \sigma^n)^{(0)}\}$  is a linearly independent family of  $N(\sigma^p)$ . Since its cardinality is  $(n - p)$  it must be a basis. As a consequence if  $\alpha \in \sigma^n$  is not a vertex of  $\sigma^p$ , with  $p \geq 1$ , then  $\iota_{e_{\sigma^n}(\alpha)}\omega(\sigma^p)$  vanishes. If on the contrary  $\alpha$  is a vertex of  $\sigma^p$ , then  $\omega(\sigma^p)$  equals  $\omega(\text{lk}(\alpha; \sigma^p)) \wedge (\alpha - \beta)$  for any other vertex  $\beta$  of  $\sigma^p$ . It follows that  $\iota_{e_{\sigma^n}(\alpha)}\omega(\sigma^p)$  equals  $(\alpha - \beta)(e_{\sigma^n}(\alpha))\omega(\text{lk}(\alpha; \sigma^p))$ , i.e.  $\omega(\text{lk}(\alpha; \sigma^p))$ .  $\square$

**Remark 5.1.12.** Using Proposition 5.1.10 and Proposition 5.1.11, we find, for all simplices  $\sigma^n$  of  $K$  and all vertices  $\beta$  of  $\sigma^n$ , that we have:

$$z_{\sigma^n}^1(e_{\sigma^n}(\beta)) = d\chi_\beta.$$

Moreover, every form  $\alpha \in \mathfrak{t}^*(\mathbb{F}_2)$  equals  $\sum_{\beta \in \sigma^n} \alpha(e_{\sigma^n}(\beta))\beta$ .

**Proposition 5.1.13.** *Let  $K$  be primitive complex in  $\mathfrak{t}^*(\mathbb{R})$  and  $\sigma^{n-1}$  be an interior simplex of  $K$ , i.e. bounding two maximal simplices  $\sigma_+^n$  and  $\sigma_-^n$ . For all vertices  $\alpha \in \sigma^{n-1}$  we denote by  $\rho_{\sigma^{n-1}}(\alpha)$  the difference  $e_{\sigma_+^n}(\alpha) - e_{\sigma_-^n}(\alpha)$ . This vector lies on the line  $N(\sigma^{n-1})$  and we denote by  $|\rho_{\sigma^{n-1}}(\alpha)| \in \mathbb{F}_2$  the associated number. Moreover, if  $\alpha_\pm$  denotes the vertex of  $\sigma_\pm^n$  opposite to  $\sigma^{n-1}$  then:*

$$\alpha_+ - \alpha_- = \sum_{\beta \in \sigma^{n-1}} |\rho_{\sigma^{n-1}}(\beta)|\beta \pmod{2}.$$

*Proof.* Let  $\alpha$  be a vertex of  $\sigma^{n-1}$  and  $\sigma^1$  be an edge of  $\sigma^{n-1}$ . Following Remark 5.1.12, we have:

$$\begin{aligned}\omega(\sigma^1)(\rho_{\sigma^{n-1}}(\alpha)) &= \omega(\sigma^1)(e_{\sigma_+^n}(\alpha) - e_{\sigma_-^n}(\alpha)) \\ &= 2d\chi_\alpha(\sigma^1) \\ &= 0.\end{aligned}$$

Since  $\{\omega(\sigma^1): \sigma^1 \leq \sigma^{n-1}\}$  spans  $T\sigma^{n-1}(\mathbb{F}_2)$ , the vector  $\rho_{\sigma^{n-1}}(\alpha)$  belongs to the normal line  $N(\sigma^{n-1})$ . By Proposition 5.1.11,  $e_{\sigma_+^n}(\alpha_+)$  equals  $e_{\sigma_-^n}(\alpha_-)$ . They are the generator  $[N(\sigma^{n-1})]$  of  $N(\sigma^{n-1})$ . Hence, for any vertex  $\beta \in \sigma^{n-1}$ , we have:

$$\begin{aligned}(\alpha_+ - \alpha_-)[N(\sigma^{n-1})] &= (\alpha_+ - \beta)[N(\sigma^{n-1})] + (\alpha_- - \beta)[N(\sigma^{n-1})] \\ &= (\alpha_+ - \beta)(e_{\sigma_+^n}(\alpha_+)) + (\alpha_- - \beta)(e_{\sigma_-^n}(\alpha_-)) \\ &= 1 + 1 \\ &= 0.\end{aligned}$$

And the form  $(\alpha_+ - \alpha_-)$  is tangent to  $\sigma^{n-1}$  modulo 2. Therefore, by Proposition 5.1.11 and Remark 5.1.12, we have the following formula:

$$\alpha_+ - \alpha_- = \sum_{\beta \in \sigma^{n-1}} (\alpha_+ - \alpha_-)(e_{\sigma_+^n}(\beta))\beta.$$

For all  $\beta \in \sigma^{n-1}$ , we have:

$$\begin{aligned}(\alpha_+ - \alpha_-)(e_{\sigma_+^n}(\beta)) &= (\alpha_+ - \beta)(e_{\sigma_+^n}(\beta)) + (\beta - \alpha_-)(e_{\sigma_+^n}(\beta)) \\ &= 1 + (\beta - \alpha_-)(e_{\sigma_-^n}(\beta)) + (\beta - \alpha_-)(\rho_{\sigma^{n-1}}(\beta)) \\ &= 1 + 1 + |\rho_{\sigma^{n-1}}(\beta)|(\beta - \alpha_-)[N(\sigma^{n-1})] \\ &= |\rho_{\sigma^{n-1}}(\beta)|,\end{aligned}$$

since  $(\beta - \alpha_-)[N(\sigma^{n-1})]$  equals<sup>1</sup> 1. □

**Proposition 5.1.14.** *For all interior simplices  $\sigma^{n-1} \in K$  we have:*

$$\sum_{\alpha \in (\sigma^{n-1})^{(0)}} \rho_{\sigma^{n-1}}(\alpha) = 0.$$

*Proof.* Let  $\sigma_+^n$  and  $\sigma_-^n$  be the two maximal simplices bounded by  $\sigma^{n-1}$ . By Proposition 5.1.11, we have:

$$\sum_{\alpha \in (\sigma^{n-1})^{(0)}} \rho_{\sigma^{n-1}}(\alpha) = e_{\sigma_+^n}(\alpha_+) + e_{\sigma_-^n}(\alpha_-).$$

However,  $e_{\sigma_+^n}(\alpha_+)$  and  $e_{\sigma_-^n}(\alpha_-)$  both equal the generator of  $N(\sigma^{n-1})$ . Hence, the proposition follows. □

---

<sup>1</sup>The opposite would imply that  $[N(\sigma^{n-1})]$  is zero.

**Definition 5.1.15.** Let  $\varepsilon \in C^0(K; \mathbb{F}_2)$ . The *first derivative*  $D\varepsilon \in H_n(K; \partial K; T^*)$  is defined for all  $\sigma^n \in K$  by the formula:

$$D\varepsilon_{\sigma^n} := (z_{\sigma^n}^1)^{-1}(\mathrm{d}\varepsilon|_{\sigma^n}).$$

The following proposition, which is a direct consequence of Definition 5.1.15, justifies the choice of terminology.

**Proposition 5.1.16.** For all  $\varepsilon \in C^0(K; \mathbb{F}_2)$ , all  $\sigma^n \in K$  and all vertices  $\alpha, \beta \in \sigma^n$  we have:

$$\varepsilon(\beta) = \varepsilon(\alpha) + D\varepsilon_{\sigma^n}(\beta - \alpha).$$

Therefore,  $D\varepsilon$  vanishes if and only if  $\varepsilon$  is constant.

**Definition 5.1.17.** Let  $\varepsilon \in C^0(K; \mathbb{F}_2)$ . The *second derivative*  $D^2\varepsilon \in H_{n-1}(K; \partial K; N)$  is defined by the formula:

$$D^2\varepsilon := \partial(D\varepsilon),$$

where  $\partial$  denotes the connecting morphism  $H_n(K; \partial K; T^*) \rightarrow H_{n-1}(K; \partial K; N)$  of the homological long exact sequence associated with the short exact sequence of cosheaves of Definition 5.1.7.

**Remark 5.1.18.** When the support of  $K$  is a closed ball the homological long exact sequence associated with the short exact sequence of cosheaves of Definition 5.1.7 splits around the dimension  $n$ . It induces the following short exact sequence:

$$0 \longrightarrow \underbrace{H_n(K; \partial K; \mathfrak{t}(\mathbb{F}_2))}_{\cong \mathfrak{t}(\mathbb{F}_2)} \longrightarrow H_n(K; \partial K; T^*) \xrightarrow{\partial} H_{n-1}(K; \partial K; N) \longrightarrow 0.$$

Because  $N$  vanishes on maximal simplices. We note that  $H_{n-1}(K; \partial K; N)$  is a cycle group.

**Proposition 5.1.19.** Let  $\sigma^{n-1}$  be an interior simplex bounding two maximal simplices  $\sigma_{\pm}^n$ , and  $\alpha_{\pm}$  be the vertex of  $\sigma_{\pm}^n$  opposite to  $\sigma^{n-1}$ . The number  $D^2\varepsilon_{\sigma^{n-1}}(\alpha_- - \beta)$  does not depend on the choice of vertex  $\beta \in \sigma^{n-1}$ . It satisfies the following property:

$$\varepsilon(\alpha_+) = \varepsilon(\alpha_-) + D\varepsilon_{\sigma_{+}^n}(\alpha_+ - \alpha_-) + D^2\varepsilon_{\sigma^{n-1}}(\alpha_- - \beta).$$

Moreover, if  $|K|$  is homeomorphic to a ball,  $D^2\varepsilon$  vanishes if and only if  $\varepsilon$  is affine.

*Proof.* Let  $\beta$  be a vertex of  $\sigma^{n-1}$ . We have:

$$\begin{aligned} \varepsilon(\alpha_+) + \varepsilon(\alpha_-) &= D\varepsilon_{\sigma_{+}^n}(\alpha_+ + \beta) + D\varepsilon_{\sigma_{-}^n}(\alpha_- + \beta) \\ &= D\varepsilon_{\sigma_{+}^n}(\alpha_+ + \alpha_-) + D^2\varepsilon_{\sigma^{n-1}}(\alpha_- + \beta). \end{aligned}$$

Hence  $\varepsilon(\alpha_+)$  equals  $\varepsilon(\alpha_-) + D\varepsilon_{\sigma_{+}^n}(\alpha_+ - \alpha_-) + D^2\varepsilon_{\sigma^{n-1}}(\alpha_- - \beta)$  and  $D^2\varepsilon_{\sigma^{n-1}}(\alpha_- - \beta)$  does not depend on  $\beta$ . The cochain  $\varepsilon$  is represented in each  $n$ -simplex  $\sigma^n$  of  $K$  by an affine function of  $\mathfrak{t}^*(\mathbb{F}_2)$  whose linear part is given by  $D\varepsilon_{\sigma^n}$ . Using the exact sequence of Remark 5.1.18, we see that if  $D^2\varepsilon$  vanishes then this linear part is the

same on every maximal simplices of  $K$  since  $K$  is connected. Hence  $\varepsilon$  is globally given by an affine map.  $\square$

**Lemma 5.1.20.** *If the primitive complex  $K$  is shellable then both  $D$  and  $D^2$  are surjective. Therefore, we have the exact sequences:*

$$0 \longrightarrow \mathbb{F}_2 \longrightarrow C^0(K; \mathbb{F}_2) \xrightarrow{D} H_n(K; \partial K; T^*) \longrightarrow 0,$$

and:

$$0 \longrightarrow \text{Aff}(\mathfrak{t}^*(\mathbb{F}_2)) \longrightarrow C^0(K; \mathbb{F}_2) \xrightarrow{D^2} H_{n-1}(K; \partial K; N) \longrightarrow 0.$$

*Proof.* Let  $\varepsilon \in C^0(K; \mathbb{F}_2)$  and  $\sigma^n$  be a maximal simplex of  $K$ . By Definition 5.1.15, we have the following formula:

$$D\varepsilon_{\sigma^n} = \sum_{\alpha \in \sigma^n} \varepsilon(\alpha) e_{\sigma^n}(\alpha).$$

Now, let  $\sigma^{n-1}$  be an interior simplex of  $K$ . By Definition 5.1.17, we have:

$$D^2\varepsilon_{\sigma^{n-1}} = (\varepsilon(\alpha_+) + \varepsilon(\alpha_-)) [N(\sigma^{n-1})] + \sum_{\alpha \in \sigma^{n-1}} \varepsilon(\alpha) \rho_{\sigma^{n-1}}(\alpha),$$

where  $\alpha_{\pm} * \sigma^{n-1}$  are the two  $n$ -simplices bounded by  $\sigma^{n-1}$ , and  $[N(\sigma^{n-1})]$  is the generator of  $N(\sigma^{n-1})$ . We can also write it as follows:

$$D^2\varepsilon_{\sigma^{n-1}} = \left( \varepsilon(\alpha_+) + \varepsilon(\alpha_-) + \sum_{\alpha \in \sigma^{n-1}} \varepsilon(\alpha) |\rho_{\sigma^{n-1}}(\alpha)| \right) [N(\sigma^{n-1})].$$

We will use this formula to show that when  $K$  is shellable,  $D^2$  is surjective. Let  $(\sigma_i^n)_{0 \leq i \leq k}$  be a shelling of  $K$ , and  $c \in H_{n-1}(K; \partial K; N)$ . We will construct a  $\varepsilon$  whose image by  $D^2$  is  $c$ . For all  $0 \leq i \leq k$ , we denote by  $K_i$  the union  $\cup_{0 \leq j \leq i} K(\sigma_j^n)$ . For all interior simplices  $\sigma^{n-1}$ , we denote by  $|\langle c; \sigma^{n-1} \rangle| \in \mathbb{F}_2$  the unique number for which  $|\langle c; \sigma^{n-1} \rangle| [N(\sigma^{n-1})]$  equals  $\langle c; \sigma^{n-1} \rangle$ . We note that  $K_{i+1}^{(0)}$  equals  $K_i^{(0)}$  if the order of  $\sigma_{i+1}^n$  is bigger than 1. Otherwise,  $K_{i+1}^{(0)} \setminus K_i^{(0)}$  is reduced to the vertex  $\text{lk}(K_i; K_{i+1})$ . It induces an order  $(\alpha_j)_{1 \leq j \leq h_1(K)}$  on the vertices of  $K$  that do not belong to  $\sigma_0^n$ . For all  $1 \leq j \leq h_1(K)$ , we denote by  $\sigma_j^{n-1}$  the simplex for which  $\sigma_j^{n-1} * \alpha_j$  is the simplex of order 1 at which  $\alpha_j$  appears. We also denote by  $\alpha_j^-$  the other vertex of the link of  $\sigma_j^{n-1}$  in  $K$ . Now we inductively define  $\varepsilon$  by the following rule:

$$\begin{cases} \varepsilon|_{\sigma_0^n} = 0 \\ \varepsilon(\alpha_j) = |\langle c; \sigma_j^{n-1} \rangle| + \varepsilon(\alpha_j^-) + \sum_{\alpha \in \sigma_j^{n-1}} \varepsilon(\alpha) |\rho_{\sigma_j^{n-1}}(\alpha)|, \quad \forall 1 \leq j \leq h_1(K). \end{cases}$$

By construction,  $D^2\varepsilon_{\sigma_j^{n-1}}$  equals  $\langle c; \sigma_j^{n-1} \rangle$  for all  $1 \leq j \leq h_1(K)$ . We claim this is also true on the other interior  $(n-1)$ -simplices of  $K$ . We will show by induction on  $0 \leq i \leq k$ , that  $D^2\varepsilon_{\sigma^{n-1}}$  equals  $\langle c; \sigma^{n-1} \rangle$  for all interior  $(n-1)$ -simplices of  $K_i$ . The assertion is true on  $K_1$  for  $\sigma_1^n$  has order 1. Let us assume it true on  $K_i$ . The



only interior  $(n-1)$ -simplices of  $K_{i+1}$  that were not already interior in  $K_i$  are those contained in  $\sigma_{i+1}^n$  that contain  $\tau_{i+1}$  (the intersection of the contact faces of  $\sigma_{i+1}^n$  with  $K_i$ ). If  $\text{ord}(\sigma_{i+1}^n)$  is 1, then by construction the property is true on  $K_{i+1}$ . If  $\text{ord}(\sigma_{i+1}^n)$  is bigger than 1, let us consider two  $(n-1)$ -simplices  $\sigma_{\pm}^{n-1}$  that contain  $\tau_i$ . Since  $D^2\varepsilon$  and  $c$  are cycles we have:

$$D^2\varepsilon_{\sigma_+^{n-1}} + D^2\varepsilon_{\sigma_-^{n-1}} = \sum_{\substack{\sigma^{n-1} \geq \sigma_+^{n-1} \cap \sigma_-^{n-1} \\ \sigma^{n-1} \neq \sigma_{\pm}^{n-1}}} D^2\varepsilon_{\sigma^{n-1}}, \quad (5.2)$$

and:

$$\langle c; \sigma_+^{n-1} \rangle + \langle c; \sigma_-^{n-1} \rangle = \sum_{\substack{\sigma^{n-1} \geq \sigma_+^{n-1} \cap \sigma_-^{n-1} \\ \sigma^{n-1} \neq \sigma_{\pm}^{n-1}}} \langle c; \sigma^{n-1} \rangle. \quad (5.3)$$

If  $\sigma^{n-1} \in K$  contains  $\sigma_+^{n-1} \cap \sigma_-^{n-1}$  and is different from  $\sigma_+^{n-1}$  and  $\sigma_-^{n-1}$  it cannot belong to  $\sigma_{i+1}^n$  for  $\sigma_+^{n-1} \cap \sigma_-^{n-1}$  has codimension 2. Hence, by Lemma 5.1.5, it belongs to  $K_i$ . Thus, the right hand sides of (5.2) and (5.3) are equal by recursion hypothesis. Therefore, we have the following relation:

$$D^2\varepsilon_{\sigma_+^{n-1}} + D^2\varepsilon_{\sigma_-^{n-1}} = \langle c; \sigma_+^{n-1} \rangle + \langle c; \sigma_-^{n-1} \rangle. \quad (5.4)$$

The vector  $[N(\sigma_+^{n-1})]$  is linearly independent from  $[N(\sigma_-^{n-1})]$ . Thus (5.4) implies that  $D^2\varepsilon_{\sigma_{\pm}^{n-1}}$  equals  $\langle c; \sigma_{\pm}^{n-1} \rangle$  for  $D^2\varepsilon_{\sigma_{\pm}^{n-1}}$  and  $\langle c; \sigma_{\pm}^{n-1} \rangle$  belong to the line  $N(\sigma_{\pm}^{n-1})$ .

Since  $K$  is embedded in a real vector space of the same dimension, its support can only be homeomorphic<sup>2</sup> to a ball. Hence, we have the exact sequence of Remark 5.1.18. From Proposition 5.1.16, Proposition 5.1.19, and the surjectivity of  $D^2$ , we have the following commutative diagram with exact rows and columns:

$$\begin{array}{ccccccc} & & 0 & & & & \\ & & \uparrow & & & & \\ 0 & \longrightarrow & H_n(K; \partial K; \mathfrak{t}(\mathbb{F}_2)) & \longrightarrow & H_n(K; \partial K; T^*) & \xrightarrow{\partial} & H_{n-1}(K; \partial K; N) \longrightarrow 0 \\ & & \uparrow \text{D} & & \uparrow \text{D} & & \uparrow \text{id} \\ 0 & \longrightarrow & \text{Aff}(\mathfrak{t}^*(\mathbb{F}_2)) & \longrightarrow & C^0(K; \mathbb{F}_2) & \xrightarrow{D^2} & H_{n-1}(K; \partial K; N) \longrightarrow 0 \\ & & \uparrow & & \uparrow & & \\ & & \mathbb{F}_2 & & \mathbb{F}_2 & & \\ & & \uparrow & & \uparrow & & \\ & & 0 & & 0 & & \end{array}$$

from which derive the exact sequences of the lemma.  $\square$

**Definition 5.1.21.** We define two enlargement of the boundary of  $K$ :

1. the sub-complex  $\mathcal{B}_0K$  of  $K$  made of all the simplices of  $K$  having all of their

<sup>2</sup>c.f. Proposition 5.1.4.

vertices in  $\partial K$ ;

2. the sub-complex  $\mathcal{B}_1 K$  of  $K$  made of the union of the closed simplices  $K(\sigma^p)$  of  $K$  for which all of their vertices  $v \in K(\sigma^p)$  satisfy  $v \in \partial K$  or  $\text{lk}(v; \sigma^p) \in \partial K$ . See Figure 5.1 for an example.

We note that  $\mathcal{B}_1 K$  contains  $\mathcal{B}_0 K$  and all the vertices of  $K$ . The simplices of  $\mathcal{B}_1 K$  that do not belong to  $\mathcal{B}_0 K$  are joins of an interior vertex of  $K$  and a simplex of  $\partial K$ . For such a simplex  $\sigma$  we denote by  $\text{ap}(\sigma)$  its interior vertex.

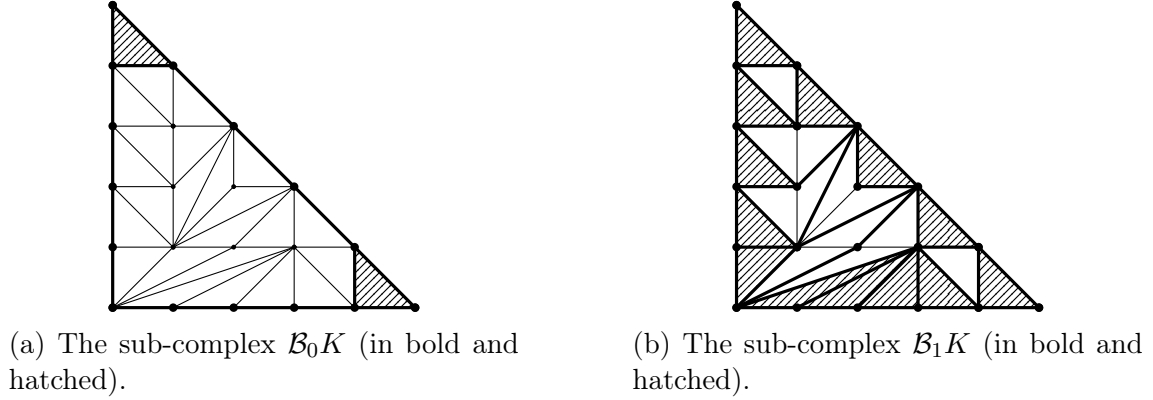

Figure 5.1: Examples of  $\mathcal{B}_0 K$  and  $\mathcal{B}_1 K$ .

**Definition 5.1.22.** Let  $\sigma^{n-1}$  be an interior simplex of  $K$ . we denote by  $I(\sigma^{n-1})$  the set of vertices  $\alpha$  of  $\sigma^{n-1}$  that do not belong to  $\partial K$  and whose link  $\text{lk}(\alpha; \sigma^{n-1})$  is not contained in  $\partial K$  either. We say that  $K$  is  $\rho$ -uniform if for all interior simplices  $\sigma^{n-1} \in K$  the restriction of  $\rho_{\sigma^{n-1}}$  to  $I(\sigma^{n-1})$  is constant. In particular, because of Proposition 5.1.14, if  $\dim K \leq 2$  then  $K$  is  $\rho$ -uniform. If  $K$  is not  $\rho$ -uniform we say that  $K$  fails to be  $\rho$ -uniform at  $\sigma^{n-1}$  if  $\rho_{\sigma^{n-1}}$  is not constant on  $I(\sigma^{n-1})$ . For all  $\rho$ -uniform complexes  $K$ , we denote by  $\rho \in C_{n-1}(K; \mathcal{B}_0 K; N)$  the chain whose value on  $\sigma^{n-1} \in K \setminus \mathcal{B}_1 K$  is  $\rho_{\sigma^{n-1}}(\alpha)$  for any  $\alpha \in I(\sigma^{n-1})$ , and whose value on  $\sigma^{n-1} \in \mathcal{B}_1 K \setminus \mathcal{B}_0 K$  is  $\rho_{\sigma^{n-1}}(\text{ap}(\sigma^{n-1}))$ .

**Proposition 5.1.23.** *If  $K$  is  $\rho$ -uniform, the chain  $\rho$  is a cycle. It induces a homology class denoted by the same symbol.*

*Proof.* Let  $\sigma^{n-2}$  be a simplex of  $K$  that does not belong to  $\partial K$ . If  $n$  equals 2 then  $\langle \partial \rho; \sigma^0 \rangle$  is  $\sum_{\sigma^1 \geq \sigma^0} \rho_{\sigma^1}(\sigma^0)$  since  $\rho$  is constant on  $\sigma^1$ . This vector is zero by definition of  $\rho_{\sigma^1}(\sigma^0)$  as the difference  $\sum_{\sigma^2 \geq \sigma^1} e_{\sigma^2}(\sigma^0)$ . Now if  $n$  is bigger than 2, then either  $\sigma^{n-2}$  belongs to  $\mathcal{B}_1 K$  or not but either way there is an interior vertex  $\alpha$  of  $\sigma^{n-2}$  for which  $\langle \partial \rho; \sigma^{n-2} \rangle$  equals to  $\sum_{\sigma^{n-1} \geq \sigma^{n-2}} \rho_{\sigma^{n-1}}(\alpha)$ . This vector vanishes for the same reason as in the case  $n = 2$ .  $\square$

## 5.2 Boundaries of the First Page

Let  $P$  be a smooth  $n$ -dimensional polytope of  $\mathfrak{t}^*(\mathbb{R})$  endowed with a primitive triangulation  $K$ . Both the numbers  $\delta(P)$  and  $\theta(K)$  equal 1, in particular  $\hat{F}_p^X$  equals  $F_p^X$ ,

for all integers  $p \geq 0$ . We adopt the convention of the previous chapter concerning the tropical sheaves and cosheaves: we will always consider them with coefficients in  $\mathbb{F}_2$ . Let  $0 \leq p \leq n-1$  be an integer, we recall from Lemma 3.3.3 that we have the following exact sequence:

$$C^p(K; \partial K; \omega_{\mathbb{F}_2}^*) \xrightarrow{g^p} H_{p,n-1-p}(X; \mathbb{F}_2) \rightarrow H_{p,n-1-p}(P; \mathbb{F}_2) \rightarrow 0. \quad (5.5)$$

For all simplices  $\sigma^p$  of  $K$ , the group  $\omega_{\mathbb{F}_2}^*(\sigma^p)$  is a line over  $\mathbb{F}_2$ . Since  $\mathbb{F}_2$  has only two elements these lines are canonically isomorphic to  $\mathbb{F}_2$  and (5.5) can be written as follows:

$$C^p(K; \partial K; \mathbb{F}_2) \xrightarrow{g^p} H_{p,n-1-p}(X; \mathbb{F}_2) \rightarrow H_{p,n-1-p}(P; \mathbb{F}_2) \rightarrow 0. \quad (5.6)$$

Let  $w(\sigma^p) = w_1(\sigma^p) \wedge \dots \wedge w_p(\sigma^p)$  denote, for all  $\sigma^p \in K$ , any choice of totally decomposed  $p$ -vector of  $\mathfrak{t}(\mathbb{F}_2)$  satisfying  $\omega(\sigma^p)(w(\sigma^p)) = 1$ . Let  $\gamma \in C^p(K; \partial K; \mathbb{F}_2)$ , following Proposition 3.3.2, the homology class  $g^p(\gamma)$  is expressed as follows:

$$g^p(\gamma) = \left[ \sum_{\sigma^{p+1} \leq \sigma^n} d(\gamma w)(\sigma^{p+1}) \otimes [\sigma^{p+1}; \sigma^n] \right]. \quad (5.7)$$

It does not depend on our choice of  $w$ . We also want to recall the Borel-Viro isomorphisms between the tropical homology and the first page of the Renaudineau-Shaw spectral sequence. Let  $\varepsilon$  denote a sign distribution and  $p, q \geq 0$  be two integers. From Proposition 4.2.22, we have the following commutative square:

$$\begin{array}{ccc} E_{p,q}^1(\mathbb{R}P) & \xrightarrow[\cong]{\text{bv}_{p,q}^P} & H_{p,q}(P; \mathbb{F}_2) \\ i_{p,q}^1 \uparrow & & \uparrow i_{p,q} \\ E_{p,q}^1(\mathbb{R}X_\varepsilon) & \xrightarrow[\cong]{\text{bv}_{p,q}^X} & H_{p,q}(X; \mathbb{F}_2) \end{array} \quad (5.8)$$

In what follows we shall always identify  $(E_{p,q}^1(\mathbb{R}P))_{p,q \geq 0}$  and  $(E_{p,q}^1(\mathbb{R}X_\varepsilon))_{p,q \geq 0}$  with  $(H_{p,q}(P; \mathbb{F}_2))_{p,q \geq 0}$  and  $(H_{p,q}(X; \mathbb{F}_2))_{p,q \geq 0}$  respectively, using the Borel-Viro isomorphisms.

**Lemma 5.2.1** (Origin). *Let  $\varepsilon \in C^0(K; \mathbb{F}_2)$  be a sign distribution,  $\sigma^p \leq \sigma^{p+1} \leq \sigma^n$  be three simplices of  $K$ , and  $W$  be a supplementary sub-space of  $N(e^p)$  in  $\mathfrak{t}(\mathbb{F}_2)$ . The point:*

$$\mathbf{O}_{\sigma^n}(e^p) := D\varepsilon_{\sigma^n} + \sum_{\sigma^0 \leq \sigma^p} e_{\sigma^n}(\sigma^0) \in \mathfrak{t}(\mathbb{F}_2),$$

satisfies  $\mathbf{O}_{\sigma^n}(e^p) + W \subset \text{Arg}_\varepsilon(\sigma^{p+1}; \sigma^n)$ .

*Proof.* Following Lemma 4.1.7, the set  $\text{Arg}_\varepsilon(\sigma^{p+1}; \sigma^n)$  is described as the following set  $\{v \in \mathfrak{t}(\mathbb{F}_2) \mid z_{\sigma^{p+1}}^1(v) \neq d\varepsilon|_{\sigma^{p+1}}\}$ . By Definition 5.1.15, the image of the vector  $D\varepsilon_{\sigma^n}$  by  $z_{\sigma^n}^1$  is  $d\varepsilon|_{\sigma^n}$ . Hence, by Proposition 5.1.10,  $z_{\sigma^{p+1}}^1(D\varepsilon_{\sigma^n})$  equals  $d\varepsilon|_{\sigma^{p+1}}$ . Let

us denote by  $v$  the vector:

$$v := \sum_{\beta \text{ vertex of } \sigma^p} e_{\sigma^n}(\beta).$$

Proposition 5.1.11 ensures that  $z_{\sigma^{p+1}}^1(v)$  equals  $d\chi_\alpha$  where  $\alpha$  is the vertex of  $\sigma^{p+1}$  opposite to  $\sigma^p$ . If  $\sigma^1$  is an edge of  $\sigma^{p+1}$  that contains  $\alpha$  then  $z_{\sigma^{p+1}}^1(D\varepsilon_{\sigma^n} + v)(\sigma^1)$  equals  $d\varepsilon(\sigma^1) + 1$ , and  $D\varepsilon_{\sigma^n} + v$  belongs to  $\text{Arg}_\varepsilon(\sigma^{p+1}; \sigma^n)$ . Let  $w \in \mathfrak{t}(\mathbb{F}_2)$  be a vector that does not belong to  $N(e^p)$ . The restriction of  $z_{\sigma^{p+1}}^1(D\varepsilon_{\sigma^n} + v + w)$  to  $\sigma^p$  is  $d\varepsilon|_{\sigma^p} + z_{\sigma^p}^1(w)$ . Since  $w$  does not belong to  $N(e^p)$ ,  $z_{\sigma^p}^1(w)$  is different from zero and, consequently,  $D\varepsilon_{\sigma^n} + v + w$  belongs to  $\text{Arg}_\varepsilon(\sigma^{p+1}; \sigma^n)$ .  $\square$

**Lemma 5.2.2** (Lift). *Let  $\varepsilon \in C^0(K; \mathbb{F}_2)$  be a sign distribution,  $0 \leq p \leq n-1$  be an integer, and  $\gamma$  be a cochain of  $C^p(K; \partial K; \mathbb{F}_2)$ . The chain:*

$$c := \sum_{\sigma^{p+1} \leq \sigma^n} d \left( \gamma x^{\mathbf{O}_{\sigma^n}} \prod_{i=1}^p (1 + x^{w_i}) \right) (\sigma^{p+1}) \otimes [\sigma^{p+1}; \sigma^n] \in \Omega_{n-1-p} \left( K; \mathcal{K}_{(p)}^{\mathbb{R}X_\varepsilon} \right),$$

has its boundary equal to:

$$\sum_{\sigma^{p+1} \leq \sigma^{n-1}} d \left( \gamma G_{\sigma^{n-1}} \prod_{i=1}^p (1 + x^{w_i}) \right) (\sigma^{p+1}) \otimes [\sigma^{p+1}; \sigma^{n-1}],$$

where  $G_{\sigma^{n-1}}(\sigma^p)$  is null on the  $p$ -simplices of the boundary and otherwise equals  $\sum_{\sigma^n \geq \sigma^{n-1}} x^{\mathbf{O}_{\sigma^n}(\sigma^p)}$ . This boundary belongs to  $\Omega_{n-2-p}(K; \mathcal{K}_{(p+1)}^{\mathbb{R}X_\varepsilon})$  and  $c$  represents the homology class  $g^p(\gamma)$ .

*Proof.* Let  $0 \leq p \leq n-1$  be an integer. By definition,  $(E_{p,q}^1(\mathbb{R}X_\varepsilon))_{q \geq 0}$  is the homology of the  $p$ -th graded piece of the filtered cosheaf  $\mathcal{K}^{\mathbb{R}X_\varepsilon}$ . By Proposition 4.2.22, this cosheaf is isomorphic to  $F_p^X$  through  $\text{bv}_p^X$ . Therefore, any homology class  $[c] \in H_{p,q}(X; \mathbb{F}_2)$  can be represented by a relative cycle, i.e. a chain  $c \in \Omega_q(K; \mathcal{K}_{(p)}^{\mathbb{R}X_\varepsilon})$  whose boundary belongs to  $\Omega_{q-1}(K; \mathcal{K}_{(p+1)}^{\mathbb{R}X_\varepsilon})$ . Let  $\sigma^{p+1} \leq \sigma^n$  be a pair of simplices of  $K$ , and  $\mathbf{O} + \langle v_1, \dots, v_p \rangle$  be a  $p$ -affine subspace of  $\mathfrak{t}(\mathbb{F}_2)$  contained in  $\text{Arg}_\varepsilon(\sigma^{p+1}; \sigma^n)$ . From Remark 4.2.23, we have:

$$\text{bv}_p^X(\sigma^{p+1}; \sigma^n) \left( x^{\mathbf{O}} \prod_{i=1}^p (1 + x^{v_i}) \right) = \bigwedge_{i=1}^p v.$$

Since  $\omega(\sigma^p)(w(\sigma^p))$  equals 1, for all  $\sigma^p \leq \sigma^{p+1}$ , the vector space  $\langle w_1(\sigma^p), \dots, w_p(\sigma^p) \rangle$  is a supplementary sub-space of  $N(\sigma^p)$  in  $\mathfrak{t}(\mathbb{F}_2)$ . Using Lemma 5.2.1, it follows that the chain:

$$c := \sum_{\sigma^{p+1} \leq \sigma^n} d \left( \gamma x^{\mathbf{O}_{\sigma^n}} \prod_{i=1}^p (1 + x^{w_i}) \right) (\sigma^{p+1}) \otimes [\sigma^{p+1}; \sigma^n],$$

lifts the chain  $\sum_{\sigma^{p+1} \leq \sigma^n} d(\gamma w) (\sigma^{p+1}) \otimes [\sigma^{p+1}; \sigma^n]$ . Let  $\sigma^q \leq \sigma^{q+n-p-2}$  be a pair of

simplices of  $K$ . We have:

$$\begin{aligned} \langle \partial c; [\sigma^q \leq \sigma^{q+n-p-2}] \rangle &= \sum_{\sigma^{q-1} \leq \sigma^q} \langle c; [\sigma^{q-1} \leq \sigma^{q+n-p-2}] \rangle \\ &\quad + \sum_{\sigma^{q+n-p-2} \leq \sigma^{q+n-p-1}} \langle c; [\sigma^q \leq \sigma^{q+n-p-1}] \rangle. \end{aligned}$$

If  $q$  is different from  $p+1$  and  $p+2$ ,  $\langle \partial c; [\sigma^q \leq \sigma^{q+n-p-2}] \rangle$  vanishes. For the remaining pieces we have:

$$\begin{aligned} \langle \partial c; [\sigma^{p+2} \leq \sigma^n] \rangle &= \sum_{\sigma^{p+1} \leq \sigma^{p+2}} d \left( \gamma x^{\mathbf{O}_{\sigma^n}} \prod_{i=1}^p (1 + x^{w_i}) \right) (\sigma^{p+1}) \\ &= 0, \end{aligned}$$

and:

$$\begin{aligned} \langle \partial c; [\sigma^{p+1} \leq \sigma^{n-1}] \rangle &= \sum_{\sigma^{n-1} \leq \sigma^n} d \left( \gamma x^{\mathbf{O}_{\sigma^n}} \prod_{i=1}^p (1 + x^{w_i}) \right) (\sigma^{p+1}) \\ &= \sum_{\sigma^p \leq \sigma^{p+1}} \gamma(\sigma^p) \sum_{\sigma^{n-1} \leq \sigma^n} (x^{\mathbf{O}_{\sigma^n(\sigma^p)}}) \prod_{i=1}^p (1 + x^{w_i(\sigma^p)}) \\ &= \sum_{\sigma^p \leq \sigma^{p+1}} \gamma(\sigma^p) G_{\sigma^{n-1}}(\sigma^p) \prod_{i=1}^p (1 + x^{w_i(\sigma^p)}) \\ &= d \left( \gamma G_{\sigma^{n-1}} \prod_{i=1}^p (1 + x^{w_i}) \right) (\sigma^{p+1}), \end{aligned}$$

since  $\gamma$  vanishes on the boundary of  $K$ . Whenever we have a triple  $\sigma^p \leq \sigma^{p+1} \leq \sigma^{n-1}$  with  $\sigma^p$  not contained in  $\partial K$ , there are two  $n$ -simplices  $\sigma_{\pm}^n$  adjacent to  $\sigma^{n-1}$ . In this case  $\text{Arg}_{\varepsilon}(\sigma^{p+1}; \sigma^{n-1})$  equals  $\text{Arg}_{\varepsilon}(\sigma^{p+1}; \sigma_{\pm}^n)$ , and  $\mathbf{O}_{\sigma_{\pm}^n} + \langle w_1(\sigma^p), \dots, w_p(\sigma^p) \rangle$  are two parallel affine sub-spaces contained in this set. Therefore  $G_{\sigma^{n-1}}(\sigma^p) \prod_{i=1}^p (1 + x^{w_i(\sigma^p)})$  belongs to  $\mathcal{K}_{(p+1)}^{\mathbb{R}X_{\varepsilon}}(\sigma^{p+1}; \sigma^{n-1})$ . Thus  $\partial c$  belongs to  $\Omega_{n-2-p}(K; \mathcal{K}_{(p+1)}^{\mathbb{R}X_{\varepsilon}})$ .  $\square$

**Proposition 5.2.3.** *Let  $\varepsilon \in C^0(K; \mathbb{F}_2)$  be a sign distribution on  $K$ ,  $0 \leq p \leq n-1$  be an integer, and  $\gamma$  be a cochain of  $C^p(K; \partial K; \mathbb{F}_2)$ . We have:*

$$\partial_{p, n-1-p}^1 g^p(\gamma) = \left[ \sum_{\sigma^{p+1} \leq \sigma^{n-1}} d(\gamma w \wedge (D^2 \varepsilon_{\sigma^{n-1}} + \rho_{\sigma^{n-1}}^p)) (\sigma^{p+1}) \otimes [\sigma^{p+1}; \sigma^{n-1}] \right],$$

where  $\rho_{\sigma^{n-1}}^p \in C^p(\sigma^{n-1}; N(\sigma^{n-1}))$  is defined, for all  $\sigma^p \leq \sigma^{n-1}$ , by the formula:

$$\rho_{\sigma^{n-1}}^p(\sigma^p) := \sum_{\alpha \text{ vertex of } \sigma^p} \rho_{\sigma^{n-1}}(\alpha).$$

*Proof.* By Lemma 5.2.2,  $\partial_{p,n-1-p}^1 g^p(\gamma)$  is given by the formula:

$$\left[ \sum_{\sigma^{p+1} \leq \sigma^{n-1}} \text{bv}_{p+1}^X(\sigma^{p+1}; \sigma^{n-1}) \left( d \left( \gamma G_{\sigma^{n-1}} \prod_{i=1}^p (1 + x^{w_i}) \right) (\sigma^{p+1}) \right) \otimes [\sigma^{p+1}; \sigma^n] \right].$$

Let  $\sigma^p \leq \sigma^{p+1} \leq \sigma^{n-1}$  be a triple of simplices with  $\sigma^p$  not contained in  $\partial K$ . From Remark 4.2.23, we have:

$$\begin{aligned} \text{bv}_{p+1}^X(\sigma^{p+1}; \sigma^{n-1}) \left( G_{\sigma^{n-1}}(\sigma^p) \prod_{i=1}^p (1 + x^{w_i(\sigma^p)}) \right) &= \left( \sum_{\sigma^n \geq \sigma^{n-1}} \mathbf{O}_{\sigma^n}(\sigma^p) \right) \wedge w(\sigma^p) \\ &= (\mathbf{D}^2 \varepsilon_{\sigma^{n-1}} + \rho_{\sigma^{n-1}}^p(\sigma^p)) \wedge w(\sigma^p). \end{aligned}$$

Therefore we find that:

$$\partial_{p,n-1-p}^1 g^p(\gamma) = \left[ \sum_{\sigma^{p+1} \leq \sigma^{n-1}} d \left( \gamma w \wedge (\mathbf{D}^2 \varepsilon_{\sigma^{n-1}} + \rho_{\sigma^{n-1}}^p) \right) (\sigma^{p+1}) \otimes [\sigma^{p+1}; \sigma^{n-1}] \right].$$

□

**Definition 5.2.4.** Let  $\varepsilon \in C^0(K; \mathbb{F}_2)$  be a sign distribution, and  $\sigma^p$  and  $\sigma^q$  be two interior simplices of  $K$  with  $p + q = n - 2$ . We denote by  $(\sigma^p; \sigma^q)_\varepsilon$  the number:

$$(\sigma^p; \sigma^q)_\varepsilon := g^p(\chi_{\sigma^p}) \cdot \partial_{q,p+1}^1 g^q(\chi_{\sigma^q}) \in H_{0,0}(X; \mathbb{F}_2) = \mathbb{F}_2,$$

where  $-\cdot-$  denotes the intersection product of Definition 3.1.22. For all integers  $p, q \geq 0$  for which  $p + q = n - 2$ ,  $M_{p,q}(\varepsilon)$  denotes the matrix whose entries are given by the numbers  $((\sigma^p; \sigma^q)_\varepsilon)_{\sigma^p, \sigma^q \in K \setminus \partial K}$ .

**Definition 5.2.5.** We assume that  $n = 2k + 1$  is odd. We define the *radical* of  $X$ , denoted by  $\text{Rad}(X)$ , to be the radical of the intersection form restricted to the kernel of  $i_{k,k} : H_{k,k}(X; \mathbb{F}_2) \rightarrow H_{k,k}(P; \mathbb{F}_2)$ . We denote by  $\text{rad}(X)$  the dimension of  $\text{Rad}(X)$ .

**Proposition 5.2.6.** *We assume that  $n = 2k + 1$  is odd. Let  $\omega_X$  denote the Poincaré dual in  $P$  of the fundamental class of  $X$ . The radical  $\text{Rad}(X)$  is generated by the classes  $i^{k,k}(\gamma) \cap [X] \in H_{k,k}(X; \mathbb{F}_2)$  for all  $\gamma \in H^{k,k}(P; \mathbb{F}_2)$  for which  $\gamma \cup \omega_X$  vanishes.*

*Proof.* The Poincaré duality in  $X$  provides us with an isomorphism between the group  $H_{k,k}(X; \mathbb{F}_2)$  and its dual  $H^{k,k}(X; \mathbb{F}_2)$ . The orthogonal of  $\ker(i_{k,k})$  is the image under this isomorphism of  $\text{im}(i^{k,k})$  i.e. is spanned by the element of the form  $i^{k,k}(\gamma) \cap [X]$  where  $\gamma$  belongs to  $H^{k,k}(P; \mathbb{F}_2)$ . If we denote by  $\omega_X$  the Poincaré dual in  $P$  of  $[X]$ , we have:

$$i_{k,k}(i^{k,k}(\gamma) \cap [X]) = (\gamma \cup \omega_X) \cap [P].$$

Therefore:

$$\text{Rad}(X) = \langle i^{k,k}(\gamma) \cap [X] \in H_{k,k}(X; \mathbb{F}_2) : \gamma \in H^{k,k}(P; \mathbb{F}_2) \text{ s.t. } \gamma \cup \omega_X = 0 \rangle.$$

□

**Proposition 5.2.7.** *Let  $\varepsilon \in C^0(K; \mathbb{F}_2)$  be a sign distribution. For all  $p+q = n-2$ ,  $M_{p,q}(\varepsilon)$  is the transpose of  $M_{q,p}(\varepsilon)$ . Moreover:*

1. *If  $n$  is even, the rank of  $M_{p,q}(\varepsilon)$  equals the rank of  $\partial_{q,n-1-q}^1$ ;*
2. *If  $n = 2k+1$  is odd, it is also the case except when  $(p,q)$  equals  $(k-1, k)$  or  $(k, k-1)$ . In the first case the rank of  $M_{k-1,k}(\varepsilon)$  equals the rank of the restriction of  $\partial_{k,k}^1$  to the kernel of  $i_{k,k}^1 : E_{k,k}^1(\mathbb{R}X_\varepsilon) \rightarrow E_{k,k}^1(\mathbb{R}P)$ , c.f. Definition 4.2.19. In the second one,  $M_{k,k-1}(\varepsilon)$  equals the rank of the composition of  $\partial_{k+1,k-1}^1$  with the projection of  $\ker(i_{k,k}^1)$  to its quotient by  $\text{Rad}(X)$ .*

*Proof.* Let  $\sigma^p, \sigma^q$  be two simplices of  $K$  satisfying  $p+q = n-2$ , i.e.  $q = n-1-(p+1)$ . By Definition 5.2.4 we have:

$$(\sigma^p; \sigma^q)_\varepsilon = g^p(\chi_{\sigma^p}) \cdot \partial_{n-1-(p+1), p+1}^1 g^q(\chi_{\sigma^q}).$$

Let  $\gamma \in H^{n-1-p,p}(X; \mathbb{F}_2)$  denote the Poincaré dual of  $g^p(\chi_{\sigma^p})$ . By Definition 3.1.22, we have:

$$\begin{aligned} (\sigma^p; \sigma^q)_\varepsilon &= \gamma(\partial_{n-1-(p+1), p+1}^1 g^q(\chi_{\sigma^q})) \\ &= (d_1^{n-1-p,p} \gamma)(g^q(\chi_{\sigma^q})), \end{aligned}$$

since  $(\partial_{a,b}^r)^*$  equals  $d_r^{a+r,b-1}$  by duality of the spectral sequences. Following Theorem 4.2.28 and Proposition A.6, we find that  $d_1^{n-1-p,p} \gamma$  is the Poincaré dual of  $\partial_{p,n-1-p}^1 g^p(\chi_{\sigma^p})$ . There is a sign in Proposition A.6, however since we consider  $\mathbb{F}_2$ -vector spaces we can discard it. Finally we have:

$$(\sigma^p; \sigma^q)_\varepsilon = \partial_{p,n-1-p}^1 g^p(\chi_{\sigma^p}) \cdot g^q(\chi_{\sigma^q}),$$

which is equal to  $(\sigma^q; \sigma^p)_\varepsilon$  since the intersection product is symmetric over  $\mathbb{F}_2$ . Now we assume  $n$  even in a first time. The family  $\{g^q(\chi_{\sigma^q}) : \sigma^q \in K \setminus \partial K\}$  spans  $E_{q,n-1-q}^1(\mathbb{R}X_\varepsilon)$  and the family  $\{(g^p(\chi_{\sigma^p}) \cdot -) : \sigma^p \in K \setminus \partial K\}$  spans  $E_1^{q+1, n-2-q}(\mathbb{R}X_\varepsilon)$ . As such the rank of  $M_{p,q}(\varepsilon)$  equals the rank of  $\partial_{q,n-1-q}^1$ . If now we assume  $n = 2k+1$  odd and that  $(p,q)$  is neither  $(k-1, k)$  nor  $(k, k-1)$ , the family:

$$\{g^q(\chi_{\sigma^q}) : \sigma^q \in K \setminus \partial K\},$$

still spans  $E_{q,n-1-q}^1(\mathbb{R}X_\varepsilon)$  and the family  $\{(g^p(\chi_{\sigma^p}) \cdot -) : \sigma^p \in K \setminus \partial K\}$  still spans  $E_1^{q+1, n-2-q}(\mathbb{R}X_\varepsilon)$ . The rank of  $M_{p,q}(\varepsilon)$  is still equal to the rank of  $\partial_{q,n-1-q}^1$ . For the two remaining cases we consider the following commutative diagram with exact

columns:

$$\begin{array}{ccccc}
 & & 0 & & \\
 & & \uparrow & & \\
 & 0 & \longrightarrow & E_{k,k}^1(\mathbb{R}P) & \longrightarrow & 0 \\
 & \uparrow & & \uparrow & & \uparrow \\
 i_{k-1,k+1}^1 & & & i_{k,k}^1 & & i_{k+1,k-1}^1 \\
 E_{k-1,k+1}^1(\mathbb{R}X_\varepsilon) & \xrightarrow{\partial_{k-1,k+1}^1} & E_{k,k}^1(\mathbb{R}X_\varepsilon) & \xrightarrow{\partial_{k,k}^1} & E_{k+1,k-1}^1(\mathbb{R}X_\varepsilon) \\
 \uparrow & & \uparrow & & \uparrow \\
 \ker(i_{k-1,k+1}^1) & \longrightarrow & \ker(i_{k,k}^1) & \longrightarrow & \ker(i_{k+1,k-1}^1) \\
 \uparrow & & \uparrow & & \uparrow \\
 0 & & 0 & & 0
 \end{array}$$

The family  $\{g^k(\chi_{\sigma^k}): \sigma^k \in K \setminus \partial K\}$  spans the kernel  $\ker(i_{k,k}^1)$  and the family  $\{(g^{k-1}(\chi_{\sigma^{k-1}}) \cdot -): \sigma^{k-1} \in K \setminus \partial K\}$  spans  $E_1^{k+1,k-1}(\mathbb{R}X_\varepsilon)$ . Therefore the rank of  $M_{k-1,k}(\varepsilon)$  equals the rank of the restriction of  $\partial_{k,k}^1$  to the kernel  $\ker(i_{k,k}^1)$ . The family  $\{(g^k(\chi_{\sigma^k}) \cdot -): \sigma^k \in K \setminus \partial K\}$  spans the cokernel of  $i_1^{k,k}$  and the family  $\{(g^{k-1}(\chi_{\sigma^{k-1}}) \cdot -): \sigma^{k-1} \in K \setminus \partial K\}$  spans  $E_{k-1,k+1}^1(\mathbb{R}X_\varepsilon)$ . The cokernel of  $i_1^{k,k}$  is the quotient of  $E_1^{k,k}(\mathbb{R}X_\varepsilon)$  by the orthogonal of  $\ker(i_{k,k}^1)$ . Using the Poincaré duality, the latter quotient is isomorphic to the quotient of  $E_{k,k}^1(\mathbb{R}X_\varepsilon)$  by the orthogonal of  $\ker(i_{k,k}^1)$  with respect to the intersection product. Since  $\partial_{k,k}^1$  takes values in  $\ker(i_{k,k}^1)$  the rank of  $M_{k-1,k}(\varepsilon)$  equals the rank of the composition of  $\partial_{k,k}^1$  with  $\ker(i_{k,k}^1) \rightarrow \ker(i_{k,k}^1) / \text{Rad}(X)$ .  $\square$

**Proposition 5.2.8.** *Let  $\varepsilon \in C^0(K; \mathbb{F}_2)$  be a sign distribution.*

1. *If  $n$  is even, then for all integers  $0 \leq p \leq n-1$ , we have:*

$$\begin{aligned}
 \dim E_{p,n-1-p}^2(\mathbb{R}X_\varepsilon) &= \dim H_{p,n-1-p}(X; \mathbb{F}_2) - \text{rk } M_{n-2-p,p}(\varepsilon) \\
 &\quad - \text{rk } M_{n-1-p,p-1}(\varepsilon).
 \end{aligned}$$

2. *If  $n = 2k+1$  is odd, then for all integers  $0 \leq p \leq n-1$ , different from  $k-1$ ,  $k$ , and  $k+1$ , we have:*

$$\begin{aligned}
 \dim E_{p,n-1-p}^2(\mathbb{R}X_\varepsilon) &= \dim H_{p,n-1-p}(X; \mathbb{F}_2) - \text{rk } M_{n-2-p,p}(\varepsilon) \\
 &\quad - \text{rk } M_{n-1-p,p-1}(\varepsilon).
 \end{aligned}$$

*In the other cases, we have:*

$$\begin{aligned}
 \dim E_{k-1,k+1}^2(\mathbb{R}X_\varepsilon) &= \dim H_{k-1,k+1}(X; \mathbb{F}_2) + -\text{rk } M_{k+1,k-2}(\varepsilon) \\
 &\quad - \text{rk } M_{k,k-1}(\varepsilon) - \delta, \\
 \dim E_{k+1,k-1}^2(\mathbb{R}X_\varepsilon) &= \dim H_{k+1,k-1}(X; \mathbb{F}_2) + -\text{rk } M_{k-2,k+1}(\varepsilon) \\
 &\quad - \text{rk } M_{k-1,k}(\varepsilon) - \delta,
 \end{aligned}$$



and:

$$\dim E_{k,k}^2(\mathbb{R}X_\varepsilon) = \dim H_{k,k}(X; \mathbb{F}_2) - \text{rk } M_{k-1,k}(\varepsilon) - \text{rk } M_{k,k-1}(\varepsilon) - 2\delta.$$

where  $\delta$  is the dimension of the cokernel of  $i_k : H_k(\mathbb{R}X_\varepsilon; \mathbb{F}_2) \rightarrow H_k(\mathbb{R}P; \mathbb{F}_2)$ . Moreover,  $\delta$  cannot exceed  $\text{rad}(X)$ . We can also note that  $H_k(\mathbb{R}X_\varepsilon; \mathbb{F}_2)$  is isomorphic to  $E_{k,k}^2(\mathbb{R}X_\varepsilon)$ .

*Proof.* The first point is a consequence of the Rank Formula and Proposition 5.2.7. We assume now that  $n = 2k + 1$  is an odd integer. On the line  $\{p + q = n - 1\}$  we have the short exact sequence of complexes:

$$0 \rightarrow (\ker(i_{p,q}^1); \partial_{p,q}^1) \rightarrow (E_{p,q}^1(\mathbb{R}X_\varepsilon); \partial_{p,q}^1) \rightarrow (E_{p,q}^1(\mathbb{R}P); \partial_{p,q}^1) \rightarrow 0.$$

The complex  $(E_{p,q}^1(\mathbb{R}P); \partial_{p,q}^1)_{p+q=n-1}$  has only one non-trivial group:  $E_{k,k}^1(\mathbb{R}P)$ . Therefore, the associated long exact sequence splits into the following exact sequences:

$$0 \rightarrow H_{p,q}(\ker(i^1)) \rightarrow E_{p,q}^2(\mathbb{R}X_\varepsilon) \rightarrow 0,$$

for all  $p + q = n - 1$  different from  $(k, k)$  and  $(k + 1, k - 1)$ . And the exact sequence:

$$0 \rightarrow H_{k,k}(\ker(i^1)) \longrightarrow E_{k,k}^2(\mathbb{R}X_\varepsilon) \xrightarrow{i_{k,k}^2} E_{k,k}^1(P) \longrightarrow \dots \quad (5.9)$$

$$\dots \longrightarrow H_{k+1,k-1}(\ker(i^1)) \rightarrow E_{k+1,k-1}^2(\mathbb{R}X_\varepsilon) \rightarrow 0.$$

The Rank Formula and Proposition 5.2.7 imply that, for all  $p + q = n - 1$  except  $(k, k)$  and  $(k - 1, k + 1)$ , the dimension of  $H_{p,q}(\ker(i^1))$  is equal to:

$$\dim E_{p,q}^1(\mathbb{R}X_\varepsilon) - \text{rk } M_{q-1,p}(\varepsilon) - \text{rk } M_{q,p-1}(\varepsilon).$$

Moreover, if we write  $\text{rk } \partial_{k-1,k+1}^1 = \text{rk } M_{k,k-1}(\varepsilon) + \delta$ ,  $\delta$  cannot exceed  $\text{rad}(X)$ , and:

$$\dim H_{k-1,k+1}(\ker(i^1)) = \dim E_{k-1,k+1}^1(\mathbb{R}X_\varepsilon) - \text{rk } M_{k,k-1}(\varepsilon) - \delta - \text{rk } M_{k+1,k-2}(\varepsilon),$$

and:

$$\dim H_{k,k}(\ker(i^1)) = \dim E_{k,k}^1(\mathbb{R}X_\varepsilon) - \dim E_{k,k}^1(\mathbb{R}P) - \text{rk } M_{k-1,k}(\varepsilon) - \text{rk } M_{k,k-1}(\varepsilon) - \delta.$$

It follows that if  $p + q = n - 1$  is different from  $(k + 1, k - 1)$ ,  $(k, k)$ , and  $(k - 1, k + 1)$  we have:

$$\begin{aligned} \dim E_{p,q}^2(\mathbb{R}X_\varepsilon) &= \dim E_{p,q}^1(\mathbb{R}X_\varepsilon) - \text{rk } M_{q-1,p}(\varepsilon) - \text{rk } M_{q,p-1}(\varepsilon) \\ &= \dim H_{p,q}(X; \mathbb{F}_2) - \text{rk } M_{q-1,p}(\varepsilon) - \text{rk } M_{q,p-1}(\varepsilon). \end{aligned}$$

Using Theorem 4.2.28 and Proposition 5.2.7 we find that:

$$\begin{aligned} \dim E_{k-1,k+1}^2(\mathbb{R}X_\varepsilon) &= \dim E_{k-1,k+1}^1(\mathbb{R}X_\varepsilon) - \operatorname{rk} M_{k,k-1}(\varepsilon) - \operatorname{rk} M_{k+1,k-2}(\varepsilon) - \delta \\ &= \dim H_{k-1,k+1}(X; \mathbb{F}_2) - \operatorname{rk} M_{k,k-1}(\varepsilon) - \operatorname{rk} M_{k+1,k-2}(\varepsilon) - \delta, \end{aligned}$$

and:

$$\begin{aligned} \dim E_{k+1,k-1}^2(\mathbb{R}X_\varepsilon) &= \dim E_{k+1,k-1}^1(\mathbb{R}X_\varepsilon) - \operatorname{rk} M_{k-1,k}(\varepsilon) - \operatorname{rk} M_{k-2,k+1}(\varepsilon) - \delta \\ &= \dim H_{k+1,k-1}(X; \mathbb{F}_2) - \operatorname{rk} M_{k-1,k}(\varepsilon) - \operatorname{rk} M_{k-2,k+1}(\varepsilon) - \delta. \end{aligned}$$

Form (5.9) we find the last formula:

$$\dim E_{k,k}^2(\mathbb{R}X_\varepsilon) = \dim H_{k,k}(X; \mathbb{F}_2) - \operatorname{rk} M_{k-1,k}(\varepsilon) - \operatorname{rk} M_{k,k-1}(\varepsilon) - 2\delta.$$

By Theorem 4.2.27 the group  $E_{k,k}^2(\mathbb{R}X_\varepsilon)$  is isomorphic to  $H_k(\mathbb{R}X_\varepsilon; \mathbb{F}_2)$ . The map  $i_{k,k}^2$  is conjugated to  $i_k : H_k(\mathbb{R}X_\varepsilon; \mathbb{F}_2) \rightarrow H_k(\mathbb{R}P; \mathbb{F}_2)$ . From (5.9) we find that the dimension of the cokernel of  $i_{k,k}^2$  is  $\delta$ .  $\square$

**Pulling Back the Boundary** Now we fix a basis  $B = (e_1, \dots, e_n)$  of  $\mathfrak{t}(\mathbb{F}_2)$ , and we say that  $e_i$  is greater than  $e_j$  whenever  $i$  is greater than  $j$ .

**Definition 5.2.9.** Let  $V$  be a sub-space of  $\mathfrak{t}(\mathbb{F}_2)$ . If  $V$  is a proper sub-space of  $\mathfrak{t}(\mathbb{F}_2)$ , we define the vector  $u_1(V) \in \mathfrak{t}(\mathbb{F}_2)$  to be the smallest vector of  $B$  that does not belong to  $V$ , and we set  $u_1(\mathfrak{t}(\mathbb{F}_2))$  to be 0. For all integers  $k \geq 1$ , we recursively define  $u_k(V) \in \mathfrak{t}(\mathbb{F}_2)$  by the formula:

$$u_{k+1}(V) := u_1(V + \langle u_1(V), \dots, u_k(V) \rangle).$$

**Proposition 5.2.10.** *Let  $V$  be a sub-space of  $\mathfrak{t}(\mathbb{F}_2)$  of codimension  $k \in \mathbb{N}$ . The sub-space  $U(V) := \langle u_1(V), \dots, u_k(V) \rangle$  is a supplementary sub-space of  $V$  in  $\mathfrak{t}(\mathbb{F}_2)$ . Moreover, the map  $V \mapsto U(V)$  is decreasing with respect to the inclusion.*

*Proof.* The sequence  $(V + \langle u_1(V), \dots, u_k(V) \rangle)_{k \geq 0}$  is non-decreasing. Since it is bounded it is stationary. By construction its stationary value is  $\mathfrak{t}(\mathbb{F}_2)$ . We denote by  $k_0$  the index at which it becomes stationary. Let  $\{v_1, \dots, v_p\}$  be a basis of  $V$ . The family  $\{v_1, \dots, v_p, u_1(V), \dots, u_{k_0}(V)\}$  spans  $\mathfrak{t}(\mathbb{F}_2)$ . If  $x_1, \dots, x_p, y_1, \dots, y_{k_0}$  are numbers satisfying:

$$\sum_{i=1}^p x_i v_i + \sum_{j=1}^{k_0} y_j u_j(V) = 0,$$

then none of the  $y_j$ 's can be non-zero by definition of the index  $k_0$ . Since  $\{v_1, \dots, v_p\}$  is a basis of  $V$ , all the  $x_i$ 's have to vanish. Therefore  $\{v_1, \dots, v_p, u_1(V), \dots, u_{k_0}(V)\}$  is a basis of  $\mathfrak{t}(\mathbb{F}_2)$ ,  $k_0$  is the codimension  $k$  of  $V$ , and  $U(V)$  is a supplementary sub-space of  $V$ . Let  $V \subset W$  be a sub-space of codimension  $l \leq k$ . For all  $0 \leq j \leq l$ ,  $V_j := V + \langle u_1(V), \dots, u_j(V) \rangle$  is a sub-space of  $W_j := W + \langle u_1(W), \dots, u_j(W) \rangle$ . This is true for  $j = 0$ . If  $u_1(V)$  is less than  $u_1(W)$  it means that  $u_1(V)$  belongs to  $W$  so  $V + \langle u_1(V) \rangle \subset W + \langle u_1(W) \rangle$ . If not, they are equal and the inclusion also holds.

Repeating this argument proves our claim. More precisely, it shows that we have the alternative  $u_{j+1}(V) = u_{j+1}(W)$  or  $u_{j+1}(V) < u_{j+1}(W)$  and  $V_{j+1}$  is contained in  $W_j$ . But as long as  $u_{j+t}(V)$  is less than  $u_j(W)$  we will have  $V_{j+t} \subset W_j$ . This implies that the sequence  $u_1(W), \dots, u_l(W)$  is contained in  $u_1(V), \dots, u_k(V)$ , i.e. that  $U(W)$  is contained in  $U(V)$ .  $\square$

**Definition 5.2.11.** The normal 1-form  $\nu \in \Omega^1(K; \mathfrak{t}(\mathbb{F}_2))$  is defined for all pairs of simplices  $\sigma^p \leq \sigma^{p+1}$  of  $K$  as the generator of the line  $N(\sigma^p) \cap U(N(\sigma^{p+1}))$ . Let  $\sigma^p \in K$  be a simplex, we denote by  $u(\sigma^p)$  the generator of  $\bigwedge^p U(N(\sigma^p))$ .

**Lemma 5.2.12.** *The square of  $\nu$  is zero, i.e.  $\nu \cup \nu = 0$ . For all simplices  $\sigma^{p+1} \in K$ , written  $\sigma^{p+1} = \alpha * \sigma^p$ , we have:*

$$\iota_{\nu(\sigma^p; \sigma^{p+1})} \omega(\sigma^{p+1}) = \omega(\sigma^p),$$

and:

$$\sum_{\sigma^p \leq \sigma^{p+1}} \nu(\sigma^p; \sigma^{p+1}) = 0.$$

Moreover, if  $\sigma^0 \leq \dots \leq \sigma^p$  are simplices of  $K$  then  $u(\sigma^p)$  equals  $\bigwedge_{i=0}^{p-1} \nu(\sigma^i; \sigma^{i+1})$ .

*Proof.* Let  $\sigma^p \leq \sigma^{p+2}$  be a pair of simplices of  $K$ , and  $V$  denote the quotient vector space  $T\sigma^{p+2}(\mathbb{F}_2)/T\sigma^p(\mathbb{F}_2)$ . This is a plane. Its dual vector space  $V^*$  is isomorphic to  $N(\sigma^p) \cap U(N(\sigma^{p+2}))$ . Let us denote by  $\sigma_{\pm}^{p+1}$  the two  $(p+1)$ -simplices adjacent to both  $\sigma^p$  and  $\sigma^{p+2}$ . If  $\alpha_{\pm}$  denotes the link of  $\sigma_{\pm}^{p+1}$  in  $\sigma^{p+2}$  and  $\beta$  is a vertex of  $\sigma^p$ , then  $\alpha_{\pm} - \beta$  is a basis of  $V$ . The two vectors  $\nu(\sigma_{\mp}^{p+1}; \sigma^{p+2})$  form the dual basis of  $V^*$ . Indeed,  $\nu(\sigma_{\pm}^{p+1}; \sigma^{p+2})$  is not zero and  $(\alpha_{\pm} - \beta)(\nu(\sigma_{\mp}^{p+1}; \sigma^{p+2}))$  vanishes by definition. Therefore,  $(\alpha_{\mp} - \beta)(\nu(\sigma_{\pm}^{p+1}; \sigma^{p+2}))$  necessarily equals 1. Moreover, since  $\nu(\sigma^p; \sigma_{\pm}^{p+1})$  is not orthogonal to  $\sigma_{\pm}^{p+1}$  but orthogonal to  $\sigma^p$ ,  $(\alpha_{\pm} - \beta)(\nu(\sigma^p; \sigma_{\pm}^{p+1}))$  equals 1. As a consequence, for some numbers  $x, y \in \mathbb{F}_2$ , we have:

$$\begin{aligned} \nu^2(\sigma^p; \sigma^{p+2}) &= \nu(\sigma^p; \sigma_+^{p+1}) \wedge \nu(\sigma_+^{p+1}; \sigma^{p+2}) + \nu(\sigma^p; \sigma_-^{p+1}) \wedge \nu(\sigma_-^{p+1}; \sigma^{p+2}) \\ &= \left( \nu(\sigma_-^{p+1}; \sigma^{p+2}) + x\nu(\sigma_+^{p+1}; \sigma^{p+2}) \right) \wedge \nu(\sigma_+^{p+1}; \sigma^{p+2}) \\ &\quad + \left( \nu(\sigma_+^{p+1}; \sigma^{p+2}) + y\nu(\sigma_-^{p+1}; \sigma^{p+2}) \right) \wedge \nu(\sigma_-^{p+1}; \sigma^{p+2}) \\ &= 2\nu(\sigma_-^{p+1}; \sigma^{p+2}) \wedge \nu(\sigma_+^{p+1}; \sigma^{p+2}) \\ &= 0. \end{aligned}$$

Let  $\sigma^{p+1} = \sigma^p * \alpha$  be a simplex of  $K$  and let  $\beta$  be a vertex of  $\sigma^p$ . Since  $\nu(\sigma^p; \sigma^{p+1})$  is orthogonal to  $\sigma^p$  and  $\omega(\sigma^{p+1})$  equals  $\omega(\sigma^p) \wedge (\alpha - \beta)$ , the interior product  $\iota_{\nu(\sigma^p; \sigma^{p+1})} \omega(\sigma^{p+1})$  equals  $(\alpha - \beta)(\nu(\sigma^p; \sigma^{p+1})) \omega(\sigma^p)$ . However, since  $\nu(\sigma^p; \sigma^{p+1})$  is not orthogonal to  $\sigma^{p+1}$ ,  $(\alpha - \beta)(\nu(\sigma^p; \sigma^{p+1}))$  must equal 1.

Let us denote the vector  $\sum_{\sigma^p \leq \sigma^{p+1}} \nu(\sigma^p; \sigma^{p+1})$  by  $v$ . By definition, it belongs to  $U(N(\sigma^{p+1}))$ . However, we have:

$$\iota_v \omega(\sigma^{p+1}) = \sum_{\sigma^p \leq \sigma^{p+1}} \omega(\sigma^p) = 0,$$

by Proposition 5.1.9. Hence,  $v$  belongs to  $N(\sigma^{p+1})$ . It must vanish for the intersection of  $N(\sigma^{p+1})$  with  $U(N(\sigma^{p+1}))$  is trivial.

Let  $\sigma^p$  be a simplex of  $K$  and  $S$  denote its barycentric subdivision. For all maximal barycentric simplices  $[\sigma^0, \dots, \sigma^p]_{\text{Bar}}$  of  $S$  we denote by  $u(\sigma^0, \dots, \sigma^p)$  the vector  $\bigwedge_{i=0}^{p-1} \nu(\sigma^i; \sigma^{i+1})$ . Since  $N(\sigma^{i+1})$  is an hyperplane of  $N(\sigma^i)$  for all  $0 \leq i \leq p-1$ , the sequence  $(U(N(\sigma^i)))_{1 \leq i \leq p}$  is increasing. The dimension increases by 1 at each step. Since  $\nu(\sigma^i, \sigma^{i+1})$  belongs to  $U(N(\sigma^{i+1})) \setminus U(N(\sigma^i))$  for all  $0 \leq i \leq p-1$ ,  $\{\nu(\sigma^0, \sigma^1), \dots, \nu(\sigma^{p-1}, \sigma^p)\}$  is a basis of  $U(N(\sigma^p))$  and  $u(\sigma^0, \dots, \sigma^p)$  equals  $u(\sigma^p)$ .  $\square$

**Definition 5.2.13.** Let  $\varepsilon$  be a sign distribution on  $K$ . We define the value of the combinatorial 1-form  $\tau_\varepsilon \in \Omega^1(K; \mathbb{F}_2)$  on the pair of simplices  $\sigma^p \leq \sigma^{p+1}$  by the formula:

$$\tau_\varepsilon(\sigma^p; \sigma^{p+1}) := \sum_{(\sigma')^p \leq \sigma^{p+1}} \varepsilon(\text{lk}((\sigma')^p; \sigma^{p+1})) \omega((\sigma')^p)(u^p(\sigma^p)).$$

**Proposition 5.2.14.** For all cochains  $\gamma \in C^p(K; \partial K; \mathbb{F}_2)$ , we have:

$$\partial_{p, n-1-p}^1 g^p(\gamma) = g^{p+1}(\text{d}\gamma + \tau_\varepsilon \cup \gamma).$$

*Proof.* Let  $\gamma$  be a cochain of  $C^p(K; \partial K; \mathbb{F}_2)$ . From Proposition 5.2.3, we have the formula:

$$\partial_{p, n-1-p}^1 g^p(\gamma) = \left[ \sum_{\sigma^{p+1} \leq \sigma^{n-1}} \text{d}(\gamma u \wedge (\text{D}^2 \varepsilon_{\sigma^{n-1}} + \rho_{\sigma^{n-1}}^p))(\sigma^{p+1}) \otimes [\sigma^{p+1}; \sigma^{n-1}] \right].$$

We consider the chain  $c$  defined by the following formula:

$$\begin{aligned} c := \sum_{\sigma^{p+1} \leq \sigma^n} & \left( \text{d}(\gamma u \wedge (\text{D}\varepsilon_{\sigma^n} + e_{\sigma^n}^p))(\sigma^{p+1}) + \text{d}\gamma(\sigma^{p+1})u(\sigma^{p+1}) \right. \\ & \left. + (\tau_\varepsilon \cup \gamma)(\sigma^{p+1})u(\sigma^{p+1}) \right) \otimes [\sigma^{p+1}; \sigma^{n-1}], \end{aligned}$$

where, for all  $\sigma^p \leq \sigma^n$ ,  $e_{\sigma^n}^p(\sigma^p)$  stands for  $\sum_{\alpha \in (\sigma^p)^{(0)}} e_{\sigma^n}(\alpha)$ . We note that in the preceding formula  $\text{D}\varepsilon_{\sigma^n}$  is understood as a constant  $p$ -cochain over  $\sigma^n$ . Let  $\sigma^p \leq \sigma^n$  be a pair of simplices. The value of the form  $\omega(\sigma^{p+1})$  on the  $(p+1)$ -vector  $\text{d}(\gamma u \wedge (\text{D}\varepsilon_{\sigma^n} + e_{\sigma^n}^p))(\sigma^{p+1})$  is:

$$\sum_{\sigma^p \leq \sigma^{p+1}} \gamma(\sigma^p) \left( \omega(\sigma^{p+1})(\text{D}\varepsilon_{\sigma^n} \wedge u(\sigma^p)) + \omega(\sigma^{p+1})(e_{\sigma^n}^p(\sigma^p) \wedge u(\sigma^p)) \right). \quad (5.10)$$

Following Proposition 5.1.11,  $e_{\sigma^n}^p(\sigma^p)$  equals  $\sum_{\alpha \in (\text{lk}(\sigma^p; \sigma^n))^{(0)}} e_{\sigma^n}(\alpha)$ . Using Proposition 5.1.11, we find that:

$$\iota_{e_{\sigma^n}^p(\sigma^p)} \omega(\sigma^{p+1}) = \omega(\sigma^p),$$

since  $\text{lk}(\sigma^p; \sigma^n) \cap \sigma^{p+1}$  is the vertex of  $\sigma^{p+1}$  opposite to  $\sigma^p$ . Following Defini-

tion 5.1.15, we have:

$$\iota_{D\varepsilon_{\sigma^n}}\omega(\sigma^{p+1}) = \sum_{\beta * \sigma^p = \sigma^{p+1}} \varepsilon(\beta)\omega(\sigma^p).$$

Therefore, by using these formulæ in (5.10), we have:

$$\begin{aligned} \omega(\sigma^{p+1})\left(d(\gamma u \wedge (D\varepsilon_{\sigma^n} + e_{\sigma^n}^p))(\sigma^{p+1})\right) &= \sum_{\sigma^p \leq \sigma^{p+1}} \gamma(\sigma^p)\tau_\varepsilon(\sigma^p; \sigma^{p+1}) + \sum_{\sigma^p \leq \sigma^{p+1}} \gamma(\sigma^p) \\ &= d\gamma(\sigma^{p+1}) + (\tau_\varepsilon \cup \gamma)(\sigma^{p+1}). \end{aligned}$$

It follows that  $c$  belongs to  $\Omega_{n-1-p}(K; F_{p+1}^X)$ . By computing its boundary we find that  $\partial_{p,n-1-p}^1 g^p(\gamma)$  equals  $g^{p+1}(d\gamma + \tau_\varepsilon \cup \gamma)$ .  $\square$

**Proposition 5.2.15.** *For all sign distributions  $\varepsilon \in C^0(K; \mathbb{F}_2)$  we have:*

$$(d + \tau_\varepsilon \cup -)^2 = 0.$$

As a consequence the morphism  $(g^p)_{0 \leq p \leq n-1}$  from  $(C^p(K; \partial K; \mathbb{F}_2); (d + \tau_\varepsilon \cup -)_{0 \leq p \leq n-1})$  to  $(E_{p,n-1-p}^1(\mathbb{R}X_\varepsilon); \partial_{p,n-1-p}^1)_{0 \leq p \leq n-1}$  is a morphism of chain complexes.

*Proof.* Let  $\sigma^p$  be a  $p$ -simplex of  $K$  and  $\sigma^{p+2}$  be a  $(p+2)$ -simplex. A direct computation yields  $(d + \tau_\varepsilon \cup -)^2 \chi_{\sigma^p}(\sigma^{p+2}) = 0$  if  $\sigma^p$  is not adjacent to  $\sigma^{p+2}$ . If  $\sigma^p \leq \sigma^{p+2}$ , we have:

$$(d + \tau_\varepsilon \cup -)^2 \chi_{\sigma^p}(\sigma^{p+2}) = \sum_{\sigma^p < \sigma^{p+1} < \sigma^{p+2}} (1 + \tau_\varepsilon(\sigma^p; \sigma^{p+1}))(1 + \tau_\varepsilon(\sigma^{p+1}; \sigma^{p+2})). \quad (5.11)$$

We will establish the following formula for  $\tau_\varepsilon$ . Let us denote by  $\sigma_\pm^{p+1}$  the two  $(p+1)$ -simplices adjacent to both  $\sigma^p$  and  $\sigma^{p+2}$ . We have:

$$\tau_\varepsilon(\sigma_\pm^{p+1}; \sigma^{p+2}) = \tau_\varepsilon(\sigma^p; \sigma_\mp^{p+1}) + \left(\omega(\sigma_\mp^{p+1})e(\sigma_\pm^{p+1})\right)\tau_\varepsilon(\sigma^p; \sigma_\pm^{p+1}). \quad (5.12)$$

Let  $\alpha_\pm$  denote the link of  $\sigma_\pm^{p+1}$  in  $\sigma^{p+2}$ . From Definition 5.2.13, we have:

$$\begin{aligned} \tau_\varepsilon(\sigma_+^{p+1}; \sigma^{p+2}) &= \sum_{\sigma^{p+1} * \beta = \sigma^{p+2}} \varepsilon(\beta)\omega(\sigma^{p+1})(u(\sigma_+^{p+1})) \\ &= \underbrace{\sum_{\substack{\sigma^{p+1} * \beta = \sigma^{p+2} \\ \beta \in \sigma^p}} \varepsilon(\beta)\omega(\sigma^{p+1})(u(\sigma_+^{p+1}))}_{x} + \varepsilon(\alpha_+) + \varepsilon(\alpha_-)\omega(\sigma_-^{p+1})(u(\sigma_+^{p+1})). \end{aligned}$$

Let  $\beta * \sigma^{p+1} = \sigma^{p+2}$  with  $\beta \in \sigma^p$  and let  $\alpha$  be a vertex of  $\sigma^p$ . We assume that  $p$  is at least equal to 1, we choose the vertex  $\alpha$  of  $\sigma^p$  different from  $\beta$ , and denote by  $\sigma^{p-1}$

the link  $\text{lk}([\alpha_+; \alpha_-]; \sigma^{p+1})$ . From Lemma 5.2.12, we have:

$$\begin{aligned}
 \omega(\sigma^{p+1})(u(\sigma_+^{p+1})) &= \omega(\sigma^{p+1})(u(\sigma^p) \wedge \nu(\sigma^p; \sigma_+^{p+1})) \\
 &= \omega(\sigma^{p-1}) \wedge (\alpha_+ - \alpha) \wedge (\alpha_- - \alpha)(u(\sigma^p) \wedge \nu(\sigma^p; \sigma_+^{p+1})) \\
 &= \omega(\sigma^{p-1}) \wedge (\alpha_- - \alpha)(u(\sigma^p)) \\
 &\quad + \left( (\alpha_- - \alpha)(\nu(\sigma^p; \sigma_+^{p+1})) \right) (\omega(\sigma^{p-1}) \wedge (\alpha_+ - \alpha))(u(\sigma^p)) \\
 &= \omega(\sigma^{p-1} * \alpha_-)(u(\sigma^p)) \\
 &\quad + \left( (\alpha_- - \alpha)(\nu(\sigma^p; \sigma_+^{p+1})) \right) \omega(\sigma^{p-1} * \alpha_+)(u(\sigma^p)) \\
 &= \omega(\sigma^{p-1} * \alpha_-)(u(\sigma^p)) \\
 &\quad + \left( \omega(\sigma_-^{p+1})(u(\sigma_+^{p+1})) \right) \omega(\sigma^{p-1} * \alpha_+)(u(\sigma^p)).
 \end{aligned}$$

Because  $\sigma^{p-1}$  is a face of  $\sigma^p$ ,  $\nu(\sigma^p; \sigma_+^{p+1})$  is orthogonal to  $\sigma^p$ ,  $(\alpha_+ - \alpha)(\nu(\sigma^p; \sigma_+^{p+1}))$  equals 1, and  $(\alpha_- - \alpha)(\nu(\sigma^p; \sigma_+^{p+1}))$  equals  $\omega(\sigma_-^{p+1})(u(\sigma_+^{p+1}))$ . Therefore, we have:

$$\begin{aligned}
 x &= \sum_{\sigma^{p-1} * \beta = \sigma^p} \varepsilon(\beta) \omega(\sigma^{p-1} * \alpha_-)(u(\sigma^p)) \\
 &\quad + \left( \omega(\sigma_-^{p+1})(u(\sigma_+^{p+1})) \right) \sum_{\sigma^{p-1} * \beta = \sigma^p} \varepsilon(\beta) \omega(\sigma^{p-1} * \alpha_+)(u(\sigma^p)),
 \end{aligned}$$

and:

$$\begin{aligned}
 \tau_\varepsilon(\sigma_+^{p+1}; \sigma^{p+2}) &= \sum_{\sigma^{p-1} * \beta = \sigma^p} \varepsilon(\beta) \omega(\sigma^{p-1} * \alpha_-)(u(\sigma^p)) + \varepsilon(\alpha_+) \\
 &\quad + \left( \omega(\sigma_-^{p+1})(u(\sigma_+^{p+1})) \right) \left( \sum_{\sigma^{p-1} * \beta = \sigma^p} \varepsilon(\beta) \omega(\sigma^{p-1} * \alpha_+)(u(\sigma^p)) + \varepsilon(\alpha_-) \right) \\
 &= \tau_\varepsilon(\sigma^p; \sigma_+^{p+1}) + \left( \omega(\sigma_-^{p+1})(u(\sigma_+^{p+1})) \right) \tau_\varepsilon(\sigma^p; \sigma_-^{p+1}).
 \end{aligned}$$

If  $p$  equals 0 then  $\sigma^0 = \beta$ ,  $\sigma^1 = [\alpha_+; \alpha_-]$ , and  $\omega(\sigma^1) = \omega(\sigma_+^1) + \omega(\sigma_-^1)$  so:

$$\begin{aligned}
 \omega(\sigma^1)(u(\sigma_+^1)) &= \omega(\sigma^1)(u(\sigma_+^1)) \\
 &= 1 + \omega(\sigma_-^1)(u(\sigma_+^1)).
 \end{aligned}$$

And we find that:

$$\begin{aligned}
 \tau_\varepsilon(\sigma_+^1; \sigma^2) &= \varepsilon(\beta) + \varepsilon(\alpha_+) + \left( \omega(\sigma_-^1)(u(\sigma_+^1)) \right) (\varepsilon(\beta) + \varepsilon(\alpha_-)) \\
 &= \tau_\varepsilon(\beta; \sigma_+^1) + \left( \omega(\sigma_-^1)(u(\sigma_+^1)) \right) \tau_\varepsilon(\beta; \sigma_-^1).
 \end{aligned}$$

If we combine the formulæ (5.12) and (5.11), we find:

$$\begin{aligned}
 (d + \tau_\varepsilon \cup -)^2 \chi_{\sigma^p}(\sigma^{p+2}) &= \sum_{\sigma^p \subset \sigma^{p+1} \subset \sigma^{p+2}} (1 + \tau_\varepsilon(\sigma^p; \sigma^{p+1})) (1 + \tau_\varepsilon(\sigma^{p+1}; \sigma^{p+2})) \\
 &= \left( 1 + \tau_\varepsilon(\sigma^p; \sigma_-^{p+1}) + \left( \omega(\sigma_-^{p+1}) e(\sigma_+^{p+1}) \right) \tau_\varepsilon(\sigma^p; \sigma_+^{p+1}) \right) \\
 &\quad \times \left( 1 + \tau_\varepsilon(\sigma^p; \sigma_+^{p+1}) \right) \\
 &\quad + \left( 1 + \tau_\varepsilon(\sigma^p; \sigma_+^{p+1}) + \left( \omega(\sigma_+^{p+1}) e(\sigma_-^{p+1}) \right) \tau_\varepsilon(\sigma^p; \sigma_-^{p+1}) \right) \\
 &\quad \times \left( 1 + \tau_\varepsilon(\sigma^p; \sigma_-^{p+1}) \right) \\
 &= \left( 1 + \tau_\varepsilon(\sigma^p; \sigma_-^{p+1}) \right) \left( 1 + \tau_\varepsilon(\sigma^p; \sigma_+^{p+1}) \right) \\
 &\quad + \left( 1 + \tau_\varepsilon(\sigma^p; \sigma_+^{p+1}) \right) \left( 1 + \tau_\varepsilon(\sigma^p; \sigma_-^{p+1}) \right) \\
 &= 0.
 \end{aligned}$$

Since  $x(1+x) = 0$  for all  $x \in \mathbb{F}_2$ . □

**Definition 5.2.16.** Let  $\varepsilon \in C^0(K; \mathbb{F}_2)$  be a sign distribution. We denote by  $\text{Aff}(\mathfrak{t}^*(\mathbb{F}_2))$  the vector space of affine functions  $\mathfrak{t}^*(\mathbb{F}_2) \rightarrow \mathbb{F}_2$ . The value of the combinatorial function  $a_\varepsilon \in \Omega^0(K; \text{Aff}(\mathfrak{t}^*(\mathbb{F}_2)))$  on the simplex  $\sigma^p \in K$  is defined as follows:

1. The value of  $a_\varepsilon(\sigma^p)$  at the origin equals:

$$a_\varepsilon(\sigma^p)(0) := \sum_{\beta * \sigma^{p-1} = \sigma^p} \varepsilon(\beta) \left( \bigwedge_{\alpha \in (\sigma^{p-1})^{(0)}} \alpha \right) (u^p(\sigma^p)).$$

2. The linear part  $\bar{a}_\varepsilon(\sigma^p)$  of  $a_\varepsilon(\sigma^p)$  is given by the formula:

$$\bar{a}_\varepsilon(\sigma^p) := \sum_{\beta * \sigma^{p-1} = \sigma^p} \varepsilon(\beta) \omega(\sigma^{p-1}) \cdot u^p(\sigma^p),$$

if  $p \geq 1$ , and 0 otherwise.

**Lemma 5.2.17.** Let  $\varepsilon \in C^0(K; \mathbb{F}_2)$  be a sign distribution,  $\sigma^p \leq \sigma^{p+1}$  be a pair of simplices of  $K$ , and  $\beta$  be the vertex of  $\sigma^{p+1}$  opposite to  $\sigma^p$ . We have:

$$\tau_\varepsilon(\sigma^p; \sigma^{p+1}) = \varepsilon(\beta) + a_\varepsilon(\sigma^p)(\beta).$$

*Proof.* Let  $\beta * \sigma^p = \sigma^{p+1}$  be a simplex of  $K$  with  $p \geq 1$ . The formula of  $\tau_\varepsilon(\sigma^p; \sigma^{p+1})$  is given in Definition 5.2.13:

$$\begin{aligned}
 \tau_\varepsilon(\sigma^p; \sigma^{p+1}) &= \sum_{(\sigma')^p \leq \sigma^{p+1}} \varepsilon(\text{lk}((\sigma')^p; \sigma^{p+1})) \omega((\sigma')^p)(u(\sigma^p)) \\
 &= \varepsilon(\beta) + \sum_{\sigma^{p-1} * \alpha \leq \sigma^p} \varepsilon(\alpha) \omega(\sigma^{p-1} * \beta)(u(\sigma^p)).
 \end{aligned}$$

By Proposition 5.1.11,  $\omega(\sigma^{p-1} * \beta)$  equals  $\omega(\sigma^{p-1}) \wedge (\beta - \alpha')$  for any vertex  $\alpha'$  of  $\sigma^{p-1}$ . Moreover,  $\omega(\sigma^{p-1})$  equals:

$$\omega(\sigma^{p-1}) = \bigwedge_{\substack{\alpha'' \in \sigma^{p-1} \\ \alpha'' \neq \alpha'}} (\alpha'' - \alpha').$$

Hence,  $\omega(\sigma^{p-1}) \wedge (\beta - \alpha')$  equals  $\bigwedge_{\alpha' \in \sigma^{p-1}} \alpha' + \beta \wedge \omega(\sigma^{p-1})$  and:

$$\begin{aligned} \tau_\varepsilon(\sigma^p; \sigma^{p+1}) &= \varepsilon(\beta) + \sum_{\sigma^{p-1} * \alpha \leq \sigma^p} \varepsilon(\alpha) \omega(\sigma^{p-1} * \beta)(u(\sigma^p)) \\ &= \varepsilon(\beta) + \sum_{\sigma^{p-1} * \alpha \leq \sigma^p} \varepsilon(\alpha) \left( \bigwedge_{\alpha' \in \sigma^{p-1}} \alpha' \right) (u(\sigma^p)) \\ &\quad + \sum_{\sigma^{p-1} * \alpha \leq \sigma^p} \varepsilon(\alpha) (\beta \wedge \omega(\sigma^{p-1})) (u(\sigma^p)) \\ &= \varepsilon(\beta) + \sum_{\sigma^{p-1} * \alpha \leq \sigma^p} \varepsilon(\alpha) \left( \bigwedge_{\alpha' \in \sigma^{p-1}} \alpha' \right) (u(\sigma^p)) \\ &\quad + \beta \left( \sum_{\sigma^{p-1} * \alpha \leq \sigma^p} \varepsilon(\alpha) \omega(\sigma^{p-1}) \cdot u(\sigma^p) \right) \\ &= \varepsilon(\beta) + a_\varepsilon(\sigma^p)(\beta). \end{aligned}$$

Let  $[\alpha; \beta]$  be an edge of  $K$ . The number  $\tau_\varepsilon(\alpha; [\alpha; \beta])$  equals  $\varepsilon(\beta) + \varepsilon(\alpha)$ , and  $a_\varepsilon(\alpha)$  is constant to  $\varepsilon(\alpha)$ . Therefore the formula also holds in this case.  $\square$

**Proposition 5.2.18.** *Let  $\varepsilon \in C^0(K; \mathbb{F}_2)$  be a sign distribution,  $0 \leq p \leq n-1$  be an integer,  $\sigma^p$  be a simplex of  $K$  not contained in  $\partial K$ , and  $\chi_{\sigma^p}$  denote the characteristic cochain of  $\sigma^p$ . For all  $\sigma^{p+1} \geq \sigma^p$ ,  $(\tau_\varepsilon \cup \chi_{\sigma^p})(\sigma^{p+1})$  vanishes if and only if  $da_\varepsilon(\sigma^p; \sigma^{p+1})$  does.*

*Proof.* We begin by proving the following fact: for all simplices  $\sigma^p$  and all vertices  $\beta$  of  $\sigma^p$ :

$$\varepsilon(\beta) = a_\varepsilon(\beta). \quad (5.13)$$

If  $\alpha$  is a vertex of  $K$ , the affine map  $a_\varepsilon(\alpha)$  is constant to  $\varepsilon(\alpha)$  by Definition 5.2.16. Let now  $\sigma^p$  be a simplex of  $K$  of dimension  $p \geq 1$ , and  $\beta, \beta'$  be two distinct vertices



of  $\sigma^p$ . We have:

$$\begin{aligned}
 a_\varepsilon(\sigma^p)(\beta) &= \sum_{\alpha * \sigma^{p-1} = \sigma^p} \varepsilon(\alpha) \left( \omega(\sigma^{p-1}) \wedge \beta(u(\sigma^p)) + \left( \bigwedge_{\alpha' \in (\sigma^{p-1})^{(0)}} \alpha' \right) (u(\sigma^p)) \right) \\
 &= \varepsilon(\beta) \left( \omega(\text{lk}(\beta; \sigma^p)) \wedge \beta(u(\sigma^p)) + \left( \bigwedge_{\alpha' \in (\text{lk}(\beta; \sigma^p))^{(0)}} \alpha' \right) (u(\sigma^p)) \right) \\
 &\quad + \sum_{\substack{\alpha * \sigma^{p-1} = \sigma^p \\ \alpha \neq \beta}} \varepsilon(\alpha) \left( \omega(\sigma^{p-1}) \wedge \beta(u(\sigma^p)) + \left( \bigwedge_{\alpha' \in (\sigma^{p-1})^{(0)}} \alpha' \right) (u(\sigma^p)) \right) \\
 &= \varepsilon(\beta) \left( \omega(\text{lk}(\beta; \sigma^p)) \wedge \beta(u(\sigma^p)) + \omega(\text{lk}(\beta; \sigma^p)) \wedge \beta'(u(\sigma^p)) \right) \\
 &\quad + \sum_{\substack{\alpha * \sigma^{p-1} = \sigma^p \\ \alpha \neq \beta}} \varepsilon(\alpha) \left( \omega(\sigma^{p-1}) \wedge \beta(u(\sigma^p)) + \omega(\sigma^{p-1}) \wedge \beta(u(\sigma^p)) \right) \\
 &= \varepsilon(\beta),
 \end{aligned}$$

since  $\bigwedge_{\alpha' \in (\sigma^{p-1})^{(0)}} \alpha'$  equals  $\omega(\sigma^{p-1}) \wedge \alpha$  for all vertices  $\alpha$  of  $\sigma^{p-1}$ . Let now  $\sigma^p \leq \sigma^{p+1}$  be a pair of simplices and  $\beta$  denote the vertex of  $\sigma^{p+1}$  opposite to  $\sigma^p$ . Lemma 5.2.17 implies that  $\tau_\varepsilon(\sigma^p; \sigma^{p+1})$  vanishes if and only if  $\varepsilon(\beta)$  equals  $a_\varepsilon(\sigma^p)(\beta)$ . Therefore, if  $da_\varepsilon(\sigma^p; \sigma^{p+1})$  vanishes i.e.  $a_\varepsilon(\sigma^p)$  equals  $a_\varepsilon(\sigma^{p+1})$  then (5.13) implies that  $\varepsilon(\beta)$  equals  $a_\varepsilon(\sigma^{p+1})(\beta) = a_\varepsilon(\sigma^p)(\beta)$ . For the reciprocal, we observe that the restriction  $a_\varepsilon(\sigma^{p+1})|_{\sigma^{p+1}}$  equals the restriction  $a_\varepsilon(\sigma^p)|_{\sigma^{p+1}}$ . In particular, the linear parts of  $a_\varepsilon(\sigma^{p+1})$  and  $a_\varepsilon(\sigma^p)$  correspond on the tangent space  $T\sigma^{p+1}(\mathbb{F}_2)$ . By construction,  $\bar{a}_\varepsilon(\sigma^{p+1})$  vanishes on  $U(N(\sigma^{p+1}))^\perp$ . Likewise,  $\bar{a}_\varepsilon(\sigma^p)$  vanishes on  $U(N(\sigma^p))^\perp$ . It follows that  $\bar{a}_\varepsilon(\sigma^p)$  is also trivial on  $U(N(\sigma^{p+1}))^\perp$  because  $U(N(\sigma^p))$  is included in  $U(N(\sigma^{p+1}))$ . Since  $U(N(\sigma^{p+1}))^\perp$  is a supplementary sub-space of  $T\sigma^{p+1}(\mathbb{F}_2)$ ,  $\bar{a}_\varepsilon(\sigma^{p+1})$  and  $\bar{a}_\varepsilon(\sigma^p)$  must be equal. Hence  $a_\varepsilon(\sigma^{p+1})$  and  $a_\varepsilon(\sigma^p)$  can only differ by a constant, however they coincide on  $\sigma^p$ , so they must be equal.  $\square$

**Proposition 5.2.19.** *Let  $\varepsilon \in C^0(K; \mathbb{F}_2)$  be a sign distribution, and  $\sigma^p \leq \sigma^q \leq \sigma^r$  be three simplices of  $K$ . If  $a_\varepsilon(\sigma^p)$  equals  $a_\varepsilon(\sigma^r)$  then so does  $a_\varepsilon(\sigma^q)$ .*

*Proof.* We assume that  $\sigma^p$  is a proper face of  $\sigma^r$ . Let  $\sigma^{p+1}$  be a simplex adjacent to both  $\sigma^p$  and  $\sigma^r$ , and  $\beta$  denote the vertex of  $\sigma^{p+1}$  opposite to  $\sigma^p$ . The number  $\varepsilon(\beta)$  equals  $a_\varepsilon(\sigma^r)(\beta)$  which is, by assumption, equal to  $a_\varepsilon(\sigma^p)(\beta)$ . Therefore, by Proposition 5.2.18,  $a_\varepsilon(\sigma^{p+1})$  equals  $a_\varepsilon(\sigma^p)$ . Hence, we find that  $a_\varepsilon(\sigma^{p+1})$  equals  $a_\varepsilon(\sigma^r)$ . The proposition follows by recursion.  $\square$

**Definition 5.2.20.** Let  $a : \mathfrak{t}^*(\mathbb{F}_2) \rightarrow \mathbb{F}_2$  be an affine function. For all sign distributions  $\varepsilon \in C^0(K; \mathbb{F}_2)$ , we denote by  $K_\varepsilon(a)$  the union of the  $K(\sigma)$ 's for all sim-

plices  $\sigma \in K$  for which  $a_\varepsilon(\sigma)$  equals  $a$ . Proposition 5.2.19 implies that the set  $\{\sigma \in K(a) \mid a_\varepsilon(\sigma) \neq a\}$  is a sub-complex of  $K_\varepsilon(a)$ . We denote by  $K'_\varepsilon(a)$  the union of  $\{\sigma \in K(a) \mid a_\varepsilon(\sigma) \neq a\}$  and  $K_\varepsilon(a) \cap \partial K$ .

**Proposition 5.2.21.** *Let  $\varepsilon \in C^0(K; \mathbb{F}_2)$  be a sign distribution. The cochain complex  $(C^p(K; \partial K; \mathbb{F}_2); (d + \tau_\varepsilon \cup -))_{0 \leq p \leq n-1}$  splits into the direct sum:*

$$(C^p(K; \partial K; \mathbb{F}_2); (d + \tau_\varepsilon \cup -))_{0 \leq p \leq n-1} = \bigoplus_{a \in \text{Aff}(t^*(\mathbb{F}_2))} (C^p(K_\varepsilon(a); K'_\varepsilon(a); \mathbb{F}_2); d)_{0 \leq p \leq n-1}.$$

*Proof.* Let  $0 \leq p \leq n-1$  be an integer and  $a$  be an affine function on  $t^*(\mathbb{F}_2)$ . The extension by zero provides us with an injection of  $C^p(K_\varepsilon(a); K'_\varepsilon(a); \mathbb{F}_2)$  into  $C^p(K; \partial K; \mathbb{F}_2)$ . Since  $(K_\varepsilon(a) \setminus K'_\varepsilon(a))_{a \in \text{Aff}(t^*(\mathbb{F}_2))}$  is a partition of  $K \setminus \partial K$  the vector space  $C^p(K; \partial K; \mathbb{F}_2)$  splits into the direct sum of the images of the extensions by zero. To complete the proof we need to show that the extensions by zero are morphisms of cochain complexes. Let  $\sigma^p$  be a simplex in  $K_\varepsilon(a) \setminus K'_\varepsilon(a)$ . Let  $\sigma^{p+1}$  be a simplex of  $K$ . If  $\sigma^{p+1}$  is not adjacent to  $\sigma^p$  then both  $d\chi_{\sigma^p}(\sigma^{p+1})$  and  $(\tau_\varepsilon \cup \chi_{\sigma^p}(\sigma^{p+1}))$  vanish. On the other hand, if  $\sigma^{p+1} \geq \sigma^p$ , then:

$$d\chi_{\sigma^p}(\sigma^{p+1}) + (\tau_\varepsilon \cup \chi_{\sigma^p}(\sigma^{p+1})) = 1 + \tau_\varepsilon(\sigma^p; \sigma^{p+1}).$$

Following Proposition 5.2.18,  $\tau_\varepsilon(\sigma^p; \sigma^{p+1})$  vanishes if and only if  $a_\varepsilon(\sigma^{p+1})$  equals  $a_\varepsilon(\sigma^p)$ , which is  $a$  in this case. Therefore,  $(d + \tau_\varepsilon)\chi_{\sigma^p}$  is the sum of the  $\chi_{\sigma^{p+1}}$  for all  $\sigma^{p+1}$  adjacent to  $\sigma^p$  and contained in  $K_\varepsilon(a)$ . It is precisely the extension by zero of  $d\chi_{\sigma^p} \in C^{p+1}(K_\varepsilon(a); K'_\varepsilon(a); \mathbb{F}_2)$ .  $\square$

## 5.3 The First and Last Boundaries

### Twists of $\mathbb{R}X_\varepsilon$

**Proposition 5.3.1.** *Let  $\sigma^n$  be a simplex of  $K$ . The lift  $\sigma_\mathbb{R}^n$  of  $\sigma^n$  in  $\mathbb{R}K$ , indexed by the vector  $D\varepsilon_{\sigma^n}$  is the only one avoided by  $\mathbb{R}X_\varepsilon$ , i.e. the only lift for which  $\sigma_\mathbb{R}^n \cap \mathbb{R}X_\varepsilon$  is empty. More generally, if  $H$  is the hypersurface of  $\sigma^n$  dual to the cocycle  $\zeta \in Z^1(\sigma^n; \mathbb{F}_2)$ , the only lift  $\sigma_\mathbb{R}^n$  of  $\sigma^n$  for which  $\sigma_\mathbb{R}^n \cap \mathbb{R}X_\varepsilon$  corresponds to  $H$  is the one indexed by the vector  $D\varepsilon_{\sigma^n} + v$  where  $z_{\sigma^n}^1(v)$  equals  $\zeta$ .*

*Proof.* Let  $\sigma_\mathbb{R}^n$  be the lift of  $\sigma^n$  indexed by the vector  $D\varepsilon_{\sigma^n} + v$ . The hypersurface  $\sigma_\mathbb{R}^n \cap \mathbb{R}X_\varepsilon$  is the dual hypersurface of the cocycle  $\zeta : \sigma^1 \mapsto d\varepsilon(\sigma^1) + \omega(\sigma^1)(D\varepsilon_{\sigma^n} + v)$ . By Definition 5.1.15,  $\omega(\sigma^1)(D\varepsilon_{\sigma^n})$  equals  $d\varepsilon(\sigma^1)$  for all edges  $\sigma^1$  of  $\sigma^n$ . Therefore,  $\zeta$  equals  $z_{\sigma^n}^1(v)$ .  $\square$

**Definition 5.3.2** (Twists). Let  $\varepsilon$  be a sign distribution on  $K$ , and  $\sigma^{n-1}$  be an interior simplex of  $K$ . For all vertices  $\beta$  of  $\sigma^{n-1}$ , we say that  $\mathbb{R}X_\varepsilon$  is *twisted along  $\sigma^{n-1}$  in the direction of  $\beta$*  if  $D^2\varepsilon_{\sigma^{n-1}}$  is different from  $\rho_{\sigma^{n-1}}(\beta)$ . The vector  $D^2\varepsilon_{\sigma^{n-1}} + \rho_{\sigma^{n-1}}(\beta)$  belongs to the line  $N(\sigma^{n-1})$ , we denote by  $|D^2\varepsilon_{\sigma^{n-1}} + \rho_{\sigma^{n-1}}(\beta)| \in \mathbb{F}_2$  the corresponding number.

**Remark 5.3.3.** Since both  $D^2\varepsilon_{\sigma^{n-1}}$  and  $\rho_{\sigma^{n-1}}(\beta)$  belong to the line  $N(\sigma^{n-1})$ , knowing if  $\mathbb{R}X_\varepsilon$  is twisted or not along a simplex in a given direction is a numerical question. The hypersurface  $\mathbb{R}X_\varepsilon$  is twisted along  $\sigma^{n-1}$  in the direction of  $\beta$  if and only if  $\varepsilon(\alpha_+) + \varepsilon(\alpha_-) + \sum_{\alpha \in \sigma^{n-1}} \varepsilon(\alpha)|\rho_{\sigma^{n-1}}(\alpha)| + |\rho_{\sigma^{n-1}}(\beta)| = 1$ , where  $\sigma^{n-1} * \alpha_\pm$  are the two  $n$ -simplices of  $K$  adjacent to  $\sigma^{n-1}$ .

Let  $\sigma^{n-1}$  be an interior simplex of  $K$ . The set of direction in which  $\mathbb{R}X_\varepsilon$  can be twisted along  $\sigma^{n-1}$  is strongly influenced by the geometry of  $K$ . The function  $\rho_{\sigma^{n-1}}$  partitions the vertices into two sets. The set of those on which the function vanishes and the set of the others. For all sign distributions  $\varepsilon$ , the hypersurface  $\mathbb{R}X_\varepsilon$  is then either twisted along  $\sigma^{n-1}$  in all the directions of the former set or in all the directions of the latter. Let  $S$  denote the closed star of  $\sigma^{n-1}$ . Since  $\sigma^{n-1}$  is interior it has exactly  $2^n$  different lifts in  $\mathbb{R}K$  and so does  $S$ . A lift of  $S$  is indexed by a vector  $v \in \mathfrak{t}(\mathbb{F}_2)$  and we denote it by  $S_v$ . The intersection of  $\mathbb{R}X_\varepsilon$  with  $S_v$  is the dual hypersurface of  $[\sigma^1 \mapsto d\varepsilon(\sigma^1) + \omega(\sigma^1)(v)]$ . Using Proposition 5.1.10, we see that the restrictions of these cocycles to  $\sigma^{n-1}$  describe the whole set of cocycle  $Z^1(\sigma^{n-1}; \mathbb{F}_2)$ . Therefore  $\mathbb{R}X_\varepsilon$  intersects  $\sigma^{n-1}$  in every possible way. By reflecting back all of the intersections  $\mathbb{R}X_\varepsilon \cap S_v$  into  $S$ , we get a collection of  $2^n$  hypersurfaces of  $S$  (some could be empty). Exactly  $2^n - 2$  of them intersect  $\sigma^{n-1}$  and are connected. For the remaining two we have the following alternative: one is empty and the other consists of two connected components that are “parallel” to  $\sigma^{n-1}$ , or none of them is empty and each is a “parallel” copy of  $\sigma^{n-1}$ . Some examples are depicted in Examples 5.3.5. Either way we have a collection of  $2^n$  connected hypersurface of  $S$ . These hypersurfaces are naturally paired by their intersection with  $\sigma^{n-1}$ . We call the pair of hypersurfaces that does not intersect  $\sigma^{n-1}$  the parallel pair. Beside the parallel pair there are also  $n$  distinguished pairs of hypersurfaces. For all vertices  $\beta$  of  $\sigma^{n-1}$ , there is exactly one pair  $\{H_1(\beta); H_2(\beta)\}$  whose intersection with  $\sigma^{n-1}$  separates  $\beta$  from the other vertices of  $\sigma^{n-1}$ .

**Proposition 5.3.4.** *The hypersurface  $\mathbb{R}X_\varepsilon$  is not twisted along  $\sigma^{n-1}$  in the direction of  $\beta$  if and only if one of the two hypersurfaces  $\{H_1(\beta); H_2(\beta)\}$  separates  $\beta$  from all the other vertices of  $S$ .*

*Proof.* Let  $\sigma_\pm^n$  denote the two  $n$ -simplices of  $S$ . Following Proposition 5.3.1, the lift of  $\sigma_\pm^n$  in which the lift of  $\beta$  is separated from all the other vertices by  $\mathbb{R}X_\varepsilon$ , is indexed by the vector  $v_\pm = D\varepsilon_{\sigma_\pm^n} + e_{\sigma_\pm^n}(\beta)$ . Indeed,  $z_{\sigma_\pm^n}^1(e_{\sigma_\pm^n}(\beta))$  equals  $d\chi_\beta$ . Let us denote by  $H_\pm$  the hypersurface of  $S$  corresponding to  $S_{v_\pm} \cap \mathbb{R}X_\varepsilon$ . By construction  $H_\pm$  belongs to  $\{H_1(\beta); H_2(\beta)\}$ . We have two cases: either  $H_+$  equals  $H_-$ , i.e.  $v_+$  equals  $v_-$ , or  $H_+$  is different from  $H_-$  and so are  $v_+$  and  $v_-$ . In the first case  $H_+$  separates  $\beta$  from all the other vertices of  $S$  and  $v_+ + v_-$  vanishes, i.e.  $D^2\varepsilon_{\sigma^{n-1}}$  equals  $\rho_{\sigma^{n-1}}(\beta)$ . Hence  $\mathbb{R}X_\varepsilon$  is not twisted along  $\sigma^{n-1}$  in the direction of  $\beta$ . In the other case,  $\mathbb{R}X_\varepsilon$  is twisted along  $\sigma^{n-1}$  in the direction of  $\beta$ , and  $H_\pm$  does not separated  $\beta$  from  $\text{lk}(\sigma^{n-1}; \sigma_\mp^n)$ .  $\square$

**Examples 5.3.5.** 1. We assume that  $n$  equals 2, so that  $\mathbb{R}X_\varepsilon$  is a curve. We consider an interior edge  $\sigma^1$  of  $K$ . Following Proposition 5.1.14, the function

$\rho_{\sigma^1}$  is constant. Hence  $\mathbb{R}X_\varepsilon$  can either be twisted along  $\sigma^1$  in all the directions or in none. This corresponds to the usual notion of twist<sup>3</sup>.

- (a) In Figure 5.2a we depicted all the intersections of  $\mathbb{R}X_\varepsilon$  with the star  $S$  of  $\sigma^1$ . In this case the curve  $\mathbb{R}X_\varepsilon$  is not twisted along  $\sigma^1$ . In Figure 5.2b, we represented all these intersections in  $S$ . The two curves intersecting  $\sigma^1$  are represented disjoint, but in reality they would meet “tangentially” at the middle of  $\sigma^1$ .

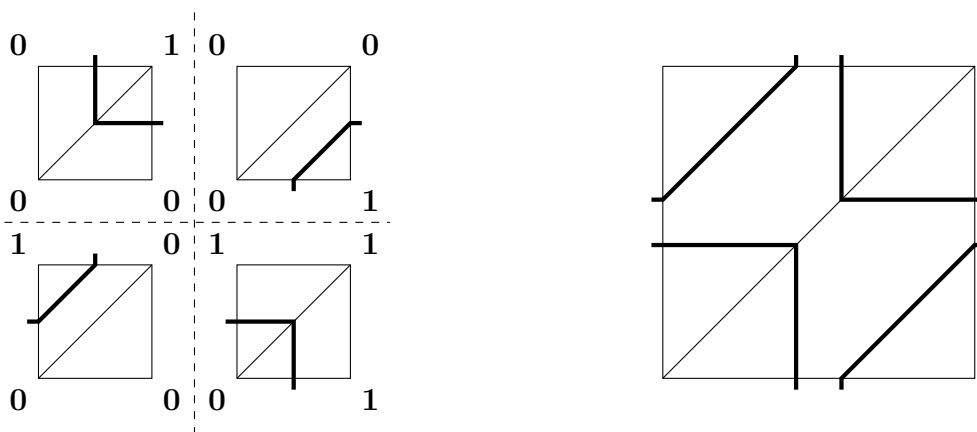

(a) The four different intersections of  $\mathbb{R}X_\varepsilon$  with the lifts of  $S$ .

(b) The four different intersections of  $\mathbb{R}X_\varepsilon$  with the lifts of  $S$  inside  $S$ .

Figure 5.2: The behavior of a curve  $\mathbb{R}X_\varepsilon$  in the star of an edge along which it is untwisted.

- (b) Figure 5.3 is the analogous of Figure 5.2 for a curve  $\mathbb{R}X_\varepsilon$ , twisted along  $\sigma^1$ . In Figure 5.3b, the two curves intersecting  $\sigma^1$  meet “transversally” at the middle point of  $\sigma^1$ .

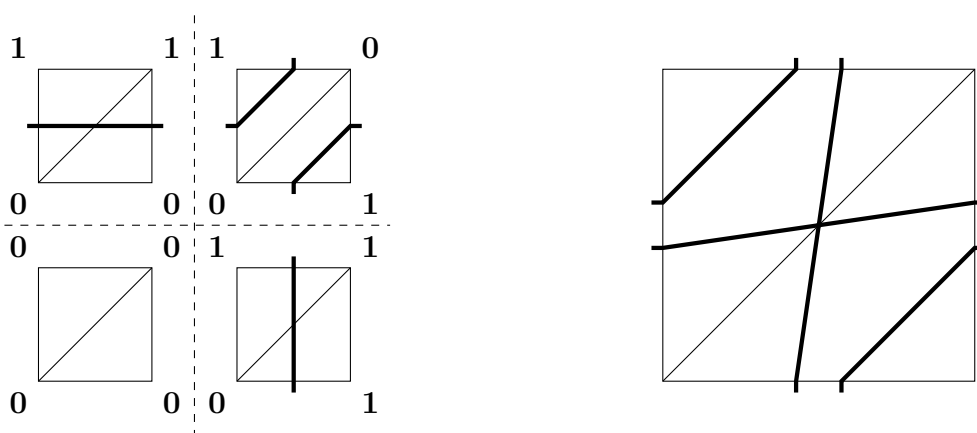

(a) The four different intersections of  $\mathbb{R}X_\varepsilon$  with the lifts of  $S$ .

(b) The four different intersections of  $\mathbb{R}X_\varepsilon$  with the lifts of  $S$  inside  $S$ .

Figure 5.3: The behavior of a curve  $\mathbb{R}X_\varepsilon$  in the star of an edge along which it is twisted.

<sup>3</sup>c.f. [RS23], §7. Case of plane curves p.28.

2. We assume now that  $n$  equals 3, so that  $\mathbb{R}X_\varepsilon$  is a surface. Let  $\sigma^2$  be an interior triangle of  $K$ . As we discussed earlier, the set of directions in which  $\mathbb{R}X_\varepsilon$  can be twisted along  $\sigma^2$  is determined by the geometry of  $K$ . If we assume that the function  $\rho_{\sigma^2}$  vanishes, then either  $\mathbb{R}X_\varepsilon$  is twisted along  $\sigma^2$  in every direction or in none.

(a) In Figure 5.4, We depicted the intersections of a surface  $\mathbb{R}X_\varepsilon$ , that is untwisted along  $\sigma^2$ , with all the lifts of the star  $S$  of  $\sigma^2$ . Figure 5.5 represents the four pairs of surfaces of  $S$  obtained by intersecting its lifts with  $\mathbb{R}X_\varepsilon$ . In Figure 5.5b, Figure 5.5c, and Figure 5.5d, the pairs of surfaces are disjoint. In reality they would meet “tangentially” along their common intersection with  $\sigma^2$ .

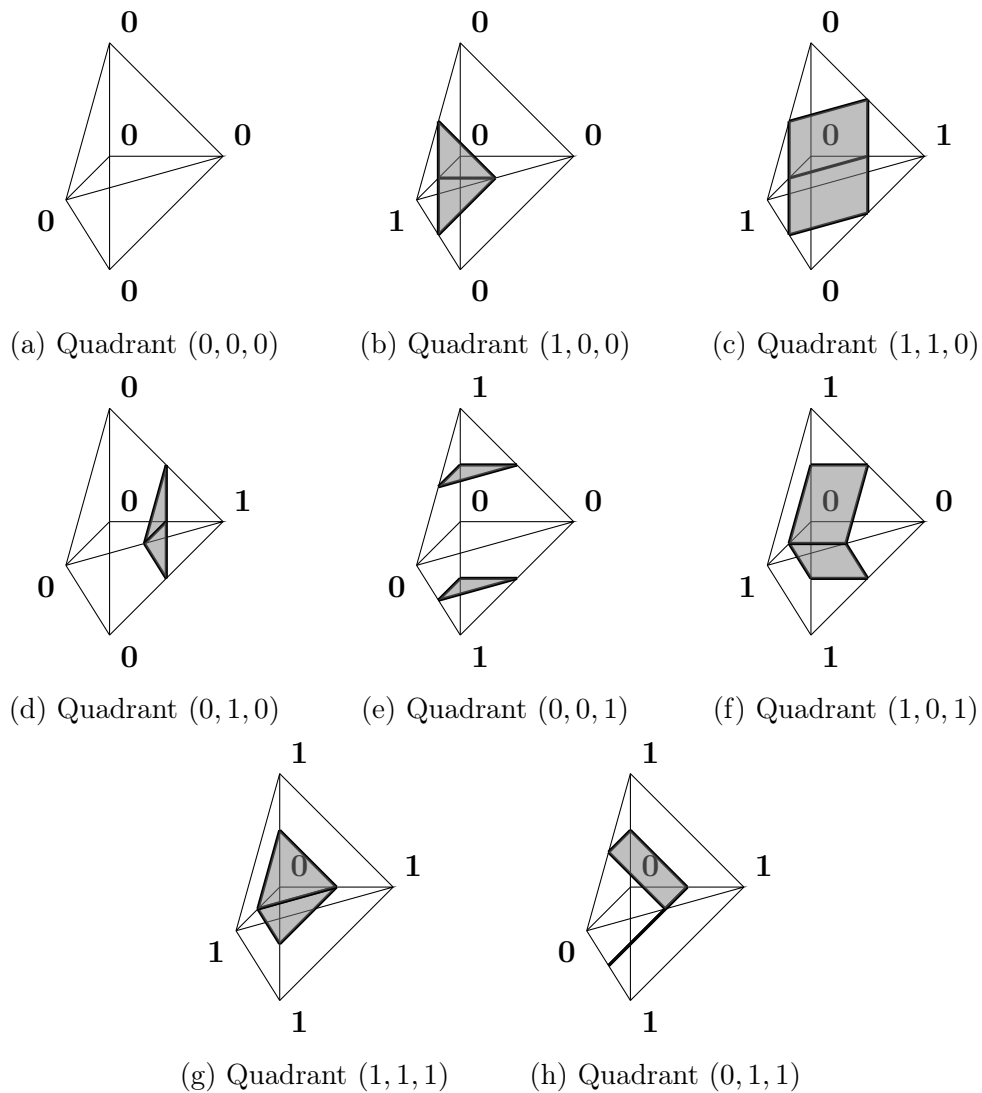
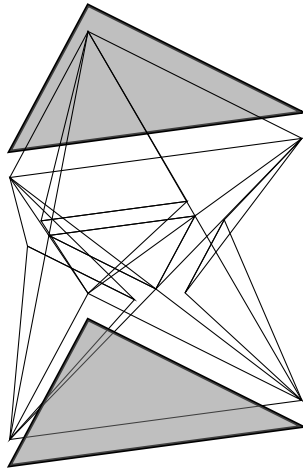
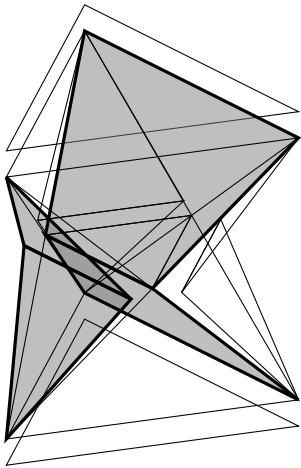

Figure 5.4: The eight intersections of  $\mathbb{R}X_\varepsilon$  with the different lifts of  $S$ . In this example  $\mathfrak{t}(\mathbb{F}_2)$  is  $\mathbb{F}_2^3$ .



(a) The parallel pair.



(b) The pair of the first vertex.

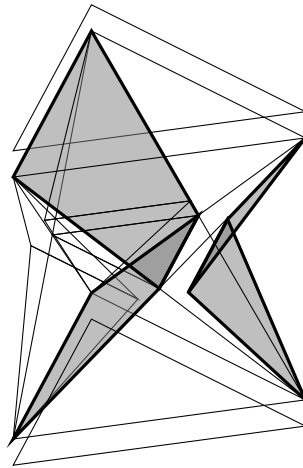

(c) The pair of the second vertex.

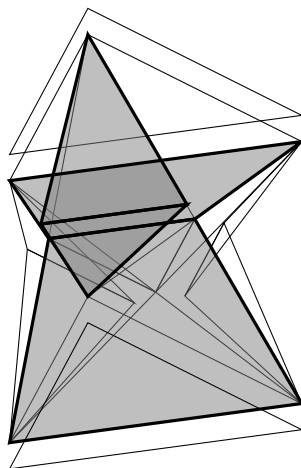

(d) The pair of the third vertex.

Figure 5.5: A representation of the four pairs of intersections of lifts of  $S$  with  $\mathbb{R}X_\varepsilon$ .

(b) Now we consider a surface  $\mathbb{R}X_\varepsilon$  that is twisted along  $\sigma^2$  in every direction. In this example Figure 5.6 is the analogous of Figure 5.4. It represents the different intersections of  $\mathbb{R}X_\varepsilon$  with the lifts of  $S$ . Figure 5.7 represents the four pairs of surfaces of  $S$  obtained by intersecting its lifts with  $\mathbb{R}X_\varepsilon$ . In Figure 5.7b, Figure 5.7c, and Figure 5.7d, the pairs of surfaces meet “transversally” along their common intersection with  $\sigma^2$ .

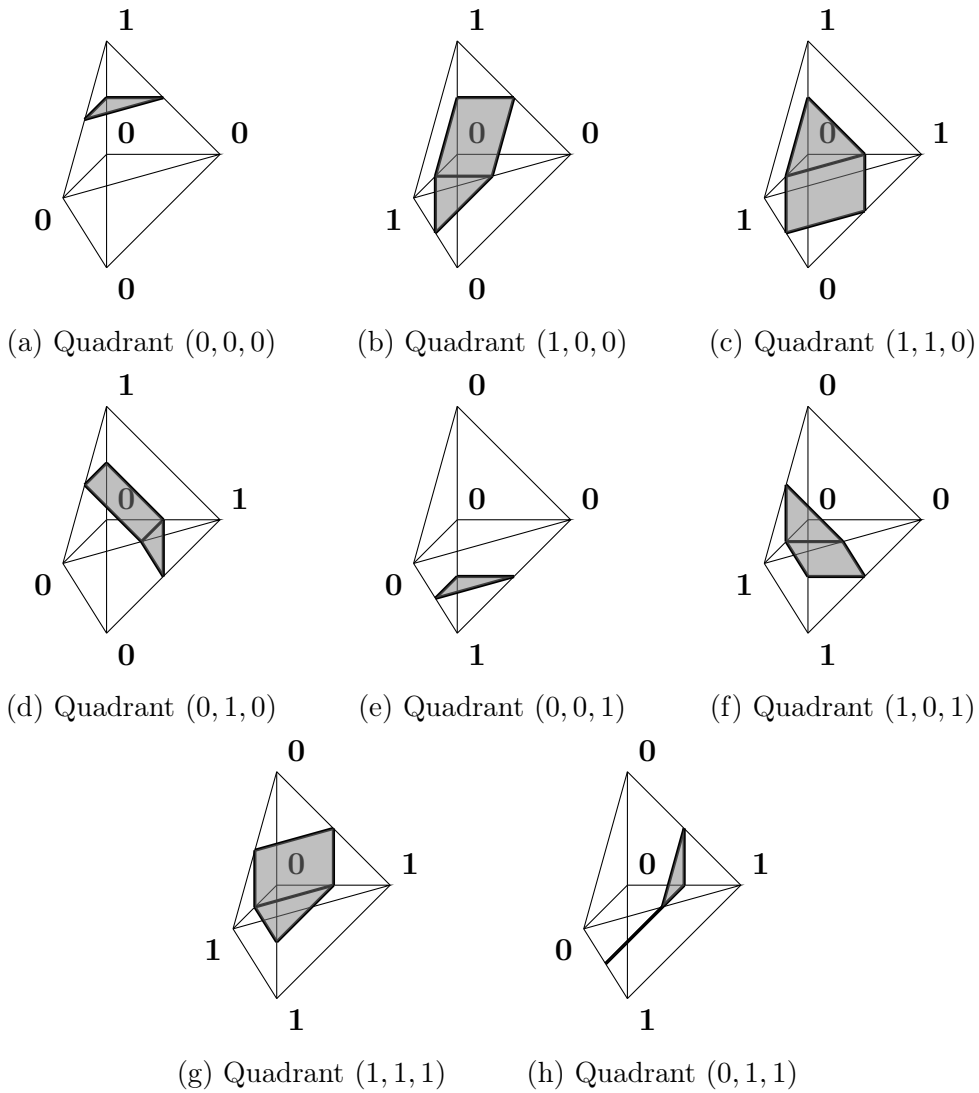
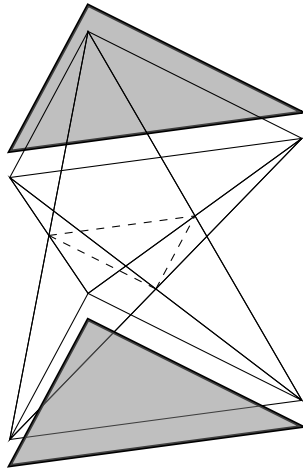
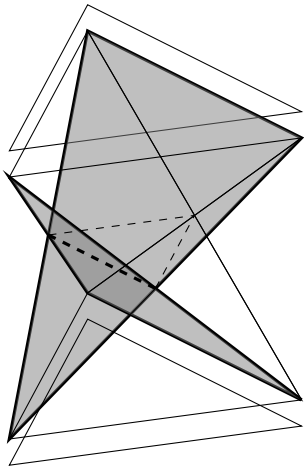

Figure 5.6: The eight intersections of  $\mathbb{R}X_\varepsilon$  with the different lifts of  $S$ .



(a) The Parallel Pair.



(b) The pair of the first vertex.

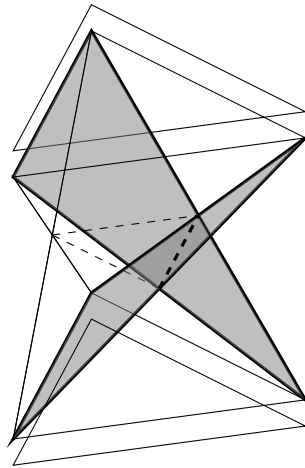

(c) The pair of the second vertex.

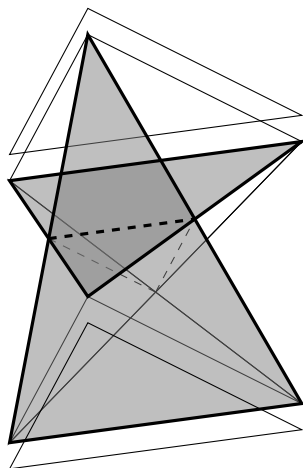

(d) The pair of the third vertex.

Figure 5.7: A representation of the four pairs of intersections of lifts of  $S$  with  $\mathbb{R}X_\varepsilon$ .



**Maximality of the number of connected component.** We recall from Theorem 1.6.4 that the number of connected components of  $\mathbb{R}X_\varepsilon$  cannot exceed the number  $1 + h^{n-1,0}(X)$ . When a T-hypersurface achieves this upper bound we will say that it has a maximal number of connected components. In this paragraph we compute the matrix  $M_{0,n-2}(\varepsilon)$  which leads us to a characterisation of T-hypersurfaces achieving this upper bound.

**Notations.** Let  $W$  be a  $p$ -dimensional sub-space of  $\mathfrak{t}(\mathbb{F}_2)$ . We denote by  $[W] \in \bigwedge^p \mathfrak{t}(\mathbb{F}_2)$  the generator of the line  $\bigwedge^p W$ .

**Lemma 5.3.6.** *Let  $\sigma^p \leq \sigma^q$  be a pair of simplices of  $K$  with  $p$  positive. We have the following alternative:*

- Either  $\sigma^q$  belongs to the boundary  $\partial K$  and  $F_{n-1}^X(\sigma^p; \sigma^q)$  vanishes;
- Or  $\sigma^q$  is interior and we have the exact sequence:

$$C_2(\sigma^p; \mathbb{F}_2) \xrightarrow{\partial} C_1(\sigma^p; \mathbb{F}_2) \xrightarrow{\Upsilon_{\sigma^p, \sigma^q}} F_{n-1}^X(\sigma^p; \sigma^q) \longrightarrow 0$$

$$c \longmapsto \sum_{\sigma^1 \leq \sigma^p} \langle c; \sigma^1 \rangle [N(\sigma^1)]$$

Moreover, if we have  $\sigma^p \leq \sigma^r \leq \sigma^q$  with  $\sigma^q$  interior, and  $c \in C_1(\sigma^p; \mathbb{F}_2)$  then  $\Upsilon_{\sigma^r, \sigma^q}(c)$  equals  $\Upsilon_{\sigma^p, \sigma^q}(c)$ .

*Proof.* If  $\sigma^q$  belongs to  $\partial K$ , then  $s := \dim \text{Sed}(\sigma^q)$  is positive. If  $s$  is greater than 1,  $\bigwedge^{n-1} \mathfrak{t}(\mathbb{F}_2) / \text{Sed}(\sigma^q)$  vanishes. This latter vector space equals  $F_{n-1}^P(\sigma^p; \sigma^q)$ . It contains  $F_{n-1}^X(\sigma^p; \sigma^q)$  which must vanish as well. If  $s$  equals 1,  $\bigwedge^{n-1} \mathfrak{t}(\mathbb{F}_2) / \text{Sed}(\sigma^q)$  is a line. Since  $\omega(\sigma^p)$  divides the generator of the dual line, the contraction against it is injective. Thus  $F_{n-1}^X(\sigma^p; \sigma^q)$  is also trivial. We assume now that  $\sigma^q$  is interior. For all  $\sigma^1 \leq \sigma^p$ , the  $(n-1)$ -vector  $[N(\sigma^1)]$  is the generator of  $F_{n-1}^X(\sigma^1; \sigma^q)$ . Hence by Definition 3.1.5, the morphism  $\Upsilon_{\sigma^p, \sigma^q}$  is surjective. Let  $\sigma^1$  be an edge of  $\sigma^p$ . The vector  $[N(\sigma^1)]$  equals  $\omega(\sigma^1) \cdot [\mathfrak{t}(\mathbb{F}_2)]$ . However, the cochain  $[\sigma^1 \mapsto \omega(\sigma^1)]$  is closed, c.f. Proposition 5.1.9. Therefore,  $[\sigma^1 \mapsto [N(\sigma^1)]]$  is also closed, and the image of  $\partial$  is contained in the kernel of  $\Upsilon_{\sigma^p, \sigma^q}$ . It follows from Proposition 5.1.11, that for all vertices  $\beta$  of  $\sigma^p$ , the set  $\{[N(\sigma^1)]: \sigma^p \geq \sigma^1 \geq \beta\}$  is linearly independent. Hence, it is a basis of  $F_{n-1}^X(\sigma^p; \sigma^q)$ , and this space has dimension  $p$ . The rank of the morphism  $\partial$  equals the codimension of the kernel of  $d : C^1(\sigma^p; \mathbb{F}_2) \rightarrow C^2(\sigma^p; \mathbb{F}_2)$ . However  $\ker(d)$  has dimension  $(p+1) - 1 = p$ . Therefore, the image of  $\partial$  has codimension  $p$  and the sequence is exact. If we have  $\sigma^p \leq \sigma^r \leq \sigma^q$  with  $\sigma^q$  interior,  $F_{n-1}^X(\sigma^p; \sigma^q)$  is included in  $F_{n-1}^X(\sigma^r; \sigma^q)$ . The last statement is then a direct consequence of the definition.  $\square$

**Lemma 5.3.7.** *Let  $\gamma$  be a cochain in  $C^0(K; \partial K; \mathbb{F}_2)$  and  $[\sum_{\sigma^n \in K} w(\sigma^n) \otimes [\sigma^n; \sigma^n]]$  be a homology class in  $H_{n-1,0}(X; \mathbb{F}_2)$ . We have the formula:*

$$g^0(\gamma) \cdot \left[ \sum_{\sigma^n} w(\sigma^n) \otimes [\sigma^n; \sigma^n] \right] = \sum_{\sigma^n \in K} \left( \sum_{\beta * \sigma^{n-1} = \sigma^n} \gamma(\beta) \omega(\sigma^{n-1}) \right) (w(\sigma^n)).$$

*Proof.* Let  $[w]$  denote the homology class  $[\sum_{\sigma^n} w(\sigma^n) \otimes [\sigma^n; \sigma^n]]$ . The intersection product  $g^0(\gamma) \cdot [w]$  equals  $\zeta[w]$  where  $\zeta \in H^{n-1,0}(X; \mathbb{F}_2)$  is the Poincaré dual of  $g^0(\gamma)$ , i.e.  $\zeta \cap [X]$  equals  $g^0(\gamma)$ . Therefore, we will begin by finding a cycle  $\zeta \in Z^0\Omega(K; F_X^{n-1})$  whose cohomology class is Poincaré dual to  $g^0(\gamma)$ . Let  $\sigma^p$  be an interior simplex of  $K$ . We denote by  $\zeta(\sigma^p)$  the unique form in  $F_X^{n-1}(\sigma^p; \sigma^p)$  satisfying:

$$\Upsilon_{\sigma^p, \sigma^p}^*(\zeta(\sigma^p)) = d\gamma|_{\sigma^p},$$

where  $\Upsilon_{\sigma^p, \sigma^p}^*$  is the adjoint morphism of  $\Upsilon_{\sigma^p, \sigma^p}$  from Lemma 5.3.6. For all simplices  $\sigma^p$  of the boundary  $\partial K$  and all vertices of  $K$ , we set  $\zeta(\sigma^p)$  to be 0. Then we have a well defined 0-cochain  $\zeta \in \Omega^0(K; F_X^{n-1})$ . Let us show that it is closed. Let  $\sigma^p \leq \sigma^{p+1}$  be an adjacent pair of simplices of  $K$ . If  $\sigma^p$  is a vertex then  $F_X^{n-1}(\sigma^p; \sigma^{p+1})$  vanishes and so does  $d\zeta(\sigma^p; \sigma^{p+1})$ . We assume now that  $p$  is positive. If  $\sigma^{p+1}$  belongs to  $\partial K$ , so does  $\sigma^p$ , and  $d\zeta(\sigma^p; \sigma^{p+1})$  vanishes. If  $\sigma^p$  belongs to  $\partial K$  but  $\sigma^{p+1}$  does not,  $d\zeta(\sigma^p; \sigma^{p+1})$  equals the image  $\zeta(\sigma^{p+1})'$  of  $\zeta(\sigma^{p+1})$  by the restriction morphism  $F_X^{n-1}(\sigma^{p+1}; \sigma^{p+1}) \rightarrow F_X^{n-1}(\sigma^p; \sigma^{p+1})$ . By Lemma 5.3.6,  $\Upsilon_{\sigma^p, \sigma^{p+1}}^*(\zeta(\sigma^{p+1})')$  equals  $d\gamma|_{\sigma^p}$ . However, the latter cocycle vanishes for  $\gamma$  is identically zero on  $\partial K$ . Since  $\Upsilon_{\sigma^p, \sigma^{p+1}}^*$  is injective, it means that  $d\zeta(\sigma^p; \sigma^{p+1})$  vanishes. If now both  $\sigma^p$  and  $\sigma^{p+1}$  are interior simplices, then:

$$\Upsilon_{\sigma^p, \sigma^{p+1}}^*(d\zeta(\sigma^p; \sigma^{p+1})) = d\gamma|_{\sigma^p} + d\gamma|_{\sigma^{p+1}} = 0.$$

The cochain  $\zeta$  is closed. By Definition 2.4.10, we have:

$$\begin{aligned} \zeta \cap \sum_{\sigma^1 \leq \sigma^n} [N(\sigma^1)] \otimes [\sigma^1; \sigma^n] &= \sum_{\sigma^1 \leq \sigma^n} \zeta(\sigma^1) [N(\sigma^1)] \otimes [\sigma^1; \sigma^n] \\ &= \sum_{\sigma^1 \leq \sigma^n} \Upsilon_{\sigma^1, \sigma^n}^*(\zeta(\sigma^1)) (\sigma^1) \otimes [\sigma^1; \sigma^n] \\ &= \sum_{\sigma^1 \leq \sigma^n} d\gamma(\sigma^1) \otimes [\sigma^1; \sigma^n]. \end{aligned}$$

The cohomology class of  $\zeta$  is the Poincaré dual of  $g^0(\gamma)$  for the fundamental class  $[X]$  is represented by the cycle  $\sum_{\sigma^1 \leq \sigma^n} [N(\sigma^1)] \otimes [\sigma^1; \sigma^n]$ . Therefore, we have:

$$g^0(\gamma) \cdot [w] = \sum_{\sigma^n \in K} \zeta(\sigma^n) (w(\sigma^n)).$$

To complete our proof we need to compute  $\zeta(\sigma^n)$  for all simplices  $\sigma^n \in K$ . Let  $\sigma^1$  and  $\sigma^{n-1}$  be two simplices of  $\sigma^n$ . The number  $\omega(\sigma^{n-1})[N(\sigma^1)]$  equals the value

of  $(\omega(\sigma^{n-1}) \wedge \omega(\sigma^1))$  on  $[\mathbf{t}(\mathbb{F}_2)]$  i.e. 1 if and only if  $\sigma^1$  is not contained in  $\sigma^{n-1}$ . Therefore, for all  $\sigma^1 \leq \sigma^n$ , we have:

$$\left( \sum_{\beta * \sigma^{n-1} = \sigma^n} \gamma(\beta) \omega(\sigma^{n-1}) \right) [N(\sigma^1)] = d\gamma(\sigma^1),$$

and the lemma follows.  $\square$

**Definition 5.3.8.** Let  $\sigma^{n-1}$  be an interior simplex of  $K$ , and  $\sigma^n \in K$  be adjacent to  $\sigma^{n-1}$ . For all vertices  $\alpha$  of  $\sigma^{n-1}$  the vector  $e_{\sigma^n}(\alpha) \pmod{N(\sigma^{n-1})}$  does not depend on the choice of  $\sigma^n$  and is denoted by  $e_{\sigma^{n-1}}(\alpha)$ .

**Proposition 5.3.9.** Let  $\varepsilon$  be a sign distribution on  $K$ . Let  $\beta$  be an interior vertex of  $K$  and  $\sigma^{n-2}$  be an interior simplex of  $K$ . We have the following alternative:

1. The intersection of the open stars of  $\beta$  and  $\sigma^{n-2}$  is empty and  $(\beta; \sigma^{n-2})_\varepsilon$  vanishes;
2. The join of  $\beta$  and  $\sigma^{n-2}$  is an  $(n-1)$ -simplex  $\sigma^{n-1}$  of  $K$  and:

$$(\beta; \sigma^{n-2})_\varepsilon [N(\sigma^{n-1})] = D^2 \varepsilon_{\sigma^{n-1}} + \rho_{\sigma^{n-1}}(\beta),$$

where  $[N(\sigma^{n-1})]$  denotes the generator of the line  $N(\sigma^{n-1})$ ;

3. The vertex  $\beta$  belongs to  $\sigma^{n-2}$  and:

$$(\beta; \sigma^{n-2})_\varepsilon [N(\sigma^{n-2})] = \sum_{\sigma^{n-1} \geq \sigma^{n-2}} e_{\sigma^{n-1}}(\beta) \wedge \left( D^2 \varepsilon_{\sigma^{n-1}} + \rho_{\sigma^{n-1}}(\text{lk}(\sigma^{n-2}; \sigma^{n-1})) \right),$$

where  $[N(\sigma^{n-2})]$  denotes the generator of the line  $\bigwedge^2 N(\sigma^{n-2})$ .

*Proof.* Let  $\sigma^{n-2}$  be an interior simplex of  $K$ . Following Proposition 5.2.3, the homology class  $\partial_{n-2,1}^1 g^{n-2}(\chi_\sigma^{n-2})$  is represented by the cycle:

$$c := \sum_{\sigma^{n-1} \geq \sigma^{n-2}} u(\sigma^{n-2}) \wedge (D^2 \varepsilon_{\sigma^{n-1}} + \rho_{\sigma^{n-1}}^{n-2}(\sigma^{n-2})) \otimes [\sigma^{n-1}; \sigma^{n-1}].$$

Since  $\sigma^{n-2}$  is interior, its link  $L$  in  $K$  is homeomorphic to a circle. We denote the vertices of  $L$  by  $\alpha_i$ , for all  $i \in \mathbb{Z}/k\mathbb{Z}$ , in such a way that  $\alpha_i$  and  $\alpha_{i+1}$  are the vertices of an edge of  $L$ . For all  $i \in \mathbb{Z}/k\mathbb{Z}$ , we denote  $\sigma^{n-2} * \alpha_i$  by  $\sigma_i^{n-1}$ , and  $\sigma^{n-2} * \alpha_i * \alpha_{i+1}$  by  $\sigma_{i,i+1}^n$ . Following Proposition 5.1.14,  $\rho_{\sigma_i^{n-1}}^{n-2}(\sigma^{n-2})$  equals  $\rho_{\sigma_i^{n-1}}(\alpha_i)$  for all  $i \in \mathbb{Z}/k\mathbb{Z}$ . Then we can write:

$$c = \sum_{i \in \mathbb{Z}/k\mathbb{Z}} u(\sigma^{n-2}) \wedge (D^2 \varepsilon_{\sigma_i^{n-1}} + \rho_{\sigma_i^{n-1}}(\alpha_i)) \otimes [\sigma_i^{n-1}; \sigma_i^{n-1}].$$

Let us consider the chain of  $\Omega_{n-1,n}(K; F_{n-1}^X)$  given by the formula:

$$b := \sum_{i \in \mathbb{Z}/k\mathbb{Z}} u(\sigma^{n-2}) \wedge (D^2 \varepsilon_{\sigma_i^{n-1}} + \rho_{\sigma_i^{n-1}}(\alpha_i)) \otimes [\sigma_i^{n-1}; \sigma_{i,i+1}^n].$$

By construction, if  $\sigma^p$  is a simplex of  $K$  that does not contain  $\sigma^{n-2}$ , then  $\langle \partial b; [\sigma^p; \sigma^p] \rangle$  vanishes. For all  $i \in \mathbb{Z}/k\mathbb{Z}$ , both  $\langle \partial b; [\sigma_i^{n-1}; \sigma_i^{n-1}] \rangle$  and  $\langle \partial b; [\sigma_{i,i+1}^n; \sigma_{i,i+1}^n] \rangle$  equal  $\langle c; [\sigma_i^{n-1}; \sigma_i^{n-1}] \rangle$ . Therefore, the cycle  $c$  is homologous to the cycle:

$$c' := \sum_{i \in \mathbb{Z}/k\mathbb{Z}} u(\sigma^{n-2}) \wedge (D^2 \varepsilon_{\sigma_i^{n-1}} + \rho_{\sigma_i^{n-1}}(\alpha_i)) \otimes [\sigma_{i,i+1}^n; \sigma_{i,i+1}^n].$$

Let  $\beta$  be an interior vertex of  $K$ . Following Lemma 5.3.7, we find that:

$$\begin{aligned} (\beta; \sigma^{n-2})_\varepsilon &= g^0(\chi_\beta) \cdot [c'] \\ &= \sum_{\substack{i \in \mathbb{Z}/k\mathbb{Z} \\ \beta \in \sigma_{i,i+1}^n}} \omega(\text{lk}(\beta; \sigma_{i,i+1}^n)) \left( u(\sigma^{n-2}) \wedge (D^2 \varepsilon_{\sigma_i^{n-1}} + \rho_{\sigma_i^{n-1}}(\alpha_i)) \right). \end{aligned} \quad (5.14)$$

It implies that  $(\beta; \sigma^{n-2})_\varepsilon$  vanishes whenever the open stars of  $\beta$  and  $\sigma^{n-2}$  are disjoint. If now the join of  $\beta$  and  $\sigma^{n-2}$  is an  $(n-1)$ -simplex of  $K$ , then  $\beta$  is  $\alpha_i$  for a certain  $i \in \mathbb{Z}/k\mathbb{Z}$ . In this case we have:

$$\begin{aligned} (\beta; \sigma^{n-2})_\varepsilon &= \omega(\text{lk}(\alpha_i; \sigma_{i,i+1}^n)) \left( u(\sigma^{n-2}) \wedge (D^2 \varepsilon_{\sigma_i^{n-1}} + \rho_{\sigma_i^{n-1}}(\alpha_i)) \right) \\ &\quad + \omega(\text{lk}(\alpha_i; \sigma_{i-1,i}^n)) \left( u(\sigma^{n-2}) \wedge (D^2 \varepsilon_{\sigma_{i-1}^{n-1}} + \rho_{\sigma_{i-1}^{n-1}}(\alpha_{i-1})) \right) \\ &= \omega(\sigma_{i+1}^{n-1}) \left( u(\sigma^{n-2}) \wedge (D^2 \varepsilon_{\sigma_i^{n-1}} + \rho_{\sigma_i^{n-1}}(\alpha_i)) \right) \\ &\quad + \omega(\sigma_{i-1}^{n-1}) \left( u(\sigma^{n-2}) \wedge (D^2 \varepsilon_{\sigma_{i-1}^{n-1}} + \rho_{\sigma_{i-1}^{n-1}}(\alpha_{i-1})) \right) \\ &= |D^2 \varepsilon_{\sigma_i^{n-1}} + \rho_{\sigma_i^{n-1}}(\alpha_i)|, \end{aligned}$$

Because  $D^2 \varepsilon_{\sigma_{i-1}^{n-1}} + \rho_{\sigma_{i-1}^{n-1}}(\alpha_{i-1})$  belongs to  $N(\sigma_{i-1}^{n-1})$ , and  $\omega(\sigma_{i+1}^{n-1}) \left( u(\sigma^{n-2}) \wedge [N(\sigma_i^{n-1})] \right)$  equals 1. Indeed, if  $\alpha$  is a vertex of  $\sigma^{n-2}$ , we have:

$$\begin{aligned} \omega(\sigma_{i+1}^{n-1}) \left( u(\sigma^{n-2}) \wedge [N(\sigma_i^{n-1})] \right) &= \omega(\sigma^{n-2}) \wedge (\alpha_{i+1} - \alpha) \left( u(\sigma^{n-2}) \wedge [N(\sigma_i^{n-1})] \right) \\ &= (\alpha_{i+1} - \alpha) ([N(\sigma_i^{n-1})]) \\ &= 1, \end{aligned}$$

since the vanishing of  $(\alpha_{i+1} - \alpha) ([N(\sigma_i^{n-1})])$  would imply the nullity of  $[N(\sigma_i^{n-1})]$ . If we assume now  $\beta$  to be a vertex of  $\sigma^{n-2}$ , the formula (5.14) implies that:

$$(\beta; \sigma^{n-2})_\varepsilon = \sum_{i \in \mathbb{Z}/k\mathbb{Z}} \omega(\text{lk}(\beta; \sigma_{i,i+1}^n)) \left( u(\sigma^{n-2}) \wedge (D^2 \varepsilon_{\sigma_i^{n-1}} + \rho_{\sigma_i^{n-1}}(\alpha_i)) \right).$$

The contraction  $\omega(\text{lk}(\beta; \sigma_{i,i+1}^n)) \cdot [t(\mathbb{F}_2)]$  equals the vector  $e_{\sigma_{i,i+1}^n}(\beta)$ . Therefore, we

have:

$$(\beta; \sigma^{n-2})_{\varepsilon}[\mathbf{t}(\mathbb{F}_2)] = u(\sigma^{n-2}) \wedge \sum_{i \in \mathbb{Z}/k\mathbb{Z}} e_{\sigma_{i,i+1}^n}(\beta) \wedge (D^2 \varepsilon_{\sigma_i^{n-1}} + \rho_{\sigma_i^{n-1}}(\alpha_i)).$$

If  $n$  equals 2, then  $u(\sigma^{n-2})$  equals 1 by Definition 5.2.11 and we have established the last formula. Now we assume that  $n$  is at least equal to 3. Let  $\sigma^1$  be an edge of  $\sigma^{n-2}$ . The number  $\omega(\sigma^1)(e_{\sigma_{i,i+1}^n}(\beta))$  equals 1 if and only if  $\beta$  belongs to  $\sigma^1$ , c.f. Proposition 5.1.11. In particular it does not depend on  $i$ . The number  $\omega(\sigma^1)(D^2 \varepsilon_{\sigma_i^{n-1}} + \rho_{\sigma_i^{n-1}}(\alpha_i))$  is 0 for all  $i \in \mathbb{Z}/k\mathbb{Z}$  for  $\sigma^1$  is contained in  $\sigma_i^{n-1}$  and  $D^2 \varepsilon_{\sigma_i^{n-1}} + \rho_{\sigma_i^{n-1}}(\alpha_i)$  belongs to  $N(\sigma_i^{n-1})$ . Using these computations we find that:

$$\begin{aligned} \omega(\sigma^1) \cdot \sum_{i \in \mathbb{Z}/k\mathbb{Z}} e_{\sigma_{i,i+1}^n}(\beta) \wedge (D^2 \varepsilon_{\sigma_i^{n-1}} + \rho_{\sigma_i^{n-1}}(\alpha_i)) &= d\chi_{\beta}(\sigma^1) \sum_{i \in \mathbb{Z}/k\mathbb{Z}} D^2 \varepsilon_{\sigma_i^{n-1}} + \rho_{\sigma_i^{n-1}}(\alpha_i) \\ &= 0, \end{aligned}$$

and that the vector  $\sum_{i \in \mathbb{Z}/k\mathbb{Z}} e_{\sigma_{i,i+1}^n}(\beta) \wedge (D^2 \varepsilon_{\sigma_i^{n-1}} + \rho_{\sigma_i^{n-1}}(\alpha_i))$  belongs to the line  $\wedge^2 N(\sigma^{n-2})$ . Since  $u(\sigma^{n-2})$  is the volume element of a supplementary sub-space of  $N(\sigma^{n-2})$  we finally find the formula:

$$(\beta; \sigma^{n-2})_{\varepsilon}[N(\sigma^{n-2})] = \sum_{i \in \mathbb{Z}/k\mathbb{Z}} e_{\sigma_{i,i+1}^n}(\beta) \wedge (D^2 \varepsilon_{\sigma_i^{n-1}} + \rho_{\sigma_i^{n-1}}(\alpha_i)).$$

□

**Proposition 5.3.10.** *For all interior vertices  $\beta$  of  $K$  and all simplices  $\sigma^{n-2} \geq \beta$  we have:*

$$\sum_{\sigma^{n-1} \geq \sigma^{n-2}} e_{\sigma^{n-1}}(\beta) \wedge \rho_{\sigma^{n-1}}(\beta) = \sum_{\sigma^{n-1} \geq \sigma^{n-2}} e_{\sigma^{n-1}}(\beta) \wedge \rho_{\sigma^{n-1}}(\text{lk}(\sigma^{n-2}; \sigma^{n-1})).$$

*Proof.* On one hand we have:

$$D^2 \chi_{\beta} = \sum_{\beta \in \sigma^{n-1}} \rho_{\sigma^{n-1}}(\beta) \otimes \sigma^{n-1}.$$

Using the formulæ of Proposition 5.3.9, we have for all  $\sigma^{n-2}$  containing  $\beta$ :

$$(\beta; \sigma^{n-2})_{\chi_{\beta}}[N(\sigma^{n-2})] = \sum_{\sigma^{n-1} \geq \sigma^{n-2}} e_{\sigma^{n-1}}(\beta) \wedge (\rho_{\sigma^{n-1}}(\beta) + \rho_{\sigma^{n-1}}(\text{lk}(\sigma^{n-2}; \sigma^{n-1}))).$$

On the other hand, a direct computation, yields:

$$d\chi_{\beta} + \tau_{\chi_{\beta}} \cup \chi_{\beta} = 0.$$

Therefore, by Proposition 5.2.7 and Proposition 5.2.15, we have:

$$\sum_{\sigma^{n-1} \geq \sigma^{n-2}} e_{\sigma^{n-1}}(\beta) \wedge \left( \rho_{\sigma^{n-1}}(\beta) + \rho_{\sigma^{n-1}}(\text{lk}(\sigma^{n-2}; \sigma^{n-1})) \right) = 0.$$

□

**Proposition 5.3.11.** *For all sign distributions  $\varepsilon$  on  $K$ , all interior vertices  $\beta$  of  $K$ , and all simplices  $\sigma^{n-2} \geq \beta$  we have:*

$$(\beta; \sigma^{n-2})_\varepsilon [N(\sigma^{n-2})] = \sum_{\sigma^{n-1} \geq \sigma^{n-2}} e_{\sigma^{n-1}}(\beta) \wedge (D^2 \varepsilon_{\sigma^{n-1}} + \rho_{\sigma^{n-1}}(\beta)).$$

*Proof.* This is a direct consequence of Proposition 5.3.9 and Proposition 5.3.10. □

**Proposition 5.3.12.** *We assume  $n$  to be equal to 2. For all interior vertices  $\beta$  of  $K$ , the number  $(\beta; \beta)_\varepsilon$  equals the parity of the number of edges of  $K$ , adjacent to  $\beta$ , along which  $\mathbb{R}X_\varepsilon$  is twisted. In other words, we have:*

$$(\beta; \beta)_\varepsilon = \sum_{\sigma^1 \geq \beta} |D^2 \varepsilon_{\sigma^1} + \rho_{\sigma^1}|.$$

*Proof.* Let  $\sigma^2$  be a triangle of  $K$  and  $\sigma^1$  be an edge of  $\sigma^2$ . For all vertices  $\beta$  of  $\sigma^2$ , the set  $\{e_{\sigma^2}(\beta); [N(\sigma^1)]\}$  forms a basis of  $\mathfrak{t}(\mathbb{F}_2)$ . Hence  $e_{\sigma^2}(\beta) \wedge [N(\sigma^1)]$  equals  $[\mathfrak{t}(\mathbb{F}_2)]$ . Moreover for all interior vertex  $\beta$  of  $K$ ,  $[N(\beta)]$  equals  $[\mathfrak{t}(\mathbb{F}_2)]$ . Therefore, Proposition 5.3.11 implies the formula of the proposition. □

**Remark 5.3.13.** When  $n$  is greater than 3 the formula of Proposition 5.3.11, can also be interpreted as a number of twists in the direction of  $\beta$  along the  $(n-1)$ -simplices of its star. However, this time some twists must be counted and some must not. For instance, if  $\beta$  is an interior vertex and  $\sigma^{n-2}$  contains  $\beta$ ,  $(\beta; \sigma^{n-2})_\varepsilon$  equals the number of twists of  $\mathbb{R}X_\varepsilon$  in the direction of  $\beta$  along the  $(n-1)$ -simplices of  $K$  for which  $u(\sigma^{n-2}) \wedge e_{\sigma^{n-1}}(\beta) \wedge [N(\sigma^{n-1})]$  equals  $[\mathfrak{t}(\mathbb{F}_2)]$ . The set of twists we are counting may depend on the choice of the basis used to construct  $u(\sigma^{n-2})$ . However, the count itself, will not.

**Theorem 5.3.14** (Generalised Haas Theorem). *Let  $P$  be a non-singular polytope of  $\mathfrak{t}^*(\mathbb{R})$  endowed with a primitive triangulation  $K$ . For all sign distributions  $\varepsilon$ , the  $T$ -hypersurface  $\mathbb{R}X_\varepsilon$  has a maximal number of connected components if and only if:*

1. *The triangulation  $K$  is  $\rho$ -uniform;*
2. *The number  $\ell(\mathbb{R}X_\varepsilon)$  is at least equal to  $\min(n-2; 1)$ ;*
3. *The sign distribution  $\varepsilon$  satisfies:*

$$D^2 \varepsilon = \rho \text{ in } H_{n-1}(K; \mathcal{B}_1 K; N). \quad (5.15)$$

4. *For all simplices  $\sigma^{n-2}$  of  $\mathcal{B}_1 K$  not contained in  $\mathcal{B}_0 K$ ,  $(\text{ap}(\sigma^{n-2}); \sigma^{n-2})_\varepsilon$  vanishes.*

*Proof.* Using Theorem 4.2.27 we have the short exact sequence:

$$0 \longrightarrow E_{0,0}^\infty(\mathbb{R}X_\varepsilon) \longrightarrow H_0(\mathbb{R}X_\varepsilon; \mathbb{F}_2) \longrightarrow E_{n-1,0}^\infty(\mathbb{R}X_\varepsilon) \longrightarrow 0.$$

Since  $E_{0,0}^\infty(\mathbb{R}X_\varepsilon)$  is isomorphic to  $E_{0,0}^1(\mathbb{R}X_\varepsilon)$ , itself isomorphic to  $H_{0,0}(X; \mathbb{F}_2)$  it has dimension 1. Hence  $\mathbb{R}X_\varepsilon$  has a maximal number of connected components if and only if  $E_{n-1,0}^\infty(\mathbb{R}X_\varepsilon)$  is isomorphic to  $E_{n-1,0}^1(\mathbb{R}X_\varepsilon)$ . We are now going to distinguish three cases:  $n$  equals 2,  $n$  equals 3, and  $n$  is greater than 3. In a first time we assume that  $n$  is greater than 3.  $E_{n-1,0}^\infty(\mathbb{R}X_\varepsilon)$  is isomorphic to  $E_{n-1,0}^1(\mathbb{R}X_\varepsilon)$  if and only if the two following morphisms vanish:

$$\begin{cases} \partial_{n-2,1}^1 : E_{n-2,1}^1(\mathbb{R}X_\varepsilon) \longrightarrow E_{n-1,0}^1(\mathbb{R}X_\varepsilon) \\ \partial_{1,1}^{n-2} : E_{1,1}^{n-2}(\mathbb{R}X_\varepsilon) \longrightarrow E_{n-1,0}^{n-2}(\mathbb{R}X_\varepsilon). \end{cases}$$

By Theorem 4.2.31 and duality  $\partial_{1,1}^{n-2}$  vanishes if and only if the morphism:

$$i^1 : H^1(\mathbb{R}P; \mathbb{F}_2) \rightarrow H^1(\mathbb{R}X_\varepsilon; \mathbb{F}_2),$$

is injective. Since  $i^0 : H^0(\mathbb{R}P; \mathbb{F}_2) \rightarrow H^0(\mathbb{R}X_\varepsilon; \mathbb{F}_2)$  is always injective,  $\partial_{1,1}^{n-2}$  vanishes if and only if  $\ell(\mathbb{R}X_\varepsilon)$  is at least equal to 1. Since  $n$  is greater than 3, Proposition 5.2.7 ensures us that  $\partial_{n-2,1}^1$  vanishes if and only if  $M_{0,n-2}(\varepsilon)$  does. The second point of Proposition 5.3.9 implies that for  $M_{0,n-2}(\varepsilon)$  to vanish we must have:

$$\rho_{\sigma^{n-1}}(\beta) = D^2\varepsilon_{\sigma^{n-1}},$$

for all interior simplices  $\sigma^{n-1}$  of  $K$ , and all vertices  $\beta$  of  $\sigma^{n-1}$  whose link  $\text{lk}(\beta; \sigma^{n-1})$  is not contained in the boundary. In particular,  $K$  must be  $\rho$ -uniform. Reciprocally, if  $K$  is  $\rho$ -uniform, then we must have:

$$D^2\varepsilon = \rho \text{ in } H_{n-1}(K; \mathcal{B}_1K; N).$$

Now if we suppose that  $K$  is  $\rho$ -uniform and  $\varepsilon$  is a solution of (5.15),  $M_{0,n-2}(\varepsilon)$  vanishes if and only if  $(\beta; \sigma^{n-2})_\varepsilon$  vanishes for all pairs of interior simplices  $\beta \leq \sigma^{n-2}$ . We assume that we have such a pair  $\beta \leq \sigma^{n-2}$  with  $\sigma^{n-2}$  containing at least 2 interior vertices, one of them being  $\beta$ . If  $\sigma^{n-1}$  contains  $\sigma^{n-2}$  then, by hypothesis, the link of  $\beta$  in  $\sigma^{n-1}$  contains at least one interior vertex of  $K$ . As a consequence of (5.15),  $D^2\varepsilon_{\sigma^{n-1}}$  equals  $\rho_{\sigma^{n-1}}(\beta)$ . Hence  $(\beta; \sigma^{n-2})_\varepsilon$  vanishes. Therefore,  $M_{0,n-2}(\varepsilon)$  vanishes if and only if  $K$  is  $\rho$ -uniform,  $\varepsilon$  is a solution of (5.15), and for all simplices  $\sigma^{n-2}$  of  $\mathcal{B}_1K \setminus \mathcal{B}_0K$ ,  $(\text{ap}(\sigma^{n-2}); \sigma^{n-2})_\varepsilon$  vanishes.

When  $n$  is at most equal to 3, Theorem 4.2.27 implies that the Renaudineau-Shaw spectral sequence of  $\mathbb{R}X_\varepsilon$  degenerates at the second page. Hence, in these cases  $\mathbb{R}X_\varepsilon$  has a maximal number of connected components if and only if  $E_{n-1,0}^2(\mathbb{R}X_\varepsilon)$  is isomorphic to  $E_{n-1,0}^1(\mathbb{R}X_\varepsilon)$ . This latter condition is equivalent<sup>4</sup> to the vanishing of

<sup>4</sup>c.f. Theorem 4.2.28.

$\partial_{n-1,0}^1$ .

Let  $n$  be equal to 2. Following Proposition 5.2.7, the vanishing of  $\partial_{1,0}^1$  equivalent to the vanishing of  $M_{0,0}(\varepsilon)$ . We recall that every primitive triangulation of a two dimensional polytope is  $\rho$ -uniform<sup>5</sup>. As in the preceding case,  $M_{0,0}(\varepsilon)$  vanishes if and only if:

$$D^2\varepsilon = \rho \text{ in } H_1(K; \mathcal{B}_1K; N),$$

and  $(\beta; \beta)_\varepsilon$  vanishes for all  $\beta \in \mathcal{B}_1K \setminus \mathcal{B}_0K$ . Finally, the rank  $\ell(\mathbb{R}X_\varepsilon)$  being always at least 0, the condition  $\ell(\mathbb{R}X_\varepsilon) \geq \min(0, 1)$  is always satisfied.

Only remains the case  $n$  equals 3. Proposition 5.2.8 provides us with the formula:

$$\dim E_{2,0}^2(\mathbb{R}X_\varepsilon) = \dim E_{2,0}^1(\mathbb{R}X_\varepsilon) - \text{rk } M_{0,1}(\varepsilon) - \delta,$$

where  $\delta$  denotes the dimension of the cokernel of  $i_1 : H_1(\mathbb{R}X_\varepsilon; \mathbb{F}_2) \rightarrow H_1(\mathbb{R}P; \mathbb{F}_2)$ . Hence,  $E_{2,0}^2(\mathbb{R}X_\varepsilon)$  is isomorphic to  $E_{2,0}^1(\mathbb{R}X_\varepsilon)$  if and only if both  $M_{0,1}(\varepsilon)$  and  $\delta$  vanish. The latter condition is equivalent to  $\ell(\mathbb{R}X_\varepsilon)$  being at least equal to 1. The former, as in the case  $n > 3$  is equivalent to  $K$  being  $\rho$ -uniform and  $\varepsilon$  satisfying:

$$D^2\varepsilon = \rho \text{ in } H_2(K; \mathcal{B}_1K; N),$$

and  $(\text{ap}(\sigma^1); \sigma^1)_\varepsilon = 0$  for all  $\sigma^1 \in \mathcal{B}_1K \setminus \mathcal{B}_0K$ . □

**Remark 5.3.15.** The case  $n$  equals 2 of Theorem 5.3.14 was already known and is due to B. Haas, c.f. [Haa97], Theorem 7.3.0.10 p.70. Our generalisation can also be formulated in terms of twists. Equation (5.15) forbids  $\mathbb{R}X_\varepsilon$  to be twisted in certain directions along the  $(n - 1)$ -simplices of  $K \setminus \mathcal{B}_1K$  and the fourth condition of Theorem 5.3.14 imposes that the weighted count of the twists of  $\mathbb{R}X_\varepsilon$  around the  $(n - 2)$ -simplices of  $\mathcal{B}_1K \setminus \mathcal{B}_0K$  has to be even. The two first conditions of the theorem are automatically satisfied for T-curves. Because of Proposition 4.2.40, the second condition is automatically satisfied when  $\iota[\omega_X] \geq 1$ . The latter condition only depends on the “degree” of  $X$ . For instance odd degree hypersurfaces in projective spaces satisfies  $\iota[\omega_X] = n - 1$ .

In the remaining of this paragraph we tackle the question of knowing if every  $\rho$ -uniform triangulation admits a sign distribution  $\varepsilon$  whose T-hypersurface  $\mathbb{R}X_\varepsilon$  has a maximal number of connected components.

**Proposition 5.3.16.** *Let  $K$  be a  $\rho$ -uniform triangulation. Any solution  $\varepsilon$  of the following equation:*

$$D^2\varepsilon = \rho \text{ in } H_{n-1}(K; \mathcal{B}_0K; N), \tag{5.16}$$

*yields a T-hypersurface  $\mathbb{R}X_\varepsilon$  with the maximal number of connected components. Moreover, the T-hypersurfaces constructed from the solutions of (5.16) are made of:*

1. *Exactly  $h^{0,n-1}(X)$  spheres, bounding disjoint balls. None of them intersect the toric divisors of  $\mathbb{R}P$ ;*

---

<sup>5</sup>c.f. Proposition 5.1.14.



2. Another connected component that intersects all of the toric divisors of  $\mathbb{R}P$ .

When (5.16) has a solution we say that  $K$  is simply integrable.

*Proof.* Let  $\varepsilon$  be a solution of (5.16) and  $\beta$  be an interior vertex of  $K$ . For all  $(n-1)$ -simplices adjacent to  $\beta$ ,  $D^2\varepsilon_{\sigma^{n-1}} + \rho_{\sigma^{n-1}}(\beta)$  vanishes. It implies that the vector  $v := D\varepsilon_{\sigma^n} + e_{\sigma^n}(\beta)$  does not depend on the choice of the  $n$ -simplex  $\sigma^n \geq \beta$  we used to compute it. For all  $\sigma^n \geq \beta$ , the cocycle  $d\varepsilon|_{\sigma^n} + z_{\sigma^n}^1(v)$  equals  $d\chi_\beta|_{\sigma^n}$ . Therefore, it follows from Proposition 5.3.1 that the intersection of  $\mathbb{R}X_\varepsilon$  with the lift of the closed star of  $\beta$  corresponding to  $v$  consists of a sphere confining the lift of  $\beta$  in its interior. Since  $\mathbb{R}X_\varepsilon$  must intersect all the toric divisors of  $\mathbb{R}P$  in a non-empty set,  $\mathbb{R}X_\varepsilon$  has at least  $1 + \text{card}(K^{(0)} \setminus \partial K^{(0)})$  connected component. However,  $\text{card}(K^{(0)} \setminus \partial K^{(0)})$  equals  $h^{n-1,0}(X)$ . Hence,  $\mathbb{R}X_\varepsilon$  has a maximal number of connected components and satisfies the description of the proposition.  $\square$

**Proposition 5.3.17.** *A shellable,  $\rho$ -uniform triangulation  $K$  of a non-singular polytope  $P$  is simply integrable if and only if  $\partial\rho = 0$  where  $\partial$  denotes the connecting morphism:*

$$\partial : H_{n-1}(K; \mathcal{B}_0K; N) \rightarrow H_{n-2}(\mathcal{B}_0K; \partial K; N),$$

of the long exact sequence associated with the triple  $\partial K \subset \mathcal{B}_0K \subset K$ .

*Proof.* Let  $K$  be a  $\rho$ -uniform triangulation. If  $K$  is simply integrable, we consider  $\varepsilon$  a solution of (5.16). In this case, the second derivative of  $\varepsilon$  belongs to  $H_{n-1}(K; \partial K; N)$  and equals  $\rho$  modulo  $\mathcal{B}_0K$ . Since the kernel of  $\partial$  is the image of  $H_{n-1}(K; \partial K; N) \rightarrow H_{n-1}(K; \mathcal{B}_0K; N)$ ,  $\partial\rho$  has to vanish. Reciprocally, if we assume  $K$  to be a  $\rho$ -uniform, shellable triangulation, then  $\partial\rho = 0$  implies that  $\rho$  has a lift  $\bar{\rho}$  in  $H_{n-1}(K; \partial K; N)$ . Since  $K$  is shellable, Lemma 5.1.20 ensures that we can find a sign distribution  $\varepsilon$ , whose second derivative equals  $\bar{\rho}$ . By Proposition 5.3.16, any such sign distribution yields a solution of (5.16).  $\square$

**T-curves.** In what follows we assume  $n$  equal to 2. In this special case, Proposition 5.1.14 implies that there is a canonical class  $\bar{\rho} \in H_1(K; \partial K; N)$  that lifts the class  $\rho \in H_1(K; \mathcal{B}_0K; N)$ . It is defined as follows:

$$\bar{\rho} := \sum_{\sigma^1 \notin \partial K} \rho_{\sigma^1} \otimes \sigma^1.$$

**Theorem 5.3.18.** *The solutions of the equation:*

$$D^2\varepsilon = \bar{\rho} \text{ in } H_1(K; \partial K; N), \quad (5.17)$$

consist of the images of the polynomial functions of degree 2 in  $C^0(K; \mathbb{F}_2)$ . As such, every 2-dimensional triangulation, even a non-shellable one, is simply integrable.

*Proof.* Let  $h$  be a quadratic sign distribution. Now let  $\beta_0$  and  $\beta_1$  be the two vertices of an interior edge of  $K$ , and  $[\beta_0; \beta_1; \alpha_\pm]$  the two triangles of  $K$  adjacent to  $[\beta_0; \beta_1]$ . Following Proposition 5.1.19, affine maps are in the kernel of  $D^2$ . Since  $h$  is quadratic,

we can assume, to compute  $D^2h_{[\beta_0; \beta_1]}$ , that  $h$  is given by  $[(x; y) \mapsto xy]$  where  $(x; y)$  are the affine coordinates in the basis  $(\beta_1 + \beta_0; \alpha_+ + \beta_0)$  with origin at  $\beta_0$ . If  $(x_-; y_-)$  are the coordinates of the vector  $\alpha_- + \beta_0$ , then  $y_-$  equals 1 for  $(\beta_1 + \beta_0; \alpha_- + \beta_0)$  is also a basis of  $\mathfrak{t}^*(\mathbb{F}_2)$ . Hence, we have:

$$\alpha_+ + \alpha_- = x_-(\beta_1 + \beta_0),$$

and  $\rho_{[\beta_0; \beta_1]}$  equals  $x_-[N([\beta_0; \beta_1])]$  by Proposition 5.1.13. Let us write:

$$D^2h_{[\beta_0; \beta_1]} = |D^2h_{[\beta_0; \beta_1]}| \left[ N([\beta_0; \beta_1]) \right].$$

Then, we have:

$$\begin{aligned} |D^2h_{[\beta_0; \beta_1]}| &= x(\alpha_+)y(\alpha_+) + x_-y_- + y_-(x(\beta_0)y(\beta_0) + x(\beta_1)y(\beta_1)) \\ &= 0 \times 1 + x_- \times 1 + x_-(0 \times 0 + 1 \times 0) \\ &= x_-. \end{aligned}$$

And  $D^2h_{[\beta_0; \beta_1]}$  equals  $\rho_{[\beta_0; \beta_1]}$ . Now by Proposition 5.1.19, the kernel of  $D^2$  is exactly the space of affine sign distributions, hence the theorem follows.  $\square$

- Remarks 5.3.19.**
1. Since  $\mathfrak{t}^*(\mathbb{F}_2)$  has dimension 2 there is essentially one quadratic polynomial function  $f : \mathfrak{t}^*(\mathbb{F}_2) \rightarrow \mathbb{F}_2$ . It is a consequence of Fermat's little theorem. Hence, all the T-curves  $\mathbb{R}X_\varepsilon$  obtained from a solution  $\varepsilon$  of (5.17) are reflections of one another;
  2. I. Itenberg and O. Viro proved<sup>6</sup> that a particular sign distribution always produces a maximal curve of a given topological type for all convex triangulations of the standard triangle of size  $d \geq 1$ :  $\{(x; y) \in \mathbb{R}_+^2 \mid x + y \leq d\}$ . They named their sign distribution the Harnack distribution. It is given by the formula  $\varepsilon(x; y) := 1 + (1 + x)(1 + y) \pmod{2}$ , hence by a quadratic polynomial.

For 2-dimensional polytopes the set of maximal distributions contains two special affine subspaces: the space of solutions of (5.16) which itself contains the solutions of (5.17). Theorem 5.3.18 describes the elements of the latter as quadratic distributions. In the following will geometrically characterise the solutions of (5.16) and of (5.17) among maximal T-curves.

**Proposition 5.3.20.** *A sign distribution  $\varepsilon$  yields a maximal curve  $\mathbb{R}X_\varepsilon$  of the surface  $\mathbb{R}P$  having only one connected component intersecting the toric divisors of  $\mathbb{R}P$  if and only if  $\varepsilon$  is a solution of (5.16).*

*Proof.* Proposition 5.3.16 ensures that every solution of (5.16) is maximal and can only have one connected component intersecting the toric divisors of  $\mathbb{R}P$ . Let  $\varepsilon$  be a sign distribution yielding a maximal curve  $\mathbb{R}X_\varepsilon$  of  $\mathbb{R}P$ , i.e. a solution of (5.15) with an even number of twisted edges around each vertex. Let us denote by  $C_1, \dots, C_k$  the

---

<sup>6</sup>c.f. [IV96], Proposition p.24.

connected components of  $\mathbb{R}X_\varepsilon$  intersecting the toric divisors of  $\mathbb{R}P$ , and by  $\mu$  the “moment” projection  $\mathbb{R}P \rightarrow P$ . The images  $\mu(C_1), \dots, \mu(C_k)$  are one dimensional sub-complexes of the cubical subdivision of  $K$ . The intersection of their support with the interior edges of  $K$  are always “transversal”. Moreover, at most two such images  $\mu(C_j)$  can intersect a given interior edge, and every edge of  $\partial K$  is reached by exactly one such image. If  $\varepsilon$  is not a solution of (5.16) then there exists at least one twisted edge  $\sigma^1$  in  $\mathcal{B}_1 K \setminus \mathcal{B}_0 K$ . Let us denote  $\alpha$  the interior vertex of  $\sigma^1$ . There is an even number of twisted edges of  $\mathcal{B}_1 K$  adjacent to  $\alpha$ . We denote by  $\{\beta_i : i \in \mathbb{Z}/2l\mathbb{Z}\}$  the set of vertices of  $\partial K$  for which  $\{[\alpha; \beta_i] : i \in \mathbb{Z}/2l\mathbb{Z}\}$  is the set of twisted edges adjacent to  $\alpha$ . We assume that the  $\beta_i$ ’s are consistently numbered with respect to a cyclic ordering of the circle  $\text{lk}(\alpha; K)$ . The edges  $\{[\alpha; \beta_i] : i \in \mathbb{Z}/2l\mathbb{Z}\}$  divide the star of  $\alpha$  into  $2l$  zones  $\{B_i : i \in \mathbb{Z}/2l\mathbb{Z}\}$ . For all  $i \in \mathbb{Z}/2l\mathbb{Z}$ , the zone  $B_i$  is bounded by the edges  $[\alpha; \beta_i]$  and  $[\alpha; \beta_{i-1}]$ . By Proposition 5.3.1, The images under  $\mu$  of the intersections of the lifts of this star in  $\mathbb{R}P$  with  $\mathbb{R}X_\varepsilon$  consist of a collection of arcs. There are  $2l$  of them that cross the edges  $\{[\alpha; \beta_i] : i \in \mathbb{Z}/2l\mathbb{Z}\}$ . For all  $i \in \mathbb{Z}/2l\mathbb{Z}$ , exactly one of them goes from  $B_i$  to  $B_{i+2}$ . Figure 5.8 depicts an example of these arcs in the star of  $\alpha$ .

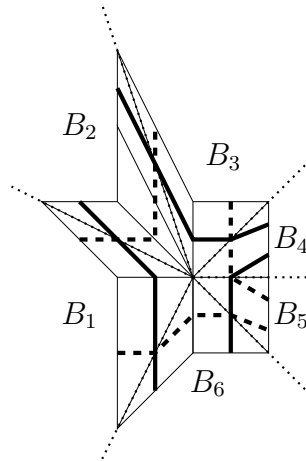

Figure 5.8: A representation of the crossing arcs of the star of  $\alpha$ .

This decomposition of the star of  $\alpha$  extend to a decomposition of  $P$  into  $2l$  zones  $\tilde{B}_1, \dots, \tilde{B}_{2l}$ . For all  $1 \leq i \leq 2l$ ,  $\tilde{B}_i$  is the closure of the connected component of  $P \setminus \bigcup_i [\alpha; \beta_i]$  that contains  $B_i$ . Let  $\sigma^1$  be an edge of  $\partial K$  located in the zone  $\tilde{B}_i$ , and  $C_j$  be the curve whose image under  $\mu$  reaches  $\sigma^1$ . Two behaviors can occur, either  $\mu(C)$  is fully contained in the zone  $\tilde{B}_i$  or  $\mu(C)$  must cross both  $[\alpha; \beta_i]$  and  $[\alpha; \beta_{i-1}]$ . If the former occurs then  $k$  must be at least equal to 2 since all the edges of the boundary are reached. We assume now that the second case occurs. We start following the curve  $C_j$  in the direction in which  $\mu(C_j)$  crosses  $[\alpha; \beta_i]$ . Before crossing this edge we must penetrate inside the star of  $\alpha$ . As we do so we must follow the arcs it contains. It leads us in the zone  $\tilde{B}_{i+2}$ . Therefore, since  $2l$  is even  $\mu(C_j)$  can only reach edges of the boundary contained in the zones whose index has the same parity than  $i$ . Hence  $k$  must be at least 2.  $\square$

Let  $f \in \mathbb{R}[X; Y]$  be a real polynomial with smooth Newton polytope  $P$ . We

assume that the real curve  $Z := \{f = 0\}$  of the projective toric surface  $Y$  associated with the polytope  $P$  is non-singular. The amoeba  $A$  of  $Z$  is the image of the intersection of the complex locus  $Z(\mathbb{C})$  with the open algebraic torus  $(\mathbb{C}^\times)^2 \subset Y(\mathbb{C})$  by the logarithmic map  $\text{Log} : (\mathbb{C}^\times)^2 \rightarrow \mathbb{R}^2$ . M. Passare and H. Rullgård proved<sup>7</sup> that the area of  $A$ , with respect to the Lebesgue measure of  $\mathbb{R}^2$ , is never greater than  $\pi^2$  times the area of the polytope  $P$ . G. Mikhalkin and H. Rullgård proved<sup>8</sup> that this inequality is sharp and characterised the curves realising this maximum. They called them *simple Harnack curves* and they satisfy the following description:

1.  $Z(\mathbb{R})$  is made of  $1 + g(Z(\mathbb{C}))$  connected components, where  $g(Z(\mathbb{C}))$  is the genus of  $Z(\mathbb{C})$ . This genus equals the number of interior lattice points of  $P$ ;
2. There are  $g(Z(\mathbb{C}))$  components of  $Z(\mathbb{R})$  located in the real torus  $(\mathbb{R}^\times)^2 \subset Y(\mathbb{R})$ . Moreover, they all bound disjoint discs;
3. If  $C$  denotes the remaining connected component of  $Z(\mathbb{R})$ , then there is a parametrisation  $\gamma : [0, 1] \rightarrow C$ , an ordering  $E_1, \dots, E_k$  of the edges of  $P$  consistent with a cyclic ordering of  $\partial P$ , and numbers  $0 = t_0 < t_1 < \dots < t_{k-1} < t_k = 1$  such that  $\gamma^{-1}(C \cap \mathbb{R}E_i)$  is contained in  $]t_{i-1}; t_i[$  for all  $1 \leq i \leq k$ .

This definition extends to  $T$ -curves and we say that  $\mathbb{R}X_\varepsilon$  is a *simple Harnack curve* if and only if it satisfies the above description.

Let  $\gamma : \mathbb{R}/\mathbb{Z} \rightarrow C$  be a parametrisation of a connected component of the  $T$ -curve  $\mathbb{R}X_\varepsilon$ . We can imagine that  $\gamma$  is the trajectory of an astroid moving into the space  $\mathbb{R}P$  in which every vertex of  $\mathbb{R}K$  represents a celestial body. We say that an instant  $t$  is critical if  $\gamma(t)$  belongs to an edge  $\sigma_{\mathbb{R}}^1$  of  $\mathbb{R}K$ , and that the astroid crosses  $\sigma_{\mathbb{R}}^1$  at the critical instant  $t$ . At a non-critical instant the astroid is located in an open triangle  $\sigma_{\mathbb{R}}^2$  of  $\mathbb{R}K$ . The trajectory of the astroid must separate one vertex  $\alpha_{\mathbb{R}}$  of  $\sigma_{\mathbb{R}}^2$  from the others. We say that the astroid is orbiting around this vertex. When we follow the trajectory of the astroid, three rules can apply when we pass through a critical instant :

1. The crossed edge  $\sigma_{\mathbb{R}}^1$  does not belong to a toric divisor  $\mathbb{R}E$ , where  $E$  is an edge of  $P$ , and  $|\sigma_{\mathbb{R}}^1|$  is not twisted. In that case the astroid continues to orbit around the same vertex;
2. The crossed edge  $\sigma_{\mathbb{R}}^1$  does not belong to a toric divisor  $\mathbb{R}E$ , where  $E$  is an edge of  $P$ , and  $|\sigma_{\mathbb{R}}^1|$  is twisted. In that case the astroid orbits the other vertex of  $\sigma_{\mathbb{R}}^1$  after crossing it;
3. The crossed edge  $\sigma_{\mathbb{R}}^1$  belongs to a toric divisor  $\mathbb{R}E$ , where  $E$  is an edge of  $P$ . In that case the astroid orbits the other vertex of  $\sigma_{\mathbb{R}}^1$  after crossing it.

Let us assume now that  $\varepsilon$  is a solution of (5.16) and that  $C$  is the component of  $\mathbb{R}X_\varepsilon$  that has non-empty intersection with the toric divisors. Since no edge of  $\mathcal{B}_1K$  are

<sup>7</sup>c.f. [PR04], Corollary 1 p.502.

<sup>8</sup>c.f. [MR01], Theorem 1 p.442.

twisted, the astroid can only orbit around the vertices of the toric divisors of  $\mathbb{R}P$  and every twisted edge divides  $P$  into two smaller polytopes that we call the sides of the edge. We say that a twisted edge is *extremal* when one of its side contains all the other twisted edges. Let  $CT$  be the inverse image of the middle of the twisted edges and boundary edges by  $\mu \circ \gamma$ . We define a map  $f : \mathbb{R}/\mathbb{Z} \rightarrow P$  homotopic to  $\mu \circ \gamma$  the following way:

1. if  $t$  belongs to  $CT$ , we set  $f(t) := \mu(\gamma(t))$ ;
2. if  $t$  belongs to a connected component  $]a; b[$  of the complementary sub-set of  $CT$ ,  $\mu(\gamma(t))$  belongs to a piece of the star of a vertex divided by the twisted edges and boundary edges adjacent to this vertex. Let us assume that  $\mu(\gamma(t))$  is between the twisted edges  $\sigma_a^1$  and  $\sigma_b^1$  with  $\mu(\gamma(a))$  the middle of  $\sigma_a^1$  and  $\mu(\gamma(b))$  the middle of  $\sigma_b^1$ . In this case we define  $f|_{]a; b[}$  to be a nowhere constant arc contained in  $\sigma_a^1 \cup \sigma_b^1$  joining  $\mu(\gamma(b))$  from  $\mu(\gamma(a))$ ;

By construction, the cyclic ordering of the boundary edges of  $K$  induced by  $f$  is identical to the cyclic ordering of  $\gamma$ . The map  $f$  will only pass twice through the middle of the twisted edges and once through the middle of the boundary edges.

**Lemma 5.3.21.** *If the astroid crosses a twisted edge  $\sigma_{\mathbb{R}}^1$  and its moment image goes from the side  $Q_1$  of  $\mu(\sigma_{\mathbb{R}}^1)$  to the other side  $Q_2$ , then the astroid must cross a toric divisor of  $\mathbb{R}P$  at a lift of an edge of  $\partial K \cap Q_2$  before its moment image can be back in  $Q_1$ .*

*Proof.* We assume that for  $t < t_0$  close to  $t_0$ ,  $f(t)$  is in  $Q_1$  and that  $f(t_0)$  belongs to  $Q_1$ . As  $t \geq t_0$  grows  $f(t)$  will eventually end up on an extremal twisted edge before passing through  $\mu(\sigma_{\mathbb{R}}^1)$  again. Indeed, let us denote by  $\sigma_0^1, \dots, \sigma_N^1$  the ordered set of twisted edges visited by  $f$  as  $t$  grows, with  $\sigma_0^1$  and  $\sigma_N^1$  equal to  $\mu(\sigma_{\mathbb{R}}^1)$ . They must come in pairs for otherwise  $f$  would be trapped in only one side of a twisted edge. Moreover, since twisted edges do not cross, one of such pair must appear in consecutive order. Such an edge is extremal by definition. Now, the side  $Q$  of this extremal twisted edge that does not contain any other twisted edge is fully visited by  $f$  before crossing the extremal edge again. Since the vertices are not confounded  $f$  must visit some edge of  $\partial K \cap Q$ .  $\square$

**Proposition 5.3.22.** *A sign distribution  $\varepsilon$  yields a simple Harnack curve of  $\mathbb{R}P$  if and only if it is a solution of (5.17). Hence, simple Harnack curves are essentially unique amongst  $T$ -curves constructed on a given triangulation.*

*Proof.* The edges of  $\mathcal{B}_0K \setminus \partial K$  are of two types. An edge  $\sigma^1 \in \mathcal{B}_0K \setminus \partial K$  is said to be of the first type if at least one of its vertices is not a vertex of the polytope  $P$ . The others are said to be of second type. We say that an edge  $\sigma^1 \in \mathcal{B}_0K \setminus \partial K$  of the first type is incident to an edge  $E$  of  $P$  if one of its vertices belongs to the relative interior of  $E$ . We denote by  $S_f$  the circle obtained from  $\mathbb{R}/\mathbb{Z}$  by contracting all the inverse image by  $f$  of the twisted edges. We denote by  $f^*E$  the image in  $S_f$  of  $f^{-1}(E)$ . We will prove the proposition in two times. First we will show that if

there is a twisted edge of first type incident to  $E$  then  $f^*E$  is not connected. Then we will finish by showing that a sign distribution whose only twisted edges are of the second type induces an order of the edges of  $P$  consistent with a cyclic order of  $\partial P$  if and if no edges are twisted.

Let  $E$  be an edge of  $P$ . We denote by  $[\alpha_0; \alpha_1], \dots, [\alpha_{k-1}, \alpha_k]$  the edges of  $\partial K$  located in  $E$  and we assume that there is a vertex  $\alpha_i$ , with  $0 < i < k$ , belonging to a twisted edge. Let us further assume that  $i$  is the smallest of such integers. Let  $t_0$  be the instant at which  $f(t_0)$  is the middle of  $[\alpha_0; \alpha_1]$ . up to reparametrisation we can assume that  $f$  moves toward  $\alpha_1$  when  $t$  grows. When  $t$  does so,  $f(t)$  will remain on  $E$  until it reaches  $\alpha_i$ , then it will follow a twisted edge  $[\alpha_i; \beta]$ . Since  $E$  is a convex set,  $\beta$  cannot belong to  $E$ . Then when  $t$  decreases from  $t_0$ ,  $f(t)$  must pass through edges of  $\partial K$  that do not belong to  $E$  before eventually passing through  $[\alpha_i; \beta]$ . Indeed, either  $[\alpha_i; \beta]$  is extremal and  $f(t)$  must pass through a boundary edge containing  $\beta$ . Either it is not extremal and  $f(t)$  will pass through a twisted edge before passing through  $\beta$ . In this case Lemma 5.3.21 ensures that it will pass through a boundary edge that does not belong to  $E$  before reaching  $\beta$  for it will enter the side of that twisted edge that does not contain  $E$ . Now we follow  $f$  as  $t$  grows from  $t_0$ . Let us denote  $[\beta_0; \beta_1], \dots, [\beta_{l-1}; \beta_l]$ , with  $[\beta_0; \beta_1] = [\alpha_i; \beta]$  the twisted edges visited by  $f$  before visiting a boundary edge. If  $\beta_l$  is not in the relative interior of  $E$  then Lemma 5.3.21 implies that the next boundary edge  $f$  passes through is not in  $E$ . Thus  $f^*E$  is not connected. If now  $\beta_l$  belongs to the relative interior of  $E$  then  $l$  must be even and  $\beta_{2i}$  must always belong to the relative interior of  $E$ . Indeed, if two consecutive vertices does not belong to the relative interior of  $E$  then  $\beta_l$  cannot belong to  $E$  by Lemma 5.3.21. Hence, once having passed through all the twisted edges, we end up on  $E$  moving in the direction of  $\alpha_{j+1}$  where  $\beta_l = \alpha_j$  and  $j > i$ . See Figure 5.9 for an example. This alternative repeats itself until we can show that  $f^*E$  is not connected or we end up on the last portion of  $E$  where there is no incident twisted edges anymore. This case is completely symmetric to following  $f$  when  $t$  decreases from  $t_0$ . Therefore, moving forward in time, we will leave  $E$  without having seen the middle of  $[\alpha_i; \alpha_{i+1}]$ . Hence,  $f^*E$  is not connected. This reasoning also shows that if there is no twisted edges of the first type incident to  $E$  then we see all of  $E$  by moving forward in time.



(a) The case  $\beta_l$  does not belong to the relative interior of  $E$ . (b) The case  $\beta_l$  belongs to the relative interior of  $E$ .

Figure 5.9: The two behaviours of the moment image of the astroid when crossing a twisted edge of the first type incident to  $E$ .

Let us now assume that the only possibly twisted edges of  $\varepsilon$  are of the second type. Let  $[\alpha_0; \alpha_1]$  and  $[\alpha_1; \alpha_2]$  be two consecutive edges of  $P$  such that  $\alpha_1$  belongs to a twisted edge. Let  $\beta$  be the other end of the twisted edge followed by  $f$  after passing through  $[\alpha_0; \alpha_1]$ . By convexity of the edges of  $P$ ,  $\beta$  cannot be neither  $\alpha_0$  nor  $\alpha_2$ . After following this twisted edge we end up on its side that contains  $[\alpha_1; \alpha_2]$ . If there are no twisted edges adjacent to  $\beta$  on this side, we will have to pass through an edge of  $P$  different from  $[\alpha_1; \alpha_2]$  before being able to pass through it. If there is, following it will lead us on its side that does not contain  $[\alpha_1; \alpha_2]$ . Hence we will also have to pass through an edge of  $P$  different from  $[\alpha_1; \alpha_2]$  before passing through it. As a consequence, for the cyclic order of the edges of  $P$  induced by  $f$  to be consistent with an ordering as boundary of the polytope we cannot have any twisted edge. The reciprocal is immediate.  $\square$

**A sharper bound for the number of connected components.** In this paragraph, we provide an estimation of the maximal number of connected components of a T-hypersurface constructed on a non- $\rho$ -uniform triangulation.

**Definition 5.3.23.** Let  $K$  be a primitive triangulation of a non-singular polytope. The distance between two simplices is the minimum of the graph length of their vertices in the 1-skeleton of  $K$ . We denote by  $\kappa(K)$  the maximal number of  $(n-1)$ -simplices of  $K$  at which it fails to be  $\rho$ -uniform and that are all at distance at least 2 of each others.

**Proposition 5.3.24.** *Let  $K$  be a primitive triangulation of a non-singular polytope. For all sign distributions  $\varepsilon \in C^0(K; \mathbb{F}_2)$  the rank of  $M_{0,n-2}(\varepsilon)$  is always at least equal to  $\kappa(K)$ . As a consequence we have the following upper bound:*

$$\dim H_0(\mathbb{R}X_\varepsilon; \mathbb{F}_2) \leq 1 + \dim H_{0,n-1}(X; \mathbb{F}_2) - \kappa(K). \quad (5.18)$$

*Proof.* Let  $\sigma_1^{n-1}, \dots, \sigma_k^{n-1}$  be simplices of  $K$  at which it fails to be  $\rho$ -uniform and that are all at distance at least 2 of each others. Let  $\varepsilon$  be a sign distribution on  $K$ . Since  $K$  fails to be  $\rho$ -uniform at the simplices  $\sigma_1^{n-1}, \dots, \sigma_k^{n-1}$ , we can find, for all  $1 \leq i \leq k$ , two different interior vertices  $\alpha_i, \beta_i$  of  $\sigma_i^{n-1}$  for which  $\rho_{\sigma_i^{n-1}}(\alpha_i)$  and  $\rho_{\sigma_i^{n-1}}(\beta_i)$  are different. Using Proposition 5.3.9, it follows that either  $(\alpha_i; \text{lk}(\alpha_i; \sigma_i^{n-1}))_\varepsilon$  or  $(\beta_i; \text{lk}(\beta_i; \sigma_i^{n-1}))_\varepsilon$  equals 1. We assume that it happens on  $\alpha_i$ , for all  $1 \leq i \leq k$ . The matrix:

$$\left( (\alpha_i; \text{lk}(\alpha_j; \sigma_j^{n-1}))_\varepsilon \right)_{1 \leq i, j \leq k},$$

is a sub-matrix of  $M_{0,n-2}(\varepsilon)$  equal to the identity matrix of size  $k$ . Indeed for all  $i$  different from  $j$ ,  $\alpha_i$  and  $\text{lk}(\alpha_j; \sigma_j^{n-1})$  are at distance at least 2. Therefore, they cannot be both included in the same simplex. Hence, the rank of  $M_{0,n-2}(\varepsilon)$  is at least equal to  $k$ . Consequently, the rank of  $M_{0,n-2}(\varepsilon)$  is at least equal to  $\kappa(K)$ , and the upper bound (5.18) follows from Proposition 5.2.8.  $\square$

**Asymptotic growth of the expected number of connected components.** We assume that we are given a smooth polytope  $P$  of  $\mathfrak{t}^*(\mathbb{R})$ , and for every integer

$d \geq 1$ , a primitive triangulation  $K_d$  of its dilate  $dP$ . We denote by  $X(d)$  the dual hypersurface of  $K_d$ . By Theorem 1.6.4 of A. Renaudineau and K. Shaw, we know that for all  $\varepsilon \in C^0(K(d); \mathbb{F}_2)$ , the number of connected components  $b_0(\mathbb{R}X_\varepsilon(d))$  is less than  $1 + h^{n-1,0}(X(d))$ , where  $h^{n-1,0}(X(d))$  is the dimension of  $H_{n-1,0}(X(d); \mathbb{F}_2)$ . In this paragraph we give an idea of the growth of the number connected components of a typical T-hypersurface as  $d$  grows to  $+\infty$ . If we choose  $\varepsilon$  uniformly at random in  $C^0(K(d); \mathbb{F}_2)$ , the number  $b_0(\mathbb{R}X_\varepsilon(d))$  becomes a random variable. We denote by  $\mathbb{E}[\xi]$  the expected value of a random variable  $\xi$ .

**Proposition 5.3.25.** *The asymptotic of  $h^{n-1,0}(X(d))$  is the following:*

$$h^{n-1,0}(X(d)) = \text{vol}_{\mathbb{Z}}(P)d^n + o(d^{n-1}),$$

where  $\text{vol}_{\mathbb{Z}}(P)$  is the integral volume of  $P$ . That is to say the Lebesgue measure of  $P$ , normalised so that a parallelogram on a basis of  $\mathfrak{t}^*(\mathbb{Z})$  has volume 1.

*Proof.* The number  $h^{n-1,0}(X(d))$  equals the number of lattice points in the relative interior of  $P$ . By Ehrhart-Macdonald reciprocity<sup>9</sup> it equals  $(-1)^n L(P; -d)$ , where  $L(P; X)$  is the Ehrhart polynomial<sup>10</sup> of  $P$ . The polynomial  $L(P; X)$  has degree  $n$  and its leading coefficient is  $\text{vol}_{\mathbb{Z}}(P)$ .  $\square$

**Proposition 5.3.26.** *Let  $P$  be a  $n$ -dimensional integral polytope of  $\mathfrak{t}^*(\mathbb{R})$  and  $(K_d)_{d \geq 1}$  be a sequence of primitive triangulations of  $(dP)_{d \geq 1}$ . The function  $d \mapsto f_1(K_d)$  is a polynomial of degree  $n$ .*

*Proof.* Let  $d \geq 1$  be an integer. The number  $f_1(K_d)$  is a linear combination of the  $h^*$ -vector of  $dP$ . In particular there is a  $\mathfrak{t}^*(\mathbb{Z})$ -translation invariant valuation  $\varphi$  on the integral polytopes of  $\mathfrak{t}^*(\mathbb{R})$  such that  $f_1(K_d)$  equals  $\varphi(dP)$  for all  $d \geq 1$ . Theorem 5 p.121 of [McM77] implies that  $d \mapsto f_1(K_d)$  is given by a polynomial of degree at most  $n$ . However, the number  $f_1(K_d)$  is not smaller than  $\frac{1}{2}f_0(K_d)$  since no vertex is isolated. Hence,  $d \mapsto f_1(K_d)$  is of degree  $n$  for  $d \mapsto f_0(K_d) = \text{card}(dP \cap \mathfrak{t}^*(\mathbb{Z}))$  is polynomial of degree  $n$ .  $\square$

**Proposition 5.3.27.** *For all sequences  $(K_d)_{d \geq 1}$  of primitive triangulations of  $(dP)_{d \geq 1}$  we have:*

$$1 \geq \limsup_{d \rightarrow +\infty} \mathbb{E} \left[ \frac{b_0(\mathbb{R}X_\varepsilon(d))}{1 + h^{n-1,0}(X(d))} \right] \geq \liminf_{d \rightarrow +\infty} \mathbb{E} \left[ \frac{b_0(\mathbb{R}X_\varepsilon(d))}{1 + h^{n-1,0}(X(d))} \right] > 0.$$

*Proof.* Let  $d \geq 1$  be an integer and  $\beta \in K_d$  be an interior vertex. We denote by  $S_\beta$  the subcomplex of cubical subdivision of  $K_d$  made of all the cubes indexed by the pairs of simplices  $\sigma^p \leq \sigma^q$  with  $p \geq 1$  and  $\sigma^p$  containing  $\beta$ . We also denote by  $\text{St}_\beta$  the open star of  $\beta$ , and  $\xi_\beta$  the Bernoulli random variable whose value is 1 if and only if  $\mathbb{R}X_\varepsilon(d)$  contains a lift of  $S_\beta$ . By Proposition 5.3.1 and Proposition 5.3.16  $\xi_\beta(\varepsilon)$  equals 1 if and only if the image of  $D^2\varepsilon$  in  $H_{n-1}(K_d(\text{St}_\beta); \partial K_d(\text{St}_\beta); N)$  equals

<sup>9</sup>c.f. [Mac71], Theorem 4.6 p.192

<sup>10</sup>c.f. [Ehr62], pp.616-618.



$\rho(\beta) = \sum_{\sigma^{n-1} \geq \beta} \rho_{\sigma^{n-1}}(\beta) \otimes \sigma^{n-1}$ . We have the following commutative diagram with exact rows and columns:

$$\begin{array}{ccccccc}
 & & & & 0 & & \\
 & & & & \downarrow & & \\
 & & & & C^0(K_d; K_d(\text{St}_\beta); \mathbb{F}_2) & & \\
 & & & & \downarrow & & \\
 0 & \longrightarrow & \text{Aff}(\mathfrak{t}^*(\mathbb{F}_2)) & \longrightarrow & C^0(K_d; \mathbb{F}_2) & \xrightarrow{D^2} & H_{n-1}(K_d; \partial K_d; N) \\
 & & \downarrow & & \downarrow & & \downarrow \\
 0 & \longrightarrow & \text{Aff}(\mathfrak{t}^*(\mathbb{F}_2)) & \longrightarrow & C^0(K_d(\text{St}_\beta); \mathbb{F}_2) & \xrightarrow{D^2} & H_{n-1}(K_d(\text{St}_\beta); \partial K_d(\text{St}_\beta); N) \\
 & & \downarrow & & \downarrow & & \downarrow \\
 & & 0 & & 0 & & 0
 \end{array}$$

Hence, we have the following exact sequence:

$$0 \longrightarrow \begin{array}{c} C^0(K_d; K_d(\text{St}_\beta); \mathbb{F}_2) \\ \oplus \text{Aff}(\mathfrak{t}^*(\mathbb{F}_2)) \end{array} \longrightarrow C^0(K_d; \mathbb{F}_2) \xrightarrow{D_\beta^2} H_{n-1}(K_d(\text{St}_\beta); \partial K_d(\text{St}_\beta); N),$$

where  $D_\beta^2$  is the composition  $D^2 \circ |_{K_d(\text{St}_\beta)}$ . Since  $D_\beta^2 \chi_\beta$  equals  $\rho(\beta)$  there is exactly  $2^{n+1+f_0(K_d)-f_0(K_d(\text{St}_\beta))}$  solutions to the equation  $D_\beta^2 \varepsilon = \rho(\beta)$ . Therefore the probability that  $\xi_\beta$  equals 1 is  $2^{n+1-f_0(K_d(\text{St}_\beta))}$ . We have the following inequality:

$$b_0(\mathbb{R}X_\varepsilon(d)) \geq 1 + \sum_{\beta \in K \setminus \partial K} \xi_\beta(\varepsilon).$$

Which implies the following one:

$$\mathbb{E} \left[ \frac{b_0(\mathbb{R}X_\varepsilon(d))}{1 + h^{n-1,0}(X(d))} \right] \geq \frac{1 + \sum_{\beta \in K \setminus \partial K} 2^{n+1-f_0(K_d(\text{St}_\beta))}}{1 + h^{n-1,0}(X(d))}.$$

The number  $f_0(K_d(\text{St}_\beta))$  equals the degree<sup>11</sup> of the vertex  $\beta$  plus 1. Hence, the number  $\sum_{\beta \in K \setminus \partial K} 2^{n+1-f_0(K_d(\text{St}_\beta))}$  equals  $2^n \sum_{\beta \in K \setminus \partial K} 2^{-\deg \beta}$ . By convexity of the function  $x \mapsto 2^{-x}$ , we have:

$$2^n \sum_{\beta \in K \setminus \partial K} 2^{-\deg \beta} \geq 2^n h^{n-1,0}(X(d)) 2^{-\frac{\sum_{\beta \in K \setminus \partial K} \deg \beta}{h^{n-1,0}(X(d))}} \geq h^{n-1,0}(X(d)) 2^{n-2 \frac{f_1(K_d)}{h^{n-1,0}(X(d))}}.$$

The sequence  $\left( \frac{f_1(K_d)}{h^{n-1,0}(X(d))} \right)_{d \geq 1}$  converges toward a number  $c > 0$  as  $d$  grows to  $+\infty$ .

Thus, the lim. inf. is at least equal to  $2^{n-2c} > 0$ . Since  $\mathbb{E} \left[ \frac{b_0(\mathbb{R}X_\varepsilon(d))}{1+h^{n-1,0}(X(d))} \right]$  is at most

<sup>11</sup>The number of edges adjacent to the vertex.

equal to 1 by A. Renaudineau and K. Shaw's inequality, the proposition follows.  $\square$

**A Discrete Dirichlet Problem for T-Curves.** This last paragraph is really a remark. In the special case of curves one can use the symmetry of  $M_{0,0}(\varepsilon)$  to define a Laplacian type operator on the space of 0-cochains of  $K$ . Doing so we can link the number of connected components of  $\mathbb{R}X_\varepsilon$  to the dimension of the space of harmonic cochains.

**Definition 5.3.28.** Let  $K$  be a primitive triangulation of the 2-dimensional polytope  $P$  and  $\varepsilon$  be a sign distribution on  $K$ . We define the *Laplacian*  $\Delta_\varepsilon$  to be the following endomorphism of  $C^0(K; \partial K; \mathbb{F}_2)$ :

$$\begin{aligned} \Delta_\varepsilon : C^0(K; \partial K; \mathbb{F}_2) &\longrightarrow C^0(K; \partial K; \mathbb{F}_2) \\ f &\longmapsto \left[ \beta \mapsto \sum_\alpha (\beta; \alpha)_\varepsilon f(\alpha) \right]. \end{aligned}$$

This operator is symmetric with respect to the canonical scalar product of  $C^0(K; \partial K; \mathbb{F}_2)$  since the matrix  $M_{0,0}(\varepsilon)$  is symmetric. Also, using Proposition 5.2.8, the number of connected components of  $\mathbb{R}X_\varepsilon$  is equal to 1 plus the dimension of the space of harmonic cochains  $\ker(\Delta_\varepsilon)$  that vanish on the boundary.

## 5.4 Examples and Non-Examples

Let  $n$  and  $d$  be two positive integers. We recall that we denote the standard  $n$ -simplex of size  $d$  by the symbol  $P_d^n$ . In this context  $\mathfrak{t}^*(\mathbb{R})$  is  $\mathbb{R}^n$ ,  $\mathfrak{t}^*(\mathbb{Z})$  is  $\mathbb{Z}^n$ ,  $e_1, \dots, e_n$  is the canonical basis of  $\mathbb{R}^n$  and  $P_d^n$  is the convex hull of  $0, de_1, \dots, de_n$ .

**Regular Triangulations of F. Knudsen.** In the third chapter of [KKMSD73], F. Knudsen introduces a family of primitive convex triangulations of  $(P_d^n)_{n,d \geq 1}$  called *regular triangulations*. For all  $n, d \geq 1$ , the regular triangulation  $R_d^n$  of  $P_d^n$  is obtained by cutting  $P_d^n$  by the following hyperplanes:

$$H_k^{i,j} := \left\{ \sum_{l=i}^j x_l = k \right\},$$

for all  $1 \leq i \leq j \leq n$ , and all  $1 \leq k \leq d-1$ . The Lemma 2.12 p.126 of [KKMSD73] implies that  $R_d^n$  is never  $\rho$ -uniform when  $n$  is bigger than 2 and  $d$  is big enough.

**Viro Triangulations.** In Definition 4.3.3 we described a method of construction of triangulations of  $P_{d+1}^{n+1}$  from a triangulation of  $P_d^{n+1}$  and of  $P_{d+1}^n$ : If  $K$  is a triangulation of  $P_d^{n+1}$  and  $L$  is a triangulation of  $P_{d+1}^n$ ,  $K + L$  is the unique triangulation of  $P_{d+1}^{n+1}$  for which:

1. The restriction of  $K + L$  to  $P_{d+1}^{n+1} \cap \{x_{n+1} \geq 1\}$  is the translation of  $K$ ;

2. For all integers  $0 \leq i \leq n$ , the restriction of  $K + L$  to the big simplex  $[e_{n+1}, e_{n+1} + de_1, \dots, e_{n+1} + de_i] * [(d+1)e_i, \dots, (d+1)e_n]$ , is the join of the restriction of the translation of  $K$  to  $[e_{n+1}, e_{n+1} + de_1, \dots, e_{n+1} + de_i]$  with the restriction of  $L$  to  $[(d+1)e_i, \dots, (d+1)e_n]$ .

If both  $K$  and  $L$  are primitive then so is  $K + L$ . By Proposition 4.3.5 the same holds for the convexity. Then we recursively defined the Viro triangulations  $(V_d^n)_{n,d \geq 1}$  by the formulæ:

$$\begin{cases} V_1^n = P_1^n & \forall n \geq 1 \\ V_{d+1}^{n+1} = V_d^{n+1} + V_{d+1}^n & \forall n, d \geq 1. \end{cases}$$

This process can be generalised. Let  $L = (L_d)_{d \geq 1}$  be a sequence of primitive triangulations of  $(P_d^n)_{d \geq 1}$  we denote by  $(V_d(L))_{d \geq 1}$  the sequence of triangulations of  $(P_d^{n+1})_{d \geq 1}$  defined by the formulæ:

$$\begin{cases} V_1(L) = P_1^n \\ V_{d+1}(L) = V_d(L) + L_{d+1} \quad \forall d \geq 1. \end{cases}$$

**Proposition 5.4.1.** *Let  $L = (L_d)_{d \geq 1}$  be a sequence of primitive triangulations of  $(P_d^{2n})_{d \geq 1}$ . Let  $d$  be an even integer. If  $L_d$  has a  $2n$ -simplex that contains only interior vertices, then  $V_D(L)$  is not  $\rho$ -uniform for all  $D \geq d + 1$ .*

*Proof.* Let  $d$  be such an integer and  $\sigma^{2n}$  be a  $2n$ -simplex of  $L_d$  whose vertices are all interior. Using Proposition 5.1.13, we see that  $V_{d+1}(L)$  does not fail to be  $\rho$ -uniform at  $\sigma^{2n}$  if and only if the two apices of the two  $(2n+1)$ -simplices adjacent to  $\sigma^{2n}$  are congruent modulo 2. Ideed, since  $\sigma^{2n}$  has an odd number of vertices, and  $\sum_{\beta \in \sigma^{2n}} \rho_{\sigma^{2n}}(\beta)$  vanishes,  $\rho_{\sigma^{2n}}$  can only be constant to 0. Now the two apices of the two  $(2n+1)$ -simplices adjacent to  $\sigma^{2n}$  are  $2e_{2n+1}$  and  $(d+1)e_{2n}$ . Since  $d$  is even they are not congruent and  $V_{d+1}(L)$  fails to be  $\rho$ -uniform at  $\sigma^{2n}$ . Since all the triangulations  $(V_D(L))_{D \geq d+1}$  contain  $V_{d+1}(L)$ , they all fail to be  $\rho$ -uniform at  $\sigma^{2n}$ .  $\square$

**Itenberg-Viro Triangulations** In Definition 4.3.3 we always perform the first subdivision of the prism  $P_{d+1}^{n+1} \cap \{0 \leq x_{n+1} \leq 1\}$  in the same order. However, we can also reverse the order of the joins.

**Definition 5.4.2.** If  $K$  is a triangulation of  $P_{d+1}^{n+1}$  and  $L$  is a triangulation of  $P_{d+1}^n$  we define  $K + (-1)L$  as the unique triangulation of  $P_{d+1}^{n+1}$  for which:

1. The restriction of  $K + (-1)L$  to  $P_{d+1}^{n+1} \cap \{x_{n+1} \geq 1\}$  is the translation of  $K$ ;
2. For all integers  $0 \leq i \leq n$ , the restriction of  $K + (-1)L$  to the big simplex  $[e_{n+1} + de_i, \dots, e_{n+1} + de_n] * [0, (d+1)e_1, \dots, (d+1)e_i]$  is the join of the restriction of the translation of  $K$  to  $[e_{n+1} + de_i, \dots, e_{n+1} + de_n]$  with the restriction of  $L$  to  $[0, (d+1)e_1, \dots, (d+1)e_i]$ .

As a direct consequence of the definition if both  $K$  and  $L$  are primitive then so is  $K + (-1)L$ . The same holds for the convexity by a small adaptation of Proposition 4.3.5. For all  $n, d \geq 1$ , let  $\text{Tr}_d^n$  denote the set of primitive triangulations of  $P_d^n$ .

For all subset  $I$  of  $\{0, \dots, n\}$  of cardinality  $(k + 1)$ , there is a map  $\pi_I : \text{Tr}_d^n \rightarrow \text{Tr}_d^k$  that sends a triangulation  $K$  to its restriction on the convex hull of  $\{de_i : i \in I\}$ , where  $e_0 = 0$  and the order of the vertices is preserved. Another direct consequence of the definition is that if  $K \in \text{Tr}_d^{n+1}$ ,  $L \in \text{Tr}_{d+1}^n$ , and  $I \subset \{0, \dots, n\}$  then  $\pi_{I \cup \{n+1\}}(K + (-1)^\eta L)$  equals  $\pi_{I \cup \{n+1\}}(K) + (-1)^\eta \pi_I(L)$  for all  $\eta \in \mathbb{F}_2$ .

Following [Ite97], we define the *Itenberg-Viro triangulations*  $(IV_d^n)_{n,d \geq 1}$  by the formulæ:

$$\begin{cases} IV_d^1 \text{ is the only primitive triangulation of } P_d^1 \\ IV_1^n = P_1^n & \forall n \geq 1 \\ IV_{d+1}^{n+1} = IV_d^{n+1} + (-1)^d IV_{d+1}^n & \forall n, d \geq 1. \end{cases}$$

An example of such triangulation is illustrated in Figure 5.10. As in the case of Viro triangulations this process can be generalised from a sequence of primitive triangulations  $(L_d)_{d \geq 1}$  of  $(P_d^n)_{d \geq 1}$  to a sequence  $(IV_d(L))_{d \geq 1}$  of triangulations of  $(P_d^{n+1})_{d \geq 1}$  by the formulæ:

$$\begin{cases} IV_1(L) = P_1^{n+1} \\ IV_{d+1}(L) = V_d(L) + (-1)^d L_{d+1} \quad \forall d \geq 1. \end{cases}$$

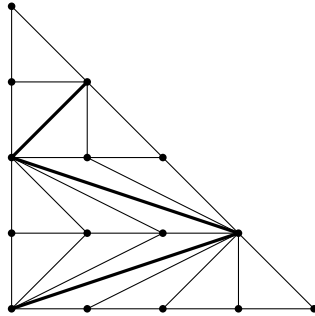

Figure 5.10: The triangulation  $IV_4^2$ .

**Proposition 5.4.3.** *The triangulations  $L_d$  are  $\rho$ -uniform for all  $d \geq 1$  if and only if the triangulations  $IV_d(L)$  are  $\rho$ -uniform for all  $d \geq 1$ .*

*Proof.* Let  $K$  be a triangulation of  $P_d^{n+1}$ . We denote, for all  $0 \leq q \leq n + 1$ , the set of  $q$ -simplices of  $K$  having at least one vertex in the interior  $K - \partial K$  by  $A_q(K)$ . If  $L$  is a triangulation of  $P_{d+1}^n$ , we denote, for all  $0 \leq q \leq n + 1$ , by  $A_q^\pm(K; L)$  the set of  $q$ -simplices of  $K + e_{n+1}$  that belong to  $A_q(K \pm L)$  but not to  $A_q(K) + e_{n+1}$ . Let us denote by  $\underline{K}$  the restriction of  $K$  to the bottom face  $[0; de_1; \dots; de_n]$  of  $P_d^{n+1}$ . We have:

$$A_n(K + L) = (A_n(K) + e_{n+1}) \amalg A_n^+(K; L) \amalg ([A_{n-1}(\underline{K}) + e_{n+1}] * (d + 1)e_n).$$

Indeed, the  $n$ -simplices of  $A_n(K + L)$  that are neither translates of simplices of  $A_n(K)$  nor in  $A_n^+(K; L)$  come from joins of simplices of  $\underline{K}$  with simplices of  $L$ . By construction the only such simplices not having all of their vertices in  $\partial(K + L)$  belong to the

subdivision of the join  $(e_{n+1} + [0; de_1; \dots; de_n]) * (d+1)e_n$ . Since  $(d+1)e_n$  belongs to  $\partial(K+L)$ , the remaining  $n$ -simplices are in the set  $([A_{n-1}(\underline{K}) + e_{n+1}] * (d+1)e_n)$ . Likewise we have:

$$A_n(K-L) = (A_n(K) + e_{n+1}) \amalg A_n^-(K; L) \amalg ([A_{n-1}(\underline{K}) + e_{n+1}] * 0).$$

Now let  $L'$  be a triangulation of  $P_{d+2}^n$ . We have:

$$A_n^-(K+L; L') = (A_n(L) + e_{n+1}) \amalg ([A_{n-1}(L) + e_{n+1}] * 2e_{n+1}),$$

and:

$$A_n^+(K-L; L') = (A_n(L) + e_{n+1}) \amalg ([A_{n-1}(L) + e_{n+1}] * (2e_{n+1} + de_n)).$$

Therefore, we have:

$$\begin{aligned} A_n(K+L-L') &= (A_n(K+L) + e_{n+1}) \amalg A_n^-(K+L; L') \amalg ([A_{n-1}(L) + e_{n+1}] * 0) \\ &= (A_n(K+L) + e_{n+1}) \amalg (A_n(L) + e_{n+1}) \\ &\quad \amalg ([A_{n-1}(L) + e_{n+1}] * 2e_{n+1}) \amalg ([A_{n-1}(L) + e_{n+1}] * 0), \end{aligned}$$

and:

$$\begin{aligned} A_n(K-L+L') &= (A_n(K-L) + e_{n+1}) \amalg A_n^+(K-L; L') \\ &\quad \amalg ([A_{n-1}(L) + e_{n+1}] * (d+2)e_n) \\ &= (A_n(K-L) + e_{n+1}) \amalg (A_n(L) + e_{n+1}) \\ &\quad \amalg ([A_{n-1}(L) + e_{n+1}] * (2e_{n+1} + de_n)) \\ &\quad \amalg ([A_{n-1}(L) + e_{n+1}] * (d+2)e_n), \end{aligned}$$

for  $\underline{K} \pm \underline{L}$  equals  $L$ . If we assume  $K+L$  to be  $\rho$ -uniform,  $K+L-L'$  is  $\rho$ -uniform as well if and only if the simplices of  $(A_n(L) + e_{n+1})$ ,  $([A_{n-1}(L) + e_{n+1}] * 2e_{n+1})$ , and  $([A_{n-1}(L) + e_{n+1}] * 0)$  satisfy the requirement of Definition 5.1.22. Let  $\sigma^n$  be a simplex of the first set. It bounds the two  $(n+1)$ -simplices  $\sigma^n * 2e_{n+1}$  and  $\sigma^n * 0$ . By Proposition 5.1.13 we have:

$$\sum_{\alpha \in \sigma^n} |\rho_{\sigma^n}(\alpha)| \alpha = 2e_{n+1} \pmod{2},$$

and therefore,  $\rho_{\sigma^n} = 0$ . Now let  $\sigma^{n-1}$  be a simplex of  $A_{n-1}(L) + e_{n+1}$ . It bounds two  $n$ -simplices of  $L + e_{n+1}$ :  $\sigma_+^n$  and  $\sigma_-^n$ , so  $\sigma^{n-1} * 2e_{n+1}$  bounds the two  $(n+1)$ -simplices of  $K+L-L'$ :  $\sigma_+^n * 2e_{n+1}$  and  $\sigma_-^n * 2e_{n+1}$ . Let  $\alpha_{\pm}$  denote the vertex of  $\sigma_{\pm}^n$  opposite to  $\sigma^{n-1}$ . From Proposition 5.1.13, we have:

$$\sum_{\beta \in \sigma^n} |\rho_{\sigma^{n-1} * 2e_{n+1}}(\beta)| \beta = \alpha_+ - \alpha_- \pmod{2}.$$

Since the difference  $\alpha_+ - \alpha_-$  belongs to the hyperplane  $\{x_{n+1} = 0\}$ , the number

$|\rho_{\sigma^{n-1}*2e_{n+1}}(2e_{n+1})|$  vanishes and the restriction of  $|\rho_{\sigma^{n-1}*2e_{n+1}}|$  to  $\sigma^{n-1}$  equals  $|\rho_{\sigma^{n-1}}^L|$  (the function  $|\rho|$  of the triangulation  $L$ ). The vertex  $2e_{n+1}$  belongs to the boundary  $\partial(K+L-L')$ . It implies that  $\rho_{\sigma^{n-1}*2e_{n+1}}$  is constant on the interior vertices  $I(\sigma^{n-1}*2e_{n+1})$  and meets the requirements of Definition 5.1.22 if and only if  $\rho_{\sigma^{n-1}}^L$  is constant on the interior<sup>12</sup> vertices  $I(\sigma^{n-1})$ . The exact same reasoning applies to the simplices of the third set  $[A_{n-1}(L) + e_{n+1}] * 0$  and we find that  $K+L-L'$  is  $\rho$ -uniform if and only if  $K$  and  $L$  are. We can also prove that  $K-L+L'$  is  $\rho$ -uniform if and only if  $K$  and  $L$  are by the same arguments. The only difference in this case is the two apices with which we suspend the horizontal  $n$ -simplices  $\sigma^n$  of  $L$ . They are  $2e_{n+1} + de_n$  and  $(d+2)e_n$ . Their difference is also 0 modulo 2 so  $\rho_{\sigma^n}$  vanishes as in the case  $K+L-L'$ . The proposition follows from the construction of the triangulations  $(IV_d(L))_{d \geq 1}$ .  $\square$

**Remark 5.4.4.** In the last proof we showed that if  $\sigma^n$  is a  $n$ -simplex of the triangulation  $IV_d(L)$  of  $\mathbb{P}_d^{n+1}$  written as a link  $\alpha * \sigma^{n-1}$  with  $\sigma^{n-1}$  in a floor  $L_k$  then the numerical value  $|\rho_{\alpha*\sigma^{n-1}}(\beta)|$  is zero for  $\beta = \alpha$  and equals  $\rho_{\sigma^{n-1}}^{L_k}(\beta)$  otherwise.

**Proposition 5.4.5.** *For all  $n, d \geq 1$ , for all  $\varepsilon \in C^0(IV_d^n; \mathbb{F}_2)$ , the number  $\ell(\mathbb{R}X_\varepsilon)$  is at least equal to  $\lfloor \frac{n-1}{2} \rfloor$ .*

*Proof.* This is Theorem 4.3.9 for Itenberg-Viro triangulations. The crucial point in the proof of Theorem 4.3.9 was Proposition 4.3.8, the fact that the restriction of the Viro triangulation to the face opposite to 0 is still a Viro triangulation. However, the same is true for the Itenberg-Viro triangulation, hence the proposition holds.  $\square$

**Theorem 5.4.6.** *For all  $n \geq 2$ , and all  $d \geq 1$ , the Itenberg-Viro triangulation  $IV_d^n$  is simply integrable. In particular, the Harnack distribution:*

$$h^n(x_1, \dots, x_n) := \sum_{i < j} x_i x_j,$$

*is a solution of (5.16).*

*Proof.* We will prove, by recursion on  $n$ , that  $h^n$  is a solution of (5.16) for all  $d \geq 1$ . Theorem 5.3.18 ensures that the property is true for  $n = 2$ . Let us now assume that the property is true for some  $n \geq 2$ . Let  $1 \leq d \leq D$  be two integers. The  $n$ -simplices of  $IV_D^{n+1} \setminus \mathcal{B}_0 IV_D^{n+1}$  that have non-empty intersection with the horizontal hyperplane  $\{x_{n+1} = D - d\}$  are  $n$ -simplices of  $IV_d^n$  and cones over  $(n-1)$ -simplices of  $IV_d^n \setminus \mathcal{B}_0 IV_d^n$ . If  $d$  is even the apices of the cones are  $(D - d - 1)e_{n+1}$  and  $(D - d + 1)e_{n+1}$ . And if  $d$  is odd, they are  $(D - d - 1)e_{n+1} + (d + 1)e_n$  and  $(D - d + 1)e_{n+1} + (d - 1)e_n$ . Either way we showed<sup>13</sup> that  $\rho_{\alpha*\sigma^{n-1}}$ , with  $\sigma^{n-1} \in IV_d^n$ , is zero on the apex  $\alpha$  of the cone and that the numerical value of  $|\rho_{\alpha*\sigma^{n-1}}|$  equals the numerical value  $|\rho_{\sigma^{n-1}}^{IV_d^n}|$  of  $IV_d^n$ . As a consequence,  $|D^2 h_{\alpha*\sigma^{n-1}}^{n+1}|$  equals  $|D^2(h^{n+1}|_{IV_d^n})_{\sigma^{n-1}}|$ . However,  $h^{n+1}|_{IV_d^n}$  only differs from  $h^n$  by an affine function. Hence, by recursion hypothesis  $|D^2(h^{n+1}|_{IV_d^n})_{\sigma^{n-1}}|$  equals  $|\rho_{\sigma^{n-1}}^{IV_d^n}|$ , thus  $|D^2 h_{\alpha*\sigma^{n-1}}^{n+1}|$

<sup>12</sup>interior inside  $L$  i.e. in  $L - \partial L$ .

<sup>13</sup>c.f. Remark 5.4.4.

equals  $|\rho_{\alpha*\sigma^{n-1}}|$ . Now, if  $\sigma^n$  belongs to  $IV_d^n$ , the two  $(n+1)$ -simplices of  $IV_D^{n+1}$  that are adjacent to  $\sigma^n$  have their apices congruent modulo 2. It implies that  $\rho_{\sigma^n}$  vanishes. These two  $(n+1)$ -simplices are identical modulo 2, and the value of  $h^{n+1}$  is the same on the two apices since they have congruent coordinates. Hence,  $D^2 h_{\sigma^n}^{n+1}$  vanishes as well. Therefore, we proved that  $h^{n+1}$  is a solution of (5.16).  $\square$

**Remark 5.4.7.** The hypersurface  $\mathbb{R}X_{h^n}$  of  $\mathbb{R}P_d^n$  has a maximal number of connected components but also intersects all the toric divisors of  $\mathbb{R}P_d^n$  along T-hypersurfaces that have a maximal number of connected components.

# Appendix A

## Duality in Spectral Sequences

Let  $\mathbb{F}$  be a field.

**Definition A.1.** An *increasingly filtered, graded, differential algebra* of finite dimension over the field  $\mathbb{F}$  is an associative  $\mathbb{F}$ -algebra  $A$  of finite dimension over  $\mathbb{F}$  together with:

1. A graduation  $A = \bigoplus_{q \leq 0} A^q$  compatible with the product in the following way: for all  $\alpha \in A^q$  and all  $\alpha' \in A^{q'}$ ,  $\alpha\alpha'$  equals  $(-1)^{qq'}\alpha'\alpha$  and belongs to  $A^{q+q'}$ ;
2. An increasing filtration  $F^0A \subset F^1A \subset \dots \subset A$  compatible with the product: for all  $p, p' \in \mathbb{N}$ ,  $F^pAF^{p'}A$  is included in  $F^{p+p'}A$ ;
3. A differential  $d : A \rightarrow A$  which is a morphism of graded vector spaces of degree 1, whose square vanishes, that is compatible with the filtration  $dF^pA \subset F^pA$ , for all  $p \in \mathbb{N}$ , and for which the Leibniz rule holds: for all  $\alpha \in A^q$  and  $\alpha' \in A^{q'}$ ,  $d(\alpha\alpha') = (d\alpha)\alpha' + (-1)^q\alpha d\alpha'$ .

Such an object is in particular a finite dimensional cochain complex. The compatibility of the filtration with the differential allows us to use the techniques of spectral sequences to compute the cohomology of  $A$ . We denote the spectral sequence associated with the filtration  $(F^pA)_{p \in \mathbb{N}}$  by  $(E_r^{p,q}(A))_{p,q,r \in \mathbb{N}}$ . We adopt the following index convention. For all integers  $p, q, r \geq 0$ :

$$E_r^{p,q}(A) := \frac{Z_r^{p,q}(A) + F^{p-1}A^q}{dZ_{r-1}^{p+r-1,q-1}(A) + F^{p-1}A^q},$$

with:

$$Z_r^{p,q}(A) := \{\alpha \in F^pA^q \mid d\alpha \in F^{p-r}A^{q+1}\},$$

and  $Z_{-1}^{p,q}(A) := 0$ . In this setting the differential  $d_r$  of the  $r$ -th page has bidegree  $(-r; +1)$  and is the factorisation of the restriction of  $d$ . By definition of the objects we consider here, we deal with first quadrant spectral sequences arising from bounded filtrations, hence, the spectral sequence  $(E_r^{p,q}(A))_{p,q,r \geq 0}$  converges<sup>1</sup> toward the cohomology of  $A$ . The compatibility of the filtration with the product ensures

---

<sup>1</sup>c.f. [McC00] Theorem 2.6 p.33.



that  $(E_r^{p,q}(A))_{p,q,r \in \mathbb{N}}$  is even a *spectral ring*. It means that there is a well defined product:

$$E_r^{p,q}(A) \otimes_{\mathbb{F}} E_r^{p',q'}(A) \rightarrow E_r^{p+p',q+q'}(A),$$

which satisfies, for all  $\alpha \in E_r^{p,q}(A)$  and  $\alpha' \in E_r^{p',q'}(A)$ , the graded commutativity:

$$\alpha\alpha' = (-1)^{qq'}\alpha'\alpha,$$

and Leibniz rule:

$$d_r^{p+p',q+q'}(\alpha\alpha') = d_r^{p,q}(\alpha)\alpha' + (-1)^q\alpha d_r^{p',q'}(\alpha').$$

These constructions are explained in §2.3. Spectral sequences of algebras pp.44-46 of [McC00]. Although we should emphasised that we did not adopt the same index convention as J. McCleary. We justify our choice by the degree of generality of the objects we discuss here. Since we do not have much context about the arising of the spectral sequence we do not find meaningful to perform the change of index  $[p \mapsto p + q]$  often used with double complexes for which it is particularly adapted.

**Definition A.2.** Let  $A$  be an increasingly filtered, graded, differential algebra of finite dimension over the field  $\mathbb{F}$ . We denote by  $A^*$  the dual chain complex. By the Universal Coefficient Theorem<sup>2</sup>, the homology of  $A^*$  is dual to the cohomology of  $A$ .

P. Deligne gave a definition of the dual filtration of a filtered object of an Abelian category. It is a filtration of the same object in the opposite category. It is defined in such a way that the graded objects of the dual filtration are dual to the graded objects of the initial filtration. This construction is designed to be used with contravariant functors.

**Definition A.3** (P. Deligne, [Del71] (1.1.6) p.7). Let  $\mathbf{C}$  be an Abelian category, we denote by  $\mathbf{C}^{\text{op}}$  the opposite category and by  $(-)^{\text{op}} : (\mathbf{C}^{\text{op}})^{\text{op}} \rightarrow \mathbf{C}$  the “identical contravariant functor”. Let  $V$  (resp.  $W$ ) be an object of  $\mathbf{C}$  endowed with an increasing (resp. decreasing) filtration  $(V^{(k)})_{k \in \mathbb{Z}}$  (resp.  $(W_{(k)})_{k \in \mathbb{Z}}$ ). The dual decreasing (resp. increasing) filtration of  $V^{\text{op}}$  (resp.  $W^{\text{op}}$ ), is defined, for all  $k \in \mathbb{Z}$ , by the formulæ:

$$(V^{\text{op}})_{(k)} := \text{im} \left( \left( V \twoheadrightarrow V / V^{(k-1)} \right)^{\text{op}} \right),$$

respectively:

$$(W^{\text{op}})^{(k)} := \text{im} \left( \left( W \twoheadrightarrow W / W_{(k+1)} \right)^{\text{op}} \right),$$

so that  $(V^{(k)} / V^{(k-1)})^{\text{op}}$  is naturally isomorphic<sup>3</sup> to  $(V^{\text{op}})_{(k)} / (V^{\text{op}})_{(k+1)}$ . If  $\mathbf{C}$  is the category of vector spaces for instance (or even of cochain complexes) over a field  $\mathbb{F}$ , applying the usual duality functor  $\text{Hom}_{\mathbb{F}}(-; \mathbb{F})$  to this abstract construction yields a filtration, in the usual sense, of opposite growth of the dual vector space (or chain complex).

---

<sup>2</sup>c.f. [CE56] Theorem 3.3a p.114.

<sup>3</sup>c.f. [Del71] (1.1.7) p.7.

Following this definition the dual chain complex  $A^*$  is naturally endowed with a dual decreasing filtration of chain complexes  $0 \subset \dots \subset F_1 A^* \subset F_0 A^* = A^*$ . We denote by  $(E_{p,q}^r(A^*))_{r,p,q \geq 0}$  the associated spectral sequence. It is defined for all integers  $p, q, r \geq 0$ , by:

$$E_{p,q}^r(A^*) := \frac{Z_{p,q}^r(A^*) + F_{p+1}A_q^*}{\partial Z_{p-r+1,q+1}^{r-1}(A^*) + F_{p+1}A_q^*},$$

with  $\partial = \text{Hom}_{\mathbb{F}}(d; \mathbb{F})$ , and:

$$Z_{p,q}^r(A^*) := \{a \in F_p A_q^* \mid \partial a \in F_{p+r} A_{q-1}^*\},$$

and the convention  $Z_{p,q}^{-1}(A^*) := 0$ . The induced boundary operators  $\partial^r$  have bidegree  $(+r; -1)$ .

**Proposition A.4.** *The spectral sequences  $(E_{p,q}^r(A^*))_{p,q,r \geq 0}$  and  $(E_r^{p,q}(A))_{p,q,r \geq 0}$  are dual of each other through a collection of duality pairings:*

$$\langle -; - \rangle : E_r^{p,q}(A) \otimes_{\mathbb{F}} E_{p,q}^r(A^*) \rightarrow \mathbb{F},$$

for all integers  $p, q, r \geq 0$ , and for which  $d_r^{p,q}$  is the adjoint of  $\partial_{p-r,q+1}^r$ .

*Proof.* Let  $q \in \mathbb{N}$ , and denote by  $\langle -; - \rangle : A^q \otimes A_q^* \rightarrow \mathbb{F}$  the usual duality pairing. By definition  $d$  and  $\partial$  are adjoints of each other i.e.  $\langle d\alpha; a \rangle = \langle \alpha; \partial a \rangle$  for all  $\alpha \in A^q$  and all  $a \in A_{q+1}^*$ . Since  $F_{p+1}A_q^*$  is the image in  $A_q^*$  of  $(A^q / F^p A^q)^*$ , it is precisely the vector space  $\{a \in A_q^* \mid \langle \alpha; a \rangle = 0, \forall \alpha \in F^p A^q\}$ . It follows that the restriction of  $\langle -; - \rangle$  to the sum of the sub-spaces:

$$\left( Z_r^{p,q}(A) + F^{p-1}A^q \right) \otimes_{\mathbb{F}} \left( \partial Z_{p-r+1,q+1}^{r-1}(A^*) + F_{p+1}A_q^* \right),$$

and:

$$\left( d Z_{r-1}^{p+r-1,q}(A) + F^{p-1}A^q \right) \otimes_{\mathbb{F}} \left( Z_{p,q}^r(A^*) + F_{p+1}A_q^* \right),$$

vanishes. Thus  $\langle -; - \rangle$  factors through the quotient map to give rise to a well define bilinear product:

$$\langle -; - \rangle : E_r^{p,q}(A) \otimes_{\mathbb{F}} E_{p,q}^r(A^*) \rightarrow \mathbb{F}.$$

The morphisms  $(d_r^{p,q})_{p,q,r \in \mathbb{N}}$  and  $(\partial_{p,q}^r)_{p,q,r \in \mathbb{N}}$  are factorisations of  $d$  and  $\partial$  respectively. Hence, they are adjoints of each others for the new pairings. By definition of the dual filtration, the pairings  $\langle -; - \rangle$  defined on  $E_0^{p,q}(A) \otimes_{\mathbb{F}} E_{p,q}^0(A^*)$  are non-degenerate for all  $p, q \in \mathbb{N}$ . Moreover, the fundamental property of spectral sequences, the one that enables us to compute a page as the cohomology (or homology) of the preceding, allows us to repetitively use the Universal Coefficients Theorem<sup>4</sup> and deduce that all the pairings are non-degenerate. We should emphasise that we only considered finite dimensional chain and cochain complexes of vector spaces.  $\square$

<sup>4</sup>c.f. [CE56] Theorem 3.3a p.114.

**Lemma A.5** (Chain Reaction). *Let  $(A; d)$  be an increasingly filtered, graded, differential algebra of finite dimension over the field  $\mathbb{F}$  and  $(E_r^{p,q}(A))_{p,q,r \geq 0}$  denote its associated spectral sequence. If there are integers  $r_0 \geq 1$ ,  $m, n \geq 0$  for which:*

1. *The vector space  $E_{r_0}^{p,q}(A)$  vanishes whenever  $p > m$  or  $q > n$ ;*
2. *The vector space  $E_{r_0}^{m,n}(A)$  has dimension 1;*
3. *The bilinear pairing  $E_{r_0}^{p,q}(A) \otimes_{\mathbb{F}} E_{r_0}^{m-p,n-q}(A) \rightarrow E_{r_0}^{m,n}(A)$  is non-degenerate,*

*then for all  $r \geq r_0$ :*

1. *The vector space  $E_r^{p,q}(A)$  vanishes whenever  $p > m$  or  $q > n$ ;*
2. *The vector space  $E_r^{m,n}(A)$  has dimension 1;*
3. *The bilinear pairing  $E_r^{p,q}(A) \otimes_{\mathbb{F}} E_r^{m-p,n-q}(A) \rightarrow E_r^{m,n}(A)$  is non-degenerate.*

*Proof.* By recursion we only need to prove the statement for  $r_0 + 1$ . The first assertion is a consequence of  $E_{r_0+1}^{p,q}(A)$  being a sub-quotient of  $E_{r_0}^{p,q}(A)$ . The second follows from the isomorphism between  $E_{r_0+1}^{m,n}(A)$  and the  $(m, n)$ -cohomology group of  $d_{r_0}$ . Indeed, around  $E_{r_0}^{n,m}$  the cochain complex is the following:

$$E_{r_0}^{m+r_0,n-1}(A) \xrightarrow{d_{r_0}^{m+r_0,n-1}} E_{r_0}^{m,n}(A) \xrightarrow{d_{r_0}^{m,n}} E_{r_0}^{m-r_0,n+1}(A).$$

By assumption, both the left hand group and the right hand group vanish. Hence,  $E_{r_0+1}^{m,n}(A)$  is isomorphic to  $E_{r_0}^{m,n}(A)$  and has dimension 1. For the last part we chose an isomorphism  $\int : E_{r_0}^{m,n}(A) \rightarrow \mathbb{F}$  and consider the musical isomorphism:

$$D_{r_0}^{p,q} : E_{r_0}^{p,q}(A) \rightarrow (E_{r_0}^{m-p,n-q}(A))^* \cong E_{m-p,n-q}^{r_0}(A^*),$$

defined by the formula  $\alpha(D_{r_0}^{p,q}(\beta)) = \int \alpha\beta$  for all  $\alpha \in E_{r_0}^{m-p,n-q}(A)$  and  $\beta \in E_{r_0}^{p,q}(A)$ . This is, up to sign, a (co)-chain complex isomorphism since:

$$\begin{aligned} \left\langle \alpha ; D_{r_0}^{p-r_0,q+1}(d_{r_0}^{p,q}\beta) \right\rangle &= \int \alpha d_{r_0}^{p,q}\beta \\ &= (-1)^q \int (d_{r_0}^{m-p+r_0,n-q-1}\alpha) \beta \\ &= (-1)^q \left\langle \alpha ; \partial_{m-p,n-q}^{r_0} D_{r_0}^{p,q}(\beta) \right\rangle. \end{aligned}$$

It induces, nonetheless, an isomorphism  $(D_{r_0}^{p,q})^*$  between  $E_{r_0+1}^{p,q}(A)$  and  $E_{m-p,n-q}^{r_0+1}(A^*)$ . We observe now that the isomorphism between  $E_{r_0+1}^{m,n}(A)$  and  $E_{r_0}^{m,n}(A)$  induces an isomorphism  $\int : E_{r_0+1}^{m,n}(A) \rightarrow \mathbb{F}$  such that for any two  $\alpha \in E_{r_0+1}^{m-p,n-q}(A)$  and  $\beta \in E_{r_0+1}^{p,q}(A)$ , respectively represented by the two cocycles  $\alpha' \in E_{r_0}^{m-p,n-q}(A)$  and  $\beta' \in E_{r_0}^{p,q}(A)$ , we have:

$$\int \alpha\beta = \int \alpha'\beta'.$$

Therefore, the bilinear pairing constructed from the product and the integration  $E_{r_0+1}^{m-p, n-q}(A) \otimes_{\mathbb{F}} E_{r_0+1}^{p, q}(A) \rightarrow \mathbb{F}$  has its musical morphism:

$$D_{r_0+1}^{p, q} : E_{r_0+1}^{p, q}(A) \longrightarrow E_{m-p, n-q}^{r_0+1}(A^*),$$

induced in cohomology by  $D_{r_0}^{p, q}$ . It is an isomorphism of chain complexes, so the third assertion follows.  $\square$

A direct consequence of this lemma is the symmetry of the pages of the spectral sequence following the  $E_{r_0}$ -page.

**Proposition A.6.** *Let  $(A; d)$  be a increasingly filtered, graded, differential algebra of finite dimension over the field  $\mathbb{F}$  and  $(E_r^{p, q}(A); d_r^{p, q})_{p, q, r \geq 0}$  denote its associated spectral sequence. If the spectral sequence of  $A$  satisfies the Poincaré duality at the  $r_0$ -th page then for all  $r \geq r_0$ , and all  $p, q \geq 0$ :*

$$D_r^{p, q} : E_r^{p, q}(A) \xrightarrow{\cong} E_{m-p, n-q}^r(A^*),$$

and:

$$d_r^{p, q} = (-1)^q (D_r^{p-r, q+1})^{-1} \circ (d_r^{m-p+r, n-q-1})^* \circ D_r^{p, q}.$$

In particular,  $E_r^{p, q}(A)$  and  $E_r^{m-p, n-q}(A)$  have the same dimension and  $d_r^{p, q}$  and  $d_r^{m-p+r, n-q-1}$  have same rank and kernel dimension.

**Lemma A.7.** *Let  $W_0 \subset V_0$  be two finite dimensional vector spaces over  $\mathbb{F}$ . Let  $V_1$  be a sub-space of  $V_0$ , and  $W_1$  denote  $V_1 \cap W_0$ . Then the image of  $V_1^\perp$  in  $W_0^*$  is  $W_1^\perp$ .*

*Proof.* The inclusion of the image of  $V_1^\perp$  in  $W_1^\perp$  is direct. Let us show that we can obtain every form of  $W_1^\perp$  as a the restriction to  $W_0$  of a form of  $V_1^\perp$ . We can write  $V_0$  as the direct sum  $W_1 \oplus U \oplus U'$  in such a way that  $W_1 \oplus U$  is  $V_1$  and  $W_1 \oplus U'$  is  $W$ . If  $\alpha \in W_1^\perp$  we extend it by 0 on  $U$  to obtain a form in  $V_1^\perp$  that restricts to the original one.  $\square$

# Bibliography

- [AN54] Yasuo Akizuki and Shigeo Nakano. Note on Kodaira-Spencer's Proof of Lefschetz Theorems. *Proceedings of the Japan Academy*, 30(4):266–272, 1 1954.
- [ARS21] Charles Arnal, Arthur Renaudineau, and Kris Shaw. Lefschetz Section Theorems for Tropical Hypersurfaces. *Annales Henri Lebesgue*, 4:1347–1387, 2021.
- [Ber10] Benoit Bertrand. Euler Characteristic of Primitive T-Hypersurfaces and Maximal Surfaces. *Journal of the Institute of Mathematics of Jussieu*, 9(1):1–27, 2010.
- [BFMvH06] Frederic Bihan, Matthias Franz, Clint Mccrory, and Joost van Hamel. Is every toric variety an M-variety ? *Manuscripta mathematica*, 120:217–232, 2006.
- [BH61] Armand Borel and Andre Haefliger. La classe d'homologie fondamentale d'un espace analytique. *Bulletin de la Société Mathématique de France*, 89:461–513, 1961.
- [Bjö84] Anders Björner. Posets, Regular CW Complexes and Bruhat Order. *European Journal of Combinatorics*, 5(1):7–16, 1984.
- [BL81] Louis J Billera and Carl W Lee. A Proof of the Sufficiency of McMullen's Conditions for f-Vectors of Simplicial Convex Polytopes. *Journal of Combinatorial Theory, Series A*, 31(3):237–255, 1981.
- [BLdMR22] Erwan Brugallé, Lucía López de Medrano, and Johannes Rau. Combinatorial Patchworking: Back from Tropical Geometry. <https://arxiv.org/abs/2209.14043>, 2022.
- [BM71] H. Bruggesser and P. Mani. Shellable decompositions of cells and spheres. *Mathematica Scandinavica*, 29(2):197–205, 1971.
- [Bot59] Raoul Bott. On a Theorem of Lefschetz. *Michigan Mathematical Journal*, 6(3):211–216, 1 1959.
- [CE56] Henri Cartan and Samuel Eilenberg. *Homological Algebra*. PMS-19. Princeton University Press, 1956.

- [CF67] G Cooke and R. Finney. *Homology of Cell Complexes*. Princeton University Press, 1967.
- [CLS11] David A. Cox, John B. Little, and Henry K. Schenck. *Toric Varieties*. Number 124 in Graduate Studies in Mathematics. American Mathematical Society, 2011.
- [Cur12] Justin Curry. Sheaves, Co-Sheaves, and Verdier Duality. <https://arxiv.org/abs/1303.3255v2>, 2012.
- [Del71] Pierre Deligne. Théorie de Hodge, II. *Publications Mathématiques de l'Institut des Hautes Études Scientifiques*, 40(1):5–57, 1971.
- [DK87] Vladimir I. Danilov and Askold Khovanskiĭ. Newton Polyhedra and an Algorithm for Computing Hodge–Deligne Numbers. *Mathematics of The Ussr-izvestiya*, 29:279–298, 1987.
- [DK99] Alexander Degtyarev and Viatcheslav Kharlamov. Topological Properties of Real Algebraic Varieties: Rokhlin’s Way. <https://hal.science/hal-00129721>, November 1999.
- [Ehr62] Eugène Ehrhart. Sur les polyèdres rationnels homothétiques à  $n$  dimensions. *Comptes rendus de l'académie des Sciences*, 254(1):616–618, january 1962.
- [For02] Robin Forman. Combinatorial Novikov–Morse Theory. *International Journal of Mathematics*, 13(4):333–368, 2002.
- [FPT00] Mikael Forsberg, Mikael Passare, and August Tsikh. Laurent Determinants and Arrangements of Hyperplane Amoebas. *Advances in Mathematics*, 151(1):45–70, 2000.
- [Ful93] William Fulton. *Introduction to Toric Varieties*. Annals of mathematics studies, no. 131.; William H. Roever lectures in geometry. Princeton University Press, 1993.
- [Ful08] William Fulton. Algebraic curves : An introduction to algebraic geometry. <https://www.math.lsa.umich.edu/wfulton/CurveBook.pdf>, 2008.
- [GKZ94] Israel M. Gelfand, Mikhail M. Kapranov, and Andrei V. Zelevinsky. *Discriminants, Resultants, and Multidimensional Determinants*. Modern Birkhäuser Classics. Birkhäuser Boston, MA, 1 edition, 1994.
- [God58] Roger Godement. *Topologie Algébrique et Théorie des Faisceaux*. Publications de l’Institut de mathématique de l’Université de Strasbourg. Hermann, Paris, 1958. OCLC: 1216318.
- [GS80] David E. Galewski and Ronald J. Stern. Classification of Simplicial Triangulations of Topological Manifolds. *Annals of Mathematics*, 111(1):1–34, 1980.

- [Haa97] Bertrand Haas. *Real Algebraic Curves and Combinatorial Constructions*. PhD thesis, Universität Basel, 1997.
- [Har76] Axel Harnack. Ueber die Vieltheiligkeit der ebenen algebraischen Curven. *Mathematische Annalen*, 10(2):189–198, 1876.
- [Hat00] Allen Hatcher. *Algebraic Topology*. Cambridge Univ. Press, Cambridge, 2000.
- [IKMZ19] Ilia Itenberg, Ludmil Katzarkov, Grigory Mikhalkin, and Ilia Zharkov. Tropical Homology. *Mathematische Annalen*, 374(1):963–1006, 2019.
- [Ite97] Ilia Itenberg. Topology of Real Algebraic T-surfaces. *Revista Matemática de la Universidad Complutense de Madrid*, 10(Supl.):131–152, 1997.
- [IV96] Ilia Itenberg and Oleg Viro. Patchworking Algebraic Curves Disproves the Ragsdale Conjecture. *The Mathematical Intelligencer*, 18(4):19–28, 1996.
- [JRS18] Philipp Jell, Johannes Rau, and Kristin Shaw. Lefschetz (1,1)-theorem in tropical geometry. *Épjournal de Géométrie Algébrique*, Volume 2, 2018.
- [Kal91] I. O. Kalinin. Cohomological Characteristics of Real Projective Hypersurfaces. *Algebra i Analiz*, 3(2):91–110, 1991.
- [Kal05] I. O. Kalinin. Cohomology of Real Algebraic Varieties. *Journal of Mathematical Sciences*, 131(1):5323–5344, 2005.
- [Kas84] Masaki Kashiwara. The Riemann–Hilbert Problem for Holonomic Systems. *Publications of the Research Institute for Mathematical Sciences*, 20(2):319–365, 1984.
- [Kha73] Viatcheslav M. Kharlamov. New Relations for the Euler Characteristic of Real Algebraic Manifolds. *Functional Analysis and Its Applications*, 7(2):147–150, 1973.
- [Kha75] Viatcheslav M. Kharlamov. Additional Congruences for the Euler Characteristic of Real Algebraic Manifolds of Even Dimensions. *Functional Analysis and Its Applications*, 9:134–141, 04 1975.
- [KKMSD73] G. Kempf, F. Knudsen, D. Mumford, and B. Saint-Donat. *Toroidal Embeddings 1*. Lecture Notes in Mathematics. Springer Berlin, Heidelberg, 1 edition, 1973.
- [Kle73] Felix Klein. Ueber Flächen dritter Ordnung. *Mathematische Annalen*, 6(4):551–581, 1873.

- [KS53] K. Kodaira and D. C. Spencer. On a Theorem of Lefschetz and the Lemma of Enriques-Severi-Zariski. *Proceedings of the National Academy of Sciences of the United States of America*, 39(12):1273–1278, 2023/08/24/ 1953.
- [Lan93] Serge Lang. *Algebra*. Graduate Texts in Mathematics. Springer New York, NY, 3 edition, 1993.
- [Lef50] Solomon Lefschetz. *L'Analysis situs et la géométrie algébrique*. Collection de monographies sur la théorie des fonctions. Gauthier-Villars, 1950.
- [LW69] Albert T. Lundell and Stephen Weingram. *The Topology of CW Complexes*. Van Nostrand Reinhold Company, 1 edition, 1969.
- [Mac71] I. G. MacDonald. Polynomials Associated with Finite Cell-Complexes. *Journal of the London Mathematical Society*, s2-4(1):181–192, 2023/09/16 1971.
- [Mat12] John Mather. Notes on Topological Stability. *Bulletin of the American Mathematical Society*, 49(4):475–506, 2012.
- [McC00] John McCleary. *A User's Guide to Spectral Sequences*. Cambridge Studies in Advanced Mathematics. Cambridge University Press, 2 edition, 2000.
- [McM71] P. McMullen. The Numbers of Faces of Simplicial Polytopes. *Israel Journal of Mathematics*, 9(4):559–570, 1971.
- [McM77] P. McMullen. Valuations and Euler-Type Relations on Certain Classes of Convex Polytopes. *Proceedings of the London Mathematical Society*, s3-35(1):113–135, 2023/10/05 1977.
- [Mik04] Grigory Mikhalkin. Decomposition into pairs-of-pants for complex algebraic hypersurfaces. *Topology*, 43(5):1035–1065, 2004.
- [MR01] Grigory Mikhalkin and Hans Rullgård. Amoebas of Maximal Area. *International Mathematics Research Notices*, 2001(9):441–451, 9/16/2023 2001.
- [MR18] Grigory Mikhalkin and Johannes Rau. Tropical Geometry. <https://math.uniandes.edu.co/j.rau/downloads/main.pdf>, 2018.
- [Mun84] James R. Munkres. *Elements of Algebraic Topology*. Addison Wesley Publishing Company, 1984.
- [Nik80] V. V. Nikulin. Integral Symmetric Bilinear Forms and some of their Applications. *Mathematics of the USSR-Izvestiya*, 14(1):103, 1980.



- [PR04] Mikael Passare and Hans Rullgård. Amoebas, Monge-Ampère measures, and triangulations of the Newton polytope. *Duke Mathematical Journal*, 121(3):481–507, 2 2004.
- [Qui68] Daniel G Quillen. On the Associated Graded Ring of a Group Ring. *Journal of Algebra*, 10(4):411–418, 1968.
- [Ris93] Jean-Jacques Risler. Construction d’hypersurfaces réelles [d’après Viro]. In *Séminaire Bourbaki : volume 1992/93, exposés 760-774*, number 216 in Astérisque. Société mathématique de France, 1993. talk:763.
- [RS23] Arthur Renaudineau and Kris Shaw. Bounding the Betti Numbers of Real Hypersurfaces Near the Tropical Limit. *Annales Scientifiques de l’École Normale Supérieure*, 56(3):945–980, 2023.
- [Rul01] Hans Rullgård. Polynomial Amoebas and Convexity. <http://www.matematik.su.se/reports/2001/8>, 2001.
- [She85] Allan D. Shepard. *A Cellular Description of the Derived Category of a Stratified Space*. PhD thesis, Brown University, 05 1985.
- [Som27] D. M. Y. Sommerville. The Relations Connecting the Angle-Sums and Volume of a Polytope in Space of n Dimensions. *Proceedings of the Royal Society of London. Series A, Containing Papers of a Mathematical and Physical Character*, 115(770):103–119, 2023/08/25/ 1927.
- [Sta80] Richard P Stanley. The Number of Faces of a Simplicial Convex Polytope. *Advances in Mathematics*, 35(3):236–238, 1980.
- [Tho69] René Thom. Ensembles et morphismes stratifiés. *Bulletin of the American Mathematical Society*, 75:240–284, 1969.
- [Vir] Oleg Viro. Mutual Position of Hypersurfaces in Projective Space. <http://129.49.88.13/oleg/math/papers/1998-hsproj.pdf>.
- [Vir06] Oleg Viro. Patchworking Real Algebraic Varieties. <https://arxiv.org/abs/math/0611382>, 2006.
- [Voi02] Claire Voisin. *Hodge Theory and Complex Algebraic Geometry I*, volume 1 of *Cambridge Studies in Advanced Mathematics*. Cambridge University Press, Cambridge, 2002.
- [Wel07] Raymond O. Wells. *Differential Analysis on Complex Manifolds*. Graduate Texts in Mathematics. Springer New York, NY, 3 edition, 2007.
- [Whi39] J. H. C. Whitehead. Simplicial Spaces, Nuclei and m-Groups. *Proceedings of the London Mathematical Society*, s2-45(1):243–327, 01 1939.
- [Whi49] J. H. C. Whitehead. Combinatorial homotopy. I. *Bulletin of the American Mathematical Society*, 55(3.P1):213 – 245, 1949.

- [Wil78] George Wilson. Hilbert's sixteenth problem. *Topology*, 17(1):53–73, 1978.
- [Zee62a] E. C. Zeeman. Dihomology I. Relations Between Homology Theories. *Proceedings of the London Mathematical Society*, s3-12(1):609–638, 01 1962.
- [Zee62b] E. C. Zeeman. Dihomology II. The Spectral Theories of a Map. *Proceedings of the London Mathematical Society*, s3-12(1):639–689, 01 1962.
- [Zee63] E. C. Zeeman. Dihomology III. A Generalization of the Poincaré Duality for Manifolds. *Proceedings of the London Mathematical Society*, s3-13(1):155–183, 01 1963.
- [Zie95] Günter M. Ziegler. *Lectures on Polytopes*. Graduate Texts in Mathematics. Springer New York, NY, 1 edition, 1995.

# Index

- Amoeba, 25
- Blow-up, 127
- Boundary Morphism, 54
- Boundary Operator, 58, 59
- Cap Product, 67
- Chain
  - Cellular, 57
  - Dihomologic, 58
- Characteristic Map, 38
- Coboundary Operator, 58
- Cochain
  - Cellular, 58
  - with Compact Support, 58
  - Dihomologic, 59
- Complex
  - CW, 38
  - Dimension, 38
  - Face, 40
  - Locally Finite, 39
  - Regular, 40
  - Sub-complex, 38
  - of Polytopes, 39
  - Polyhedral, 29
    - Convex, 31
  - Simplicial, 39
- Cosheaf
  - Cellular, 50
  - Characteristic, 51
  - Dihomologic, 52
  - Localisation, 52
  - Subdivision, 52
- Cotangent Cosheaf, 142
- Cup Product
  - Dihomologic, 64
  - Singular, 62
- Degeneracy Index, 125
- $\Delta$ -complex, 41
- Differential, 58, 59
- Edge, 39
- Extension Morphism, 50
- $f$ -Vector, 19
- Fan, 12
  - Complete, 12
- Geometric Realisation, 39
- $h$ -Vector, 21
- Homology Manifold, 45
  - Boundary, 45
- Intersection Product, 86
- Irrelevant, 122
- Join
  - Simplicial, 41
- Leibniz Rule, 62
- Link, 41
- Local System of Coefficients, 51
- Maximal
  - M-Variety, 9
  - Curve, 7
  - Variety, 9
- Moment Map, 16
- Moment Polytope, 17
- Morphism of Cellular Cosheaves, 51
- Morphism of Cellular Sheaves, 51
- Normal Cosheaf, 142

- Open Cell, 38
  - Adjacent, 40, 45
  - Dihomologic, 43
  - Orientation, 54, 55
- Patchwork, 32, 106
  - Combinatorial, 34
- Polyhedral Cone
  - Dual Cone, 10
  - Face, 10
  - Non-singular, 11
  - Rational, 10
  - Simplicial, 11
  - Strongly Convex, 10
- Polyhedral Subdivision, 75
  - Convex, 76
  - Integral, 76
  - Primitive, 76
  - Smooth, 76
  - Triangulation, 76
- Polyhedron, 28
- Polytope, 13, 75
  - Dimension, 13, 75
  - Dual Fan, 13
  - Face, 13
  - Full Dimensional, 75
  - Integral, 13, 75
  - Newton, 25, 27
  - Non-singular, 13, 75
  - Polar, 19
  - Relative Interior, 19
  - Simple, 13, 75
  - Simplicial, 20
  - Smooth, 75
  - Tangent Space, 75
  - Very Ample, 18
- Projective Space, 2
  - Sub-space, 3
- Quadrant, 34
- Radical, 153
- Rank, 125
- Rational Sub-Space, 75
- Real Chart, 16
- Relevant, 122
- Restriction Morphism, 50
- Sedentarity, 16
- Sheaf
  - Cellular, 50
  - Dihomologic, 52
  - Subdivision, 52
- Shellable, 140
- Shelling, 20, 140
  - Order, 140
  - Order of a Simplex, 20
- Sign Distribution, 34, 106
- Simple Harnack Curve, 183
- Simplex, 14, 39
  - Integral, 15
  - Non-singular, 15
  - Primitive, 15
- Simplicial Ordering, 63
- Skeleton, 38
- Spectral Ring, 196
- Star
  - Closed, 40
  - Open, 40
- Subdivision, 41
  - Barycentric, 41, 42
  - Dihomologic, 43
- Support, 38
- T-Hypersurface, 36, 106
  - Degree, 106
- Toric Divisors, 14
- Toric Variety
  - of a Fan, 13
  - Normal Affine, 9
  - of a Polytope, 13
  - Positive Locus, 11, 13
  - Tropical Locus, 28
- Triangulation, 39
  - Convex, 32
  - Primitive, 32
  - $\rho$ -Uniform, 149
  - Simply Integrable, 180
  - Viro, 135
- Tropical Cohomology, 82

Saturated, 82	Combinatorially Ample, 28
Tropical Cosheaf	Tropical Semi-Field, 23
Saturated, 79	Tropical Sheaf
Tropical Cosheaves	Saturated, 79
$F_p^P$ , 77	Tropical Sheaves
$F_p^X$ , 77	$F_P^p$ , 77
Sed, 76	$F_X^p$ , 78
Tropical Homology, 82	Twist, 165
Saturated, 82	Veronese Morphism/Embedding, 17
Tropical Hypersurface, 28	Vertex, 39

# Notations

## CW-Complexes and Simplicial Complexes.

$ K $	the support of a CW-complex or geometric realisation of a simplicial complex, c.f. Definition 2.1.1 and Definition 2.1.3;
$K^{(k)}$	the $k$ -skeleton of $K$ , c.f. Definition 2.1.1 and Definition 2.1.3;
$K(A)$	the smallest sub-complex of $K$ that contains the set $A$ , c.f. Definition 2.1.1;
$K - A$	the biggest sub-complex of $K$ whose support is disjoint from $A$ , c.f. Definition 2.1.11;
$\text{St}(e; K)$	the open star of $e$ in $K$ , c.f. Lemma 2.1.10;
$\text{lk}(\sigma; K)$	the link of $\sigma$ in $K$ , c.f. Definition 2.1.12;
$\sigma * \sigma'$	the join of $\sigma$ and $\sigma'$ , c.f. Definition 2.1.12;
$\text{Sd } K$	the barycentric subdivision of $K$ , c.f. Definition 2.1.15.

## Cellular Homology.

$\mathbb{Z}(e)$	the group $H_k( K ;  K  \setminus e; \mathbb{Z})$ or equivalently $H_k(\bar{e}; \bar{e} \setminus e; \mathbb{Z})$ , where $k$ is the dimension of the cell $e$ , c.f. Definition 2.3.1;
$[L; M]$	the characteristic cosheaf of the complex $L$ with coefficient in the module $M$ , c.f. Definition 2.2.5;
$[K; L; M]$	the quotient of $[K; M]$ by $[L; M]$ , c.f. Definition 2.2.5;
$F_e$	the localisation of $F$ at $e$ , c.f. Definition 2.2.6;

$C_k(K; F)$	the group of cellular chains with coefficients in $F$ , c.f. Definition 2.3.3;
$C^k(K; F)$	the group of cellular cochains with coefficients in $F$ , c.f. Definition 2.3.3;
$C_c^k(K; F)$	the group of cellular cochains with compact support and coefficients in $F$ , c.f. Definition 2.3.3;
$\Omega_k(K; F)$	the group of dihomologic chains with coefficients in $F$ , c.f. Definition 2.3.4;
$\Omega^k(K; F)$	the group of dihomologic cochains with coefficients in $F$ , c.f. Definition 2.3.4;
$-\cup-$	cup product, c.f. Definition 2.4.4, Definition 2.4.6, and Definition 2.4.8;
$-\cap-$	cap product, c.f. Definition 2.4.10 and Definition 2.4.13;
$-\cdot-$	intersection product, c.f. Definition 3.1.22.

### Polytopes and their Subdivisions.

$\mathfrak{t}^*(\mathbb{Z})$	a free Abelian group of rank $n$ ;
$\mathfrak{t}^*(R)$	the tensor product of $\mathfrak{t}^*(\mathbb{Z})$ with the ring $R$ ;
$\mathfrak{t}(R)$	the free $R$ -module $\text{Hom}_{\mathbb{Z}}(\mathfrak{t}^*(\mathbb{Z}); R)$ ;
$P$	the ambient integral polytope, c.f. Definition 1.2.10 and Definition 3.1.2;
$K$	the integral polyhedral subdivision of $P$ , c.f. Definition 3.1.3;
$Y_P$	the toric variety of the polytope $P$ , c.f. Definition 1.2.11;
$X$	the dual hypersurface of the complex $K$ , c.f. Definition 3.1.4;
$f_i(K)$	the number of $i$ -cells of $K$ ;

$\mathbf{f}_K$	the polynomial $\sum_{i=-1}^n f_i(K)X^{n-i}$ , c.f. Definition 5.1.1;
$h_i(K)$	the number of simplices of order $i$ of a shelling of $K$ when it is a shellable triangulation, c.f. Definition 5.1.2;
$\mathbf{h}_K$	the polynomial $\sum_{i=0}^{n+1} h_i(K)X^{n+1-i}$ , c.f. Definition 5.1.2;
$\delta(P)$	the least common multiple of the exponents of the groups $\Delta(Q)$ for all $Q \leq P$ . c.f. Definition 3.2.5;
$\theta(K)$	the least common multiple of the indices of the groups $F_p^X(\sigma^q; \sigma^r)$ in $\hat{F}_p^X(\sigma^q; \sigma^r)$ for all $p \geq 0$ , and $\sigma^p \leq \sigma^r \in K$ , c.f. Definition 3.1.12;
$\kappa(K)$	the maximal number of disjoint 1-codimensional simplices of $K$ at which it fails to be $\rho$ -uniform, c.f. Definition 5.3.23;
$\iota[\omega_{\mathbb{R}X}]$	the biggest integer $q_0$ such that the cup product $[\omega_{\mathbb{R}X}] \cup - : H^q(\mathbb{R}P; \mathbb{F}_2) \rightarrow H^{q+1}(\mathbb{R}P; \mathbb{F}_2)$ is injective for all $q \leq q_0$ , c.f. Definition 4.2.36;
$\text{rad}(X)$	the dimension of $\text{Rad}(X)$ , c.f. Definition 5.2.5;
$\text{Sed}$	the sedentarity cosheaf, c.f. Definition 3.1.5;
$\text{Sed}_{(1)}$	the smoothed sedentarity cosheaf, c.f. Definition 3.2.5;
$\Delta$	the quotient of $\text{Sed}$ by $\text{Sed}_{(1)}$ , c.f. Definition 3.2.5;
$F_p^P$	the $p$ -th tropical cosheaf of $P$ , c.f. Definition 3.1.5;
$F_P^p$	the $p$ -th tropical sheaf of $P$ , c.f. Definition 3.1.5;
$F_p^X$	the $p$ -th tropical cosheaf of $X$ , c.f. Definition 3.1.5;
$F_X^p$	the $p$ -th tropical sheaf of $X$ , c.f. Definition 3.1.5;
$\hat{F}_p^X$	the $p$ -th saturated tropical cosheaf of $X$ , c.f. Definition 3.1.7;



$\hat{F}_X^p$	the $p$ -th saturated tropical sheaf of $X$ , c.f. Definition 3.1.7;
$N$	the normal cosheaf, c.f. Definition 5.1.7;
$T^*$	the cotangent cosheaf, c.f. Definition 5.1.7;
$H_{p,q}(P; R)$	the $(p, q)$ -th tropical homology group of $P$ , c.f. Definition 3.1.13;
$H^{p,q}(P; R)$	the $(p, q)$ -th tropical cohomology group of $P$ , c.f. Definition 3.1.13;
$H_{p,q}(X; R)$	the $(p, q)$ -th tropical homology group of $X$ , c.f. Definition 3.1.13;
$H^{p,q}(X; R)$	the $(p, q)$ -th tropical cohomology group of $X$ , c.f. Definition 3.1.13;
$\hat{H}_{p,q}(X; R)$	the $(p, q)$ -th saturated tropical homology group of $X$ , c.f. Definition 3.1.13;
$\hat{H}^{p,q}(X; R)$	the $(p, q)$ -th saturated tropical cohomology group of $X$ , c.f. Definition 3.1.13;
$\text{Rad}(X)$	the radical of the intersection form of an even dimensional dual hypersurface $X$ restricted to $\ker(i_{k,k})$ , c.f. Definition 5.2.5;
$i_p$	the inclusion $F_p^X \rightarrow F_p^P$ , c.f. Definition 3.1.5;
$i^p$	the adjoint morphism of $i_p$ , c.f. Definition 3.1.7;
$\hat{i}_p$	the inclusion $\hat{F}_p^X \rightarrow F_p^P$ , c.f. Definition 3.1.7;
$\hat{i}^p$	the adjoint morphism of $\hat{i}_p$ , c.f. Definition 3.1.7;
$i_{p,q}$	the morphism $H_{p,q}(X; R) \rightarrow H_{p,q}(P; R)$ induced by $i_p$ , c.f. Definition 3.1.13;
$i^{p,q}$	the morphism $H^{p,q}(P; R) \rightarrow H^{p,q}(X; R)$ induced by $i^p$ , c.f. Definition 3.1.13;

$\hat{i}_{p,q}$	the morphism $\hat{H}_{p,q}(X; R) \rightarrow H_{p,q}(P; R)$ induced by $\hat{i}_p$ , c.f. Definition 3.1.13;
$\hat{i}^{p,q}$	the morphism $H^{p,q}(P; R) \rightarrow \hat{H}^{p,q}(X; R)$ induced by $\hat{i}^p$ , c.f. Definition 3.1.13;
$\omega(\sigma^p)$	the generator of $\bigwedge^p T\sigma^p$ , c.f. Definition 5.1.8;
$\omega_X$	the dual cochain of $X$ in $P$ , c.f. Definition 3.1.20;
$[X]$	the fundamental class of $X$ , c.f. Definition 3.1.19;
$[P]$	the fundamental class of $P$ , c.f. Definition 3.1.18;
$e_{\sigma^n}(\alpha)$	the local dual basis of $\mathfrak{t}(\mathbb{F}_2)$ , c.f. Proposition 5.1.11;
$\rho_{\sigma^{n-1}}(\alpha)$	the difference of the $e_{\sigma^n}(\alpha)$ 's for all $\sigma^n \geq \sigma^{n-1}$ , c.f. Proposition 5.1.13;
$\rho$	the class $\rho$ of a $\rho$ -uniform primitive triangulation, c.f. Definition 5.1.22;
$w(\sigma^p)$	a totally decomposed $p$ -vector satisfying $\omega(\sigma^p)(w(\sigma^p)) = 1$ ;
$u(\sigma^p)$	the generator of the line $\bigwedge^p U(N(\sigma^p))$ , c.f. Definition 5.2.11.

### T-Hypersurfaces.

$\mathbb{R}P$	the CW-complex structure of $Y_P(\mathbb{R})$ associated with the moment polytope $P$ , c.f. Definition 4.1.1;
$\mathbb{R}K$	the subdivision of $\mathbb{R}P$ induced by the triangulation $K$ of $P$ , c.f. Definition 4.1.1;
$\mathbb{R}X_\varepsilon$	the T-Hypersurface constructed from the sign distribution $\varepsilon$ , c.f. Definition 4.1.3
$\text{Arg}_\varepsilon(\sigma^p; \sigma^q)$	the set of arguments of lifts of the cube $\sigma^p \leq \sigma^q$ that belong to $\mathbb{R}X_\varepsilon$ ;
$K_\varepsilon(a)$	the sub-complex associated to the affine function $a$ , c.f. Definition 5.2.20

$K'_\varepsilon(a)$	c.f. Definition 5.2.20
$\mathbb{F}_2[V]$	the group algebra of $V$ , c.f. Definition 4.2.1;
$\mathcal{O}(V)$	the algebra of functions $V \rightarrow \mathbb{F}_2$ , c.f. Definition 4.2.6;
$\mathfrak{m}_V$	the augmentation ideal of $\mathbb{F}_2[V]$ , c.f. Definition 4.2.1;
$f \cdot P$	the contraction of $f \in \mathcal{O}(V)$ and $P \in \mathbb{F}_2[V]$ , c.f. Definition 4.2.14
$\mathcal{K}^{\mathbb{R}P}$	the sign cosheaf of $\mathbb{R}P$ , c.f. Definition 4.2.18;
$\mathcal{K}^{\mathbb{R}P}_{(p)}$	the $p$ -th filtered piece of the augmentation filtration of $\mathcal{K}^{\mathbb{R}P}$ , c.f. Definition 4.2.18;
$\mathcal{K}^{\mathbb{R}X_\varepsilon}$	the sign cosheaf of $\mathbb{R}X_\varepsilon$ , c.f. Definition 4.2.19;
$\mathcal{K}^{\mathbb{R}X_\varepsilon}_{(p)}$	the $p$ -th filtered piece of the augmentation filtration of $\mathcal{K}^{\mathbb{R}X_\varepsilon}$ , c.f. Definition 4.2.19;
$\mathcal{O}_{\mathbb{R}P}$	the dual sign sheaf of $\mathbb{R}P$ , c.f. Definition 4.2.18;
$\mathcal{O}_{\mathbb{R}P}^{(p)}$	the $p$ -th filtered piece of the dual augmentation filtra- tion of $\mathcal{O}_{\mathbb{R}P}$ , c.f. Definition 4.2.18;
$\mathcal{O}_{\mathbb{R}X_\varepsilon}$	the dual sign sheaf of $\mathbb{R}X_\varepsilon$ , c.f. Definition 4.2.19;
$\mathcal{O}_{\mathbb{R}X_\varepsilon}^{(p)}$	the $p$ -th filtered piece of the dual augmentation filtra- tion of $\mathcal{O}_{\mathbb{R}X_\varepsilon}$ , c.f. Definition 4.2.19;
$E_{p,q}^r(\mathbb{R}P)$	the $(p, q)$ -th group of the $r$ -th page of the Renaudineau-Shaw spectral sequence of $\mathbb{R}P$ , c.f. Definition 4.2.18;
$E_r^{p,q}(\mathbb{R}P)$	the $(p, q)$ -th group of the $r$ -th page of the dual Renaudineau-Shaw spectral sequence of $\mathbb{R}P$ , c.f. Definition 4.2.18;
$E_{p,q}^r(\mathbb{R}X_\varepsilon)$	the $(p, q)$ -th group of the $r$ -th page of the Renaudineau-Shaw spectral sequence of $\mathbb{R}X_\varepsilon$ , c.f. Definition 4.2.19;
$E_r^{p,q}(\mathbb{R}X_\varepsilon)$	the $(p, q)$ -th group of the $r$ -th page of the dual Renaudineau-Shaw spectral sequence of $\mathbb{R}X_\varepsilon$ , c.f. Definition 4.2.19;

$i_*$	the inclusion $\mathcal{K}^{\mathbb{R}X_\varepsilon} \rightarrow \mathcal{K}^{\mathbb{R}P}$ , c.f. Definition 4.2.19;
$i^*$	the projection $\mathcal{O}_{\mathbb{R}P} \rightarrow \mathcal{O}_{\mathbb{R}X_\varepsilon}$ , c.f. Definition 4.2.19;
$\text{bv}_p^P$	the Borel-Viro morphism $\mathcal{K}_{(p)}^{\mathbb{R}P} \rightarrow F_p^P$ , c.f. Definition 4.2.18;
$\text{bv}_P^p$	the Borel-Viro morphism $\mathcal{O}_{\mathbb{R}P}^{(p)} \rightarrow F_P^p$ , c.f. Definition 4.2.18;
$\text{bv}_p^X$	the Borel-Viro morphism $\mathcal{K}_{(p)}^{\mathbb{R}X_\varepsilon} \rightarrow F_p^X$ , c.f. Definition 4.2.22;
$\text{bv}_X^p$	the Borel-Viro morphism $\mathcal{O}_{\mathbb{R}X_\varepsilon}^{(p)} \rightarrow F_X^p$ , c.f. Definition 4.2.24;
$i_{p,q}^r$	the morphism $E_{p,q}^r(\mathbb{R}X_\varepsilon) \rightarrow E_{p,q}^r(\mathbb{R}P)$ induced by $i_*$ , c.f. Definition 4.2.19;
$i_r^{p,q}$	the morphism $E_r^{p,q}(\mathbb{R}P) \rightarrow E_r^{p,q}(\mathbb{R}X_\varepsilon)$ induced by $i^*$ , c.f. Definition 4.2.19;
arg	the argument map, c.f. Definition 4.1.1;
$ \cdot $	the module map $\mathbb{R}P \rightarrow P$ , c.f. Definition 4.1.1;
$\mathbf{O}_{\sigma^n}$	the origin, c.f. Lemma 5.2.1;
$(\sigma^p; \sigma^q)_\varepsilon$	the intersection product $g^p(\chi_{\sigma^p}) \partial_{p-1,q}^1 g^q(\chi_{\sigma^q})$ , c.f. Definition 5.2.4;
$M_{p,q}(\varepsilon)$	the matrix the $(\sigma^p; \sigma^q)_\varepsilon$ 's, c.f. Definition 5.2.4;
$D\varepsilon_{\sigma^n}$	the first derivative of $\varepsilon$ , c.f. Definition 5.1.15;
$D^2\varepsilon_{\sigma^{n-1}}$	the second derivative of $\varepsilon$ , c.f. Definition 5.1.17
$\omega_{\mathbb{R}X}$	the dual cochain of $\mathbb{R}X_\varepsilon$ in $\mathbb{R}P$ , c.f. Definition 4.1.2.

### Miscellaneous.

$\chi_A$	the indicatrix function (or cochain) of the set $A$ ;
$\iota$	the injectivity index, c.f. Definition 4.2.36

$u_k(V)$	the $k$ -th vector of the basis of the supplementary subspace of $V$ , c.f. Definition 5.2.9;
$U(V)$	the supplementary subspace of $V$ , c.f. Definition 5.2.9;
$[W]$	the generator of the line $\bigwedge^{\dim W} W$ ;
$\alpha \cdot v$	the contraction of $\alpha$ and $v$ , c.f. Definition 3.1.6.

# List of Figures

1.1	Les droites projectives de trois corps. . . . .	3
1.2	Les sept droites de $\mathbb{P}^2(\mathbb{F}_2)$ , la droite à l'infini est en gras. . . . .	4
1.3	Quelques courbes algébriques de $\mathbb{P}^2(\mathbb{R})$ . . . . .	6
1.4	Allure des arrangements de courbes réalisables jusqu'au degré 5. . . . .	8
1.5	Le plan affine comme variété torique affine. . . . .	10
1.6	Une surface de l'espace affine réalisée comme variété torique affine. . . . .	11
1.7	Un polytope et son éventail dual. . . . .	13
1.8	Le lieu réel de la variété torique associée au carré de la Figure 1.7 et ses diviseurs toriques. . . . .	14
1.9	Le lieu réel du plan projectif et sa décomposition cellulaire induite par l'action du tore unitaire. . . . .	16
1.10	Le lieu réel du plan projectif pondéré $\mathbb{P}(1, 1, 2)$ et sa décomposition cellulaire induite par l'action du tore unitaire. . . . .	17
1.11	Un polytope et son polaire. . . . .	20
1.12	Le graphe de $F = 0 +_{\mathbb{T}} 0W +_{\mathbb{T}} (-1)W^2$ . . . . .	24
1.13	Convergence de $\text{Log}_t(\Gamma_t)$ vers le graphe de $F = 0 +_{\mathbb{T}} 0W +_{\mathbb{T}} (-1)W^2$ . . . . .	25
1.14	Une collection d'amibes planes. . . . .	26
1.15	Deux amibes associées au même polytope de Newton avec un nombre de composantes complémentaires différent. . . . .	26
1.16	Convergence de la famille $(\mathcal{A}_t(X_t))_{t>1}$ vers le lieu de non-différentiabilité de $F$ (en gras). . . . .	27
1.17	L'adhérence de certaines droites vectorielles dans le plan projectif tropical. . . . .	29
1.18	Une courbe tropicale singulière de bidegré $(2; 2)$ dans le lieu tropical de $\mathbb{P}^1 \times \mathbb{P}^1$ . . . . .	30
1.19	Les lieux réels et les cartes de quelques courbes. . . . .	33
1.20	Une subdivision du triangle de taille 4 et une quartique plane obtenue comme patchwork sur cette subdivision. . . . .	34
1.21	Le patchwork combinatoire d'une quintique plane maximale. . . . .	35
2.1	The barycentric subdivision of the triangle. . . . .	41
2.2	The homeomorphism from the barycentric subdivision of the segment to the initial segment. . . . .	42
2.3	The dihomologic pseudo-subdivision of a regular CW-complex structure of the disc. . . . .	44

2.4	The dihomologic subdivision of the triangle. . . . .	47
2.5	The subdivision of a cube into six tetrahedra, the convex hull of $\{(0; 0; 0); (1; 0; 0); (1; 0; 1); (1; 1; 1)\}$ is marked. . . . .	48
2.6	The dihomologic subdivision of an octahedron. . . . .	48
2.7	The lattice of faces and the dihomologic square associated with a pair of relative codimension 2. . . . .	48
2.8	The shape of the dihomologic cell associated with the adjacent pair $e^0 \leq e^3$ . . . . .	49
2.9	The orientation of the boundary. . . . .	55
3.1	Two examples of dual hypersurfaces. . . . .	76
3.2	An edge $Q^1$ of a 2-dimensional face $Q^2$ and their respective sedentarity. . . . .	77
3.3	A cube and the groups associated by $F_2^P$ to some of its faces. . . . .	77
3.4	A triangle and the groups associated by $F_1^X$ to some of its dihomologic cells. . . . .	78
3.5	A curve in the weighted projective plane $\mathbb{P}(1, 1, 2)$ whose integral tropical homology does not satisfy the tropical version of the Lefschetz hyperplane section theorem. . . . .	99
3.6	A singular surface in $\mathbb{P}^1 \times \mathbb{P}^1 \times \mathbb{P}^1$ whose integral tropical homology does not satisfy the tropical version of the Lefschetz hyperplane section theorem. . . . .	100
4.1	An example of T-curve in $\mathbb{P}^1(\mathbb{R}) \times \mathbb{P}^1(\mathbb{R})$ . . . . .	107
4.2	Some page of the spectral sequence of a T-hypersurface of dimension 3. . . . .	122
4.3	A blow-up of $\mathbb{P}^1 \times \mathbb{P}^1$ . . . . .	128
4.4	Canonical Triangulation of the Product of a Segment with a Triangle. . . . .	133
4.5	A Triangulation $K + L$ . . . . .	134
4.6	The Viro triangulation $V_5^2$ . . . . .	135
4.7	Antipodal identifications. . . . .	136
4.8	Some portion of a T-surface $\mathbb{R}X_\epsilon$ constructed from a sign distribution on the Viro triangulation $V_4^3$ . . . . .	137
4.9	The unfolding isotopy from Proposition 4.3.1 applied to the portion of a T-surface $\mathbb{R}X_\epsilon$ on $V_4^3$ located in the suspension of the equatorial ball. . . . .	139
5.1	Examples of $\mathcal{B}_0K$ and $\mathcal{B}_1K$ . . . . .	149
5.2	The behavior of a curve $\mathbb{R}X_\epsilon$ in the star of an edge along which it is untwisted. . . . .	167
5.3	The behavior of a curve $\mathbb{R}X_\epsilon$ in the star of an edge along which it is twisted. . . . .	167
5.4	The eight intersections of $\mathbb{R}X_\epsilon$ with the different lifts of $S$ . In this example $\mathfrak{t}(\mathbb{F}_2)$ is $\mathbb{F}_2^3$ . . . . .	168
5.5	A representation of the four pairs of intersections of lifts of $S$ with $\mathbb{R}X_\epsilon$ . . . . .	169
5.6	The eight intersections of $\mathbb{R}X_\epsilon$ with the different lifts of $S$ . . . . .	170

5.7	A representation of the four pairs of intersections of lifts of $S$ with $\mathbb{R}X_\varepsilon$ . . . . .	171
5.8	A representation of the crossing arcs of the star of $\alpha$ . . . . .	182
5.9	The two behaviours of the moment image of the astroid when crossing a twisted edge of the first type incident to $E$ . . . . .	185
5.10	The triangulation $IV_4^2$ . . . . .	191



# List of Tables

- 4.1 The value of  $\iota[\omega_{\mathbb{R}X}]$  as well as the corresponding upper bound on the degeneracy index of a T-hypersurface in a product of two projective spaces as functions of the bidegree. . . . . 130
- 4.2 The value of  $\iota[\omega_{\mathbb{R}X}]$  as well as the corresponding upper bound on the degeneracy index of a T-hypersurface in the blow-up as a function of the degree and the intersection with the exceptional divisor. . . . . 130



# Homologie des T-Hypersurfaces

**Résumé:** Notre objet d'étude est la topologie, en particulier l'homologie, des T-hypersurfaces. Ces espaces topologiques construits de manière combinatoire sont une généralisation des *patchworks* combinatoires d'O. Viro. Ils sont naturellement plongés dans les lieux réels de variétés toriques et sont nés d'un besoin en hypersurfaces algébriques réelles ayant une topologie riche. Nous prenons comme point de départ de notre étude la suite spectrale de Renaudineau-Shaw et le théorème de Lefschetz tropical. Nous généralisons ce dernier théorème à certaines hypersurfaces de variétés toriques singulières et en tirons une famille génératrice de l'homologie tropicale. Ensuite, nous démontrons une dualité de Poincaré dans la suite spectrale de Renaudineau-Shaw. Ceci nous mène à un critère de dégénérescence pour cette suite. Grâce à ces résultats nous parvenons à caractériser les T-hypersurfaces ayant un nombre maximal de composantes connexes au sens des inégalités de Renaudineau-Shaw.

**Mots clés:** Géométrie Algébrique Réelle ; Géométrie Tropicale ; Géométrie Torique ; Topologie Algébrique ; Patchwork de Viro.

## *Homology of T-Hypersurfaces*

**Abstract:** Our main focus is the topology, especially the homology, of T-hypersurfaces. These topological spaces, combinatorial in nature, are a generalisation of O. Viro's combinatorial patchworks. They are naturally embedded in the real loci of toric varieties and were considered to find real algebraic hypersurfaces with a rich topology. The starting point of our study is the Renaudineau-Shaw spectral sequence and the Tropical Lefschetz Theorem. We generalise this latter theorem to certain hypersurfaces of singular toric varieties and deduce a generating family of their tropical homology. Then, we establish a Poincaré duality in the Renaudineau-Shaw spectral sequence. It leads us to a degeneracy criterion for the sequence. Using the aforementioned results we are able to characterise the T-hypersurfaces having a maximal number of connected components in the sense of the Renaudineau-Shaw inequalities.

**Keywords:** Real Algebraic Geometry ; Tropical Geometry ; Toric Geometry ; Algebraic Topology ; Viro's Patchwork.

**Image en couverture :** Portion d'une T-surface projective, illustration produite par l'auteur.

