



HAL
open science

Investigating the Apparent Haptic Motion Illusion to Provide Navigation Guidance in a Handle

Inès Lacôte

► **To cite this version:**

Inès Lacôte. Investigating the Apparent Haptic Motion Illusion to Provide Navigation Guidance in a Handle. Robotics [cs.RO]. Insa de Rennes, 2024. English. NNT : . tel-04826541v2

HAL Id: tel-04826541

<https://theses.hal.science/tel-04826541v2>

Submitted on 12 Dec 2024

HAL is a multi-disciplinary open access archive for the deposit and dissemination of scientific research documents, whether they are published or not. The documents may come from teaching and research institutions in France or abroad, or from public or private research centers.

L'archive ouverte pluridisciplinaire **HAL**, est destinée au dépôt et à la diffusion de documents scientifiques de niveau recherche, publiés ou non, émanant des établissements d'enseignement et de recherche français ou étrangers, des laboratoires publics ou privés.

THÈSE DE DOCTORAT D'INÈS LACÔTE

L'INSTITUT NATIONAL DES
SCIENCES APPLIQUÉES DE RENNES

ÉCOLE DOCTORALE N° 601

*Mathématiques, Télécommunications, Informatique, Signal, Systèmes,
Électronique*

Spécialité : *Automatique, Productique et Robotique*

Investigating the Apparent Haptic Motion Illusion to Provide Navigation Guidance in a Handle

Étude de l'illusion Haptique du Mouvement Apparent pour la Création d'une Poignée d'Aide à la Navigation

Date de soutenance : Rennes, le 28 mai 2024

Unité de recherche : IRISA, INSA Rennes

Thèse N° : 24ISAR 08 / D24 - 08

Rapporteurs avant soutenance :

Pr. Astrid Kappers Professeure à Eindhoven University of Technology (TU/e)
Dr. Monica Gori Directrice de Recherche à Italian Institute of Technology (IIT)

Composition du Jury :

President :	Dr. Gilles Bailly	Directeur de recherche CNRS à ISIR, Sorbonne Université
Examineurs :	Pr. Astrid Kappers	Professeure à Eindhoven University of Technology (TU/e)
	Dr. Monica Gori	Directrice de Recherche à Italian Institute of Technology (IIT)
	Dr. Gilles Bailly	Directeur de recherche CNRS à ISIR, Sorbonne Université
Dir. de thèse :	Pr. Maud MARCHAL	Professeure des Universités, INSA Rennes, IUF
Co-sup. de thèse :	Dr. Claudio PACCHIEROTTI	Chercheur au CNRS, IRISA, Rennes
Co-sup. de thèse :	Dr. David GUEORGUIEV	Chercheur au CNRS, ISIR, Paris

Invité(s) :

Pr. Marie BABEL Professeure des Universités, INSA Rennes

À Hélène Dumontet

To Hélène Dumontet

ABSTRACT

In the field of navigation assistance, we encounter many challenges, particularly when considering pedestrians and their diverse needs. Haptics enables conveying rich information in a private and distributed manner and is thus a relevant modality for providing navigation indications on the hand. In that respect, we designed and validated a new haptic device for assisted navigation using the apparent haptic motion illusion (AHM) principle. An adaptive handle was designed with the capacity to house the desired actuators, which were custom-designed and hand-made, able to elicit vibrotactile and tapping stimuli. Signals were designed and chosen to convey a proper apparent haptic motion illusion, enabling the discrimination of directional information. The robustness of this illusion was investigated through four psychophysics studies. Finally, the implementation of a study with the handle mounted on a walker in conditions close to real-life conditions was achieved, validating our work and design. This work aimed to address the needs of a larger group by introducing a hand-held device for navigation guidance. It provides solutions to the three main scientific challenges which were the central focus of my research. These challenges are designing haptic signals for clear directional communication, designing haptic directional cues for an ergonomic haptic handle and navigation strategies utilising a hand-held device.

TABLE OF CONTENTS

1	Introduction	9
1.1	Navigation assistance: General context and growing needs	9
1.1.1	General context	9
1.1.2	The Dornell Project: Advancing Haptic Solutions for Multi-sensory and Adaptive Mobility Assistance	10
1.1.3	The context and target population of the Dornell Project	11
1.1.4	Consequences of sensory impairments on daily life and needs in the context of navigation assistance	12
1.2	Thesis context, scientific challenges and contributions	13
1.2.1	Thesis Scope: Investigating Haptic Illusions in the Context of Mobility Assistance	15
1.2.2	Scientific contributions towards the three challenges	17
2	Related Work	21
2.1	Haptics	22
2.1.1	Haptics and the tactile system	23
2.1.2	The principles behind tactile perception	24
2.1.3	The haptic illusions and the apparent haptic motion	27
2.2	Haptic devices	29
2.2.1	Existing technologies and common classification	29
2.2.2	Existing devices and applications	31
2.3	Haptic devices for navigation assistance	34
2.3.1	Multimodal haptic devices for navigation assistance	36
2.3.2	Haptic devices for navigation assistance	37
2.3.3	The Apparent Haptic Motion Illusion for navigation assistance	47
2.4	Conclusion	48

I	Design and evolution of a navigation assistance device	51
3	Conception, adaptation and improvement of the haptic device	53
3.1	The handle	54
3.2	Actuators	57
II	Studying the haptic perception of the apparent haptic motion for navigation information	61
4	Robustness of the Apparent Haptic Motion for Directional Information	63
4.1	Introduction	64
4.2	User Study	65
4.2.1	Experimental setup and signals	66
4.2.2	Experimental design	68
4.2.3	Participants	69
4.2.4	Experimental procedure	70
4.3	Results	71
4.4	Discussion	74
4.4.1	Impact of the hand rest curvature	74
4.4.2	Comparison of the two modes of stimulation	75
4.5	Conclusion	75
5	Speed Discrimination in the Apparent Haptic Motion Illusion	77
5.1	Introduction	78
5.2	User study	79
5.2.1	Experimental set-up and signals	79
5.2.2	Experimental design	80
5.2.3	Participants	80
5.2.4	Experimental procedure	81
5.3	Results	81
5.4	Discussion	84
5.5	Conclusion	84

6	Directional Information in 2D Within a Handle	86
6.1	Introduction	87
6.2	User Study	88
6.2.1	Experimental setup and signals	89
6.2.2	Experimental design	90
6.2.3	Participants	92
6.2.4	Experimental procedure	92
6.3	Results	93
6.4	Discussion	96
6.4.1	Impact of the handle position and identification of directions	96
6.4.2	Comparison of the stimulation modes	96
6.4.3	Impact of the directional information	97
6.5	Conclusion	97
6.6	Additional tests with participants with visual impairments	99
6.6.1	Participants presentation	99
6.6.2	Proceedings of the tests	100
6.6.3	Results and conclusion of the tests	101
III	Application to a navigation assistance and mobility aid	103
7	Navigation Information through Uni-manual or Bi-manual Strategies	105
7.1	Introduction	106
7.2	User Study	107
7.2.1	Experimental setup and methods	107
7.2.2	Experimental design	111
7.2.3	Participants	112
7.2.4	Experimental procedure	112
7.3	Results	112
7.4	Discussion	117
7.5	Conclusion	118
8	Ecological Study: Testing Navigation strategies in walking situation	120
8.1	Introduction	121
8.2	User Study	121

TABLE OF CONTENTS

8.2.1	Experimental Setup and Methods	122
8.2.2	Experimental Task and Design	125
8.2.3	Participants and Collected Data	126
8.3	Results	126
8.4	Discussion	131
8.4.1	Impact of the strategy	131
8.4.2	Comparison between modes	131
8.5	Conclusion	132
9	Conclusion and Perspectives	133
9.1	Take-home messages from this thesis	133
9.1.1	I. Using the Apparent Haptic Motion for navigational instructions in various actuation modalities	133
9.1.2	II. Integrate the directional messages into a handle shape device	136
9.1.3	III. Developing Navigation Strategies Utilising a Hand-held Device	137
9.2	Perspectives	138
	Bibliography	141
	Appendix	160

INTRODUCTION

Contents

1.1	Navigation assistance: General context and growing needs . . .	9
1.1.1	General context	9
1.1.2	The Dornell Project: Advancing Haptic Solutions for Multisensory and Adaptive Mobility Assistance	10
1.1.3	The context and target population of the Dornell Project	11
1.1.4	Consequences of sensory impairments on daily life and needs in the context of navigation assistance	12
1.2	Thesis context, scientific challenges and contributions	13
1.2.1	Thesis Scope: Investigating Haptic Illusions in the Context of Mobility Assistance	15
1.2.2	Scientific contributions towards the three challenges	17

1.1 Navigation assistance: General context and growing needs

While vehicular navigation systems, based on GPS technologies, have advanced notably through turn-by-turn systems, offering sufficiently efficient guidance for these application scales, these tools could be better suited for pedestrians who need significantly more detailed information [69].

1.1.1 General context

With automotive navigation systems' growing success and popularity, the demand for pedestrian navigation services (PNS) has increased significantly in recent years [70].

Although PNS share some features with automotive navigation systems in calculating the best path, their design must address pedestrians' unique orientation and navigation needs and preferences. Limitations of these systems have been identified on the existing outdoor PNS, with, for example, their reliance on road networks, resulting in ineffective tracking of pedestrians, who often walk on pavements with more segments and narrower paths than traditional roads. Works like Karimi et al.'s [70] have highlighted and addressed challenges such as the development of PNS, including the establishment of appropriate sidewalk networks, continuous real-time tracking of users on sidewalks without interruption, and the ability to provide personalised directions and routes.

Adequately and efficiently calculating the path to follow is a significant concern for navigation guidance. However, conveying the information is just as crucial. No matter how efficient the pedestrian navigation system is, if the translation to intelligible and complete information is not ensured, the guiding system does not provide any added value. In that respect, most of today's navigation aids provide visual feedback on smartphone screens [160]. For more detailed information and to free the users' visual attention, most devices are also designed to provide auditory cues or use vibration. Overall, their functioning relies on a small set of simple cues and can lack adaptability for some users with different needs, especially sensory or mobility deficiencies.

1.1.2 The Dornell Project: Advancing Haptic Solutions for Multi-sensory and Adaptive Mobility Assistance

This PhD thesis is part of the Dornell project. The Dornell project, held by Pr. Marie Babel and Dr. Claudio Pacchierotti, which is funded by Inria under the Grand Challenges programme in 2020, identified more in-depth the challenges of navigation assistance and accessibility. Its goal is to study and devise a viable and efficient solution for daily assisted guidance for a broader range of users. This includes people with no alteration of their sensory impairments or mobility abilities, but it especially includes people with sensory and/or motor impairments. In that perspective, channels other than visual and auditory channels, such as the haptic channel, have to be prioritised. Dornell wishes to offer an innovative, multisensory, multimodal, and intelligent haptic handle that can be easily installed on mobility aids, such as power wheelchairs, white canes, precane, walkers, etc. Specifically designed to meet the largest range of individuals' needs, the project aims to develop a handle with tactile sensations in a portable and

ready-to-use format, combining haptic feedback and assistive technologies into a single device. During navigation tasks, we can provide several different types of information. It is essential to study and understand which are most relevant and through which sensory channel is better to provide them, also according to the capabilities of the user. Indeed, to navigate safely, we could provide various types of information, such as the distance from obstacles or the direction to follow. In this respect, the proposed handle addresses a crucial need in assistive technologies: delivering rich navigation information in a discrete, cost-effective, natural, personalised, user-friendly manner which is also adaptive to the majority of users and existing mobility aids. A key element of this project is the involvement of diverse actors from the engineering, medical, and clinical domains potential users. This process of co-creation wishes to achieve a close understanding of the users' needs, along with professional and clinical advice to best fit the expectations. The project thus gathers several intities and partners in France: teams from INRIA (MFX in Nancy, RAINBOW in Rennes), ISIR (INTERACTION team) in Paris, INSA Rennes (LCGCM team), Institut des jeunes aveugles (Les Charmettes, Yzeure), Pôle de Médecine Physique et de Réadaptations St Héliier (Living Lab, ISAR, Rennes)). More details on the project can be found on the Dornell website [31].

To better understand of the context and specific challenges addressed by the Dornell project, we need to go into more detail about the considered population and its particular needs.

1.1.3 The context and target population of the Dornell Project

The world population is globally getting older and older, especially in northern countries. In 2013, the United Nations estimated that in 2050, people above 50 years old will be 2.1 billion and represent 20% of the world population [108]. The World Health Organisation (WHO) has pointed out the consequences implied by the ongoing demographic change on the prevalence of some medical conditions closely linked to ageing [113]. The elderly are a population particularly affected by an increase in physical deficiencies compromising their mobility, as well as sensory and cognitive impairments. This inevitably leads to an increase in the part of those medical conditions in the population [39, 38]. More than 6% of the global population is affected by deafness (it is estimated that this proportion will exceed 9% by 2050) [162, 115]. In 2007, over 2% of the global population was suffering from total blindness or severe

visual impairment [163]. In 2014, they were 3.9% [49]. The prevalence of sensory impairments has been shown to severely increase with age. The WHO evaluated that more than 80% of people with total blindness around the world are more than 50 years old. In Europe only, 90% of the individuals with moderate to severe visual impairments (MSVI) are above 60 years old. The part of the population with MSVI is expected to increase by two million every year.

Within the population of people suffering from sensory or physical impairments, the elderly are the most fragile population. The elderly blinds, specifically, have larger inherent risks of developing walking disabilities [159].

1.1.4 Consequences of sensory impairments on daily life and needs in the context of navigation assistance

Researches on the impact of congenital or acquired sensory impairments and mobility deficiencies have been conducted. Dammeyer [25] highlights, in his study on congenital deafblindness, the higher prevalence of mental health disorders and pathology, considered as co-morbidity for patients affected by sensory impairments. Studies have shown a wide variability in the nature of the co-morbidity, going from the autism spectrum to depression.

Dammeyer and Koppe [26] focus on the relationship between body movement and social interaction, which also has a major impact on mental health. This mainly explains why people living with the absence, loss or decrease of mobility and autonomy experience severe consequences on their mental health [102]. As mentioned previously, congenital and acquired impairments affect differently the development of people's representation of the world and their self-representation. This, for example, also affects how people "map" the environment and their self-representation in the world. The absence or loss of sensory acuity is also a primary source of autonomy loss and a massive decrease in social interactions. Mobility deficiencies create the same kind of consequences on the personal and social life. This is also accompanied by a decrease in overall mobility and physical exercise, which can lead to other medical conditions or co-morbidity. In everyday life, this affects patients' mental development and health, causing mental illness such as depression or other disorders [25].

In response to this assessment, works are conducted to create a proper technical aid for assisted guidance which could improve some daily life aspects that have deteriorated

for some parts of the population. From the discussion with locomotion instructors and clinicians, we collected information on the key features of an optimal navigation aid. Here are the mentioned requirements. It is first crucial to acknowledge that patients and potential users of mobility aids can present specific needs that should be considered when designing assistive technology. The goal of the assistive device should be to convey indications so as to enable the displacement from a first position to a known or unknown one via a path that might be new at a macro scale, as a GPS-based interface could do nowadays. Nevertheless, this is not the only task of a mobility aid. On a local scale, the indications also have to permit obstacle avoidance. Moreover, the device has to be easy to use or “*intuitive*”, and thus should not need a long learning phase. The indications broadcast through the device should be easy to perceive, understand and interpret so that it would not increase the cognitive load during the navigation task. To ensure that users will be able to truly rely on their assistive device, efficient and safe displacements must be enabled while being robust and secure so that users truly have confidence when navigating with the device. If users have the impression that they cannot trust the device, they might develop a compensating strategy, likely to increase the cognitive load of the task. The assistive technology should not require the presence of someone else in daily usage so as to enhance the users’ autonomy. Finally, for better inclusiveness, it would be beneficial to develop an assistive device that adapts to existing mobility aids. A customised device is a possible solution to adapt widely to users and their preferences regarding what information they want to receive and how.

1.2 Thesis context, scientific challenges and contributions

As mentioned earlier, it appears that nowadays, no ideal navigation assistive device has been developed to assist pedestrians in navigation, especially individuals with combined sensory impairments and mobility deficiencies. This is mainly due to the fact that people with special needs use specific and dedicated tools, which are limited. In France, Sander et al. found that only 2% of the French MSVI population actually used mobility aids in 2005 [137] because of their limited capacities. A similar analysis was given by Roentgen et al. in 2008 [133], showing that MSVI individuals often face dangerous and risky situations even with a white cane. Nguyen et al. 2020 took

another example of people in electric power wheelchairs and found that they were people were widely subject to collisions [109]. Answering a larger amount of needs and constraints could enable the design of a more adaptive tool. Firstly, it is often found that assistive devices focus their capabilities towards specific and unique deficiencies and not combined. For example, white canes, one of the most known apparatuses for people having MSVI, are not an option for some people having physical deficiencies preventing them from walking properly or people needing a walker. Power wheelchairs are a crucial help to compensate for physical deficiencies but can be dangerous to use if a person is also subject to low vision issues. To deal with a variety of individual situations, assistive devices should ideally cover a wide range of cases and needs.

Among the specific issues that have come to our attention, we can identify, for example, the use of auditory signals as a guiding tool added on canes or walkers used in various mobility aid cases for individuals with MSVI. Indeed, even though the usage of oral indications can appear easy to broadcast and interpret thanks to the use of clear semantics, it also implies various drawbacks. For example, it inevitably excludes people with deafblindness or hearing impairments. It also prevents the use of assistive devices in silent spaces such as libraries, theatres, etc. Besides, we need to take into account that some users might want their assistive device to be discrete and to be able to use it while having a conversation without being interrupted. Another motivation is that people with MSVI rely more on their other senses to acknowledge important information in their surrounding environment, typically in outdoor environments, to ensure safety. Finally, it has been explained that spacial conception is not a universal concept, as one could think [94]. Indeed, the way we spatialise the world depends, among other things, on linguistic structures and constraints, such as the available vocabulary. In some languages, such as Tenejapa (indigenous community in Mexico) [14] or in Guugu Yimithirr (autochthonous community of Australia) [93], spatialisation does not use egocentric referential, as the words *left*, *right*, *front*, *back*, *next to* do not exist. Thus, relativistic space does not exist in those contexts and is replaced by absolute orientation systems comparable to the cardinal system. Levinson [94] also explains the crucial impact and need of cognitive and sensory propensities to go from a complete egocentric spatial conceptualisation used by children to relative and absolute reference frames used later in life. For these reasons, some people with cognitive or sensory impairments might have a different way of orienting themselves and understanding the space around them. This ability to abstract oneself and picture the environment as an

on-top view 2D plan is often referred to as “mapping”.

Thus, for reasons of inclusiveness, safety, and effectiveness, it is essential to provide a device that does not use the audio channel for guiding tasks. In that perspective, some works have shown very interesting results in favour of using haptics as a means of communication. Indeed, various studies such as works by Goldreich et al. [48], and Heer [56] investigated the haptic perception of people having visual and/or hearing impairments. In [103], Mc Intyre et al. show that the tactile acuity in exploration tasks decreases with age. However, they also show through their experiment that people with visual impairments tend to score as well as 10-year younger sighted people, demonstrating an increased tactile acuity among MSVI individuals. Similarly, Norman and Bartholome [112] found that participants with blindness scored 30% better than same-age sighted participants in the discrimination task they were evaluating. These studies pave the way to interesting haptic device designs for navigation tasks.

1.2.1 Thesis Scope: Investigating Haptic Illusions in the Context of Mobility Assistance

This PhD thesis aims to investigate the haptic perception of directional signals on the hand to achieve the conception of a haptic device transmitting clear navigation instructions that could be used by a wide range of individuals with or without sensory or physical impairments.

In that perspective and to achieve a convincing functioning of the handle, we have to investigate the human perception of haptic cues as a source of navigational information. We want to design relevant haptic signals and evaluate how convincing they can be to convey directional indications. Through our studies, we should achieve consistent perception and interpretation of directional cues by users, indicating a robust and intuitive interpretation. We also want low variability in the efficiency of interpretation for all participants so that the system can be more or less generalised to a large range of users with possible customisation.

The scientific studies within this thesis will tackle three main scientific challenges:

I. Designing Haptic Signals for Clear Directional Communication Our primary objective is to articulate directional messages, ensuring the most natural and comprehensive transmission of information from the transmitter (motors) to the receiver (the hand). This requires a comprehensive approach that includes both hardware refinement and signal design. By prioritising signal perception only within the referential framework of the hand, we intentionally isolate it from the human interpretative aspect. We address this challenge by designing psychophysical experiments that aim to study the haptic perception of signals and their robustness.

II. Designing haptic directional cues for an ergonomic haptic handle. The second challenge focuses on integrating the haptic cues that were studied within the first challenge into a practical handle-shaped device. Building on the knowledge gained from the initial studies that validated our signal design, this next phase aims to ensure the effective transmission of these signals through the proposed device. The validation of haptic signal perception within the context of a handle-shaped device becomes paramount, serving as a crucial step to affirm that the device aligns with our expectations.

The work for this challenge includes perception evaluation and conception efforts of both shape and actuators for optimal functionality and adaptive implementations.

III. Developing Navigation Strategies Utilising a Hand-held Device The third challenge focuses on navigation and aims to extrapolate the findings from psychophysics and perception studies into real-world navigation scenarios. Through the resolution of challenges I and II, we focus on identifying and validating the haptic signals transmitted and perceived within the hand's reference frame, particularly through curved and handle-shaped devices and across various configurations affecting the handle orientation.

From these perception studies with the validated technical object functioning as the information carrier, we transition towards deploying the assistive device in a navigation context. A pivotal aspect of this phase involves validating the developed technique by incorporating human interpretation. Given that certain mobility aids feature either one or two handles, it becomes imperative to explore potential differences in navigation strategies based on the number of handles employed.

Our objective is to ensure the robust and consistent interpretation of signals during participant tests and between participants, thereby validating effective navigation strategies and optimal usage patterns. Ultimately, the overarching challenge lies in guiding individuals through real-world displacements, facilitating their journey to reach a designated target position.

1.2.2 Scientific contributions towards the three challenges

In order to address our three challenges, we designed three devices and conducted five user studies. These experiments were step-by-step perception and psychophysics human studies aiming to validate our assumptions and answer various scientific questions.

Answer and contribution to challenge I. To address this first challenge, we studied the apparent haptic motion illusion delivered differently from other works in the literature, studying how tapping sensations can substitute vibratory signals.

This implied a first work in choosing the type of messages we wished to send. In the context of navigation tasks, we can either indicate a position or a direction. An indication of position is given through a single static indication in a given referential framework, whereas direction can be indicated through the production of motion. If one can identify a starting point and a distinct ending point, he/she can identify a motion along an axis standing for a direction. A second step was to identify whether we wished to indicate a direction to follow, i.e. a target to walk to, or the presence of an obstacle, in other words, a location from which one needs to get away. Based on the indications given by health professionals, it seems more natural to follow instructions than to do the opposite. In that respect, we have to take into account that the user will wait for the information to arrive before moving in any direction. This implies a continuum in the broadcast of the tactile signal. It also means that the signals have to be intense enough to be understood but not too much so as not to create discomfort or perception alteration, even during prolonged use. The use of haptic illusions thus emerged as a promising tool to achieve our goal application, which can facilitate the transmission of complex information with rather reduced hardware. In the scope of using tactile patterns relying on haptic illusions, we had to find the proper signal to convey directional cues that

would be convincing in the context of navigation assistance. Because we chose to use a navigation strategy based on indications to follow, we identified the Apparent Haptic Motion illusion (AHM) as an interesting and valuable information carrier. The apparent haptic motion conveys a sensation of continuous motion on the skin when the stimulations actually consist of the asynchronous activation of discrete stimulation points [15]. From the literature, we noticed that most of the devices with the same type of goal, which convey directional information or the AHM, use vibrations (see Tables 1.1, 1.2, 2.1, 2.2, 2.3). This led us to consider a new scientific challenge in finding a possible alternative to vibrations. In that context, various alternatives exist, such as shape-changing devices. They have been greatly investigated and showed very nice results in other studies [144]. In our work, however, we wished to find an alternate stimulation modality that would be less constraining than shape-changing for easier adaptation to the mentioned mobility aids. In order to address the viability of an alternative to the vibrations, in all our experiments, we set experimental protocols comparing tactile patterns using vibrations with the same patterns in a non-vibratory stimulation mode. This comparison appears in all experiments, for which you can refer to Chapters 3 to 7. To adapt to the majority of users, we want to consider the ability of our developed system to convey information in various modalities and be adaptive to the users' preferences.

Research conducted on the apparent haptic motion has helped find the optimal function for temporal and spatial parameters in order to convey the most realistic illusion [141]. Our interest in conveying complex navigation instructions through touch made us consider using temporal parameters as a way to give speed indications. Concerning the ability to use the temporal parameters of the apparent haptic motion illusion to convey speed indication, we chose to use a reference delay between the actuator's activation and compare the ability of users to find the fastest signal between the reference and different signals. The entire study is described in Chapter 5.

Answer and contribution to challenge II. To address this second challenge, we focused on the integration of our initial findings from a haptic perception point of view into a technical tool. This step not only leads to crucial adaptations but also prompts significant studies within the context of the thesis. Identifying gaps in the existing literature, we focused on proving the effectiveness of the apparent haptic

motion illusion on curved and cylindrical surfaces. This validation is essential for our goal of creating an adaptive handle.

From the literature, we can see that the AHM is an interesting tool for motion and directional indications on the forearm and the back [61], between two hands holding a tangible object [173]. However, because the majority of these devices use planar surfaces or convey the AHM on planar body parts, our specific case demands in-depth perception studies to adapt to a handle, which is not straightforward; we thus needed to study whether the effect holds in a different shape. In Chapter 4, we took the first step towards addressing this challenge by investigating the effects of curvature. Indeed, we have to consider a handle-shaped device when most of the studies have been done on planar surfaces or wearable haptics, such as belts, which are completely different from a cylindrical hand-held device. It is thus crucial to validate curved applications to later properly integrate the model into a handle. In our first experiment, participants received distal to proximal and proximal to distal signals along the palm and middle finger using the AHM illusion. To address the challenge of the planar or curved nature of the hand rest used, we conducted the experiment using five different curvatures of the hand rest, from flat to almost cylindrical.

The third study, presented in chapter 6, marks the integration of our preliminary work into a 3D-printed handle-shaped device. Here, we not only improved the actuators but also introduced a novel configuration by positioning two additional actuators to form a cross-shaped array. This innovation allowed us to transmit patterns not only along the palm and middle finger but also across the metacarpal bones, introducing a 2D patterning capability within a handle. Further refinement was achieved by comparing perceptions in three different grip positions relative to the user.

To fulfil the vision of a fully adaptive device, in line with the user cases discussed earlier, we aimed not only to convey four directions in the framework of the hand but also to ensure consistent pattern recognition regardless of the position and orientation of the hand. This adaptability is crucial for a variety of applications, including pre-canes, walkers, electric wheelchairs and white canes. Importantly, this experiment, presented in Chapter 6, validated the functionality of our custom-designed actuators in configurations, mimicking the positioning of the hand on the mentioned mobility aids. This experiment was thus a significant step towards achieving our project goals.

Answer and contribution to challenge III. To address this second challenge, we focused on designing functional navigation strategies that serve as a concrete validation of both our signal design and the technical device as applied to our target context—navigation guidance with mobility aids. By actively engaging users in the interpretation process, we ensured that the device met our expectations as a complete and reliable guiding system.

In our fourth experiment, detailed in Chapter 7, we assessed the effectiveness of twelve different tactile patterns, utilising one or two handles at a time, to elicit directional indications. This was meant to explore the potential and abilities of our system to be used on various mobility aids, where the user mobilises one hand (white cane, power wheelchair) or two (walker, precane). To simulate a realistic scenario for individuals with complex impairments, we placed the handles on a walker. This implementation not only identified the most promising tactile patterns but also concretely validated the device.

After a first validation where participants orally interpreted the directions without actually moving, we challenged participants to follow trajectories using *only* haptic indications from the handles. This challenging task involved navigating with a walker in an indoor environment, following a non-visible virtual trajectory based on the haptic indications sent through the handles of the mobility aid. Documented in Chapter 8, this experiment in a more ecological setting not only validated the haptic device as a navigation guide but also demonstrated flexibility in actuation modality, tactile patterns, and the number of handles used. These promising results point towards the potential development of an adaptive and customised assistive device.

In conclusion, the studies performed within this PhD contributed to streamlining the design and implementation of navigation aids. With an optimistic outlook, a future could be envisioned where a product akin to the current iteration of our device could potentially be commercialised, thereby improving the lives of many individuals.

RELATED WORK

Contents

2.1 Haptics	22
2.1.1 Haptics and the tactile system	23
2.1.2 The principles behind tactile perception	24
2.1.3 The haptic illusions and the apparent haptic motion	27
2.2 Haptic devices	29
2.2.1 Existing technologies and common classification	29
2.2.2 Existing devices and applications	31
2.3 Haptic devices for navigation assistance	34
2.3.1 Multimodal haptic devices for navigation assistance	36
2.3.2 Haptic devices for navigation assistance	37
2.3.3 The Apparent Haptic Motion Illusion for navigation assistance	47
2.4 Conclusion	48

Navigation assistance stands as the primary focal point of this thesis. Our interest in this area arises from the clear deficiencies in current solutions, particularly their lack of adaptability and efficiency. Through our review of existing literature, we explore attempts focused on creating navigation aids for individuals, especially those with sensory impairments like visual limitations.

In that perspective, and to situate our work in the field of haptics and navigation aid systems, the state of the art presented in this chapter is divided into three sections.

Firstly, an overview of what haptics is, its general functioning and the potential of haptic illusions is given. Among these haptic illusions, the special case of Apparent

Haptic Motion (AHM) illusion, which will be used in our contributions, is presented in more detail.

A second section is then devoted to haptic devices, looking at their technological classification, application sectors and fields.

In the last section, we will take a closer look at haptic devices dedicated to navigation assistance. Starting by looking at multimodal devices (using audio or visuals in addition to haptics), we will finally go into a lot more detail in the literature on haptic devices serving the purpose of aiding navigation. We categorise these efforts into two primary groups: wearable and hand-held devices.

2.1 Haptics

The term “haptics” comes from the Greek “*απτικός*” meaning “able to come in contact” [116] and was coined by the German Max Dessoir (1867-1947) and then popularised by the Dutch-Hungarian psychologist Géza Révész (1878-1955) [50]. It is now considered the scientific research field which studies the sense of touch and the different pieces of information we receive when physically interacting with the surrounding environment [92]. The sense of touch is a fundamental aspect of human perception and is crucial for communication, emotional connection and interaction with our environment. By analogy with acoustics and optics, haptics refers to the discipline that studies and explores the sense of touch. Just as graphics and audio target a person’s vision and hearing to convey information, haptic technology targets a person’s somatosensory system - the sense of touch - to provide context and convey specific information, such as the feeling of touching virtual and remote environments or to provide navigation cues. In recent years, advances in haptics technologies have revolutionised the way we experience touch in virtual and physical environments. It also studies the tactile and kinesthetic interactions on our skin and motor organs. Culbertson et al. [21] detail the definition of tactile and kinesthetic interactions as follows: “Tactile sensations, such as pressure, shear, and vibration, are sensed by specialised sensory end organs known as mechanoreceptors that are embedded in the skin. Kinesthetic sensations are forces and torques that are sensed in the muscles, tendons, and joints”. Haptics also questions the perceptions of very diverse parameters directly or indirectly linked to touch.

This first section of the state of the art takes inspiration from the Lecture taught by Pr. Vincent Hayward at Pierre and Marie Curie University [54]. It presents what is haptics, its biological functioning, and finally, the apparent illusions, which are of main interest and place themselves between the fundamental understanding of haptics biology and the technological integration.

2.1.1 Haptics and the tactile system

When studying the sense of touch, we can find multiple analogies with the visual, auditory or vestibular systems, with which it shares many characteristics. The haptic system, like other sensory systems, has its own strong peculiarities. The study of haptics focuses on the sensations perceived and the behaviours resulting from physical contact. We use our haptic system for all kinds of tasks in our daily lives, from walking, grasping objects, writing, etc. Besides, the understanding of the biological aspects of the tactile system proves to be useful for designing devices to stimulate our sensory and motor organs. A large number of haptic cues have been designed to correspond to a wide range of applications. Common devices that provide haptic sensations include smartphones, game controllers and wearable devices such as smartwatches. Smartphones often use vibrotactile feedback to simulate touch, for example, to provide alerts and notifications. Game controllers, such as joysticks, incorporate haptic feedback to provide tactile responses during gaming experiences, adding a new dimension to gameplay [13]. In addition, wearable devices such as smartwatches use haptic technology to deliver notifications through subtle vibrations, increasing user engagement and interaction with the device. Other types of haptic cues are less common to find in daily used apparatuses; there are, for example, devices using thermal technologies, deformation [32], force, pseudo-force [90] and ultrasonic cues and electro-stimulation [80]. Haptic vests, for example, provide immersive feedback by using vibratory motors strategically placed throughout the garment to simulate sensations such as impact, texture or environmental conditions. Thermal devices can modulate temperature to provide sensations of warmth or cold [116]. Electrotactile interfaces use electrical stimulation to create tactile sensations on the skin, providing a precise and customisable way to convey information or simulate touch. These less common haptic interfaces demonstrate the diverse applications and potential of haptic technology beyond traditional devices, showing how diverse and unexplored the field is. All of those elicit a multitude of hap-

tic sensations used in different areas such as medicine, rehabilitation, teleoperation, robotics, mobility, cultural accessibility, video games, car safety, etc. Haptic research covers a wide range of topics related to touch-based interaction, understanding the mechanisms behind the sense of touch, developing new haptic interfaces, and exploring tactile sensations in various applications. In fact, haptics research explores how to incorporate touch into many areas, such as medicine and rehabilitation, virtual simulations, multi-sensory displays, navigation, robotics and haptic prosthetics, to expand the possibilities of touch-based interactions and sensory experiences. In this Chapter, we will browse the biological aspects of haptics in Section 2.1.2 and then present the definition and importance of haptic illusions in Section 2.1.3.

2.1.2 The principles behind tactile perception

Our focus in the area of haptic perception is on tactile perception. As mentioned, the skin is a major component of our tactile perception and our largest organ. Tactile stimulations are typically sensed through our skin, yet the skin is not one homogeneous organ. It is crucial to distinguish three skin types: glabrous, hairy and mucosal skin. While the mucosal skin covers the “internal” surfaces of the body and is thus less exploited, the hairy and glabrous skins are intensively used in haptics. In this thesis, the focus is specifically on the hand. The hand is a favourite limb for haptic exploration and stimulation because it is the most sensitive part and the one that is used most often for grasping, manipulating and probing the environment. For this reason, the glabrous skin which composes the hand palm has been widely studied. As investigated by Paré et al. in 2002 [120], the glabrous skin has a relatively thick superficial layer of keratin that is, therefore not innervated. The skin houses many receptors such as mechanoreceptors, which sense mechanical stimuli, thermoreceptors for temperature, and nociceptors sensing pain and injury [116]. Mechanoreceptors are the most interesting for our purposes as they provide information about applied pressure, shape, deformation and vibration. The inner layer of the epidermis, on the other hand, is composed of living cells, and its remarkable geometry is such that the papillae of the dermo-epidermal junction are twice as numerous as the ridges [73, 111], as shown in Figure 2.1. This is where two types of mechanoreceptors responsible for haptic perception can be found. The folds of these papillae house Meissner’s corpuscles [58]. Merkel’s complexes (which contain a large number of branching nerve fibres) terminate

in a multitude of endings on the crests of the papillae [119, 120]. The largest receptors in the skin are the Pacini corpuscles, found in the deeper regions of the dermis layers. Hairy skin, on the other side, has a less deeper organisation than the glabrous skin.

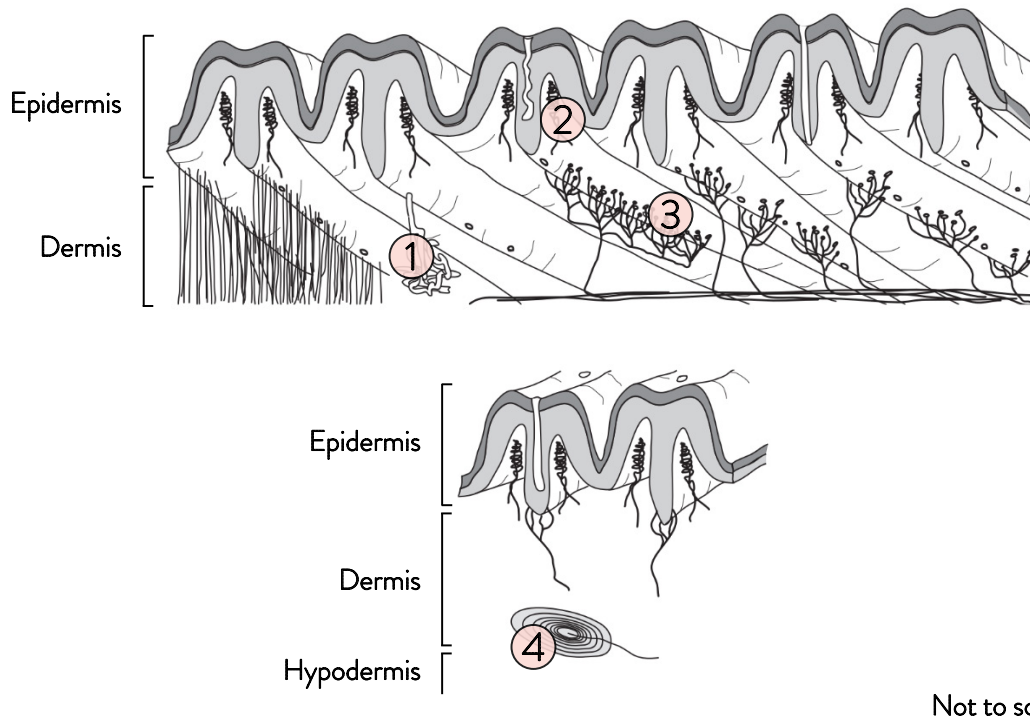

Figure 2.1 – Cross-section of hairless/glabrous skin showing the print and the receptors organisation. The top figure is a superficial representation presenting the dermis and epidermis, the bottom figure is a deeper cross-section where the subcutaneous layer can be seen. 1) Sweat gland, one per pore. 2) Meissner corpuscle. 3) Merkel complex with neurites that can cover a considerable territory spanning over several pores. The majority of them however have a territory confined between two sweat glands. 4) Pacinian corpuscle located deeper than the other mechanoreceptors [120]. Drawings taken from [54] on which legends have been added.

The mechanoreceptors are innervated by descending activating fibres and ascending stretch-responsive fibres, which are activated by tactile stimuli. Haptic mechanoreceptors play a crucial role in our tactile perception, providing information about pressure, shape, distortion, and vibration. These receptors are distributed across our body, with different densities and categorisations based on their receptive fields and rates of adap-

tation. Fast-adapting (FA) mechanoreceptors respond to initial and removal stimuli and especially vibratory signals (FA-I: responding from 5 Hz to 50 Hz with localised sensation of wobble or flutter sensation and FA-II: responding from about 50 Hz to 700 Hz with buzz sensation) [161], while slow-adapting (SA) ones remain active throughout stimulus contact. The high density of these receptors in the hand's glabrous skin results in heightened cutaneous sensibility. Mechanoreceptors relay information about mechanical stimuli, while thermoreceptors detect temperature changes. When applied to the skin, these stimuli trigger complex mechanical, perceptual, and cognitive responses. The skin rapidly deforms to match the object's surface, and receptors encode this information as action potential spikes. This data is then transmitted to the central nervous system for higher-level processing, allowing the brain to create a coherent tactile sensation of the object. They are, therefore, the information carriers [9, 52, 64].

There are two types of tactile stimulation: active and passive. The difference between these two ways of using the sense of touch lies in whether or not a movement is attributed to the hand, enabling the perception of certain characteristics. On the one hand, *active tactile* perception, which is referred to as *exploration*, is induced by haptic gesture. The palm and fingers move on a surface or an object, allowing manipulation and enabling the discrimination of numerous properties such as shape, size, material, etc. *Passive touch*, on the other hand, subjects the palm and often immobile fingers to stimulation [46], giving them a smaller amount of information. Indeed, Loomis and Lederman explain that with active touch, in addition to the cutaneous information available to the passive observer, the active observer has the information provided by afferent and efferent kinesthesia as well as the ability to control the pickup of information [98]. This information is thus less numerous in passive touch but perhaps, to some extent, more precise. This is because, during active touch, the fingers and palm go through successive phases of flexion and extension [57]. As Jones and Lederman explain in *Human Hand Function* [65], the movements involved in manual exploration create stretches of skin on the dorsal part of the hand. These are then responsible for stimulating and activating some of the mechanoreceptors mentioned earlier, thus transmitting information with no apparent connection to the object being manipulated.

2.1.3 The haptic illusions and the apparent haptic motion

Illusions are described as “the marked and often surprising discrepancy between a physical stimulus and its corresponding percept” by Lederman and Jones [91]. Haptic illusions are misleading sensations with respect to the reality of the received haptic signal conveyed. They found their analogies among the other senses with visual and auditory illusions. Haptic illusions have a wide potential as a key element in enriching devices and their transmitted messages in various applications [92]. In that respect, they are able to convey rich sensations through relatively simple stimulation techniques, making them an essential focus of research in the field [91]. Lederman and Jones [91] discuss the relatively limited exploration of perceptual illusions involving the haptic system compared to vision or auditory senses. They highlight the significance of studying illusions to gain insights into cognitive processes and sensory information. In the context of virtual environments, illusions are considered valuable tools for simplifying design and enhancing immersion [43]. They also show the impact of tactile and haptic illusions on designing haptic displays.

They propose a categorisation of tactile and haptic illusions, offering a conceptual framework based on somatosensory function, specifically distinguishing between object-related information processing and haptic space perception. In the category dedicated to objects and their properties, differentiation is made between (i) illusions of material—with texture, stiffness, temperature, and weight—and (ii) illusions of geometry—considering size and shape. For the illusions of haptic space, we find (i) illusions of the external haptic space—including parallelism or the oblique effect— and (ii) illusions of body space— which are considered the illusions of body schema and tactile illusions on the skin. This last group is of main interest for the creation of haptic devices to convey a multitude of signals and a large variety of information, even with limited hardware. Among the interesting illusions on the skin, the tau effect is an illusion where the perceived distance between tactile stimuli is influenced by the temporal interval between them [91]. Another phenomenon, the Weber’s illusion, reveals that the perceived distance on the skin is affected by the site of the body being stimulated and the orientation of stimuli. Additionally, the text explores the influence of stimulus orientation on perceived distance, with transverse distances perceived differently than longitudinal distances on certain body parts [91].

This category also gathers illusions such as the cutaneous rabbit, the funnelling illusion or the Apparent Haptic Motion (AHM) [61]. The cutaneous rabbit, also called the saltation illusion, is the haptic illusion where localised stimulation points are activated in sequence; for example, on the forearm, through which one feels a sensation of saltation between two discrete stimulation points, however, this zone had not been stimulated.

The funneling or phantom illusion, is the simultaneous activation of two separate stimulation points. If the two stimulations have the same intensity, it creates an illusion of a one-and-only stimulation point located in the centre (equal distance) of the real stimulation points. If the intensity varies between the stimulation points, the perceived stimulation location is not felt in the middle but closer to the more intense stimulation. To create that variation of intensity and thus of perceived localisation, the illusion is created using vibrotactile actuators.

The apparent haptic motion (AHM) has also garnered significant attention in the domain of haptics perception. This illusion involves actuating discrete stimulation points on the skin asynchronously, creating a sensation of continuous motion along a line [15, 141]. The illusion lies in the fact that a series of stimuli is activated in sequence with a sufficient temporal overlap—corresponding to the optimal intervals based on the stimuli duration, the delay between the activation of stimulation points and the number of activated stimulators—convey the impression of perceiving a continuous movement across the skin. The phenomenon is illustrated in Figure 2.2.

Studies have demonstrated its effectiveness on various body parts, such as the arm [110], hands [173], the forearm and back [61]. This illusion is quite fascinating as it presents great potential for various applications and rendering techniques. By eliciting a sensation of movement while only stimulating local points on the skin, we can think of very different information to broadcast, such as motion indication, direction instructions or speed.

Conclusion Overall, haptic illusions, notably the Apparent Haptic Motion (AHM), offer promising avenues for enriching sensory experiences and conveying information through tactile stimuli. By eliciting a sensation of continuous motion, this illusion appears relevant for applications such as in navigation assistance through directional or speed indications. By using the AHM as a tool and an information carrier, we unlock major possibilities for creating a suitable haptic device. For these reasons, an in-depth

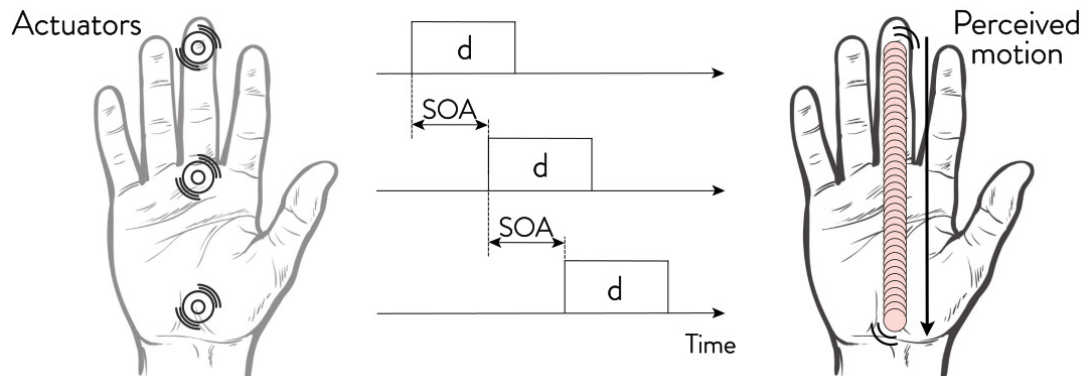

Figure 2.2 – Illustration of the Apparent Haptic Motion illusion theory inspired by [61]. Three isolated stimulation points activated in sequence with a proper overlap convey a sensation of continuous motion along a line traced between the two actuators. The duration is equal for all three actuators and is noted d . The Stimuli Onset Asynchrony (SOA) is the delay between the activation of two actuators. The perceived sensation is an impression of continuous movement along the actuators' positions.

analysis of the application of this illusion in the context of navigation assistance is given in Section 2.3.3 of this Chapter.

2.2 Haptic devices

This section exposes the second part of our general presentation of haptics, more precisely, the haptic technologies and their applications. A first step into the details of current haptic technologies and their classification is made in Section 2.2.1 before an overview of the different domains of applications, along with some relevant examples.

2.2.1 Existing technologies and common classification

Culbertson et al. [21] present the state of the art in the design, control and application of non-invasive haptic devices that artificially generate haptic sensations, essentially those perceived by the hand. They describe the existence of different technologies, also described by Pacchierotti et al. [118], which can be divided into three main categories: known as *graspable* or *hand-held* apparatuses, *wearable* devices and finally *touchable* devices. These technologies are illustrated in Figure 2.3.

Graspable haptic devices or hand-held devices are grounded or ungrounded devices which can be held by the hand. They can be kinesthetic devices that are grounded (e.g., to a table) and provide force-feedback [21]. They can also be tactile devices that are held in the hand, such as skin-stretch, vibratory or thermal feedback.

Wearable haptic devices are typically tactile (cutaneous) devices that are mounted on the body and display sensations directly to the skin [21]. Wearable haptic interfaces should be small, easy to carry, comfortable, and they should not impair the motion of the wearer [118].

Touchable haptic devices enable users to actively engage with the entire surface. These systems may function solely through touch, providing changing properties, like texture, according to the user’s interaction, for instance, by providing varying levels of friction across the surface. Alternatively, they can be a combination of tactile and kinesthetic devices, modifying not only their shape and mechanical characteristics but also their surface properties [21].

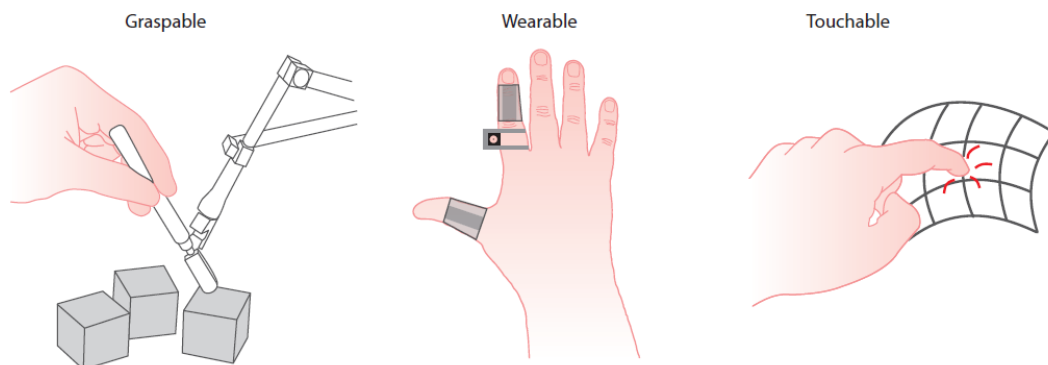

Figure 2.3 – General classification of haptic devices introduced in [21].

Other classifications of haptic devices can also be made based on the actuation technology they use or the type of cues that are conveyed through the device, e.g. force feedback, skin deformation, vibrotactile or thermal stimulations. Another categorisation is proposed by Hayward and Astley, where the interfaces are classified based on their performance measures [55]. The proposed categories are, for example, the degrees of freedom, the motion range, peak force, inertia and damping, peak acceleration, and energy flux.

2.2.2 Existing devices and applications

Based on the first categorisation introduced in Section 2.2.1, we give here an overview of existing haptic devices and their very diverse applications.

Touchable haptic devices Touchable haptics are typically one of the most used technologies in our daily life, considering smartphones and all kinds of tactile displays enabling interactions such as vibrations or poking when tapping down a message through the device keyboard. Apart from common displays, other touchable devices have been developed for a wide range of applications. Different types of feedback modalities, such as mid-air stimulations, have been developed for immersive interactions. In Figure 2.4a), the device uses mid-air stimulation, expelling air in specific locations to create a force feedback conveying the sensation of touching various floating forms. No contact with the device itself is needed [59]. Touchable assistive devices have also been developed towards users with visual impairments for reading, such as Braille tablets from Blitab (see Figure 2.4b)). Apart from Braille translators, various communication devices for blind people have been designed to meet the compensation need for information and social interaction. One way of doing this is to use vibrotactile devices, which can, for example, generate different types of vibration depending on the message to be conveyed [74]. For more intuitive and fluid interactions than with a Braille tablet, Duvernoy [34] designed a haptic device called the HaptiComm (see Figure 2.4c)) able to convert speech and text to tactile finger-spelling characters, thus enabling communication without demanding any exploration task from the user.



Figure 2.4 – a) PUMAH, mid-air interface [59]. b) Refreshable Blitab Braille tablet from Blitab Technology. c) HaptiComm device for tactile finger spelling designed by Duvernoy [34].

Wearable haptic devices Wearable devices have a lot of possible applications and shapes of the devices. There are, for example, vests, gloves, armbands, etc. We can think of the hRing, a wearable device using the rotation of the actuators to create skin-stretch and thus convey a sensation of normal or shear force [117]. Finally, Figure 2.5d) introduces haptic gloves, which have been created by the Spanish company NeuroDigital for the realistic sensation of tactile exploration. Specifically, the company collaborated with Prague’s National Museum on a project for art accessibility dedicated to people with visual impairments to enable them to “see” art through touch. In the same area, the company bHaptics has designed haptic vests and armbands to increase realism when using virtual reality and video games.

The sub-figure a) presents the WeATaViX device, a tangible and graspable object attached to the user’s wrist and designed by de Tanguy et al. [152]. The robotic mechanism enables contact on the palm when needed based on the virtual environment associated. Hence, when interacting with an object in the Virtual Reality (VR) simulation, players do not interact with a game-pad or controller but really get the sensation of manipulating the object. Based on the virtual scene and the tracking of the hand position, the tangible ball is brought to the palm by the robotic actuation, thus providing the realistic sensation of grasping an object.

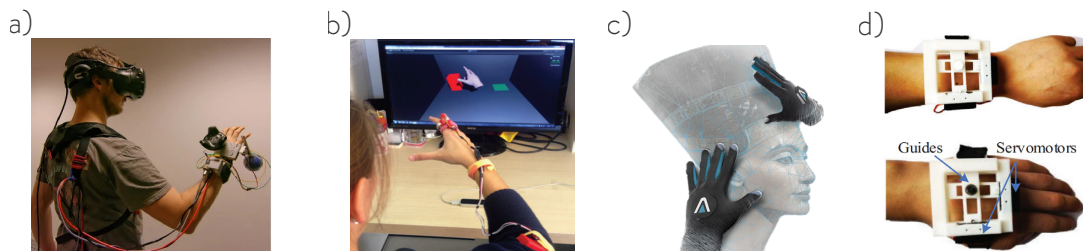

Figure 2.5 – a) WeATaViX paired with Virtual Reality [152]. b) hRing using rotative actuators for tactile exploration [117]. c) NeuroDigital gloves for art tactile representation. d) Wearable skin-stretch device for movement or direction indications [81].

After a stroke or because of neurological damage and disease, one’s capacity to walk properly might be affected. Haptic solutions have arisen to compensate and enhance rehabilitation, such as in Hu et al. work [60] using vibrotactile stimulations on the leg and the feet for gait rehabilitation.

Hand-held haptic devices This last category is of main interest for our research. In the context of the Dornell project, which aims to create a handle device, this PhD thesis work enters into the group of hand-held (graspable) devices. Following the example of touchable and wearable technologies, hand-held haptics are found in a large variety of shapes, forms and applications. Surgery and teleoperation are fields that especially benefit from hand-held haptic research. Work such as Rahal et al. 's [129] explore this field of haptics for enhancing robotics, more specifically telemanipulation and teleoperation (see Figure 2.6). They are a major improvement in the transparency and realism of haptic sensations for teleoperation. Ongoing research works on implementing haptic feedback to have the most accurate rendering when operating with this type of robotic devices [138].

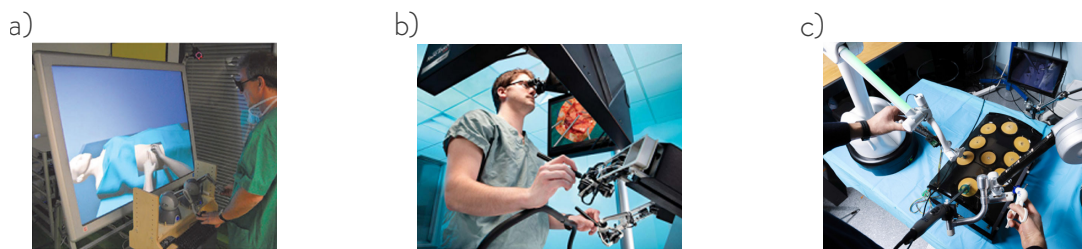

Figure 2.6 – a) The simulator uses two Phantom Omni haptic devices [37] improved by Ullrich and Kuhlen modifications on the end effector to provide a lightweight palpation pad [155]. c) Neurosurgery resident testing a NeuroTouch prototype [27]. d) Improved laparoscopy with haptics feedback.

Translating information through comprehensive tactile patterns is also beneficial to other types of assistive tasks, such as navigation guidance for people with visual impairments, the elderly and people with cognitive or physical disabilities. Our work enters into this group of devices. Figure 2.7 presents three different haptic devices for navigation assistance. Figure 2.7a) is the smart cane designed by Gallo et al. with sensors to detect obstacles and vibrotactile actuators to alert for their presence [41]. In Figure 2.7b) is presented the Haptic Sandwich (or Animotus device) by Spiers et al. [145], which rotates and indicates the direction to follow like a haptic compass. Finally, Figure 2.7c) presents the SWALKIT, a walker equipped with sensors and vibrotactile actuators to convey information of an approaching obstacle by specialising alerts through vibratory signals on the different handles [51].

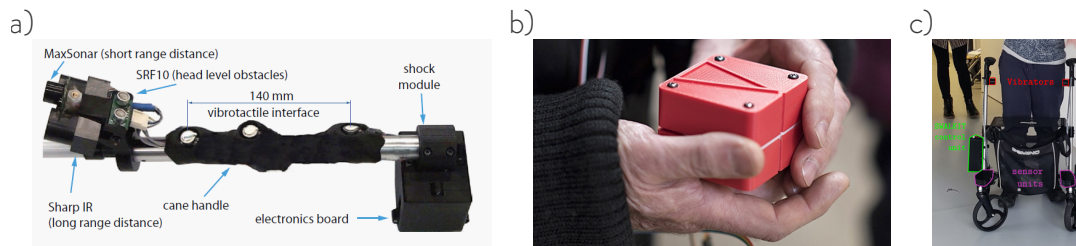

Figure 2.7 – a) Gallo et al. design an enhanced white cane with vibrotactile actuators [41]. b) The animotus device acting like a tactile compass [145]. c) The smart walker, SWALKIT to help avoiding collisions [51].

2.3 Haptic devices for navigation assistance

In the field of navigation assistance today, we encounter many challenges, particularly when considering the diverse needs of different user groups. While vehicular navigation systems have advanced notably through turn-by-turn systems, offering sufficiently efficient guidance for these application scales, these tools are not so well suited for pedestrians who need significantly more detailed information [69]. The limitations of today’s tools become even more apparent when we consider the accessibility aspect and the specific needs of sensory-impaired individuals, especially people with visual impairment. As mentioned in Chapter 1 For them, the auditory senses become paramount to acknowledge their environment, evolve safely or even socially interact with others. In that context, the current technologies using non-visual feedback solely focus on providing auditory-based navigation, ending in overloading the auditory sense. Nowadays, most guidance is provided through visual, auditory, or audiovisual stimuli, which is limiting in many situations [107, 7].

Beyond sensory considerations, there is a broader issue of inclusiveness. Although many navigation assistance devices have been developed, many are still not designed for a large diversity of needs or accepted by users. For example, young individuals with visual impairments may struggle with the complexity of certain technologies, leading to exclusion, as reported by Gori et al. [49]. Similarly, elderly individuals encountering challenges in managing new technologies are disadvantaged. Furthermore, people with physical and mobility deficiencies may face barriers to using devices that cannot

adapt to their specific needs. However, they often use mobility aids, which could be augmented with navigation feedback systems.

Keeping or restoring autonomy is crucial for individuals with sensory impairments, and considerable efforts have been directed towards developing tools to assist them in their movements [25]. By recognising the significance of autonomy in ensuring mental well-being for those with sensory impairments [24], researchers have dedicated efforts to create innovative tools facilitating independent mobility. Using the haptic channel for navigation information is promising and beneficial due to its ability to convey rich information in a private and distributed manner. It has been successfully developed in applications such as navigation systems [127], guidance in industrial teleoperation [1], and locomotion support for individuals with sensory disabilities [69, 47, 128].

Among the haptic devices developed to help people with visual impairments in their displacement, solutions are very diverse. In order to visualise this diversity of works, we categorise devices into main groups. After studying the literature, we tabled down the analysed works. We based this classification on what we considered objective categories and subcategories based on the literature. In this work, we follow the example of [69] for its scientific research monitoring methodology, applied to haptic devices in navigation assistance. Some papers presented user studies, while others focused on the device design. We included both, also considering walking situations studies and static perception studies.

An in-depth literature review shows that most of it focuses on single sensory impairments, some on cognitive deficiencies, and very few on combined sensory impairments with mobility/physical deficiencies. However, Dammeyer et al. [25] explain that people with combined sensory and mobility difficulties are highly impacted in their daily autonomy.

Our literature analysis is organised as follows: In Section 2.3.1, we give an overview of the works developing multimodal devices, including haptics for MSVI navigation assistance. Because it is our primary focus, we will then present in deeper detail our analysis of the solutions using only haptic feedback for this same population of users in Section 2.3.2.

2.3.1 Multimodal haptic devices for navigation assistance

Multimodal haptic devices for navigation assistance represent an approach to enhancing spatial awareness and navigation experiences through the integration of multiple sensory modalities. By combining tactile feedback with auditory or visual cues, these devices offer users a comprehensive and intuitive way to interact with their surroundings, particularly in complex environments or for individuals with sensory impairments. Of course, in the latter case, the choice of sensory modalities must be made according to the specific needs of the user. In Section 2.3, we acknowledged the expansion of devices for assistive navigation. However, we also notice that the most common practice for developing such technology was often to focus on visuo-auditory, visuo-tactile or audio-tactile feedback. Such multimodal signals do not fit all individuals, especially when having sensory impairments. Going into detail in this category of multimodal devices using haptics is interesting. Accessibility is a major topic in urban development plans, town politics, and all sorts of companies; however, it is a relatively new concern, even in academic research. Indeed, over the papers gathered in this state of the art, one of the most ancient paper is from 1974 [72]. Kay et al. highlight the idea of using the remaining audio and haptic channels to allow the blind to receive directional information. In the paper, only the white cane, introduced in the US in the 1940s, is described as a haptic solution for visually impaired people, presenting, however major drawbacks such as the limited detection range and distance. This paper paved the way for new assistive devices using the auditory and tactile channels. To the best of our knowledge and from our collection work, we need to jump to 1990 to find a study of an enhanced/electronic haptic device for navigation assistance dedicated to people with visual impairments. Borenstein et al. [11] developed a vibrotactile belt. It is worn on the waist and also delivers audio indications through earphones. Vibrating motors in the belt are used to indicate the presence of an obstacle. In the meantime, changing intensity depending on the distance to the obstacle, while auditory cues are delivered to indicate the direction to follow.

This first work initiated other research and gives us a perfect transition to a first classification of the literature: devices that support multimodal cues (auditory or visual cues along with haptic) and those which are fully haptic. On that basis, we can gather various papers such as [11, 40, 44, 79, 45, 42, 166, 168] which do not solely rely on haptics but also use audio or like [8, 126] proposing haptics combined with visual cues.

The last two mentioned papers, the visual cues do not adequately fit our study case. These works do not properly address the challenge of conveying complex directional information but rather focus on lowering the cognitive load or attention issues that occur in navigation tasks. The other papers, however, are interesting to look into in more detail. Among the selected papers, eight do not use fully haptic technology but also use audio cues. Two of them are vibrotactile wearable devices stimulating the waist [11] and stimulating both the waist and the shoulders [166]. The other papers use hand-held haptics, with vibrotactile feedback on the fingers [44, 45], on the hand [40, 42, 168], sometimes combined with skin-stretch stimulations [79]. These technologies are a crucial part of the navigation assistance literature, yet we have seen earlier the urge to free the auditory channel from any disturbance or cognitive load. In that respect, fully haptic devices have been developed towards users with sensory impairments, using quite diverse haptic stimulation types. A main reason for that is that individuals with MSVI often rely on their hearing to collect complementary information to navigate safely in outdoor environments [10]. Hence, there is a preference for assistive devices to operate quietly and privately without attracting attention, adding some cognitive load on the auditory channel or just even disrupting conversations.

Non-visual aids often fall short outside of the auditory scope to answer these challenges. In that respect, there is a growing interest in exploring alternative means for providing navigation information, with a notable focus on haptic cues for navigation either through wearable devices or hand-held apparatus [69]. The haptic cues and technologies come in multiple forms and thus lead to quite diverse research, including various forms of devices, various haptic modalities with kinesthetic, skin stretch and tactile feedback, leading to multiple types of haptic cues, such as force, pseudo-force, vibrations [41], shape-changing, deformation [81], thermal [107] or electro-stimulation [124].

2.3.2 Haptic devices for navigation assistance

In navigation tasks, we have seen that passive touch is leveraged, allowing users to focus on mobility without actively seeking information, receiving indications seamlessly [68]. Tactile stimulations have raised considerable interest and have proven effective in a wide range of applications, device shapes, the nature of feedback or the type of information conveyed.

For the following analyses, we propose two classification tables as a way to overview the literature in a comprehensive manner. The following presented works are fully haptic devices and are divided in two sections based on the classification given earlier by Culbertson et al. [21]. The first classification focuses on wearable haptic devices meant for visually impaired people or that could adapt to them based on the technologies and used modalities. Sometimes, papers do not position their haptic device as a solution specific to the MSVI individuals but dedicate their work to decrease the cognitive load during the navigation task, to assist people in mobility rehabilitation or people with mobility deficiencies (PRM). A second classification is done for hand-held haptic devices for navigation guidance. The shared objective of these diverse navigation systems is usually presented as aiming to provide rich navigation information comfortably, enabling a broader range of individuals with sensory disabilities to achieve independence.

Wearable haptics for navigation assistance

For wearable devices, we classify the papers based on various categories—the object itself, the haptic modality, the type of haptic cue, the body part used to convey the information, the nature of the information given to the user, whether or not the haptic signal relies on a haptic illusion, the target population and whether or not the device is being tested in walking situations. This collection shows diversity in the form of devices and body parts stimulated but less on the haptic cues. Indeed, from Tables Table 1.1 and Table 1.2, 90% of the wearable haptic devices for navigation that are presented in this analysis use vibrotactile cues. This may be explained by the fact that vibrotactile actuators present the advantages of being easy to integrate, they also achieve high effectiveness while being miniaturised, quite thin and low energy consuming, making them good candidates for wearable portable devices. Technologies relying on vibrotactile feedback enable to enhance the amount of information delivered by devices while maintaining clarity, intuitiveness, and comfort through diverse patterns and stimulation methods. Nevertheless, when conveying intricate vibratory messages or integrating multiple vibrotactile signals, there is a potential drawback of distorting perception or generating tactile noise, “clutter” as shown by Van Erp in 2005 [157]. This becomes particularly relevant during extended usage, such as in navigation tasks. In Liao et al.’ user study [95], participants used a wearable device strapped on one calf

using six vibrotactile motors distributed around the leg. The psychophysical experiment was designed so that participants had to walk towards a virtual target only with the help of haptic instructions. Indications of direction were given using the funneling illusion phenomenon where the simultaneous activation of two vibrators, one next to the other, gives a sensation of a single point stimulation located between the two actuators. Participants experienced fatigue and perceptual distortion.

Consequently, a compelling research avenue revolves around exploring other modes of stimulation to determine whether they could serve as viable, informative, and comfortable alternatives to vibrations in conveying navigation guidance instructions. Table [Table1.1](#) and Table [Table1.2](#) show two tested alternatives to the vibrations, which are shape-changing and electro-stimulation technologies. The use of electric signals in the context of tactile electro-stimulation has proven to have interesting advantages and results. However, it has also shown some limits, for example, the difficulty in calibrating the cues because of the variability in the subjects' perception [80]. Skin-stretch is another interesting alternative to the vibrations but is less common in wearable haptics [18]. Kon et al. [77], for example, create skin deformation thanks to airbags on the waist. Here, we identify a limit where airbags around the waist can be uncomfortable and are a fragile choice. As mentioned, wearable haptic devices take advantage of the ability to use multiple body parts, which is reflected in the diversity of devices and body parts they are placed on: belts on the waist, vest for the back, torso or both, armband, wristband, gloves, etc. Concerning the nature of the information conveyed to the user, it is either an indication to follow or an indication of an obstacle to avoid. Directional indications are the most common type of information in the context of navigation assistance; they indicate the directions to follow. In the papers collected in the category of wearable haptics, 60 % were tested in walking conditions, making them one step closer to concrete application compared to solely psychophysics and perception studies, which are anyway a first necessary step in order to properly design the device. Finally, four of the papers use haptic illusion to their advantage in order to enrich the haptic stimuli.

Wearable haptic devices

<i>Paper</i>	<i>Device</i>	<i>Haptic modality</i>	<i>Haptic Cues</i>	<i>Body Part</i>	<i>Info type</i>	<i>Haptic illusion</i>	<i>Target need</i>	<i>Walking experiment</i>
Kon et al. 2017 [77]	Belt	Skin-stretch	Shape-changing	Waist	Direction	•	MSVI	
Kuang et al. 2017 [81]	Headband, wristband	Skin-stretch	Shape-changing	Head/wrist	Direction		MSVI	•
Pfeiffer et al. 2015 [124]	Electrodes	Tactile	Electro-stimulation	Leg	Direction	•	Cog, MSVI	•
Wozniak et al. 2022 [165]	Belt	Tactile	Vibrations	Torso	Obstacles		Cog, MSVI	•
Katzschmann et al. 2018 [71]	Belt	Tactile	Vibrations	Torso, waist	Obstacles		MSVI	•
Tsukada et al. 2004 [154]	Belt	Tactile	Vibrations	Waist	Direction		MSVI	•
van Erp et al. 2005 [35]	Belt	Tactile	Vibrations	Waist	Direction, Distance		Cog, MSVI	
Cosgun et al. 2014 [20]	Belt	Tactile	Vibrations	Waist	Direction		MSVI	
Srikulwong et al. 2013 [148]	Belt, vest	Tactile	Vibrations	Waist, back	Direction	•	MSVI	•
Ertan et al. 1998 [36]	Vest	Tactile	Vibrations	Back	Direction		MSVI	•
Devigne et al. 2020 [28]	Armband	Tactile	Vibrations	Arm	Direction		PRM	•
Ogrinc et al. 2018 [114]	Armband	Tactile	Vibrations	Arm	Direction		Deafblind	•
Dobbelstein et al. 2016 [30]	Wristband	Tactile	Vibrations	Wrist	Direction		Cog, MSVI	•
Mancini et al. 2018 [100]	Gloves	Tactile	Vibrations	Hand	Direction		MSVI	

Table 1.1: Categorisation of wearable haptic devices literature (Table 1/2). MSVI = Moderate to Severe Visual Impairments, Cog = Cognitive Load, PRM = Person with Reduced Mobility.

Wearable haptic devices

<i>Paper</i>	<i>Device</i>	<i>Haptic modality</i>	<i>Haptic Cues</i>	<i>Body Part</i>	<i>Info type</i>	<i>Haptic illusion</i>	<i>Target need</i>	<i>Walking experiment</i>
Culbertson et al. 2017 [22]	Finger straps	Tactile	Vibrations	Fingers	Direction		MSVI	
Liao et al. 2020 [95]	Legband	Tactile	Vibrations	Legs	Direction	•	Cog, MSVI	•
Petrausch et al. 2018 [123]	Wrist, anklebands	Tactile	Vibrations	Ankle	Direction, Obstacles		Cog, MSVI	
Simon et al. 2020 [149]	Anklet	Tactile	Vibrations	Ankle	Direction		Cog, MSVI	
Kammoun et al. 20 [67]	Inner sole	Tactile	Vibrations	Ankle, foot	Direction, Obstacles		MSVI	•
Meier et al. 2015 [104]	Footband, shoes, belt, wristband	Tactile	Vibrations	Ankle, foot, waist, wrist	Direction		Cog, MSVI	
Dim et al. 2017 [29]	Ear-ring, necklace, watch, glove, shirt, belt, sock, shoe	Tactile	Vibrations	Ankle, foot, waist, wrist, ears, neck, hand, fingers, torso	Direction		Cog, MSVI	•

Table 1.2: Categorisation of wearable haptic devices literature (Table 2/2). MSVI = Moderate to Severe Visual Impairments, Cog = Cognitive Load, PRM = Person with Reduced Mobility.

Hand-Held haptics for navigation assistance

We will now look at hand-held haptics for navigation assistance. This type of device implies fewer variations on the body parts used as they mostly stimulate the fingers or the hand but show a lot more diversity in the different haptic cues broadcast. As their name suggests, hand-held devices are objects that can be held in the hand and whose purpose is to convey haptic stimuli on the hand or finger's skin to transmit information. Contrary to wearable haptics, hand-held devices have the advantage of not imposing their use as a user can just decide to let go or put down the object. Compared to the previous analysis, we see in Table [Table2.1](#), Table [Table2.2](#) and Table [Table2.3](#) that these devices have a larger diversity in the type of actuation and feedback. Indeed, the haptic modalities and cues are a lot more diversified and offer kinesthetic, skin-stretch and tactile feedback. This might be explained by the fact that the object being held does not need to comply with the size constraints such as devices presented in Tables [1.1](#) and [1.2](#). The form factor and comfort are easier parameters when the device is not worn but held. The types of tactile cues in hand-held technologies also vary more. We can cite force, pseudo-force, shape-changing, thermal, and vibrations. In this second analysis, the vibrations are also dominant, with 40 % of the collected papers using this actuation modality. Just as we mentioned before, vibrators are usually robust, cheap, small, low consuming and are easy to integrate, and thus interesting related to navigation aids. From the literature, we can also notice that these devices come in multiple forms, which can help to better fit individuals' needs and preferences. Over 60 % of the vibrotactile hand-held devices presented here use to their advantage the fact that a majority of users nowadays use mobile phones and their included vibrotactile actuators. While it represents a smart solution compared to the bulk and inconvenience that an external added device can bring compared to a phone, the later one has some important limitations, including the number of actuators and the vibratory patterns that can be made. Some works like [\[135\]](#) add some motors outside the phone to enhance the actuation mode. The other apparatuses all present interesting advantages and limits. Devices using kinesthetic feedback show relevant techniques of guiding by applying a force on the hand, such as with the motorised cane [\[169, 170\]](#) or with a motorised walker [\[172, 106\]](#) by directly pulling the user towards the desired directions, comparable to the pulling sensation of a guide dog. This technique appears as one of the most natural, and intuitive to interpret.

However, in the case of robotic devices, it is fundamental to keep in mind that the users do not have control and thus are leaving their volition to the machine. The question of autonomy and safeness can in this cases be raised. The works presented by [78, 105, 109, 158] on an electric power-wheelchair (EPW) joysticks, or the handles of a walker seem less invasive, as they act more as a suggested instruction than a direct displacement generator. In this context, [101] developed a robotic wheelchair trainer that utilises kinesthetic cues from a force-feedback joystick to guide users along a predefined path. Results demonstrated improved steering abilities, also for children with severe motor impairment, highlighting the potential of integrating haptic feedback into mobility training devices. All these devices could, however, benefit from some alteration to get miniaturised and more adaptive to different populations in need. The most common device found in all three kinesthetic, skin-stretch and tactile divisions are the objects such as small boxes, handles or controller-shape devices. The Animotus [144], for example, is a cube-like device with a moving upper half that conveys heading and proximity information through shape changes felt by the user's fingers. The S-Ban [142], a hand-held haptic interface, offers 2-DoF spatial information. Finally we can also highlight some integration efforts on the cane [121, 75, 41] or on walkers [159] [51], intentionally leaving all control to the user by using vibrotactile cues and not kinesthetic modality pulling the users towards a direction.

These haptic aids are designed to create different types of messages, from assisting users in following a predetermined path [101, 17, 82] to notifying them of potential obstacles [158, 136, 51].

Similarly to wearable devices, about 13 % of the reviewed hand-held apparatus rely on haptic illusions to widen the possibilities offered by their haptic system and improve the conveyed sensation. [19, 151] use asymmetric stimulation to convey a sensation of rotation, this is also called the hanger effect. [150] induce pulling sensation through vibrotactile stimulations. [3, 4, 5] create a pseudo-attraction force, resulting in pulling or pushing sensations by using asymmetrical displacements induced by DC motors. Finally [41] created an impression of impact with a cane by using the apparent haptic motion illusion into the handle of their smart cane.

Overall, we can also highlight the fact that efforts for considering individuals with mobility deficiencies are made but are noted predominantly: 20% of the presented works. They are often dedicated to a unique mobility aid context, e.g. walker or electric power-wheelchair.

Hand-Held Haptic Devices

	<i>Device</i>	<i>Haptic modality</i>	<i>Haptic cues</i>	<i>Info type</i>	<i>Haptic illusion</i>	<i>Target need</i>	<i>Walking experiment</i>
Hashimoto et al. 2006 [53]	JoystickWalker	Kinesthetic	Force	Obstacle		Cog	•
Yokota et al. 2013 [170, 169]	Motorised cane	Kinesthetic	Force	Go/ No go		PRM, MSVI, Cog	•
Kondo et al. 2008 [78]	EPW joystick	Kinesthetic	Force	Direction		PRM	•
Morère et al. 2015 [105]	EPW joystick	Kinesthetic	Force	Direction		PRM	•
Nguyen et al. 2020 [109]	EPW joystick	Kinesthetic	Force	Direction		PRM	
Vander Poorten et al. 2012 [158]	EPW joystick	Kinesthetic	Force	Direction		PRM, cog	•
Zhang et al. 2018 [172]	Walker	Kinesthetic	Force	Direction		cog	•
Morris et al. 2003 [106]	Walker	Kinesthetic	Force	Direction		PRM, Cog	•
Jimenez et al. 2020 [63]	Walker	Kinesthetic	Force	Direction		PRM, MSVI, Cog	•

Table2.1: Categorisation of hand-held haptic devices literature (Table 1/3). MSVI = Moderate to Severe Visual Impairments, Cog = Cognitive Load, PRM = Person with Reduced Mobility.

Hand-Held Haptic Devices

	<i>Device</i>	<i>Haptic modality</i>	<i>Haptic cues</i>	<i>Info type</i>	<i>Haptic illusion</i>	<i>Target need</i>	<i>Walking experiment</i>
Amemiya et al. 2009 [3, 4, 5, 2]	Box	Kinesthetic	Pseudo-force	Direction, Obstacle	•	MSVI	•
Ando et al. 2015 [6]	Handle	Kinesthetic	Pseudo-force	Obstacle	•	MSVI	•
Choinière et al. 2017 [19]	Handle	Kinesthetic	Pseudo-force	Direction	•	MSVI	•
Borenstein et al. 1997 [12]	Motorised cane	Kinesthetic	Pseudo-force	Direction		MSVI	•
Ulrich et al. 2001 [156]	Motorised cane	Kinesthetic	Pseudo-force	Direction		MSVI	•
Wiehr et al. 2023 [164]	Handle	Skin stretch	Shape-changing	Direction		Cog	•
Liu et al. 2021 [97]	Handle	Skin stretch	Shape-changing	Direction		MSVI	•
Spiers et al. 2015-2022 [143, 146, 145, 144, 147, 142]	Box	Skin-stretch	Shape-changing	Direction		MSVI	• •
Chen et al. 2019 [16]	Handle	Tactile	Skin stretch	Direction		Cog	
Nasser et al. 2020 [107]	Handle	Tactile	Thermal	Direction		MSVI	•
Tanabe et al. 2021 [151]	Box	Tactile	Vibrations	Direction	•	Cog	
Kim et al. 2013 [75]	Cane	Tactile	Vibrations	Obstacle		MSVI	•
Pariti et al. 2020 [121]	Cane	Tactile	Vibrations	Obstacle		MSVI	•
Gallo et al. 2010 [41]	Cane	Tactile	Vibrations	Direction	•	MSVI	•

Table2.2: Categorisation of hand-held haptic devices literature (Table 2/3). MSVI = Moderate to Severe Visual Impairments, Cog = Cognitive Load, PRM = Person with Reduced Mobility.

Hand-Held Haptic Devices

	<i>Device</i>	<i>Haptic modality</i>	<i>Haptic cues</i>	<i>Info type</i>	<i>Haptic illusion</i>	<i>Target need</i>	<i>Walking experiment</i>
Robinson et al. 2009 [131]	Mobile PC	Tactile	Vibrations	Direction		Cog	•
Rovelo et al. 2015 [134]	Phone	Tactile	Vibrations	Direction		Cog	•
Pielot et al. 2011 [126]	Phone	Tactile	Vibrations	Direction		Cog	•
Robinson et al. 2010 [132]	Phone	Tactile	Vibrations	Direction		Cog	•
Jacob et al. 2012 [130]	Phone	Tactile	Vibrations	Direction, Obstacle		Cog	•
Jacob et al. 2011 [62]	Phone	Tactile	Vibrations	Direction		MSVI, Cog	•
Pielot et al. 2010 [125]	Phone	Tactile	Vibrations	Direction		Cog	•
Yasui et al. 2019 [167]	Phone	Tactile	Vibrations	Direction		Cog	•
Lin et al. 2008 [96]	Phone	Tactile	Vibrations	Direction		MSVI, Cog	•
Rumelin et al. 2011 [135]	Phone	Tactile	Vibrations	Direction		MSVI, Cog	
Azencot et al. 2011 [7]	Phone	Tactile	Vibrations	Direction		MSVI	•
Kuribayashi et al. 20 [83]	Phone	Tactile	Vibrations	Direction		MSVI	•
Tanabe et al. 20 [150]	Vibrotactile transducer	Tactile	Vibrations	Direction	•	Cog	
Wachaja et al. 20 [159]	Walker	Tactile	Vibrations	Direction		PRM, MSVI, Cog	•

Table2.3: Categorisation of hand-held haptic devices literature (Table 3/3). MSVI = Moderate to Severe Visual Impairments, Cog = Cognitive Load, PRM = Person with Reduced Mobility.

2.3.3 The Apparent Haptic Motion Illusion for navigation assistance

As detailed in our first mentioned of the haptic illusions in Section 2.1.3, the apparent haptic motion illusion has emerged as a main point of interest to become our tool in conveying directional information. In the pursuit of enhancing mobility assistance devices, this type of illusions provide a means to convey clearer and more complete sensations through simple actuation paradigms, contributing to the development of more informative haptic interfaces [89, 18]. By creating a sensation of continuous motion across the discrete stimulation points on the skin asynchronously activated, the AHM emerges as a interesting solution to convey a sensation of motion and, consequently, provide directional instructions.

Even though the AHM illusion presents such a relevant information carrier, it has almost been exclusively studied through vibratory stimulation [15, 41, 61, 141]. We indeed saw in the literature that vibrations cues are widely used in devices for navigation assistance. However, it is essential to recognise that vibratory stimulations, as they currently stand, do not inherently convey indications of direction. Addressing this limitation requires a focused effort on device design to create distinguishable points of stimulation, such as right and left handles. Without this differentiation, vibrations prove quite ineffective in conveying directional instruction. Yet, if device size and stimulation point constraints exist, it appears difficult to create such physical distinction between left and right. Vibrations end up giving more of binary information, such as “go/no go” indications.

For the specific case of the AHM, it has been extensively researched in terms of spatial and temporal dimensions, demonstrating its effectiveness in conveying directional information through both 1D and 2D patterns [122]. Expanding on the AHM studies, researchers have tested its robustness on various body parts [110, 61] to understand essential parameters driving this sensory illusion, presenting this illusion as a notable candidate for further exploration [61, 173, 159] in navigation tasks. While Gallo et al. [41] developed a smart cane integrating the AHM illusion to induce a collision sensation, their investigation did not encompass an in-depth psychophysical study of the AHM's.

Additionally, temporal parameters of the illusion such as activation delays between motors, have arisen as interesting elements to explore so as to deepen our understanding of the illusion mechanisms [76, 140, 141]. Notably, some studies have shown that temporal parameters different from those initially proposed can efficiently elicit this illusion [61]. Despite this progress, there is a noticeable gap in research focusing on the perception of speed and duration as sources of information in the AHM. These aspects could be particularly relevant for representing moving obstacles or indicating a recommended walking speed based on the current environment. The literature emphasises the versatility of AHM in conveying directional information and its effectiveness through vibrotactile cues [61, 173].

We identify two main aspects to investigate in the use of the AHM for navigation assistance. The first one is the ability to convey clear directional cues to inform the user on the path to follow; the second one is the impact of the curvature of a handle-shape support such as of a white cane handle, on the perceived haptic sensation. These observations highlight the need for more comprehensive research, considering that the majority of existing literature has focused on AHM studies on plane surfaces and predominantly with vibrotactile cues. The scientific road ahead offers ample opportunities for the exploration of haptic illusions and their practical application in mobility assistance devices.

2.4 Conclusion

The analysis of the haptic literature gives here the introduction of what is haptics and how do tactile sensations and the human haptic system function. Understanding the anatomy of the human hand and haptic system has paved the way to the field of haptic engineering to create all sorts of devices and interfaces implying the sense of touch [65]. A relevant aspect of the study of the haptic sensation is the existence of haptic illusions [91]. Just like with the visual and the auditory sense, the haptic sense can be fooled to perceive a different sensation from what is really physically transmitted. This is a crucial insight in the design of haptic interfaces in a lot of domains that we saw are very diverse and multiple. Robotics [129], medicine [37], entertainment [152], culture, accessibility [34] and mobility [51] are key sectors where haptics has started and keeps playing a main role. A meaningful application of the haptic

technologies are the assistance to people who have a disability or sensory impairments. Indeed, access to social interactions, culture, reading, autonomous displacements seem common and banal in people everyday life. However, for people with sensory, cognitive or mobility impairments, this access is considerably reduced, causing the loss of social life, activities, mobility, sometimes causing a list of mental and physical medical conditions [25].

In response to this, research labs have investigated the possibilities for information transfer for these applications. While some research are conducted on the communication aspect itself [34], other are investigating solutions for easier and more autonomous mobility [41]. Navigation assistance is our main focus in this thesis. A reason to our interest in this application is the lack of adaptability and efficiency in the proposed solution. We show in this state of the art the efforts to create navigation aid for people with sensory, mainly visual impairments, that we divided in two main groups : wearable and hand-held devices. While wearable device present the advantage of being in the right place and freeing the hand, they have the limitation of focusing mainly on vibrotactile actuators for size and comfort constraint, which do not allow for a lot of diversity in the actuation modalities. However, the vibrations have been described to engender fatigue and blur the tactile perception during prolonged use, making them a terrible candidate for navigation assistance [157]. Nevertheless, based on the literature compilation presented earlier, we can see that a wide part of the research also for hand-held devices are done with vibrations. Other type of haptic cues have been investigated, they are for example, kinesthetic and skin-stretch. In the large part of cases, kinesthetic devices, apply a pulling or a pushing force to the user through a handle. In those scenarios, the volition of the users is somehow muted and they have to leave it all to the device. This functioning can be stressful or frightening for users. We thus believe that there is an enthusiasm to be made in the haptic technologies using skin-stretch actuation.

Another lack found in the literature is the poorness and insufficiency of devices offering solutions not only for people with sensory impairments but also physical deficiencies. In that perspective, research has to be made to design an adaptive solution which could be implemented in a large variety of existing mobility aids.

To convey directional information, we saw that some devices are designed using haptic illusions. They enable the creation of richer and clearer haptic messages. One of them is the apparent haptic motion (AHM) illusion, where the asynchronous activation

of discrete stimulation points elicit a sensation of continuous motion. By creating a impression of motion, it also conveys an indication of direction. This has been studied mainly on flat surfaces and with vibratory signals. However, we explained our will to find an alternative to vibrations and we consider hand-held devices an interesting approach to be adapted on a large diversity of mobility devices (walkers, electric power wheelchair, precane, white cane,...)

This analysis of the literature strengthen our assertion and our will to answer three main scientific challenges that we introduced in the Introduction of the thesis to: 1) Design the haptic signals to convey a intelligible directional indication, 2) Integrate the validated directional messages into a handle shape device, 3) Create navigation strategies using a handle.

As the literature does not provide the sufficient insight about an interesting way to convey the apparent haptic motion without vibrations, or how could be affected the illusion of the perceived direction by the curvature of the handle, user studies have to be conducted in that respect. Experiments also have to be conducted to verify the possible implementation of the haptic cues and of the integration of the haptic handles on a mobility aid, and finally to confirm the validity of one or multiple navigation strategies enabling the guiding of users only through touch.

PART I

Design and evolution of a navigation assistance device

INTRODUCTION

This Thesis presents three main contributions corresponding to three *Parts*. In the first Part I, we will go through the conception, design and evolution of the haptic device built to convey directional information. It mainly shows the work, reflection, and iterations made to address Challenge #2 presented in Section 1.2.2, corresponding to integrating the validated directional messages into a handle shape device. Part II details the investigations of the haptic perceptions in order to answer Challenge #1 of designing the proper haptic signals to convey an intelligible directional indication and enabling the integration into a handle-shape device (Challenge #2). Finally, Part III present the ultimate steps to achieve the in-walking-condition use of the device, addressing Challenge #3 of creating and evaluating the proper navigation strategies.

This first part thus focuses on the elaboration and transformation of the device used in our studies from a haptic hand rest to a ready-to-use and complete handle. This work has been assisted by Frédéric Marie, engineer at INSA de Rennes for the device itself, Thomas Voisin for the actuators' soft 3D printing elements and Fabien Grzeskowiak and François Pasteau, research engineers at INSA de Rennes for the miniaturisation of electronics for portability purposes.

CONCEPTION, ADAPTATION AND IMPROVEMENT OF THE HAPTIC DEVICE

Based on the literature, our reflection is that hand-held apparatuses offer a more comprehensive range of possibilities, especially in actuation modalities [69]. Indeed, when browsing through wearable devices, we see that most of them are vibrotactile technologies [66]. Because some works have shown the limitations of the vibrations [157, 95], we wish to find a suitable design for a different actuation mode. This excludes mobile and smartphone devices from the possible hand-held device types as they solely use built-in vibrotactile actuators. However, a disadvantage of the conception of a hand-held device is that having a device constantly in the hand can reveal itself to be impractical. Most importantly, it can be non-compatible with other mobility aids that individuals already use, such as a white cane, a walker, a power wheelchair or a pre-cane. A relevant solution in that case appeared to be an adaptive handle, able to fit the existing mobility aids. It has to provide a comfortable grip for repeated and prolonged usage to enable the transmission of intelligible navigation information, be adaptive to mobility aid and customised to users' preferences and needs in size, actuation and navigation strategy.

We designed our device to test key features of the stimulation and improved it throughout the studies to achieve a satisfactory design for efficient and viable usage for daily navigation tasks. The device itself is composed of two elements: the actuators and the support. This work led us to the design and creation of three versions of the actuators and three versions of the support, which became the handle.

3.1 The handle

Dev-v1.0: The first version of our manipulandum is dedicated to preliminary investigations on the haptic perception. Because the literature introduces very few works about the apparent haptic motion on curved surfaces, we created a first experimental device to offer the possibility of evaluating the haptic perception on various curvatures. The device is composed of a rigid PLA 3D printed base, on which two rigid stops can be inserted. These stops are the elements that keep in place the final part of the device: the flexible hand rest in contact with the skin. The actuators (Act-v1.0 presented in Section 3.2) are mounted on the flexible hand rest, which can be set to 5 different curvatures, as shown in Fig. 3.2.

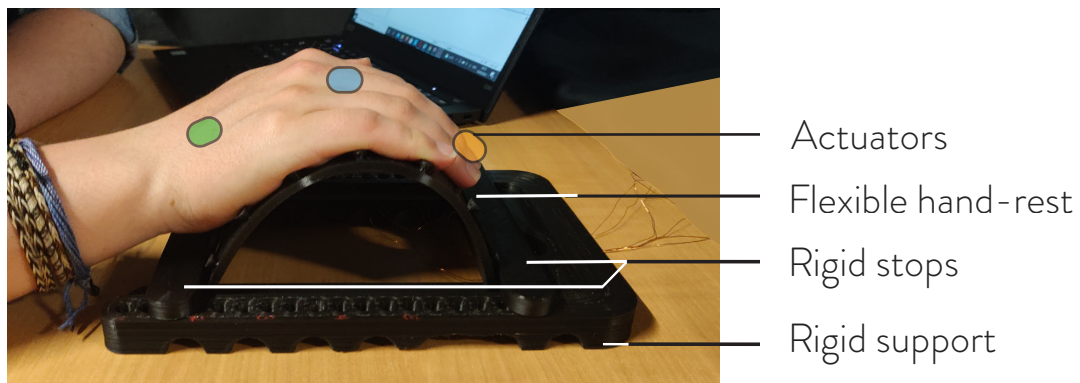

Figure 3.1 – Dev-v1.0 is composed of a rigid support on which is placed the flexible hand rest. The rigid stops enable the adaptation of the hand rest to five curvatures. The coloured dots show the contact points of the actuators (Act-v1.0) on the hand.

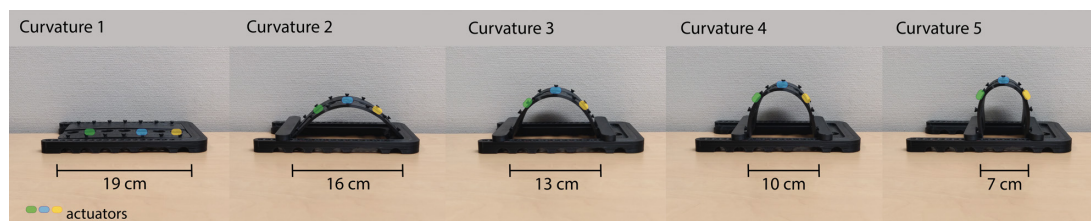

Figure 3.2 – Flexible 3D printed hand rest on the five tested curvatures, from flat to cylindrical.

Dev-v1.1: After confirming the functioning of the hand rest in different curvature, an alteration of the Dev-v1.0 was made to set the curvature 3 (in Figure 3.2) to a fixed bending enabling a comfortable resting position of the hand. This version of the hand rest was created to perform a psychophysical study in the perspective of determining the most relevant signals for navigation assistance.

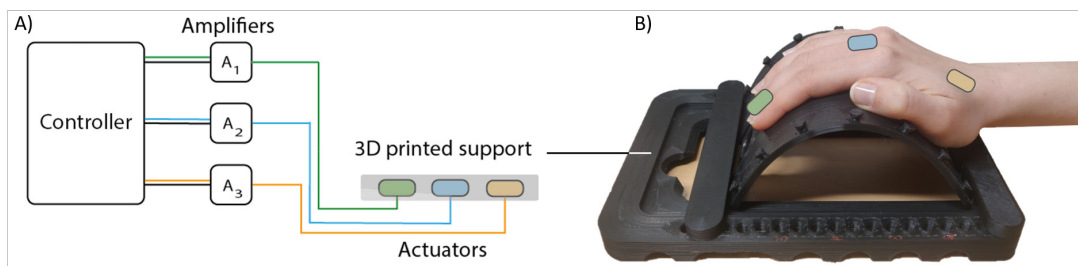

Figure 3.3 – Dev-v1.1: a) The signals are generated via a controller and then amplified before being played by the custom-built actuators (Act-v1.0). b) Three electromagnetic actuators are placed on a fixed curved hand rest. The coloured dots show the contact points of the actuators on the hand palm.

Dev-v2.0: Version 2.0 of the device states an important step in our project with the first realisation of a hand-held device with a cylindrical shape. It was found that a cylinder was not the optimal shape to maximise the contact surface between the hand and the handle. As a consequence, the Dev-v2.0 shape was designed to fit the hand snugly, and thus, it is not a perfect cylinder with a more planar side for the thumb. It was then 3D printed with soft material (Filaflex 82A, 0.4-mm thickness). The handle houses five custom actuators distributed across the structure in dedicated alcoves so as to stimulate the hand in crossing directions (see Fig. 3.4). Along the handle, the actuators stimulate the metacarpal bones; around the handle, they stimulate the thumb, the palm and the middle finger. This version of the device holds the actuators Act-v2.0 3.7.

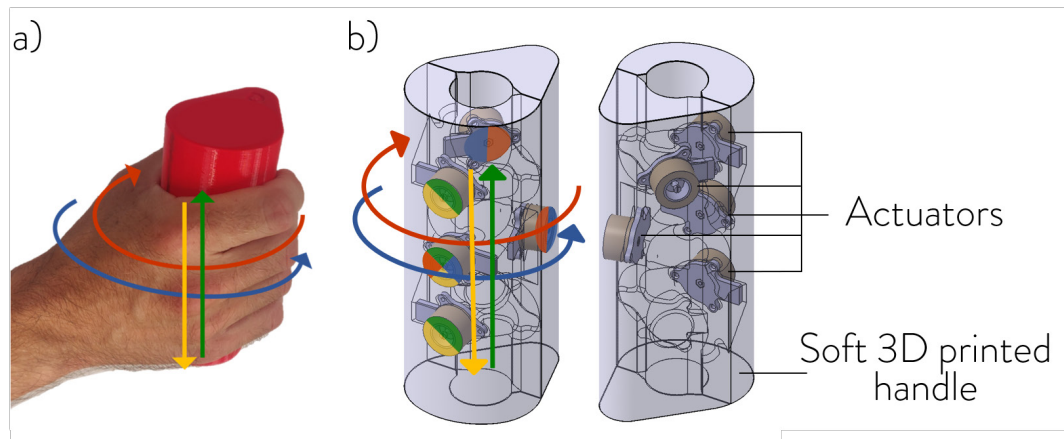

Figure 3.4 – Dev-v2.0: Haptic handle able to provide directional cues in 2D. We considered four directions to recognise: the first two (*green* and *yellow* arrows) run vertically along the axial direction of the handle, providing haptic cues across the hand metacarpals; the second two, (*blue* and *red* arrows), run around the lateral surface of the handle, providing haptic cues between the thumb and the middle fingers and across the palm. a) A user comfortably holding the handle with a power grasp. b) CAD model of the handle (two views) housing five custom electromagnetic actuators (Act-v2.0).

Dev-v3.0: For the final version of the device, we redesigned a haptic handle composed of five electromagnetic actuators, shown in Figure 3.5. Its design is inspired by the previous version Dev-v2.0, but features some improvements. First, the positioning of the alcoves housing the actuators has been revised. In the Dev-v2.0, the actuators were positioned to create a cross shape, thus stimulating the middle finger and the thumb. In this new version, the actuators are distributed across the handle in a “T”-configuration so as to stimulate the metacarpal bones of the palm (three motors), thumb (one motor), and index (one motor) fingers. Around the handle, the pattern thus created by the actuators’ locations aligns the tip of the thumb with the body of the second metacarpal bone and, finally, the tip of the index finger, as shown in red and blue in Figure 3.5.a). Along the handle, the actuators stimulate the metacarpal bones represented by the green and yellow arrows in Figure 3.5.a). This handle is also 3D printed out of TPU soft material (Filaflex 82A, 0.8 mm thickness). The inner dimensions are designed to be mounted on a standard walker (ErgoClick 4-wheel walker), replacing the default handles of this assistive device.

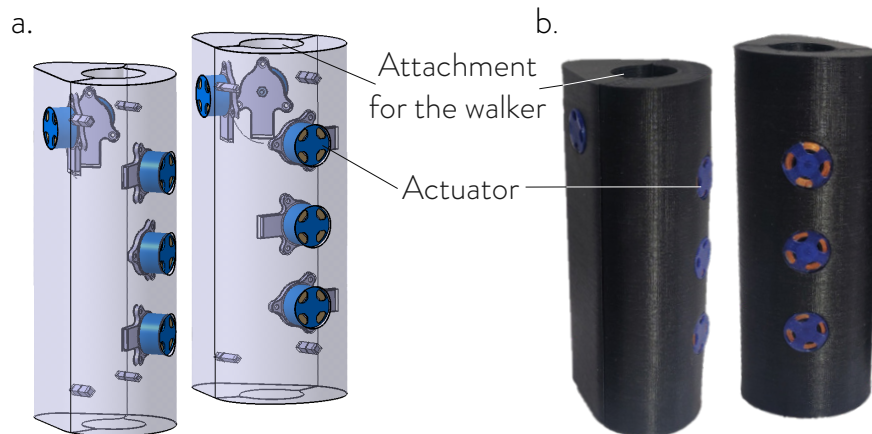

Figure 3.5 – Dev-v3.0: Right and left haptic handles for giving directional tactile sensations. a) CAD of the soft 3D printed handle made out of TPU, five alcoves are included to house the actuators along and around the handle in a “T”-shape, so as to stimulate the thumb, the second metacarpal bone of the palm, and the index finger. b) Picture of the two handles, symmetrically designed to fit the two hands.

3.2 Actuators

Act-1.0: The motors used for our device are not commercial actuators. They were custom-designed for our experiments and to meet our needs. These motors are electromagnetic actuators inspired by Duvernoy’s actuators for the HaptiComm device [33]. They are composed of two parts: a stator (static element) and a mover (dynamic element). The stator is composed of a 3D-printed support on which a coil is hand-made of copper wire with a winding machine. The mover is composed of two magnets glued in their repulsive so as to amplify the magnetic field. The coil is put under tension (from -6.5 to 6.5V). The mover goes up and down in the coil depending on whether the tension is positive or negative. A representation of the actuators is given in Fig. 3.6. This design utilises the same principle as a voice coil and can vibrate like vibrotactile actuators. However, the fact that the mover can come in contact with the hand and can be actuated with vibratory signals or sole impulses enables the use of the actuators *both* as vibratory stimulators and sustained non-vibrating pressure points, e.g., to produce “tap” sensations.

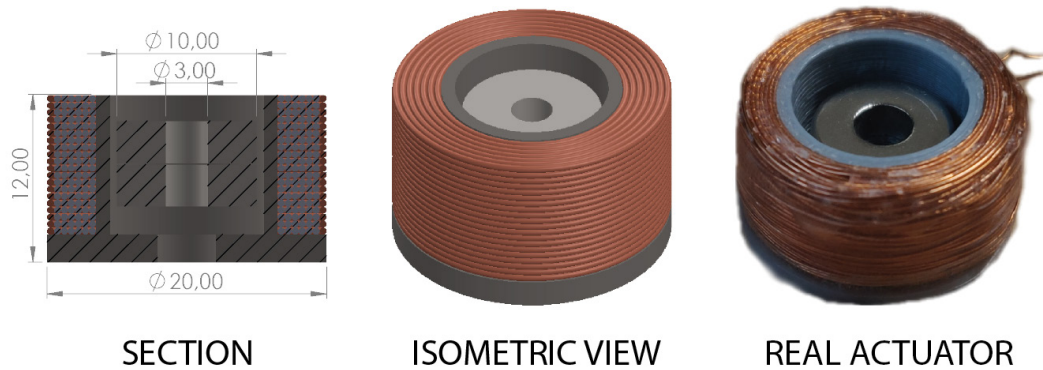

Figure 3.6 – Act-v1.0: CAD and picture of the custom electromagnetic actuators. The coil structure (dark grey) is 3D printed, and two magnets (light grey) glued in their repulsive position constitute the mover. The design is inspired by Duvernoy's [33]. Dimensions are in mm. a) Cut view. b) Isometric View. c) Picture of the actuator.

Act-2.0: For the integration of the actuators into Dev-v2.0, we had to decrease the size of the actuators, adjust their base's shape and think of a way to keep the mover horizontal in the stator. The second version of the actuator presents two major improvements. First, the 3D-printed support changes its shape to an arrow. This new shape enables a stable positioning within the handle Dev-v2.0 and houses smaller magnets. The second major improvement is in the inside part of the coil. When using the Act-v1.1 of the actuators, we noticed that the magnets had room to flip inside the coil. This sometimes made them stuck in the coil or made them pop out of it if no hand was stopping the magnets' trajectory. The actuators were improved here by adding a brass screw in the centre of the cavity where the ring magnets rest. The screw acts like a pillar, a guide along which the magnets slide. Two brass washers with a smaller inner diameter than the magnets' hole prevent the magnets from falling out of the coil, enabling the use of these actuators with the mover not pointing upwards. With this design, the head of the screw does pass through the magnet's holes but is stopped by the brass washer glued between the two magnets. By doing this and fixing the screw in the coil so that it just brushed the top of the coil, the mover is able to go out of the coil at about half its height. However, the magnets can never completely go out of the coil. This design was key for the implementation in a cylindrical hand-held device and its use in omni-directional positions. Nonetheless, it was found that the screw, although very practical, engenders too much friction and slows down the mover. It was found

to be mainly affecting the perception of tapping (non-vibrating) stimulation mode. Indeed, compared to the vibratory mode, which makes the whole actuator vibrate, the tapping mode relies almost solely on the perception of impact between the mover and the skin. Because of friction, this tap perception was lowered. When inserted in the Dev-v2.0 handle, the built-in membrane of the handle lowered the tactile sensation conveyed by the actuators.

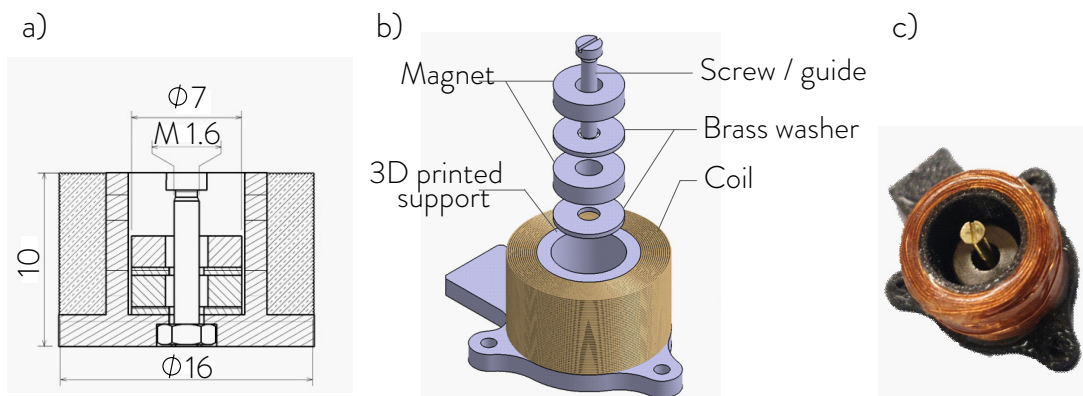

Figure 3.7 – Act-v2.0: Custom electromagnetic actuators used in the handle (Dev-v2.0). They are made with 3D printed support, 0.22 mm wire, two magnets, two brass washers, and a brass screw. The brass guide and the two brass washers running through the centre of the cavity prevent the magnets from falling out of the coil, enabling the use of these actuators in all positions, including upside-down positions. a) Cut view. b) Isometric View. c) Picture of the actuator.

Act-3.0: Our third and last version of the actuators gets rid of the screw as a guiding system because of the generated friction. It thus goes back to a more simple mover made only of two magnets. The improvements lie in the creation of a new membrane. This soft 3D-printed membrane made out of TPU, as soft as silicon, is created as a lid to be put on the actuator. It enables a larger deformation of the contact surface between the actuator and the user's skin. In this version, the mover is glued in the centre of the membrane and thus has its resting position up in the coil. For this actuator, an additional negative impulse was added to the signal sent to the actuators so that the movers get momentum before pushing the membrane out against the user's skin.

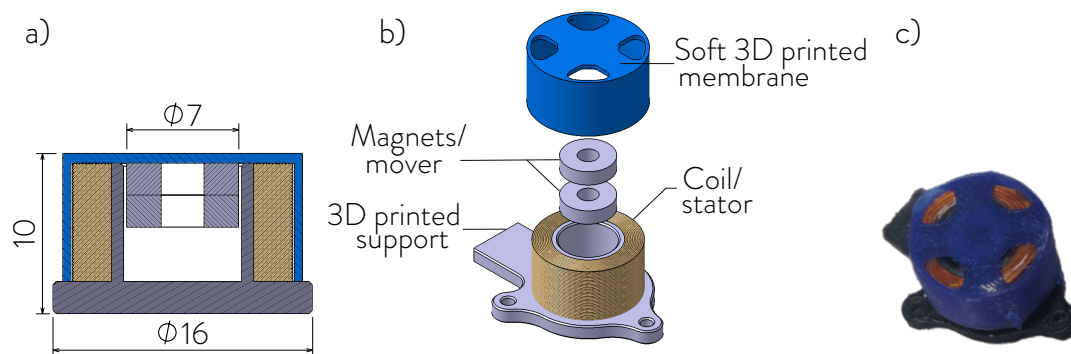

Figure 3.8 – Act-v3.0: Our custom-design electromagnetic actuator with the soft 3D-printed membrane. Five of these actuators are housed inside each handle. a) Cut view. b) Isometric View. c) Picture of the actuator.

PART II

**Studying the haptic perception of the
apparent haptic motion for navigation
information**

INTRODUCTION

This second part of the thesis details the investigations of the haptic perception, addressing two of the challenges presented in the Introduction of the manuscript. As a first achievement, the work on the device, along with the conducted experimental evaluations, enabled the design and validate the proper haptic signals to convey an intelligible directional indication (Challenge #1). Secondly, the in-depth work on the device shape variability enabled the integration into a handle-shape device (Challenge #2). In that respect, Part II details three user studies. The first one in Chapter 4 investigates the robustness of the apparent haptic motion illusion through the variation of the stimulation mode—vibrations and a proposed alternate “tapping” mode—and through the study of the curvature impact on the perceived haptic sensation. The study presented in Chapter 5 emerged from the will to further investigate the potential of the apparent haptic motion temporal parameters not only as optimal fixed values to convey the illusion but as a varying and rich source of information. Finally, Chapter 6 illustrates the first integration of the validated haptic signals to a handle-shape device to fit the aimed application of an adaptive haptic handle for navigation assistance. In this final study, the goal is to attest the proper perception of the haptic patterns in the spatial referential of the hand, thus as an objective evaluation of the haptic perception on the stimulated zones of the palm and not their subjective interpretation. All three studies presented in this Part have been approved by Inria’s ethics committee (COERLE Dornell - Saisine 513). This work has been assisted by Louise Devigne, a research engineer at INSA de Rennes, who handled both the application files and procedure for the ethics committee approval. Sebastien Thomas, engineer at INSA de Rennes, designed a virtual environment for a demonstration at EuroHaptics 2022. Dr. Emilie Leblong, Marie Dandois, Bastien Fraudet, Laure Mahe, from the Pôle St-Hélier clinic, Rennes, France and Carine Aumenier, locomotion instructor from Voir Ensemble Association, Centre Auvergne Bourgogne, France were consulted in the design process and participated to preliminary tests as members of the Dornell project.

VIBRATIONS VS “TAPS” FOR DIRECTIONAL INFORMATION ON CURVED SURFACES

Contents

4.1	Introduction	64
4.2	User Study	65
4.2.1	Experimental setup and signals	66
4.2.2	Experimental design	68
4.2.3	Participants	69
4.2.4	Experimental procedure	70
4.3	Results	71
4.4	Discussion	74
4.4.1	Impact of the hand rest curvature	74
4.4.2	Comparison of the two modes of stimulation	75
4.5	Conclusion	75

This Chapter presents the findings and analyses published as an IEEE Haptics Symposium 2022 technical paper and invited to be presented at EuroHaptics 2022: Inès Lacôte, Claudio Pacchierotti, Marie Babel, David Gueorguiev, Maud Marchal: *"Tap Stimulation": An Alternative To Vibrations To Convey The Apparent Haptic Motion Illusion* [84].

4.1 Introduction

As mentioned in Sections 2.1.3 and 2.3.3 of the related work Chapter 2, vibrotactile sensations can be used to elicit the apparent haptic motion illusion (AHM), which consist of using discrete vibration stimuli to convey an illusory continuous moving sensation across the skin. Such illusion, extensively studied in the vibrotactile literature, has been successfully employed and has proven efficient in eliciting directional or navigation information. However, experiencing vibrations during a prolonged period, as could be the case in navigation tasks, is also known to increase the cognitive load as well as a sensation of fatigue in the stimulated area.

In response to that limitation encountered with vibrotactile stimulations, we focused our first work on proposing a non-vibratory alternative. We refer to these stimulations as “taps”, corresponding to the tapping sensation they create. Based on this assessment, this study aims to compare the vibrotactile apparent haptic motion with a continuous non-vibratory stimulation (“tap”), which has been investigated for other applications with pin arrays, e.g. in Seizova et al. [139] or Duvernoy’s work [33].

This tapping AHM sensation is elicited by continuous mechanical signals activated in sequence. The main objective of this first perception study is thus to investigate whether the alternate stimulations could also create a convincing illusion of the AHM across the skin and convey a proper sensation of motion, hence of direction. This paves the way to answer our scientific Challenge #1 on designing the haptic signals to convey intelligible directional indications.

When crossing the literature of assistive devices and the one of the apparent haptic motion illusion, we saw in Section 2.3.3 that few researches actually take advantage of the AHM illusion potential in this field. While the apparent haptic motion has been studied on a large number of body parts, as mentioned in Section 2.1.3, the integration of haptic motion on curved surfaces such as handles seems to have been poorly investigated. This gap led us to go further in our user study by testing whether an increased curvature of the contact surface could impact the quality of the perceived illusion. This was made by using a flexible hand rest that we positioned on five different curvatures. It also represents the first step in addressing our second scientific challenge, which is to integrate validated directional messages into a handle-shaped device.

Chapter 4 thus presents a comparative perceptual experiment which enrolled eighteen participants, showing that the proposed “tap” stimulation is as efficient as a 120 Hz

vibrotactile stimulation in conveying the AHM illusion and the correct directional indication on the hand palm. Moreover, results showed that the curvature of the contact surface had little effect on the quality of the sensation. Thus, using continuous mechanical stimulations that do not vibrate can be a good alternative to vibrations for rendering haptic sensations in a cylindrical hand-held device.

This Chapter is organised as follows. Section 4.2 presents the materials and methods of the user study, Section 4.3 the results and statistical analysis across the considered conditions and Section 4.4 discusses the results. Finally, Section 4.5 concludes and proposes future directions and perspectives.

4.2 User Study

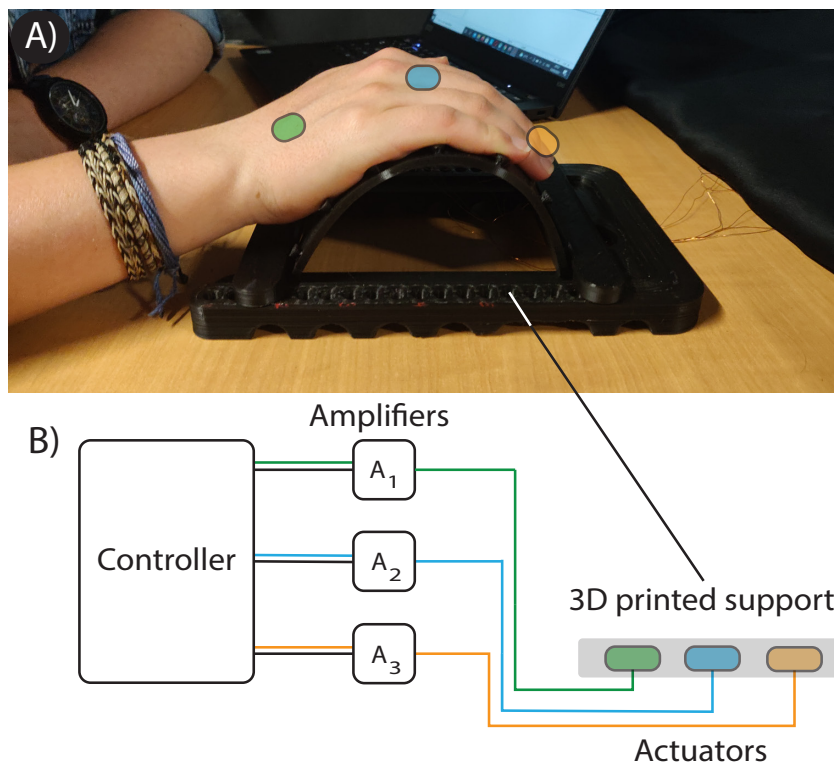

Figure 4.1 – a) The experimental setup is composed of 3 electromagnetic actuators (Act-v1.0) placed on a flexible hand rest (Dev-v1.0), adaptable to various curvatures. The participants answered questions regarding the illusory effect on a GUI interface located in front of them. The coloured dots show the contact points of the actuators on the hand. b) The signals are generated via a controller and then amplified before being played by the custom-built actuators.

This study aims to compare the effectiveness of vibratory and continuous mechanical stimulations, referred to as “tap” stimulations, for eliciting an apparent haptic motion illusion on a surface with variable curvature. Three different contact points on the palm and the middle finger are stimulated to convey the apparent haptic motion illusion either through subsequent vibrations or “taps”. Only one type of motor was used to provide both types of stimulations to keep the experimental setup as similar as possible between the stimulation modes.

4.2.1 Experimental setup and signals

The experimental setup of our first study is shown in Figure 4.1. All mentioned iterations of the haptic device or the actuators have first been developed in Chapter 3. It is composed of three custom actuators of the first version (Act-v1.0). With a coil as a stator and two magnets glued together in their repulsive position as a mover, freely placed in the coil. More details on the technical specifications of the actuators and their different versions are given in Section 3.2. The representation of the actuators used in our first study (Act-v1.0) is given in Figure 3.6. The device designed and experimented in this user study is the hand rest referred to as Dev-v1.0. It is presented in Section 3.1. This device is a flexible 3D printed (TPU) hand rest fixed onto a PLA rigid support designed to be set to 5 different curvatures during the experiment, as shown in Figure 4.2.

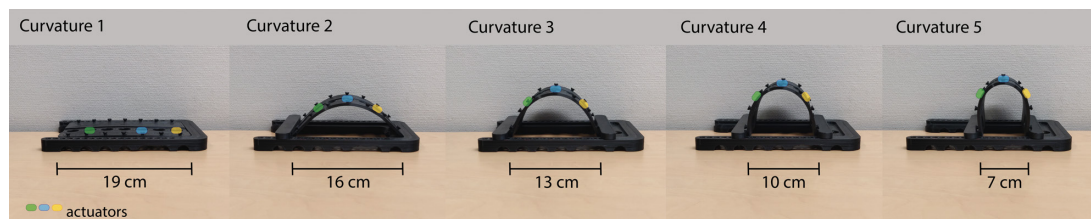

Figure 4.2 – Flexible 3D printed hand rest on the five tested curvatures, from flat to curved.

The commands for the three actuators are created via Matlab and then provided through a National Instrument USB-6343 series controller, which sends them to three amplifiers, enabling the delivery of a 6.5V signal to the motors, corresponding to a force of approximately 0.4 N exerted on the palm and the finger. Figure 4.3 presents

the superposed force data of five activations of an actuator recorded with a Nano17 force sensor (ATI, USA) at a sampling rate of 5000Hz.

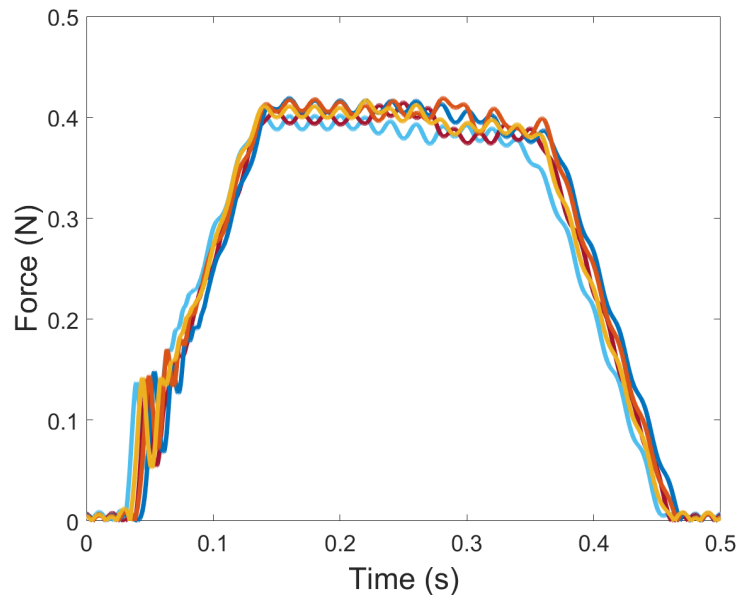

Figure 4.3 – Characterized force feedback for “tap” stimulations. The curves represent five consecutive trials.

The two magnets of the electromagnetic actuators go upward and downward in the centre of the coil, depending on the electrical tension passing through it. This design enables the implementation of the two stimulation modes for the study: (i) the vibratory mode and (ii) the “tap” mode. The vibratory mode consists of an oscillation of the magnets at a chosen frequency. This is implemented with the tension signal following a sinusoidal carrier within a ramp envelope, see Figure 4.4a). The second mode, also called “tap” mode, corresponds to a unique upward displacement of the magnets inside the coils, which is maintained during a time period called the Duration of Signal (DoS) before going back to their resting position, see Figure 4.4b).

The two modes provide asynchronous stimulations at the same three locations on the hand (see Figure 4.1). For both stimulation techniques, ramps corresponding to the activation of the voice coil actuators are delayed but overlap each other, as illustrated in Figure 4.4. The time delay between the actuators, also called Stimuli Onset Asynchrony (SOA) and DoS, are fixed parameters. Based on pilot tests and the

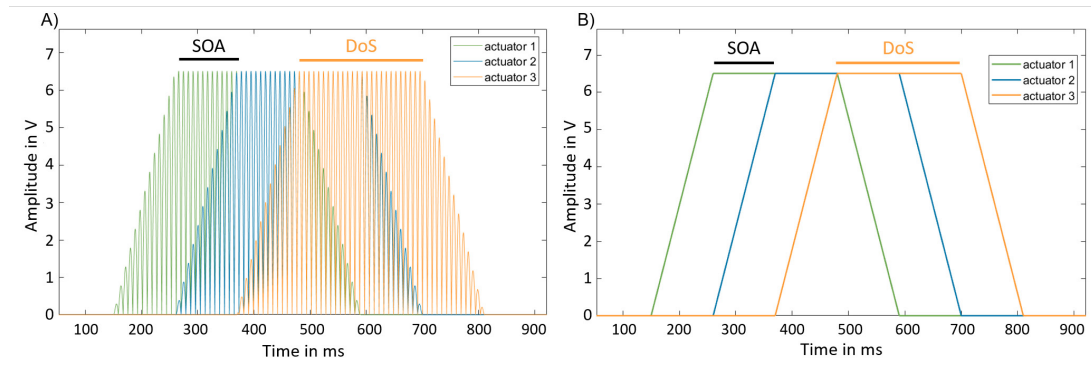

Figure 4.4 – Signals sent to the three actuators in both actuation modes. a) Vibratory mode, made of sinusoidal oscillations at 120 Hz within ramp envelopes. b) “tap” mode made of single ramp signals. Values for the DoS and SOA are fixed to $DoS = 220\text{ ms}$ and $SOA = 110\text{ ms}$.

AHM literature, we set the SOA and the DoS parameters to $SOA = 110\text{ ms}$ and $DoS = 220\text{ ms}$ in both stimulation conditions. A review on the AHM illusion with vibrotactile stimulations [173] helped determine the vibrating frequency of the motors, complemented by pilot tests, so as to ensure that frequency and intensity were pleasant for the user. Finally, the vibration frequency was set to 120 Hz . A unique maximum intensity, set through the signal voltage value at 6.5 V , is used during the entire experiment, enabling a sufficient force to be applied on the hand with no signal saturation.

4.2.2 Experimental design

The study was designed as follows: During the experiment, users are asked to comfortably rest their hands on the structure without applying any additional force. The experiment is designed so that the stimulations are conveyed along the middle finger to the bottom of the palm, and several conditions are tested. Besides (i) the two ways of stimulating (vibratory and “tap”), we also consider (ii) five different curvatures of the contact surface (Figure 4.2) and (iii) two directions of motion.

(ii) The five curvatures are obtained by bending the flexible hand support in which the motors are embedded. The obtained distances between the top and the bottom of the flexible support, as a result of the bending, are respectively 19 (totally flat, Curvature 1 in Figure 4.2), 16, 13, 10, and 7 cm (fully curved, Curvature 5 in Figure 4.2). The curvatures are chosen to range from the standard flat position to a curvature that resembles the one of a handle or joystick.

(iii) The two directions are either proximal-to-distal or distal-to-proximal along the hand (respectively green towards orange or orange towards green in Figure 4.1). They are described to the participants in “upward” and “downward” directions and are represented on a drawing.

Both the temporal and amplitude parameters are fixed for the study. The time delay between the actuator activation (SOA) and the duration of the signals (DoS) is constant, and the speed of the illusory motion is a fixed parameter. Finally, the signal maximum intensity is given at 6.5V for all stimulations, making the signal amplitude constant.

The study is organised to test the changing parameters as follows. The curvatures are tested one by one, and their presentation order is counter-balanced across participants to avoid habituation. For practicality, both modes (vibrations or “taps”) are tested one after the other in random order on a specific curvature before the curvature is modified. A block of stimulations is composed of 6 trials, of which the only changing parameter is the direction. A block is thus made of only vibratory or only “tap” stimulations, of which three are identical distal-to-proximal stimulations, and three are identical proximal-to-distal stimulations. Hence, blocks are differentiated by the type of signal that is provided (vibratory or “tap”) and by the curvature of the support (curvature from 1 to 5). The order of the six trials within a block is also pseudo-randomised. Moreover, a stimulation is made of three repetitions of the AHM pattern stimulation to ensure that the participants are able to perceive the signal before answering.

4.2.3 Participants

Eighteen persons participated in the experiment, of which eleven were women, seven were men between twenty-one and fifty-seven years old, and one was left-handed. Stimuli were delivered on the dominant hand and determined with a questionnaire before the experiment. None of the participants have had trauma on the tested hand that could affect his/her tactile perception. Participants were naive about the objectives and hypotheses of the experiment and had not seen or tried the setup before participating in the study.

4.2.4 Experimental procedure

Participants carry out the experiment in a dark room, with a box placed above the setup so that they cannot see the device before or during the experiment. They also wear noise-cancelling headphones to avoid any auditory information about the received stimuli. They receive no indication about the number of embedded motors in the setup nor about the number of activated ones, but they are told that the number would not vary within a block of stimulations. Indications about the global number of stimulations and repetitions are given before the experiment, along with the sum-up of the questions participants have to answer during the test. A Matlab script manages the transmissions of signals to the National Instrument controller card and stores the characteristics of the trials sent as well as the participants' answers. The presentation order of the five curvatures is given when launching the script for a user.

To begin with, the first curvature is set on the flexible hand rest. The participants keep their hand in a static position upon the support after the investigator has positioned it correctly on the hand rest. The correct positioning of the hand is checked throughout the experiment. After each trial, the participants answered two questions about what they perceived: (i) What was the direction of the stimulations? (ii) Rate the smoothness of the apparent motion generated by this particular trial on a seven-point Likert scale, from 1 (discrete) to 7 (continuous). Here, the evaluated parameters are the curvature, the mode of actuation and the direction of the motion. After the sixth trial, corresponding to the end of the block, participants are asked to rate three other perceptual dimensions of their tactile experience during the block: (iii) the ease of answering the up/down question from 1 (very difficult) to 7 (very easy), (iv) the pleasantness of the stimulation 1 (very unpleasant) to 7 (very pleasant), and finally (v) the fatigue perceived on their stimulated hand from 1 (not tiring at all) to 7 (very tiring). For this second part, the evaluated parameters are the curvature and the mode of actuation. The directions being mixed within a block are not evaluated for those questions. This process is repeated for the other mode of stimulation and on the five curvatures, which are tested in a counter-balanced order.

The data is then processed and organised to create the matrix of interest to study the impact of the curvatures, the difference in perception of the two stimulation modes

and the effect of the direction of the pattern. The participants were also able to give free comments and feedback about their sensations and the experiment at the end of their participation in the study.

4.3 Results

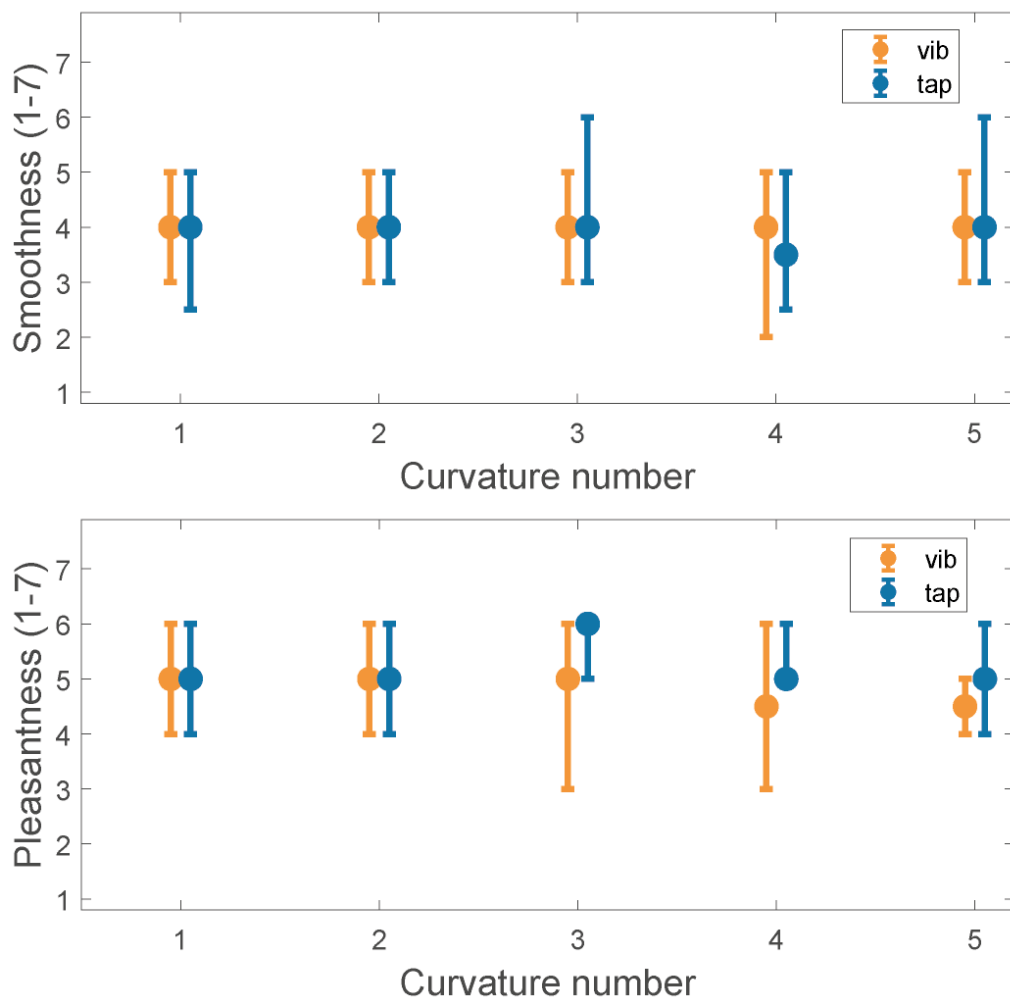

Figure 4.5 – Rates on a 7-point Likert scale for the AHM. a) The smoothness was rated after each trial of the experiment, and each data point was averaged over an experimental block. The middle points correspond to the median value, while the error bars give the first and third quartiles. The same plot was made for the pleasantness.

The results showed that whatever the curvature and the stimulation mode, the participants could perfectly sense the direction of the apparent haptic motion, as the median, first and third quartile of scores were all at 100% of success. Thus, the quality of the AHM illusion was assessed by the additional questions which participants had to answer.

For each of these questions, we performed a Generalised Linear Model (GLM) statistical analysis on the independent variables of our study. For the smoothness score, which was answered after each trial, these variables were the curvature, the mode of stimulation and the direction of the movement. The GLM analysis showed no statistical effect of curvature ($p = 0.450$) nor an effect of the stimulation mode ($p = 0.484$). Only the direction of the stimulation showed a weakly significant effect on the perceived smoothness ($p < 0.05$). To investigate this effect further, we performed a post-hoc statistical analysis that confirmed that the perceived smoothness was significantly different (Mann-Whitney ranked test: $U = 135349$, $p = 0.038$) between the two directions of stimulation. Its score was 3.85 ± 1.53 when stimulating proximal-to-distal AHM and 4.05 ± 1.60 for distal-to-proximal AHM. Interestingly, both stimulation modes showed an identical perceived level of smoothness that corresponds to a slightly above-average perception of smoothness reported in Figure 4.5a).

A similar GLM analysis was performed on the answers about the pleasantness (Figure 4.5b), the ease to answer (Figure 4.6a) and the perceived fatigue (Figure 4.6b). Since these questions were answered after experimental blocks that mixed the two directions of stimulation, we considered solely the stimulation mode and the curvature as independent variables. The GLM analysis only showed a significant effect of the amount of curvature on the fatigue ($p=0.009$). In the subsequent post-hoc analysis, we only found a significant effect of the curvature (Friedman test $n = 18$, $Q(4) = 11.47$, $p = 0.049$) for fatigue results when using “tap” signals. However, the influence of curvature on fatigue was not found significant when stimulating with vibrations (Friedman test $n = 18$, $Q(4) = 5.515$, $p = 0.24$). As a consequence, the “tap” mode was found to be slightly more tiring in the highest curvature: Wilcoxon matched-pairs signed rank $n = 90$, $W = -364$, $p = 0.0018$.

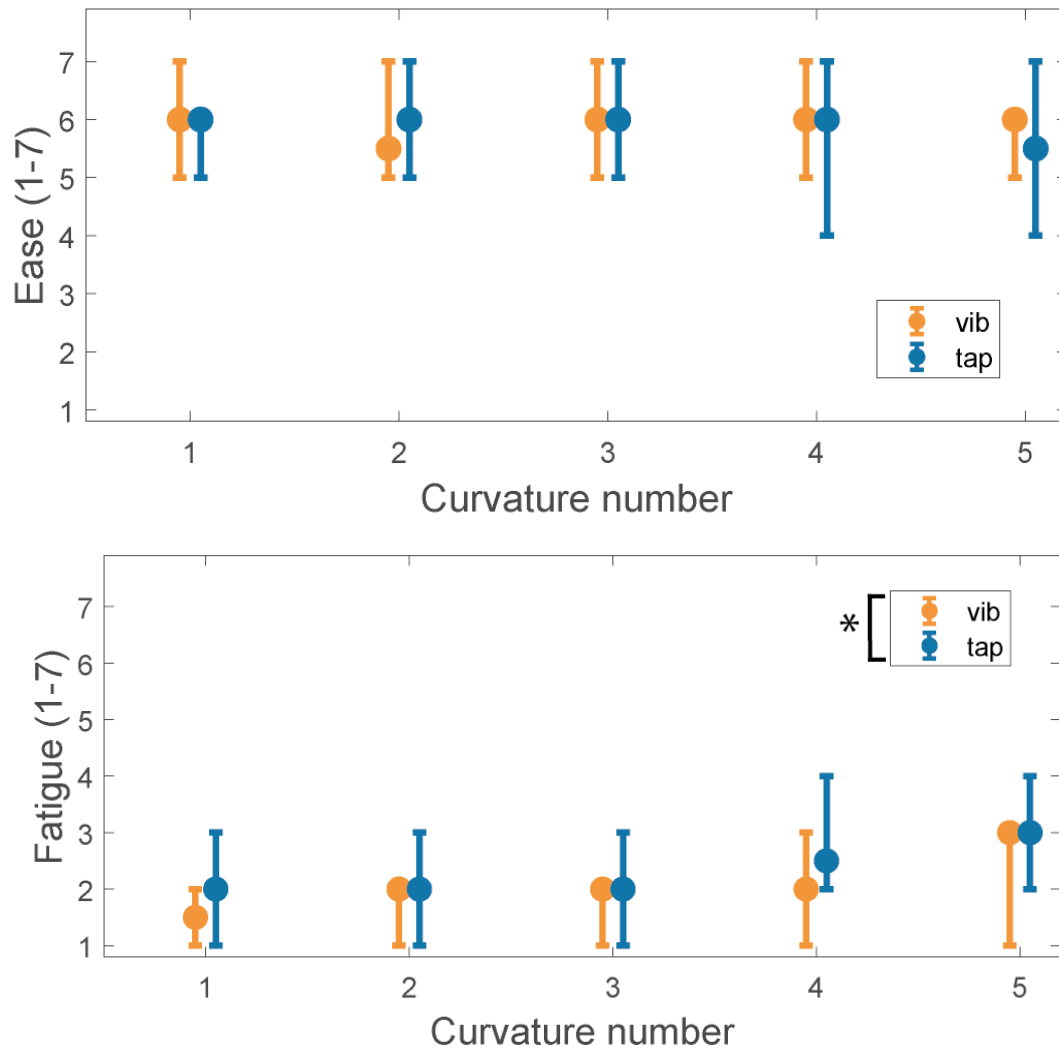

Figure 4.6 – Rates on a 7-point Likert. Points represent the median value, and the error bars give the first and third quartiles. a) Perceived ease to find the direction of the AHM. b) Perceived fatigue on the hand.

4.4 Discussion

The apparent haptic motion (AHM) has been largely studied in vibrotactile stimulations and on flat surfaces and has proven efficient. In this study, we wanted to explore the perceptual potential of the AHM illusion with an alternate stimulation mode and on bent surfaces. To that end, we investigated the effect of the hand rest curvature on the perception of the apparent haptic motion on the hand. Besides this, we also investigated whether vibration is a mandatory component in conveying this illusion. Thus, a continuous mechanical stimulation induced by sustained pressure of the actuator on the skin was implemented in the study. Both objective and subjective aspects of haptic perception were evaluated in the study.

4.4.1 Impact of the hand rest curvature

A main objective of this study was to determine whether the curvature of a hand rest would have a significant impact on the perception of the apparent haptic motion on the hand. To better understand the perceptual strength of the apparent motion, we conducted a study to test the illusion with parameters validated by other studies like Gallo et al.'s [41] on a hand rest, taking five different curvatures. It was decided to use a flat surface as one of the five hand rest positions to have a reference model that could easily be transposed to the existing literature. Secondly, we tested bending that went until the highest curve of the support, still enabling the magnets to remain in the coil despite gravity. The palm and the middle finger were chosen to be the stimulated zone because some studies already exist about the AHM on the hand. Moreover, this area, being the largest on the hand, enabled the separation of the stimulation points to their maximum distance for two reasons: testing the maximum robustness of the illusion with a small amount of material and being free of electromagnetic interference considerations. The study, conducted on 18 participants, tested, between other elements, the clearness and comprehensibility of the direction conveyed on the five curvatures. It showed no significant impact of the bending on the perception of the directional cues, nor did it have an effect on the perception difficulty, pleasantness of the stimulation or perceived smoothness. An effect was statistically found on the fatigue perceived on the highest curvatures. Our hypothesis is that the sensation was mainly unpleasant because of the uncomfortable wrist position that participants had to keep during the

experiment, which caused fatigue. Overall, the apparent motion illusion was found to generate auspicious, stable perception across every bending of the contact surface. Opening a very optimistic path to a proper integration of our system in a handle-shape device (Challenge #2).

4.4.2 Comparison of the two modes of stimulation

Besides being widely tested on flat surfaces, experiments on the apparent haptic motion illusion have mainly been conducted with vibrations and proved its efficiency. However, vibrations are also known to engender various difficulties when used for an extended period of time, such as a sensation of fatigue or tactile noise, which can sometimes be confusing. An interesting solution to this issue would be to find an alternative method to the vibration. In this study, we propose a mode of stimulation that does not constantly vibrate. We thus compare two modes of activation, which are vibratory stimulations and continuous mechanical stimuli causing a “tap” stimulation. For every mentioned curvature, participants scored equally on the identification of the direction of the AHM along their palm and their middle finger. Besides, the “tap” stimulations were found to be as smooth, easy to understand, and pleasant as the vibratory mode. Only the fatigue experienced by participants was slightly higher with the “tap” mode for the most curved contact surfaces. However, since the task was easy and participants’ fatigue was very low in both modes, our thoughts are that the difference might be due to the transient nature of the changes in the “tap” mode. For their free comments, several participants reported that the “taps” were perceived as more delicate stimulations and that their amplitude was felt lower than the vibrations’. As a consequence, some of the participants suggested the vibrations appeared more as alert signals.

4.5 Conclusion

This Chapter presents our first user study investigating the haptic perception of the apparent haptic motion (AHM) illusion as a tool for navigation guidance. We conducted this experiment on eighteen participants. There were multiple tasks to be completed in this study. Participants had to determine the directional indication conveyed through

a tactile pattern on their palm. These patterns were based on the apparent haptic motion illusion. After identifying the direction of the motions, participants had to rate various subjective parameters such as the pleasantness, the smoothness, and the ease of identifying the direction.

To fill in the identified gap in the literature, which represents crucial aspects for the realisation and implementation of our assistive handle, we conducted our experiment on five different curvatures to investigate the impact of the surface bending on the haptic perception of the AHM and the direction. Because we wish to find a relevant alternative to the vibratory signals, we compared them to “taps”.

Through this initial exploration, we successfully validated the discrimination of direction in 1D along the palm and middle finger using the apparent haptic motion illusion with just three actuators and two distinct stimulation modes. This validation marks a crucial step in conveying tactile patterns for information indication.

Importantly, the robustness of our patterns on curved surfaces, crucial for accommodating a cylindrical handle, was concretely tested. Results indicate a high level of robustness over varying curvatures, as all participants accurately discriminated the movement direction on their hand. Additional inquiries revealed no significant differences, affirming the consistency of the AHM illusion. Participants equally appreciated both stimulation modes, considering them smooth, pleasant, and equally easy for discriminating motion direction. In essence, the AHM illusion demonstrates resilience across a broad range of curvatures, and the “tap” stimulation emerges as a viable alternative to vibrations.

The findings of this study carry profound implications for navigation applications and lay the foundation for optimising our haptic device.

However, intriguing questions remain unanswered from this initial experiment. Can actuators be enhanced to deliver a more intense "tap" stimulation? Is it possible for the AHM to convey a more comprehensive array of information types, such as speed, thereby expanding its potential applications? These unresolved queries provide avenues for future research, signalling the ongoing evolution and refinement of haptic technology based on the AHM illusion.

SPEED DISCRIMINATION: THE AHM TEMPORAL PARAMETER AS A SOURCE OF INFORMATION

Contents

5.1 Introduction	78
5.2 User study	79
5.2.1 Experimental set-up and signals	79
5.2.2 Experimental design	80
5.2.3 Participants	80
5.2.4 Experimental procedure	81
5.3 Results	81
5.4 Discussion	84
5.5 Conclusion	84

This Chapter presents the work published as a full paper at EuroHaptics 2022 and presented at this same conference.

Inès Lacôte, David Gueorguiev, Claudio Pacchierotti, Marie Babel, Maud Marchal: *Speed Discrimination in the Apparent Haptic Motion Illusion* [88].

This paper received the Best Paper Award.

5.1 Introduction

The first study in Chapter 4 validated that the apparent haptic motion illusion was a robust haptic cue to convey directional information with vibrations or “taps” on both flat and curved surfaces. When talking about the AHM illusion, timing is crucial. Indeed, the temporal parameters are some of the most discussed parameters for providing the smoothest illusion. One of the objectives of our haptic perception series of studies was to determine the potential or limitations for wider information types using the AHM. From the literature, we know that Sherrick et al. [141] theorised functions of the temporal parameters to create an accurate illusion. However, to the best of our knowledge, the temporal parameters have not been studied as a source of information, e.g., as an indication of walking speed or the velocity of a moving obstacle. The goal of this second study is thus to investigate how the modification of the temporal parameters of the AHM illusion can elicit different velocity indications. To go further and comparably to the first study, we also tested this identification task with two modes of stimulation. Indeed, while the AHM is conventionally conveyed with vibrations, the work presented in Chapter 4 suggested that the illusion can also be conveyed by “taps”. To explore that possibility, we conducted a study with two main objectives. First, we determine and compare the threshold of velocity differences enabling the discrimination of the apparent motion speeds using both vibrations and pressure intervals (“taps”) on the skin. Secondly, we study the impact of these modes on the participants’ confidence when answering. Both investigated questions are key elements to address Challenge #1, aiming to determine persuasive haptic cues for navigation scenarios.

Chapter 5 thus presents a user study conducted on ten participants to investigate the discrimination of velocity when changing the actuation delay in the AHM and the robustness of this perception, considering two stimulating sensations and two directions of motion along the palm and middle finger. As expected, results show that participants were better at discriminating the velocity of the illusory motion when comparing simulations with higher differences in the actuators’ activation delay. Results also show limitations for the integration of this approach in everyday life applications.

This Chapter is organised as follows. Section 5.2 presents the materials and methods of the user study, Section 5.3 the results and statistical analysis across the considered

conditions, and finally, Section 5.4 discusses the results and proposes future directions and perspectives.

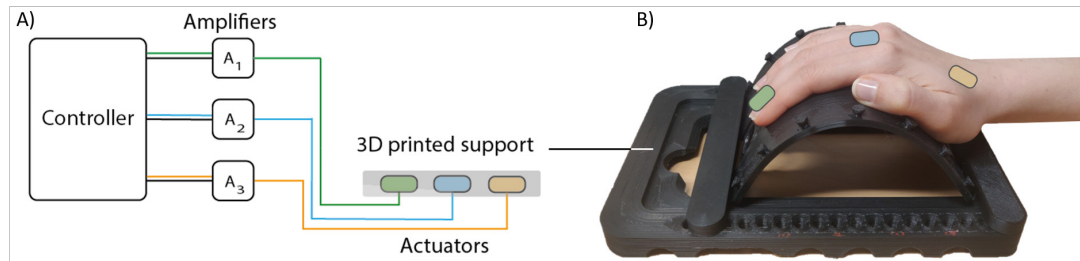

Figure 5.1 – Experimental set-up. a) The signals are generated via a controller and then amplified before being played by the custom-built actuators (Act-v1.0). b) Three electromagnetic actuators are placed on a fixed curved hand rest (Dev-v1.0). The coloured dots show the contact points of the actuators on the hand palm.

5.2 User study

This study aims to investigate the ability to discriminate velocity differences in the AHM illusion, comparing vibratory and tapping stimulation modes on a fixed curved surface.

5.2.1 Experimental set-up and signals

The experimental setup is shown in Figure 5.1. For this second experiment, we used the same device (Dev v1.0) with the same actuators (Act v1.0) as in the first study (see 4.2). In this study, however, we fixed the hand rest position to a comfortable bend for the participants, as the curvature showed no effect on the perception of the AHM direction or smoothness. Identically to the previous experience, the signals for the three actuators are first created with Matlab and then processed through a National Instrument USB-6343 series controller, which sends them to three amplifiers, enabling them to deliver a 6.5V signal to the motors. The two magnets of the electromagnetic actuators move upward and downward into the coil, depending on the electrical tension passing through it. For the vibratory mode, frequency is set based on previous studies investigating the apparent haptic motion illusion with vibrotactile stimuli at 120 Hz. The signals sent to the actuators are given in Figure 4.4. This Figure shows the signals imparted to the three motors in the two stimulation modes. In both modes, asynchronous overlapping stimulations are sent to the same three locations on the hand

(see Figure 5.1). While the duration of activation of the actuators is fixed, we seek to change the time delay between the actuators' activation, also called Stimuli Onset Asynchrony (SOA). Based on pilot tests and [41], we set the $DoS = 220$ ms and the reference $SOA = 110$ ms in both stimulation modes. In the following experiment, we tested SOA values of 90%, 80%, 70%, 60% and 50% of the reference SOA, making the compared SOA values [99, 88, 77, 66, 55] ms.

5.2.2 Experimental design

Stimulations are conveyed along the middle finger and the proximal part of the palm, as shown in Figure 5.1. We consider the two stimulation modes presented in Section 5.2.1, vibratory and tapping, as well as two directions of motion, proximal-to-distal (orange-to-green in Figure 5.1) and distal-to-proximal (green-to-orange).

The two modes (vibrations or “taps”) are tested in two blocks, carried out one after the other. A block is thus made of only vibratory or only “taps” trials. Each block is composed of 80 trials of which the changing parameters are the SOA and the direction of the motion. A trial is a sequence of the reference signal with a $SOA=110$ ms and then a comparison signal with a different SOA, both having the same orientation (see also Section 5.2.4). The sequence of two signals is repeated a second time before the participants answer the questions. The order of the signal presentation is pseudo-randomised. Thus, blocks are only differentiated by the type of signal that is provided (vibratory or “taps”) and the order of the comparison, pseudo-randomised differently for each block and each participant.

5.2.3 Participants

Ten persons participated in the experiment. They were all between twenty-one and thirty years old, of which two were women, and one was left-handed. Stimulations were delivered on the dominant hand. Participants were naive about the hypotheses and process of the experiment. Participants carried out the experiment while wearing headphones and playing white noise to mask the sound coming from the motors. Indications about the global number of stimulations and questions were given before the experiment.

5.2.4 Experimental procedure

During a trial, participants would receive, in a random order, (i) the reference stimulation ($SOA = 110$ ms), delivered with the stimulation mode of the block at hand, and (ii) one of the comparison signals having a different SOA, delivered with the same stimulation mode and same orientation. The identical sequence was played a second time to end a trial. After each trial, the participants answered two questions about what they perceived: (i) “Which one of the two motions was faster?” and (ii) “How certain are you of your answer?”. The data collected from the participants were the index of the signal that seemed faster (1 or 2) and their confidence from 0 (no confidence at all) to 100 (total certainty). The mode of the starting block was counterbalanced between participants. At the end of the experiment, participants were also able to give open comments and feedback about their sensations and the experiment in general.

5.3 Results

Results are reported in Figs. 5.2 and 5.3. Figure 5.2 shows the rate of correct responses (score), while Figure 5.3 shows the reported confidence. These two parameters are the dependent variables of our statistical analysis. As independent variables, we report the results for five SOA levels and four experimental conditions: two directions of motion (proximal-to-distal or distal-to-proximal) and two types of stimulation (vibrations or “taps”).

Results showed a significant decrease in correct answers when the time delay between actuators, the SOA, increases and, thus, gets closer to the reference SOA. This performance trend is observable in all conditions, both in “taps” and in vibration mode, as well as with proximal-to-distal or distal-to-proximal direction patterns. To confirm the visual perception, we performed a Friedman statistical test on the four experimental conditions. The test highlighted the effect of the changing value of the SOA on the participants’ performance to discriminate the fastest stimulation they received for the conditions of proximal-to-distal “taps”, distal-to-proximal “taps”, proximal-to-distal vibrations and distal-to-proximal vibrations ($p < 0.01$).

An identical Friedman test was performed on the effect the compared SOAs have on the confidence rates. A significant effect was also noted for the four experimental conditions ($p < 0.01$).

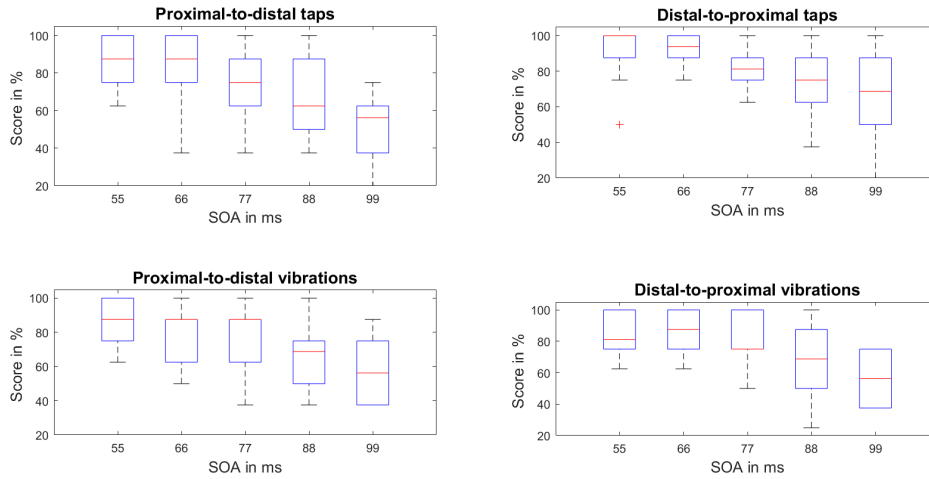

Figure 5.2 – Score when comparing five different SOAs with the reference $SOA_{ref} = 110\text{ ms}$, across the two directions of motion (proximal-to-distal or distal-to-proximal) and type of stimulation (vibrations or “taps”). The boxplot gives the median, 25 and 75 percentiles with extrema values.

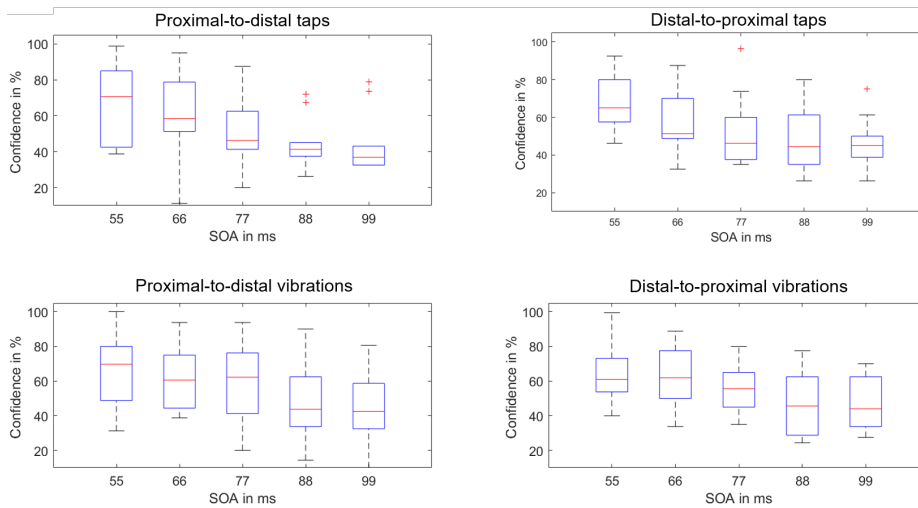

Figure 5.3 – Reported confidence of answer when comparing the SOAs across the two directions of motion (proximal-to-distal or distal-to-proximal) and type of stimulation (vibrations or “taps”). The boxplot gives the median, 25 and 75 percentiles with extrema values.

To interpret the effect of the direction (distal-to-proximal or proximal-to-distal) and the stimulation mode (“taps” or vibration), we performed matched-pairs Wilcoxon tests. The test showed no significant effect of the stimulation mode ($p > 0.05$), but it showed significant differences in the score between the proximal-to-distal and distal-to-proximal direction in tapping stimulations ($p < 0.01$). However, a post-hoc test operated separately for each SOA did not show a significant difference for any of the comparisons.

Finally, the matching between performance and confidence was tested by a Spearman correlation test Figure 5.4 and was found significant for all conditions but with a rather low r coefficient of around 0.4.

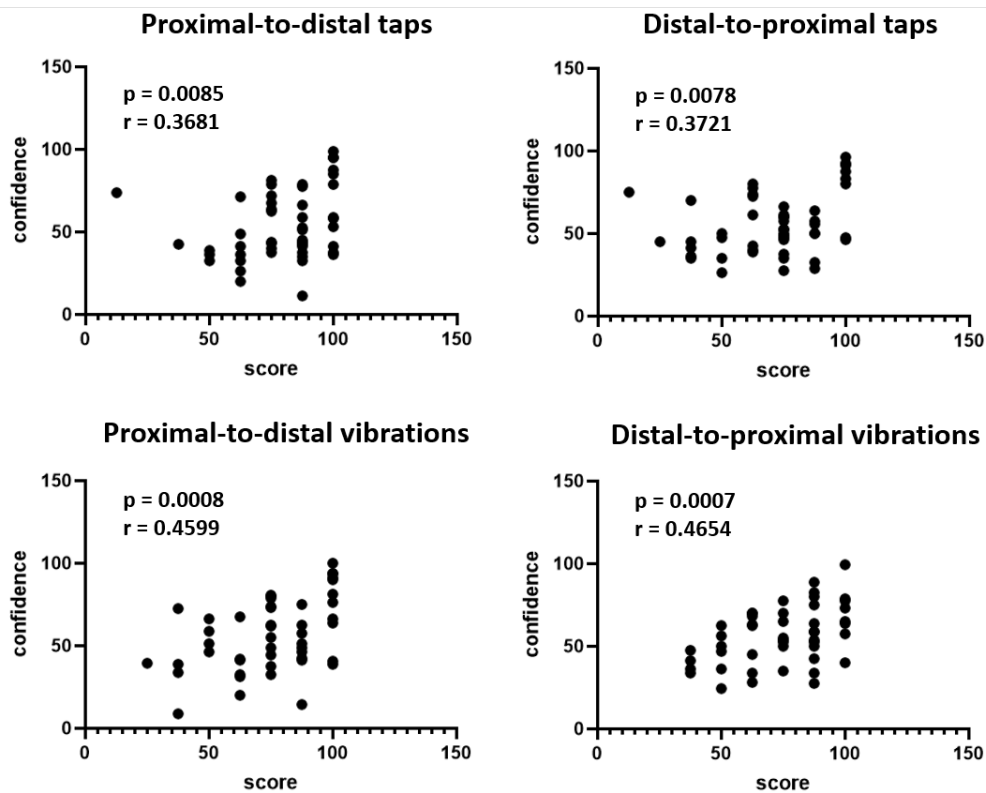

Figure 5.4 – Spearman correlation tests with the corresponding p-values and statistical dependence factors “ r ”. We tested the correlation between the confidence and the score for the different conditions of mode and direction.

5.4 Discussion

This study investigated the perception of the velocity of the apparent haptic movement as well as the impact of two experimental conditions: the direction of the AHM and the stimulation mode. These two stimulation modes are the standard vibrations and the “taps” to the palm of the hand. We also considered two directions of motion, from the fingertip to the palm and vice-versa. We studied the role of the delay between the activation of the actuators in the perception of velocity. As expected, the smaller the delay compared to the reference, the better the participants’ speed discrimination. However, it was surprising to observe performance around 85% even for the easiest comparison stimuli, for which the SOA was divided by a factor 2 compared to the reference, where our hypothesis was to have almost no error. Another important objective was to determine the matching between participants’ performance and their confidence. As expected, the confidence and score correlated, but the r coefficient was surprisingly low, suggesting that participants struggled to assess their own performance. There was no significant influence of the mode of stimulation on the score or confidence, which showed a similar perception of both modes. Overall, the task was very challenging for participants, and a few of them highlighted the difficulty of the task in their free comments. Thus, AHM illusions with different speeds might not be intuitive enough for people to use during everyday navigation tasks. The outcomes of the experiment were very interesting in terms of haptic perception and confirmed that human perception of tactile speed is inaccurate and prone to artefacts.

5.5 Conclusion

This Chapter presents a user study conducted on ten participants and aims to study the impact of variations in the temporal parameter of the AHM and determine if this variation could be used as informative data. The exploration of tactile speed perception and discrimination has often been studied through experiments involving textures and vibrations [23]. It also has traditionally revolved around surfaces sliding under the middle fingertip, generating contact and skin stretch. However, this experiment takes a distinctive approach to understanding the haptic perception of speed in the AHM illusion, revealing limitations in the use of temporal parameters within this illusion as a dependable source of information. Notably, in such rapid haptic cues, the differences

in the activation delay are too low and make it challenging to ensure accurate velocity discrimination between patterns when compared to a reference delay (the Stimuli Onset Asynchrony). Indeed, when looking closely at the results of the experiment, we see that temporal parameters of the apparent haptic motion illusion are unlikely to serve as a reliable source of information for daily tasks such as navigation. While a 50% reduction in the delay between actuators (SOA) achieves a high level of speed discrimination, it is not foolproof, and demands heightened attention, limiting the variability in tactile instructions. Similarly to the first experiment, no significant difference was found between the vibratory mode and "taps" regarding their ability to discriminate different speeds. This finding aids decision-making in stimulation design to address Challenge #1.

Despite these limitations, the apparent haptic motion holds promise as a valuable directional cue, particularly for integration into navigation devices designed for individuals with impairments, such as power wheelchairs [28], walkers, and precane. However, the modulation of speed may not offer sufficiently informative cues. To address this, future experiments are suggested wherein participants can determine optimal parameters for the apparent haptic motion, including duration, delay, and intensity. In light of the study's outcomes, the subsequent research will concentrate on refining the apparent haptic motion to enhance its efficacy as a directional signal (Challenge #1). Recognising the potential for further exploration, the study also acknowledges the need for additional work on speed discrimination, exploring temporal parameters beyond SOA, and identifying optimal parameters for tapping stimulations.

Building on the second study's outcomes, the focus shifts towards diversifying directional instructions to include four directions and implementing them on a cylindrical handle. This strategic focus aims to enhance the practical application of haptic feedback in assisting individuals with impaired navigation, taking into account the limitations identified in the study.

HAPTIC PERCEPTION OF 2D DIRECTIONAL INFORMATION WITHIN A HANDLE

Contents

6.1	Introduction	87
6.2	User Study	88
6.2.1	Experimental setup and signals	89
6.2.2	Experimental design	90
6.2.3	Participants	92
6.2.4	Experimental procedure	92
6.3	Results	93
6.4	Discussion	96
6.4.1	Impact of the handle position and identification of directions	96
6.4.2	Comparison of the stimulation modes	96
6.4.3	Impact of the directional information	97
6.5	Conclusion	97
6.6	Additional tests with participants with visual impairments	99
6.6.1	Participants presentation	99
6.6.2	Proceedings of the tests	100
6.6.3	Results and conclusion of the tests	101

This Chapter presents the work published as an IEEE Transaction on Haptics short paper at the IEEE World Haptics Conference 2023 and presented at this same conference.

Inès Lacôte, Claudio Pacchierotti, Marie Babel, David Gueorguiev, Maud Marchal: *Investigating the Haptic Perception of Directional Information Within a Handle* [87].

6.1 Introduction

Our first two studies presented in Chapter 4 and Chapter 5 gave crucial insights on what could or could not be done to transmit navigation information should it be about the direction to follow or to convey velocity indications. We concluded that the apparent haptic motion was a robust illusion to convey an indication of direction but that the variability in the temporal parameters would be difficult to exploit as a source of information. The results of our first experiment paved the way for more in-depth work on the potential offered by the AHM illusion for directional information with both vibratory and non-vibratory stimulation, which was proven in our study to also work on curved surfaces.

With a third experiment, our goal was to finally answer Challenge #1, consisting of designing, evaluating and validating the most interesting and viable haptic signals. This includes implementing a second dimension to the pattern so as to be able to convey four directions for later interpretation as left/right/front/back instructions. Secondly, our will was also to concretely address Challenge #2 by integrating the actuators in a handle device. By changing the hand rest to a cylindrical device, we wished to validate the viability of the project realisation. From that perspective, the first step is to verify the proper perception of the pattern in the hand referential, check if participants receive it, and properly identify the motion direction on their palm. This does not include asking participants for conversion or interpretation of the sensation to the cardinal or relative egocentric direction (right/left/front/back). We are thus investigating an objective metric and not a navigational interpretation. To be as complete as possible and because we aim to create a handle device adaptive to a large variety of mobility assistive apparatus, in this new study, besides testing the device itself, participants realised directional identification tasks in various positions, mimicking the ones of a walker, a precane and a power wheelchair joystick.

Chapter 6 thus presents a user study conducted on twenty-four participants to investigate their ability to identify the direction of the motion elicited by the AHM phenomenon on the palm. By testing out three different positions of the handle, we wished to evaluate the robustness in perceiving the four directions onto the hand and ensure repeatability between participants. Results show that participants were able to identify the four different patterns on their palm with both vibratory and “tap” stimulation and the different positions. Lower results in the vertical position of

the handle corresponding to the power wheelchair lead us to consider making new improvements to the actuators' design.

This Chapter is organised as follows. Section 6.2 presents the materials and methods of the user study, Section 6.3 the results and statistical analysis across the considered conditions, and finally, Section 6.4 discusses the results. Finally, Section 6.5 concludes the Chapter.

6.2 User Study

Our experimental evaluation aims to investigate the human ability to recognise the stimulation direction induced through the asynchronous activation of the actuators in the handle. Eventually, the aim of the study is to highlight the performance and limitations of our device. For our study, we wish to investigate various parameters related to the application of our device. That led us to input three positions of the handle, two modes of stimulation and four direction indications.

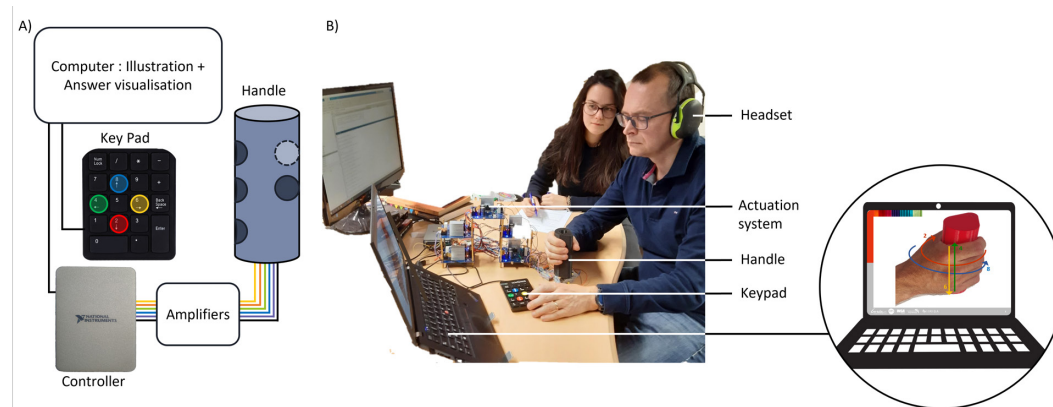

Figure 6.1 – Experimental setup for the user study. The handle (Dev-v2.0) houses five electromagnetic actuators (Act-v2.0) attached to a set of amplifiers controlled by a National Instrument card NI 9264. Participants are asked to hold the handle according to the considered positioning (“wheelchair joystick” in this Figure, see also Figure 6.4) and recognise the conveyed direction. The answer is given based on the illustration shown to the participants on the screen, which is registered using a numerical keypad. Both the illustration and the keypad rotate to best fit the current position of the participant.

6.2.1 Experimental setup and signals

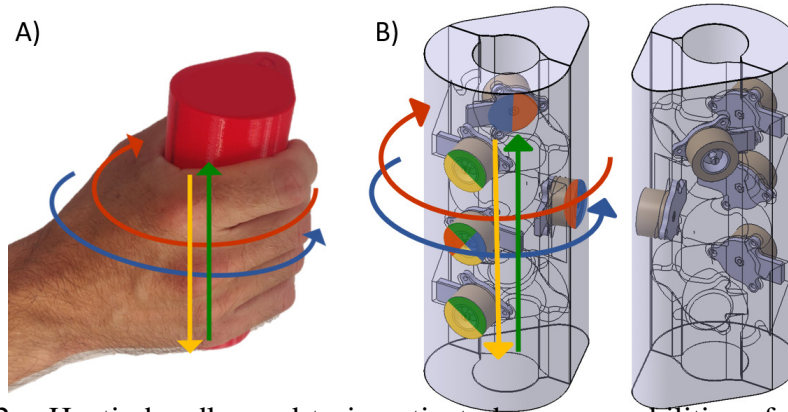

Figure 6.2 – Haptic handle used to investigate human capabilities of discerning directional information. We considered four directions to recognise: the first two (*green* and *yellow* arrows) run vertically along the axial direction of the handle, providing haptic cues across the hand metacarpals; the second two, (*blue* and *red* arrows), run around the lateral surface of the handle, providing haptic cues between the thumb and the middle fingers and across the palm. a) A user comfortably holds the handle with a power grasp. The handle is 3D printed using a soft plastic material. b) CAD model of the handle (two views) housing five custom electromagnetic actuators.

The setup, shown in Figure 6.1, is composed of a custom handle (Dev-v2.0), 3D printed out of soft material (Filaflex 82A, 0.4-mm thickness). It corresponds to the second iteration of the device referred to as Dev-v2.0 in Chapter 3, taking the shape of a concrete cylindrical handle. It houses five of the second generation of our custom actuators (Act-v2.0), distributed across the structure in dedicated alcoves, so as to stimulate the hand in crossing directions (see Figure 6.2 and Sec. 6.2.2). The actuators went under a first improvement to increase their robustness in omni-directional use cases, as shown in Figure 6.3.

Similarly to the previous experiments presented in Chapters 4 and 5, the actuators use amplifiers with a gain $G_a = 10$, which are connected to a differential -9/+9 V power supply and a National Instrument card for tension control. The output of the amplifiers is a tension varying between 0 V and 6.5 V.

As mentioned in Section 6.1, we considered two types of haptic sensations (vibrations, “taps”), three positioning/configurations of the handle with respect to the user’s body (resembling how a user holds a precane, walker, wheelchair joystick), and 2×2 directions (two along the axial direction of the handle, two around its lateral surface).

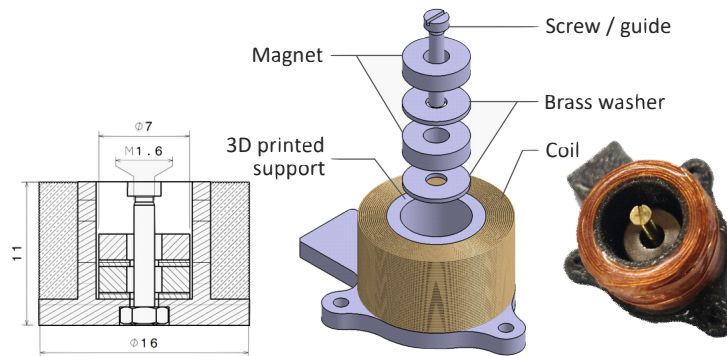

Figure 6.3 – Custom electromagnetic actuators (Act-2.0) used in the handle (Dev-v2.0). They are made with 3D printed support, 0.22 mm wire, two magnets, two brass washers, and a brass screw. The brass guide and the two brass washers running through the centre of the cavity prevent the magnets from falling out of the coil, enabling the use of these actuators in non-vertical positions.

Type of haptic sensations. We consider two different ways of providing haptic cues, identically to Chapter 4 and 5. Vibrations are generated by the actuators receiving an input tension as a 120 Hz sine signal within a ramp envelope (see Chapter 4 and Figure 4.4 for details). On the other hand, “taps” are generated by the actuators as non-vibrating pressure points induced by maintaining a 6.5 V command for 220 ms, which results in a tapping sensation (see 4).

Positioning of the handle. We consider three different ways of positioning the handle, normal to the sagittal body plane, coronal plane, and transverse plane, which resemble the way a user holds onto a precane, a walker, and a power wheelchair, respectively (see Figure 6.4).

Navigation direction. We consider four directions of motion. The first two directions, *green* and *yellow* arrows in Figure 6.2, go along the axial direction of the handle, corresponding to stimulation across the metacarpals; the two other directions, *blue* and *red* arrows, run around the lateral surface of the handle, for stimulations between the thumb and the middle fingers passing through the centre of the palm.

6.2.2 Experimental design

Participants are asked to hold the handle in a power grasp and determine the direction of the stimulation, answering with a numerical pad in front of them. They are also provided with a picture similar to Figure 6.2, adapted for the handle positioning

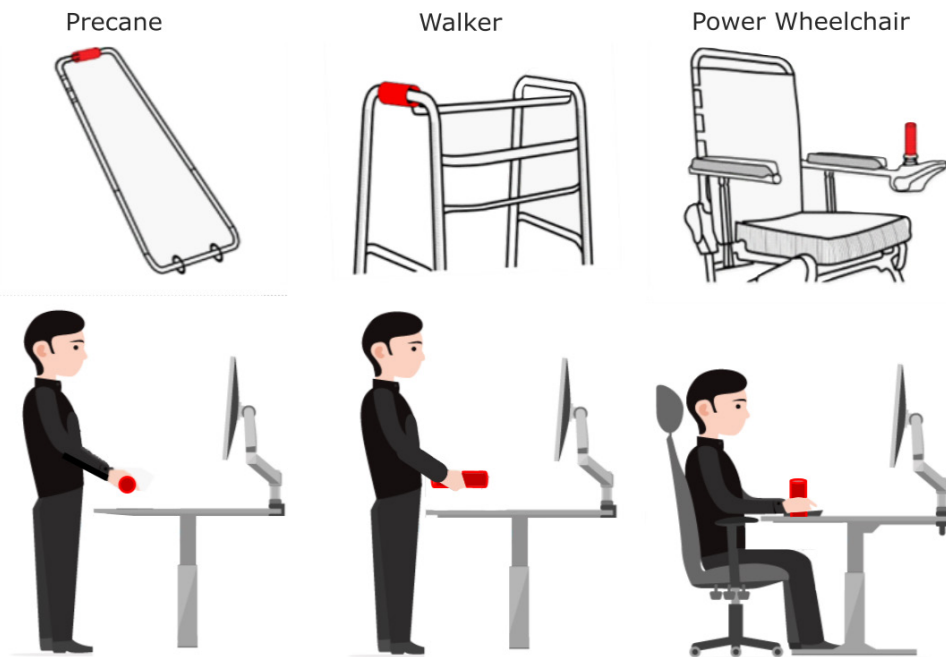

Figure 6.4 – Positions of the participant holding the handle (in red) during the experiment. These three configurations of the handle with respect to the participant’s body match the way users commonly hold onto a precane (left), walker (centre), and power wheelchair (right).

currently under examination, so as to better understand which keystroke represented which direction. After they selected a direction, participants were also asked to rate their confidence in their response using a 9-point Likert scale. A participant carrying out the experiment is shown in Figure 6.1.

The experiment is composed of three parts, each corresponding to a position of the handle (precane, walker, wheelchair). For each part/position, the participants carried out eight blocks of sixteen stimulations each: four blocks with vibratory signals and four blocks with “tap” signals. Each block is composed of four repetitions of the four directions presented in a pseudo-randomised order. After every part, the participants take a break and start the new set of blocks with a new positioning of the handle. This experimental protocol leads to $3 \text{ (handle position)} \times 2 \text{ (stimulation mode)} \times 4 \text{ (blocks)} \times 4 \text{ (directions)} \times 4 \text{ (repetitions)} = 384$ recognition trials.

6.2.3 Participants

We enrolled twenty-four participants between 21 and 54 years old, nine being women, three left-handed, and two ambidextrous. Their dominant hand was determined by a ten-question questionnaire about their daily habits. The two ambidextrous participants had more “right hand” answers than “left hand” or “no preference” answers. For this reason, we decided to make them use their right hand for the experiment. None of the participants had lesions or tactile perception loss on their dominant hand, which is the one being stimulated for the study. The experiment lasted between one hour and one hour and a half. The participants were naive about the objectives and hypotheses of the study. During the experiment, they wore noise-cancelling headphones and faced two screens: one visualising their answers and one showing the four directions to choose on a picture of a user holding the handle (similar to Figure 6.2). All participants completed the task. The presentation order of the three handle positions was counterbalanced between participants; half of them started with the vibratory stimulation and half with the “tap” stimulation.

6.2.4 Experimental procedure

Participants started the experimental session by reading and signing the consent form. They answered demographic questions and a form to identify their dominant hand as well as possible haptic sensory impairments.

The start of the experiment was induced by the participants by pressing a button, after which they received the first stimulation of the sixteen composing the block. For each trial, the user gave the perceived direction and his/her confidence rate on a 9-point Likert scale. After four blocks of signals were made in one stimulation mode, the participant received four other blocks using the other mode. After eight blocks in a position and a break, participants continued to the next position. The data collected from the participants were the numbers on the keypad corresponding to the direction they perceived (*2-red, 4-green, 6-yellow or 8-blue*) and their confidence rate from 1 (no confidence at all) to 9 (total certainty). At the end of the experiment, participants also gave open comments and feedback about their sensations and the experiment in general.

6.3 Results

This Section presents the recognition performance of the directional cues presented by the handle.

Sent directions	Red	72.3%	4.9%	4.5%	18.3%
	Green	2.2%	79.3%	15.1%	3.3%
	Yellow	2.9%	22.7%	71.1%	3.2%
	Blue	19.1%	3.6%	5.4%	71.9%
		Red	Green	Yellow	Blue
		Participant answers			

Figure 6.5 – Confusion matrix across all trials and all participants from the study of the true directions sent to the participants and their answers for the two modes: vibrations or pressure points (“taps”). Directions *green* and *yellow* run vertically along the axial direction of the handle to stimulate the hand metacarpals; directions *blue* and *red* run around the lateral surface of the handle stimulating the thumb and the middle fingers and across the palm (see Figure 6.2).

Results overview: First, to have a global overview of the data, we generated a confusion matrix of the participants’ answers, shown in Figure 6.5. As we can see, the majority of answers are present in the diagonal from the top left to the bottom right, corresponding to the correct answers. However, we can also clearly see that the other diagonal contains several answers. This means that most of the errors done by the participants come from detecting the correct sequence of motors but with the wrong direction, i.e. mixing *red* with *blue* and vice-versa, as well as *green* with *yellow* and vice-versa (see Figure 6.2). Other errors corresponding to the other cases of the matrix are less numerous.

Generalised Linear Mixed Model: We studied the participant responses using a generalised linear mixed model (GLMM). Since the dependent variable is a binary categorical variable, a binary logistic model was chosen. Independent variables were

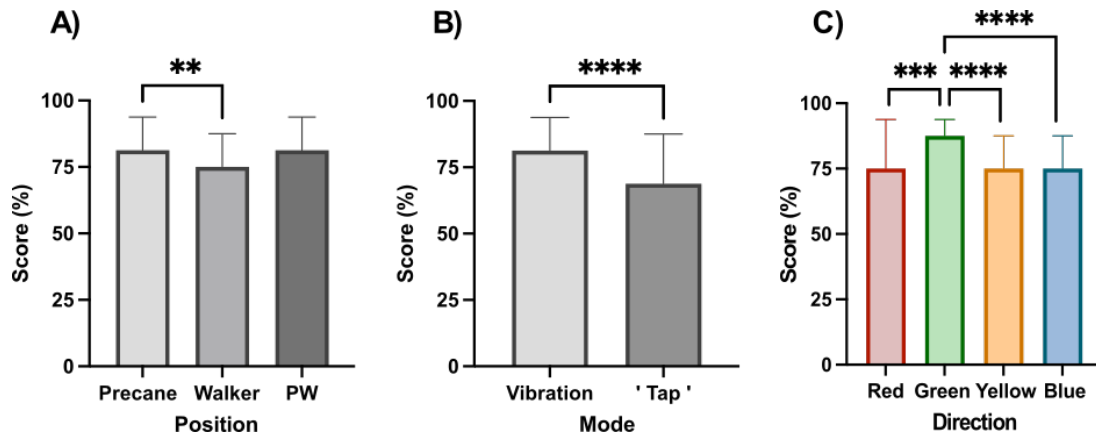

Figure 6.6 – Score results: barplots using the median value and the interquartile range for the error bar. a) Score for the different positions of the handle (PW = power wheelchair). b) Score for the two modes of stimulation. c) Score for the different directions conveyed via the handle. All scores are given in % of correct answers. Statistically significant differences are indicated with ** when $p < 0.01$, with *** when $p < 0.001$ and with **** with $p < 0.0001$.

the direction of the apparent motion (*green, yellow, blue, red*), the position of the handle (precane, walker, wheelchair), and the stimulation mode (“tap” or vibration). Participants were considered as a random effect in the model. We performed an analysis of deviance, showing a statistically significant effect of the mode ($df = 1$, Wald Chi-Square = 137.56, $p < 0.001$), direction ($df = 3$, Wald Chi-Square = 52.20, $p < 0.001$), and position ($df = 2$, Wald Chi-Square = 12.24, $p = 0.002$).

Post-hoc analysis: The three variables that we considered for the handle’s test showed to have a significant impact. We thus performed a Wilcoxon repeated-measures post-hoc analysis showing a significant effect of the handle position between the precane and the walker ($W = -3010$, $p = 0.0146$) on the performance in identifying the correct directions, highlighting better scores in the precane position as shown in Figure 6.6.a). Secondly, a similar post-hoc analysis showed a significant effect of the mode of stimulation ($W = -17732$, $p < 0.001$), highlighting the fact that vibratory cues tend to be easier to classify (see Figure 6.6.b)). Finally, the analysis showed that the score for direction *green* was significantly different from the other directions: *green* VS *red* ($W = -2896$, $p = 0.003$), *green* VS *yellow* ($W = -3213$, $p < 0.001$), *green* VS *blue* ($W = -3043$, $p < 0.001$),

showing the fact that the direction *green*, through the metacarpals from the little finger to the index is the direction best recognised during the experiment (see Figure 6.6c)).

Confidence rate: Finally, we looked more into the correlation between the score and the confidence rate of the participants for each answer, presented in Figure 6.7.A for the vibrations and 6.7.B for the “taps”. A linear regression analysis showed a correlation with a factor $r = 0.44$, where we also found through a Wilcoxon analysis, that the mode had a significant effect on the confidence rate ($W=-30790$, $p<0.0001$) as shown in Figure 6.7.C. Our analysis showed a higher confidence when receiving vibratory cues.

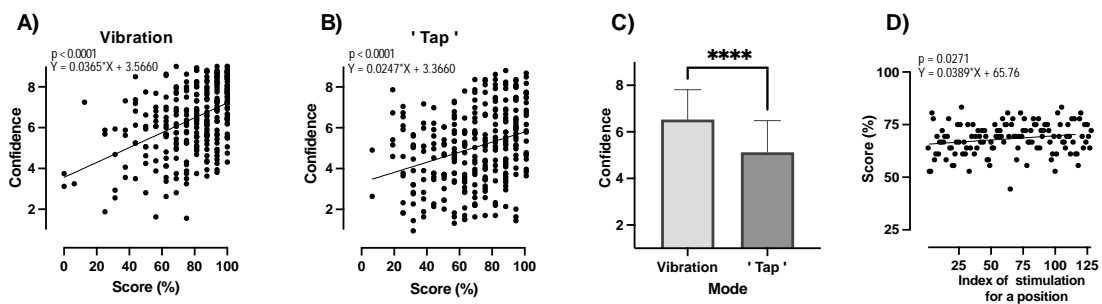

Figure 6.7 – a) Correlation between score and confidence for vibratory cues. b) Correlation between score and confidence for “tap” signals. c) Participants’ confidence in the two modes of stimulation. The results are given with barplots using the median value and the interquartile range for the error bar. d) Evolution of the scores along the four blocks of stimulations for “taps” signals.

Habituation effect: We also wanted to see if there could be a habituation effect during the experiment and thus studied the evolution of the score. Considering the entire experiment, we found no significant evolution of the score throughout the experiment in this respect. However, when looking at the evolution along the four consecutive blocks of each mode, it appears that participants scored better towards the end of “tap” stimulations, showing possible habituation of users to the stimulation (Figure 6.7d), $p=0.0271$). Such an effect was not found with the vibratory signals ($p=0.1544$).

6.4 Discussion

The human subject study enrolled 24 participants testing the recognition performance on three different positions of the handle with both vibratory signals and “taps” cues. The objective of the experiment was to study the impact of handle position and the different modes of stimulation on the tactile perception of directional information on a handle.

6.4.1 Impact of the handle position and identification of directions

Results showed that the position of the precane is better than that of the walker in receiving the directional information through our handle, i.e., it leads to better recognition rates. A possible explanation is that, despite the improvements in the design of the motors with respect to [84] (see Section 6.2.1), work is still needed to enable a flawless omni-directional use of those actuators. Indeed, when turning the handle to the walker or power wheelchair positions, the majority of the actuators are facing the side or down, which affects their performance.

From the confusion matrix of Figure 6.5, we can also appreciate that most incorrect answers are due to an error in identifying the correct direction of motion, meaning that participants could anyway still differentiate between the two dimensions.

6.4.2 Comparison of the stimulation modes

Such additional improvements could also respond to the difference in the efficiency of the motors between the vibratory and the “tap” modes, specifically maintaining higher constant force when using “tap” stimulations. Indeed, even though the 3D printed membrane is soft, its stiffness still reduces the force exerted by the magnets on the skin, especially in up-side-down positions, where the magnets already touch the membrane, affecting its course in “tap” signals.

The study of potential habituation effects showed that there was no strong evolution of the score throughout the whole experiment. However, if we consider the “tap” stimulation alone, a significant increase in the score was highlighted along the four consecutive blocks of stimulation with this mode. These two results together, i.e., participants recognising vibration patterns with more confidence and a habituation on the “tap” mode, might mean that participants are less used to being guided by “taps”.

This insight opens an interesting question regarding the study of less common/used haptic patterns, which might – at first glance – seem less efficient than other more common ones such as localised vibratory points for 3D directional information [99] or left/right armband [114], but only because of the lack of training.

At the end of the experiment, we also gathered free comments from the participants, which were rather different from one person to another. Some of the participants preferred “taps” over vibrations, while others preferred vibrations, but very few were able to explain why. People with larger hands tended to be more tense and have a less relaxed position on the handle. The size and shape of the hand with respect to the handle is another interesting aspect that could be taken into account for the customisation of haptic rendering, which is an open and interesting topic in the field [171].

6.4.3 Impact of the directional information

Our statistical analysis also highlighted that the *green* direction, along the handle from the fifth metacarpal to the first one (on the palm, from little finger to index), was the easiest direction to identify and where participants scored significantly better. This result might be due to the fact that humans are more used to receiving vibration patterns that move in this direction, e.g., tapping with a cane or umbrella on the ground.

We also found an interesting correlation between the score and the reported confidence, with vibrations leading to both better scores and confidence rates.

6.5 Conclusion

In this Chapter, we present the third user study using, for the first time a cylindrical hand-held device. The investigation revolves around identifying directions conveyed on the volar side of the hand through the apparent haptic motion illusion.

Compared to the previous experiments, two additional directions for the haptic pattern conveyed on the hand are added. Furthermore, we explored the impact of handle orientation, considering potential implications for adapting to various mobility aids.

The human subjects study assessed recognition rates for four directions rendered on the handle, utilising either vibratory signals or “tap” cues, across three distinct handle positions. These positions emulate common mobility aids – precane, walker,

and power wheelchair – streamlining the translation of results for applications in mobility assistance.

Despite inherent limitations, a substantial majority of participants across all conditions demonstrated an ability to recognise rendered directions, surpassing expectations with recognition rates consistently exceeding 70% and surpassing 75% in precane and power wheelchair configurations. This performance, particularly in dealing with four directions on a 2D system (chance level = 25%), exceeded the challenges posed by the previous experiments involving only two directions on a 1D axis (chance level = 50%).

Unlike previous studies, notable differences in stimulation modes emerged, favouring vibratory stimulations. Our hypothesis on vibrations outperforming "tap" sensations in user feedback is dual. First, it is a possibility that the familiarity of humans with vibration stimuli benefits this actuation modality. Our second thought lays on the fact that variations were also observed based on handle positioning. It thus appears that the multi-directional use of the handle sorely tested the capacity of the actuators, giving them a lot less momentum to come in contact with the skin in "taps" compared to the previous study. This element asked for an improvement of the actuators' design in order to convey robust "tapping" sensations.

Despite the identified limitations conditioned by the design, the results presented in this Chapter conclude the investigation for Challenge #1, affirming the suitability of haptic patterns for integration into our final implementation as a handle and navigation assistance device.

Overall, this experiment represents significant progress toward the development of a handle-shaped device capable of providing navigation information through the AHM illusion. Through a user study involving twenty-four participants, valuable insights were gathered on optimising our design and addressing its limitations.

The focus will now shift to Part III of this manuscript, where further development and practical implementation will take place. The next steps of this research include the integration and evaluation of this technology in mobility aids, customisation of haptic rendering and handle design, enhancement of actuators for omni-directional use enabling finer perception, and finally, the design of a functioning navigation strategy.

6.6 Additional tests with participants with visual impairments

In the DORNELL project, the research work is accompanied by clinicians from the Pôle St Hélier in Rennes and a locomotion instructor from the association Voir Ensemble from Centre Auvergne Bourgogne region. This handle would aid in locomotion and navigation for people who use technical mobility aids but are not completely autonomous, and it would reduce the mental workload of people using a technical aid independently. Ready to use, it can be easily adapted to technical mobility aids (cane, walker, electric wheelchair). Working with these different partners enabled practical tests of how to handle young adults with visual impairments. The tests were carried out with five users of the children's section of the CAB centre.

The same task as presented in the previous user study was given to participants. The organisation of trials was, however, less restricted to fit the participants' focus abilities, preferences, fatigue, etc. During this phase of testing with young people, it was decided to use the terms "towards Inès", "towards me [the participants]", "towards Fanny", and "towards Carine" instead of "front", "behind", "to the right" or "to the left" to make the answers more reliable.

The young people who tested the device experienced vibratory and tapping stimulations; they mainly tested the handle by positioning it parallel to their sagittal plane, resembling the walker or cane position. They almost all placed their index finger differently to mimic the hold of a white cane. The test lasted a maximum of one hour for each young person.

6.6.1 Participants presentation

Five young people tested the handle. Here is a small presentation based on the locomotion instructor report. User 1 was 18 years old and visually impaired (no light perception on the left and a nasal hemifield for the right eye with a central area of vision). He was also diagnosed with hearing impairment and Autistic Spectrum Disorder. He can detect fairly large obstacles (steps on the pavement, posts, dustbins) but has difficulty with changes in terrain. He does not use compensatory aids (e.g., a white cane) to get around. He is enrolled in a schooling course called CAP.

User 2 was 15 years old and visually impaired (legal blindness, perception of

contrasting surfaces, objects in close vision without reliable visual identification, fragmented perception). He uses a white cane in his daily displacements. User 2 uses Braille and follows classes in school.

User 3 was 15 years old and blind (light perception on the left eye). She uses a white cane in her daily displacement and reads Braille. She also follows classes at school.

User 4 was 18 years old and visually impaired (moderate visual impairment with most function in the right eye. Her left eye vision is very poor. The peripheral visual field appears to be somewhat reduced overall). She does not need any compensatory aids to get around. User 4 is in vocational determination and is not currently following classes.

Finally, user 5 was 16 years old and visually impaired (very blurred vision with a reduced binocular visual field in the extreme periphery). He uses a white cane all the time. Antoine is a braille-using student in an agricultural college.

6.6.2 Proceedings of the tests

User 1 was very curious and gave lots of answers. However, it was noticed that fatigue became an issue after 30 minutes of trials. User 1 preferred the vibratory stimulations.

User 2 was highly motivated and excited by each new sensation. He commented that the stimulations were tickling. User 2 appreciated using a second hand to understand the functioning of the handle and identify the actuators' positions, thus retracing the stimuli paths. It was noticed that the participant needed more time and concentration to get to a focused moment full of attention. Identifying the direction appeared not too demanding, but rating its own confidence on a 9-point Likert scale seemed to be too much of a task at this point. An adaptation of the task was given by describing the confidence rate as very sure/moderately sure/not sure at all. He seemed more sure of himself as the experiment progressed after about forty minutes. He verbalised a lot of his enthusiasm for the device. User 2 preferred the tapping stimulations. He also wanted to explore the whole system and understand its functioning.

User 3 quickly understood the task and the direction in the hand. She was very enthusiastic about answering all questions quickly. It seems that the task was somehow rushed a little bit, as she sometimes answered before the end of the vibrations. She

preferred the tapping stimulations. She was always very confident about her answers but seemed to not fully appropriate the Likert scale, often answering more than hundreds or thousands on a scale from 1 to 9. It was found that this task probably did not fit her.

User 4 appeared less confident of her answers with the tapping. She was especially less confident in forwarding directions in “taps”. With the vibratory mode, she was immediately much more confident in her responses. She seemed to have a better understanding of the axis along the handle than around the handle.

User 5 was the most comfortable and focused user on the task. He enjoyed less the tapping and thus preferred to stick to vibratory trials. User 5 also noted that the handle material could be improved to make it more pleasant. Because of holding the position, which he described as not optimal, user 5 said that the idea of following the instructions over a long period could be exhausting, but he finds it very useful for occasional use.

6.6.3 Results and conclusion of the tests

	User 1	User 2	User 3	User 4	User 5
Total Score (%)	33,04	46,25	26,25	41,02	79,17
Score in Vibrations (%)	32,81	43,75	6,25	32,81	85
Score in “Taps” (%)	33,33	46,88	39,58	49,22	68,75
Number of Trials	224	80	80	256	96
Number of Trials (vibrations)	128	16	32	128	80
Number of Trials (“taps”)	96	64	48	128	16

Compilation of participants’ scores in identifying the directions with the handle and number of trials tested.

Overall, the young people were proud to participate in this experiment. Each time they discovered the handle, they smiled, laughed, made positive comments, and were very grateful. Their results are given in Table 6.1.

Of the five young people, only one (user 5) had results in line with his confidence in the results of his answers (> 70%). The results show higher rates of success for the “tap” answer, except for participant number 5. However, user 5 received very few tapping stimulations (16 tapping trials and 80 vibratory trials) because he asked to receive only vibrations. For this reason, there are so few trials in “taps”, making his scores quite different based on the mode of stimulation. When looking at the rate of correct

answers, we can see that it was above the chance level (25%) but below the average answers from the previous study made with adults with no sensory impairments, except for user 5's score.

In that respect, it seems that cognitive abilities really have an impact on the understanding of information, whether it is vibratory or tap information. A learning phase could enable an easier adoption of the device. It was highlighted that the design of the handle could be improved for easier positioning and considering the stimulation of the index finger. Both vibratory and tapping stimulations appear relevant, as there is no unanimous preference between the two sensations among the participants. As the tapping sensation was described to be less powerful, it was proposed to improve the design to create less friction and thus less reduction of the tapping sensation on the skin.

Besides these tests, we also presented the device to clinicians at the Pôle Saint-Hélier in Rennes, France. We did not conduct an experiment per se. Instead, some trials were run to collect clinicians' impressions and sensations of the device. Four clinicians tested the handle for a duration of about 5 to 10 minutes and gave different comments. They perceived the vibrations as easier to perceive because they found they were more intense than tapping. Overall, they suggested that a learning phase was necessary to make the task less demanding, especially in terms of cognitive load. Similarly to the locomotion educator and the users from the association Voir Ensemble, clinicians suggested having a keyed connection design so that the participants would position and have the appropriate grip all the time. Some suggested that a unique localised vibration could be easier to interpret, and others advocated that the movement could be interesting for some users because it is a longer stimulus and conveys a motion intention.

PART III

**Application to a navigation assistance
and mobility aid**

INTRODUCTION

The third and last part of the thesis presents the implementation of the signals studied and validated in Part II to achieve a functioning device able to be used in walking situations and its adaptation to a mobility aid: a walker. This part finishes to address the integration into a handle-shape device (Challenge #2) and presents the design process and validation of the viable navigation strategies (Challenge #3). In that respect, Part III starts with the implementation of the haptic signals in the final design of the handle and investigates the possible interpretation of the tactile patterns through the use of one or two handles mounted on a walker in Chapter 7. This psychophysic study was conducted in a static position and aimed to validate the device and navigation strategies in a safe environment. Based on this validation, a final ecological study could finally be conducted and is presented in Chapter 8. This final work confirms the functioning of the device and identifies the most intuitive navigation strategy to follow a path with only tactile information. Both of these studies were approved by the Inria's ethics committee (COERLE, n°2021 – 39). This work has been assisted by Louise Devigne, an engineer at INSA de Rennes, who handled both the application file and procedure for the ethics committee approval. Dr. Emilie Leblong, Marie Dandois, Bastien Fraudet, Laure Mahe, from the Pôle St-Hélier clinic, Rennes, France and Carine Aumenier, locomotion instructor from Voir Ensemble Association, Centre Auvergne Bourgogne, France were consulted and participated to preliminary tests as members of the Dornell project. Chapter 8 presents a study where the setup was shared for two experiments: Pierre Cabaret's and mine. Pierre Cabaret, a PhD student (Univ Rennes, INSA, IRISA, Inria, CNRS – Rennes, France), set the tracking system for the experiment and designed the guiding algorithm used for the study.

THE HAPTIC PERCEPTION OF NAVIGATION INFORMATION USING A UNI-MANUAL OR BI-MANUAL STRATEGY ON A WALKER

Contents

7.1	Introduction	106
7.2	User Study	107
7.2.1	Experimental setup and methods	107
7.2.2	Experimental design	111
7.2.3	Participants	112
7.2.4	Experimental procedure	112
7.3	Results	112
7.4	Discussion	117
7.5	Conclusion	118

This chapter presents the work published and presented as a technical paper at the Haptics Symposium 2024 conference.

Inès Lacôte, Claudio Pacchierotti, Frédéric Marie, François Pasteau, Fabien Grzeskowiak, Marie Babel, David Gueorguiev, Maud Marchal: *Comparing the Haptic Perception of Directional Information Using a Uni-manual or Bi-manual Strategy on a Walker* [85].

7.1 Introduction

Our preliminary works on the haptic perception presented in Chapters 4, 5 and 6 enabled the creation of a base for the design of haptic signals that we validated in two aspects. First, they are relevant cues for conveying directional information on the hand palm, which are well identified by participants along the palm and fingers (Chapter 4 and Chapter 6) and orthogonally across the metacarpal bones (Chapter 6). Secondly, the robustness of the apparent haptic motion illusion as a directional guide was tested on curved surfaces (Chapter 4) and on a cylindrical apparatus (Chapter 6). The signals proved efficient in both vibratory and tapping modes, suggesting a promising alternative to the vibrations to reduce the fatigue and vibratory noise on the haptic perception.

With a fourth experiment, our objective is dual: first, answering completely Challenge #2 for an efficient integration of our work onto an improved handle and confirming its adaptability on a mobility aid. Secondly, we wish to address Challenge #3 by combining two handles and testing various patterns to define the most interesting and viable navigation strategy. Similarly to our previous experiments, we tested the use of either vibration bursts or pressure “taps” to convey different directions of motion, relying on the concept of the apparent haptic motion illusion.

Chapter 7 thus presents a user study conducted on fourteen participants to evaluate the haptic perception of directional cues conveyed through one or two handles mounted on a walker, with the objective of devising haptic rendering techniques for aiding people with diverse mobility, sensory, and cognitive impairments. The user study tests twelve different patterns along and around the handles, activating one or two of them at a time to investigate the impact of using uni-manual or bi-manual conditions and to identify the most effective tactile patterns in a navigation assistance scenario. Results show that the proposed technique is an effective approach for providing navigational cues. We identified specific patterns that were highly effective both in uni or bi-manual conditions in conveying directional instructions towards the front (93.7%), the back (90.5%), the left (97.2%), and the right (84.5%) directions, highlighting the viability of both strategies and their adaptability to various single or dual-handle mobility devices.

This chapter is organised as follows. Section 7.2 presents the materials and methods of the user study, Section 7.3 the results and statistical analysis across the considered conditions and Section 7.4 discusses the results. Finally, Section 7.5 concludes on the study.

7.2 User Study

This study aims to validate an improved design of the handle, the integration of haptic patterns for directional instruction, and finally and more importantly, the goal is to design an efficient navigation strategy by knowing how the number of handles affects the perception of the signals developed through the previous studies. This haptic perception validation is a first step in validating all the parameters in a static safe environment to further be tested in walking situations. We thus carried out this experiment to understand whether (i) the different stimulation modes (vibrations, “taps”), (ii) the rendering patterns (twelve patterns, distributed around or along the handles), and (iii) the number of active handles (one, two) affect the performance of navigation assistance on a walker delivered through the apparent haptic motion paradigm.

7.2.1 Experimental setup and methods

For this fourth experiment, the handle is designed to be attached to a standard walker, replacing the default handles of this assistive device. These handles are the third version (Dev-v3.0) of the device (see 2.2). Figure 7.1.b shows how a user holds the handle and how it is attached to the walker. The actuators used for this experiment are the third and final version of the device (Act-v3.0), described in Section 2.2. The actuators are distributed across the handle in a “T”-configuration so as to stimulate the metacarpal bones of the palm (three motors), thumb (one motor), and index (one motor) fingers as opposed to the middle finger in the previous experiment. This improvement in the actuators’ placement emerged from the convergence of two main elements that were discussed with the participants and the clinicians interacting with the project. From the participants’ comments, we received feedback on the possible improvements in comfort that could be made to the handle. It appeared in the free comments of participants that it would seem more intuitive to have the alcove previously dedicated to the middle finger actuator placed higher on the handle to fit the index finger. Secondly, a consultant on the project, who is a locomotor educator, suggested that using the index finger would be beneficial for later adaptation on white canes, as the users of this device highly solicit their index finger when holding their white cane. The contact between the actuators and the user’s skin is made through a custom membrane, 3D printed out

of TPU soft material, and designed to be threaded onto the coil with a cross shape on the top, keeping its top sufficiently soft and elastic, with a central space to glue the magnets (see Fig 7.2.b). Contrary to the previous version of the handle and actuators where the membrane was 3D printed all in one with the handle, here the membrane is part of the actuator and is detachable.

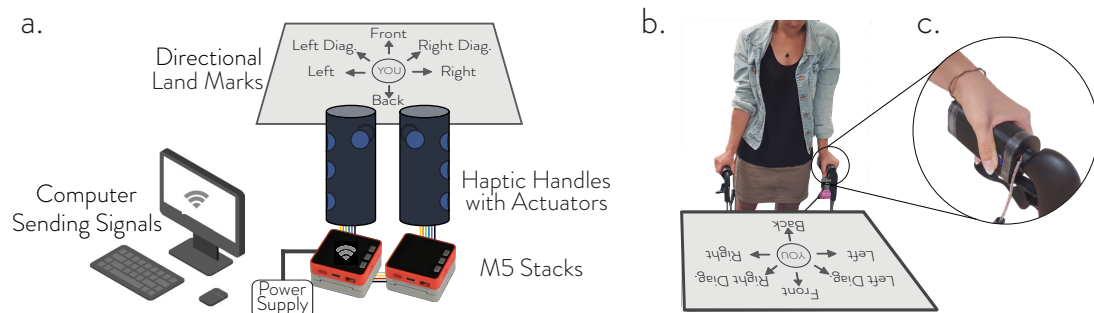

Figure 7.1 – a) Scheme of the experimental setup. The handles are powered and controlled through an M5 Stacks connected in WiFi with the PC sending the signals. The handles are used by the participants during the experiment as shown in b) and mounted on the walker as shown in c). b) shows a participant during an experiment. The participant faces the illustration of the possible interpretations and gives her answers orally after receiving the directional cues. c) Focus on the handle mounted on the walker and a participant’s hand position.

These improvements on the handle and the actuators’ design were made after the results of the third experiment presented in Chapter 6 suggested that the design could benefit from some changes for better omni-directional use.

Overall, the setup is composed of a standard walker (ErgoClick 4 wheels walker), equipped with two haptic handles (Figure 7.1b.), which are placed at 48 cm from each other, while their height can be adjusted for the comfort of the user. The handles are controlled thanks to signals conveyed and amplified through the M5 Stacks blocks connected to WiFi. The walker has its brakes on, and the participants stand behind it, hands placed on the haptic handles, as an everyday user would do. Participants wear noise-cancelling headphones and face a table where they can see the optional directional interpretation they can answer. The walker and the user do not move throughout the experiment.

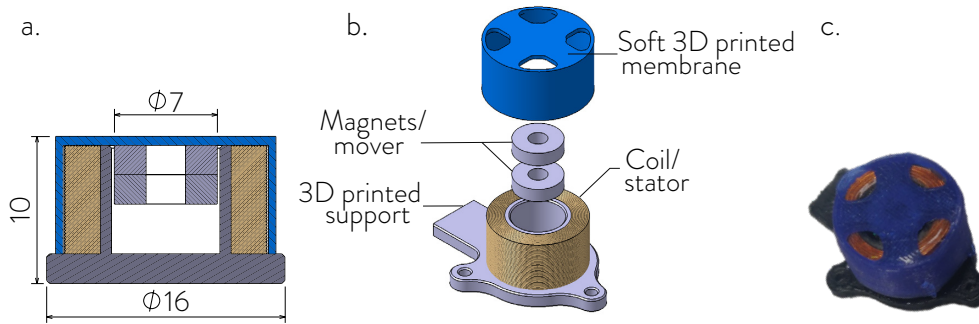

Figure 7.2 – Our custom-design electromagnetic actuator (Act-v3.0) with the soft 3D-printed membrane. Five of these actuators are housed inside each handle (see Figure 7.1). a) Cut view. b) Isometric View. c) Picture of the actuator.

Characterisation of tactile patterns

Similarly to our previous experiments, we employ the principle of the apparent haptic motion to deliver navigation cues, activating single actuators in sequences to give a sensation of continuous motion that can be interpreted as directional instructions.

We considered twelve different tactile patterns, all of which were provided through vibrations and “taps”. Six of them use one handle, and six use two handles. The considered patterns are illustrated in Figure 7.3. There are two groups of stimulations: First, there are the AHM stimulations around the handle(s), with actuators positioned under the tip of the thumb, the second metacarpal bone and the tip of the index finger. Secondly, the AHM signals are elicited by the actuators positioned along the handle across the metacarpal bones. Patterns involving only one handle (top row) are referred to with labels beginning with “1H”, while patterns’ involving two handles (second row) begin with “2H”. The second part of the signal labels corresponds to the direction of the conveyed AHM: “-1” and “-2” are AHM towards the left, “-3” is the AHM towards the front, “-4” and “-5” are AHM towards the right, and “-6” is the AHM towards the back. The coloured arrows show the pattern of activation for each considered signal; their colour gradient, from green to red, shows the temporal activation of the motors. For example, signal 1H-1 activates the three motors across the handle hold by the user’s left hand, stimulating, in sequence, the thumb, the second metacarpal bone (across the purlicue), and finally the index; conversely, signal 1H-2 activates the three motors across the handle hold by the user’s right hand, stimulating, in sequence, the index, the second metacarpal bone, and finally the thumb. In both cases, only one handle is active.

As an additional example, signal 2H-1 activates the three motors around *both* handles simultaneously, stimulating, first, the left thumb and the right index, then the second metacarpal bone of both hands and finally, the left index and right thumb; conversely, signal 2H-2 activates, in sequence, the three motors around the right handle and then those on the left handle hold by the user’s left hand (i.e., the difference between 2H-1 and 2H-2 lies solely in the motors’ temporal activation, shown by the different gradient across the arrows in Figure 7.3).

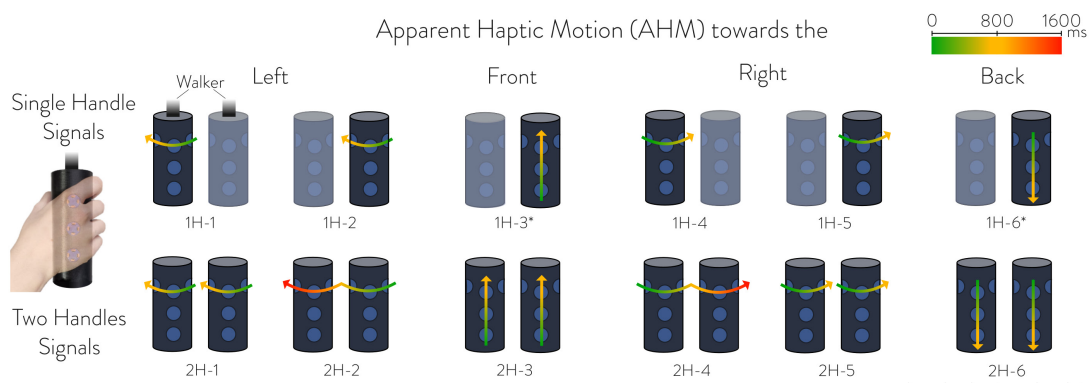

Figure 7.3 – Directional patterns using the AHM illusion. Each of the six handle pairs represents a stimulation. The top row shows patterns using only one handle, 1H-* (we greyed out the handle that is not activated), whereas the bottom row shows patterns using both handles, 2H-*. The coloured arrows show the pattern of activation; their colour gradient shows the temporal activation of the motors, green first, then yellow, and finally red. Each motor is activated for a period of 220 ms, either to provide a tapping sensation or a vibratory sensation, according to the condition at hand.

Type/mode of haptic actuation: vibrations vs. “taps”

Because one of our objectives is to validate a viable alternative to the vibrations, which has been a scientific challenge following all experiments, we consider two different ways of providing haptic cues, vibrations and “taps”, delivered by changing the activation mode of the electromagnetic actuators. The tap stimulation consists of a 220 ms square signal, while the vibration stimulation consists of 120 Hz sine within a 220 ms square signal envelope. A detail, however, changes from our previous experiments. For both modes, the signals are preceded by a negative impulse pulling the magnets down in the coil before pushing it out so as to give them momentum. This impulse was added based on the new design of the actuators, where the magnets are

already up in the coil, glued on the membrane, in contact with the skin, even in their resting position. When two actuators need to be activated in sequence (see Figure 7.3), they are activated with a delay of 110 ms between their beginnings, also called the Stimuli Onset Asynchrony (SOA).

Navigation direction

We asked participants to identify the different signals of Figure 7.3 as directional cues. We considered six possible directional interpretations of these signals, presented as directional landmarks in Fig 7.1.a: left, left diagonal, front, right diagonal, right, and back. As walking backwards is less common, we decided to reduce the instructions indicating such movements, not considering back diagonal instructions. These directions are illustrated on the table in front of the participant, as shown in Figure 7.1.b.

7.2.2 Experimental design

Participants are asked to stand behind the walker and hold both handles as if they were to navigate with it (see Fig 7.1). While standing in this position, they receive the stimulations. For each stimulation, participants are asked to interpret the perceived motion as one of the possible six directional instructions (Sections 7.2.1). After selecting a direction, they rate their confidence on a 9-point Likert scale. Answers are given orally and transcribed by the experimenter.

The experiment is divided into six series of stimulations, i.e., three in each mode (vibrations and “taps”). Each series is composed of thirty-six stimulations, being three repetitions of the twelve different signals, presented to the participant in a randomised order. Each series is delivered with the same type of haptic actuation, meaning all thirty-six stimulations in a series are either vibrating or tapping signals. To prevent participants from becoming accustomed to the stimuli and mitigate learning bias, the type of actuation is alternated. Half of the participants start the first series with tapping and the other half with vibrations. This experimental protocol leads to $12 \text{ (signals)} \times 3 \text{ (repetitions)} \times 3 \text{ (series)} \times 2 \text{ (actuation type)} = 216$ direction identification trials per participant.

7.2.3 Participants

We enrolled fourteen participants between 20 and 50 years old: four women, ten men, and all being right-handed. Their dominant hand was determined by the ten-item version of the EHI (Edinburgh Handedness Inventory) about their daily habits. The participants were naive about the objectives and hypotheses of the study. The experiment lasted one hour.

7.2.4 Experimental procedure

Participants start the experimental session by reading and signing the consent form, as well as answering demographic questions about their gender, age, and handedness (the identification of their dominant hand). Finally, they start the direction identification task detailed in Sections 7.2.1.

The data collected from the participants were the direction they perceived (“left”, “left diagonal”, “front”, “right diagonal”, “right”, “back”, see Figure 7.1) and their confidence rate evaluated on a 9-point Likert scale, from 1 (no confidence at all) to 9 (total certainty). At the end of the experiment, participants also gave open comments and feedback about the experiment and setup.

Participants were told before the experiment that the tactile indications used the principle of the apparent haptic motion illusion along the handles and around the handles. The experimenter explained the phenomenon of the AHM illusion and made trials to show the participants what the AHM was towards the front, the back, the right and the left. Finally, participants were told that no fixed match was established between the patterns and the desired directions, meaning they were free to interpret the signals the way it seemed the most intuitive for them.

7.3 Results

For a global overview of the data, we generated radar graphs to show the overall tendency in the identification of directions, shown in Figure 7.4. The radar graphs present the percentage of answers distribution given by all participants when receiving a signal, pooling together vibrating and “taps” feedback types. Figures 7.4a, b, c, d show these results for patterns employing the AHM towards the left, front, right, and

back of the handle(s). For example, from Figures 7.4b and d, we can notice that signals 2H-3 and 2H-6 show a clear tendency to be interpreted as directional cues towards the “front” and “back”, respectively, with very few alternative interpretations. Conversely, signals 1H-3 and 1H-6 have been mostly recognised as indicating directional cues either towards “front” or “right” and “back” or “right”, respectively. In Figures 7.4a and c, we can see that interpretations are more varied. While signals are still mostly recognised as indicating directional cues following the movement of the AHM pattern (i.e., 1H-1, 2H-1, 1H-2, 2H-2 towards the “left”; 1H-4, 2H-4, 1H-5, 2H-5 towards the “right”), we registered other interpretations, especially involving the diagonal directions when only one handle was activated (i.e., 1H-1, 1H-4 towards the “left-diagonal”; 1H-2, 1H-5 towards the “right-diagonal”).

Generalised Linear Mixed Model (GLMM): The data were processed using RStudio software (version 4.3.1). To assess the impact of the pattern, the fact that the strategy was uni- or bi-manual and the actuation type/mode (vibration vs tap) on the comprehension of directional information, we employed a Generalised Linear Mixed Model (GLMM). The GLMMs were fitted using maximum likelihood estimation (Laplace Approximation) with a logit link function and binomial error distribution. The Wald Chi-square test (signal, uni/bi-manual, actuation mode) performed on the GLMM showed a significant effect of the signal sent ($\chi^2(1) = 11.767$, $p = 0.001$) but no significant effect of uni-manual vs bi-manual ($\chi^2(1) = 0.110$, $p = 0.741$) or the actuation mode ($\chi^2(1) = 0.102$, $p = 0.750$). For this statistical analysis, we assume the presence of *correct* and *wrong* answers to have binary data. In order to do that, we considered correct: (i) *Left* or *Left Diagonal* answers when conveying AHM patterns moving towards the left of the handle, (ii) *Right* or *Right Diagonal* answers when conveying AHM moving towards the right, (iii) *Front* answers for AHM moving towards the front, and finally (iv) *Back* answers for AHM moving towards the back (the user).

The GLMM analysis showed a significant difference between the signals to evoke successfully what we determined as the good answers. For the following data, you can refer to Table 7.1 for p-values and significance. From this analysis, it was found that to elicit an instruction in the left direction, the signal 1H-1, which uses one handle, is considered better and significantly different from signal 2H-1 and signal 1H-2. Signal 2H-2, using both handles, is also considered significantly different from signal 2H-1 and from signal 1H-2.

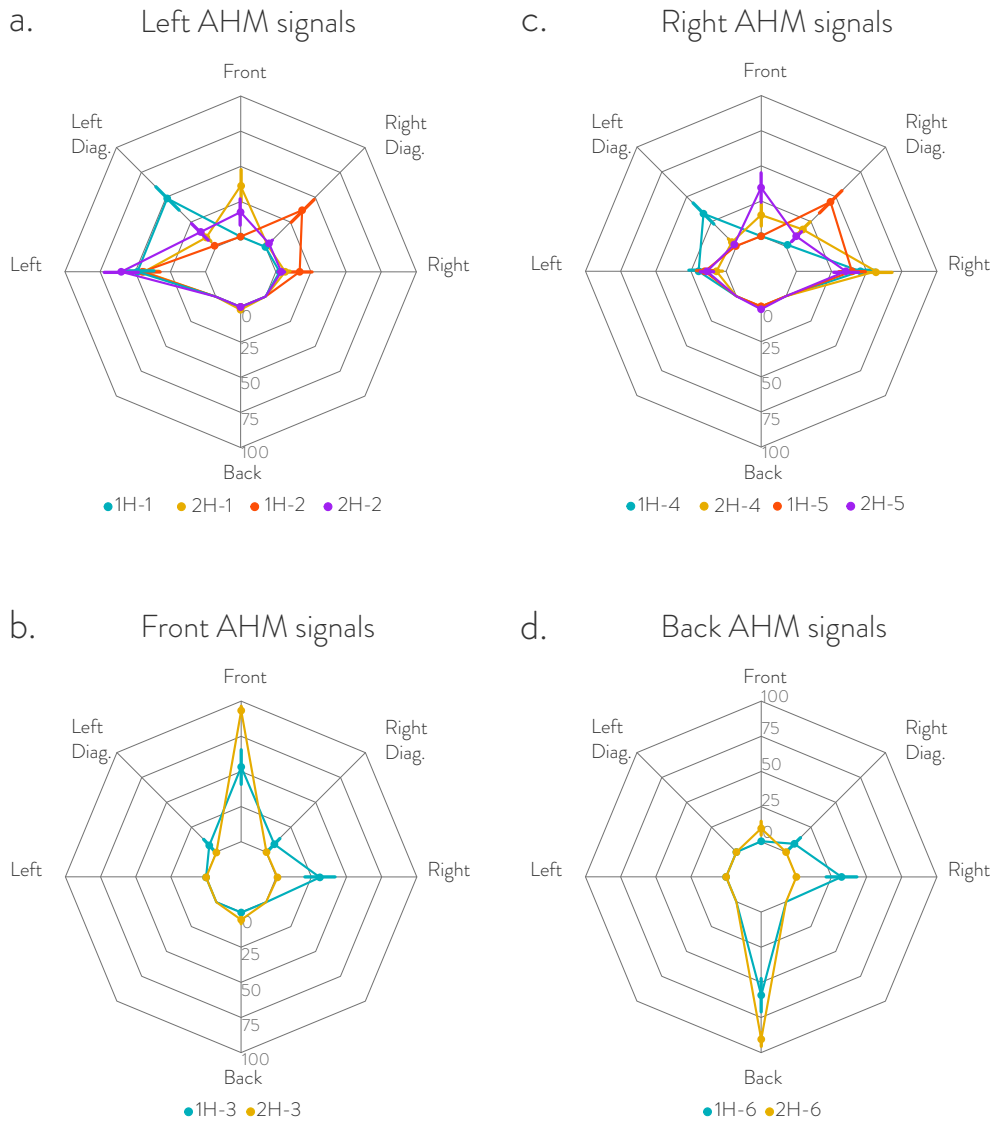

Figure 7.4 – Radar graphs showing the user’s identification answers based on the sent signal. a) Signals 1H-1, 2H-1, 1H-2 and 2H-2, using the apparent haptic motion (AHM) towards the left side of the handle. b) Signals 1H-3 and 2H-3, using the AHM towards the front of the handle. c) Signals 1H-4, 2H-4, 1H-5, and 2H-5 using the AHM towards the right of the handle. d) Signals 1H-6 and 2H-6, using the AHM towards the back of the handle.

		Signal interpretations						
		Left	Left Diag.	Front	Right Diag.	Right	Back	
AHM towards the	Left	1H-1	48.4	48.8			2.8	
		2H-1	43.7	9.5	36.1	2.0	6.7	2.0
		1H-2	44.8	1.2		36.9	17.1	
		2H-2	59.9	15.1	17.5	3.6	4.0	
	Front	1H-3		7.1	53.6	8.3	31.0	
		2H-3			93.7	0.4	0.8	5.2
	Right	1H-4	19.4	32.9		1.6	45.6	0.4
		2H-4	6.7	4.4	15.1	17.1	56.7	
		1H-5	15.1	0.4		44.8	39.7	
		2H-5	13.5	2.0	34.5	10.3	35.3	2.0
	Back	1H-6			0.4	8.3	32.1	59.1
		2H-6			9.5			90.5

Figure 7.5 – Distribution of answers (in %) depending on the signal sent. In green are the answers toward the same direction as the AHM, and in orange, toward a different direction.

Even though the difference between signal 1H-1 and 2H-2 is not significant, we can see on Table 7.5 that 1H-1 is better at evoking answers toward the *Left* or *Left Diagonal* (1st and 2nd columns in Table 7.5) and almost no contradictory interpretations compared to 2H-2 which has 17.5% in *Front* answers (3th column of Table 7.5). Signal 1H-1 with the AHM towards the left on the left handle thus appears to be the best pattern to convey a guiding instruction towards the left. Similarly, observations and conclusions can be made for the signals using the AHM towards the right. Signal 1H-5 uses one handle and is considered better and significantly different from signals 1H-4 and 2H-5. Signal 2H-4, which uses both handles, is considered better and significantly different from signals 1H-4 and 2H-5. Even though the difference between signal 1H-5 and 2H-4 is not significant, Table 7.5 shows that most of 1H-5 results gather in *Right* and *Diagonal Right* (4th and 5th), whereas signal 2H-4 presents higher contradictory interpretations. Signal 1H-5 with the AHM towards the right on the right handle thus appears to be the best pattern to convey a guiding instruction towards the left.

For the AHM towards the front, we compare signal 1H-3, using one handle on the side of the dominant hand, with signal 2H-3, made of two AHM elicited on both handles simultaneously. Just as Figure 7.4 shows, the GLMM indicates significant difference and better performance of signal 2H-3 over 1H-3 see Table 7.1. Signal

2H-3 gathers 93.7% of answers in the *Front* answer (Table 7.5). Finally, For the AHM towards the back, we compare the signal 1H-6, using one handle on the side of the dominant hand, with signal 2H-6 made of two AHM elicited on both handles simultaneously. The GLMM validates the first observations on Figure 7.4 and indicates significant difference and better performance of signal 2H-6 (90.5% success Table 7.5) over signal 1H-6 (59.1%).

Experimental evaluation: Signal labels in bold are the most effective when in presence with a significant difference.

Conditions	<u>Active handles</u>
	1H (one handle), 2H (two handles)
	<u>AHM stimuli</u>
	six ways of providing AHM stimuli towards the left (←), bottom (↓), right (→), or top (↑) side of the handle (see Figure 7.3)

Statistical analysis: direction identification

Comparisons for signals with AHM cues in the same direction

	1H-1 vs 2H-1	$p = 0.002^*$	1H-1 vs 1H-2	$p < 0.001^*$
←	1H-1 vs 2H-2	$p = 0.471$	2H-2 vs 2H-1	$p = 0.001^*$
	2H-2 vs 1H-2	$p < 0.001^*$		
↓	1H-3 vs 2H-3	$p = 0.002^*$		
	1H-5 vs 2H-4	$p = 0.569$	1H-5 vs 1H-4	$p < 0.001^*$
→	1H-5 vs 2H-5	$p < 0.001^*$	2H-4 vs 1H-4	$p < 0.001^*$
	2H-4 vs 2H-5	$p < 0.001^*$		
↑	1H-6 vs 2H-6	$p = 0.019^*$		

Wilcoxon repeated-measures analysis: In the GLMM model, we saw the effect of the signal on the interpretation of the direction, highlighting the optimal patterns to use to indicate left, right, front and back directions. We performed a Wilcoxon repeated-measures post-hoc analysis between all the six possible answers of all twelve signals (180 tests), showing a significant effect of the signals on the interpretations. The post-hoc analysis also confirms the absence of a significant effect of the mode on the interpretation, with equivalent performances and interpretations for both vibrations and tap signals.

7.4 Discussion

We conducted an experiment with fourteen participants, who received signals on one or two handles with both vibrations and “taps” signals. They provided interpretative responses based on the direction cue they perceived and the possible six interpretations they were given. Our analysis focused on determining which stimulation mode, rendering pattern, and number of active handles are best to provide navigation assistance using a walker.

To compare the performance of the two conditions, a relevant manner of analysing the device and the strategies is by looking into more details at the directional instructions we wish to convey to the user. We decompose it in Left & Right Directions and Front & Back Directions.

Left/Right Direction: Signal 1H-1, which employed a single handle, was more effective at conveying a “left” direction cue compared to other signals using the AHM towards the left. This is shown by the combination of Left and Diagonal Left, with less than 3% of alternate response. It is true that 2H-2 has more answers on the Left axis, but it also engenders contradictory interpretations with more than 15% of answers on the Front axis. Similarly, for the right side, Signal 1H-5, using a single handle, outperformed signals 1H-4, 2H-4, and 2H-5. This result suggests that a single-handle pattern with the AHM towards the left on the left handle or an AHM towards the right on the right handle emerged as the most effective pattern for side instructions. Signals 2H-2 and 2H-4, however lightly less efficient, are good two-handle alternatives to elicit such navigational instructions. Without a learning phase, we see here that the duality of information for left/right instructions can be misleading.

Front/Back Direction: Signals 2H-3 and 2H-3, conveying the AHM cues along both handles simultaneously towards, respectively, the front and the back, demonstrated superior performance in conveying the desired directional cues compared to signals 1H-3 and 1H-6. This result suggests that a pattern involving simultaneous activation of both handles was more effective in that case, as the presence of two identical pieces of information seems to reinforce the information on the front/back.

In Figure 7.4.b and d, we can also notice an ambiguity leading to some alternate interpretations of the single-handle answers (in blue). Those misled interpretations mainly gathered on the right axis. We interpret this artefact as a consequence of the use of the dominant hand for the Signals 1H-3 and 1H-6, all on the right handle, as all the participants were right-handed. It also appears that for the signals 1H-2 and 1H-4, respectively, on Figure 7.4.a and b and Table 7.5, we can clearly see that the interpretation is split into two main groups, which are the side of the AHM direction and the opposite direction. The confusion here seems to come from the fact that the motion indicates one direction different from the side of the activated handle. For example, signal 1H-2 is an AHM towards the left side but conveyed onto the right hand.

Overall, we found no significant difference between using one or two handles. Neither did we find a significant difference between the vibratory and the tapping modalities to deliver the target navigation information. These results mean that, first, the guiding strategy can be employed with limited hardware on a single handle, which is easier to adapt to other mobility assistance devices that only have one holdable end-effector, such as white canes or power wheelchairs. Two-handles can be used in some cases to reinforce the information, depending on the user's preference.

Similarly, as no actuation mode was found to be better than the other, it can be chosen according to the user preference as well as the capabilities of the considered haptic actuation system. Overall, our findings revealed that the AHM paradigm can be used to provide rich directional cues.

7.5 Conclusion

This Chapter presents the results of an experimental evaluation aiming to compare different haptic rendering techniques on a walker as a guiding device.

Based on previous studies and conclusions, this Chapter thus aimed to assess the effectiveness of different patterns in conveying directional information through the Apparent Haptic Motion Illusion (AHM), with the objective of developing rich navigation techniques for mobility aid systems, such as a walker. Not only did we investigate if the patterns are well perceived in the hand referential—which was the previous experiment’s goal—but also how it translates to actual directional instructions based on the users’ interpretation, which is the focus of this Chapter.

We enrolled fourteen participants in a human-subjects experiment to evaluate the haptic perception of directional cues conveyed through two handles attached to a walker. We investigated three key elements: the difference between uni-manual and bi-manual guiding strategies, the identification of the most effective tactile patterns and finally, the actuation modality (vibrations and “taps”) for navigation assistance. For this study, we designed a haptic handle with five custom electromagnetic actuators, able to give sensations of movement in four directions through the AHM illusion on the hand.

The results of the study are promising, highlighting several key findings: The study identified specific patterns that were highly effective in conveying directional instructions towards the front (93.7%), the back (90.5%), the left ((Left = 48.4%) + (Left Diagonal = 48.8%) = 97.2%), and the right ((Right = 39.7%) + (Right Diagonal = 44.8%) = 84.5%). The study also identified cases where participants’ interpretations were divided, often influenced by the side of the stimulated handle vs. the direction of the AHM moving pattern. The result and statistical analysis showed no significant difference between using vibratory vs. tapping modes for conveying directional cues. Because there was also no significant difference induced by providing vibrotactile cues on one or two handles, the guiding strategy can be adapted to both uni-manual and bi-manual setups and assistive devices. This adaptability makes the technology suitable for various mobility aids, such as white canes, power wheelchairs, walkers and precanes.

This research wishes to contribute to the development of assistive devices that enhance the autonomy and safety of people with sensory impairments.

In future works, the aim will be to help users on a walker follow complex trajectories by using tactile instructions.

ECOLOGICAL STUDY: DO VIBROTACTILE PATTERNS ON BOTH HANDS IMPROVE GUIDED NAVIGATION WITH A WALKER?

Contents

8.1 Introduction	121
8.2 User Study	121
8.2.1 Experimental Setup and Methods	122
8.2.2 Experimental Task and Design	125
8.2.3 Participants and Collected Data	126
8.3 Results	126
8.4 Discussion	131
8.4.1 Impact of the strategy	131
8.4.2 Comparison between modes	131
8.5 Conclusion	132

This chapter presents the work published and presented as a technical paper at EuroHaptics 2024.

Inès Lacôte, Pierre Cabaret, Claudio Pacchierotti, Marie Babel, David Gueorguiev, Maud Marchal: *Do Vibrotactile Patterns on both Hands Improve Guided Navigation with a Walker?* [86].

8.1 Introduction

Given the encouraging results described in Chapters 4, 5, 6 and 7 investigating from the perception point of view, the potential the AHM as a haptic cue in a handle to convey directional indications, we decided to go one step further by implementing an ecological study, i.e. a dynamic user experiment. This final step of the implementation of our work is to concretely guide users in their displacements. To validate our device and the proposed haptic stimulation choices, an ecological study has to be conducted reassembling the conditions of practical use. In that perspective, we gathered the results of our previous studies and specifically the conclusions of our fourth experiment presented in Chapter 7 to design a final user study, where people have to follow a path using only haptic indications. By conducting this experiment, our goal is also to complete our answer to the scientific Challenge #2 and #3.

We conducted a user study on eighteen participants who used two haptic handles mounted on a walker in walking condition. We implemented three types of patterns for guidance where one or two handles were used depending on the direction and the strategy. Each tactile pattern uses the principle of the apparent haptic motion, which has been studied and validated as a source of directional information in our previous studies. Although the previous study results showed no significant difference in the actuation mode (vibrations/“taps”), we also compared vibration and tapping stimulation modes in this final study to test for their potential influence on the guiding strategy, the users’ performances and their preference. This study thus aims to evaluate the capacity of tactile patterns delivered by haptic handles to guide users walking with a walker in following a predefined path.

Results showed no significant effect of the strategy or the stimulation mode on the accuracy of following the target path but showed that the use of a single handle presented a lower satisfaction rate, giving a sensation of being mentally more demanding to users, lowered the confidence rate in succeeding the task and decreased the navigation speed.

This chapter is organised as follows. Section 8.2 presents the materials and methods of the user study, Section 8.3 the results and statistical analysis across the considered conditions and Section 8.4 discusses the results. Finally, Section 8.5 concludes the Chapter.

8.2 User Study

This study investigates the performance of two haptic handles embedded in a walker in delivering navigation information. The handles use the apparent haptic motion (AHM) illusion to deliver rich directional indications to users, whose task is to follow a predefined path.

Our objective is to evaluate the effectiveness of providing rich and precise navigation

assistance through the apparent haptic motion (AHM) paradigm delivered with our custom hand-held interfaces. More precisely, our focus is to compare the fidelity rates achieved with different tactile patterns using one or both hands/handles to identify the most intuitive ones for the walker users in navigation tasks.

8.2.1 Experimental Setup and Methods

The experimental setup featured the same walker as in the previous Chapter, equipped with two haptic handles described in Chapter 7, which housed the handle controlled by the electronic setup. The same device as in Chapter 7 was indeed used, with the only difference of using a power bank instead of being plugged into the mains for portability and mobility reasons. The participants navigated in an 8×8 m room in which their position and orientation were tracked using a Vive tracking system, with base stations in the four corners of the room ceiling and a tracker on the walker. The room was empty, with a pillar close to the centre. Participants were asked to follow precisely predefined virtual paths. The position and orientation tracking enabled the evaluation of the proper tactile patterns to be given as directional instructions to the user, according to the experimental condition at hand.

To answer our previously mentioned objective, we carried out a human subjects study aiming to test our devices and strategies in the context of following unknown trajectories through tactile instructions in actual walking modalities. The study focuses on three key factors to be tested: (i) stimulation *Modes*: standard vibrations or discrete “tapping” sensations; (ii) pattern *Strategies*: Bi-manual (using both handles for all directional instructions), Dual (using either one or two handles depending on the instruction), and Uni-manual (only using the handle on the dominant hand side) with patterns distributed around or along the handles; and (iii) complexity of the *Path* to follow.

No visual information or details about the trajectory to follow were given to the participants, and there were no visual clues except for the starting points marked with tape on the floor. We considered two starting points, diagonal to each other, positioned at a distance of 8×8 m from the room corner. We considered the coordinates of the starting point as the origin of the spatial referential $(x_{start}; y_{start}) = (0; 0)$, and the closest corner $(x_{corn}; y_{corn}) = (-1; -1)$. Fig. 8.3 shows the room dimensions and the *Paths* starting at $(x_{start}; y_{start}) = (0; 0)$. In this representation, the starting points were merged to have a consistent representation and superimposed *Paths*, implying a 180° rotation of the participants’ trajectories when they started in the opposite corner.

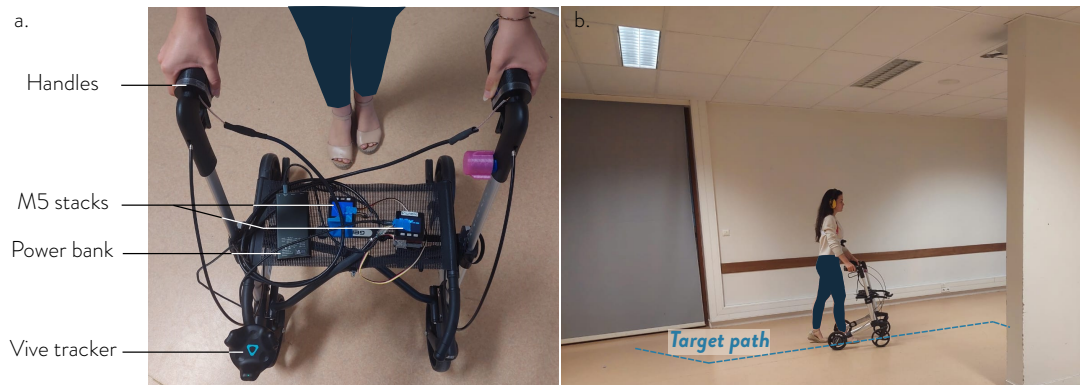

Figure 8.1 – a) Experimental setup: The handles are mounted on the walker. Signals are amplified and sent to the handles by the M5 Stacks controllers connected via WiFi. The motors are powered through the M5 Stacks cabled to a power bank. b) Navigation: The participant is guided by the tactile patterns along a target virtual path (not visible by the user, dashed blue line in the Figure).

Tactile patterns

Three strategies to provide directional information were considered: Bi-manual, Dual, and Uni-manual. Figure 8.2 shows the three navigating strategies and the tactile patterns associated. Building on a previous study on directional indication in a static position [85], we selected tactile patterns utilising the apparent haptic motion (AHM) illusion for navigation cues. These patterns, activated through electromagnetic actuators, conveyed directional information either on a single handle (three actuators) or both handles (six actuators). They are distributed around or along the handles. The coloured arrows in Fig. 8.2 illustrate the activation patterns for each signal. The gradient of colours, ranging from green to red, depicts the temporal activation of the motors.

Type of haptic stimuli

Two distinct methods of delivering haptic cues – vibrations and “taps” – were considered, achieved by altering the activation *Mode* of the electromagnetic actuators within the handles. The “tap” stimulations comprised a 220 ms square signal, while the vibration stimulation consisted of a 120 Hz sinusoidal signal within a 220 ms square envelope. In both *Modes*, signals were preceded by a negative impulse to pull the magnets down in the coil before pushing them out. The Stimuli Onset Asynchrony (SOA), the activation delay between two subsequent actuators, was set at 110 ms (see [87]).

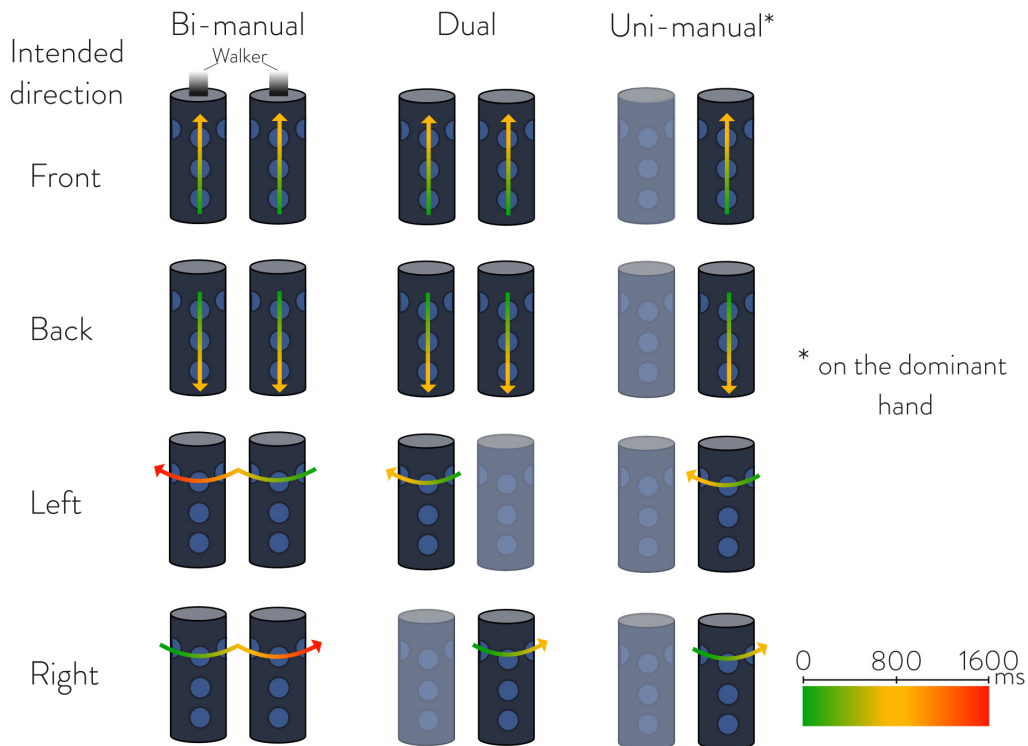

Figure 8.2 – Directional patterns using the AHM illusion organised in strategies. The coloured arrows depict the pattern of activation, with the colour gradient indicating temporal activation (green to red). Each motor is individually activated, providing tapping or vibratory sensations. For example, when considering the *Front* signal of the *Bi-manual Strategy*, it initiates the progressive activation of the three motors along each handle held by the users. On the other side, the *Front* signal of the *Uni-manual Strategy* activates the three actuators along the user’s dominant side handle. For *Left/Right* indications, the sequential activation stimulates the thumb first, the second metacarpal bone (across the purlicue), and the index finger.

Paths to follow

Participants had to follow virtual *Paths*. We created three of them to vary in complexity and make sure participants would not learn them. Paths were designed to have multiple turns, between four and six, with at least two right turns and two left turns. We differentiated *Paths* by the angles of their turns. “Path 1” presents only 90° turns, “Path 2” only 45° turns, and “Path 3” both 45° and 90° turns (see Fig. 8.3).

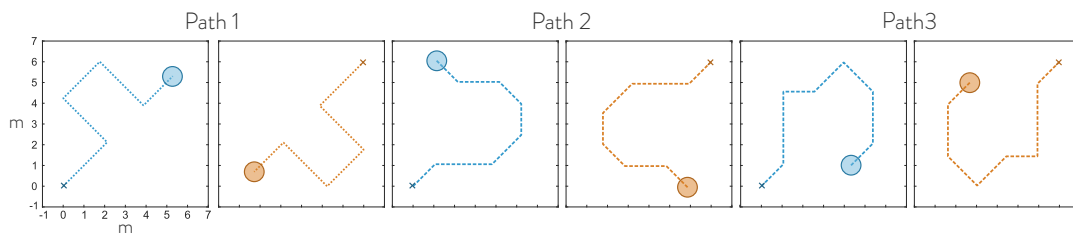

Figure 8.3 – Paths that participants were tasked to follow. The blue and orange paths are identical but start from two different starting points (\times and \times). The coloured discs (\bullet and \bullet) represent the arrival area, where the target is considered reached.

8.2.2 Experimental Task and Design

Participants were tasked with manoeuvring the walker based on the directional information provided through the handle(s), with no prior knowledge of the trajectory. Signals were generated at a frequency of 0.5 Hz, offering directional information every two seconds. The tracking system monitored the walker’s position and rotation, which were used to compute and select the directional pattern to be displayed by the handle(s). Users were guided towards a point one meter ahead on the path, similarly to [47]. The tactile patterns were evaluated depending on the angle computed to reach the target position. If the target is located at $\pm 15^\circ$ compared to the orientation facing by the user, being the 0° reference, the instruction given to the users is *Front*, creating a cone of 30° of tolerance for *Front* direction, comparable to the parameters used in [159]. The *Back* instruction was sent for a target point located at $\pm 127.5^\circ$ compared to the orientation of the user.

The experiment comprised three blocks (for the three *Strategies*), each featuring two series, one per stimulation *Mode* (“taps” or vibrations). Within each series, participants walked three trials corresponding to the three different targets *Paths*. To prevent learning bias, participants alternated between starting points, and the order of presentation of the *Path*, *Mode*, and *Strategy*

conditions were counter-balanced. This protocol resulted in 18 navigation trials per participant corresponding to the 18 conditions: 3 *Paths*×2 *Modes*×3 *Strategies*, with no repetition.

8.2.3 Participants and Collected Data

Eighteen participants, aged between 21 and 35, ($mean = 25.2$, $sd = 4.4$), including four left-handed people, six women, eleven men, and a participant identifying as non-binary, took part in the experiment. Participants were naive about the study hypotheses and design. The experiment lasted one hour. They signed an informed consent form and completed demographic questionnaires. Then, they got 2 minutes to experience manoeuvring the walker without receiving tactile patterns on the handles. Before each change of *Strategy* and *Mode*, participants received the patterns while the experimenter indicated what was the given interpretation of each tactile pattern. During the following tasks, participants wore noise-cancelling headphones. Throughout the task, we collected the participant position, the walker orientation, and navigation information, as well as their level of agreement on a 7-point Likert scale to various statements, as detailed in Section 8.3. At the end of the experiment, we collected the user's preferred guiding *Strategy* and *Mode*, as well as open comments and general feedback.

8.3 Results

Fig. 8.4 shows the data of all eighteen participants' trajectories, categorised according to the *Strategy* and the stimulation *Mode* conditions for the three different target *Paths*. Each graph presents the target *Path* (dotted black line) and the eighteen participants' courses (coloured lines) for each condition.

For our data analysis, we considered the following variables. For the independent variables, we considered the navigation strategies, which lead to different tactile patterns using one or two handles (Uni-manual, Dual, Bi-manual), the stimulation *Mode* ("taps" and vibrations), and target *Paths* (see Fig. 8.3). For the dependent variables, we considered (i) the Dynamic Time Wrapping (DTW) computed on participants' trajectories, (ii) the duration of their courses, and (iii) the total distance covered during each trial. To these objective measurements, we added a subjective evaluation that users gave on 1-7 Likert scales on 14 questions detailed further in this section, as well as qualitative evaluations on their preferred navigation *Strategy* and *Mode*.

Dynamic Time Wrapping (DTW). We computed the Dynamic Time Wrapping distance as a measure of the distance between matching pairs of points in the target *Path* and the participant trajectories. More specifically, the DTW identifies a wrapping *Path* between the target signal

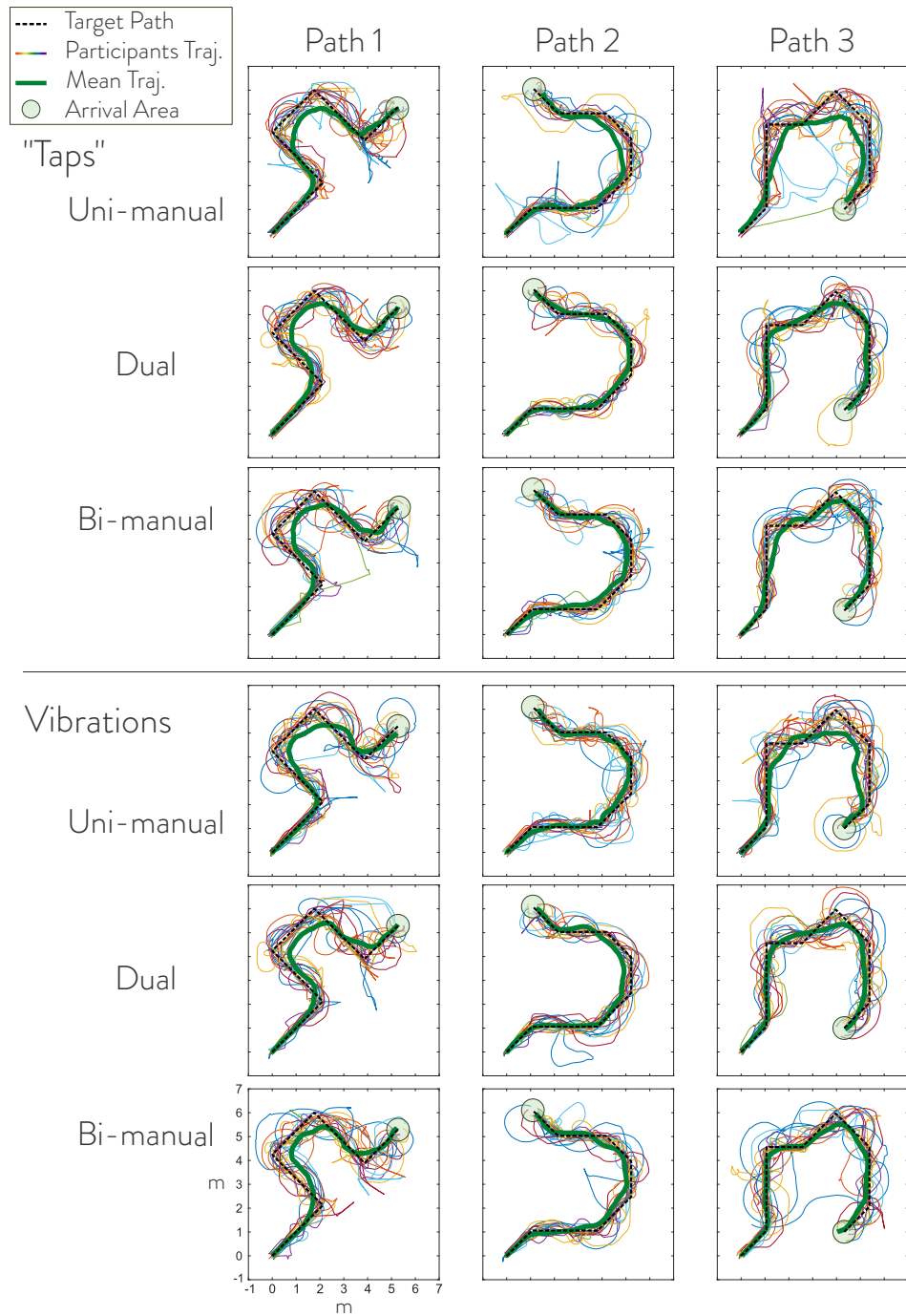

Figure 8.4 – Collection of all participants trajectories for each condition of guiding *Strategy*, stimulation *Mode*, and *Path* number. The dashed black line represents the target *Path*, the thick green line is the mean trajectory among the 18 participants, and each other coloured line is a participant trajectory. The light green disc represents a 0.5 m radius area around the arrival point, considered as the arrival area. The axis represents the 2D space of the room, with the origin placed at the beginning point of the task.

and the participant trajectory signal so as to find the closest corresponding point on the target and create the corresponding pairs of points. We used the package “SimilarityMeasures” on RStudio and the function DTW [153]. Because the DTW is the sum of the Euclidian distance calculated on each new pair of points, this sum varies depending on the number of these points, and we have three different *Paths* and different numbers of points based on the participant time to achieve the task. For this reason, we normalised the DTW by the number of points in the participant trajectory. We thus obtained a mean value of distance to the target *Path* along the whole trajectory. Data showed overall: a mean value of distance from the target $D_{mean} = 0.58m$; median $D_{med} = 0.49m$ and standard deviation $D_{std} = 0.38m$ over all participants and conditions. As the data distribution does not follow a normal distribution, we ran a Generalised Linear Mixed Model analysis, considering as independent variables the three navigation *Strategies*, the stimulation *Modes*, and the three different *Paths*. From the Wald Chi-square test performed on the GLMM, none of the three factors has an impact on the distance to the target calculated through the DTW ($p > 0.05$).

Trajectories duration. For the measure of the duration, we looked at the impact of the independent variables *Strategy and Mode*. Because Paths 1, 2 and 3 have different lengths, we separated the data based on the *Path*. Furthermore, as the data did not satisfy the normality requirements to perform an ANOVA, we ran a GLM analysis to investigate the possible effect of the *Strategy* and the *Mode* of stimulation on the time (thus the velocity of participants) and the total distance covered by participants during a trajectory. For the time data, the Wald Chi-square test (*Strategy, Mode*) performed on the GLM showed no impact of the *Mode* ($p > 0.05$), however showed a significant effect of the *Strategy*. For Path 1 : $\chi^2(2) = 13.176$, $p = 0.001$; for Path 2 : $\chi^2(2) = 11.523$, $p = 0.003$; for Path 3 : $\chi^2(2) = 14.618$, $p < 0.001$. The post-hoc Holm test on the *Strategy* showed that Uni-manual *Strategy* significantly increases the course time compared to Bi-manual ($p < 0.01$) and to Dual ($p < 0.01$). No significant difference was found between Bi-manual and Dual *Strategy*. Data showed overall : a mean value of time $T_{mean} = 83; 75; 88s$ for *Paths* 1 ; 2 3; median $D_{med} = 74; 63; 74s$ and standard deviation $D_{std} = 34; 36; 41s$ over all participants and conditions.

Total covered distance for each trajectory.

We look at the total distance of participants’ trajectories, separating once again the data based on the studied *Path* number, also analysing the impact of the *Strategy* and *Mode*. From the Wald Chi-square test (*Strategy, Mode*) performed on the GLM, none of the two factors had an impact on the total distance ($p > 0.05$).

Subjective Evaluation.

After each *Path*, *Mode*, and *Strategy*, participants had to evaluate on a 7-point Likert scale how much they agreed with the given statement, 1 being “totally disagree” and 7 “totally agree”. Statements are reported in Table 8.1.

For the statements *S1* to *S7*, the same statements are given for vibrations and “taps”. Each data is answered according to the three *Paths* covered in the same *Strategy* and *Mode* conditions. We performed a GLMM with a Poisson model, where *Strategy* and *Mode* are the two independent variables. For each answer, the participants did three trajectories (Path 1-2-3) in each *Mode* and *Strategy*. The post-hoc Holm test results are reported in Table 8.1 and illustrated in Fig. 8.5. The significant effects are shown using “*”. No effect of the *Mode* was found on these statements ($p > 0.05$).

For statements *S8* to *S14*, the question/answers were given after a *Strategy* performance, compiling data for “tap” and vibratory *Mode* or the *Path*. Only the *Strategy* is an independent variable. Answers are still given on a 1-7 Likert scale. This type of data required the Krustal-Wallis rank sum test as the data did not comply with normal distribution requirements for Anova.

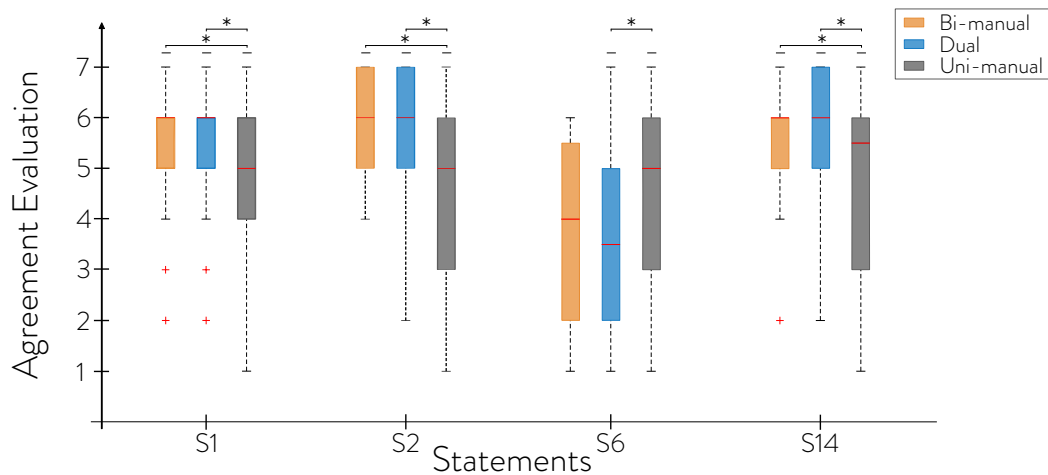

Figure 8.5 – Participants’ evaluation of given statements showing a significant effect of the *Strategy*. Answers are given on a 7-point Likert scale. Red markers indicate the median value. The bottom and top edges of the box indicate the 25th and 75th percentiles, respectively. The whiskers extend to the most extreme data points, not considering outliers. Outliers are plotted using the +.

	Strategy comparison		
	Dual - Bi	Uni - Dual	Uni - Bi
S1: I think I succeeded in completing the task.	$p > 0.05$	$p = 0.032^*$	$p = 0.032^*$
S2: The guiding Strategy is easy to use.	$p > 0.05$	$p = 0.037^*$	$p = 0.024^*$
S3: The stimulations are pleasant.	$p > 0.05$	$p > 0.05$	$p > 0.05$
S4: The stimulation intensity is appropriate.	$p > 0.05$	$p > 0.05$	$p > 0.05$
S5: The use of the device is effortless.	$p > 0.05$	$p > 0.05$	$p > 0.05$
S6: The task is mentally demanding.	$p > 0.05$	$p = 0.030^*$	$p > 0.05$
S7: The task is physically demanding.	$p > 0.05$	$p > 0.05$	$p > 0.05$
S8: I confidently navigated.	$p > 0.05$	$p > 0.05$	$p > 0.05$
S9: The haptic assistance is useful to follow the trajectory.	$p > 0.05$	$p > 0.05$	$p > 0.05$
S10: The haptic assistance is easy to use.	$p > 0.05$	$p > 0.05$	$p > 0.05$
S11: I could use the device without prior instructions.	$p > 0.05$	$p > 0.05$	$p > 0.05$
S12: I learnt how to use the device quickly.	$p > 0.05$	$p > 0.05$	$p > 0.05$
S13: It is fun to use.	$p > 0.05$	$p > 0.05$	$p > 0.05$
S14: I am satisfied with the navigation Strategy (tactile patterns).	$p > 0.05$	$p = 0.042^*$	$p = 0.042^*$

POST-HOC HOLM TESTS RESULTS FOR THE QUALITATIVE EVALUATION ON THE STIMULI STIMULATIONS. DATA FOR ALL 18 PARTICIPANTS.

8.4 Discussion

In this study, various factors concerning navigation strategies were examined using different tactile patterns, stimulation modes (“taps” and vibrations), and target paths. Statistical analyses were conducted on dependent variables such as participant trajectories—to evaluate the distance to the target, course duration—to determine the impact on intuitiveness and confidence, total distance—to see if participants would over-walk in certain conditions, and Likert scale evaluations—to have a qualitative evaluation.

8.4.1 Impact of the strategy

The Dynamic Time Wrapping distance was employed for trajectory analysis, revealing no significant impact of *Strategy*, *Mode*, or *Path*. The same observation was made on the total distance covered during the trajectories. However, course duration was significantly influenced by strategy, with the Uni-manual approach making the participants’ courses longer in time, suggesting the Uni-manual strategy affected the confidence of participants when having no training in the task. Likert scale evaluations indeed indicated that the Uni-manual strategy negatively affected participants’ confidence, as they perceived their success in the task lower and found the guiding strategy was less easy to use, mentally more demanding, and less satisfied with this strategy. However, it is important to notice that their actual displacements were as good with the Uni-manual strategy as with the other two and that training could potentially improve the perceived shift between strategies. About the participant’s preferences, over the eighteen users, nine preferred the Dual and nine preferred the Bi-manual strategy.

8.4.2 Comparison between modes

Statistically, the mode did not have an impact on the users’ ability to follow the predefined paths, nor did it affect their subjective evaluation of their own performances or their evaluation of the devices. No strict conclusion could be made on the mode or strategy preferences, as nine participants preferred “taps” and nine preferred. Overall, these findings highlight the importance of strategy in influencing both objective performance metrics and subjective user experiences during navigation tasks. The design of the handles and the results on participants’ faithfulness to follow a *path* with all three *strategies* makes it easy to adapt to different mobility aids that will be tested in the future, such as the precanes, the power-wheelchair, the cane, for people with single or multiple impairments.

8.5 Conclusion

We conducted a user study with eighteen participants who walked on virtual paths with the sole help of tactile indications provided on custom walker haptic handles. We tested out three strategies of tactile patterns, using one or two handles and putting into practice the validated signals based on the AHM illusion.

By conducting this experiment, our goal was also to complete our answer to the scientific Challenges that structured our entire scientific reflection over the past three years and led us to these experimental implementations and validations. By testing our device in realistic conditions, we implement the tactile signals that have been tested in our perception studies and proved efficient for directional information (Challenge #1). Not only did we validate vibrotactile patterns, but we also guided people on different trajectories with an alternative stimulation mode: “tap” stimulations. No difference was found between the two modes of stimulation, paving the way for a promising use of the device in both actuation modalities.

As the handles are designed to be adaptable to multiple mobility aids, e.g., walkers, wheelchairs, precanes, and white canes, these results may be readily applicable to a much broader range of situations and systems. Creating versatile and easily mountable hand-held devices appears to be a promising navigation aid solution for people suffering from sensory and mobility deficiencies, should they use a walker or another aid apparatus.

CONCLUSION AND PERSPECTIVES

9.1 Take-home messages from this thesis

In the field of navigation assistance, we encounter a large number of challenges, particularly when considering the different user groups, such as pedestrian needing their attention to be focused on the environment and not on their navigation device or people with more specific needs related to sensory or physical impairments. For this last group, and more specifically for visually impaired people, the limitations of today's apparatus or navigation system become even more apparent due to the lack of devices' lack of adaptability. In that respect, we developed and validated a new tool for assisted navigation using haptics. An adaptive handle was designed with the capacity to house the desired actuators, which were custom-designed and hand-made, able to elicit vibrotactile and tapping stimuli. Signals were designed and chosen to convey a proper apparent haptic motion illusion, enabling the discrimination of directional information. Finally, the implementation of a study with the handle mounted on a walker in conditions close to real-life conditions was achieved, validating our work and design. This work aimed to address the needs of a larger group by introducing a hand-held device for navigation guidance. It provides solutions to the three main scientific challenges outlined in Chapter 1, which were the central focus of my research. The answers provided and the work that has been realised are detailed in the following sections.

9.1.1 I. Using the Apparent Haptic Motion for navigational instructions in various actuation modalities

A main focus of this thesis work was to find and validate a viable alternate stimulation mode which would be as efficient as vibrations. Throughout our five experiments, we used the apparent haptic motion illusion in both vibratory and tapping modalities. The tapping mode was designed and evaluated in order to be used in applications in which vibrotactile feedback is not suitable. In the setup, the "taps" were induced by the same electromagnetic actuators as for the vibratory mode. Throughout our experiments, we achieved to create signal inducing

no significant difference in directional or speed identification tasks compared to vibrations, providing an alternative to this stimulation in conveying the apparent haptic motion illusion.

Using the Apparent Haptic Motion for directional information Our first experiment presented in Chapter 4 successfully validated the discrimination of directions using the AHM illusion on the palm and middle finger, even on curved surfaces. Participants accurately identified motion direction using both vibratory and tapping signals, indicating the resilience of the AHM illusion across varying parameters. This study was the first step in utilising the AHM illusion as a tool for navigation indication.

Chapter 6 introduces a cylindrical hand-held device and investigates the AHM’s ability to convey directions on the volar, i.e., the palmar side of the hand in 2D—along and around the handle. Participants confirmed the efficiency of the AHM to draw identifiable directional patterns within the hand palm.

Chapter 7 evaluates different haptic rendering techniques on a walker as a guiding device. Specific patterns effective in conveying directional instructions were identified, with no significant difference between using vibratory versus tapping modes for conveying directional cues. This highlights the AHM’s potential as a reliable directional cue for mobility aid systems.

In Chapter 8, a user study involving virtual paths and custom walker haptic handles tested various tactile patterns, including both vibrotactile and tapping signals based on the AHM illusion. No difference was found between the two modes of stimulation, indicating promising use of both actuation modalities for conveying directional information.

Overall, these chapters demonstrate the AHM’s effectiveness in conveying directional information for navigation assistance. The AHM illusion shows promise as a valuable tool for developing assistive devices in mobility aid systems. Further research aims to refine the AHM and optimise stimulation parameters for practical implementation in various navigation scenarios. Besides the promising results in the interpretation of directional instructions through the AHM, some limitations were found in the subjective evaluation of the smoothness of the illusion, which would benefit from further work to improve.

“Taps” as an alternative to the vibrations in the Apparent Haptic Motion illusion

The results and conclusions of these five studies provided relevant insights on the fact that “taps” can be an alternative to vibrations in conveying directional information through the Apparent Haptic Motion (AHM) illusion, and thus key insights about their ability to constitute relevant and efficient cues to convey the desired information.

Chapter 4 constitutes the initial exploration of the AHM illusion for navigation guidance. It compared vibratory signals with tapping signals as alternatives for conveying directional

information. The results indicated that both stimulation modes were effective in discriminating motion direction. Participants found both modes smooth, pleasant, and easy to identify direction, suggesting that tapping signals could be an alternative to vibrations.

Expanding on the initial study, Chapter 6 introduced a cylindrical hand-held device and investigated the impact of handle orientation on perception. While participants demonstrated an ability to recognise directions conveyed through both vibratory and tapping cues, notable differences in stimulation modes emerged. Vibratory signals were favoured over tapping sensations as participants' scores in discriminating directions were higher with vibrations. This was found to be a possible effect of the familiarity of humans with vibration stimuli. However, our hypothesis was that the design of the device and of the actuators affected the handle functioning in "tap" mode. Indeed, by using the handle in various positions, we tested the capacity of our gravity-dependant actuators to function in up-side-down configurations. While we worked on the design to address this concern, the experiment highlighted the need for improvement in their design to convey robust tapping sensations that were suffering from excessive friction in the centre guiding shaft.

After significant design improvement of the device and especially on the actuators, Chapter 7 compared different haptic rendering techniques on a walker as a guiding device. The improvements were made by changing the centre guide for a built-in membrane, deleting the excessive friction and ensuring the use of the actuators in omni-directional positions. The study identified specific patterns effective in conveying directional instructions, with no significant difference between using vibratory versus tapping modes for conveying directional cues. This finding suggests that even for more complex patterns tested in this experiment, no difference between the tapping and vibration modes was observed.

Finally, our last experiment in walking conditions confirmed the preliminary results. More specifically, a user study was conducted to guide participants along virtual paths using custom walker haptic handles. The study implemented validated signals based on the AHM illusion, including both vibrotactile patterns and tapping stimulations. Importantly, no difference was found between the two modes of stimulation, showing that both techniques enabled efficient guiding of the users throughout the predefined path.

Overall, these experiments provide consistent evidence that tapping signals can be comparable to vibrations in conveying directional information through the AHM illusion. While vibratory signals may be favoured in some scenarios, tapping sensations offer a viable alternative. Further research may focus on improving the actuator design and optimising stimulation parameters to refine the accuracy of the perceived direction, e. g. with diagonal indications.

Studying the AHM temporal parameters as a source of information Indicating the velocity of a moving obstacle or urging a user to slow down is essential in the context of assisted navigation tasks. For this reason, Chapter 5 delved deeper into the temporal parameters of the AHM illusion and investigated its potential for such use. Nevertheless, the experiment revealed limitations in using variations changing the SOA of the apparent haptic motion illusion as a reliable source of information on speed discrimination. Because the haptic patterns used in our device are made of less than 0.5 s long signals, variations on such short timing are difficult to perceive. As a consequence, attention was then focused on conveying directional information.

9.1.2 II. Integrate the directional messages into a handle shape device

The integration of signals into a handle-shaped device is a main objective of our project and has been explored across multiple studies. Our first study presented in Chapter 4 introduces the psychophysics validation on curved surfaces as an initial step before integrating the haptic signals into a handle shape device. By confirming the absence of a significant impact of the curvature on the AHM haptic perception, we obtained the first encouraging results for the viability of our concept and stimulation strategy into a handle device.

The third study (see Chapter 6) presents the implementation step into a handle. Using an almost cylindrical shape device, the guiding system provides directional information through the AHM illusion. It is also the first introduction of 2D patterns with the possibility of eliciting stimulations along four different directions. A major point in this experiment was to validate the possible use of the handle in various positions to adapt it, for example, to mobility aids like walkers, precanes, and electric power wheelchairs. As mentioned earlier, this study also highlighted some limits in the actuators eminently linked to the close-to-cylindrical shape of the handle, requiring the actuators' design to be improved for possible usage in all orientations.

Our fourth experiment (Chapter 7) compared the different validated haptic rendering techniques on a walker as a guiding device. We mentioned earlier improvements that enabled our device to achieve results with no significant difference in either actuation mode. These changes also allowed to achieve a proper handle design. Indeed, thanks to the improvement of the actuators' design, we could achieve a reliable functioning of the device and its motors even in upside-down positions, which represents a main constraint in the setup. The improvements consisted of integrating a soft and flexible lid onto the actuators and fixing the mover on this membrane to remove friction-related issues. The handles were convincing at conveying directional information through the AHM signals, which could be intuitively interpreted by the participants. The participants' interpretations of the signals gave us major insights on how to

build the navigation strategies to be tested in our last experiment.

The final study validates all the precedent work in a first ecological scenario where participants walked on virtual paths with the help of tactile indications provided on custom walker haptic handles. The navigation results are encouraging towards the quick adoption of the handles and their functioning by end users, with a mean distance to the target path of $0.58\text{ m} \pm 0.38\text{ m}$ and an evaluation rate from participants on the ease to use the device of $6.0 \pm 1.0/7$ in two of the three strategies they tested while walking with the walker.

Overall, these chapters highlight the potential of integrating the AHM illusion into handle-shaped devices for navigation assistance, emphasising various aspects. The handles are adaptive, considering they can be used alone or mounted on a mobility aid based on the results obtained in various configurations and our final evaluation of walking conditions.

9.1.3 III. Developing Navigation Strategies Utilising a Hand-held Device

Overall, the process of developing the navigation strategies to achieve viable guiding instructions was reached in two steps. First, it was verified and proved through various experiments (Chapter 4 and 6) that the apparent haptic motion illusion was a convincing way to indicate a pattern direction on the hand by eliciting a motion on the palm either along the palm and fingers or across the metacarpal bones of the hand. Even without asking any interpretation in an egocentric framework, participants were able to distinguish the direction of the motion in their hands. Based on this prior validation, the second step was to confirm the validity of such a tool as a guiding strategy, meaning that users were able to convert the tactile information as directional instructions translating to left, right, front and back instructions. It was found in the fourth experiment (see Chapter 7) that diagonals were not intuitive for everyone and that it would be more practical to adjust the position and orientation of the users with right and left instructions without introducing too complex alternatives.

Finally, we developed three navigation strategies using one or two handles. It was shown that all three strategies enabled the task of path following in an indoor environment with no statistical difference in the distance to the target path. Differences were, however, noted on objective and subjective evaluations, such as the time needed to complete the task or users' own rating of their success, where the uni-manual condition was found to leave participants with lower confidence and required more time to complete the task (which could correlate with the lower confidence rate). The uni-manual condition is very useful if users walk with a white cane or if they want to keep a hand free of stimulations. Our hypothesis is that for this condition, more than for the other two, participants would highly benefit from a training phase

to learn to acquire more automatic and natural responses to the stimulation and increase their confidence in the device using only one handle.

9.2 Perspectives

Going further in the investigation of the AHM temporal and spatial parameters

One of our main scientific questions was about whether the speed of the AHM is discriminated. Presented in Chapter 5, this user study opens questions on what are the parameters influencing the perception of speed in the apparent haptic motion illusion. Accurately determining the impact of temporal parameters could lead to improved signal design and a more complete device giving directional and velocity indications.

Based on our comparison of the vibration and tapping stimulations, another interesting point would be to determine optimal temporal parameters to convey directional information within the handle. Indeed, we based our signal design on the literature, which managed to convey a convincing AHM illusion. Some studies have investigated the optimal parameters to theorise a function of the temporal parameters of the AHM [141, 140]. It would be relevant to investigate it on a handle shape device to highlight possible similarities or differences. In that perspective, psychometric studies could be performed with potentiometers enabling the participant to freely choose the DOS (Duration of Signal) and the SOA (Stimuli Onset Asynchrony, which is the time delay between two actuators' activation) for the most pleasant and smooth AHM. This experiment could typically highlight some differences in the optimal timings when using vibrations or "taps".

An additional investigation to conduct would be on the impact of the distance between stimulation points. Because we want easy adaptation from our device, we could also design customised handle sizes. The experiment on the temporal parameters mentioned above could be conducted on two sizes depending on the participants' hand size and thus also conclude on the impact that the spatial parameters, the distance between actuators can have on the perceived AHM.

Hopefully, future experiments could lead to optimal temporal parameters for smooth AHM within a handle based on the spatial parameter mentioned above. Based on the findings conducting to new optimal spatial and temporal parameters of the AHM in a handle shape device, the domain of navigation assistance and specifically our project would benefit from investigating and finding the optimal speed to convey directional information in a daily navigation aid or other type of velocity information. This could be achieved with a discriminating task such as the study presented in Chapter 5 but changing both the DOS and SOA.

Improving the handle adaptability As mentioned before, further work can be done on the handle design for enhanced adaptability. Based on the participants' free comments and on the clinicians' expertise, a first step could be to design a second handle of a smaller size to better fit children, young adults or women who often declared to apply excessive force during grip because it was sometimes a little wide for their hands. This proposition could also be accompanied by an improvement in the ergonomic grip. More specifically, the handle would benefit from the addition of a strict shape in the design, allowing a one-and-only hand position. This would enable an easy grip at all times and ensure that users position their hands the right way.

Additionally, a major work to go further in our study and development of our guiding system would be to mount the handles on other mobility aids to test and validate viable navigation strategies, as in our last experiment.

One key challenge lies in ensuring the haptic feedback is tailored to the specific needs and abilities of individuals with disabilities. This involves understanding the diverse range of disabilities and designing a handle that can accommodate various sensory sensitivities and motor skills, enabling easy customisation of the design and rendering. Another critical challenge is the need for the haptic handle to be robust and reliable in different environments. People with disabilities rely heavily on assistive devices for daily activities, so the handle must be durable, resistant to wear and tear, and capable of providing consistent feedback over time. Moreover, the design should take into account factors like ergonomics and comfort to ensure prolonged use without causing discomfort or fatigue. Furthermore, integrating haptic technology into a handle requires a multidisciplinary approach. Following what was done within DORNELL, collaboration between engineers, designers, healthcare professionals, and end-users is essential to create a solution that meets both technical requirements and user needs. This collaborative effort should focus on user-centred design principles to ensure that the haptic handle is not only functional but also enhances the overall quality of life for individuals with disabilities. Finally, the need for tracking technologies, both globally and locally, is crucial for ensuring the safety and performance of this assisted navigation system. For a complete and operative guiding system, the handles and the guiding algorithm should be linked to a GPS system and detection sensors equipping the mobility aid or on the user (e.g. on a belt). This would allow viable and autonomous use of the device in outdoor environments.

BIBLIOGRAPHY

- [1] Firas Abi-Farraj et al., « A haptic shared-control architecture for guided multi-target robotic grasping », *in: IEEE Transactions on Haptics* 13.2 (2019), pp. 270–285.
- [2] Tomohiro Amemiya and Hiroaki Gomi, « Buru-Navi3: behavioral navigations using illusory pulled sensation created by thumb-sized vibrator », *in: Proceedings of the 41th International SIGACCESS Conference on Computers and Accessibility*, Association for Computing Machinery, 2014.
- [3] Tomohiro Amemiya and Hisashi Sugiyama, « Haptic handheld wayfinder with pseudo-attraction force for pedestrians with visual impairments », *in: Proceedings of the 36th International SIGACCESS Conference on Computers and Accessibility*, Association for Computing Machinery, 2009, pp. 107–114.
- [4] Tomohiro Amemiya and Hisashi Sugiyama, « Navigation in eight cardinal directions with pseudo-attraction force for the visually impaired », *in: 2009 IEEE International Conference on Systems, Man and Cybernetics*, IEEE, 2009, pp. 27–32.
- [5] Tomohiro Amemiya and Hisashi Sugiyama, « Orienting kinesthetically: A haptic handheld wayfinder for people with visual impairments », *in: Transactions on Accessible Computing (TACCESS)* 3.2 (2010), pp. 1–23.
- [6] Bruno Andò et al., « A haptic solution to assist visually impaired in mobility tasks », *in: IEEE Transactions on Human-Machine Systems* 45.5 (2015), pp. 641–646.
- [7] Shiri Azenkot, Richard E Ladner, and Jacob O Wobbrock, « Smartphone haptic feedback for nonvisual wayfinding », *in: Proceedings of the 13th International SIGACCESS Conference on Computers and Accessibility*, Association for Computing Machinery, 2011, pp. 281–282.

-
- [8] Tim Bakker et al., « Development of a haptic device with tactile and proprioceptive feedback for spatial design tasks », in: *Proceedings of the IEEE International Symposium on Mixed and Augmented Reality (ISMAR-Adjunct)*, IEEE, 2017, pp. 223–228.
- [9] Ingvars Birznieks et al., « Slowly adapting mechanoreceptors in the borders of the human fingernail encode fingertip forces », in: *Journal of Neuroscience* 29.29 (2009), pp. 9370–9379.
- [10] Ludmilla Vilas Boas et al., « Auditory processing performance in blind people », in: *Brazilian Journal of Otorhinolaryngology* 77.4 (2011), pp. 504–509.
- [11] Johann Borenstein, « The navbelt-a computerized multi-sensor travel aid for active guidance of the blind », in: *CSUN's Fifth Annual Conference on Technology and Persons with Disabilities*, 1990, pp. 107–116.
- [12] Johann Borenstein and Iwan Ulrich, « The guidecane-a computerized travel aid for the active guidance of blind pedestrians », in: *Proceedings of International Conference on Robotics and Automation*, vol. 2, IEEE, 1997, pp. 1283–1288.
- [13] Elodie Bouzbib et al., « “Can i touch this?”: Survey of virtual reality interactions via haptic solutions: Revue de littérature des interactions en réalité virtuelle par le biais de solutions haptiques », in: *Proceedings of the 32nd Conference on l'Interaction Homme-Machine*, 2021, pp. 1–16.
- [14] Penelope Brown and Stephen C Levinson, « ‘Left’ and ‘right’ in Tenejapa: investigating a linguistic and conceptual gap », in: *STUF-Language Typology and Universals* 45.1-4 (1992), pp. 590–611.
- [15] Harold E Burt, « Tactual illusions of movement. », in: *Journal of experimental Psychology* 2.5 (1917), p. 371.
- [16] Daniel KY Chen, Jean-Baptiste Chossat, and Peter B Shull, « Haptivec: Presenting haptic feedback vectors in handheld controllers using embedded tactile pin arrays », in: *Proceedings of the CHI Conference on Human Factors in Computing Systems*, 2019, pp. 1–11.
- [17] Xi Chen and Sunil K Agrawal, « Assisting versus repelling force-feedback for human learning of a line following task », in: *Proceedings of the 4th IEEE RAS & EMBS International Conference on Biomedical Robotics and Biomechatronics (BioRob)*, IEEE, 2012, pp. 344–349.

-
- [18] Francesco Chinello et al., « Design and evaluation of a wearable skin stretch device for haptic guidance », in: *IEEE Robotics and Automation Letters* 3.1 (2017), pp. 524–531.
- [19] Jean-Philippe Choiniere and Clement Gosselin, « Development and experimental validation of a haptic compass based on asymmetric torque stimuli », in: *IEEE Transactions on Haptics* 10.1 (2016), pp. 29–39.
- [20] Akansel Cosgun, E Akin Sisbot, and Henrik I Christensen, « Evaluation of rotational and directional vibration patterns on a tactile belt for guiding visually impaired people », in: *Proceedings of the IEEE Haptics Symposium (HAPTICS)*, IEEE, 2014, pp. 367–370.
- [21] Heather Culbertson, Samuel B Schorr, and Allison M Okamura, « Haptics: The present and future of artificial touch sensation », in: *Annual Review of Control, Robotics, and Autonomous Systems* 1 (2018), pp. 385–409.
- [22] Heather Culbertson et al., « WAVES: A wearable asymmetric vibration excitation system for presenting three-dimensional translation and rotation cues », in: *Proceedings of the CHI Conference on Human Factors in Computing Systems*, 2017, pp. 4972–4982.
- [23] Chris J Dallmann, Marc O Ernst, and Alessandro Moscatelli, « The role of vibration in tactile speed perception », in: *Journal of neurophysiology* 114.6 (2015), pp. 3131–3139.
- [24] Jesper Dammeyer, « Deafblindness: A review of the literature », in: *Scandinavian journal of public health* 42.7 (2014), pp. 554–562.
- [25] Jesper Dammeyer, « Mental and behavioral disorders among people with congenital deafblindness », in: *Research in developmental disabilities* 32.2 (2011), pp. 571–575.
- [26] Jesper Dammeyer and Simo Køppe, « The relationship between body movements and qualities of social interaction between a boy with severe developmental disabilities and his caregiver », in: *Intellectual and developmental disabilities* 51.3 (2013), pp. 154–163.
- [27] Sébastien Delorme et al., « NeuroTouch: a physics-based virtual simulator for cranial microneurosurgery training », in: *Operative Neurosurgery* 71 (2012), pp. 32–42.

-
- [28] Louise Devigne et al., « Power wheelchair navigation assistance using wearable vibrotactile haptics », in: *IEEE Transactions on Haptics* 13.1 (2020), pp. 52–58.
- [29] Nem Khan Dim and Xiangshi Ren, « Investigation of suitable body parts for wearable vibration feedback in walking navigation », in: *International Journal of Human-Computer Studies* 97 (2017), pp. 34–44.
- [30] David Dobbelsstein, Philipp Henzler, and Enrico Rukzio, « Unconstrained pedestrian navigation based on vibro-tactile feedback around the wristband of a smartwatch », in: *Proceedings of the CHI Conference Extended Abstracts on Human Factors in Computing Systems*, 2016, pp. 2439–2445.
- [31] *DORNELL Website— INRIA Rennes, France*, URL: <https://www.inria.fr/fr/dornell> (visited on 02/03/2024).
- [32] Christian Duriez et al., « Realistic haptic rendering of interacting deformable objects in virtual environments », in: *IEEE Transactions on visualization and computer graphics* 12.1 (2005), pp. 36–47.
- [33] Basil Duvernoy et al., « Electromagnetic actuator for tactile communication », in: *Proceedings of the 11th International Conference, EuroHaptics*, Springer, 2018, pp. 14–24.
- [34] Basil Duvernoy et al., « Hapticomm: A touch-mediated communication device for deafblind individuals », in: *IEEE Robotics and Automation Letters* 8.4 (2023), pp. 2014–2021.
- [35] Jan BF Van Erp et al., « Waypoint navigation with a vibrotactile waist belt », in: *Transactions on Applied Perception (TAP)* 2.2 (2005), pp. 106–117.
- [36] Sevgi Ertan et al., « A wearable haptic navigation guidance system », in: *Proceedings of the 2nd International Symposium on Wearable Computers*, IEEE, 1998, pp. 164–165.
- [37] David Escobar-Castillejos et al., « A review of simulators with haptic devices for medical training », in: *Journal of medical systems* 40 (2016), pp. 1–22.
- [38] Seth R Flaxman et al., « Global causes of blindness and distance vision impairment 1990–2020: a systematic review and meta-analysis », in: *The Lancet Global Health* 5.12 (2017), e1221–e1234.

-
- [39] Allen Foster and Serge Resnikoff, « The impact of Vision 2020 on global blindness », in: *Eye* 19.10 (2005), pp. 1133–1135.
- [40] Emily Fujimoto and Matthew Turk, « Non-visual navigation using combined audio music and haptic cues », in: *Proceedings of the 16th International Conference on Multimodal Interaction*, 2014, pp. 411–418.
- [41] Simon Gallo et al., « Augmented white cane with multimodal haptic feedback », in: *Proceedings of the 3rd IEEE RAS & EMBS International Conference on Biomedical Robotics and Biomechatronics*, IEEE, 2010, pp. 149–155.
- [42] Alejandro Rafael García Ramirez, R Fonseca, and Alejandro Durán Carrillo de Albornoz, « Electronic long cane for locomotion improving on visual impaired people. A case study », in: *Pan American health care exchanges* (2011), pp. 58–61.
- [43] Benoît Geslain et al., « Visuo-haptic illusions for motor skill acquisition in virtual reality », in: *Proceedings of the 2021 Symposium on Spatial User Interaction*, Association for Computing Machinery, 2021, pp. 1–9.
- [44] Giuseppe Ghiani, Barbara Leporini, and Fabio Paternò, « Vibrotactile feedback as an orientation aid for blind users of mobile guides », in: *Proceedings of the 10th International Conference on Human computer interaction with mobile devices and services*, 2008, pp. 431–434.
- [45] Giuseppe Ghiani, Barbara Leporini, and Fabio Paternò, « Vibrotactile feedback to aid blind users of mobile guides », in: *Journal of Visual Languages & Computing* 20.5 (2009), pp. 305–317.
- [46] James J Gibson, « Observations on active touch. », in: *Psychological review* 69.6 (1962), p. 477.
- [47] Paolo Robuffo Giordano and Claudio Pacchierotti, « Design of a 2-DoF Haptic Device for Motion Guidance », in: *Proceedings of the 13th International Conference on Human Haptic Sensing and Touch Enabled Computer Applications, EuroHaptics*, vol. 13235, Springer Nature, 2022, p. 198.
- [48] Daniel Goldreich and Ingrid M Kanics, « Tactile acuity is enhanced in blindness », in: *Journal of Neuroscience* 23.8 (2003), pp. 3439–3445.

-
- [49] Monica Gori et al., « Devices for visually impaired people: High technological devices with low user acceptance and no adaptability for children », in: *Neuroscience & Biobehavioral Reviews* 69 (2016), pp. 79–88.
- [50] Martin Grunwald and Matthias John, « German pioneers of research into human haptic perception », in: *Human haptic perception: basics and applications*, Springer, 2008, pp. 15–39.
- [51] Fabien Grzeskowiak et al., « SWALKIT: A generic augmented walker kit to provide haptic feedback navigation assistance to people with both visual and motor impairments », in: *Proceedings of the International Conference on Rehabilitation Robotics (ICORR)*, IEEE, 2022, pp. 1–6.
- [52] W Hamann, « Mammalian cutaneous mechanoreceptors », in: *Progress in biophysics and molecular biology* 64.1 (1995), pp. 81–104.
- [53] H Hashimoto et al., « Walker with hand haptic interface for spatial recognition », in: *Proceedings of the 9th IEEE International Workshop on Advanced Motion Control, 2006*. IEEE, 2006, pp. 311–316.
- [54] Vincent Hayward, *Lecture: Introduction to Haptics*, 2009.
- [55] Vincent Hayward and Oliver R Astley, « Performance measures for haptic interfaces », in: *Proceedings of the Robotics research: The seventh International Symposium*, Springer, 1996, pp. 195–206.
- [56] JWR de Heer, « Haptic perception in people with deafblindness », MA thesis, 2017.
- [57] Morton A Heller, « Active and passive touch: The influence of exploration time on form recognition », in: *The Journal of general psychology* 110.2 (1984), pp. 243–249.
- [58] David N Herrmann et al., « In vivo confocal microscopy of Meissner corpuscles as a measure of sensory neuropathy », in: *Neurology* 69.23 (2007), pp. 2121–2127.
- [59] Thomas Howard et al., « PUMAH: pan-tilt ultrasound mid-air haptics for larger interaction workspace in virtual reality », in: *IEEE Transactions on Haptics* 13.1 (2019), pp. 38–44.

-
- [60] Siyao Hu et al., « A brake-based overground gait rehabilitation device for altering propulsion impulse symmetry », *in: Sensors* 21.19 (2021), p. 6617.
- [61] Ali Israr and Ivan Poupyrev, « Control space of apparent haptic motion », *in: Proceedings of the IEEE World Haptics Conference*, IEEE, 2011, pp. 457–462.
- [62] Ricky Jacob, Peter Mooney, and Adam C Winstanley, « Guided by touch: Tactile pedestrian navigation », *in: Proceedings of the 1st International workshop on Mobile location-based service*, 2011, pp. 11–20.
- [63] Mario F Jimenez et al., « Assistive locomotion device with haptic feedback for guiding visually impaired people », *in: Medical Engineering & Physics* 80 (2020), pp. 18–25.
- [64] Roland S Johansson and ÅB Vallbo, « Spatial properties of the population of mechanoreceptive units in the glabrous skin of the human hand », *in: Brain research* 184.2 (1980), pp. 353–366.
- [65] Lynette A Jones and Susan J Lederman, *Human Hand Function*, Oxford university press, 2006.
- [66] Esteban Bayro Kaiser and Michael Lawo, « Wearable navigation system for the visually impaired and blind people », *in: Proceedings of the IEEE/ACIS 11th International Conference on Computer and Information Science*, IEEE, 2012, pp. 230–233.
- [67] Slim Kammoun, Wahiba Bouhani, and Mohamed Jemni, « Sole based tactile information display for visually impaired pedestrian navigation », *in: Proceedings of the 8th International Conference on PErvasive Technologies Related to Assistive Environments*, Association for Computing Machinery, 2015, pp. 1–4.
- [68] Slim Kammoun et al., « Guiding blind people with haptic feedback », *in: Frontiers in Accessibility for Pervasive Computing (Pervasive 2012)* 3 (2012).
- [69] Astrid ML Kappers et al., « Hand-held haptic navigation devices for actual walking », *in: IEEE Transactions on Haptics* 15.4 (2022), pp. 655–666.
- [70] Hassan A Karimi, Ming Jiang, and Rui Zhu, « Pedestrian navigation services: challenges and current trends », *in: Geomatica* 67.4 (2013), pp. 259–271.

-
- [71] Robert K Katzschmann, Brandon Araki, and Daniela Rus, « Safe local navigation for visually impaired users with a time-of-flight and haptic feedback device », in: *IEEE Transactions on Neural Systems and Rehabilitation Engineering* 26.3 (2018), pp. 583–593.
- [72] Leslie Kay, « A sonar aid to enhance spatial perception of the blind: engineering design and evaluation », in: *Radio and Electronic Engineer* 44.11 (1974), pp. 605–627.
- [73] Edward J Kelly et al., « Nerve fibre and sensory end organ density in the epidermis and papillary dermis of the human hand », in: *British journal of plastic surgery* 58.6 (2005), pp. 774–779.
- [74] Shah Khusro et al., « Haptic feedback to assist blind people in indoor environment using vibration patterns », in: *Sensors* 22.1 (2022), p. 361.
- [75] Sung Yeon Kim and Kwangsu Cho, « Usability and design guidelines of smart canes for users with visual impairments », in: *International Journal of Design* 7.1 (2013).
- [76] Jacob H Kirman, « Tactile apparent movement: The effects of interstimulus onset interval and stimulus duration », in: *Perception & Psychophysics* 15.1 (1974), pp. 1–6.
- [77] Yuki Kon, Takuto Nakamura, and Hiroyuki Kajimoto, « Interpretation of navigation information modulates the effect of the waist-type Hanger Reflex on walking », in: *Proceedings of the IEEE Symposium on 3D User Interfaces (3DUI)*, IEEE, 2017, pp. 107–115.
- [78] Yasumasa Kondo et al., « Navigation guidance control using haptic feedback for obstacle avoidance of omni-directional wheelchair », in: *Proceedings of the Symposium on Haptic Interfaces for Virtual Environment and Teleoperator Systems*, IEEE, 2008, pp. 437–444.
- [79] Rebecca L Koslover et al., « Mobile navigation using haptic, audio, and visual direction cues with a handheld test platform », in: *IEEE Transactions on Haptics* 5.1 (2011), pp. 33–38.
- [80] Panagiotis Kourtesis et al., « Electrotactile feedback applications for hand and arm interactions: A systematic review, meta-analysis, and future directions », in: *IEEE Transactions on Haptics* 15.3 (2022), pp. 479–496.

-
- [81] Lisheng Kuang et al., « Wearable cutaneous device for applying position/location haptic feedback in navigation applications », in: *Proceedings of the IEEE Haptics Symposium (HAPTICS)*, IEEE, 2022, pp. 1–6.
- [82] Ayse Kucukyilmaz and Yiannis Demiris, « Learning shared control by demonstration for personalized wheelchair assistance », in: *IEEE Transactions on Haptics* 11.3 (2018), pp. 431–442.
- [83] Masaki Kuribayashi et al., « Corridor-Walker: Mobile indoor walking assistance for blind people to avoid obstacles and recognize intersections », in: *Proceedings of the Human-Computer Interaction Conference 6.MHCI* (2022), pp. 1–22.
- [84] Inès Lacôte et al., « “Tap Stimulation”: An Alternative To Vibrations To Convey The Apparent Haptic Motion Illusion », in: *Proceedings of the IEEE Haptics Symposium (HAPTICS)*, IEEE, 2022, pp. 1–6.
- [85] Inès Lacôte et al., « Comparing the Haptic Perception of Directional Information Using a Uni-manual or Bi-manual Strategy on a Walker », in: *Proceedings of the IEEE Haptics Symposium (HAPTICS)*, 2024.
- [86] Inès Lacôte et al., « Do Tactile Patterns on both Hands Improve Guided Navigation with a Walker? », in: *Submission to Haptics: Science, Technology, Applications (EuroHaptics). Lecture Notes in Computer Science*, 2024.
- [87] Inès Lacôte et al., « Investigating the haptic perception of directional information within a handle », in: *IEEE Transactions on Haptics* (2023).
- [88] Inès Lacôte et al., « Speed discrimination in the apparent haptic motion illusion », in: *Proceedings of the International Conference on Human Haptic Sensing and Touch Enabled Computer Applications*, Springer, 2022, pp. 48–56.
- [89] Stephen Lakatos and Roger N Shepard, « Constraints common to apparent motion in visual, tactile, and auditory space. », in: *Journal of Experimental Psychology: Human Perception and Performance* 23.4 (1997), p. 1050.
- [90] Anatole Lécuyer et al., « Pseudo-haptic feedback: Can isometric input devices simulate force feedback? », in: *Proceedings IEEE Virtual Reality 2000 (Cat. No. 00CB37048)*, IEEE, 2000, pp. 83–90.

-
- [91] Susan J Lederman and Lynette A Jones, « Tactile and haptic illusions », *in: IEEE Transactions on Haptics* 4.4 (2011), pp. 273–294.
- [92] Susan J Lederman and Roberta L Klatzky, « Haptic perception: A tutorial », *in: Attention, Perception, & Psychophysics* 71.7 (2009), pp. 1439–1459.
- [93] Stephen C Levinson, « Language and space », *in: Annual review of Anthropology* 25.1 (1996), pp. 353–382.
- [94] Stephen C Levinson, « Relativity in spatial conception and description », *in: Rethinking linguistic relativity*, Cambridge University Press, 1996, pp. 177–202.
- [95] Zhenyu Liao, Jose V Salazar Lucas, and Yasuhisa Hirata, « Human navigation using phantom tactile sensation based vibrotactile feedback », *in: IEEE Robotics and Automation Letters* 5.4 (2020), pp. 5732–5739.
- [96] Ming-Wei Lin, Yun-Maw Cheng, and Wai Yu, « Using tactons to provide navigation cues in pedestrian situations », *in: Proceedings of the 5th Nordic Conference on Human-computer interaction: building bridges*, 2008, pp. 507–510.
- [97] Guanhong Liu et al., « Tactile compass: Enabling visually impaired people to follow a path with continuous directional feedback », *in: Proceedings of the CHI Conference on Human Factors in Computing Systems*, 2021, pp. 1–13.
- [98] Jack M Loomis and Susan J Lederman, « Tactual perception », *in: Handbook of Perception and Human Performances* 2.2 (1986), p. 2.
- [99] Matteo Macchini et al., « Hand-worn haptic interface for drone teleoperation », *in: Proceedings of the IEEE International Conference on Robotics and Automation (ICRA)*, IEEE, 2020, pp. 10212–10218.
- [100] Adriano Mancini, Emanuele Frontoni, and Primo Zingaretti, « Mechatronic system to help visually impaired users during walking and running », *in: IEEE Transactions on Intelligent Transportation Systems* 19.2 (2018), pp. 649–660.
- [101] Laura Marchal-Crespo, Jan Furumasu, and David J Reinkensmeyer, « A robotic wheelchair trainer: design overview and a feasibility study », *in: Journal of neuroengineering and rehabilitation* 7 (2010), pp. 1–12.

-
- [102] Michele Capella McDonnall, « Risk factors for depression among older adults with dual sensory loss », *in: Aging & mental health* 13.4 (2009), pp. 569–576.
- [103] Sarah McIntyre et al., « The effects of ageing on tactile function in humans », *in: Neuroscience* 464 (2021), pp. 53–58.
- [104] Anita Meier et al., « Exploring vibrotactile feedback on the body and foot for the purpose of pedestrian navigation », *in: Proceedings of the 2nd International Workshop on Sensor-based Activity Recognition and Interaction*, 2015, pp. 1–11.
- [105] Yann Morère et al., « Haptic control for powered wheelchair driving assistance », *in: Innovation and Research in BioMedical Engineering* 36.5 (2015), pp. 293–304.
- [106] Aaron Morris et al., « A robotic walker that provides guidance », *in: Proceedings of the IEEE International Conference on Robotics and Automation*, vol. 1, IEEE, 2003, pp. 25–30.
- [107] Arshad Nasser, Kai-Ning Keng, and Kening Zhu, « ThermalCane: Exploring thermotactile directional cues on cane-grip for non-visual navigation », *in: Proceedings of the 22nd International SIGACCESS Conference on computers and accessibility*, Association for Computing Machinery, 2020, pp. 1–12.
- [108] Unated Nations, « World population ageing 2013 », *in: Department of Economic and Social Affairs PD* (2013).
- [109] Viet Thuan Nguyen et al., « Joystick haptic force feedback for powered wheelchair- a model-based shared control approach », *in: IEEE International Conference on Systems, Man, and Cybernetics (SMC)*, IEEE, 2020, pp. 4453–4459.
- [110] Masataka Niwa et al., « Determining appropriate parameters to elicit linear and circular apparent motion using vibrotactile cues », *in: Proceedings of the World Haptics-Third Joint EuroHaptics Conference and Symposium on Haptic Interfaces for Virtual Environment and Teleoperator Systems*, IEEE, 2009, pp. 75–78.
- [111] Maria Nolano et al., « Quantification of myelinated endings and mechanoreceptors in human digital skin », *in: Annals of neurology* 54.2 (2003), pp. 197–205.

-
- [112] J Farley Norman and Ashley N Bartholomew, « Blindness enhances tactile acuity and haptic 3-D shape discrimination », *in: Attention, Perception, & Psychophysics* 73 (2011), pp. 2323–2331.
- [113] Alana Officer and Aleksandra Posarac, « World report on disability », *in: World Health Organ: Geneva, Switzerland* (2011).
- [114] Matjaž Ogrinc et al., « Horseback riding therapy for a deafblind individual enabled by a haptic interface », *in: Assistive Technology* 30.3 (2018), pp. 143–150.
- [115] World Health Organization et al., *Strategic plan for Vision 2020: the right to sight*, tech. rep., WHO Regional Office for South-East Asia, 2000.
- [116] Claudio Pacchierotti and Domenico Prattichizzo, « Cutaneous/tactile haptic feedback in robotic teleoperation: Motivation, survey, and perspectives », *in: IEEE Transactions on Robotics* (2023).
- [117] Claudio Pacchierotti et al., « The hRing: A wearable haptic device to avoid occlusions in hand tracking », *in: Proceedings of the IEEE haptics symposium (HAPTICS)*, IEEE, 2016, pp. 134–139.
- [118] Claudio Pacchierotti et al., « Wearable haptic systems for the fingertip and the hand: taxonomy, review, and perspectives », *in: IEEE Transactions on Haptics* 10.4 (2017), pp. 580–600.
- [119] Michel Pare et al., « The Meissner corpuscle revised: a multiafferented mechanoreceptor with nociceptor immunochemical properties », *in: Journal of Neuroscience* 21.18 (2001), pp. 7236–7246.
- [120] Michel Paré, Allan M Smith, and Frank L Rice, « Distribution and terminal arborizations of cutaneous mechanoreceptors in the glabrous finger pads of the monkey », *in: Journal of Comparative Neurology* 445.4 (2002), pp. 347–359.
- [121] Jagannadh Pariti, Vinita Tibdewal, and Tae Oh, « Intelligent mobility cane-lessons learned from evaluation of obstacle notification system using a haptic approach », *in: Extended Abstracts of the CHI Conference on Human Factors in Computing Systems*, 2020, pp. 1–8.

-
- [122] Jaeyoung Park et al., « Rendering moving tactile stroke on the palm using a sparse 2d array », in: *Proceedings of the 10th International Conference, EuroHaptics*, Springer, 2016, pp. 47–56.
- [123] Vanessa Petrausch, Thorsten Schwarz, and Rainer Stiefelhagen, « Prototype development of a low-cost vibro-tactile navigation aid for the visually impaired », in: *Proceedings of the 16th International Conference Computers Helping People with Special Needs (ICCHP)*, Springer, 2018, pp. 63–69.
- [124] Max Pfeiffer et al., « Cruise control for pedestrians: Controlling walking direction using electrical muscle stimulation », in: *Proceedings of the 33rd Annual Conference on Human Factors in Computing Systems*, Association for Computing Machinery, 2015, pp. 2505–2514.
- [125] Martin Pielot, Benjamin Poppinga, and Susanne Boll, « PocketNavigator: vibro-tactile waypoint navigation for everyday mobile devices », in: *Proceedings of the 12th International Conference on Human computer interaction with mobile devices and services*, 2010, pp. 423–426.
- [126] Martin Pielot et al., « 6th senses for everyone! The value of multimodal feedback in handheld navigation aids », in: *Proceedings of the 13th International Conference on multimodal interfaces*, 2011, pp. 65–72.
- [127] Manoj Prasad et al., « Haptimoto: Turn-by-turn haptic route guidance interface for motorcyclists », in: *Proceedings of the SIGCHI Conference on Human Factors in Computing Systems*, 2014, pp. 3597–3606.
- [128] Pornthep Preechayasomboon, Ali Israr, and Majed Samad, « Chasm: A screw based expressive compact haptic actuator », in: *Proceedings of the CHI Conference on Human Factors in Computing Systems*, 2020, pp. 1–13.
- [129] Rahaf Rahal et al., « Haptic-guided grasping to minimise torque effort during robotic telemanipulation », in: *Autonomous Robots* 47.4 (2023), pp. 405–423.
- [130] Jacob Ricky et al., « Pedestrian navigation using the sense of touch », in: *Computers, Environment and Urban Systems* 36.6 (2012), pp. 513–525.
- [131] Simon Robinson, Parisa Eslambolchilar, and Matt Jones, « Evaluating haptics for information discovery while walking », in: *Proceedings of the 23rd Conference Celebrating People and Technology*, BCS Learning & Development, 2009.

-
- [132] Simon Robinson et al., « " I did it my way" moving away from the tyranny of turn-by-turn pedestrian navigation », in: *Proceedings of the 12th International Conference on Human computer interaction with mobile devices and services*, 2010, pp. 341–344.
- [133] Uta R Roentgen et al., « Inventory of electronic mobility aids for persons with visual impairments: A literature review », in: *Journal of Visual Impairment & Blindness* 102.11 (2008), pp. 702–724.
- [134] Gustavo Rovelo et al., « Studying the user experience with a multimodal pedestrian navigation assistant », in: *Proceedings of the 10th International Conference on Computer Graphics Theory and Applications*, 2015, pp. 438–445.
- [135] Sonja Rümelin, Enrico Rukzio, and Robert Hardy, « NaviRadar: a novel tactile information display for pedestrian navigation », in: *Proceedings of the 24th annual Symposium on User Interface Software and Technology*, Association for Computing Machinery, 2011, pp. 293–302.
- [136] M Sahnoun and G Bourhis, « Haptic feedback to assist powered wheelchair piloting », in: *Assoc. Adv. Model. Simul. Techn. Enterprises* 67 (2006), pp. 53–63.
- [137] MS Sander, MCBF Lelievre, and DA Tallec, « Les personnes en situation de handicap visuel. apports de l'enquete handicaps-incapacités-dépendances », in: *Rapport d'enquete du Ministere Francais de la Santé et des Solidarités* (2005).
- [138] Charlélie Saudrais et al., « End-of-instrument stiffness perception device based on sensory augmentation for laparoscopic surgery », in: *Proceedings of the Conference on New Technologies for Computer and Robot Assisted Surgery*, 2022, <https://cras.fr>.
- [139] Tatjana Seizova-Cajic et al., « Lateral skin stretch influences direction judgments of motion across the skin », in: *Proceedings of the 9th International Conference, EuroHaptics 2014*, Springer, 2014, pp. 425–431.
- [140] Carl E Sherrick, « Bilateral Apparent Haptic Movement », in: *Perception & Psychophysics* 4.3 (1968), pp. 159–160.
- [141] Carl E Sherrick and Ronald Rogers, « Apparent haptic movement », in: *Perception & Psychophysics* 1.3 (1966), pp. 175–180.

-
- [142] Adam Spiers, Eric Young, and Katherine J Kuchenbecker, « The s-ban: Insights into the perception of shape-changing haptic interfaces via virtual pedestrian navigation », *in: Association for Computing Machinery Transactions on Computer-Human Interaction* 30.1 (2023), pp. 1–31.
- [143] Adam Spiers et al., « First validation of the haptic sandwich: A shape changing handheld haptic navigation aid », *in: Proceedings of the International Conference on Advanced Robotics (ICAR)*, IEEE, 2015, pp. 144–151.
- [144] Adam J Spiers and Aaron M Dollar, « Design and evaluation of shape-changing haptic interfaces for pedestrian navigation assistance », *in: IEEE Transactions on Haptics* 10.1 (2016), pp. 17–28.
- [145] Adam J Spiers and Aaron M Dollar, « Outdoor pedestrian navigation assistance with a shape-changing haptic interface and comparison with a vibrotactile device », *in: Proceedings of the IEEE Haptics Symposium (HAPTICS)*, IEEE, 2016, pp. 34–40.
- [146] Adam J Spiers et al., « Development and experimental validation of a minimalist shape-changing haptic navigation device », *in: Proceedings of the IEEE International Conference on Robotics and Automation (ICRA)*, IEEE, 2016, pp. 2688–2695.
- [147] Adam J Spiers et al., « Testing a shape-changing haptic navigation device with vision-impaired and sighted audiences in an immersive theater setting », *in: IEEE Transactions on Human-Machine Systems* 48.6 (2018), pp. 614–625.
- [148] Mayuree Srikulwong and Eamonn O’Neill, « Wearable tactile display of directions for pedestrian navigation: Comparative lab and field evaluations », *in: Proceedings of the World Haptics Conference (WHC)*, IEEE, 2013, pp. 503–508.
- [149] Simon Stock et al., « Feedi-a smart wearable foot-band for navigation and guidance using haptic feedback », *in: Proceedings of the 2nd International Conference on Human Interaction and Emerging Technologies: Future Applications (IHJET)*, Springer, 2020, pp. 349–355.
- [150] Takeshi Tanabe, Hiroaki Yano, and Hiroo Iwata, « Evaluation of the perceptual characteristics of a force induced by asymmetric vibrations », *in: IEEE Transactions on Haptics* 11.2 (2017), pp. 220–231.

-
- [151] Takeshi Tanabe et al., « Pulling illusion based on the phase difference of the frequency components of asymmetric vibrations », in: *IEEE/ASME Transactions on Mechatronics* 26.1 (2020), pp. 203–213.
- [152] Xavier de Tinguy et al., « Weatavix: wearable actuated tangibles for virtual reality experiences », in: *Haptics: Science, Technology, Applications: 12th International Conference, EuroHaptics*, Springer, 2020, pp. 262–270.
- [153] Kevin Toohey and Matt Duckham, « Trajectory similarity measures », in: *Proceedings of the Sigspatial Special Conference*, vol. 7, 1, Association for Computing Machinery, 2015, pp. 43–50.
- [154] Koji Tsukada and Michiaki Yasumura, « Activebelt: Belt-type wearable tactile display for directional navigation », in: *Proceedings of the International Conference on Ubiquitous Computing*, Springer, 2004, pp. 384–399.
- [155] Sebastian Ullrich and Torsten Kuhlen, « Haptic palpation for medical simulation in virtual environments », in: *IEEE Transactions on Visualization and Computer Graphics* 18.4 (2012), pp. 617–625.
- [156] Iwan Ulrich and Johann Borenstein, « The GuideCane-applying mobile robot technologies to assist the visually impaired », in: *IEEE Transactions on Systems, Man, and Cybernetics-Part A: Systems and Humans* 31.2 (2001), pp. 131–136.
- [157] Jan BF Van Erp et al., « Guidelines for the use of vibro-tactile displays in human computer interaction », in: *Proceedings of the Haptics: Science, Technology, Applications: 2th International Conference, EuroHaptics*, vol. 2002, Citeseer, 2002, pp. 18–22.
- [158] Emmanuel B Vander Poorten et al., « Powered wheelchair navigation assistance through kinematically correct environmental haptic feedback », in: *Proceedings of the IEEE International Conference on Robotics and Automation*, IEEE, 2012, pp. 3706–3712.
- [159] Andreas Wachaja et al., « Navigating blind people with walking impairments using a smart walker », in: *Autonomous Robots* 41 (2017), pp. 555–573.
- [160] Qu Wang et al., « Recent advances in pedestrian navigation activity recognition: a review », in: *IEEE Sensors Journal* 22.8 (2022), pp. 7499–7518.

-
- [161] György Wersényi, « Perception Accuracy of a Multi-Channel Tactile Feedback System for Assistive Technology », *in: Sensors* 22.22 (2022), p. 8962.
- [162] WHO, *Ear and Hearing Survey Handbook*, tech. rep., World Health Organization, 2020.
- [163] WHO, *VISION 2020*, tech. rep., New Delhi, Inde: East Asia Office - World Health Organization, 2007.
- [164] Frederik Wiehr, Adrien Unger, and Antonio Krueger, « HapticPole: Running Navigation Through Skin Drag and Shape Change », *in: Proceedings of the Augmented Humans International Conference*, 2023, pp. 354–356.
- [165] Mikolaj P Wozniak et al., « Gapeau: Enhancing the Sense of Distance to Others with a Head-Mounted Sensor », *in: Proceedings of the 16th International Conference on Tangible, Embedded, and Embodied Interaction*, 2022, pp. 1–19.
- [166] Shuchang Xu et al., « Virtual Paving: Rendering a smooth path for people with visual impairment through vibrotactile and audio feedback », *in: Transactions on Computer-Human Interaction on Interactive, Mobile, Wearable and Ubiquitous Technologies* 4.3 (2020), pp. 1–25.
- [167] Tomonori Yasui et al., « Evaluation of a vibration-based route indication for children who are not familiar with maps », *in: Proceedings of the IEEE 8th Global Conference on Consumer Electronics (GCCE)*, IEEE, 2019, pp. 40–44.
- [168] Yiting Yi and Lunfu Dong, « A design of blind-guide crutch based on multi-sensors », *in: Proceedings of the 12th International Conference on Fuzzy Systems and Knowledge Discovery (FSKD)*, IEEE, 2015, pp. 2288–2292.
- [169] Sho Yokota et al., « The assistive walker using hand haptics », *in: Proceedings of the IECON 39th Annual Conference of the Industrial Electronics Society*, IEEE, 2013, pp. 8329–8334.
- [170] Sho Yokota et al., « The assistive walker using hand haptics—The design of the prototype », *in: Proceedings of the 6th International Conference on Human System Interactions (HSI)*, IEEE, 2013, pp. 214–218.
- [171] Eric M Young et al., « Compensating for fingertip size to render tactile cues more accurately », *in: IEEE Transactions on Haptics* 13.1 (2020), pp. 144–151.

-
- [172] Minhua Zhang et al., « Gait study of parkinson's disease subjects using haptic cues with a motorized walker », *in: Sensors* 18.10 (2018), p. 3549.
- [173] Siyan Zhao, Ali Israr, and Roberta Klatzky, « Intermanual Apparent Tactile Motion on Handheld Tablets », *in: Proceedings of the IEEE World Haptics Conference (WHC)*, IEEE, 2015, pp. 241–247.

APPENDIX

Titre : Étude de l'illusion Haptique du Mouvement Apparent pour la Création d'une Poignée d'Aide à la Navigation

Mot clés : Dispositif Haptique - Perception Haptique - Illusions Haptiques - Guidage

1. Aide à la navigation : Contexte général et besoins croissants

Si les systèmes de navigation embarqués, basés sur les technologies GPS, ont considérablement progressé grâce aux systèmes de guidage virage par virage, offrant une assistance suffisamment efficace pour ces échelles d'application, ces outils ne sont pas aussi bien adaptés aux piétons qui ont besoin d'informations beaucoup plus détaillées [69].

1.1 Contexte général

Avec le succès et la popularité croissants des systèmes de navigation automobile, la demande de systèmes de navigation pour piétons (PNS) a considérablement augmenté ces dernières années [70]. Bien que les PNS partagent certaines caractéristiques avec les systèmes de navigation automobile en calculant les trajets optimaux, leur conception doit spécifiquement prendre en compte les besoins et préférences uniques des piétons en matière d'orientation et de navigation. Les limites de ces systèmes ont été identifiées sur les PNS dédiés aux déplacements extérieurs, avec par exemple leur dépendance aux réseaux routiers, ce qui entraîne un guidage inefficace des piétons, qui marchent souvent sur des trottoirs avec plus de segments et des chemins plus étroits que les routes traditionnelles. Des travaux tels que ceux de Karimi et al. ont mis en évidence et abordé des défis tels que le développement de systèmes de navigation piéton, avec notamment l'établissement de réseaux de trottoirs appropriés, le suivi continu en temps réel des utilisateurs sur les trottoirs sans interruption, et la capacité de fournir des directions et des itinéraires personnalisés. Le calcul adéquat et efficace de la trajectoire à suivre

est une préoccupation majeure pour l'assistance à la navigation. Cependant, la transmission de cette information de guidage est tout aussi cruciale. En effet, quelle que soit l'efficacité du système de navigation piétonne, si la traduction en informations intelligibles et complètes n'est pas assurée, le système de guidage n'apporte aucune valeur ajoutée. À cet égard, la plupart des aides à la navigation actuelles fournissent un retour visuel sur les écrans des smartphones [160]. Pour obtenir des informations plus détaillées et libérer l'attention visuelle de l'utilisateur, la plupart des dispositifs sont également conçus pour fournir des indices auditifs ou utiliser des vibrations. Dans l'ensemble, leur fonctionnement repose sur un petit nombre de signaux simples et peut manquer d'adaptabilité pour certains utilisateurs ayant des besoins différents, notamment en cas de handicaps sensoriels ou de mobilité.

1.2 Le projet Dornell : Faire progresser les solutions haptiques pour une assistance à la mobilité multisensorielle et adaptative

Cette thèse de doctorat fait partie du projet Dornell. Le projet Dornell, mené par le Pr. Marie Babel et Dr. Claudio Pacchierotti, financé par Inria dans le cadre du programme Grand Challenges en 2020, a permis d'identifier plus en profondeur les enjeux de l'aide à la navigation et de l'accessibilité. Son objectif est d'étudier et de concevoir une solution viable et efficace de l'aide au déplacement au quotidien pour un plus large éventail d'utilisateurs. Cela inclut les personnes dont les déficiences sensorielles ou les capacités de mobilité n'ont pas été altérées, mais surtout les personnes souffrant de handicap sensoriels (vue, ouïe, ...) et/ou motrices. Dans cette perspective, l'utilisation d'autres canaux que les canaux visuels et auditifs, tels que le canal haptique, est une piste majeure à considérer.

Le projet Dornell souhaite proposer une poignée haptique innovante, multisensorielle, multimodale et intelligente pouvant être facilement installée sur les aides à la mobilité, telles que les fauteuils roulants électriques, les cannes blanches, les précanes, les déambulateurs, etc. Spécialement conçu pour répondre aux besoins les plus divers des individus, le projet vise à développer une poignée à sensations tactiles dans un format portable et prêt à l'emploi. Lors des tâches de navigation, il est possible de fournir différents types d'informations. Il est important d'étudier et de comprendre lesquelles sont les plus pertinentes et par quel canal sensoriel il est préférable de les fournir, en fonction également des capacités de l'utilisateur. En effet, pour orienter un individu en toute sécurité, différents types d'informations peuvent être transmis, telles que la distance par rapport aux obstacles ou la direction à suivre. À cet égard, la poignée proposée répond à un besoin crucial en matière de technologies d'assistance : fournir des informations de navigation riches de manière discrète, rentable, naturelle, personnalisée et conviviale, tout en s'adaptant à la majorité des utilisateurs et des aides à la mobilité existantes.

Un élément clé de ce projet est l'implication de divers acteurs des domaines de l'ingénierie, de la médecine et de la clinique, ainsi que des utilisateurs potentiels. Ce processus de co-création vise à obtenir une compréhension étroite des besoins des utilisateurs, ainsi que des conseils professionnels et cliniques pour répondre au mieux à leurs attentes. Le projet regroupe ainsi plusieurs entités et partenaires en France : équipes de l'INRIA (MFX à Nancy, RAINBOW à Rennes), ISIR (équipe INTERACTION) à Paris, INSA Rennes (équipe LCGCM), Institut des jeunes aveugles (Les Charmettes, Yzeure), Pôle de Médecine Physique et de Réadaptations St Hélier (Living Lab, ISAR, Rennes). Plus de détails sur le projet sont disponibles sur le site web de Dornell [31].

Pour mieux comprendre le contexte et les défis spécifiques abordés par le projet Dornell, nous devons entrer dans les détails de la population considérée et des besoins particuliers.

1.3 Le contexte et la population cible du projet Dornell

La démographie mondiale tend vers le vieillissement de la population, davantage encore dans les pays du Nord. En 2013, les Nations unies ont estimé qu'en 2050, les personnes âgées de plus de 50 ans seront au nombre de 2,1 milliards et représenteront 20% de la population mondiale [108]. L'Organisation Mondiale de la Santé (OMS) a souligné les conséquences de l'évolution démographique en cours sur la prévalence de certaines pathologies étroitement liées au vieillissement [113]. Les personnes âgées sont une population particulièrement touchée par une augmentation des déficiences physiques compromettant leur mobilité, ainsi que des déficiences sensorielles et cognitives. Cela conduit inévitablement à une augmentation de la part de ces conditions médicales dans la population [39, 38].

Plus de 6% de la population mondiale est atteinte de surdit  (on estime que cette proportion dépassera 9% d'ici 2050). En 2007, plus de 2% de la population mondiale souffrait de cécité totale ou de déficience visuelle grave [163]. En 2014, ils étaient 3,9% [49]. La prévalence des déficiences sensorielles augmente fortement avec l'âge. L'OMS a évalué que plus de 80% des personnes atteintes de cécité totale dans le monde ont plus de 50 ans. En Europe seulement, 90% des personnes souffrant de déficiences visuelles modérées à sévères ont plus de 60 ans. La part de la population souffrant de déficiences visuelles modérées à sévères devrait augmenter de 2 millions de personnes chaque année.

Parmi les personnes souffrant de déficiences sensorielles ou physiques, les personnes âgées constituent la population la plus fragile. Les personnes âgées aveugles ou malvoyantes, en particulier, ont des risques inhérents plus importants de développer des troubles de la marche [159].

1.4 Conséquences des déficiences sensorielles sur la vie quotidienne et besoins dans le cadre de l'aide à la navigation

Des recherches ont été menées sur l'impact des déficiences sensorielles congénitales ou acquises et des déficiences motrices. Dans son étude sur la surdité congénitale, Dammeyer [25] souligne la prévalence plus élevée des troubles et des pathologies mentales, considérée comme une comorbidité pour les patients atteints de déficiences sensorielles. Les études ont montré une grande variabilité dans la nature de la comorbidité, allant du spectre autistique à la dépression.

Dans leurs travaux, Dammeyer et Koppe [26] se concentrent sur la relation entre le mouvement du corps et l'interaction sociale, qui ont également un impact majeur sur la santé mentale. Cela explique principalement pourquoi les personnes vivant avec l'absence, la perte ou la diminution de la mobilité et de l'autonomie subissent de graves conséquences sur leur santé mentale [102]. Comme indiqué précédemment, les déficiences congénitales et acquises affectent différemment le développement de la représentation du monde et de la représentation de soi. Cela affecte également, par exemple, la façon dont les personnes "cartographient" l'environnement et la représentation qu'elles ont d'elles-mêmes dans l'espace. L'absence ou la perte d'acuité sensorielle est également une source majeure de perte d'autonomie et de diminution massive des interactions sociales. Les handicaps physiques affectant la mobilité ont le même type de conséquences sur la vie personnelle et sociale. Elles s'accompagnent également d'une diminution de la mobilité générale et de l'exercice physique, ce qui peut entraîner d'autres troubles médicaux ou une comorbidité. Dans la vie de tous les jours, cela affecte le développement et la santé mentale des patients, provoquant des maladies mentales telles que la dépression ou d'autres troubles [25].

En réponse à cette évaluation, des travaux sont menés pour créer une aide technique appropriée pour l'assistance à la navigation qui pourrait améliorer certains aspects de la vie quotidienne qui sont détériorés pour une partie de la population. Dans le cadre de notre projet, les discussions avec les instructeurs en locomotion et les cliniciens ont permis de recueillir des informations sur les caractéristiques attendues d'une aide à la navigation optimale. Il est tout d'abord essentiel de reconnaître que les patients et les utilisateurs potentiels d'aides à la mobilité peuvent présenter des besoins spécifiques qui doivent être pris en compte lors de la conception de la technologie d'assistance. Le dispositif de guidage doit fournir les indications complètes afin de permettre le déplacement d'un point de départ vers une destination connue ou inconnue, via un chemin qui pourrait être nouveau (macro-échelle), comme pourrait le faire aujourd'hui une interface basée sur un système GPS. Néanmoins, il ne s'agit pas de la seule tâche d'une telle aide à la mobilité. À l'échelle locale, les indications doivent également

permettre d'éviter les obstacles. En outre, le dispositif doit être facile à utiliser ("intuitif"), et ne doit donc pas nécessiter une longue phase d'apprentissage. Les indications diffusées par le dispositif doivent être faciles à percevoir, à comprendre et à interpréter afin de ne pas augmenter la charge cognitive pendant la tâche de navigation.

2. Contexte de la thèse, défis et contributions scientifiques

Comme indiqué précédemment, il semble qu'aucun dispositif d'assistance à la navigation idéal n'ait été mis au point pour aider les piétons à naviguer, en particulier les personnes souffrant à la fois de handicaps sensoriels et de déficiences motrices. Cela est principalement dû au fait que les personnes ayant des besoins particuliers utilisent des outils spécifiques et dédiés qui sont limités. En France, Sander et al. ont constaté que seuls 2% de la population française atteinte de cécité ou déficience visuelle sévère utilisaient des aides à la mobilité en 2005 [137], en raison de leurs capacités limitées. Une analyse similaire a été réalisée par Roentgen et al. en 2008 [133], montrant que les personnes malvoyantes sont souvent confrontées à des situations dangereuses et risquées, pendant leurs déplacements avec une canne blanche. Nguyen et al. en 2020 [109] ont pris l'exemple des personnes en fauteuil roulant électrique, et ont constaté qu'elles étaient largement sujettes aux collisions. Répondre à un plus grand nombre de besoins et de contraintes pourrait permettre de concevoir un outil plus adaptatif. Tout d'abord, on constate souvent que les dispositifs d'assistance concentrent leurs capacités sur des déficiences spécifiques et uniques et ne les combinent pas. Par exemple, les cannes blanches, l'un des appareils les plus connus pour les personnes atteintes d'IVMS, ne sont pas une option pour les personnes souffrant de déficiences physiques les empêchant de marcher correctement ou pour les personnes ayant besoin d'un déambulateur. Les fauteuils roulants électriques constituent une aide cruciale pour compenser les déficiences physiques, mais leur utilisation peut s'avérer dangereuse si la personne est également sujette des problèmes sévères affectant sa vue. Pour faire face à la diversité des situations individuelles, les dispositifs d'assistance devraient idéalement couvrir un large éventail de cas et de besoins.

Parmi les questions spécifiques qui ont été portées à notre attention, nous pouvons identifier, par exemple, l'utilisation du signal auditif comme outil de guidage tel que les cannes ou les déambulateurs utilisés dans diverses aides à la mobilité pour les personnes atteintes de déficiences visuelles. En effet, même si l'utilisation d'indications orales peut sembler facile à diffuser et à interpréter grâce à l'utilisation d'une sémantique claire, elle implique également divers inconvénients. Par exemple, elle exclut inévitablement les personnes malentendantes ou atteintes de surdité. Elle empêche également l'utilisation du dispositif d'assistance dans

des espaces silencieux tels que les bibliothèques, les théâtres, etc. En outre, nous devons tenir compte du fait que certains utilisateurs peuvent souhaiter que leur dispositif d'assistance soit discret et qu'ils puissent l'utiliser tout en ayant une conversation sans être interrompus. Une autre motivation est que les personnes malvoyantes s'appuient davantage sur leurs autres sens pour reconnaître les informations importantes dans leur environnement, généralement en extérieur, afin d'assurer leur sécurité. Enfin, il a été expliqué que la conception spatiale n'est pas un concept universel, comme on pourrait le penser [94]. En effet, la façon dont nous spatialisons le monde dépend, entre autres, des structures et des contraintes linguistiques, telles que le vocabulaire disponible.

Dans certaines langues, comme le Tenejapa (communauté indigène du Mexique) [14] ou le Guugu Yimithirr (communauté autochtone d'Australie) [93], la spatialisation n'utilise pas de référentiel égocentrique, car les mots *gauche*, *droite*, *devant*, *derrière*, *à côté* n'existent pas. Ainsi, l'espace relativiste n'existe pas dans ces contextes et est remplacé par des systèmes d'orientation absolus, comparables au système cardinal. Levinson [94] explique également l'impact crucial et la nécessité des propensions cognitives et sensorielles pour passer d'une conceptualisation spatiale égocentrique complète utilisée dans l'enfance à des cadres de référence relatifs et absolus utilisés plus tard dans la vie.

Pour ces raisons, certaines personnes souffrant de troubles cognitifs ou sensoriels peuvent avoir une manière différente de s'orienter et de comprendre l'espace qui les entoure. Cette capacité à s'abstraire et à se représenter l'environnement sous la forme d'un plan 2D en surimpression est souvent appelée "cartographie". Ainsi, pour des raisons d'inclusion, de sécurité et d'efficacité, il est important de fournir un dispositif qui n'utilise pas le canal audio pour les tâches de guidage. Dans cette perspective, certains travaux ont montré des résultats très intéressants en faveur de l'utilisation de l'haptique comme moyen de communication. En effet, diverses études, comme celles de Goldreich et al. [48] et de Heer [56], ont porté sur la perception haptique chez des personnes souffrant de déficiences visuelles et/ou auditives. Dans [103], Mc Intyre et al. montrent que l'acuité tactile dans les tâches d'exploration diminue avec l'âge. Cependant, ils montrent également dans leur expérience que les personnes souffrant de déficiences visuelles ont tendance à obtenir d'aussi bons résultats que des personnes voyantes de 10 ans plus jeunes, ce qui démontre une acuité tactile accrue chez les personnes atteintes aveugles et malvoyantes. De même, dans leur étude [112], Norman et Bartholome ont constaté que les participants aveugles obtenaient des résultats 30% supérieurs à ceux des participants voyants du même âge dans la tâche de discrimination qu'ils évaluaient. Ces études ouvrent la voie à une conception intéressante de dispositifs haptiques pour les tâches de navigation.

2.1 Champ d'application de la thèse : étude des illusions haptiques dans le contexte de l'assistance à la mobilité

Cette thèse de doctorat vise à étudier la perception haptique des signaux directionnels sur la main afin de concevoir un dispositif haptique transmettant des instructions de navigation claires qui pourraient être utilisées par un large éventail d'individus ayant ou non des déficiences sensorielles ou physiques.

Dans cette perspective et pour parvenir à un fonctionnement convaincant de la poignée, nous devons étudier la perception humaine des signaux haptiques en tant que source d'informations de navigation. Nous voulons concevoir des signaux haptiques pertinents et évaluer dans quelle mesure ils peuvent être convaincants pour transmettre des indications directionnelles. Nos études devraient nous permettre d'obtenir une perception et une interprétation cohérentes des signaux directionnels par les utilisateurs, ce qui indiquerait une interprétation robuste et intuitive. Nous souhaitons également obtenir une faible variabilité de l'efficacité de l'interprétation pour tous les participants, afin que le système puisse être plus ou moins généralisé à un large éventail d'utilisateurs, avec la possibilité de le personnaliser.

Les études scientifiques menées dans le cadre de cette thèse s'attaquent à trois grands défis scientifiques :

I. Conception de signaux haptiques pour une communication directionnelle claire

Notre objectif principal est d'articuler des messages directionnels, en garantissant la transmission la plus naturelle et la plus complète de l'information de l'émetteur (les moteurs) au récepteur (la main). Cela nécessite une approche globale qui comprend à la fois l'amélioration du matériel et la conception des signaux. En donnant la priorité à la perception du signal uniquement dans le cadre référentiel de la main, nous isolons intentionnellement l'aspect interprétatif humain. Nous relevons ce défi en concevant des expériences psychophysiques qui visent à étudier.

II. Conception d'indices directionnels haptiques pour une poignée haptique ergonomique

. Le deuxième défi consiste à intégrer les signaux haptiques étudiés dans le cadre du premier défi dans un dispositif pratique en forme de poignée. En s'appuyant sur les connaissances acquises lors des études initiales qui ont validé la conception de nos signaux, cette phase suivante vise à assurer la transmission efficace de ces signaux à travers le dispositif proposé. La validation de la perception des signaux haptiques dans le contexte d'un dispositif en forme de poignée devient primordiale, servant d'étape cruciale pour affirmer que le dispositif est conforme à nos attentes.

Le travail pour ce défi comprend l'évaluation de la perception et les efforts de conception de la forme et des actionneurs pour une fonctionnalité optimale et des implémentations adaptatives.

III. Développement de stratégies de navigation à l'aide d'un appareil portable Le troisième défi porte sur la navigation et vise à extrapoler les résultats des études psychophysiques et de perception dans des scénarios de navigation réels. Grâce à la résolution des défis I et II, nous nous concentrons sur l'identification et la validation des signaux haptiques transmis et perçus dans le cadre de référence de la main, en particulier à travers des dispositifs courbés et en forme de poignée et dans diverses configurations affectant l'orientation de la poignée.

À partir de ces études de perception avec l'objet technique validé fonctionnant comme support d'information, nous passons au déploiement du dispositif d'assistance dans un contexte de navigation. Un aspect essentiel de cette phase consiste à valider la technique développée en intégrant l'interprétation humaine. Étant donné que certaines aides à la mobilité comportent une ou deux poignées, il devient impératif d'explorer les différences potentielles dans les stratégies de navigation en fonction du nombre de poignées utilisées.

Notre objectif est de garantir une interprétation solide et cohérente des signaux pendant les tests des participants et entre les participants, validant ainsi des stratégies de navigation efficaces et des schémas d'utilisation optimaux. En fin de compte, le défi principal consiste à guider les individus à travers les déplacements du monde réel, en facilitant leur voyage pour atteindre une position cible désignée.

2.2 Contributions scientifiques aux trois défis

Pour répondre aux défis scientifiques identifiés, le travail de thèse a été décomposé en cinq études utilisateurs. Ces études de perception haptique ont permis de déterminer les signaux à envoyer afin de transmettre des informations claires de navigation telles que la direction à suivre ou des informations de vitesse. Ces études psychophysiques ont permis la conception et le développement étape par étape d'une poignée haptique d'assistance à la navigation indiquant les directions à suivre. Pour cela il a été choisi d'utiliser l'illusion haptique du mouvement apparent et d'étudier sa robustesse sur différentes courbures afin d'assurer son bon fonctionnement dans une poignée. Un travail sur le dispositif et son adaptabilité a permis ensuite d'équiper un déambulateur pour recréer une étude de cas visée par le dispositif.

Titre : Étude de l'illusion Haptique du Mouvement Apparent pour la Création d'une Poignée d'Aide à la Navigation

Mot clés : Dispositif Haptique, Perception Haptique, Illusions Haptique, Guidage

Résumé : Dans le domaine de l'assistance à la navigation, nous rencontrons un grand nombre de défis, en particulier lorsqu'il s'agit de prendre en compte les différents groupes d'utilisateurs tels que les piétons ne voulant pas déporter leur attention sur un dispositif de navigation, ou pour les personnes ayant des besoins plus spécifiques liés à des déficiences sensorielles ou physiques. À cet égard, nous avons développé et validé un nouvel outil de guidage haptique basé sur le principe de l'illusion haptique du mouvement apparent. Une poignée adaptative a été conçue afin d'accueillir des actionneurs spécialement conçus pour produire des stimuli vibrotactiles et de tapotements. Des signaux ont été conçus et choisis pour transmettre une illusion de mouvement apparent permettant la transmission d'informations direction-

nelles. La robustesse de cette illusion a été étudiée dans le cadre de quatre études psychophysiques validant son utilisation dans une poignée. Enfin, la mise en oeuvre d'une étude avec la poignée montée sur un déambulateur dans des conditions proches des conditions réelles a été réalisée, validant notre travail et notre conception. En résumé, cette thèse vise à répondre aux besoins d'un groupe plus large en introduisant un dispositif portatif et adaptatif pour l'aide à la navigation. Elle propose des solutions aux trois principaux défis scientifiques identifiés : 1. Concevoir des signaux haptiques pour une communication directionnelle claire, 2. Concevoir des repères directionnels haptiques pour une poignée haptique ergonomique et 3. Développer des stratégies de navigation utilisant un dispositif portatif.

Title: Investigating the Apparent Haptic Motion Illusion to Provide Navigation Guidance in a Handle

Keywords: Haptic device, Haptic perception, Haptic Illusion, Navigation guidance

Abstract: In the field of navigation assistance, we encounter a large number of challenges, particularly when considering the different user groups, such as pedestrian needing their attention to be focused on the environment and not their navigation device or people with more specific needs related to sensory or physical impairments. In that respect, we developed and validated a new tool for assisted navigation using haptics using the principle of the apparent haptic motion illusion (AHM). An adaptive handle was designed with the capacity to house the desired actuators, which were custom-designed and hand-made, able to elicit vibrotactile and tapping stimuli. Signals were designed and chosen to convey a proper apparent haptic motion illusion,

enabling the discrimination of directional information. The robustness of this illusion was investigated through four psychophysical studies. Finally, the implementation of a study with the handle mounted on a walker in conditions close to real-life conditions was achieved, validating our work and design. This work aimed to address the needs of a larger group by introducing a hand-held device for navigation guidance. It provides solutions to the three main scientific challenges which were the central focus of my research. These challenges are: Designing haptic signals for clear directional communication, designing haptic directional cues for an ergonomic haptic handle and developing navigation strategies utilising a hand-held device.
