



HAL
open science

Workload analysis and recommendations for optimizing human performance in professional offshore sailors

Kilian Philippe

► **To cite this version:**

Kilian Philippe. Workload analysis and recommendations for optimizing human performance in professional offshore sailors. Other. Université de Pau et des Pays de l'Adour, 2022. English. NNT : 2022PAUU3062 . tel-04831572

HAL Id: tel-04831572

<https://theses.hal.science/tel-04831572v1>

Submitted on 11 Dec 2024

HAL is a multi-disciplinary open access archive for the deposit and dissemination of scientific research documents, whether they are published or not. The documents may come from teaching and research institutions in France or abroad, or from public or private research centers.

L'archive ouverte pluridisciplinaire **HAL**, est destinée au dépôt et à la diffusion de documents scientifiques de niveau recherche, publiés ou non, émanant des établissements d'enseignement et de recherche français ou étrangers, des laboratoires publics ou privés.



THÈSE DE DOCTORAT

Analyse de la charge de travail et
recommandations pour l'optimisation de la
performance humaine en course au large.

Kilian PHILIPPE

Laboratoire Mouvement, Equilibre, Performance, Santé.
(EA 445)

**Présentée en vue de l'obtention du grade
de docteur en :**

Sciences et Techniques des Activités Physiques et Sportives de l'Université de Pau et des Pays de l'Adour.

Dirigée par : Jacques Prioux

Co-encadrée par : Thierry Paillard

Soutenue le : 13 Décembre 2022

Devant le jury, composé de :

Arnaud Guevel : Professeur des Universités, Université de Nantes, Rapporteur.

Stéphane Perrey : Professeur des Universités, Université de Montpellier, Rapporteur.

Patrick Bot : Enseignant-chercheur en mécanique des fluides à l'Ecole navale, Examinateur.

Workload analysis and recommendations for optimizing human performance in pro- fessional offshore sailors.

By Kilian PHILIPPE

Supervised by : Jacques Prioux and Thierry Paillard

Jury

Reporters :

Arnaud Guevel : Professeur des Universités, Université de Nantes.

Stéphane Perrey : Professeur des Universités, Université de Montpellier.

Examiners :

Patrick Bot : Enseignant-chercheur en mécanique des fluides à l'Ecole navale.



“Resiliency, is the art of sailing
through torrents.”

-Boris Cyrulnik

Certificate of authorship and originality of thesis

I, Kilian Philippe, declare that this thesis is submitted in fulfilment of the requirements for the award of Doctor of Sports Science, in the Faculty of Sports Science at the University of Pau and Pays de l'Adour.

This thesis is wholly my own work, unless otherwise referenced or acknowledged. In addition, I certify that all information sources and literature used are indicated in the thesis.

This document has not been submitted for qualifications at any other academic institution.



Kilian Philippe

Acknowledgements

I embarked on this journey with an idea of providing coaching staffs and performance practitioners with information for improving their sailor's performance. My goal was to bridge the gap between theory and practice in competitive sailing workload management. Initially, the idea was vague, speculative and needed shaping into a strategic framework that would allow me to guide my work efficiently. My PhD journey often seemed difficult for many reasons, but upon reflection I appreciate that it was actually made very easy for me by the support and encouragement provided by many people. I am thoroughly proud of my achievement and am equally proud in acknowledging the people that helped me to the finish line.

Firstly, thank you to my thesis supervisors **Jacques Prioux** and **Thierry Paillard**.

Professor **Jacques Prioux** (co-director), although skeptic after our first call, you invited me to visit your laboratory and challenged me on my, what was then, "understanding" of the term "performance". I had no awareness of the demands and dedication a thesis represented. Yet, after months of developing a framework you agreed to assist a firefighter, strength and conditioning coach, house renovator and, what would later be, a father of three into this challenge of a lifetime. Thank you for your time, patience, expertise, energy, trust, tolerance, courage... Thank you for following me into this risky and unknown "escape route" that emerged during the Covid-19 obstacle. We can both be proud of that audacious yet hazardous move. I know you will understand when I say I need some time off to enjoy my family, to rest and to go out sailing when this journey will end... However, my passion for research has grown and I am sure we will be able to collaborate again in the near future. It has been a long adventure and I hope you will be proud of the result.

Professor **Thierry Paillard** (co-director), who trusted Professor **Jacques Prioux** by accepting me into his sports science laboratory. Our exchanges have always been extremely productive and have led to the optimisation of the published articles. I admire your professionalism and dedication. Thank you again for your valuable feedback and considerations. I would generally receive an answer to my questions by mail within a minute or two... even after 11 pm. The laboratory's support (**Julien Maitre**) was a sturdy pillar for my studying balance.

Professor **Arnaud Guevel**, who has motivated my work throughout his numerous publications. Your observations and insights to inshore and windsurfing performance have assisted me in bringing the best out of my athletes. Participating in the Olympic Games (2020... 2021) was a dream come true. Again... thank you. I hope you will enjoy my small contribution to your field of interest.

Professor **Stephane Perrey**, your expertise in the understanding of fatigue is astonishing and motivating. I would like to thank you for sharing your research with performance practitioners. Reading your articles gave me the tools to better manage fatigue

in multiple renowned offshore sailing competitions (Route du Rhum x 2, Solitaire du Figaro x 3, Vendée Globe x 2, Volvo Ocean Race x 3,...). Thank you for accepting my invitation. I hope I can contribute to your field of expertise within the sailing environment.

Professor **Patrick Bot**, I believe we have crossed paths before. A few years ago, maybe on a cold and foggy winter morning in Lanveoc-Poulmic. My mission with Team France for the America's Cup allowed me to better understand the full aspects of performance on such projects. Your passion for optimising the vessel's performance is admirable. Thank you for accepting this invitation. I hope my work for understanding the aspects of human performance in sailing will interest you as well.

Professor **Jeremy Moody**, although you were not on my supervisory team, your input and contributions changed the course of this PhD. You accepted me to your MSc program during some difficult times. Coming to Wales was a relief and an unforgettable adventure. Although my grades didn't represent my enthusiasm, I must assure you that you and your team ignited my envy to pursue in the field of S&C. It was a blessing to hear you share your experience and knowledge in the cosy classrooms of **Cardiff Metropolitan University**. I now start my answers with "*It depends*"... because it does.

To all the **Athletes** I have worked with. Thank you for understanding my interest in developing a better understanding for human performance. Your patience and professionalism have allowed me to be confident when undergoing strenuous and long study procedures.

To the **French** and **Portuguese** sailing federations. Thank you for your confidence and support during these last years.

The **Ecole Nationale de Voile et des Sports Nautiques** for their support and fantastic installations.

The **Paris Fire Brigade**, who accepted me to join them the week after finishing my BSc. You have taught me to cope with fatigue and to be resilient in the hardest of times. Without these assets I would have never gotten up from the tough times encountered during this thesis. "*Pain is just an information to the brain*" – Training instructor, after spending 8 months of training in a sleep deprived state.

United Kingdom Strength and Conditioning Association, for providing me with an excellent source of information with online conferences and research articles. It is an honour to be an accredited member.

To my family.

Mom & Dad. I feel very humble writing this part. If I hadn't listened to your advice, I would be nowhere close to where I am today. Your actions spoke larger than words. You have always assisted me in all my projects and provided me with an escape route in case things went wrong. Knowing that your family has your back can only make you go forward. I also recall the time I told you, **Dad**, that I "hated" reading. I would like to rephrase this today... "I love reading... peer reviewed articles". I am proud to follow in your footsteps... I am sure you paved the path for me to follow. **Mom**, thank you for all

your support and coping with all the changes in my life. You have always had the greatest impact and the best advice in my decisions. I love you two, thank you.

Hélène, my partner and most patient person ever. Thank you for supporting me through this long adventure. I have waited for this day for a long time. You have had to deal with me the most during this process, a book of acknowledgements should be dedicated to you. As I promised, once this is over I will make up the time with you and the family. انت عمري.

Youn, Louison & Coline. Where do I start... You were long awaited and you arrived... the three of you... in a two-year time gap... during my PhD. The most precious of times are those I share in your presence. Daddy has been very busy lately with his studies and numerous other jobs but I promise that it will lead to creating many memories in your company. I already see your endeavour to work and play sports. You enjoy life the way it is meant to be lived. I am already so proud of you. Ho karout a ran.

Josselin Philippe, my brother. Your courage and adventurous mindset have motivated me to start projects I thought would be impossible. You have largely contributed to my envy of continuing my studies. Thank you.

Sterenn Philippe... my sister. I admire your perfectionism and attention to detail. You have helped me in so many ways in developing my current career. Although I do not know where you are, what you are doing, nor if I will ever see you again... I pray that you are in good hands and that you are enjoying life to its fullest.

My grandparents **Celsa & André Suzon**. You have always assisted and believed in me since day 1. Your love of family and passion for traveling has had a great impact on my way of life. To many more memories to come by your side.

My grandparents **Jeanine & Jean Philippe**, you have passed down your culture for hard work and perseverance. I will always cherish the memories in your company and not a day goes by where I don't think about you. I wish you could have met your three great-grandchildren; they would have loved to help on the farm.

To all my family for all the great moments spent together and for the many others to come. It is pleasure and a privilege to be on this earth with you.

To my friends.

Robin, Yvon, Fish, Yoann, Timur, les Legruiecs, les Cantones, Daniel, Jarrett, Alex, David, Lucas, Mika, my fire shift... and many more. You have been a real source of inspiration.

To my friends and colleagues who left too soon. You'll never walk alone.

Preface

This thesis was carried out for the Doctorate degree in Sports Science and has the format of a conventional thesis. The thesis respects the “Procedures for the presentation and submission of theses for higher degrees of the University of Pau and Pays de l’Adour.”

The data collected by the candidate enabled the publication of two articles in peer-reviewed journals. A third article is undergoing the publication process. In addition, the work here has enabled participation in numerous international sports performance conferences. The thesis begins with an introduction permitting a better understanding research problem’s context, followed by two reviews of literature which, combined, provide a synthesis of the human performance factors of offshore sailing with implications for workload (WL) analysis. A chapter is then devoted to the personal contributions of the author. Each study is presented in manuscript form, comprising an introduction, methodology section, results, discussion, and conclusion, including practical applications. Figures and tables appear in the thesis as published. A final chapter provides a synthesis of the thesis’s contribution towards the optimisation of performance but also guides the interests for the lines of future research. The referencing style “American Psychological Association” (APA) is used in the thesis with a list of references made available in the penultimate chapter.

List of publications and conference participation

Publications in international peer reviewed journals (as they appear in the text):

Accepted

- **Philippe, K.**, Paillard, T., Dubois, R., Maurelli, O. & Prioux, J. (2021).

Key performance indicators in Tour de France sailing. *Journal of Sports Science*. 39(8):944-954. doi:10.1080/02640414.2020.1851925.

- **Philippe, K.**, Paillard, T., Maurelli, O., Moody, J., & Prioux, J. (2022).

Effects of an Offshore Sailing Competition on Anthropometry, Muscular Performance, Subjective Wellness, and Salivary Cortisol in Professional Sailors. *International Journal of Sports Physiology and Performance*. 17(8):1205-1212. <https://doi.org/10.1123/ijsp.2021-0575>.

Publication process

- **Philippe, K.**, Paillard, T., Maurelli, O., Moody, J & Prioux, J. (2022).

Workload distribution and monitoring markers in crewed offshore sailing.

Other peer-reviewed publications relevant to the thesis:

Accepted

- Dubois, R., Bru, N., Paillard, T., Le Cunuder, A., Lyons, M., Maurelli, O., **Philippe, K.** & Prioux, J. (2020).

Game performances and weekly workload: Using of data mining process to enter in the complexity. *PLoS One*. doi:10.1371/journal.pone.0228107.

Publication process

- Hu, X., Bru, N., Boisbluche, S., **Philippe, K.**, Maurelli, O., Schichang, L., Xu, B. & Prioux, J. (2020).

Effects of preseason training on body composition, running performance, biochemical markers and workload variation in professional rugby union players.

Conference proceedings during the thesis

► **Philippe, K., Paillard, T., Le Cunuder, A., Dubois, R., Maurelli, O., & Prioux, J.** (2019, October 28-31).

Tour de France à la Voile : Etude du profil physiologique de marins de haut niveau. Presented at the 18th « Association des Chercheurs en Activités Physiques et Sportives (ACAPS) », Paris, France.

► **Philippe, K., Paillard, T., Le Cunuder, A., Dubois, R., Maurelli, O., & Prioux, J.** (2020, July 1-3).

Anthropometric, physical, physiological and performance profiles of international in-shore sailors.

Presented at the 25th European College of Sports Sciences, Sevilla, Spain.

► **Philippe, K., Paillard, T., Maurelli, O., & Prioux, J.** (2021, October 27-29).

Relationships between training load, subjective markers of recovery, salivary cortisol and physical capacity in professional offshore sailors.

Presented at the 19th « Association des Chercheurs en Activités Physiques et Sportives (ACAPS) », Montpellier, France.

► **Philippe, K., Paillard, T., Maurelli, O., & Prioux, J.** (2021, October 8-10).

Relationships between training load, subjective markers of recovery, salivary cortisol and physical capacity in professional offshore sailors.

Presented at the 26th European College of Sports Sciences, Virtual.

► **Philippe, K., Paillard, T., Maurelli, O., Moody, J & Prioux, J.** (2022, August 30 – September 2).

Effects of an offshore sailing competition on anthropometry, muscular performance, subjective wellness and salivary cortisol in professional sailors.

Presented at the 27th European College of Sports Sciences, Sevilla, Spain.

Thesis abstract (English)

Sailing is a physically and cognitively demanding multidisciplinary sport with sailors competing in the presence of multifaceted performance-related stressors. The high level of stress sailors face during training and competition ignites the necessity for a better understanding of the dose-response relationship related to sailing workload (WL). Indeed, WL monitoring of sailors must be practised extensively to; a) adapt the training schedule, b) provide the skipper with valuable information on potential risks of injury and overtraining, and c) ensure adequate recovery programming to enhance performance. Hence, quantifying the WL in professional sailors involves multiple aspects to properly investigate the training and competition dose-response relationship. Historically, monitoring WL in elite sports environments has been based on the theoretical “general adaptive syndrome” model, whereby performance can be predicted through variables of fitness and fatigue over acute and chronic mathematical systems. However, offshore sailing has received limited interest concerning WL and its’ effects on morphological, physical, and physiological adaptations. Furthermore, the scarcity of data in such unexplored environments makes it a strenuous task for human performance practitioners aiming at planning and structuring efficient training interventions.

This thesis contains three studies that aim to build a novel conceptual model of WL analysis by identifying valid and reliable monitoring assessments that relate to competition performance in professional offshore sailing. *Study One* attempted to overcome the common misconception that sailing is considered a “light” exercise (Bernardi et al., 1990) by proving that sailing performance is linked to fitness profiles. The findings identified multiple physical variables able to discriminate between successful- and less-successful sailors. Indeed, successful sailors were characterised by stronger handgrip, more powerful bench pull, and stronger isometric mid-thigh pull. *Study Two* observed and described the distribution of WL throughout a pre-competition period. Furthermore, it intended the identification of data smoothing mathematical models capable of predicting the effects of WL on neuromuscular performance, well-being, and salivary cortisol (SC). The results highlighted the complexity of managing high and variant WLs throughout a season. Significant associations were also established between WL parameters and markers of subjective and objective fatigue. Moreover, monitoring tools were identified as valid and reliable methods for monitoring the preparedness of an offshore sailing crew. Hence some variables can be integrated into the monitoring systems used by human performance practitioners to enhance the efficiency of human resources. Data smoothing models, commonly used for analysing acute to chronic (acute : chronic) ratios, were found to be intuitive predictors of performance. *Study Three* explored the issue of understanding the effects of competition on the ‘fitness-fatigue’ model. It documented the characteristics of the race, described the physiological responses to competition, and examined neurophysiological and psychological fatigue patterns. These

findings can greatly assist strength and conditioning and nutritionists alike in elaborating adapted interventions capable of enhancing athletic and sailing performance.

Collectively, the thesis emphasised the importance of physical readiness as a key performance indicator (KPI), observed the complexity of planning in offshore sailing, and provided practitioners with valid and reliable tools for enhancing offshore sailing performance. Moreover, it identified human performance elements to consider in such a complex environment.

Keywords: workload, sailing, performance, monitoring.

Thesis abstract (French)

La voile est un sport pluridisciplinaire exigeant à la fois physiquement et cognitivement. Lors de compétitions, les marins s'affrontent et font face à divers facteurs de stress environnementaux impactant directement leur performance. Le taux de stress important auquel les marins font face suscite l'intérêt de développer une meilleure compréhension des réponses physiologiques et psychologiques aux charges de travail (WL) liées à la voile. En effet, le monitoring de WL chez les marins devrait être fréquent et poussé afin d' : a) adapter le programme et la planification de l'entraînement, b) informer le skipper des risques éventuels de blessure et/ou de surentrainement et c) optimiser la performance des marins en planifiant des interventions de récupération.

La quantification de WL chez les marins professionnels nécessite l'assimilation de multiples paramètres propres à la pratique de la voile. A l'origine, l'analyse de WL dans le sport de haut niveau s'est basée sur le modèle théorique du « syndrome d'adaptation général ». Cette performance peut être prédite à l'aide des paramètres de fitness et de fatigue intégrés à des modèles mathématiques chroniques et aigus. Toutefois, la course au large a reçu une quantité limitée d'intérêt concernant WL et ses effets sur les adaptations morphologiques, physiques et physiologiques. De plus, le manque de données dans des contextes si peu explorés rend la tâche difficile aux acteurs de la performance désirant planifier et structurer des interventions d'entraînement efficaces.

Cette thèse contient trois études qui visent à construire un nouveau modèle conceptuel d'analyse de WL en identifiant des outils d'évaluations fiables et valides liés à la performance lors des compétitions de course au large au niveau professionnel. *La première étude* a tenté de surmonter les fausses idées néanmoins courantes, considérant la voile comme étant une activité à demande physique « légère » (Bernardi et al., 1990) en apportant un aperçu concernant les liens reliant les profils physiques et la performance. Les résultats ont identifié plusieurs variables physiques capables de faire la distinction entre les marins performants et les marins moins performants. En effet, les marins performants se caractérisent par une préhension plus forte, une puissance de tirage plus importante et une force maximale isométrique de poussée verticale plus conséquente. *La deuxième étude* a observé et décrit la répartition de WL tout au long d'une période précédant la compétition. Elle a tenté d'identifier des modèles mathématiques de lissage capables de prédire les effets de WL sur les performances neuromusculaires, le bien-être et le cortisol salivaire. Les résultats ont mis en évidence la complexité de la gestion de WL dû aux larges variations du volume d'entraînement. Des associations significatives ont également été établies entre les paramètres d'analyses et les marqueurs de fatigues subjectives et objectives. De plus, des outils de suivi ont été identifiés comme des méthodes valides et fiables pour surveiller l'état de préparation d'un équipage de navigation hauturière. Ainsi, certains paramètres peuvent être intégrés dans les systèmes de suivi afin de guider les praticiens de la performance humaine. Les modèles de lissage

des données, couramment utilisés pour analyser les ratios aiguë/chronique, se sont révélés être des prédictifs intuitifs de la performance. *La troisième étude* a développé la compréhension des effets d'une compétition sur le modèle « fitness-fatigue ». Elle a documenté les caractéristiques de la course, décrit les réponses physiologiques à la compétition et examiné les schémas de fatigue neurophysiologique et psychologique des marins. Ces résultats peuvent grandement aider les spécialistes de la préparation physique ainsi que les nutritionnistes à élaborer des interventions adaptées capables d'améliorer la performance physique liée à la voile.

Dans l'ensemble, la thèse a souligné l'importance du statut physique en tant qu'indicateur clé de la performance. Elle a observé la complexité de la planification en navigation hauturière et a fourni aux praticiens des outils valides et fiables pour améliorer les performances de navigation. De plus, elle a identifié des éléments de performance humaine à prendre en compte dans un environnement aussi complexe.

Mots clés : charge de travail, voile, performance, suivi.

Table of contents

Certificate of authorship and originality of thesis	3
Acknowledgements	4
Preface	7
List of publications and conference participation	8
Thesis abstract (English)	10
Thesis abstract (French)	12
Table of contents	14
List of figures	19
List of tables	25
List of acronyms	27
Sailing glossary	29
Chapter one Introduction	31
1.1 Background	32
1.2 Research question	35
1.3 Research objectives	35
1.3 Thesis structure.....	37
Chapter two Offshore sailing background	39
2.1 Offshore sailing.....	40
2.2 Principles of sailing	40
2.3 Sailing vessels	42
2.4 Crew roles	44
2.5 Types of competition	44
Chapter three Literature review: Human performance in offshore sailing ...	54
3.1 Synopsis	55
3.2 Activity profiles during offshore sailing.....	56
3.2.1 Analysis of sailing tasks	56
3.2.2 Work to rest ratio	59
3.2.3 Energy expenditure	60
3.2.4 Sleeping patterns.....	62
Key takeaways: Activity profiles in offshore sailing	63

3.3 Indicators of offshore sailing performance at a competitive level.....	63
3.3.1 Anthropometry.....	64
3.3.2 Physical capacity.....	65
3.3.3 Cognitive skills.....	65
3.3.4 Sleep management.....	66
Key takeaways: Indicators of performance.....	67
3.4 Management of offshore sailing as an extreme sport.....	67
3.4.1 Epidemiology of injuries.....	68
3.4.1.1 Injury incidence.....	69
3.4.1.2 Type of injury.....	69
3.4.1.3 Injury occurrence.....	70
3.4.1.4 Cause of injury.....	77
3.4.1.5 Injury prevention recommendations.....	71
3.4.2 Illness in offshore sailing.....	74
3.4.3 Sleep deprivation.....	75
3.4.3.1 Effects of sleep deprivation.....	80
Key takeaways: Extreme sport management.....	81
3.5 Dose-response generated by competition.....	81
3.5.1 Body composition.....	82
3.5.2 Muscular function.....	82
3.5.3 Cardiovascular function.....	83
3.5.4 Biochemical markers.....	84
3.5.5 Subjective wellness.....	85
3.5.6 Neurocognitive fatigue.....	86
Key takeaways: Dose-response relationships.....	87
Chapter four Literature review: Workload management generalisation and application to offshore sailing.....	88
4.1 Synopsis.....	89
4.2 Models of stress response.....	90
4.2.1 General adaptation syndrome.....	91
4.2.2 The supercompensation curve.....	92
4.2.3 Stimulus-fatigue-recovery-adaptation theory.....	93

4.2.4 Fitness-fatigue paradigm	94
Key takeaways: Dose-response relationships	95
4.3 Workload accumulation: mechanisms of fatigue	95
4.3.1 Central fatigue.....	97
4.3.2 Peripheral fatigue	99
4.3.3 Cognitive fatigue	102
Key takeaways: Mechanisms of fatigue.....	104
4.4 Effects of prolonged activity on task performance: application to offshore sailing	104
4.4.1 Power output	105
4.4.2 Strength	107
4.4.3 Movement control and coordination.....	108
4.4.4 Postural control	109
4.4.5 Sleep quality	110
4.4.6 Cognitive function	112
Key takeaways: Effects of prolonged activity.....	113
4.5 Workload transmutation and realization: recovery-adaptation	113
4.5.1 Recovery time course.....	114
4.5.2 Adjustments and adaptations.....	116
Key takeaways: Recovery adaptation	118
4.6 Workload transition/ exhaustion: detraining and overtraining	118
4.6.1 Detraining	118
4.6.2 Overtraining.....	121
Key takeaways: Overtraining and detraining	123
4.7 Workload quantification	123
4.7.1 External workload.....	124
4.7.1.1 Video-analysis.....	125
4.7.1.2 Global positioning system	125
4.7.1.3 Accelerometry	126
4.7.1.4 Work endurance recovery method	127
4.7.1.5 Training Stress Score	128
4.7.2 Internal workload.....	129

4.7.2.1 Training impulse.....	131
4.7.2.2 Near-infrared spectroscopy	133
4.7.2.3 Rate of perceived exertion	134
4.7.3 Predicting injury and performance	136
Key takeaways: Workload quantification	139
4.8 Monitoring fatigue-recovery: application to offshore sailing.....	139
4.8.1 Neuromuscular markers.....	140
4.8.2 Heart rate	141
4.8.3 Biomarkers	142
4.8.4 Cognitive function	142
Key takeaways: Monitoring fatigue recovery.....	143
Chapter five Personal contribution	144
5.1 Responding to the research questions.....	145
5.2 Study 1: Key performance indicators in Tour de France sailing	149
5.2.1 Introduction	150
5.2.2 Materials and methods	152
5.2.3 Results.....	158
5.2.4 Discussion.....	163
5.2.5 Study limitations	167
5.2.6 Practical applications.....	167
5.2.7 Conclusion.....	167
5.3 Study 2: Workload management in professional offshore sailing during a pre-competition period.....	168
5.3.1 Introduction	169
5.3.2 Methods	170
5.3.3 Results	175
5.3.4 Discussion.....	180
5.3.5 Study limitations	183
5.3.6 Practical applications.....	183
5.3.7 Conclusion.....	184

5.4 Study 3: Effects of an offshore sailing competition on anthropometry, muscular performance, subjective wellness and salivary cortisol in professional sailors	185
5.4.1 Introduction	186
5.4.2 Methods	187
5.4.3 Results	191
5.4.4 Discussion	197
5.4.5 Practical applications	199
5.4.6 Conclusion	199
Chapter six Discussion	201
6.1 Main findings of the thesis	202
6.2 Limitations	203
6.3 The researcher-practitioner	204
6.4 Research perspectives	205
6.5 Practical application	206
6.6 Conclusion	207
Chapter seven References	208
Chapter eight Appendix	265
8.1 Study 1	266
8.2 Study 2	277
8.3 Study 3	296

List of figures

Figure 1. Evolution of sailing vessels.

Figure 2. Evolution of time needed to circumnavigate the world.

Figure 3. Heavy weather and occurrence of injury.

Figure 4. Thesis structure.

Figure 5. Point of sail. Adapted from Santos et al. (2016).

Figure 6. Possible courses of a sailing yacht with respect to the wind. According to Erkens et al. (2010).

Figure 7. Upwind tacking: to go from leeward to the windward mark is not possible to point directly to the target. According to Ferretti and Festa (2019).

Figure 8. Principle of Velocity Made Good.

Figure 9. Sailboat nomenclature.

Figure 10. From top to bottom: Instantaneous power; force; angular velocity; intrathoracic pressure measured during a trimming manoeuvre. According to Bernardi et al. (1990).

Figure 11. Offshore sailing specific tasks: grinding (A); hoisting (B); winching (C); stacking (D); hauling (E); and helming (F).

Figure 12. Components of total daily energy expenditure (TDEE). Adapted from Maclean et al. (2011).

Figure 13. Energy turnover (ET) vs energy intake (EI) and endogenous energy (EE). According to Branth et al. (1996).

Figure 14. Energy Intake and distance sailed daily. According to Myers et al. (2008).

Figure 15. Indicators of Performance. According to Pita (2013).

Figure 16. A top view of a windward mark rounding including three phases: approach, rounding and exit. According to Pluijms et al. (2014).

Figure 17. Subtype of injuries as a proportion of total injuries sustained throughout the British Telecom Global Challenge 1996–1997. According to Price et al. (2002).

Figure 18. Part of keelboat associated with injury, n = 1,226. According to Nathanson et al. (2008).

Figure 19. Daily total sleep time and onboard incidents. According to Theunynck et al. (2010).

Figure 20. Total sleep time and sailing distance. According to Hurdiel et al. (2013).

Figure 21. Organisation of polyphasic sleep (nap count and duration). According to Hurdiel et al. (2013).

Figure 22. Total sleep time per day during four days of racing. According to Galvani et al. (2015).

Figure 23. Questionnaire for evaluation of fatigue and anxiety instructions: “We would like to know how you feel at the present time”. According to Hagin et al. (2012).

Figure 24. Sleep monitoring (ambulatory polysomnography) during the two phases: Atlantic and Mediterranean schedules. According to Leger et al. (2007).

Figure 25. Performance on a 5-minute serial reaction time test before and after competition. According to Hurdiel et al. (2012).

Figure 26. Reaction time alterations during an offshore sailing race. According to Hurdiel et al. (2012).

Figure 27. Cardiovascular adaptations to offshore sailing. According to Ghiani et al. (2020).

Figure 28. Cortisol levels during three legs of the Ocean Race. According to Gunnarson et al. (2004).

Figure 29. Relationship between wind force, sleep duration and anxiety during 62 days of offshore sailing competition. According to Hagin et al. (2011).

Figure 30. Reaction time alterations during an offshore sailing race. According to Hurdiel et al. (2012).

Figure 31. Integrated view on load, load capacity, performance and health in sport. Dotted lines represent negative relationships and solid lines represent positive relationships. According to Verhagen and Gabbett (2019).

Figure 32. Patterned responses of the general adaptation syndrome. A) corresponds to the accumulation phase, B) Transmutation and realisation phase and C) Transition phase. According to Stone et al. (2007).

Figure 33. Schematic illustration highlighting some key neuromuscular responses to exercise. According to Stone et al. (2007).

Figure 34. The general adaptation syndrome with reference to performance supercompensation following an applied stressor. According to Fry (1998).

Figure 35. Biological adaptation through cycles of loading and recovery. Adapted from Meeusen et al. (2013).

Figure 36. Stimulus-fatigue-recovery-adaptation theory. Adapted by Yakovlev (1967) ; Verkoshanski (1979).

Figure 37. Fitness-fatigue paradigm demonstrating the relationship between performance and fitness after-effects. According to Chiu and Barnes (2004).

Figure 38. Potential sites that can contribute to muscle fatigue. According to Bigland and Richie (1981).

Figure 39. Classification of central and peripheral fatigue.

Figure 40. Summary of findings related to central fatigue during maximal and submaximal contractions. Adapted from Taylor and Gandevia (2008).

Figure 41. Assessment of sarcolemmal excitability through compound muscle action potential recording (M-wave). Adapted from Rodriguez-Falces and Place (2018).

Figure 42. Assessment of excitation-contraction coupling mechanisms through the use of Db₁₀:100 ratio for the quadriceps. Adapted from Verges et al. (2008).

Figure 43. Effects of Ca⁺ on muscle force during sustained contractions. Adapted from Westerblad et al. (1991).

Figure 44. Overview of the multifaceted elements leading to decreased task performance. Adapted from Rudroff et al. (2016).

Figure 45. Ergometer for power output testing. Pearson et al. (2009b).

Figure 46. Coordinating forward and backward grinding for line trimming. Pearson et al. (2006).

Figure 47. Behavioural states of humans and phase changes throughout the sleep wake cycle. Adapted from Hobson (2013).

Figure 48. Odds ratios for likelihood of moderate to severe problems being reported for cognitive effects as a function of maximum 6-hour root mean square acceleration. According to Pisula et al. (2012).

Figure 49. Response times for simple and complex level response times after 100 hours of exercise and sleep deprivation. According to Lucas et al. (2009).

Figure 50. Dose-response curve for the effects of duration of training cessation on A) maximal power, B) maximal strength and C) submaximal strength. Adapted from Bosquet et al. (2013).

Figure 51. Well-being continuum. Adapted from Fry et al. (1991).

Figure 52. Exercise training adaptation (A) and maladaptation (B). Adapted from Fry et al. (1992).

Figure 53. Illustration of video analysis for time motion analysis.

Figure 54. Illustration of GPS unit installation to monitor external WL.

Figure 55. Illustration of different accelerometry units available for WL quantification.

Figure 56. Heart rate during manoeuvres. According to Bernardi et al. (1990).

Figure 57. Oxygen consumption and Heart rate during racing. According to Bernardi et al. (1990).

Figure 58. Illustration of a Heart rate monitor.

Figure 59. Weighting coefficients according to % of maximal heart rate. Adapted from Stagno et al. (2007).

Figure 60. Illustration of a NIRS device.

Figure 61. Examples of psychophysical scales used to monitor perception of effort. A) Borg rating scale, b) modified 10 scale version of RPE and c) 100 scale version. Adapted from Borg (1982) ; Borg (2007) ; Morree and Marcora (2015).

Figure 62. Conceptual model of the dose-response relationship. Adapted from Banister et al. (1975).

Figure 63. Conceptual model of the workload-injury relationship. Adapted from Windt and Gabbett (2016).

Figure 64. Acute: chronic load ratio. Adapted from Gabbett (2016).

Figure 65. Isokinetic flexion of the knee. Adapted from Wilcock et al. (2008).

Figure 66. A typical electrocardiogram with a R-R interval trace. Adapted from Young and Benton (2018).

Figure 67. Illustration of the equipment necessary for a 5-minute serial simple reaction-time test.

Figure 68. Overview of the experimental design during *The Ocean Race 2021*.

Figure 69. Side and top view of a DIAM24 One Design multihull. The figure shows the position and roles of the 3 athletes on-board. In winds over 10 knots all three sailors are hiking on the same hull.

Figure 70. A typical Tour de France nautical stadium course. (1) Represents the downwind portion and (2) the upwind portion. (1) And (2) can be sailed up to three times according to race committee. Teams must go through the gates and can chose to round either mark (3). (4) Represents the final straight before gybing towards the finish line.

Figure 71. Testing battery of Tour de France sailors; Theme 1.

Figure 72. Jamar© handgrip dynamometer used to test handgrip strength

Figure 73. Illustration of the isometric mid-thigh pull with force plates.

Figure 74. Linear transducer disposition on smith machine.

Figure 75. Cardiocoach metabolic analyser.

Figure 76. Pre-competition monitoring protocol of offshore sailors; Theme 2.

Figure 77. A) Schematic diagram showing the workload structure of the pre-competition blocks. The preparation was divided into seven distinct periods including two sailing camps. B) Organization of sample weeks and training sessions. BSL: Baseline; TB₁₋₇: Training Block; W₁₋₂₈: Week; Test₁₋₇: Testing Battery; R: Rest; RPM: Revolutions Per Minute.

Figure 78. CMJ test with arms akimbo.

Figure 79. Hooper index questionnaire. According to Hooper and McKinnon (1995).

Figure 80. Soma cube lateral flow device reader.

Figure 81. A) Weekly workload during the 27 weeks of preparation. Data are mean (\pm SD). B) Training block variations of weekly workload average. Data are mean (\pm SD). 1, 2, 3, 4, 5, 6 and 7: indicates to which TB it is significantly different ($p \leq 0.05$). AU: Arbitrary Units; TB₁₋₇: Training Block.

Figure 82. Repartition of workload specificity during each training block.

Figure 83. Correlations between workload parameters and monitoring markers (95% CI). ●: CMJ; ■: BP_{1RM}; ▲: HI; ◆: SC. CMJ: Countermovement Jump; BP_{1RM}: Bench Press

1RM; HI: Hooper Index; SC: Salivary Cortisol. * Correlation coefficient is significant at $p \leq 0.05$. ** Correlation coefficient is significant at $p \leq 0.01$.

Figure 84. Timeline of TOR 2021 and assessments during 3 weeks of study. BSL: Baseline; Post₁₋₃: Measurements obtained after Leg₁₋₃; R: Recovery.

Figure 85. Monitoring protocol of offshore sailors during multi-leg competition; Theme 3.

Figure 86. Changes in countermovement jump height throughout TOR. BSL: Baseline Level; CMJ: Countermovement Jump; Post₁₋₃: Measurements obtained after Leg₁₋₃. * Difference is significant to BSL at $p \leq 0.05$; †† Significant difference with values of preceding Test; $p \leq 0.01$.

Figure 87. Changes in handgrip strength throughout TOR. HGS_d: Dominant Handgrip Strength; HGS_{nd}: Non-Dominant Handgrip Strength; HGS_{sum}: Sum of HGS_d and HGS_{nd}; BSL: Baseline Level. * Difference is significant to BSL at $p \leq 0.05$. ** Difference is significant to BSL at $p \leq 0.01$. † Significant difference with values of preceding Test; $p \leq 0.05$

Figure 88. Changes in subjective wellbeing parameters and Hooper Index during TOR. DOMS: Delayed Onset Muscle Soreness; HI: Hooper Index; BSL: Baseline Level. * Difference is significant to BSL at $p \leq 0.05$. ** Difference is significant to BSL at $p \leq 0.01$. † Significant difference with values of preceding Test; $p \leq 0.05$. †† Significant difference with values of preceding Test; $p \leq 0.01$.

Figure 89. Changes in salivary cortisol during TOR. BSL: Baseline Level. * Difference is significant to BSL at $p \leq 0.05$. ** Difference is significant to BSL at $p \leq 0.01$. † Significant difference with values of preceding Test; $p \leq 0.05$.

List of tables

Table 1. Main characteristics of the boats found in peer reviewed articles.

Table 2. Relationship between strength-power measures from the bench press and backward grinding performance at two different loads. According to Pearson et al. (2009c).

Table 3. Relationship between strength-power measures from the bench pull and backward grinding performance at two different loads. According to Pearson et al. (2009c).

Table 4. Summary of specific sailing tasks and physical/ physiological demands.

Table 5. Categorisation of physical intensity as a percentage of wake time. According to Galvani et al. (2015).

Table 6. Energy Expenditure, distance covered and boat speed. According to Galvani et al. (2015).

Table 7. Studies showing delayed recovery after acute fatiguing intervention using tests of functional performance and response to high- and low-frequency stimulation.

Table 8. Workload adaptations at a muscular level.

Table 9. Neural adaptations to workload.

Table 10. Short- and long-term effect of detraining on cardiovascular performance in highly trained individuals. Adapted from Mujika and Padilla (2000) ; Bosquet and Mujika (2012) ; Chang (2016).

Table 11. Short- and long-term effect of detraining on muscular performance in highly trained individuals. Adapted from Mujika and Padilla (2001) ; Encarnacao et al. (2022).

Table 12. Signs and symptoms of sympathetic and parasympathetic forms of overtraining. Adapted from Stone et al. (1991) ; Armstrong et al. (2022) ; Carrard et al. (2022).

Table 13. Heart rate of elite sailors during a 155 nautical mile race. According to Portier et al. (2008).

Table 14. Differences in sailing parameters between successful boats and less successful boats.

Table 15. Age and anthropometric characteristics (mean (SD)) of TDF sailors.

Table 16. Physical and physiological characteristics (mean (SD)) of TDF sailors.

Table 17. Changes (mean \pm SD) in monitoring markers throughout the preparation period.

Table 18. External and internal load of TOR.

Table 19. Description of body composition and energy intake throughout TOR.

List of acronyms

[C]: Cortisol Concentration
[T]: Testosterone Concentration
 Σ_3 Skinfold: Sum of Three point Skinfold
1RM: One Repetition Maximum
ACWR: Acute Chronic Workload Ratio
AEE: Activity Energy Expenditure
ANOVA: One-Way Analysis of Variance
BCAA: Branch Chained Amino Acids
BMR: Basal Metabolic Rate
BP: Bench Pull
BP_{MPV}: Bench Pull Mean Propulsive Velocity
BP_{ress}: Bench Press
BSL: Baseline Level
CMJ: Counter Movement Jump
CMJ_H: Countermovement Jump Height
CMJ_{PP}: Countermovement Jump Peak Power
CR: Coastal Raid
EE: Endogenous Energy
EI: Energy Intake
ET: Energy Turnover
EWMA: Exponentially Moving Weighted Average
GAS: General Adaptation Syndrome
HGS: Hand Grip Strength
HGS_d: Dominant Handgrip Strength
HGS_{nd}: Non-Dominant Handgrip Strength
HGS_{sum}: Sum of Left and Right Handgrip Strength
HI: Hooper Index
HI_{doms}: Delayed Onset Muscle Soreness
HI_{fatigue}: Subjective Fatigue
HI_{sleep}: Sleep Quality
HI_{stress}: Stress Level
IMTP: Isometric Mid-Thigh Pull
IMTP_w: Relative Isometric Mid-Thigh Pull
ISAF: International Sailing Federation
KPI: Key Performance Indicator
LOA: Length Overall
LSA: Less Successful Athlete
LSB: Less Successful Boat

MET: Metabolic Equivalents
MOU_{T25}: Step Incremental Test
MPO: Mean Power Output
MRWT: Modified Rowing Wingate Test
NM: Nautical Mile(s)
NS: Nautical Stadium
POMS: Profile of Mood State
PPVT : Psychomotor Vigilance Test
PV: Pulmonary Ventilation
QEFA : Questionnaire for Evaluation of Fatigue and Anxiety
RPE: Rate of Perceived Exertion
SA: Successful Athlete
SB: Successful Boat
SC: Salivary Cortisol
SFRA: Stimulus-Fatigue-Recovery-Adaptation
SJ: Squat Jump
SJ_H: Squat Jump Height
SJ_{PP}: Squat Jump Peak Power
sRPE: Session Rate of Perceived Exertion
TDF:TDF: Tour de France
TEE: Total Energy Expenditure
TOR: The Ocean Race
TST: Total Sleep Time
VCO₂: Volume of Exhaled Carbon Dioxide
 \dot{V}_E : Pulmonary Ventilation
VMG: Velocity Made Good
VO₂: Oxygen₂ Consumption
VO₂max: Maximal Oxygen Consumption
WL: Workload
WL_{mono}: Workload Monotony
WL_{str}: Workload Strain

Sailing glossary

Aft: This is a piece of sailboat terminology that describes the back of the ship.

Beam: The width of a boat at its widest part.

Boom: This is the horizontal pole that extends out from the mast for adjusting the direction of the sail.

Bow: This describes the front of the ship.

Broad-reach: A point of sailing in which the wind blows over a boat's quarter, between the beam and the stern.

Close-hauled: Sailing close to the wind direction with the sails trimmed along the centre line of the boat.

Downwind (sailing): sailing a Broad-reach course to gain distance to leeward.

Heading: Projected course of the boat.

Heel: The leaning action of a boat owing to pressure of wind in the sails or crew weight distribution.

Helming: The action of steering a boat.

Hiking: Sitting out on the opposite side of a boat to the sails to counteract the heel produced by the wind in the sails.

Jibing: This is an action in which the stern of the boat will go through the wind changing the wind from one side to the other. Whenever a tack or jib occurs the boom will have to shift in order to catch the wind on the new side.

Lay line: An imaginary line drawn from the windward buoy relative to the wind that would be followed by a close-hauled yacht sailing on a single tack towards the buoy.

Leeward: This is the direct opposite of the Windward direction and often given as a guide when a boat is moving into the wind.

Leg: Section of a sailing course between two buoys.

Mast: This is the main component point where the sail is raised.

Port: Port is the left-hand side of the boat while you are facing the bow and standing inside of it.

Rudder: This is a mechanism beneath the boat that is usually flat and design that of a strong material. The rudder is connected to a mechanical device on the top of the ship that controls its direction back and forth. Smaller sailboats can control this rudder with a direct mechanism whereas larger sailboats have a full-sized wheel. The rudder directs the vessel by displacing water like a paddle.

Starboard: This is the right-hand side of the boat as you are facing the bow while standing in the boat.

Stern: The rear or the backside of the boat.

Tacking: This is a manoeuvre that involves turning the bow of the boat into the wind so that it changes from one side of the boat to the other side.

Windward: This term refers to the main direction that the wind is blowing and making the windward direction means moving with the wind.

Trimming (boat): Action of modifying the balance of the boat by adjustment of body position relative to the wind.

Trimming (sails): Action of modifying the angle of the boat's sails relative to the wind direction.

Upwind (sailing): sailing a close-hauled course to gain distance to windward.

Chapter one | *Introduction*



“There are some things
you learn best in calm,
and some in storm.”

-Willa Cather

1.1 Background

Sailing is a multi-disciplinary and environmental dependent sport requiring sustained cognitive involvement for boat handling, navigation, and tactical skills (Hurdiel et al., 2012) combined with physically strenuous activities to manoeuvre the boat (Oldenburg et al., 2013).

The advent and profusion of hydro-foiling knowledge and technology has led the sailing environment to an important turnover in competition organization during the last two decades (Bot et al., 2022). Indeed, sailing venues have seen the development and implementation of advanced material technologies and hydrodynamic design extremes (Figure 1) being tested in various spectacular competitions (Sjøgaard et al., 2015). The constant quest for improvement and performance has led boats to reach record speeds. For example, the time taken to circumnavigate the world has drastically decreased in the last decades (Figure 2). However, the evolution of these highly performing, ultra-technological yachts has increased the multifaceted challenges sailors are faced with. Hence the increase in the number and intensity of regattas have required a reflection on the issues of physical preparation and recovery for sailors. Moreover, these boats have radically enhanced the physical and physiological demands of sailors onboard. The physical profiles of sailors have also evolved positively. For instance, a gradual increase in lean muscle mass has been observed in most sailing competitions (Neville et al., 2009b).

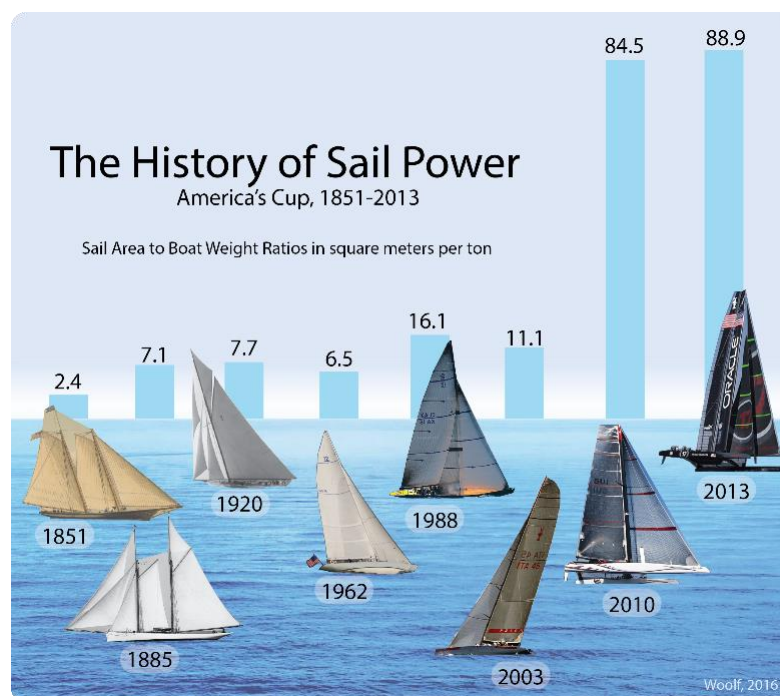

Figure 1. Evolution of sailing vessels.

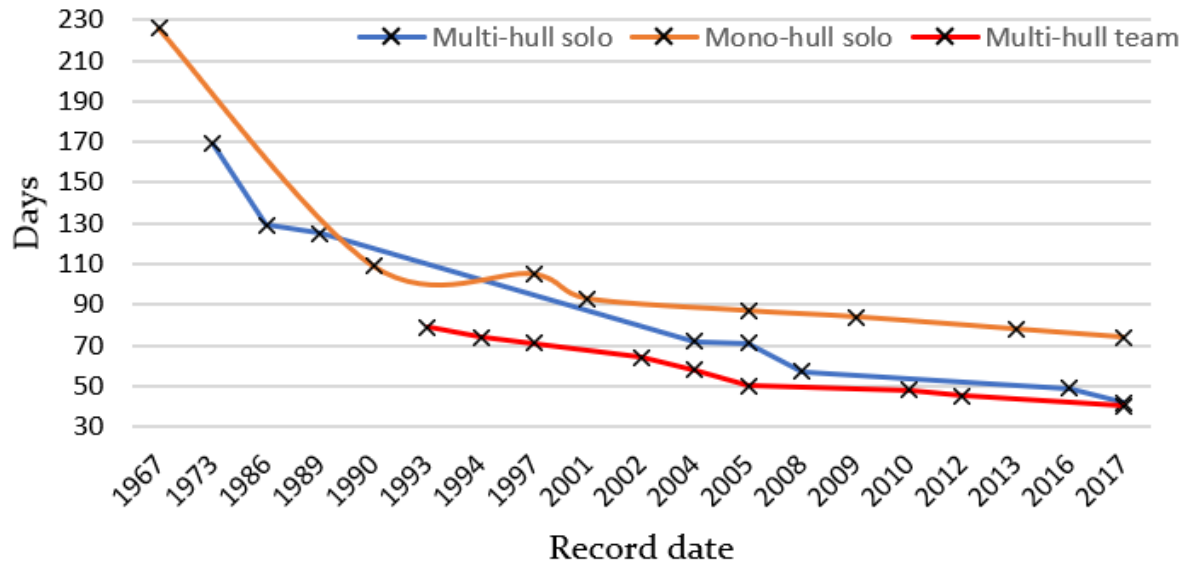

Figure 2. Evolution of time needed to circumnavigate the world.

Professional sailors also experience performance-related stressors which may impact their fatigue and recovery status and hence influence their capacity to perform on board. Indeed, sailors are faced with sleep deprivation and little comfort on board (nutrition, noise, hygiene...) that may impede on their decision-making skills and/or physical actions.

With physical and cognitive performance of offshore sailing being more demanding than ever, the interest of injury and illness epidemiology has increased proportionally. Indeed, by the nature of the sport, sailors are confronted to a large panel of injuries and other health issues that can endanger their lives (Nathanson, 2019). Many studies have attempted to understand the causes of such risks to reduce the burden of sailing injuries. Injury prevention aboard a vessel is particularly important due to the limited access to medical care and medical supplies when offshore. Nevertheless, most studies have been limited by small data sets and are restricted to a specific geographical location, regatta and sailboat class (Allen, 2000 ; Price et al., 2002). Nathanson (2010) conducted a survey with 1188 respondents to determine the epidemiology rate of sailors during a 12-month period. A total of 1715 injuries and, 559 illnesses was reported of which most were caused by tacking, gybing and heavy weather. These rates seem to be dependent of the sailing class, population, and collection methods. A study of America's Cup racing found an injury rate of 2.2 injuries per 1000 hours of sailing, and another study found the rate among novice dinghy sailors of 0.29 injuries per 1000 hours of sailing. These injuries vary according to localisation, timepoint of the race, situation, task being completed, vessel category and level of experience. Nathanson et al. (2008) have also observed the effects of heavy weather conditions on the occurrence of injury (Figure 3). Other researchers have also outlined the impact of injuries and illnesses on the performance of sailing teams, thus demonstrating the necessity monitoring the WL induced by training and competition volume (Price et al., 2002). As in other sports, WL analysis

and management have received a great amount of interest in literature. Performance practitioners have been trying to determine associations between dose and response adaptations in a goal to better monitor athletes. Thus, the tools and statistical methods of analysis have become widely popular. However, to date, very little research has investigated the effects of WL on sailing performance and physiological adaptations in professional offshore sailors.

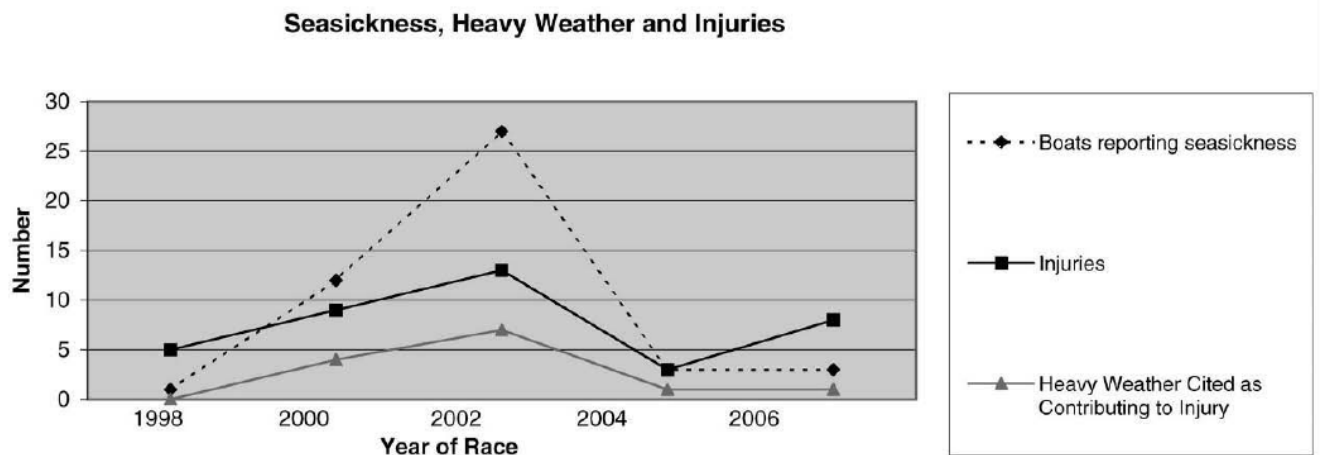

Figure 3. Heavy weather and occurrence of injury. According to Nathanson et al. (2008).

As outlined above, the physical demands of offshore sailing have increased in concomitance with technological advances. Amongst other qualities, considerations on the development of physical qualities are more relevant than ever. The issues related to the development and optimization of physical qualities, longevity, intensification of sailing regattas as well as the preservation of the sailor’s health represents the main objectives in human performance strategies. Hence, the increasing demand for developing performant sailors represents an important challenge for all human performance practitioners in offshore sailing. **Therefore, bridging the gap between WL parameters and physiological adaptations is necessary to better guide training interventions in the build-up to competition.**

Understanding the needs of the sport calls for identifying and underpinning the mechanics, energetics and coordination demands linked to performance. As of today, the sailing environment suffers from the lack of literature investigating the importance of anthropometry, morphology, and physiological characteristics in performance outcome. Past research has also reported the minimal physical demands necessary for manoeuvring a boat (Bernardi et al., 1990). This not to account for the technology development (Kerdraon et al., 2020 ; Scarpellini et al., 2021 ; Mancuso & Tumino, 2022) and economic pressure leading to increased needs on human performance. Hence, strength and conditioning practitioners are provided very few tools and with a narrow range of knowledge on which they can draw. Inadequate exercise prescription, WL management and planning can lead to a high risk of injury in elite level environments. **It is**

therefore crucial for coaches to rely on valid information and reliable monitoring tools capable of identifying the response to WL completed and neuromuscular performance regularly throughout training and competition as to evaluate the sailors' readiness status.

1.2 Research question

Information concerning practical implications for planning, programming, and monitoring professional athletes in offshore sailing is scarce. To start, sailing has suffered from past research and common beliefs associating its activity as a leisure sport with low physical requirements (Bernardi et al., 1990). As of today, few research has aimed at bridging the gap between physical characteristics and competition outcome. Secondly, despite the importance of planning and programming in extreme sports being acknowledged (Trease et al., 2022), no research has outlined the complexity of WL management and monitoring in such environments. Hence, little is known about which data to collect, analyse and provide appropriate actions for optimizing the training process. Lastly, no studies have examined the acute and chronic dose-response relationship of a renowned offshore sailing regatta on a professional mixed crew. Taken together, this created the questions that guided this thesis:

- 1) What peer reviewed literature is made available to assist practitioners and sailors in their quest for enhanced performance?
- 2) What place and what importance do anthropometric and fitness attributes hold in an elite sailing environment?
- 3) How does an extensive and structured pre-competition period impact sailors on a multifactorial level? Can mathematical models help predict these impacts?
- 4) What effects does a renowned offshore competition have on anthropometry, physiology, and subjective wellness parameters in professional sailors?

1.3 Research objectives

Multiple studies were undertaken to address the research problems mentioned above. *Chapter Two* provides an overview and presentation of the offshore sailing context. It highlights the principles of sailing and presents famous competitions in its' environment. *Chapter Three* will present the literature supporting scientific knowledge of offshore sailing performance to give a better understanding of the difficulties encountered by performance practitioners in this environment. *Chapter Four* will review literature concerning current WL analysis practices and how they can be utilised in the offshore sailing context. Furthermore, it will discuss the current knowledge regarding the dose-response relationship on physical, psychological and wellness parameters. Following the reviews of literature, *Chapters Five* of the thesis will present a series of original investigations that aim to bridge the gap in the current understanding of the importance

of physical preparation characteristics, analysing the WL distribution of a pre-competition phase, methods for enhancing the efficiency of athlete monitoring and acute/chronic dose-response of an offshore sailing competition on subjective wellness, neuromuscular output and hormonal stress.

Study One will provide a better understanding of the needs for physical training as a way of enhancing sailing performance by discriminating between successful and less-successful sailors. *Study Two* will investigate the complexity of planning and programming the preparation of a renowned offshore sailing regatta and bring forward monitoring tools to aid performance practitioners in this challenge. *Study Three* will provide insights on the dose-response, during and after, of an offshore sailing competition on physical, psychological, and hormonal parameters. A schematic representation of the thesis is provided in Figure 4. *Study One and Three* have been accepted for publication in peer-reviewed journals. *Study two* is undergoing the publication process. A summary of their purpose and practical implication is detailed below.

► **Study One (Chapter Five) – Key Performance Indicators in Tour de France Sailing.**

Purpose: The aim of this present study was threefold. First, our objective was to analyse and report the nature of sailing during the Sailing Tour de France (TDF). Second, we attempted to identify the KPIs associated with racing outcome. Third, we directed a descriptive analysis of anthropometric, physical, and physiological profiles of elite-level sailors participating in the TDF.

Practical application: This study may provide useful information to coaches, sports scientists and sailors in the planning and implementation of physical and technical training interventions. Where practitioners wish to evaluate and provide sailors with reliable training interventions the use of handgrip strength (HGS), submaximal pulling velocity and isometric mid-thigh pull testing protocols are suitable. We believe that future studies should focus on two particular aspects: (1) identifying the effects of internal and external WL on technical and physical performance indicators during the preparation and competitive phase of the TDF and (2) examining sailors' experience (e.g., vessel, position, WL) in order to identify potential performance and/or talent pathways.

► **Study Two (Chapter Five) – Workload Distribution and Monitoring Markers in Crewed Offshore Sailing.**

Purpose: The aim of this present study was two-fold. First, our objective was to describe the WL distribution during the preparation of a crewed offshore regatta and to investigate the changes induced by the preparation period on neuromuscular adaptations, subjective markers of recovery and hormonal biomarkers. Second, to analyse the correlations between WL parameters and monitoring markers to establish a possible dose-response relationship.

Practical implication: Objective and subjective markers of recovery/preparedness were found to be associated with WL parameters. These may be useful to suggest if sailors have recovered from the previous week of training or from a high sailing volume phase. Although fatigue and preparedness are multifactorial, performance practitioners, in the sailing environment, should insist on frequent monitoring of athletes to (i) optimally adapt the training plan according to the situation/weather, (ii) inform the skipper on potential risks of injury/overtraining and (iii) ensure adequate recovery methods to enhance performance.

► **Study Three (Chapter Five) – Effects of an Offshore Sailing Competition on Anthropometry, Muscular Performance, Subjective Wellness and Salivary Cortisol in Professional Sailors.**

Purpose: The aim is to provide an overview of offshore sailing demands by a) examining sailing specific activities during competition and b) investigating the physiological responses and fatigue patterns in a professional mixed-sex crew.

Practical implication: There are several practical applications from this study that are of relevance to human performance practitioners and sailors. Over an intensified period of offshore sailing competition, when there is insufficient time to recover between legs, fatigue accumulates. High levels of fatigue before sailing may compromise the boat's performance by impairing physical and cognitive capabilities. As such, cautious WL monitoring should be implemented by practitioners during a competitive phase to determine a sailor's readiness and recovery status. Upper body and lower body neuromuscular capabilities, as well as SC, were impacted by an offshore sailing competition. Markers obtained from countermovement jump (CMJ) and HGS appear to be sensitive ways of detecting fatigue during a crewed offshore competition. Questionnaires that assess subjective perception of fatigue and wellbeing parameters are useful tools for monitoring fatigue and recovery during offshore sailing competition.

1.4 Thesis structure

The thesis structure is presented in Figure 4. The thesis is built into 8 chapters. This includes an overview, scientific background, three main themes, discussion, bibliography, and appendices. The three themes aim to chronologically target the thesis questions and aims. Each theme is divided into three parts, which provide deeper insight to the publication(s) belonging to that theme. This includes a scientific background behind the questions and aim of the theme, the chosen research methods and their logic, the publication itself, and an open discussion of the results.

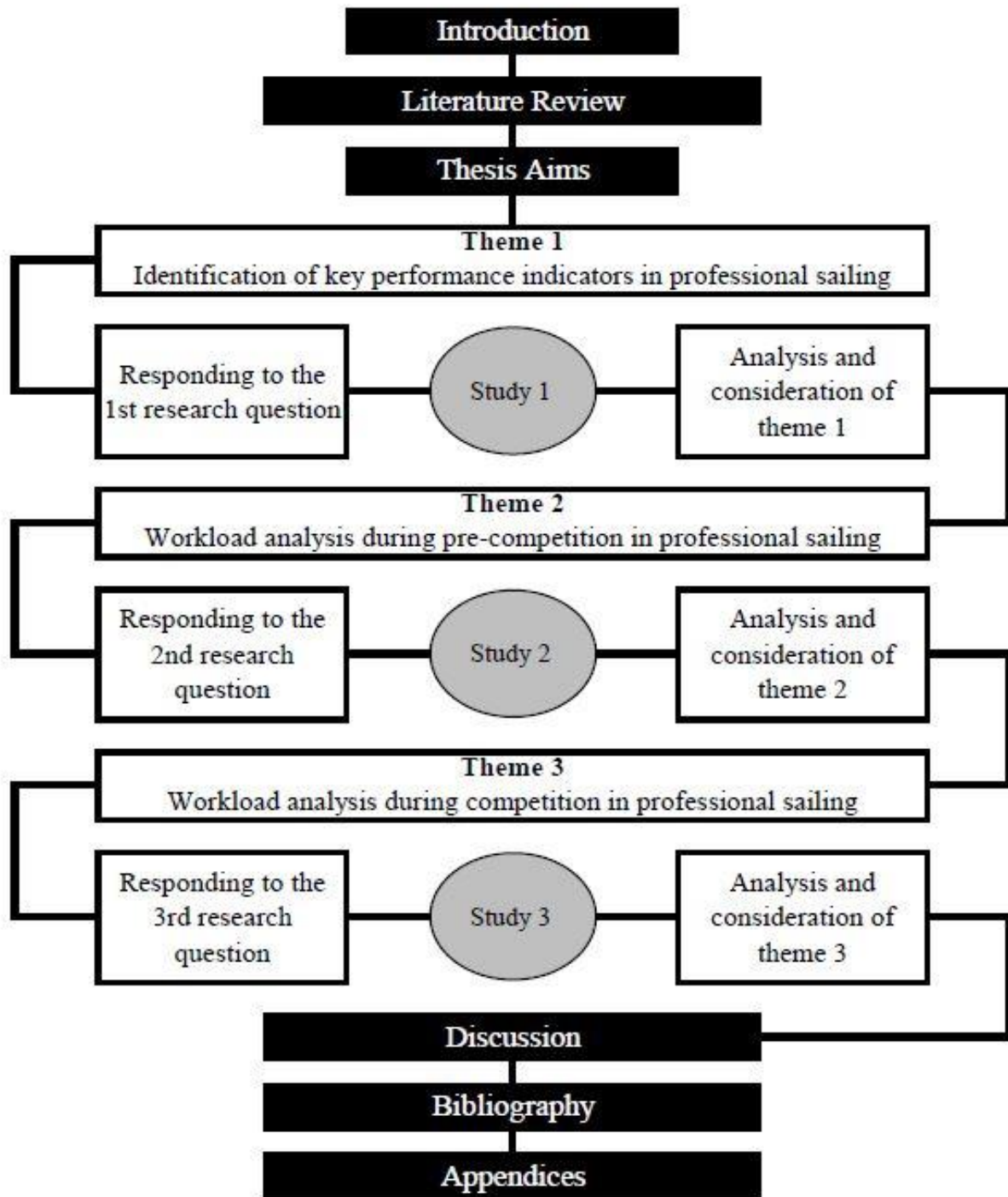

Figure 4. Thesis structure.

Chapter two | *Offshore sailing background*



“The pessimist complains about the wind; the optimist expects it to change; the realist adjusts the sails.”

-William Arthur Ward

2.1 Offshore Sailing

By far the largest wilderness areas on earth are oceans and lakes which cover over 71% of the planet's surface. For over 5000 years, societies have prioritised maritime transport to increase their commercial activities and become richer and more powerful (Nathanson, 2019). Owing to technological developments, such as the invention of steam engines in the late 18th century, commercial sailing became obsolete and gradually transitioned into a recreational and sporting activities. Today, sailing encompassed a broad spectrum of activities. Many scientific studies are conducted sailboat optimisation. These studies are mainly concerned with finding the best route by maximising the boat speed while minimising voyage time, as well as determining the optimal shapes and sizes of the boat and the rig. However, little is known concerning the optimisation of human performance.

2.2 Principles of sailing

Sailing is the action of employing the wind to propel a craft on the surface of the water over a chosen course. It relies on the physics of sails by deriving power from the wind, which generates both lift and drag. The vessel may move upwind or downwind when combining the force transmitted to the sails and those of resistance from the hull, keel, and rudder. Therefore, sailors can choose the point of sail (Figure 5) and manage boat speed by modifying sail trim, centreboard/keel position, the balance of the boat, and boat trimming.

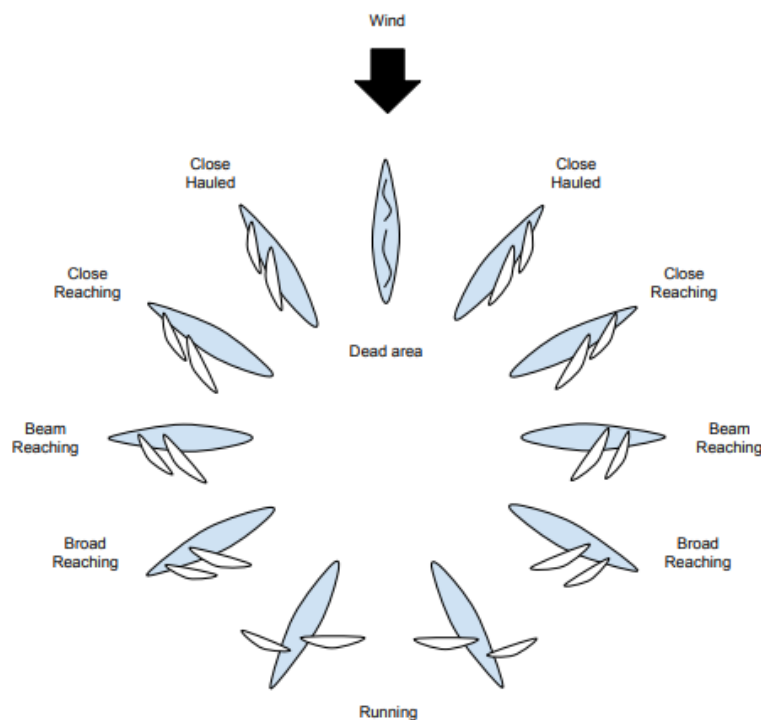

Figure 5. Point of sail. Adapted from Santos et al. (2016).

✓ ***Manoeuvring a Boat.*** It is worth noting that not all target directions can be followed by a sailboat. Generally, a sailboat cannot sail directly into the wind (Figure 6). Indeed, when angling too sharply into the wind, the forces of the boat become unbalanced. The angle at which a boat can sail upwind depends on its architecture, buoyancy, weight, and sails. Therefore, a sailor intending to travel windward towards a point exactly in line with the direction of the wind will have to tack zig-zag manoeuvres to reach its target (Figure 7). Contrarily, when sailing downwind (wind at the back of the boat), a boat could sail pointed directly downwind; nevertheless, this is not recommended as a shift of wind could cause a flying gybe (sails changing sides unexpectedly). Hence, sailors must gybe, zig-zag manoeuvres, to reach their target.

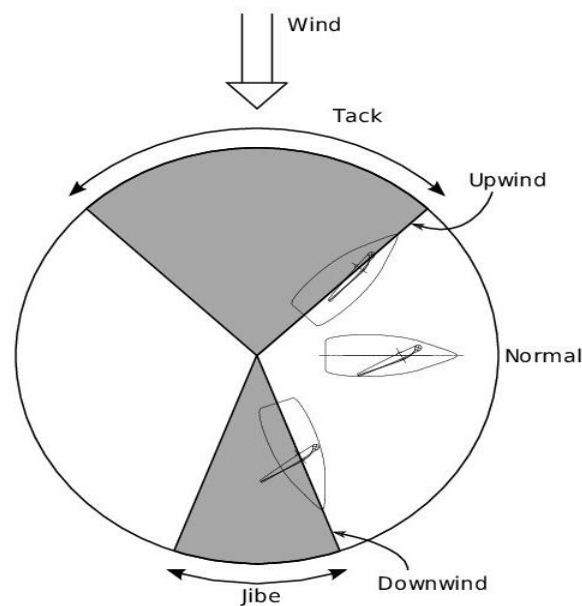

Figure 6. Possible courses of a sailing yacht with respect to the wind. According to Erkens et al. (2010).

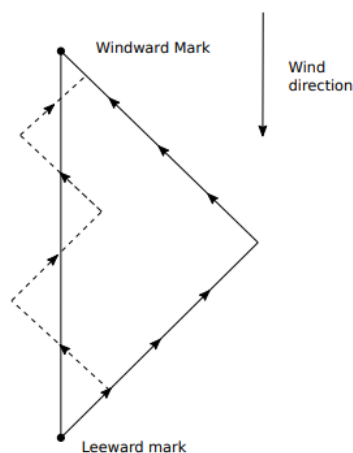

Figure 7. Upwind tacking: to go from leeward to the windward mark is not possible to point directly to the target. According to Ferretti and Festa (2019).

✓ **Velocity made good.** Velocity made good (VMG) in upwind, downwind, and broad reach courses is the technical variable that determines performance in many sailing events (Caraballo et al., 2020). It is defined as the speed that the boat reaches directly in windward and leeward courses (Castagna & Brisswalter, 2007) and measures the progress of the vessel along the rhumb line (Figure 8). This line is the straight line from the starting point to the finish line and represents the shortest distance to complete the course.

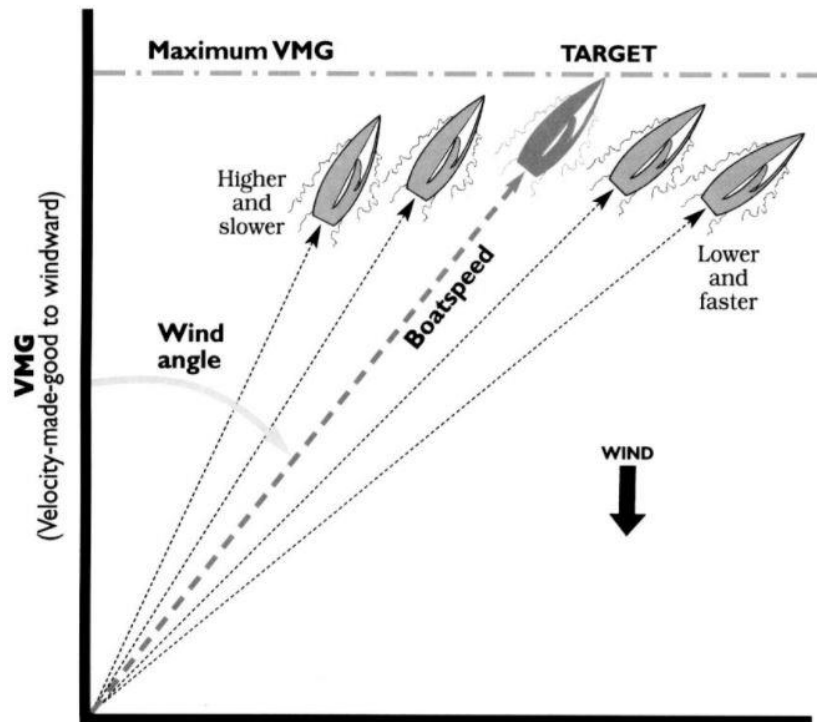

Figure 8. Principle of Velocity Made Good.

2.3 Sailing vessels

World Sailing, previously the International Sailing Federation (ISAF), denotes a total of five sailing classes: dinghies, keelboats, multihulls, boards and radio-controlled. These boats, come in all shapes and sizes but maintain a common denominator of using sails mounted on masts to harness the power of the wind and propel the vessel (Figure 9).

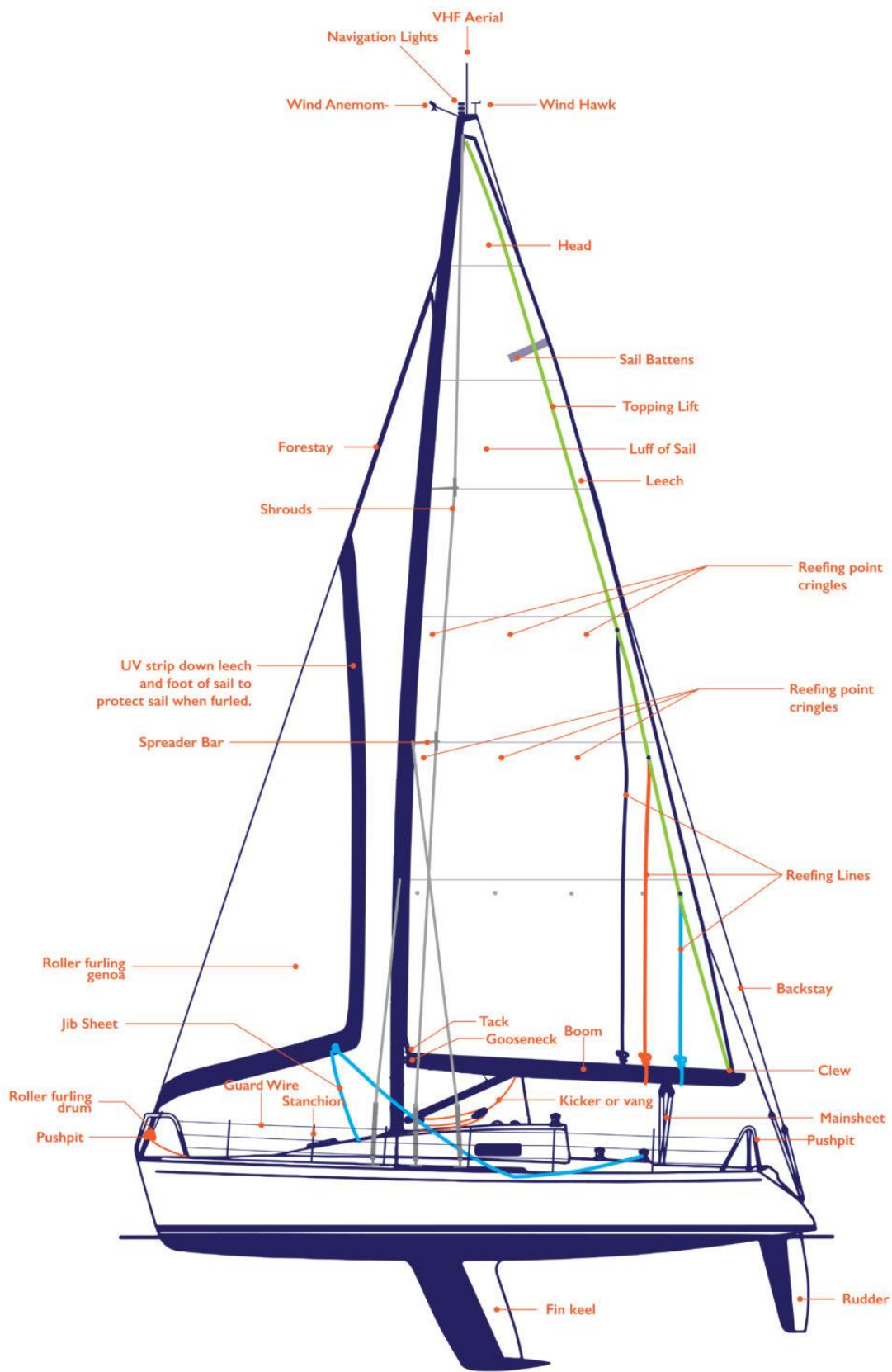

Figure 9. Sailboat nomenclature.

2.4 Crew roles

Crew positions and roles depend on crew count and vessel type. Sailing a boat successfully implies great coordination and teamwork between all crew members. This ensures that all manoeuvres (leaving a mooring, hoisting sails, changing tacks, reefing an entering a marina) are completed with efficiency and optimal balance.

- ***Skipper:*** Responsible for the boat's safety and performance. He/she is positioned in the afterguard and usually doubles up as helmsman, tactician, or strategist. The skipper holds the position of captain/leader of the team.
- ***Tactician:*** Responsible for the positioning of the boat on the course. The tactician analyses environmental factors by considering the wind, tide, sea conditions and state of the race. He/she gives feedback to the crew as to which course is to be taken.
- ***Navigator:*** In charge of all electronic instruments on board, which provide information on conditions, performance, and meteorological input.
- ***Helmsman:*** Responsible for driving the boat as fast as possible.
- ***Mainsheet Trimmer:*** Controls the sheets (ropes) that set the shape of the mainsail. Works closely with grinders/winches to coordinate sheeting in or sheeting out.
- ***Headsail Trimmer:*** Controls the sheets (ropes) that set the shape of the headsail (jib or genoa). Works closely with grinders/winches to coordinate sheeting in or sheeting out.
- ***Pitman:*** Occupies a central position and controls halyards (ropes that hoist and drop sails). Provides a link between afterguard and the bow (front of the boat). Can help grinders during primary manoeuvres.
- ***Bowman:*** Is active at the front of the boat. Involved in hoisting, dropping, and controlling the headsails. During manoeuvres he is responsible for the passing of the sheets across the spinnaker pole.
- ***Grinder:*** The grinder supplies the power to the winch which is activated by the trimmer. Their action revolves around the pedestal and trims mainsail, headsails, and runners.

2.5 Types of competition

Offshore sailing competition entails a variety of different disciplines/categories. In its essence, oceanic racing occurs over long distances and in open water. These universal disciplines include racing and cruising in waters from inshore (where shelter and rescue are not available) to transoceanic races without external assistance. The races differ in nature, according to the organisers, and require different technological and human demands. World Sailing defines oceanic racing as “*any race offshore race over 800 miles*”.

Today, these events can either be raced solitary, double handed or fully crewed. Table 1 overlooks and highlights the different races that have been observed in research.

a) Solitary Offshore Sailing

Solitary sailing, also known as solo or single-handed sailing, faces magnified activities compared to crewed sailing. A solo sailor must carry out a large range of tasks (navigation, rigger, helmsman, captain). To be successful, a sailor must respond to environmental factors (tide and weather) and adapt sail configuration to set for optimal course and sailing speed. This results in sailors being exposed to high physical WL and significant mental stress. These races can either be in a fleet format (i.e., racing against other boats) or in a speed sailing format (i.e., racing to beat a record).

Solitaire du Figaro: An annual solitary event (since 1970) sailed in multiple legs. Hosted in France, it hosts professional and amateur sailors alike. The *Solitaire du Figaro* is considered as the mother race of offshore racing.

** Last edition: The 2022 edition included three legs for an accumulated 1980 nautical miles (nm) and a duration of 15 days of sailing. Sailors competed onboard of the *Figaro Benneteau 3*.

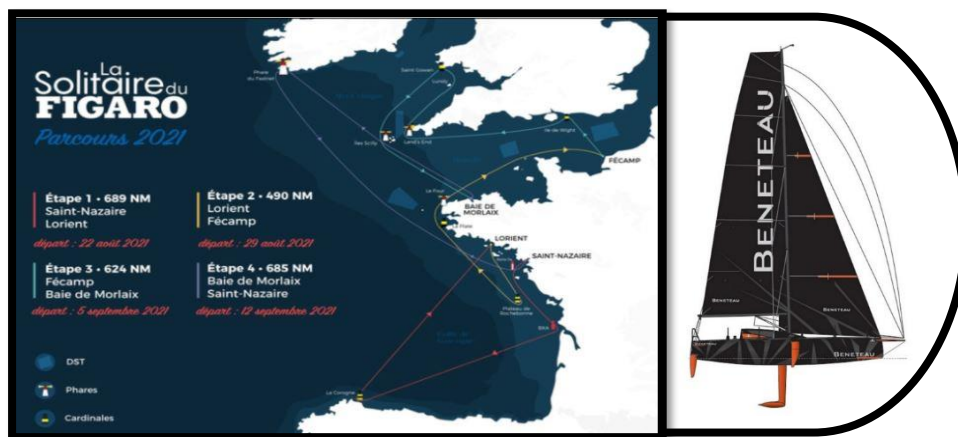

Vendee Globe: Created in 1989, the *Vendee Globe*, also known as “the Everest of the seas”, is a solitary around the world race that occurs every four years. Open to professionals only, sailors must race around the world without assistance nor stop-overs. The race is one of the hardest of offshore venues. It is characterised by its multiple forfaits/abandonments and fatalities.

** Last edition: The 2020 edition was raced in 80 days 3 hours 44 mins for the fastest and 116 days 18 hours 15 mins for the slowest. The winner sailed a total of 28584 nm for

a theoretical distance of 24365 nm. Sailors competed onboard of the *IMOCA 60* (*International Monohull Open Class Association*).



Route du Rhum: Created in 1978, the *Route du Rhum* is a transatlantic single-handed yacht race rallying Saint-Malo (Brittany, France) to Pointe-à-Pitre (Guadeloupe) for a theoretical distance of 3510 miles. Unlike the *Vendée Globe*, sailors are allowed stop-over and assistance under certain conditions. The current record stands at 7 days 14 hours 21 minutes with an average speed of 23.95 knots.

** Last edition: The 2018 event saw six boat categories take off for the 11th edition. Sailors competed in either monohull (*IMOCA 60*, *CLASS 40*, *Rhum Mono*) or multihull (*Ultime*, *Multi 50*, *Rhum Multi*).



Mini Transat 6.50: Created in 1977, the *Mini Transat 6.5* is a transatlantic solitary race without assistance. After departing from France, one stopover of 10 days (in Canary Islands or Madeira) is scheduled before rallying the West Indies. The race is scheduled every two years and sees more than 80 participants on the starting line.

** Last edition: The 2021 event saw 90 boats race for 1350 miles (1st leg) and 2700 miles (2nd leg). This edition was characterised by the eruption of the Cumbre Vieja which caused incidents regarding arrival in the Canary Islands. Sailors compete in the *Class Mini 6.50*.

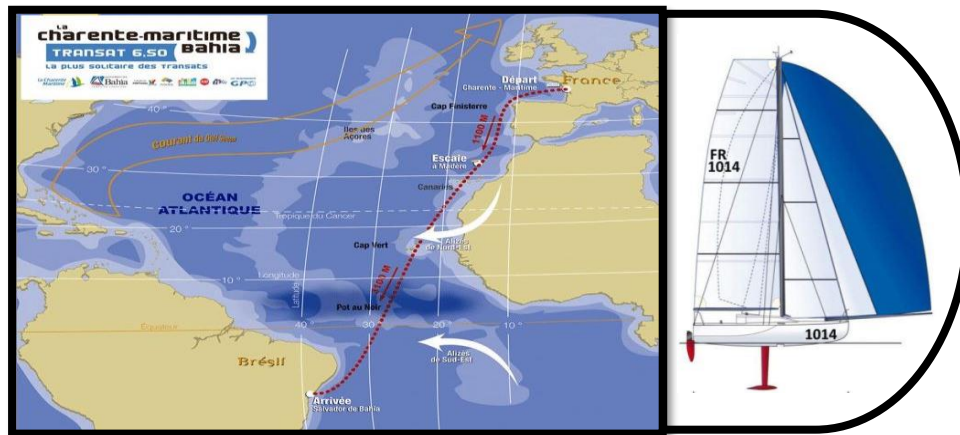

b) Crewed Offshore Sailing

Modern offshore racing yachts are more like a large dinghy than a conventional displacement yacht. Skippers must therefore sail with crews to potentiate the yachts potential by counterbalancing the boat and compensating for the waves (Branth et al., 1996). Each crew member has a specific task on board and usually work in shifts to enhance recovery volume. Crewed offshore sailing is characterised by its more “intense” nature due to the watch system permitting sailors to rest before engaging in strenuous onboard activity.

Fastnet Race: Created in 1925, the *Fastnet Race* is a crewed race without stopovers. After leaving the harbour of Cowes (UK), sailors must round the Fastnet Rock (Ireland) and Bishop Rock (UK) before heading to Plymouth (UK). The race is scheduled every two years and holds two distinct rankings: Real time and International Rating Certificate (IRC).

** Last edition: The 2021 event saw over 300 boats compete over the 700 nm. This edition was characterised by the large fleet which led organizers to modify the racecourse by rallying Cowes to Cherbourg (France). Sailors compete in either multihull *Ultime* or monohull *VO65*, *IMOCA 60*, *Class 40*, *IRC*.



The Ocean Race: Previously known as the *Whitbread Round-the-World Race* and *The Volvo Ocean Race*, *The Ocean Race* has been held every three years since 2008 (created in 1973). The race consists of multiple legs to circumnavigate the globe, with in-port races at many of the stopover cities. The harsh environment and sailing conditions make this race one of the hardest races in the world.

** Last event: The 2017 event saw 7 teams sail a 45000 nm course consisting of 11 offshore and in-port legs. Crews consisted of either 7 male sailors or 9 sailors if 2 women were in the team. This edition was sadly characterised by the fatality of a crewmember and a local fisherman. Sailors compete in the *VOR 65*.

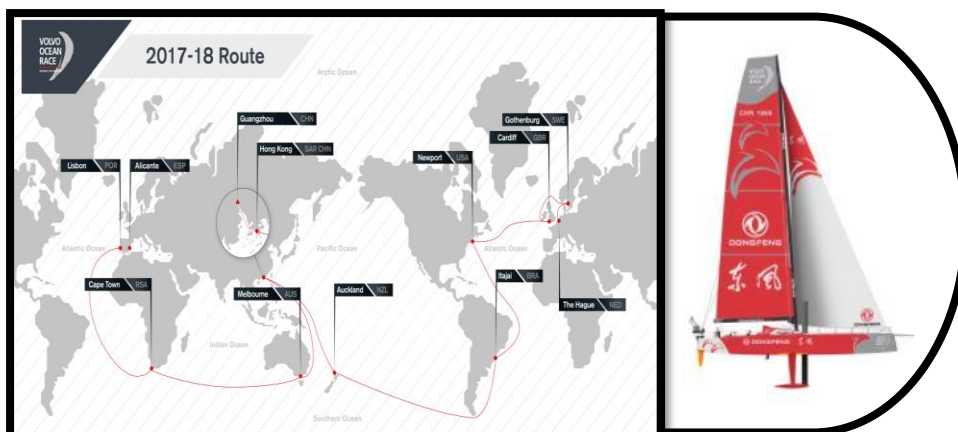

Trophée Jules Verne: Created in 1972, this challenge is of unique nature as the goal is to set a round-the-world record without any assistance or stop-overs. Crews of 6-8 sailors must constantly observe meteorological conditions to schedule their departure date.

** Last record: The record stands at 40d 23h 30m 30s and was realised in 2017. A total of 22461 nm was sailed with an average speed of 26.85 knots for a theoretical route of 22461 nm.

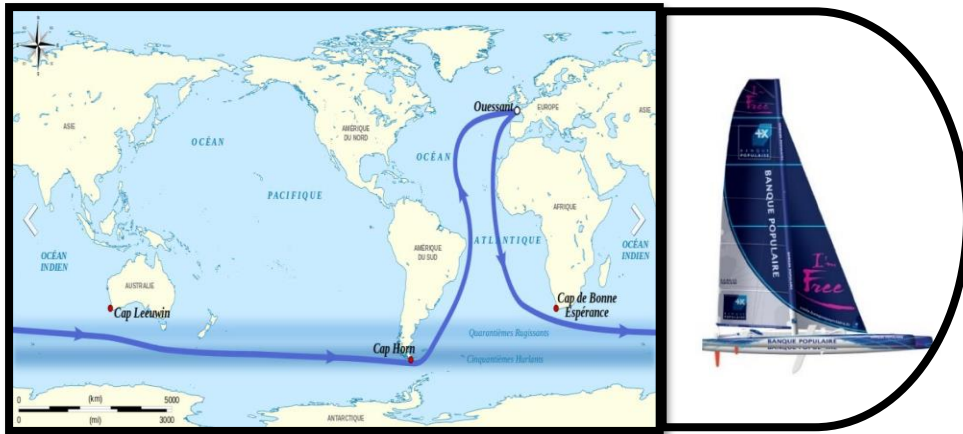

Transat Jacques Vabre: Created in 1993, the *Transat Jacques Vabre* is double-handed yacht race that follows the historic coffee trading route between Le Havre (France) and Salvador de Bahia (Brazil) for a theoretical distance of 4335 miles. The venue occurs every 2 years and no assistance or stopovers are allowed.

** Last edition: The 2021 edition saw *Ultime Multihulls, Multi 50, IMOCA 60 and Class 40* boats line up for the race.



Sydney-Hobart: Created in 1945, the *Sydney-Hobart* is a race that rallies Sydney to Hobart (Tasmania) every 26th of December. A total of 630 miles are sailed in crewed IRC boats. This race is considered one of the most famous IRC races in the world. The current record stands at 1d 9h 15m 24s.

** Last edition: The 2021 edition saw a total of 91 boats form the fleet. Sailors compete in IRC categories. A *Maxi Yacht* was declared winner of the last edition.



Clipper Round the World Yacht Race: This crewed race was created in 1995 and is raced around the world. Crews are made of amateurs and one professional skipper. The race is held every 2 years and is scheduled/planned to allow for high volume of downwind sailing.

** Last edition: The 2019 edition was characterised by the victory of a female skipper. A total of 11 identical boats are sailed by sailors: the *Clipper 70*.

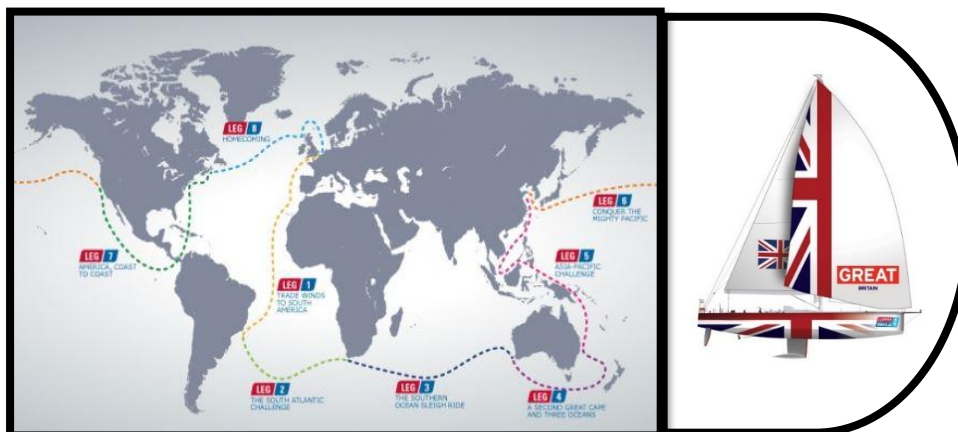

Sailing Tour de France: This crewed race was created in 1978 and is raced on annual basis. Crews are made of amateurs and professional sailors. The race starts in the north of France and finishes in Nice (France). A dozen legs make up the competition. During each act sailors compete to tally points in coastal raids (offshore specificity) and nautical stadiums (inshore specificity). This competition has allowed some of the world's best sailors to compete along the French coastline.

** Last edition: The 2021 edition was characterised by the distance extension during the coastal raids to challenge the sailors' offshore skills.

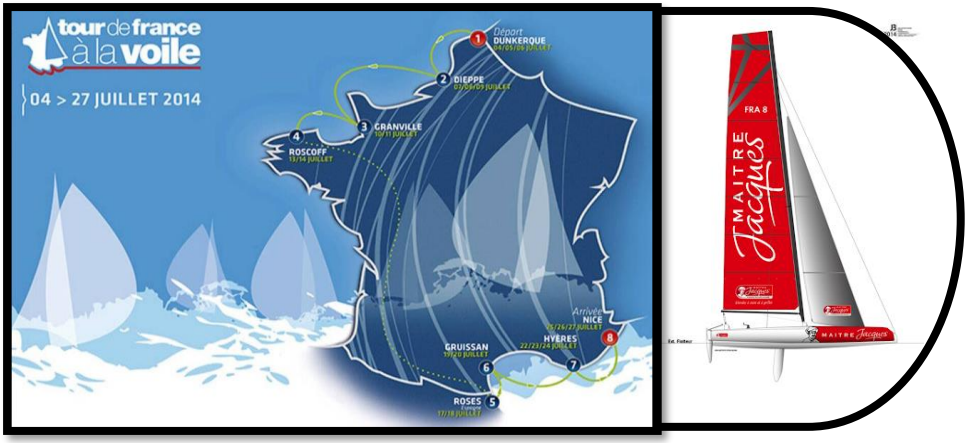







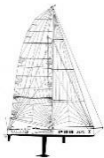









Table 1. Main characteristics of the boats found in peer reviewed articles.

Boat name	Boat Class	Design	LOA (m)	Upwind Sail area (m ²)	Downwind Sail area (m ²)	Key research
Challenge 67	Monohull		20.42	228	441	Price et al. (2002)
Class 40	Monohull		12.18	115	160	Ghiani et al. (2018) Giacon et al. (2022) Galvani et al. (2015)
Dufour 45	Monohull		13.6	113		Portier et al. (2008)
FARR 30	Monohull		9.43	56	133	Léger et al. (2008)
Fast 42	Monohull		12.7	102.9	177.9	Galvani et al. (2015)
Figaro	Monohull		10.15	68	123	Loddé et al. (2016) Hurdiel et al. (2014)
GP 42	Monohull		12.8	90		Galvani et al. (2015)

Hobbie Cat 20 Formula	Catamaran		5.97	23.22	39.11	Groslander et al. (2008)
IMOCA 60	Monohull		18.29	300	600	Fearnley et al. (2008) Myers et al. (2008) Lafère et al. (2020) Hurdie et al. (2013) Weston et al. (2009)
IMX 38	Monohull		11.41	89.09	151.92	Galvani et al. (2015)
Meteor	Monohull		6.0	16.2	21.2	Bernardi et al. (1990)
Mini 6.50	Monohull		6.5	42	96	Hurdie et al. (2012) Filardi et al. (2020)
Multi 50	Trimaran					Lafère et al. (2020)
Selection 37	Monohull		11.35	70.25	108.7	Portier et al. (2008)
VO60	Monohull		22.14	296-451	578+	Gunnarsson et al. (2008) Branth et al. (1996) Spalding et al. (2005)

LOA: length overall

Chapter three | *Literature review* *Human performance in offshore sailing*



“The art of the sailor is to
leave nothing to chance.”

Annie Van De Wiele

3.1 Synopsis

Technological advances and hydrodynamic knowledge, combined with the quest for sports performance, have led offshore sailing to fully incorporate multidisciplinary human performance support staff (Neville et al., 2006). Indeed, the development of high-performing and technologically packed vessels has raised the necessity to observe the impact of competition on physical and cognitive attributes. These ultra-technological boats require high levels of alertness, vigilance, and concentration to optimise sailing efficiency and security onboard. Sailors must also face harsh weather conditions and limited comfort on board which can lead to injuries and other health problems that may endanger their lives. Hence, offshore sailing relies on an interdisciplinary focus on human performance parameters. However, the offshore sailing context remains hardly explored. This lack of literature can be explained, in part, by the complexity of conducting research protocols in such a challenging environment. For instance, the utilization of wearable technology, such as heart rate (HR) monitoring devices, on yawing and rolling vessels stumbles upon practical difficulties when sailing offshore for multiple days (Galvani et al., 2015). Nevertheless, designing and implementing optimal training and competition-based strategies necessitates a thorough understanding of the sport's KPIs.

Human performance is an interdisciplinary focus. It draws together methodologies across numerous scientific disciplines to understand the fundamental skills, mechanisms, and outcomes of performance activities and experiences (Clark & Williamon, 2016). Performance enhancement teams are often formed to combine expertise in all components: fitness, physiology, nutrition, and sports psychology. These specialists aim to assist the athletes in bringing out optimal performance during competition. Measuring human performance has increased drastically in both popularity and desire due to the quality and affordability of biometric sensor technology. Hence, this environment needs to be explored as it remains relatively untouched. Offshore sailing is a universal but versatile activity characterised by its varied duration and risky nature. It challenges both the cognitive and physical capacities of competing athletes. It is undeniable that vessel speed and efficient racing strategy is of great importance for competition success. The following literature review addresses the research aiming to understand the various effects of various attributes on offshore sailing performance. Therefore, while attempting to be as inclusive as possible, this first review will focus its examination on the various studies that have analysed (i) the activity profiles of sailors, (ii) the indicators of offshore sailing performance, (iii) the management of offshore sailing as an extreme sport and (iv) the dose-response generated by competition. **Thus, this review has three objectives: a) to review the peer-reviewed studies on the factors that have an impact on the speed performance of the boat, b) to summarise the scientific knowledge concerning the elements sailors are faced with and that impede on the vessels performance, with the goal of promoting research on the various**

components, and c) to propose practical implications to sailors and performance practitioners alike.

3.2 Activity profiles during offshore sailing

Offshore sailing can be competed either in solitarily or in crews. Race duration varies according to the venue and environmental factors, from a few hours to several weeks. Nevertheless, the finality remains the same, finishing the course in the least amount of time and in front of adversity, all while having the same characteristic of using wind energy as the lone means of propulsion (Spurway et al., 2007). It is undeniable that vessel speed and efficient racing strategy is of great importance for competition success. Notably, the main objective of the competition is to cross the finish line before the opponents. This can only be achieved with efficient manoeuvres and adequate strategy, which extensively challenge both the cognitive and physical capacities of competing sailors. Hence, this first section aims to explore the studies that have analysed the different aspects of human performance in the offshore sailing context. This review will underpin and highlight a better understanding of the sailor's activity onboard.

3.2.1 Analysis of sailing tasks

Hoisting, stacking, winching, trimming, and grinding are all specific actions of offshore sailing (Figure 11). These sailing-specific tasks are essential for optimising manoeuvre efficiency and boat speed. They correspond to the high-intensity efforts contributing largely to the physiological demands of giving speed to a vessel (Neville et al., 2009b). Nevertheless, very few studies have provided interest in analysing the mechanics and energetics responsible for executing these actions. Bernardi et al. (1990) were among the first to report observations of sailing-specific tasks on physiological demands. Their research concentrated on analysing the movement

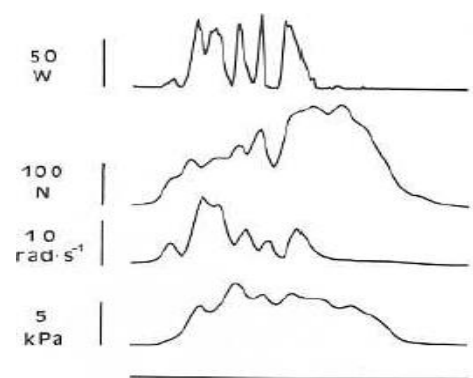

Figure 10. From top to bottom: Instantaneous power; force; angular velocity; intrathoracic pressure measured during a trimming manoeuvre. According to Bernardi et al. (1990).

of hauling ropes (trimming and hoisting) via winches without cranks. Their observations concluded that at the beginning of the manoeuvre, the force opposed by the wind on the sail was minimal, and the angular velocity of movement was maximal (Figure 10). When the sail gets closer to the wind, the force needed to perform the movement progressively increases, and rotational speed decreases until the maximal voluntary contraction is reached. Furthermore, grinding has received some interest from inshore sailing competitions (Pearson et al., 2004, 2009a, 2009b, 2009c ; Neville et al., 2009c, 2010

; Adami et al., 2015). Their research focused on determining the physiological and bio-mechanical demands of the upper body pedestal. Their findings highlight the need for high levels of maximal pushing and pulling strength and anaerobic and aerobic power to be performant during this action. Indeed, they report strong correlations between these physical attributes and grinding performance (Tables 2 and 3).

Table 2. Relationship between strength-power measures from the bench press and backward grinding performance at two different loads. According to Pearson et al. (2009c).

Variable	Mean (SD) <i>n</i> = 11	Correlation with moderate load (p-value)	Mean (SD) <i>n</i> = 6	Correlation with heavy load (p-value)
1RM (kg)	119.7 (23.9)	0.88 (0.000)	133.7 (23.8)	0.99 (0.000)
Max Force (N)	1176.3 (232.0)	0.87 (0.000)	1311.3 (233.2)	0.99 (0.000)
Max Velocity (m/s)	0.95 (0.14)	-0.03 (0.940)	0.95 (0.18)	0.18 (0.734)
Max Power (W)	304.7 (68.6)	0.55 (0.081)	323.7 (89.5)	0.49 (0.326)
Pmax load (%1RM)	53.3 (1.7)	-0.47 (0.142)	52.8 (2.1)	-0.54 (0.264)

Table 3. Relationship between strength-power measures from the bench pull and backward grinding performance at two different loads. According to Pearson et al. (2009c).

Variable	Mean (SD) <i>n</i> = 11	Correlation with moderate Load (p-value)	Mean (SD) <i>n</i> = 6	Correlation with heavy Load (p-value)
1RM (kg)	99.4 (15.4)	0.90 (0.000)	107.0 (16.3)	0.95 (0.000)
Max Force (N)	983.9 (146.7)	0.87 (0.000)	1049.4 (159.7)	0.95 (0.004)
Max Velocity (m/s)	1.20 (0.16)	0.56 (0.074)	1.22 (0.20)	0.97 (0.001)
Max Power (W)	499.1 (87.0)	0.85 (0.001)	539.8 (96.7)	0.98 (0.000)
Pmax load (%1RM)	78.6 (5.7)	-0.34 (0.311)	77.6 (5.3)	-0.45 (0.372)



Figure 11. Offshore sailing specific tasks: grinding (A); hoisting (B); winching (C); stacking (D); hauling (E); and helming (F).

These specific tasks are considered isometric efforts for the lower body as they do not generate displacement but work to maintain constant proprioceptive muscle tension to counter the swaying of the hull (Blacha et al., 2019). Moreover, the upper limb activity is explosive and often maximal (using grinders and winches to shape the sails). These efforts have been found to vary in frequency and duration according to the vessel's performance of the boat (Table 4). For instance, activity expenditure has been found to be moderately correlated with speed and strongly correlated with distance covered during competition (Galvani et al., 2015). Furthermore, these authors observed that sailing fast requires continuous trimming and frequent sail changes in response to wind strength and direction modifications. Moreover, task frequency and duration alterations seem to differ between solitary and crewed sailing. More research is therefore needed to fully understand the contribution of each task during manoeuvres and when sailing in different directions (i.e., downwind, upwind, reaching...).

Table 4. Summary of specific sailing tasks and physical/physiological demands.

Task	Description	Requirements	Reference
Grinding	Grinding is the action of arm cranking while standing. This action is either used to hoist or trim the sails by driving the winches attached to the sail lines. In modern races, it is used to maintain hydraulic pressure. It is used on most of the essential manoeuvres to facilitate sail transfer and tension. Activity usually starts at 120-150 revolutions.min ⁻¹ and decreases exponentially as tension rises.	<ul style="list-style-type: none"> . High muscle power. . High anaerobic capacity. . High aerobic capacity. . Core strength. . Transfer of force. . High grip strength. 	Pearson et al. (2005, 2007, 2009a, 2009b, 2009c). Bernardi et al. (2007). Adami et al. (2015). Olesen et al. (2015). Neville et al. (2009a, 2009b, 2009c, 2010)
Hoisting	To raise or haul up a sail by pulling on the halyards.	<ul style="list-style-type: none"> . Elevated peak power outputs on pulling movements (~580W). . Bilateral upper body coordination. 	Bernardi et al. (1990). Bay and Larsson (2013). Bojsen-Moller et al. (2015).
Stacking	Stacking sails is the action of moving sails and sail bags from one side of the boat to the other to give more stability, hence optimizing speed.	<ul style="list-style-type: none"> . Core stability. . Lower limb strength. . High grip strength. 	Not available
Hauling	The act of pulling or dragging sheets and ropes.		Bernardi et al. (1990)
Helming	Steering the boat either through steering a wheel or a tiller	<ul style="list-style-type: none"> . Grip strength. . Fine movement control. 	Not available

3.2.2 Work to rest ratio onboard

Sailing is defined, in the literature, as an intermittent sport where long physical and cognitive solicitation periods are interspersed with bouts of high-intensity efforts (Neville & Folland 2009). Theunynck et al. (2010) have shown an interest in understanding the daily organisation of working activity onboard by professional offshore sailors participating in the *Vendée Globe*. These authors observed that solitary sailors rest only when they are sleeping/napping (21% of a 24-hour day). The rest of the time is dedicated to cognitive activity (25%: routing, reading weather reports, etc.), physical tasks (32%: trimming, stacking, hoisting, etc.), or eating (7%). Furthermore, Galvani et al. (2015) have analysed and categorised the intensity of physical activity (PA) as a percentage of total wake time (Table 5). In their study, participants slept for a total sleep time of 181 ± 30 min per day. They also reported 2.6 ± 0.7 bouts of at least 10 min of intense activity. However, little is known concerning the work-to-rest ratio in crewed offshore sailing. To date, has objectively evaluated the specificity of physical work in different crew positions of offshore sailors. Nevertheless, Neville et al. (2009b) have quantified the activity patterns and exercise intensities of different crew positions during sailing. Although their study focuses on *America's Cup* (an inshore venue over a restricted course), the information collected concerning the activity pattern of bowmen and grinders can be of great value for offshore sailing. For instance, it is not rare to see many successions of gybes and tacks in a short time when boats get close to “no sailing zones.” Moreover, sail trimming (3.7 ± 2.1 s) is the most frequent activity onboard, as the sails are adjusted continuously according to wind and sea conditions. In addition, the work-to-rest ratio in grinders has been observed at 1:6 and has reached as high as 1:3 in races where ma-

manoeuvre count was specifically elevated. The research has also shown that gybing manoeuvres lasted twice as long as tacking manoeuvres when analysing grinding and trimming actions (11.2 vs. 5.5 s).

Table 5. Categorisation of physical intensity as a percentage of wake time. According to Galvani et al. (2015).

Crew	SED (% AT)	LPA (% AT)	MPA (% AT)	VPA (% AT)	MVPA (% AT)
1	48.4±3.0	40.9±4.5	10.5±1.4	0.1±0.1	10.6±1.5
2	65.7±21.6	28.3±17.9	5.6±3.6	0.4±0.0	6.0±3.7
3	41.0±11.8	51.7±12.9	6.5±1.1	0.8±0.0	7.3±1.1
4	48.1±18.6	43.4±10.9	7.6±1.5	0.8±0.9	8.4±2.0
Mean±SD	51.2±14.5	40.8±13.3	7.6±2.7	0.3±0.3	8.0±2.6

SED: sedentary; LPA: light physical activity; MPA: moderate physical activity; VPA: vigorous physical activity; MVPA: sum of the minutes spent during moderate and vigorous activity.

3.2.3 Energy expenditure

Total energy expenditure (TEE) is composed of three components; 1) the energy costs of the processes that are essential to life (BMR), 2) the energy necessary to digest, absorb and convert food (Thermic Effect of Food), and 3) the EE during PA (Maclean et al., 2011) (Figure 12). TEE is prone to fluctuations due to the variability of EE during PA. In sports requiring heavy sustained exercise, such as offshore sailing, TEE can be as high as five-fold the BMR over several weeks (Westertep et al., 1985). Hence, understanding the TEE of a specific sport is necessary to evaluate the appropriate Energy Intake (EI) for optimal body function and sporting performance (Thomas et al., 2016).

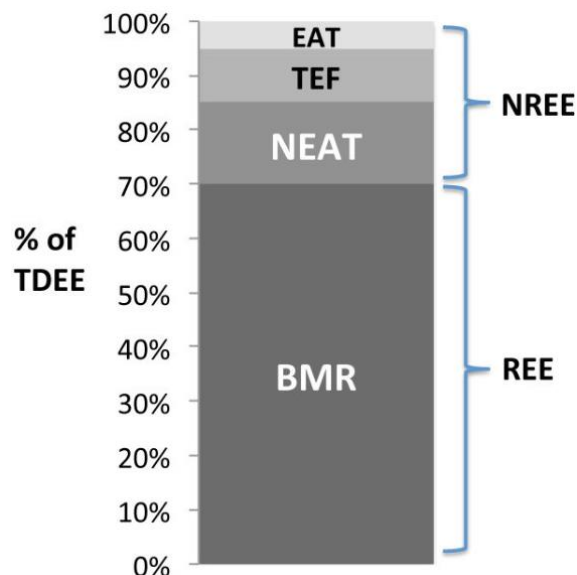

Figure 12. Components of total daily energy expenditure (TDEE). Adapted from Maclean et al. (2011). BMR: Basal Metabolic Rate; NEAT: non-exercise activity thermogenesis; TEF: thermic effect of food; EAT: exercise activity thermogenesis; REE: resting energy expenditure; NREE: non-resting energy expenditure.

Currently, data concerning EE of offshore sailing is limited and leaves human practitioners with little information concerning diet strategy during competition. Indeed, offshore sailing faces methodological difficulties in measuring TEE and EI, which may explain the lack of research in this field. Nevertheless, research has attempted to stimulate, under controlled laboratory conditions, the physiological demands of performing offshore sailing tasks (Bernardi et al., 1990 ; Blacha et al., 2019). Bernardi et al. (1990) reported a low rate of

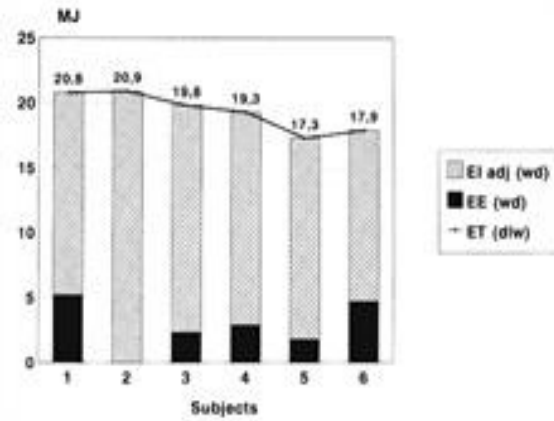

Figure 13. Energy turnover (ET) vs energy intake (EI) and endogenous energy (EE). According to Branth et al. (1996).

EE (10.3 kJ), comparable to everyday light exercise, such as walking, when evaluating the cardiovascular output of offshore sailing competition. Although the authors state that offshore sailing can be “*listed among the light exercises useful for aerobic recreational training,*” more recent research has observed considerably higher TEE levels (Myers et al., 2007 ; Portier et al., 2008 ; Fearnley et al., 2012). Indeed, sailing has substantially evolved in terms of technological development. This evolution has made boats more physical, more strenuous, and more stressful, thus increasing the importance for human performance practitioners to better understand the energy turnovers found during competition. Furthermore, recent research has reported that sailors lose weight due to EI not matching TEE (Branth et al., 1996 ; Myers et al., 2008 ; Fearnley et al., 2012) (Figure 13). Other factors that may not be found in laboratory settings (sleep deprivation, extreme climatic conditions, eating habits, and competition stress) may alter TEE further. Moreover, racing rules and regulations limiting the weight of the boat may lead to inadequate quantities of food stored onboard.

Table 6. Energy Expenditure, distance covered and boat speed. According to Galvani et al. (2015).

Crew	AEE (MJ/day)	TEE MJ/day	PAL	DIS km/day	s m/s
1	6.09±0.11	16.18±0.08	1.91±0.02	283±80	3.28±0.93
2	3.63±2.26	12.54±2.77	1.63±0.31	267±39	3.10± 0.45
3	5.37±0.74	13.96±0.59	1.94±0.14	229±42	2.65±0.49
4	5.23±0.82	14.51±0.92	1.85±0.12	206±50	2.39±0.57
Mean±SD	5.06±1.42	14.27±1.89	1.83±0.14	246±57	2.85±0.66

AEE: Activity energy expenditure, *i.e.*, the average amount of energy spent per day for physical activities; TEE: total energy expenditure, *i.e.*, the average of the total amount of energy spent per day; PAL: physical activity level, calculated as the ratio between TEE and resting energy expenditure; DIS: average distance covered per day during the competition; s: average speed maintained during the competition. DIS and s refer to the second, third and fourth days of the race.

Despite the difficulty of generating sound research protocols on TEE and EI observation, research in offshore sailing has found a particular interest in bridging the gap between energy consumption and energy demands. Ghiani et al. (2018) estimated the nutritional expenditure of a solitary sailor during the *Solo Globe* circumnavigation by using a wearable device (Armband Fit Core; BodyMedia, Pittsburgh, PA) and found a TEE of

13.02 MJ.day⁻¹. Galvani et al. (2015) evaluated the Activity Energy Expenditure (AEE) of four double-handed boats (Table 6) and found TEE to be higher than in solitary sailors (14.26 ± 1.89MJ.day⁻¹). Furthermore, their findings have identified significant correlations between AEE, distance sailed per day (r=0.6; p=0.004) and sailing speed (r=0.45; p=0.04). Hence, it seems that energy output onboard may be related to boat success/ranking. Contrarily, Myers et al. (2008) reported poor correlations (r=0.31; p<0.05) between distance sailed and daily TEE (Figure 14). Saliva and urine samples were tested via spectrometry to quantify isotope presence to identify TEE during the 13-day Atlantic Ocean crossing. They observed a TEE of 14.5 MJ.day⁻¹ (range 7.7 – 18.6 MJ.day⁻¹). Furthermore, bigger crews, such as those found in The Volvo Ocean Race, reported higher values than in other studies analysing TEE values (19.3 MJ.day⁻¹) (Branth et al., 1996). Unfortunately, Branth et al. (1996) could only analyse TEE during the 3rd leg of the race in six sailors because the experimental period using the Doubly Labeled Water Technique could not last for more than 2-weeks at this level of energy turnover.

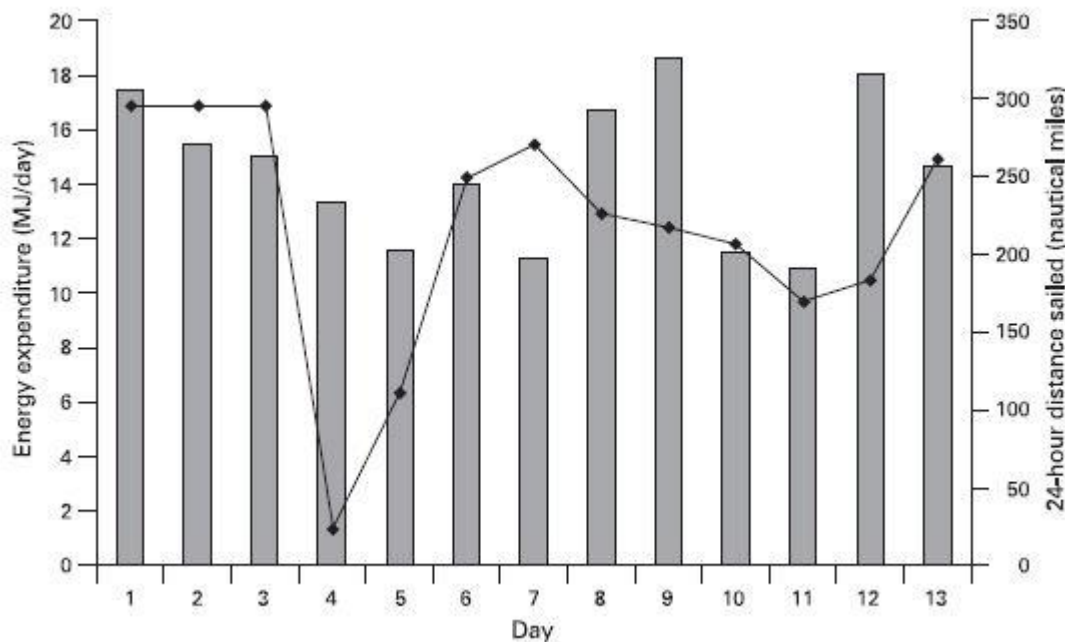

Figure 14. Energy Intake and distance sailed daily. According to Myers et al. (2008).

3.2.4 Sleeping patterns

Sleeping patterns have received noticeable interest in offshore sailing research. Campbell and Murphy (2007) have analysed the sleeping patterns into three distinct categories; (1) monophasic pattern, which consists of sleeping once per day, (2) biphasic pattern – sleeping twice per day and (3) polyphasic pattern – sleeping multiple times per day. Polyphasic sleep consists of multiple daily sleep periods that commonly encompass short night sleep duration of not more than three hours with short naps of 20-30 min throughout the day. This practice has been found to be common in some working populations and university students during examination periods. It aims at reducing

total sleep time and increasing working hours. Solitary and double-handed sailors have been found to adopt this strategy during competition. In 1989, Stampi (1989) used actimetry systems to show that polyphasic sleeping strategies improved performance in sailors. Professional sailors have confirmed that *“this intermittent strategy is adapted to the multiple constraints of helming a boat”* (Theunynck et al., 2010). Filardi et al. (2020) found that the polyphasic sleeping strategy increased subjective sleep quality in Mini Transat sailors. Nevertheless, this technique provokes severe sleep restrictions, leading to decreased cognitive performance, alertness, and PA (Hurdiel et al., 2014). On the other hand, fully crewed offshore sailors have adapted shift/watch systems in order to increase the amount of recovery time onboard. Gunnarson et al. (2004) found crews working on a 4-hour shift system. These shifts involved sailing, standby, and rest/sleep. On the other hand, Fogelholm and Lahtinen (1991) and Branth et al. (1996) observed sailors practising a biphasic system where sailors go on 4-hour “watches” followed by a 3-hour sleep/rest period. These shift/watch systems, although feasible because of crew quantity, make it impossible to get a full night of sleep. Therefore, crews may have to work additional hours, are forced to sleep when they feel awake and face disturbances from vessel activity. **Hence, sleeping patterns during offshore sailing depend on crew number, race type, vessel model, environmental parameters, and strategic time points.**

Key Takeaways: Activity profiles in offshore sailing

- ▶ Onboard activity depends of vessel, regatta regulations and crew size.
- ▶ Manoeuvres rely on anaerobic and aerobic power.
- ▶ Work to rest ratios depend on shift strategy implemented onboard.
- ▶ Energetic demands of offshore sailing are extremely high since sailors hold constant proprioceptive muscle tension to counter the swaying of the hull.
- ▶ Sleep strategy depends of the type of sailing and crew count but can easily be interrupted according to environment conditions.

3.3 Indicators of offshore sailing performance at a competitive level

Peak performance is a state of superior functioning where athletes perform at their optimal levels to achieve the best results (Privette, 1983). Identifying the KPIs provides valuable insights concerning competitive sports' physiological, technical, and tactical requirements (O'Donoghue, 2014). This identification leads to a better understanding of sports-specific actions. Furthermore, it guides the human performance process and bridges the gap between performance variables and success in athletes and/or teams (Sampaio & Leite, 2013). Figure 15 summarises the types of demands that can be analysed

to identify the KPIs. Unlike controlled environment sports (e.g., football, basketball, volleyball, or tennis), offshore sailing covers a wide variety of competition and vessel types. With hundreds of boat classes, countless competitions, and various crew positions, distinct training regimens, physiological/psychological demands, and specific injury vulnerabilities exist. Furthermore, the constant changing of environmental conditions increases the challenge of establishing valid and reliable research protocols. **Hence, identifying the KPIs through associations and comparison remains a complex task. To date, few research has sought to identify performance indicators capable of discriminating between successful and less-successful sailors (Neville et al., 2009b ; Castagna et al., 2008 ; Carabalo et al., 2020, 2021). Nevertheless, research has observed variables capable of bridging the gap between specific human performance key points and various sailing-specific characteristics.**

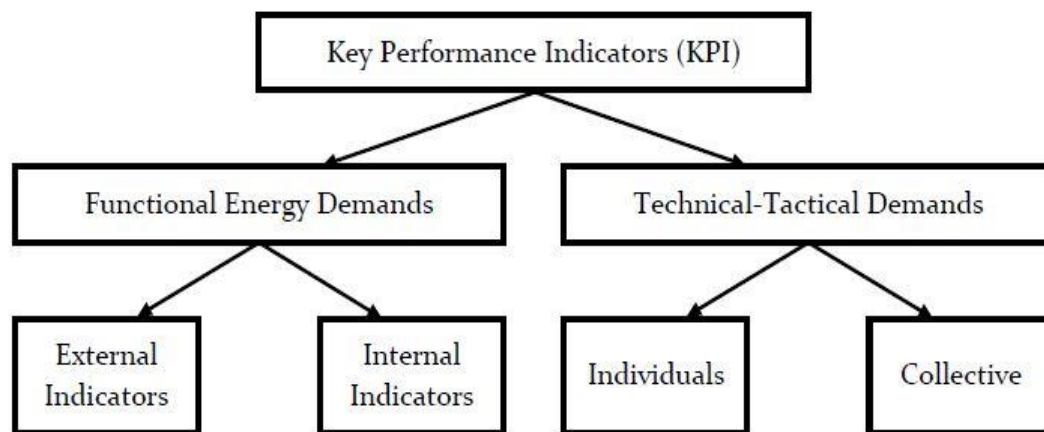

Figure 15. Indicators of Performance. According to Pita (2013).

3.3.1 Anthropometry

Establishing normative data for anthropometric measurements in offshore sailing is a complex and arduous task. Anthropometric characteristics vary according to competitive status, crew position, publishing date, and sailing classification (Larsson et al., 1996). In offshore sailing, body composition and anthropometry have mainly been assessed to observe the dose-response relationship between sailing and energy balance onboard. Hence, as of today, no research has studied the association between body composition and performance in offshore sailing. Nevertheless, inshore sailing has identified KPIs that may be reproducible in offshore sailing. Perez-Turpin et al. (2009) observed board sailors and found moderate correlations ($r^2=0.1953$; $p<0.01$) between body fat and final championship rank. Furthermore, America’s Cup sailors have progressively shown lower body fat percentages throughout the last editions. This may indicate a substantial increase in the demands of lean body mass for sailing performance (Hadala et al., 2012).

3.3.2 Physical activity

Onboard physical effort during offshore sailing may seem comparable with inshore activity (Galvani et al., 2015). Nevertheless, evidence remains scarce, difficult to obtain, and limited to measuring the effects of activity after the competition (Giacon et al., 2021). Neville et al. (2009b) compared sailing activity and physical fitness of two teams of different standards and experience. These authors show that successful teams realised gybing and tacking manoeuvres 20% faster than their less successful counterparts. This is of great importance as very little sailing speed difference was noticed between the two boats. As a result, the successful team had greater strength and strength endurance (bench press, push-ups, and sit-ups) than their opponents. Other research has also established relationships between professional status and anthropometric/physical attributes (Vangelakoudi et al., 2007). These authors found that elite-level dinghy sailors exhibited superior lower-body isometric and dynamic endurance than local club sailors. In an offshore context, Galvani et al. (2015) observed significant correlations between onboard EE and the vessel's performance. These researchers found a positive and strong correlation ($r=0.6$; $p<0.01$) between daily AEE and distance sailed ($\text{km}\cdot\text{day}^{-1}$). AEE was also found to be moderately associated ($r=0.45$; $p<0.05$) with the average boat speed. Hence, it seems that boats where sailors are most active onboard, maybe more performant than boats where sailors have a larger daily volume of rest. This corroborates the findings by Araujo and Serpa (1999), which observed a greater number of actions onboard in professional sailors than in recreational ones. Moreover, Blacha et al. (2019) observed significant differences in force production accuracy between professional and recreational sailors after sailing. From a practical standpoint, their findings provide insights concerning the degradation of kinaesthetic differentiation after exposure to an unstable sailing vessel.

3.3.3 Cognitive skills

Among the factors contributing to successful performance in competitive sports are perceptual-cognitive skills. Pluijms et al. (2014) analysed the visual search behaviour of international- and recreational-level sailors rounding the windward marks (Figure 16). Their analysis found that performance on this task was associated with gaze, movement behaviour, dinghy control, and environmental conditions. Their work highlighted that better sailing performance when rounding a windward mark was related to gazing at the mark's tangent point. Furthermore, sailors were more performant when rounding the mark without opponents. Sailing without a direct opponent allows for an optimal search of relevant information concerning sailing strategy (i.e., wind direction, waves, and current). Araujo et al. (2010) analysed the ecological dynamics of the decision-making of 15 young sailors during a regatta competition. They observed that competition success is conditioned by the ability to assimilate the environmental variables and carry out the most relevant action according to the existing conditions. Indeed, this ability to

process information quickly to choose the best tactical option might be what differentiates a successful sailor from a less successful one (Walls et al., 1998). Hence, expertise and experience seem to be essential to performance. Moreover, Araujo and Serpa (1997) found that expert sailors carried out a greater number of actions and perceived more stimuli than non-sailing subjects. In another study, Araujo et al. (2005) also found that the total time spent on a sailing course was significantly predicted by expertise. On the other hand, from a social-cognitive perspective, Terrien et al. (2020) explored interactions between 2 professional Nacra 17 crew members during training sessions leading to the Olympic Games. Their findings highlight multiple forms of interactions between teammates. These interactions give significant information capable of optimising anticipation concerning what actions his or her teammate will do and when they will execute them.

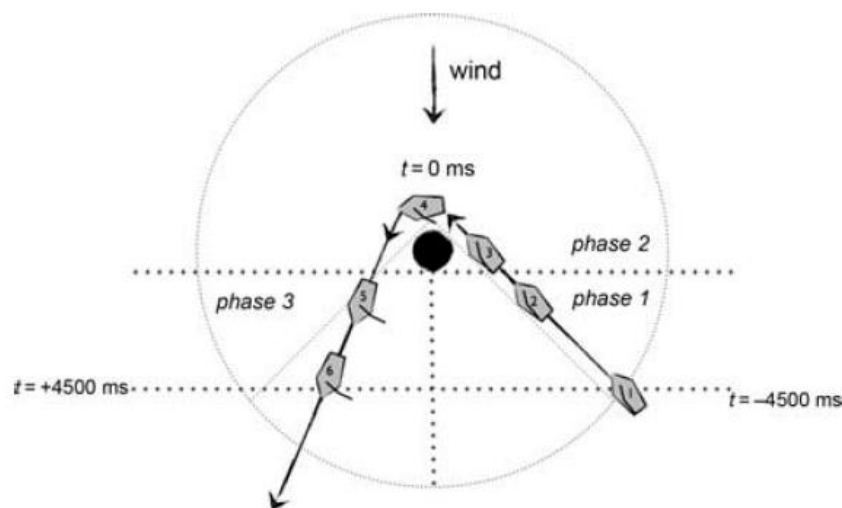

Figure 16. A top view of a windward mark rounding including three phases: Approach, rounding and exit. According to Pluijms et al. (2014).

3.3.4 Sleep management

Due to the extreme conditions of offshore sailing, the complexity of performing studies on sleep performance makes it difficult to establish relationships between performance and functional impairment (Hurdiel et al., 2012). Indeed, measuring sleep quality and sleep duration can be challenging on a moving vessel (Stampi, 1989). Research has highlighted that sleep disturbances induce a decrease in physical and cognitive performance (Hurdiel et al., 2014), but a few research have examined the direct effect on sailing outcome/rank/success. Léger et al. (2007) studied the effects of sleep debt and total sleep time on board on multiple crews participating in an offshore competition (*Sailing Tour de France*). They compared the final ranking with different sleeping variables and observed that successful teams were those who managed to achieve a lower total sleep debt and, therefore, a lower total sleep time on board. Furthermore, their findings high-

light the importance of pre-race sleep management as it seems to be linked to performance in extreme competitive conditions. The winning teams had better quality and quantity of sleep between each sailing leg than the losing teams. Galvani et al. (2015) corroborate these findings when establishing a rank relationship with total sleep time. For instance, they found that well-ranked double-handed crews had a lower total daily mean sleep duration than the less successful crews. They also observed that sailors with lower total sleep time (TST) also had better ranking and reported successful sailors slept for periods of 30-40 min for a total of 3-4 hours of sleep per day. Contrarily, Hurdiel et al. (2012) did not find any significant correlation between total mean sleep duration and final rankings in a solitary transatlantic race (*Transat 650*). Moreover, these authors suggest that extreme sleep curtailment may not be a prerequisite factor in solitary sailing performance.

Key Takeaways: Indicators of performance

- ▶ Although no normative data, concerning body composition and performance, is available in offshore sailing, it seems that training and nutritional strategies have brought sailors to leaner and fitter profiles.
- ▶ Physical fit sailors realise faster manoeuvres than their less-fit opponents.
- ▶ AEE is linked to vessel performance and race outcome.
- ▶ Professional sailors carry out more actions and perceive more stimuli than recreational sailors.
- ▶ Lower daily sleep quantity seems to be linked to sailing success in crewed sailing.

3.4 Management of offshore sailing as an extreme sport

With increasing demands and socio-economic pressures being placed on professional sports stakeholders, it is not surprising that a large variety of stressors have been identified in sports science literature. Selye (1946) stated that exposure to an extreme environment requires adaptations that induce a “stress reaction.” This process can be successful, leading to an appropriate adaptation of basal homeostasis, or unsuccessful, and lead to a condition of “distress.” Extreme sports have been characterised as featuring high speed, height, real or perceived danger, a high level of physical exertion, and involving elements of increased risk (Kraeutler et al., 2020). Moreover, with the growing popularity of extreme sports, studies exploring the physiological and psychological adaptations to extreme environments are gaining scientific attention. The extreme nature of offshore sailing has been well-accepted by sports scientists (Allen & De Jong, 2006). Indeed, offshore sailing is characterised as an activity implying prolonged periods spent

at sea, in an extremely harsh and hostile environment, in isolation, far from safe harbours, and with limited access to external aid or rescue (Sjøgaard et al., 2015). Moreover, sailors involved in offshore sailing are exposed to injuries and other health problems that can endanger their lives (Nathanson, 2013). Nevertheless, the literature exploring short- and medium-term adaptations to offshore sailing is still insufficient (Giacon et al., 2021). Notably, the distance from onshore health facilities and the lack of professional presence onboard might explain the scarcity of available scientific data. **Therefore, while attempting to be as inclusive as possible, this section will focus its examination on the various studies that have analysed (i) the epidemiology of injuries, (ii) the epidemiology of illnesses, and (iii) the acute and chronic effects of sleep deprivation that offshore sailors face during competition.**

3.4.1 Epidemiology of injuries

Despite all the benefits of participating in recreational and professional sports - such as improvements in body composition, psychological well-being, and cardiovascular function- participating in a sport with heavy physical demands in an unstable and dangerous environment, may result in a greater risk of injury and/or illness. Offshore sailors are particularly prone to such risks as they are in a constant state of alertness all while under extreme magnitudes of central and peripheral fatigue. This leads to difficulties in race management and boat performance, considering the distance from onshore health facilities and the lack of professional help onboard. The literature on offshore sailing injuries is predominantly descriptive, with scarce analytical data. While some focus on recreational competition and others on professional athletes, understanding the epidemiology of offshore sailing is of great importance. Indeed, it identifies the distribution of diseases and injuries, factors underlying their origin, their cause, and methods for their control. Furthermore, it provides practical information for efficient prevention and therapeutic interventions (Fuller & Drawer, 2004).

‘Sports-related injury’ denotes the “*loss of bodily function or structure that is the object of observations in clinical examinations*” (Timpka, 2014). This definition is a simplified version from Neville and Folland (2009), which defines injury in sailing as “*any physical complaint sustained by a sailor that results from sailing or sailing-related activities. Any injury that results in a sailor receiving medical attention should be referred to as a ‘medical attention injury,’ and an injury that results in a sailor being unable to take a full part in future sailing or sailing-related activities should be referred to as a ‘time loss injury.’*” An injury is classified by location, body side and mechanism of injury (traumatic or overuse), and whether the injury was a recurrence (Fuller et al., 2006). As indicated in *Chapter Two*, sailors face extreme conditions during competition leading to an increased risk for acute, overuse, and environmental injuries. Nevertheless, with hundreds of boat classes and various crew positions, there are distinct injury profiles due to physiological stresses and demands. A major focus for human performance practitioners and

sailors alike is to reduce the risk of injury. **Hence, it is crucial to understand the occurrence, type, and cause of injury to design human performance strategies that address possible injury prevention and performance.**

3.4.1.1 Injury incidence

In offshore sailing, the incidence of injury rates varies from 1.5 (0.37 injuries/1000 hours of sailing), in amateurs, to 3.2 (0.79 injuries/1000 hours of sailing) in professional sailors racing around the world. Although this may not stand out from other sports (Drawer & Fuller, 2002), the high fatality rate of 1.19 per million sailing days is relatively high compared to other sports and symbolises the risky nature of the sport's context. The gruelling nature of offshore racing is evident by the six fatalities in the Volvo Ocean Race since 1974, the fifteen in the Rolex Fastnet Race since 1979, and the six during the Sydney to Hobart Yacht Race in 1998. Nevertheless, common injuries in offshore sailing have been well documented. They include impact injuries (contusions and lacerations), fractures, and sprains, with the common injury site being the upper limbs, regardless of level (professionals and amateurs). Two-thirds of these injuries occur on deck, whereas one-third occur below deck (Spalding et al., 2005). Indeed, sailors spend considerable time below deck due to the watch system and are therefore faced with violent and sudden movements of the yacht and hardware found inside. Price et al. (2002) also observed that less experienced sailors were more prone to injury in the first third of a race. This, in turn, corroborates findings from Lethuiller (1986), who studied traumatic pathologies of professional sailors participating in the transatlantic regatta and reported that trauma was more frequent among less experienced sailors than more experienced ones.

3.4.1.2 Type of injury

The most common injury location in offshore sailors is the upper body, with the lumbar area, shoulders, and wrists accounting for 40 to 57.4% of injuries (Price et al., 2002 ; Spalding et al., 2005) (Figure 17). The most common types of injuries are impact injuries, such as contusions (12-40%) and lacerations (5-26%), fractures, and sprains which account for around 75% of injuries without differentiation between professional and amateur sailors (Bugge, 1986 ; Price et al., 2002). Since the nature of offshore sailing tasks are asymmetrical and coupled with bouts of intense activity on an unstable surface, these results are not surprising. Regarding upper body injuries, injuries to the lumbar spine (23%), wrist (17%), and shoulders (17%) are the most frequent in professional sailors. On the other hand, finger and hand injuries accounted for a high percentage (16%) in amateur sailors. During a 635 nautical mile race, Nathanson et al. (2008) observed that 47% of injuries were inflicted on the hands and fingers. In another study by the same author (Nathanson, 2010), leg contusions (11%) and hand lacerations (8%) were the most common. Nevertheless, most injuries reported in renowned offshore sailing venues seem to be impact injuries (contusions and lacerations), fractures, and sprains.

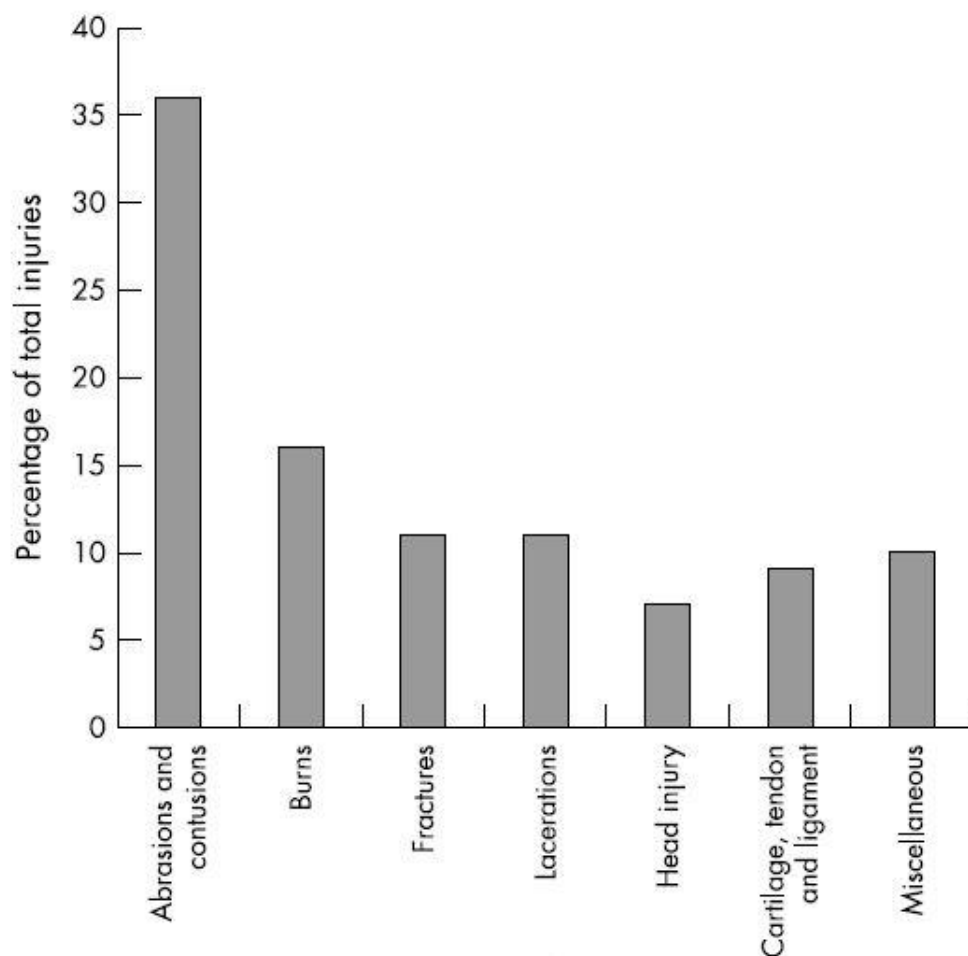

Figure 17. Subtype of injuries as a proportion of total injuries sustained throughout the British Telecom Global Challenge 1996–1997. According to Price et al. (2002).

3.4.1.3 Injury occurrence

Injury occurrence seems to vary according to crew position onboard. Indeed, physical actions around a sailboat are unnatural, leading to rotation, hyperextension, locking, and joint twisting. Hence, all positions onboard seem to be at risk but with the occurrence of injuries originating from sailing tasks. The mastman seems more at risk than the race tactician (3.1 vs. 1.7 injuries per leg) (Spalding et al., 2005). His/her role on board demands high levels of physical effort, and his presence is subject to risks of injuries due to the constant handling of rigging gear. Furthermore, helmspersons seem to experience mostly overuse upper body injuries, while bowmen (2.9 injuries per leg) and mastmen (3.1 injuries per leg) are at greater risk of contracting an acute injury. Nevertheless, Grinders and bowmen seem to be at the highest risk of injury due to the repetitive nature of their tasks (Allen & De Jong, 2006 ; Hadala & Barrios, 2009 ; Neville et al., 2010). Spalding et al. (2005) found that helmsmen, although being less at risk (2.6 injuries per leg), were susceptible to upper body overuse injury (i.e., rotator cuff impingement, wrist

tenosynovitis, and carpal tunnel syndrome) due to the demands of heavy weather steering. Furthermore, chronic and overuse injuries to the shoulder, elbow, and back are common in sailors frequently engaging in grinding activity.

3.4.1.4 Cause of injury

Green (2009) found that injuries were predictable in identified areas of the boat (i.e., foredeck, galley, winches, and helm). Indeed, many injuries (30%) result from falls onboard, which can be attributed to movement on a wet, unstable, and steeply inclined deck often cluttered with lines, winches, and hatches (Nathanson, 2019). Impact injuries from rigging, flogging sails, and contact with other crewmembers have also been identified as major causes of injury (Nathanson et al., 2010). Furthermore, the stacking of sails poses a particular risk since maintaining proper form on a moving vessel demands high levels of balance and stability. The equipment found on board is a major cause of injury. Operating the winch, grinding the pedestal, and handling sheets/lines under tension are the origins of hand/finger injuries (Bennet, 1973 ; Bugge, 1986 ; Lethuillier, 1986) (Figure 18). Increases in wind strength and hazardous sea states have also been found to be a leading contributing factor to injuries. In addition, these factors place exponentially higher loads on rigging and increase the chances of vessel capsizing and were observed to be responsible for 35% of injury cases (Nathanson, 2005). Furthermore, Price et al. (2002) found that the roughest sea conditions in the Southern Ocean caused significantly more injuries ($p=0.02$) than in calmer seas. Manoeuvring (i.e., tacking and jibing) has also been identified as a contributing factor to injury occurrence. This is likely due to the crossing of the boom overhead (Nathanson, 2010). Moreover, since many actions in sailing are sudden, sporadic, and realised on an unstable surface, muscles are at high risk of injury. Indeed, lifting, pulling, and pushing actions are amplified due to the difficulty of maintaining proper form on a moving vessel (Crafer, 1995). Allen (1999) also highlighted that the forward flexed and rotated spine position during grinding, pulling ropes, and trimming sails made sailors more prone to lumbar injuries. Such musculoskeletal issues, which may reside in inherent postural problems, are usually due to the changing forces on opposite muscle groups while sailing. Hence, some injuries may result from a lack of general fitness, overuse, fatigue, and/or overtraining.

While most sailing injuries are of a relatively minor outcome, severe injuries do occur. Severe injuries requiring evacuation or immediate hospitalisation mainly originate from jibing manoeuvres (boom or mainsheet impacts), collisions with other boats, dismasting, and falls through the various companionways on deck. Moreover, fatalities are more common than in other on-land sports. Ryan et al. (2016) reported 271 sailing-related fatalities in the USA between 2000 and 2011. Drowning (73%), trauma (10%), and hypothermia (4%) were the most common causes of death. Falls overboard (41%), capsizing (7%), sinking (7%), and collisions (5%) were the leading mechanisms behind these fatalities.

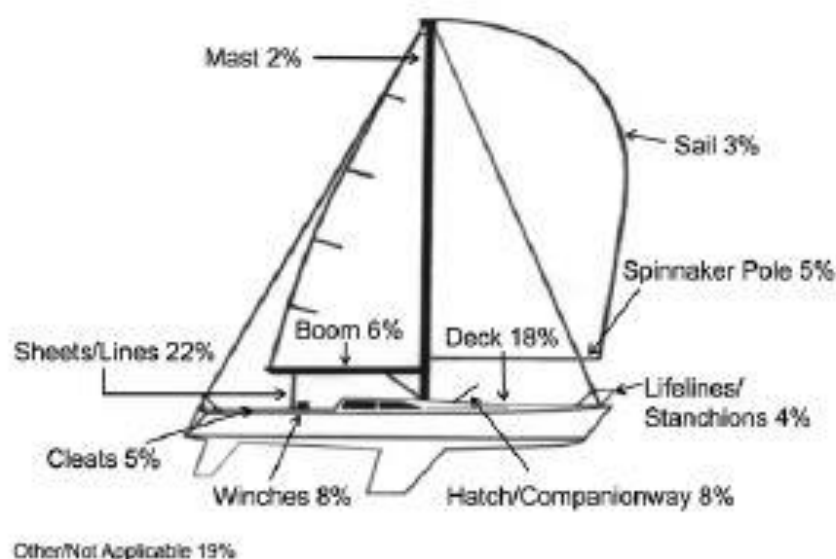

Figure 18. Part of keelboat associated with injury, n = 1,226. According to Nathanson et al. (2008).

3.4.1.5 Injury prevention recommendations

As established by O'Brien et al. (2019), after possible risk factors have been identified, risk reduction strategies should be implemented. These strategies aim at raising the robustness and resilience of the sailor, reduce external stress and enhance performance. Practitioners have identified guidance and support to sailors engaging in competition. It seems that most onboard injuries can be addressed through appropriate strength and condition programming, boat ergonomic development, proper nutrition, appropriate clothing and practiced onboard sports medicine. This field of science holds a particular importance in offshore sailing as boats are usually far from harbours and have limited access to external aid making first aid interventions, such as suturing, difficult in rough sea conditions (Sjøgaard et al., 2015). Furthermore, illness and environmental influences may affect injuries in sailing, making appropriate prevention, including proper clothing, adequate nutrition and safety measures highly recommended (Payson, 1989 ; Waggoner, 1992 ; Allen, 2006).

✓ **Strength and conditioning.** There is limited amount of research to support strength and conditioning interventions for injury prevention in offshore sailing programs. Nevertheless, authors have stressed the inclusion of general flexibility, hip flexor mobility and core stability in training programmes as a mean to reduce injury risk (Allen et al., 2000 ; Allen & DeJong, 2006 ; Neville & Folland, 2009). Strengthening joint stabilizing tissue and the synergist muscle groups should be performed by all sailors. Indeed, the resilience of specific body regions at high risk can be increased through specific strength training. Forearms, posterior shoulder, lower back, abdominal and core stability have been signalled as being important to train for offshore sailors (Rovere, 1987 ;

Blackburn, 1994). For instance, muscle imbalances such as shoulder weakness in grinders have been observed (Neville et al., 2006). In addition, the strengthening of the lower limbs should be incorporated to increase the transfer of force and, thus, avoid force leakage during grinding, stacking and steering (Molloy et al., 2005).

✓ **Nutrition.** Research concerning nutrition as a mean to prevent the incidence of injury is scarce. Nevertheless, links have been established between poor nutrition strategies and injury risk (Burke, 2003). Indeed, weight loss, which is usually observed in offshore sailing, may provoke changes in movement patterns, dehydration, decreased energy levels, and impaired cognitive capacities (Branth et al., 1996 ; Muller et al., 2016 ; Lafere et al., 2020). Furthermore, these factors may impair movement coordination, transfer of force and concentration and, thus, increase the risk of injury onboard. This is to be considered seriously by human performance practitioners as the nutritional challenges (i.e., quantity, time available...) faced by sailors competing in trans-oceanic races have been shown to be substantial (Branth et al., 1996). Hence, profiling strategies such as the determination of TEE and nutritional intake through the use of post-race questionnaires may be relevant for preventing injuries originating from poor nutrition strategies.

✓ **Ergonomy.** Racing boats have gradually evolved to become performance oriented with few concessions to sailor's comfort (Giacon et al., 2021). Past researchers have stressed the necessity for improving functional design on-board. The unstable environment and constant movement of the boat can lead to traumatic impact and overuse injuries. For instance, Spalding et al. (2005) suggested optimising on-deck instalments, such as increased friction of the steering wheel, height and thickness adjustments of the helming wheel and broader helmsman foot platform as to help reduce the risk of acute and chronic injuries when helming. Traumatic injuries could be avoided by keeping away from pulleys, winches, and trolleys during manoeuvres. Neville and Folland (2009) also gave suggestions for grinding pedestal predisposition by highlighting the need for customised handle shapes and increased handle friction. Furthermore, optimising the pedestal's height could reduce the degree of lumbar flexion and minimize back stress (Spalding et al., 2005 ; Neville et al., 2010).

✓ **Clothing.** Exposure to the elements in offshore sailing is unavoidable. The sun, in particular, is responsible for a large amount of photoinduced pathologies (28%) such as sunburn, which can lead to infection, dehydration, heatstroke, cancers, cataracts, and pterygium (Gentile & Auerbach, 1987). Protecting against the harmful effects of ultraviolet light is extremely important and can be accounted for by wearing protective clothing such as hats, long sleeve shirts, sunglasses, and the use of sun protection factor waterproof sunscreen (Downs & Harrison, 2018). Rope burns have also been reported in a few studies relating to offshore racing (Price et al., 2002 ; Nathanson et al., 2008) and

are most likely due to a basic reflex which consists of trying to grab a rope/sheet that has been accidentally released. Sailing gloves may provide maximum dexterity which may protect fingers and hands from lacerations and abrasions when operating winches, sheets, and other sailing apparatus.

✓ **Sports medicine.** Authors, such as Neville et al. (2006) have emphasized the need for sailors to undergo regular health screening procedures which should comprise both clinical and kinesiological investigations. By doing so, medical issues as well as muscle and biomechanical imbalances could be identified (Bojsen-Moller et al., 2007) and addressed by performance practitioners. Hence, medical support should be encouraged in the prevention of injury and not only in the treatment of acute and chronic injuries (Hootman et al., 2007). For instance, providing informed medical advice on positioning during different tasks (e.g., using the thumb over grip when grinding with wrist tenosynovitis) has been reported as a functional rectification for injury prevention. Moreover, medical equipment provided by race organisers should undergo constant development and updating for optimising first aid onboard (Price et al., 2002). Also, there is a need for sailors to be trained in basic life support and trauma management to meet international standards (e.g., Advanced Trauma Life Support) (Cahill, 1995).

3.4.2 Illness in offshore sailing

An illness is defined by the consensus of the International Olympic Committee, as “*a complaint or disorder experienced by an athlete, not related to the injury. Illnesses include health-related problems in physical (e.g., influenza), mental (e.g., depression), or social well-being or removal or loss of vital elements (air, water, warmth)*”. An illness can be detrimental to an athlete’s health, resulting in a possible reduction of performance and time-loss from training and competition (Schwellnus et al., 2016). Increased WLs, frequent commuting, malnutrition, sleep deprivation and poor hygiene may all contribute to increased risks of illness (Saunders & Smith, 2010 ; Ugurlu et al., 2015 ; Garbarino et al., 2021). Hence, due to the nature of the sport, offshore sailors may experience an increased risk of illness. For instance, the motion of the vessel, prolonged exposure to the elements, poor hygiene and confined living quarters may predispose sailors to various amounts of disorders. Moreover, sailors may suffer from illnesses especially during periods of high training volume (Nieman, 2003 ; Gabbett, 2004 ; Neville et al., 2006). Therefore, understanding the incidence and consequences of illnesses during sailing regatta may provide useful information to better prevent these disorders and better support athletes during periods of illness.

✓ **Illness incidence.** In offshore sailing, illnesses and non-injury complaints account for a large proportion of medical conditions (63% 1981 Whitbread, 56% BT Global Challenge and 36% 2001 Volvo Ocean Race) (Buge, 1986 ; Price et al., 2002 ; Spalding et

al., 2005). A wide array of illnesses has been documented in previous research examining offshore sailing.

✓ **Gastrointestinal ailment.** Gastrointestinal problems form the largest group of offshore sailing illnesses (22.5-51%) (Allen & De Jong, 2006). Gastroenteritis (51%), dyspepsia (24%), and constipation (10%) are common conditions found onboard but can lead to evacuation and surgical emergency. These viral illnesses are difficult to contain and cluster outbreaks have been found to occur on crewed boats (Price et al., 2002). Although some drugs may help provide relief for the ill, food and water supply should be regularly and seriously accounted for to avoid such epidemics.

✓ **Seasickness.** Seasickness, or motion sickness, has been found to be one the most common illness on board (8-15% of all illnesses) and is directly correlated to rough sea conditions (Price et al., 2002 ; Nathanson, 2010). Indeed, acclimatation to motion appears to occur within 72 hours and, although seasickness is rarely fatal, such disorders may enhance the risk of dehydration, hypothermia, and possible injury. Female sailors who experience migraines at sea were found to be more subject to seasickness than their male counterparts. When seasickness is established, oral drugs seem to be ineffective, and athletes can usually heal after three days if the sea of the state remains constant. Hence, sailors are advised to take medication (e.g., scopolamine) before embarkation or at the very first onset of symptoms (Nathanson, 2010).

✓ **Dermatologic conditions.** Dermatological conditions have been found to account for 21% of all medical cases. Exposure to the elements (sun, wind, and salt water) and lack of personal hygiene are contributing factors to such infections (Price et al., 2002). Gunwale bottom, boils, eczema, sunburn, fungal infections, and rashes were commonly found as acute conditions in sailors during competition. Chronic conditions such as skin cancer, cataracts and pterygium are a result of prolonged exposure to the sun. Sailors are advised to apply healing lotions (calamine, E45 cream, etc.) and to treat skin issues to avoid deep infection (Price et al., 2002). Furthermore, adapted dry suits with effective wrist and neck seals could help prevent specific rashes.

3.4.3 Sleep deprivation

Sleep is a highly complex state that arises from interactions between neurotransmitter pathways, brain regions, and hormones (Foster, 2012). Carskadon and Dement (2005) define sleep as “*a recurring, reversible neurobehavioral state of relative perceptual disengagement from and unresponsiveness to the environment. Sleep is typically accompanied (in humans) by postural recumbence, behavioural quiescence, and closed eyes.*” Furthermore, a “good night’s sleep” is a night composed of sufficient sleep duration that

provides the completion of wake-sleep homeostasis (Buysse et al., 1991). Although sleeping duration, according to age groups and specific activities, has been well documented and established by structures such as the National Sleep Foundation, the application of such qualitative and quantitative measures in a professional sailing environment seems impossible to fulfil. Indeed, offshore sailors suffer from extreme, acute, and chronic sleeping restrictions due to their task of maintaining vessel performance 24 hours daily (Hurdiel, 2012). The adverse effects of sleep deprivation vary and have been a substantial field of interest in offshore sailing literature. Walters (2002) has defined sleep deprivation as “*a state in which adequate sleep has not been attained.*” It is a common condition often purposefully carried out to significantly prolong wakefulness in a quest for increased productivity (Reynolds & Banks, 2010). The effects of sleep deprivation on human function and performance are various and complex. Moreover, the impairments in human function due to restricted sleep appear to follow a dose-response relationship (Van Dongen et al., 2003). Indeed, exposure to insufficient sleep can lead to acute- and chronic- health-related issues. Bennet (1973) was the first to report that sailors could not perform at their maximum potential during the 1972 solitary transatlantic race. He suggested that impaired performances were linked to adverse environmental conditions. Hence, understanding the reasons and the outcomes of sleep deprivation during competition may help to optimise sleeping strategies for offshore sailors. Indeed, sailors must cope with disruptions to both the circadian (a non-24-hour schedule of sleep) and the homeostatic (amount of sleep debt) determinants of sleep (Leger et al., 2008).

Past researchers have used actimetry measurements, sleep logs, night caps, and ambulatory polysomnography to monitor sleep disturbances during racing. The findings have led sailors to adopt sleep management strategies before and during racing (Leger et al., 2008). These race sleeping strategies adopted, such as polyphasic sleeping, bring the sailors to significantly lower TST (-24%) than that on-shore (Hagin et al., 2011). An overview of this research is listed here below:

Theunynck et al. (2010) examined the sleeping habits of 9 male professional sailors (38 ± 7 years of age) participating in the Vendée Globe (solitary around the world race). They administered the use of an actimetry watch, sleep recorder, and a journal log to track sleep quantity and quality. During the 104 days of sailing, total sleep time was recorded at 220-240 min per day, of which 8 phases were inferior to 5 min of sleep (Figure 19).

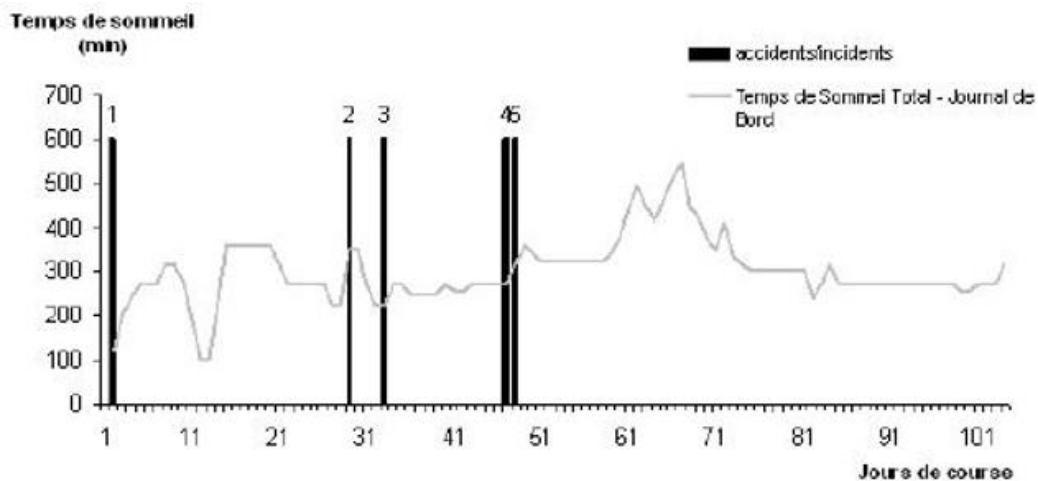

Figure 19. Daily total sleep time and onboard incidents. According to Theunynck et al. (2010).

Hurdiel et al. (2013a) examined the effects of sleep restriction on reaction time during three races (150 nm, 300 nm, and 350 nm) in 12 male professional sailors (30 ± 6 years of age, 177 ± 7 cm, body mass: 78 ± 10 kg, body fat: $20 \pm 6\%$). Recordings were made possible using two tri-axial actigraphs and an onboard electronic sleep diary. During the 150 nm race, 22 ± 30 min of TST were recorded, 92 ± 34 min during the 300 nm, and 172 ± 122 during the 350 nm (Figure 20).

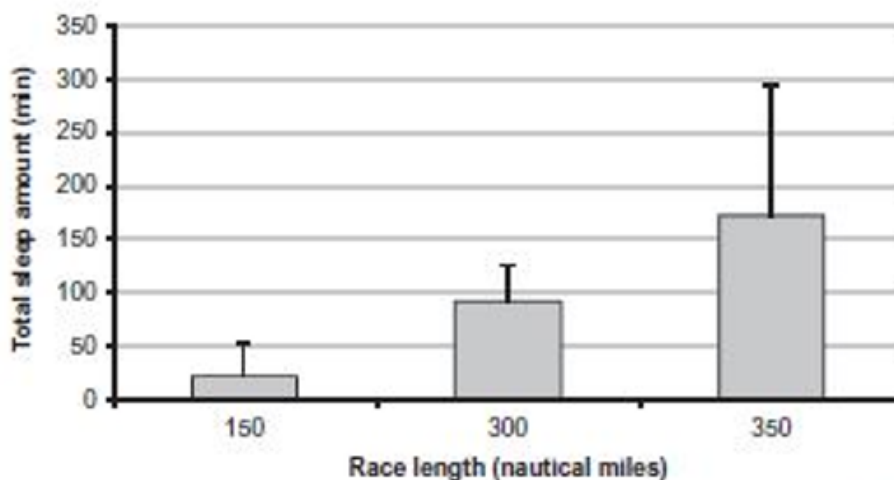

Figure 20. Total sleep time and sailing distance. According to Hurdiel et al. (2013).

Hurdiel et al. (2013b) attempted to predict cognitive performance through mathematical systems in solitary offshore sailors. Eleven male sailors (31.1 ± 6.5 years of age) used an electronic agenda and actimeters during two solitary races (36 and 50 hours) to record their TST. Sailors slept for 88.3 ± 4.3 min with naps lasting 16.1 ± 3.8 min for the 36-hour race, whereas TST for the 50-hour race was 225.5 ± 37.8 min with naps of 19.9 ± 3.3 min (Figure 21).

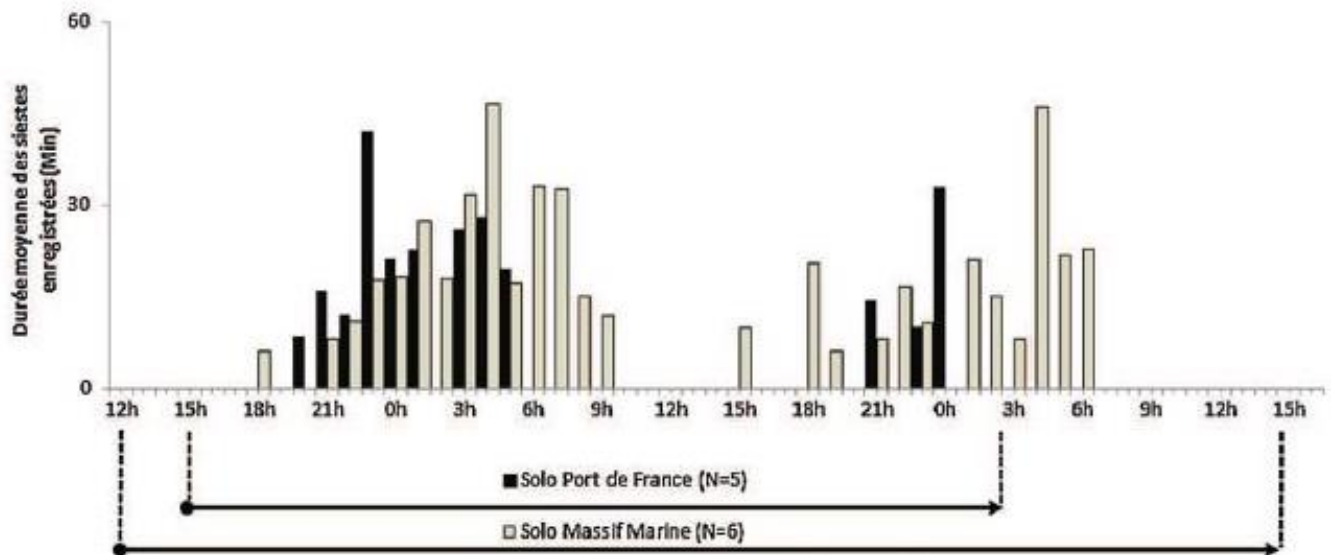

Figure 21. Organisation of polyphasic sleep (nap count and duration). According to Hurdiel et al. (2013).

Galvani et al. (2015) examined PA, sleeping patterns, and EE in 8 professional male sailors (46.3 ± 3.4 years of age; height 180 ± 13 cm; Body Mass Index: 26.7 ± 1.7 kg/m²) during 500 nm double-handed regatta lasting 5928 ± 1050 min. Sleeping quantity was measured through an actimeter, and it was found that sailors had a TST of 181 ± 30 min. Sailors slept 5 ± 1.4 times per day for 36 ± 9 min (Figure 22).

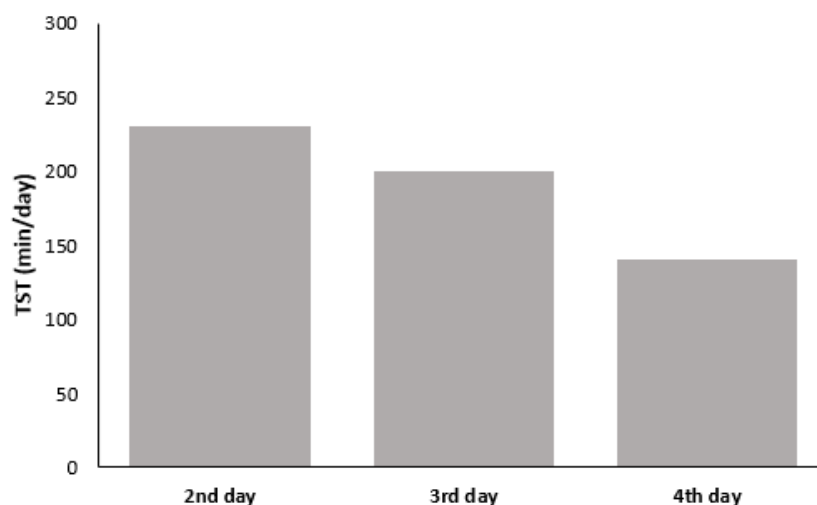

Figure 22. Total sleep time per day during four days of racing. According to Galvani et al. (2015).

Myers et al. (2007) analysed EE during a single-handed transatlantic yacht race in a 36-year-old professional sailor during the Transat (2800 nm solitary race). Sleep quantity was recorded through a race log that showed the longest continuous sleep to be only 75 min and a daily TST of 2 hours.

Hagin et al. (2012) examined the influence of a conservative sleeping management strategy during a solitary crossing of the Pacific Ocean in a male professional sailor (35 years old). During 4482 nm, the sailors completed a Questionnaire for Evaluation of Fatigue

and Anxiety daily (Figure 23). Daily TST was recorded at 5.4 ± 2.1 by sleeping phases of 20 min to 2 hours during the 62-day crossing.

Items	Not at all	Somewhat	Moderately so	Very much
1. I feel self-confident				
2. I feel depressed				
3. I feel relaxed				
4. I feel nervous				
5. I feel happy				
6. I feel anxious				
7. I feel peaceful				
8. I feel irritable				
9. I feel tired				
10. I feel able to think				
11. I feel on form				
12. I feel energetic				
13. I am somnolent				
14. I feel awkward				
15. I have muscular pains				
16. I have a strong will				
17. I have the desire to succeed				
18. I have a good appetite				
19. I feel sleepy				

Figure 23. Questionnaire for evaluation of fatigue and anxiety instructions: “We would like to know how you feel at the present time”. According to Hagin et al. (2012).

Leger et al. (2007) observed the sleep and performance management in 8 competitive sailors participating in the Tour de France à la voile. A sleeping log and a night cap were used to collect sleeping data during two sailing legs. During leg 1, sailors slept mainly at night (116.7 ± 131.8 min), with sleeping duration ranging from 2 min to 20 min throughout 15.2 ± 6.8 phases. During leg 2, TST during the day was 74.8 ± 49.1 min and TST at night 131.2 ± 139.8 min throughout 16.6 ± 10.2 phases (Figure 24).

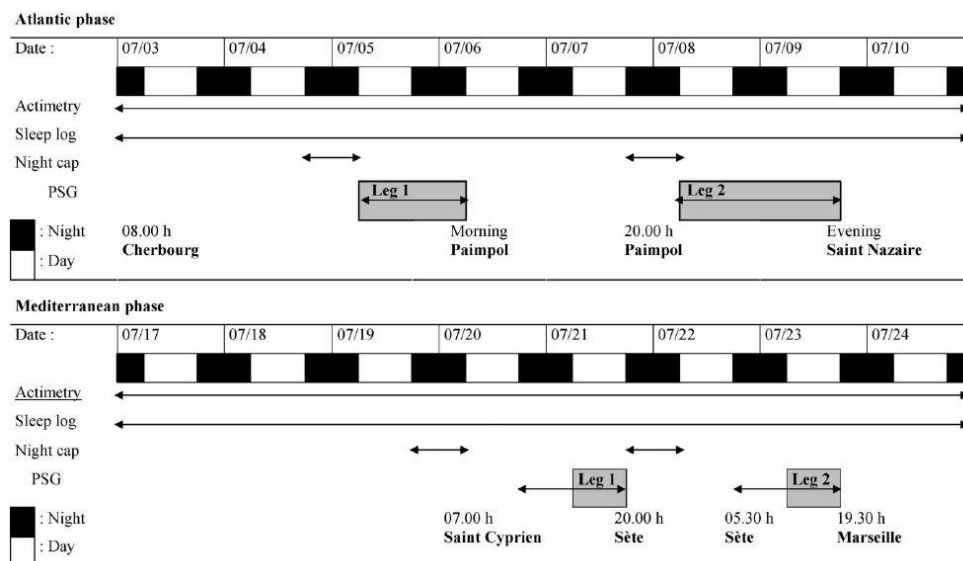

Figure 24. Sleep monitoring (ambulatory polysomnography) during the two phases: Atlantic and Mediterranean schedules. According to Leger et al. (2007).

3.4.3.1 Effects of sleep deprivation

Psychological and physical well-being can be maintained through proper sleep quantity and quality. If the sleeping rhythm (the circadian rhythm of 24 hours) is impaired, sleepiness may be felt when it is necessary to be awake (Folkard et al., 2005). The effects of sleep deficiency have been well-documented in previous research. Adverse effects on alertness, attention, memory, mood, decision-making and executive functioning have been reported (Lim & Dinges, 2010 ; Jackson et al., 2011). Perturbation in circadian rhythm from sleep deprivation due to watch shifts may influence mental performance by leading to greater anxiety, anger, depression, and fatigue perception (Balkin et al., 2004 ; Lim & Dinges, 2010 ; Fullagar et al., 2014). For instance, Baranski et al. (2002) observed decrements in serial response times, logical reasoning, visual comparison, mathematical logic, vigilance, and multitasking after subjects were exposed to 40 hours of sleep deprivation. Lagarde and Batejat (1995) highlighted that sleep deprivation negatively impacts mental performance but does not affect short-term maximal exercise capacity. Nevertheless, effects of sleep deprivation have been observed on maximal force (Ben Cheikh, 2017), repeated sprint ability (Skein et al., 2011), and aerobic capacity (Oliver et al., 2009). Moreover, acute sleep deprivation may even alter EE (Jung et al., 2011). Indeed, AEE and PA increase with fragmented sleep, associated with an increase in carbohydrates- and a reduction of fat- oxidation. Hence, such effects may impact offshore sailing performance since sailors face environmental factors such as noise, vibration, and adverse weather conditions that impair sleep quality (Pisula et al., 2012).

Offshore sailors are not exempt from the negative effects of sleep deprivation. They have been found to suffer from substantial functional impairments, such as increased technical errors, subjective fatigue, and hallucinations (Portier et al., 2008 ; Hurdiel et al., 2012). Gros Lambert et al. (2008) reported that anxiety and perceived fatigue were directly affected by the cumulative effects of sleep deprivation during a transatlantic crossing. Hurdiel et al. (2012) used a 5-min serial simple reaction time test (Figure 25) to observe significant differences in reaction time performance before and after sailing (150 nm, 300 nm, 350 nm). One year later, they carried out the same test 42 times during a 36-hour race with 88.3 ± 4.3 min of TST and found a significant increase in reaction time throughout the race (Figure 26). In 2012, Hagin et al. (2012) evaluated the level of anxiety by using a subjective questionnaire on a daily basis during a 62 days Pacific Ocean record attempt and found a significant negative correlation ($r=-0.32$, $p<0.05$) between daily TST (5.4 ± 2.4 hours) and the state of anxiety. On the other hand, Filardi et al. (2020) used the Epworth Sleepiness Scale to assess sleep quality during pre-race sleeping strategies and found that sleep-deprived sailors had significantly lower sleeping quality than those using polyphasic sleeping strategies.

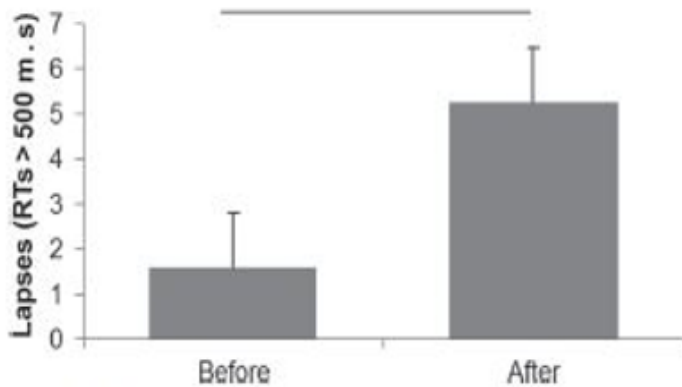

Figure 25. Performance on a 5-minute serial reaction time test before and after competition. According to Hurdiel et al. (2012).

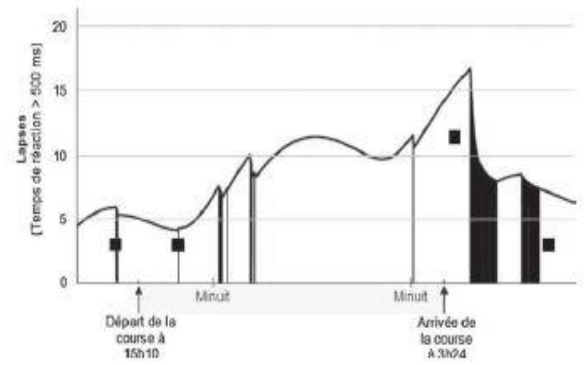

Figure 26. Reaction time alterations during an offshore sailing race. According to Hurdiel et al. (2012).

Key Takeaways: Extreme sport management

- ▶ Sailors face harsh and extreme conditions that drastically increase the risk of injury. A wide array of strategies exists to limit this occurrence.
- ▶ Most dermatological conditions can be treated with basic hygiene methods, oral antibiotics and/or topical steroid ointment.
- ▶ Sleep deprivation is inevitable, yet many methods exist to better understand one's way to optimise sleeping strategy.
- ▶ The polyphasic sleeping strategy is the most used during competitive offshore sailing.
- ▶ Low TST can lead to impaired cognitive and physical performance.

3.5 Dose-Response generated by competition

By analysing the dose-response relationship generated by competition and training and their effect on acute/chronic fatigue responses, it is hoped that training and human performance prescription will be optimised (Impellizzeri et al., 2005 ; Oxendale et al., 2016 ; Thorpe et al., 2017). Indeed, there is an increasing requirement to evaluate specific variables considered at the origin of fatigue responses for any given system (Ream & Richardson, 1996 ; Vanrenterghem et al., 2017). Although data regarding human performance during offshore sailing seems comparable with inshore sailing (Galvani et al., 2015), the evidence is scarce, difficult to obtain, and limited to basic measurements. Weight loss, fat percentage decrease, lower limb vs. upper limb strength, and EE are often reported. Cognitive demands, environmental stress, and the high physical demands of offshore sailing generate high levels of acute and chronic fatigue (Bennet, 1973). **Sailing exposure, “the total number of hours of sailing, from when the first**

sail is hoisted until when the last sail is dropped” (Neville & Folland, 2009), can therefore provoke a reduction in physical abilities, disturb physiological homeostasis, impair cognitive performance and modify body composition.

3.5.1 Body composition

The alterations in body composition generated by competition or training are often measured through pre- and post-intervention methodologies. Offshore sailing has received reasonable research interest in this area. Indeed, the negative energy balance often observed during competition results in weight loss, muscle mass reduction, and decreased body fat proportionally to the length of the race (Bigard et al., 1998 ; Allen & Dejong, 2006 ; Branth et al., 2006 ; Myers et al., 2008 ; Fearnley et al., 2012 ; Ghiani et al., 2018 ; Lafère et al., 2020 ; Giacom et al., 2021). Moreover, rapid weight loss has been found to have a detrimental effect on cognitive function and mood (Hall & Lane, 2001 ; Marttinen et al., 2011 ; Durguerian et al., 2016) as well as on the central factor of reaction time (Cullen et al., 2015). Hence, one of the main challenges for sailors involves weight management while racing. Significant bodyweight reductions have been demonstrated at the expense of fat mass (Lafère et al., 2020). These researchers observed a decrease of 3.6% ($p < 0.01$) in body weight, 17% ($p < 0.01$) in body fat, and 3.6% ($p < 0.01$) in BMI for 8 sailors participating in the Transat Jacques Vabre (4335 nautical miles). They also found a reduction in skinfold measurements of the upper body (tricipital, subscapular, supra-spinal, and umbilical), contrarily to lower body measurements. Muscle circumference was maintained in the upper body but decreased in the lower limbs. Ghiani et al. (2018) corroborate these observations through a case study analysis of a solitary sailor participating in a Solo Class 40 record. The sailor suffered a 6% decrease in thigh muscle area, whereas upper limb muscle mass was maintained. Fearnley et al. (2012) affirm that weight loss is inevitable in a prolonged offshore sailing competition. Markedly, the sailor observed a total loss of 7.9 kg during the Vendee Globe, of which most is attributed to fat mass decrease. Fat-free mass only suffered a 0.4 kg decrease during the 99 days of sailing. Moreover, Giani et al. (2018) and Lafère et al. (2020) reported fat mass loss and maintenance of FFM during two other long-distance events: the Solo Globe circumnavigation and the Jacques Varbre Trophy.

3.5.2 Muscular function

Few studies have focused on the effects of offshore sailing competition on muscular function (Portier et al., 2008 ; Ghiani et al., 2018 ; Blacha et al., 2019 ; Lafère et al., 2020). These studies have found contradicting results concerning the expression of strength, power, kinaesthesia, and maximal work output during specific assessments (squat jump, HGS, leg extension, and cranking/cycling exercise). Lafère et al. (2020) confirmed these varying results by showing different effects on lower body power expression during a

squat jump test. These authors found that monohull sailors were confronted with substantial impairments of lower body physical capacity (reduction of jump height, speed, and power) contrarily to Multi 50 sailors who saw squat jump performance increase. These differences may be due to the physical demands linked to the architecture of the boat (i.e., Multi 50 more walking distance to cover than IMOCA 60) and to the essentially submaximal isometric contractions produced onboard. Post-sailing results show a decrease of approximately 6% in jump height during a countermovement jump after 4335 nautical miles of racing. The changes in jump height were found to be inversely correlated to time spent at sea ($r=-0.81$; $p<0.01$). Contrarily to these findings, Portier et al. (2008) found no significant differences in jump height after a 33-hour offshore sailing crew race. Ghiani et al. (2018), on the other hand, found an increase in lower body maximum WL (+4.8%) during a cycling incremental exercise test after 64 days of sailing on Class 40. Similarly, Blacha et al. (2019) found kinaesthetic differences for left (79.12%) and right knee (0.7%) extension force production accuracy after one month of sailing. Upper body measures of maximal HGS remained constant after sailing (Portier et al., 2008 ; Lafère et al., 2020). The authors outline that maximal anaerobic power has been found to be preserved after several days of intensive physical exercise and sleep deprivation (Guezennec et al., 1994 ; Lagarde & Batejat, 1995). Nevertheless, Ghiani et al. (2018) observed a decrease (-22.2%) in maximum WL on a cranking incremental exercise test. The controversial results outline the complexity of analysing the impact of sailing on neuromuscular activity due to the wide variety of competition and vessel types (Pisula et al., 2012).

3.5.3 Cardiovascular function

It is widely accepted that regular PA is beneficial for cardiovascular health (Nystoriak & Bhatnagar, 2018). Observing the specific hemodynamic effects that influence the type and degree of exercise-induced cardiac remodelling is crucial for understanding the metabolic stress induced by WL (Martinez et al., 2021). In offshore sailing, little research has analysed the effects of competition load on cardiovascular adaptations. Ghiani et al. (2020) assessed different parameters before and after a 64-day offshore sailing competition. These researchers found changes in variables related to physical capacity during arm cranking and cycling incremental assessments after the sailing bout (Figure 27). Interestingly, $\dot{V}O_2\max$ (+9.1%), $\dot{V}CO_2\max$ (+21.9%), \dot{V}_E (+15.3%), respiratory exchange rate (+12.5%) and

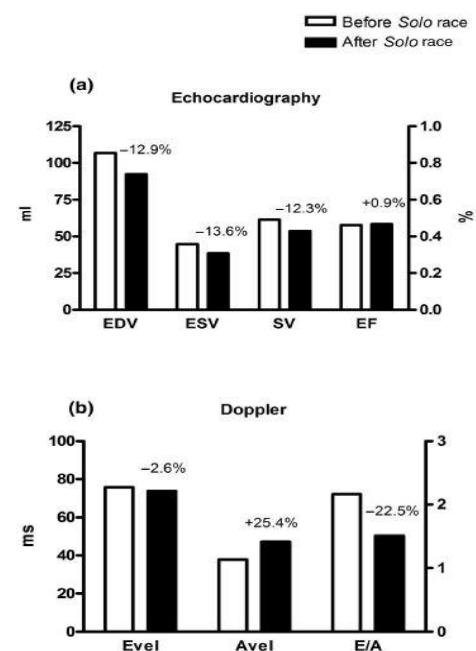

Figure 27. Cardiovascular adaptations to offshore sailing. According to Ghiani et al. (2020).

oxygen pulse (+9.1%) increased in the arm crank evaluation. By contrast, $\dot{V}O_2\text{max}$ (-21.5%), $\dot{V}CO_2\text{max}$ (-28%), \dot{V}_E (-16.5%) and oxygen saturation (-19.5%) decreased during the post-sailing assessments. A doppler echocardiography also revealed that end-diastolic volume (-12.9%), end-systolic volume (-13.6%), and stroke volume (-12.3%) showed reductions after the solitary race. Pulse wave Doppler recording also collected data concerning the left ventricular diastolic functions. The solitary race led to an increase in atrial transmitral filling peak velocity (+25.4%) and a decrease in the early/atrial transmitral filling peak velocity ratio (-22.5%).

3.5.4 Biochemical markers

✓ **Anabolic and catabolic hormones.** Decreased neuromuscular function and body composition modifications are not the only physiological effects of offshore sailing competition. The intensity of sailing, associated with sleep deprivation, malnutrition, and psychological stress, cause changes in homeostasis, which is particularly observable through the response of the endocrine system (Chovtiya & Medzhitov, 2014). Although few research have assessed such biomarkers, some studies have observed modification in the anabolic hormone testosterone [T] and [C] (Gunnarson et al., 2004 ; Portier et al., 2008 ; Giacon et al., 2021). These studies show alterations of normal cortisol secretion patterns due to the modification of the nycthemeral rhythm during racing. Nevertheless, the degree found in these alterations proved to be different across the three studies. Gunnarson et al. (2008) observed a flattening of the diurnal curve (Figure 28) with sustained high [C] levels during three legs (23 days, 22 days, and 12 days) of crewed offshore sailing. This blunted effect has been found to occur in shift workers (Hung et al., 2016) and long-distance transportation professionals (Sluiter et al., 1998). Moreover, a flattened diurnal curve has been highly associated with extreme stress factors (Adam et al., 2017). Nevertheless, although statistically non-significant ($p=0.08$), morning [C] during recovery between legs increased drastically to 70% of baseline levels after five legs of sailing. Furthermore, Giacon et al. (2021) show that a 2-day competition induced a 15% increase ($p<0.05$) in [C] compared to the resting value measured pre-competition. This significant increase is likely associated with poor sleep quality, fatigue, and physical exertion. Portier et al. (2008) unexpectedly found reduced [C] despite sailors being faced with elevated PA, cold weather, and sleep deprivation during a 3-day race. However, these authors also found specifically elevated midnight plasma [C]. Physical and mental stress can also alter [T] levels (Zitzmann & Nieschlag, 2001). Gunnarson et al. (2004) reported that [T] levels were at their lowest where mental stress was the most pronounced (i.e., sailing close to the Antarctic where collision with an iceberg was risked).

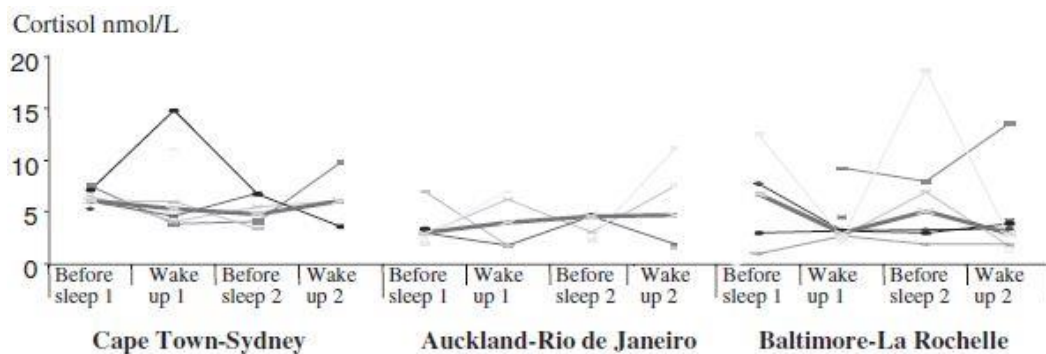

Figure 28. Cortisol levels during three legs of the Ocean Race. According to Gunnarson et al. (2004).

✓ **Oxidative stress.** The relationship between exercise and oxidative stress is extremely complex and depends on the mode, intensity, and duration of exercise (Pington et al., 2015). Although past research has investigated oxidative stress markers in inshore sailing competitions (Barrios et al., 2011), little is known about the offshore environment. Indeed, Giaccon et al. (2021) seem to be the only researchers to have investigated the impact of an offshore sailing competition on oxidative stress markers. These authors highlight that offshore sailors suffer a significant increase ($p < 0.01$) in radical oxygen species production rate of about 100%, a decrease ($p < 0.001$) in total antioxidant capacity of 12%, and an increase ($p < 0.01$) in the oxidative stress-related damage to lipids of 87%. Hence, such findings, although scarce, attest the magnitude of oxidative stress induced by an offshore sailing competition.

3.5.5 Subjective wellness

After offshore sailing, changes in objective markers, such as neuromuscular and biological characteristics, can induce changes in subjective markers of physiological stress, anxiety, and/or perceived wellness. Gros Lambert et al. (2008) and Hagin et al. (2011) have evaluated the perception of fatigue using the QEFA (Questionnaire for the evaluation of fatigue and anxiety) Likert scale. This questionnaire involves nine items on which the perceived fatigue varied from a minimum score of 9 to a maximum score of 36. These authors had sailors answer the questionnaire daily. Using this questionnaire both research teams have been able to define relationships between wind speed ($r = 0.83$, $p < 0.01$; $r = 0.51$, $p < 0.01$) and sleep deprivation ($r = 0.29$, $p < 0.05$; $r = 0.82$, $p < 0.01$) with subjective perception of fatigue. Lafère et al. (2020) showed that sailors' subjective evaluation of initial fatigue increased by 26% ($p < 0.01$) upon arrival after a transatlantic race. Portier et al. (2008) evaluated fatigue perception through a visual analogue scale. Their findings corroborate the results of other researchers concerning the association between fatigue with wind speed ($r = 0.51$; $p < 0.01$) and fatigue with sleep quality ($r = 0.82$; $p < 0.01$). This research also showed an interest in Branched Chain Amino Acids (BCAA) supplementation. The authors observed that the perception of fatigue was lower ($p < 0.05$) in the BCAA group than in the control group

The QEFA also measures anxiety. Gros Lambert et al. (2008) and Hagin et al. (2011) were also interested in understanding the effects of offshore sailing on the state of anxiety. Using this questionnaire, Gros Lambert et al. (2008) found significant associations between anxiety and the sailing distance covered ($r=0.57$; $p<0.01$) and between anxiety and wind force ($r=0.57$; $p<0.01$). Hagin et al. (2011) also found associations between anxiety with wind force ($r=0.62$; $p<0.01$), appetite ($r=-0.46$; $p<0.01$), and sleep desire (Figure 29). Their results also highlight a non-significant relationship (4%, $p=0.058$) between pre- and in-race anxiety.

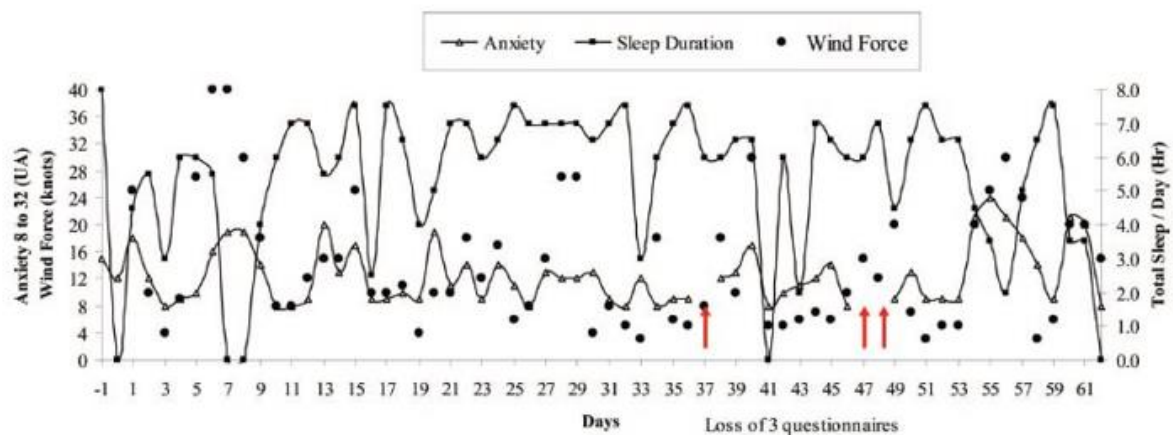

Figure 29. Relationship between wind force, sleep duration and anxiety during 62 days of offshore sailing competition. According to Hagin et al. (2011).

3.5.6 Neurocognitive fatigue

Most offshore sailors have declared substantial decay of cognitive performance (Theunynck et al., 2010) during competition. Impaired factors, such as difficulty in interpreting weather/tactical reports, realising manoeuvres, trimming efficiency, and taking tactical choices, have been reported. These periods of deterioration have also been accompanied by auditory and/or visual hallucinations in races, usually lasting less than 20 days. Apart from sleep deprivation, the constant instability due to the motion of the boat and the maritime environment significantly impacts cognitive performance (Colwell, 2005 ; Pisula et al., 2012). Hurdiel et al. (2013a, 2013b), Portier et al. (2008), and Lafère et al. (2020) have observed the effects of offshore sailing on the central nervous system. All these studies show a decrease in the central nervous system's response which can result in a reduction of neurocognitive processes through objective measures such as reaction time, short-term memory, and cerebral arousal (Psychomotor Vigilance Task, Critical Flicker Fusion Frequency, and Memory Search Test). Hurdiel et al. (2013a, 2013b) corroborate these results by observing an increase in reaction time, measured via the Psychomotor Vigilance Test (PPVT), of 300% after a 36-hour solitary race (Figure 30) and 384% after solitary races lasting 24-48 hours. Portier et al. (2008) found an increase in the percentage of error (+78.4, $p<0.05$) during the four letters memorisation test in twelve sailors after a 33-hour offshore sailing race. This study also observed a

lower error percentage ($p < 0.05$) of short-term memory in sailors who took BCAA supplementation than those who didn't. Moreover, Lafère et al. (2020) found a decrease in cerebral arousal (-5.6%, $p = 0.028$) in eight sailors upon completing a 4335 nm transatlantic crossing.

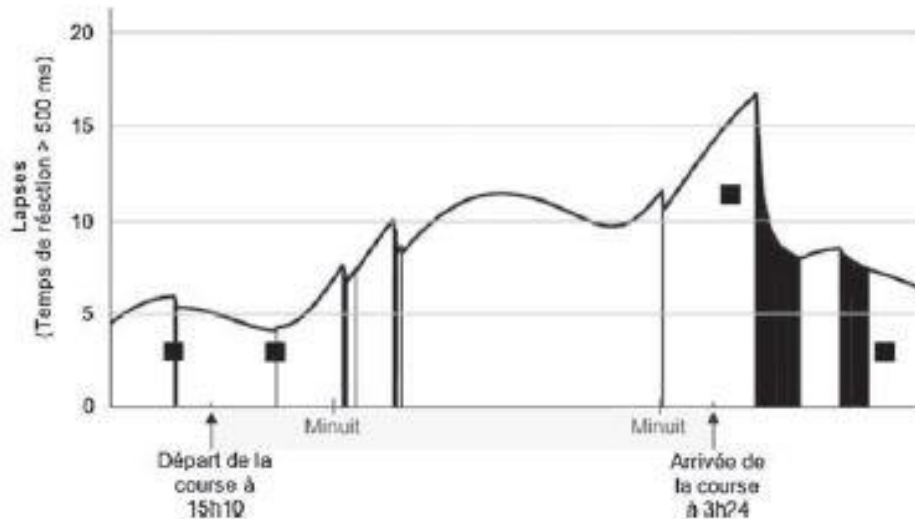

Figure 30. Reaction time alterations during an offshore sailing race. According to Hurdiel et al. (2012).

Key Takeaways: Dose-response relationships

- ▶ Body composition will inevitably be impacted by offshore sailing competition. Weight loss and atrophy (lower limbs) have been observed in many studies.
- ▶ The effects of sailing on muscular function varies according to the physical demands of the boat, the surface available for movement and the length of the race.
- ▶ Biological markers provide valid objective measures of fatigue. Cortisol and oxidative stress have been found to rise during, between and after sailing legs.
- ▶ Associations between wind force, appetite, sleep desire and sailed distance with anxiety have been established through valid and reliable onboard questionnaires.
- ▶ Sleep deprivation, boat movement and harsh environmental conditions have a detrimental effect on sailors' cognitive performance and central nervous system function.

Chapter four | *Literature review*

Workload management generalisation and application to off-shore sailing



“A theory is just a mathematical model to describe the observations.”

-Karl Popper

4.1 Synopsis

WL management is the deliberate temporary reduction of external physiological stressors intended to facilitate global improvements in athlete wellness and performance while preserving musculoskeletal and metabolic health (Figure 31). It aims to optimally configure training, competition, and other loads to maximise adaptations and performance with minimal risk of injury (Soligard et al., 2016). WL is a widely used concept in training prescription and monitoring. Indeed, scientific progress has led to the understanding that inadequate WL management can lead to insufficient recovery, hindered performance, and overtraining injuries (Jones et al., 2017). However, despite the widespread use of WL management and monitoring in sports, no research has established the efficacy of this practice in offshore sailing. Cognitive and physical fatigue in multi-day adventure/tactical sports is key to performance and safety (Russel et al., 2021). Furthermore, offshore sailors are faced with stressful and extreme conditions that may provoke alterations in body function, injury, and overall performance. Hence, understanding the effects of WL on fatigue may help bridge the gap between theory and practice in performance-enhancing training strategies. **Therefore, this section aims to describe the theoretical basis underpinning WL quantification methods and to outline an overview of their contribution to decision-making processes in training planning and delivery to offshore sailors.**

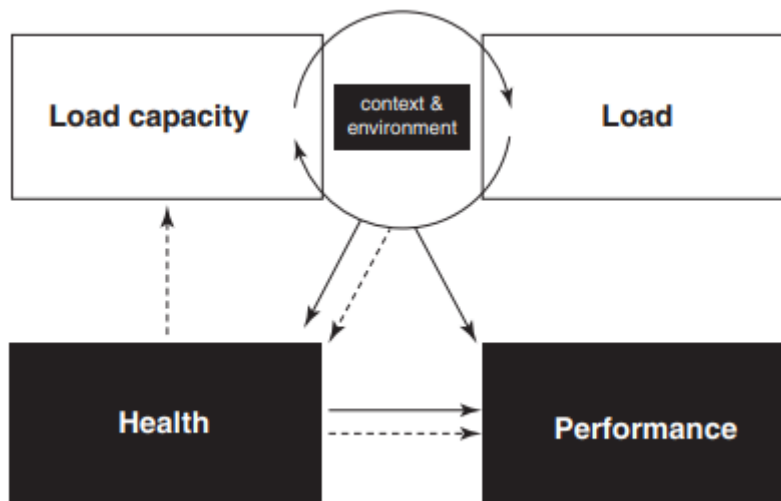

Figure 31. Integrated view on load, load capacity, performance, and health in sport. Dotted lines represent negative relationships and solid lines represent positive relationships. According to Verhagen and Gabbett (2019).

This literature review addresses the general concepts of WL management, training effects, and current practices of WL quantification and analysis. The review begins by examining the models of stress response upon which today's performance practitioners rely as the conceptual frameworks for the training process. This section's chronological

order follows the different stages of the general adaptation syndrome (GAS): accumulation, transmutation/realisation, and transition (Figure 32). First, the mechanisms of WL accumulation are considered by exploring the different types of fatigue and how they can impact the methods used to investigate WL in the offshore sailing context. Then, an overview of WL transmutation concerning recovery time course and adaptations to mechanical and metabolic stress is discussed. The definition of overtraining and detraining in the scientific literature is considered by discussing how these different effects may have a detrimental impact on human performance. Finally, a review of general WL management methods is provided and opens to monitoring tools used in prolonged activity sports.

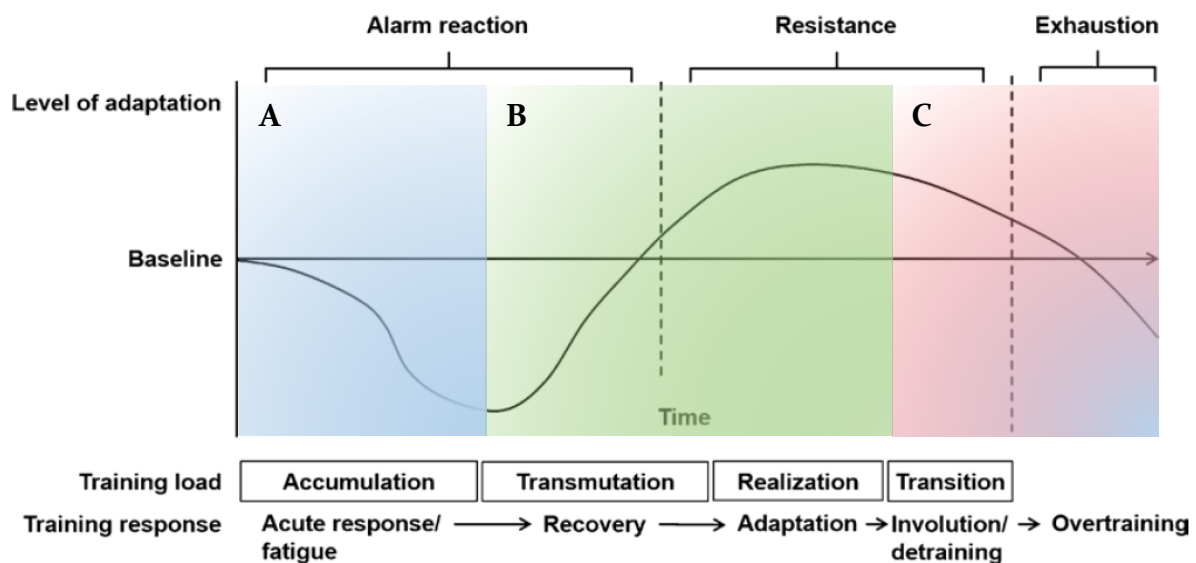

Figure 32. Patterned responses of the general adaptation syndrome. A) corresponds to the accumulation phase, B) Transmutation and realisation phase and C) Transition phase. According to Stone et al. (2007).

4.2 Models of stress response

The theoretical foundation for integrative sequential training is centred upon the adaptive process. This process has been largely based on fundamental biological constructs such as Hans Selye's general adaptation syndrome (GAS) (Haff, 2004). Over the years, researchers have provided upgrades and additional clarity to this concept (Yakolev, 1967 ; Chiu & Barnes, 2003). Taken collectively, these theories suggest that the various training factors in a training plan result in various performance and physiological adaptations (Figure 33). These adaptations are expressed as residual training effects, which produce varying durations of stability and express different involution rates (Haff & Haff, 2012).

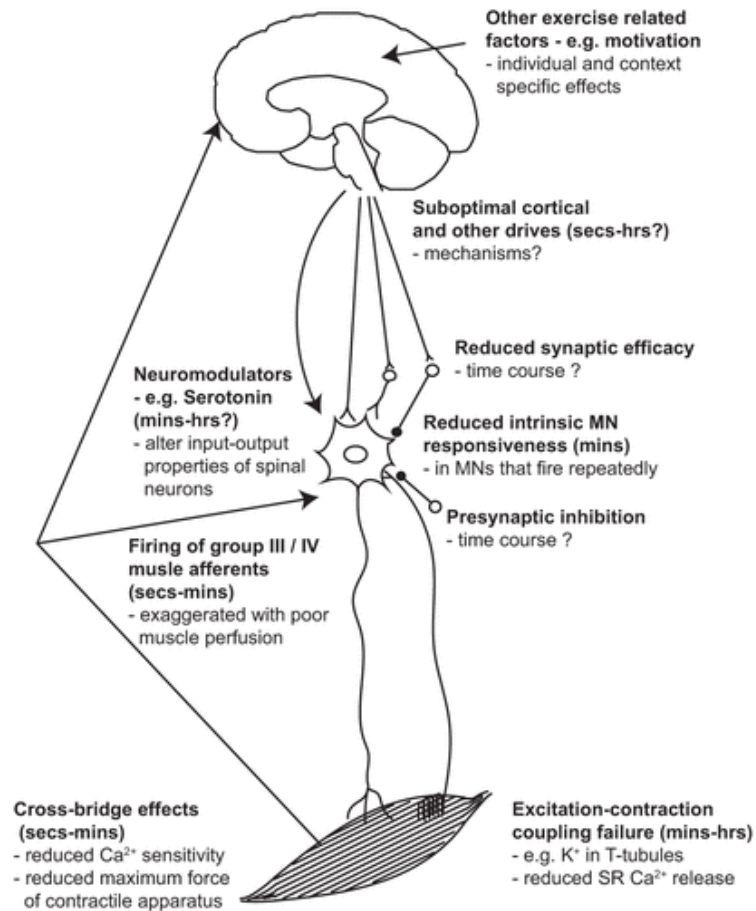

Figure 33. Schematic illustration highlighting some key neuromuscular responses to exercise. According to Stone et al. (2007).

4.2.1 General adaptation syndrome

In 1951, Hans Selye proposed the GAS to explain how living organisms respond to stress (Selye, 1951). Stress has been identified as being the disturbance of homeostasis. Selye integrated established concepts regarding the stress response, including Bernard's "milieu interieur" and Cannon's "homeostasis", to provide a unifying model of stress and adaptation (Selye, 1951). The homeostasis concept has supported physiology and medicine theory for decades. Today, the interpretation of homeostasis implies a constant internal regulation and is considered the "base level" or "before fatigue." In a biological system, stress stimulates adaptive responses beyond recovery until supercompensation is attained (Selye, 1956). The GAS model states that when stressors are encountered, three reactions are visible – alarm, resistance, and exhaustion (Figure 34).

- *Alarm phase:* An accumulation of fatigue, soreness, stiffness, and a reduction in energy stores which all inhibit performance capacity (Stone et al., 2007).
- *Resistance phase:* In which the body is returned to either its pre-exercise homeostasis or its newly adapted higher state (i.e., supercompensation).
- *Exhaustion phase:* May provoke overtraining if continued over a prolonged period (Stone et al., 2007).

Hence, with respect to the sports environment, this means that to provoke physiological adaptation, an overload must be imposed on the athlete. However, exhaustion and overtraining may occur if the stress is more important than the organism's adaptive capabilities. The response phase is proportionate to the magnitude of the stimulus and, if recovery is sufficient, can lead to improved physical readiness.

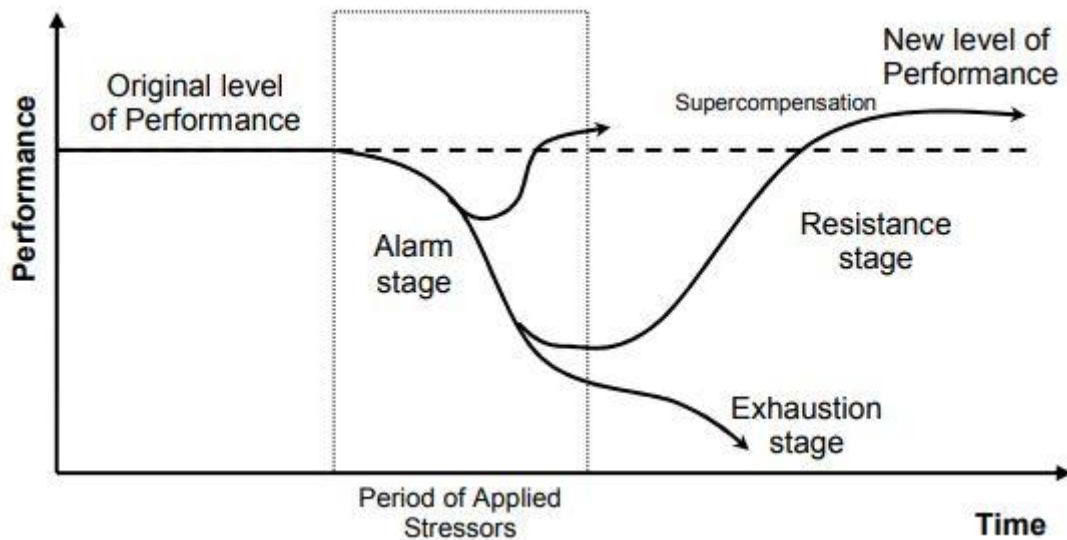

Figure 34. The general adaptation syndrome with reference to performance supercompensation following an applied stressor. According to Fry (1998).

4.2.2 The supercompensation curve

The GAS model is widely accepted and has originally led the way for the conception of periodisation models (Cunanan, 2018). Indeed, a time course of recovery after exposure to a training stimulus leads to physiological adaptations that result in functional enhancements (Cunanan et al., 2018). The supercompensation model (Figure 35) is the most straightforward representation of the training adaptation process (Gambetta, 2006). The concept suggests that fatigue accumulates in proportion to the magnitude and duration of the stimulus (Kataoka et al., 2021). Following the stimulus, the body recovers, which enables the dissipation of fatigue and supercompensation (physiological adaptations) to occur. It is thought that the greater the training duration, the longer the residual effects of training will last (Zatsiorsky & Kraemer, 2006).

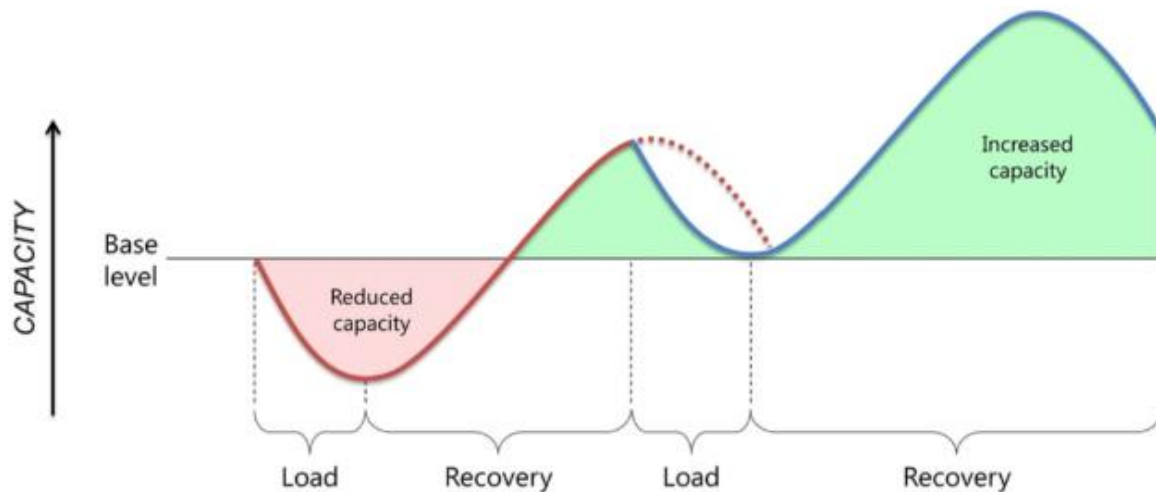

Figure 35. Biological adaptation through cycles of loading and recovery. Adapted from Meeusen et al. (2013).

4.2.3 Stimulus-fatigue-recovery-adaptation theory

Originally introduced by Verkhoshansky, the stimulus-fatigue-recovery-adaptation (SFRA) concept suggests that fatigue accumulates according to the magnitude and duration of training (Figure 36). It also defends the idea that involution will occur if the stress is not applied frequently (e.g., detraining). Involution time is influenced by the length of the preparation period (Stone et al., 2007), where residual effects last longer after greater training periods. Stone, during a roundtable organised by Haff (2007), described the SFRA theory as an extension of the GAS as it primarily deals with the concept of supercompensation. Furthermore, Verkhoshansky (2009) noted that this concept is not limited to a single exercise stimulus response but may be viewed from a longer viewpoint of training adaptations.

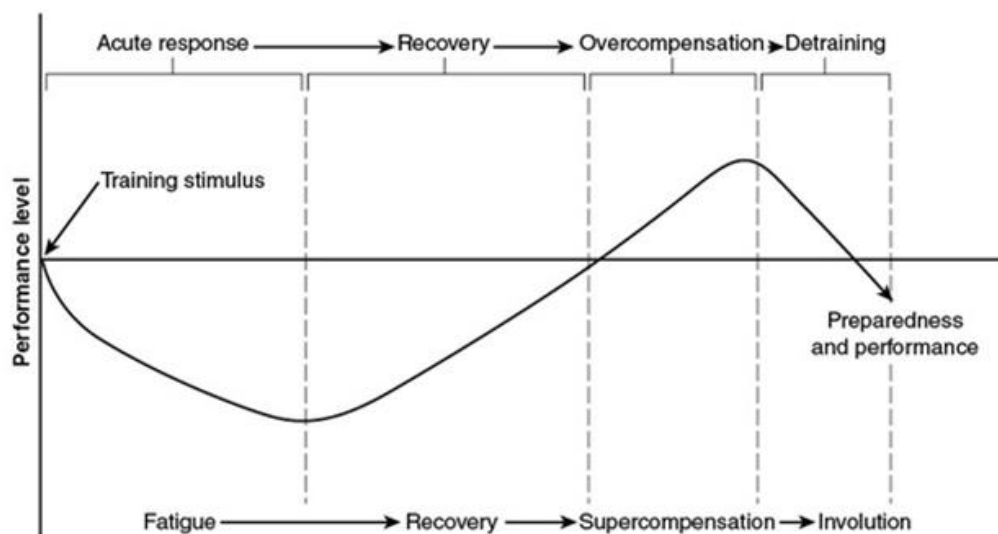

Figure 36. Stimulus-fatigue-recovery-adaptation theory. Adapted by Yakovlev (1967) ; Verkhoshanski (1979).

4.2.4 Fitness-fatigue paradigm

The fitness-fatigue theory, as defined by Zatsiorsky (1995) and depicted in Figure 37, describes the links between fitness, fatigue, and readiness. In theory, an acute WL creates two distinct physiological adjustments, fatigue and fitness, which combine to influence readiness and performance (Chiu & Barnes, 2003). Unlike the GAS and SFRA models, which assume that fitness and fatigue share a dose-response relationship, the fitness-fatigue model proposes that these variables hold an inverse relationship. Indeed, Banister (1991) proposed that acute physical stressors' immediate effects consist of positive and negative physiological responses. Furthermore, he suggests that performance readiness at any given point in time can be described as fitness minus fatigue. An additional key difference is that the fitness-fatigue paradigm concept differentiates between the actions of various stressors, such as neuromuscular and metabolic stress (Chiu & Barnes, 2003). This implies that the after-effect of fatigue and fitness is exercise specific (Zatsiorsky & Kraemer, 2006). Bompa and Haff (2009) stated that fatigue dissipates at a faster rate than fitness, which means that an athlete's readiness is allowed to increase along with performance.

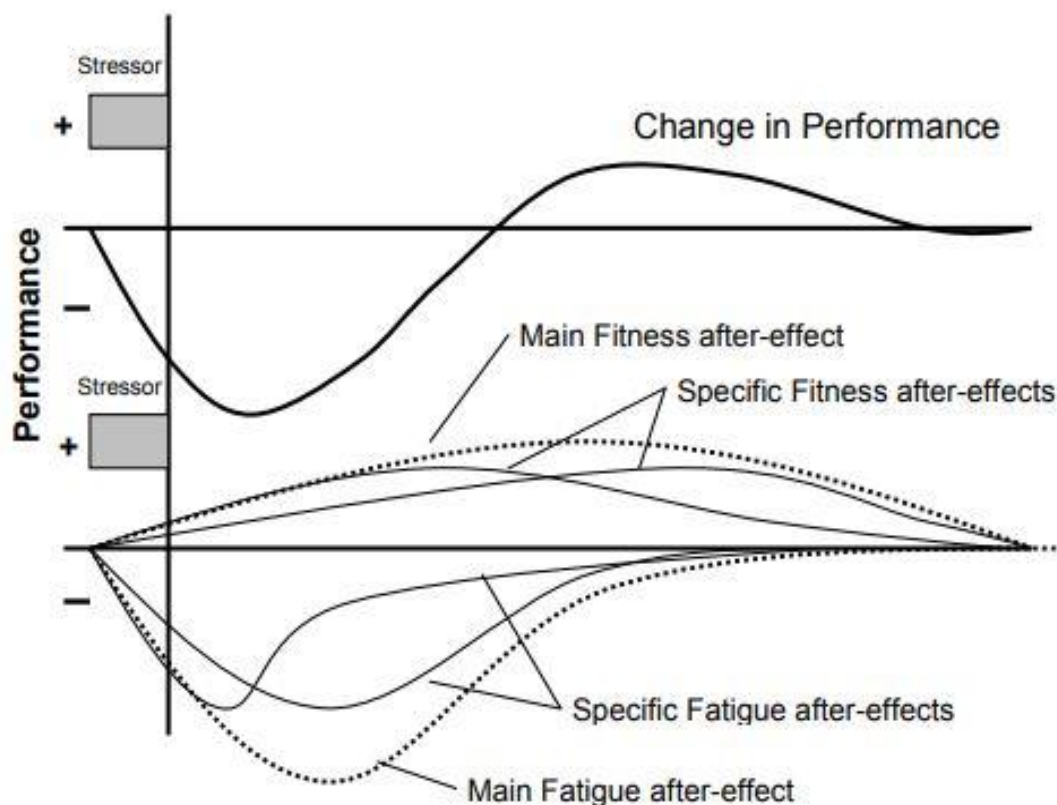

Figure 37. Fitness-fatigue paradigm demonstrating the relationship between performance and fitness after-effects. According to Chiu & Barnes (2004).

Key Takeaways: Models of Stress Response

- ▶ The GAS provides a mechanistic model to understand the relationship between stress, adaptation, and fatigue.
- ▶ The current models of stress response are originally based on a body's nonspecific response to disease. Current knowledge of neural and endocrine systems has led to improved analytical techniques.
- ▶ Stress causes a temporary decrease in function followed by an adaptation that improves function.
- ▶ The concept of periodisation and chronological sequencing is based on the management of the training residual effects.

4.3 Workload accumulation: mechanisms of fatigue

Fatigue is a slippery concept to define that holds a crucial role in stimulating the body to morpho-functional adaptations (Calandro et al., 2020) (Figure 32A). Indeed, fatigue has been analysed in a wide array of contexts. Most definitions agree that fatigue causes a reduction of force output or the failure to maintain an expected force in the short-term following an exercise or workout (Williams & Ratel, 2009). Other researchers have simply referred to fatigue as an exercise-induced diminishment or impairment of performance (Edwards, 1981). Abd-Elfattah et al. (2015) have defined fatigue as a decrease in physical performance related to a rise in the real/perceived difficulty of a task or exercise, as well as the inability of the muscles to keep up with the specified level of strength during exercises. Nevertheless, it seems that fatigue may affect athletic performance on many other levels. Moreover, Abiss & Laursen (2007) suggest that fatigue may be defined according to the discipline it is being analysed in:

- Psychology: subjective sensation/perception of tiredness and/or a decrease in cognitive function.
- Neurology: reduced motor drive or neural activation.
- Physiology: limitation of a specific physiological system.
- Biomechanics: a reduction in force output of a muscle or its efficiency.

Furthermore, several principles seem to stress that there is no single mechanism to induce fatigue but that a complex mechanism may include central nervous system (CNS) abnormalities, peripheral nervous system dysfunctions, and/or skeletal disease (Boyas & Guevel, 2011). Figure 38 depicts the different sites from which muscular fatigue can originate (Bigland-Richie, 1981). Hence, research has categorised muscular fatigue into two distinct categories: central and peripheral fatigue (Figure 39). The dearth of research on neuromuscular fatigue is particularly apparent in offshore sailing science. Notably, field research has been relatively under-researched among all the physiological and biomechanical adaptations in response to physical exercise due to the difficulty of

analysing the multiple conditions affecting performance (Noakes, 2012). Although fatigue has been considered a contributing factor to sailing injuries, diminished cognitive performance, and altered mood state, the effect of any specific sailing movement on the onset and pattern of fatigue is conjectural. Apparently, very little research has focused on understanding the aetiology of neuromuscular fatigue in this context. Nonetheless, knowledge can be gained and assimilated from exercise science about the multi-factorial nature of fatigue, central and peripheral (Tornero-Aguilera et al., 2022).

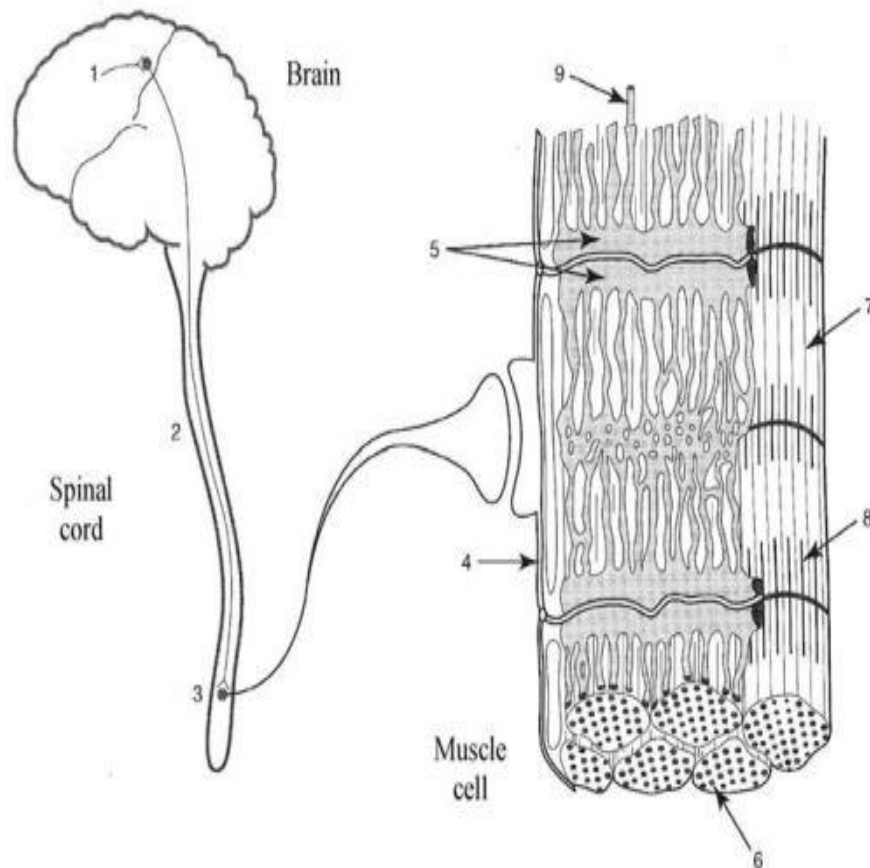

Figure 38. Potential sites that can contribute to muscle fatigue. According to Bigland and Richie (1981). Fatigue may be due to alterations in: (1) activation of the primary motor cortex; (2) propagation of the command from the central nervous system to the motoneurons (the pyramidal pathways); (3) activation of the motor units and muscles; (4) neuromuscular propagation (including propagation at the neuromuscular junction); (5) excitation-contraction coupling; (6) availability of metabolic substrates; (7) state of the intracellular medium; (8) performance of the contractile apparatus; (9) blood flow.

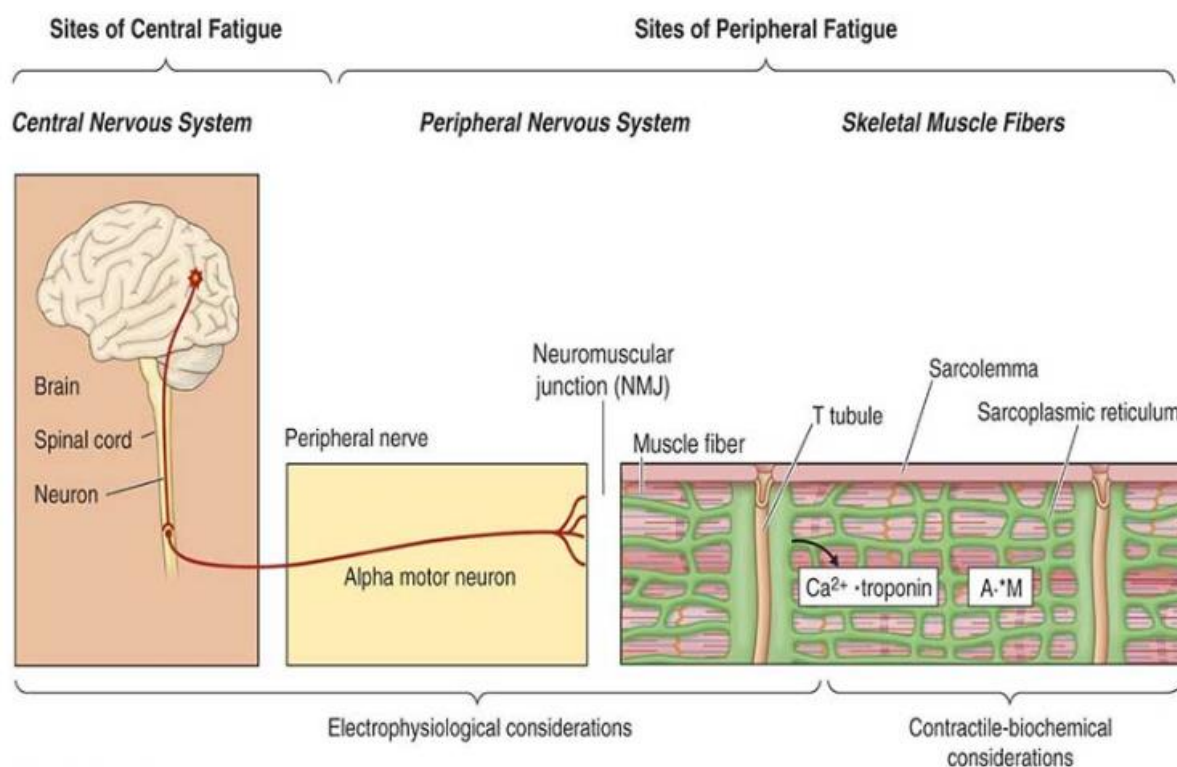

Figure 39. Classification of central and peripheral fatigue.

4.3.1 Central fatigue

Sports science studies generally explore how fatigue impacts the motor system through muscular activity alterations. Indeed, significant peripheral fatigue is a result of fatiguing tasks requiring muscular contractions, but central fatigue may add substantially to performance decline. Central fatigue develops during sustained or intermittent muscular contractions. It is defined as a deficient drive of cortical motor output which attenuates performance by affecting inhibitory and excitatory processes (Ament & Verkeke, 2009). This process impairs physical and cognitive performance (see section: 4.3.3 Cognitive fatigue). It designates a decrease in voluntary activation of the muscle through neural processes (i.e., decrease in firing rate, motor unit recruitment). It is described as fatigue coming not from the muscle but from the central nervous system and the transmission of signals from the brain to the muscle (Noakes, 2012), which makes it related to the brain and spinal cord (Zajac et al., 2015). These alterations have been found to influence mood, perception of effort, and tolerance to pain and discomfort (Leavitt & DeLuca, 2010). Moreover, extending a state of CNS fatigue has been found to lead to sleep disturbances, depression, pain, subjective fatigue, diminished cognitive vigilance, and reduced mental attention (Leavitt & DeLuca, 2010). Although fatigue impairs performance, it also acts as a potential mechanism to safeguard from further damage or injury (Cheung & Sleivert, 2004). The mechanisms highlighting the brain's inability to maintain the drive necessary to produce desired force output (Nybo & Secher, 2004 ; Hasegawa et al., 2008) and motoneuron processes (Carroll et al., 2017) are less well understood than peripheral ones. The maximal voluntary effort is less than that

which can be achieved when the muscle is activated directly by electrical stimulation of the motor nerve (Asmussen, 1979). These central nervous system changes have been found to occur before muscles fail to perform a task. The mechanisms are complex and are still relatively misunderstood. Indeed, this uncertainty has led researchers to develop potential theories concerning central fatigue (Figure 40).

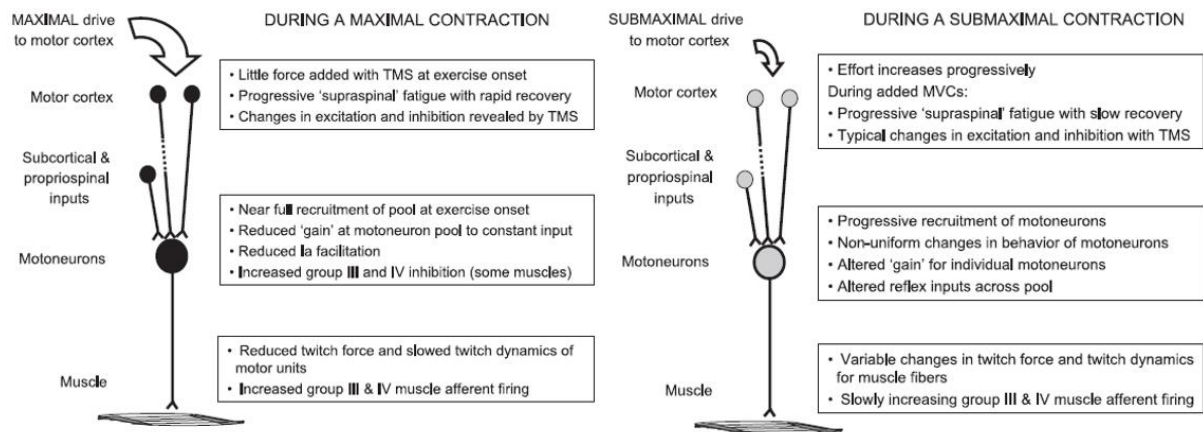

Figure 40. Summary of findings related to central fatigue during maximal and submaximal contractions. Adapted from Taylor and Gandevia (2008).

Traditionally, researchers thought that the origin of central fatigue was caused at any point of the neuromuscular transmission that affects cross bridges (Zajac et al., 2015). Current research has, however, suggested that it is in the brain where central fatigue originates. Multiple processes in the nervous system contribute to muscle fatigue, which begins at the onset of voluntary contraction (Taylor et al., 2016). These force loss contributions are linked to supraspinal and spinal mechanisms:

- **Supra-Spinal mechanisms.** Supra-spinal fatigue can be defined as an exercise-induced decline in force caused by suboptimal output from the motor cortex. During physical fatigue, sensory input from the peripheral system activates an inhibition system to limit motor output from the primary cortex (Zajac et al., 2015). Other brain regions related to the integration of sensory input from skeletal muscle, such as the anterior and dorsal cerebellar and vestibular nuclei (Delp et al., 2001), have been shown to have increased blood flow during exercise. The insular cortex holds particular importance in regulating central fatigue as its activity is associated with volitional exertion related to exercise (Williamson et al., 1999). Moreover, concepts such as the “serotonin-fatigue hypothesis” have received great interest and seem to be a clear rationale for understanding the causes of CNS fatigue. When exercise intensity increases, serotonergic activity produces a feeling of lethargy, loss of neural drive, and loss of motor unit recruitment (Meeusen et al., 2006). Other neurotransmitters, such as dopamine, glutamate, and gamma-aminobutyric acid, have also received considerable interest,

and all seem to impact CNS fatigue. Hence, it seems that the alterations in brain biochemistry may explain the aetiology of CNS fatigue through complex interactions.

- **Spinal mechanisms.** Changes at the spinal level occur due to the altered input from muscle spindles, Golgi tendon organ, and group III and IV muscle afferents that innervate the fatiguing muscle (Gandevia, 2001). However, muscle spindle inputs have been found to be sensitive to the discharge rate of neighbouring motor units, particularly when this declines below fusion frequencies (Christakos & Whindhorst, 1986). The firing of Golgi tendon organs, which sample the forces produced by muscle fibres from several motor units, has also been found to decrease with the fall in maximal voluntary contraction (MVC), and inhibitory input to homonymous motoneuron decreases (Lafleur et al., 1992). Moreover, small diameter muscle afferents (groups III and IV) are more sensitive to toxic chemical and mechanical stimuli. These afferents facilitate endurance performance via the optimisation of O₂ supply to the working muscles (Amann et al., 2011), contribute to motor command, and sense both mechanical and metabolic stimuli.

4.3.2 Peripheral fatigue

Contrarily to central fatigue, peripheral fatigue implies that the ability of the muscle to produce force is reduced (Ce et al., 2019). It is defined as the reduction in the efficacy of the neuromuscular function as metabolic and biochemical properties change within the muscle (Korzeniewski, 2019). Traditionally, peripheral fatigue and the inability to complete a physical task resided in the muscle's accumulated lactate concentration (Kirkendall, 1990) or a lowered pH within the muscle due to rising hydrogen ion concentration during anaerobic metabolism muscular contractions (Hole, 1993). However, more recent research highlighted that hydrogen ion concentration might not be an obligate mechanism of muscle fatigue (Olsson et al., 2022). Peripheral fatigue has recently received much interest in sports science literature and has increased the understanding of the processes occurring at the muscular level. Research has divided peripheral fatigue into high frequency (HFF) and low-frequency fatigue (LFF), where HFF is related to the impairment of muscle action potential propagation and LFF is related to the impairment of activation-contraction coupling (Tornero-Aguilera et al., 2022).

Peripheral fatigue appears when (i) depletion of energy stores occurs, (ii) accumulation of by-products increases, or (iii) impairment of muscle contractile mechanism is attained in response to PA (Allen et al., 2008 ; Reid, 2008). Furthermore, peripheral fatigue has been suggested to be related to immunological and genetic responses (Poole et al., 2008 ; Jones et al., 2008 ; Keyser, 2010 ; Vanhatalo et al., 2010 ; Finsterer, 2012). Moreover, peripheral fatigue has been found to be affected by energy supply (Ortenblad et al., 2013), muscle fibre type distribution (Hamada et al., 2003), pre-fatigue strength

(Enoka & Duchateau, 2008), and the muscle's length (Baumert et al., 2021). Furthermore, peripheral fatigue has been described as the decrease in the contractile strength of muscle fibres with changes in mechanisms underlying the transition of muscle action potentials (Millet et al., 2012; Zajac et al., 2015). These mechanisms are complex and differ in origin:

- **Loss of sarcolemma excitability.** Sarcolemmal excitability is defined as the inward current required to depolarise the sarcolemma enough to reach the threshold potential that triggers enough Na^+ channels to elicit an action potential (Sejersted & Sjogaard, 2000). The electrical signals from the central nervous system stimulate action potentials that travel to activated muscle fibres (Figure 41). Therefore, the muscle fibre membrane (sarcolemma) is the first point at which peripheral fatigue can occur. These action potentials have been found to be reduced by fatiguing exercise (Clausen, 2011). Moreover, this mechanism reduces muscle fiber force due to diminished action potentials that reach the T-Tubules (synchronises calcium release from the sarcoplasmic reticulum). The process by which this happens could be twofold. First, this could occur through the generation of reactive oxygen species that are known to inhibit the sodium-potassium pump (Apel & Hirt, 2004). Secondly, the muscle cell membrane could be damaged due to the production of phospholipases triggered by the accumulation of calcium ions in the cytoplasm (Berezhnov et al., 2010). Moreover, reduced excitability of the sarcolemma membrane may be due to intensive contractile activity-related damage (Piitulainen et al., 2008).

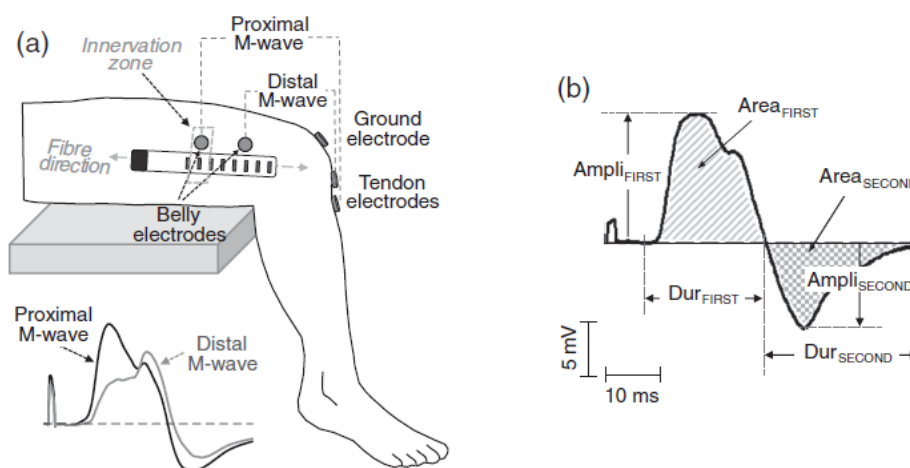

Figure 41. Assessment of sarcolemma excitability through compound muscle action potential recording (M-wave). Adapted from Rodriguez-Falces and Place (2018).

- **Excitation-contraction coupling failure (E-C).** This is known as LFF. It happens when no calcium ions are released into the muscle fibre, leading to force reductions at low frequencies (Figure 42). LFF is characterised by a proportionately greater reduction in tetanic force at low stimulation frequencies rather than

at high ones (Skurvydas et al., 2006). The mechanisms behind this flaw may reside in (i) the accumulation of phosphate ions which could bind with calcium ions in the sarcoplasmic reticulum, which inevitably reduces their availability (Dutka et al., 2005), (ii) disruptions to minor protein in the triadic junctions, which are responsible for maintaining structure composure (Balog, 2010), (iii) a decrease in calcium sensitivity to troponin (Ramirez-Correa et al., 2010 ; DeBold, 2016), (iv) poor conduction of action potential in the T tubules (Tomazin et al., 2008) and (v) reduced reuptake of calcium in the sarcoplasmic reticulum (Allen et al., 2008). Along with affecting performance via reduced force production, the occurrence of LFF may also affect the central drive and perception of effort (Keeton & Binder-Macleod, 2006).

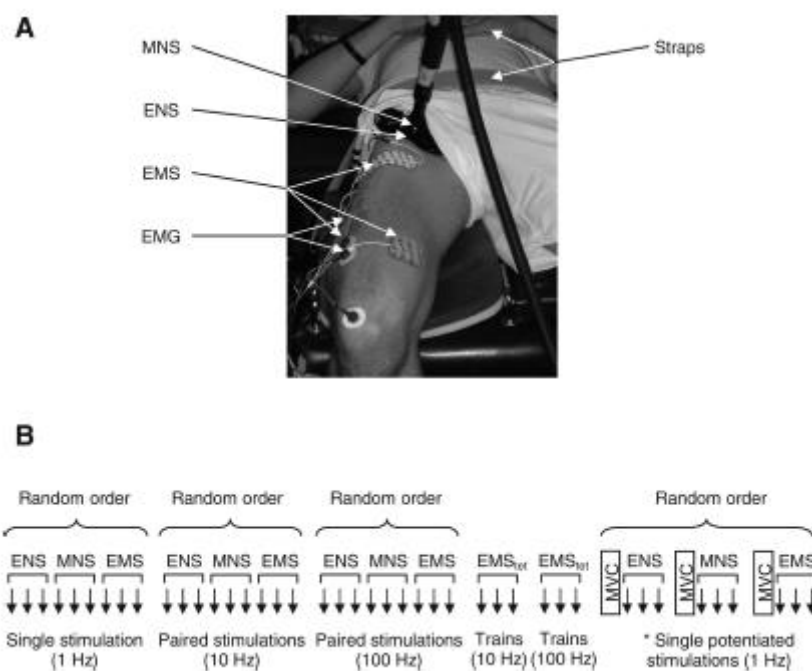

Figure 42. Assessment of excitation-contraction coupling mechanisms using Db10:100 ratio for the quadriceps. Adapted from Verges et al. (2009).

- **Loss of myofibrillar calcium ion sensitivity.** During normal muscle activation, calcium ion release from the SR is followed by a series of complex molecular events that ultimately lead to tropomyosin moving over the surface of actin to reveal the myosin binding sites (Gordon et al., 2000). This results from the failure of troponin to detect the presence of calcium ions (Figure 43). Moreover, current findings have highlighted the magnitude of the depression of muscle function that can be attributed to decreased calcium ion sensitivity. Although this mechanism of peripheral fatigue has received some interest, it seems that the mechanism is still being explored. Ament and Verkerke (2009) suggests that phosphate and hydrogen ions play an important role in losing muscle force and velocity. During fatiguing contractions, it likely reduces the number of strongly bound

heads at any calcium level, which decreases thin filament activation (Debold et al., 2006). Reactive oxygen and nitrogen species (ROS/RNS) have also been found to hold a causative role in the fatigue process (Westerblad & Allen, 2011). Indeed, there is strong evidence that ROS/RNS may alter the structure and function of the muscle's regulatory proteins through multiple complex mechanisms (Debold, 2015).

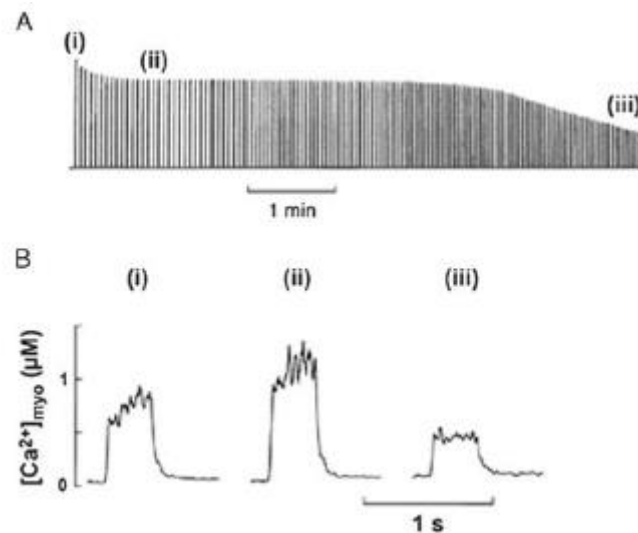

Figure 43. Effects of Ca⁺ on muscle force during sustained contractions. A) is a representative force record during sustained activation and b) is the corresponding record of intracellular level of Ca⁺. Adapted from Westerblad et al. (1991).

- **Crossbridge cycle.** The formation of actin-myosin cross-bridges is the origin of muscle tension that leads to force being produced (Srbolujub et al., 2017). If myosin cannot bind to actin or if cross-bearing structures (i.e., myofibrils and the cytoskeleton) are damaged, the force will be impaired and will not transfer force efficiently to the tendon (Crameri et al., 2007). One way this may happen is through the accumulation of phosphates which inhibit the flow of energy within the cross-bridge structure (Kawai et al., 2021). Also, myofibrillar remodelling, after lengthening fast twitch fibres, could result in mechanical tension and calcium ion-induced release of proteases (enzymes that catalyse hydrolysis of peptide bonds in proteins and polypeptides) (Eijsink et al., 2011).

4.3.3 Cognitive fatigue

Cognitive or mental fatigue is caused by prolonged periods of demanding cognitive activity (Van Custem et al., 2017) and has been found to have a detrimental impact on sports performance (McMorris, 2020). This type of fatigue has manifested itself in three distinct categories:

- Subjective: feelings of tiredness, lack of energy, decreased motivation, and alertness.

- Behavioural: decline of accuracy and reaction time of cognitive tasks.
- Physiological: alteration in brain activity.

It is well established that sleep deprivation (Dawson & McCulloch, 2005) and prolonged task performance (Lorist et al., 2005) are factors that cause mental fatigue. This seems to be the greatest challenge in offshore sailing as sailors must perform non-stop while accumulating fatigue caused by sleep deprivation, anxiety, and the state of constant alertness. Sailors are not immune to functional impairments such as technical errors, mood changes, and hallucinations (Portier et al., 2008 ; Hurdiel et al., 2012). For instance, reaction time was impaired when actigraphy assessments were given to mentally fatigued sailors (Tiberge, 1992 ; Hurdiel, 2013), even after just 1-day of offshore sailing. These results align with Van Dongen and Dinges's (2005) findings, which outline the effects of acute and chronic sleep deprivation on cognitive performance.

Furthermore, decrements in cognitive performance have also been correlated with thresholds of ship motion (Pisula et al., 2011 ; Weerts et al., 2013). Nevertheless, research has outlined the impact of mental fatigue on sports incorporating a high cognitive reliance (i.e., fine motor movement and specific decision-making qualities) compared to gross motor execution (i.e., stroke rate of a swimmer) (Fullagar et al., 2015). Decrements in cognitive performance have received extensive research in studies exploring sleep deprivation's effects and restriction. These declines have been attributed to disruptions to pre-frontal cortex functioning (Harrison & Horne, 2000). However, the neuroanatomical mechanisms behind this state are intricately complex (Taber & Hurley, 2006). Indeed, in a psychologically fatigued state, it appears that the large decrease in cerebral metabolism is apparent in the thalamus, cerebellum, and pre-frontal, posterior parietal, and temporal cortices (Drummon et al., 2001). These neural mechanisms and the reduced metabolic rates within these regions have been correlated with decreased cognitive performance, highlighting their influence on optimal cognitive functioning (Thomas et al., 2000).

The process by which mental fatigue affects physical performance is still misunderstood. However, studies have found that physiological variables traditionally associated with endurance performance (HR, lactate, $\dot{V}O_2$, and cardiac output) were not directly affected by mental fatigue after prolonged exercise lasting 30-100 minutes (Van Cutsem et al., 2017). Moreover, mental fatigue did not affect maximal strength, power and anaerobic work. Nevertheless, it seems that mental fatigue may be associated with a higher-than-normal perceived exertion (Van Cutsem et al., 2017). This perception of effort may increase due to the alterations in motor control to increase the subject's central motor command and muscle recruitment to produce the same power as when the central and peripheral fatigue is not present (Van Cutsem et al., 2017). For instance, Pageaux et al. (2015) observed increased electromyography root mean square of the vastus lateralis during whole-body endurance tasks in mentally fatigued patients. Moreover, studies exploring mental fatigue after longer and more strenuous tasks have observed aggravated autonomic imbalance and magnesium deficiency vasomotor anomalies,

which subsequently develop cardiovascular dysfunctions, autonomic imbalance, impaired thermoregulatory processes, and impaired HR variability (HRV) (Takase et al., 2004 ; Lucas et al., 2008). According to neurophysiological theories, it seems that mental fatigue may have a double nature. Indeed, it may (i) activate inhibition centres of the brain, which increases perceived effort for a task and decrease drive and willingness to act, and (ii) deactivate facilitative brain centres responsible for motivating behaviour and increasing drive to reward (Schipof-Godart et al., 2015).

Key Takeaways: Mechanisms of fatigue

- ▶ Fatigue is an integral part of the training process. Without it, supercompensation and adaptation would not occur.
- ▶ Intensity and duration are probably among the most influencing factors of fatigue.
- ▶ Task variables include muscle activation pattern, type of muscle group involved and the type of muscle contraction.
- ▶ Athletic fatigue is a difficult concept to define, making its measurement equally problematic.
- ▶ Fatigue is a complex process by which performance is impaired. It can be categorised into distinct categories: central and peripheral.
- ▶ A given stressor stimulates a unique and specific response.
- ▶ It is also critical that an understanding of the type of fatigue present is delineated. Such assessments carried out on a regular basis will allow sports coaches and support staff to monitor individual variation in response to normal training and during periods of high physical loading.

4.4 Effects of prolonged activity on task performance: application to offshore sailing

Events that exceed 6 hours in duration have been classified as ultra-endurance exercises (Zaryski & Smith, 2005). In the current literature, studies have analysed the origin of fatigue in prolonged exercise during running, cycling, skiing, and military operations (Nindl et al., 2002 ; Millet & Lepers, 2004). Some of those activities last over 24 hours and thus combine sleep deprivation with exercise, which is well examined separately but poorly understood if happening simultaneously. It is generally accepted that the onset of fatigue due to short-term exercise is mainly caused by metabolic factors or muscle damage (Millet & Lepers, 2004). However, there is a lack of integrative studies

involving human subjects that analyse the effects of prolonged exercise on task performance. Indeed, during prolonged exercise, such as offshore sailing, the aetiology of fatigue is more multifaceted. **The different mechanisms of fatigue during prolonged activity may lead to impairments in offshore sailing task-related performance (Figure 44).** In offshore sailing, it is understood that physical and cognitive parameters are important performance factors (Giacon et al., 2021). This section reviews the detrimental effects of offshore sailing on decreased task performance to provide practical implications for human performance practitioners.

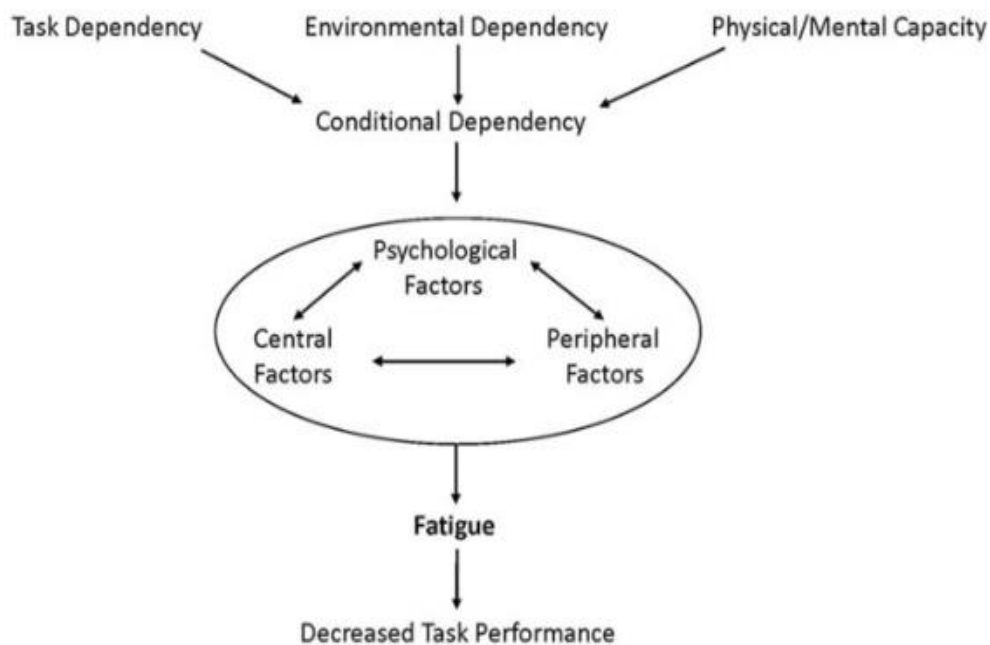

Figure 44. Overview of the multifaceted elements leading to decreased task performance. Adapted from Rudroff et al. (2016).

4.4.1 Power output

The grinding winches are responsible for the movement of the sails during manoeuvres and are used for trimming the sails to optimise wind usage (Pearson et al., 2007). Sailors transfer generated power output to the grinding winches, which pull in lines under tension, intending to optimise sailing efficiency (Figure 45). During the intense grinding activity, near- $\dot{V}O_{2max}$ (e.g., 58-61 mL. min⁻¹.kg⁻¹) (Bernardi et al., 2003 ; Bernardi et al., 2007) is usually reached, and anaerobic power values are comparable to that of other elite athletes (e.g., peak power 929-1420 W) (Pearson et al., 2007 ; Neville et al., 2009a). These physical efforts are considered inconstant and characterised by high-intensity anaerobic efforts and $\dot{V}O_2$ capabilities to recover between bouts (Allen & De Jong, 2006 ; Bernardi et al., 2007 ; Neville et al., 2009a ; Galvani et al., 2015). Moreover, sailors must be able to perform non-stop under central and peripheral fatigue caused

by repetitive bursts of muscular work, sleep deprivation, psychological stress, and cognitive fatigue (Sjogaard et al., 2015).



Figure 45. Ergometer for power output testing. Adapted from Pearson et al. (2009b).

The effects of prolonged exercise stress on power output remain unclear. For instance, researchers have reported no negative effects (Guezennec et al., 1994). Others reduced peak and mean power outputs after 4 hours of sleep deprivation (Abdelmalek et al., 2013), whereas Nindl et al. (2002) have reported selective decrements in mean but not peak power output after 72 hours of sustained military operations. Temesi et al. (2013) found that impaired high intensity cycling bouts were attributed to incomplete muscle glycogen replenishment from sleep deprivation. It has been found that anaerobic exercise can induce prolonged oxidative stress up to 24 hours after effort (Shi et al., 2007). These oxidative stress markers were also found to be higher than baseline levels in America's Cup sailors after the competition (Barrios et al., 2011). However, the prolonged effect of offshore sailing competition may permit full oxidative stress balancing from an adapted antioxidant response (Bloomer & Goldfarb, 2004 ; Mrakic-Sposta et al., 2020). Indeed, power output was reduced by one-third after 24 hours of ultra-endurance exercise (Lucas et al., 2008). Furthermore, research analysing sustained military operations lasting up to 60 hours (Rodgers et al., 1995) and 96 to 120 hours of military field operations (Hackney et al., 1991) observed 5-8% drops in peak and mean power, respectively. Moreover, Nindl et al. (2002) reported that 72 hours of sustained operations significantly impacted anaerobic mean power production for under and over-utilized muscle, whereas peak power was not. The interplay and link between aerobic fitness and repeated "high-intensity tasks" ability has been clearly demonstrated in a variety of sports (Glaister, 2005). During a high-intensity bout of work, such as manoeuvring or changing sails, muscle phosphocreatine (PCr) and glycogen concentrations will inevitably decrease (Bogdanis et al., 1996). After this effort, PCr resynthesis occurs via the rephosphorylation of creatine by aerobically produced adenosine triphosphate (ATP)

(McMahon & Jenkins, 2002). Furthermore, Glaister (2005) observed elevated levels of $\dot{V}O_2$ during recovery and concluded that it was needed to restore homeostasis via specific processes such as the replenishment of tissue oxygen stores, the resynthesis of PCr, the metabolism of lactate, and the removal of accumulated intracellular inorganic phosphate. Nevertheless, some research has examined the effects of prolonged activity and sleep deprivation on cardiorespiratory functions. The duration of effort seems to negatively affect cardiorespiratory variables to a higher degree than exercise intensity (Neumyar et al., 2003). These researchers observed a decline of 10% in HR every 10 hours of exercise. Kim and Park (2020) observed myocardial hypertrophy and contractile dysfunction after a 622 km marathon. Moreover, left ventricular function has been found to decrease after prolonged exercise (Middleton et al., 2006). The mechanisms underlying this down-regulation may be due to elevated catecholamine levels (Kvasnicka et al., 2019), elevated levels of free fatty acids (Ning et al., 2018), alterations in myofilament sensitivity to calcium (Van der Velden et al., 2004), and abnormal sarcoplasmic reticulum calcium reuptake (Zile & Brutsaert, 2002). Notably, extreme periods of sleep loss (i.e., 100 hours of sleep restriction) may be more likely to affect these variables than acute sleep deprivation (24 to 36 hours) (Reilly & Walsh, 1981 ; Neumyar et al., 2003). Therefore, aerobic function deficits related to prolonged exercise may be twofold: (i) post-exercise decreases in left ventricular function (Serrano et al., 2013) and (ii) the influence of perception of effort from sleep deprivation (Oliver et al., 2009).

4.4.2 Strength

Upper- and lower-body strength is of paramount importance for offshore sailors. Indeed, strength is necessary to (i) execute rigging and manoeuvring tasks on board and (ii) optimise injury prevention. Performing movement onboard also increases the demands of higher grip force and forearm strength when the equipment is wet (Neville & Folland, 2009). Muscular strength has been widely studied in various sports and has been identified as an important factor attributed to task performance. Moreover, it can differentiate between successful and less successful sailors (Neville et al., 2009b ; Carballo et al., 2019 ; Pan et al., 2022). Lower limb strength and muscle mass reduction are often reported in professional offshore sailors (Allen & De Jong, 2006 ; Myers et al., 2008 ; Fearnley et al., 2012 ; Ghiani et al., 2018 ; Lafère et al., 2020). Moreso, the negative energy balance found during racing often results in muscle mass and muscular capacity reductions proportionally to the length of the race (Bigard et al., 1998 ; Lafère et al., 2020). However, the cause of this reduction is controversial. Some studies highlight the effects of detraining as the leading cause of strength deficits (Ghiani et al., 2018 ; Lafère et al., 2020), whereas others have placed the cause on the accumulation of fatigue due to sleep impairment and repetitive physical output (Branth et al., 1996). Nevertheless, caution should be used when generalising the inferences between muscular strength variations and offshore sailing. Visibly, the physical demands of sailing vary according

to the type of vessel, wind speed, and the sailor's position on board (Bernardi et al., 2006 ; Neville et al., 2009b ; Neville & Folland, 2009).

The effects of prolonged exercise on maximal and submaximal strength output remain relatively unclear. Some studies have shown that MVC was not impaired by prolonged exercise or sleep deprivation. For instance, Reilly and Hales (1988) observed that back and grip strength was maintained following sleep reduction. In contrast, others have found that 3 hours of sleep reduction would negatively affect both maximal and submaximal tasks, with greater effects observed on submaximal tasks (Reilly & Piercy, 1994). Knapik et al. (1990) found reductions in isometric and isokinetic upper body strength of professional soldiers after 5 days of infantry manoeuvres. Furthermore, Lucas et al. (2009) observed decrements (17% and 11% in over-utilised and under-utilised muscle groups, respectively) in MVC and decrements (18% and 13% in over-utilised and under-utilised muscle groups, respectively) in strength endurance (time to failure at 70% MVC) after a 100-hour adventure race. The authors highlight a centrally mediated reduction in force generation due to the similar effects on different muscle groups. On the other hand, Deely et al. (2022) suggest that the substantial decrements in MVC following 72 hours of an intense football training camp were largely attributable to peripheral mechanisms. This is supported by Millet et al. (2003), that found no decrement of grip strength after a prolonged running exercise but significant decreases in lower body MVC. The conflicting results between studies may depend on several issues, such as small sample size resulting in low statistical power, differences in the experimental environment, exercise protocols used, fitness levels of the participants, and even intra-individual responsiveness to prolonged exercise and sleep deprivation (Fullagar et al., 2015).

4.4.3 Movement control and coordination

Sailing, in general, is a sport necessitating high levels of tactical and technical proficiency to optimise boat speed during specific manoeuvres and rigging actions (Neville et al., 2009b ; Santos et al., 2016 ; Myers et al., 2017 ; Nathanson, 2019). To adjust boat course and trimming parameters, sailors must constantly use their senses to analyse external signs (e.g., auditory, visual, etc.). Nevertheless, very little research has provided a detailed analysis of optimal and economical movement patterns during specific manoeuvres. However, the only available study (Pluijms et al., 2014) observing these performance parameters found that the timing of the release of trimming lines during the approach of a windward mark predicted windward mark rounding performance (i.e., time to complete and speed maintenance). In addition to manoeuvring tasks, sailors continuously pull or release trimming lines to control the shape of the sail (Davidson, 2009 ; Deparday et al., 2018) (Figure 46). These tasks require efficient movement control and motor skills. Moreover, Araujo et al. (2005) observed significant differences in mo-

tor skills between experienced sailors and less experienced ones. Hence, in offshore sailing, sailors must manage and maintain optimal movement control, despite the accumulation of fatigue, to optimise boat speed through trimming and manoeuvring efficacy.



Figure 46. Coordinating forward and backward grinding for line trimming. Pearson et al. (2006).

Current literature has identified that neuromuscular fatigue may affect muscle contraction timing (Rozand et al., 2015), coordination (Gorelick et al., 2003), the response time (Gates & Dingwell, 2008), alter reflexes (Gandevia, 2001), and force variability (Selen et al., 2007). At a localised level, fatigue has resulted in muscle imbalances between agonist and antagonist muscle groups (Alizzadehkhayat et al., 2007). Moreover, Todd et al. (2010) suggest that the central nervous system may not adapt to the altered relationships between neural output and force or sensory feedback due to fatigue. However, the deterioration due to the mechano-electrical transduction may impair a subject's ability to deliver proper motor commands to produce coordinated force vectors across different muscle groups (Aune et al., 2001). These findings are in line with those of Billaut et al. (2004). They highlighted that fatigue's activation and deactivation dynamics could modify muscle coordination in repeated bouts of intense efforts. Their results suggest that the central nervous system's inability to maintain optimal intra-muscular coordination may hold a preponderant reason for performance decrements. Furthermore, Cowley et al. (2014) suggest that both central and peripheral fatigue affect movement differently. At a peripheral level, fatigue led to a greater reorganisation of movement coordination in muscle activation patterns. At a central level, it seems that there may be less control over task-irrelevant elements of movement.

4.4.4 Postural control

Offshore sailing performance is linked to the sailor's ability to manoeuvre efficiently and uphold demanding onboard activity (Neville et al., 2009c ; Santos et al., 2016 ; Myers et al., 2017 ; Nathanson, 2019). Nevertheless, to realise these tasks, they are faced with constant proprioceptive tension to maintain postural balance on board (Blacha et al., 2019). Notably, the incessant yawing of the boat leads to constant postural control ad-

justments (Blacha et al., 2019). This constant stimulus accentuates the mechanical loading of hip flexors and extensors, eventually leading to neuromuscular fatigue. The onset of fatigue is, therefore, inevitable and can lead to performance decrements in terms of postural control deficiencies. On-deck tasks necessitate movement on a confined surface to stack, trim, fix and hoist sails and material. Moreover, sailors are also subject to these movements even when they are not engaging in physically demanding tasks.

Postural deficiencies have been linked to injuries and decreased task performance (Gribble & Hertel, 2004 ; Thedon et al., 2011). Hence, it is of great importance to understand the effects of prolonged exercise on unstable surfaces and its impact on postural control. Indeed, this understanding can provide insightful information for human performance practitioners when planning and programming interventions aiming to develop the sailor's capabilities to withstand the fatigue impairments on postural control. Investigating the effect of neuromuscular fatigue on postural control in athletes has been an interest for many researchers (Thiele et al., 2015 ; Troester & Duffield, 2019). Consequently, athletic and task performance simultaneously need musculoskeletal system integrity and well-developed postural control (Ohlendorf et al., 2020). Postural control is a complex function that involves keeping the vertical projection of the centre of gravity within the base of support (Paillard, 2012). It results from the integration of sensory information by the central nervous system to recruit muscles adequately (Horak, 2009). It has been widely documented that postural balance impairments may affect physical performance (Zemkova, 2014) and increase the risks for sports injuries, especially in the lower limbs (Paterno et al., 2010). Postural control involves marked changes in motor recruitment and rate coding to compensate and maintain standing balance for fatigue-induced strength loss (Maluf & Enoka, 2005). Moreover, the conduction velocity of afferent inputs undergoes a deceleration, which induces a decreased movement velocity of the motor output necessary for postural control (Enoka & Duchateau, 2008). These disturbances depend on the magnitude of physiological disturbances, mechanical constraints, and the subject's hydration status and can be impaired by visual, vestibular, and somatosensory system dysfunctions. However, neuromuscular fatigue has also been found to impair the muscle's mechanical properties (Bilodeau et al., 2001) and the proprioceptive system (Hiemstra et al., 2001), which is responsible for optimal postural control.

4.4.5 Sleep quality

Sleep stands out as an indispensable treatment for "post-exercise recovery" (Mamiya et al., 2021) and is necessary for life, physiological growth, and repair (Venter, 2014) (Figure 47). In sports, sleep is a crucial aspect of performance to consider and, in some sports, such as offshore sailing, has a crucial impact on overall performance. Indeed, the importance of sleep volume and quality has been well established in the literature concerning offshore sailing performance (Leger et al., 2007 ; Myers et al., 2008 ; Hurdiel et

al., 2013 ; Galvani et al., 2015 ; Filardi et al., 2020). To maintain adequate sailing performance, sailors adopt polyphasic sleeping techniques, which inevitably results in cognitive and alertness decreases (Hurdziel et al., 2014), physical alterations (Oldenburg et al., 2013), and psychological impairments (Carotenuto et al., 2012). Although sleeping strategies in offshore sailing have been widely studied, little research has analysed prolonged exercise's effects on sleep quality. Past research has observed delayed start and reduced volume of rapid eye movement sleep after prolonged exercise with elevated energy demands (Driver et al., 1994). Taylor et al. (1997) observed an increase in physical movements during sleep (+6%) in swimmers engaging in heavy training volumes, suggesting alterations to sleep quality. Moreover, the alterations in sleep quality during periods of prolonged and/or high-frequency training may be due to changes in immune function. Several aspects of innate and adaptive immunity (e.g., reduced neutrophil function, lymphocyte proliferation, and a number of circulating T cells) can be depressed following heavy WL (Walsh et al., 2011 ; Cadebiani & Kater, 2017). Such depressed immune systems have been shown to impair sleep quality (Imeri & Opp, 2009). However, the lack of research analysing the reciprocal relationship of cause and effect makes it difficult to determine the direction of the relationships between sleep, immune function, stress, and mood.

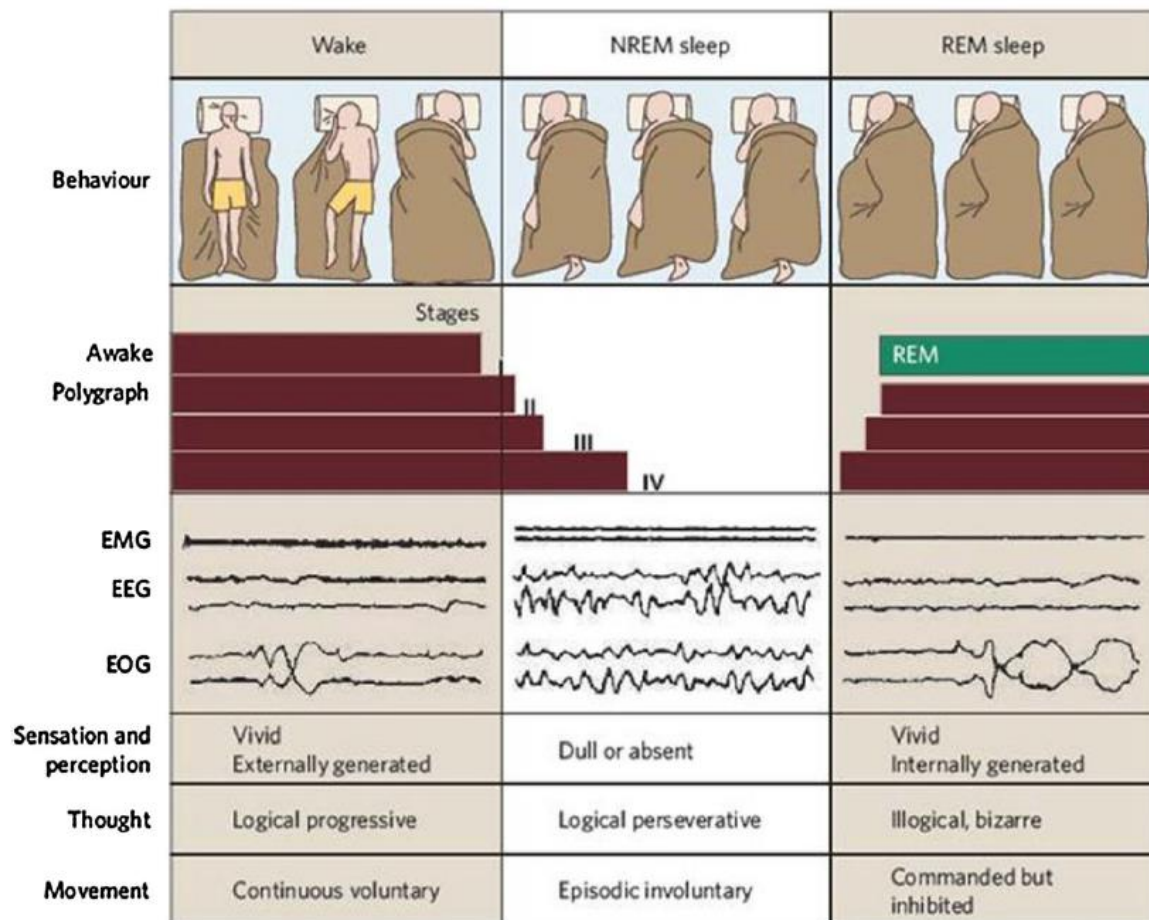

Figure 47. Behavioural states of humans and phase changes throughout the sleep wake cycle. Adapted from Hobson (2013). EEG: electroencephalogram; EMG: electromyogram; EOG: electrooculogram; NREM: non-rapid eye movement; REM: rapid eye movement.

4.4.6 Cognitive function

Offshore sailing confronts sailors with high levels of stress and high cognitive demands to optimise boat performance (Shepard, 1997). Thill (1983) stated that competition success is conditioned by the ability to assimilate the environmental variables and to carry out the most relevant action according to the existing conditions. However, offshore sailors are faced with variables that may impede their cognitive performance (Figure 48). For instance, ship motion has been correlated to cognitive performance in naval personnel at sea (Pisula et al., 2012), perturbations in circadian rhythm from sleep deprivation due to watch shifts (Hagin et al., 2012 ; Galvani et al., 2015) and prolonged exercise may affect cognitive processes (Lucas et al., 2009).

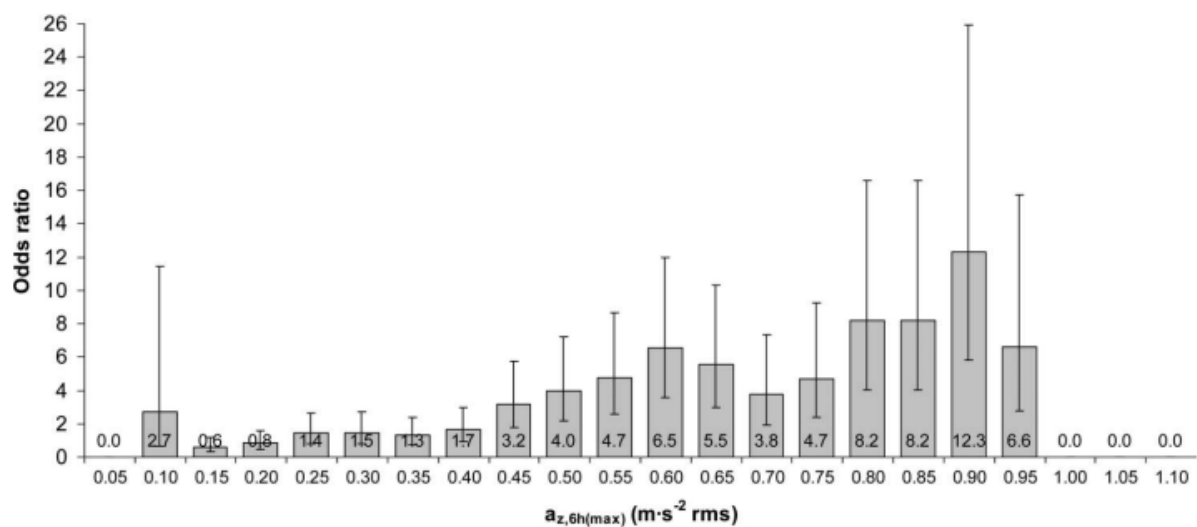

Figure 48. Odds ratios for likelihood of moderate to severe problems being reported for cognitive effects as a function of maximum 6-hour root mean square acceleration. According to Pisula et al. (2012).

There has been a limited number of investigations on the effects of concurrent exercise and sleep deprivation on cognitive performance. These few studies have reported conflicting observations (Reilly & Deykin, 1983 ; Scott et al., 2006 ; Lucas et al., 2009). For instance, Reilly and Deykin (1983) and Lucas et al. (2009) observed the positive arousing effect of exercise on sleep-deprived cognitive performance. On the other hand, Scott et al. (2006) indicated impairments resulting from PA's distracting influence. Impaired cognitive performance for both simple and choice reaction time tasks has been observed in sleep-deprived and prolonged exercise studies (Van Den Berg & Neely, 2006 ; Scott et al., 2006 ; Alhola & Polo-Kantola, 2007) (Figure 49). Moreover, circadian rhythms may also influence cognitive performance strategies (Blatter & Cajochen, 2007). Nevertheless, Dinges (1992) emphasised the importance of context on fatigued-state cognitive performance. This suggests that the greater the physiological sleepiness brought on by sleep loss, the more dependent the brain becomes on the local environment to maintain wakefulness and the more vulnerable it becomes to environmental

monotony. Motivation and incentive can contribute to, or override, this environmental effect, but for a limited time (Dinges, 1992).

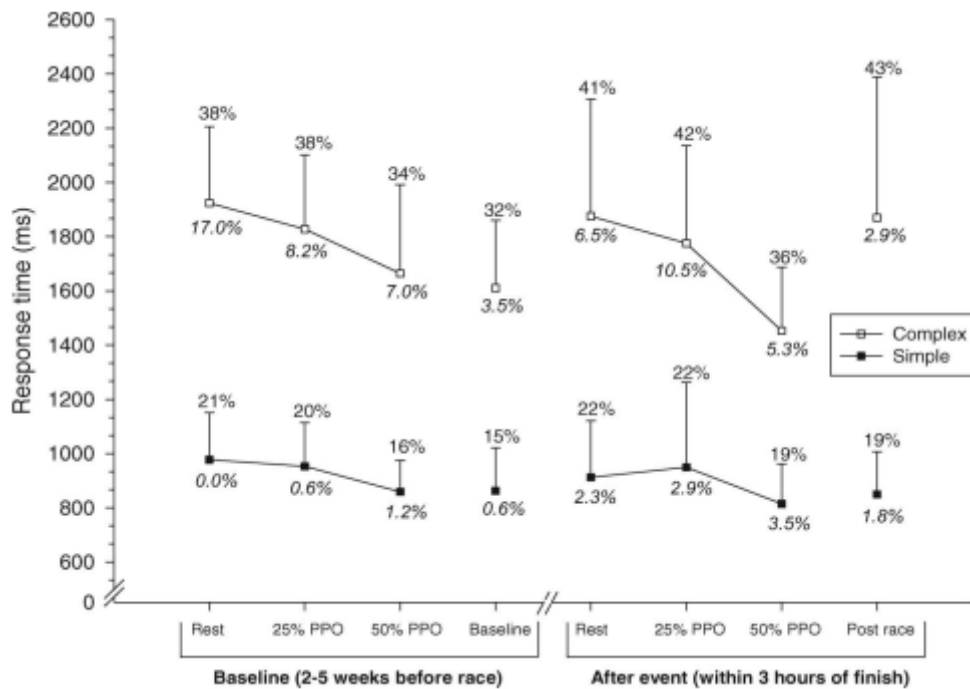

Figure 49. Response times for simple and complex level response times after 100 hours of exercise and sleep deprivation. According to Lucas et al. (2009).

Key Takeaways: Effects of prolonged activity

- ▶ Onboard activity depends of vessel, nature of regatta and crew size.
- ▶ Manoeuvres rely on anaerobic and aerobic power.
- ▶ Work to rest ratios depend on shift strategy implemented onboard.
- ▶ Energetic demands of offshore sailing are extremely high since sailors hold constant proprioceptive muscle tension to counter the swaying of the hull.
- ▶ Sleep strategy depends of the type of sailing and crew count but can easily be interrupted according to environment conditions.

4.5 Workload transmutation and realisation: recovery-adaptation

Recovery is an inter- and intra-individual multilevel (e.g., psychological, physiological, social) process in time for the re-establishment of performance abilities (Kellman & Kallus, 2001) (Figure 32B). It can be categorised in three terms: (i) immediate recovery between bouts of exertions, (ii) short-term recovery between repeats (e.g., interval bouts or resistance sets), and (iii) between training sessions (Bishop et al., 2008). In

Selye's GAS, during the latter part of the second stage, a marked improvement in resistance to stress is highlighted when an animal's organs return to near-normal conditions (Selye, 1946). Indeed, it must be recalled that the GAS was not initially built upon the imposition of sports-related WL but on toxins and other invasive stressors (Selye 1946). This enhanced resistance to the original stress consists of the concept that there is an increase in "adaptation energy." Harre and Barsch (1982) better described the idea of the recovery-adaptation principle: "The process of adaptation is the result of a correct interplay of work and recovery. By using up potentials of function and energy, the training session first releases a process of fatigue which temporarily lowers the functioning ability of the organism. **The decisive stimulus that releases the functional and morphological adaptation process occurs primarily during the recovery phase. From the biological viewpoint, this process not only renews the sources of spent energy (regeneration) but also regenerates beyond the initial level (overcompensation). Overcompensation is the basis for the improvement in function and performance.**"

4.5.1 Recovery time course

Residual fatigue is a factor that must be considered for the subsequent training session or competition due to the negative impact of incomplete recovery on performance, chronic fatigue, and injuries (Barnett, 2006). Although the mechanisms responsible for the alterations of muscular and neuromuscular function are well-identified after short- and long-duration exercise, the time course of these alterations is still poorly understood (Girard et al., 2015). The consensus is that recovery from "normal" training could take 24 to 72 hours (Kenta & Hassmen, 1998 ; Smith & Norris, 2000). This lack of knowledge may reside in the problematic issue of neuromuscular fatigue assessment (1 to 3 min after effort termination) of central and peripheral fatigue. However, significant recovery has been shown to occur within 1-2 min (Froyd et al., 2013) after high intensity or maximal contractions and more than 10 min after prolonged submaximal efforts (Taylor & Gandevia, 2008). Moreover, it is unclear if these effects are due to central sensitisation or continuing afferent activity (Taylor & Gandevia, 2008), and it is suggested that central feature disruptions may impact performance to a higher degree than muscle force (Gandevia, 1998). Furthermore, acute muscular fatigue at the peripheral level seems to recover relatively rapidly after WL cessation (Carroll et al., 2016). Blood flow, reversal of metabolic changes, and force recovery seem to return to normal within 5-10 min after effort (Bruton et al., 1998 ; Saltin et al., 1998). In contrast, repeated prolonged muscular contractions seem to provoke greater alterations in M-wave amplitudes (Jammes et al., 1997) and sarcolemma excitability (Piitulainen et al., 2008). Researchers have analysed the effects of WL on time course recovery through laboratory and functional performance assessments (Table 7). The use of laboratory equipment to

assess neuromuscular fatigue through high- and low-stimulated contractions has enabled the identification of impairments in the excitation-contraction-relaxation process. For instance, Edwards et al. (1997) observed that low-frequency contraction stimulation diminished to a greater extent than high-frequency stimulations in the hours and days preceding fatiguing WL. Along with studies measuring neuromuscular performance in a laboratory setting, researchers have applied the use of field tests to highlight functional performance impairments. Nevertheless, caution should be used when analysing such results as the relationship between neuromuscular and functional assessments is still lacking investigation. However, Raastad and Hallen (2000) observed similar patterns of change between CMJ performance and LFF after a bout of heavy resistance WL. Conversely, Petersen et al. (2007) observed decreased muscle power in CMJ without changes in muscle twitch characteristics following a marathon race, suggesting that peripheral fatigue was not responsible for functional performance decrements.

Again, fatigue is a complex process encompassing centrally regulated (subconscious) and cognitive (conscious) fatigue models. The interplay between these mechanisms has sparked controversial findings within the sports science community. Hence, understanding the onset and duration of fatigue mechanisms should not be reduced to a single isolated phenomenon (Perrey et al., 2010).

Table 7. Studies showing delayed recovery after acute fatiguing intervention using tests of functional performance and response to high- and low-frequency stimulation.

Fatiguing Task	Subjects	Measured Parameters	Pre-Post Decrease	Recovery time	Reference
60 mins box-stepping at a fixed rate of 20 steps/min.	Males (n=5)	Peak twitch torque Tetanic torque (20Hz) 20-50Hz ratio	25% 55% not re-reported	> 20 h > 20 h > 20 h	Davies and White (1981).
20 x 1 back squat 100% 1RM.	Strength athletes males (n=10) females (n=9)	MVC (males) MVC (females)	24% 21%	2-24 h 2-24 h	Hakkinen (1993).
10 x 10 back squats 70% 1RM.	Strength athletes males (n=10) females (n=9)	MVC (males) MVC (females)	47% 29%	48 h 24 h	Hakkinen (1994).
10 x 10 back squats 70% 1RM.	Healthy males (n=5) and females (n=3)	MVC CMJ height SJ height DJ height	~ 20% ~ 9% ~ 14% ~ 10%	4-7 days 3-4 days 3-4 days 3-4 days	Byrne and Eston (2002).
100 drop jumps performed continuously (5 bouts of 20 jumps with 10s between bouts).	Healthy untrained males (n=12)	MVC Tetanic torque (20Hz) Tetanic torque (50Hz) 20-50Hz ratio CMJ height	19% 50% 23% 37% 44%	> 24 h > 24 h > 24 h > 24 h > 24 h	Skurvydas et al. (2007).
Australian football match.	Professional ARF players (n=22)	CMJ flight time CMJ mean power	4% 9%	> 24 h > 24 h	Cormack et al. (2008).
Cycling at ~60% $\dot{V}O_2$ peak until fatigue repeated 3 days in a row.	Active, untrained students males (n=6) females (n=6)	MVC Tetanic torque (10Hz) Tetanic torque (100Hz)	13% 35-40% NS	>3 days >3 days >3 days	Stewart et al. (2008).
Plyometric exercise.	Healthy recreationally trained men (n=24)	MVC CMJ height SJ height	NS 8% 8%	NA 72-96h 72-96h	Chatzinikolaou et al. (2010).

Rugby league match.	Professional rugby league players (n=12)	CMJ height CMJ power	not reported not reported	4-48h 4-48h	McClean et al. (2010).
Ironman Triathlon.	Experienced, well trained triathlete (n=1)	MVC CMJ and SJ height	50% 50%	≤ 24 h ≤ 8 d	Nosaka et al. (2010).
Rugby league match.	Professional rugby league players (n=17)	CMJ peak force CMJ peak power CMJ PRFD	19% 30% 36%	< 24 h 24-48 h 24-48 h	McLellan et al. (2011).
High intensity strength training session.	Club standard rowers (n=8)	CMJ height SJ height	18% at 2h 10% at 2h	> 48 h > 48 h	Gee et al. (2011).
Repeated sprinting bouts (6 x 15m every 30s) for 2 bouts of 35 min.	Well trained athletes (n=9)	MVC M-Wave Amplitude Central activation ratio	~ 20% ~ 23% ~ 10%	> 24 h > 24 h > 24 h	Mynett et al. (2013).
3 x 5, 6 x 5 and 3 x 10 bench press and Squat protocols.	Highly resistance trained males (n=10)	CMJ height Movement velocity BP Movement velocity SQ 75% 1RM Squat 75% 1RM Bench Press	13-37% 1-13% 8-14% 5-15% 2-26%	6-24h 6-74h 48-72h 48h 48h	Moran Navarro et al. (2017).
10 km race.	Recreational street runner males (n=30)	Triple hop performance Extensor peak torque	4% 11%	>24h >24h	Dantas et al. (2019).
100 drop jumps, with hands on hips, from a box height of 0.4 m to 90-degree knee flexion, followed by an immediate maximal countermovement rebound, with a 20 s interval between jumps.	Healthy, physically active females (n=17)	Maximum isometric torque Tetanic torque (20Hz) Tetanic torque (100Hz)	33% 80% 43%	> 7 days > 7 days > 7 days	Kamandulis et al. (2019).
Cycling repeated sprints (10 x 10s with 30s recovery) at 20w and 60-70 RPM. During 2-days with 24 and 48h recovery between bouts.	Healthy males (n=10)	MVC Potentiated doublet (10Hz) Potentiated doublet (100Hz) M-Wave amplitude	12% NS 18% NS	24h NS 24h NS	Milioni et al. (2020).

1RM: one repetition maximum; BP: bench press; CMJ: counter movement jump; DJ: drop jump; MVC: maximal voluntary contraction; NS: non-significant; PRFD: peak rate of force development; SJ: squat jump; SQ: squat

4.5.2 Adjustments and adaptations

Changes in muscular strength are generally attributed to either neural or muscular factors (Lieber & Friden, 2000). Current studies have made it evident that adaptations can occur at all levels in the neuromuscular system and are underpinned by neural and/or morphological adaptations (Folland & Williams, 2007). These changes occur when the muscular system is mechanically or metabolically overloaded. The mechanisms result in specific and different adaptations that enhance performance (Pollock & Harridge, 2015). Moreover, the magnitude of these adaptations resides in the category of exercise, its duration, intensity, and frequency. Furthermore, Bouchard and Rankinen (2001) suggest that the degree of adaptation to a given WL may also reside in the athlete's initial fitness level and genetics. Fatiguing exercise induces central (Table 8) and peripheral adaptations (Table 9). The mechanisms of adaptation differ according to contraction mode.

Table 8. Workload adaptations at a muscular level.

Strength Training	Endurance Training
Increased muscular Cross sectional area (Aagard et al., 2001).	Enhanced capillarisation in type 1 and type 2 muscle fibres (Ingjer, 1979).
Hypertrophy at cellular level (Aagard et al., 2002).	Increased number and size of mitochondria (Granata et al., 2018).
Changes in muscle architecture (Mirzaev, 2017).	Increase oxidative phosphorylation efficiency (Balan et al., 2019).

Table 9. Neural adaptations to workload.

Strength Training	Endurance Training
Presynaptic inhibition (Weier et al., 2012).	Enhanced cortical plasticity (Tatemoto et al., 2019).
Decreased force threshold at which motor units are recruited (Van Cutsem et al., 1998).	Motor unit discharge rate decrease (Vila-Cha et al., 2010).
Increased central drive (Aagard et al., 2002).	Slower rate of decline in motor unit conduction velocity during sustained contractions (Vila-Cha et al., 2012).
Decreased co-activation of antagonist muscles (Hakkinen et al., 2003).	Decrease in motor unit recruitment threshold (Pollock & Harridge, 2015).
Increased motor unit synchronization (Pucci et al., 2006).	
Increased motor unit firing rate (Vila-Cha et al., 2010).	

It is well documented that chronic resistance training induces marked increases in muscle size and strength, both of which are secondary to a wide range of morphological adaptations (Folland & Williams, 2007). Indeed, resistance training induces performance-enhancing chronic morphological and neural adaptations (Enoka & Fuglevand, 2001). These positive adaptations, which result in an improvement of force, are believed to be due to changes in muscle activation patterns resulting in increased discharge rate or a number of motoneurons being recruited (Enoka, 2012 ; Krutki et al., 2015). These studies suggest that WL intensifies the neural drive and, in turn, increases force output. In contrast to fatigue-induced performance impairments, some mechanisms have been found to enhance the acute output of the neuromuscular system (McComas, 1997). While the indirect evidence for neural adaptations after strength training is convincing, the specific nature of those adaptations is elusive. Although fatigue is the most noticeable effect on muscular activity, muscular contractile activity can also improve perfor-

mance. Brief periods of activity have been found to increase the electrical and mechanical output above resting values (Blazevich & Babault, 2019). This mechanism, termed post-activation potentiation, has recently gained an increasing interest in sports science literature. At a physiological level, these acute adjustments affect a multitude of different factors. Monosynaptic responses, miniature endplate potentials, M-Waves, twitch force, and the discharge of muscle spindle receptors are examples of these enhanced capabilities (Hodgson et al., 2005 ; Rodriguez-Falces et al., 2014). Today, performance practitioners use these adaptations to instigate enhanced performance. Indeed, by manipulating evoked and voluntary contractions, afferent feedback from peripheral receptors to central neuromuscular centres during voluntary contractions may lead to a central inhibition of subsequent muscle performance (Froyd et al., 2016).

Key Takeaways: Recovery-adaptation

- ▶ The decisive stimulus that releases the functional and morphological adaptation process occurs primarily during the recovery phase.
- ▶ Understanding the onset and duration of fatigue mechanisms should not be reduced to a single isolated phenomenon.
- ▶ The mechanisms of adaptation differ according to contraction mode.
- ▶ Monosynaptic responses, miniature endplate potentials, M-Waves, twitch force, and the discharge of muscle spindle receptors are examples of these enhanced capabilities in response to training.

4.6 Workload transition/ exhaustion: detraining and overtraining

Although different in nature, detraining and overtraining occur when WLs are improperly managed (Figure 34C). These “situations” both lead to decrements in performance and enhanced risks of injury. However, both situations are preventable. Hence, it is crucial for performance practitioners to understand their aetiology and effects to adopt preventive strategies.

4.6.1 Detraining

Detraining is defined as the partial or complete loss of training-induced anatomical, physiological or performance adaptations because of training reduction or cessation (Mujika & Padilla, 2000). It is also known as the principle of reversibility, by which stopping or reducing WL induces a partial or complete reversal of past training adaptations (Hawley & Burke, 1998). These interruptions in an athlete’s systematic programme of

physical conditioning may occur because of illness, injury, postseason interruption, or other factors. Research has observed different quantitative and qualitative losses of training-induced adaptations related to the duration of insufficient training stimulus (Neufer, 1989). Hence, the effects of short-term (< 4 weeks) and long-term (> 4 weeks) detraining, as well as pre-accumulated WL, have different impacts on the magnitude of reversibility. Understanding the effects of detraining on an athlete's physiological adaptations is of great importance when working on WL management and implementing training strategies. Indeed, detraining has been found to impact cardiorespiratory, metabolic, muscular, and hormonal functions at different magnitudes. Regarding the cardiorespiratory function, Bosquet and Mujika (2012) observed decrements of 4-25% in endurance performance after 3 to 4 weeks of detraining. $\dot{V}O_{2max}$ seems to decrease quickly during training cessation (Christensen, 2011). For instance, $\dot{V}O_{2max}$ declined 7% during the first 21-days of inactivity and stabilised after 56-days 16% below the initial trained value in highly trained athletes (Coyle et al., 1984). $\dot{V}O_{2max}$ seems to decline proportionally to the trained state during 8 weeks of detraining and stabilises onwards (Drinkwater & Horvath, 1972). Drops of 7-25% in time to exhaustion have also been observed within 2 to 4 weeks of cessation (Fardy, 1969). Furthermore, Houmard et al. (1992) found no change in running economy at submaximal exercise intensities, suggesting that loss in cardiorespiratory system function is largely responsible for impaired performance in highly trained individuals. This is furtherly illustrated by an increased $\dot{V}O_2$ during submaximal exercise (Coyle et al., 1985). Endurance performance is, therefore, directly affected by either short-term or long-term detraining effects (Table 10).

Table 10. Short- and long-term effect of detraining on cardiovascular performance in highly trained individuals. Adapted from Mujika and Padilla (2000); Bosquet and Mujika (2012) ; Chang (2016).

Short term	Long Term
↓ Maximal O ₂ uptake	↓ Maximal O ₂ uptake
↓ Blood volume	↓ Blood volume
↓ Stroke volume during exercise	↓ Stroke volume
↓ Maximal Cardiac output	↓ Maximal Cardiac output
↓ Ventricular dimension/mass	↓ Ventricular dimension/mass
↓ Maximal ventilatory volume	↓ Maximal ventilatory volume
↓ O ₂ pulse	↓ O ₂ pulse
↑ Maximal HR	↑ Maximal HR
↑ Submaximal HR	↑ Submaximal HR
↑ Mean blood pressure	↑ Recovery HR
↑ Ventilatory equivalent	↑ Mean blood pressure
	↑ Ventilatory equivalent
↑ indicates increased; ↓ indicates decreased.	

Performance in strength and power tasks also suffers from detraining periods (Figure 50). Nevertheless, the impact of detraining seems to have less impact than it does on endurance performance. For instance, Hwang et al. (2017) observed that trained men retained strength and muscle mass during 2 weeks of detraining. However, although strength performance is generally retained up to 4 weeks of inactivity, it seems that sport-specific power may suffer more significant declines than non-sport-specific qualities (Tran et al., 2017). Furthermore, the rate at which strength declines may differ between contraction types. For instance, concentric strength has been reported to decline at a much higher rate than eccentric strength after 5 weeks of detraining (Sato et al., 2021). The magnitude of detraining is also influenced by the type of training that precedes the detraining period. Indeed, speed-strength seems better maintained if the previous WL were based on developing explosive strength (Hodikin, 1982). Moreover, neural adaptations are maintained if athletes implement eccentric-specific training in their training routines before WL cessation (Coratella & Schena, 2016). Hence, like endurance performance, muscular performance is also impacted at different magnitudes according to training cessation duration (Table 11).

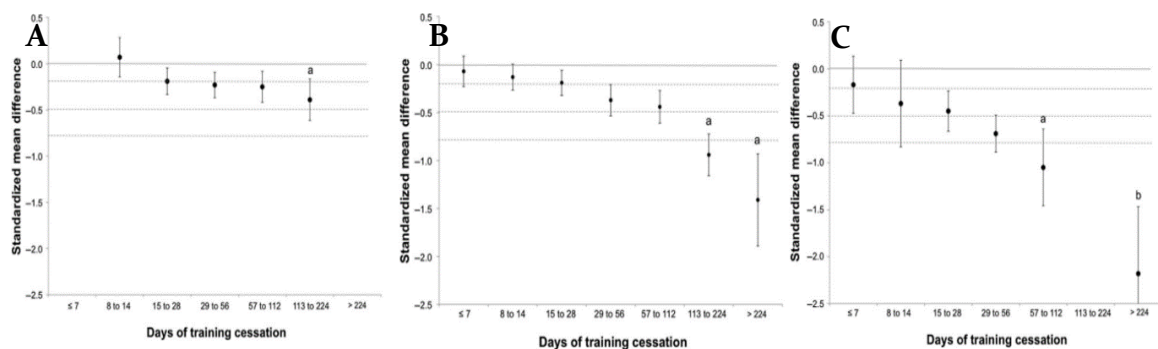

Figure 50. Dose-response curve for the effects of duration of training cessation on A) maximal power, B) maximal strength and C) submaximal strength. Adapted from Bosquet et al. (2013).

Table 11. Short- and long-term effect of detraining on muscular performance in highly trained individuals. Adapted from Mujika and Padilla (2001) ; Encarnacao et al. (2022).

Short term	Long Term
↓ Capillary density	↓ Capillary density
↓ Oxidative enzyme activity	↓ Arterial-venous oxygen difference
↓ Glycogen synthase activity	↓ Oxidative enzyme activity
↓ Mitochondrial ATP production	↓ Mean fibre cross-sectional area
↓ Mean fibre cross sectional area	↓ Fast twitch : slow twitch ratio
↓ EMG activity	↓ Muscle mass
↓ EMG activity	

EMG= electromyography; FT= fast twitch; ST= slow twitch; ↓ indicates decreased.

4.6.2 Overtraining

Overtraining is a term used to describe the condition of imbalance between accumulated WL-induced stress and inadequate recovery (Fry et al., 1991). This negative training state occurs when inadequate recovery is provided in response to WL (Kentta & Hassmen, 1998) (Figure 52). Accumulating immediate WL effects to “superimpose” existing ones impairs the recovery process for full restoration of homeostasis, which will lead to inadequate adaptations. This condition places a specific demand on the musculoskeletal system that may lead to injury (Kreher & Schwartz, 2012) and performance decrements (Mackinnon, 2000). To avoid maladaptation, continual and precise monitoring must be practiced observing individual responses to WL to assess the athlete’s current tolerance of stress or fatigue (Zhegari et al., 2019). According to Kellman et al. (2001), each athlete has a critical point or threshold where their reserve capacities cannot cope with accumulated fatigue. The magnitude and duration of symptoms have classified overtraining into three distinct levels (Figure 51):

- **Functional overreaching (FOR).** An accumulation of training and non-training stress resulting in a short-term decrement in performance capacity with or without related physiological and psychological signs and symptoms of overtraining in which restoration of performance capacity may take several days to several weeks (Dupuis et al., 2010 ; Bellenger et al., 2017).
- **Non-functional overreaching (NFOR).** Normal outcome for elite athletes (Halsen & Jeukendrup, 2004). It is, however, characterised by longer recovery periods to restore homeostasis. Indeed, performance decrements, severe psychological and physiological fatigue, including muscle soreness, overuse injuries, and increased perceived effort, may persist for months (Kajaia et al., 2021).
- **Overtraining syndrome (OTS).** Recognized as a persisting performance decrement that may take several weeks to months to restore and can seriously harm an athlete’s health (Meeuson et al., 2006). It is the end state of chronic NFOR.

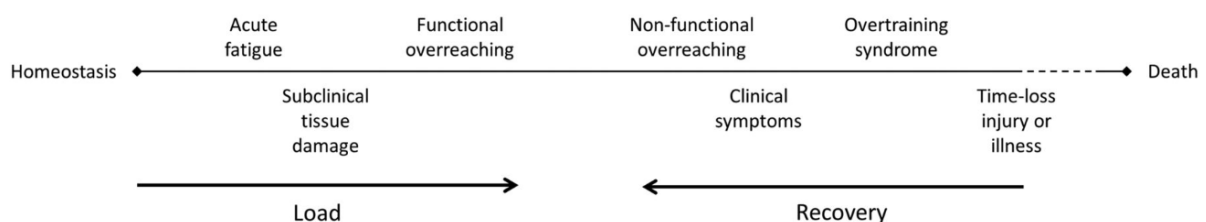

Figure 51. Well-being continuum. Adapted from Fry et al. (1991).

OTS has received a considerable amount of interest in current sports science literature. The common symptoms of OTS and NFOR, which have been linked to a range of sympathetic and parasympathetic symptoms (Armstrong et al., 2022), are presented in Table 12. The data surrounding physiological, biochemical, and immunological measures lead to equivocal information, which has even prompted OTS to be redefined

as unexplained underperformance syndrome (Lewis et al., 2018). The continuous nature and unclear turning point between positive and negative aspects of training and FOR make OTS difficult to diagnose (Stellingwerff, 2021).

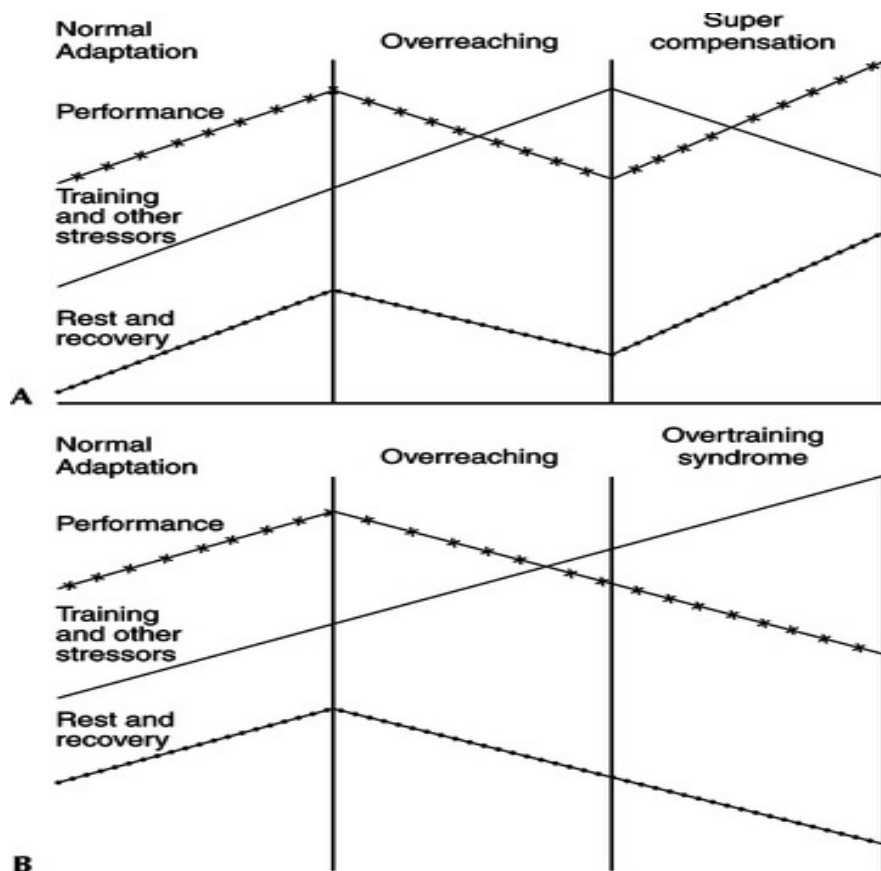

Figure 52. Exercise training adaptation (A) and maladaptation (B). Adapted from Fry et al. (1992).

Currently, the most effective and practical way of detecting overtraining is thought to be through psychological markers and/or direct performance measurements (Saw et al., 2016). Consequently, athletes suffering from OTS usually complain about heavy legs during moderate exercise and mood disturbances (Urhausen et al., 2002). The psychological pressure placed on professional athletes may also add to the stress of training and therefore increase the likelihood of OTS occurring (Kreider et al., 1998). Also, athletes may try to improve their declining performance by training even harder, inevitably slipping into an overtrained state (Derman et al., 1997). Furthermore, Meussen et al. (2013) suggest that OTS can be diagnosed if there are no signs of organic disease: endocrinological disorders, iron deficiency with anaemia, or infectious diseases.

Table 12. Signs and symptoms of sympathetic and parasympathetic forms of overtraining. Adapted from Stone et al. (1991) ; Armstrong et al. (2022) ; Carrard et al. (2022).

Sympathetic	Parasympathetic
↓ Decreased sports performance	↓ Sports performance
↓ Maximal blood lactate concentrations	↓ Resting HR
↓ Maximal power output	↓ Blood lactate concentrations during submaximal and maximal exercise
↓ Body weight	↓ Emotional behaviour
↓ Appetite	
↓ Desire to exercise	
↑ Resting HR	
↑ Resting blood pressure	
↑ Time to recover after exercise	
↑ Irritability and depression	
↑ Risk of injury	
↑ Incidence of infection	

↑ indicates increased; ↓ indicates decreased.

Key Takeaways: Overtraining and detraining

- ▶ Neural adaptations are maintained if athletes implement eccentric-specific training in their training routines before WL cessation.
- ▶ The rate at which strength declines may differ between contraction types.
- ▶ Currently, the most effective and practical way of detecting overtraining is thought to be through psychological markers and/or direct performance measurements.
- ▶ Each athlete has a critical point or threshold where their reserve capacities cannot cope with accumulated fatigue.
- ▶ To avoid maladaptation, continual and precise monitoring must be practiced observing individual responses to WL.

4.7 Workload quantification

WL quantification and evaluation of fatigue and readiness status can be provided using a wide panel of monitoring tools. Current technological advances have increased the amount of valid and reliable tools, such as external and internal WL measures (Impellizzeri et al., 2005 ; Wallace et al., 2014), training response markers including neuromuscular fatigue assessments, biomarkers, subjective questionnaires and performance tests. Extracting data using these tools can support a practitioner's decision regarding

planning and delivery of training interventions at an individual and team level to optimise readiness for competition. Moreover, in practice, the objective information provided by these assessments is often combined with the coach's experience to make decisions concerning the sequencing of WL interventions. For instance, performance practitioners often consider analysing previous training and/or competition data with their athletes' objective and subjective response to better tailor future training volume and content. **Alterations in an athlete's WL are usually achieved through the manipulation of training variables such as duration, intensity, and content of the metabolic and mechanical stimulus. Such modifications are made to minimise injury risk and optimise physiological and psychological recovery during the training and competition phases.**

4.7.1 External Workload

Wallace et al. (2009) defined external WL as the combination of training duration, intensity, and frequency. It is considered the work completed by the athlete independently of their internal stress (Bourdon et al., 2017). External WL is related to the physical demands of the motor requirements inherent to practice, which can be obtained through analysis of effort quantification. It is often measured as exposure time (total duration or time spent accomplishing specific tasks), speed, distance, movement volume, or movement intensity (Caparros et al., 2016 ; Campos-Vazques et al., 2017). With the evolution of wearable technology, current research has seen an exponential rise in interest. Advances in microtechnology, such as global positioning system (GPS) units, have permitted measuring a large variety of external WL variables (Halson, 2014). As a result, team sports have fully integrated microtechnology as a means of collecting and quantifying WL (Akenhead & Nassis, 2016). The common use of such means has led performance practitioners to integrate micro-electrical mechanical systems (MEMS), such as triaxial accelerometers, magnetometers, and gyroscopes. These technologies increase the quantity and quality of data being collected. However, the choice of variables used for analysis needs to be understood, reliable and valid to provide human performance stakeholders with insightful information. Time motion analysis (TMA) can be defined as the progressive changes in position and speed over time (Hamill & Knutzen, 1995). It refers to the frame-by-frame examination of an athlete during both training and competition by registering the recording of time and distance data, movement patterns, frequency, mean duration, and total time spent in a specific activity. It has been used as a non-invasive method for assessing external WL and exploring work-to-rest ratios in many sports. In addition, the results of TMA may increase the specificity of physical conditioning as they provide insight into the energy system utilisation and, in some cases, specific movement patterns used throughout a game (Ramseyer, 2019). Moreover, it has been shown to provide a valid means of quantifying activity profiles

(Deutsch et al., 2007). Most TMA methods rely on the use of video-based systems. However, the use of GPS to extract external WL data has gradually developed with the evolution of systems capable of analysing specific sporting events. Although once regarded as the most effective method for assessing the physiological demands placed on athletes (Bangsbo, 1994), the TMA process expresses several limitations. These include the time needed to complete analysis, defining different movement categories, parallax error and reliability issues (Dobson & Keogh, 2007), and underestimation of external WL due to the classification of static high-intensity actions (i.e., jumps, collisions) as being low-intensity actions (Gomez-Carmona et al., 2020).

4.7.1.1 Video-analysis

Video-based analysis has been considered the most economical and user-friendly method to provide TMA in team sports (Canovas-Lopez et al., 2014). In general, the strength of video analysis is that it allows for dynamic and complex situations in sports to be quantified in an objective, reliable and valid manner (McDonald et al., 2011).

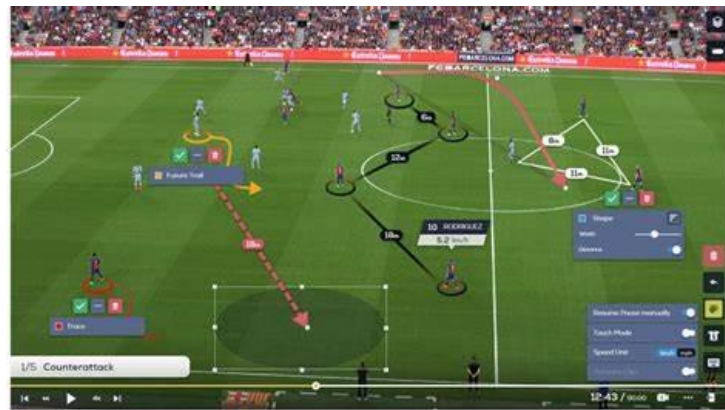

Figure 53. Illustration of video analysis for time motion analysis.

Performing TMA involves three distinct phases (Figure 53): (i) Establishing a set with the most common types of movements found in the sport, (ii) Providing a velocity range for each type of movement by means of velocity tests, and (iii) Filming the game and obtaining data to quantify movement frequency and duration, distance covered and specific movement speed.

Limitations. Much of the research concerning WL quantification through video analysis is that there is a lack of evidence surrounding the implementation into everyday practice by coaches and practitioners (Colomer et al., 2020). Video analysis also suffers from manually operated tracking and time-consuming assessment, resulting in delayed output (Asan & Montague, 2014). Furthermore, it seems that video analysis research lacks standardised filming techniques and has a tendency towards reductionism (MacKenzie & Cushion, 2013). Moreover, several studies (Jennings et al., 2010 ; Post et al., 2018) have indicated that the increased speed of the assessed athletes caused a decrease in intra-observer reliability.

4.7.1.2 Global positioning system

According to Castellano et al. (2011), a practical way of controlling training response for athletes is TMA by using GPS technology (Figure 54). The use of GPS technology for

sports performance has seen an exponential rise this last decade (Akenhead & Nassis, 2016). Indeed, the systematic and continuous assessment of data on competitive and training performance in elite sports has been fully integrated into performance pathways (Buchheit et al., 2014 ; Ravé et al., 2020). Furthermore, GPS tools and the evolution of frequency bands allow the collection of

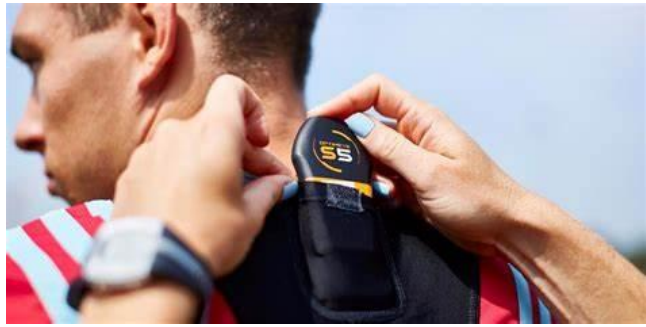

Figure 54. Illustration of GPS unit installation to monitor external WL.

large amounts of WL data free from recall bias and compliance. Correlations between ranges of GPS variables and internal WL factors and sports performance have been found in many sports (Bauer et al., 2015 ; Redvka et al., 2018) and have provided insightful information for bridging the gap between theoretical knowledge and practical application. For instance, Fernandez and Ezquerro (2005) observed tactical decisions based on optimist dinghy positioning on the water and identified the key performance indicators of decision-making during competition.

Limitations. While GPS technology can provide performance stakeholders with valuable information on the physical demands of training and competition, information on the technical and tactical performance of individual athletes or teams requires notational analysis from video footage (Gabbett, 2014). Using GPS data for predicting athletic performances remains challenging. Rawstorn et al. (2014) highlighted the accuracy of GPS units in measuring distances and average speed in linear courses but warned about the systems' efficiency at higher speeds and during non-linear courses. Furthermore, Cardinal and Varley (2017) suggested that, although there is an increasing number of wearable devices on the market, many have not been validated and may provoke erroneous analyses. However, large variations have been observed between different GPS units when comparing acceleration efforts (Buchheit et al., 2014). Hence, great caution should be made when making inferences from raw data.

4.7.1.3 Accelerometry

The development of technology in wearable accelerometers into tracking units may provide solutions for overcoming the limitations of TMA. Indeed, these systems have provided the opportunity to analyse new load parameters, such as the magnitude of three cardinal plane accelerations during specific sports movements, to calculate the external load of an overall performance (Boyd et al., 2013). Also, these trackers, being non-intrusive and wearable during a competition (Figure 55), provide a solution for quantifying external WL without requiring cameras. Furthermore, the reliability of accelerometers in the sports setting has been shown to have a coefficient of variation of <2% for both static and dynamic activity (Edgecomb & Norton, 2006 ; Boyd et al., 2011). Moreover, the validity of accumulated accelerometry-based WL has been compared

with other internal WL variables such as session rating of perceived exertion (sRPE) (Casamichana et al., 2013), muscle oxygen saturation (Gomez-Carmona et al., 2019) and $\dot{V}O_{2max}$ (Barrett et al., 2014).

Limitations. Although the use of accelerometry-based indexes to quantify WL has developed greatly, caution should be taken with respect to the sport being analysed. For instance, accelerometers do not provide information about static actions when an effort is performed without acceleration (Gomez-Carmona et al., 2020). Hence, accelerometry-based indexes should be incorporated with other external and internal WL indicators to optimally quantify WL data (Carey et al., 2017). Nevertheless, it seems that these systems may represent a valid and practical alternative to TMA and offer distinct advantages, such as the simplification of data analysis using either proprietary or defined algorithms that quantify movement (Ferioli et al., 2020).



Figure 55. Illustration of different accelerometry units available for WL quantification.

4.7.1.4 Work endurance recovery method

The work endurance recovery (WER) method was developed by Desgorces et al. (2007) to quantify WL during intermittent exercise and enhance its accuracy regarding more traditional methods such as training impulse (TRIMP) and sRPE. It aims to determine the level of exercise-induced physiological stress using the ratio of cumulated work (CW)/endurance limit (Endlim), which is associated with the work/recovery Napierian logarithm. WER assumes that external WL is directly linked to physiological stress by using the ratio between accumulated work and time to exhaustion. By using this method, the total time or repetition count of a given exercise indicates the maximal capacity of its metabolic response. The calculation of WL using WER is as follows:

$$WER = \frac{CW}{Endlim} + \ln \left(1 + \frac{DCW}{DCR} \right)$$

Total time (CW) is calculated for a given exercise session and is the sum of the work task completed at the required intensity. *Endlim* is the individual result recorded in the corresponding test session. *CW* and *Endlim* are expressed in the same unit: in minutes for endurance, seconds for sprints, and repetitions for strength. The duration of cumulated recovery periods (*DCR*) is calculated from the sum of the recovery periods occurring during the session and is expressed in seconds. The duration of cumulated work (*DCW*) is the sum of the total work tasks during the session (in seconds). *DCW* differs

from CW only in strength sessions, in which CW is expressed in repetition count. This method of quantifying WL has been tested in combat sports (Morales et al., 2016) and ball games (Belgith et al., 2012) and has been considered a highly appropriate method for quantifying intermittent exercise. Moreover, it allows the comparison of athletes' WL as well as appropriate exercise and programme design (Desgorces et al., 2007).

Limitations. Unwanted variations have been observed when using WER for WL quantification when intensity distribution was changed within the session (Hourcade et al., 2018). Moreover, it requires practitioners to establish the achievable endurance limit of each exercise session and align the structure according to assessment results (Desgorces et al., 2020). Indeed, *Endlim* appears to be modified after prolonged periods of significant WL changes and, thus, needs to be re-evaluated at different time points of a competitive season (Heubert et al., 2003).

4.7.1.5 Training Stress Score

Dr. Andrew Cogan introduced the training stress score (TSS) in his coaching platform (i.e., TrainingPeaks) to represent the duration and intensity of a single training session into one parameter. TSS is, as of today, one of the most widely used methods to measure WL in cycling (Van Dijk & Van Megen, 2017) and running (Coggan, 2003). Notably, recent technological development, such as pedal-mounted power meters, have made external WL parameters increasingly popular. In this method, a training session's duration and power data are interpolated with Functional Threshold Power (FTP), resulting in an estimation of the overall internal and external WL. Moreover, the intensity factor (IF) provides the ratio of normalised power to functional threshold power (FTP), which is used to pinpoint TSS. The formula used for calculating TSS in the cycling context is described as follows:

$$\text{TSS} = \frac{D * P_{norm} * IF}{FTP * 3600} * 100$$

TSS is calculated using the following formula, where *D* denotes exercise duration (in seconds), *P_{norm}* is the normalised power output, *IF* the intensity factor by which *P_{norm}* is divided by *FTP*. In the running environment, GPS watches have been able to provide data related to distance travelled and running speed to give a more detailed view of WL. Skiba (2008) adapted a calculation method of TSS to fit running WL:

$$\text{TSS}_{run} = \frac{s * NGP * IF}{FTP * 3600} * 100$$

Where *FTP* is the functional threshold power, *IF* the intensity factor, *NGP* the normalised graded pace and *s* the duration of the training session (in seconds).

Limitations. It is important to note that although the TSS formulas were created for external WL parameters, they currently lack substantial scientific validity. Indeed, few research have investigated the validity and reliability of this method; hence, caution should be used when inferring decisions based on TSS.

4.7.2 Internal workload

Physical training aims to induce optimal physiological and biomechanical response with minimal fatigue (Impellizzeri et al., 2019). This response corresponds to the internal load, which may be considered the athlete's ability to cope with the requirements of a specific stressor. Internal WL is defined as the physiological or subjective response to a given external WL (Halson, 2014). It is regarded as the relative psychophysical stress imposed and consequently determines the response to WL (Bourdon et al., 2017). Laboratory modalities for quantifying internal WL provide the gold standard for measuring physiological response to a physical stressor. Although these measurements provide practitioners with accurate data, they are often difficult to apply in training or competition settings. Several approaches have been used to analyse internal WL with HR, metabolic by-products (e.g., lactate), near-infrared spectroscopy, and RPE being highly popular in sports science literature.

Olympic and America's Cup sailing have received much research interest. Few studies have monitored the internal WL markers of sailors during offshore sailing. Indeed, sailing on a yawing and rolling vessel limits the use of wearable technology (Gros Lambert et al., 2008 ; Hagin et al., 2012). Moreover, the use of HR monitoring devices on moving platforms is a strenuous task and has thus received little interest. Some authors have had to calibrate HR with integrated accelerometry to validate such tools (Galvani et al., 2015). Furthermore, sailing-specific clothing and safety equipment combined with harsh weather conditions can lead to oil skin chafing and other skin conditions (Price et al., 2002), highlighting the complexity of data collection in racing situations. Among these rare studies, Portier et al. (2008) analysed the evolution of HR in 12 elite sailors during a 155-nautical-mile race lasting 33-hour (Table 13). These authors show that the studied sailors had higher HRs, ranging from 79.0-83.6 beats.min⁻¹, than those at rest ($p < 0.05$). However, the low HR recordings in the study may be explained by long periods of sailing without manoeuvres and by the fact that the subjects switched their sailing-specific functions during the race. Sailing includes many specific tasks attributed to different crew roles/positions (Blacha et al., 2019). Bernardi et al. (1990) studied the metabolic demands of a Bowman during 8-hours of offshore sailing. The Bowman's specific tasks (hoisting and hauling manoeuvres) raised the HR to a mean level of 120 beats.min⁻¹ (Figure 56). Maximal HR (HR_{max}) was found when a complete change of sails was ac-

completed ($180 \text{ beats}\cdot\text{min}^{-1}$). They also evaluated O_2 consumption ($\dot{V}\text{O}_2$) and pulmonary ventilation (\dot{V}_E) of the midshipman during repeated bouts of manoeuvres and found that $\dot{V}\text{O}_2$ increased by $1.3 \text{ l}\cdot\text{min}^{-1}$ and \dot{V}_E by $30 \text{ l}\cdot\text{min}^{-1}$ after 5 min of manoeuvring activity. However, this study's small number of subjects obliges us to consider this data cautiously. Near $\dot{V}\text{O}_{2\text{max}}$ has been reached on boats equipped with grinding pedestals (Bernardi et al., 2007) during manoeuvres (Figure 57). Grinding activity depends on boat configuration, but it seems to be categorised by its short duration and high intensity (10 s tacking and 20 s gybing).

HR frequency is not the only parameter to quantify an activity's internal load. Some researchers have analysed metabolic equivalents (MET) to determine the internal markers during competition. Galvani et al. (2015) evaluated eight professional sailors participating in the "500 nautical miles" double-handed offshore regatta. An incremental ramp Step Test was assigned to determine the relationship between HR and metabolic EE. They found that sailors spent most of their wake time (85%) in a sedentary and light PA zone ($p < 0.01$) compared to moderate and vigorous PA. An average of 2.6 ± 0.7 bouts of high-intensity work lasting at least 10-min were recorded. Indeed, most research has stressed that onboard manoeuvres relied on short bursts of PA, resulting in high anaerobic energy demands (Allen & De Jong, 2006 ; Bernardi et al., 2007 ; Neville et al., 2009a, 2009b, 2009c). Moreover, MET was observed to be much higher during crewed offshore sailing. Branth et al. (1996) found that sailors racing in crews never experienced any periods with basal (BMR) or sleeping metabolic rate. Nevertheless, these researchers state that the physical WL associated with shifting and trimming sails is intense but not frequent. Hence, many other factors may impact internal load. These factors may be linked to the continuous movement of the boat that calls for constant compensatory muscle activity to keep balance. Others may come from continuous psychological stress and irregular biological rhythms due to sleep deprivation.

Table 13. Heart rate of elite sailors during a 155 nautical mile race. According to Portier et al. (2008).

Periods (bpm)	CON	BCAA
Rest control	63.0 ± 4.2	64.9 ± 6.9
Period 1	$79.0 \pm 1.5^*$	$83.6 \pm 5.9^*$
Period 2	$75.5 \pm 2.5^*$	$72.0 \pm 2.1^*$
Period 3	$78.4 \pm 1.2^*$	$71.5 \pm 1.7^*$

CON control, BCAA BCAA and protein supplementation

Values are given \pm SEM

* Significantly different between rest period ($P < 0.05$)

Period 1: 9a.m.–7 p.m. D1; Period 2: 8 p.m.–6 a.m. D1–D2 and Period 3: 8 a.m.–6 p.m. D2

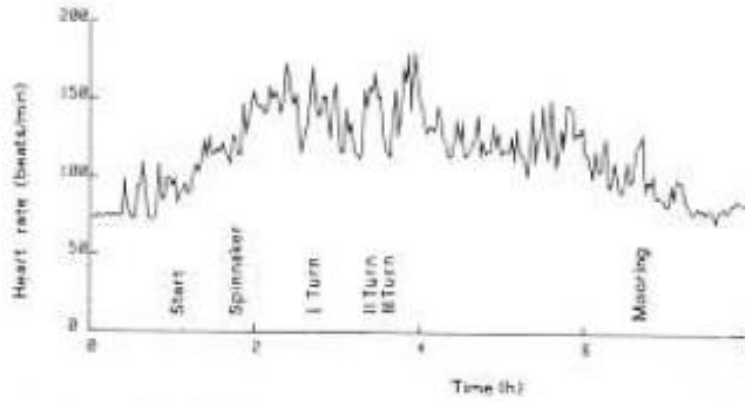

Figure 56. Heart rate during manoeuvres. According to Bernardi et al. (1990).

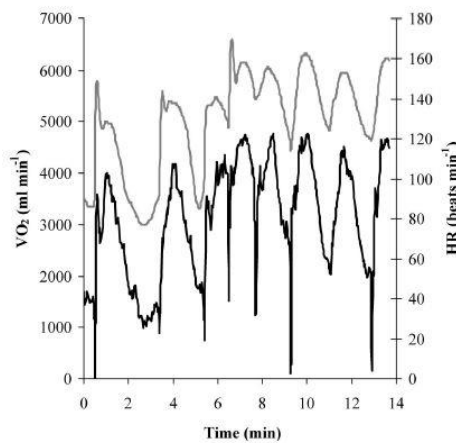

Figure 5. Oxygen uptake ($\dot{V}O_2$, black trace) and heart rate (HR, grey trace) during a series of gybes performed by a grinder (see text).

Figure 57. Oxygen consumption and Heart rate during racing. According to Bernardi et al. (1990).

4.7.2.1 Training impulse

TRIMP was first introduced by Banister et al. (1991) as a means of simplifying WL management and has since been one of the most frequently used methods for quantifying WL. The method is used for combining internal (HR parameters; Figure 58) and external WL parameters (training duration) into one single factor (arbitrary units). This method significantly simplifies WL quantification from a practical point of view. These authors propose to use the formula below to calculate WL:

$$\text{TRIMPS (AU)} = \text{session duration (minutes)} \times \% \text{HRR} \times Y$$

HRR represents $\text{HR}_{\text{max}} - \text{resting HR}$. Y is a weighing coefficient of $0.64e^{1.92x}$ for men and $0.86e^{1.67x}$ for women.

This formula can also be used by implementing external WL parameters only. Indeed, Busso et al. (1990) used percentages of a one-repetition maximum performance (1RM) and aerobic power to make TRIMP more applicable and accurate. Other researchers have worked on upgrading Banister et al.'s (1991) TRIMP model. For example, Lucia et al. (2003) based their measure of WL on analysing ventilatory thresholds (VT₁ and VT₂). In this method, three distinct zones are attributed to a pondering coefficient (Low <VT₁: coeff. 1; Moderate VT₁-VT₂: coeff. 2; High >VT₂: coeff. 3). This method has been widely used in the cycling environment as the studies were established during the Tour de France and Vuelta cycling competitions. Although this technique has been shown to relate well to continuous endurance performance (Amann et al., 2006), doubts can be instigated concerning the arbitrary attribution of training zones.



Figure 58. Illustration of a Heart rate monitor.

Edwards (1994) proposed an HR zone-based method for calculating WL. Each HR zone (5 zones based on 10% widths of HR_{max}) is assigned an arbitrary coefficient. The time spent in each zone is then multiplied by its coefficient and accumulated to give a total session score (AU). Although this method gained popularity as a precursor of HR quantification systems, it implies that physiological adaptations are related to a degree of difficulty. Also, the

Zone	% Maximal heart rate	Weighting	Training Type
5	93–100	5.16	Maximal training
4	86–92	3.61	OBLA training
3	79–85	2.54	Steady-state training
2	72–78	1.71	Lactate threshold training
1	65–71	1.25	Moderate activity

Figure 59. Weighting coefficients according to % of maximal heart rate; adapted from Stagno et al. (2007).

HR zones are predefined and exempt any metabolic or physiological performance thresholds. Nevertheless, Castagna et al. (2011) did find a dose-response relationship between time spent in the HR zone above 90% and changes in fitness. Stagno et al. (2007) proposed a modified version of this method to attempt WL quantification for a field team-based sport (i.e., field hockey). Instead of using a generic equation to reflect a hypothetical blood lactate profile, the authors used a weighting scale according to the team's mean blood lactate profiles. Therefore, five HR zones were computed (Figure 59) with coefficients established around an arbitrary metabolic coefficient. Although significant correlations were found between time spent in high-intensity activity with changes in $\dot{V}O_{2max}$ and OBLA, limitations of this model are to be accounted for. The model supposes that lactate parameters are arbitrary and not individualised (i.e., OBLA at 4 mmol.L⁻¹ and lactate threshold at 1.5 mmol.L⁻¹). Also, it seems that the researchers overlooked the lactate response in intermittent sports. Indeed, past research has high-

lighted that $\dot{V}O_2$ during intermittent sports differs from continuous sports at a high intensity (Bangsbo, 1994). Therefore, this may alter the weightings in intermittent sports (Akubat et al., 2011). As of today, many other researchers have aimed at adapting Banister's TRIMP method to specific sports by integrating the specific needs related to performance. For instance, Tran et al. (2012) developed the T2 minute method to quantify rowing WL from varied training sessions. On the other hand, Manzi et al. (2009) worked on individualising the TRIMP method and found linear associations with changes in the aerobic performance of recreational distance runners.

Limitations. One of the main limitations of TRIMP resides in its inability to quantify endurance and strength training as one. Busso et al. (1990) replaced HR parameters by the percentage of one repetition maximum (% 1RM) and training duration by repetition count. However, this method did not provide enough accuracy to be used as a resistance training WL method. Moreover, although HR has been used and researched extensively within the scientific database, it should be stressed that training practice has shown little usefulness in strength training, interval training, and training in irregular environments (Achten & Jeukendrup, 2003). Indeed, one of the main limitations of HR monitoring seems to be the low sensitivity of HR response to some exercise features. Analysts have observed 3-7% alterations in HR_{max} with aerobic training and detraining (Zavorsky et al., 2000). Furthermore, HR depends on many factors related to emotional state, the magnitude of rest, hydration status, and environmental conditions (Carter et al., 2005 ; Broman et al., 2021).

4.7.2.2 Near-infrared spectroscopy

Recently, near-infrared spectroscopy (NIRS) devices have been used to provide an objective measure of internal WL (Figure 6o). NIRS measures myoglobin O_2 saturation in muscle cytoplasm and haemoglobin in blood vessels of muscle microcirculation (Perrey & Ferrari, 2018). Measuring O_2 saturation in muscles provides a real-time indicator of local muscle O_2 and O_2 utilisation during WL. It may provide a robust method to track rapid changes in muscle activation and its metabolic status in the applied context, as well as detailed information on training potential by discerning upper and lower body muscle participation (Perrey, 2022). According to many researchers, NIRS represents a simple and safe way to evaluate exercise capacity during maximal contractions (Cettolo et al., 2007) and to determine the training zones utilised during training (Crum et al., 2017) and competition (Paquette et al., 2018). For instance, Klusiewicz et al. (2021) observed a significant increase in lactate in relation to muscle O_2 saturation decrease. Hence, the use of NIRS may be a valuable



Figure 6o. Illustration of a NIRS device.

tool to measure maximal lactate steady state by optimising time/cost efficiency without using invasive measuring devices. NIRS devices also allow for the measurements in the applied settings, as evidenced for a while in various challenging and extreme sports (Paquette et al., 2018, 2020). Hence, NIRS has the possibility to be used to assess exercise training-induced adaptations following specific training protocols (Jones et al., 2013).

Limitations. While NIRS can bring interesting information necessary for highlighting internal WL and limiting factors of metabolic performance, information concerning the validity and reliability of muscle O₂ saturation for quantifying WL is scarce. Furthermore, limitations concerning measuring devices are also visible due to (i) interference with adipose tissue thickness, (ii) unknown contribution of myoglobin to the muscle NIRS signal, and (iii) simultaneous changes in flow and volume (Ferrari et al., 2004).

4.7.2.3 Rate of perceived exertion

The extensive availability and use of technology to measure WL has increased the complexity and cost of using such methods. According to Foster et al. (2017), adopting simplicity when monitoring WL may be the most crucial element for optimal efficiency. The use of sRPE is considered easy, non-invasive, valid, and reliable for the coaching staff to assess daily WL on athletes (Wallace et al., 2009 ; Mujika, 2017 ; Foster et al., 2021). It has been used and validated in resistance training (Neto et al., 2020), endurance training (Garcin et al., 1998), and team sports (Clarke et al., 2013). Moreover, this method has been found to be significantly correlated ($r=0.41$ to 0.97 ; $p<0.05$) to other objective measures of WL. The sRPE method uses the combination of an objective WL parameter (i.e., time) with a subjective one (i.e., rate of perceived exertion). The athlete is asked to rate the difficulty of the training session 30 min prior to training using the Borg scale (Figure 61). This calculation results in a WL index calculated in arbitrary units (AU) (Haddad et al., 2017). Moreover, the sRPE method seems to hold valid agreement, in terms of perceived difficulty, between athletes and coaches during physical, technical, and tactical training sessions (Redvka et al., 2017). The sRPE method has also gained popularity because of its qualities as a WL management tool. By collecting and recording data, practitioners can analyse daily, weekly, and monthly WL to make inferences about recovery and fitness preparedness. WL strain (WL_{str}) and WL monotony (WL_{mon}) have gained popularity in such practice for their ability to indicate the need for recovery in a micro-cycle (Nobari et al., 2021, 2022a, 2022b). WL_{mon} is a measure of day-to-day training variability and has been found to be related to overtraining when monotonous training is combined with high weekly WL (Foster, 1998). WL_{mon} is calculated as the mean of the WL during 7-days divided by its standard deviation. WL_{str} has been found to be advantageous for indicating fatigue, as recovery only becomes fundamental to training when a high weekly WL is undertaken (Putlur et al., 2004). WL_{str} is calculated as the weekly WL multiplied by WL_{mon}. Recently, the sRPE method has been subject to modifications of quantification in the quest to optimise the relevance of the information being made available to performance staff. LosArcos et al. (2014) propose an alternative

and suggest changing from global quantification to more specific exertion ratings (i.e., metabolic stress, mechanical stress). The rating of mechanical stress can also be specific to the upper and lower body. Furthermore, Weston et al. (2015) have considered integrating sRPE into cognitive and technical dimensions. Hence, the score of training sessions depends on their origin and aims. For instance, McLaren et al. (2016) show that the perception of effort linked to metabolic stress and lower body resistance training was significantly higher during conditioning sessions. Furthermore, technical training sessions had more impact on the cognitive perception of effort.

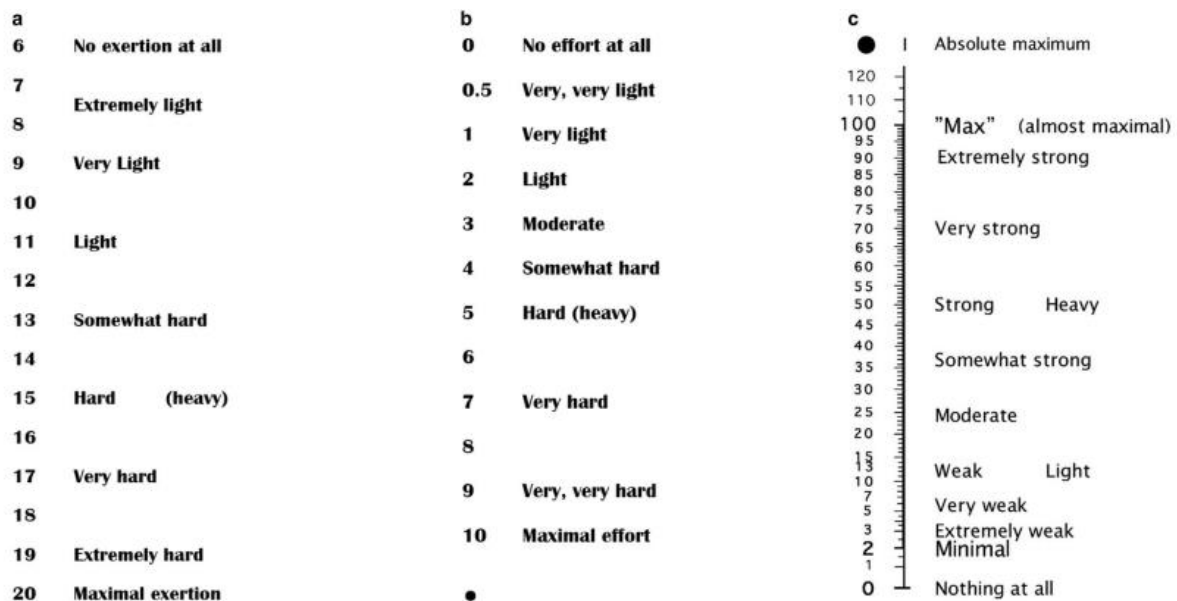

Figure 61. Examples of psychophysical scales used to monitor perception of effort. a) Borg rating scale, b) modified 10 scale version of RPE and c) 100 scale version. Adapted from Borg (1982) ; Borg (2007) ; Morree et al. (2012).

Limitations. sRPE provides a quick and accessible means to calculate WL and is available to all athletes and performance coaches regardless of competition level (Turner et al., 2015). Although practical, limitations to subjective WL quantification should be acknowledged (Haddad et al., 2017). For instance, the variation in HR-based models could only be explained by 50% of the sRPE score, adding to the debate concerning sRPE's validity as an exercise intensity measure (Foster et al., 2001). Although sRPE may give a better representation of the overall load on the athlete than other models, it should not be interpreted as a representation of physiological or biomechanical load (Coyne et al., 2018). However, if other factors are of paramount importance for WL monitoring, then sRPE may be less relevant. Moreover, using the common 10-point scale (CR₁₀) may reduce the sensitivity to account for the range of biomechanical and physiological exertion during training (McLaren et al., 2018). Furthermore, athletes may not answer honestly if they are being evaluated for selection or looking to modify future training sessions (Coyne et al., 2018). Hence, educating the athlete on why giving accurate responses is vital for optimal performance is essential.

4.7.3 Predicting injury and performance

The multifaceted nature of sporting performance requires athletes to employ a variety of training methods. It seems that the interactions between different training methods are poorly understood (Coyle, 1995). Researchers have been attempting to understand better the process for optimising and periodising training by developing systems modelling constructs (Taha & Thomas, 2003). For instance, Banister et al. (1975) and Windt and Gabbett (2016) proposed a simple model to explain the training response to a given WL and the resultant impact on performance and injury prediction. They suggested that performance at any given time point is determined by two main components: a fitness response and a fatigue response (Figures 62 and 63). Indeed, it is thought that quantifying the positive and negative effects of training and competition will allow WL dose-response and subsequent adaptations to be examined (Hayes & Quinn, 2009).

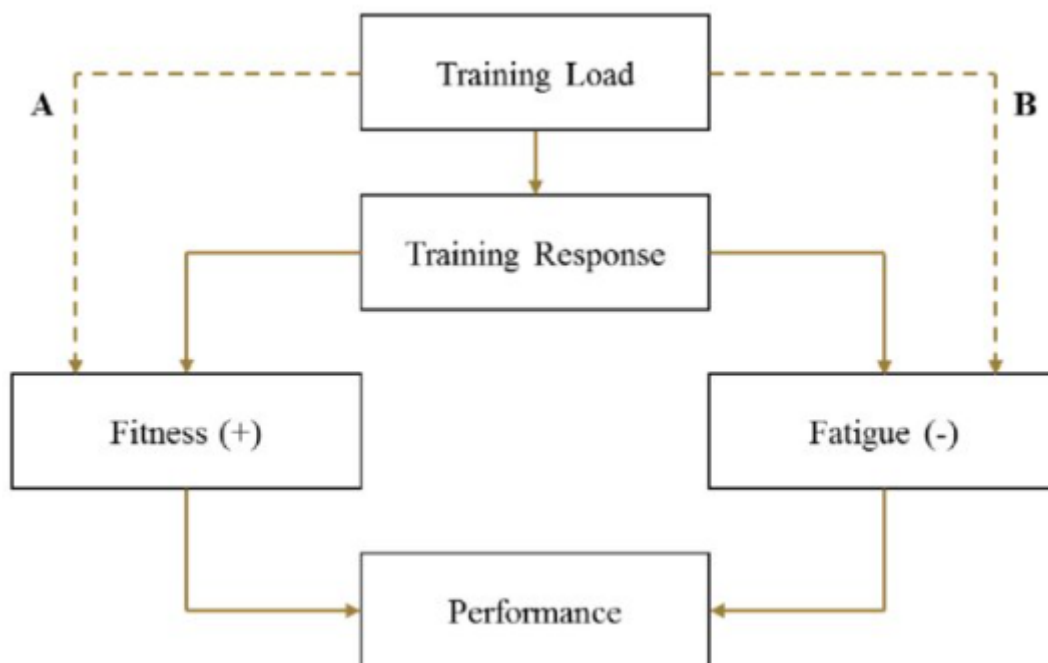

Figure 62. Conceptual model of the dose-response relationship. Adapted from Banister et al. (1975).

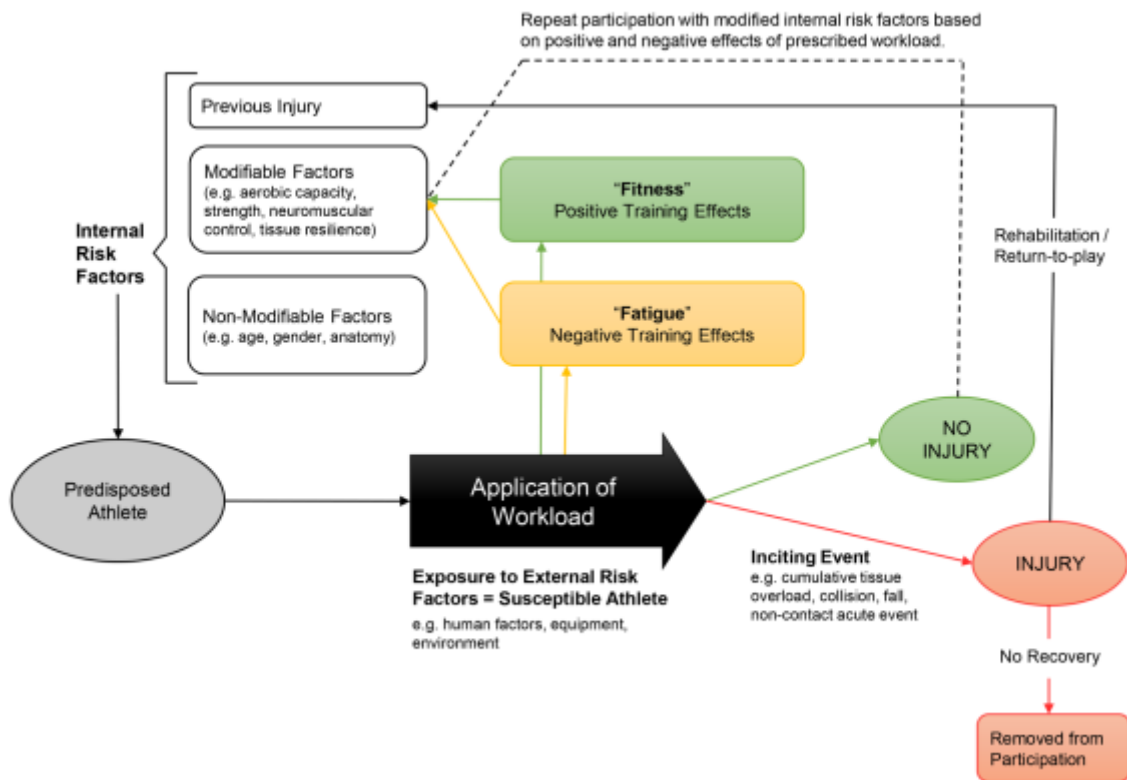

Figure 63. Conceptual model of the workload-injury relationship. Adapted from Windt and Gabbett (2016).

Physical training is widely regarded as a primordial element of an athlete's competition preparation. However, increased and uncontrolled WL is associated with increased injury risk and underperformance (Finch & Owen, 2001). Numerous studies have investigated the association between WL and injury risk (Gabbett, 2016 ; Jones et al., 2017 ; Damsted et al., 2018). Indeed, injuries occur when athletes perform more activity than their bodies can withstand (Wang et al., 2020). To minimise injury risk and optimise performance outcomes, athletes and coaches need to determine WL thresholds. To do so, the International Olympic Committee has recommended using the acute-to-chronic (acute:chronic) ratio (ACWR) to monitor WL and give insights into WL management for performance practitioners (Soligard et al., 2016). The ACWR has received a growing interest in recent years to monitor WL during competition and training. It is an index of training stress an athlete experiences relative to their fitness accumulated through chronic exposure to WL (Hulin et al., 2015). It is based on the fitness-fatigue theory of the body's response to WL (Zatsiorsky & Kraemer, 2003) and was developed to assist coaches in WL management. The ACWR can be calculated using two models: the rolling average model (ACWR_{RA}) and the exponentially weighted moving average model (ACWR_{EWMA}).

- The ACWR_{RA} is calculated by dividing the current WL (i.e., acute 7-days) by the past WL (i.e., chronic 28-days) (Hulin et al., 2014).

- The $ACWR_{EWMA}$ determines ACWR by implementing a decreasing weighting for each past WL value to give importance to the most recent WL (Williams et al., 2017):

$$ACWR(EWMA) = WL \times \lambda_a + ((1 - \lambda_a) \times EWMA(\text{yesterday}))$$

Where λ_a is a value between 0 and 1 that represents the degree of decay, with higher values discounting older observations in the model at faster rate. The λ_a is calculated as:

$$\lambda_a = 2 / (N + 1)$$

Where N is the chosen time decay constant, with a 1-week WL (7-days) and 4-weeks WL (28-days) used to represent acute and chronic WL, respectively. To date, many studies have explored the relationship between WL and injury occurrence in athletes using both ACWR models. For instance, Gabett (2016) identified reduced- and increased-injury zones based on the monitoring of WL (Figure 64). This model was currently validated through data from rugby league, cricket, and Australian football studies (Hulin et al., 2016 ; Blanch & Gabbett, 2015). However, findings from these studies are controversial as some found positive associations between ACWR and injury rate (Colby et al., 2017 ; Murray et al., 2017), while others did not seem to provide any reliability to the ACWR model (Fanchini et al., 2018 ; Impellizzeri et al., 2020a). Indeed, there seem to be limitations to the proposed model of ACWR. Wang et al. (2020) investigated the literature around the ACWR and provided a summary of the observed limitations:

- The ACWR is a measure of the proportion of activity rather than the change.
- It uses unweighted averages to calculate WL.
- The ACWR does not account for tapering before competition.
- It is a continuous measure that has been discretised.
- Established ACWR model is based on sparse data.
- Increased injury risk at low ACWR is expected due to bias.
- It does not address unmeasured confounding.
- It is difficult applying the model to subsequent injuries.

Most researchers agree that the ACWR can act as a useful and practical tool to monitor WL throughout a season. Moreover, researchers have outlined that the $ACWR_{EWMA}$ may be a more useful tool for interpreting an athlete's risk of injury than the $ACWR_{RA}$ (Foster et al., 2018). These researchers suggest using this model with wellness scores and sRPE WL to optimise the analysis compared to only using absolute WL values. Nevertheless, new systems must be explored to prevent bias in the ACWR for injured athletes and to apply the model for recurrent injuries (Wang et al., 2012). Future research should also address the methodological limitations identified before providing definitive inferences concerning the ACWR models (Andrade et al., 2020).

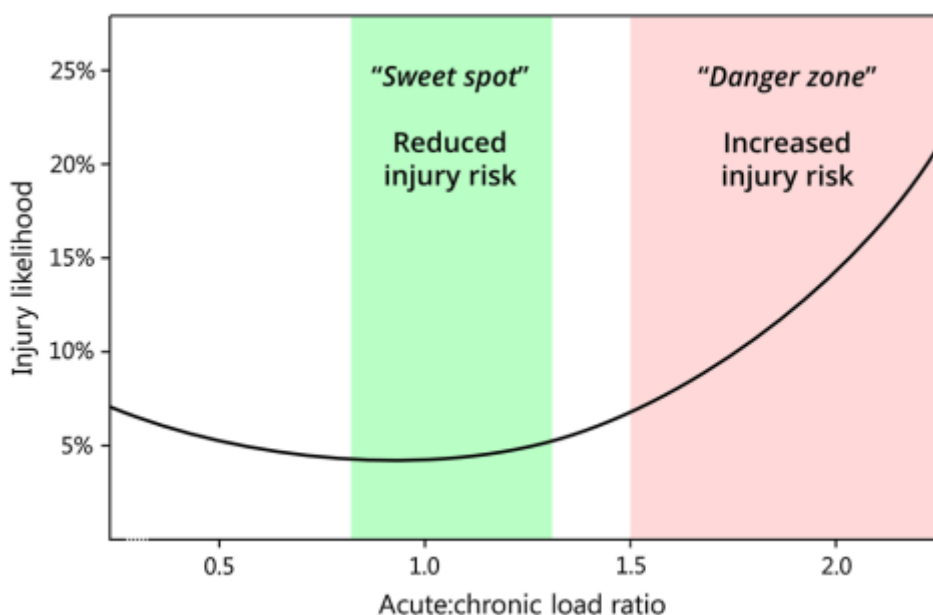

Figure 64. Acute: chronic load ratio. Adapted from Gabbett (2016).

Key Takeaways: Workload quantification

- ▶ Poor load and fatigue management and insufficient recovery strategies may lead to suboptimal or maladaptation, immunosuppression, injury, or overtraining.
- ▶ Alterations in an athlete's WL are usually achieved through the manipulation of training variables such as duration, intensity, and content of the metabolic and mechanical stimulus.
- ▶ ACWR can act as a useful and practical tool to monitor WL throughout a season.
- ▶ It is thought that quantifying the positive and negative effects of training and competition will allow WL dose-response and subsequent adaptations to be examined.

4.8 Monitoring fatigue-recovery: application to offshore sailing

Monitoring the adaptations and the fatigue is necessary to determine an athlete's dose response to WL (Halson, 2014). By doing so, information concerning the athlete's adaptations to training and readiness to compete will be made available to the coach. Measuring fluctuations in the performance capacities of offshore sailors would be ideal through the implementation of maximal performance tests during regattas. However, a multitude of difficulties is associated with this approach. Indeed, repeated maximal performance efforts are likely to contribute to a fatiguing effect that is impractical during the preparation of competition. Furthermore, identifying a maximal performance assessment for offshore sailing is challenging. **Currently, a plethora of physiological,**

biochemical, psychological, and performance markers are made available to assist in informing the coaching staff of the athlete's current state of fatigue and recovery.

4.8.1 Neuromuscular markers

Monitoring the activity-recovery relationship not only provides information regarding the optimal recovery of athletes (Crowther et al., 2017) but can also indicate the session's volume and intensity to reduce athlete burnout and injury risk because of insufficient neuromuscular control. Due to the constant instability of the maritime environment, neuromuscular activity is significantly impacted (Pisula et al., 2012). Indeed, compensatory strategies may develop while at sea to reduce muscle tension and enhance muscle balance on a swaying deck, which inevitably leads to modifications in post-sailing dryland neuromuscular function (Riccio & Stoffregen, 1991 ; Stoffregen & Smart, 1998). Moreover, the physically demanding tasks for a prolonged time and severe sleep deprivation will certainly provoke a high level of neuromuscular fatigue. However, little insight is made available concerning assessments to monitor the neuromuscular status of offshore sailors. Monitoring neuromuscular fatigue in a sport-specific activity has been suggested as the most optimal method for evaluating neuromuscular function status (Bishop et al., 2008) (Figure 65). Indeed, modified neuromuscular function tests have been implemented due to the impractical nature of stimulating sports activity (Gathercole et al., 2015). For instance, the vertical jump assessment is a convenient model to evaluate the neuromuscular function and has been used in many studies investigating prolonged exercise's impact on neuromuscular fatigue (Avela et al., 1999 ; Kuitunen et al., 2002, 2004 ; Petersen et al., 2007). The iso-inertial stretch-shortening cycle action found in CMJ and SJ has been suggested to be a suitable tool for monitoring long-lasting LFF caused by E-C coupling impairments after fatiguing activity (Fowles, 2006). Moreover, current research suggests that the underlying mechanisms of fatigue are task-specific (Cairns et al., 2005). Maximal strength assessments have also been observed in such studies. Notably, maximal dynamic strength may be an important performance indicator, and as such, has been observed during 40 weeks of long-distance running training (Beattie et al., 2016). Similarly, statistically significant changes in 1RM squat and bench press have been observed in military personnel during 8 weeks of tactical training (Vantarakis et al., 2020). Furthermore, the objective measure of MVC (voluntary or evoked) through laboratory assessments has been widely used to determine



Figure 65. Isokinetic flexion of the knee. Adapted from Wilcock et al. (2008).

the origin of fatigue after prolonged exercise (central vs. peripheral). Research has, however, shown a poor relationship between fatigue-induced changes in isometric strength and strength during dynamic contractions (Akagi et al., 2020). To date, novel assessment methods replicating sport-specific tasks have been developed as alternatives to bridge the gap with sport-specific demands (Garrett, 2018).

4.8.2 Heart rate

Research concerning the evaluation of HR variables to monitor WL stress is rather scarce in sailing. Ghiani et al. (2018) found no significant alteration between pre- and post-solo globe sailing maximal- and submaximal HR. However, the post-testing intervention occurred 10-days after arrival, which allowed significant time for recovery. Galvani et al. (2015) used HR variables to determine the EE during a 500-mile double-handed offshore race. Moreover, Portier et al. (2008) analysed HR variation during a 33-hour offshore race and found that sailors never returned to resting HR once onboard. However, these studies give little information on how HR variables may be used to analyse offshore sailing-induced fatigue. Hence the use of HR monitoring in offshore sailing seems to be a field of opportunity. HR has been used extensively in sports requiring prolonged activity (O'Toole et al., 1998). Variables, such as altered HRV, have been observed during the negative impact of WL on the autonomic nervous system (Bosquet et al., 2008). Research has supported the use of HRV as an objective physiological indicator of stress and recovery to variations in WL among athletes during prolonged exercise (Aubert et al., 2003 ; Iellamo et al., 2004 ; Parrado et al., 2010) (Figure 66). RHR also seems to indicate an increased sympathetic tone resulting from overreaching (Kuipers & Keizer, 1988). Furthermore, HR monitoring using the HR interval monitoring system is a valid and reliable marker for assessing accumulated physiological stress (Lamberts et al., 2011). These variables have received high interest in many prolonged activity sports and may provide insights about human performance measures in offshore sailing.

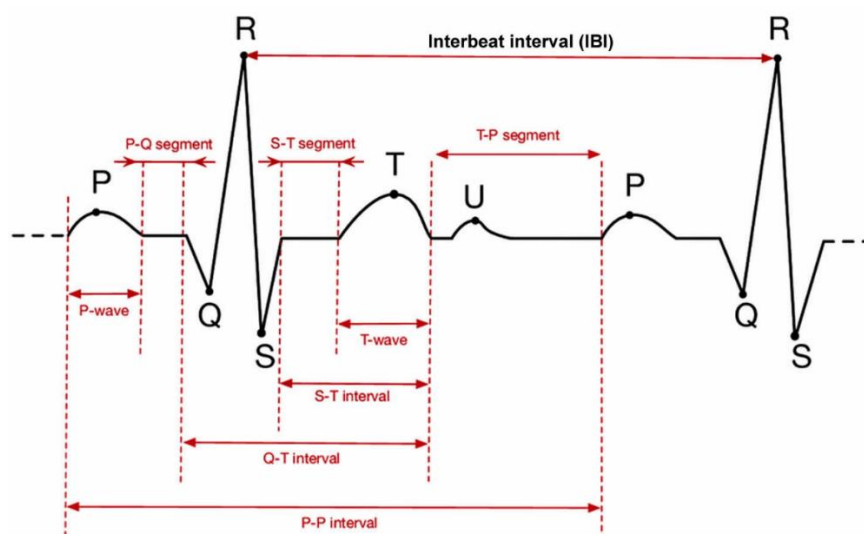

Figure 66. A typical electrocardiogram with a R-R interval trace. Adapted from Young and Benton (2018).

4.8.3 Biomarkers

Biomarkers have been used extensively as an objective measure used to assess and measure performance and progress in training and for identifying overtraining (Palacios et al., 2015). These biomarkers are collected and measured in blood, urine, and saliva. WL elicits a range of acute and chronic neuroendocrine responses that may highlight the magnitude of recovery or fatigue experienced by an athlete (Gunnarson et al., 2004). Using novel technology with intrinsic data, such as biochemical and haematological data, can be powerful in identifying the balance between training and recovery in everyone (Lee et al., 2017). While the acute neuroendocrine response to acute WL is generally well documented, the data on these hormonal responses to long-term WL accumulation and the resulting fatigue response is controversial (Atlaoui et al., 2007 ; Cormack et al., 2008). The use of biomarkers in offshore sailing has received considerable interest in assessing the neuroendocrine response to competition. For instance, Giacon et al. (2021) found that 3-days of offshore sailing significantly impacted oxidative stress and cortisol levels. These results were corroborated by Portier et al. (2008) and Gunnarson et al. (2004), who also identified cortisol alterations after 33 hours and 9 months of sailing, respectively. Moreover, monitoring biomarkers helped observe iron deficiencies, which may decrease human performance, from chronic and repeated elevations in serum hepcidin in soldiers during a 7-day ski march (McClung et al., 2013). To conclude, individualised values of biomarkers may fluctuate day to day and week to week but managing and tracking chronic biomarker changes can provide important information associated with risks of injury, overtraining, and decreased performance (Lee et al., 2017).

4.8.4 Cognitive function



Figure 67. Illustration of the equipment necessary for a 5-min serial simple reaction-time test.

In tactical sports, self-report, and performance techniques to track the dynamically changing state of fatigue without compromising task performance is an arduous task (Jiao et al., 2013). Nevertheless, a vast majority of research focuses on using subjective questionnaires to assess the athlete's mental fatigue status. Indeed, measuring mental fatigue in offshore sailing is a laborious task. However, subjective questionnaires seem more practical due to their non-invasive nature and their simplicity. Hagin et al. (2012) used subjective measures of perceived exertion (Figure 67) to evaluate fatigue and anxiety, whereas Hurdiel et al. (2014) evaluated mental fatigue by assessing reaction time performance using a 5-min serial simple reaction-time test (Wilkinson & Houghton, 1982) in solitary offshore sailors. Other sports and tactical activities have used a wide array of tools to

observe mental fatigue after long periods of physical and cognitive tasks. These methods may give interesting insights into the future of scientific studies concerning offshore sailing. Rabinowitz et al. (2009) used a computerised multitasking measure to evaluate neurocognitive functioning before and after- flight operations in deployed military aviators while LeDuc et al. (2005) observed ocular indices of fatigue in helicopter aviators. More recently, a mobile phone application has been developed to measure mental fatigue through gaze measurements (Valliappan et al., 2020). However, the use of an electroencephalogram is currently the most pragmatic way to monitor human brain activity changes while exercising. Although once tested in offshore sailing (Leger et al., 2007), measurements did not evaluate the mental fatigue aspect of sailing but concentrated on sleep quality before and after sailing. It seems that this technique may be difficult to use in an offshore context due to its invasive nature.

Key Takeaways: Monitoring fatigue-recovery

- ▶ Onboard activity depends of vessel, regatta rules and crew size.
- ▶ Disruptive stress needs to be carefully tailored so that recovery and regeneration are possible and that it does not cause maladaptation by exceeding the athlete's physiological and psychological capacities to cope with the stressor.
- ▶ The choice of an appropriate fatigue measure needs to be made in relation to the situation being monitored.
- ▶ It may be more useful to find tools that allow the monitoring of regular daily fatigue and recovery in order to better understand the short-term fluctuations in performance capacities that result from successive training bouts.
- ▶ Numerous modalities are available for monitoring training stress and fatigue, with limited scientific investigations confirming the validity of each.

Chapter five | *Personal contribution*



“Life is about growth and contribution, not perfection.”

-Anonymous

5.1 Responding to the research questions

The identification of performance indicators has gained a considerable amount of interest in scientific literature over the last 30 years (Rico & Bangsbo, 1996 ; Hughes & Franks, 2004 ; O'Donoghue, 2007 ; Cooper et al., 2007 ; Sampaio et al., 2013). It is generally agreed upon that identifying the key performance indicators of a sport is essential to measuring the aspects that are most critical to sporting success (Hughes et al., 2012). However, there is limited information available to human performance practitioners in terms of performance analytics despite the increased professionalism and substantial growth of sailing worldwide. Although more common in field-based sports, research analysing sailing performance is limited to studies examining Olympic dinghy racing and Americas cup racing. Indeed, researchers are faced with a substantial practical challenge when analysing sailing performance due to its inherent qualities (Allen & Dejong, 2006). Sailing covers a wide spectrum of competition, boat classes and physiological demands which makes comparison of data relatively difficult. Moreover, sailing in general relies on the ever-changing climate and environmental conditions (Philipott et al., 2004). This has led to scientific progress in the fields of hydrodynamic and aerodynamic boat performance, but human performance factors remain less understood. Therefore, the lack of information available for human performance practitioners leaves space to doubt and uncertainty when establishing training protocols. Taken altogether, this created the first questions of the thesis:

- 1) Is it possible to discriminate between successful and less successful boats according to sailing performance indicators?
- 2) Is there a difference in body composition and/or fitness parameters between a successful sailor and a less successful one?

This in turn responded to the first theme of the thesis, mentioned in the research objectives section:

- 1) To analyse and report the nature of sailing during the *Sailing Tour de France*.
- 2) To identify the key performance indicators associated with racing outcome.
- 3) To direct a descriptive analysis of anthropometric, physical, and physiological profiles of elite-level sailors participating in the TDF.

The original plan of the thesis was to continue the investigation with the same population for the upcoming season. Indeed, the aim was to conduct a longitudinal study during a pre-competition period and to analyse the effects of WL on the KPIs observed during the transversal experiment. Many professional teams agreed to participate and a total of 3-months of WL data was collected. Unfortunately, the Covid-19 pandemic abruptly halted the research by cancelling the competition. The research protocol was

therefore reconducted for the following year. However, there was no certitude concerning the magnitude of effects on the competition's "subsistence". Hence, it seemed unreasoned to turn down a work offer with an offshore sailing team. A critical decision was therefore taken to shift the context from inshore sailing to offshore sailing. We later found out the relevance of our choice when TDF postponed any racing for the next two years and lost its professional status.

The problematic concerning offshore sailing did not cause specific perturbations to our research objectives. Indeed, like inshore sailing, the offshore context lacks in research analysing WL throughout a competitive season. We therefore maintained the initial themes and established a protocol that was conducted over a full preparation towards TOR. Unfortunately, Covid-19 struck again and our plans to instigate such a protocol were challenged when traveling restrictions were faced. The certainty of being able to conduct the same testing battery throughout a whole offshore sailing season was doubtful. Therefore, we decided to distinguish two distinct longitudinal studies during this project (Figure 68): pre-competition (theme 2) and competition (theme 3).

Theme 2 answered the following questions:

- 1) How is WL distributed during a pre-competition phase for a renowned offshore sailing race?
- 2) How can a human performance specialist optimise WL in offshore sailing?

This responded to the second objective of the thesis, mentioned in the research objectives section:

- 1) To describe WL distribution and investigate the physiological adaptations observed during the pre-competition phase.
- 2) To determine if a dose response relationship exists between WL parameters and monitored markers.

Elite offshore sailors, particularly those in the professional context, are exposed to the incessant evolution of material and technology development. This constant evolution has increased the competition load sailors are faced with. These high loads reflect various factors, including increased physical demands of the boats as well as a higher intensity of competition due to the cognitive demands for sailing in technology packed vessels. Hence, monitoring fatigue and gaining an understanding of a sailor's status may provide valuable insights for attaining information pertaining to sailor physical preparedness, injury, and illness risk. Furthermore, understanding the effects of competition on objective and subjective measurements is a crucial process for determining the athletic qualities necessary for athletic and sports performance. Indeed, an in-depth needs analysis highlights the metabolic demands, biomechanical demands, and the recurrent

injuries specific to the sport. This information guides performance practitioners to making informed and rationalized choices regarding program design, schedule structure and monitoring assessments.

It is generally agreed upon that screening protocols consisting of multiple assessments should be considered to collect a wide array of information. However, constraints within the “real-world” offshore sailing setting need to be considered when selecting assessments. Indeed, while adhering to the fundamental assessing procedures, fatigue monitoring tools should be non-invasive, time efficient and avoid any additional loading during the competition phase. Moreover, gaining access to relevant data is crucial when aiming to investigate the dose-response relationship linked to sailing load. Hence, tests that are valid, reliable and can be repeated with relative ease should be sought after and prioritized. The format of the race was modified by the organisers to adapt to international travelling sanitary restrictions. Hence, it was not possible to keep the same testing battery since time in between legs was significantly reduced in comparison to past editions. Nevertheless, theme 3, despite the struggle to maintain an organized testing protocol, responded to the following interrogation:

What are the effects of an offshore sailing competition on physiological and fatigue patterns in a mixed sex crew?

The subjects participating in this longitudinal study were professional sailors of the Portuguese boat *Mirpuri Foundation*. The sailors held prestigious backgrounds in Olympic, *Ocean Race*, *Solitaire du Figaro*, *Route du Rhum*, *Fastnet*, etc. races. At the time of the study, all the sailors were contracted to being full-time with the team.

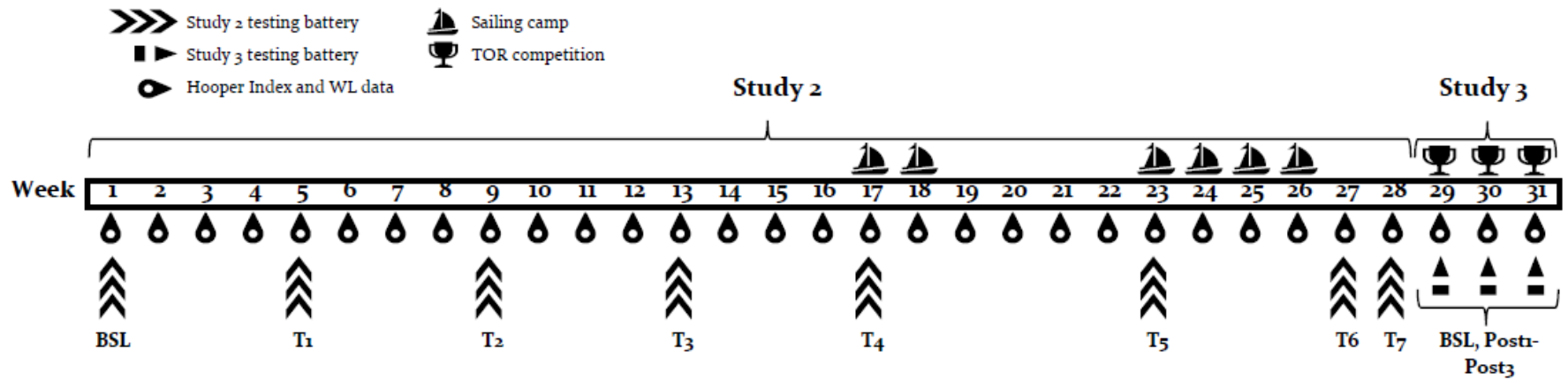

Figure 68. Overview of the experimental design during *The Ocean Race 2021*.

BSL: Baseline levels ; T1-T7: Testing timepoints ; Post1-Post3: Competition testing timepoints.

Study one | *Personal contribution* *Theme one*



PHILIPPE K , PAILLARD T , DUBOIS R, MAURELLI
O & PRIOUX J.

**Key performance indicators in Tour de France
sailing.**

Journal of Sports Sciences

2021; 39(8):944-954

5.1 Study I: Key performance indicators in Tour de France sailing

5.2.1 Introduction

This study focuses on inshore sailing performance in multihull-crewed vessels. The TDF is one of Europe's major annual inshore sailing event. For over 40 years, this competition has allowed some of the world's best sailors to compete along the French coastline. Today, the competition sees teams engage in regattas aboard the Diam24 One Design (D24) trimaran.

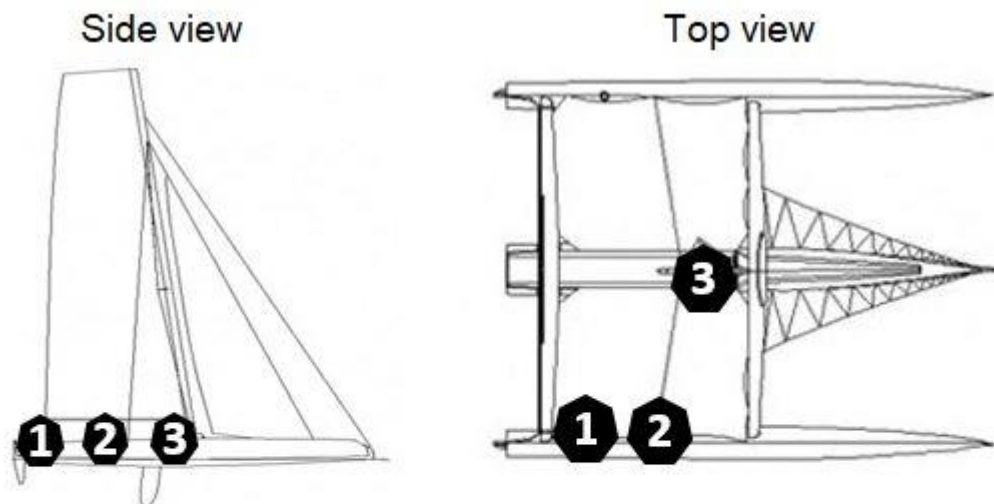

- 1. Helmsman:** responsible for manoeuvring the boat by acting directly on the rudders.
- 2. Trimmer:** Trims the shape of the sails by acting on the cranks.
- 3. Bowman:** Responsible for the hoisting and the dropping of the sails.

Figure 69. Side and top view of a DIAM24 One Design multihull. The figure shows the position and roles of the 3 athletes on-board. In winds over 10 knots all three sailors are hiking on the same hull.

The D24 vessel is 7.5 m long, 5.62 m wide, has a mast height of 11.5 m, a total sail area of 70 m² and is primarily made of composite material. It is maneuvered by three highly skilled sailors; helmsman, trimmer, and bowman (Figure 69). During the TDF, the boat competes in different stages; the “nautical stadium” (NS; n=10) and “coastal raid” (CR; n=5) events. A NS is a short but intense stage that consists of qualification heats (2-6 per NS Day). Teams race to tally points in the aim to qualify for the daily final (Figure 70). The boats are sailed in a fleet-race format (i.e., two groups of 11-12 teams) around a 1-3 lap (according to committee) beam reach, downwind and upwind course of 2672.9 ± 610.3 m. The best four teams of each fleet are selected to advance to the daily final. A CR is an event that tests the sailor's ability to race on larger and longer courses (59100 ± 19400 m) upon the coastline.

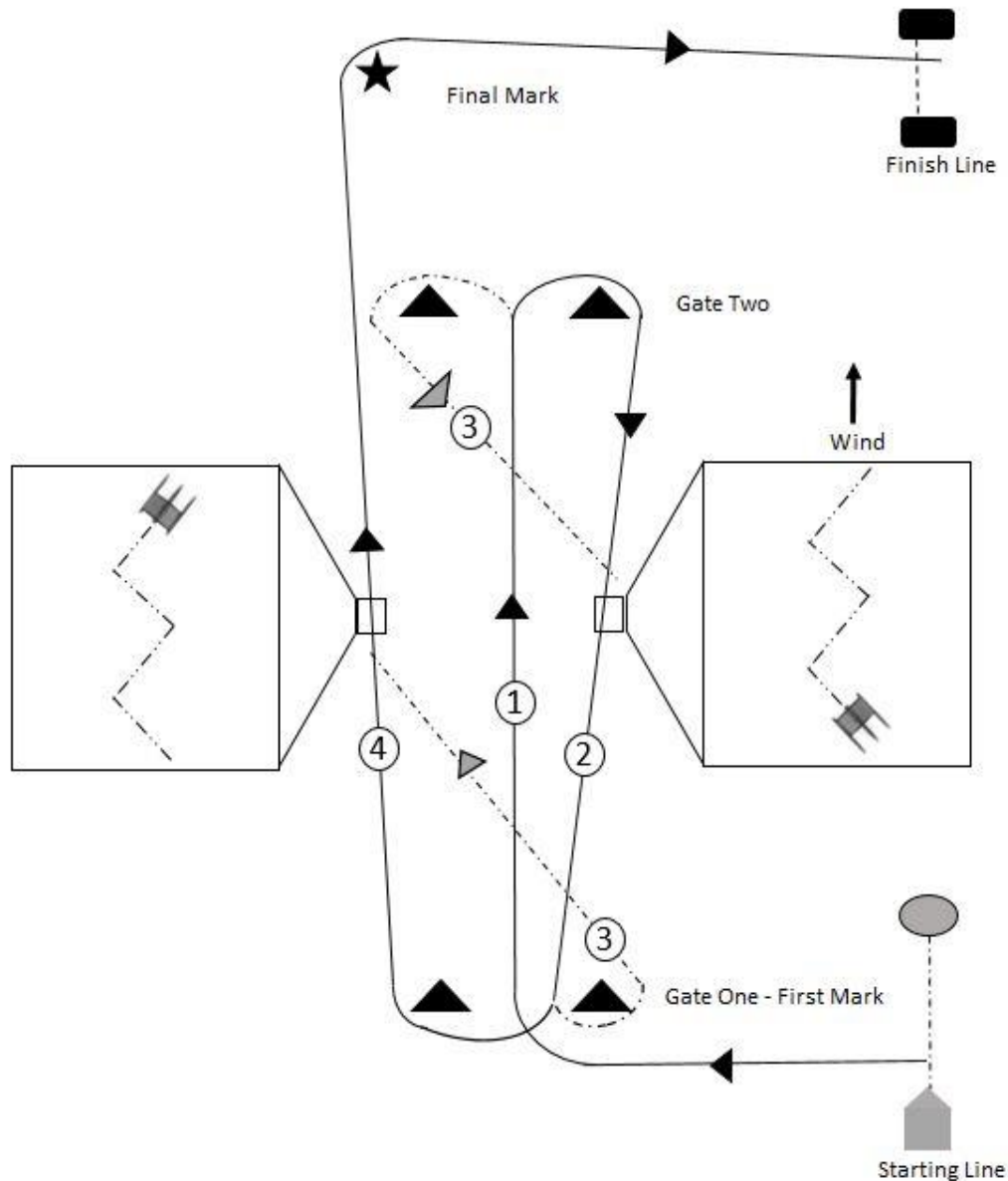

Figure 70. A typical Tour de France nautical stadium course. (1) Represents the downwind portion and (2) the upwind portion. (1) and (2) can be sailed up to three times according to race committee. Teams must go through the gates and can chose to round either mark (3). (4) Represents the final straight before gybing towards the finish line.

Although the TDF has established its' importance in the sailing environment, performance studies are still scarce in sports literature. This is partly due to two distinguishing external parameters that make such analysis unsteady. First, the TDF is unique in that the format changes annually according to host cities participating to the edition. The influence of geographical location has a significant impact on uncontrollable parameters such as

weather and sea conditions. Second, the ever-evolving development of technology and hydrodynamic research leads to constant changes of the official TDF vessel. This ultimately influences the conditions specific to the race. Nevertheless, despite the singular nature of the TDF, it would be interesting to collect data relative to sailing events (i.e., race task analysis) and qualities required (i.e., KPIs) to better prepare athletes for this sport competition.

Sport performance requires the optimal exploitation of the athletes' potential, but little is known about the contribution of different factors (i.e., physiological, psychological, technical and tactical/strategic) in sailing performance. To date, it was mainly reported that sailing is a sport for which bio-informational and strategic qualities are fundamental (Araújo et al., 2015). Although the anthropometric, physical and physiological characteristics are essential to performance in most sports, their influence on sailing performance still remains to be analysed. Establishing normative data, by engaging in profiling approaches, would be a valuable mean to understanding the needs for optimizing sport specific performance. Such data would be promoting a better understanding for identifying talent (Roczniok et al., 2013), determining an athlete's strengths and weaknesses (Duthie, 2006), guiding tactical choices (Fernandez-Fernandez et al., 2009) and elaborating sport-specific strength and conditioning programs. Therefore, the purpose of this study was to: (i) document the nature and technical KPIs of the TDF and (ii) provide insights into the anthropometric, physical and physiological characteristics of elite inshore sailors. We hypothesized that sailing performance factors (e.g., distance covered at different sailing speeds) and anthropophysiological characteristics would be identified and contribute to racing success and ranking.

5.2.2 Materials and methods

Subjects

Professional male international inshore sailors (N=21; mean \pm SD; age=23.81 \pm 4.18 years; height=179.32 \pm 7.30 cm; body mass=74.78 \pm 6.56 kg) were assessed in the final preparation phase leading up to the 2019 TDF. Subjects were informed of the testing procedures, potential risks, and the purpose of their participation. All subjects had already competed in international competitions. Their collective experience included 59 TDF campaigns. At the time of testing, the subjects had completed 6 months of sailing training and had been actively participating in strength and conditioning programs for at least three years. None of the participants reported injuries or diseases that would impair their physical performance. The study protocol was approved by the ethics committee of the local University. Written informed consent was obtained from all participants before the start of the study. In this

study, criteria used to qualify an athlete's performance was based on the team's final ranking. An athlete was categorized as "successful" (SA, n=10) if he crewed a successful boat (SB). Less successful athletes (LSA, n=11) crewed a less successful boat (LSB).

Procedures

Subjects were signed up for 2 testing sessions: anthropometry and physical and physiological (Figure 71). Both a) and b) testing sessions were completed on the same day. Subjects were instructed to rest adequately 72 hours before testing and to maintain normal eating and drinking habits during this period. The first session consisted of anthropometric measurements. These measurements took place in the morning upon waking up. Athletes were asked to refrain from eating two hours prior to testing and to avoid caffeine consumption twelve hours before. The second session was directed towards evaluating the physical and physiological components. The testing took place two hours post breakfast. The subjects were asked to not change their nutritional habits during this meal. Before all testing, a standardized warm-up was completed including jogging, dynamic movements, and stretches. Each physical and physiological quality measured was fully explained and demonstrated before testing.

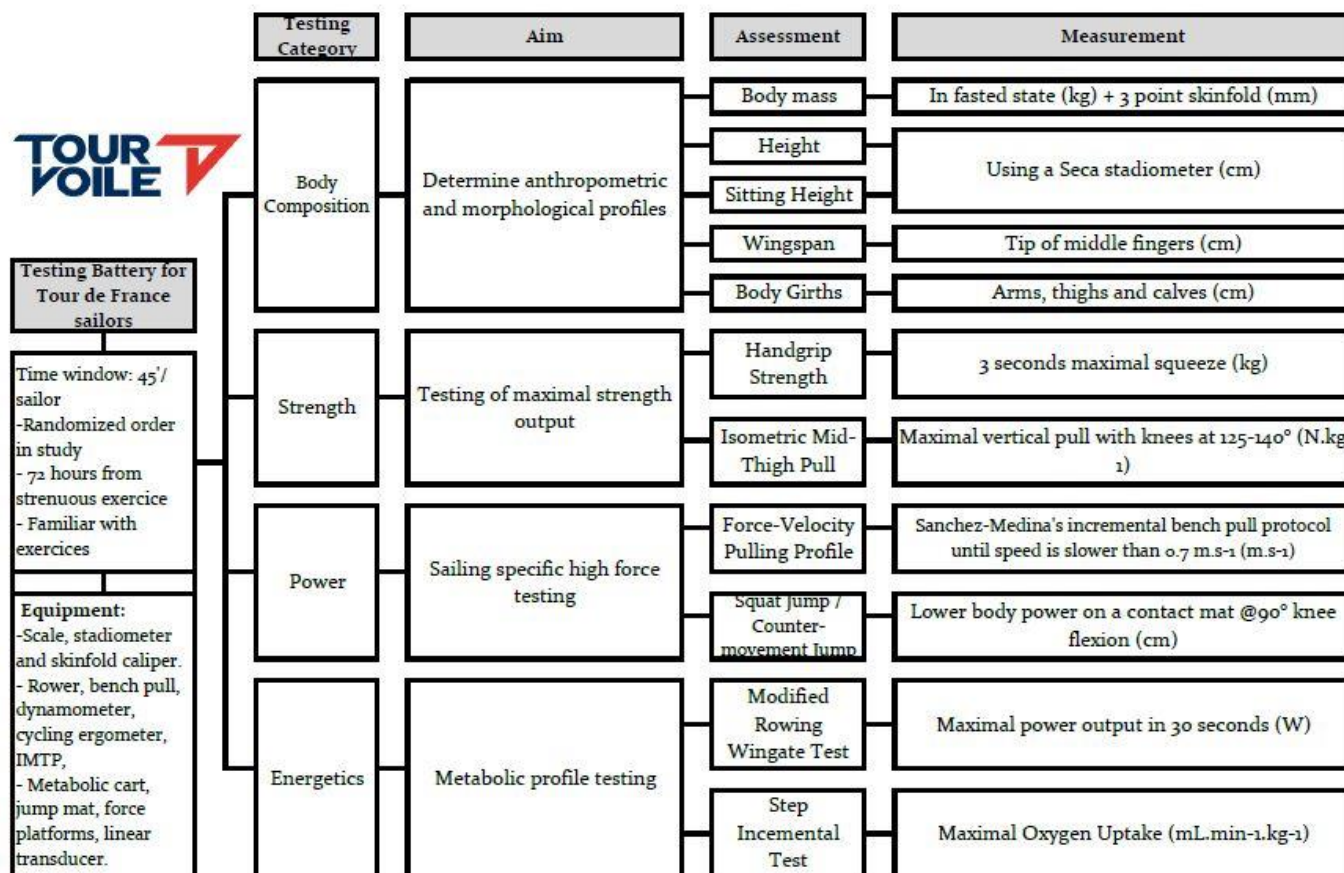

Figure 71. Testing battery of Tour de France sailors; Theme 1.

Regatta analysis

The 42nd sailing Tour de France took place in July 2019 and was held in 7 French coastal cities. This edition was disputed between 23 international teams over 17 days (10 NS and 5 CR) interspersed by two days of recovery. This resulted in 99 races (84 qualifying heats, 10 finals and 5 CR). Points were attributed daily according to results (i.e.: 1st receives 50 points, 2nd receives 49... last receives 28) and were accumulated throughout the competition. The final ranking established the winner of the TDF.

Race data – including sailing distance (m), average speed (m.s⁻¹), maximal speed (m.s⁻¹), course coverage (%) (i.e., distance sailed/course distance), start performance (rank and time gap at the first mark) and manoeuvres (tack and gybe; count) – were collected during all 84 qualifying heats and 5CR. GPS units (Mylaps® X5 Global Positioning System; 9-channel GPS receiver; location measurement accuracy 2.5 m; dimensions 109 × 59 × 22 mm; weight 95 g; temperature range -20 – +55°C) were placed on all of the 23 boats. A boat was categorized as “successful” (SB, n=7) if it qualified for more than half of the daily finals. Less successful boats (LSB, n=16) qualified for half or less of the daily finals.

Anthropometric, physical, and physiological assessment

Session 1: Anthropometric measurement.

Anthropometric characteristics were measured in the following order: weight, height, sitting height, wingspan, skinfolds, and body girths. A weighing scale (Seca®, Hamburg, Germany) and a stadiometer (Seca®, Barcelona, Spain) were used to measure weight and height respectively. Measurements for height (standing and sitting) and weight were made with an accuracy of 0.5 cm and 0.1 kg respectively. Wingspan was measured to the nearest 0.1 cm, from one middle fingertip to the other using a measuring tape (Seca®, Barcelona, Spain). Three skinfolds (Σ_3 Skinfold) were taken on the right side of each participant (pectoral, abdominal and thigh) according to recommendations by Jackson and Pollock (Jackson & Pollock, 1978). The skinfolds were measured with a Harpenden skinfold calliper (Harpenden®, Burgess Hill, UK) with 10-g.mm⁻² of constant pressure. Body density was assessed (Jackson & Pollock, 1978) while body fat was calculated using Brozek’s equation (Brozek et al., 1963). A measuring tape (Seca®, Barcelona, Spain) was used to measure the girth of relaxed arms, thighs and calves on left and right sides following measuring recommendations of the international society for the advancement of kinanthropometry (ISAK; Marfell-Jones et al., 2006).

Session 2: Physical testing.

Physical and physiological characteristics were measured in randomized order.

Handgrip strength. Maximal isometric HGS was assessed with a Jamar® handgrip dynamometer (Sammons Preston Corp., Bolingbrook, Ill., USA) (Figure 72). The test positions were standardized (Svantesson et al., 2009). Three trials were performed on each hand. The first three trials started with the right hand. Subjects were instructed to squeeze the device as hard as possible for 3 s. The time between each trial was 15 s and 3 min of rest was allowed when changing hands. The maximal measure of the three trials was retained in kilograms (Kg). Sum (HGS_{sum}) of both hands and dominant hand (HGS_{dom}) measures were assessed and included in the results.



Figure 72. Jamar© handgrip dynamometer used to test handgrip strength.

Vertical jumps. Lower body power was tested on the SJ and CMJ using a chronojump contact mat (Chronojump-Boscosystem™, Software, Spain). Each subject had three attempts per jump with 1 min of rest between trials. Subjects started with SJ and, after a 3 min passive recovery, were assessed on CMJ. Instructions for the jumps were explained and controlled with a goniometer for the SJ. Subjects were instructed to descend to 90° knee flexion. Once position was reached, a countdown of “3, 2, 1, jump” was indicated orally. A validated and reliable smartphone application (Balsalobre-Fernandez et al., 2015) was used for lateral video analysis. This allowed to track lateral kinematics and thus avoid collecting results that involved a countermovement action. Both the SJ and CMJ were done with subjects placing hands on their hips as to avoid arm movement. For the CMJ, athletes were instructed to perform a rapid eccentric phase, immediately followed by a rapid concentric phase with the intention to jump as high as possible. Height and peak power of the best SJ (SJ_H and SJ_{PP}) and CMJ (CMJ_H and CMJ_{PP}) performances were reported for analysis.

Isometric mid-thigh pull. Testing for isometric mid-thigh pull (IMTP) was conducted on a customized pulling rack apparatus specifically developed for data collection (Figure 73). IMTP was performed using two portable force platforms sampling at 1000 Hz (Pasco™, Rosedale, USA) and previously validated (Peterson Silveira et al., 2017). The force plates were connected to a portable laptop running the Capstone Software Program (Pasco™, Rosedale, USA). Knee angle was measured with a goniometer, to ensure a range of 125-140°

(Haff et al., 2013). The bar height was adjusted to meet the testing criteria and to accommodate to the athlete's size. Once the test had been thoroughly described and testing parameters were set, a specific warm-up was conducted. Athletes were provided with two warm-up pulls, 1 at 50% and 1 at 75% of perceived maximum effort, separated by 1 min of rest. Once body position was stabilized (verified by observation and live force measures), the subject was given a countdown of "3, 2, 1, pull." Minimal pre-tension was allowed to ensure that there was no slack in the subject's body before initiation of the pull. Athletes performed 3 maximal IMTP with the instruction to pull the bar with maximal effort as quickly as possible and push the feet down into the force platform. The time between each trial was 1 min. Each maximal isometric trial was performed for 5 s. The best trial was used for data collection and was analysed relatively to the athlete's body weight (IMTP_w).

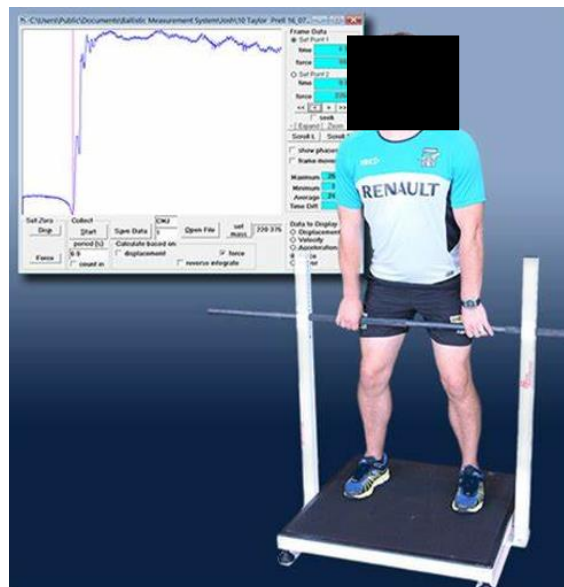

Figure 73. Illustration of the isometric mid-thigh pull with force plates.

Force-velocity pulling profile. Force-velocity curve testing on the BP was conducted on an elevated bench-pull device placed above a guided squat rack (Smith machine) (Figure 74). The Smith machine (Technogym®, Cesena, Italy) allowed for vertical displacement through guided rods. A Chronojump linear position transducer (Chronojump™, Barcelona, Spain) was placed below the bar and automatically calculated the kinematic parameters of every repetition. Subjects were instructed to pull the bar with maximum effort until the barbell hit the bench 8 cm below the subject's chest. The barbell was then lowered and a brief pause of 1 s was observed to avoid the rebound effect or any stretch-shortening cycle interference. The protocol followed Sanchez-Medina's instructions (Sanchez-Medina et al., 2014). Initial load started at 20 kg and increased by increments of 10 kg until mean propulsive

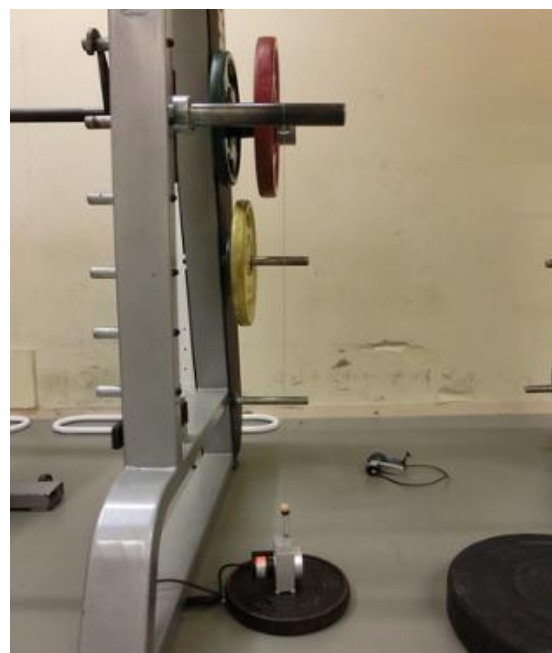

Figure 74. Linear transducer disposition on smith machine.

velocity (BP_{MPV}) was lower than $0.7 \text{ m}\cdot\text{s}^{-1}$. Three attempts were executed for light ($< 50\%$ 1RM), 2 for medium ($50\text{--}80\%$ 1RM) and only 1 for the heaviest ($> 80\%$ 1RM) loads. Inter-set rest intervals were 3 min for the light and medium loads and 5 min for the heaviest loads. The fastest bar speed for each load was recorded. The maximum load that could be lifted once was considered the athlete's 1RM (BP_{1RM}). BP_{MPV} was calculated for the loads that were completed by all subjects (BP_{MPV20} , BP_{MPV30} , BP_{MPV40} and BP_{MPV50}).

Anaerobic capacity. Anaerobic capacity was tested using a modified rowing Wingate test (MRWT) on a rowing ergometer Concept II-D (Concept 2 INC™, Vermont, USA). The fly-wheel was set at 130 drag factor. Subjects were allowed 3 min of warm-up at a rate of perceived exertion of 5 out of 10. Athletes then completed the 30 s all-out test. Exercise performance was expressed as mean power output (MPO) in watts (W) and was calculated automatically by Concept II-D. The procedure has been described previously (Riechman et al., 2002).

Maximal oxygen uptake. $\dot{V}O_{2\max}$ was assessed through a step incremental test (MOU_{T25}) on an electromagnetically braked cycle ergometer (Kettler® Ense-Parsit, Germany). $\dot{V}O_{2\max}$, expressed as $\text{ml}\cdot\text{min}^{-1}\cdot\text{kg}^{-1}$, measures were collected using a portable self-contained metabolic cart CardioCoach (Korr Medical Technologies®, Salt Lake City, UT) and previously validated (Dieli-Conwright et al, 2009) (Figure 75). Subjects were given time to adjust seat and bar height before starting the test. MOU_{T25} started at 20 W and increased by $25 \text{ W}\cdot\text{min}^{-1}$ until voluntary exhaustion (Amann et al., 2004). A cadence of 90-100 RPM was standardized throughout the test. During the MOU_{T25} the following variables were constantly registered: HR, \dot{V}_E and $\dot{V}O_2$. Prior to each test, the gas analyser was calibrated according to the manufacturer's specifications. $\dot{V}O_{2\max}$ was determined when physical signs suggestive of exhaustion were apparent and at least one of the following two criteria were met: (i) HR_{\max} was no less than 15 beats below the predicted maximum [$220 - (0.65 \times \text{age})$; Spiro 1977] and (ii) a steady state of $\dot{V}O_2$ despite an increase in WL (Vehrs et al., 2007).



Figure 75. Cardiocoach metabolic analyser.

Statistics

Data was calculated through standard statistical methods and are presented as mean \pm standard deviation. All variables were considered normally distributed through analysis with the Shapiro-Wilk test, histograms and skewness values prior to analysis. One-way

analysis of variance (ANOVA) was used to compare anthropometric, physiological and physical measures for the different crew positions. Independent t-tests were performed to determine if significant differences existed between physical profiles (SA vs. LSA) and technical parameters (SB vs. LSB). When results were significantly different, an effect size (ES) calculation was used. ES was evaluated using Cohen's d along with 95% confidence intervals. ES of ≤ 0.2 , 0.21-0.60, 0.61-1.20, 1.21-2.0, ≥ 2.0 were considered as trivial, small, moderate, large and very large, respectively (Batterham & Hopkins, 2006). Finally, Spearman's Rank Order Correlation (r) was used to identify the relationship between outcome (race and overall standings) and the KPIs identified as significant in the independent t-tests. Statistical analyses were performed using the SPSS package (15.0 version; SPSS, Inc., Chicago, IL, USA). The level of significance was set at $p < 0.05$.

5.2.3 Results

Regatta analysis

Mean race duration was 17 ± 2 min for NS and 244 ± 35 min for CR. Course distance was 2672.9 ± 610.3 m for NS and 59000 ± 17500 m for CR. Teams participated between 47 and 57 races and accumulated 474.3 ± 38.3 manoeuvres (NS: 355.1 ± 37.8 ; CR: 119.1 ± 6.6). Gybes (downwind manoeuvre; lasted ~ 12 s) were more recurrent than tacks (upwind manoeuvre; lasted ~ 8 s), respectively 259.3 ± 26.8 vs. 214.9 ± 26.1 . Manoeuvre count per NS heat was 8.7 ± 0.9 and 23.8 ± 1.3 for CR. Sailing distance for NS heats was 4161.8 ± 80.1 m and 78500 ± 34900 m for CR. Course coverage for NS was $158.5 \pm 3.0\%$ and $133.8 \pm 4.9\%$ for CR.

Technical key performance indicators

Sailing parameters collected during the TDF are analysed in Table 14 for SB, LSB and all boats. Race outcome for NS was significantly correlated ($p < 0.01$) with starting performance ($r = .52$), maximal speed ($r = .33$) and average speed ($r = .76$). Coastal raid ranking was correlated ($p < 0.01$) with starting performance ($r = .58$), maximal speed ($r = .43$) and average speed ($r = 0.81$). All three of the highlighted performance parameters were also significantly correlated to final rankings of the TDF.

Profiling and physical key performance indicators

Table 15 shows mean (\pm SD) for the age and anthropometric characteristics of professional male TDF sailors. No significant differences were observed in anthropometric parameters between crew positions (Table 15) and success attribute. The physical and physiological profiles of sailors are reported in Table 16. Successful sailors had stronger HGS_{Dom} ($ES = 0.82$) and $IMTP_W$ relatively to body weight ($ES = 0.93$) and exerted faster $BP_{MPV_{20}}$ ($ES = 1.18$) than their less successful counterparts. The differences between SA and LSA were

significant ($p=0.001$). HGS_{Dom} ($r=0.54$), $IMTP_W$ ($r=0.41$) and $BP_{MPV_{20}}$ ($r=0.61$) were significantly correlated ($p<0.01$) to rank in NS heats. CR results were correlated to HGS_{Dom} ($r=0.37$; $p<0.05$) and $BP_{MPV_{20}}$ ($r=0.74$; $p<0.01$). $BP_{MPV_{20}}$ showed strong correlation with final TDF rankings ($r=0.8$; $p<0.05$).

Table 14. Differences in sailing parameters between successful boats and less successful boats.

	All boats (n=23)		Successful Boats (n=7)		Less successful boats (n=16)	
	Mean (SD)	[Range]	Mean (SD)	[Range]	Mean (SD)	[Range]
Nautical Stadium						
Sailing distance (m)	4168.5 (76.2)	[4014.8-4318.7]	4131.9 (65.3)	[4048.5-4235.5]	4175.8 (82.7)	[4014.8-4318.7]
Average speed (m.s ⁻¹)	4.1 (0.2)	[3.8-4.4]	4.2 (0.1)	[4.1-4.4]	4.0 (0.1)**	[3.8-4.3]
Maximal speed (m.s ⁻¹)	7.3 (0.2)	[7.0-7.6]	7.5 (0.1)	[7.3-7.6]	7.2 (0.1)**	[7.0-7.5]
Course coverage (%)	158.5 (3.0)	[152.74-164.6]	157.4 (2.0)	[155.0-160.5]	159.0 (3.3)	[152.4-164.6]
Total Manoeuvres	8.6 (0.9)	[6.8-10.3]	8.9 (0.8)	[7.9-10.3]	8.5 (0.9)	[6.7-10.0]
Tacks	3.8 (0.6)	[2.7-5.0]	4.1 (0.4)	[3.6-4.5]	3.7 (0.7)	[2.7-5.0]
Gybes	4.8 (0.6)	[3.7-6.0]	4.9 (0.5)	[4.2-5.7]	4.8 (0.7)	[3.7-6.0]
Start (rank)	5.9 (1.5)	[3.5-9.3]	4.8 (0.9)	[3.5-5.9]	6.6 (1.3)**	[4.8-9.3]
Start (s)	25.4 (8.2)	[12.2-44.9]	18.8 (4.0)	[12.2-22.8]	28.5 (7.7)**	[18.2-44.9]
Coastal Raid						
Sailing distance (m)	78500 (3500)	[69600-82500]	78600 (3200)	[71200-81700]	78500 (3600)	[69600-82500]
Average speed (m.s ⁻¹)	5.4 (0.3)	[4.7-5.7]	5.5 (0.3)	[4.9-5.7]	5.3 (0.2)*	[4.7-5.5]
Maximal speed (m.s ⁻¹)	9.1 (0.4)	[8.1-10.3]	9.3 (0.4)	[8.8-10.3]	9.0 (0.3)**	[8.1-9.3]
Course coverage (%)	134.0 (4.8)	[118.0-139.5]	134.4 (2.4)	[130.0-138.2]	133.6 (5.7)	[118.0-139.5]
Total Manoeuvres	23.9 (1.3)	[20.4-25.8]	24.0 (1.8)	[20.4-25.8]	23.8 (1.0)	[22.2-25.8]
Tacks	11.6 (1.2)	[9.4-13.8]	12.1 (1.1)	[10.2-13.8]	11.5 (1.3)	[9.4-13.6]
Gybes	12.2 (1.0)	[10.2-13.6]	12.0 (1.1)	[10.2-13.6]	12.4 (1.0)	[10.6-13.6]
Start (rank)	11.7 (4.3)	[5.0-20.0]	9.1 (2.3)	[5.0-12.0]	12.9 (4.4)*	[7.0-20.0]
Start (s)	219.1 (103.1)	[71.6-479.8]	162.2 (65.0)	[71.6-236.2]	245.6 (107.1)*	[108.0-479.8]

* Significant difference with values of successful boats; P ≤ 0.05.

** Significant difference with values of successful boats; P ≤ 0.01.

Table 15. Age and anthropometric characteristics (mean (SD)) of TDF sailors.

	n	TDF (cam- paigns)	Age (years)	Weight (kg)	Height (cm)	Sitting Height (cm)	Arm Span (cm)	BMI (kg.m ⁻²)	Σ3 Skin- fold (mm)	Body Fat (%)	LBM (kg)	Girth Arm (cm)	Girth Thigh (cm)	Girth Calves (cm)
Successful														
Helmsmen	4	2.8 (0.5)	22.0 (1.4)	70.9 (5.9)	176.4 (9.4)	93.1 (4.6)	181.3 (7.5)	22.8 (1.2)	29.6 (11.0)	13.2 (3.8)	61.5 (5.3)	30.4 (1.8)	53.0 (1.6)	34.8 (1.6)
Bowmen	3	2.7 (0.6)	22.3 (2.1)	71.8 (6.1)	175.5 (5.3)	91.0 (2.6)	190.0 (2.1)	23.3 (0.6)	22.0 (4.4)	10.7 (1.7)	64.1 (4.3)	30.8 (2.0)	54.3 (0.9)	36.0 (0.9)
Trimmers	3	3.0 (0.0)	23.7 (1.2)	77.8 (4.2)	183.3 (6.0)	95.7 (3.3)	188.3 (10.4)	23.1 (0.6)	26.0 (15.4)	12.0 (5.2)	68.4 (5.0)	32.7 (1.3)	55.3 (1.8)	34.5 (1.8)
All	10	2.8 (0.4)	22.6 (1.6)	73.3 (5.8)	178.2 (7.5)	93.3 (3.8)	185.8 (7.7)	23.0 (0.8)	26.3 (10.4)	12.1 (3.6)	64.4 (5.3)	31.2 (1.8)	54.1 (1.3)	35.1 (1.5)
Less-Suc- cessful														
Helmsmen	3	2.7 (1.2)	23.7 (4.5)	68.4 (3.9)	176.4 (14.2)	92.3 (4.6)	186.0 (12.5)	21.4 (2.3)	29.1 (8.0)	13.2 (2.6)	59.4 (3.8)	29.1 (1.4)	52.2 (3.2)	33.8 (1.3)
Bowmen	4	2.7 (1.3)	25.0 (5.9)	79.1 (8.0)	175.5 (1.9)	92.9 (1.6)	183.8 (4.2)	24.3 (2.3)	20.1 (4.6)	10.1 (1.6)	71.0 (6.5)	32.3 (4.0)	53.1 (7.0)	39.8 (6.2)
Trimmers	4	3.0 (0.0)	25.8 (6.9)	79.1 (3.8)	183.3 (6.2)	91.4 (4.3)	184.3 (3.8)	24.2 (1.9)	42.0 (13.5)	17.5 (4.5)	65.1 (3.6)	31.1 (2.6)	55.4 (1.3)	35.9 (1.4)
All	11	2.7 (0.4)	24.9 (5.5)	73.5 (7.6)	180.4 (7.3)	92.2 (3.4)	184.6 (6.5)	23.5 (2.4)	30.5 (13.1)	13.65 (4.0)	65.7 (6.5)	31.0 (3.0)	53.7 (4.4)	36.7 (4.4)
Total														
All	21	2.8 (0.9)	23.8 (4.2)	74.8 (6.6)	179.3 (7.3)	92.7 (3.5)	185.1 (6.9)	23.3 (1.8)	28.5 (11.8)	12.91 (4.0)	65.0 (5.9)	31.1 (2.5)	53.9 (3.2)	35.9 (3.3)
Range		[1-4]	[17-33]	[65.5- 88.8]	[163.5- 190.5]	[85.5- 100]	[173.5- 200]	[19.3- 26.8]	[13- 54.5]	[7.6-22]	[55.3- 78.9]	[27.5- 37]	[44.5- 61.5]	[32.5- 41]

TDF: Tour de France; BMI: Body Mass Index; LBM: Lean Body Mass; Note: Successful, sailors finishing in the top 7 teams; Less successful, sailors finishing 8th to 23rd.

* Significant difference with values of successful athletes; P ≤ 0.05 (**; P ≤ 0.01).

† Significant difference with values of successful athletes at same position; P ≤ 0.05 (††; P ≤ 0.01)

Table 16. Physical and physiological characteristics (mean (SD)) of TDF sailors.

	n	HGS _{Dom} (kg)	HGS _{Sum} (kg)	SJ _H (cm)	CMJ _H (cm)	IMTP (N)	IMTP _W (N.kg ⁻¹)	MRWT- MPO (W)	BP _{1RM} (kg)	BP _{MPV20} (m.s ⁻¹)	BP _{MPV30} (m.s ⁻¹)	BP _{MPV40} (m.s ⁻¹)	BP _{MPV50} (m.s ⁻¹)	$\dot{V}O_{2max}$ (ml.mn ⁻¹ .kg ⁻¹)
Successful														
Helmsmen	4	59.3 (5.6)	113.5 (9.7)	32.7 (4.8)	37.6 (5.2)	2649.9 (397.6)	37.3 (3.4)	501.3 (82.3)	73.8 (6.3)	1.5 (0.02)	1.2 (0.1)	1.1 (0.1)	0.9 (0.1)	53.5 (6.4)
Bowmen	3	72.0 (6.9)	138.0 (11.1)	42.8 (5.5)	37.6 (2.2)	2894.1 (189.7)	40.4 (1.1)	623.7 (115.0)	83.3 (2.9)	1.7 (0.1)	1.4 (0.1)	1.2 (0.2)	1.0 (0.1)	52.5 (14.0)
Trimmers	3	66.3 (8.5)	127.3 (20.1)	35.6 (1.0)	39.0 (2.4)	2955.6 (144.9)	38.0 (2.2)	632.7 (126.0)	81.7 (10.4)	1.7 (0.1)	1.5 (0.1)	1.3 (0.1)	1.2 (0.1)	56.5 (2.2)
All	10	65.2 (8.3)	125.0 (16.3)	35.6 (1.0)	37.9 (38.6)	2814.9 (293.5)	38.4 (2.7)	577.4 (114.2)	79.0 (7.8)	1.6 (0.1)	1.3 (0.1)	1.2 (0.2)	1.0 (0.1)	54.1 (7.8)
Less-Successful														
Helmsmen	3	56.3 (15.4)	110.3 (27.5)	39.3 (7.7)	36.5 (4.7)	2433.4 (776.7)	35.2 (9.8)	488.7 (46.0)	67.5 (4.3)	1.3 (0.2)	1.1 (0.0)	1.0 (0.06)	0.8 (0.06)	48.7 (13.6)
Bowmen	4	58.3 (9.9)	114.3 (18.9)	36.8 (5.8)	38.7 (7.5)	2723.2 (614.7)	34.3 (5.7)	586.0 (109.4)	88.8 (20.15)	1.5 (0.1)†	1.4 (0.2)	1.2 (0.2)	1.0 (0.2)	57.3 (13.6)
Trimmers	4	57.3 (5.9)	110.8 (11.8)	31.0 (5.6)	35.8 (6.8)	2527.7 (377.5)	31.9 (3.4)†	575.0 (66.4)	70.0 (13.5)	1.3 (0.1)††	1.2 (0.1)††	1.1 (0.1)†	0.9 (0.3)	51.4 (6.8)
All	11	57.4 (9.4)*	111.9 (17.5)	35.4 (6.7)	37.1 (6.1)	2573.1 (540.8)	33.7 (5.9)*	555.5 (84.9)	76.1 (16.8)	1.3 (0.2)**	1.2 (0.2)	1.1 (0.1)	0.9 (0.2)	52.8 (9.4)
Total														
All		61.1 (9.5)	118.1 (17.8)	36.0 (6.2)	38.6 (5.6)	2688.2 (447.5)	35.9 (5.1)	565.9 (97.9)	77.5 (13.0)	1.5 (0.2)	1.3 (0.2)	1.1 (0.2)	1.0 (0.2)	53.4 (8.5)
Range		[46-80]	[90-150]	[24.1- 49.1]	[26.2- 46.7]	[1567.5- 3160]	[24.5- 43.7]	[430-774]	[50- 105]	[1.04- 1.83]	[1.06- 1.63]	[0.92- 1.45]	[0.77- 1.29]	[36.5- 76.8]

HGS_{Dom}: Dominant Hand Grip Strength; HGS_{Sum}: Sum of Hand Grip Strength; SJ_H: Squat Jump Height; SJ_{PP}: Squat Jump Peak Power; CMJ_H: Countermovement Jump Height; CMJ_{PP}: Countermovement Jump Peak Power; IMTP: Isometric Mid-Thigh Pull; IMTP_W: Isometric Mid-Thigh Pull relative to Weight; MRWT-MPO: Modified Rowing Wingate Test Mean Power Output; BP_{1RM}: Bench Press 1RM; BP_{MPV20}: Bench Press Velocity at 20 kg; BP_{MPV30}: Bench Press Velocity at 30 kg; BP_{MPV40}: Bench Press Velocity at 40 kg; BP_{MPV50}: Bench Press Velocity at 50 kg; $\dot{V}O_{2max}$: Maximal Oxygen Uptake. Note: Successful, sailors finishing in the top 7 teams; Less successful, sailors finishing 8th to 23rd;

* Significant difference with values of successful athletes; P ≤ 0.05 (**; P ≤ 0.01).

† Significant difference with values of successful athletes at same position; P ≤ 0.05 (††; P ≤ 0.01)

5.2.4 Discussion

The aim of this present study was threefold. First, our objective was to analyse and report the nature of sailing during the TDF. Second, we attempted to identify the KPIs associated with racing outcome. Third, we directed a descriptive analysis of anthropometric, physical, and physiological profiles of elite level sailors participating in the TDF. Most prominently, the analysis has indicated the capacity to discriminate between SB/LSB and SA/LSA by considering technical and physical parameters.

Regatta analysis

This is the first report on the nature of sailing during the TDF. Overall, sailors travelled 541300 ± 64900 m in 1792.3 ± 409.3 min during the 15 days of competition. Mean race duration (SN: 17 min; CR: 244 min) and the number of manoeuvres were highly variable due to external parameters (e.g., race course and tactics, environmental condition). Insights on the nature of energetic demands and work to rest ratio can nevertheless be estimated. In sailing, particularly where sailors must hike, work to rest ratio should be re-evaluated as a dynamic to static effort ratio. Tacking manoeuvres lasted around 8 s while a gybe lasted around 12 s. High intensity efforts, linked to the demands of manoeuvring (Neville et al., 2009b), occurred on a 1:14 ratio in NS and 1:50 in CR. Dynamic to static ratio reached as high 1:10 when boats chose to sail a course close to shoreline (CR). Hence, it can be assumed that the anaerobic energy system is significantly stressed during TDF racing. However, the TDF competition also requires a good aerobic level to endure the 15 days of sailing and to optimize recovery when racing (NS: 77 ± 14 min.stage⁻¹; CR: 244 ± 35 min.stage⁻¹).

Technical key performance indicators

GPS technology permits performance analysts to monitor external WL (Cummins et al., 2013) and collect data to identify technical and tactical performance indicators in sailing activities (Perez-Turpin et al. 2009). Research has identified the technical performance indicators in windsurfing (Anastasiou et al., 2019), match racing (Neville et al., 2009b) and kiteboarding (Caimmi & Samprini, 2017). To the best of our knowledge, this is the first study to analyse such parameters in fleet racing.

With regards to our results, we observed variability in the distance covered and time to finish a heat. Wind direction and wind speed influences the organisation committee in course settings (Perez-Turpin et al., 2009). Nevertheless, it should be noted that sailing also relies on cognitive skills (Araújo et al., 2015) and that different racing strategies exist. Teams must regularly analyse weather and oceanographic reports to determine the most appropriate course (Thill, 1982). Other external parameters (e.g., position in the fleet, changes of racing conditions, placement of opponents on course) can provoke variations and modifications in initial strategy (Araujo & Sepra, 1997 ; Wardet al., 2002 ; Manzanares et al., 2012).

Speed parameters have previously discriminated between successful and less successful athletes in other sailing competitions (Caimmi & Samprini, 2017 ; Anastasiou et al., 2019). This confirms our findings in that both average speed and maximal speed were significantly correlated to both race and TDF overall outcome. Based on bio-informational data, one can assume that SB were more efficient in determining the most favourable course to take in order to optimize boat speed. Pluijms et al. (2015) have investigated the difference in visual fixation behaviour between top and bottom-ranked sailors. On the one hand, bottom ranked sailors focus their centre of attention on the boat and thus might discard important environmental information. On the other hand, top ranked sailors, were capable of “feeling” the changes in boat speed and direction through mechanical and proprioceptive feedback. SB also displayed better starting performance (rank and time gap at first mark) than LSB. Starting performance was significantly correlated with race outcome and overall TDF ranking. This could be due to sailors changing their gaze to look for relevant environmental information that might enhance the boat’s performance (Pluijms et al., 2015). Indeed, if boats arrived first at the first mark, they would not have to account for other information concerning opposing team position.

Profiling and physical key performance indicators

Although sailing has acquired research interest through important international events (i.e., Americas Cup and Olympic Games), none has analysed the anthropometric, physical, and physiological demands for multihull fleet racing. Hence, we can only compare our data to those of similar sailing events. The mean data for height and weight of the 21 subjects (179.3 ± 7.3 cm and 74.8 ± 6.6 kg) are different to those found in other studies. Indeed, offshore sailors tended to be smaller and heavier (177 ± 7 cm and 78 ± 10 kg; Hurdiel et al., 2014) whilst measures reported on the 2002 TDF outlined the smaller and lighter profiles of sailors at the time (173 ± 6 cm and 62.6 ± 9.3 kg; Leger et al., 2008). The body fat of athletes in the study hereby ($12.91 \pm 4\%$) was similar to previously reported data of America’s Cup sailors ($13 \pm 4\%$; Neville et al., 2009b), and seems within the range (10-15%) of international and Olympic dinghy sailors (Bojsen-Moller et al., 2007 ; Vangelakoudi et al., 2007). Anthropometric characteristics vary according to competitive status, crew position, publishing date and sailing classification (Larsson et al., 1996). Surprisingly, there was no significant difference in anthropometric data in regard to crew position (Table 15). This could be the result of the race organization’s choice to set the minimal total crew weight to 210 kg and supports findings by Neville et al., 2009b that highlights the modern sailors’ strategy to reduce body fat of the whole crew as to maximize lean muscle mass for roles demanding higher physical output. This outlines the complexity when establishing normative data for sailing in general.

The physical and physiological characteristics reported in the present study also varied when compared to other sailing studies. $\dot{V}O_{2max}$ of our present study ($53.4 \pm 8.5 \text{ ml}\cdot\text{mn}^{-1}\cdot\text{kg}^{-1}$), seems to be (i) lower than in elite laser sailors ($58.2 \pm 4.7 \text{ ml}\cdot\text{mn}^{-1}\cdot\text{kg}^{-1}$; Castagna & Brisswalter, 2006), (ii) higher than Finn sailors ($47.6 \pm 3.5 \text{ ml}\cdot\text{mn}^{-1}\cdot\text{kg}^{-1}$; Bojsen-Moller et al., 2007) and (iii) similar to America's Cup grinders ($52.2 \pm 4.6 \text{ ml}\cdot\text{mn}^{-1}\cdot\text{kg}^{-1}$; Bernardi et al., 2007). The differences outlined in these studies could be related to the effect induced by the various peculiar onboard activity and/or the use of various testing methodologies. Nevertheless, research has outlined the low aerobic demands during a dinghy regatta (Portier et al., 2003). Indeed, sailors participating on TDF engage in high intensity hoisting and trimming actions when manoeuvring. Between the different manoeuvres, the sailors are involved in quasi-isometric hiking. Previous studies showed a significantly decreased oxygenation pattern in the m. Vastus Lateralis during hiking (inherent to isometric contractions $> 30\%$ maximal voluntary contraction), indicating an imbalance between oxygen supply and demand, and probably due to restricted muscle blood flow (Bourgois et al., 2016). The sailors undertaking the MRWT-MPO test in this study ($565.9 \pm 97.9 \text{ W}$) held similar anaerobic capacity than highly trained college level rowers ($548.97 \pm 95.57 \text{ W}$; Shaharudin & Zanutto, 2014). This comforts our understanding that TDF sailors rely significantly on anaerobic energy delivery during racing.

Lower body power was assessed using SJ and CMJ protocols. Few other studies have analysed such parameters on sailors. Indeed, only one has assessed national level sailors for lower body power (Tan et al., 2006) and found similar results to the present study (36.0 ± 6.2 vs $34.0 \pm 4.0 \text{ cm}$) on the SJ. Nevertheless, it seems that no correlation between jumping performance and hiking potential exists (Tan et al., 2006). Hiking is characterized by strong isometric contractions and coactivation of the muscles involved: quadriceps, hamstrings, abdominal and paravertebral muscles (Larsson et al., 1996 ; Tan et al., 2006). Numerous studies have analysed isokinetic muscle strength of knee, hip and trunk flexors and extensors of elite level sailors (Aagaard et al., 1998 ; Chicoy & Encarnacion-Martinez, 2015). These studies have highlighted the high demands of these specific strengths on hiking performance. In the present study, to assess maximal isometric strength of the lower body, an IMTP test was performed. To date, this is the first study to use such a protocol in an elite sailing environment. Relative strength should be considered when assessing sailors, or other sports, where body weight is regulated by competition rules. Isometric maximal voluntary force, using the IMTP test, has been linked to functional performance in sport (Ran-Wang et al., 2016). We aimed at analysing isometric strength at hip/knee angles like those of other sailing studies (Chicoy & Encarnacion-Martinez, 2015) by using the IMTP. Interestingly, maximal IMTP discriminated between SA and LSA when the results were compared relatively to bodyweight (IMTP_w). IMTP_w performance was significantly correlated ($r=0.41$; $p<0.01$) with rank on NS courses. These results suggest that a high level of relative strength

is necessary in TDF sailors and supports the findings in other studies analysing the relationship between lower body strength and sailing performance (Blackburn & Hubinger, 1995).

Trimming and hoisting actions requires powerful and energetic movements on the sheets (Bay & Larsson, 2013). By doing so, sailors increase the amount of apparent wind that covers the sail and, thus, increase boat speed. Indeed, it was thought that sailors participating in the TDF would have high amounts of maximal strength due to the predominance of pulling actions necessary when manoeuvring the boat. Differences can be outlined for the one repetition maximum between Americas Cup sailors (99.41 ± 5.4 kg; Pearson et al., 2009a) and TDF sailors of this present study (77.5 ± 13.0 kg). Nevertheless, it should be noted that the America's cup sailors were heavier (97.8 ± 12.5 vs 74.8 ± 6.6 kg). Bar velocity at fixed loads was also evaluated and turned out to be significantly different between SA and LSA at 20 kg loads. Neville et al. (2009b) reported that successful boats maneuver faster than less successful boats. Faster bar velocity at submaximal loads could be directly correlated to hoisting/trimming efficiency and, thus, sailing performance through faster manoeuvres. BP_{mpv20} was in fact significantly correlated to racing outcome (NS and CR) and TDF final ranking ($r=0.80$; $p<0.05$). Future research should therefore aim at establishing associations between bar velocities at fixed loads with hoisting actions.

HGS has received a considerable amount of interest in past research. Indeed, it has been linked to performance in many sports (Cronin et al., 2017). Significant decreases in grip strength between pre- and post-sailing training sessions have been reported in junior male semi-elite sailors (Bateup et al., 2016). The TDF sailors (61.1 ± 9.5 kg) reported stronger HGS_{Dom} than collegiate dinghy sailors (48.28 ± 5.31 kg; Pular, 2011). These results outline the high mechanical stress placed on forearms when manoeuvring TDF boats. HGS_{Dom} was found to significantly discriminate between SA and LSA. It was also correlated to racing outcome (NS and CR). These results could indicate more efficiency to manoeuvre the D24 at higher speeds (i.e., optimized gripping ease against high resistance in sheets and cranks). It would seem interesting to analyse the acute and chronic load effects of sailing on HGS.

An interesting finding of this study was that no significant difference was found between crew positions for physical and physiological parameters. This could indicate an equal importance of overall fitness of TDF sailors to manoeuvre the boat. Indeed, it was not rare to see sailors switch position when racing or during specific manoeuvres throughout the TDF. Comparison of physical and physiological parameters from 21 elite sailors indicated that SA had greater strength (HGS_{Dom}), muscular voluntary contraction ($IMTP_W$) and power (BP_{mpv20}) compared to LSA. Differences were most marked between trimmers ($IMTP_W$, BP_{mpv20} , BP_{mpv30} and BP_{mpv40}) and bowmen (BP_{mpv20}) which are primarily responsible for trimming and material handling (sails, ropes, and cranks). A possible explanation highlighting the difference in HGS_{Dom} found in this study could result from WLs on-water and off-of SA (Bateup et al., 2016).

5.2.5 Study limitations

Some limitations in the present study have been identified during the analysis process. First, the sample size of 21 elite level sailors accounted for 6 fully crewed boats out of 23. Testing more crew members may have permitted to perform more significant correlational analysis between crew characteristics, as a mean or sum, and ranking. Second, as previously mentioned, sailing relies on bio-informational and strategic qualities to perform. Indeed, overall, and specific sailing experience was not accounted for and could have influenced performance and account for discrimination of success.

5.2.6 Practical applications

This study may provide useful information to coaches, sports scientists and sailors in the planning and implementation of physical and technical training interventions. Where practitioners wish to evaluate and provide sailors with reliable training interventions the use of HGS, submaximal pulling velocity and isometric mid-thigh pull testing protocols are suitable. We believe that future studies should focus on two aspects: (i) identifying the effects of internal and external WL on technical and physical performance indicators during the preparation and competitive phase of the TDF and (ii) examining sailors' experience (e.g., vessel, position, WL) to identify potential performance and/or talent pathways.

5.2.7 Conclusion

Overall, the findings have identified multiple variables (technical and physical) that discriminate between successful and less successful athletes/boats. The results can be used as normative data to compare, detect and guide athletes in their preparation for performance. The present study highlights successful sailors having stronger grip strength, more powerful bench-pull and higher IMTP than their less successful counterparts. Successful boats displayed a faster average speed, maximal speed, and more efficient starting performance. Nevertheless, these findings should be applied with caution to other populations (i.e., youths, less experimented sailors, and other sailing categories).

Study two | *Personal contribution* *Theme two*



PHILIPPE K , PAILLARD T , MAURELLI O, MOODY J
& PRIOUX J.

**Workload management in professional offshore sailing
during a pre-competition period.**
(Article submission process)

5.3 Study II: Workload management in professional offshore sailing during a pre-competition period

5.3.1 Introduction

The incessant evolution of material and technology has raised the competitive demands of offshore sailing. Thus, along with other factors, sailing performance is confronted to more physically demanding vessels and enhanced risks of injury (Philippe et al., 2021). Optimizing human performance and physical readiness is therefore becoming an increasingly important component of the training process. This study focuses on offshore sailing performance in mixed-sex crewed monohull vessels. TOR holds a 50-year reputation of being one of the toughest races offshore racing venue and is categorized as an “extreme sport” (Laver et al., 2017) due to its’ risky nature. The competition has seen some of the world’s most famous sailors compete with crews in a goal to circumnavigate the world.

Quantification of training and competition WL has currently received a considerable amount of interest in sports science literature. Indeed, WL monitoring has become the gold standard for measuring stress induced by PA. Halson (2014) highlighted the importance of monitoring WL to determine if an athlete is adapting to a training program and to minimize the risks of non-functional overreaching, injury and illness. Other studies have analysed the influence of WL, WL_{str} , WL_{mono} and data smoothing methods on neuromuscular adaptations, hormonal balance, and sports performance (Nohari et al., 2022). Hence, WL monitoring and its management has become an imperative tool to consider in the elite sporting environment.

Despite the current trend of interest aiming to bridge the gap between WL and indicators of performance, few studies have focused on predominantly strategy-based sports, such as sailing. Indeed, whilst conspicuous by its absence, scientific literature concerning offshore sailing suffers from the sport’s inconstancy and dependency to climatic and meteorological factors (Pérez Fernandez, 2013). The ever-shifting weather conditions are likely to disrupt training programs, affecting WL management and, therefore, physical preparedness. However, performance in sailing is still linked to fitness (Philippe et al., 2021) and, despite this precept, the relationship between variations in fitness levels and accumulated WL is not yet clearly established. Therefore, the aim of this study was two-fold. The first purpose was to describe the WL distribution of a professional offshore sailing team during a 6-month pre-competition period. The second aim was to investigate and identify the best dose-response predictors of periodically monitored indices with WL variables, ACWR and EWMA quantification methods. It was hypothesized that the monitored indices would be directly affected by WL accumulation and that, due to the decaying nature of fitness and fatigue, data

smoothing models would better predict neuromuscular performance, wellbeing, and SC adaptations.

5.3.2 Methods

Experimental Approach to the Problem

This study used a longitudinal prospective design to analyse the relationship between WL, neuromuscular performance, wellbeing, and SC. All data were collected during the preparation of TOR 2021. The study was completed over a 27-week (W_{1-27}) pre-competition period. Figure 76 illustrates the training that was planned and scheduled by the skipper. Monday was considered the first day of each 7-day week. Planning was adjusted to accommodate to weather conditions and Covid-19 crisis related restrictions as required. When sailing or training facilities were not available, sailors were prescribed training sessions by the strength and conditioning coach. Training was implemented to adapt appropriately to the ever-changing schedule of a sailing environment and to the individual needs of each sailor. On-land training included resistance training and metabolic conditioning (Figure 77B). All gym sessions were conducted in the Club Naval de Cascais (Portugal) or at home, when needed. The subjects were familiar with all exercises as they were part of their usual training process.

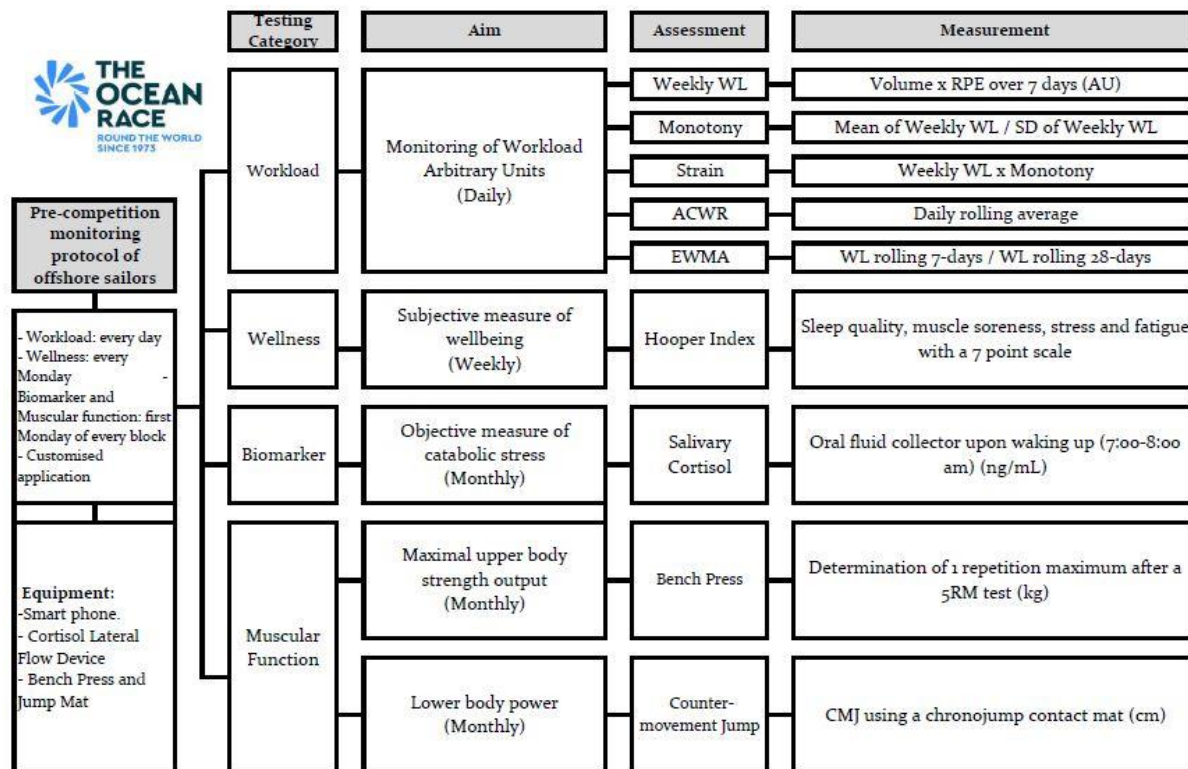

Figure 76. Pre-competition monitoring protocol of offshore sailors; Theme 2.

Together with WL variables, monitoring contained several subjective and objective markers of adaptation. Subjective markers included a wellness questionnaire for monitoring fatigue and were assessed weekly (Mondays). Objective markers included monitoring of strength and power abilities as well as salivary hormonal biomarkers. These measurements were assessed during seven testing batteries (Test₁₋₇) which were held on the first day of each of the 7 training blocks (TB₁₋₇) (Figure 77A). Test₁₋₇ were conducted in the team's training facilities, located at the Club Naval de Cascais (Portugal), to ensure minimal disruption to the established sailing program. Athletes were requested to abstain from caffeinated drinks and alcohol 24 hours prior to testing. Data collection was made possible through a customized smartphone application (Appsheat) to facilitate wellbeing and WL data collection. Athletes were permanently supervised by a qualified team doctor and nutritionist.

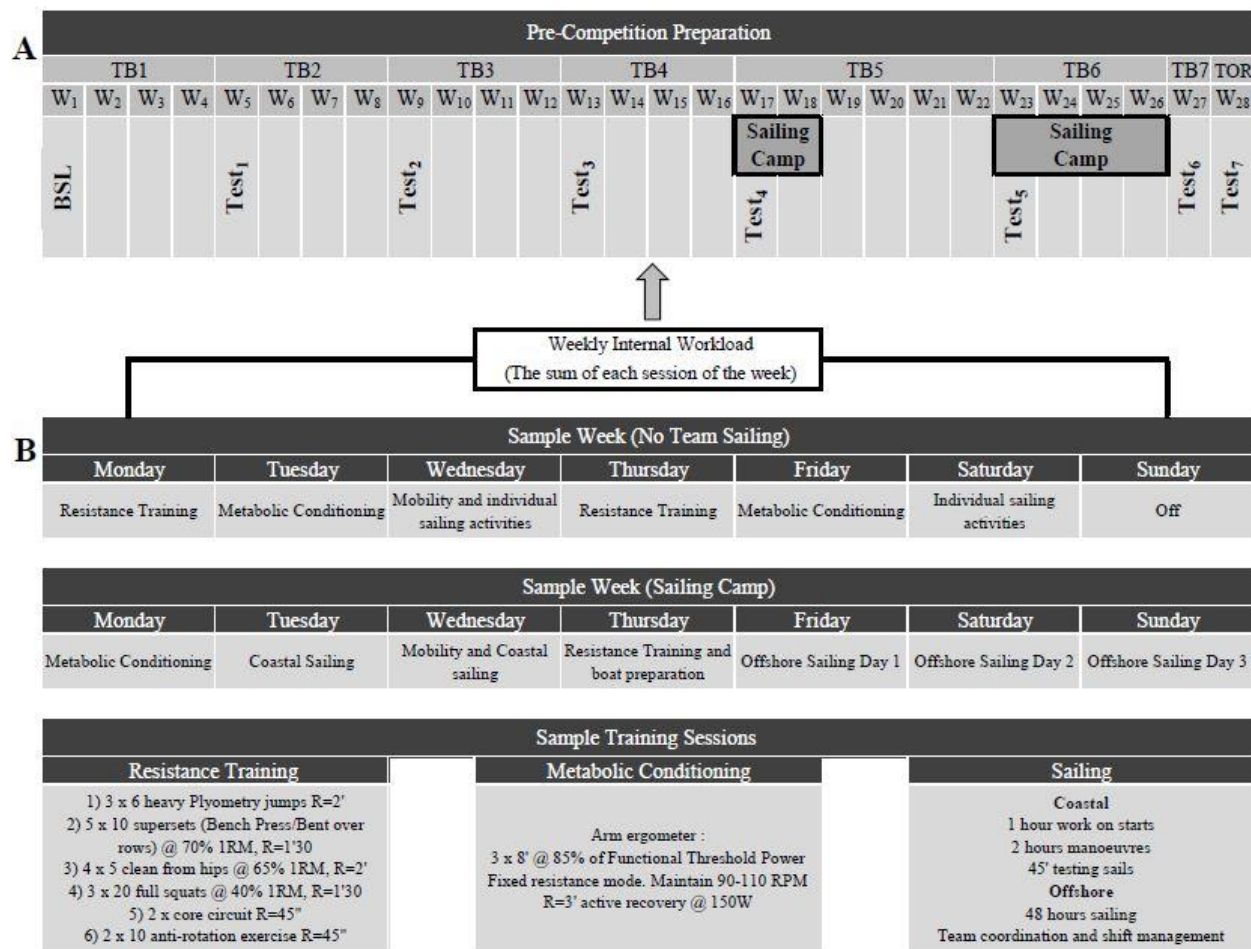

Figure 77. A) Schematic diagram showing the workload structure of the pre-competition blocks. The preparation was divided into seven distinct periods including two sailing camps. B) Organization of sample weeks and training sessions. BSL: Baseline; TB₁₋₇: Training Block; W₁₋₂₈: Week; Test₁₋₇: Testing Battery; R: Rest; RPM: Revolutions Per Minute.

Subjects

Ten professional sailors (8 males and 2 females) volunteered to take part in the study (mean \pm SD; age = 32.2 ± 3.96 years; stature = 179.1 ± 7.30 cm; body mass = 84.4 ± 11.8 kg). All subjects were contracted in the same sailing team and trained full time in the build-up to TOR. All sailors had extensive training experience and were familiar with the assessments found in the testing battery. None of the subjects reported injuries or diseases that would impair their physical performance at least 6 months before the start of the protocol. The study protocol was approved by the ethics committee of Rennes University (France) and in accordance with the principles set forth in the Helsinki declaration. Written informed consent was obtained from all subjects prior to the commencement of the study.

Procedures

Baseline Measures

On the first week of the pre-competition period, sailors underwent a medical screening battery. The testing battery occurred on Monday of the first week of the preparation phase and established the BSL measurements. The protocol consisted of neuromuscular performance, wellbeing, and SC testing. Sailors had not participated in high intensity training in the week prior to testing.

Workload Monitoring.

WL was evaluated using sRPE methods. Several variables were recorded; WL_{wk} , WL_{mono} , WL_{str} , and acute-chronic WL ratio smoothing models using (i) ACWR and (ii) EWMA. Following each training session, sailors were requested to subjectively measure their physical exertion. RPE was recorded using the modified Borg 0 to 10 Scale (Lovell et al., 2013). Athletes answered the question “How was your session?” within 30 min of finishing to maximize the accuracy of assessment of the full training session. sRPE was then measured by calculating RPE x the duration of the session (in minutes) (Foster et al., 2001). When offshore sailing data was collected for measurement, the time spent asleep or resting was subtracted from the total sailing time. The following variables were then calculated: (i) WL_{week} as the sum of all WL during the week (Monday-Sunday), (ii) WL_{mono} as the mean of the WL during the seven days divided by the standard deviation of WL_{wk} and (iii) WL_{str} as WL_{wk} multiplied by WL_{mono} (Nohari et al., 2022). Data smoothing models were then used: (i) ACWR as the daily rolling averages calculated by dividing the acute WL (rolling 7-days) by the chronic WL (rolling 28-days) (Hulin et al., 2014) and (ii) EWMA as calculated by Williams et al (Williams et al., 2017):

$$EWMA_{today} = Load_{today} \times \lambda_a + ((1 - \lambda_a) \times EWMA_{yesterday})$$

Where λ_a is a value between 0 and 1 that represents the degree of decay, with higher values discounting older observations in the model at faster rate. The λ_a is calculated as:

$$\lambda_a = 2 / (N + 1)$$

Where N is the chosen time decay constant, with a 1-week WL (7-days) and 4-weeks WL (28-days) used to represent acute and chronic WL respectively. Although the use of such mathematical models for injury prediction is subject to conflicting debates (Impellizzeri et al., 2020b ; Maupin et al., 2020), their role of predicting fatigue and physical preparedness appears to be validated (Gabbett, 2016).

Neuromuscular adaptations to the pre-competition training period.

Neuromuscular performance was evaluated using CMJ and BP_{ress} tests. Lower body power was tested on the CMJ using a Chronojump contact mat (Chronojump-Boscosystem™, Software, Spain). Each subject completed three attempts with 1 min of rest between trials. For the execution of each attempt, a count-down of “3, 2, 1, jump” was indicated orally (Figure 78). All attempts were completed with subjects placing arms akimbo to avoid movement disruption. Athletes were instructed to perform a rapid eccentric phase, immediately followed by an explosive concentric contraction with the intention to jump as high as possible. The height of the best CMJ performance was reported for analysis (Focke et al., 2011). Markovic et al. (2004) observed that CMJ, when measured by means of contact mat and a digital timer, is a valid and reliable field test for estimating explosive power of the lower limbs.



Figure 78. CMJ test with arms akimbo.

Maximal upper body pushing strength was assessed using the 1RM estimation based on Brzycki's equations (Brzycki, 1993). The estimation was calculated during sets with less than 6-repetitions to avoid an overestimation of the 1RM. A standardized warm-up was incorporated to avoid variability and risk of injury. BP_{1RM} was not tested for Test₇ to avoid the delayed onset of muscle soreness before the start of TOR. Reliability of Brzycki's equation for measuring maximal strength on the BP_{1RM} from a submaximal test has been validated by Amarante do Nascimento et al. (2007).

Wellbeing fluctuations during the pre-competition training period.

Wellbeing was assessed using the Hooper-Index (HI). HI was measured using a questionnaire-based on the recommendations of Hooper and Mackinnon (Hooper & McKinnon,

1995) (Figure 79). Athletes answered the questionnaire every Monday morning upon waking (Figure 79). Levels of sleep quality, muscle soreness, stress and fatigue were scored on a 7-point scale on which “1” and “7” represent “very, very good” and “very, very poor” respectively. The HI was computed by summing its four subgroups (sleep quality, delayed onset muscle soreness, stress, and fatigue). The reliability of using the HI for monitoring sports induced fatigue has previously been demonstrated (Rabbani et al., 2019).



Figure 79. Hooper index questionnaire; according to Hooper and McKinnon (1995).

Hormonal adaptations to the pre-competition training period.

Hormonal adaptations were evaluated using SC samples which were collected upon waking (between 7:00 and 8:00 am). To ensure more rigorous testing and to limit cortisol measurement errors, athletes were required to refrain from eating, brushing their teeth and chewing gum prior to testing. Sailors placed the swab (Soma Bioscience, Wallingford, United Kingdom) on their tongue and closed their mouth (Figure 80). When the indicator on the swab’s stem turned blue, the test was considered complete (swab collected 0.5 mL of oral fluid). The swab was then placed in the buffer bottle of assay (sodium phosphate, salts, detergents, and preservatives) before gently mixing the sample for 2 min. Two drops of the sample were then placed in the window of the lateral flow device. The device was left still during the incubation period (10 min). The strip was then placed in the real-time reader and the results were ready within 20 s. SC was then collected as nanograms per millilitre (ng/mL). Soma Bioscience oral fluid collector has been validated against enzyme linked immunosorbent assay (ELISA) and have been proven as a reliable method to collect and analyse SC (Fisher et al., 2015).



Figure 80. Soma cube lateral flow device reader.

Statistical Analyses

Over the 27-week study period, data from 148.12 ± 17.53 training sessions was collected

and analysed. Data was calculated through standard statistical methods and is presented as mean \pm standard deviation (SD). All variables were considered normally distributed through analysis with the Shapiro-Wilk test, histograms, and skewness values prior to analysis. One-way ANOVA with repeated measures was used to determine the differences between the different parameters measured at Test₁₋₇. The Pearson correlation coefficient (r) was used to assess the associations between WL variables and monitoring markers. Correlation coefficients were interpreted as: < 0.1 (trivial), from 0.1 to 0.3 (small), from 0.3 to 0.5 (moderate), from 0.5 to 0.7 (large), from 0.7 to 0.9 (very large), and ≥ 0.9 (nearly perfect) (Cohen, 1988). The correlations were consistently presented with 95% confidence interval (CI). For all analyses, α was set at 0.05 . Statistical analyses were performed using the SPSS package (15.0 version; SPSS, Inc., Chicago, IL, USA).

5.3.3 Results

Figure 81A illustrates the weekly distribution of WL during the 27 analysed weeks of TOR pre-competition preparation. WL_{wk} variation displayed a high coefficient of variation (CV=1.18). Higher ($p<0.001$) WL_{wk} were observed during weeks of sailing camp (19792.6 ± 9428 AU; W₁₇₋₁₈ & W₂₃₋₂₆) compared to those not included in the camps (2813.2 ± 817.3 AU; W₁₋₁₆, W₁₉₋₂₂ & W₂₇). Higher WL were observed in the training blocks towards the end of the preparation schedule (Figure 81B). TB₆ (22313 ± 6679.8 AU) confirmed higher WL ($p<0.001$) than TB₁ (2537.9 ± 289.1 AU), TB₂ (2555.3 ± 375.5 AU), TB₃ (2717.8 ± 642.5 AU), TB₄ (3236.3 ± 1074.7 AU), TB₅ (7652.3 ± 718.6 AU) and TB₇ (3116.3 ± 712.7 AU). TB₅ was also significantly different ($p<0.001$) to all the other TB. TB₇, which was considered a taper week, showed lower ($p<0.001$) WL_{wk} when compared to TB₅ and TB₆ (Figure 81B). Repartition of WL during TB₁₋₇ is presented in Figure 82.

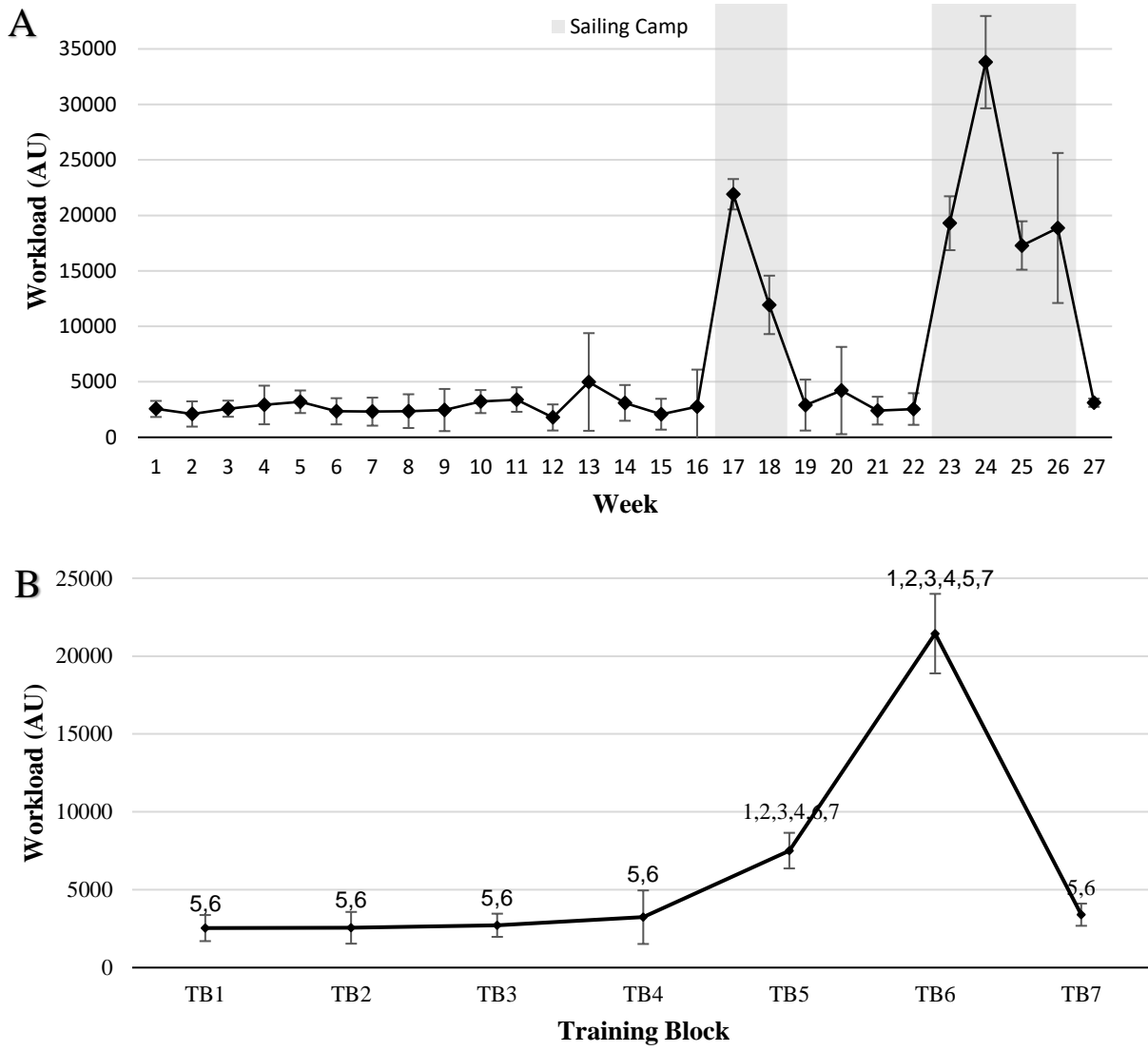

Figure 81. **A)** Weekly workload during the 27 weeks of preparation. Data are mean (\pm SD). **B)** Training block variations of weekly workload average. Data are mean (\pm SD). 1, 2, 3, 4, 5, 6 and 7: indicates to which TB it is significantly different ($p \leq 0.05$). AU: Arbitrary Units; TB₁₋₇: Training Block.

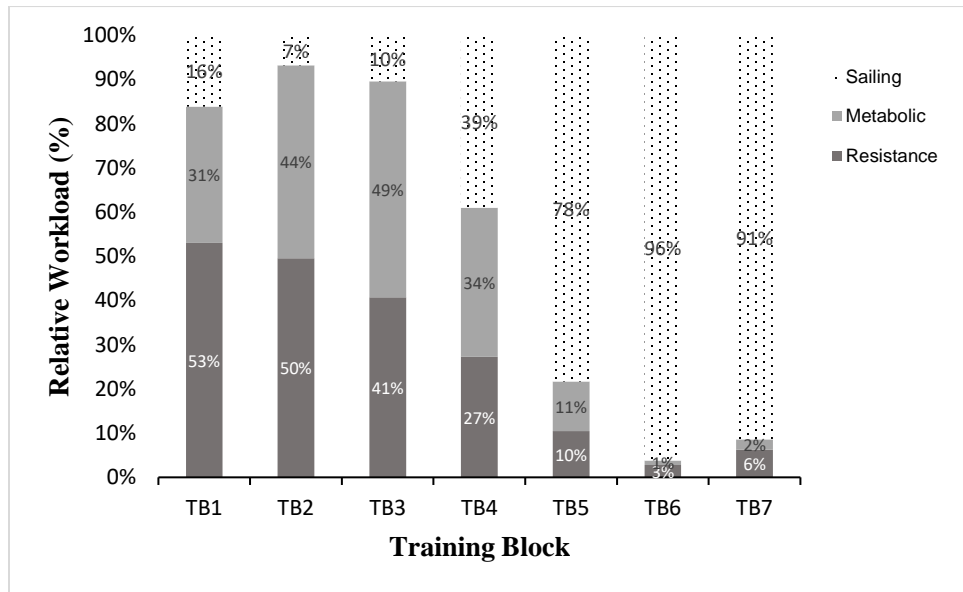

Figure 82. Repartition of workload specificity during each training block.

Within-group changes concerning CMJ, BP_{ress} , 1RM, HI and SC, during the different phases of preparation, are provided in Table 17. CMJ and BP_{ress} , 1RM were significantly different ($p \leq 0.05 < p < p \leq 0.01$) from BSL during Test₁, Test₂, Test₃, Test₄, Test₅, Test₆ and Test₇ respectively. HI ($p=0.05$) and SC ($p=0.05$) were both significantly different from BSL only at Test₆.

Table 17. Changes (mean \pm SD) in monitoring markers throughout the preparation period.

	BSL	Test ₁	Test ₂	Test ₃	Test ₄	Test ₅	Test ₆	Test ₇
CMJ (cm)	34.1 \pm 8.5	37.2 \pm 9.9 ^{*†}	40.1 \pm 9.6 ^{**†}	39.8 \pm 8.1 ^{**}	42.6 \pm 7.5 ^{**†}	43.0 \pm 8.1 [*]	37.4 \pm 6.6 ^{*†}	42.6 \pm 6.7 ^{**††}
BP _{ress} _{iRM} (kg)	78.5 \pm 25.5	81.3 \pm 26.3 ^{*†}	83.6 \pm 28.4 [*]	84.8 \pm 27.9 [*]	84.9 \pm 28.9 [*]	88.6 \pm 30.3 [*]	88.1 \pm 29.3 [*]	
HI (AU)	13.2 \pm 3.3	13.7 \pm 2.2	14.8 \pm 2.1	12.2 \pm 2.3 [†]	13.8 \pm 2.9	13.3 \pm 3.0	17.6 \pm 2.9 ^{††}	13.5 \pm 2.8 ^{††}
C (ng/mL)	16.1 \pm 11.3	16.4 \pm 11.2	12.9 \pm 6.6 ^{††}	16.3 \pm 7.2	8.8 \pm 3.9 [†]	14.7 \pm 10.1 ^{††}	25.4 \pm 9.8 ^{*††}	12 \pm 4.6 ^{††}

BSL: Baseline; Test₁₋₇: Testing Battery; CMJ: Counter Movement Jump; BP_{iRM}: Bench Press _{iRM}; HI: Hooper Index; SC: Salivary Cortisol; * Significant difference with values of BSL; $p \leq 0.05$. ** Significant difference with value of BSL; $p \leq 0.01$; † Significant difference with values of preceding Test; $p \leq 0.05$. †† Significant difference with values of preceding Test; $p \leq 0.01$.

Correlation outcomes between WL variables and monitored markers are presented in Figure 83. Large and very large positive correlations were found between WL_{wk} and BP_{ress} 1RM ($r=0.69$, 95% CI [0.11;0.92], $p=0.02$), HI ($r=0.85$, 95% CI [0.47;0.96], $p<0.001$) and SC ($r=0.84$, 95% CI [0.44;0.96], $p=0.001$). Moderate negative correlations were also found between WL_{wk} and CMJ ($r=-0.39$, 95% CI [-0.81;0.31], $p=0.05$). WL_{mono} showed large positive correlations to the HI ($r=0.55$, 95% CI [-0.12;0.87], $p=0.05$). WL_{str} showed moderate negative correlations with CMJ ($r=-0.48$, 95% CI [-0.85;0.21], $p=0.04$) and large positive correlations with BP_{ress} 1RM ($r=0.52$, 95% CI [-0.16;0.87], $p=0.05$). WL_{str} also showed very large positive correlations with SC ($r=0.83$, 95% CI [0.42;0.96], $p=0.002$) and very large positive correlations with the HI ($r=0.88$, 95% CI [0.56;0.97], $p<0.001$). ACWR data showed a large positive correlation with the HI ($r=0.64$, 95% CI [0.02;0.9], $p=0.04$) and a very large negative ($r=-0.75$, 95% CI [-0.94;-0.23], $p<0.001$) and positive ($r=0.72$, 95% CI [0.17;0.93], $p=0.01$) correlation with both the CMJ and SC respectively. Contrastingly, EWMA showed very large negative correlations with CMJ ($r=-0.73$, 95% CI [-0.93;-0.17], $p<0.001$) and BP_{ress} 1RM ($r=-0.78$, 95% CI [-0.95;-0.32], $p<0.001$).

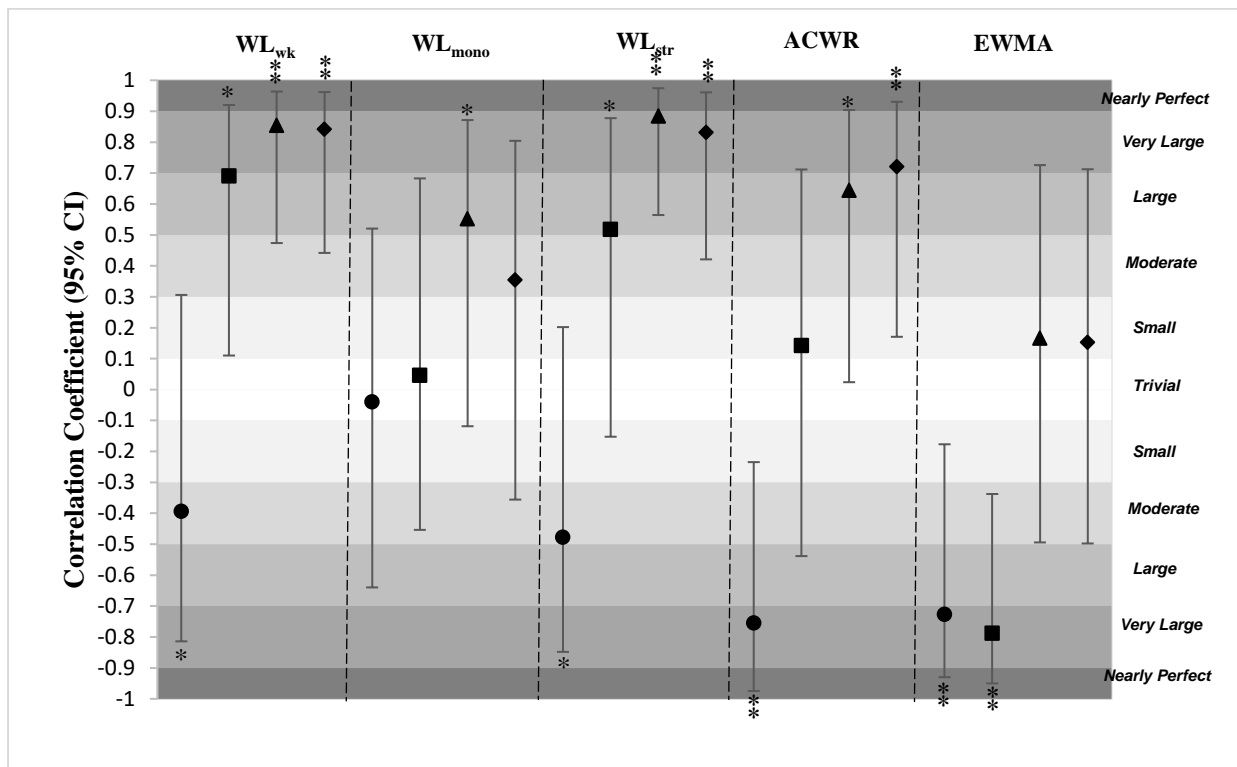

Figure 83. Correlations between workload parameters and monitoring markers (95% CI). ●: CMJ; ■: BP_{ress} 1RM; ▲: HI; ◆: SC. CMJ: Countermovement Jump; BP_{ress} 1RM: Bench Press 1RM; HI: Hooper Index; SC: Salivary Cortisol. * Correlation coefficient is significant at $p \leq 0.05$. ** Correlation coefficient is significant at $p \leq 0.01$.

5.3.4 Discussion

The present study (i) described the WL distribution during the pre-competition training period of a renowned crewed offshore regatta and (ii) aimed to identify the best dose-response predictors of periodically monitored indices with WL variables and data smoothing mathematical models. The results indicate the value of these assessments to monitor neuromuscular performance, wellbeing, and SC adaptations. Indeed, the analysis showed correlations between WL parameters and the monitored indices. Furthermore, EWMA and ACWR appeared as mathematical models capable of predicting recovery and preparedness. These findings can be used to guide planning and programming decisions in professional crewed offshore sailing through careful monitoring of sailors' WL.

Although Olympic and America's Cup sailing have received extensive scientific interest (Neville et al., 2009b ; Pearson et al., 2009a), the offshore sailing context remains scarcely explored. Indeed, limited research concerning sailing WL and its' effects on neuromuscular performance, wellbeing and SC adaptations has been documented (Galvani et al., 2015 ; Gicon et al., 2021). This lack of literature may be explained, in part, by the complexity of conducting research protocols in such a challenging environment. For instance, the utilization of wearable technology, such as HR monitoring devices, on yawing and rolling vessels stumbles upon practical difficulties when sailing offshore for multiple days (Galvani et al., 2015). Hence, as a substitute to objective exercise intensity, the researchers in this study used the RPE to quantify the psycho-physiological responses to training (Galvani et al., 2015). Moreover, sRPE is a practical method for measuring WL completed through various training modalities such as cross-training and resistance training (Ryan et al., 2020). Mathematical models (ACWR and EWMA) have emerged to calculate and predict an athlete's ability to tolerate sudden changes in WL (Gabbett, 2016). WL_{mono} and WL_{str} indexes can be calculated from sRPE data methods. WL_{mono} is a measure of day-to-day training variability and has been found to be related to overtraining when monotonous training is combined with high WL_{wk} (Foster, 1998). WL_{str} has been found to be an advantageous tool as recovery only becomes fundamental to training when high WL_{wk} are being undertaken (Putlur et al., 2004).

Regarding WL_{wk} , it was found that the pre-competition period showed variations during the 27 weeks. Indeed, a difference of 703% in WL_{wk} was found between weeks of training during sailing camp (19792.6 ± 9428 AU; W_{17-18} & W_{23-26}) and on land training weeks (2813.2 ± 817.3 AU; W_{1-16} , W_{19-22} & W_{27}) (Figure 81A). Also, a decrease of 50.4% was observed in WL_{wk} during taper week (3116.3 ± 712.7 AU; W_{27}) compared to preceding WL (6731.5 ± 8497.3 AU; W_{1-26}) (Figure 81A). The significant difference ($p < 0.001$) in WL between sailing weeks and non-sailing weeks suggests that the training regime is linked to the complexity of planning.

Indeed, variations in WL may be due to the numerous extraneous weather and environmental conditions as confirmed in previous research (Allen et al., 2008). Moreover, the high CV in the WL_{wk} repartition ($CV=1.18$) highlights the complexity to manage WL in sailing environments. Similar values of WL_{wk} , during non-sailing weeks, have been reported in other sports (Dubois et al., 2017). However, it appears no other studies have exposed such high quantities of WL (i.e., sailing weeks). To date, research focusing on the sailing environment has provided information on EE, sleep deprivation, nutritional challenge, and epidemiology, however WL management is conspicuous by its absence. Recently, high WL have been associated with risks of overtraining, injury (Impellizzeri et al., 2020a) and decreased performance (Arcos et al., 2015). Consequently, because of the high WL_{wk} observed in this study, the necessity for strict WL monitoring practices in offshore sailing environments seems crucial for optimizing human performance. Besides the WL patterns observed during the preparation of TOR, the effects of various WL parameters on neuromuscular function, wellbeing and SC were analysed. It was observed that the monitored indices varied throughout the season. Previous research has focused on establishing associations capable of predicting neuromuscular adaptations and sports performance (Borresen & Lambert, 2009). However, associations in environment-based sports, such as sailing are yet to be fully investigated. The results found in this study could, therefore, provide further insights for WL management in such environments.

Current literature has observed the effects of offshore sailing on lower body strength and power exertion (Philippe et al., 2022). Moreover, maintaining constant proprioceptive tension, due to hull movement, seems to increase the mechanical loading of hip extensors and hip flexors and, thus, impair CMJ performance during and after competition (Philippe et al., 2022). CMJ tests are commonly used to assess neuromuscular fatigue in professional athletes (Cormack et al., 2013). In the current study, the negative correlations found between WL parameters (WL_{wk} , WL_{str} , ACWR and EWMA) and the CMJ (Figure 83) seems to agree with research analysing the effects of WL on power expression (Malone et al., 2017). Indeed, high WL accumulation was also found to impair CMJ performance in professional rugby (Dubois et al., 2017), football players (Arcos et al., 2015) and other “long distance sports” (Balsalobre-Fernandez et al., 2014). Moreover, high chronic WL has been associated with inflammatory response, catabolic state and muscle damage which results in neuromuscular disturbances (McLellan et al., 2010). Hence, this could partially explain the adverse effects of WL_{wk} on CMJ as TB_6 was a high sailing volume block and provoked a 15% decrease, from $Test_5$, in CMJ performance. Indeed, these results coincide with findings highlighting neuromuscular function impairment due to the constant proprioceptive muscle tension encountered by sailors during the yawing, rolling, and pitching motions of the hull (Stoffregen & Smart, 1998). Furthermore, a 55% decrease in WL_{wk} during TB_7 provided supercompensation from TB_6 , on the CMJ (+14 %). This highlights the sensitivity of CMJ performance to

fatigue and overcompensation (Borresen & Lambert, 2009).

In contrast, our results found that when WL_{wk} increased, the expression of strength (BP_{ress} 1RM) also significantly increased. Moreover, although on land training WL (i.e., resistance training and metabolic conditioning) decreased exponentially after TB_3 (Figure 82), BP_{ress} 1RM was observed to evolve positively (Table 17). The vessel in this study was equipped with upper body pedestals used to hoist and trim sails by driving the winches attached to the sail lines. Grinding, action of activating the upper body pedestal, has received considerable amount of interest in sailing literature (Pearson et al., 2009a). Indeed, the demands of grinding on the upper body have been well established and bench press performance has been associated with sailing success (Pearson et al., 2009a) and manoeuvre efficiency (Neville et al., 2009b). Also, the work-to-rest ratio, on the pedestals, appears to permit appropriate recovery between bouts of intense activity (Neville et al., 2009b) and, thus, avoid risks of overtraining. This may explain the positive upper body neuromuscular adaptations in response to a high sailing WL.

A novel aspect of the hereby study was the monitoring of professional sailors' perceptual wellbeing across a full pre-competition period. To the best of the author's knowledge, this has been reported, to some extent, elsewhere in the literature. Indeed, past research in off-shore sailing has shown interest in establishing dose-response relationships between environmental and wellbeing factors such as anxiety and perception of fatigue (Hagin et al., 2012). Similarly, when comparing to longer assessments (i.e., QEFA Likert scale), the HI has been found to be (i) a promising tool for monitoring training induced fatigue in team sports (Oliveira et al., 2019) and (ii) associated with WL in professional athletes (Moalla et al., 2016). In the present study, the $Test_{1-7}$ HI (Figure 83) was found to be positively correlated with WL_{wk} , WL_{str} and WL_{mono} . In addition, the ACWR data smoothing model seems to be a valid tool for predicting HI. These findings are of important value when aiming to bridge the gap between WL and fatigue markers. The HI can therefore be considered as an affordable and practical solution for monitoring physiological and psychological stress in a professional sailing environment.

From a physiological point of view, changes in SC may have an impact on neuromuscular and cognitive performance. Indeed, cortisol could alter the activity of the sympathetic nervous system, the muscles' contractile properties and/or behaviour (Crewther et al., 2011) and seems to be a primary indicator of physiological stress (Lindsay et al., 2015). There is a substantial body of literature addressing [C] increase in response to WL and competition. In the current study, the interactions between WL (WL_{wk} , WL_{str} and ACWR) and SC were predominantly clear (Figure 83). Indeed, the hormonal response to training seems to be impacted by short (7-days) preceding WL. This observation is similar to findings in other team sports (Rowell et al., 2018) where SC increased in response to WL. In our study, the SC concentrations at $Test_6$ were the highest observed during the pre-competition period and were

significantly different from baseline levels. These results suggest that high sailing WL may have an impact on stress hormone balance. This is in-line with reported studies that have analysed biomarkers in sailing activities (Giacon et al., 2021). The increase in SC may indicate the athletes' natural response to the previous training phase (Oliveira et al., 2019).

5.3.5 Study limitations

Although our findings provide important and novel information for performance practitioners in the offshore sailing environment, there are some limitations that warrant discussion. First, we acknowledge that the data were collected on a small sample of sailors (i.e., one team). The use of larger sample sizes (e.g., more teams) would allow further and more precise correlational analysis. Second, due to sailing's dependency on climatic variables, the training structure may represent a different organization when compared to other sports. Future research, based on sailing, could therefore explore the effects of sailing WL on markers of adaptation through daily measurements. Indeed, exploring external load (e.g., GPS tracking, manoeuvre count) may prove to be useful for establishing valid methods able to quantify sailing WL. Furthermore, the findings of the present study are based on data from one professional sailing crew, thus, the applicability to all sailing classes is unknown. A further limitation of the study might reside in the timeframe when data collection occurred. Indeed, Covid-19 crisis restrictions did not allow for more sailing camps to be programmed.

5.3.6 Practical applications

This study provides initial guidelines on the relationship between WL and neuromuscular performance, wellbeing, and SC in offshore sailing. Indeed, because voluminous and varying WL are observable in this environment, WL monitoring must be practiced daily during a pre-competition phase. By analysing this data, performance practitioners will be guided to (i) optimally adapt the training plan according to the situation/weather, (ii) provide the skipper with valuable information on potential risks of injury/overtraining and (iii) plan and ensure adequate recovery interventions to enhance performance.

5.3.7 Conclusion

This is the first longitudinal study to provide information on WL parameters in a professional mixed-sex crew offshore sailing team during the preparation period of a renowned offshore regatta. This investigation observed (i) significant differences between BSL levels and periodical evaluations and (ii) significant correlations between WL parameters and neuromuscular performance, wellbeing, and SC. In addition, BP_{ress} 1RM, CMJ and SC may be used as objective markers of preparedness for an offshore regatta. HI may provide valu-

able information concerning physiological and psychological stress with less time-consuming/costly procedures. Also, due to the decaying nature of fitness and fatigue, the EWMA data smoothing model seems to be a reliable predictor of neuromuscular preparedness. The ACWR, on the other hand, appears to better predict subjective markers of fatigue. The results presented in this study confirm the importance of managing WL in professional offshore sailing in the quest to optimizing training related adaptations and recovery.

Study three | *Personal contribution* *Theme three*



PHILIPPE K , PAILLARD T , MAURELLI O, MOODY J
& PRIOUX J.

Effects of an offshore sailing competition on anthropometry, muscular performance, subjective wellness, and salivary cortisol in professional sailors.

International Journal of Sports Physiology and Performance
2022; 17(8):1205-1212

5.4 Study III: Effects of an offshore sailing competition on anthropometry, muscular performance, subjective wellness, and salivary cortisol in professional sailors.

5.4.1 Introduction

Offshore sailing is a strategy-based sport that is intermittent in nature, with periods of high intensity activity (e.g., stacking, trimming and grinding) and low intensity recovery (e.g., standing and sleeping) (Ghiani et al., 2018). Depending on the nature of the race, vessels are sailed by lone sailors or crews and can last from days to months. Over the course of a crewed boat race, such a TOR, sailors are required to compete for many days during legs that rally the host cities. Few days are given to recover in between legs. Therefore, sailors need to recover quickly to start the following leg in an optimal state of readiness. Although studies from other team sports have outlined the acute effects of WL on anthropometrical, physiological and psychological variables (Gorostiaga et al., 2006 ; Dubois et al., 2020), the research conducted in a professional offshore crew-sailing environment is scarce (Branth et al., 1996 ; Portier et al., 2008). Moreover, given the physical demands imposed during sailing, sailors typically experience high physiological stress and prolonged symptoms of fatigue (Oldenburget al., 2013). This is in part due to the various weather conditions and the extensive physical demands of manoeuvring. Indeed, to optimize the vessel's speed, a sailor must be able to withstand high levels of physiological stress associated with weather conditions (temperature, wind, and sea state) (Sagayama et al., 2019). To counterbalance the movement of the boat, and thus promote faster speed, stacking and trimming sails on deck requires high levels of physical readiness (Sagayama et al., 2019). Sailors must also adapt to sleep deprivation and little comfort (nutrition, noise and hygiene) in order to limit impairments on cognitive performance, necessary for establishing routing strategies and evaluating weather forecasts. Past studies have investigated the impacts of sailing bouts on neuromuscular functions, energy demands and stress hormones. These studies have reported increases in neuromuscular fatigue (Portier et al., 2008), muscular damage (Barrios et al., 2011), cognitive impairment (Hurdiel et al., 2014), motion sickness (Giacon et al., 2022) and elevated [C] levels after a sailing bout (Hayes et al., 2015). Although the current literature suggests that significant fatigue is induced by offshore sailing, little evidence is available in a crewed context. For this reason, monitoring the physiological and psychological adaptations from competition are thought to be important. Indeed, this can provide a better understanding of the demands of the sport and, thus, help bridge the gap between theory and practice for offshore sailing performance pathways.

Therefore, this article attempts to provide an overview of offshore sailing demands by (i) documenting the characteristics of the race and (ii) describing the physiological responses

to competition and (iii) examining the neurophysiological and psychological fatigue patterns in a professional mixed-sex crew. It was hypothesized that offshore sailing would (i) provoke body composition turnover, (ii) decrease muscular performance and (iii) generate stress and perception of fatigue.

5.4.2 Methods

Subjects

Ten (8 males and 2 females) professional sailors (mean \pm SD; age: 32.2 ± 3.96 years; stature: 179.1 ± 7.30 cm; body mass: 84.2 ± 12.1 kg) volunteered to participate in the study. There were no reported injuries or diseases that would impair physical performance from any subject. Before starting the protocol, sailors attended a presentation and received information outlining the experimental procedures. The study protocol was approved by the ethics committee of Rennes University, France. Written informed consent was obtained from all subjects prior to the commencement of the study and all subjects were free to withdraw from the study at any time without penalty.

Design

All data was collected during a renowned international offshore sailing venue over a 3-week period. The TOR 2021 competition took place in June. All sailors competed in the same crew and had been training for 7-months preceding the race. Anthropometric measurements, muscular function testing, subjective recovery markers and SC were obtained during BSL measurements and after each of the 3-legs (Post₁₋₃). The testing protocol was adjusted to fit the complexity of the sport. BSL measurements occurred 3 hours before the start of Leg 1 and Post₁₋₃ occurred within 30-min of docking in. Over the 3-week study period, data from 10 days of sailing was collected and analysed (Figure 84). Testing was conducted at the team's base, located in the different host cities, to ensure minimal disruption to the recovery process. Throughout the competition period, athletes were monitored by a qualified team doctor, physiotherapist, strength and conditioning coach and nutritionist. During recovery days, sailors underwent light cardiovascular activation (e.g., 20-min of jogging at 60% of maximal heart rate), sports massage and mobility sessions (e.g., static, and dynamic stretching).

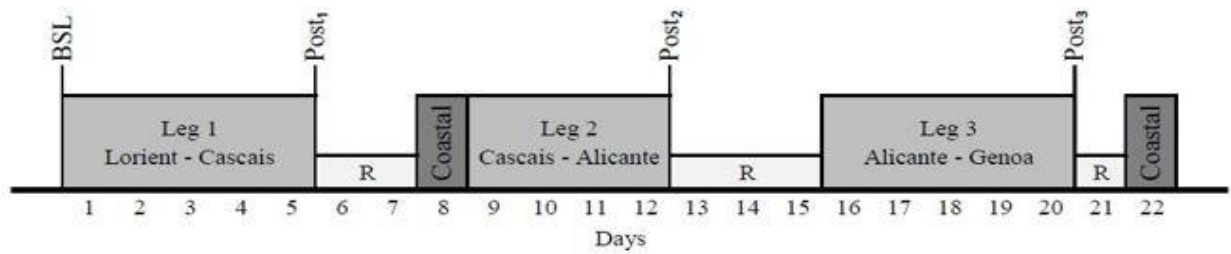

Figure 84. Timeline of TOR 2021 and assessments during 3-weeks of study. BSL: Baseline; Post₁₋₃: Measurements obtained after Leg₁₋₃; R: Recovery.

Methodology

Baseline Measures

On the morning of the first day of competition, 3-hours prior to starting Leg 1 of TOR, sailors underwent the testing battery (Figure 85). The crew was at the end of a tapering week and therefore had not participated in high intensity training the week prior to testing. The testing battery consisted of anthropometric measurements, fitness testing, wellness questionnaire control and SC collection. To account for diurnal variation, SC was collected within 1-hour of waking up, between 7:00-8:00 AM. The results from the first testing battery established the BSL.

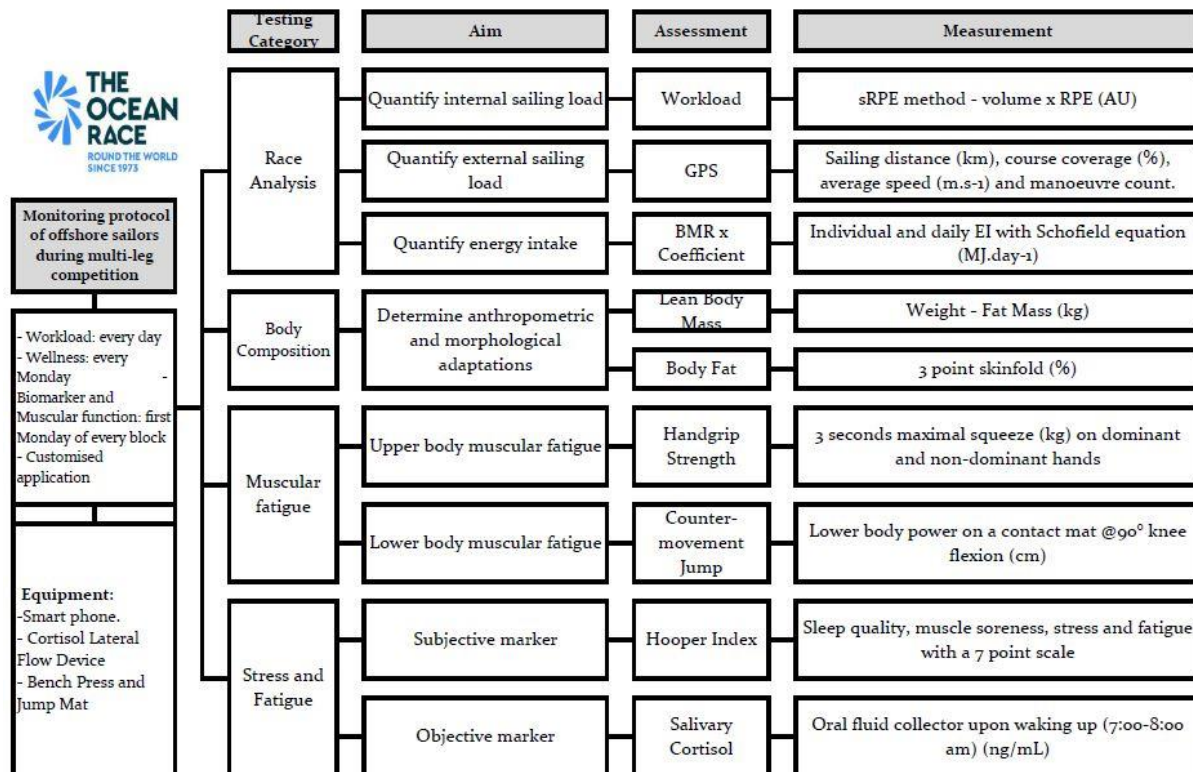

Figure 85. Monitoring protocol of offshore sailors during multi-leg competition; Theme 3.

Testing Battery

Anthropometric measurement.

Anthropometric characteristics were measured in the following order: body mass and skinfolds. A weighing scale (Seca[®], Hamburg, Germany) was used to measure body mass. Measurements for body mass were made with an accuracy of 0.1 kilograms (kg). $\Sigma 3$ Skinfold were taken on the right side of each sailor (male: pectoral, abdominal and thigh; female: triceps, abdominal and thigh) according to recommendations by Jackson and Pollock (Jackson & Pollock, 1978). The skinfolds were measured with a Harpenden skinfold calliper (Harpenden[®], Burgess Hill, UK) with 10 g.mm⁻² of constant pressure. Body density was assessed while body fat (BF) was calculated using Brozek's equation (Brozek et al., 1963). Lean body mass (LBM) was calculated by subtracting BF from total weight.

Muscular performances

Countermovement Jump

Lower body power was tested on the CMJ using a chronojump contact mat (Chronojump-Boscosystem[™], Software, Spain). Each sailor completed three attempts with 1-min of rest between trials. For the execution of each attempt, a countdown of “3, 2, 1, jump” was indicated orally. All attempts were completed with sailors placing arms akimbo to avoid movement disruption. Sailors were instructed to perform a rapid eccentric phase, immediately followed by an explosive concentric contraction with the intention to jump as high as possible. The height of the best CMJ performance was reported for analysis.

Handgrip strength

Maximal isometric HGS was assessed with a Jamar[®] handgrip dynamometer (Sammons Preston Corp., Bolingbrook, Ill., USA). The test positions were standardized (Svantesson et al., 2009). Three trials were performed on each hand. The first three trials started with the right hand. Sailors were instructed to squeeze the device as hard as possible for 3-s. The time between each trial was 15-s and 3-min of rest was given when changing hands. The maximal measure of the three trials was retained in Kg. Sum (HGS_{sum}) of both, dominant hand (HGS_d) and non-dominant hand (HGS_{nd}), measures were assessed and included in the results.

Subjective Recovery Status

The HI was measured using a customized questionnaire based on the recommendations of Hooper and Mackinnon (Hooper, 1995). Levels of sleep quality (HI_{sleep}), delayed onset muscle soreness (HI_{doms}), stress (HI_{stress}) and fatigue (HI_{fatigue}) were scored on a 7-point scale on which “1” and “7” represent “very, very good” and “very, very poor” respectively. The

Hooper-Index was computed by summing its four subgroups. It was applied 30-min after the leg arrival (Post₁₋₃). All questions and answers were completed individually.

Salivary Stress Marker

Sailors' saliva samples were collected upon waking (between 7:00 and 8:00 am). To ensure more rigorous testing and to limit cortisol measurement errors, sailors were required to refrain from eating, brushing their teeth and chewing gum prior to testing. Sailors placed the swab (Soma Bioscience, Wallingford, United Kingdom) on their tongue and closed their mouth. When the indicator on the swab's stem turned blue, the test was considered complete (swab collected 0.5 mL of oral fluid). The swab was then placed in the buffer bottle of assay (sodium phosphate, salts, detergents, and preservatives) before gently mixing the sample for 2-min. Two drops of the sample were then placed in the window of the lateral flow device. The device was left still during the incubation period (10-min). The strip was then placed in the real-time reader and the results were ready within 20-s. SC was then collected as nanograms per millilitre (ng/mL). Soma Bioscience oral fluid collector has been validated against enzyme linked immunosorbent assay (ELISA) and have been proven as a reliable method to collect and analyse SC (Ducker et al., 2020).

Race analysis

Internal Sailing Load

Subjective internal load was estimated using the session-rating of perceived exertion (s-RPE), with ratings (Borg 0-10 scale) obtained from each individual sailor within 30 min of completing each leg. Each sailor was familiarized with the scale before starting the study. The obtained value was multiplied by the time sailed (in min) during the leg to register a sailing load in AU (Foster et al., 2001).

External Sailing Load

Race data - including sailing distance, average speed, course coverage and manoeuvre count (tack and gybe) were collected during the 3-legs of competition. Data was made available through GPS units and shared by the navigation specialist of the team. Route and manoeuvre count were measured by the official TOR tracker.

Energy intake

EI was measured to prepare individual meal plans prior to TOR. BMR was calculated using the Schofield equation (Schofield, 1985) and was multiplied by a PA coefficient which was determined by categorizing each position on-board by its physical demands (Myers et al., 2008). Individual EI was prepared before each leg and controlled upon arrival by the human performance practitioner.

Statistical Analysis

Data was calculated through standard statistical methods and is presented as mean \pm standard deviation. All variables were considered normally distributed through analysis with the Shapiro-Wilk test, histograms, and skewness values prior to analysis. One way ANOVA with repeated measures was used to determine the differences between the different parameters during the 3-legs. When results were significantly different, an effect size (ES) calculation was used. ES was evaluated using Cohen's d along with 95% confidence intervals (CI). ES of ≤ 0.2 , 0.21-0.60, 0.61-1.20, 1.21-2.0, ≥ 2.0 were considered as trivial, small, moderate, large, and very large, respectively (Cohen, 1988). Statistical analyses were performed using the SPSS package (15.0 version; SPSS, Inc., Chicago, IL, USA). The level of significance was set at $p < 0.05$.

5.4.3 Results

Table 18 describes the external and internal load statistics across the 3-legs of TOR. A total of 5167-km was sailed in 10 days 4h 31 min at an average speed of $5.87 \text{ m}\cdot\text{s}^{-1}$. 88 manoeuvres (i.e., 53 tacks and 35 gybes) were performed with each one occurring every 58.7 km. Leg 1, the longest leg of the three, was characterised by its downwind nature, fast speed (i.e., $7.5 \text{ m}\cdot\text{s}^{-1}$) and accounted for 51 % of the total distance of TOR. Leg 2 reported to have the most tacking manoeuvres (i.e., 28) and outlined a higher RPE (7.8 ± 2), although time at sea was the shortest of the three. It was characterized by its upwind nature and high manoeuvre frequency (1 every 2h 02 min). Leg 3 held the most manoeuvres (i.e., 35) and was characterised by its slow speed (i.e., $4.02 \text{ m}\cdot\text{s}^{-1}$).

The multilevel ANOVA (Table 19) found no significant difference in anthropometric parameters during the 3 legs of racing when compared to BSL. Differences were nevertheless observed at Post₃ for BF ($p=0.004$; ES = 0.25) when compared to Post₂.

Table 18. External and internal load of TOR.

Variables	Leg 1	Leg 2	Leg 3	Total
<i>External load</i>				
Course distance (km)	2411.3	1074.2	1070.5	4556.0
Distance sailed (km)	2655.8	1299.9	1211.8	5167.5
Course coverage (%)	110	121	113	113.5
Time at sea	4 days 1h 8 min	2 days 15h 31 min	3 days 11h 52 min	10 days 4h 31 min
Total manoeuvres	22	31	35	88
<i>Tacks</i>	0	28	25	53
<i>Gybes</i>	22	3	10	35
Manoeuvre/time	4h 24 min	2h 02 min	2h 29 min	2h 47 min
Average speed (m.s ⁻¹)	7.5	5.68	4.02	5.87
<i>Internal load</i>				
RPE	7.45 ± 2.2	7.8 ± 2.0	5.85 ± 1.4	
s-RPE (AU)	43418.6 ± 12548.8	29725.8 ± 7579.5	30490.2 ± 7477.6	

Tack: Upwind Manoeuvre; Gybe: Downwind Manoeuvre; s-RPE: Session Rate of Perceived Exertion.; AU: Arbitrary Units.

Table 19. Description of body composition and energy intake throughout TOR.

Variables	BSL	Post ₁	Post ₂	Post ₃
<i>Body Composition</i>				
Body Mass (kg)	84.24 ± 12.7	83.79 ± 12.8	83.57 ± 12.8	84.38 ± 12.5
LBM (kg)	70.72 ± 11.4	70.66 ± 10.3	70.74 ± 10.6	70.42 ± 10.0
BF (%)	16.04 ± 5.6	15.66 ± 4.9	15.34 ± 4.9	16.54 ± 4.7 ^{††}
<i>Energy Intake</i>				
BMR (cal.day ⁻¹)	1802.67 ± 173.3			
Coefficient	2.23 ± 0.3			
EI (MJ.day ⁻¹)		15.57 ± 2.6	16.43 ± 2.5	16.8 ± 2.6
<i>Carbohydrates (%)</i>		57.34 ± 11.7	54.42 ± 12.2	56.75 ± 8.6
<i>Protein (%)</i>		21.55 ± 4.1	23.3 ± 6.4	24.2 ± 5.7
<i>Fat (%)</i>		21.11 ± 8.5	23.28 ± 7.3	19.05 ± 4.3

BSL: Baseline; Post₁₋₃: Measurements obtained after Leg₁₋₃; LBM: Lean Body Mass; BF: Body Fat; BMR: Basal Metabolic Rate; EI: Energy Intake. †† Significant difference with values of preceding Test; p≤0.01.

Compared with BSL (37.0 ± 8.0 cm), CMJ height (Figure 86) significantly decreased at Post₂ (33.1 ± 6.6 cm; $p=0.05$; ES = 0.53) and Post₃ (33.2 ± 7.7 cm; $p=0.05$; ES = 0.49). A significant decline was observed between Post₁ and Post₂ ($p=0.007$; ES = 0.58). Upper body strength (Figure 87) decreased for HGS_{sum} when compared with BSL (113 ± 22.3 kg) at Post₁ (107.0 ± 19.6 kg; $p=0.01$; ES = 0.29), Post₂ (102.4 ± 19.0 kg; $p=0.001$; ES = 0.51) and Post₃ (108.6 ± 18.8 kg; $p=0.05$; ES = 0.21). Post₂ ($p=0.03$; ES = 0.24) and Post₃ ($p=0.03$; ES = 0.3) were significantly different from preceding legs. HGS_d also decreased at Post₁ (55.4 ± 10.7 kg; $p=0.002$; ES = 0.44), Post₂ (52.9 ± 10.0 kg; $p<0.001$; ES = 0.62) and Post₃ (56.2 ± 10.4 kg; $p=0.02$; ES = 0.31) when compared to BSL (59.7 ± 11.9 kg). HGS_d was significantly different from preceding legs at Post₂ ($p=0.04$; ES = 0.25) and Post₃ ($p=0.02$; ES = 0.33). HGS_{nd} was only significantly different from BSL (53.3 ± 10.7 kg) at Post₂ (49.5 ± 9.5 ; $p=0.02$; ES = 0.37).

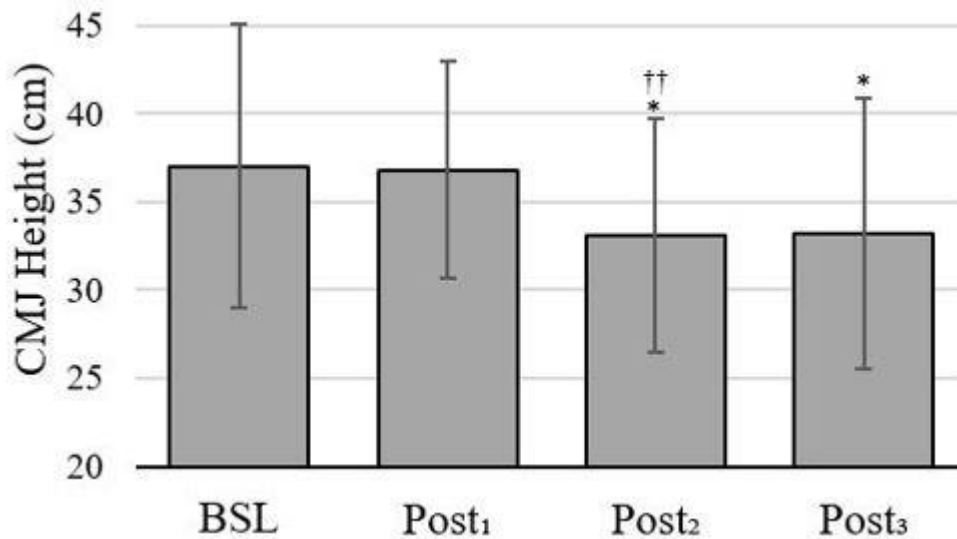

Figure 86. Changes in countermovement jump height throughout TOR. BSL: Baseline Level; CMJ: Countermovement Jump; Post₁₋₃: Measurements obtained after Leg₁₋₃. * Difference is significant to BSL at $p \leq 0.05$; †† Significant difference with values of preceding Test; $p \leq 0.01$.

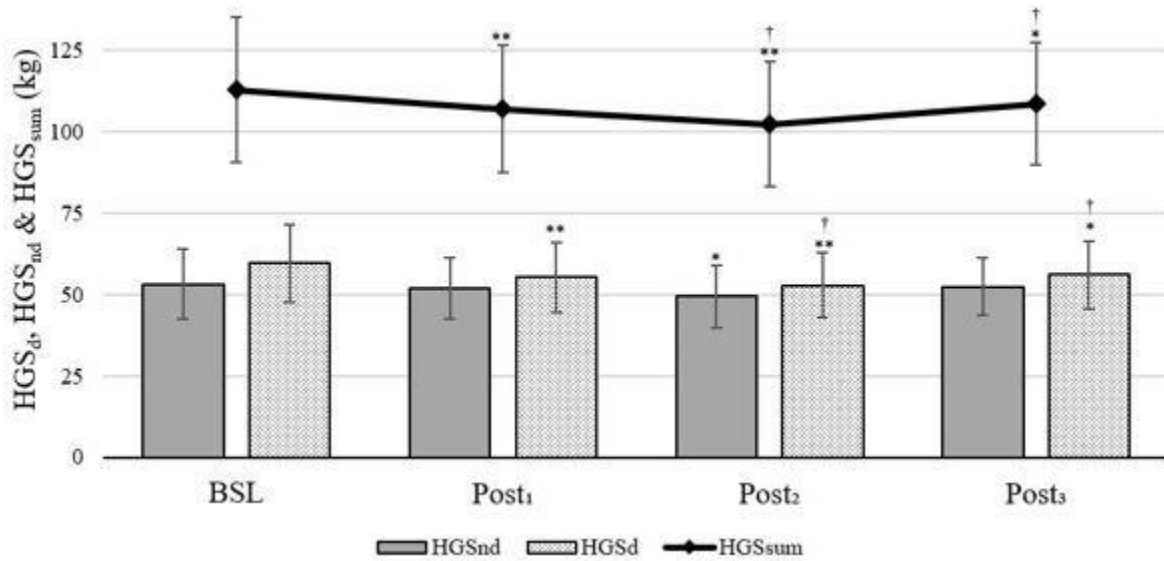

Figure 87. Changes in handgrip strength throughout TOR. HGS_d: Dominant Handgrip Strength; HGS_{nd}: Non-Dominant Handgrip Strength; HGS_{sum}: Sum of HGS_d and HGS_{nd}; BSL: Baseline Level. * Difference is significant to BSL at $p \leq 0.05$. ** Difference is significant to BSL at $p \leq 0.01$. † Significant difference with values of preceding Test; $p \leq 0.05$.

The Hooper Index (Figure 88) increased significantly at Post₁ (17.4 ± 2.9 AU; $p=0.001$; ES = 1.43) and Post₂ (19.2 ± 2.7 AU; $p=0.001$; ES = 2.23) when compared to BSL (13.7 ± 2.2 AU). HI was significantly different between Post₂ and Post₃ ($p=0.005$; ES = 1.65). Sleep quality decreased significantly at Post₁ (4.6 ± 0.9 AU; $p=0.04$; ES = 1.05) and Post₂ (5.4 ± 1.1 AU; $p=0.006$; ES = 1.76) when comparing with BSL (3.7 ± 0.8 AU) and at Post₃ ($p=0.04$; ES = 1.34) when comparing with preceding leg. Perception of fatigue was significantly different from BSL (3.4 ± 0.5 AU) at Post₃ (4.2 ± 0.9 AU; $p=0.04$; ES = 1.09). Stress at Post₁ (4.9 ± 0.5 AU; $p < 0.001$; ES = 2.33) and Post₂ (5.7 ± 0.6 AU; $p < 0.001$; ES = 3.26) was significantly different to BSL (3.2 ± 0.9 AU). Muscle soreness did not differentiate with BSL (3.4 ± 0.7 AU) during the race.

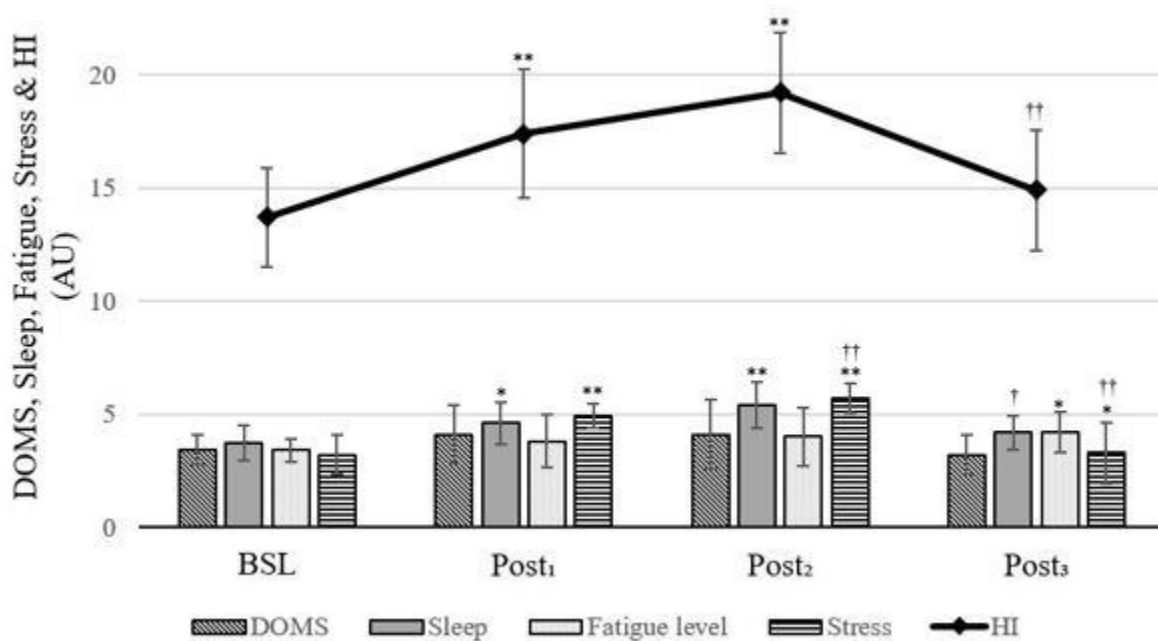

Figure 88. Changes in subjective wellbeing parameters and Hooper Index during TOR. DOMS: Delayed Onset Muscle Soreness; HI: Hooper Index; BSL: Baseline Level. * Difference is significant to BSL at $p \leq 0.05$. ** Difference is significant to BSL at $p \leq 0.01$. † Significant difference with values of preceding Test; $p \leq 0.05$. †† Significant difference with values of preceding Test; $p \leq 0.01$.

SC levels (Figure 89) varied throughout the competition. Post₁ (18.6 ± 5.6 ng/mL; $p=0.005$; ES = 1.44), Post₂ (14.2 ± 2.9 ng/mL; $p=0.03$; ES = 0.76) and Post₃ (16.2 ± 6.7 ng/mL; $p=0.02$; ES = 0.84) were all significantly different from BSL (11.5 ± 4.1 ng/mL). Variation with preceding legs was significant at Post₂ ($p=0.03$; ES = 0.97).

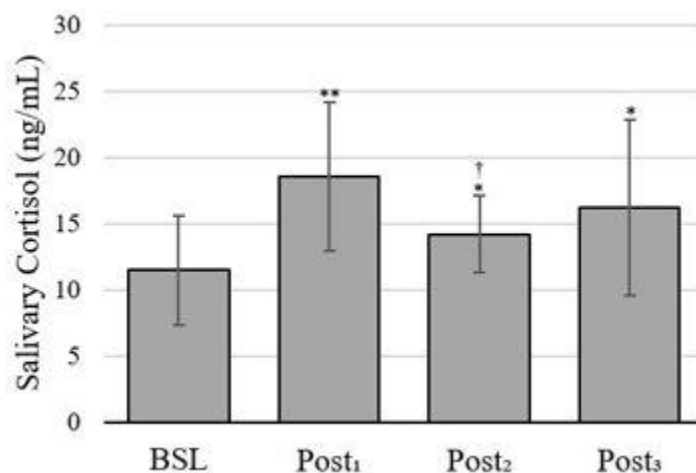

Figure 89. Changes in salivary cortisol during TOR. BSL: Baseline Level. * Difference is significant to BSL at $p \leq 0.05$. **Difference is significant to BSL at $p \leq 0.01$. † Significant difference with values of preceding Test; $p \leq 0.05$.

5.4.4 Discussion

The hypotheses initially stated were globally validated since body composition was partially modified, muscular performance decreased, and objective and subjective fatigue were observed during and after the competition.

Although previous research in sailing have observed weight loss, fat percentage and lean body mass decreases after competition (Branth et al., 1996 ; Hurdiel et al., 2014 ; Ghiani et al., 2018 ; Philippe et al., 2021), the results of the current study found only significant changes in BF (%) at Post₃. Indeed, during the 3-weeks of competition, when comparing BSL levels with post₁₋₃, no significant differences were observed. A potential reason for differentiation with other research may be due to sailors being tested extensively to determine their individual energetic needs on-board. Previous research has highlighted that loss in body mass and, more particularly, lean body mass decrease, could eventually hinder physical and cognitive performance (Lafère et al., 2020). It was therefore essential to provide the sailors with the adequate EI as they were confronted to irregular biological rhythm, sleep deprivation, incessant compensatory muscle activity and continuous stress (Branth et al., 1996). Elevated EI values (i.e., 15-17 MJ.day⁻¹) have been reported in other research with considerable weight loss still being observed (Branth et al., 1996). Nevertheless, it should be noted that the legs studied here were shorter and occurred in warmer climate. Also, daily protein consumption was more important in the present study (23% vs. 14% in the previous study mentioned) and could explain, in part, the maintenance of LBM (Choma et al., 1998) throughout TOR.

The results from the current study confirm that sailors experienced a significant decline in CMJ height (Figure 86) during and after TOR. Similar responses during competition have been observed across various “long distance sports” (Martens & Westerterp, 2014). A decrease in lower body strength and power abilities immediately after sailing is common in professional sailors (Balsalobre et al., 2014). However, this study provides new insights that, to the author’s knowledge, have never been investigated in professional crews. Indeed, contrarily to past research, the sailors in this study did not suffer from body mass loss and/or muscle wastage during the competition. These results are in line with findings highlighting muscular function impairment due to the yawing, rolling, and pitching motions (sway) of the hull (Blacha et al., 2019). Moreover, the downwind specificity of Leg 1 (i.e., 22 gybes) elicited no impairment to lower body muscular function contrarily to Leg 2 and Leg 3, which were mainly upwind. Upwind legs seemed to affect lower limbs muscular function more than the downwind leg despite Leg 1 being two times longer than Leg 2 and Leg 3 (Tables 17 and 18). This alteration may be linked with the constant swaying of the hull caused by swell in upwind sailing conditions. Indeed, maintaining constant proprioceptive tension, due to hull movement, seems to increase the mechanical loading of hip extensors and hip flexors.

HGS (Figure 87) has received a considerable amount of interest in previous research. Indeed, it has been associated with greater upper body strength, ballistic performance, lean body mass (Stoffregen & Smart, 1998), athlete level differentiation (Cronin et al., 2017) and success (Grant et al., 1996). The offshore sailors in our study reported superior HGS_d at BSL compared to other offshore sailing research (i.e., in the present study 59.7 ± 11.9 kg vs. 53.6 ± 8.3 kg and 40 kg in previous studies (Portier et al., 2008 ; Philippe et al., 2021) and similar to crewed dinghy racing (61.1 ± 9.5 kg in another study; Grant et al., 1996). Indeed, the physical WL associated with grinding, hoisting, stacking, and trimming the sails is intense and requires a fair amount of grip strength. Nevertheless, previous research reported that HGS performance was preserved after offshore sailing competition (Portier et al., 2008 ; Philippe et al., 2021). However, in this current research, the sailors observed a progressive decay of maximal strength in HGS during each leg. The decrease in performance detected in our study could be explained by the specific physical demands of the vessel used in TOR. Indeed, the racing conditions are known to be more extreme and the boat harder to handle due to its low displacement and facilitation to plane (Branth et al., 1996). Hence, we can assume that the sailors underwent extensive upper body solicitation during TOR and suffered from high levels of neuromuscular fatigue.

The Hooper Index and its subsets (i.e., sleep quality, fatigue, stress, and muscle soreness) has recently been shown to be a promising tool for monitoring indices of fatigue and preparedness in many sports (Clementic et al., 2017). However, research examining the effects of sailing on subjective recovery variables is scarce. Indeed, research has mainly focused on sleep quality and highlights the effects of sleep deprivation on cognitive performance (Barrios et al., 2011). These studies have put forward the need to identify an optimal balance between wakefulness and planned to sleep to optimize sailing performance. The results in our study (Figure 88) found that HI_{sleep} and HI_{stress} were more pronounced during the legs where the RPE was higher (i.e., Post₁ and Post₂). Despite the multiple physical stressors involved in sailing, HI_{doms} was preserved during TOR, whereas HI_{fatigue} increased linearly throughout the race and was significantly different from BSL at Post₃. Nevertheless, it should be noted that sailors were provided protein supplementation on-board and in-between legs to optimize muscular recovery (Pasiakos et al., 2014) and to avoid muscle atrophy linked to the accumulation of high [C] during sailing (Hurdiel et al., 2014). In fact, sailors had been training regularly 7-months prior to competition which could have generated morphological adaptations in the muscle fibres necessary to withstand the induced mechanical stress without causing structural alterations.

Intensified WL periods have been found to increase [C] (Tierman et al., 2019). This hormonal increase has been associated to stress tolerance disturbances and decreases in performance. Studies in other long distance/duration sports have shown that athletes experi-

enced greater concentration of SC in post competition phases (Branco et al., 2018). In sailing, few studies have considered analysing catabolic hormone alterations despite significant increases in [C] being observed at sea (Oldenburg & Jensen, 2019). Indeed, sailors in the current study showed an elevation of SC levels at Post₁₋₃ (Figure 89) which corresponded to the s-RPE fluctuations observed during the legs (Table 18). Moreover, HI did not differentiate from BSL at Post₃ despite its' correlation to SC (Chida & Steptoc, 2009). This finding may be due to the crew's winning performance during the final leg. Indeed, subjective wellness seems to be associated with competition outcome (Abbott et al., 2018). Nevertheless, it was found that SC levels increased significantly after intense bouts of offshore sailing. This seems to be in line with other studies analysing the effects of prolonged change of circadian rhythms in confined environments (Depero et al., 2021).

5.4.5 Practical Application

This study has revealed several practical applications that are relevant to human performance practitioners and sailors alike. Over an intensified period of offshore sailing competition, when there is insufficient time to recover between legs, physiological and psychological fatigue accumulates. Impaired readiness when sailing may compromise the boat's performance by reducing physical and cognitive capabilities. As such, cautious WL monitoring should be implemented by practitioners during a competitive phase to determine a sailor's readiness and recovery status. Upper body and lower body muscular capabilities, as well as SC, were impacted by an offshore sailing competition and markers obtained from CMJ and HGS appear to be sensitive ways of detecting muscular fatigue. Questionnaires that assess subjective wellness parameters are useful tools for monitoring fatigue and recovery during offshore sailing competition. Such questionnaires are non-invasive and non-expensive tools that can be used frequently to provide useful information on an athlete's readiness to sail. This research was conducted over a reduced 3-week competition as an adaptation to the current covid-19 crisis. Future research, during longer events, is required to conduct correlational analyses aiming to identify relationships between sailing specific external load and monitoring markers. Larger sample sizes would also allow further exploration of activity profiles, according to crew position, on-board. In addition, as laboratory measures are expensive markers, further investigations are needed to examine the relationship between external WL parameters and subjective markers of recovery found in questionnaires. Furthermore, using micro-captors and video analysis, researchers could observe position specific activity and determine the physical and physiological demands for each maneuver and/or sailing situation (Lacome et al., 2014).

5.4.6 Conclusion

To the best of our knowledge, this is the first longitudinal study to provide information on the effects of offshore sailing on physiological parameters and fatigue patterns in a professional mixed-sex crew sailing team. This investigation confirmed (i) very little effect on anthropometric parameters (ii) significant decreases in lower- and upper body muscular abilities, (iii) significant variations of wellness parameters during the different legs and (iv) increases of SC stress hormone during and after competition. Therefore, the current study presents the impacts that offshore sailing has on athletes. The results will provide helpful information for sports scientists, sailing coaches and performance practitioners to appropriately manage the training and recovery processes in their quest to optimize human performance.

Chapter six | *General discussion*

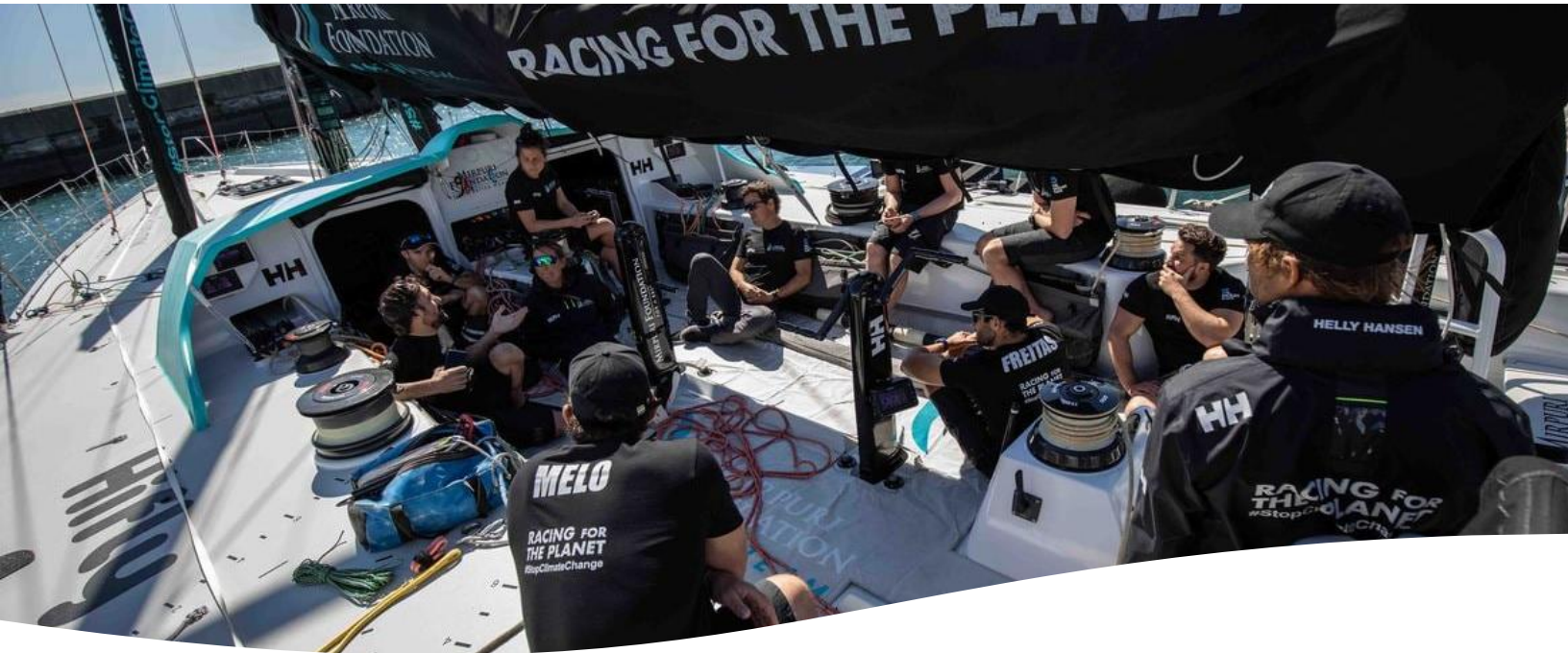

“In the middle of difficulty lies an opportunity.”

- Albert Einstein

6.1 Main findings of the thesis

The general aim of this thesis was to contribute to the development of strength and conditioning practices in offshore sailing literature. This work was divided into three themes – the main aims and subsequent findings from which are as follows:

► **Theme 1.** In this first section, we aimed to investigate the differences between successful and less successful sailors in a renowned competition. To do so, we introduced a sound and scientifically based testing battery to establish anthropometry and physical profiles of sailors participating in the *Sailing Tour de France*. Professional sailors volunteered to participate in two testing sessions (11 tests) prior to the start of the competition. The screening protocol included various field (Hand grip strength, SJ/CMJ, and Modified Rowing Wingate) and laboratory tests (IMTP and $\dot{V}O_2\text{max}$). Furthermore, data were collected from all the sailboats' GPS units during the competition. The data analysis allowed us to document the nature of the race and to establish associations between testing parameters and the final ranking. This data was also used to observe technical differences between successful and less successful boats. Specifically, 21 professional sailors were assessed, and 89 legs were analysed. The findings were able to identify multiple technical and physical variables capable of discriminating sailors based on performance. Successful sailors were significantly stronger ($p < 0.01$ in handgrip, isometric mid-thigh pull, and bench pull performances) than their less successful counterparts. The bench pull test was strongly correlated to the final rankings with HGSDom ($r = 0.54$), IMTPW ($r = 0.41$) and BPMPV20 ($r = 0.61$) were significantly correlated ($p < 0.01$) to rank in NS heats. CR results were correlated to HGSDom ($r = 0.37$; $p < 0.05$) and BPMPV20 ($r = 0.74$; $p < 0.01$). On a technical overview, ($p < 0.01$) with starting performance ($r = 0.52$), maximal speed ($r = 0.33$) and average speed ($r = 0.76$) were found to be associated with final rankings. Unfortunately, the low sample size (i.e., 21) accounted for 6 fully crewed boats out of 23. Testing more crew members could have permitted more significant correlational analysis in the crew-specific positions.

► **Theme 2.** Our aim in theme 2 was to focus on WL monitoring during the pre-competition phase of an offshore competition and to observe associations between objective and subjective markers of adaptation. To do so, we organised a monitoring protocol to collect daily, weekly, and monthly data of sailors participating in *The Ocean Race*. Professional sailors ($n = 10$) from the same team volunteered to participate in the 6-months longitudinal study. The monitoring strategy consisted of collecting data daily (WL parameters), weekly (subjective wellness), and monthly (objective measures of adaptation). Data was collected through the utilisation of a customised smartphone application. The findings identified (i) significant differences between baseline levels and periodical evaluations and (ii) significant

correlations between WL parameters and markers of recovery/adaptation. SC, bench-press 1RM, and the countermovement jump were found to be valid and reliable objective assessments for evaluating progression. The Hooper-Index provided interesting subjective information concerning physiological and psychological stress. After analysis of statistical methods of WL monitoring, ACWR was a good predictor of subjective markers of fatigue, whereas EWMA predicted muscular preparedness. Furthermore, our results highlight the complexity of WL monitoring in an offshore sailing environment due to the high variation of weekly WL originating from sailing training. Unfortunately, the sanitary crisis at the time (Covid-19) provoked sailing restrictions during the pre-competition period. This would have allowed us to conduct a more precise dose-response analysis concerning sailing load.

► **Theme 3.** The objective of theme 3 was to observe the effects of competition on physiological parameters and fatigue patterns. We developed a succinct protocol to evaluate sailors before, during, and after the competition. The subjects were the same studied during theme 2 (n= 10). Sailors were tested the day before the competition and upon arrival in the different harbours. Body composition, muscular function, subjective wellness, and SC were assessed. Furthermore, GPS data of the boat's external load (distance, speed, manoeuvre count, and course coverage) was collected and analysed to document the nature of the race. The findings were able to identify that the offshore competition (i) had little effect on body composition, (ii) significantly decreased lower- and upper-body neuromuscular abilities, (iii) provoked significant variations of wellness parameters during the three legs, and (iv) increased catabolic stress hormone during and after the competition. Unfortunately, the competition restrictions due to Covid-19 shortened the official round the world to a tour of Europe. Hence, data collection and analysis did not allow us to establish associations between sailing load and physiological/psychological adaptations. Nevertheless, helpful information was made available for performance practitioners in the offshore environment.

6.2 Limitations

Although the results of this thesis provide significant contributions to the literature by improving the understanding of sailing monitoring processes both practically and statistically, identifying KPIs, and establishing multivariate relationships, they are not without their limitations. Individual limitations for each study are provided in Chapter 5. This section will focus on the overall limitations of the thesis. One of the key limitations of this thesis is the difference in the nature of competition between study 1 (*Tour de France*) and studies 2 and 3 (*The Ocean Race*), which increases the difficulty of making inferential statements. Indeed, the sanitary crisis (Covid-19) directly impacted our initial thesis strategy: to carry out all three themes in the same competition. Nevertheless, we were able to jump

back onto another professional subject requiring just as much literature as our first project. A second limitation was the sample size throughout all three protocols. This is a common problem in professional cohorts (Ruddy et al., 2019). In our first study, we were not able to observe differences in performance in different crew positions. Carrying out such testing protocols requires important logistical means. Indeed, organising testing procedures for the different teams meant that the researcher had to travel with the equipment to different locations where the teams had their headquarters. Ideally, 23 boats of 3-4 sailors would have been tested. As one can imagine, testing over 90 sailors prior to competition would require many researchers and material, which was not feasible during this thesis. Also, it would have been interesting to observe sailing experience and expertise as training variables that may be associated with rankings.

Throughout this thesis, attempts have been made to maximise ecological validity by assessing the relationships between measures of sailor monitoring, WL variables, and success. Study 2 permitted such analysis, whereas difficulties were encountered in study 3. Indeed, it would have been interesting to observe the physiological and psychological adaptations during a longer competition period. Unfortunately, the duration of the race was limited to 3 legs which increased the difficulty of making sustainable inferential statements. Also, data collected and analysed in studies 2 and 3 were collected from the same team, with each study examining data from one full season. Therefore, raw data and subsequent results of analyses may reflect the demographics, physical characteristics, performance of sailors, and periodisation strategy employed by the skipper and human performance practitioners during these stages. Nevertheless, future researchers should collaborate with other sailing teams participating in the same competition to combine datasets with the goal of better bridging the gap between sailing performance and physical/physiological characteristics.

6.3 The researcher-practitioner

One of the key benefits of this thesis is the fully applied nature due to the role held by the author. Indeed, such a role permits great ecological validity to be conducted. Jones et al. (2019) stressed that the role of a researcher is to bridge the gap between laboratory-based studies (pure scientific validity) and field-based studies (pure ecological validity). The skill-set required is quite similar, but the methods by which they are applied are different. Indeed, researchers aim to identify the most scientifically accurate way of conducting a study, whereas practitioners apply all elements of their critical thinking to find the best way of conducting the study in the given field. A common misleading perception is that practitioners work solely on the evidence available. However, the researcher/practitioner here attempts to bridge the gap by providing scientific validity and field-based practicability.

Certain methods in this thesis highlight this balancing act. For instance, short subjective wellness questionnaires, such as the RPE and the Hooper Index were used, contrarily to longer tests, such as the REST QA and POMS. Moreover, spending 60 min per day filling in forms is not viable in such an environment. Hence, the questionnaires were more practical because of their short duration. Unfortunately, the scientific use of these questionnaires is yet to be fully validated. It is therefore the role of the researcher to evaluate whether they have any scientific validity and if they are applicable to practice.

6.4 Research perspectives

Many takeaway points have been observed during our research, and although many aspects of our approach worked well, the creation of future research perspectives can provide valuable information. Albeit the limitations, this thesis yielded important insights and openings for future research considerations. Interesting findings have been observed in testing protocols during the statistical analyses. For instance, HGS, BP, and IMTP have been able to discriminate between successful and less successful sailors. Future research should focus on identifying the demands of the different sailing classes and competitions. Furthermore, studies analysing the dose-response relationship between sailing load and muscular response would greatly improve current knowledge of WL monitoring. To the best of our knowledge, this is the first time an attempt to monitor WL in an offshore sailing environment has been observed. We collected the data via subjective AU of sRPE. This method may need to be validated in sports characterised by prolonged activity. In addition, future research should scrutinise the relationship between different internal and external markers to provide a valid and reliable tool for WL analysis. Moreover, with the advances in technology, the use of micro-captors combined with video analysis may provide interesting information concerning athletes' internal and external load during different phases of sailing. This type of research would give important information concerning sailing-specific activity, work-to-rest ratios, and crew position-specific work patterns and highlight the physical demands of specific manoeuvres. Furthermore, qualitative insights concerning onboard performance may provide important tools for qualifying successful manoeuvres from less successful ones.

Studies 2 and 3 suffered from political restrictions. It is hoped that more data will be made available soon by increasing the number of legs and time spent at sea. Indeed, a great need exist to establish valid and reliable associations between competition load, recovery, and preparedness. Our observations highlight important impacts on physiological and psychological markers. Hence, with a better understanding of the cause-to-effect paradigm, human performance practitioners will be able to provide sound training regimens to prepare their sailors better. Body composition and EI have received significant interest in the

literature. For example, we observed very little anthropometric variation during competition and supposed that the EI was responsible for this maintenance. Comparative studies between different EI and macronutrient distribution in multiple crews would greatly develop the understanding of homeostasis maintenance during high levels of stress by including appropriate nutrition strategies.

The challenges of conducting methodological designs in a difficult performance setting have greatly impacted the research interest in offshore sailing. Indeed, research has mainly focused on observing the effects of competition on body composition, energy turnover, and sleep management difficulties. To the best of our knowledge, we have provided a first step for WL monitoring in offshore sailing, and we hope future research will build on this field of study.

6.5 Practical application

Identifying the demands of a sport and establishing a valid and reliable monitoring protocol/testing battery is a complex and arduous task. Hence, it is important to synthesise our results to share practical applications with human performance practitioners confronted with such demands in the sailing environment.

Hence, the parameters that seem to stand out from our research are:

- ▶ HGS seems to be a common dominator of sailing performance. Understanding the anatomy and principles of forearm training may provide important information when designing strength and conditioning programmes.
- ▶ Stronger sailors are more successful than their “weaker” counterparts. Developing high fitness levels may help sailors optimise their vessel’s speed and performance at the start. Furthermore, movement efficiency may promote cognitive performance, which limits physical exhaustion.
- ▶ Wide panels of objective and subjective markers are necessary for optimising the monitoring process. Furthermore, it is crucial that the skipper and strength and conditioning coach regularly exchange training modifications. Indeed, on-land training should be adapted and modified according to weather conditions and the skipper’s strategy. Moreover, the performance practitioner should provide the skipper with insightful information concerning overtraining and injury potential if WL analysis detects any upcoming risks.
- ▶ Establishing appropriate energy intake may limit the adverse effects of offshore sailing on body composition, muscle function, and cognitive performance. Hence, realising extensive assessments to determine individual needs are necessary to promote performance onboard.

- ▶ Monitoring fatigue in multi-leg competition is crucial to implementing optimal recovery strategies in-between legs. Objective and subjective measures may provide important information concerning the athlete's preparedness.

6.6 Conclusion

This thesis provides valuable information for future sailing performance research, despite the complications encountered during the sanitary crisis (Covid-19). We have provided data concerning the nature of two renowned sailing competitions, presented valid and reliable monitoring tools, given insights for strength and conditioning considerations, as well as other human performance fields, and promoted the field of strength and conditioning in sailing by establishing associations of physical capacities with performance. All of which are extensively rationalised and discussed.

Our studies also highlight the complexity of WL monitoring in offshore sailing and open the need for future research in this ever-evolving sport. Due to the long duration, the novel data concerning extreme sports puts forward the need to develop tools that are specific to extensive exercise. We also promote the necessity for regular monitoring within a multifactorial context. However, caution is warranted when applying our considerations to other sailing classes and/or competitions. Therefore, our proposed means of monitoring must be tested in other fields of sailing to build on the current findings and considerations to develop knowledge and interest in sailing performance.

Chapter seven | *References*



“The sea is nothing but a library of all the tears in history.”

-Lemony Snicket

- Aagaard, P., Beyer, N., Simonsen, E. B., Larsson, B., Magnusson, S. P. & Kjaer, M. (1998). Isokinetic muscle strength and hiking performance in elite sailors. *Scandinavian Journal of Medicine & Science in Sports*, 8, 138-144.
- Aagaard, P., Andersen, J. L., Dyhre-Poulsen, P., Leffers, A. M., Wagner, A., Magnusson, S. P., Halkjaer-Kristensen, J., & Simonsen, E. B. (2001). A mechanism for increased contractile strength of human pennate muscle in response to strength training: changes in muscle architecture. *The Journal of physiology*, 534(Pt. 2), 613-623. <https://doi.org/10.1111/j.1469-7793.2001.t01-1-00613.x>
- Aagaard, P., Simonsen, E. B., Andersen, J. L., Magnusson, P., & Dyhre-Poulsen, P. (2002). Increased rate of force development and neural drive of human skeletal muscle following resistance training. *Journal of applied physiology (Bethesda, Md. : 1985)*, 93(4), 1318-1326. <https://doi.org/10.1152/jappphysiol.00283.2002>
- Abbiss, C.R., & Laursen, P.B. (2007). Is part of the mystery surrounding fatigue complicated by context? *Journal of science and medicine in sport*, 10 5, 277-9 .
- Abd-Elfattah, H.M., Abdelazeim, F.H., & Elshennawy, S. (2015). Physical and cognitive consequences of fatigue: A review. *Journal of Advanced Research*, 6, 351 - 358.
- Abedelmalek, S., Chtourou, H., Aloui, A., Aouichaoui, C., Souissi, N., & Tabka, Z. (2013). Effect of time of day and partial sleep deprivation on plasma concentrations of IL-6 during a short-term maximal performance. *European journal of applied physiology*, 113(1), 241-248. <https://doi.org/10.1007/s00421-012-2432-7>
- Achten, J., & Jeukendrup, A. E. (2003). Heart rate monitoring: applications and limitations. *Sports medicine (Auckland, N.Z.)*, 33(7), 517-538. <https://doi.org/10.2165/00007256-200333070-00004>
- Adam, E.K., Quinn, M.E., Tavernier, R., McQuillan, M.T., Dahlke, K., & Gilbert, K.E. (2017). Diurnal cortisol slopes and mental and physical health outcomes: A systematic review and meta-analysis. *Psychoneuroendocrinology*, 83, 25-41.
- Adami, P.E., Delussu, A.S., Rodio, A., Squeo, M.R., Corsi, L., Quattrini, F.M., Fattorini, L., & Bernardi, M. (2015). Upper limb aerobic training improves aerobic fitness and all-out performance of America's Cup grinders. *European Journal of Sport Science*, 15, 235 - 241.
- Akagi, R., Hinks, A., Davidson, B., & Power, G. A. (2020). Differential contributions of fatigue-induced strength loss and slowing of angular velocity to power loss following repeated

maximal shortening contractions. *Physiological reports*, 8(3), e14362.
<https://doi.org/10.14814/phy2.14362>

- Akenhead, R., & Nassis, G.P. (2016). Training Load and Player Monitoring in High-Level Football: Current Practice and Perceptions. *International journal of sports physiology and performance*, 11 5, 587-93 .
- Alhola, P., & Polo-Kantola, P. (2007). Sleep deprivation: Impact on cognitive performance. *Neuropsychiatric Disease and Treatment*, 3, 553 - 567.
- Alizadehkhayat, O., Fisher, A.C., Kemp, G.J., Vishwanathan, K., & Frostick, S.P. (2007). Upper limb muscle imbalance in tennis elbow: A functional and electromyographic assessment. *Journal of Orthopaedic Research*, 25.
- Allen, J.B. (1999). Sports medicine and sailing. *Physical medicine and rehabilitation clinics of North America*, 10 1, 49-65 .
- Allen, J. B., & De Jong, M. R. (2006). Sailing and sports medicine: a literature review. *British journal of sports medicine*, 40(7), 587-593. <https://doi.org/10.1136/bjism.2002.001669>
- Allen, P.H., Wadsworth, E., & Smith, A. (2008). Seafarers' fatigue: a review of the recent literature. *International maritime health*, 59 1-4, 81-92 .
- Allen, D.G., Lamb, G.D., & Westerblad, H. (2008). Impaired calcium release during fatigue. *Journal of applied physiology*, 104 1, 296-305 .
- Amann, M., Subudhi, A.W., & Foster, C.C. (2004). Influence of testing protocol on ventilatory thresholds and cycling performance. *Medicine and science in sports and exercise*, 36 4, 613-22 .
- Amann, M., Blain, G.M., Proctor, L.T., Sebranek, J.J., Pegelow, D.F., & Dempsey, J.A. (2011). Implications of group III and IV muscle afferents for high-intensity endurance exercise performance in humans. *The Journal of Physiology*, 589.
- Ament, W., & Verkerke, G.J. (2009). Exercise and Fatigue. *Sports Medicine*, 39, 389-422.
- Anastasiou, A., Jones, T.W., Mullan, P.C., Ross, E.Z., & Howatson, G. (2019). Descriptive analysis of Olympic class windsurfing competition during the 2017-2018 regatta season. *International Journal of Performance Analysis in Sport*, 19, 517 - 529.
- Andrade, R., Wik, E.H., Rebelo-Marques, A., Blanch, P.D., Whiteley, R., Espregueira-Mendes, J., & Gabbett, T.J. (2020). Is the Acute: Chronic Workload Ratio (ACWR) Associated with Risk of

Time-Loss Injury in Professional Team Sports? A Systematic Review of Methodology, Variables and Injury Risk in Practical Situations. *Sports Medicine*, 1-23.

Apel, K., & Hirt, H. (2004). Reactive oxygen species: metabolism, oxidative stress, and signal transduction. *Annual review of plant biology*, 55, 373-399. <https://doi.org/10.1146/annurev.arplant.55.031903.141701>

Araújo, D., & Sepra, S. (1997). Towards a construction of methodological design to measuring decision making in externally paced sport : the case of sailing. In *In Innovations in sport psychology : linking theory and practice : proceedings, pt. I, The Zinmann College of Physical Education and Sport Sciences, The Wingate Institute for Physical Education and Sport*, p.76-78.

Araújo, D., Davids, K., & Serpa, S. (2005). An ecological approach to expertise effects in decision-making in a simulated sailing regatta. *Psychology of Sport and Exercise*, 6, 671-692.

Araújo, D., Davids, K., & Hristovski, R. (2006). The ecological dynamics of decision making in sport. *Psychology of Sport and Exercise*, 7, 653-676.

Araújo, D., Davids, K., & Passos, P. (2007). Ecological Validity, Representative Design, and Correspondence Between Experimental Task Constraints and Behavioral Setting: Comment on Rogers, Kadar, and Costall (2005). *Ecological Psychology*, 19, 69 - 78.

Araújo, D., Davids, K., Diniz, A., Rocha, L., Santos, J. C., Dias, G., & Fernandes, O. (2015). Ecological dynamics of continuous and categorical decision-making: The regatta start in sailing. *European Journal of Sport Science*, 15(3), 195-202.

Arcos, A.L., Yanci, J., Mendiguchia, J.S., & Gorostiaga, E.M. (2014). Rating of Muscular and Respiratory Perceived Exertion in Professional Soccer Players. *Journal of Strength and Conditioning Research*, 28, 3280-3288.

Arcos, A.L., Martínez-Santos, R., Yanci, J., Mendiguchia, J.S., & Mendez-villanueva, A. (2015). Negative Associations between Perceived Training Load, Volume and Changes in Physical Fitness in Professional Soccer Players. *Journal of sports science & medicine*, 14 2, 394-401 .

Armstrong, L.E., Bergeron, M.F., Lee, E.C., Mershon, J.E., & Armstrong, E.M. (2021). Overtraining Syndrome as a Complex Systems Phenomenon. *Frontiers in Network Physiology*.

Asan, O., & Montague, E.N. (2014). Using video-based observation research methods in primary care health encounters to evaluate complex interactions. *Informatics in primary care*, 21 4, 161-70 .

- Asmussen E. (1979). Muscle fatigue. *Medicine and science in sports*, 11(4), 313–321.
- Atlaoui, D., Pichot, V., Lacoste, L., Barale, F., Lacour, J.R., & Chatard, J. (2007). Heart rate variability, training variation and performance in elite swimmers. *International journal of sports medicine*, 28 5, 394-400 .
- Aubert, A.E., Seps, B., & Beckers, F. (2003). Heart Rate Variability in Athletes. *Sports Medicine*, 33, 889-919.
- Aune, T., Ettema, G.J., Ingvaldsen, R.P., & Whiting, H.T. (2001). THE EFFECT OF PHYSICAL FATIGUE ON MOTOR CONTROL AND COORDINATION IN A MULTIJOINT TIMING TASK. *Medicine and Science in Sports and Exercise*, 33.
- Avela, J., Kyröläinen, H., & Komi, P.V. (1999). Altered reflex sensitivity after repeated and prolonged passive muscle stretching. *Journal of applied physiology*, 86 4, 1283-91 .
- Balan, E., Schwalm, C., Naslain, D., Nielens, H., Francaux, M., & Deldicque, L. (2019). Regular Endurance Exercise Promotes Fission, Mitophagy, and Oxidative Phosphorylation in Human Skeletal Muscle Independently of Age. *Frontiers in Physiology*, 10.
- Balkin, T.J., Bliese, P.D., Belenky, G., Sing, H.C., Thorne, D.R., Thomas, M.L., Redmond, D.P., Russo, M., & Wesensten, N.J. (2004). Comparative utility of instruments for monitoring sleepiness-related performance decrements in the operational environment. *Journal of Sleep Research*, 13.
- Balog, E.M. (2010). Excitation-Contraction Coupling and Minor Triadic Proteins in Low-Frequency Fatigue. *Exercise and Sport Sciences Reviews*, 38, 135-142.
- Balsalobre-Fernández, C., Tejero-González, C.M., & del Campo-Vecino, J. (2014). Hormonal and neuromuscular responses to high-level middle- and long-distance competition. *International journal of sports physiology and performance*, 9 5, 839-44 .
- Balsalobre-Fernández, C., Glaister, M., & Lockey, R.A. (2015). The validity and reliability of an iPhone app for measuring vertical jump performance. *Journal of Sports Sciences*, 33, 1574 - 1579.
- Bangsbo, J. (1994). Energy demands in competitive soccer. *Journal of sports sciences*, 12 Spec No, S5-12 .
- Banister, “Modeling Elite Athletic Performance,” (1991) in *Physiological Testing of the High-Performance Athlete*, D. MacDougall, H. A. Wenger, and H. J. Green, Eds. 2nd ed. Champaign, Illinois: Human Kinetics Books.

- Baranski, J.V., Gil, V., McLellan, T., Moroz, D.E., Buguet, A., & Radomski, M.W. (2002). Effects of Modafinil on Cognitive Performance During 40 Hr of Sleep Deprivation in a Warm Environment. *Military Psychology*, 14, 23 - 47.
- Barnett A. (2006). Using recovery modalities between training sessions in elite athletes: does it help?. *Sports medicine (Auckland, N.Z.)*, 36(9), 781-796. <https://doi.org/10.2165/00007256-200636090-00005>
- Barrett, S., Midgley, A.W., & Lovell, R. (2014). PlayerLoad™: reliability, convergent validity, and influence of unit position during treadmill running. *International journal of sports physiology and performance*, 9 6, 945-52 .
- Barrios, C., Hadala, M., Almansa, I., Bosch-Morell, F., Palanca, J.M., & Romero, F.J. (2010). Metabolic muscle damage and oxidative stress markers in an America's Cup yachting crew. *European Journal of Applied Physiology*, 111, 1341-1350.
- Bateup, B., Thornton, H., Withers, S. & Duthie, G. (2016) The Influence of Training Load on Markers of Fatigue in Junior Male Semi-Elite Sailors. *Journal of Australian Strength & Conditioning*, 24(6), 21-22.
- Batterham, AM. and Hopkins, WG. (2006). Making meaningful inferences about magnitudes. *International Journal of Sports Physiology and Performance*, 1, 50-57.
- Bauer, A.M., Young, W., Fahrner, B.B., & Harvey, J.T. (2015). GPS variables most related to match performance in an elite Australian football team. *International Journal of Performance Analysis in Sport*, 15, 187 - 202.
- Baumert, P., Temple, S., Stanley, J.M., Cocks, M., Strauss, J.A., Shepherd, S.O., Drust, B., Lake, M.J., Stewart, C.E., & Erskine, R.M. (2019). Neuromuscular fatigue and recovery after strenuous exercise depends on skeletal muscle size and stem cell characteristics. *Scientific Reports*, 11.
- Bay, J., & Larsson, B. (2013). Bay testen. En fysiologisk performance test for 49'er gaster [A physiological performance test for 49'er crewmen] (Unpublished thesis). Copenhagen: Team Danmark and Department of Nutrition, Exercise and Sports Sciences, University of Copenhagen/Team Danmark.
- Beattie, K., Carson, B.P., Lyons, M., Rossiter, A., & Kenny, I.C. (2017). The Effect of Strength Training on Performance Indicators in Distance Runners. *Journal of Strength and Conditioning Research*, 31, 9-23.

- Belgith, A., Ahmaidi, S., Maillé, P., Noirez, P., & Desgorces, F.D. (2012). Quantification de la charge d'entraînement imposée au footballeur professionnel en phase de réhabilitation athlétique post-blessure. *Science & Sports*, 27, 169-174.
- Bellenger, C. R., Thomson, R. L., Robertson, E. Y., Davison, K., Nelson, M. J., Karavirta, L., & Buckley, J. D. (2017). The effect of functional overreaching on parameters of autonomic heart rate regulation. *European journal of applied physiology*, 117(3), 541-550. <https://doi.org/10.1007/s00421-017-3549-5>
- Ben Cheikh, R., Latiri, I., Dogui, M., & Ben Saad, H. (2017). Effects of one-night sleep deprivation on selective attention and isometric force in adolescent karate athletes. *The Journal of sports medicine and physical fitness*, 57 6, 752-759 .
- Bennet, G.C. (1973). Medical and psychological problems in the 1972 singlehanded transatlantic yacht race. *Lancet*, 2 7832, 747-54 .
- Berezhnov, A.V., Fedotova, E., Nenov, M.N., Zinchenko, V.P., & Dynnik, V.V. (2010). Role of phospholipases in cytosolic calcium overload and cardiomyocytes death in the presence of activated fatty acid derivatives. *Biochemistry (Moscow) Supplement Series A: Membrane and Cell Biology*, 4, 56-63.
- Bernardi, M., Felici, F., Marchetti, M., & Marchettoni, P. (1990). Cardiovascular load in off-shore sailing competition. *The Journal of sports medicine and physical fitness*, 30(2), 127-131.
- Bigard, A.X., Guillemot, P., Chauve, J., Duforez, F., Portero, P., & Guézennec, C.Y. (1998). Nutrient intake of elite sailors during a solitary long-distance offshore race. *International journal of sport nutrition*, 8 4, 364-76 .
- Bigland-Ritchie B. (1981). EMG/force relations and fatigue of human voluntary contractions. *Exercise and sport sciences reviews*, 9, 75-117.
- Billaut, F., Basset, F.A., Giacomoni, M., Lemaître, F., Tricot, V., & Falgairette, G. (2006). Effect of high-intensity intermittent cycling sprints on neuromuscular activity. *International journal of sports medicine*, 27 1, 25-30 .
- Bilodeau, M., Henderson, T.K., Nolte, B.E., Pursley, P.J., & Sandfort, G.L. (2001). Effect of aging on fatigue characteristics of elbow flexor muscles during sustained submaximal contraction. *Journal of applied physiology*, 91 6, 2654-64 .
- Bishop, P. A., Jones, E., & Woods, A. K. (2008). Recovery from training: a brief review: brief review. *Journal of strength and conditioning research*, 22(3), 1015-1024. <https://doi.org/10.1519/JSC.ob013e31816eb518>

- Błacha, R., Zatoń, K., Piwowarczyk, P., Jastrzębska, A.D., & Szczepan, S. (2019). Repeatability of force production as a measure of kinaesthetic sense in seagoing sailors and recreational sailors. *Human Movement*.
- Blackburn, M.J., & Hubinger, I. (1995). Determination of physiological profiles and exercise training programs for competitive dinghy sailors. *National Sports Research Centre*, 1-16.
- Blanch, P.D., & Gabbett, T.J. (2015). Has the athlete trained enough to return to play safely? The acute:chronic workload ratio permits clinicians to quantify a player's risk of subsequent injury. *British Journal of Sports Medicine*, 50, 471 - 475.
- Blatter, K., & Cajochen, C. (2007). Circadian rhythms in cognitive performance: Methodological constraints, protocols, theoretical underpinnings. *Physiology & Behavior*, 90, 196-208.
- Blazevich, A.J., & Babault, N. (2019). Post-activation Potentiation Versus Post-activation Performance Enhancement in Humans: Historical Perspective, Underlying Mechanisms, and Current Issues. *Frontiers in Physiology*, 10.
- Bloomer, R.J., & Goldfarb, A.H. (2004). Anaerobic exercise and oxidative stress: a review. *Canadian journal of applied physiology = Revue canadienne de physiologie appliquee*, 29 3, 245-63 .
- Bogdanis, G. C., Nevill, M. E., Lakomy, H. K., Graham, C. M., & Louis, G. (1996). Effects of active recovery on power output during repeated maximal sprint cycling. *European journal of applied physiology and occupational physiology*, 74(5), 461-469. <https://doi.org/10.1007/BF02337727>
- Bojsen-Møller, J., Larsson, B., Magnusson, S. P., & Aagaard, P. (2007). Yacht type and crew-specific differences in anthropometric, aerobic capacity, and muscle strength parameters among international Olympic class sailors. *Journal of Sports Sciences*, 25(10), 1117-1128.
- Bojsen-Møller, J., Larsson, B., & Aagaard, P. (2015). Physical requirements in Olympic sailing. *European Journal of Sport Science*, 15, 220 - 227.
- Bompa, T.O., & Haff, G.G. (2009). *Periodization : theory and methodology of training*.
- Borg, G.A. (1982). Ratings of perceived exertion and heart rates during short-term cycle exercise and their use in a new cycling strength test. *International journal of sports medicine*, 3 3, 153-8 .
- Borresen, J., & Lambert, M.I. (2009). The Quantification of Training Load, the Training Response and the Effect on Performance. *Sports Medicine*, 39, 779-795.

- Bosquet, L., Merkari, S., Arvisais, D., & Aubert, A.E. (2008). Is heart rate a convenient tool to monitor over-reaching? A systematic review of the literature. *British Journal of Sports Medicine*, 42, 709 - 714.
- Bosquet, L., Berryman, N., Dupuy, O., Mekary, S., Arvisais, D., Bherer, L., & Mujika, I. (2013). Effect of training cessation on muscular performance: A meta-analysis. *Scandinavian Journal of Medicine & Science in Sports*, 23.
- Bosquet, Laurent & Mujika, Iñigo. (2012). Detraining.
- Bot, Patrick & Flay, Richard & Fossati, Fabio. (2014). Special issue on Yacht Engineering. 10.1016/j.oceaneng.2014.09.025.
- Bot, Patrick & Voisin, DIMITRI & Soulier, Antoine & Braud, Caroline & ASTOLFI, JACQUES. (2022). A NEW SENSOR TO CHARACTERIZE FLOW SEPARATION ON A HYDROFOIL. The 9th Conference on Computational Methods in Marine Engineering (Marine 2021). 1. 10.2218/marine2021.6779.
- Bouchard, C., & Rankinen, T. (2001). Individual differences in response to regular physical activity. *Medicine and science in sports and exercise*, 33 6 Suppl, S446-51; discussion S452-3 .
- Bourdon, P.C., Cardinale, M., Murray, A., Gatin, P.B., Kellmann, M., Varley, M.C., Gabbett, T.J., Coutts, A.J., Burgess, D.J., Gregson, W., & Cable, N.T. (2017). Monitoring Athlete Training Loads: Consensus Statement. *International journal of sports physiology and performance*, 12 Suppl 2, S2161-S2170 .
- Bourgois, J. G., Callewaert, M., Celie, B., De Clercq, D., & Boone, J. (2016). Isometric quadriceps strength determines sailing performance and neuromuscular fatigue during an upwind sailing emulation. *Journal of Sports Sciences*, 34(10), 973-979.
- Boyas, S., & Guével, A. (2011). Neuromuscular fatigue in healthy muscle: underlying factors and adaptation mechanisms. *Annals of physical and rehabilitation medicine*, 54 2, 88-108 .
- Boyd, L.J., Ball, K.A., & Aughey, R.J. (2011). The reliability of MinimaxX accelerometers for measuring physical activity in Australian football. *International journal of sports physiology and performance*, 6 3, 311-21 .
- Boyd, L.J., Ball, K.A., & Aughey, R.J. (2013). Quantifying external load in Australian football matches and training using accelerometers. *International journal of sports physiology and performance*, 8 1, 44-51 .

- Branth, S., Hambraeus, L., Westerterp, K.R., Andersson, A.B., Edsgren, R., Mustelin, M., & Nilsson, R. (1996). Energy turnover in a sailing crew during offshore racing around the world. *Medicine and science in sports and exercise*, 28 10, 1272-6 .
- Broman, M., Vincent, J.L., Ronco, C., Hansson, F., & Bell, M. (2021). The Relationship Between Heart Rate and Body Temperature in Critically Ill Patients. *Critical Care Medicine*, 49, e327 - e331.
- Broughton & R. Ogilvie (Eds.), Sleep, arousal and performance:
- Brožek, J., Grande, F., Anderson, J., & Keys, A.B. (1963). DENSITOMETRIC ANALYSIS OF BODY COMPOSITION: REVISION OF SOME QUANTITATIVE ASSUMPTIONS *. *Annals of the New York Academy of Sciences*, 110.
- Bruton, J.D., Lännergren, J., & Westerblad, H. (1998). Mechanisms underlying the slow recovery of force after fatigue: importance of intracellular calcium. *Acta physiologica Scandinavica*, 162 3, 285-93 .
- Brzycki, M. (1993). Strength Testing—Predicting a One-Rep Max from Reps-to-Fatigue. *The Journal of Physical Education, Recreation & Dance*, 64, 88-90.
- Buchheit, M., Al Haddad, H., Simpson, B.M., Palazzi, D.A., Bourdon, P.C., Di Salvo, V., & Mendez-villanueva, A. (2014). Monitoring accelerations with GPS in football: time to slow down? *International journal of sports physiology and performance*, 9 3, 442-5 .
- Bugge, M.B. (1986). The Third Whitbread Round the World Race. *Injury*, 17 3, 196-8.
- Burke, L.M. (2003). The IOC consensus on sports nutrition 2003: new guidelines for nutrition for athletes. *International journal of sport nutrition and exercise metabolism*, 13 4, 549-52 .
- Busso, T., Häkkinen, K., Pakarinen, A.J., Carasso, C., Lacour, J.R., Komi, P.V., & Kauhanen, H. (2004). A systems model of training responses and its relationship to hormonal responses in elite weight-lifters. *European Journal of Applied Physiology and Occupational Physiology*, 61, 48-54.
- Buyse, D.J., Reynolds, C.F., Monk, T.H., Hoch, C.C., Yeager, A., & Kupfer, D.J. (1991). Quantification of subjective sleep quality in healthy elderly men and women using the Pittsburgh Sleep Quality Index (PSQI). *Sleep*, 14 4, 331-8 .
- Byrne, C., & Eston, R. (2002). The effect of exercise-induced muscle damage on isometric and dynamic knee extensor strength and vertical jump performance. *Journal of Sports Sciences*, 20, 417 - 425.

- Cadegiani, F.A., & Kater, C.E. (2017). Hormonal aspects of overtraining syndrome: a systematic review. *BMC Sports Science, Medicine and Rehabilitation*, 9.
- Cahill, C.J. (1995). ATLS--essential training for Naval medical officers? Advanced Trauma Life Support. *Journal of the Royal Naval Medical Service*, 80 3, 122-3 .
- Caimmi, G., & Semprini, G. (2017). Heart rate and GPS data analysis of kiteboard course racing during the Italian Championship. *Sport Sciences for Health*, 13, 79-85.
- Cairns, S. P., Knicker, A. J., Thompson, M. W., & Sjøgaard, G. (2005). Evaluation of models used to study neuromuscular fatigue. *Exercise and sport sciences reviews*, 33(1), 9–16.
- Calandro, A.J., Esposito, G., & Altavilla, G. (2020). Intermittent training and improvement of anthropometric parameters and aerobic capacity in youth football. *Journal of Human Sport and Exercise*, 599-608.
- Campbell, S.S., & Murphy, P.J. (2007). The nature of spontaneous sleep across adulthood. *Journal of Sleep Research*, 16.
- Campos-Vazquez, M.A., Toscano-Bendala, F.J., Mora-ferrera, J.C., & Suarez-Arrones, L. (2016). Relationship Between Internal Load Indicators And Changes On Intermittent Performance After The Preseason In Professional Soccer Players. *Journal of Strength and Conditioning Research*.
- Cánovas López, M., Arias, J.L., García Marín, P., & Yuste, J.L. (2014). Time-Motion Analysis Procedure in Team Sports: Example for Youth Basketball. *Strength and Conditioning Journal*, 36, 71–75.
- Caparrós, T., Casals, M., Solana, Á., & Peña, J. (2018). Low External Workloads Are Related to Higher Injury Risk in Professional Male Basketball Games. *Journal of sports science & medicine*, 17 2, 289-297 .
- Caraballo, I., González-Montesinos, J.L., & Alías, A. (2019). Performance Factors in Dinghy Sailing: Laser Class. *International Journal of Environmental Research and Public Health*, 16.
- Caraballo, I., Conde-Caveda, J., Pezelj, L., Milavić, B., & Castro-Piñero, J. (2020). GNSS Applications to Assess Performance in Olympic Sailors: Laser Class. *Applied Sciences*.
- Caraballo, I., Lara-Bocanegra, A., & Bohórquez, M.R. (2021). Factors Related to the Performance of Elite Young Sailors in a Regatta: Spatial Orientation, Age and Experience. *International Journal of Environmental Research and Public Health*, 18.

- Cardinale, M., & Varley, M.C. (2017). Wearable Training-Monitoring Technology: Applications, Challenges, and Opportunities. *International journal of sports physiology and performance*, 12 Suppl 2, S255-S262 .
- Carey, D.L., Blanch, P.D., Ong, K., Crossley, K.M., Crow, J., & Morris, M.E. (2017). Training loads and injury risk in Australian football—differing acute: chronic workload ratios influence match injury risk. *British Journal of Sports Medicine*, 51, 1215 - 1220.
- Carotenuto, A., Molino, I., Fasanaro, A.M., & Amenta, F. (2012). Psychological stress in seafarers: a review. *International maritime health*, 63 4, 188-94 .
- Carrard, J., Rigort, A. C., Appenzeller-Herzog, C., Colledge, F., Königstein, K., Hinrichs, T., & Schmidt-Trucksäss, A. (2022). Diagnosing Overtraining Syndrome: A Scoping Review. *Sports health*, 14(5), 665–673. <https://doi.org/10.1177/19417381211044739>
- Carroll, L. J., Lis, A., Weiser, S., & Torti, J. (2016). How Well Do You Expect to Recover, and What Does Recovery Mean, Anyway? Qualitative Study of Expectations After a Musculoskeletal Injury. *Physical therapy*, 96(6), 797–807. <https://doi.org/10.2522/ptj.20150229>
- Carroll, T.J., Taylor, J.L., & Gandevia, S.C. (2017). Recovery of central and peripheral neuromuscular fatigue after exercise. *Journal of applied physiology*, 122 5, 1068-1076 .
- Carskadon, M.A., & Dement, W.C. (2005). Chapter 2 - Normal Human Sleep : An Overview.
- Carter, J.R., Kupiers, N., & Ray, C.A. (2005). Neurovascular responses to mental stress. *The Journal of Physiology*, 564.
- Casamichana, D., Castellano, J., González, J.C., & Román, J.S. (2013). The use of accelerometers to quantify the training load in soccer.
- Castagna, O., & Brisswalter, J. (2007). Assessment of energy demand in Laser sailing: influences of exercise duration and performance level. *European Journal of Applied Physiology*, 99(2), 95–101.
- Castagna, O., Brisswalter, J., Lacour, J.R., & Vogiatzis, I. (2008). Physiological demands of different sailing techniques of the new Olympic windsurfing class. *European Journal of Applied Physiology*, 104, 1061-1067
- Castagna, C., Impellizzeri, F.M., Chaouachi, A., Bordon, C., & Manzi, V. (2011). Effect of Training Intensity Distribution on Aerobic Fitness Variables in Elite Soccer Players: A Case Study. *Journal of Strength and Conditioning Research*, 25, 66-71.

- Castellano, J., & Casamichana, D. (2010). Heart Rate and Motion Analysis by GPS in Beach Soccer. *Journal of sports science & medicine*, 9 1, 98-103 .
- Cé, E., Longo, S., Limonta, E., Coratella, G., Rampichini, S., & Esposito, F. (2019). Peripheral fatigue: new mechanistic insights from recent technologies. *European Journal of Applied Physiology*, 120, 17-39.
- Cettolo, V., Ferrari, M., Biasini, V., & Quaresima, V. (2007). Vastus lateralis O₂ desaturation in response to fast and short maximal contraction. *Medicine and science in sports and exercise*, 39 11, 1949-59 .
- Chatzinikolaou, A., Fatouros, I. G., Gourgoulis, V., Avloniti, A., Jamurtas, A. Z., Nikolaidis, M. G., Douroudos, I., Michailidis, Y., Beneka, A., Malliou, P., Tofas, T., Georgiadis, I., Mandalidis, D., & Taxildaris, K. (2010). Time course of changes in performance and inflammatory responses after acute plyometric exercise. *Journal of strength and conditioning research*, 24(5), 1389-1398. <https://doi.org/10.1519/JSC.ob013e3181d1d318>
- Cheung, S.S., & Sleivert, G.G. (2004). Multiple Triggers for Hyperthermic Fatigue and Exhaustion. *Exercise and Sport Sciences Reviews*, 32, 100-106.
- Chicoy, I., & Encarnación-Martínez, A. (2015). DETERMINING FACTORS IN THE PERFORMANCE OF HIKING IN DINGHY SAILING: A LITERATURE REVIEW.
- Chiu, L.Z., & Barnes, J.L. (2003). The Fitness-Fatigue Model Revisited: Implications for Planning Short- and Long-Term Training. *Strength and Conditioning Journal*, 25, 42-51.
- Chovatiya, R., & Medzhitov, R. (2014). Stress, inflammation, and defense of homeostasis. *Molecular cell*, 54 2, 281-8 .
- Christakos, C.N., & Windhorst, U. (1986). The information carried by spindle afferents on motor unit activity as revealed by spectral analysis. *Brain Research*, 367, 52-62.
- Christensen, P. M., Krstrup, P., Gunnarsson, T. P., Kiilerich, K., Nybo, L., & Bangsbo, J. (2011). VO₂ kinetics and performance in soccer players after intense training and inactivity. *Medicine and science in sports and exercise*, 43(9), 1716-1724. <https://doi.org/10.1249/MSS.ob013e318211c01a>
- Chun, S., Park, J., Kim, T., & Kim, Y. (2022). Performance analysis based on GPS data of Olympic class windsurfing. *International Journal of Performance Analysis in Sport*, 22, 332 - 342.
- Clark, T., & Williamon, A. (2016). Applications within Performance Psychology.

- Clarke, N., Farthing, J.P., Norris, S.R., Arnold, B.E., & Lanovaz, J.L. (2013). Quantification of Training Load in Canadian Football: Application of Session-RPE in Collision-Based Team Sports. *Journal of Strength and Conditioning Research*, 27, 2198–2205.
- Clausen, T. (2011). In isolated skeletal muscle, excitation may increase extracellular K⁺ 10-fold; how can contractility be maintained? *Experimental Physiology*, 96.
- Coggan, A. (2003). "Training and racing using a power meter: An introduction
- Cohen, J. The concepts of power analysis. 2nd ed. Hillsdale, New Jersey, 1988.
- Colby, M.J., Dawson, B., Peeling, P., Heasman, J., Rogalski, B., Drew, M.K., Stares, J., Zouhal, H., & Lester, L. (2017). Multivariate modelling of subjective and objective monitoring data improve the detection of non-contact injury risk in elite Australian footballers. *Journal of science and medicine in sport*, 20 12, 1068-1074 .
- Colomer, C., Pyne, D. B., Mooney, M., McKune, A., & Serpell, B. G. (2020). Performance Analysis in Rugby Union: a Critical Systematic Review. *Sports medicine - open*, 6(1), 4. <https://doi.org/10.1186/s40798-019-0232-x>
- Colwell, J.L. (2005). Modeling Ship Motion Effects on Human Performance for Real Time Simulation. *Naval Engineers Journal*, 117, 77-90.
- Coratella, G., & Schena, F. (2016). Eccentric resistance training increases and retains maximal strength, muscle endurance, and hypertrophy in trained men. *Applied physiology, nutrition, and metabolism = Physiologie appliquee, nutrition et metabolisme*, 41 11, 1184-1189 .
- Cormack SJ, Newton RU and McGuigan M. (2008) Neuromuscular and endocrine
- Cormack, S.J., Newton, R.U., & McGuigan, M.R. (2008). Neuromuscular and endocrine responses of elite players to an Australian rules football match. *International journal of sports physiology and performance*, 3 3, 359-74 .
- Cormack, S.J., Mooney, M.G., Morgan, W., & McGuigan, M.R. (2013). Influence of neuromuscular fatigue on accelerometer load in elite Australian football players. *International journal of sports physiology and performance*, 8 4, 373-8 .
- Cowley, J.C., Dingwell, J.B., & Gates, D.H. (2014). Effects of local and widespread muscle fatigue on movement timing. *Experimental Brain Research*, 232, 3939-3948.
- Coyle, E. F., Martin, W. H., 3rd, Sinacore, D. R., Joyner, M. J., Hagberg, J. M., & Holloszy, J. O. (1984). Time course of loss of adaptations after stopping prolonged intense endurance

- training. *Journal of applied physiology: respiratory, environmental and exercise physiology*, 57(6), 1857–1864. <https://doi.org/10.1152/jappl.1984.57.6.1857>
- Coyle, E.F., Martin, W.H., Bloomfield, S.A., Lowry, O.H., & Holloszy, J.O. (1985). Effects of detraining on responses to submaximal exercise. *Journal of applied physiology*, 59 3, 853-9 .
- Coyle, E.F. (1995). Integration of the Physiological Factors Determining Endurance Performance Ability. *Exercise and Sport Sciences Reviews*, 23, 25–64.
- Coyne, J.O., Gregory Haff, G., Coutts, A.J., Newton, R.U., & Nimphius, S. (2018). The Current State of Subjective Training Load Monitoring—a Practical Perspective and Call to Action. *Sports Medicine - Open*, 4.
- Crafer S. Taking the strain. *Yachts and yachting* Feb, 1995:4–7.
- Crameri, R. M., Aagaard, P., Qvortrup, K., Langberg, H., Olesen, J., & Kjaer, M. (2007). Myofibre damage in human skeletal muscle: effects of electrical stimulation versus voluntary contraction. *The Journal of physiology*, 583(Pt 1), 365–380. <https://doi.org/10.1113/jphysiol.2007.128827>
- Crewther, B. T., Cook, C., Cardinale, M., Weatherby, R. P., & Lowe, T. (2011). Two emerging concepts for elite athletes: the short-term effects of testosterone and cortisol on the neuromuscular system and the dose-response training role of these endogenous hormones. *Sports medicine (Auckland, N.Z.)*, 41(2), 103–123. <https://doi.org/10.2165/11539170-000000000-00000>
- Cronin, J., Lawton, T., Harris, N., Kilding, A., & McMaster, D. T. (2017). A Brief Review of Handgrip Strength and Sport Performance. *Journal of strength and conditioning research*, 31(11), 3187–3217. <https://doi.org/10.1519/JSC.0000000000002149>
- Crowther, F., Sealey, R., Crowe, M.J., Edwards, A.M., & Halson, S.L. (2017). Team sport athletes' perceptions and use of recovery strategies: a mixed-methods survey study. *BMC Sports Science, Medicine and Rehabilitation*, 9.
- Crum, E.M., O'Connor, W.J., Van Loo, L., Valckx, M., & Stannard, S.R. (2017). Validity and reliability of the Moxy oxygen monitor during incremental cycling exercise. *European Journal of Sport Science*, 17, 1037 - 1043.
- Cullen, S., Dolan, E., McGoldrick, A., Brien, K. O., Carson, B. P., & Warrington, G. (2015). The impact of making-weight on cognitive performance in apprentice jockeys. *Journal of sports sciences*, 33(15), 1589–1595. <https://doi.org/10.1080/02640414.2014.1002104>

- Cummins, C., Orr, R., O'Connor, H., & West, C. (2013). Global positioning systems (GPS) and microtechnology sensors in team sports: a systematic review. *Sports medicine (Auckland, N.Z.)*, 43(10), 1025–1042. <https://doi.org/10.1007/s40279-013-0069-2>
- Cunanan, A.J., DeWeese, B.H., Wagle, J.P., Carroll, K.M., Sausaman, R.W., Hornsby, W.G., Haff, G.G., Triplett, N.T., Pierce, K.C., & Stone, M.H. (2018). Authors' Reply to Buckner et al.: 'Comment on: "The General Adaptation Syndrome: A Foundation for the Concept of Periodization"'. *Sports Medicine*, 48, 1755-1757.
- Damsted, C., Glad, S., Nielsen, R. O., Sørensen, H., & Malisoux, L. (2018). IS THERE EVIDENCE FOR AN ASSOCIATION BETWEEN CHANGES IN TRAINING LOAD AND RUNNING-RELATED INJURIES? A SYSTEMATIC REVIEW. *International journal of sports physical therapy*, 13(6), 931–942.
- Dantas, G.A., Barros, A., Silva, B., Belém, L., Ferreira, V., Fonseca, A.R., Castro, P., Santos, T., Lemos, T.M., & Héricksen, W. (2019). Cold-Water Immersion Does Not Accelerate Performance Recovery After 10-km Street Run: Randomized Controlled Clinical Trial. *Research Quarterly for Exercise and Sport*, 91, 228 - 238.
- Davies C and White M. (1981) Muscle weakness following eccentric work in man.
- Davison, T. (1979). *The Laser Book: Laser Sailing from Start to Finish*.
- Dawson, D., & McCulloch, K. (2005). Managing fatigue: it's about sleep. *Sleep medicine reviews*, 9, 365-80 .
- Day, M. L., McGuigan, M. R., Brice, G., & Foster, C. (2004). Monitoring exercise intensity during resistance training using the session RPE scale. *Journal of strength and conditioning research*, 18(2), 353–358. <https://doi.org/10.1519/R-13113.1>
- Debold, E.P. (2015). Potential molecular mechanisms underlying muscle fatigue mediated by reactive oxygen and nitrogen species. *Frontiers in Physiology*, 6.
- Debold, E.P. (2016). Decreased Myofilament Calcium Sensitivity Plays a Significant Role in Muscle Fatigue. *Exercise and Sport Sciences Reviews*, 44, 144–149.
- Debold, E.P., Romatowski, J., & Fitts, R.H. (2006). The depressive effect of Pi on the force-pCa relationship in skinned single muscle fibers is temperature dependent. *American journal of physiology. Cell physiology*, 290 4, C1041-50 .

- Deely, C., Tallent, J., Bennett, R., Woodhead, A., Goodall, S., Thomas, K., & Howatson, G. (2022). Etiology and Recovery of Neuromuscular Function Following Academy Soccer Training. *Frontiers in Physiology*, 13.
- Delp, M.D., Armstrong, R.B., Godfrey, D.A., Laughlin, M.H., Ross, C.D., & Wilkerson, M.K. (1999). Exercise increases blood flow to locomotor, vestibular, cardiorespiratory and visual regions of the brain in miniature swine. *The Journal of physiology*, 533 Pt 3, 849-59 .
- Deparday, J., Augier, B., & Bot, P. (2018). Experimental analysis of a strong fluid–structure interaction on a soft membrane—Application to the flapping of a yacht downwind sail. *Journal of Fluids and Structures*.
- Derman, W., Schwellnus, M.P., Lambert, M.I., Emms, M., Sinclair-Smith, C.C., Kirby, P., & Noakes, T.D. (1997). The 'worn-out athlete': a clinical approach to chronic fatigue in athletes. *Journal of sports sciences*, 15 3, 341-51 .
- Desgorces, F., Sénégas, X., García, J., Decker, L., & Noirez, P. (2007). Methods to quantify intermittent exercises. *Applied physiology, nutrition, and metabolism = Physiologie appliquee, nutrition et metabolisme*, 32 4, 762-9 .
- Desgorces, F., Hourcade, J., Dubois, R., Toussaint, J.F., & Noirez, P. (2020). Training load quantification of high intensity exercises: Discrepancies between original and alternative methods. *PLoS ONE*, 15.
- Deutsch, M. U., Kearney, G. A., & Rehrer, N. J. (2007). Time - motion analysis of professional rugby union players during match-play. *Journal of sports sciences*, 25(4), 461-472. <https://doi.org/10.1080/02640410600631298>
- Dieli-Conwright, C. M., Jency, N. E., Battaglia, G. M., McCauley, S. A., & Schroeder, E. T. (2009). Validation of the CardioCoachCO₂ for submaximal and maximal metabolic exercise testing. *Journal of strength and conditioning research*, 23(4), 1316-1320. <https://doi.org/10.1519/JSC.ob013e3181a3c5e8>
- Dinges, D. F. (1992). Probing the limits of functional capacity:
- Dobson, B.P., & Keogh, J.W. (2007). Methodological Issues for the Application of Time-Motion Analysis Research. *Strength and Conditioning Journal*, 29, 48-55.
- Douroudos I, Michailidis Y, Beneka A, Malliou P, Tofas T, Georgiadis I, Mandalidis
- Downs, N.J., & Harrison, S.L. (2018). A comprehensive approach to evaluating and classifying sun-protective clothing. *British Journal of Dermatology*, 178.

- Drawer, S., & Fuller, C.W. (2002). Evaluating the level of injury in English professional football using a risk based assessment process. *British Journal of Sports Medicine*, 36, 446 - 451.
- Drinkwater, B.L., & Horvath, S.M. (1972). Detraining effects on young women. *Medicine and Science in Sports and Exercise*, 4, 91-95.
- Driver, H. S., Rogers, G. G., Mitchell, D., Borrow, S. J., Allen, M., Luus, H. G., & Shapiro, C. M. (1994). Prolonged endurance exercise and sleep disruption. *Medicine and science in sports and exercise*, 26(7), 903-907.
- Drummond, S.P., Gillin, J.C., & Brown, G.G. (2001). Increased cerebral response during a divided attention task following sleep deprivation. *Journal of Sleep Research*, 10.
- Dubois, R., Bru, N., Paillard, T., Le Cunuder, A., Lyons, M., Maurelli, O., Philippe, K., & Prioux, J. (2020). Rugby game performances and weekly workload: Using of data mining process to enter in the complexity. *PloS one*, 15(1), e0228107. <https://doi.org/10.1371/journal.pone.0228107>
- Dubois, R., Paillard, T., McGrath, D., Chamari, K., Maurelli, O., Polly, S., & Prioux, J. (2017). Changes in training load, running performance, lower body power and biochemical characteristics of back players throughout a professional Rugby Union season. *Journal of Human Sport and Exercise*, 12, 1-16.
- Duchateau, J., & Enoka, R.M. (2008). Neural control of shortening and lengthening contractions: influence of task constraints. *The Journal of Physiology*, 586.
- Dupuy, O., Renaud, M., Bherer, L., & Bosquet, L. (2010). Effect of functional overreaching on executive functions. *International journal of sports medicine*, 31 9, 617-23 .
- Durguerian, A., Bougard, C., Drogou, C., Sauvet, F., Chennaoui, M., & Filaire, E. (2016). Weight Loss, Performance and Psychological Related States in High-level Weightlifters. *International journal of sports medicine*, 37 3, 230-8 .
- Duthie G. M. (2006). A framework for the physical development of elite rugby union players. *International journal of sports physiology and performance*, 1(1), 2-13. <https://doi.org/10.1123/ijsp.1.1.2>
- Dutka, T.L., Cole, L., & Lamb, G.D. (2005). Calcium phosphate precipitation in the sarcoplasmic reticulum reduces action potential-mediated Ca²⁺ release in mammalian skeletal muscle. *American journal of physiology. Cell physiology*, 289 6, C1502-12 .

- Edgecomb, S.J., & Norton, K.I. (2006). Comparison of global positioning and computer-based tracking systems for measuring player movement distance during Australian football. *Journal of science and medicine in sport*, 9 1-2, 25-32 .
- Edwards, R.H. (1981). Human muscle function and fatigue. *Ciba Foundation symposium*, 82, 1-18 .
- Edwards, S. (1993). *The Heart Rate Monitor Book*.
- Eijsink, V., Matthews, B.W., & Vriend, G. (2011). The role of calcium ions in the stability and instability of a thermolysin-like protease. *Protein Science*, 20.
- Encarnação, I.G., Viana, R.B., Soares, S.R., Freitas, E.D., de Lira, C.A., & Ferreira-Júnior, J.B. (2022). Effects of Detraining on Muscle Strength and Hypertrophy Induced by Resistance Training: A Systematic Review. *Muscles*.
- Enoka, R.M., & Fuglevand, A.J. (2001). Motor unit physiology: Some unresolved issues. *Muscle & Nerve*, 24.
- Enoka, R.M. (2012). Muscle fatigue--from motor units to clinical symptoms. *Journal of biomechanics*, 45 3, 427-33 .
- Enoka, R.M., & Duchateau, J. (2016). Translating Fatigue to Human Performance. *Medicine and science in sports and exercise*, 48 11, 2228-2238 .
- Falk Neto, J.H., Tibana, R.A., de Sousa, N.M., Prestes, J., Voltarelli, F.A., & Kennedy, M.D. (2020). Session Rating of Perceived Exertion Is a Superior Method to Monitor Internal Training Loads of Functional Fitness Training Sessions Performed at Different Intensities When Compared to Training Impulse. *Frontiers in Physiology*, 11.
- Fanchini, M., Rampinini, E., Riggio, M., Coutts, A.J., Pecci, C., & McCall, A. (2018). Despite association, the acute:chronic work load ratio does not predict non-contact injury in elite footballers. *Science and Medicine in Football*, 2, 108 - 114.
- Fardy, P.S. (1969). Effects of soccer training and detraining upon selected cardiac and metabolic measures. *Research quarterly*, 40 3, 502-8 .
- Fearnley, D., Sutton, L., O'Hara, J., Brightmore, A., King, R., & Cooke, C. (2012). Case study of a female ocean racer: prerace preparation and nutritional intake during the Vendée Globe 2008. *International journal of sport nutrition and exercise metabolism*, 22(3), 212-219. <https://doi.org/10.1123/ijsnem.22.3.212>

- Ferioli, D., Bosio, A., Bilsborough, J.C., La Torre, A., Tornaghi, M., & Rampinini, E. (2018). The Preparation Period in Basketball: Training Load and Neuromuscular Adaptations. *International journal of sports physiology and performance*, 13 8, 991-999 .
- Ferioli, D., Schelling, X., Bosio, A., La Torre, A., Rucco, D., & Rampinini, E. (2019). Match Activities in Basketball Games: Comparison Between Different Competitive Levels. *Journal of Strength and Conditioning Research*.
- Fernández, M. & Ezquerro, M. (2005). Diferencias tácticas entre los tramos de ceñida de una misma regata. *Kronos*, 4(8), 10-15.
- Fernández, J.F., Rivas, D.S., & Villanueva, A. (2009). A Review of the Activity Profile and Physiological Demands of Tennis Match Play. *Strength and Conditioning Journal*, 31, 15-26.
- Fernandez, R.P. The seasickness as marine problem-case study. *J. Marine. Sci. Appl.* 12, 58-64 (2013). <https://doi.org/10.1007/s11804-013-1172-y>
- Ferrari, M., Mottola, L., & Quaresima, V. (2004). Principles, techniques, and limitations of near infrared spectroscopy. *Canadian journal of applied physiology = Revue canadienne de physiologie appliquee*, 29 4, 463-87 .
- Ferretti, Roberto & Festa, Adriano. (2019). Optimal Route Planning for Sailing Boats: A Hybrid Formulation. *Journal of Optimization Theory and Applications*. 181. 10.1007/s10957-019-01506-x.
- Filardi, M., Morini, S., & Plazzi, G. (2020). Pre-Race Sleep Management Strategy and Chronotype of Offshore Solo Sailors. *Nature and Science of Sleep*, 12, 263 - 269.
- Finch, C.F., & Owen, N. (2001). Injury prevention and the promotion of physical activity: what is the nexus? *Journal of science and medicine in sport*, 4 1, 77-87 .
- Finsterer, J. (2012). Biomarkers of peripheral muscle fatigue during exercise. *BMC Musculoskeletal Disorders*, 13, 218 - 218.
- Fisher, R., Mclellan, C.P., & Sinclair, W. (2015). The validity and reliability for a salivary cortisol point of care test. *Journal of Athletic Enhancement*, 2015, 1-6.
- Focke, Anne & Räßple, Stefan & Kurz, Gunther & Schwameder, Hermann. (2011). Counter movement jump in performance diagnostics. Use of the correct jumping technique. *European Journal of Sport Science*. 12. 231-237. 10.1080/17461391.2011.566369.
- Fogelholm, G.M., & Lahtinen, P. (1991). Nutritional evaluation of a sailing crew during a transatlantic race. *Scandinavian Journal of Medicine & Science in Sports*, 1.

- Folkard, S., Lombardi, D.A., & Tucker, P. (2005). Shiftwork: safety, sleepiness and sleep. *Industrial health*, 43 1, 20-3 .
- Folland, J.P., & Williams, A.G. (2007). Morphological and Neurological Contributions to Increased Strength. *Sports Medicine*, 37, 145-168.
- Foster, C.C. (1998). Monitoring training in athletes with reference to overtraining syndrome. *Medicine and science in sports and exercise*, 30 7, 1164-8 .
- Foster, C.C., Florhaug, J.A., Franklin, J., Gottschall, L.L., Hrovatin, L.A., Parker, S., Doleshal, P., & Dodge, C. (2001). A New Approach to Monitoring Exercise Training. *Journal of Strength and Conditioning Research*, 15, 109-115.
- Foster, Russell. (2012). A good introduction to sleep and sleep disorders. *The Lancet Neurology*. 11. 848. 10.1016/S1474-4422(12)70222-3.
- Foster, C.C., Rodríguez-Marroyo, J.A., & de Koning, J.J. (2017). Monitoring Training Loads: The Past, the Present, and the Future. *International journal of sports physiology and performance*, 12 Suppl 2, S22-S28 .
- Foster, C.C., Boullosa, D.A., McGuigan, M.M., Fusco, A., Cortis, C., Arney, B.E., Orton, B., Dodge, C., Jaime, S.J., Radtke, K., van Erp, T., de Koning, J.J., Bok, D., Rodríguez-Marroyo, J.A., & Porcari, J.P. (2021). 25 Years of Session Rating of Perceived Exertion: Historical Perspective and Development. *International journal of sports physiology and performance*, 1-10 .
- Fowles, J.R. (2006). Technical issues in quantifying low-frequency fatigue in athletes. *International journal of sports physiology and performance*, 1 2, 169-71 .
- Froyd, C., Millet, G.Y., & Noakes, T.D. (2013). The development of peripheral fatigue and short-term recovery during self-paced high-intensity exercise. *The Journal of Physiology*, 591.
- Froyd, C., Beltrami, F.G., Millet, G.Y., & Noakes, T.D. (2016). No Critical Peripheral Fatigue Threshold during Intermittent Isometric Time to Task Failure Test with the Knee Extensors. *Frontiers in Physiology*, 7.
- Fry, R.W., Morton, A.R., & Keast, D.N. (1991). Overtraining in Athletes. *Sports Medicine*, 12, 32-65.
- Fry, R.W., Morton, A.R., & Keast, D. (1992). Periodisation and the prevention of overtraining. *Canadian journal of sport sciences = Journal canadien des sciences du sport*, 17 3, 241-8 .

- Fry, A. C. (1998). The role of training intensity in resistance exercise overtraining and overreaching. In R. B. Kreider, A. C. Fry & M. L. O'Toole (Eds.), *Overtraining in Sport* (pp. 107-130). Champaign, IL: Human Kinetics
- Fullagar, H.H., Duffield, R., Skorski, S., Coutts, A.J., Julian, R., & Meyer, T. (2015). Sleep and Recovery in Team Sport: Current Sleep-Related Issues Facing Professional Team-Sport Athletes. *International journal of sports physiology and performance*, 10 8, 950-7 .
- Fuller, C.W., & Drawer, S. (2004). The Application of Risk Management in Sport. *Sports Medicine*, 34, 349-356.
- Fuller, C.W., Ekstrand, J., Junge, A., Andersen, T.E., Bahr, R., Dvořák, J., Hägglund, M., McCrory, P., & Meeuwisse, W.H. (2006). Consensus statement on injury definitions and data collection procedures in studies of football (soccer) injuries. *British Journal of Sports Medicine*, 40, 193 - 201.
- Gabbett, T.J. (2014). Data collection in high-performance sport: Is it making a difference? *Journal of Science and Medicine in Sport*, 18.
- Gabbett T. J. (2016). The training-injury prevention paradox: should athletes be training smarter and harder?. *British journal of sports medicine*, 50(5), 273-280. <https://doi.org/10.1136/bjsports-2015-095788>
- Galvani, C., Ardigò, L. P., Alberti, M., Daniele, F., & Capelli, C. (2015). Physical activity, sleep pattern and energy expenditure in double-handed offshore sailing. *The Journal of sports medicine and physical fitness*, 55(12), 1480-1488.
- Gambetta, V. (2006). *Athletic Development: The Art & Science of Functional Sports Conditioning*.
- Gandevia, S.C. (1998). Neural control in human muscle fatigue: changes in muscle afferents, moto neurones and moto cortical drive. *Acta Physiologica Scandinavica*, 162, 275-283.
- Gandevia, S.C. (2001). Spinal and supraspinal factors in human muscle fatigue. *Physiological reviews*, 81 4, 1725-89 .
- Garbarino, S., Lanteri, P., Bragazzi, N. L., Magnavita, N., & Scoditti, E. (2021). Role of sleep deprivation in immune-related disease risk and outcomes. *Communications biology*, 4(1), 1304. <https://doi.org/10.1038/s42003-021-02825-4>
- Garcin, M., Vautier, J.F., Vandewalle, H., & Monod, H. (1998). Ratings of perceived exertion (RPE) as an index of aerobic endurance during local and general exercises. *Ergonomics*, 41 8, 1105-14 .

- Garrett, J., Graham, S.R., Eston, R., Burgess, D.J., Garrett, L.J., Jakeman, J.R., & Norton, K.I. (2019). A Novel Method of Assessment for Monitoring Neuromuscular Fatigue in Australian Rules Football Players. *International journal of sports physiology and performance*, 14 5, 598-605 .
- Gates, D.H., & Dingwell, J.B. (2008). The effects of neuromuscular fatigue on task performance during repetitive goal-directed movements. *Experimental Brain Research*, 187, 573-585.
- Gathercole, R.J., Sporer, B.C., Stellingwerff, T., & Sleivert, G.G. (2015). Alternative countermovement-jump analysis to quantify acute neuromuscular fatigue. *International journal of sports physiology and performance*, 10 1, 84-92 .
- Gee, T.I., French, D.N., Howatson, G., Payton, S., Berger, N., & Thompson, K.G. (2011). Does a bout of strength training affect 2,000 m rowing ergometer performance and rowing-specific maximal power 24 h later? *European Journal of Applied Physiology*, 111, 2653-2662.
- Gentile, D.A., & Auerbach, P.S. (1987). The sun and water sports. *Clinics in sports medicine*, 6 3, 669-84 .
- Ghiani, G., Magnani, S., Doneddu, A., Sainas, G., Pinna, V., Caboi, M., Palazzolo, G., Tocco, F., & Crisafulli, A. (2018). Case Study: Physical Capacity and Nutritional Status Before and After a Single-Handed Yacht Race. *International journal of sport nutrition and exercise metabolism*, 28(5), 558-563. <https://doi.org/10.1123/ijsnem.2017-0345>
- Giacon, T. A., Bosco, G., Vezzoli, A., Dellanoce, C., Cialoni, D., Paganini, M., & Mrakic-Sposta, S. (2022). Oxidative stress and motion sickness in one crew during competitive offshore sailing. *Scientific reports*, 12(1), 1142. <https://doi.org/10.1038/s41598-022-05219-6>
- Girard, O., Brocherie, F., & Millet, G.P. (2015). Can analysis of performance and neuromuscular recoveries from repeated sprints shed more light on its fatigue-causing mechanisms? *Frontiers in Physiology*, 6.
- Glaister M. (2005). Multiple sprint work : physiological responses, mechanisms of fatigue and the influence of aerobic fitness. *Sports medicine (Auckland, N.Z.)*, 35(9), 757-777. <https://doi.org/10.2165/00007256-200535090-00003>
- Gómez-Carmona, C.D., Bastida-Castillo, A., Ibáñez, S.J., & Pino-Ortega, J. (2020). Accelerometry as a method for external workload monitoring in invasion team sports. A systematic review. *PLoS ONE*, 15.
- Gómez-Carmona, C.D., Bastida-Castillo, A., Ibáñez, S.J., & Pino-Ortega, J. (2020). Accelerometry as a method for external workload monitoring in invasion team sports. A systematic review. *PLoS ONE*, 15.

- Gómez-Carmona, C.D., Bastida-Castillo, A., Rojas-Valverde, D., de la Cruz Sánchez, E., García-Rubio, J., Ibáñez, S.J., & Pino-Ortega, J. (2019). Lower-limb Dynamics of Muscle Oxygen Saturation During the Back-squat Exercise: Effects of Training Load and Effort Level. *Journal of Strength and Conditioning Research*.
- Gordon, A.M., Homsher, E., & Regnier, M. (2000). Regulation of contraction in striated muscle. *Physiological reviews*, 80 2, 853-924 .
- Gorelick, M.L., Brown, J.M., & Groeller, H. (2003). Short-duration fatigue alters neuromuscular coordination of trunk musculature: implications for injury. *Applied ergonomics*, 34 4, 317-25 .
- Granata, C., Jamnick, N. A., & Bishop, D. J. (2018). Training-Induced Changes in Mitochondrial Content and Respiratory Function in Human Skeletal Muscle. *Sports medicine (Auckland, N.Z.)*, 48(8), 1809–1828. <https://doi.org/10.1007/s40279-018-0936-y>
- Green A. Sydney-Hobart report. (1999) *RYA Magazine*. 9: 11–14.
- Gribble, P.A., & Hertel, J. (2004). Changes in Postural Control during a 48-Hr. Sleep Deprivation Period. *Perceptual and Motor Skills*, 99, 1035 - 1045.
- Groslambert, A., Candau, R. B., & Millet, G. P. (2008). Effect of Sleep Deprivation on Anxiety and Perceived Fatigue During a One-Man Atlantic Ocean Crossing on a Sport Catamaran. *Environment and Behavior*, 40(1), 96–110. <https://doi.org/10.1177/0013916507300116>
- Guézennec, C.Y., Satabin, P., Legrand, H., & Bigard, A.X. (2004). Physical performance and metabolic changes induced by combined prolonged exercise and different energy intakes in humans. *European Journal of Applied Physiology and Occupational Physiology*, 68, 525-530.
- Gunnarsson, Lars-Gunnar & Bäck, Hans & Jones, Ian & Olsson, Tommy. (2004). Stress recovery during an ocean boat race. *Stress and Health*. 20. 165 - 171. 10.1002/smi.1008.
- Hackney, A.C., Shaw, J.M., Hodgdon, J.A., Coyne, J.T., & Kelleher, D.L. (1991). Cold exposure during military operations: effects on anaerobic performance. *Journal of applied physiology*, 71 1, 125-30 .
- Hadala, M., & Barrios, C. (2009). Different strategies for sports injury prevention in an America's Cup yachting crew. *Medicine and science in sports and exercise*, 41 8, 1587-96 .

- Hadala, M., Vera, P., & Barrios, C. (2012). Anthropometry Profile and its Influence on Injury Pattern in America's Cup Racing Crew.
- Haddad, M., Stylianides, G., Djaoui, L., Dellal, A., & Chamari, K. (2017). Session-RPE Method for Training Load Monitoring: Validity, Ecological Usefulness, and Influencing Factors. *Frontiers in neuroscience*, *11*, 612. <https://doi.org/10.3389/fnins.2017.00612>
- Haff, G.G. (2004). Roundtable Discussion: Periodization of Training???Part 1. *Strength and Conditioning Journal*, *26*, 50-69.
- Haff, G., Nimphius, S. and Sheppard, JM. (2013). The reliability of isometric force-time variables collected on a portable mid-thigh pull testing device. *Journal of Strength Conditioning Research*, *27*(10), 98-99.
- Hagin, V., Gonzales, B. R., Candau, R. B., & Gros Lambert, A. (2012). Influence of a conservative sleep management strategy during a solo Pacific Ocean crossing on anxiety and perceived fatigue: a case study. *Journal of sports sciences*, *30*(4), 395-402. <https://doi.org/10.1080/02640414.2011.644248>
- Häkkinen, K. (1993). Neuromuscular fatigue and recovery in male and female athletes during heavy resistance exercise. *International journal of sports medicine*, *14* 2, 53-9 .
- Häkkinen, K. (1994). Neuromuscular fatigue in males and females during strenuous heavy resistance loading. *Electromyography and clinical neurophysiology*, *34* 4, 205-14 .
- Hall, C. J., & Lane, A. M. (2001). Effects of rapid weight loss on mood and performance among amateur boxers. *British journal of sports medicine*, *35*(6), 390-395. <https://doi.org/10.1136/bjism.35.6.390>
- Halson S. L. (2014). Monitoring training load to understand fatigue in athletes. *Sports medicine (Auckland, N.Z.)*, *44* Suppl 2(Suppl 2), S139-S147. <https://doi.org/10.1007/s40279-014-0253-z>
- Halson, S.L. (2014). Monitoring Training Load to Understand Fatigue in Athletes. *Sports Medicine (Auckland, N.z.)*, *44*, 139 - 147.
- Halson, S.L., & Jeukendrup, A.E. (2004). Does Overtraining Exist? *Sports Medicine*, *34*, 967-981.
- Hamada, T., Sale, D.G., Macdougall, J.D., & Tarnopolsky, M.A. (2003). Interaction of fibre type, potentiation and fatigue in human knee extensor muscles. *Acta physiologica Scandinavica*, *178* 2, 165-73 .
- Hamill, J., & Knutzen, K.M. (1995). Biomechanical Basis of Human Movement.

- Harre, D., & Barsch, J.D. (1982). Principles of sports training : introduction to the theory and methods of training.
- Harrison, Y., & Horne, J.A. (2000). The impact of sleep deprivation on decision making: a review. *Journal of experimental psychology. Applied*, 6 3, 236-49 .
- Hasegawa, H., Piacentini, M.F., Sarre, S., Michotte, Y., Ishiwata, T., & Meeusen, R. (2008). Influence of brain catecholamines on the development of fatigue in exercising rats in the heat. *The Journal of Physiology*, 586.
- Hawley, J.A., & Burke, L.M. (1998). Peak Performance: Training and Nutritional Strategies for Sport.
- Hayes, P.R., & Quinn, M.D. (2009). A mathematical model for quantifying training. *European Journal of Applied Physiology*, 106, 839-847.
- Heubert, R., Bocquet, V., Koralsztein, J.P., & Billat, V.L. (2003). [Effect of 4 weeks of training on the limit time at VO₂ max]. *Canadian journal of applied physiology = Revue canadienne de physiologie appliquee*, 28 5, 717-36 .
- Hiemstra, L.A., Lo, I.K., & Fowler, P.J. (2001). Effect of fatigue on knee proprioception: implications for dynamic stabilization. *The Journal of orthopaedic and sports physical therapy*, 31 10, 598-605 .
- Hobson, J.A. (2009). REM sleep and dreaming: towards a theory of protoconsciousness. *Nature Reviews Neuroscience*, 10, 803-813.
- Hodgson, M., Docherty, D., & Robbins, D. (2005). Post-activation potentiation: underlying physiology and implications for motor performance. *Sports medicine (Auckland, N.Z.)*, 35(7), 585-595. <https://doi.org/10.2165/00007256-200535070-00004>
- Hole, J. W. (1987). *Human anatomy and physiology*. McGraw-Hill Science, Engineering & Mathematics.
- Hooper, S. L., & Mackinnon, L. T. (1995). Monitoring overtraining in athletes. Recommendations. *Sports medicine (Auckland, N.Z.)*, 20(5), 321-327. <https://doi.org/10.2165/00007256-199520050-00003>
- Hootman, J., Dick, R.W., & Agel, J. (2007). Epidemiology of collegiate injuries for 15 sports: summary and recommendations for injury prevention initiatives. *Journal of athletic training*, 42 2, 311-9 .

- Horak, F.B. (2009). Postural Compensation for Vestibular Loss. *Annals of the New York Academy of Sciences*, 1164.
- Houmar, J. A., Hortobágyi, T., Johns, R. A., Bruno, N. J., Nute, C. C., Shinebarger, M. H., & Welborn, J. W. (1992). Effect of short-term training cessation on performance measures in distance runners. *International journal of sports medicine*, 13(8), 572–576. <https://doi.org/10.1055/s-2007-1024567>
- Hulin, B. T., Gabbett, T. J., Blanch, P., Chapman, P., Bailey, D., & Orchard, J. W. (2014). Spikes in acute workload are associated with increased injury risk in elite cricket fast bowlers. *British journal of sports medicine*, 48(8), 708–712. <https://doi.org/10.1136/bjsports-2013-092524>
- Hulin, B. T., Gabbett, T. J., Lawson, D. W., Caputi, P., & Sampson, J. A. (2016). The acute:chronic workload ratio predicts injury: high chronic workload may decrease injury risk in elite rugby league players. *British journal of sports medicine*, 50(4), 231–236. <https://doi.org/10.1136/bjsports-2015-094817>
- Hung, E.W., Aronson, K.J., Leung, M., Day, A.G., & Tranmer, J.E. (2016). Shift work parameters and disruption of diurnal cortisol production in female hospital employees. *Chronobiology International*, 33, 1045 - 1055.
- HURDIEL, R., MONACA, C., MAUVIEUX, B., MCCAULEY, P., VAN DONGEN, H. P., & THEUNYNCK, D. (2012, July 25). Field study of sleep and functional impairments in solo sailing races. *Sleep and Biological Rhythms*, 10(4), 270–277. <https://doi.org/10.1111/j.1479-8425.2012.00570.x>
- Hurdiel, R., Van Dongen, H. P., Aron, C., McCauley, P., Jacolot, L., & Theunynck, D. (2013, September 9). Sleep restriction and degraded reaction-time performance in Figaro solo sailing races. *Journal of Sports Sciences*, 32(2), 172–174. <https://doi.org/10.1080/02640414.2013.815359>
- Hurdiel, R., Van Dongen, H. P., Aron, C., McCauley, P., Jacolot, L., & Theunynck, D. (2014). Sleep restriction and degraded reaction-time performance in Figaro solo sailing races. *Journal of sports sciences*, 32(2), 172–174. <https://doi.org/10.1080/02640414.2013.815359>
- Hwang, P. S., Andre, T. L., McKinley-Barnard, S. K., Morales Marroquín, F. E., Gann, J. J., Song, J. J., & Willoughby, D. S. (2017). Resistance Training-Induced Elevations in Muscular Strength in Trained Men Are Maintained After 2 Weeks of Detraining and Not Differentially Affected by Whey Protein Supplementation. *Journal of strength and conditioning research*, 31(4), 869–881. <https://doi.org/10.1519/JSC.0000000000001807>

- Iellamo, F., Pigozzi, F., Spataro, A., Lucini, D., & Pagani, M. (2004). T-wave and heart rate variability changes to assess training in world-class athletes. *Medicine and science in sports and exercise*, 36 8, 1342-6 .
- Imeri, L., & Opp, M.R. (2009). How (and why) the immune system makes us sleep. *Nature Reviews Neuroscience*, 10, 199-210.
- Impellizzeri, F.M., Margonato, V., Cé, E., Vanni, R., Veicsteinas, A., & Esposito, F. (2005). The use of heart rate reserve to monitor soccer-specific exercises.
- Impellizzeri, F.M., Wookcock, S., McCall, A., Ward, P., & Coutts, A.J. (2019). The acute-chronic workload ratio-injury figure and its 'sweet spot' are flawed.
- Impellizzeri, F.M., Tenan, M.S., Kempton, T., Novak, A.R., & Coutts, A.J. (2020a). Acute:Chronic Workload Ratio: Conceptual Issues and Fundamental Pitfalls. *International journal of sports physiology and performance*, 1-7 .
- Impellizzeri, F.M., Wookcock, S., Coutts, A.J., Fanchini, M., McCall, A., & Vigotsky, A.D. (2020b). Acute to random workload ratio is 'as' associated with injury as acute to actual chronic workload ratio: time to dismiss ACWR and its components.
- Ingjer, F. (1979). Effects of endurance training on muscle fibre ATP-ase activity, capillary supply and mitochondrial content in man. *The Journal of Physiology*, 294.
- Jackson, A. S., & Pollock, M. L. (1978). Generalized equations for predicting body density of men. *The British journal of nutrition*, 40(3), 497-504. <https://doi.org/10.1079/bjn19780152>
- Jackson, M.L., Grant, D.A., Belenky, G., & Dongen, H.V. (2011). Changes in positive and negative affect across two weeks of simulated night shift.
- Jammes, Y., Caquelard, F., & Badier, M. (1998). Correlation between surface electromyogram, oxygen uptake and blood lactate concentration during dynamic leg exercises. *Respiration physiology*, 112 2, 167-74 .
- Jean-Christophe, H., Philippe, N., Michel, S., Jean-François, T., & François, D. (2018). Effects of intensity distribution changes on performance and on training loads quantification. *Biology of sport*, 35 1, 67-74 .
- Jennings, D., Cormack, S.J., Coutts, A.J., Boyd, L.J., & Aughey, R.J. (2010). The validity and reliability of GPS units for measuring distance in team sport specific running patterns. *International journal of sports physiology and performance*, 5 3, 328-41 .

- Jiao, X., Bai, J., Chen, S., & Li, Q. (2013). Monitoring Mental Fatigue in Analog Space Environment Using Optical Brain Imaging. *Engineering*, 05, 53-57.
- Jones, B., Hesford, C.M., & Cooper, C.E. (2013). The use of portable NIRS to measure muscle oxygenation and haemodynamics during a repeated sprint running test. *Advances in experimental medicine and biology*, 789, 185-191 .
- Jones, C. M., Griffiths, P. C., & Mellalieu, S. D. (2017). Training Load and Fatigue Marker Associations with Injury and Illness: A Systematic Review of Longitudinal Studies. *Sports medicine (Auckland, N.Z.)*, 47(5), 943-974. <https://doi.org/10.1007/s40279-016-0619-5>
- Jones, C. M., Griffiths, P. C., & Mellalieu, S. D. (2017). Training Load and Fatigue Marker Associations with Injury and Illness: A Systematic Review of Longitudinal Studies. *Sports medicine (Auckland, N.Z.)*, 47(5), 943-974. <https://doi.org/10.1007/s40279-016-0619-5>
- Joo C. H. (2016). The effects of short-term detraining on exercise performance in soccer players. *Journal of exercise rehabilitation*, 12(1), 54-59. <https://doi.org/10.12965/jer.160280>
- Jung, C., Melanson, E.L., Frydendall, E., Perreault, L., Eckel, R.H., & Wright, K.P. (2011). Energy expenditure during sleep, sleep deprivation and sleep following sleep deprivation in adult humans. *The Journal of Physiology*, 589, 235 - 244.
- Kajaia, T., Maskhulia, L., Chelidze, K., Akhalkatsi, V., & Kakhabrishvili, Z. (2021). ASSESSMENT OF EFFECTS OF NON-FUNCTIONAL OVERREACHING AND OVERTRAINING ON RESPONSES OF SKELETAL MUSCLE AND CARDIAC BIOMARKERS FOR MONITORING OF OVERTRAINING SYNDROME IN ATHLETES. *Georgian medical news*, (311), 79-84.
- Kamandulis, S., Muanjai, P., Skurvydas, A., Brazaitis, M., Snieckus, A., Venckunas, T., Streckis, V., Mickevičienė, D., & Jones, D.A. (2019). The contribution of low-frequency fatigue to the loss of quadriceps contractile function following repeated drop jumps. *Experimental Physiology*, 104, 1701 - 1710.
- Kataoka, R., Vasenina, E., Hammert, W.B., Ibrahim, A.H., Dankel, S.J., & Buckner, S.L. (2021). Is there Evidence for the Suggestion that Fatigue Accumulates Following Resistance Exercise? *Sports Medicine*, 52, 25-36.
- Kawai, M., Stehle, R., Pfitzer, G., & Iorga, B.I. (2021). Phosphate has dual roles in cross-bridge kinetics in rabbit psoas single myofibrils. *The Journal of General Physiology*, 153.
- Keeton, R.B., & Binder-Macleod, S.A. (2006). Low-frequency fatigue. *Physical therapy*, 86 8, 1146-50 .

- Kellmann, M., & Kallus, K.W. (2001). Recovery-stress questionnaire for athletes: User manual.
- Kellmann, M., Altenburg, D., Lormes, W., & Steinacker, J.M. (2001). Assessing stress and recovery during preparation for the world championships in rowing. *Sport Psychologist*, 15, 151-167.
- Kenttä, G., & Hassmén, P. (1998). Overtraining and recovery. A conceptual model. *Sports medicine (Auckland, N.Z.)*, 26(1), 1-16. <https://doi.org/10.2165/00007256-199826010-00001>
- Kenttä, G., & Hassmén, P. (1998). Overtraining and Recovery. *Sports Medicine*, 26, 1-16.
- Kerdraon, Paul & Horel, Boris & Bot, Patrick & Letourneur, Adrien & Le Touzé, David. (2020). Development of a 6-DOF Dynamic Velocity Prediction Program for offshore racing yachts. *Ocean Engineering*. 212. 107668. [10.1016/j.oceaneng.2020.107668](https://doi.org/10.1016/j.oceaneng.2020.107668).
- Keyser R. E. (2010). Peripheral fatigue: high-energy phosphates and hydrogen ions. *PM & R : the journal of injury, function, and rehabilitation*, 2(5), 347-358. <https://doi.org/10.1016/j.pmrj.2010.04.009>
- Keyser, R.E. (2010). Peripheral Fatigue: High-Energy Phosphates and Hydrogen Ions. *PM&R*, 2.
- Kim, Y. J., & Park, K. M. (2020). Effects of Super-ultramarathon Running on Cardiac Structure and Function in Middle-aged Men. *Journal of cardiovascular imaging*, 28(3), 202-210. <https://doi.org/10.4250/jcvi.2020.0020>
- Kirkendall, D.T. (1990). Mechanisms of peripheral fatigue. *Medicine and science in sports and exercise*, 22 4, 444-9 .
- Klusiewicz, A., Rębiś, K., Ozimek, M., & Czaplicki, A. (2021). The use of muscle near-infrared spectroscopy (NIRS) to assess the aerobic training loads of world-class rowers. *Biology of Sport*, 38, 713 - 719.
- Knapik, J.J., Daniels, W.L., Murphy, M.M., Fitzgerald, P.I., Drews, F., & Vogel, J.A. (2004). Physiological factors in infantry operations. *European Journal of Applied Physiology and Occupational Physiology*, 60, 233-238.
- Korzeniewski, B. (2019). Pi-induced muscle fatigue leads to near-hyperbolic power-duration dependence. *European Journal of Applied Physiology*, 119, 2201 - 2213.
- Kraeutler, Matthew & Laver, Lior & Mei-Dan, Omer. (2020). Extreme Sports. [10.1007/978-3-030-36790-9_54](https://doi.org/10.1007/978-3-030-36790-9_54).
- Kreher, J.B., & Schwartz, J.B. (2012). Overtraining Syndrome. *Sports Health*, 4, 128 - 138.
- Kreider, R.B., Fry, A.C., & O'Toole, M.L. (1997). Overtraining in Sport.

- Krutki, P., Hałuszka, A., Mrówczyński, W., Gardiner, P.F., & Celichowski, J. (2015). Adaptations of motoneuron properties to chronic compensatory muscle overload. *Journal of neurophysiology*, *113*(7), 2769-77 .
- Kuipers, H., & Keizer, H. A. (1988). Overtraining in elite athletes. Review and directions for the future. *Sports medicine (Auckland, N.Z.)*, *6*(2), 79-92. <https://doi.org/10.2165/00007256-198806020-00003>
- Kuitunen, S., Avela, J., Kyröläinen, H., & Komi, P.V. (2003). Voluntary activation and mechanical performance of human triceps surae muscle after exhaustive stretch-shortening cycle jumping exercise. *European Journal of Applied Physiology*, *91*, 538-544.
- Kuitunen, S., Avela, J., Kyröläinen, H., Nicol, C., & Komi, P.V. (2002). Acute and prolonged reduction in joint stiffness in humans after exhausting stretch-shortening cycle exercise. *European Journal of Applied Physiology*, *88*, 107-116.
- Kvasnička, J., Zelinka, T., Petrák, O., Rosa, J., Štrauch, B., Krátká, Z., Indra, T., Markvartová, A., Widimský, J., Jr, & Holaj, R. (2019). Catecholamines Induce Left Ventricular Subclinical Systolic Dysfunction: A Speckle-Tracking Echocardiography Study. *Cancers*, *11*(3), 318. <https://doi.org/10.3390/cancers11030318>
- Lafère, P., Gatzoff, Y., Guerrero, F., Provyn, S., & Balestra, C. (2020). Field study of anthropomorphic and muscle performance changes among elite skippers following a transoceanic race. *International maritime health*, *71*(1), 20-27. <https://doi.org/10.5603/IMH.2020.0007>
- Lafleur, J., Zytnicki, D., Horcholle-Bossavit, G., & Jami, L. (1992). Depolarization of Ib afferent axons in the cat spinal cord during homonymous muscle contraction. *The Journal of Physiology*, 445.
- Lagarde, D., & Batéjat, D. (1995). Disrupted Sleep-Wake Rhythm and Performance: Advantages of Modafinil. *Military Psychology*, *7*, 165-191.
- Lamberts, R., Maskell, S., Borresen, J., & Lambert, M.I. (2011). Adapting workload improves the measurement of heart rate recovery. *International journal of sports medicine*, *32*(9), 698-702.
- Larsson, B., Beyer, N., Bay, P., Biønd, L., Aagaard, P., & Kjaer, M. (1996). Exercise performance in elite male and female sailors. *International journal of sports medicine*, *17*(7), 504-508. <https://doi.org/10.1055/s-2007-972886>
- Laver, L., Pengas, I. P., & Mei-Dan, O. (2017). Injuries in extreme sports. *Journal of orthopaedic surgery and research*, *12*(1), 59. <https://doi.org/10.1186/s13018-017-0560-9>

- Leavitt, V.M., & DeLuca, J. (2010). Central Fatigue: Issues Related to Cognition, Mood and Behavior, and Psychiatric Diagnoses. *PM&R*, 2.
- LeDuc, P. A., Greig, J. L., & Dumond, S. L. (2005). Involuntary eye responses as measures of fatigue in US Army Apache aviators. *Aviation, space, and environmental medicine*, 76(7 Suppl), C86–C91.
- Lee, E. C., Fragala, M. S., Kavouras, S. A., Queen, R. M., Pryor, J. L., & Casa, D. J. (2017). Biomarkers in Sports and Exercise: Tracking Health, Performance, and Recovery in Athletes. *Journal of strength and conditioning research*, 31(10), 2920–2937. <https://doi.org/10.1519/JSC.0000000000002122>
- Léger, D., Elbaz, M., Raffray, T., Metlaine, A., Bayon, V., & Duforez, F. (2007). Sleep management and the performance of eight sailors in the Tour de France à la voile yacht race. *Journal of sports sciences*, 26(1), 21–28. <https://doi.org/10.1080/02640410701348636>
- Lethuillier, D. (1986). Pathologie traumatique de la Transat des Alizés 84.
- Lewis, N. A., Redgrave, A., Homer, M., Burden, R., Martinson, W., Moore, B., & Pedlar, C. R. (2018). Alterations in Redox Homeostasis During Recovery From Unexplained Underperformance Syndrome in an Elite International Rower. *International journal of sports physiology and performance*, 13(1), 107–111. <https://doi.org/10.1123/ijsp.2016-0777>
- Lieber, R.L., & Fridén, J. (2000). Functional and clinical significance of skeletal muscle architecture. *Muscle & Nerve*, 23.
- Lim, J., & Dinges, D.F. (2010). A meta-analysis of the impact of short-term sleep deprivation on cognitive variables. *Psychological bulletin*, 136 3, 375-89 .
- Lindsay, A., Lewis, J., Scarrott, C., Draper, N., & Gieseg, S. P. (2015). Changes in acute biochemical markers of inflammatory and structural stress in rugby union. *Journal of sports sciences*, 33(9), 882–891. <https://doi.org/10.1080/02640414.2014.971047>
- Loddé, B., Mahé, C., Jacolot, L., Pougnet, R., Lucas, D., Jegaden, D., Dewitte, J. D., Misery, L., & Lucas, R. (2016). Skin Diseases Affecting High-Level Competition Sailors: Descriptive Study Carried Out During the 2012 AG2R Transatlantic Boat Race. *Wilderness & environmental medicine*, 27(1), 39–45. <https://doi.org/10.1016/j.wem.2015.10.011>
- Lorist, M. M., Boksem, M. A., & Ridderinkhof, K. R. (2005). Impaired cognitive control and reduced cingulate activity during mental fatigue. *Brain research. Cognitive brain research*, 24(2), 199–205. <https://doi.org/10.1016/j.cogbrainres.2005.01.018>

- Lovell, T. W., Sirotic, A. C., Impellizzeri, F. M., & Coutts, A. J. (2013). Factors affecting perception of effort (session rating of perceived exertion) during rugby league training. *International journal of sports physiology and performance*, 8(1), 62–69. <https://doi.org/10.1123/ijsp.8.1.62>
- Lucas, S.J., Anglem, N., Roberts, W.S., Anson, J.G., Palmer, C.D., Walker, R.J., Cook, C.J., & Cotter, J.D. (2008). Intensity and physiological strain of competitive ultra-endurance exercise in humans. *Journal of Sports Sciences*, 26, 477 - 489.
- Lucas, S.J., Anson, J.G., Palmer, C.D., Hellemans, I.J., & Cotter, J.D. (2009). The impact of 100 hours of exercise and sleep deprivation on cognitive function and physical capacities. *Journal of Sports Sciences*, 27, 719 - 728.
- Lucia, A., Hoyos, J., Santalla, A., Earnest, C.P., & Chicharro, J.L. (2003). Tour de France versus Vuelta a España: which is harder? *Medicine and science in sports and exercise*, 35 5, 872-8 .
- Mackenzie, R.J., & Cushion, C.J. (2013). Performance analysis in football: A critical review and implications for future research. *Journal of Sports Sciences*, 31, 639 - 676.
- Mackinnon, L.T. (2000). Overtraining effects on immunity and performance in athletes. *Immunology and Cell Biology*, 78.
- Maclean, P. S., Bergouignan, A., Cornier, M. A., & Jackman, M. R. (2011). Biology's response to dieting: the impetus for weight regain. *American journal of physiology. Regulatory, integrative and comparative physiology*, 301(3), R581–R600. <https://doi.org/10.1152/ajpregu.00755.2010>
- Malone, S., Owen, A., Newton, M., Mendes, B., Collins, K. D., & Gabbett, T. J. (2017). The acute:chronic workload ratio in relation to injury risk in professional soccer. *Journal of science and medicine in sport*, 20(6), 561–565. <https://doi.org/10.1016/j.jsams.2016.10.014>
- Maluf, K.S., & Enoka, R.M. (2005). Task failure during fatiguing contractions performed by humans. *Journal of applied physiology*, 99 2, 389-96 .
- Mamiya, A., Morii, I., & Goto, K. (2021). Effects of partial sleep deprivation after prolonged exercise on metabolic responses and exercise performance on the following day. *Physical Activity and Nutrition*, 25, 1 - 6.
- Mancuso A, Tumino D. (2022).Advanced Techniques for Design and Manufacturing in Marine Engineering. *Journal of Marine Science and Engineering*. 10(2):122. <https://doi.org/10.3390/jmse10020122>
- Manzanares Serrano, Aarón & Segado, Francisco & Menayo Antúnez, Ruperto. (2012). Decisive factors in Sailing Performance: Literature review. *Cultura, Ciencia y Deporte*. 20. 125-134.

- Manzi, V., Impellizzeri, F.M., & Castagna, C. (2014). Aerobic Fitness Ecological Validity in Elite Soccer Players: A Metabolic Power Approach. *Journal of Strength and Conditioning Research*, 28, 914–919.
- Marfell-Jones, M.J., Stewart, A.D., & Ridder, J.D. (2012). International standards for anthropometric assessment.
- Markovic, G., Dizdar, D., Jukic, I., & Cardinale, M. (2004). Reliability and factorial validity of squat and countermovement jump tests. *Journal of strength and conditioning research*, 18(3), 551–555. [https://doi.org/10.1519/1533-4287\(2004\)18<551:RAFVOS>2.0.CO;2](https://doi.org/10.1519/1533-4287(2004)18<551:RAFVOS>2.0.CO;2)
- Martinez, M. W., Kim, J. H., Shah, A. B., Phelan, D., Emery, M. S., Wasfy, M. M., Fernandez, A. B., Bunch, T. J., Dean, P., Danielian, A., Krishnan, S., Baggish, A. L., Eijsvogels, T., Chung, E. H., & Levine, B. D. (2021). Exercise-Induced Cardiovascular Adaptations and Approach to Exercise and Cardiovascular Disease: JACC State-of-the-Art Review. *Journal of the American College of Cardiology*, 78(14), 1453–1470. <https://doi.org/10.1016/j.jacc.2021.08.003>
- Marttinen, R. H., Judelson, D. A., Wiersma, L. D., & Coburn, J. W. (2011). Effects of self-selected mass loss on performance and mood in collegiate wrestlers. *Journal of strength and conditioning research*, 25(4), 1010–1015. <https://doi.org/10.1519/JSC.ob013e318207ed3f>
- Maupin, D., Schram, B., Canetti, E., & Orr, R. (2020). The Relationship Between Acute: Chronic Workload Ratios and Injury Risk in Sports: A Systematic Review. *Open access journal of sports medicine*, 11, 51–75. <https://doi.org/10.2147/OAJSM.S231405>
- McClung, J. P., Martini, S., Murphy, N. E., Montain, S. J., Margolis, L. M., Thrane, I., Spitz, M. G., Blatny, J. M., Young, A. J., Gundersen, Y., & Pasiakos, S. M. (2013). Effects of a 7-day military training exercise on inflammatory biomarkers, serum hepcidin, and iron status. *Nutrition journal*, 12(1), 141. <https://doi.org/10.1186/1475-2891-12-141>
- McComas, A., Quartly, C.A., & Griggs, R.C. (1997). Early and late losses of motor units after poliomyelitis. *Brain : a journal of neurology*, 120 (Pt 8), 1415–21 .
- McDonald, D.A., Delgadillo, J.Q., Fredericson, M., McConnell, J., Hodgins, M., & Besier, T.F. (2011). Reliability and Accuracy of a Video Analysis Protocol to Assess Core Ability. *PM&R*, 3.
- McLaren, S.J., Weston, M., Smith, A., Cramb, R., & Portas, M.D. (2016). Variability of physical performance and player match loads in professional rugby union. *Journal of science and medicine in sport*, 19 6, 493–7 .

- McLean, B.D., Coutts, A.J., Kelly, V.G., McGuigan, M.R., & Cormack, S.J. (2010). Neuromuscular, endocrine, and perceptual fatigue responses during different length between-match micro-cycles in professional rugby league players. *International journal of sports physiology and performance*, 5 3, 367-83 .
- McLellan, C. P., Lovell, D. I., & Gass, G. C. (2010). Creatine kinase and endocrine responses of elite players pre, during, and post rugby league match play. *Journal of strength and conditioning research*, 24(11), 2908–2919. <https://doi.org/10.1519/JSC.obo13e3181c1fcb1>
- McLellan, C.P., Lovell, D.I., & Gass, G.C. (2011). Markers of Postmatch Fatigue in Professional Rugby League Players. *Journal of Strength and Conditioning Research*, 25, 1030-1039.
- McMahon, S., & Jenkins, D.G. (2002). Factors Affecting the Rate of Phosphocreatine Resynthesis Following Intense Exercise. *Sports Medicine*, 32, 761-784.
- McMorris, T. (2020). Cognitive Fatigue Effects on Physical Performance: The Role of Interoception. *Sports Medicine*, 50, 1703 - 1708.
- Meeusen, R., Watson, P., Hasegawa, H., Roelands, B., & Piacentini, M.F. (2006). Central Fatigue. *Sports Medicine*, 36, 881-909.
- Meeusen, R., Duclos, M., Foster, C.C., Fry, A.C., Gleeson, M., Nieman, D.C., Raglin, J.S., Rietjens, G.J., Steinacker, J.M., & Urhausen, A. (2013). Prevention, diagnosis and treatment of the overtraining syndrome: Joint consensus statement of the European College of Sport Science (ECSS) and the American College of Sports Medicine (ACSM). *European Journal of Sport Science*, 13, 1 - 24.
- Middleton, N., Shave, R.E., George, K.P., Whyte, G.P., Hart, E.C., & Atkinson, G. (2006). Left ventricular function immediately following prolonged exercise: A meta-analysis. *Medicine and science in sports and exercise*, 38 4, 681-7 .
- Mijailovich, S. M., Nedic, D., Svicevic, M., Stojanovic, B., Walklate, J., Ujfalusi, Z., & Geeves, M. A. (2017). Modeling the Actin.myosin ATPase Cross-Bridge Cycle for Skeletal and Cardiac Muscle Myosin Isoforms. *Biophysical journal*, 112(5), 984–996. <https://doi.org/10.1016/j.bpj.2017.01.021>
- Milioni, F., Azevedo, R.D., Zagatto, A.M., & Millet, G.Y. (2020). Time Course of Recovery after Cycling Repeated Sprints. *Medicine & Science in Sports & Exercise*, 53, 413 - 420.
- Millet, G.Y., Martin, V., Lattier, G., & Ballay, Y. (2003). Mechanisms contributing to knee extensor strength loss after prolonged running exercise. *Journal of applied physiology*, 94 1, 193-8 .

- Millet, G. Y., & Lepers, R. (2004). Alterations of neuromuscular function after prolonged running, cycling and skiing exercises. *Sports medicine (Auckland, N.Z.)*, 34(2), 105–116. <https://doi.org/10.2165/00007256-200434020-00004>
- Millet, G.Y., Muthalib, M., Jubeau, M., Laursen, P.B., & Nosaka, K. (2012). Severe hypoxia affects exercise performance independently of afferent feedback and peripheral fatigue. *Journal of applied physiology*, 112 8, 1335-44 .
- Mirzayev, J.A. (2017). Effect of strength training on muscle architecture (review).
- Moalla, W., Fessi, M. S., Farhat, F., Nouira, S., Wong, D. P., & Dupont, G. (2016). Relationship between daily training load and psychometric status of professional soccer players. *Research in sports medicine (Print)*, 24(4), 387–394. <https://doi.org/10.1080/15438627.2016.1239579>
- Molloy J, Neville VJ, Wood I, et al. Posterior interosseous nerve entrapment. *NZ J Sports Med* 2005; 33 (2): 48-51
- Morales, J., Franchini, E., Garcia-Massó, X., Solana-Tramunt, M., Buscà, B., & González, L. M. (2016). The Work Endurance Recovery Method for Quantifying Training Loads in Judo. *International journal of sports physiology and performance*, 11(7), 913–919. <https://doi.org/10.1123/ijsp.2015-0605>
- Morán-Navarro, R., Pérez, C.E., Mora-Rodriguez, R., Cruz-Sánchez, E.D., González-Badillo, J.J., Sánchez-medina, L., & Pallarés, J.G. (2017). Time course of recovery following resistance training leading or not to failure. *European Journal of Applied Physiology*, 117, 2387–2399.
- Moreira, A., McGuigan, M. R., Arruda, A. F., Freitas, C. G., & Aoki, M. S. (2012). Monitoring internal load parameters during simulated and official basketball matches. *Journal of strength and conditioning research*, 26(3), 861–866. <https://doi.org/10.1519/JSC.ob013e31822645e9>
- Morree, H.M., Klein, C., & Marcora, S.M. (2012). Perception of effort reflects central motor command during movement execution. *Psychophysiology*, 49 9, 1242-53 .
- Mrakic-Sposta, S., Gussoni, M., Vezzoli, A., Dellanoce, C., Comassi, M., Giardini, G., Bruno, R. M., Montorsi, M., Corciu, A., Greco, F., & Pratali, L. (2020). Acute Effects of Triathlon Race on Oxidative Stress Biomarkers. *Oxidative medicine and cellular longevity*, 2020, 3062807. <https://doi.org/10.1155/2020/3062807>
- Mujika, I., & Padilla, S. (2000). Detraining: Loss of Training-Induced Physiological and Performance Adaptations. Part I. *Sports Medicine*, 30, 79-87.

- Mujika, I., & Padilla, S. (2001). Muscular characteristics of detraining in humans. *Medicine and science in sports and exercise*, 33 8, 1297-303 .
- Mujika, I. (2017). Quantification of Training and Competition Loads in Endurance Sports: Methods and Applications. *International journal of sports physiology and performance*, 12 Suppl 2, S29-S217 .
- Müller, M. J., Enderle, J., & Bosy-Westphal, A. (2016). Changes in Energy Expenditure with Weight Gain and Weight Loss in Humans. *Current obesity reports*, 5(4), 413-423. <https://doi.org/10.1007/s13679-016-0237-4>
- Murray, N. B., Gabbett, T. J., Townshend, A. D., & Blanch, P. (2017). Calculating acute:chronic workload ratios using exponentially weighted moving averages provides a more sensitive indicator of injury likelihood than rolling averages. *British journal of sports medicine*, 51(9), 749-754. <https://doi.org/10.1136/bjsports-2016-097152>
- Myers, S. D., Leamon, S. M., Nevola, V. R., & Llewellyn, M. G. (2008). Energy expenditure during a single-handed transatlantic yacht race. *British journal of sports medicine*, 42(4), 285-288. <https://doi.org/10.1136/bjism.2007.041533>
- Nascimento, M.A., Cyrino, E.S., Nakamura, F.Y., Romanzini, M., Pianca, H.J., & Queiroga, M. (2007). Validation of the Brzycki equation for the estimation of 1-RM in the bench press. *Revista Brasileira De Medicina Do Esporte*, 13, 47-50.
- Nathanson, A. T., Fischer, E. G., Mello, M. J., & Baird, J. (2008). Injury and illness at the Newport-Bermuda race 1998- 2006. *Wilderness & environmental medicine*, 19(2), 129-132. <https://doi.org/10.1580/07-WEME-BR-1471.1>
- Nathanson, A. T., Baird, J., & Mello, M. (2010). Sailing injury and illness: results of an online survey. *Wilderness & environmental medicine*, 21(4), 291-297. <https://doi.org/10.1016/j.wem.2010.06.006>
- Nathanson A. (2019). Sailing Injuries: A Review of the Literature. *Rhode Island medical journal* (2013), 102(1), 23-27.
- Neufer, P.D. (1989). The Effect of Detraining and Reduced Training on the Physiological Adaptations to Aerobic Exercise Training. *Sports Medicine*, 8, 302-320.
- Neville, V., Molloy, J.H., Brooks, J.H., Speedy, D.B., & Atkinson, G. (2006). Epidemiology of injuries and illnesses in America's Cup yacht racing. *British Journal of Sports Medicine*, 40, 304 - 312.

- Neville, V., & Folland, J. P. (2009). The epidemiology and aetiology of injuries in sailing. *Sports medicine (Auckland, N.Z.)*, 39(2), 129–145. <https://doi.org/10.2165/00007256-200939020-00003>
- Neville, V., Pain, M. T., & Folland, J. P. (2009a). Aerobic power and peak power of elite America's Cup sailors. *European journal of applied physiology*, 106(1), 149–157. <https://doi.org/10.1007/s00421-009-1002-0>
- Neville, V., Calefato, J., Pérez-Encinas, C., Rodilla-Sala, E., Rada-Ruiz, S., Dorochenko, P., & Folland, J. P. (2009b). America's Cup yacht racing: race analysis and physical characteristics of the athletes. *Journal of sports sciences*, 27(9), 915–923. <https://doi.org/10.1080/02640410902946485>
- Neville, V., Pain, M.T., & Folland, J.P. (2009c). Elite America's Cup Sailors Are Among The Most Powerful Upper Body Trained Athletes: 2075. *Medicine and Science in Sports and Exercise*, 41, 224.
- Neville, V., Pain, M. T., Kantor, J., & Folland, J. P. (2010). Influence of crank length and crank-axle height on standing arm-crank (grinding) power. *Medicine and science in sports and exercise*, 42(2), 381–387. <https://doi.org/10.1249/MSS.obo13e3181b46f3a>
- Nieman, D.C. (2003). Current perspective on exercise immunology. *Current Sports Medicine Reports*, 2, 239–242.
- Nindl, B. C., Leone, C. D., Tharion, W. J., Johnson, R. F., Castellani, J. W., Patton, J. F., & Montain, S. J. (2002). Physical performance responses during 72 h of military operational stress. *Medicine and science in sports and exercise*, 34(11), 1814–1822. <https://doi.org/10.1097/00005768-200211000-00019>
- Noakes, T.D. (2012). Fatigue is a Brain-Derived Emotion that Regulates the Exercise Behavior to Ensure the Protection of Whole Body Homeostasis. *Frontiers in Physiology*, 3.
- Nobari, H., Mainer-Pardos, E., Adsuar, J. C., Franco-García, J. M., Rojo-Ramos, J., Cossio-Bolaños, M. A., Urzua Alul, L., & Pérez-Gómez, J. (2021). Association Between Endocrine Markers, Accumulated Workload, and Fitness Parameters During a Season in Elite Young Soccer Players. *Frontiers in psychology*, 12, 702454. <https://doi.org/10.3389/fpsyg.2021.702454>
- Nobari, H., Arslan, E., Martins, A. D., & Oliveira, R. (2022a). Are acute:chronic workload ratios of perceived exertion and running based variables sensible to detect variations between player positions over the season? A soccer team study. *BMC sports science, medicine & rehabilitation*, 14(1), 51. <https://doi.org/10.1186/s13102-022-00445-x>

- Nobari, H., Barjaste, A., Haghghi, H., Clemente, F. M., Carlos-Vivas, J., & Pérez-Gómez, J. (2022b). Quantification of training and match load in elite youth soccer players: a full-season study. *The Journal of sports medicine and physical fitness*, 62(4), 448-456. <https://doi.org/10.23736/S0022-4707.21.12236-4>
- Nosaka, K., Abbiss, C.R., Watson, G., Wall, B.A., Suzuki, K., & Laursen, P.B. (2010). Recovery following an Ironman triathlon: A case study. *European Journal of Sport Science*, 10, 159 - 165.
- Nybo, L., & Secher, N.H. (2004). Cerebral perturbations provoked by prolonged exercise. *Progress in Neurobiology*, 72, 223-261.
- Nystoriak, M.A., & Bhatnagar, A. (2018). Cardiovascular Effects and Benefits of Exercise. *Frontiers in Cardiovascular Medicine*, 5.
- O'Brien, W.H., Horan, K.A., Singh, S., Moeller, M.M., Wasson, R.S., Jex, S.M., Matthews, R.A., & Barratt, C.L. (2019). Relationships among Training, Mindfulness, and Workplace Injuries among Nurse Aides Working in Long-Term Care Settings. *Occupational Health Science*, 3, 45-58.
- O'Donoghue, P.G. (2014). An Introduction to Performance Analysis of Sport.
- Ohlendorf, D., Pflaum, J., Wischnewski, C., Schamberger, S., Erbe, C., Wanke, E.M., Holzgreve, F., & Groneberg, D.A. (2020). Standard reference values of the postural control in healthy female adults aged between 31 and 40 years in Germany: an observational study. *Journal of Physiological Anthropology*, 39.
- Oldenburg, M., Hogan, B., & Jensen, H. J. (2013). Systematic review of maritime field studies about stress and strain in seafaring. *International archives of occupational and environmental health*, 86(1), 1-15. <https://doi.org/10.1007/s00420-012-0801-5>
- Oliveira, R., Brito, J. P., Martins, A., Mendes, B., Marinho, D. A., Ferraz, R., & Marques, M. C. (2019). In-season internal and external training load quantification of an elite European soccer team. *PloS one*, 14(4), e0209393. <https://doi.org/10.1371/journal.pone.0209393>
- Oliver, S. J., Costa, R. J., Laing, S. J., Bilzon, J. L., & Walsh, N. P. (2009). One night of sleep deprivation decreases treadmill endurance performance. *European journal of applied physiology*, 107(2), 155-161. <https://doi.org/10.1007/s00421-009-1103-9>
- Olsson, K., Cheng, A.J., Al-Ameri, M., Wyckelsma, V.L., Rullman, E., Westerblad, H., Lanner, J.T., Gustafsson, T., & Bruton, J.D. (2019). Impaired sarcoplasmic reticulum Ca²⁺ release is the

- major cause of fatigue-induced force loss in intact single fibres from human intercostal muscle. *The Journal of Physiology*, 598.
- Ørtenblad, N., Westerblad, H., & Nielsen, J. (2013). Muscle glycogen stores and fatigue. *The Journal of Physiology*, 591.
- O'Toole, M. L., Douglas, P. S., & Hiller, W. D. (1998). Use of heart rate monitors by endurance athletes: lessons from triathletes. *The Journal of sports medicine and physical fitness*, 38(3), 181–187.
- Oxendale, C.L., Twist, C., Daniels, M., & Highton, J. (2016). The Relationship Between Match-Play Characteristics of Elite Rugby League and Indirect Markers of Muscle Damage. *International journal of sports physiology and performance*, 11 4, 515-21 .
- Pageaux, B., Marcora, S.M., Rozand, V., & Lepers, R. (2015). Mental fatigue induced by prolonged self-regulation does not exacerbate central fatigue during subsequent whole-body endurance exercise. *Frontiers in Human Neuroscience*, 9.
- Paillard, T. (2012). Effects of general and local fatigue on postural control: A review. *Neuroscience & Biobehavioral Reviews*, 36, 162-176.
- Palacios, G., Pedrero-Chamizo, R., Palacios, N., Maroto-Sánchez, B., Aznar, S., González-Gross, M., & EXERNET Study Group (2015). Biomarkers of physical activity and exercise. *Nutricion hospitalaria*, 31 Suppl 3, 237–244. <https://doi.org/10.3305/nh.2015.31.sup3.8771>
- Pan, D., Zhong, B., Guo, W., & Xu, Y. (2022). Physical fitness characteristics and performance in single-handed dinghy and 470 classes sailors. *Journal of exercise science and fitness*, 20(1), 9–15. <https://doi.org/10.1016/j.jesf.2021.11.001>
- Paquette, M., Bieuzen, F., & Billaut, F. (2018). Muscle Oxygenation Rather Than VO₂max as a Strong Predictor of Performance in Sprint Canoe-Kayak. *International journal of sports physiology and performance*, 1-9 .
- Paquette, M., Bieuzen, F., & Billaut, F. (2020). Effect of a 3-Weeks Training Camp on Muscle Oxygenation, V̇O₂ and Performance in Elite Sprint Kayakers. *Frontiers in Sports and Active Living*, 2.
- Parrado, E., Cervantes, J.C., Pintanel, M., Rodas, G., & Capdevila, L. (2010). Perceived Tiredness and Heart Rate Variability in Relation to Overload during a Field Hockey World Cup. *Perceptual and Motor Skills*, 110, 699 - 713.

- Paterno, M.V., Schmitt, L.C., Ford, K.R., Rauh, M.J., Myer, G.D., Huang, B., & Hewett, T.E. (2010). Biomechanical Measures during Landing and Postural Stability Predict Second Anterior Cruciate Ligament Injury after Anterior Cruciate Ligament Reconstruction and Return to Sport. *The American Journal of Sports Medicine*, 38, 1968 - 1978.
- Payson H. Medical emergencies at sea: are you prepared? *Sail* 1988;19:54-6.
- Pearson, S.N., Hume, P., Ackland, T., & Slyfield, D. (2004). ANTHROPOMETRY AND STRENGTH PREDICTORS OF GRINDING PERFORMANCE IN AMERICA'S CLIP SAILORS.
- Pearson, S.N. (2006). Power output of America's Cup grinders can be improved with a biomechanical technique intervention.
- Pearson, S., Hume, P., Slyfield, D., & Cronin, J. (2007). External work and peak power are reliable measures of ergometer grinding performance when tested under load, deck heel, and grinding direction conditions. *Sports biomechanics*, 6(1), 71-80. <https://doi.org/10.1080/14763140601058565>
- Pearson, S. N., Hume, P. A., Cronin, J. B., & Slyfield, D. (2009a). Strength and power determinants of grinding performance in America's Cup sailors. *Journal of strength and conditioning research*, 23(6), 1883-1889. <https://doi.org/10.1519/JSC.ob013e3181b2ba55>
- Pearson, S. N., Cronin, J. B., Hume, P. A., & Slyfield, D. (2009b). Effects of a power-focussed resistance training intervention on backward grinding performance in America's Cup sailing. *Sports biomechanics*, 8(4), 334-344. <https://doi.org/10.1080/14763140903414433>
- Pearson, S. N., Cronin, J. B., Hume, P. A., & Slyfield, D. (2009c). Kinematics and kinetics of the bench-press and bench-pull exercises in a strength-trained sporting population. *Sports biomechanics*, 8(3), 245-254. <https://doi.org/10.1080/14763140903229484>
- Pérez-Turpin, J. A., Cortell-Tormo, J. M., C. Suárez-Llorca, Andreu-Cabrera, E., Llana-Belloch, S., & Pérez-Soriano, P. (2009). Relationship between Anthropometric Parameters, Physiological Responses, Routes and Competition Results in Formula Windsurfing. *Acta Kinesiologiae Universitatis Tartuensis*, 14, 95-110.
- Perrey, S., Smirmaul, B.P., Fontes, E.B., Noakes, T.D., Bosio, A., Impellizzeri, F.M., Meeusen, R., Nakamura, F.Y., Abbiss, C.R., Peiffer, J.J., Smith, S., Murphy, M.N., Bishop, D.J., Vrijer, A.D., Mendez-villanueva, A., Williamson, J.W., Girard, O., Racinais, S., Place, N., Kayser, B., Millet, G.P., Millet, G.Y., Hettinga, F.J., Light, A.R., Dousset, E., Prilutsky, B.I., Gregor, R.J., Gagnon, P., Saey, D., Maltais, F., Taylor, J., Gandevia, S.C., Burnley, M., Jones, A.M., & Wright, R.A. (2010). Comments on Point:Counterpoint: Afferent feedback from fatigued

- locomotor muscles is/is not an important determinant of endurance exercise performance. *Journal of Applied Physiology*, 108, 458-468.
- Perrey, S., & Ferrari, M. (2018). Muscle Oximetry in Sports Science: A Systematic Review. *Sports medicine (Auckland, N.Z.)*, 48(3), 597-616. <https://doi.org/10.1007/s40279-017-0820-1>
- Perrey, S. (2022). Muscle Oxygenation Unlocks the Secrets of Physiological Responses to Exercise: Time to Exploit it in the Training Monitoring. *Frontiers in Sports and Active Living*, 4.
- Petersen, K., Hansen, C., Aagaard, P., & Madsen, K. (2007). Muscle mechanical characteristics in fatigue and recovery from a marathon race in highly trained runners. *European Journal of Applied Physiology*, 101, 385-396.
- Peterson Silveira, R., Stergiou, P., Carpes, FP., Castro, FA., Katz, L and Stefanyshyn, DJ. (2017). Validity of a portable force platform for assessing biomechanical parameters in three different tasks. *Sports Biomechanics*, 16(2), 177-186
- Philippe, K., Paillard, T., Dubois, R., Maurelli, O., & Prioux, J. (2021). Key performance indicators in Tour de France sailing. *Journal of sports sciences*, 39(8), 944-954. <https://doi.org/10.1080/02640414.2020.1851925>
- Philippe, K., Paillard, T., Maurelli, O., Moody, J., & Prioux, J. (2022). Effects of an Offshore Sailing Competition on Anthropometry, Muscular Performance, Subjective Wellness, and Salivary Cortisol in Professional Sailors. *International journal of sports physiology and performance*, 17(8), 1205-1212. <https://doi.org/10.1123/ijpspp.2021-0575>
- Piitulainen, H., Komi, P.V., Linnamo, V., & Avela, J. (2008). Sarcolemmal excitability as investigated with M-waves after eccentric exercise in humans. *Journal of electromyography and kinesiology : official journal of the International Society of Electrophysiological Kinesiology*, 18 4, 672-81 .
- Pingitore, A., Lima, G.P., Mastorci, F., Quinones, A., Iervasi, G., & Vassalle, C. (2015). Exercise and oxidative stress: potential effects of antioxidant dietary strategies in sports. *Nutrition*, 31 7-8, 916-22 .
- Pisula, P., Lewis, C.H., & Bridger, R.S. (2012). Vessel motion thresholds for maintaining physical and cognitive performance: a study of naval personnel at sea. *Ergonomics*, 55, 636 - 649.
- Pita, H.B. (2013). Aplicación de una batería multidimensional de indicadores de rendimiento para la evaluación de la prestación competitiva de las selecciones participantes en el Campeonato Mundial de Sudáfrica 2010.

- Pitfalls. *International journal of sports physiology and performance*, 1–7. Advance online publication. <https://doi.org/10.1123/ijsp.2019-0864>
- Pluijms, J. P., Cañal-Bruland, R., Hoozemans, M. J., & Savelsbergh, G. J. (2015). Visual search, movement behaviour and boat control during the windward mark rounding in sailing. *Journal of sports sciences*, 33(4), 398–410. <https://doi.org/10.1080/02640414.2014.946075>
- Pollock, R.D., & Harridge, S.D. (2015). *Neuromuscular Adaptations to Exercise*.
- Poole, D.C. (2009). Resolving the determinants of high-intensity exercise performance. *Experimental Physiology*, 94.
- Portier, H., Chatard, J. C., Filaire, E., Jaunet-Devienne, M. F., Robert, A., & Guezennec, C. Y. (2008). Effects of branched-chain amino acids supplementation on physiological and psychological performance during an offshore sailing race. *European journal of applied physiology*, 104(5), 787–794. <https://doi.org/10.1007/s00421-008-0832-5>
- Portier, Hugues & Guezennec, Charles. (2003). Oxygen cost assessment during small craft competition. *Science and Sports*. 18. 111-113.
- Post, A., Koncan, D., Kendall, M., Cournoyer, J., Michio Clark, J., Kosziwka, G., Chen, W., Grau Amezcuca, S., & Blaine Hoshizaki, T. (2018). Analysis of speed accuracy using video analysis software. *Sports Engineering*, 21, 235-241.
- Price, C. J., Spalding, T. J., & McKenzie, C. (2002). Patterns of illness and injury encountered in amateur ocean yacht racing: an analysis of the British Telecom Round the World Yacht Race 1996-1997. *British journal of sports medicine*, 36(6), 457–462. <https://doi.org/10.1136/bjism.36.6.457>
- Privette, G. (1983). Peak experience, peak performance, and flow: A comparative analysis of positive human experiences. *Journal of Personality and Social Psychology*, 45(6), 1361–1368. <https://doi.org/10.1037/0022-3514.45.6.1361>
- Pucci, A., Griffin, L., & Cafarelli, E. (2006). Maximal motor unit firing rates during isometric resistance training in men. *Experimental Physiology*, 91.
- Putlur, P., Foster, C., Miskowski, J. A., Kane, M. K., Burton, S. E., Scheett, T. P., & McGuigan, M. R. (2004). Alteration of immune function in women collegiate soccer players and college students. *Journal of sports science & medicine*, 3(4), 234–243.
- Pulur, A. (2011). Determination of physical and physiological profiles of international elite sailors. *African Journal of Business Management*, 5 (8), 3071-3075.

- Qin, P., & Feng, W. (2021). Design of the Exercise Load Data Monitoring System for Exercise Training Based on the Neural Network. *Journal of healthcare engineering*, 2021, 7340140. <https://doi.org/10.1155/2021/7340140>
- Raastad, T., & Hallén, J. (2000). Recovery of skeletal muscle contractility after high- and moderate-intensity strength exercise. *European Journal of Applied Physiology*, 82, 206-214.
- Rabbani, A., Clemente, F. M., Kargarfard, M., & Chamari, K. (2019). Match Fatigue Time-Course Assessment Over Four Days: Usefulness of the Hooper Index and Heart Rate Variability in Professional Soccer Players. *Frontiers in physiology*, 10, 109. <https://doi.org/10.3389/fphys.2019.00109>
- Ramírez-Correa, G.A., Cortassa, S., Stanley, B.A., Gao, W.D., & Murphy, A.M. (2010). Calcium sensitivity, force frequency relationship and cardiac troponin I: critical role of PKA and PKC phosphorylation sites. *Journal of molecular and cellular cardiology*, 48 5, 943-53 .
- Ramseyer, F.T. (2019). Motion Energy Analysis (MEA).
- Ravé, G., Granacher, U., Boullosa, D.A., Hackney, A.C., & Zouhal, H. (2020). How to Use Global Positioning Systems (GPS) Data to Monitor Training Load in the “Real World” of Elite Soccer. *Frontiers in Physiology*, 11.
- Ravussin, E., & Bogardus, C. (1989). Relationship of genetics, age, and physical fitness to daily energy expenditure and fuel utilization. *The American journal of clinical nutrition*, 49(5 Suppl), 968-975. <https://doi.org/10.1093/ajcn/49.5.968>
- Rawstorn, J.C., Maddison, R., Ali, A., Foskett, A., & Gant, N. (2014). Rapid Directional Change Degrades GPS Distance Measurement Validity during Intermittent Intensity Running. *PLoS ONE*, 9.
- Ream, E., & Richardson, A. (1996). Fatigue: a concept analysis. *International journal of nursing studies*, 33 5, 519-29 .
- Redkva, P.E., Gregório da Silva, S., Paes, M., & dos-Santos, J.W. (2017). The Relationship Between Coach and Player Training Load Perceptions in Professional Soccer. *Perceptual and Motor Skills*, 124, 264 - 276.
- Redkva, P.E., Paes, M., Fernandez, R., & da-Silva, S.G. (2018). Correlation between Match Performance and Field Tests in Professional Soccer Players. *Journal of Human Kinetics*, 62, 213 - 219.

- Reid, M.B. (2008). Free radicals and muscle fatigue: Of ROS, canaries, and the IOC. *Free radical biology & medicine*, 44 2, 169-79 .
- Reilly, T., & Walsh, T.J. (1981). Physiological, psychological and performance measures during an endurance record for five-a-side soccer. *British Journal of Sports Medicine*, 15, 122 - 128.
- Reilly, T., & Deykin, T. (1983). Effects of partial sleep loss on
- Reilly, T., and A. Hales (1988). Effects of partial sleep deprivation on performance measures in females. *Contemporary Ergonomics*. E.D. McGraw. London, Taylor and Francis: 509-513
- Reilly, T., & Piercy, M.F. (1994). The effect of partial sleep deprivation on weight-lifting performance. *Ergonomics*, 37 1, 107-15 .
- Reynolds, A.C., & Banks, S. (2010). Total sleep deprivation, chronic sleep restriction and sleep disruption. *Progress in brain research*, 185, 91-103 .
- Riccio, G.E., & Stoffregen, T.A. (1991). An ecological Theory of Motion Sickness and Postural Instability. *Ecological Psychology*, 3, 195-240.
- Riechman, S. E., Zoeller, R. F., Balasekaran, G., Goss, F. L., & Robertson, R. J. (2002). Prediction of 2000 m indoor rowing performance using a 30 s sprint and maximal oxygen uptake. *Journal of sports sciences*, 20(9), 681-687. <https://doi.org/10.1080/026404102320219383>
- Roczniok, R., Stanula, A., Maszczyk, A., Mostowik, A., Kowalczyk, M., Fidos-Czuba, O., & Zajac, A. (2016). Physiological, physical and on-ice performance criteria for selection of elite ice hockey teams. *Biology of sport*, 33(1), 43-48. <https://doi.org/10.5604/20831862.1180175>
- Rodgers, C.D., Paterson, D.H., Cunningham, D.A., Noble, E.G., Pettigrew, F., Myles, W.S., & Taylor, A.W. (1995). Sleep deprivation: effects on work capacity, self-paced walking, contractile properties and perceived exertion. *Sleep*, 18 1, 30-8 .
- Rodríguez-Falces, J., Izquierdo, M., González-Izal, M., & Place, N. (2014). Comparison of the power spectral changes of the voluntary surface electromyogram and M wave during intermittent maximal voluntary contractions. *European Journal of Applied Physiology*, 114, 1943-1954.
- Rodríguez-Falces, J., & Place, N. (2018). End-of-Fiber Signals Strongly Influence the First and Second Phases of the M Wave in the Vastus Lateralis: Implications for the Study of Muscle Excitability. *Frontiers in Physiology*, 9.
- Rolfes SR, Pinna K, Whitney EN. Understanding normal and clinical nutrition. 9th ed. Belmont (CA): Wadsworth, Cengage Learning; 2012

- Rovere, G.D. (1987). Low Back Pain in Athletes. *The Physician and sportsmedicine*, 15 1, 105-17 .
- Rowell, A. E., Aughey, R. J., Hopkins, W. G., Esmaeili, A., Lazarus, B. H., & Cormack, S. J. (2018). Effects of Training and Competition Load on Neuromuscular Recovery, Testosterone, Cortisol, and Match Performance During a Season of Professional Football. *Frontiers in physiology*, 9, 668. <https://doi.org/10.3389/fphys.2018.00668>
- Rozand, V., Lebon, F., Papaxanthis, C., and Lepers, R. (2015). Effect of mental fatigue on speed-accuracy trade-off. *Neuroscience* 297, 219–230. doi: 10.1016/j.neuroscience.2015.03.066
- Rudroff, T., Kindred, J.H., & Ketelhut, N.B. (2016). Fatigue in Multiple Sclerosis: Misconceptions and Future Research Directions. *Frontiers in Neurology*, 7.
- Russell, B., McDaid, A.J., Toscano, W., & Hume, P. (2021). Predicting Fatigue in Long Duration Mountain Events with a Single Sensor and Deep Learning Model. *Sensors (Basel, Switzerland)*, 21.
- Ryan, K.M., Nathanson, A.T., Baird, J., & Wheelhouse, J. (2016). Injuries and Fatalities on Sailboats in the United States 2000-2011: An Analysis of US Coast Guard Data. *Wilderness & environmental medicine*, 27 1, 10-8 .
- Ryan, Samuel & Kempton, Thomas & Impellizzeri, Franco & Coutts, Aaron. (2019). Training monitoring in professional Australian football: theoretical basis and recommendations for coaches and scientists. *Science and Medicine in Football*. 4. 1-7. 10.1080/24733938.2019.1641212.
- Salazar, H., Svilar, L., Aldalur-Soto, A., & Castellano, J. (2020). Differences in Weekly Load Distribution Over Two Euroleague Seasons with a Different Head Coach. *International journal of environmental research and public health*, 17(8), 2812. <https://doi.org/10.3390/ijerph17082812>
- Saltin, B., Rådegran, G., Koskolou, M.D., & Roach, R.C. (1998). Skeletal muscle blood flow in humans and its regulation during exercise. *Acta physiologica Scandinavica*, 162 3, 421-36
- Sampaio, J., & Leite, N.M. (2013). PERFORMANCE INDICATORS IN GAME SPORTS.
- Sánchez-Medina, L., González-Badillo, J. J., Pérez, C. E., & Pallarés, J. G. (2014). Velocity- and power-load relationships of the bench pull vs. bench press exercises. *International journal of sports medicine*, 35(3), 209–216. <https://doi.org/10.1055/s-0033-1351252>

- Santos, J. C., Dias, G., Couceiro, M. S., Mendes, P., & Santos, A. C. (2016). Influence of the physical fitness, anthropometry profile and body composition on sailing performance. *Journal of Sport and Human Performance*, 4(1). <https://doi.org/10.12922/jshp.v4i1.77>
- Sato, S., Yoshida, R., Kiyono, R., Yahata, K., Yasaka, K., Nosaka, K., & Nakamura, M. (2021). Cross-education and detraining effects of eccentric vs. concentric resistance training of the elbow flexors. *BMC Sports Science, Medicine and Rehabilitation*, 13.
- Saunders, J., & Smith, T.R. (2010). Malnutrition: causes and consequences. *Clinical medicine*, 10 6, 624-7 .
- Saw, A.E. (2016). Self-report measures in athletic preparation. *British Journal of Sports Medicine*, 51, 1377 - 1378.
- Scarpellini, A., Finazzi, V., Schito, P., Bionda, A., Ratti, A., & Demir, A. G. (2021). Laser Powder Bed Fusion of a Topology Optimized and Surface Textured Rudder Bulb with Lightweight and Drag-Reducing Design. *Journal of Marine Science and Engineering*, 9(9), 1032. <https://doi.org/10.3390/jmse9091032>
- Schiphof-Godart, L., Roelands, B., & Hettinga, F.J. (2018). Drive in Sports: How Mental Fatigue Affects Endurance Performance. *Frontiers in Psychology*, 9.
- Schwellnus, M.P., Soligard, T., Alonso, J.M., Bahr, R., Clarsen, B., Dijkstra, H.P., Gabbett, T.J., Gleeson, M., Häggglund, M., Hutchinson, M.R., Janse van Rensburg, C., Meeusen, R., Orchard, J.W., Pluim, B.M., Raftery, M., Budgett, R., & Engebretsen, L. (2016). How much is too much? (Part 2) International Olympic Committee consensus statement on load in sport and risk of illness. *British Journal of Sports Medicine*, 50, 1043 - 1052.
- Scott, J. P., McNaughton, L. R., & Polman, R. C. (2006). Effects of sleep deprivation and exercise on cognitive, motor performance and mood. *Physiology & behavior*, 87(2), 396-408. <https://doi.org/10.1016/j.physbeh.2005.11.009>
- Sejersted, O.M., & Sjøgaard, G. (2000). Dynamics and consequences of potassium shifts in skeletal muscle and heart during exercise. *Physiological reviews*, 80 4, 1411-81 .
- Selen, L.P., Beek, P.J., & van Dieën, J.H. (2007). Fatigue-induced changes of impedance and performance in target tracking. *Experimental Brain Research. Experimentelle Hirnforschung. Experimentation Cerebrale*, 181, 99 - 108.
- Selye, H. (1946). The general adaptation syndrome and the diseases of adaptation. *The Journal of clinical endocrinology and metabolism*, 6, 117-230 .

- Selye, H. (1951). The general-adaptation-syndrome. *Annual review of medicine*, 2, 327-42 .
- Selye, H. (1956). Endocrine reactions during stress. *Current researches in anesthesia & analgesia*, 35 3, 182-93 .
- Serrano Ostariz, E., López Ramón, M., Cremades Arroyos, D., Izquierdo Álvarez, S., Catalán Edo, P., Baquer Sahún, C., & Legaz Arrese, A. (2013). Post-exercise left ventricular dysfunction measured after a long-duration cycling event. *BMC research notes*, 6, 211. <https://doi.org/10.1186/1756-0500-6-211>
- Shaharudin, S., Zanotto, D. & Agrawal, S. (2014). Muscle Synergy during Wingate Anaerobic Rowing Test of Collegiate Rowers and Untrained Subjects. *International Journal of Sports Science*, 4, 165-172.
- Shephard, R.J. (1997). Biology and Medicine of Sailing. *Sports Medicine*, 23, 350-356.
- Shi, M., Wang, X., Yamanaka, T., Ogita, F., Nakatani, K., & Takeuchi, T. (2007). Effects of anaerobic exercise and aerobic exercise on biomarkers of oxidative stress. *Environmental Health and Preventive Medicine*, 12, 202-208.
- Sjøgaard, G., Inglés, E., & Narici, M. (2015). Science in sailing: interdisciplinary perspectives in optimizing sailing performance. *European journal of sport science*, 15(3), 191-194. <https://doi.org/10.1080/17461391.2015.1008583>
- Skein, M., Duffield, R., Edge, J., Short, M. J., & Mündel, T. (2011). Intermittent-sprint performance and muscle glycogen after 30 h of sleep deprivation. *Medicine and science in sports and exercise*, 43(7), 1301-1311. <https://doi.org/10.1249/MSS.0b013e31820abc5a>
- Skurvydas, A., Sipaviciene, S., Krutulytė, G., Gailiūnienė, A., Stasiulis, A., Mamkus, G., & Stanislovaitis, A. (2006). Dynamics of indirect symptoms of skeletal muscle damage after stretch-shortening exercise. *Journal of electromyography and kinesiology : official journal of the International Society of Electrophysiological Kinesiology*, 16 6, 629-36 .
- Skurvydas, A., Mamkus, G., Dudonienė, V., Kamandulis, S., Mickevičienė, D., Masiulis, N., Stanislovaitis, A., & Streckis, V. (2007). The Time-Course of Voluntary and Electrically Evoked Muscle Performance During and After Stretch-Shortening Exercise is Different. *Journal of sports science & medicine*, 6 4, 408-16 .
- Sluiter, J.K., van der Beek, A.J., & Frings-Dresen, M.H. (1999). The influence of work characteristics on the need for recovery and experienced health: a study on coach drivers. *Ergonomics*, 42 4, 573-83 .

- Smith, D.J., & Norris, S.R. (2000). Changes in glutamine and glutamate concentrations for tracking training tolerance. *Medicine and science in sports and exercise*, 32 3, 684-9 .
- Soligard, T., Schwelunus, M.P., Alonso, J.M., Bahr, R., Clarsen, B., Dijkstra, H.P., Gabbett, T.J., Gleeson, M., Hägglund, M., Hutchinson, M.R., Janse van Rensburg, C., Khan, K.M., Meeusen, R., Orchard, J.W., Pluim, B.M., Raftery, M., Budgett, R., & Engebretsen, L. (2016). How much is too much? (Part 1) International Olympic Committee consensus statement on load in sport and risk of injury. *British Journal of Sports Medicine*, 50, 1030 - 1041.
- Spalding T, Malinen T, Tomson M, et al. Analysis of medical problems during the 2001-2002 Volvo Ocean Race. *NZ J Sports Med*. 2005;33:38-42.
- Speranza, Domenico & Di Bernardo, Romolo & Martorelli, Massimo & Gloria, Antonio & Pensa, Claudio & Papa, Stefano. (2022). Basic Design and Virtual Prototyping of a Hydrofoil Hybrid Daysailer. 10.1007/978-3-031-15928-2_11.
- Spiro, S.G. (1977). Exercise testing in clinical medicine. *British journal of diseases of the chest*, 71 3, 145-72 .
- Spurway, N., Legg, S., & Hale, T. (2007). Sailing physiology. *Journal of sports sciences*, 25(10), 1073-1075. <https://doi.org/10.1080/02640410601165171>
- Stagno, K.M., Thatcher, R., & van Someren, K. (2007). A modified TRIMP to quantify the in-season training load of team sport players. *Journal of Sports Sciences*, 25, 629 - 634.
- Stampi, C. (1989). Polyphasic sleep strategies improve prolonged sustained performance: A field study on 99 sailors. *Work & Stress*, 3, 41-55.
- Stellingwerff, T., Heikura, I. A., Meeusen, R., Bermon, S., Seiler, S., Mountjoy, M. L., & Burke, L. M. (2021). Overtraining Syndrome (OTS) and Relative Energy Deficiency in Sport (RED-S): Shared Pathways, Symptoms and Complexities. *Sports medicine (Auckland, N.Z.)*, 51(11), 2251-2280. <https://doi.org/10.1007/s40279-021-01491-0>
- Stenqvist, T. B., Torstveit, M. K., Faber, J., & Melin, A. K. (2020). Impact of a 4-Week Intensified Endurance Training Intervention on Markers of Relative Energy Deficiency in Sport (RED-S) and Performance Among Well-Trained Male Cyclists. *Frontiers in endocrinology*, 11, 512365. <https://doi.org/10.3389/fendo.2020.512365>
- Stewart, R.D., Duhamel, T.A., Rich, S.M., Tupling, A.R., & Green, H.J. (2008). Effects of consecutive days of exercise and recovery on muscle mechanical function. *Medicine and science in sports and exercise*, 40 2, 316-25 .

- Stoffregen, T. A., & Smart, L. J., Jr (1998). Postural instability precedes motion sickness. *Brain research bulletin*, 47(5), 437-448. [https://doi.org/10.1016/s0361-9230\(98\)00102-6](https://doi.org/10.1016/s0361-9230(98)00102-6)
- Stone, M.H., Collins, D., Plisk, S.S., Haff, G.G., & Stone, M.E. (2002). Training Principles: Evaluation of Modes and Methods of Resistance Training. *Strength and Conditioning Journal*, 22, 65.
- Stone, M.H., Stone, M.E., & Sands, W.A. (2007). Principles and Practice of Resistance Training.
- Svantesson, U., Nordé, M., Svensson, S., & Brodin, E. (2009). A comparative study of the Jamar® and the Grippit® for measuring handgrip strength in clinical practice. *Isokinetics and Exercise Science*, 17, 85-91.
- Taber, K.H., & Hurley, R.A. (2006). Functional neuroanatomy of sleep and sleep deprivation. *The Journal of neuropsychiatry and clinical neurosciences*, 18 1, 1-5 .
- Tafti, M., Besset, A., & Billiard, M.M. (1992). Effects of zopiclone on subjective evaluation of sleep and daytime alertness and on psychomotor and physical performance tests in athletes. *Progress in Neuro-Psychopharmacology and Biological Psychiatry*, 16, 55-63.
- Taha, T., & Thomas, S. (2003). Systems Modelling of the Relationship Between Training and Performance. *Sports Medicine*, 33, 1061-1073.
- Takase, B., Akima, T., Uehata, A., Ohsuzu, F., & Kurita, A. (2004). Effect of chronic stress and sleep deprivation on both flow-mediated dilation in the brachial artery and the intracellular magnesium level in humans. *Clinical cardiology*, 27(4), 223-227. <https://doi.org/10.1002/clc.4960270411>
- Tan, B., Aziz, A. R., Spurway, N. C., Toh, C., Mackie, H., Xie, W., Wong, J., Fuss, F. K., & Teh, K. C. (2006). Indicators of maximal hiking performance in Laser sailors. *European journal of applied physiology*, 98(2), 169-176. <https://doi.org/10.1007/s00421-006-0260-3>
- Tatemoto, T., Tanaka, S., Maeda, K., Tanabe, S., Kondo, K., & Yamaguchi, T. (2019). Skillful Cycling Training Induces Cortical Plasticity in the Lower Extremity Motor Cortex Area in Healthy Persons. *Frontiers in Neuroscience*, 13.
- Taylor, S. R., Rogers, G. G., & Driver, H. S. (1997). Effects of training volume on sleep, psychological, and selected physiological profiles of elite female swimmers. *Medicine and science in sports and exercise*, 29(5), 688-693. <https://doi.org/10.1097/00005768-199705000-00016>
- Taylor, J., & Gandevia, S.C. (2008). A comparison of central aspects of fatigue in submaximal and maximal voluntary contractions. *Journal of applied physiology*, 104 2, 542-50 .

- Taylor, J., Amann, M., Duchateau, J., Meeusen, R., & Rice, C.L. (2016). Neural Contributions to Muscle Fatigue: From the Brain to the Muscle and Back Again. *Medicine and science in sports and exercise*, 48 11, 2294-2306 .
- Temesi, J., Arnal, P. J., Davranche, K., Bonnefoy, R., Levy, P., Verges, S., & Millet, G. Y. (2013). Does central fatigue explain reduced cycling after complete sleep deprivation?. *Medicine and science in sports and exercise*, 45(12), 2243-2253. <https://doi.org/10.1249/MSS.0b013e31829ce379>
- Terrien, E., Huet, B., Iachkine, P., & Saury, J. (2020). Coordination between Crew Members on Flying Multihulls: A Case Study on a Nacra 17. *Journal of sports science & medicine*, 19 2, 298-308 .
- Theдон, T., Mandrick, K., Foissac, M., Mottet, D., & Perrey, S. (2011). Degraded postural performance after muscle fatigue can be compensated by skin stimulation. *Gait & posture*, 33 4, 686-9 .
- Theunynck, D., Hurdiel, R., Pezé, T., Estruch, X., & Bui-Xuân, G. (2010). Sommeil et course au large en solitaire : comportements des coureurs et étude de faisabilité d'un « agenda interactif de sommeil ». *Perspectives Interdisciplinaires sur le Travail et la Santé*.
- Thiele, R., Conchola, E.C., Palmer, T.B., DeFreitas, J.M., & Thompson, B.J. (2015). The effects of a high-intensity free-weight back-squat exercise protocol on postural stability in resistance-trained males. *Journal of Sports Sciences*, 33, 211 - 218.
- Thill, E. (1982). La detection sportive a partir de criteres psychologiques. In *Dans, Rioux, G. et Thill, E. (eds.), Competition sportive et psychologie: Journées europeennes de psychologie du sport, Paris, Chiron, c1982, p. 77-94.*
- Thomas, D. T., Erdman, K. A., & Burke, L. M. (2016). Position of the Academy of Nutrition and Dietetics, Dietitians of Canada, and the American College of Sports Medicine: Nutrition and Athletic Performance. *Journal of the Academy of Nutrition and Dietetics*, 116(3), 501-528. <https://doi.org/10.1016/j.jand.2015.12.006>
- Thomas, M.L., Sing, H.C., Belenky, G., Holcomb, H.H., Mayberg, H.S., Dannals, R.F., Wagner JR., H., Thorne, D.R., Popp, K.A., Rowland, L., Welsh, A.B., Balwinski, S.M., & Redmond, D.P. (2000). Neural basis of alertness and cognitive performance impairments during sleepiness. I. Effects of 24 h of sleep deprivation on waking human regional brain activity. *Journal of Sleep Research*, 9.

- Thorpe, R.T., Atkinson, G., Drust, B., & Gregson, W. (2017). Monitoring Fatigue Status in Elite Team-Sport Athletes: Implications for Practice. *International journal of sports physiology and performance*, 12 Suppl 2, S227-S234 .
- Tiberge, M. (1992). Sommeil et performances. Editions Médicales
- Timpka, T., Jacobsson, J., Bickenbach, J., Finch, C.F., Ekberg, J., & Nordenfelt, L. (2011). What is a Sports Injury? *Sports Medicine*, 44, 423-428.
- Todd, G., Gandevia, S.C., & Taylor, J. (2010). Change in manipulation with muscle fatigue. *European Journal of Neuroscience*, 32.
- Tomažin, K., Dolenc, A., & Strojnik, V. (2008). High-frequency fatigue after alpine slalom skiing. *European Journal of Applied Physiology*, 103, 189-194.
- Tornero-Aguilera, J. F., Fernandez-Elias, V. E., & Clemente-Suárez, V. J. (2022). Ready for Combat, Psychophysiological Modifications in a Close-Quarter Combat Intervention After an Experimental Operative High-Intensity Interval Training. *Journal of strength and conditioning research*, 36(3), 732-737. <https://doi.org/10.1519/JSC.0000000000003495>
- Tran, T.T., Lundgren, L.E., Secomb, J.L., Farley, O.R., Haff, G.G., Nimphius, S., Newton, R.U., Brown, L.E., & Sheppard, J.M. (2017). Effect of Four Weeks Detraining on Strength, Power, and Sensorimotor Ability of Adolescent Surfers. *The Open Sports Sciences Journal*, 10, 71-80.
- Trease, L., Albert, E., Singleman, G., & Brymer, E. (2022). What Is an Extreme Sports Healthcare Provider: An Auto-Ethnographic Study of the Development of an Extreme Sports Medicine Training Program. *International Journal of Environmental Research and Public Health*, 19(14), 8286. MDPI AG. Retrieved from <http://dx.doi.org/10.3390/ijerph19148286>
- Troester, J.C., & Duffield, R. (2019). Monitoring residual 36 h post-match neuromuscular fatigue in rugby union; a role for postural control? *European Journal of Sport Science*, 19, 1312 - 1319.
- Turner, A., Bishop, C., Marshall, G., & Read, P.J. (2015). How to monitor training load and mode using sRPE.
- Uğurlu, Z., Karahan, A., Ünlü, H., Abbasoğlu, A., Özhan Elbaş, N., Avcı Işık, S., & Tepe, A. (2015). The Effects of Workload and Working Conditions on Operating Room Nurses and Technicians. *Workplace health & safety*, 63(9), 399-407. <https://doi.org/10.1177/2165079915592281>

- Urhausen, A., & Kindermann, W. (2002). Diagnosis of overtraining: what tools do we have?. *Sports medicine (Auckland, N.Z.)*, 32(2), 95–102. <https://doi.org/10.2165/00007256-200232020-00002>
- Valliappan, N., Dai, N., Steinberg, E.H., He, J., Rogers, K., Ramachandran, V., Xu, P., Shojaeizadeh, M., Guo, L., Kohlhoff, K.J., & Navalpakkam, V. (2020). Accelerating eye movement research via accurate and affordable smartphone eye tracking. *Nature Communications*, 11.
- Van Cutsem, J., Marcora, S., De Pauw, K., Bailey, S., Meeusen, R., & Roelands, B. (2017). The Effects of Mental Fatigue on Physical Performance: A Systematic Review. *Sports medicine (Auckland, N.Z.)*, 47(8), 1569–1588. <https://doi.org/10.1007/s40279-016-0672-0>
- van den Berg, J., & Neely, G. (2006). Performance on a Simple Reaction Time Task While Sleep Deprived. *Perceptual and Motor Skills*, 102, 589 - 599.
- van der Velden, J., Merkus, D., Klarenbeek, B. R., James, A. T., Boontje, N. M., Dekkers, D. H., Stienen, G. J., Lamers, J. M., & Duncker, D. J. (2004). Alterations in myofilament function contribute to left ventricular dysfunction in pigs early after myocardial infarction. *Circulation research*, 95(11), e85–e95. <https://doi.org/10.1161/01.RES.0000149531.02904.09>
- Van Dijk, H. and R. Van Megen (2017). The secret of running: Maximum performance gains through effective power metering and training analysis. Meyer & Meyer Sport (cit. on pp. 42, 44).
- Van Dongen, H.P., & Dinges, D.F. (2005). Sleep, circadian rhythms, and psychomotor vigilance. *Clinics in sports medicine*, 24 2, 237-49, vii-viii .
- Van Dongen, H.P., Maislin, G., Mullington, J.M., & Dinges, D.F. (2003). The cumulative cost of additional wakefulness: dose-response effects on neurobehavioral functions and sleep physiology from chronic sleep restriction and total sleep deprivation. *Sleep*, 26 2, 117-26.
- Vangelakoudi, A., Vogiatzis, I., & Geladas, N. (2007). Anaerobic capacity, isometric endurance, and Laser sailing performance. *Journal of Sports Sciences*, 25(10), 1095–1100.
- Vanhatalo, A., Fulford, J., DiMenna, F.J., & Jones, A.M. (2010). Influence of hyperoxia on muscle metabolic responses and the power–duration relationship during severe-intensity exercise in humans: a ³¹P magnetic resonance spectroscopy study. *Experimental Physiology*, 95.
- Vanrenterghem, J., Nedergaard, N.J., Robinson, M.A., & Drust, B. (2017). Training Load Monitoring in Team Sports: A Novel Framework Separating Physiological and Biomechanical Load-Adaptation Pathways. *Sports Medicine*, 47, 2135-2142.

- Vantarakis, A., Chatzinikolaou, A., Avloniti, A.A., Vezos, N., Douroudos, I.I., Draganidis, D., Jamurtas, A.Z., Kambas, A., Kalligeros, S., & Fatouros, I.G. (2017). A 2-Month Linear Periodized Resistance Exercise Training Improved Musculoskeletal Fitness and Specific Conditioning of Navy Cadets. *Journal of Strength and Conditioning Research*, 31, 1362–1370.
- Vehrs, P. R., Keller, D. M., George, J. D., Hager, R. L., & Fellingham, G. W. (2007). Monitoring VO₂max during fourteen weeks of endurance training using the CardioCoach. *Journal of strength and conditioning research*, 21(1), 62–66. <https://doi.org/10.1519/00124278-200702000-00012>
- Venter, R.E. (2014). Perceptions of team athletes on the importance of recovery modalities. *European Journal of Sport Science*, 14, S69 - S76.
- Vergès, S., Maffiuletti, N.A., Kerhervé, H.A., Decorte, N., Wuyam, B., & Millet, G.Y. (2009). Comparison of electrical and magnetic stimulations to assess quadriceps muscle function. *Journal of applied physiology*, 106 2, 701-10 .
- Verhagen, E.A., & Gabbett, T.J. (2018). Load, capacity and health: critical pieces of the holistic performance puzzle. *British Journal of Sports Medicine*, 53, 5 - 6.
- Verkoshansky, Y and Siff, M. Supertraining, 6th Edition Expanded Version. Self published; 2009. pp. 396.
- Vickery, W., Dascombe, B.J., Baker, J., Higham, D.G., Spratford, W.A., & Duffield, R. (2014). Accuracy and Reliability of GPS Devices for Measurement of Sports-Specific Movement Patterns Related to Cricket, Tennis, and Field-Based Team Sports. *Journal of Strength and Conditioning Research*, 28, 1697–1705.
- Vila-Chã, C., Falla, D., & Farina, D. (2010). Motor unit behavior during submaximal contractions following six weeks of either endurance or strength training. *Journal of applied physiology (Bethesda, Md. : 1985)*, 109(5), 1455–1466. <https://doi.org/10.1152/jappphysiol.01213.2009>
- Vila-Chã, C., Falla, D., Correia, M.V., & Farina, D. (2012). Adjustments in motor unit properties during fatiguing contractions after training. *Medicine and science in sports and exercise*, 44 4, 616-24 .
- Waggoner B, Grin OD. (1992). Concussion. *American Sailor* ;13:34–6.
- Wallace, L. K., Slattery, K. M., & Coutts, A. J. (2009). The ecological validity and application of the session-RPE method for quantifying training loads in swimming. *Journal of strength and conditioning research*, 23(1), 33–38. <https://doi.org/10.1519/JSC.ob013e3181874512>

- Wallace, L.K., Slattery, K.M., Impellizzeri, F.M., & Coutts, A.J. (2014). Establishing the Criterion Validity and Reliability of Common Methods for Quantifying Training Load. *Journal of Strength and Conditioning Research*, 28, 2330–2337.
- Walls, J.T., Bertrand, L., Gale, T.J., & Saunders, N.R. (1998). Assessment of upwind dinghy sailing performance using a Virtual Reality Dinghy Sailing Simulator. *Journal of science and medicine in sport*, 1 2, 61-72 .
- Walsh, N.P., Gleeson, M., Pyne, D.B., Nieman, D.C., Dhabhar, F.S., Shephard, R.J., Oliver, S.J., Bermon, S., & Kojenien, A. (2011). Position statement. Part two: Maintaining immune health. *Exercise immunology review*, 17, 64-103 .
- Walters, P.H. (2002). Sleep, the Athlete, and Performance. *Strength and Conditioning Journal*, 24, 17–24.
- Wang, R., Hoffman, J. R., Tanigawa, S., Miramonti, A. A., La Monica, M. B., Beyer, K. S., Church, D. D., Fukuda, D. H., & Stout, J. R. (2016). Isometric Mid-Thigh Pull Correlates With Strength, Sprint, and Agility Performance in Collegiate Rugby Union Players. *Journal of strength and conditioning research*, 30(11), 3051–3056. <https://doi.org/10.1519/JSC.0000000000001416>
- Wang, C., Vargas, J. T., Stokes, T., Steele, R., & Shrier, I. (2020). Analyzing Activity and Injury: Lessons Learned from the Acute:Chronic Workload Ratio. *Sports medicine (Auckland, N.Z.)*, 50(7), 1243–1254. <https://doi.org/10.1007/s40279-020-01280-1>
- Ward, P., Williams, A. M., & Bennett, S. J. (2002). Visual search and biological motion perception in tennis. *Research quarterly for exercise and sport*, 73(1), 107–112. <https://doi.org/10.1080/02701367.2002.10608997>
- Weerts, A. P., Pattyn, N., Van de Heyning, P. H., & Wuyts, F. L. (2014). Evaluation of the effects of anti-motion sickness drugs on subjective sleepiness and cognitive performance of healthy males. *Journal of psychopharmacology (Oxford, England)*, 28(7), 655–664. <https://doi.org/10.1177/0269881113516201>
- Weier, A. T., Pearce, A. J., & Kidgell, D. J. (2012). Strength training reduces intracortical inhibition. *Acta physiologica (Oxford, England)*, 206(2), 109–119. <https://doi.org/10.1111/j.1748-1716.2012.02454.x>
- Westerblad, H., & Allen, D.G. (2011). Emerging roles of ROS/RNS in muscle function and fatigue. *Antioxidants & redox signaling*, 15 9, 2487-99 .

- Westerterp, K. R., Saris, W. H., van Es, M., & ten Hoor, F. (1986). Use of the doubly labeled water technique in humans during heavy sustained exercise. *Journal of applied physiology (Bethesda, Md. : 1985)*, 61(6), 2162–2167. <https://doi.org/10.1152/jappl.1986.61.6.2162>
- Weston, N.J., Thelwell, R.C., Bond, S., & Hutchings, N.V. (2009). Stress and Coping in Single-Handed Round-the-World Ocean Sailing. *Journal of Applied Sport Psychology*, 21, 460 - 474.
- Weston, M., Siegler, J.C., Bahnert, A., McBrien, J., & Lovell, R. (2015). The application of differential ratings of perceived exertion to Australian Football League matches. *Journal of science and medicine in sport*, 18 6, 704-8 .
- Wilcock, A., Maddocks, M., Lewis, M., Howard, P., Frisby, J., Bell, S., El Khoury, B., Manderson, C., Evans, H., & Mockett, S.P. (2008). Use of a Cybex NORM dynamometer to assess muscle function in patients with thoracic cancer. *BMC Palliative Care*, 7, 3 - 3.
- Wilkinson, R.T., & Houghton, D. (1982). Field Test of Arousal: A Portable Reaction Timer with Data Storage. *Human Factors: The Journal of Human Factors and Ergonomics Society*, 24, 487 - 493.
- Williams, C.A., & Ratel, S. (2009). Human muscle fatigue.
- Williams, S., West, S.W., Cross, M., & Stokes, K. (2016). Better way to determine the acute:chronic workload ratio? *British Journal of Sports Medicine*, 51, 209 - 210.
- Williams, S., West, S., Cross, M. J., & Stokes, K. A. (2017). Better way to determine the acute:chronic workload ratio?. *British journal of sports medicine*, 51(3), 209–210. <https://doi.org/10.1136/bjsports-2016-096589>
- Williamson, J.W., Mccoll, R.W., Mathews, D., Ginsburg, M.I., & Mitchell, J.H. (1999). Activation of the insular cortex is affected by the intensity of exercise. *Journal of applied physiology*, 87 3, 1213-9 .
- Windt, J., & Gabbett, T.J. (2016). How do training and competition workloads relate to injury? The workload—injury aetiology model. *British Journal of Sports Medicine*, 51, 428 - 435.
- Yakovlev NN. Sports biochemistry. Leipzig: Deutsche Hoch- schule fu¨r Kultur; 1967.
- Young, H.A., & Benton, D. (2018). Heart-rate variability: a biomarker to study the influence of nutrition on physiological and psychological health? *Behavioural Pharmacology*, 29, 140 - 151.

- Zajac, A., Chalimoniuk, M., Maszczyk, A., Gołasz, A., & Lngfort, J. (2015). Central and Peripheral Fatigue During Resistance Exercise - A Critical Review. *Journal of human kinetics*, 49, 159–169. <https://doi.org/10.1515/hukin-2015-0118>
- Zapata, K. A., Wang-Price, S. S., Sucato, D. J., Thompson, M., Trudelle-Jackson, E., & Lovelace-Chandler, V. (2015). Spinal Stabilization Exercise Effectiveness for Low Back Pain in Adolescent Idiopathic Scoliosis: A Randomized Trial. *Pediatric physical therapy : the official publication of the Section on Pediatrics of the American Physical Therapy Association*, 27(4), 396–402. <https://doi.org/10.1097/PEP.000000000000174>
- Zaryski, C., & Smith, D. (2005). Training principles and issues for ultra-endurance athletes. *Current Sports Medicine Reports*, 4, 165-170.
- Zatšiorskiĭ, V.M., & Kraemer, W.J. (1995). Science and practice of strength training.
- Zavorsky G. S. (2000). Evidence and possible mechanisms of altered maximum heart rate with endurance training and tapering. *Sports medicine (Auckland, N.Z.)*, 29(1), 13–26. <https://doi.org/10.2165/00007256-200029010-00002>
- Zeghari, L., Moufti, H., Arfaoui, A., & Habki, Y. (2019). The prevention of overtraining with the monitoring training loads: case of football. *International Journal of Physical Education, Fitness and Sports*.
- Zemková, E. (2013). Sport-Specific Balance. *Sports Medicine*, 44, 579-590.
- Zhu, N., Jiang, W., Wang, Y., Wu, Y., Chen, H., & Zhao, X. (2018). Plasma levels of free fatty acid differ in patients with left ventricular preserved, mid-range, and reduced ejection fraction. *BMC cardiovascular disorders*, 18(1), 104. <https://doi.org/10.1186/s12872-018-0850-0>
- Zile, M.R., & Brutsaert, D.L. (2002). New concepts in diastolic dysfunction and diastolic heart failure: Part I: diagnosis, prognosis, and measurements of diastolic function. *Circulation*, 105 11, 1387-93 .
- Zitzmann, M., & Nieschlag, E. (2001). Testosterone levels in healthy men and the relation to behavioural and physical characteristics: facts and constructs. *European journal of endocrinology*, 144 3, 183-97.

Chapter eight | Appendix



“There is no real ending. It’s just the place where you stop the story.”

-Frank Herbert

8.1 Study 1.

JOURNAL OF SPORTS SCIENCES
<https://doi.org/10.1080/02640414.2020.1851925>

 **Routledge**
Taylor & Francis Group

SPORTS PERFORMANCE

 Check for updates

Key performance indicators in Tour de France sailing

Kilian Philippe^a, Thierry Paillard^a, Romain Dubois^a, Olivier Maurelli^b and Jacques Prioux^c

^aLaboratory of Movement, Balance, Performance and Health, University of Pau and Pays de l'Adour, Tarbes, France EA-4445; ^bLaboratory of Muscular Dynamism and Metabolism (UMR-866), University of Montpellier, Montpellier France; ^cFaculty of Sport Science, Movement, Sport and Health Laboratory (EA-1274), Rennes, Faculty of Sports Science, Rennes, France

ABSTRACT

This study aimed to determine the key performance indicators of inshore sailing during the sailing Tour de France. Technical and physical parameters were investigated to determine the discriminating factors between successful and less successful international level sailors. Measurements from 21 sailors (mean \pm SD; age = 23.81 ± 4.18 years) were conducted prior to the sailing Tour de France. Global Positioning System data of all participating teams ($n = 23$) was analysed. Sailors were divided into two groups (i.e. successful and less successful) according to qualifying performance percentage. The differences between successful and less successful sailors were explored by means of independent t-tests. Results indicate that successful boats displayed higher maximal speed, higher average speed and more efficient starting performance per race than less successful boats. Successful sailors have stronger handgrip strength, higher isometric maximal voluntary force relative to bodyweight (isometric mid-thigh pull) and more powerful submaximal pulling (bench pull) actions than their less successful counterparts. The results of this study suggest that multiple sailing, physical and physiological variables are related to sailing performance in inshore sailing. Therefore, we emphasize the importance of integrating specific testing protocols to evaluate the performance potential of inshore sailors participating in the sailing Tour de France.

ARTICLE HISTORY

Accepted 12 November 2020

KEYWORDS

Sailing; Tour de France; Elite Athletes; inshore sailing

Introduction



This study focuses on inshore sailing performance in multihull-crewed vessels. The sailing tour de France (TDF) is one of Europe's major annual inshore sailing event. For over 40 years, this competition has allowed some of the world's best sailors to compete along the French coastline. Today, the competition sees teams engage in regattas aboard the Diam24 One Design (D24) trimaran.

The D24 vessel is 7.5 m long, 5.62 m wide, has a mast height of 11.5 m, a total sail area of 70 m² and is primarily made of composite material. It is manoeuvred by three highly skilled sailors; helmsman, trimmer and bowman (Figure 1). During the TDF, the boat competes in different stages; the "nautical stadium" (NS; $n = 10$) and "coastal raid" (CR; $n = 5$) events. An NS is a short but intense stage that consists of qualification heats (2–6 per NS day). Teams race to tally points in the aim to qualify for the daily final (Figure 2). The boats are sailed in a fleet-race format (i.e. two groups of 11–12 teams) around a 1–3 lap (according to committee) beam reach, downwind and upwind course of 2672.9 ± 610.3 m. The best four teams of each fleet are selected to advance to the daily final. A CR is an event that tests the sailor's ability to race on larger and longer courses (59100 ± 19400 m) upon the coastline.

Although the TDF has established its' importance in the sailing environment, performance studies are still scarce in sports literature. This is partly due to two distinguishing external parameters that make such analysis unsteady. First, the TDF

is unique in that the format changes annually according to host cities participating to the edition. The influence of geographical location has a significant impact on uncontrollable parameters such as weather and sea conditions. Second, the ever-evolving development of technology and hydrodynamic research leads to constant changes of the official TDF vessel. This ultimately influences the conditions specific to the race. Nevertheless, despite the singular nature of the TDF, it would be interesting to collect data relative to sailing events (i.e. race task analysis) and qualities required (i.e. key performance indicators) in order to better prepare athletes for this sport competition.

Sport performance requires the optimal exploitation of the athletes' potential, but little is known about the contribution of different factors (i.e. physiological, psychological, technical and tactical/strategic) in sailing performance. To date, it was mainly reported that sailing is a sport for which bio-informational and strategic qualities are fundamental (Araújo et al., 2015). Although the anthropometric, physical and physiological characteristics are essential to performance in most sports, their influence on sailing performance still remains to be analysed. Establishing normative data, by engaging in profiling approaches, would be a valuable mean to understanding the needs for optimizing sport-specific performance. Such data would be promoting a better understanding for identifying talent (Rocznik et al., 2013), determining an athlete's strengths and weaknesses (Duthie, 2006), guiding tactical choices (Fernandez-Fernandez et al., 2009) and elaborating sport-specific strength and conditioning programmes. Therefore,

CONTACT Kilian Philippe  kaj.philippe@gmail.com  Laboratory of Movement, Balance, Performance and Health, University of Pau and Pays de l'Adour, 11 rue Morane Saulnier, Quartier Bastillac, 65000 TARBES, France
© 2020 Informa UK Limited, trading as Taylor & Francis Group

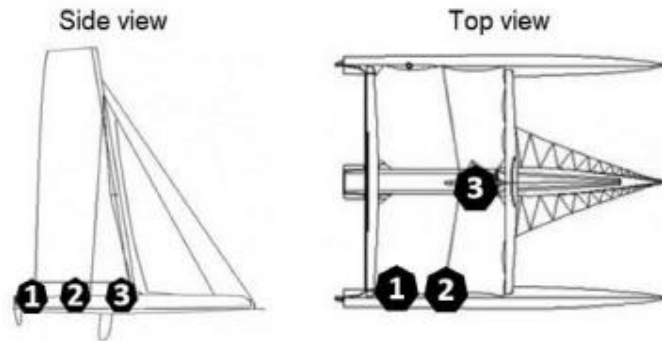

Figure 1. Side and top view of a DIAM24 One Design multihull. The figure shows the position and roles of the 3 athletes on-board. In winds over 10 knots all three sailors are hiking on the same hull.

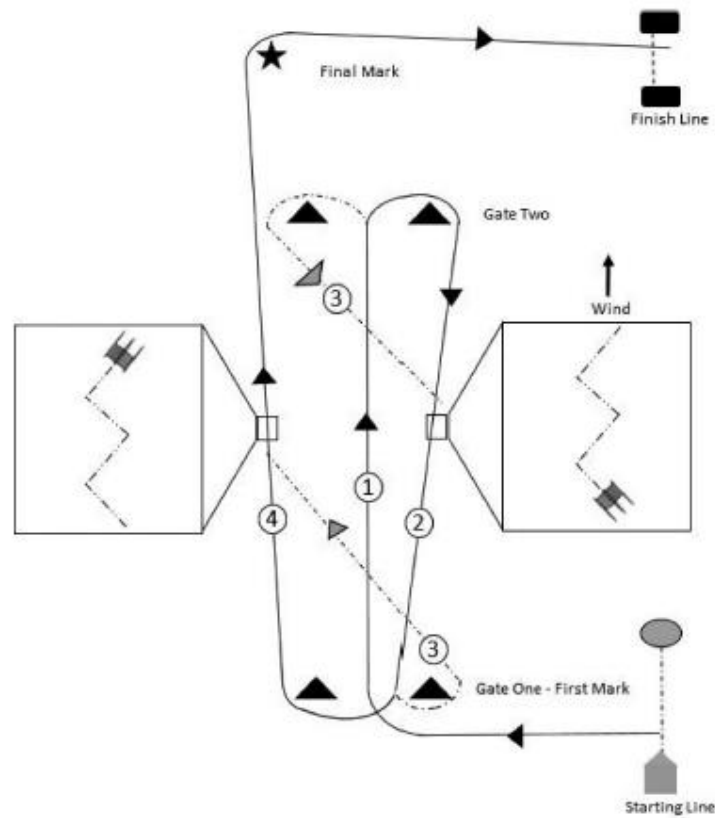

Figure 2. A typical Tour de France nautical stadium course. (1) Represents the downwind portion and (2) the upwind portion. (1) And (2) can be sailed up to three times according to race committee. Teams must go through the gates and can chose to round either mark (3). (4) Represents the final straight before gybing towards the finish line.

the purpose of this study was to: (1) document the nature and technical key performance indicators of the TDF; (2) provide insights into the anthropometric, physical and physiological characteristics of elite inshore sailors. We hypothesized that

sailing performance factors (e.g. distance covered at different sailing speeds) and anthropophysiological characteristics would be identified and contribute to racing success and ranking.

Materials and methods

Subjects

Professional male international inshore sailors ($N = 21$; mean \pm SD; age = 23.81 ± 4.18 years; height = 179.32 ± 7.30 cm; body mass = 74.78 ± 6.56 kg) were assessed in the final preparation phase leading up to the 2019 TDF. Subjects were informed of the testing procedures, potential risks and the purpose of their participation. All subjects had already competed in international competitions. Their collective experience included 59 TDF campaigns. At the time of testing, the subjects had completed 6 months of sailing training and had been actively participating in strength and conditioning programs for at least 3 years. None of the participants reported injuries or diseases that would impair their physical performance. The study protocol was approved by the ethics committee of Rennes University. Written informed consent was obtained from all participants before the start of the study. In this study, criteria used to qualify an athlete's performance was based on the team's final ranking. An athlete was categorized as "successful" (SA, $n = 10$) if he crewed a successful boat (SB). Less successful athletes (LSA, $n = 11$) crewed a less successful boat (LSB).

Procedures

Subjects were signed up for two testing sessions: a) anthropometry and b) physical and physiological. Both a) and b) testing sessions were completed on the same day. Subjects were instructed to rest adequately 72 hours before testing and to maintain normal eating and drinking habits during this period. The first session consisted of anthropometric measurements. These measurements took place in the morning upon waking up. Athletes were asked to refrain from eating 2 hours prior to testing and to avoid caffeine consumption 12 hours before. The second session was directed towards evaluating the physical and physiological components. The testing took place 2-hours post breakfast. The subjects were asked to not change their nutritional habits during this meal. Before all testing, a standardized warm-up was completed including jogging, dynamic movements, and stretches. Each physical and physiological quality measured was fully explained and demonstrated before testing.

Regatta analysis

The 42nd sailing Tour de France took place in July 2019 and was held in 7 French coastal cities. This edition was disputed between 23 international teams over 17 days (10 NS and 5 CR) interspersed by two days of recovery. This resulted in 99 races (84 qualifying heats, 10 finals and 5 CR). Points were attributed daily according to results (i.e.: 1st receives 50 points, 2nd receives 49 ... last receives 28) and were accumulated throughout the competition. The final ranking established the winner of the TDF.

Race data – including sailing distance (m), average speed ($m \cdot s^{-1}$), maximal speed ($m \cdot s^{-1}$), course coverage (%) (i.e. distance sailed/course distance), start performance (rank and time gap at the first mark) and manoeuvres (tack and gybe; count) – were

collected during all 84 qualifying heats and 5CR. GPS units (Mylaps® X5 Global Positioning System; 9-channel GPS receiver; location measurement accuracy 2.5 m; dimensions $109 \times 59 \times 22$ mm; weight 95 g; temperature range -20 – $+55^\circ\text{C}$) were placed on all of the 23 boats. A boat was categorized as "successful" (SB, $n = 7$) if it qualified for more than half of the daily finals. Less successful boats (LSB, $n = 16$) qualified for half or less of the daily finals.

Anthropometric, physical and physiological assessment

Session 1: anthropometric measurement

Anthropometric characteristics were measured in the following order: weight, height, sitting height, wingspan, skinfolds and body girths. A weighing scale (Seca®, Hamburg, Germany) and a stadiometer (Seca®, Barcelona, Spain) were used to measure weight and height, respectively. Measurements for height (standing and sitting) and weight were made with an accuracy of 0.5 cm and 0.1 kg, respectively. Wingspan was measured to the nearest 0.1 cm, from one middle fingertip to the other using a measuring tape (Seca®, Barcelona, Spain). Three skinfolds were taken on the right side of each participant (pectoral, abdominal and thigh) according to recommendations by Jackson and Pollock (Jackson & Pollock, 1978). The skinfolds were measured with a Harpenden skinfold calliper (Harpenden®, Burgess Hill, UK) with $10\text{-g}\cdot\text{mm}^{-2}$ of constant pressure. Body density was assessed (Jackson & Pollock, 1978) while body fat was calculated using Brozek's equation (Brozek et al., 1963). A measuring tape (Seca®, Barcelona, Spain) was used to measure the girth of relaxed arms, thighs and calves on left and right sides following measuring recommendations of the international society for the advancement of kinanthropometry (ISAK; Marfell-Jones et al., 2006).

Session 2: physical testing

Physical and physiological characteristics were measured in randomized order.

Handgrip strength. Maximal isometric hand-grip strength (HGS) was assessed with a Jamar® handgrip dynamometer (Sammons Preston Corp., Bolingbrook, Ill, USA). The test positions were standardized (Svantesson et al., 2009). Three trials were performed on each hand. The first three trials started with the right hand. Subjects were instructed to squeeze the device as hard as possible for 3 s. The time between each trial was 15 s and 3 min of rest was allowed when changing hands. The maximal measure of the three trials was retained in kilograms (Kg). Sum (HGS_{sum}) of both hands and dominant hand (HGS_{dom}) measures were assessed and included in the results.

Vertical jumps. Lower body power was tested on the squat jump (SJ) and countermovement jump (CMJ) using a chronojump contact mat (Chronojump-Boscossystem™, Software, Spain). Each subject had three attempts per jump with 1 min of rest between trials. Subjects started with SJ and, after a 3 min passive recovery, were assessed on CMJ. Instructions for the jumps were explained and controlled with a goniometer for the SJ. Subjects were instructed to descend to 90° knee flexion. Once position was reached, a countdown of

"3, 2, 1, jump" was indicated orally. A validated and reliable smartphone application (Balsalobre-Fernandez et al., 2015) was used for lateral video analysis. This allowed to track lateral kinematics and thus avoid collecting results that involved a countermovement action. Both the SJ and CMJ were done with subjects placing hands on their hips as to avoid arm movement. For the CMJ, athletes were instructed to perform a rapid eccentric phase, immediately followed by a rapid concentric phase with the intention to jump as high as possible. Height and peak power of the best SJ (SJ_H and SJ_{PP}) and CMJ (CMJ_H and CMJ_{PP}) performances were reported for analysis.

Isometric mid-thigh pull. Testing for isometric mid-thigh pull (IMTP) was conducted on a customized pulling rack apparatus specifically developed for data collection. IMTP was performed using two portable force platforms sampling at 1000 Hz (Pasco™, Rosedale, USA) and previously validated (Peterson Silveira et al., 2017). The force plates were connected to a portable laptop running the Capstone Software Programme (Pasco™, Rosedale, USA). Knee angle was measured with a goniometer, to ensure a range of 125–140° (Haff et al., 2015). The bar height was adjusted to meet the testing criteria and to accommodate to the athlete's size. Once the test had been thoroughly described and testing parameters were set, a specific warm-up was conducted. Athletes were provided with two warm-up pulls, 1 at 50% and 1 at 75% of perceived maximum effort, separated by 1 min of rest. Once body position was stabilized (verified by observation and live force measures), the subject was given a countdown of "3, 2, 1, pull." Minimal pre-tension was allowed to ensure that there was no slack in the subject's body before initiation of the pull. Athletes performed three maximal IMTP with the instruction to pull the bar with maximal effort as quickly as possible and push the feet down into the force platform. The time between each trial was 1 min. Each maximal isometric trial was performed for 5 s. The best trial was used for data collection and was analysed relatively to the athlete's body weight (IMTP_W).

Force-velocity pulling profile. Force-velocity curve testing on the bench-pull (BP) was conducted on an elevated bench-pull device placed above a guided squat rack (Smith machine). The Smith machine (Technogym®, Cesena, Italy) allowed for vertical displacement through guided rods. A Chronojump linear position transducer (Chronojump™, Barcelona, Spain) was placed below the bar and automatically calculated the kinematic parameters of every repetition. Subjects were instructed to pull the bar with maximum effort until the barbell hit the bench 8 cm below the subject's chest. The barbell was then lowered and a brief pause of 1 s was observed to avoid the rebound effect or any stretch-shortening cycle interference. The protocol followed Sanchez-Medina's instructions (Sánchez-Medina et al., 2014). Initial load started at 20 kg and increased by increments of 10 kg until mean propulsive velocity (BP_{MPV}) was lower than 0.7 m.s⁻¹. Three attempts were executed for light (< 50% 1RM), 2 for medium (50–80% 1RM) and only 1 for the heaviest (>80% 1RM) loads. Inter-set rest intervals were 3 min for the light and medium loads and 5 min for the heaviest loads. The fastest bar speed for each load was recorded. The maximum load that could be lifted once was considered the athlete's 1RM (BP_{1RM}).

BP_{MPV} was calculated for the loads that were completed by all subjects (BP_{MPV20}, BP_{MPV30}, BP_{MPV40} and BP_{MPV50}).

Anaerobic capacity. Anaerobic capacity was tested using a modified rowing Wingate test (MRWT) on a rowing ergometer Concept II-D (Concept 2 INC™, Vermont, USA). The flywheel was set at 130 drag factor. Subjects were allowed 3 min of warm-up at a rate of perceived exertion of 5 out of 10. Athletes then completed the 30 s all-out test. Exercise performance was expressed as mean power output (MPO) in watts (W) and was calculated automatically by Concept II-D. The procedure has been described previously (Riechman et al., 2002).

Maximal oxygen uptake. Maximal oxygen uptake ($\dot{V}O_{2max}$) was assessed through a step incremental test (MOU_{T25}) on an electromagnetically braked cycle ergometer (Kettler® Ense-Parsit, Germany). $\dot{V}O_{2max}$, expressed as ml.min⁻¹.kg⁻¹, measures were collected through the use of a portable self-contained metabolic cart CardioCoach (Korr Medical Technologies®, Salt Lake City, UT) and previously validated (Dielis-Conwright et al., 2009). Subjects were given time to adjust seat and bar height before starting the test. MOU_{T25} started at 20 W and increased by 25 W.min⁻¹ until voluntary exhaustion (Amann et al., 2004). A cadence of 90–100 RPM was standardized throughout the test. During the MOU_{T25} the following variables were constantly registered: heart rate (HR), minute ventilation (\dot{V}_E) and oxygen uptake ($\dot{V}O_2$). Prior to each test, the gas analyser was calibrated according to the manufacturer's specifications. $\dot{V}O_{2max}$ was determined when physical signs suggestive of exhaustion were apparent and at least one of the following two criteria were met; (1) HR_{max} was no less than 15 beats below the predicted maximum (220 – (0.65 x age); Spiro (1977)) and (2) a steady state of $\dot{V}O_2$ despite an increase in workload (Vehrs et al., 2007).

Statistics

Data were calculated through standard statistical methods and are presented as mean ± standard deviation. All variables were considered normally distributed through analysis with the Shapiro-Wilk test, histograms and skewness values prior to analysis. One-way analysis of variance (ANOVA) was used to compare anthropometric, physiological and physical measures for the different crew positions. Independent t-tests were performed to determine if significant differences existed between physical profiles (SA vs. LSA) and technical parameters (SB vs. LSB). When results were significantly different, an effect size (ES) calculation was used. ES was evaluated using Cohen's d along with 95% confidence intervals. ES of ≤0.2, 0.21–0.60, 0.61–1.20, 1.21–2.0, ≥2.0 were considered as trivial, small, moderate, large and very large, respectively (Batterham & Hopkins, 2006). Finally, Spearman's Rank Order Correlation (r) was used to identify the relationship between outcome (race and overall standings) and the key performance indicators identified as significant in the independent t-tests. Statistical analyses were performed using the SPSS package (15.0 version; SPSS, Inc., Chicago, IL, USA). The level of significance was set at p < 0.05.

Results

Regatta analysis

Mean race duration was 17 ± 2 min for NS and 244 ± 35 min for CR. Course distance was 2672.9 ± 610.3 m for NS and 59000 ± 17500 m for CR. Teams participated between 47 and 57 races and accumulated 474.3 ± 38.3 manoeuvres (NS: 355.1 ± 37.8 ; CR: 119.1 ± 6.6). Gybes (downwind manoeuvre; lasted ~12 s) were more recurrent than tacks (upwind manoeuvre; lasted ~8 s), respectively, 259.3 ± 26.8 vs. 214.9 ± 26.1 . Manoeuvre count per NS heat was 8.7 ± 0.9 and 23.8 ± 1.3 for CR. Sailing distance for NS heats was 4161.8 ± 80.1 m and 78500 ± 34900 m for CR. Course coverage for NS was $158.5 \pm 3.0\%$ and $133.8 \pm 4.9\%$ for CR.

Technical key performance indicators

Sailing parameters collected during the TDF are analysed in Table 1 for SB, LSB and all boats. Race outcome for NS was significantly correlated ($p < 0.01$) with starting performance ($r = .52$), maximal speed ($r = .33$) and average speed ($r = .76$). Coastal raid ranking was correlated ($p < 0.01$) with starting performance ($r = .58$), maximal speed ($r = .43$) and average speed ($r = 0.81$). All three of the highlighted performance parameters were also significantly correlated to final rankings of the TDF.

Profiling and physical key performance indicators

Table 2 shows mean (\pm SD) for the age and anthropometric characteristics of professional male TDF sailors. No significant differences were observed in anthropometric parameters between crew positions (Table 2) and success attribute. The physical and physiological profiles of sailors are reported in Table 3. Successful sailors had stronger HGS_{Dom} ($ES = 0.82$) and IMTP_W relatively to body weight ($ES = 0.93$) and exerted faster BP_{MPV20} ($ES = 1.18$) than their less successful counterparts. The

differences between SA and LSA were significant ($p = 0.001$). HGS_{Dom} ($r = 0.54$), IMTP_W ($r = 0.41$) and BP_{MPV20} ($r = 0.61$) were significantly correlated ($p < 0.01$) to rank in NS heats. CR results were correlated to HGS_{Dom} ($r = 0.37$; $p < 0.05$) and BP_{MPV20} ($r = 0.74$; $p < 0.01$). BP_{MPV20} showed strong correlation with final TDF rankings ($r = 0.8$; $p < 0.05$).

Discussion

The aim of this present study was threefold. First, our objective was to analyse and report the nature of sailing during the TDF. Second, we attempted to identify the key performance indicators associated with racing outcome. Third, we directed a descriptive analysis of anthropometric, physical and physiological profiles of elite-level sailors participating in the TDF. Most prominently, the analysis has indicated the capacity to discriminate between SB/LSB and SA/LSA by considering technical and physical parameters.

Regatta analysis

This is the first report on the nature of sailing during the TDF. Overall, sailors travelled 541300 ± 64900 m in 1792.3 ± 409.3 min during the 15 days of competition. Mean race duration (SN: 17 min; CR: 244 min) and the number of manoeuvres were highly variable due to external parameters (e.g. race course and tactics, environmental condition). Insights on the nature of energetic demands and work to rest ratio can nevertheless be estimated. In sailing, particularly where sailors must hike, work to rest ratio should be re-evaluated as a dynamic to static effort ratio. Tacking manoeuvres lasted around 8 s while a gybe lasted around 12 s. High intensity efforts, linked to the demands of manoeuvring (Neville et al., 2009), occurred on a 1:14 ratio in NS and 1:50 in CR. Dynamic to static ratio reached as high 1:10 when boats chose to sail a course close to shoreline (CR). Hence, it can be assumed that the anaerobic energy system is significantly stressed

Table 1. Differences in sailing parameters between successful boats and less successful boats.

	All boats (n = 23)		Successful Boats (n = 7)		Less successful boats (n = 16)	
	Mean (SD)	[Range]	Mean (SD)	[Range]	Mean (SD)	[Range]
Nautical Stadium						
Sailing distance (m)	4168.5 (76.2)	[4014.8–4318.7]	4131.9 (65.3)	[4048.5–4235.5]	4175.8 (82.7)	[4014.8–4318.7]
Average speed (m.s ⁻¹)	4.1 (0.2)	[3.8–4.4]	4.2 (0.1)	[4.1–4.4]	4.0 (0.1)**	[3.8–4.3]
Maximal speed (m.s ⁻¹)	7.3 (0.2)	[7.0–7.6]	7.5 (0.1)	[7.3–7.6]	7.2 (0.1)**	[7.0–7.5]
Course coverage (%)	158.5 (3.0)	[152.74–164.6]	157.4 (2.0)	[155.0–160.5]	159.0 (3.3)	[152.4–164.6]
Total Manoeuvres	8.6 (0.9)	[6.8–10.3]	8.9 (0.8)	[7.9–10.3]	8.5 (0.9)	[6.7–10.0]
Tacks	3.8 (0.6)	[2.7–5.0]	4.1 (0.4)	[3.6–4.5]	3.7 (0.7)	[2.7–5.0]
Gybes	4.8 (0.6)	[3.7–6.0]	4.9 (0.5)	[4.2–5.7]	4.8 (0.7)	[3.7–6.0]
Start (rank)	5.9 (1.5)	[3.5–9.3]	4.8 (0.9)	[3.5–5.9]	6.6 (1.3)**	[4.8–9.3]
Start (s)	25.4 (8.2)	[12.2–44.9]	18.8 (4.0)	[12.2–22.8]	28.5 (7.7)**	[18.2–44.9]
Coastal Raid						
Sailing distance (m)	78500 (3500)	[69600–82500]	78600 (3200)	[71200–81700]	78500 (3600)	[69600–82500]
Average speed (m.s ⁻¹)	5.4 (0.3)	[4.7–5.7]	5.5 (0.3)	[4.9–5.7]	5.3 (0.2)*	[4.7–5.5]
Maximal speed (m.s ⁻¹)	9.1 (0.4)	[8.1–10.3]	9.3 (0.4)	[8.8–10.3]	9.0 (0.3)**	[8.1–9.3]
Course coverage (%)	134.0 (4.8)	[118.0–139.5]	134.4 (2.4)	[130.0–138.2]	133.6 (5.7)	[118.0–139.5]
Total Manoeuvres	23.9 (1.3)	[20.4–25.8]	24.0 (1.8)	[20.4–25.8]	23.8 (1.0)	[22.2–25.8]
Tacks	11.6 (1.2)	[9.4–13.8]	12.1 (1.1)	[10.2–13.8]	11.5 (1.3)	[9.4–13.6]
Gybes	12.2 (1.0)	[10.2–13.6]	12.0 (1.1)	[10.2–13.6]	12.4 (1.0)	[10.6–13.6]
Start (rank)	11.7 (4.3)	[5.0–20.0]	9.1 (2.3)	[5.0–12.0]	12.9 (4.4)*	[7.0–20.0]
Start (s)	219.1 (103.1)	[71.6–479.8]	162.2 (65.0)	[71.6–236.2]	245.6 (107.1)*	[108.0–479.8]

* Significant difference with values of successful boats; $P \leq 0.05$.

** Significant difference with values of successful boats; $P \leq 0.01$.

Table 2. Age and anthropometric characteristics (mean (SD)) of TDF sailors.

	n	TDF (campaigns)	Age (years)	Weight (kg)	Height (cm)	Sitting Height (cm)	Arm Span (cm)	BMI (kg·m ⁻²)	Σ3 Skinfold (mm)	Body Fat (%)	LBM (kg)	Girth Arm (cm)	Girth Thigh (cm)	Girth Calves (cm)
Successful														
Helmsmen	4	2.8 (0.5)	22.0 (1.4)	70.9 (5.9)	176.4 (9.4)	93.1 (4.6)	181.3 (7.5)	22.8 (1.2)	29.6 (11.0)	13.2 (3.8)	61.5 (5.3)	30.4 (1.8)	53.0 (1.6)	34.8 (1.6)
Bowmen	3	2.7 (0.6)	22.3 (2.1)	71.8 (6.1)	175.5 (5.3)	91.0 (2.6)	190.0 (2.1)	23.3 (0.6)	22.0 (4.4)	10.7 (1.7)	64.1 (4.3)	30.8 (2.0)	54.3 (0.9)	36.0 (0.9)
Trimmes	3	3.0 (0.0)	23.7 (1.2)	77.8 (4.2)	183.3 (6.0)	95.7 (3.3)	188.3 (10.4)	23.1 (0.6)	26.0 (15.4)	12.0 (5.2)	68.4 (5.0)	32.7 (1.3)	55.3 (1.8)	34.5 (1.8)
All	10	2.8 (0.4)	22.6 (1.6)	73.3 (5.8)	178.2 (7.5)	93.3 (2.8)	185.8 (7.7)	23.0 (0.8)	26.3 (10.4)	12.1 (3.6)	64.4 (5.3)	31.2 (1.2)	54.1 (1.3)	35.1 (1.5)
Less-Successful														
Helmsmen	3	2.7 (1.2)	23.7 (4.5)	68.4 (3.9)	176.4 (14.2)	92.3 (4.6)	186.0 (12.5)	21.4 (2.3)	29.1 (8.0)	13.2 (2.6)	59.4 (3.8)	29.1 (1.4)	52.2 (3.2)	33.8 (1.3)
Bowmen	4	2.7 (1.3)	25.0 (5.9)	79.1 (8.0)	175.5 (1.9)	92.9 (1.6)	183.8 (4.2)	24.3 (2.3)	20.1 (4.6)	10.1 (1.6)	71.0 (6.5)	32.3 (4.0)	53.1 (7.0)	39.8 (6.2)
Trimmes	4	3.0 (0.0)	25.8 (6.9)	79.1 (3.8)	183.3 (6.2)	91.4 (4.3)	184.3 (3.8)	24.2 (1.9)	40.0 (13.5)	17.5 (4.5)	65.1 (3.6)	31.1 (2.6)	55.4 (1.3)	35.9 (1.4)
All	11	2.7 (0.4)	24.9 (5.5)	73.5 (7.6)	180.4 (7.3)	92.2 (3.4)	184.6 (6.5)	23.5 (2.4)	30.5 (13.1)	13.65 (4.0)	65.7 (6.5)	31.0 (3.0)	53.7 (4.4)	36.7 (4.4)
Total														
All	21	2.8 (0.9)	23.8 (4.2)	74.8 (6.6)	179.3 (7.3)	92.7 (3.5)	185.1 (6.9)	23.3 (1.8)	28.5 (11.8)	12.91 (4.0)	65.0 (5.9)	31.1 (2.5)	53.9 (3.2)	35.9 (3.3)
Range		[1–4]	[17–33]	[65.5–88.8]	[163.5–190.5]	[85.5–100]	[173.5–200]	[19.3–26.8]	[13–54.5]	[7.6–22]	[55.3–78.9]	[27.5–37]	[44.5–61.5]	[32.5–41]

Table 3. Physical and physiological characteristics (mean (SD)) of TDF sailors.

	n	HGS _{open} (kg)	HGS _{5m} (kg)	S _{1/4} (cm)	CM _{1/4} (cm)	IMTP (N)	IMTP _w (N kg ⁻¹)	MIRWT-MPO (W)	BP ₁₀₀ (kg)	BP _{max2} (m. s ⁻¹)	BP _{max3} (m. s ⁻¹)	BP _{max4} (m. s ⁻¹)	BP _{max5} (m. s ⁻¹)	BP _{max6} (m. s ⁻¹)	VO _{2max} (ml.min ⁻¹ kg ⁻¹)
Successful															
Helmsmen	4	59.3 (5.6)	113.5 (9.7)	32.7 (4.8)	37.6 (5.2)	2649.9 (397.6)	37.3 (3.4)	501.3 (82.3)	71.8 (6.3)	1.5 (0.02)	1.2 (0.1)	1.1 (0.1)	1.1 (0.1)	0.9 (0.1)	53.5 (6.4)
Bowmen	3	72.0 (6.9)	138.0 (11.1)	42.8 (5.9)	37.6 (2.2)	2094.1 (189.7)	40.4 (1.1)	623.7 (115.0)	83.3 (2.8)	1.7 (0.1)	1.4 (0.1)	1.2 (0.2)	1.0 (0.1)	1.0 (0.1)	52.5 (14.0)
Trimmers	3	66.3 (8.5)	127.3 (20.1)	35.6 (1.0)	38.0 (2.4)	2955.6 (144.9)	38.0 (2.2)	632.7 (126.0)	81.7 (10.4)	1.7 (0.1)	1.5 (0.1)	1.3 (0.1)	1.2 (0.1)	1.2 (0.1)	56.5 (2.2)
All	10	65.2 (8.3)	125.0 (16.3)	35.6 (1.0)	37.9 (3.6)	2814.9 (293.5)	38.4 (2.7)	577.4 (114.2)	79.0 (7.8)	1.6 (0.1)	1.3 (0.1)	1.2 (0.2)	1.0 (0.1)	1.0 (0.1)	54.1 (7.8)
Less-															
Successful															
Helmsmen	3	56.3 (15.4)	110.3 (27.5)	39.3 (7.7)	36.5 (4.7)	2433.4 (776.7)	35.2 (9.8)	480.7 (46.0)	67.5 (4.3)	1.3 (0.2)	1.1 (0.0)	1.0 (0.06)	1.0 (0.06)	0.8 (0.06)	48.7 (13.6)
Bowmen	4	58.3 (9.9)	114.3 (18.9)	36.8 (5.8)	38.7 (7.5)	2723.2 (614.7)	34.3 (5.7)	586.0 (108.4)	88.8 (20.15)	1.5 (0.1)	1.4 (0.2)	1.2 (0.2)	1.2 (0.2)	1.0 (0.2)	57.3 (13.6)
Trimmers	4	57.3 (5.9)	110.8 (11.8)	31.0 (5.6)	35.8 (6.8)	2527.7 (377.5)	31.9 (3.4)†	575.0 (66.4)	70.0 (13.5)	1.3 (0.1)†	1.2 (0.1)†	1.1 (0.1)†	1.1 (0.1)†	0.9 (0.3)	51.4 (6.8)
All	11	57.4 (9.4)†	111.9 (17.5)	35.4 (6.7)	37.1 (6.1)	2573.1 (540.8)	33.7 (5.9)†	555.5 (84.9)	76.1 (16.8)	1.3 (0.2)†	1.2 (0.2)	1.1 (0.1)	1.1 (0.1)	0.9 (0.2)	52.8 (9.4)
Total															
All	61.1 (9.5)	118.1 (17.8)	36.0 (6.2)	38.6 (5.6)	2688.2 (447.5)	35.9 (5.1)	565.9 (97.9)	77.5 (13.0)	77.5 (13.0)	1.5 (0.2)	1.3 (0.2)	1.1 (0.2)	1.1 (0.2)	1.0 (0.2)	53.4 (8.5)
Range	[46-80]	[90-150]	[24.1-49.1]	[26.2-46.7]	[1567.5-3160]	[24.5-43.7]	[430-774]	[50-105]	[1.04-1.83]	[1.06-1.63]	[0.92-1.45]	[0.77-1.29]	[0.77-1.29]	[0.77-1.29]	[36.5-76.8]

during TDF racing. However, the TDF competition also requires a good aerobic level to endure the 15 days of sailing and to optimize recovery when racing (NS: $77 \pm 14 \text{ min}\cdot\text{stage}^{-1}$; CR: $244 \pm 35 \text{ min}\cdot\text{stage}^{-1}$).

Technical key performance indicators

GPS technology permits performance analysts to monitor external training load (Cummins et al., 2013) and collect data to identify technical and tactical performance indicators in sailing activities (Pérez-Turpin et al., 2009). Research has identified the key technical performance indicators in windsurfing (Anastasiou et al., 2019), match racing (Neville et al., 2009) and kiteboarding (Caimmi & Semprini, 2017). To the best of our knowledge, this is the first study to analyse such parameters in fleet racing.

With regards to our results, we observed variability in the distance covered and time to finish a heat. Wind direction and wind speed influences the organisation committee in course settings (Pérez-Turpin et al., 2009). Nevertheless, it should be noted that sailing also relies on cognitive skills (Araújo et al., 2015) and that different racing strategies exist. Teams must regularly analyse weather and oceanographic reports to determine the most appropriate course (Thill, 1982). Other external parameters (e.g. position in the fleet, changes of racing conditions, placement of opponents on course) can provoke variations and modifications in initial strategy (Araújo & Septra, 1997; Manzanera Serrano et al., 2012; Ward et al., 2002).

Speed parameters have previously discriminated between successful and less successful athletes in other sailing competitions (Anastasiou et al., 2019; Caimmi & Semprini, 2017). This comforts our findings in that both average speed and maximal speed were significantly correlated to both race and TDF overall outcome. On the basis of bio-informational data, one can assume that SB were more efficient in determining the most favourable course to take in order to optimize boat speed. Pluijms et al. (2015) have investigated the difference in visual fixation behaviour between top and bottom-ranked sailors. On the one hand, bottom ranked sailors focus their centre of attention on the boat and thus might discard important environmental information. On the other hand, top ranked sailors, were capable of "feeling" the changes in boat speed and direction through mechanical and proprioceptive feedback. SB also displayed better starting performance (rank and time gap at first mark) than LSB. Starting performance was significantly correlated with race outcome and overall TDF ranking. This could be due to sailors changing their gaze to look for relevant environmental information that might enhance the boat's performance (Pluijms et al., 2015). Indeed, if boats arrived first at the first mark they would not have to account for other information concerning opposing team position.

Profiling and physical key performance indicators

Although sailing has acquired research interest through important international events (i.e. Americas Cup and Olympic Games), none has analysed the anthropometric, physical and physiological demands for multihull fleet racing. Hence, we can only compare our data to those of similar sailing events. The mean data for height and weight of the 21 subjects

($179.3 \pm 7.3 \text{ cm}$ and $74.8 \pm 6.6 \text{ kg}$) are different to those found in other studies. Indeed, offshore sailors tended to be smaller and heavier ($177 \pm 7 \text{ cm}$ and $78 \pm 10 \text{ kg}$; Hurdiel et al., 2014) whilst measures reported on the 2002 TDF outlined the smaller and lighter profiles of sailors at the time ($173 \pm 6 \text{ cm}$ and $62.6 \pm 9.3 \text{ kg}$; Léger et al., 2008). The body fat of athletes in the study hereby ($12.91 \pm 4\%$) was similar to previously reported data of America's Cup sailors ($13 \pm 4\%$; Neville et al., 2009), and seems within the range (10–15%) of international and Olympic dinghy sailors (Bojsen-Møller et al., 2007; Vangelakoudi et al., 2007). Anthropometric characteristics vary according to competitive status, crew position, publishing date and sailing classification (Larsson et al., 1996). Surprisingly, there was no significant difference in anthropometric data in regards to crew position (Table 2). This could be the result of the race organization's choice to set the minimal total crew weight to 210 kg and supports findings by Neville et al. (2009) that highlights the modern sailors' strategy to reduce body fat of the whole crew as to maximize lean muscle mass for roles demanding higher physical output. This outlines the complexity when establishing normative data for sailing in general.

The physical and physiological characteristics reported in the present study also varied when compared to other sailing studies. $\dot{V}O_{2\text{max}}$ of our present study ($53.4 \pm 8.5 \text{ ml}\cdot\text{mn}^{-1}\cdot\text{kg}^{-1}$), seems to be (i) lower than in elite laser sailors ($58.2 \pm 4.7 \text{ ml}\cdot\text{mn}^{-1}\cdot\text{kg}^{-1}$; Castagna & Brisswalter, 2007), (ii) higher than finn sailors ($47.6 \pm 3.5 \text{ ml}\cdot\text{mn}^{-1}\cdot\text{kg}^{-1}$; Bojsen-Møller et al., 2007) and (iii) similar to America's Cup grinders ($52.2 \pm 4.6 \text{ ml}\cdot\text{mn}^{-1}\cdot\text{kg}^{-1}$; Bernardi et al., 2007). The differences outlined in these studies could be related to the effect induced by the various peculiar onboard activity and/or the use of various testing methodologies. Nevertheless, research has outlined the low aerobic demands during a dinghy regatta (Portier & Guezennec, 2003). Indeed, sailors participating on TDF engage in high intensity hoisting and trimming actions when manoeuvring. Between the different manoeuvres, the sailors are involved in quasi-isometric hiking. Previous studies showed a significantly decreased oxygenation pattern in the m. Vastus Lateralis during hiking (inherent to isometric contractions >30% maximal voluntary contraction), indicating an imbalance between oxygen supply and demand, and probably due to restricted muscle blood flow (Bourgeois et al., 2016). The sailors undertaking the MRWT-MPO test in this study ($565.9 \pm 97.9 \text{ W}$) held similar anaerobic capacity than highly trained college-level rowers ($548.97 \pm 95.57 \text{ W}$; Shaharudin et al., 2014). This comforts our understanding that TDF sailors rely significantly on anaerobic energy delivery during racing.

Lower body power was assessed using SJ and CMJ protocols. Few other studies have analysed such parameters on sailors. Indeed, only one has assessed national level sailors for lower body power (Tan et al., 2006) and found similar results to the present study (36.0 ± 6.2 vs $34.0 \pm 4.0 \text{ cm}$) on the SJ. Nevertheless, it seems that no correlation between jumping performance and hiking potential exists (Tan et al., 2006). Hiking is characterized by strong isometric contractions and coactivation of the muscles involved: quadriceps, hamstrings, abdominal and paravertebral muscles (Larsson et al., 1996; Tan et al., 2006). Numerous studies have analysed isokinetic muscle strength of knee, hip and trunk flexors and extensors of elite-

level sailors (Aagaard et al., 1998; Chicoy & Encarnación-Martínez, 2015). These studies have highlighted the high demands of these specific strengths on hiking performance. In the present study, to assess maximal isometric strength of the lower body, an IMTP test was performed. To date, this is the first study to use such a protocol in an elite sailing environment. Relative strength should be considered when assessing sailors, or other sports, where body weight is regulated by competition rules. Isometric maximal voluntary force, using the IMTP test, has been linked to functional performance in sport (Ran-Wang et al., 2016). We aimed at analysing isometric strength at hip/knee angles like those of other sailing studies (Chicoy & Encarnación-Martínez, 2015) by using the IMTP. Interestingly, maximal IMTP discriminated between SA and LSA when the results were compared relatively to body-weight ($IMTP_w$). $IMTP_w$ performance was significantly correlated ($r = 0.41$; $p < 0.01$) with rank on NS courses. These results suggest that a high level of relative strength is necessary in TDF sailors, and supports the findings in other studies analysing the relationship between lower body strength and sailing performance (Blackburn & Hubinger, 1995).

Trimming and hoisting actions require powerful and energetic movements on the sheets (Bay & Larsson, 2013). By doing so, sailors increase the amount of apparent wind that covers the sail and, thus, increase boat speed. Indeed, it was thought that sailors participating in the TDF would have high amounts of maximal strength due to the predominance of pulling actions necessary when manoeuvring the boat. Differences can be outlined for the one repetition maximum between Americas Cup sailors (99.41 ± 5.4 kg; Pearson et al., 2009) and TDF sailors of this present study (77.5 ± 13.0 kg). Nevertheless, it should be noted that the America's cup sailors were heavier (97.8 ± 12.5 vs 74.8 ± 6.6 kg). Bar velocity at fixed loads was also evaluated and turned out to be significantly different between SA and LSA at 20 kg loads. Neville et al. (2009) reported that successful boats manoeuvred faster than less successful boats. Faster bar velocity at submaximal loads could be directly correlated to hoisting/trimming efficiency and, thus, sailing performance through faster manoeuvres. BP_{mpv20} was in fact significantly correlated to racing outcome (NS and CR) and TDF final ranking ($r = .80$; $p < 0.05$). Future research should therefore aim at establishing associations between bar velocities at fixed loads with hoisting actions.

Handgrip strength has received a considerable amount of interest in past research. Indeed, it has been linked to performance in many sports (Cronin et al., 2017). Significant decreases in grip strength between pre- and post-sailing training sessions have been reported in junior male semi-elite sailors (Bateup et al., 2016). The TDF sailors (61.1 ± 9.5 kg) reported stronger HGS_{Dom} than collegiate dinghy sailors (48.28 ± 5.31 kg; Pular, 2011). These results outline the high mechanical stress placed on forearms when manoeuvring TDF boats. HGS_{Dom} was found to significantly discriminate between SA and LSA. It was also correlated to racing outcome (NS and CR). These results could indicate more efficiency to manoeuvre the D24 at higher speeds (i.e. optimized gripping ease against high resistance in sheets and cranks). It would seem interesting to analyse the acute and chronic load effects of sailing on handgrip strength.

An interesting finding of this study was that no significant difference was found between crew positions for physical and physiological parameters. This could indicate an equal importance of overall fitness of TDF sailors to manoeuvre the boat. Indeed, it was not rare to see sailors switch position when racing or during specific manoeuvres throughout the TDF. Comparison of physical and physiological parameters from 21 elite sailors indicated that SA had greater strength (HGS_{Dom}), muscular voluntary contraction ($IMTP_w$) and power (BP_{mpv20}) compared to LSA. Differences were most marked between trimmers ($IMTP_w$, BP_{mpv20} , BP_{mpv30} and BP_{mpv40}) and bowmen (BP_{mpv20}) which are primarily responsible for trimming and material handling (sails, ropes and cranks). A possible explanation highlighting the difference in HGS_{Dom} found in this study could result from higher training loads on-water and off- of SA (Bateup et al., 2016).

Study limitations

Some limitations in the present study have been identified during the analysis process. First, the sample size of 21 elite level sailors accounted for 6 fully crewed boats out of 23. Testing more crew members may have permitted to perform more significant correlational analysis between crew characteristics, as a mean or sum, and ranking. Second, as previously mentioned, sailing relies on bio-informational and strategic qualities to perform. Indeed, overall and specific sailing experience was not accounted for and could have influenced performance and account for discrimination of success.

Conclusion

Overall, the findings have identified multiple variables (technical and physical) that discriminate between successful and less successful athletes/boats. The results can be used as normative data to compare, detect and guide athletes in their preparation for performance. The present study highlights successful sailors having stronger grip strength, more powerful bench-pull and higher IMTP than their less successful counterparts. Successful boats displayed a faster average speed, maximal speed and more efficient starting performance. Nevertheless, these findings should be applied with caution to other populations (i.e. youths, less experimented sailors and other sailing categories).

Practical applications

This study may provide useful information to coaches, sports scientists and sailors in the planning and implementation of physical and technical training interventions. Where practitioners wish to evaluate and provide sailors with reliable training interventions the use of handgrip strength, submaximal pulling velocity and isometric mid-thigh pull testing protocols are suitable. We believe that future studies should focus on two particular aspects: (1) identifying the effects of internal and external training load on technical and physical performance indicators during the preparation and competitive phase of the TDF and (2) examining sailors' experience (e.g. vessel, position, training load) in order to identify potential performance and/or talent pathways.

TDF: Tour de France; BMI: Body Mass Index; LBM: Lean Body Mass; Note: Successful, sailors finishing in the top seven teams; Less successful, sailors finishing 8th to 23rd.

* Significant difference with values of successful athletes; $P \leq 0.05$ (**; $P \leq 0.01$).

† Significant difference with values of successful athletes at same position; $P \leq 0.05$ (†; $P \leq 0.01$).

HGS_{Dom}: Dominant Hand Grip Strength; HGS_{Sum}: Sum of Hand Grip Strength; SJ_J: Squat Jump Height; SJ_{PP}: Squat Jump Peak Power; CMJ_J: Countermovement Jump Height; CMJ_{PP}: Countermovement Jump Peak Power; IMTP: Isometric Mid-Thigh Pull; IMTP_W: Isometric Mid-Thigh Pull relative to Weight; MRWT-MPO: Modified Rowing Wingate Test Mean Power Output; BP_{1RM}: Bench Press 1RM; BP_{MPV20}: Bench Press Velocity at 20 kg; BP_{MPV30}: Bench Press Velocity at 30 kg; BP_{MPV40}: Bench Press Velocity at 40 kg; BP_{MPV50}: Bench Press Velocity at 50 kg; $\dot{V}O_{2max}$: Maximal Oxygen Uptake. Note: Successful, sailors finishing in the top seven teams; Less successful, sailors finishing 8th to 23rd;

* Significant difference with values of successful athletes; $P \leq 0.05$ (**; $P \leq 0.01$).

† Significant difference with values of successful athletes at same position; $P \leq 0.05$ (†; $P \leq 0.01$).

Acknowledgments

The investigators would like to acknowledge the Sailing Federation (France) and Georacing* for their continued collaboration.

Disclosure statement

No potential conflict of interest was reported by the authors.

References

- Aagaard, P., Beyer, N., Simonsen, E. B., Larsson, B., Magnusson, S. P., & Kjaer, M. (1998). Isokinetic muscle strength and hiking performance in elite sailors. *Scandinavian Journal of Medicine & Science in Sports*, 8(3), 138–144. <https://doi.org/10.1111/j.1600-0838.1998.tb00183.x>
- Amann, M., Subudhi, A., & Foster, C. (2004). Influence of testing protocol on ventilatory thresholds and cycling performance. *Medicine and Science in Sports and Exercise*, 36, No., 4(4), 613–622. <https://doi.org/10.1249/01.MSS.0000122076.21804.10>
- Anastasidou, A., Jones, T., Mullan, P., Ross, E., & Howatson, G. (2019). Descriptive analysis of Olympic class windsurfing competition during the 2017-2018 regatta season. *International Journal of Performance Analysis in Sport*, 19(4), 517–529. <https://doi.org/10.1080/24748668.2019.1631054>
- Araújo, D., Davids, K., Diniz, A., Rocha, L., Santos, J. C., Dias, G., & Fernandes, O. (2015). Ecological dynamics of continuous and categorical decision-making: The regatta start in sailing. *European Journal of Sport Science*, 15(3), 195–202. <https://doi.org/10.1080/17461391.2014.928749>
- Araújo, D., & Sepra, S. (1997). Towards a construction of methodological design to measuring decision making in externally paced sport: The case of sailing. In *Innovations in sport psychology: Linking theory and practice: Proceedings, pt. 1, The Zinnmann college of physical education and sport sciences, The Wingate Institute for Physical Education and Sport* (pp. 76–78).
- Balsalobre-Fernandez, C., Gialster, M., & Lockey, R. A. (2015). The validity and reliability of an iPhone app for measuring vertical jump performance. *Journal of Sports Sciences*, 33(15), 1574–1579. <http://doi.org/10.1080/02640414.2014.996184>
- Bateup, B., Thornton, H., Withers, S., & Duthie, G. (2016). The influence of training load on markers of fatigue in junior male semi-elite sailors. *Journal of Australian Strength & Conditioning*, 24(6), 21–22. <http://doi.org/10.13140/RG.2.2.30.398.48966>
- Batterham, A. M., & Hopkins, W. G. (2006). Making meaningful inferences about magnitudes. *International Journal of Sports Physiology and Performance*, 1(1), 50–57. <https://doi.org/10.1123/ijsp.1.1.50>
- Bay, J., & Larsson, B. (2013). *Bay testen. En fysiologisk performance test for 49'er gaster [A physiological performance test for 49'er crewmen]* [Unpublished thesis]. Team Danmark and Department of Nutrition, Exercise and Sports Sciences, University of Copenhagen/Team Danmark.
- Bernardi, M., Quattrini, F., Rodio, A., Fontana, G., Madaffari, A., Brugnoli, M., & Marchetti, M. (2007). Physiological characteristics of America's Cup sailors. *Journal of Sports Sciences*, 10(10), 1141–1152. <https://doi.org/10.1080/02640410701287172>
- Blackburn, M. J., & Hubinger, L. (1995). Determination of physiological profiles and exercise training programs for competitive dinghy sailors: full report. *Applied Sports Research Program, National Sports Research Centre (Australia)*.
- Bojsten-Møller, J., Larsson, B., Magnusson, S. P., & Aagaard, P. (2007). Yacht type and crew-specific differences in anthropometric, aerobic capacity, and muscle strength parameters among international Olympic class sailors. *Journal of Sports Sciences*, 25(10), 1117–1128. <https://doi.org/10.1080/02640410701287115>
- Bourgols, J. G., Callewaert, M., Celle, B., De Clercq, D., & Boone, J. (2016). Isometric quadriceps strength determines sailing performance and neuromuscular fatigue during an upwind sailing emulation. *Journal of Sports Sciences*, 34(10), 973–979. <https://doi.org/10.1080/02640414.2015.1082613>
- Brozek, J., Grande, F., Anderson, J. T., & Keys, A. (1963). Densitometric analysis of body composition: Revision of some quantitative assumptions. *Annual New York Academic Science*, 110(1), 113–140. <https://doi.org/10.1111/j.1749-6632.1963.tb17079.x>
- Calmmi, G., & Semprini, G. (2017). Heart rate and GPS data analysis of kiteboard course racing during the Italian Championship. *Sport Sciences for Health*, 13(1), 79–85. <https://doi.org/10.1007/s11332-017-0346-9>
- Castagna, O., & Brisswalter, J. (2007). Assessment of energy demand in Laser sailing: Influences of exercise duration and performance level. *European Journal of Applied Physiology*, 99(2), 95–101. <https://doi.org/10.1007/s00421-006-0336-0>
- Chicoy, L., & Encarnación-Martínez, A. (2015). Determining factors in the performance of Hiking in Dinghy sailing: A literature review. *Matricidad: European Journal of Human Movement*, 34(1), 15–33. <http://eurjhm.com/index.php/eurjhm/article/view/328/561>
- Cronin, J., Lawton, T., Harris, N., Kilding, A., & McMaster, D. T. (2017). A brief review of handgrip strength and sport performance. *Journal of Strength & Conditioning Research*, 31(11), 3187–3217. <https://doi.org/10.1519/JSC.0000000000002149>
- Cummins, C., Orr, R., O'Connor, H., & West, C. (2013). Global positioning systems (GPS) and microtechnology sensors in team sports: A systematic review. *Sports Medicine*, 43(10), 1025–1042. <https://doi.org/10.1007/s40279-013-0069-2>
- Diell-Conwright, C., Jensky, N., Battaglia, G., McCauley, S., & Todd Schroeder, E. (2009). Validation of the CardioCoachCO2 for submaximal and maximal metabolic exercise testing. *Journal of Strength and Conditioning Research*, 23(4), 1316–1320. <https://doi.org/10.1519/JSC.0b013e3181a3c5e8>
- Duthie, G. M. (2006). A framework for the physical development of Elite Rugby union players. *International Journal of Sports Physiology & Performance*, 1(1), 2–13. <https://doi.org/10.1123/ijsp.1.1.2>
- Fernandez-Fernandez, J., Sanz-Rivas, D., & Mendez-Villanueva, A. (2009). A review of the activity profile and physiological demands of tennis match play. *Strength and Conditioning Journal*, 31(4), 15–26. <http://doi.org/10.1519/ssc.0b013e3181ada1cb>
- Haff, G.G., Ruben, R.P., Uider, J., Twine, C., & Cormie, P. (2015). A comparison of methods for determining the rate of force development during isometric mid-thigh clean pulls. *Journal of Strength & Conditioning Research*, 29(2), 386–395. <http://doi.org/10.1519/JSC.0000000000000705>
- Hurdlel, R., Van Dongen, H., Aron, C., McCauley, P., Jacolot, L., & Theunynck, D. (2014). Sleep restriction and degraded reaction-time performance in Figaro solo sailing races. *Journal of Sports Sciences*, 32(2), 172–174. <https://doi.org/10.1080/02640414.2013.815359>

- Jackson, A. S., & Pollock, M. L. (1978). Generalized equations for predicting body density of men 1978. *British Journal of Nutrition*, 40(3), 497–504. <https://doi.org/10.1079/BJN19780152>
- Larsson, B., Beyer, N., Bay, P., Blond, L., Aagaard, P., & Kjaer, M. (1996). Exercise performance in elite male and female sailors. *International Journal of Sports Medicine*, 17(7), 504–508. <https://doi.org/10.1055/s-2007-972886>
- Léger, D., Elbaz, M., Raffray, T., Metlaine, A., Bayon, V., & Duforez, F. (2008). Sleep management and the performance of eight sailors in the Tour de France à la voile yacht race. *Journal of Sports Sciences*, 26(1), 21–28. <http://doi.org/10.1080/02640410701348636>
- Manzanares Serrano, A., Segado Segado, F., & Menayo Antúnez, R. (2012). Factores determinantes del rendimiento en vela deportiva: Revisión de la literatura/Decisive factors in sailing performance: Literature review. *Cultura, Ciencia Y Deporte*, 7(20), 125–134. <https://doi.org/10.12800/ccd.v7i20.58>
- Marfell-Jones, M., Olds, T., Stewart, A., & Carter, J. E. L. (2006). *International standards for anthropometric assessment*. ISAK.
- Neville, V., Calefato, J., Pérez-Encinas, C., Rodilla-Sala, E., Rada-Ruiz, S., Dorochenko, P., & Folland, J. (2009). America's Cup yacht racing: Race analysis and physical characteristics of the athletes. *Journal of Sports Sciences*, 27(9), 915–923. <https://doi.org/10.1080/02640410902946485>
- Pearson, S. N., Hume, P. A., Cronin, J. B., & Slyfield, D. (2009). Strength and power determinants of grinding performance in America's Cup Sailors. *Journal of Strength & Conditioning Research*, 23(6), 1883–1889. <https://doi.org/10.1519/JSC.0b013e3181b2ba55>
- Pérez-Turpin, J. A., Cortell-Tormo, J. M., Suárez-Llorca, C., Andreu-Cabrera, E., Llana-Belloch, S., & Pérez-Soriano, P. (2009). Relationship between anthropometric parameters, physiological responses, routes and competition results in formula windsurfing. *Acta Kinesiologicae Universitatis Tartuensis*, 14(1), 95–110. <https://doi.org/10.12697/akut.2009.14.07>
- Peterson Silveira, R., Stergiou, P., Carpes, F. P., Castro, F. A., Katz, L., & Stefanyshyn, D. J. (2017). Validity of a portable force platform for assessing biomechanical parameters in three different tasks. *Sports Biomechanics*, 16(2), 177–186. <https://doi.org/10.1080/14763141.2016.1213875>
- Pluijms, J. P., Canal-Bruland, R., Hoozemans, M. J. M., & Savelsbergh, G. J. P. (2015). Visual search, movement behaviour and boat control during the windward mark rounding in sailing. *Journal of Sports Sciences*, 33(4), 398–410. <https://doi.org/10.1080/02640414.2014.946075>
- Portier, H., & Guezennec, C. Y. (2003). Estimation de la dépense énergétique lors d'une regate en dériveur/Oxygen cost assessment during small craft competition. *Science & Sports*, 18(2), 111–113. [https://doi.org/10.1016/S0765-1597\(02\)00051-5](https://doi.org/10.1016/S0765-1597(02)00051-5)
- Pulur, A. (2011). Determination of physical and physiological profiles of international elite sailors. *African Journal of Business Management*, 5(8), 3071–3075. <http://doi.org/10.5897/AJBM10.258>
- Riechman, S. E., Zoeller, R. F., Balasekaran, G., Goss, F. L., & Robertson, R. J. (2002). Prediction of 2000 m indoor rowing performance using a 30 s sprint and maximal oxygen uptake. *Journal of Sports Sciences*, 20(9), 681–687. <https://doi.org/10.1080/026404102320219383>
- Roczniok, R., Maszczyk, A., Stanula, A., Czuba, M., Pietraszewski, P., Kantyka, J., & Starzynski, M. (2013). Physiological and physical profiles and on-ice performance approach to predict talent in male youth ice hockey players during draft to hockey team. *Isokinetics & Exercise Science*, 21(2), 121–127. <https://doi.org/10.3233/IES-130487>
- Sánchez-Medina, L., González-Badillo, J. J., Pérez, C. E., & Pallarés, J. G. (2014). Velocity- and power-load relationships of the bench pull vs. Bench Press exercises. *International Journal of Sports Medicine*, 35(3), 209–216. <http://doi.org/10.1055/s-0033-1351252>
- Shaharudin, S., Zanotto, D., & Agrawal, S. (2014). Muscle synergy during wingate anaerobic rowing test of collegiate rowers and untrained subjects. *International Journal of Sports Science*, 4(5), 165–172. <http://10.5923/j.sports.20140405.03>
- Spiro, S. G. (1977, July). Exercise testing in clinical medicine. *British Journal of Diseases of the Chest*, 71(3), 145–172. [https://doi.org/10.1016/0007-0971\(77\)90106-1](https://doi.org/10.1016/0007-0971(77)90106-1)
- Svantesson, U., Nordé, M., Svensson, S., & Brodin, E. (2009). A comparative study of the Jamar® and the Grippit® for measuring handgrip strength in clinical practice. *Isokinetics & Exercise Science*, 17(2), 85–91. <https://doi.org/10.3233/IES-2009-0338>
- Tan, B., Atz, A. R., Spurway, N. C., Toh, C., Mackie, H., Xie, W., Wong, J., Fuss, F. K., Chuan Teh, K., Xie, W., Wong, J., & Teh, K. C. (2006). Indicators of maximal hiking performance in Laser sailors. *European Journal of Applied Physiology*, 98(2), 169–176. <https://doi.org/10.1007/s00421-006-0260-3>
- Thill, E. (1982). La detection sportive a partir de criteres psychologiques. In G. Dans Rioux & E. Thill (Eds.), *Compétition sportive et psychologie: Journées européennes de psychologie du sport* (pp. 77–94). Chiron, c1982.
- Vangelakoudi, A., Vogiatzis, I., & Geladas, N. (2007). Anaerobic capacity, isometric endurance, and Laser sailing performance. *Journal of Sports Sciences*, 25(10), 1095–1100. <https://doi.org/10.1080/02640410601165288>
- Vehrs, P. R., Keller, D. M., George, J. D., Hager, R. L., & Fellingham, G. W. (2007). Monitoring O₂max during fourteen weeks of endurance training using the cardiocoach. *Journal of Strength & Conditioning Research*, 21(1), 62–66. <https://doi.org/10.1519/00124278-200702000-00012>
- Wang, R., Hoffman, J. R., Tanigawa, S., Miramonti, A. A., La Monica, M. B., Beyer, K. S., Church, D., Fukuda, D., & Stout, J. R. (2016). Isometric mid-thigh pull correlates with strength, sprint, and agility performance in collegiate rugby union players. *Journal of Strength and Conditioning Research*, 30(11), 3051–3056. <https://doi.org/10.1519/JSC.0000000000001416>
- Ward, P., Williams, A. M., & Bennett, S. J. (2002). Visual search and biological motion perception in tennis. *Research Quarterly for Exercise & Sport*, 73(1), 107–112. <https://doi.org/10.1080/02701367.2002.10608997>

8.2 Study 2.

Workload Distribution and Monitoring Markers in Crewed Offshore Sailing.

Kilian Philippe¹, Thierry Paillard¹, Olivier Maurelli², Jeremy Moody^{3,4}, & Jacques Prioux⁵.

¹ Laboratory of Movement, Balance, Performance and Health (MEPS, EA-4445), University of Pau and Pays de l'Adour, Tarbes, France.

² Laboratory of Muscular Dynamism and Metabolism (UMR-866), University of Montpellier, France.

³ Cardiff School of Sport and Health Science, Cardiff Metropolitan University, Cardiff, United-Kingdom.

⁴ School of Physical Education and Sports, Nisantasi University, Istanbul, Turkey.

⁵ Movement, Sport and Health laboratory (EA-1274), Faculty of sport science, Rennes, France.

Corresponding author

Kilian Philippe

Tel : + (33) 6 59 39 70 56

Email : kilian.philippe@yahoo.fr

Linkedin : Kilian Philippe

1 Abstract

2

3 Introduction: Inadequate management of workload (WL) can lead to insufficient recovery and,
4 thus, provoke a decrease in performance and increased risk of overtraining injuries. The aim of
5 this study was to examine the distributions of WL and to highlight the effects on neuromuscular
6 adaptations, subjective markers of recovery and salivary biomarker cortisol in an elite offshore
7 sailing environment. Methods: 10 professional offshore sailors (8 male and 2 female) were
8 assessed periodically during a 27-week preparation period. Weekly WL (WLweek), strain
9 (WLstrain), monotony (WLmonotony), and acute:chronic workload ratio smoothing models
10 (rolling averages and exponentially-weighted moving averages) were quantified using the
11 session-rating of perceived exertion (sRPE). Subjective markers of recovery were collected at
12 the start of each week using the Hooper-index (HI). Salivary cortisol (SC), countermovement
13 jump height (CMJ) and maximal strength on bench press (BP1RM) were evaluated at the start
14 of each training block. Results: Significant correlations were confirmed between monitored
15 indices and the WL variables. WLweek reported associations with CMJ, BP1RM, HI and SC.
16 WLmonotony was correlated to the HI. WLstrain was associated with CMJ, BP1RM, HI and
17 SC. Data smoothing model ACWR showed large correlations with CMJ, HI and SC. The
18 EWMA method was very largely and negatively associated with CMJ and BP1RM.
19 Conclusion: The results of this study highlight the need for strict monitoring in offshore sailing
20 crews. The collected data suggests that the combination of objective and subjective monitoring
21 tools may provide practitioners with valuable information for optimising performance.

22

23 Introduction

24 This study focuses on offshore sailing performance in mixed-sex crewed monohull vessels.
25 The Ocean Race (TOR) holds a 50-year reputation of being one of the toughest races around
26 the world. The competition has seen some of the world's most famous sailors compete with
27 crews in a goal to navigate around the world. Its' risky nature categorises it in what is known
28 as an 'extreme sport'¹.

29 The incessant evolution of material and technology development has raised the
30 competitive demands of offshore sailing. Thus, along with other factors, sailing performance
31 is confronted to more physically demanding vessels and enhanced risks of injury². Optimising
32 human performance and physical preparedness is therefore becoming an increasingly important
33 factor in professional offshore sailing projects. In a general manner, optimal sports preparation

34 requires training programmes that are well balanced in terms of workload (WL), i.e. neither
35 too much (generating overtraining) nor too little (not being optimal). Hence, workload (WL)
36 monitoring, its' management and the quest of developing optimal adaptations are important
37 parameters to consider in elite-team environments³. Indeed, many studies have analysed the
38 influence of WL, strain (WL_{strain}), monotony ($WL_{monotony}$) and data smoothing methods on
39 neuromuscular adaptations, hormonal balance and sports performance⁴⁻⁵. Inadequate WL
40 analysis can lead to insufficient recovery and, thus, provoke a decrease in performance and
41 increased risks of associated overtraining injuries⁶. Currently, WL analysis is widely used as a
42 monitoring guide tool for strength and conditioning practitioners in many sports.

43 Despite the current trend of interest on bridging the gap between WL and indicators of
44 sports performance, few studies have focused on predominantly strategy-based sports, such as
45 sailing. Indeed, whilst conspicuous by its absence, one of the main reasons offshore sailing
46 receives insufficient interest may reside in the sport's inconstancy and dependency to climatic
47 and meteorological factors⁷. Adverse weather conditions are likely to disrupt training
48 programmes, affecting WL and therefore fitness. However, performance in sailing is still linked
49 to fitness⁸. Despite this precept, the relationship between variations in fitness levels and
50 accumulated WL is not yet clearly established. Therefore, the main objectives of this study
51 were a) to describe the WL distribution of a professional offshore sailing team during a 6-
52 month pre-competition phase and b) to verify the effects of WL on neuromuscular adaptations,
53 subjective markers of recovery and salivary biomarker cortisol. We hypothesized that training
54 markers would be directly affected by WL which impacts (positively and negatively) on sailing
55 performance.

56

57 **Methods**

58 **Subjects**

59 Ten professional sailors (8 male and 2 female) volunteered to take part in the study (mean \pm
60 SD; age = 32.2 ± 3.96 years; stature = 179.1 ± 7.30 cm; body mass = 84.4 ± 11.8 kg). All
61 subjects were contracted in the same sailing team and trained full time in the build-up to TOR.
62 None of the subjects reported injuries or diseases that would impair their physical performance
63 at least 6 months before the start of the protocol. The study protocol was approved by the ethics
64 committee of Rennes University, France. Written informed consent was obtained from all
65 subjects prior to the commencement of the study.

66

67 Design

68 All data was collected during the preparation of TOR 2021. The study was completed over a
69 27-week (W_{1-27}) pre-competition phase. Figure 1 illustrates the training that was planned and
70 scheduled by the skipper. Monday was considered the first day of each 7-day week. Planning
71 was adjusted to accommodate weather conditions and Covid-19 crisis related restrictions as
72 required. When sailing or training facilities were not available, sailors were prescribed training
73 sessions by the strength and conditioning coach. Training was implemented to adapt
74 appropriately to the ever-changing schedule of a sailing environment and to the individual
75 needs of each sailor. On-land training included resistance training and metabolic conditioning
76 (Figure 1). All gym sessions were conducted in the Club Naval de Cascais (Portugal) or at
77 home, when needed. The subjects were familiar with all exercises as they were part of their
78 usual training regime.

79 Together with WL variables, monitoring contained a number of subjective and objective
80 markers of adaptation. Subjective markers included a wellness questionnaire for monitoring
81 fatigue and were assessed weekly (Mondays). Objective markers included neuromuscular
82 monitoring of strength and power abilities as well as salivary hormonal biomarkers. These
83 measurements were assessed during seven testing batteries ($Test_{1-7}$) which were held on the
84 first day of each of the 7 training blocks (TB_{1-7}) (Figure 1).

85

86 Material and method

87 $Test_{1-7}$ were conducted in the team's training facilities, located at the Club Naval de Cascais
88 (Portugal), to ensure minimal disruption to the established sailing program. Athletes were
89 requested to abstain from caffeinated drinks and alcohol 24 hours prior to testing. Data
90 collection was made possible through a customised smartphone application (Appsheet) to
91 facilitate wellness and WL data collection. During the complete pre-competition period,
92 athletes were supervised by a qualified team doctor and nutritionist.

93

94 Baseline Measures

95 On the first week of the pre-competition period, sailors underwent a medical screening battery.
 96 The testing battery occurred on Monday of the first week of the preparation phase and
 97 established the baseline (BSL) measurements. Testing day consisted of salivary cortisol (SC)
 98 collection, wellness questionnaire and fitness testing. Sailors had not participated in high
 99 intensity training in the week prior to testing.

100

101 *Workload*

102 Together with individual monitoring, WL was evaluated using session-rating of perceived
 103 exertion (sRPE) methods. A number of variables were recorded; WL_{week} , $WL_{monotony}$, WL_{strain} ,
 104 and acute:chronic WL ratio smoothing models using a) rolling WL averages (ACWR) and b)
 105 exponentially weighted moving averages (EWMA). Following each training session, sailors
 106 were requested to subjectively measure their physical exertion. RPE was recorded using the
 107 modified Borg 0 to 10 Scale⁹. Athletes answered the question "How was your session?" within
 108 30 min of finishing to maximise the accuracy of assessment of the full training session¹⁰. sRPE
 109 was then measured by calculating RPE x the duration of the session (in minutes)¹¹. The
 110 following variables were then calculated: (i) WL_{week} as the sum of all WL during the week
 111 (Monday-Sunday); (ii) $WL_{monotony}$ as the mean of the WL during the seven days divided by the
 112 standard deviation of WL_{week} and; (iii) WL_{strain} as WL_{week} multiplied by $WL_{monotony}$ ⁴. Data
 113 smoothing models were then used: (i) ACWR as the daily rolling averages calculated by
 114 dividing the acute WL (rolling 7-days) by the chronic WL (rolling 28-days)¹² and (ii) EWMA
 115 as calculated by Williams et al¹³:

$$116 \quad EWMA_{today} = Load_{today} \times \lambda_a + ((1 - \lambda_a) \times EWMA_{yesterday})$$

117 Where λ_a is a value between 0 and 1 that represents the degree of decay, with higher
 118 values discounting older observations in the model at faster rate. The λ_a is calculated as:

$$119 \quad \lambda_a = 2 / (N + 1)$$

120 Where N is the chosen time decay constant, with a 1-week WL (7-days) and 4-weeks
 121 WL (28-days) used to represent acute and chronic WL respectively.

122 *Weekly Assessment*

123 *Wellness*

124 The Hooper-Index (HI) was measured using a customised questionnaire based on the
125 recommendations of Hooper and Mackinnon¹⁴. Athletes answered the questionnaire every
126 Monday morning upon waking. Levels of sleep quality, muscle soreness, stress and fatigue
127 were scored on a 7-point scale on which “1” and “7” represent “very, very good” and “very,
128 very poor” respectively. The Hooper-Index was computed by summing its four subgroups
129 (sleep quality, delayed onset muscle soreness, stress and fatigue).

130

131 *Training block assessment*

132 *Countermovement Jump (CMJ)*

133 Lower body power was tested on the CMJ using a chronojump contact mat (Chronojump-
134 Boscosystem™, Software, Spain). Each subject completed three attempts with 1 min of rest
135 between trials. For the execution of each attempt, a countdown of “3, 2, 1, jump” was indicated
136 orally. All attempts were completed with subjects placing arms akimbo to avoid movement
137 disruption. Athletes were instructed to perform a rapid eccentric phase, immediately followed
138 by an explosive concentric contraction with the intention to jump as high as possible. The
139 height of the best CMJ performance was reported for analysis.

140 *Bench Press (BP)*

141 Maximal upper body pushing strength was assessed using the 1 repetition maximal (BP_{1RM})
142 estimation based on Brzycki's equations¹⁵. The estimation was calculated during sets with less
143 than 6-repetitions to avoid an overestimation of the 1 RM. A standardised warm-up was
144 incorporated to avoid variability and risk of injury. BP_{1RM} was not tested for Test₇ to avoid
145 delayed onset muscle soreness before the start of TOR.

146 *Salivary Cortisol (SC)*

147 Sailors' saliva samples were collected upon waking (between 7:00 and 8:00 am). To ensure
148 more rigorous testing and to limit cortisol measurement errors, athletes were required to refrain
149 from eating, brushing their teeth and chewing gum prior to testing. Sailors placed the swab
150 (Soma Bioscience, Wallingford, United Kingdom) on their tongue and closed their mouth.
151 When the indicator on the swab's stem turned blue, the test was considered complete (swab
152 collected 0.5 mL of oral fluid). The swab was then placed in the buffer bottle of assay (sodium
153 phosphate, salts, detergents and preservatives) before gently mixing the sample for 2 minutes.

154 Two drops of the sample were then placed in the window of the lateral flow device. The device
155 was left still during the incubation period (10 minutes). The strip was then placed in the real-
156 time reader and the results were ready within 20 seconds. SC was then collected as nanograms
157 per millilitre (ng/mL). Soma Bioscience oral fluid collector has been validated against enzyme
158 linked immunosorbent assay (ELISA) and have been proven as a reliable method to collect and
159 analyse SC¹⁶.

160

161 Statistical Analysis

162 Over the 27-week study period, data from 148.12 ± 17.53 training sessions was collected and
163 analysed. Data was calculated through standard statistical methods and are presented as mean
164 \pm standard deviation (SD). All variables were considered normally distributed through analysis
165 with the Shapiro-Wilk test, histograms and skewness values prior to analysis. One way
166 ANOVA with repeated measures was used to determine the differences between the different
167 parameters measured at Test₁₋₇. The Pearson correlation coefficient (r) was used to assess the
168 associations between WL variables and monitoring markers. Correlation coefficients were
169 interpreted as: < 0.1 (trivial), from 0.1 to 0.3 (small), from 0.3 to 0.5 (moderate), from 0.5 to
170 0.7 (large), from 0.7 to 0.9 (very large), and ≥ 0.9 (nearly perfect)¹⁷. The correlations were
171 consistently presented with 95% confidence interval (CI). For all analyses, α was set at 0.05.
172 Statistical analyses were performed using the SPSS package (15.0 version; SPSS, Inc.,
173 Chicago, IL, USA).

174

175 Results

176 Figure 2A illustrates the weekly distribution of WL during the 27 analysed weeks of TOR pre-
177 competition preparation. WL_{week} variation displayed a high coefficient of variation (CV=1.18).
178 Higher ($p<0.001$) WL_{week} were observed during weeks of sailing camp (19792.6 ± 9428 AU;
179 W_{17-18} & W_{23-26}) compared to those not included in the camps (2813.2 ± 817.3 AU; W_{1-16} , W_{19} ,
180 W_{21} & W_{27}). Higher WL were observed in the training blocks towards the end of the preparation
181 schedule (Figure 2B). TB₆ (22313 ± 6679.8 AU) confirmed higher WL ($p<0.001$) than TB₁
182 (2537.9 ± 289.1 AU), TB₂ (2555.3 ± 375.5 AU), TB₃ (2717.8 ± 642.5 AU), TB₄ ($3236.3 \pm$
183 1074.7 AU), TB₅ (7652.3 ± 718.6 AU) and TB₇ (3116.3 ± 712.7 AU). TB₅ was also significantly
184 different ($p<0.001$) to all the other TB. TB₇, which was considered a taper week, showed lower

185 ($p < 0.001$) WL_{week} when compared to TB_5 and TB_6 (Figure 2B). Repartition of TB_{1-7} volume
186 specificity is presented in Figure 3.

187 Within-group changes concerning CMJ, BP_{1RM} , HI and SC, during the different phases of
188 preparation, are provided in Table 1. CMJ and BP_{1RM} were significantly different ($p \leq 0.05 < p <$
189 $p \leq 0.01$) from BSL during Test₁, Test₂, Test₃, Test₄, Test₅, Test₆ and Test₇ respectively. HI
190 ($p = 0.05$) and SC ($p = 0.05$) were both significantly different from BSL only at Test₆.

191 Correlation outcomes between WL variables and monitored markers are presented in Figure 4.
192 Large and very large positive correlations were found between WL_{week} and BP_{1RM} ($r = 0.69$,
193 95% CI [0.11;0.92], $p = 0.02$), HI ($r = 0.85$, 95% CI [0.47;0.96], $p < 0.001$) and SC ($r = 0.84$, 95%
194 CI [0.44;0.96], $p = 0.001$). Moderate negative correlations were also found between WL_{week} and
195 CMJ ($r = -0.39$, 95% CI [-0.81;0.31], $p = 0.05$). WL_{monotony} showed large positive correlations to
196 the HI ($r = 0.55$, 95% CI [-0.12;0.87], $p = 0.05$). WL_{strain} showed moderate negative correlations
197 with CMJ ($r = -0.48$, 95% CI [-0.85;0.21], $p = 0.04$) and large positive correlations with BP_{1RM}
198 ($r = 0.52$, 95% CI [-0.16;0.87], $p = 0.05$). WL_{strain} also showed very large positive correlations
199 with SC ($r = 0.83$, 95% CI [0.42;0.96], $p = 0.002$) and very large positive correlations with the
200 HI ($r = 0.88$, 95% CI [0.56;0.97], $p < 0.001$). ACWR data showed a large positive correlation
201 with the HI ($r = 0.64$, 95% CI [0.02;0.9], $p = 0.04$) and a very large negative ($r = -0.75$, 95% CI [-
202 0.94;-0.23], $p < 0.001$) and positive ($r = 0.72$, 95% CI [0.17;0.93], $p = 0.01$) correlation with both
203 the CMJ and SC respectively. Contrastingly, EWMA showed very large negative correlations
204 with CMJ ($r = -0.73$, 95% CI [-0.93;-0.17], $p < 0.001$) and BP_{1RM} ($r = -0.78$, 95% CI [-0.95;-0.32],
205 $p < 0.001$).

206

207 Discussion

208 This is the first study to (i) document the organisation of a pre-competition phase to an elite
209 level offshore race and (ii) analyse the changes in monitoring markers in regards to WL
210 parameters to the knowledge of the authors. The aim of this present study was two-fold. First,
211 our objective was to describe the WL distribution during the preparation of a crewed offshore
212 regatta and to investigate the changes induced by the preparation period on neuromuscular
213 adaptations (i.e. CMJ and BP_{1RM}), subjective markers of recovery (i.e. HI) and hormonal
214 biomarkers (i.e. SC). Second, to analyse the correlations between WL parameters (i.e. WL_{week} ,
215 WL_{monotony} , WL_{strain} , ACWR and EWMA) and monitoring markers to establish a possible dose-

216 response relationship. Most prominently, the analysis has indicated the capacity to establish
217 associations between WL parameters and monitoring markers.

218 Regarding WL_{week} , it was found that the preparation phase showed variations during the 27
219 weeks. Indeed, a difference of 703 % in WL_{week} was found between weeks of training during
220 sailing camp (19792.6 ± 9428 AU; W_{17-18} & W_{23-26}) and on land training weeks (2813.2 ± 817.3
221 AU; W_{1-16} , W_{19-22} & W_{27}) (Figure 2A). Also, a decrease of 50.4 % was observed in WL_{week}
222 during taper week (3116.3 ± 712.7 AU; W_{27}) compared to preceding workloads ($6731.5 \pm$
223 8497.3 AU; W_{1-26}) (Figure 2A). The significant difference ($p < 0.001$) in WL between sailing
224 weeks and non-sailing weeks suggests that the training regime is linked to the complexity of
225 planning. Indeed, variations in WL may be due to the numerous extraneous weather and
226 environmental conditions as confirmed in previous research¹⁸. Moreover, the high CV in the
227 WL_{week} repartition (CV=1.18) highlights the complexity to manage WL in sailing
228 environments. Similar values of WL_{week} , during non-sailing weeks, have been reported in other
229 sports¹⁹⁻²⁰. However, it appears no other studies have exposed such high quantities of WL (i.e.
230 sailing weeks). To date, research focusing on the sailing environment has provided information
231 on energy expenditure, sleep deprivation, nutritional challenge and epidemiology, however
232 WL management is conspicuous by its absence. Recently, high WL have been associated with
233 risks of overtraining and injury²¹. Consequently, because of the high WL_{weeks} observed in this
234 study, the necessity for strict WL monitoring practices in an offshore sailing environment
235 seems crucial for optimising human performance. Besides the WL patterns observed during the
236 preparation of TOR, the associations between WL parameters and monitoring measurements
237 were tested. It was observed that objective and subjective markers varied throughout the
238 season. Previous research has focused on establishing associations capable of predicting
239 neuromuscular adaptations²² and sports performance²³. However, currently associations in
240 environment-based sports, such as sailing are yet to be fully investigated. The results found in
241 this study could, therefore, provide further insight for WL management in such environments.

242 The negative correlations found between WL parameters (i.e. WL_{week} , WL_{strain} , ACWR and
243 EWMA) and the CMJ (Figure 4) seems to be in agreement with research analysing the effects
244 of WL on power expression²⁴. High WL accumulation was also found to impair CMJ
245 performance in professional rugby²⁰ and football players²⁵. Indeed, high chronic WL has been
246 associated with inflammatory response, catabolic state and muscle damage which results in
247 neuromuscular disturbances²⁶. Hence, this could partially explain the adverse effects of WL_{week}
248 on CMJ as TB_6 was a high sailing volume block and provoked a 15 % decrease, from $Test_5$, in

249 CMJ performance. Indeed, these results coincide with findings highlighting neuromuscular
250 function impairment due to the constant proprioceptive muscle tension encountered by sailors
251 during the yawing, rolling and pitching motions of the hull²⁷. Furthermore, a 55% decrease in
252 WL_{week} during TB₇ provided supercompensation from TB₆, on the CMJ (+14 %). This
253 highlights the sensitivity of CMJ performance to fatigue and overcompensation²³.

254 In contrast, our results found that when WL_{week} increased, strength abilities (BP_{1RM}) also
255 significantly increased. Bench press performance has been associated with sailing success⁸,
256 manoeuvre efficiency and grinding demands²⁸. The demands of grinding on the upper body
257 have been well established in the sailing environment²⁹. Indeed, grinding demands high levels
258 of push/pull power and strength to carry out efficient manoeuvres and trimming²⁸. The work-
259 to-rest ratio, on the grinder, appears to permit appropriate recovery between bouts of intense
260 activity²⁸. Thus, this may explain the positive upper body neuromuscular adaptations in
261 response to a high sailing volume.

262 A novel aspect of the current study was the monitoring of professional sailors' perceptual
263 wellness across a full pre-competition phase, currently not reported elsewhere in the literature
264 to the author's knowledge. The HI has been found to be (i) a promising tool for monitoring
265 training induced fatigue in team sports³⁰ and (ii) associated with WL in professional athletes³¹.
266 In the present study, the Test_{1.7}HI (Figure 4) was found to be positively correlated with WL_{week} ,
267 WL_{strain} and WL_{monotony} . In addition, the ACWR data smoothing model seems to be a valid tool
268 for predicting HI. These findings assist to bridge the gap between subjective and objective
269 markers of fatigue. The HI can therefore be considered as an affordable and practical solution
270 for monitoring physiological and psychological stress in a sailing environment.

271 From a physiological point of view, changes in SC may have an impact on neuromuscular and
272 cognitive performance. Indeed, cortisol could alter the activity of the sympathetic nervous
273 system, the muscles' contractile properties and/or behaviour³². There is a substantial body of
274 literature addressing cortisol increase in response to WL and competition. In the current study,
275 the interactions between WL (WL_{week} , WL_{strain} and ACWR) and SC were predominantly clear
276 (Figure 4). Indeed, the hormonal response to training seems to be impacted by short (7-days)
277 preceding WL. This finding is similar to previous work in basketball³³ and football³⁴ where SC
278 increased in response to WL. This study confirms, the most significant difference with baseline
279 SC measures was found during Test₆. This permits the assumption that the high sailing volume
280 during the corresponding block had an impact on stress hormone balance which is in-line with

281 reported studies that have analysed the biomarkers in sailing activities³⁵⁻³⁶. The increase in SC
282 may indicate the athletes' natural response to the previous training phase, as previous research
283 has reported that elevated cortisol levels are a primary indicator of physiological stress³⁷.

284 **Practical Application**

285 Objective and subjective markers of recovery/preparedness were found to be associated with
286 WL parameters. These may be useful to suggest if sailors have recovered from the previous
287 week of training or from a high sailing volume phase. Although fatigue and preparedness are
288 multifactorial, performance practitioners, in the sailing environment, should insist on frequent
289 monitoring of athletes in order to (i) optimally adapt the training plan according to the
290 situation/weather, (ii) inform the skipper on potential risks of injury/overtraining and (iii)
291 ensure adequate recovery methods to enhance performance.

292 This research was conducted over a pre-competition period for a mixed-sex crewed sailing
293 offshore event. Due to sailing's dependency on climatic variables, the training structure may
294 represent a different type of organisation when compared to other sports. Thus, to facilitate the
295 task of human performance in offshore sailing, exploring external load (e.g. GPS tracking,
296 manoeuvre count) may prove to be useful for establishing valid methods able to quantify sailing
297 WL. Future research, based on sailing, could therefore explore the effects of sailing load on
298 markers of adaptation through daily measurements. The use of larger sample sizes (e.g. more
299 teams) would allow further and more precise exploration aiming at optimising the use of
300 acute:chronic data smoothing methods. Moreover, the findings of the present study are based
301 on data from one professional sailing crew thus the applicability to all clubs is unknown. A
302 further limitation of the study might reside in the timeframe when data collection occurred.
303 Indeed, Covid-19 crisis restrictions did not allow for more sailing camps to be programmed.

304 **Conclusion**

305 To the best of the author's knowledge, this is the first longitudinal study to provide information
306 on WL parameters in a professional mixed-sex crew sailing team during the preparation phase
307 of a renowned offshore regatta. This investigation confirmed (i) significant differences between
308 BSL levels and periodical evaluation and (ii) significant correlations between WL parameters
309 and markers of recovery/preparedness. SC, BP_{1RM} and CMJ may be used as objective markers
310 of preparation for an offshore regatta. HI may also provide valuable information concerning
311 physiological and psychological stress with less time-consuming procedures/expensive

312 modalities. Also, due to the decaying nature of fitness and fatigue, the EWMA data smoothing
313 model seems to be a reliable predictor of neuromuscular preparedness. The ACWR, on the
314 other hand, appears to better predict subjective markers of fatigue. Nevertheless, a combination
315 of subjective and objective monitoring markers will provide practitioners with sufficient
316 information to manipulate WL and recovery strategies.

317 Acknowledgments

318 The authors thank the Club Naval de Cascais, skipper and sailors for their participation in this
319 study.

320

321

322

323

324

325

326

327

328

329

330 References

331

332 1 Laver L, Pengas IP, Mei-Dan O. Injuries in extreme sports. *J Orthop Surg Res.*
333 2017;12(1):59. Published 2017 Apr 18. doi:10.1186/s13018-017-0560-9

334

335 2 Bourdon PC, Cardinale M, Murray A, et al. Monitoring Athlete Training Loads: Consensus
336 Statement. *Int J Sports Physiol Perform.* 2017;12(Suppl 2):S2161-S2170.
337 doi:10.1123/IJSPP.2017-0208

338

339 3 Zeghari, Lotfi & Hicham, Moufti & Amine, Arfaoui & Yassir, Habki. (2019). The
340 prevention of overtraining with the monitoring training loads: case of football. *International*
341 *Journal of Physical Education, Fitness and Sports.* 8. 42-50. 10.26524/ijpefs1935.

342

343 4 Nobari H, Mainer-Pardos E, Adsuar JC, et al. Association Between Endocrine Markers,
344 Accumulated Workload, and Fitness Parameters During a Season in Elite Young Soccer

- 345 Players. *Front Psychol.* 2021;12:702454. Published 2021 Aug 31.
346 doi:10.3389/fpsyg.2021.702454
347
- 348 5 Stenqvist TB, Torstveit MK, Faber J, Melin AK. Impact of a 4-Week Intensified Endurance
349 Training Intervention on Markers of Relative Energy Deficiency in Sport (RED-S) and
350 Performance Among Well-Trained Male Cyclists. *Front Endocrinol (Lausanne).*
351 2020;11:512365. Published 2020 Sep 25. doi:10.3389/fendo.2020.512365
352
- 353 6 Jones CM, Griffiths PC, Mellalieu SD. Training Load and Fatigue Marker Associations
354 with Injury and Illness: A Systematic Review of Longitudinal Studies. *Sports Med.*
355 2017;47(5):943-974. doi:10.1007/s40279-016-0619-5
356
- 357 7 Pérez Fernández, Rodrigo. (2013). The seasickness as marine problem-case study. *Journal*
358 *of Marine Science and Application.* 12. 10.1007/s11804-013-1172-y.
359
- 360 8 Philippe K, Paillard T, Dubois R, Maurelli O, Prioux J. Key performance indicators in Tour
361 de France sailing. *J Sports Sci.* 2021;39(8):944-954. doi:10.1080/02640414.2020.1851925
362
- 363 9 Lovell TW, Sirotic AC, Impellizzeri FM, Coutts AJ. Factors affecting perception of effort
364 (session rating of perceived exertion) during rugby league training. *Int J Sports Physiol*
365 *Perform.* 2013;8(1):62-69. doi:10.1123/ijsp.8.1.62
366
- 367 10 Day ML, McGuigan MR, Brice G, Foster C. Monitoring exercise intensity during
368 resistance training using the session RPE scale. *J Strength Cond Res.* 2004;18(2):353-358.
369 doi:10.1519/R-13113.1
370
- 371 11 Foster C, Florhaug JA, Franklin J, et al. A new approach to monitoring exercise training. *J*
372 *Strength Cond Res.* 2001;15(1):109-115.
373
- 374 12 Hulin BT, Gabbett TJ, Blanch P, Chapman P, Bailey D, Orchard JW. Spikes in acute
375 workload are associated with increased injury risk in elite cricket fast bowlers. *Br J Sports*
376 *Med.* 2014;48(8):708-712. doi:10.1136/bjsports-2013-092524
377
- 378 13 Williams S, West S, Cross MJ, Stokes KA. Better way to determine the acute:chronic
379 workload ratio?. *Br J Sports Med.* 2017;51(3):209-210. doi:10.1136/bjsports-2016-096589
380
- 381 14 Hooper SL, Mackinnon LT. Monitoring overtraining in athletes.
382 Recommendations. *Sports Med.* 1995;20(5):321-327. doi:10.2165/00007256-199520050-
383 00003
384
- 385 15 Brzycki M. Strength testing—Predicting a one-rep max from reps-to-fatigue. *J Phys Educ*
386 *Recreat Dance* 64: 88–90, 1993.
387
- 388 16 Ducker KJ, Lines RLJ, Chapman MT, Peeling P, McKay AKA, Gucciardi DF. Validity
389 and reliability evidence of a point of care assessment of salivary cortisol and α -amylase: a
390 pre-registered study. *PeerJ.* 2020;8:e8366. Published 2020 Jan 8. doi:10.7717/peerj.8366
391
- 392 17 Cohen, J. The concepts of power analysis. 2nd ed. Hillsdale, New Jersey, 1988.
393

- 394 18 Blacha, Ryszard & Zatoń, Krystyna & Piwowarczyk, Piotr & Jastrzebska, Agnieszka &
395 Szczepan, Stefan. (2019). Repeatability of force production as a measure of kinaesthetic sense
396 in seagoing sailors and recreational sailors. *Human Movement*. 20. 10.5114/hm.2019.83219.
397
- 398 19 Salazar H, Svilar L, Aldalur-Soto A, Castellano J. Differences in Weekly Load
399 Distribution Over Two Euroleague Seasons with a Different Head Coach. *Int J Environ Res*
400 *Public Health*. 2020;17(8):2812. Published 2020 Apr 19. doi:10.3390/ijerph17082812
401
- 402 20 Dubois, Romain & Paillard, Thierry & McGrath, David & Chamari, Karim & Maurelli,
403 Olivier & Polly, Stephane & Prioux, Jacques & Lyons, Mark. (2017). Changes in training
404 load, running performance, lower body power and biochemical characteristics of back players
405 throughout a professional Rugby Union season. *Journal of Human Sport and Exercise*. 12. 1-
406 16. 10.14198/jhse.2017.121.01.
407
- 408 21 Qin P, Feng W. Design of the Exercise Load Data Monitoring System for Exercise
409 Training Based on the Neural Network. *J Healthc Eng*. 2021;2021:7340140. Published 2021
410 Sep 24. doi:10.1155/2021/7340140
411
- 412 22 Ferioli D, Bosio A, Bilsborough JC, La Torre A, Tornaghi M, Rampinini E. The
413 Preparation Period in Basketball: Training Load and Neuromuscular Adaptations. *Int J Sports*
414 *Physiol Perform*. 2018 Sep 1;13(8):991-999. doi: 10.1123/ijsp.2017-0434. Epub 2018 Sep
415 10. PMID: 29345555.
416
- 417 23 Borresen J, Lambert MI. The quantification of training load, the training response and the
418 effect on performance. *Sports Med*. 2009;39(9):779-95. doi: 10.2165/11317780-000000000-
419 00000. PMID: 19691366.
420
- 421 24 Malone S, Owen A, Newton M, Mendes B, Collins KD, Gabbett TJ. The acute:chronic
422 workload ratio in relation to injury risk in professional soccer. *J Sci Med Sport*.
423 2017;20(6):561-565. doi:10.1016/j.jsams.2016.10.014
424
- 425 25 Arcos AL, Martínez-Santos R, Yanci J, Mendiguchia J, Méndez-Villanueva A. Negative
426 Associations between Perceived Training Load, Volume and Changes in Physical Fitness in
427 Professional Soccer Players. *J Sports Sci Med*. 2015 May 8;14(2):394-401. PMID: 25983590;
428 PMCID: PMC4424470.
429
- 430 26 McLellan CP, Lovell DI, Gass GC. Creatine kinase and endocrine responses of elite
431 players pre, during, and post rugby league match play. *J Strength Cond Res*.
432 2010;24(11):2908-2919. doi:10.1519/JSC.0b013e3181c1fcb1
433
- 434 27 Stoffregen TA, Smart LJ Jr. Postural instability precedes motion sickness. *Brain Res Bull*.
435 1998;47(5):437-448. doi:10.1016/s0361-9230(98)00102-6
436
- 437 28 Neville V, Calefato J, Pérez-Encinas C, Rodilla-Sala E, Rada-Ruiz S, Dorochenko P,
438 Folland JP. America's Cup yacht racing: race analysis and physical characteristics of the
439 athletes. *J Sports Sci*. 2009 Jul;27(9):915-23. doi: 10.1080/02640410902946485. PMID:
440 19629841.
441

- 442 29 Pearson SN, Hume PA, Cronin JB, Slyfield D. Strength and power determinants of
443 grinding performance in America's Cup sailors. *J Strength Cond Res.* 2009 Sep;23(6):1883-9.
444 doi: 10.1519/JSC.0b013e3181b2ba55. PMID: 19675468.
445
- 446 30 Oliveira R, Brito JP, Martins A, Mendes B, Marinho DA, Ferraz R, Marques MC. In-
447 season internal and external training load quantification of an elite European soccer team.
448 *PLoS One.* 2019 Apr 22;14(4):e0209393. doi: 10.1371/journal.pone.0209393. PMID:
449 31009464; PMCID: PMC6476476.
450
- 451 31 Moalla W, Fessi MS, Farhat F, Noura S, Wong DP, Dupont G. Relationship between
452 daily training load and psychometric status of professional soccer players. *Res Sports Med.*
453 2016;24(4):387-394. doi:10.1080/15438627.2016.1239579
454
- 455 32 Crewther BT, Cook C, Cardinale M, Weatherby RP, Lowe T. Two emerging concepts for
456 elite athletes: the short-term effects of testosterone and cortisol on the neuromuscular system
457 and the dose-response training role of these endogenous hormones. *Sports Med.*
458 2011;41(2):103-123. doi:10.2165/11539170-000000000-00000
459
- 460 33 Moreira, A., McGuigan, M. R., Arruda, A. F., Freitas, C. G., and Aoki, M. S. (2012).
461 Monitoring internal load parameters during simulated and official basketball matches. *J.*
462 *Strength Cond. Res.* 26, 861–866. doi: 10.1519/JSC.0b013e31822645e9
463
- 464 34 Rowell AE, Aughey RJ, Hopkins WG, Esmaeili A, Lazarus BH, Cormack SJ. Effects of
465 training and competition load on neuromuscular recovery, testosterone, cortisol, and match
466 performance during a season of professional football. *Front Physiol.* 2018;9:668. PubMed ID:
467 29930514 doi:10.3389/fphys.2018.00668
468
- 469 35 Portier H, Chatard JC, Filaire E, Jaunet-Devienne MF, Robert A, Guezennec CY. Effects
470 of branched-chain amino acids supplementation on physiological and psychological
471 performance during an offshore sailing race. *Eur J Appl Physiol.* 2008 Nov;104(5):787-94.
472 doi: 10.1007/s00421-008-0832-5. Epub 2008 Aug 13. PMID: 18704484.
473
- 474 36 Giacon, Tommaso & Bosco, Gerardo & Vezzoli, Alessandra & Dellanoce, Cinzia &
475 Danilo, Cialoni & Paganini, Matteo & Mrakic-Sposta, Simona. (2021). Oxidative Stress and
476 Motion Sickness during Offshore Sailing. 10.21203/rs.3.rs-654012/v1.
477
- 478 37 Lindsay A, Lewis J, Scarrott C, Draper N, Gieseg SP. Changes in acute biochemical
479 markers of inflammatory and structural stress in rugby union. *J Sports Sci.* 2015;33(9):882-
480 891. doi:10.1080/02640414.2014.971047
481
- 482
- 483
- 484
- 485
- 486

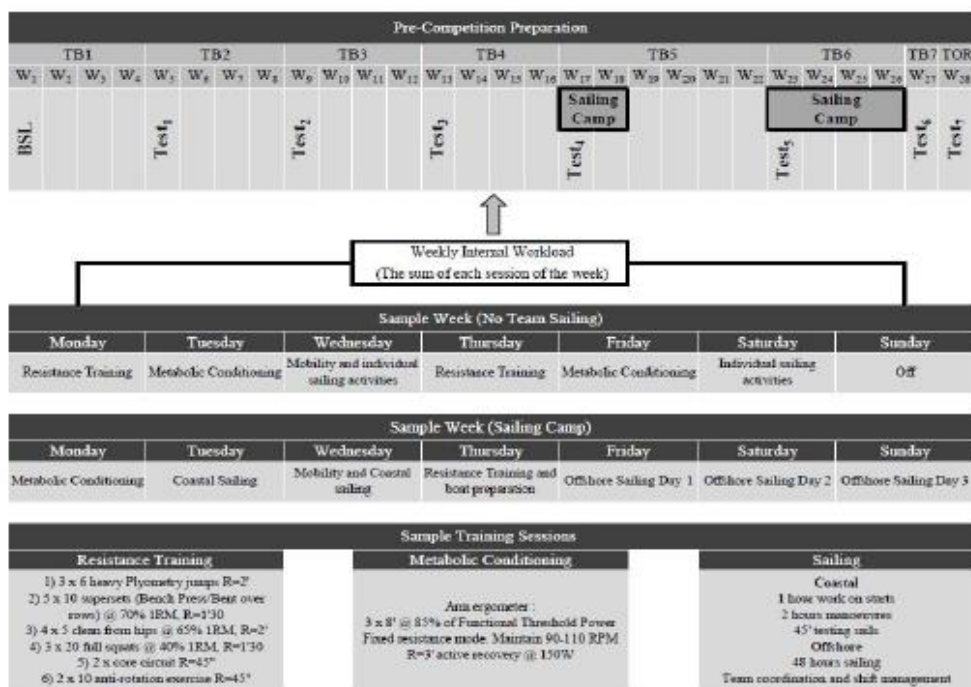

506

507 **Figure 1.** Schematic diagram showing the workload structure of the pre-competition blocks. The preparation was divided into
 508 seven distinct periods including two sailing camps. BSL: Baseline; TB₁₋₇: Training Block; W₁₋₂₈: Week; Test₁₋₇: Testing
 509 Battery; R: Rest; RPM: Revolutions Per Minute.

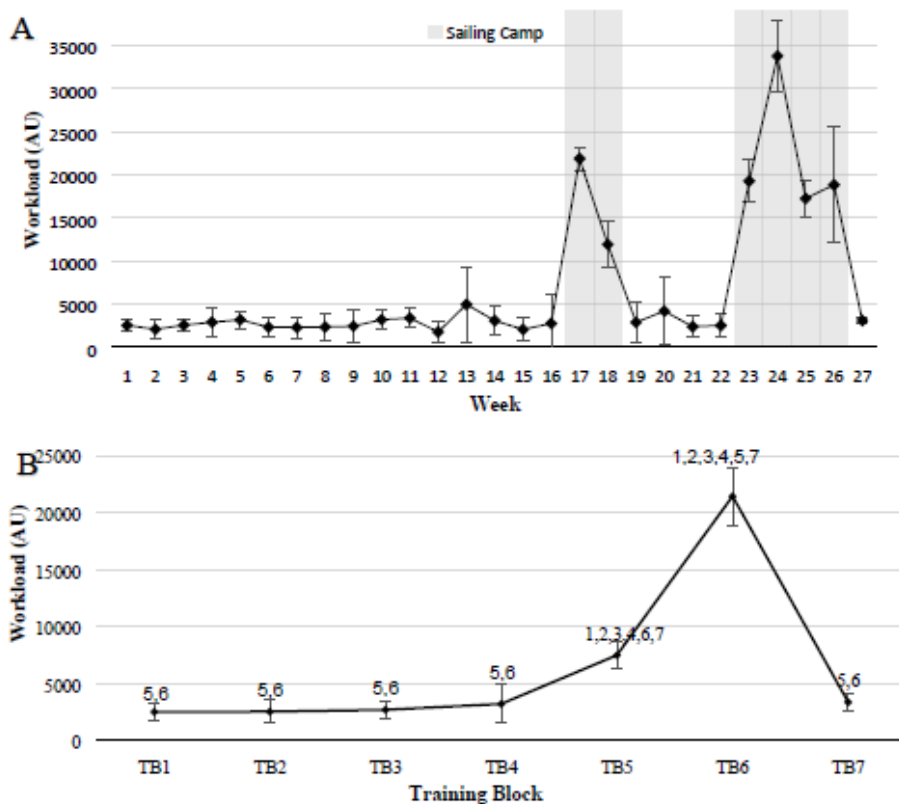

510

511

512 **Figure 2. A)** Weekly workload during the 27 weeks of preparation. Data are mean (\pm SD). **B)** Training block variations of
 513 weekly workload average. Data are mean (\pm SD). 1, 2, 3, 4, 5, 6 and 7: indicates to which TB it is significantly different
 514 ($p < 0.05$). AU: Arbitrary Units; TB₁₋₇: Training Block.

515

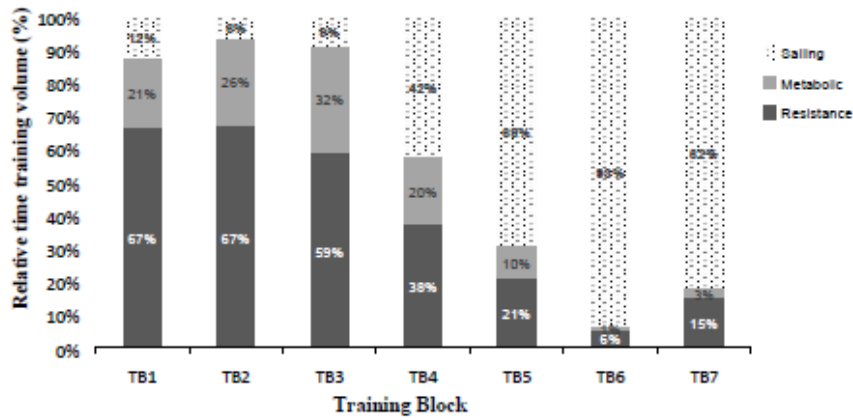

516
517 Figure 3. Repartition of training volume specificity during each training block.

518
519
520

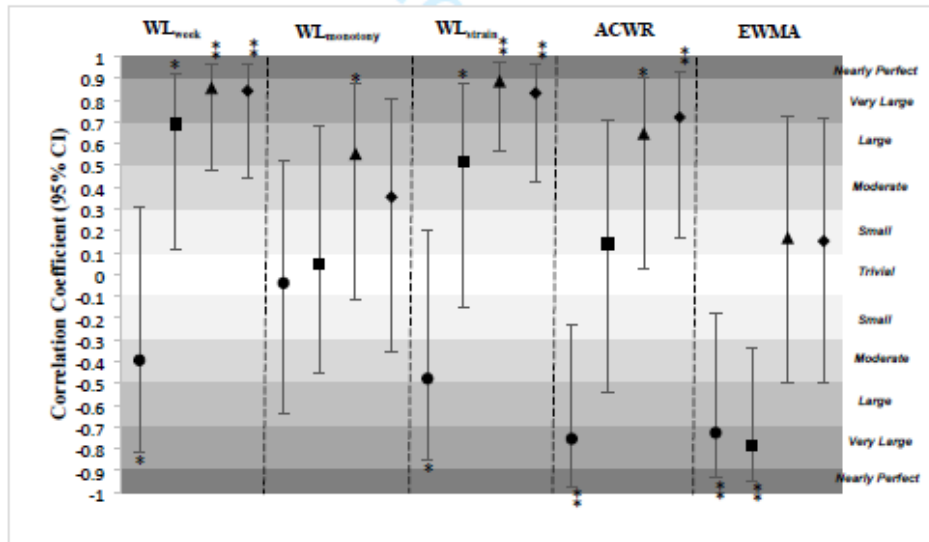

521
522 Figure 4. Correlations between workload parameters and monitoring markers (95% CI). •: CMJ; ■: BP_{1RM}; ▲: HI; ◆: SC.
523 CMJ: Countermovement Jump; BP_{1RM}: Bench Press 1RM; HI: Hooper Index; SC: Salivary Cortisol. * Correlation coefficient
524 is significant at p≤0.05. ** Correlation coefficient is significant at p≤0.01.

525
526
527

528

529

530 **Table 1.** Changes (mean \pm SD) in monitoring markers throughout the preparation period.

	BSL	Test ₁	Test ₂	Test ₃	Test ₄	Test ₅	Test ₆	Test ₇
CMJ (cm)	34.1 \pm 8.5	37.2 \pm 9.9 ^{††}	40.1 \pm 9.6 ^{†††}	39.8 \pm 8.1 ^{**}	42.6 \pm 7.5 ^{†††}	43.0 \pm 8.1 [*]	37.4 \pm 6.6 ^{††}	42.6 \pm 6.7 ^{††††}
BP _{1RM} (kg)	78.5 \pm 25.5	81.3 \pm 26.3 ^{††}	83.6 \pm 28.4 [*]	84.8 \pm 27.9 [*]	84.9 \pm 28.9 [*]	88.6 \pm 30.3 [*]	88.1 \pm 29.3 [*]	
HI (AU)	13.2 \pm 3.3	13.7 \pm 2.2	14.8 \pm 2.1	12.2 \pm 2.3 [†]	13.8 \pm 2.9	13.3 \pm 3.0	17.6 \pm 2.9 ^{†††}	13.5 \pm 2.8 ^{††}
C (ng/mL)	16.1 \pm 11.3	16.4 \pm 11.2	12.9 \pm 6.6 ^{††}	16.3 \pm 7.2	8.8 \pm 3.9 [†]	14.7 \pm 10.1 ^{††}	25.4 \pm 9.8 ^{†††}	12 \pm 4.6 ^{††}

BSL: Baseline; Test₁₋₇: Testing Battery; CMJ: Counter Movement Jump; BP_{1RM}: Bench Press 1RM; HI : Hooper Index ; SC: Salivary Cortisol ; * Significant difference with values of BSL; p \leq 0.05. ** Significant difference with value of BSL; p \leq 0.01; † Significant difference with values of preceding Test; p \leq 0.05. †† Significant difference with values of preceding Test; p \leq 0.01.

531

532

533

534

8.3 Study 3.

Effects of an Offshore Sailing Competition on Anthropometry, Muscular Performance, Subjective Wellness, and Salivary Cortisol in Professional Sailors

Kilian Philippe,¹ Thierry Paillard,¹ Olivier Maurelli,² Jeremy Moody,^{3,4} and Jacques Prioux⁵

¹Laboratory of Movement, Balance, Performance and Health (MEPS, EA-4445), University of Pau and Pays de l'Adour, Tarbes, France; ²Laboratory of Muscular Dynamism and Metabolism (UMR-866), University of Montpellier, Montpellier, France; ³Cardiff School of Sport and Health Science, Cardiff Metropolitan University, Cardiff, United Kingdom; ⁴School of Physical Education and Sports, Nisantasi University, Istanbul, Turkey; ⁵Movement, Sport and Health Sciences Laboratory (M2S, EA-1274), University of Rennes 2, Rennes, France

Introduction: Evidence regarding the impact of offshore sailing on fatigue and readiness variables is conspicuous by its absence. This study investigated the acute effects of an offshore sailing regatta on anthropometry, muscular performance, subjective recovery, and salivary biomarker cortisol. **Methods:** Ten professional offshore sailors from a mixed-sex crew partook in the study ($N = 10$; mean [SD] age = 32.2 [3.96] y; stature = 179.1 [7.30] cm; body mass = 84.2 [12.1] kg). The race involved 3 offshore legs over a 3-week period. Baseline measures of anthropometry, lower- and upper-body muscular function, perceptions of subjective wellness, and salivary cortisol were assessed 3 hours prior to competition (ie, before the first leg). These measures were repeated within 30 minutes after the cessation of each leg. During each leg, boat movements were recorded via global positioning system units. **Results:** There were significant reductions in lower (effect size [ES] = 0.49) and upper muscular (ES = 0.21) functions, as well as in subjective wellness (ES = 1.65). Salivary cortisol levels increased (ES = 0.84). **Conclusion:** These results demonstrate that, during an intensified period of sailing competition, fatigue will progressively increase. This may impede sailing performance by reducing physical and cognitive efficiency. Furthermore, countermovement jump, handgrip strength, perception of subjective wellness, and cortisol concentration appear to be sensitive measures for monitoring fatigue and readiness in professional sailors.

Keywords: training load, workload, monitoring, fatigue, readiness

Offshore sailing is a strategy-based sport that is intermittent in nature, with periods of high-intensity activity (eg, stacking, trimming, and grinding) and low-intensity recovery (eg, standing and sleeping).¹ Depending on the nature of the race, vessels are sailed by lone sailors or crews and can last from days to months. Over the course of a crewed boat race, such as The Ocean Race (TOR), sailors are required to compete for many days during legs that rally the host cities. Few days are given to recover in between legs. Therefore, sailors need to recover quickly to start the following leg in an optimal state of readiness. Although studies from other team sports have outlined the acute effects of workload (WL) on anthropometrical, physiological, and psychological variables,^{2,3} the research conducted in a professional offshore crew-sailing environment is scarce.^{4,5} Moreover, given the physical demands imposed during sailing, sailors typically experience high physiological stress and prolonged symptoms of fatigue.⁶ This is in part due to the various weather conditions and the extensive physical demands of maneuvering. Indeed, to optimize the vessel's speed, a sailor must be able to withstand high levels of physiological stress associated with weather conditions (temperature, wind, and sea state).⁷ To counterbalance the movement of the boat, and thus promote faster speed, stacking and trimming sails on deck require high levels of physical readiness.⁷ Sailors must also adapt to sleep deprivation and little comfort (nutrition, noise, and hygiene) in order to limit impairments on cognitive performance, necessary for establishing routing strategies and evaluating weather forecasts. Past studies have investigated the impacts of sailing bouts on

neuromuscular functions, energy demands, and stress hormones. These studies have reported increases in neuromuscular fatigue,⁴ muscular damage,⁸ cognitive impairment,⁹ motion sickness,¹⁰ and elevated cortisol levels after sailing bouts.¹¹ Although the current literature suggests that significant fatigue is induced by offshore sailing, little evidence is available in a crewed context. For this reason, monitoring the physiological and psychological adaptations from competition is thought to be important. Indeed, this can provide a better understanding of the demands of the sport and, thus, help bridge the gap between theory and practice for offshore sailing performance pathways.

Therefore, this article attempts to provide an overview of offshore sailing demands by (1) documenting the characteristics of the race, (2) describing the physiological responses to competition, and (3) examining the neurophysiological and psychological fatigue patterns in a professional mixed-sex crew. It was hypothesized that offshore sailing would (1) provoke body composition turnover, (2) decrease muscular performance, and (3) generate stress and perception of fatigue.

Methods

Subjects

Ten (8 males and 2 females) professional sailors (mean [SD]; age: 32.2 [3.96] y; stature: 179.1 [7.30] cm; body mass: 84.2 [12.1] kg) volunteered to participate in the study. There were no reported injuries or diseases that would impair physical performance from any subject. Before starting the protocol, sailors attended a presentation and received information outlining the experimental

Philippe (kilian.philippe@yahoo.fr) is corresponding author.

procedures. The study protocol was approved by the ethics committee of Rennes University, France. Written informed consent was obtained from all subjects prior to the commencement of the study, and all subjects were free to withdraw from the study at any time without penalty.

Design

All data were collected during a renowned international offshore sailing venue over a 3-week period. The TOR 2021 competition took place in June. All sailors competed in the same crew and had been training for 7 months preceding the race. Anthropometric measurements, muscular function testing, subjective recovery markers, and salivary cortisol (SC) were obtained during baseline (BSL) measurements and after each of the 3 legs (Post₁₋₃). The testing protocol was adjusted to fit the complexity of the sport. BSL measurements occurred 3 hours before the start of leg 1, and Post₁₋₃ occurred within 30 minutes of docking in. Over the 3-week study period, data from 10 days of sailing were collected and analyzed (Figure 1). Testing was conducted at the team's base, located in the different host cities, to ensure minimal disruption to the recovery process. Throughout the competition period, athletes were monitored by a qualified team doctor, physiotherapist, strength and conditioning coach, and nutritionist. During recovery days, sailors underwent light cardiovascular activation (eg, 20 min of jogging at 60% of maximal heart rate), sports massage, and mobility sessions (eg, static and dynamic stretching).

Methodology

BSL Measures

On the morning of the first day of competition, 3 hours prior to starting leg 1 of TOR, sailors underwent the testing battery. The crew was at the end of a tapering week and therefore had not participated in high-intensity training the week prior to testing. The testing battery consisted of anthropometric measurements, fitness testing, wellness questionnaire control, and SC collection. To account for diurnal variation, SC was collected within 1 hour of waking up, between 7:00 and 8:00 AM. The results from the first testing battery established the BSL.

Testing Battery

Anthropometric Measurement. Anthropometric characteristics were measured in the following order: body mass and skinfolds. A weighing scale (Seca) was used to measure body mass. Measurements for body mass were made with an accuracy of 0.1 kg. Three skinfolds (\sum 3 skinfolds) were taken on the right side of each sailor

(male: pectoral, abdominal, and thigh; female: triceps, abdominal, and thigh) according to recommendations by Jackson and Pollock.¹² The skinfolds were measured with a Harpenden skinfold caliper (Harpenden) with 10 g·mm⁻² of constant pressure. Body density was assessed while body fat (BF) was calculated using Brozek's equation.¹³ Lean body mass was calculated by subtracting BF from total weight.

Muscular Performances. *Countermovement jump:* Lower body power was tested on the countermovement jump (CMJ) using a chronojump contact mat (Chronojump-Boscosystem). Each sailor completed 3 attempts with 1 minute of rest between trials. For the execution of each attempt, a countdown of "3, 2, 1, jump" was indicated orally. All attempts were completed with sailors placing arms akimbo to avoid movement disruption. Sailors were instructed to perform a rapid eccentric phase, immediately followed by an explosive concentric contraction with the intention to jump as high as possible. The height of the best CMJ performance was reported for analysis.

Handgrip strength: Maximal isometric handgrip strength (HGS) was assessed with a Jamar handgrip dynamometer (Sammons Preston Corp). The test positions were standardized.¹⁴ Three trials were performed on each hand. The first 3 trials started with the right hand. Sailors were instructed to squeeze the device as hard as possible for 3 seconds. The time between each trial was 15 seconds, and 3 minutes of rest was given when changing hands. The maximal measure of the 3 trials was retained in kilograms. Sum (HGS_{sum}) of both, dominant hand (HGS_d) and nondominant hand (HGS_{nd}), measures were assessed and included in the results.

Subjective Recovery Status. The Hooper index (HI) was measured using a customized questionnaire based on the recommendations of Hooper and Mackinnon.¹⁵ Levels of sleep quality (HI_{sleep}), delayed onset muscle soreness (HI_{doms}), stress (HI_{stress}), and fatigue (HI_{fatigue}) were scored on a 7-point scale on which "1" and "7" represent "very, very good" and "very, very poor," respectively. The HI was computed by summing its 4 subgroups. It was applied 30 minutes after the leg arrival (Post₁₋₃). All questions and answers were completed individually.

Salivary Stress Marker. Sailors' saliva samples were collected upon waking (between 7:00 and 8:00 AM). To ensure more rigorous testing and to limit cortisol measurement errors, sailors were required to refrain from eating, brushing their teeth, and chewing gum prior to testing. Sailors placed the swab (Soma Bioscience) on their tongue and closed their mouth. When the indicator on the swab's stem turned blue, the test was considered complete (swab collected 0.5 mL of oral fluid). The swab was then placed in the buffer bottle of assay (sodium

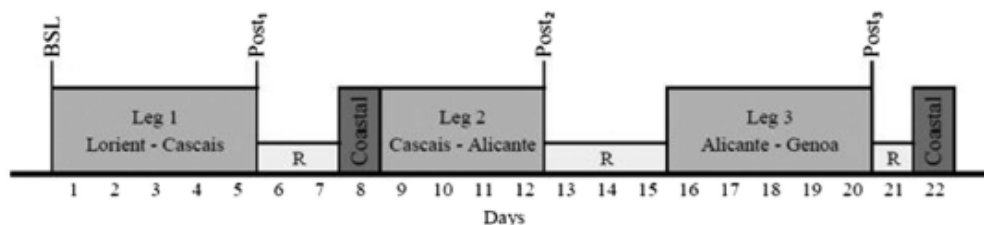

Figure 1 — Timeline of The Ocean Race 2021 and assessments during 3 weeks of study. BSL indicates baseline; Post₁₋₃, measurements obtained after legs 1 to 3; R, recovery.

(Ahead of Print)

phosphate, salts, detergents, and preservatives) before gently mixing the sample for 2 minutes. Two drops of the sample were then placed in the window of the lateral flow device. The device was left still during the incubation period (10 min). The strip was then placed in the real-time reader, and the results were ready within 20 seconds. SC was then collected as nanograms per milliliter. Soma Bioscience oral fluid collector has been validated against enzyme linked immunosorbent assay and has been proven as a reliable method to collect and analyze SC.¹⁶

Race Analysis

Internal sailing load: Subjective internal load was estimated using the session rating of perceived exertion, with ratings (Borg 0–10 scale) obtained from each individual sailor within 30 minutes of completing each leg. Each sailor was familiarized with the scale before starting the study. The obtained value was multiplied by the time sailed (in minutes) during the leg to register a sailing load in arbitrary units (AU).¹⁷

External sailing load: Race data—including sailing distance, average speed, course coverage, and maneuver count (tack and gybe)—were collected during the 3 legs of competition. Data were made available through global positioning system units and shared by the navigation specialist of the team. Route and maneuver count were measured by the official TOR tracker.

Energy Intake

Energy intake (EI) was measured to prepare individual meal plans prior to TOR. Basal metabolic rate was calculated using the Schofield¹⁸ equation and was multiplied by a physical activity coefficient which was determined by categorizing each position onboard by its physical demands.¹⁹ Individual EI was prepared before each leg and controlled upon arrival by the human performance practitioner.

Statistical Analysis

Data were calculated through standard statistical methods and is presented as mean (SD). All variables were considered normally distributed through analysis with the Shapiro–Wilk test, histograms, and skewness values prior to analysis. One-way analysis

of variance with repeated measures was used to determine the differences between the different parameters during the 3 legs. When results were significantly different, an effect size (ES) calculation was used. ES was evaluated using Cohen *d* along with 95% confidence intervals. ES of ≤ 0.2 , 0.21 to 0.60, 0.61 to 1.20, 1.21 to 2.0, and ≥ 2.0 were considered as trivial, small, moderate, large, and very large, respectively.²⁰ Statistical analyses were performed using the SPSS package (version 15.0). The level of significance was set at $P < .05$.

Results

Table 1 describes the external and internal load statistics across the 3 legs of TOR. A total of 5167 km was sailed in 10 days 4 hours 31 minutes at an average speed of $5.87 \text{ m}\cdot\text{s}^{-1}$. Eighty-eight maneuvers (ie, 53 tacks and 35 gybes) were performed with each one occurring every 58.7 km. Leg 1, the longest leg of the 3, was characterized by its downwind nature, fast speed (ie, $7.5 \text{ m}\cdot\text{s}^{-1}$), and accounted for 51% of the total distance of TOR. Leg 2 reported to have the most tacking maneuvers (ie, 28) and also outlined a higher rating of perceived exertion (7.8 [2]), although time at sea was the shortest of the 3. It was characterized by its upwind nature and high maneuver frequency (1 every 2 h 2 min). Leg 3 held the most maneuvers (ie, 35) and was characterized by its slow speed (ie, $4.02 \text{ m}\cdot\text{s}^{-1}$).

The multilevel analysis of variance (Table 2) found no significant difference in anthropometric parameters during the 3 legs of racing when compared with BSL. Differences were nevertheless observed at Post₃ for BF ($P = .004$; ES = 0.25) when compared with Post₂.

Compared with BSL (37.0 [8.0] cm), CMJ height (Figure 2) significantly decreased at Post₂ (33.1 [6.6] cm; $P = .05$; ES = 0.53) and Post₃ (33.2 [7.7] cm; $P = .05$; ES = 0.49). A significant decline was observed between Post₁ and Post₂ ($P = .007$; ES = 0.58). Upper body strength (Figure 3) decreased for HGS_{sum} when compared with BSL (113 [22.3] kg) at Post₁ (107.0 [19.6] kg; $P = .01$; ES = 0.29), Post₂ (102.4 [19.0] kg; $P = .001$; ES = 0.51), and Post₃ (108.6 [18.8] kg; $P = .05$; ES = 0.21). Post₂ ($P = .03$; ES = 0.24) and Post₃ ($P = .03$; ES = 0.3) were significantly different from preceding legs. HGS₄ also decreased at Post₁ (55.4 [10.7] kg; $P = .002$; ES = 0.44), Post₂ (52.9 [10.0] kg; $P < .001$; ES = 0.62),

Table 1 External and Internal Load of The Ocean Race

Variable	Leg 1	Leg 2	Leg 3	Total
External load				
Course distance, km	2411.3	1074.2	1070.5	4556.0
Distance sailed, km	2655.8	1299.9	1211.8	5167.5
Course coverage, %	110	121	113	113.5
Time at sea	4 d 1 h 8 min	2 d 15 h 31 min	3 d 11 h 52 min	10 d 4 h 31 min
Total maneuvers	22	31	35	88
Tacks (upwind maneuvers)	0	28	25	53
Gybes (downwind maneuvers)	22	3	10	35
Maneuver/time	4 h 24 min	2 h 2 min	2 h 29 min	2 h 47 min
Average speed, $\text{m}\cdot\text{s}^{-1}$	7.5	5.68	4.02	5.87
Internal load				
RPE	7.45 (2.2)	7.8 (2.0)	5.85 (1.4)	
s-RPE, AU	43,418.6 (12,548.8)	29,725.8 (7579.5)	30,490.2 (7477.6)	

Abbreviations: AU, arbitrary units; RPE, rating of perceived exertion; s-RPE, session rRPE.

(Ahead of Print)

Table 2 Description of Body Composition and Energy Intake Throughout The Ocean Race

Variable	Baseline	Post ₁	Post ₂	Post ₃
Body composition				
Body mass, kg	84.24 (12.7)	83.79 (12.8)	83.57 (12.8)	84.38 (12.5)
Lean body mass, kg	70.72 (11.4)	70.66 (10.3)	70.74 (10.6)	70.42 (10.0)
Body fat, %	16.04 (5.6)	15.66 (4.9)	15.34 (4.9)	16.54 (4.7)††
Energy intake				
Basal metabolic rate, cal·d ⁻¹	1802.67 (173.3)			
Coefficient	2.23 (0.3)			
Energy intake, MJ·d ⁻¹		15.57 (2.6)	16.43 (2.5)	16.8 (2.6)
Carbohydrates, %		57.34 (11.7)	54.42 (12.2)	56.75 (8.6)
Protein, %		21.55 (4.1)	23.3 (6.4)	24.2 (5.7)
Fat, %		21.11 (8.5)	23.28 (7.3)	19.05 (4.3)

Abbreviations: Post₁₋₃, measurements obtained after legs 1 to 3.

†Significant difference with values of preceding test; $P \leq .01$.

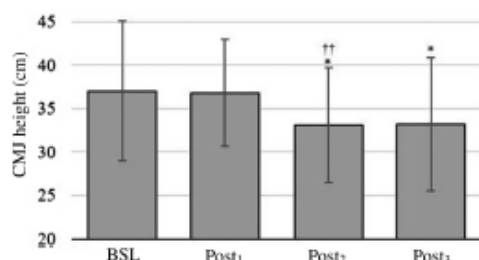

Figure 2 — Changes in CMJ height throughout The Ocean Race. BSL indicates baseline; CMJ, countermovement jump; Post₁₋₃, measurements obtained after legs 1 to 3. *Difference is significant to BSL at $P \leq .05$. ††Significant difference with values of preceding test; $P \leq .01$.

and Post₃ (56.2 [10.4] kg; $P = .02$; ES = 0.31) when compared with BSL (59.7 [11.9] kg). HGS₄ was significantly different from preceding legs at Post₂ ($P = .04$; ES = 0.25) and Post₃ ($P = .02$; ES = 0.33). HGS_{3rd} was only significantly different from BSL (53.3 [10.7] kg) at Post₂ (49.5 [9.5]; $P = .02$; ES = 0.37).

The HI (Figure 4) increased significantly at Post₁ (17.4 [2.9] AU; $P = .001$; ES = 1.43) and Post₂ (19.2 [2.7] AU; $P = .001$; ES = 2.23) when compared with BSL (13.7 [2.2] AU). HI was significantly different between Post₂ and Post₃ ($P = .005$; ES = 1.65). Sleep quality decreased significantly at Post₁ (4.6 [0.9] AU; $P = .04$; ES = 1.05) and Post₂ (5.4 [1.1] AU; $P = .006$; ES = 1.76) when comparing with BSL (3.7 [0.8] AU) and at Post₃ ($P = .04$; ES = 1.34) when comparing with preceding leg. Perception of fatigue was significantly different from BSL (3.4 [0.5] AU) at Post₃ (4.2 [0.9] AU; $P = .04$; ES = 1.09). Stress at Post₁ (4.9 [0.5] AU; $P < .001$; ES = 2.33) and Post₂ (5.7 [0.6] AU; $P < .001$; ES = 3.26) was significantly different to BSL (3.2 [0.9] AU). Muscle soreness did not differentiate with BSL (3.4 [0.7] AU) during the race.

The SC levels (Figure 5) varied throughout the competition. Post₁ (18.6 [5.6] ng·mL⁻¹; $P = .005$; ES = 1.44), Post₂ (14.2 [2.9] ng·mL⁻¹; $P = .03$; ES = 0.76), and Post₃ (16.2 [6.7] ng·mL⁻¹; $P = .02$; ES = 0.84) were all significantly different from BSL (11.5

[4.1] ng·mL⁻¹). Variation with preceding legs was significant at Post₂ ($P = .03$; ES = 0.97).

Discussion

The hypotheses initially stated were globally validated since body composition was partially modified, muscular performance decreased, and objective and subjective fatigues were observed during and after the competition.

Although previous research in sailing have observed weight loss, fat percentage, and lean body mass decreases after competition,^{1,5,9,21} the results of the current study found only significant changes in BF (in percentage) at Post₃. Indeed, during the 3 weeks of competition, when comparing BSL levels with Post₁₋₃, no significant differences were observed. A potential reason for differentiation with other research may be due to sailors being tested extensively to determine their individual energetic needs onboard. Previous research has highlighted that loss in body mass and, more particularly, lean body mass decrease, could eventually hinder physical and cognitive performance.²² It was therefore essential to provide the sailors with the adequate EI as they were confronted to irregular biological rhythm, sleep deprivation, incessant compensatory muscle activity, and continuous stress.⁵ Elevated EI values (ie, 15–17 MJ·d⁻¹) have been reported in other research with considerable weight loss still being observed.⁵ Nevertheless, it should be noted that the legs studied here were shorter and occurred in warmer climate. Also, daily protein consumption was more important in the present study (23% vs 14% in the previous study mentioned⁵) and could explain, in part, the maintenance of lean body mass²³ throughout TOR.

The results from the current study confirm that sailors experienced a significant decline in CMJ height (Figure 2) during and after TOR. Similar responses during competition have been observed across various “long distance sports.”²⁴ A decrease in lower body strength and power abilities immediately after sailing is common in professional sailors.²⁵ However, this study provides new insights that, to the author’s knowledge, have never been investigated in professional crews. Indeed, contrary to past research, the sailors in this study did not suffer from body mass loss and/or muscle wastage during the competition. These results are in line with findings highlighting muscular function impairment due to the yawing, rolling, and pitching motions (sway) of the

(Ahead of Print)

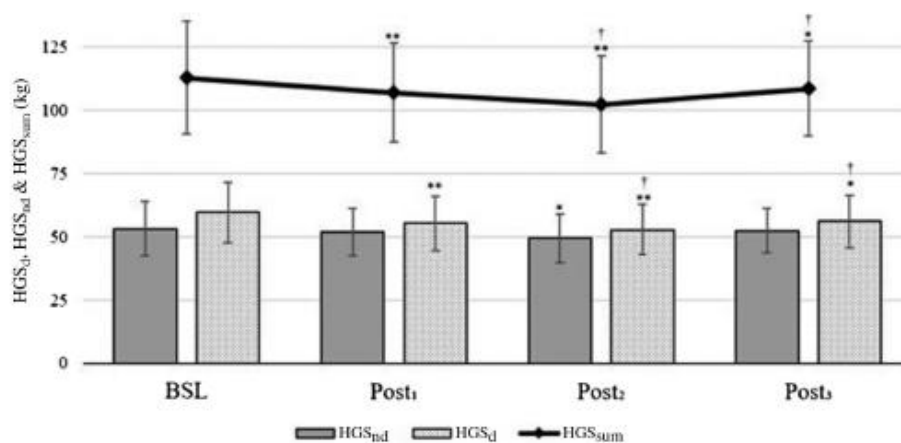

Figure 3 — Changes in handgrip strength throughout The Ocean Race. BSL indicates baseline; HGS_d, dominant handgrip strength; HGS_{nd}, nondominant handgrip strength; HGS_{sum}, sum of HGS_d and HGS_{nd}; Post₁₋₃, measurements obtained after legs 1 to 3. *Difference is significant to BSL at $P \leq .05$. **Difference is significant to BSL at $P \leq .01$. †Significant difference with values of preceding test; $P \leq .05$.

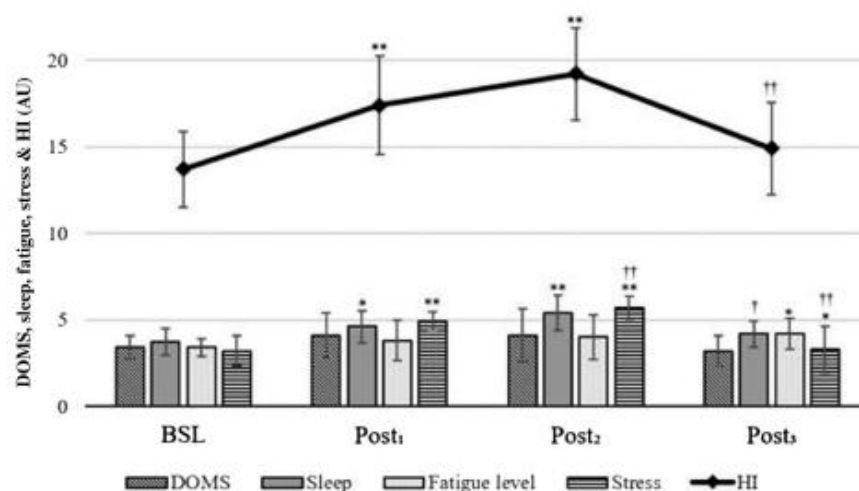

Figure 4 — Changes in subjective well-being parameters and HI during The Ocean Race. AU indicates arbitrary unit; BSL, baseline; DOMS, delayed-onset muscle soreness; HI, Hooper index; Post₁₋₃, measurements obtained after legs 1 to 3. *Difference is significant to BSL at $P \leq .05$. **Difference is significant to BSL at $P \leq .01$. †Significant difference with values of preceding test; $P \leq .05$. ††Significant difference with values of preceding test; $P \leq .01$.

hull.²⁶ Moreover, the downwind specificity of leg 1 (ie, 22 gybes) elicited no impairment to lower body muscular function contrary to legs 2 and 3, which were mainly upwind. Upwind legs seemed to affect lower limbs muscular function more than the downwind leg, despite leg 1 being 2 times longer than legs 2 and 3 (Table 1). This alteration may be linked with the constant swaying of the hull caused by swell in upwind sailing conditions. Indeed, maintaining constant proprioceptive tension, due to hull movement, seems to increase the mechanical loading of hip extensors and hip flexors.

The HGS (Figure 3) has received a considerable amount of interest in previous research. Indeed, it has been associated with greater upper body strength, ballistic performance, lean body mass,²⁷ athlete level differentiation,²⁸ and success.²⁹ The offshore sailors in our study reported superior HGS_d at BSL compared with other offshore sailing research (ie, in the present study 59.7 [11.9] kg vs 53.6 [8.3] kg and 40 kg in previous studies^{4,21}) and similar to crewed dinghy racing (61.1 [9.5] kg in another study²⁹). Indeed, the physical WL associated with grinding, hoisting,

(Ahead of Print)

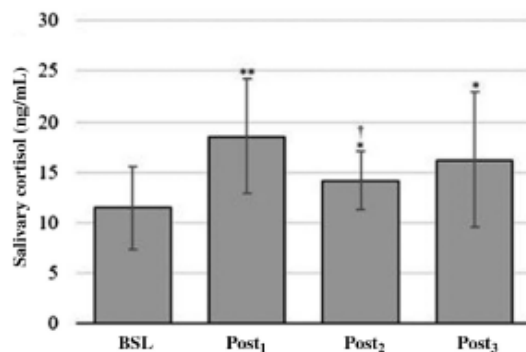

Figure 5 — Changes in salivary cortisol during The Ocean Race. BSL indicates baseline; Post₁₋₃, measurements obtained after legs 1 to 3. *Difference is significant to BSL at $P \leq .05$. **Difference is significant to BSL at $P \leq .01$. †Significant difference with values of preceding test; $P \leq .05$.

stacking, and trimming the sails is intense and requires a fair amount of grip strength. Nevertheless, previous research reported that HGS performance was preserved after offshore sailing competition.^{4,21} However, in this current research, the sailors observed a progressive decay of maximal strength in HGS during each leg. The decrease in performance detected in our study could be explained by the specific physical demands of the vessel used in TOR. Indeed, the racing conditions are known to be more extreme and the boat harder to handle due to its low displacement and facilitation to plane.⁵ Hence, we can assume that the sailors underwent extensive upper body solicitation during TOR and suffered from high levels of neuromuscular fatigue.

The HI and its subsets (ie, sleep quality, fatigue, stress, and muscle soreness) has recently been shown to be a promising tool for monitoring indices of fatigue and preparedness in many sports.³⁰ However, research examining the effects of sailing on subjective recovery variables is scarce.²¹ Indeed, research has mainly focused on sleep quality and highlights the effects of sleep deprivation on cognitive performance.⁸ These studies have put forward the need to identify an optimal balance between wakefulness and planned sleeping to optimize sailing performance. The results in our study (Figure 4) found that HI_{sleep} and HI_{stress} were more pronounced during the legs where the rating of perceived exertion was higher (ie, Post₁ and Post₂). In spite of the multiple physical stressors involved in sailing, HI_{dom} was preserved during TOR, whereas HI_{fatigue} increased linearly throughout the race and was significantly different from BSL at Post₃. Nevertheless, it should be noted that sailors were provided protein supplementation onboard and in-between legs to optimize muscular recovery³¹ and to avoid muscle atrophy linked to the accumulation of high levels of cortisol during sailing.⁹ In fact, sailors had been training regularly 7 months prior to competition, which could have generated morphological adaptations in the muscle fibers necessary to withstand the induced mechanical stress without causing structural alterations.

Intensified WL periods have been found to increase cortisol concentration.³² This hormonal increase has been associated to stress tolerance disturbances and decreases in performance. Studies in other long-distance/duration sports have shown that athletes

experienced greater concentration of SC in postcompetition phases.³³ In sailing, few studies have considered analyzing catabolic hormone alterations despite significant increases in cortisol concentration being observed at sea.³⁴ Indeed, sailors in the current study showed an elevation of SC levels at Post₁₋₃ (Figure 5) which corresponded to the session rating of perceived exertion fluctuations observed during the legs (Table 1). Moreover, HI did not differentiate from BSL at Post₃ despite its correlation to SC.³⁵ This finding may be due to the crew's winning performance during the final leg. Indeed, subjective wellness seems to be associated with competition outcome.³⁶ Nevertheless, it was found that SC levels increased significantly after intense bouts of offshore sailing. This seems to be in line with other studies analyzing the effects of prolonged change of circadian rhythms in confined environments.³⁷

Practical Application

This study has revealed a number of practical applications that are relevant to human performance practitioners and sailors alike. Over an intensified period of offshore sailing competition, when there is insufficient time to recover between legs, physiological and psychological fatigue accumulates. Impaired readiness when sailing may compromise the boat's performance by reducing physical and cognitive capabilities. As such, cautious WL monitoring should be implemented by practitioners during a competitive phase to determine a sailor's readiness and recovery status. Upper body and lower body muscular capabilities, as well as SC, were impacted by an offshore sailing competition, and markers obtained from CMJ and HGS appear to be sensitive ways of detecting muscular fatigue. Questionnaires that assess subjective wellness parameters are useful tools for monitoring fatigue and recovery during offshore sailing competition. Such questionnaires are noninvasive and nonexpensive tools that can be used frequently to provide useful information on an athlete's readiness to sail. This research was conducted over a reduced 3-week competition as an adaptation to the current COVID-19 crisis. Future research during longer events is required to conduct correlational analyses aiming to identify relationships between sailing specific external load and monitoring markers. Larger sample sizes would also allow further exploration of activity profiles according to crew position onboard. In addition, as laboratory measures are expensive markers, further investigations are needed to examine the relationship between external WL parameters and subjective markers of recovery found in questionnaires. Furthermore, through the use of micro-captors and video analysis, researchers could observe position-specific activity and determine the physical and physiological demands for each maneuver and/or sailing situation.³⁸

Conclusion

To the best of our knowledge, this is the first longitudinal study to provide information on the effects of offshore sailing on physiological parameters and fatigue patterns in a professional mixed-sex crew sailing team. This investigation confirmed (1) very little effect on anthropometric parameters, (2) significant decreases in lower and upper body muscular abilities, (3) significant variations of wellness parameters during the different legs, and (4) increases of SC stress hormone during and after competition. Therefore, the current study presents the impacts that offshore sailing has on athletes. The results will provide helpful information for sports scientists, sailing coaches, and performance practitioners to

(Ahead of Print)

appropriately manage the training and recovery processes in their quest to optimize human performance.

References

- Ghiani G, Magnani S, Doneddu A, et al. Case study: physical capacity and nutritional status before and after a single-handed yacht race. *Int J Sport Nutr Exerc Metab.* 2018;28(5):558–563. PubMed ID: 29252058 doi:10.1123/ijsem.2017-0345
- Dubois R, Lyons M, Paillard T, Maurelli O, Prioux J. Influence of weekly workload on physical, biochemical and psychological characteristics in professional rugby union players over a competitive season. *J Strength Cond Res.* 2020;34(2):527–545. PubMed ID: 30074967 doi:10.1519/JSC.0000000000002741
- Gorostiaga EM, Granados C, Ibañez J, González-Badillo JJ, Izquierdo M. Effects of an entire season on physical fitness changes in elite male handball players. *Med Sci Sports Exerc.* 2006;38(2):357–366. PubMed ID: 16531907 doi:10.1249/01.mss.0000184586.74398.03
- Portier H, Chatard JC, Filaire E, Jaunet-Devienne MF, Robert A, Guezennec CY. Effects of branched-chain amino acids supplementation on physiological and psychological performance during an offshore sailing race. *Eur J Appl Physiol.* 2008;104(5):787–794. PubMed ID: 18704484 doi:10.1007/s00421-008-0832-5
- Branth S, Hanibraeus L, Westertorp K, et al. Energy turnover in a sailing crew during offshore racing around the world. *Med Sci Sports Exerc.* 1996;28(10):1272–1276. PubMed ID: 8897384 doi:10.1097/00005768-199610000-00010
- Oldenburg M, Hogan B, Jensen HJ. Systematic review of maritime field studies about stress and strain in seafaring. *Int Arch Occup Environ Health.* 2013;86(1):1–15. PubMed ID: 22915144 doi:10.1007/s00420-012-0801-5
- Sagayama H, Toguchi M, Yasukata J, Yonaha K, Higaki Y, Tanaka H. Total energy expenditure, physical activity level, and water turnover of collegiate dinghy sailors in a training camp. *Int J Sport Nutr Exerc Metab.* 2019;29(4):350–353. PubMed ID: 30299186 doi:10.1123/ijsem.2018-0204
- Barrios C, Hadala M, Almansa I, Bosch-Morell F, Palanca JM, Romero FJ. Metabolic muscle damage and oxidative stress markers in an America's Cup yachting crew. *Eur J Appl Physiol.* 2011;111(7):1341–1350. PubMed ID: 21153417 doi:10.1007/s00421-010-1762-6
- Hurdie R, Van Dongen HP, Aron C, McCauley P, Jacolot L, Theunynck D. Sleep restriction and degraded reaction-time performance in Figaro solo sailing races. *J Sports Sci.* 2014;32(2):172–174. PubMed ID: 24015907 doi:10.1080/02640414.2013.815359
- Giacon T, Bosco G, Vezzoli A, et al. Oxidative stress and motion sickness during offshore sailing. *Sci Rep.* 2022, January 21;12(1):1142. doi:10.1038/s41598-022-05219-6
- Hayes LD, Grace FM, Baker JS, Sculthorpe N. Exercise-induced responses in salivary testosterone, cortisol, and their ratios in men: a meta-analysis. *Sports Med.* 2015;45(5):713–726. PubMed ID: 25655373 doi:10.1007/s40279-015-0306-y
- Jackson AS, Pollock ML. Generalized equations for predicting body density of men 1978. *Br J Nutr.* 2004;91(1):161–168. PubMed ID: 14748950
- Brozek J, Grande F, Anderson JT, Keys A. Densitometric analysis of body composition: revision of some quantitative assumptions. *Ann NY Acad Sci.* 1963;110:113–140. PubMed ID: 14062375 doi:10.1111/j.1749-6632.1963.tb17079.x
- Svantesson U, Norde M, Svensson S, Brodin E. A comparative study of the Jamar (R) and the Grippit (R) for measuring handgrip strength in clinical practice. *Isokinet Exerc Sci.* 2009;17:85–91. doi:10.3233/IES-2009-0338
- Hooper SL, Mackinnon LT. Monitoring overtraining in athletes. *Sports Med.* 1995;20(5):321–327. PubMed ID: 8571005 doi:10.2165/00007256-199520050-00003
- Ducker KJ, Lines RLJ, Chapman MT, Peeling P, McKay AKA, Gucciardi DF. Validity and reliability evidence of a point of care assessment of salivary cortisol and α -amylase: a pre-registered study. *PeerJ.* 2020;8:e8366. PubMed ID: 31938581 doi:10.7717/peerj.8366
- Foster C, Florhaug JA, Franklin J, et al. A new approach to monitoring exercise training. *J Strength Cond Res.* 2001;15(1):109–115. PubMed ID: 11708692
- Schofield WN. Predicting basal metabolic rate, new standards and review of previous work. *Hum Nutr Clin Nutr.* 1985;39(suppl 1):5–41.
- Myers SD, Leamon SM, Nevola VR, Llewellyn MG. Energy expenditure during a single-handed transatlantic yacht race. *Br J Sports Med.* 2008;42(4):285–288. PubMed ID: 18048436 doi:10.1136/bjsm.2007.041533
- Cohen J. The concepts of power analysis. In: Cohen J. *Statistical Power Analysis for the Behavioral Sciences* 2nd ed. Routledge; 1988:1–17.
- Laflère P, Gatzoff Y, Guerrero F, Provyn S, Balestra C. Field study of anthropomorphic and muscle performance changes among elite skippers following a transoceanic race. *Int Marit Health.* 2020;71(1):20–27. PubMed ID: 32212144 doi:10.5603/IMH.2020.0007
- Choma CW, Sforzo GA, Keller BA. Impact of rapid weight loss on cognitive function in collegiate wrestlers. *Med Sci Sports Exerc.* 1998;30(5):746–749. PubMed ID: 9588618 doi:10.1097/00005768-199805000-00016
- Martens EA, Westertorp-Plantenga MS. Protein diets, body weight loss and weight maintenance. *Curr Opin Clin Nutr Metab Care.* 2014;17(1):75–79. PubMed ID: 24310056 doi:10.1097/mco.000000000000006
- Balsalobre-Fernández C, Tejero-González CM, del Campo-Vecino J. Hormonal and neuromuscular responses to high-level middle- and long-distance competition. *Int J Sports Physiol Perform.* 2014;9(5):839–844. PubMed ID: 24436350 doi:10.1123/ijssp.2013-0539
- Błacha R, Zatoń K, Piwowarczyk P, Jastrzebska A, Szczepan S. Repeatability of force production as a measure of kinesthetic sense in seagoing sailors and recreational sailors. *Hum Mov.* 2019;20(2):57–63. doi:10.5114/hm.2019.83219
- Stoffregen TA, Smart LJ. Postural instability precedes motion sickness. *Brain Res Bull.* 1998;47(5):437–448. PubMed ID: 10052572 doi:10.1016/S0361-9230(98)00102-6
- Cronin J, Lawton T, Harris N, Kikling A, McMaster DT. A brief review of handgrip strength and sport performance. *J Strength Cond Res.* 2017;31(11):3187–3217. PubMed ID: 28820854 doi:10.1519/JSC.0000000000002149
- Grant S, Hynes V, Whittaker A, Aitchison T. Anthropometric, strength, endurance and flexibility characteristics of elite and recreational climbers. *J Sports Sci.* 1996;14(4):301–309. doi:10.1080/02640419608727715
- Philippe K, Paillard T, Dubois R, Maurelli O, Prioux J. Key performance indicators in Tour de France sailing. *J Sports Sci.* 2021;39(8):944–954. PubMed ID: 33246399 doi:10.1080/02640414.2020.1851925
- Clemente FM, Mendes B, Nikolaidis PT, Calvete F, Carriço S, Owen AL. Internal training load and its longitudinal relationship with seasonal player wellness in elite professional soccer. *Physiol Behav.* 2017;179:262–267. PubMed ID: 28668619 doi:10.1016/j.physbeh.2017.06.021
- Pasiakos SM, Lieberman HR, McLellan TM. Effects of protein supplements on muscle damage, soreness and recovery of muscle

(Ahead of Print)