



HAL
open science

Structure financière, relation de financement et performances des entreprises

Julien Salin

► **To cite this version:**

Julien Salin. Structure financière, relation de financement et performances des entreprises. Economies et finances. Université de Nanterre - Paris X, 2021. Français. NNT : 2021PA100082 . tel-04861131

HAL Id: tel-04861131

<https://theses.hal.science/tel-04861131v1>

Submitted on 2 Jan 2025

HAL is a multi-disciplinary open access archive for the deposit and dissemination of scientific research documents, whether they are published or not. The documents may come from teaching and research institutions in France or abroad, or from public or private research centers.

L'archive ouverte pluridisciplinaire **HAL**, est destinée au dépôt et à la diffusion de documents scientifiques de niveau recherche, publiés ou non, émanant des établissements d'enseignement et de recherche français ou étrangers, des laboratoires publics ou privés.

Membre de l'université Paris Lumières

Julien Salin

Structure Financière, Relation de Financement et Performance des Entreprises

Thèse présentée et soutenue publiquement le 8 juillet 2021
en vue de l'obtention du doctorat de **Sciences économiques**
de l'Université Paris Nanterre
sous la direction de Mme Nadine Levratto (Université Paris Nanterre)

Jury* :

Rapporteur :	M. Fabio Bertoni	Professeur, Skema Business School
Rapporteuse :	Mme. Josée St-Pierre	Professeure titulaire, Université de Québec à Trois-Rivières
Président du jury :	M. Lionel Ragot	Professeur des Universités, Université Paris Nanterre
Examineur :	M. Philippe Mutricy	Directeur de l'évaluation des études et de la prospective, Bpifrance
Directrice de thèse	Mme. Nadine Levratto	Directrice de recherche au CNRS, EconomiX, Université Paris Nanterre

Remerciements

Je tiens d'abord et avant tout à remercier chaleureusement Nadine Levratto, qui a encadré mon travail doctoral lors de ces trois dernières années. Son aide pédagogique a été d'un grand soutien durant ce travail doctoral et c'est sans hyperbole qu'il m'est permis de dire rien n'aurait été possible sans elle. Nadine, un énorme merci pour toutes nos discussions, elles ont été pour moi une source constante d'inspiration et de motivation. S'il m'est permis de dire qu'il y a un avant et un après thèse, c'est à toi que je le dois, si j'ai pu m'épanouir dans cette thèse c'est également à toi que je le dois, pour tous ces apports et ceux auxquels je ne pense pas au moment d'écrire ces lignes un grand MERCI.

Je souhaite également exprimer ma gratitude à Fabio Bertoni Philippe Mutricy, Lionel Ragot et Josée St-Pierre pour avoir accepté de faire partie de mon jury et de consacrer leur temps précieux à m'aider à améliorer ma réflexion et mes travaux de recherche.

Ce travail doctoral a pu s'effectuer, au sein de Bpifrance et en collaboration avec France Angels, dans des conditions d'une qualité rare pour lesquelles je tiens à remercier l'équipe managériale du Lab : Philippe Mutricy, Elise Tissier et Vivien Pertusot ainsi que France Angels pour la mise à disposition des données. Je remercie également chaleureusement les collègues du Lab (il faut le dire avec l'accent du Sud (!)), Aurélien Lemaire, Barbara Levi-Ortega, Cécile Schoenberg, David Targy, Frédérique Savel, Jérôme Lebacle, Justine Lansac, Kenza El Qaoumi, Laura Parmigiani et Thomas Bastin avec lesquels j'ai pu travailler ou simplement échanger sur des sujets professionnels ou plus personnels. Je les remercie de leur soutien et de leurs encouragements tout au long de mon contrat à Bpifrance (mais aussi après). Une mention (très) spéciale pour Frédérique Savel. Ce serait un euphémisme de dire que son encadrement et son soutien quotidien ont été d'une aide précieuse pour la construction de cette thèse. Je suis très heureux et honoré d'avoir été encadré par une personne d'une telle qualité humaine et intellectuelle, notre rencontre est et restera pour moi un moment important structurant.

Je tiens également à souligner l'apport qu'a eu Jean-Charles Bricongne tout au long de mon parcours, de la licence à aujourd'hui. L'éveil intellectuel qu'il m'a apporté a été le déclencheur de ma volonté de poursuivre mes études après le master. Merci Monsieur.

Je tiens à ce titre à remercier l'ensemble des membres d'EconomiX, les années de thèse resteront un souvenir agréable grâce à eux. Un grand Merci à Valérie Mignon sans le concours de laquelle cette thèse n'aurait jamais été initiée (pas avec moi en tout cas !). Un

grand merci à Frédéric Hammerer pour sa disponibilité et sa réactivité. Je suis également reconnaissant envers les collègues (toujours avé l'accent du Sud) du bureau Giuseppe Arcuri, Julien Bergeot, Mathieu Chtioui, Thibault Mirabel et Aurélien Quignon. Spéciale dédicace au poto Aurélien, compagnon tourangeau de fortune et d'infortune durant ces trois années. Nos moments d'échanges formels et informels et nos universités d'été constituent des moments d'échanges et de partages inoubliables (partager la même chambre ça rapproche).

Je pense également chaleureusement aux membres du 6^e, le 601 et le 602, Capucine, Fanny, Margaux, Maria, Mathilde, Morel et Rémi. Votre bonne humeur et votre soutien durant cette dernière année ont été d'une aide précieuse pour garder le cap. Je tiens également à souligner le soutien des collègues (on n'oublie pas l'accent du sud) du master EIPMC, une équipe formidable s'est construite depuis le master jusqu'en thèse, débutée ensemble. Je pense à Florian Morvillier (aka The publisher), sa détermination et sa rigueur intellectuelle ont constitué une source d'inspiration et de motivation des plus stimulantes, depuis nos sessions de « street work-out » à Nanterre Pref^o jusqu'à cette fin de thèse. Oui, je sais Flo, «*Chiller fait pas manger GUCCI*». Je pense à Chouaib Jouf (aka LE choubi), que je remercie pour sa bonne humeur et son amitié, une épaule et une oreille toujours disponible pour m'écouter me plaindre ainsi qu'un compagnon de discussion, d'une fiabilité et d'une pédagogie rare. Pierre Durand, et Charles Emmanuel-Teuf (aka tic et tac) avec qui j'ai partagé de nombreux moments depuis le master, merci pour également votre amitié qu'elle se matérialise en présentiel ou sur le salon du matchmaking d'Age Of Empire II. Je remercie enfin Axel Ehouman et Josph-Ange Yapi (aka les BOSS), leur exigence académique, leur vivacité d'esprit ainsi que leur joie de vivre constituent un moteur de motivation et d'inspiration constant.

Enfin, je souhaite remercier chaleureusement mes amis d'enfance tourangeaux. Merci de m'avoir soutenu et de continuer à le faire. Ces remerciements n'auraient que peu de valeur sans louer le rôle moteur de Maria José Estevez Roncal, ta présence et ton aide au quotidien tout au long de cette thèse (et bien avant) ont été une source de réconfort dans laquelle j'ai pu puiser la force nécessaire pour entreprendre d'abord et mener à bien ensuite cette thèse doctorale. Je termine en remerciant ma famille. Vincent et Camille qui, patiemment, très patiemment, vraiment, très patiemment ont écouté mes coups de gueule et mes explications alambiquées sur mes travaux au cours des (longs, il faut bien meubler, c'est commode) repas de famille. Ma gratitude va enfin à mes parents, leurs conseils et leur bienveillance m'ont porté jusqu'à et pendant cette thèse, merci de me (sup)porter.

Vous la saviez commencée, pour vous mes papis

Table des matières

Introduction générale Pourquoi soutenir l'innovation ?	1
1.1 Faillites de marché, contribution à la croissance et limites de l'action publique	1
1.1.1 Faillites de marché	1
1.1.2 Contribution à la croissance.....	2
1.1.3 Théorie de la défaillance étatique	3
1.2 Le soutien l'innovation en Europe.....	5
1.2.1 Entre histoire économique et politique	5
1.3 Les politiques publiques d'innovation en France	8
1.3.1 Les politiques publiques d'innovation en France : un développement en trois temps	8
1.3.2 Le cas du capital risque.....	11
1.3.3 Le cas des banques de développement	14
1.4 L'évaluation : une nécessité encore en développement.....	18
1.5 Principaux résultats et contribution de la thèse.	19
1.6 References	23
1 Chapitre 1 Are business angel-backed companies truly different? a comparative analysis of the financial structure	29
1.1 Introduction	29
1.2 Literature review: The multidimensional effect of BAN intervention	31
1.2.1 Theoretical development for entrepreneurial finance	31
1.2.2 Business Angels' activity and networks	33
1.2.3 Hypotheses development	33
1.3 Empirical strategy and variable operationalization	37
1.3.1 Definition and measure of variables	37
1.3.2 Comparison strategy	38
1.4 Results	41
1.4.1 Investment process and firm characteristic.....	41
1.4.2 Assessment of BANs influence	43
1.5 Robustness checks	47
1.6 Conclusion and research agenda.....	47
1.7 References	49
Appendix	56
2 Chapitre 2 Participative loan for innovative firms in France	65
2.1 Introduction	65

For decades, worldwide authorities have constructed and conducted various programs to allocate public funds to innovation financing, producing extended but heterogeneous empirical literature	66
2.2 Literature review: entrepreneurship's contribution to growth and its public support	69
2.2.1 Does size matter: from firm size to growth	69
2.2.2 The role of governmental support for innovation: the case of direct support	71
2.3 Hypotheses development	77
2.3.1 Input effects: resource accumulation	77
2.3.2 Hypotheses development: output effect.....	78
2.4 Data and methodology	79
2.4.1 Programme design	79
2.4.2 Sample description.....	80
2.4.3 Methodology	80
2.5 Results	82
2.6 Robustness	85
2.7 Discussion.....	87
2.7.1 Programme theory failure	88
2.7.2 Implementation failure.....	89
2.7.3 Methodology failure	91
2.8 Conclusion	91
2.9 References	92
3 Chapitre 3 The babel tower of public support for entrepreneurship and small businesses: a systematic literature review.....	109
3.1 Introduction	109
3.2 Research design and empirical setting.....	111
3.2.1 Information sciences and social sciences: Theory and practice	111
3.2.2 Research design: The Subject-Action-Object framework	112
3.2.3 Empirical setting	114
3.2.4 Bibliometrics.....	116
3.3 Results	118
3.3.1 Bibliometric results.....	118
3.3.2 Cluster analysis	120
3.3.3 Literature review results	130

3.3.4	Co-(Key)word analysis (CWA)	131
3.4	Sensitivity analysis	137
3.4.1	Authors' co-citations.....	137
3.4.2	Authors' bibliographic couplings	138
3.4.3	Document bibliographic couplings.....	140
3.4.4	Literature review: Sensitivity analysis.....	142
3.4.5	Keyword co-occurrence using the Web of Science Core Collection..	144
3.5	Discussion and limitations	149
3.5.1	Information science sources: Scopus and Web of Science.....	149
3.5.2	Knowledge accumulation, external validity process and evidence-based policies	151
3.5.3	Limitations	152
3.6	Concluding remarks.....	157
3.7	References	159
4	Conclusion générale	177
4.1	Principaux résultats et contributions.....	177
4.1.1	Le financement d'amorçage de l'innovation par capital risque.....	178
4.1.2	Banque de développement et développement des entreprises innovantes en France	179
4.1.3	Les politiques publiques basées sur la preuve, un processus complexe	181
4.2	Agenda de recherche	183
4.3	References	184

TABLE DES FIGURES

Figure 0-1	- Investissements en capital-risque dans les pays de l'OCDE, 2016, % PIB	11
Figure 0-2	- Evolution des investissements en capital risque en France.....	12
Figure 0-3	- Evolution des investissements des Business Angels en France (en millions d'euros).....	13
Figure 0-4	- Histoire de Bpifrance	14
Figure 0-5	- Offre de financements de Bpifrance.....	17
Figure 1-1	- Smooth matching using Mahalanobis distance	58

Figure 1-2 - Test of smooth matching Kernel, 5-NN matching and 1-NN matching	63
Figure 2-1 - Direct and indirect public funds as a percentage of GDP	72
Figure 2-2 - Empirical methodology.....	81
Figure 2-3 - Direct and Indirect public support in France.....	102
Figure 3-1 - Research exclusion criteria	116
Figure 3-2 - Co-citation and bibliographic coupling illustration	118
Figure 3-3 - Publications by year	118
Figure 3-4 - Publications by country	120
Figure 3-5 - Authors' contributions	120
Figure 3-6 - Authors' co-citation analysis using Scopus	124
Figure 3-7 - Authors' bibliographic coupling using Scopus	126
Figure 3-8 - Documents' bibliographic coupling (DBCA) using Scopus.....	129
Figure 3-9 - Keyword co-occurrence analysis using Scopus (KWA).....	134
Figure 3-10 - Authors' co-citation analysis using WOS-CC	138
Figure 3-11 - ABCA using WOS-CC	140
Figure 3-12 - Document bibliographic couplings using WoS-CC.....	142
Figure 3-13 - Keyword co-occurrence (using WoS).....	145

TABLE DES TABLEAUX

Tableau 0-1 - Causes de la défaillance du soutien public	4
Tableau 0-2 - Objectifs des moyens des politiques publiques en France.....	10
Tableau 0-3 - Evolutions des instruments publics de financement en France entre 2000 et 2015	10
Table 1-1 - Probability of being invested by Angels	42
Table 1-2 - Result of the ATT	46
Table 1-3 - Road map of matching methods	56
Table 1-4 - Definitions and descriptive statistics	56
Table 1-5 - Correlation matrix	57
Table 1-6 - Smooth matching using Mahalanobis distance	57
Table 1-7 - Alternative matching approaches	59
Table 1-8 - Robustness test for smooth matching using alternative methods.....	62

Table 1-9 - Pre-trend Assumption (PTA).....	63
Table 2-1 - MCDiD Result.....	82
Table 2-2 - Alternative specifications of the treatment effect.....	87
Table 2-3 - Risk/return profile of financing instruments	102
Table 2-4 - The Mezzanine Finance Landscape.....	103
Table 2-5 – Descriptive statistics	104
Table 2-6 - Correlation Matrix	105
Table 2-7 - Loan Amount Distribution	105
Table 2-8 - Step (2) Adjustment Quality.....	106
Table 3-1 - Articles best covering the fields based on bibliographic couplings (Scopus)	135
Table 3-2 - Articles best covering the fields based on bibliographic couplings (Web of Science Core Collection).....	146
Table 3-3 - Main results according to the bibliometric tools using the Scopus database	155

ABSTRACT / RÉSUMÉ

In the mainstream knowledge economy paradigm, innovation and its financing are crucial to ensure a stable inclusive growth. In this view, numerous programs are defined to help small young and innovative firms, a class of firms particularly affected by market frictions while being an essential source of value-added, productivity and employment. Numerous evaluations are made to ensure the rationality of public spending from an evidence-based policy perspective. This thesis explores the public support for innovation in the early stages. In the first chapter, the French early-stage equity market is explored by studying the impact of business angels on the financial structure of backed firms. While statistically modest, the certification effect of the business angels on backed firms is asserted on both commercial and banking partners. The second chapter investigates the impact of national development bank through participative loans for innovative start-ups. The impact on innovative activities is positive, but the impact on employment and productivity growth appears to be negative, highlighting the importance of the loan design and implementation process. Finally, the third chapter reconsiders the importance of knowledge accumulation on the formulation of evidence-based policies; it uses bibliometric analysis to explore academic research in public policies debates. The results indicate that the lack of conclusive findings limiting the use of academic findings in public debates may originate in the diverse use of terms to depict small businesses and entrepreneurs.

Keywords: Innovation, Impact Evaluation, Public policies, Corporate finance, participative loan, Information science, microeconometrics.

* * *

Dans le paradigme dominant de l'économie de la connaissance, l'innovation et son financement sont essentiels pour assurer une croissance stable et inclusive. Dans cette optique, de nombreux programmes sont définis pour aider les petites entreprises jeunes et innovantes, particulièrement touchées par les frictions du marché, étant donné leur importante contribution à la valeur ajoutée, à la productivité et à l'emploi. De nombreuses évaluations sont ensuite effectuées pour garantir la rationalité des dépenses publiques. Cette thèse explore le soutien public à l'innovation en phase d'amorçage. Dans un premier chapitre, le marché français de l'amorçage est exploré à travers l'impact des business-angels sur la structure financière des entreprises soutenues. Bien que statistiquement modeste, l'effet de certification des business angels est affirmé à la fois sur les partenaires commerciaux mais aussi bancaires. Le deuxième chapitre étudie l'impact des banques nationales de développement à travers l'étude d'un prêt participatif pour les start-ups innovantes. L'impact de ce dispositif est positif mais celui sur l'emploi et la croissance de la productivité semble être négatif. Les résultats mettent l'accent sur l'importance de la conception et de l'implémentation du dispositif. Enfin, le troisième chapitre reconsidère l'importance de l'accumulation de connaissances sur la formulation de politiques publiques basées sur la preuve scientifique ; il utilise une analyse bibliométrique et explore l'utilisation de la recherche académique dans les débats sur les politiques publiques. Les résultats indiquent que le manque de résultats concluants de la littérature académique qui limite l'utilisation des résultats académiques dans les débats publics pourrait provenir de l'utilisation éclectique des termes pour décrire les petites et moyennes entreprises et les entrepreneurs.

Mots-Clés : Evaluation d'impact, Innovation, Politiques publiques, Finance entrepreneuriale, Prêt participatif, Sciences de l'information, microeconometrics.

INTRODUCTION GENERALE

POURQUOI SOUTENIR L'INNOVATION ?

1.1 Failles de marché, contribution à la croissance et limites de l'action publique

1.1.1 Failles de marché

L'analyse économique a souvent fourni à la sphère politique des éléments de justifications pour ses interventions¹. En matière de politique de l'innovation la théorie néo-classique d'efficacité des marchés ne fait pas exception (Arrow & Debreu, 1954 ; Mazzucato & Penna, 2016). En identifiant des failles de marché, elle ouvre la possibilité aux pouvoirs publics d'intervenir sur les marchés et d'orienter les comportements des acteurs privés.

La première justification trouve ses racines dans la nature de l'innovation comme bien public (non-rival et non-excluable) à l'origine d'externalités. Le soutien public apparaît donc nécessaire pour ajuster les anticipations des agents quant aux rendements de leurs investissements. Le second argument tient compte de la nature même de ces investissements ; les rendements de l'innovation sont par définition incertains. Cette incertitude est renforcée dans le cas d'organisations présentant des structures informationnelles opaques telles que les petites et moyennes entreprises et les entrepreneurs (notées PME&Es par la suite). En effet, les PME&Es peuvent ne pas disposer de l'information demandée (manque d'historique financier ou de garanties) ou être peu disposées à transmettre l'information à des tiers pour des questions de compétitivité (information commerciale sur le projet innovant) ou de gouvernance (volonté de rester indépendant), créant une asymétrie d'information. Cette dernière, conduit à une augmentation des coûts de coordination, à une baisse concomitante de la disponibilité du financement externe et, finalement, engendre des problèmes de liquidités pesant notamment sur les investissements. Ces conséquences sont d'autant plus marquées que

¹ Les premiers économistes ont été fortement impliqués dans la sphère politique. Jean Bodin (1529-1596) était substitut du procureur du roi Charles IX (1567) puis commissaire à la réforme des forêts de Normandie (1570), Colbert (1619-1683) était contrôleur général des finances de Louis XIV (1665), Hume (1711-1776) était sous-secrétaire d'état au Royaume-Uni sous George III (1768) et Jacques Turgot (1727-1781) était contrôleur général des finances de Louis XVI (1774). Plus près de nous, Janet Yellen et Mario Draghi illustrent la place occupée par les économistes dans la gestion des affaires publiques.

les activités innovantes sont menées au sein de petites structures en début de cycle de vie (Hall & Lerner, 2010)².

Si les failles de marchés semblent avérées en matière de financement de l'innovation, elles ne constituent pas en tant que telles un argument suffisant pour justifier le soutien public aux jeunes entreprises innovantes (Mazzucato & Penna, 2016). L'action discriminante en faveur des jeunes et/ou petites entreprises, laissant de côté les plus grandes organisations établies, requiert un argumentaire supplémentaire qui repose sur leur contribution à l'activité économique (Haltiwanger et al., 2013 et Criscuolo et al., 2014).

1.1.2 Contribution à la croissance

Le rôle des jeunes entreprises à caractère innovant dans la dynamique économique a fait l'objet de nombreuses analyses qui rendent notamment compte de leur contribution à l'emploi. Dans les pays de l'OCDE, les PME représentent en général 99 % du tissu productif, les micro-firmes ayant de 1 à 9 salariés en constituant la grande majorité. Leur part dans l'emploi est substantielle, mais également très hétérogène selon pays. En effet, en 2016, alors que les PME représentent 88,38% des emplois en Grèce, ce taux n'est que de 53,08 % en Grande Bretagne. En France, 63,26 % des emplois sont dans les PME (OECD, 2019).³ Au-delà de leur poids en terme de nombre de salariés, ces entreprises sont également considérées comme des moteurs économiques ainsi que l'ont montré les travaux pionniers de Birch (1981 et 1990) à l'origine de la notion de *gazelles*. Selon ces auteurs, dont les travaux ont inspiré une abondante littérature (Acs et al., 2008 ; Haltiwanger et al., 2013 ; Henrekson & Johansson, 2010 et Nightingale & Coad, 2014), les jeunes et petites entreprises ayant une croissance rapide seraient à l'origine d'une importante partie des créations d'emplois.

La contribution des PME&Es à la valeur ajoutée est également soulignée par nombre de rapports et d'analyses. Elle varie entre 34,26 % aux Etats-Unis en 2015 et 76 % en Estonie en 2016 (OECD, 2019). Dans ce domaine aussi, les firmes à haut potentiel de croissance (*High-growth firms*) contribuent plus que proportionnellement à la création de valeur et aux gains de productivité (Hölzl, 2016). Bien que très souvent repris par les analystes et les

² Les plus grandes structures sont moins soumises à ces effets négatifs. D'abord, leur taille permet un rendement d'échelle, si bien qu'un même projet peut trouver des débouchés dans plusieurs activités de l'entreprise. Ensuite, les plus grandes organisations peuvent compenser les pertes d'un projet par les gains d'un autre ce qui est plus rarement le cas dans une PME qui se construit et se concentre sur un projet.

³ Les données sont tirées du rapport annuel sur les PME et l'entrepreneuriat (2019) disponible à l'adresse suivante : <https://doi.org/10.1787/888933923583>

décideurs publics, ces résultats sont largement dépendants des seuils retenus pour différencier les classes de taille d'entreprises ainsi que la distinction entre créations nettes et brutes (Benett, 2014). En effet, même si les firmes à fort potentiel de croissance semblent être d'importants contributeurs dans l'absolu, le fort taux de défaillance qui les caractérise réduit leur contribution nette à l'emploi (Schreyer, 1999 ; Picard, 2006 ; Tessier & Ramadan, 2020).

Les failles du marché dans le financement de l'innovation, couplées au poids important et croissant des PME dans l'activité économique constituent une justification de l'action publique. Ce point de vue est remis en question avec la considération selon laquelle l'Etat ne fait pas mieux que le marché en matière de réduction des imperfections (Grand, 1991) et que les politiques de soutien peuvent être contre-productives (Minniti, 2008). La littérature met ainsi en exergue l'importance de la caractérisation de la faille de marché et l'adéquation de l'instrument utilisé pour la réduire (Montmartin et Massard 2015 ; Hottenrott et Richstein 2020). Ainsi, les externalités de connaissances peuvent conduire à une situation de surinvestissement ou de sous-investissement impliquant dans le premier cas une subvention et dans le second cas une taxe toutes deux proportionnelles au niveau d'innovation.⁴

1.1.3 Théorie de la défaillance étatique

La théorie de la défaillance étatique part du principe que l'Etat n'est pas meilleur que le marché pour identifier ses failles et les corriger, car cela suppose une identification pertinente des contraintes pesant sur le marché et une expertise pour mettre en place des mécanismes compensateurs (Grand, 1991 ; Keech & Munger, 2015). Dans la lignée de Mazzucato & Semieniuk (2017), Tullock et al., (2002) mettent en évidence deux principales contraintes à la mise en place d'une politique publique. Du point de vue de l'identification des failles de marchés mais aussi des entreprises les plus prometteuses, les institutions peuvent ne pas posséder le savoir ou la technologie permettant un meilleur filtrage que le marché pour assurer la viabilité d'un projet à risque. De plus, des distorsions peuvent apparaître en cas

⁴ Montmartin et Massard (2015) mettent en évidence que l'innovation, et le stock de connaissances associé, peuvent être conçus comme un processus cumulatif intertemporel (i) (« *standing on shoulders of giants* ») ; dans cette perspective, l'innovation d'aujourd'hui bénéficie de celles des périodes antérieures. Par ailleurs le stock de connaissance peut également être vu comme un processus non cumulatif (ii) (« *fishing on the same lake* »), dans lequel l'innovation d'aujourd'hui est moins productive car elle intègre les gains de productivité résultant d'innovations antérieures. Si (i) est supérieur à (ii), alors une situation de sous-investissement se produit, réduite avec une incitation via une subvention proportionnelle. Dans le cas contraire, une situation de sur-investissement se produit impliquant la mise en place d'un processus désincitatif via une taxe proportionnelle au niveau d'innovation.

d'accapuration des objectifs publics par des intérêts personnels ou politiques (Mason & Brown, 2013) menant à un clientélisme stratégique de la part des autorités (Keech & Munger, 2015).

D'autres éléments viennent s'ajouter aux limites de l'intervention publique sur le marché de l'innovation. En effet, il peut y avoir un effet d'éviction quand les programmes de financement ciblent des firmes qui auraient été financées dans tous les cas par le privé (Shane, 2009). *A contrario*, le financement public pourrait créer un marché de « lemons » si seules les entreprises à faible potentiel sont présentes sur les marchés du financement public (Greenwald et al., 1984; Gustafsson et al., 2020; Santarelli & Vivarelli, 2007). Arshed et al., (2014), reprenant les idées de Shane (2009) et de Storey (2003), évoquent une source de défaillance à travers la formulation volontairement générique et floue des politiques publiques par les pouvoirs publics, que ce soit en termes de ciblage ou d'objectifs. Le Tableau 0-1, issu des travaux de Bennett (2014) résume la discussion de cette section concernant les principales sources de biais liées à la mise en place d'une politique publique pour les PME&Es.

Tableau 0-1 - Causes de la défaillance du soutien public

Aspect	Définition
Éligibilité (<i>Elibility game</i>)	Certaines firmes peuvent modifier leurs caractéristiques afin de convenir au programme ou alors passent des dépenses courantes pour des dépenses de R&D
Formulation (<i>Formulation</i>)	La formulation des politiques publiques par les pouvoirs publics en termes de ciblage et d'objectifs sont trop imprécises pour donner lieu à des évaluations pertinentes, qui peuvent conclure à une « mauvaise » politique (Arshed et al., 2014)
Poids mort (<i>Deadweight</i>)	Action envers des entreprises qui auraient été soutenues dans tous les cas.
Déplacement (<i>Displacement</i>)	Le soutien public à une firme réduit (respectivement augmente) les parts de marché (respectivement les coûts) d'une firme non soutenue, contribuant à son remplacement par la firme soutenue.
Eviction (<i>Crowding out</i>)	Les incitations du secteur privé sont réduites par l'intervention publique qui crée une concurrence inégale, sapant l'effort des investisseurs.
Dépendance (<i>Dependency</i>)	L'apport public constitue le seul élément contribuant à la survie. C'est souvent le cas dans le domaine agricole. Adelet McGowan et al. (2018) parlent dans ce cas de « firmes zombies ».
Aléa moral (<i>Moral hazard</i>)	Le soutien public peut éroder la motivation de l'entreprise incitant à plus de prise de risques et concourant à une « chasse à la subvention » qui est entreprise par les firmes les moins productives (Gustafsson et al., 2020)
Selection adverse (<i>Adverse selection</i>)	Le soutien public est accordé aux entreprises les plus en difficulté plutôt qu'à celles présentant le meilleur rendement.

Distortion des incitations (Incentives' distortion) et effet pervers (Perverse side effect)	Désincitations à la croissance créée par les incitations envers les PME. Garicano et al. (2016) montrent que la réglementation française concernant le seuil de 50 salariés n'est pas bénéfique du point de vue du bien-être global ⁵ .
Option facile (Easy option)	Ciblage peu discriminant de secteurs ayant de faibles failles de marché comme, par exemple, la garantie de prêt du small business act (SBA) aux Etats-unis aux secteurs des services avec une forte concurrence.

Réalisation de l'auteur sur la base de (Bennett, 2014)

La mise en place d'une politique publique ciblée, limitant les problèmes de défaillance, semble ainsi être l'objectif à atteindre pour toute organisation publique en charge du soutien aux PME&Es⁶.

Après avoir passé en revue les raisons d'être du soutien public à l'innovation dans les PME&Es ainsi que ses limites, nous allons étudier la mise en place de la politique Européenne dans la prochaine section.

1.2 *Le soutien l'innovation en Europe*

1.2.1 *Entre histoire économique et politique*

Au niveau mondial, la reconnaissance de la science comme domaine d'intervention légitime de l'Etat prend racine avec la publication de « *Science the endless frontier* » par Vannevar Bush en 1945. Alors qu'aux États-Unis cette publication a été la source d'un grand nombre de recherches débouchant rapidement sur la mise en place d'une politique dédiée aux PME en 1953 (Small Business Act), en Europe la reconnaissance de l'importance du soutien aux développements scientifiques et technologiques apparaît plus tardivement. Cette section revient sur le développement des politiques industrielles et d'innovation européennes pour en comprendre les orientations et objectifs.

Sur le plan économique, la fin de la Seconde Guerre mondiale assoit le rôle de l'Etat dans le soutien à l'économie, particulièrement dans une Europe ravagée par les combats et les bombardements. Cette période voit aussi l'avènement de la notion d'économie d'échelle et consacre la production de masse organisée par un état centralisé, qu'il soit socialiste ou capitaliste (Galbraith et al., 1968). Puisant dans les travaux de Schumpeter (1942) sur l'importance de l'innovation et sur l'avantage qu'auraient les grandes organisations, les

⁵ Pour obtenir un effet négatif de la régulation sur le bien-être, une hypothèse de rigidité des prix a été introduite.

⁶ Un jeu d'éligibilité peut également apparaître où certaines firmes peuvent être incitées à fournir des informations erronées pour convenir aux critères du programme ou faire passer des dépenses courantes en dépenses de R&D.

politiques de développement économique sont alors structurées par une gestion de la demande keynésienne (stimulation de la demande et relance budgétaire) à travers des politiques industrielles de soutien aux grandes entreprises, généralement en situation de monopole et/ou contrôlées par l'Etat (Landström et al., 2012). La hausse de l'inflation aux États-Unis au début des années 1970, la reprise concomitante du chômage de masse et les chocs pétroliers des années 1970 viennent mettre fin au modèle de politique économique basé sur les grands conglomérats (Nightingale & Coad, 2014), phénomène accéléré par l'émergence d'un nouveau paradigme technologique (celui des TICs). Sur le plan politique, l'arrivée au pouvoir de Ronald Reagan aux États-Unis (1981-1989) et de Margaret Thatcher (1975-1990) au Royaume-Uni marque le tournant vers le libéralisme économique, offrant aux PME&Es⁷ une place centrale à l'intérieur du modèle émergent de « l'économie de la connaissance » (Landström, 2008).

Les années 1980 et 1990 marquent également un tournant dans l'organisation Européenne. Elles servent de terrain d'entraînement pour la formulation de la politique industrielle et technologique (Plan Cadre de Recherche et le Développement Technologique (PCRD)) avec la signature des différents traités organisant les pays membres (Rome 1957, Maastricht, 1992, Amsterdam, 1997).

À partir des années 2000, la stratégie européenne s'étoffe avec les processus de Lisbonne (2000) et de Barcelone (2002)⁸ supposés faire entrer l'Union Européenne, à compter de 2010, dans une « l'économie de la connaissance la plus compétitive et la plus dynamique du monde ». Les mesures prises en ce sens visent à stimuler l'innovation, et notamment son financement, à travers une amélioration de l'accès au marché du capital risque et une augmentation des dépenses publiques directes (subvention, prêt) ou indirectes (incitations fiscales, garanties de crédit). Parallèlement, l'initiative de Bologne de l'OCDE (2000) souligne également l'importance croissante accordée aux PME&Es dans les politiques publiques et la croissance économique tirée par l'innovation. Le traité de Lisbonne de 2007, entré en vigueur en 2009, semble parachever la mise en place de la politique industrielle

⁷ Hébert & Link (2006) ont distingué trois groupes de théories de l'entrepreneuriat : l'école autrichienne, l'école allemande et l'école de Chicago, fortement imprégnée de l'influence autrichienne.

⁸ Le traité de Barcelone fixe des objectifs chiffrés visant à porter à 3% du PIB la dépense intérieure en R&D (DRID) avec un accent sur le secteur public supposé conduire ce changement à hauteur de deux tiers.

structurée au niveau Européen.⁹ Il introduit les politiques publiques structurantes tournées vers les défis auxquels les économies et les sociétés contemporaines sont confrontées (Mazzucato, 2016 ; Mazzucato et Penna, 2016). Pour autant, malgré ces initiatives, les contraintes de financement des PME&Es sont renforcées par la crise financière globale de 2008. Elles ont conduit certains commentateurs (Blavy et Allard, 2011) à mettre en évidence, la faiblesse du modèle économique européen basé sur les banques plutôt que sur les marchés en comparaison avec les Etats-Unis. Cette différence serait responsable du retard de l'Europe en matière d'innovation et de reprise de l'activité économique¹⁰

Face à ce constat, l'intervention européenne mobilise de manière croissante, à travers le Plan Juncker créé en 2014 et le Fonds Européen d'Investissement Stratégique (*EFSI* en anglais), les services de la Banque Européenne d'Investissement (BEI)¹¹ et met également en avant le rôle des banques nationales de développement dans le financement des PME&Es (Mertens et Thiemann, 2018). En plus de faciliter les canaux bancaires traditionnels avec une nouvelle régulation, plus souple concernant les prêts aux PME&Es, la Commission Européenne a également proposé un plan d'action pour améliorer le financement des PME&Es avec, notamment, la volonté de faciliter l'accès aux nouvelles formes de financement via le marché unique du capital risque (*CMU* en anglais) (EC, 2016 ; Block et al., 2018). Plus récemment, le programme COSME intégré au plan « Horizon 2020 » s'est focalisé sur les PME avec les Programmes-cadres pour la recherche et le développement technologique (PCRD) Européens. Doté de 2,3 milliards d'euros, le programme est destiné à (i) améliorer le financement, (ii) faciliter l'accès au marché et (iii) promouvoir l'esprit d'entreprise¹².

⁹ De plus, en réponse à l'initiative américaine initiée plus de cinquante ans auparavant, le SBA Européen est lancé en 2008 dans l'objectif de renforcer la culture entrepreneuriale au sein de l'Union Européenne.

¹⁰ La littérature sur la finance entrepreneuriale met en évidence les pressions réglementaires importantes (Bâle III) subies par les banques Européennes à la suite de la crise de 2008, qui les ont obligées à purger leur bilan des créances douteuses entraînant une réduction des volumes de prêts en direction du financement risqué au premier rang duquel se trouvent les PME et l'innovation (Block et al., 2018)

¹¹ et sa filiale Fonds Européen d'Investissement (FEI)

¹² La récente crise sanitaire liée au COVID-19 a poussé la Commission Européenne à tenir compte des difficultés des PME relatives aux chaînes d'approvisionnement à travers de nouvelles résolutions en avril et novembre 2020 concernant la nouvelle stratégie industrielle. Elle a autorisé à ce titre le déblocage d'une enveloppe de 7 milliards pour la France.

Influencée par l'accumulation de connaissance académique sur l'innovation¹³; (Baumol, 1968, 1996; Lundvall, 1999; Nelson, 1986) la stratégie européenne se décompose en actions nationales et régionales, qui tiennent compte des spécificités culturelles, institutionnelles et économiques nationales. Théorisée par (Lundvall, 1985) et repris par l'OCDE en 1997, les systèmes nationaux d'innovation sont définis sur le plan microéconomique par les interactions des différentes parties prenantes du système (Etat, entreprises, start-ups, universités, organismes de transfert de technologie et acteurs étrangers) et, sur le plan macroéconomique, par un cadre structurant incluant une langue, une culture et une structure politique communes.

La prochaine section s'applique à étudier l'application par les pouvoirs publics français de la stratégie européenne, en l'adaptant à la situation nationale.

1.3 Les politiques publiques d'innovation en France

L'adaptation des politiques françaises au cadre européen s'effectue à partir d'un système réputé fortement centralisé, en dépit des réformes de décentralisation introduites par la Loi dite Defferre en 1982. En effet, dans l'un de ses premiers rapports, la CNEPI (2016) met en évidence l'importance de l'Etat central qui attribue 8 551 millions d'euros d'aides à l'innovation (87,2 % du total), loin devant les Régions qui distribuent 527 millions d'euros (5,4%), suivies par les autres collectivités territoriales (départements, métropoles, communautés de communes, communes) qui injectent 289 millions d'euros (2,9%). À cela s'ajoutent les financements provenant directement de l'Europe qui représentent un montant de 441 millions d'euros (4.5% du total). Cette répartition est le produit d'une histoire des politiques publiques françaises et des acteurs sur lesquels elle repose.

1.3.1 Les politiques publiques d'innovation en France : un développement en trois temps

Pendant la période de reconstruction qui suit la Seconde Guerre mondiale, la France, soucieuse de reconquérir son indépendance et sa puissance économique mais aussi militaire, cherche à reconstruire son industrie et développer sa capacité scientifique. Des assises et débats pour définir une politique française industrielle et scientifique sont initiés dès la fin de

¹³ L'innovation n'apparaît que tardivement dans le champ lexical des politiques publiques. Les politiques d'innovation font le lien entre les politiques de recherche technologiques et les politiques industrielles. Son introduction va de pair avec l'avènement de la théorie des « systèmes nationaux d'innovation » (Lundvall, 1985, and OECD, 1999) dans la littérature institutionnelle et académique.

la guerre avec la mise en place des plans de modernisation de l'équipement (PMDE)¹⁴. La planification productive nationale suit les dates les PCRD de la Commission Européenne, intégrant à partir du 10ème plan (1989-1992) le cadre de travail macroéconomique présenté par la Commission Européenne à travers le second PCRD (1987 1991). Depuis lors, les convergences entre le plan Français et les directives européennes en matière de politique d'innovation apparaissent grandissantes sans pour autant cacher l'orientation souvent qualifiée de "colbertiste" dominée par les dépenses militaires et des grands programmes technologiques.¹⁵

Depuis les années 1990, la France connaît une un recul de sa présence sur les marchés extérieurs et une érosion de l'industrie expliqués, notamment, par un faible investissement privé en particulier en R&D (Demmou, 2010 ; Gallois, 2012).¹⁶ En réponse à cette situation et pour tenter d'inverser la tendance, de nombreux dispositifs d'aides et un système de subventions ont été mis en place jusqu'au début des années 2000. Elles sont distribuées par les ministères des Armées ou en charge de la recherche et par le biais de grands programmes cadres (Fond national pour la science (1999), Fonds pour la recherche technologique (1999)).

Sur la base du coût budgétaire de ces mesures et des rapports sur la France qui dénoncent l'excessif interventionnisme de l'Etat et sa trop grande implication en tant qu'acteur de la production (Bpifrance, 2015, OCDE, 1999), la politique française en faveur de l'innovation va connaître un tournant qui débute avec la loi Allègre adoptée en 1999. Elle marque le passage d'une politique fondée sur l'intervention directe à une action principalement fondée sur des incitations fiscales (avec l'extension du «crédit d'impôt recherche» créé en 1983) et confie une partie de la mise en œuvre de la politique à de grands opérateurs publics indépendants (OSEO qui deviendra plus tard Bpifrance) (Fontagné et al., 2014). L'adoption de la vision européenne et la montée en puissance des travaux académiques sur l'importance de l'entrepreneuriat et des jeunes entreprises innovantes dans la croissance, (CGP, 2003)¹⁷ vont conjointement contribuer à une transformation des politiques publiques d'innovation françaises qui vont se déployer sur cinq axes : (i) augmenter les capacités

¹⁴ Le plan « Monnet » initié en 1946, vise à doter la France d'un appareil productif industriel détruit par la guerre. Il est centré sur le charbon, l'électricité, le ciment, le machinisme agricole, le transport et l'acier. On y voit déjà un embryon de convergence avec la Communauté européenne du charbon et de l'acier instaurée (1951)

¹⁵ Sur ce thème, voir Minard (2008).

¹⁶ Les mécanismes sont en partie développés par Demmou (2010).

¹⁷ Le lien entre l'innovation et la croissance de long terme est développé par (Aghion et Howitt, 1990) et récemment par (Bloom et al., 2019). Les statistiques de croissance sont fournies par l'INSEE.

privées en R&D, notamment grâce au dispositif «crédit d'impôt recherche», (ii) accroître les retombées économiques de la recherche privée, (iii) développer des projets de coopération entre acteurs et réseaux, (iv) promouvoir l'entrepreneuriat innovant et (v) soutenir le développement des entreprises innovantes. Chaque objectif se voit doté d'une ligne budgétaire propre comme le souligne le Tableau 0-2 .

Cette recherche doctorale se concentre sur le volet financier des politiques d'innovation dont nous cherchons à mettre en évidence l'importance. Cette question est en effet centrale, nombre de travaux ayant mis en évidence l'importance de la contrainte financière dans l'engagement à l'innovation des entreprises (St-Pierre, 2004 ; St-Pierre & Fadil, 2011 ; CGP, 2003 ; Julien, St-Pierre, Beaudouin, 1996). Le Tableau 0-2 montre qu'en France les politiques publiques de soutien financier à l'innovation et aux jeunes entreprises innovantes se concentrent les incitations fiscales visant à renforcer l'investissement innovant dans les entreprises (Chapitre 1) et sur l'action de Bpifrance via l'octroi de subventions, de prêts, et des prises de participation (Chapitre 2).

Tableau 0-2 - Objectifs des moyens des politiques publiques en France

Famille d'objectifs	Millions d'euros	En %
1/ Augmenter les capacités privées en R&D	6001,5	70,2 %
2/ Accroître les retombées économiques de la recherche publique	225,9	2,6%
3/ Développer les projets de coopération entre acteurs et réseaux	613,5	7,2 %
4/ Promouvoir l'entrepreneuriat innovant	304,7	3,6 %
5/ Soutenir le développement d'entreprises innovantes	1406,0	16,4 %
Total	8551,6	100%

Source : CNEPI (2016)

Tableau 0-3 - Evolutions des instruments publics de financement en France entre 2000 et 2015

Modalités	2000		2015		Variation 2015-2000 en volume	
	Millions €	%	Millions €	%	Millions €	%
Incitations fiscales	584	16,5%	6341	74,2 %	+ 5644	810 %
Subventions	2854	80,9%	1636	19,9	- 1770	- 52 %
Prêts	0	0 %	198	2.	+ 198	-
Participation	91	2,6 %	376	4,4 %	+ 267	246 %
Total	3529,3	100 %	8551	100 %	+ 4339	103 %

Source : CNEPI (2016)

La présente recherche doctorale se concentre sur le volet financier des politiques d'innovation dont nous cherchons à mettre en évidence l'importance. Cette question est en effet centrale, nombre de travaux ayant mis en évidence l'influence de la contrainte financière dans l'engagement à l'innovation des entreprises (St-Pierre, 2004 ; St-Pierre & Fadil, 2011 ; CGP, 2003). Ainsi, le Tableau 0-3 montre comment les politiques publiques de soutien financier à l'innovation et aux jeunes entreprises innovantes se sont concentrées sur les incitations fiscales visant à renforcer l'investissement innovant dans les entreprises (Chapitre 1) et sur l'action de Bpifrance via l'octroi de subventions, de prêts, et des prises de participation (Chapitre 2).

1.3.2 Le cas du capital risque

Le financement par capital risque est, en France comme dans nombre d'autres pays européens, souvent jugé comme insuffisant, notamment par rapport aux Etats-Unis (CNEPI, 2016) comme le montre la Figure 0-1.

Figure 0-1 - Investissements en capital-risque dans les pays de l'OCDE, 2016, % PIB

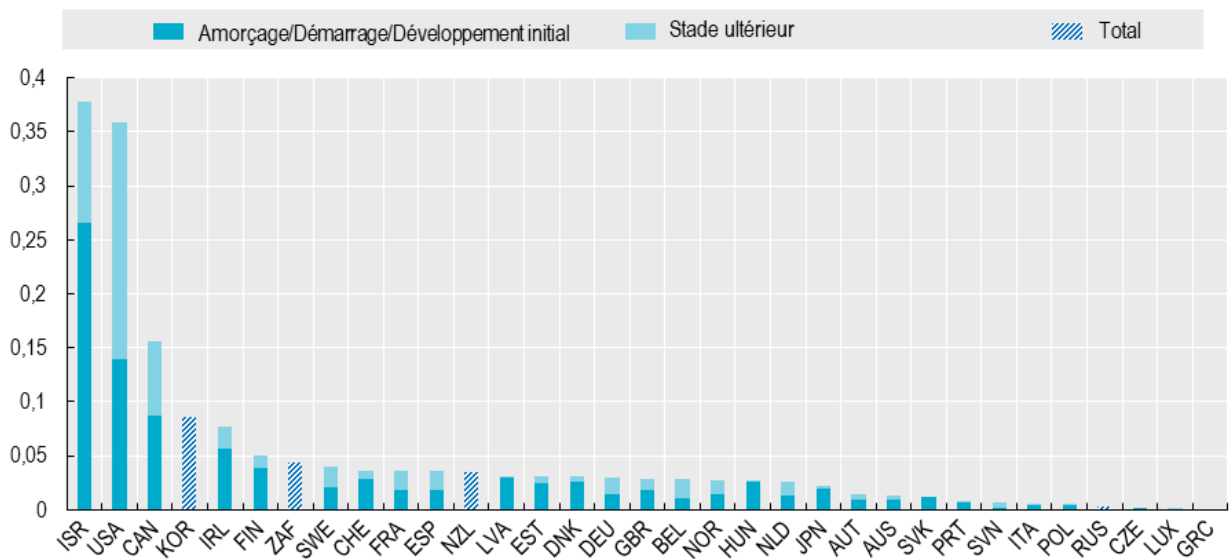

Source : Panorama de l'entrepreneuriat 2017 (OCDE, 2018)

Souvent soulignée et déplorée (CGP, 2003), l'insuffisance du financement de l'innovation par capital risque a resurgi avec la crise de 2008 qui a mis en évidence une meilleure résilience des économies de marché par rapport aux économies bancaires (Allard et

Blavy, 2011)¹⁸. En effet, le durcissement des conditions de crédit à la suite de la crise a obligé acteurs privés et publics à trouver des substituts de financement, au premier rang desquels se place le capital-risque (Fontagné et al., 2014). Parallèlement, le succès des économies comme Israël ou les Etats-Unis met en évidence l’avantage du marché du capital risque comme vecteur de financement de projets peu ou mal appréciés de la part des banques¹⁹.

Comme le montre la figure 0-2, depuis 2009, la France connaît une hausse quasi-continue des investissements en capital-risque (3,7 milliards en 2009 et 18,7 milliards d’euros en 2018) qui s’accompagne, sur le plan politique, de réclamations de la part des acteurs du secteur concernant l’amélioration du cadre réglementaire relatif aux incitations fiscales à l’investissement productif (Ministère du redressement productif, 2012). Au-delà du cadre institutionnel et réglementaire, l’environnement des affaires à travers les infrastructures, l’accès au financement, aux compétences et aux actifs innovants est devenu un facteur déterminant dans le dynamisme de l’investissement pour la consolidation du tissu entrepreneurial (OCDE, 2019).

Figure 0-2 - Evolution des investissements en capital risque en France

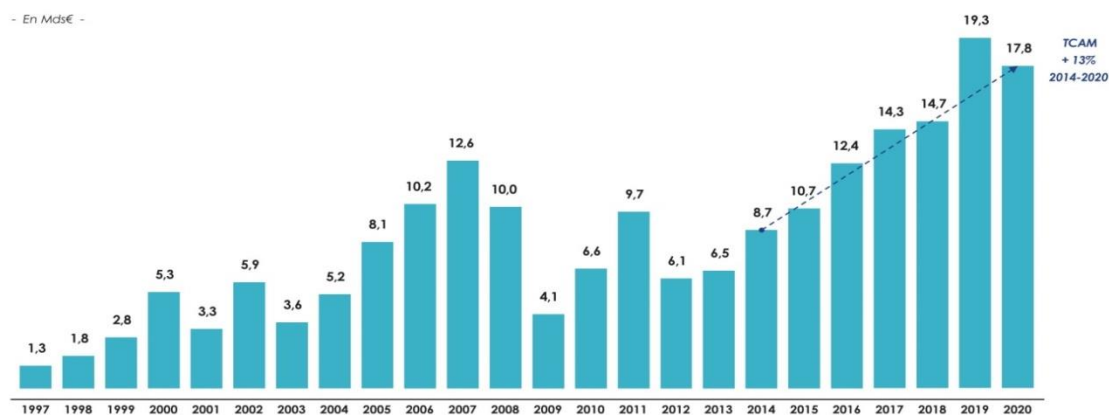

Source : France Invest (2020)

¹⁸ Ce retard est d’autant plus préoccupant qu’il provient d’une faiblesse des fonds d’amorçage relativement aux fonds d’expansion (EY, 2015, 2020).

¹⁹ Le principal argument avancé par la littérature réside dans la faible mobilisation de l’épargne privée à destination du capital-risque comparée aux États-Unis. Les fonds proviennent en Europe davantage des compagnies d’assurance ou des banques privées.

Parmi les différents acteurs du secteur, les Business Angels, investisseurs indépendants souvent structurés en réseaux (*Business Angels Networks* - *BANs* en anglais)²⁰, sont considérés comme les plus aptes à soutenir les projets en émergence, souvent rejetés par les banques faute de garanties suffisantes et encore trop petits pour les capitaux-risqueurs (Croce et al., 2021; Politis, 2008; Tenca et al., 2018). Le développement des Business Angels en France passe également par les partenariats et les liens qu'ils peuvent créer avec les acteurs notamment du capital amorçage, à l'instar de Bpifrance et de sa plateforme Euroquity mais également des réseaux d'incubateurs (1Kubator) de capital investissement (Raise) et de crowdfunding (Sowefund). La présence de France Angels et de ses réseaux offre une opportunité unique de financement par capital risque, avec un volume d'activité qui ne fléchit pas, même durant les crises comme en attestent les 40 millions d'euros investis en 2010, mais également la mise en place d'une continuité de l'activité durant la crise sanitaire liée au COVID-19 (Figure 0-3). Les entreprises financées exercent pour la plupart dans des secteurs technologiques avec 52 % des volumes d'investissement orientés vers les secteurs des biotechnologies et du digital en 2019. Sur le plan géographique, la région parisienne polarise la plupart des entreprises financées (33,4 %), mais également des montants (33 %) et des investisseurs (54,5 %) (Source : France Angels, 2019).

Figure 0-3 - Evolution des investissements des Business Angels en France (en millions d'euros)

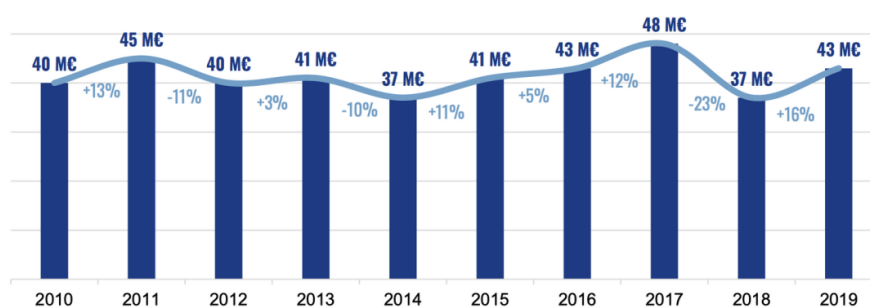

Source : France Angels (2019)

Le premier chapitre de la thèse se consacre à ce segment du marché dont il interroge l'efficacité. Il vise à apporter un regard récent sur le financement des entreprises par capital

²⁰ Les business angels sont pour la plupart structurés en réseaux, entités associatives permettant la mise en relation entre investisseurs et entrepreneurs à une fréquence généralement mensuelle. Fortement insérés dans le tissu économique régional les réseaux mais pouvant également se déployer sur des projets internationaux, les réseaux sont structurés en fonction géographique, thématique ou affinitaire. France Angels, fédération des réseaux de business angels regroupe 64 réseaux de business angels depuis sa création en 2001 pour un total de 686 millions € investis et vise à représenter, promouvoir, relayer et soutenir l'action des Business Angels.

risque en France en étudiant le cas d'entreprises financées par France Angels. Il propose notamment d'étudier l'impact des BANs sur la structure du capital et le développement des entreprises financées.

1.3.3 Le cas des banques de développement

En France, Bpifrance, désormais acteur majeur de la politique d'innovation, constitue le bras armé des pouvoirs publics en matière de financement de l'innovation. La banque de développement, filiale de la caisse de dépôts est créée en 2012 par la fusion d'OSEO, de CDC entreprises, du FSI et des FSI régions. La nouvelle entité centralise des activités qui étaient dispersées parmi de nombreux opérateurs. Bpifrance est l'héritière d'une longue tradition historique interventionniste (Figure 0-4), initiée en 1929 par Jacques Branger avec la caisse nationale des marchés de l'Etat (CNME) qui sera créée en 1936. La CNME, a pour ambition de sortir la France de la dépression grâce à une planification rigoureuse (Gaston-Breton, 2015). La Figure 0-4 résume les principales étapes concourant à la constitution de Bpifrance et de ses prérogatives et met en évidence l'importance précoce accordée aux PME&Es dans le financement public. Couvrant les marchés du capital amorçage jusqu'au capital-transmission, l'offre de Bpifrance se décline pour toutes les tailles d'entreprises comme le résume Figure 0-5.²¹

Figure 0-4 - Histoire de Bpifrance

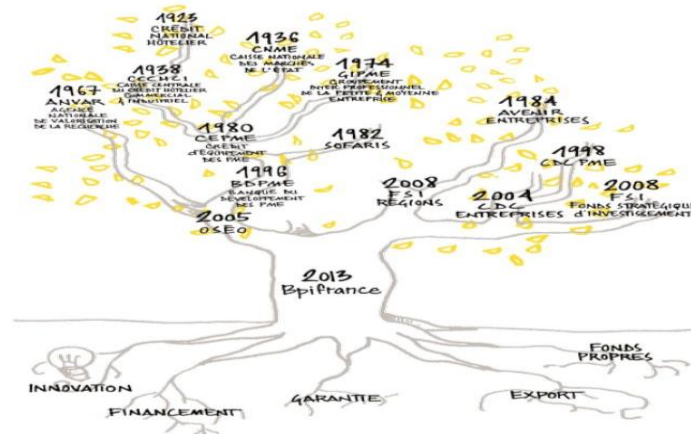

Source : Gaston-Breton (2015)

²¹ Le cas du développement historique au niveau mondial (Banque internationale pour la reconstruction et le développement (BIRD)) et européen (Banque Européenne d'investissement (BEI) et Fonds Européen d'investissement (FEI)) sont en dehors de la portée de cette introduction. Des précisions au sujet de ces institutions sont fournies par Mazzucato et Penna (216) et Mertens et Thiemann (2019).

Le poids croissant de l'action de Bpifrance va dans le sens de la littérature qui met en évidence l'importance du rôle des banques publiques de développements (BPDs) comme alternative au financement bancaire traditionnel à la suite de la crise de 2008. Les développements théoriques sont récents et fournissent peu d'éléments pratiques pour déterminer le contour de leurs missions objectifs (Ferrer, 2018; Mertens et Thiemann, 2019). Leur dénomination même ne fait pas l'objet d'un consensus.²² Mazzucato et Penna (2016) et Mertens et Thiemann (2019) mettent en évidence quatre rôles principaux de BPDs, chacun motivé par la réduction d'une faille de marché : (i) le rôle contra-cyclique, (ii) le rôle de développement, (iii) le rôle de soutien à la création et au développement d'entreprises et (iv) la création de nouveaux marchés orientés vers les défis sociétaux. Alors que le rôle contra-cyclique (i) est justifié par le manque de coordination des agents, le rôle de développement (ii) est, quant à lui, motivé par l'incomplétude des marchés liée au caractère de bien public de l'innovation (externalités positives) qui empêche une internalisation complète du bénéfice par les agents. La concurrence imparfaite, notamment sur le marché de l'innovation et à l'exportation (coûts d'entrée et externalités positives), fournit également une justification du rôle de développement des BPDs. La justification du soutien à la création et au développement d'entreprises (iii) prend racine dans l'asymétrie d'information qui limite l'accès des entreprises innovantes au financement (Guiso, 1998). L'incertitude sur les rendements liés à l'innovation et les difficultés pour les jeunes firmes à assurer de leur qualité (via un collatéral ou un historique financier) contribuent à augmenter les coûts de transaction et engendrent un « fossé financier » (*funding gap*). La création de nouveaux marchés ou segments de marchés tient dans l'incapacité des acteurs privés à changer de direction de manière autonome (marchés aveugles). Le marché ne se projette que dans le paradigme technologique dans lequel il se trouve, mais ne permet pas d'en changer, ce qui justifie l'intervention de l'Etat pour l'« orienter » vers de nouveaux paradigmes (transition écologique, croissance inclusive, etc.).

Cette question est approfondie dans le deuxième chapitre de cette thèse qui en propose l'étude en prenant comme référence le soutien qu'accorde Bpifrance à travers un prêt participatif amorçage en faveur des jeunes entreprises innovantes. Par sa nature et ses objectifs, ce dispositif fait écho aux objectifs (ii) et (iii) précédemment mentionnés. L'action

²² Ferrer (2018) parle de : « national promotional banks and institutions » (NPBIs), tandis que Mazzucato et Penna (2015) les dénomment « state investment banks » (SIB).

de Bpifrance s'inscrivant dans une dynamique de transition environnementale et numérique, ce dispositif relève aussi de l'objectif (iv) dans la mesure où il comble le besoin de financement de projets à fort impact social. Son examen permettra donc de déterminer si et comment une banque publique peut exercer une influence sur l'innovation.

Figure 0-5 - Offre de financements de Bpifrance



Source : Bpifrance <https://www.thinglink.com/scene/670641663617531905>

1.4 L'évaluation : une nécessité encore en développement

Les premiers programmes d'évaluation ont vu le jour aux États-Unis au début du XXe siècle. Le *General Accounting Office*, équivalent des Cours des comptes européennes, est créé en 1921. Cet organisme, qui dépend du Congrès, devient à partir de 1970 un acteur central de l'évaluation et instaure une approche principalement quantitative de cette démarche. Après la Seconde Guerre mondiale, la pratique de l'évaluation se répand aux autres pays anglo-saxons (Canada, Nouvelle-Zélande) et à l'Europe du nord. Les développements de l'évaluation des politiques publiques trouvent leurs origines principalement dans la rationalisation croissante de dépenses publiques couplée à un mouvement plus récent en faveur des politiques publiques basées sur la démonstration scientifique (*evidence-based policy*).

Si les pratiques d'évaluations sont répandues de longue date dans les pays anglo-saxons²³, la France a pris plus tardivement le virage de l'évaluation des politiques publiques entrée en vigueur avec le 10^{ème} plan de modernisation de l'équipement et la création d'organismes scientifiques dédiés à l'évaluation. Ces pratiques sont cependant désormais inscrites dans la constitution. Ainsi, déjà consacrée par la loi organique relative aux lois de finance (LOLF) en 2001, l'article 47-2 (2008) de la constitution consacre l'importance de l'évaluation des politiques publiques. Alors que la dette publique atteint 98,1 % du PIB en 2019 selon Eurostat et que l'Etat est fortement engagé dans le soutien aux entreprises suite à la crise du COVID (France stratégie, 2021 ; Banque de France, 2021) l'évaluation devrait être amenée à occuper une place centrale dans la conception et la mise en œuvre des politiques publiques (Bozio & Romanello, 2017).

Les politiques d'innovation se matérialisent par de nombreux programmes peu lisibles²⁴, résultant d'adaptations, d'un processus de sédimentation et de l'absence d'évaluation de la pertinence de dispositifs (Encaoua, 2017). A ce titre, l'inspection générale des finances en 2013 note : « Des flux importants sont constatés entre collectivités et avec les organismes publics, montrant à la fois la multiplicité d'acteurs et de potentiels doublons. »²⁵ De plus, sur un même territoire, la diversité des aides publiques et la multiplicité des acteurs

²³ Les premiers travaux d'évaluation des politiques publiques concernent les grands programmes américains de lutte contre la pauvreté initiés par l'administration Johnson dans les années 1960.

²⁴ Le rapport de la Commission d'évaluation des politiques d'innovation (CNEPI, 2016) recense 60 dispositifs nationaux, excluant les dispositifs d'aides régionales et les programmes Européens. Larédo (2015) résume le phénomène avec la phrase : « Un ministre, un colloque, une loi ».

²⁵ Rapport N° 2013-M-016-02 Inspection générale des finances, 2013.

les proposant ne contribuent pas à accroître leur lisibilité. Selon la formule consacrée, ce manque de lisibilité lié au «mille-feuilles» d'aides contribue à une relative inefficacité des dépenses publiques visant à stimuler l'innovation dans PME&Es et nuit à leur financement et donc finalement à leur développement (Battini, 2015)²⁶.

Afin de s'assurer de la rationalité des dépenses publiques et en raison de la multiplicité des instruments, les pouvoirs publics, les *Think tanks* et les chercheurs réalisent de nombreuses évaluations à l'origine de résultats hétérogènes qui compliquent la conduite et le changement des politiques adoptées (Becker, 2015; Dimos & Pugh, 2016; Dvouletý et al., 2020; Zúñiga-Vicente et al., 2014). Ces conclusions, divergentes sur l'efficacité de l'action publique en matière d'innovation, seraient à l'origine de leur faible appropriation par les décideurs. Ces derniers sont en effet enclins à s'appuyer sur d'autres modalités que l'évaluation pour nourrir l'information sur les politiques adoptées comme le prévoit le troisième pilier du triptyque de (Weiss, 1983),²⁷.

C'est dans cet esprit que le chapitre 3 de cette recherche doctorale s'interroge sur la manière dont la littérature influence ou reflète les dispositifs d'évaluation. En effet, la variété, voire le caractère contradictoire, des résultats empiriques obtenus permet en effet de comprendre une partie des raisons pour lesquelles les décideurs publics négligent ce champ de recherche.

1.5 Principaux résultats et contribution de la thèse.

L'objectif central de cette thèse est d'apporter un éclairage sur les moyens mis en œuvre pour renforcer l'innovation et l'analyse de leur efficacité. Elle repose sur une démarche empirique, essentiellement quantitative, reposant sur des dispositifs français complétés par une revue de littérature portée par une méthodologie originale. La recherche s'organise en trois chapitres, chacun étudiant le financement de l'innovation et les politiques publiques associées. Les deux premiers chapitres proposent une analyse microéconomique par contrefactuel de deux modes d'intervention auprès des jeunes entreprises innovantes portés par deux parmi les principaux acteurs du financement d'amorçage en France. Le premier s'intéresse aux Business Angels et analyse leur influence sur la trajectoire et les

²⁶ La loi Pinel est mise en cause pour expliquer le recul de 4,7% des immatriculations d'entreprises entre 2014 et 2015

²⁷ Weiss (1983) développe le modèle des trois «i» pour idéologie, intérêt et information pour expliquer les déterminants de la prise de décision publique.

performances des firmes investies au regard d'entreprises semblables qui ne bénéficient pas d'un tel accompagnement. Le second place la focale sur Bpifrance et plus particulièrement sur les prêts participatifs d'amorçage. Contrairement aux précédents qui s'intéressent à un dispositif particulier, le troisième chapitre prend de la distance par rapport à l'action publique en proposant une revue systématique de la littérature sur l'évaluation des dispositifs de soutien direct à l'innovation en Europe. Il vise ainsi à explorer l'accumulation et l'utilisation de connaissances scientifiques en matière de soutien public à l'innovation.

Le premier chapitre, intitulé « *Are business angel-backed companies truly different? a comparative analysis of the financial structure* » propose d'étudier le marché de l'amorçage en France à travers le capital-risque et l'intervention de France Angels, la fédération nationale des réseaux de Business Angels français. Ce chapitre, aborde la question de la contribution des BAs au développement des entreprises soutenues via la modification de la structure du capital (Gosh 2008). Il propose une analyse empirique de cette question à partir d'une méthodologie d'appariement et de double différence sur des données françaises couvrant la période 2009-2014. Les apports réalisés sont avant tout empiriques. Ils mettent en évidence une certaine professionnalisation de la prise de décision, positivement influencée par les performances économiques ainsi que par la taille des entreprises. La capacité des BANs à modifier le sentier de croissance des entreprises soutenues via une action sur la structure du capital trouve un support, bien que modeste, à travers la réduction du poids de la dette commerciale, interprétée comme une réduction de l'asymétrie d'information. Les implications de ce chapitre concernent, du côté de l'offre de financement, l'importance de la mise en place d'une collecte de données systématique et rigoureuse. Cette dernière doit aborder des aspects quantitatifs (date de l'investissement, montants, nombres d'investisseurs) et qualitatif (âge, formation, passé entrepreneurial) pouvant permettre d'étudier la stratégie d'investissement des BANs ainsi que leur impact sur les entreprises financées et sur l'écosystème du capital-risque (Croce et al., 2020). Sur le plan des politiques publiques, la mise en évidence d'un effet de certification marginal pourrait servir de base argumentaire pour légitimer les dépenses publiques en matière d'incitation à l'investissement dans le capital risque (exonérations de charges).

Le deuxième chapitre intitulé « *Participative loan for innovative firms in France* » s'attache à étudier l'impact d'un prêt participatif amorçage administré par Bpifrance sur la période 2006-2014. Reprenant une méthodologie d'appariement en double différence, le chapitre étudie l'additionnalité du soutien public en termes d'intrants et d'extrants (*input et*

output additionality) et étudie aussi la certification des dépenses publiques. Alors que la finance mezzanine apparaît être un instrument flexible de financement, particulièrement adapté aux entreprises jeunes et innovantes, son utilisation est relativement récente, du moins en France, et son étude au niveau académique ne bénéficie pas d'un développement équivalent à celui des dépenses fiscales ou des subventions directes (Marti and Quas, 2018 ; Bertoni et al. 2019). Structuré pour accompagner les entreprises dans l'objectif d'une levée de fonds future, le prêt participatif amorçage cible des jeunes entreprises à fort caractère innovant pour soutenir leur croissance. Pour étudier l'impact du prêt sur les entreprises soutenues et contrôler le biais de sélection, nous comparons les trajectoires des entreprises financées avec celles d'entreprises ayant une structure innovante similaire (présence d'une aide à l'innovation) sur la base de données de bilan fournies par l'INSEE. Les résultats mettent en évidence un effet positif sur l'accumulation du capital immatériel interprété comme une additionnalité d'intrant positive. Pour autant l'impact sur l'emploi, les ventes et la productivité ne permettent pas de conclure à une additionnalité en termes d'extrant. Les analyses de sensibilité mettent en évidence l'importance de paramètres d'implémentation de l'instrument. Nous constatons également que les périodes de crise catalysent l'effet du traitement sur l'emploi, renforcé pendant la crise et atténué en dehors. Enfin, nous observons, en accord avec la littérature, que les petites entreprises sont plus affectées par le traitement que les entreprises de plus grande taille. Ce chapitre débouche sur des recommandations en matière de politiques publiques. Il souligne en effet l'importance de l'opérationnalisation des instruments de soutien et le besoin de définition claire des objectifs visés. Les résultats obtenus conduisent à inviter les pouvoirs publics à tenir compte de la possibilité d'effets d'arbitrage non anticipés, voire d'effets d'aubaine, par les firmes soutenues et les acteurs qui les accompagnent.

Le troisième chapitre intitulé « *The babel tower of public support for entrepreneurship and small businesses: a systematic literature review* » revient sur la littérature consacrée au financement public à l'innovation en Europe depuis 2010. Dans la lignée des deux chapitres précédents, il revient sur le soutien public direct à l'innovation pour les jeunes entreprises à caractère innovant en étudiant l'évolution de la littérature académique sur le sujet à l'aide d'une revue structurée de la littérature et d'outils bibliométriques. La sélection, effectuée sur deux bases de données académiques permet d'évaluer la pertinence et la couverture relative des bases de données sur le sujet et constitue l'un des apports principaux du chapitre à la littérature bibliométrique. Confirmant les résultats des précédentes études

systematiques sur le soutien public et le financement de l'innovation, la contribution de ce chapitre réside dans la mise en évidence de l'importance accordée aux considérations méthodologiques (Storey, 2003) laissant en partie de côté les considérations relatives à la définition des concepts utilisés pour caractériser les firmes (Hölzl, 2016 ; Coad & Srhoj, 2020). Nous observons ensuite que cette hétérogénéité conceptuelle contrarie l'émergence de constats homogènes pouvant servir à la construction de politiques publiques basées sur la preuve. Fortement liées au sujet de l'évaluation, les implications de ce chapitre concernent autant la sphère académique que politique. Pour la première la recherche de validité externe pour asseoir la crédibilité des résultats conduit à des comparaisons davantage basées sur le vocabulaire que sur une attention aux réalités économiques sous-jacentes, réduisant potentiellement la portée des résultats et, finalement, la portée des recommandations. Sur le plan politique, les résultats obtenus alerte sur la production de savoir à destination de la prise de décisions en matière de politique publique et sur l'importance qui doit également être accordée à la comparaison des échantillons en plus de celle déjà accordée aux méthodes.

Encadré 1 Eléments de cadrage conceptuels

Politique publique

Dans le contexte de cette thèse les politiques publiques sont envisagées à la lumière de la définition proposée par Storey (2003) : « this we mean those [public policies] which use taxpayers' funds to directly or indirectly target primarily or exclusively SMEs » (Acs & Audretsch , 2006).

Innovation

L'INSEE (2020) propose la définition suivante : « L'innovation désigne l'introduction sur le marché d'un produit ou d'un procédé nouveau significativement amélioré par rapport à ceux précédemment élaborés par l'unité légale. » Cette définition prend donc un point de vue interne à la firme plutôt qu'un point de vue externe, centré sur le marché. La définition fournie par l'INSEE en France est conforme aux définitions Européennes encadrées par le manuel d'Oslo (OECD & Eurostat, 2018) qui voit l'innovation comme : « est la mise en œuvre d'un produit (bien ou service) ou d'un procédé nouveau ou sensiblement amélioré, d'une nouvelle méthode de commercialisation ou d'une nouvelle méthode organisationnelle dans les pratiques de l'entreprise, l'organisation du lieu de travail ou les relations extérieures » Manuel d'Oslo, 3e édition, OCDE, 2005. Le manuel de Frascati, antérieur à celui d'Oslo, (OECD, 2015) se consacrait uniquement aux ressources dédiées à la RD. Il s'attachait à définir de facto, pour des besoins de comparaison statistiques internationales la recherche et développement (R&D)

PME&Es

Littéralement « Petites, Moyennes Entreprises & Entrepreneurs », cette définition ad hoc renvoie à la définition américaine de « small businesses » (Bennett, 2014) utilisée pour définir les firmes d'amorçage, à la fois considérée sous l'angle entrepreneurial, insistant sur les caractéristiques personnelles (Rojas & Huergo, 2016) ou sur les caractéristiques de l'entreprise naissante (Vanino et al., 2019)

1.6 References

- Acs, Z., & AUDRETSCH, D. (2006). Handbook of entrepreneurship research: An interdisciplinary survey and introduction (Vol. 1). Springer Science & Business Media.
- Acs, Z. J., Parsons, W., & Tracy, S. (n.d.). High-Impact Firms: Gazelles Revisited. 92.
- Aghion, P., & Howitt, P. (1990). A model of growth through creative destruction. National Bureau of Economic Research.
- Arrow, K. J., & Debreu, G. (1954). Existence of an Equilibrium for a Competitive Economy. 22(3), 27. <https://www.jstor.org/stable/1907353>
- Arshed, N., Carter, S., & Mason, C. (2014). The ineffectiveness of entrepreneurship policy: Is policy formulation to blame? *Small Business Economics*, 43(3), 639–659.
- Battini, P. (2015). La problématique de l'innovation en France. *Vie Sciences de l'entreprise*, 2, 119–141.
- Baumol, W. J. (1968). Entrepreneurship in economic theory. *The American Economic Review*, 58(2), 64–71.
- Baumol, W. J. (1996). Entrepreneurship: Productive, unproductive, and destructive. *Journal of Business Venturing*, 11(1), 3–22. [https://doi.org/10.1016/0883-9026\(94\)00014-X](https://doi.org/10.1016/0883-9026(94)00014-X)
- Becker, B. (2015). Public R&D policies and private R&D investment: A survey of the empirical evidence. *Journal of Economic Surveys*, 29(5), 917–942.
- Bennett, R. J. (2014). Entrepreneurship, small business and public policy: Evolution and revolution. Routledge.
- Birch, D. L. (1981). Who creates jobs? *The Public Interest*, 65, 3.
- Birch, D. L. (1990). Sources of job growth—And some implications. In *Jobs, earnings, and employment growth policies in the United States* (pp. 71–76). Springer.
- Blavy, R., & Allard, J. (2011). Market Phoenixes and Banking Ducks Are Recoveries Faster in Market-Based Financial Systems?
- Block, J. H., Colombo, M. G., Cumming, D. J., & Vismara, S. (2018). New players in entrepreneurial finance and why they are there. *Small Business Economics*, 50(2), 239–250. <https://doi.org/10.1007/s11187-016-9826-6>
- Bloom, N., Van Reenen, J., & Williams, H. (2019). A Toolkit of Policies to Promote Innovation. *Journal of Economic Perspectives*, 33(3), 163–184. <https://doi.org/10.1257/jep.33.3.163>
- Bozio, A., & Romanello, L. (2017). Évaluation des politiques publiques: Le bilan contrasté du quinquennat. *Notes IPP*, 25.
- Bpifrance (2015). SME Investment and Innovation France, Germany, Italy and Spain
- Coad, A., & Srhoj, S. (2020). Catching Gazelles with a Lasso: Big data techniques for the prediction of high-growth firms. *Small Business Economics*, 55(3), 541–565. <https://doi.org/10.1007/s11187-019-00203-3>

- CNEPI (2016), *Quinze ans de politiques d'innovation en France*, rapport de la Commission présidée par Jean Pisani-Ferry, janvier 2016. <http://www.strategie.gouv.fr/publications/quinze-ans-de-politiques-dinnovation-France>
- Commissariat General au Plan (CGP) (2003), *Les jeunes entreprises innovantes une priorité pour la croissance*
- Criscuolo, C., Gal, P. N., & Menon, C. (2014). The dynamics of employment growth: New evidence from 18 countries.
- Croce, A., Ughetto, E., Bonini, S., & Capizzi, V. (2021). Gazelles, ponies, and the impact of business angels' characteristics on firm growth. *Journal of Small Business Management*, 59(2), 223–248. <https://doi.org/10.1080/00472778.2020.1844489>
- Demmou, L. (2010). Le recul de l'emploi industriel en France entre 1980 et 2007. Ampleur et principaux déterminants : Un état des lieux. *Economie et statistique*, 438(1), 273–296. <https://doi.org/10.3406/estat.2010.9607>
- Dimos, C., & Pugh, G. (2016). The effectiveness of R&D subsidies: A meta-regression analysis of the evaluation literature. *Research Policy*, 45(4), 797–815. <https://doi.org/10.1016/j.respol.2016.01.002>
- Dvouletý, O., Srhoj, S., & Pantea, S. (2020). Public SME grants and firm performance in European Union: A systematic review of empirical evidence. *Small Business Economics*. <https://doi.org/10.1007/s11187-019-00306-x>
- Encaoua, D. (2017). Repenser les politiques d'innovation en France? *Revue Française d'Economie*, 32(3), 90–135.
- EY (2015) *Baromètre du capital-risque en France, Bilan annuel 2015*
- EY (2020) *Baromètre du capital-risque en France, Bilan annuel 2020*
- Ferrer, J. N. (2018). Financial Instruments and Promotional Banking in the EU are Growing—But is this Justified? *Intereconomics*, 53(6), 326–331.
- Fontagné, L., Mohnen, P., & Wolff, G. (2014). Pas d'industrie, pas d'avenir? *Notes Du Conseil Danalyse Economique*, 3, 1–12.
- Galbraith, J. K., Crémieux-Brilhac, J.-L., Le Nan, M., & Crémieux-Brilhac, J.-L. (1968). *Le nouvel État industriel: Essai sur le système économique américain*. Gallimard.
- Gallois, L. (2012), *Pacte pour la compétitivité de l'industrie française*
- Garicano, L., Lelarge, C., & Van Reenen, J. (2016). Firm size distortions and the productivity distribution: Evidence from France. *American Economic Review*, 106(11), 3439–3479.
- Gaston-Breton, T. (2015) *Servir l'avenir : Un siècle de banque publique*
- Grand, J. (1991). The theory of government failure. *British Journal of Political Science*, 423–442.
- Greenwald, B. C., Stiglitz, J. E., & Weiss, A. (1984). Informational imperfections in the capital market and macro-economic fluctuations. *National Bureau of Economic Research*.
- Guiso, L. (1998). High-tech firms and credit rationing. *Journal of Economic Behavior & Organization*, 35(1), 39–59.
- Gustafsson, A., Tingvall, P. G., & Halvarsson, D. (2020). Subsidy Entrepreneurs: An Inquiry into Firms Seeking Public Grants. *Journal of Industry, Competition and Trade*, 20(3), 439–478. <https://doi.org/10.1007/s10842-019-00317-0>

- Hall, B. H., & Lerner, J. (2010). The financing of R&D and innovation. In *Handbook of the Economics of Innovation* (Vol. 1, pp. 609–639). Elsevier.
- Haltiwanger, J., Jarmin, R. S., & Miranda, J. (2013). Who creates jobs? Small versus large versus young. *Review of Economics and Statistics*, 95(2), 347–361.
- Hébert, R. F., & Link, A. N. (2006). Historical Perspectives on the Entrepreneur. *Foundations and Trends® in Entrepreneurship*, 2(4), 261–408. <https://doi.org/10.1561/03000000008>
- Henrekson, M., & Johansson, D. (2010). Gazelles as job creators: A survey and interpretation of the evidence. *Small Business Economics*, 35(2), 227–244.
- Hölzl, W. (2016). High growth firms in Europe. European Commission, *Science, Research and Innovation Performance of the EU*, 247–276.
- Inspection générale des finances (2013). Pour des aides simple et efficaces au service de la compétitivité, Raport N° 2013-M-016-02
- Keech, W. R., & Munger, M. C. (2015). The anatomy of government failure. *Public Choice*, 164(1), 1–42.
- Landström, H. (2008). Entrepreneurship research: A missing link in our understanding of the knowledge economy. *Journal of Intellectual Capital*, 9(2), 301–322. <https://doi.org/10.1108/14691930810870355>
- Landström, H., Harirchi, G., & Åström, F. (2012). Entrepreneurship: Exploring the knowledge base. *Research Policy*, 41(7), 1154–1181. <https://doi.org/10.1016/j.respol.2012.03.009>
- Larédo, P. (2015). La situation française: Les exercices stratégiques actuels comme révélateurs des tendances longues et des transformations en cours.
- Lundvall, B.-A. (1985). Product innovation and user-producer interaction. *The Learning Economy and the Economics of Hope*, 19, 19–60.
- Lundvall, B.-Å. (1999). National Business Systems and National Systems of Innovation. *International Studies of Management & Organization*, 29(2), 60–77. <https://doi.org/10.1080/00208825.1999.11656763>
- Mason, C., & Brown, R. (2013). Creating good public policy to support high-growth firms. *Small Business Economics*, 40(2), 211–225.
- Mazzucato, M., & Penna, C. C. (2016). Beyond market failures: The market creating and shaping roles of state investment banks. *Journal of Economic Policy Reform*, 19(4), 305–326.
- Mazzucato, M., & Semieniuk, G. (2017). Public financing of innovation: New questions. *Oxford Review of Economic Policy*, 33(1), 24–48.
- Mertens, D., & Thiemann, M. (2018). Market-based but state-led: The role of public development banks in shaping market-based finance in the European Union. *Competition & Change*, 22(2), 184–204. <https://doi.org/10.1177/1024529418758479>
- Mertens, D., & Thiemann, M. (2019). Building a hidden investment state? The European Investment Bank, national development banks and European economic governance. *Journal of European Public Policy*, 26(1), 23–43. <https://doi.org/10.1080/13501763.2017.1382556>
- Minard, P. (2008). Economie de marché et Etat en France : mythes et légendes du colbertisme. *L'Économie politique*, 1(1), 77-94. <https://doi.org/10.3917/leco.037.0077>

- Minniti, M. (2008). The role of government policy on entrepreneurial activity: Productive, unproductive, or destructive? *Entrepreneurship Theory and Practice*, 32(5), 779–790.
- Ministère de redressement productif (2012). Évaluation de l’impact de l’action des Business Angels en France, Rapport final
- Nelson, R. R. (1986). Institutions supporting technical advance in industry. *The American Economic Review*, 76(2), 186–189.
- Nightingale, P., & Coad, A. (2014). Muppets and gazelles: Political and methodological biases in entrepreneurship research. *Industrial and Corporate Change*, 23(1), 113–143. <https://doi.org/10.1093/icc/dtt057>
- OECD (1997), National Innovation Systems, OECD, Paris, <https://www.oecd.org/science/inno/2101733.pdf>.
- OECD. (1999). Managing National Innovation Systems. OECD. <https://doi.org/10.1787/9789264189416-en>
- OECD. (2015). Frascati Manual 2015: Guidelines for Collecting and Reporting Data on Research and Experimental Development. OECD. <https://doi.org/10.1787/9789264239012-en>
- OECD. (2019). OECD SME and Entrepreneurship Outlook 2019. OECD. <https://doi.org/10.1787/34907e9c-en>
- OECD & Eurostat. (2018). Oslo Manual 2018: Guidelines for Collecting, Reporting and Using Data on Innovation, 4th Edition. OECD. <https://doi.org/10.1787/9789264304604-en>
- Picard, C. (2006) : Les gazelles en France. Document de travail INSEE N° G2006/02
- Politis, D. (2008). Business angels and value added: What do we know and where do we go? *Venture Capital*, 10(2), 127–147. <https://doi.org/10.1080/13691060801946147>
- Rojas, F., & Huergo, E. (2016). Characteristics of entrepreneurs and public support for NTBFs. *Small Business Economics*, 47(2), 363–382.
- Santarelli, E., & Vivarelli, M. (2007). Entrepreneurship and the process of firms’ entry, survival and growth. *Industrial and Corporate Change*, 16(3), 455–488.
- Schumpeter, J. A. (1942). *Capitalism. Socialism and democracy*, 3, 167.
- Schreyer, P. (1999). The contribution of information and communication technology to output growth. *Statistical Working Party* (99), 4.
- Shane, S. (2009). Why encouraging more people to become entrepreneurs is bad public policy. *Small Business Economics*, 33(2), 141–149.
- Storey, D. J. (2003). Entrepreneurship, small and medium sized enterprises and public policies. In *Handbook of entrepreneurship research* (pp. 473–511). Springer.
- St-Pierre, J. (2004). La gestion du risque: Comment améliorer le financement des PME et faciliter leur développement. PUQ.
- St-Pierre, J., & Fadil, N. (2011). La recherche en finance entrepreneuriale: Critique sur l’état actuel des connaissances et proposition d’un nouveau cadre de réflexion. *Revue Internationale PME Économie et Gestion de La Petite et Moyenne Entreprise*, 24(3–4), 255–300.

- Tenca, F., Croce, A., & Ughetto, E. (2018). Business Angels research in entrepreneurial finance : a literature review and research agenda. *Journal of Economic Surveys*, 32(5), 1384–1413. <https://doi.org/10.1111/joes.12224>
- Tessier, L., & Ramadan, M. (2020). Sélectionner, contrôler et accompagner: Le credo du Business Angel pour réduire le risque de l'entreprise. *Revue de l'Entrepreneuriat*, 19(2), 93–120. Cairn.info. <https://doi.org/10.3917/entre1.192.0093>
- Tullock, G., Brady, G. L., & Seldon, A. (2002). *Government failure: A primer in public choice*. Cato Institute.
- Vanino, E., Roper, S., & Becker, B. (2019). Knowledge to money: Assessing the business performance effects of publicly-funded R&D grants. *Research Policy*, 48(7), 1714–1737.
- Weiss, C. H. (1983). The stakeholder approach to evaluation: Origins and promise. *New Directions for Program Evaluation*, 1983(17), 3–14.
- Zúñiga-Vicente, J. Á., Alonso-Borrego, C., Forcadell, F. J., & Galán, J. I. (2014). Assessing the effect of Public subsidies on firm R&D investment: a survey. *Journal of Economic Surveys*, 28(1), 36–67. <https://doi.org/10.1111/j.1467-6419.2012.00738.x>

1 CHAPITRE 1¹

ARE BUSINESS ANGEL-BACKED COMPANIES TRULY DIFFERENT? A COMPARATIVE ANALYSIS OF THE FINANCIAL STRUCTURE

1.1 Introduction

Recent advances in the dynamics of financing instruments for entrepreneurship (Drover et al., 2017; Wallmeroth et al., 2017) have highlighted Business Angels² (BAs hereafter) as prominent investors in the early stages for young and innovative firms (European Commission, 2016; Lanstrom & Mason, 2016; Wirtz 2015). This perspective, however, does not find univocal academic support. Despite the growing interest for this market segment (Edelman et al., 2017), results from both theoretical and empirical analyses on angels' activity still differ according to the methodological choices made and the dataset used. The informational opacity created by the positioning of angels in early stage financing (Kraemer-Eis et al., 2018), their willingness to remain anonymous (Mason and Harrison, 2004) and the lack of tangibles and comparable data at the early stage means that studies in this promising field of research have not yet been undertaken. Debate is thus still open regarding the influence of the business angels networks³ (BANs hereafter) on backed-companies (White & Dumay, 2017) especially in bank-based economies such as the French one (Bonini & Capizzi, 2019).

¹ Co-authored with Nadine Levratto. This chapter has been presented in KID 2018 International Summerschool - Knowledge Dynamics, Industry Evolution, Economic Development, InSHS CNRS and UCA^{JEDI}, Nice, France. It benefited from the useful comments of Catalina Martinez. This chapter also benefited from the valuable comments and advice of Richard Duhautois and Aurélien Quignon. Finally, it benefited from the inestimable statistical help granted by Luc Tessier. The authors are grateful to France Angels, which provided a list of companies backed by business angels between 2009 and 2015. *This research is supported by a public grant overseen by the French National Research Agency (ANR) as part of the "Investissements d'avenir" program (reference: ANR-10-EQPX-17 – Centre d'accès sécurisé aux données – CASD).*

² Following Mason and Harrison (2008), a Business angel is: a high net worth individual, acting alone or in a formal or informal syndicate, who invests his or her own money directly in an unquoted business in which there is no family connection and who, after making the investment, generally takes an active involvement in the business, for example, as an advisor or member of the board of directors. (Mason and Harrison (2008) p.309). For BAN characteristics, one can refer to Politis (2008), Capizzi (2015) or Landström and Mason (2016).

³ Since the 1990s (Mason & Harisson, 1997) angels tends to regroup into networks that facilitates decision making and monitoring while reducing risk sharing and increasing diversification. The structuration of angels' market in the wake of the 2000s leads to a visibility of the angels' financing process and market and improves the mechanisms of agency cost reduction (Witz et al., 2015).

This chapter seeks to shed some light empirically on the BANs' capacity to reduce information asymmetry and improve external financing conditions of backed firms thanks to several financial structure indicators. The investigation undertaken uses a unique dataset made up of French firms funded by French BANs over the 2009-2015 period to compare BAN-backed to non-BAN-backed firms, using propensity score methods. Our results show that the angels' influence on firm financial structure is marginal; they do not radically reduce the information asymmetry either toward banking and financial systems, or toward business stakeholders in the firm environment. Moreover, we also clarify the relationship between bank and trade credit and find marginal support of substitutability between these two prominent financing instruments to SMEs.

The Chapter is distinguished from previous literature by the uniqueness of its dataset which encompasses a total of 679 companies invested in by BANs over the 2009-2015 periods. The length and homogeneity of the period under review also mark a difference from previous empirical papers that either use one-shot surveys, cross-section analysis or reduced panel datasets.⁴ By covering the wake of the global and financial crisis, we are considering angels' impact in a recovery context (Mason & Harison, 2015). Moreover, the length of the covered period enables us to distinguish between the short- and medium-term effects of angel financing on the capital structure of invested firms which is an under-researched question (Collewaert, 2016). Finally, the contribution of our research comes from the consideration of angels' certification effect compared to any other equity investment.

To this end, we pay attention to several aspects of the financial structure to capture the multifaced dimension of angels' intervention on backed-firms' financial decision-making which is to our knowledge new in the literature (Landström & Sørheim, 2019). We notably focus on the leverage ratio and interest charges to explore external finance availability from banking institutions following BANs' funding, reflecting certification effect. We also investigate angel's certification effect by studying the terms for the use of trade debt, reflecting relationship with business stakeholders. While the two first indicators lead to exploring the lending relationship with financial systems, the latter two ratios allow the short-term financial environment that backed firms construct with stakeholders to be explored.

⁴ See Landstrom and Sorheim (2019) for a survey on literature of previous generation of studies on business angels' activity.

Taken together, these aspects offer a new framework from which we draw fresh insights into BANs contribution to firms' development and growth.

Our research contributes to the entrepreneurship literature in a two ways. From a theoretical perspective, the chapter goes beyond the issue of the dilemma between the trade-off and the pecking order theories which admit the existence of an ideal capital structure but disagree on how it is established (Daskalakis et al., 2017; Fama & French, 2002). Considering that firm- and environment- specific characteristics influence of firms' financial decisions (Myers, 2001), we focus on the role played by BANs to determine the extent to which their presence can shape the financial structure of the companies in which they invest. This aspect is to our knowledge under-researched in the angel literature (Landström & Sorheim, 2019). The second contribution to the entrepreneurial literature is related to the signalling theory (Leland & Pyle, 1977; Ross, 1977) since we show that the presence of BAN among the pool of investors is not neutral but, on the contrary, signals information to outside investors. In the vein of the signal theory, we show that angels' presence can be beneficial to backed firms due to the reduction of information asymmetry between insiders and outsiders but not in a systematic way.

The remainder of the chapter is structured as follows: Section 2 reviews the literature and proposes hypotheses to be tested; Section 3 defines the econometric strategy; Section 4 presents and discusses the results obtained; Section 5 proposes robustness checks; and Section 6 concludes.

1.2 Literature review: The multidimensional effect of BAN intervention

1.2.1 Theoretical development for entrepreneurial finance

Given the important agency costs and information asymmetry in entrepreneurial financing decisions (Cassar, 2004), this chapter uses traditional finance theory (Myers 1984; Myers & Majlouf, 1984) and signalling theory (Ross, 1977; Spence, 2002) to investigate the financial structure of backed firms funded by business angels.

Traditional pecking order theory (POT) states that financing instruments follow a hierarchical order (Myers 1984; Myers & Majlouf, 1984): internal funds are preferred to bank

debt, which is in turn preferred to external equity to avoid control rights.⁵ Although the theory was built for larger and listed firms, recent research has extended, under conditions⁶, prior findings to small, young and innovative firms (Epure & Guasch, 2019; Collewaert et al., 2010). Innovative and young firms often lack internal funds to finance investment opportunities and need outside financing to take investment opportunities (Vanacker & Manigart, 2010). However, their risk profile implied by a high information asymmetry issue, limits recourse to bank debt. In turn, young and innovative businesses could be more likely to turn to private equity (like BANs) than to banks (Tessier and Ramadan, 2020). Indeed, while internal are still preferred to external funds, the literature suggest a reversed order in the use of external finance where equity can be preferred to bank debt (Minola et al., 2013).⁷

The trade-off theory (TOT) states that capital structure is driven by a trade-off between the costs, like bankruptcy and agency costs, and the benefits, tax and agency conflicts associated with debt (Titman, 1984; Shyam-Sunder & Myers, 1999; Frank & Goyal, 2008). Given the entrepreneurial context, capital structure decisions are less affected by fiscal considerations than by information asymmetry and, therefore, we use the POT to explore BAN-backed companies' financial structure (Cassar, 200; Minola et al., 2013).⁸

Developed concomitantly with corporate finance and agency theories (Jensen and Meckling 1976), signal theory aims to depict how observables, discriminatory and, costly signals can reduce the information gap between firms insiders and outsiders (Spence, 2002). In an equity financing context with high information asymmetry, firms must signal their value to outside investors to obtain funding to finance future growth opportunities (Elitzur & Gaviious, 2003). Signal theory can support and even supersede traditional corporate finance theories to explain financing decision in an equity financing context for young and innovative firms (Epure and Guasch 2019; Hogan et al., 2017; Mina & Lahr, 2018).

⁵ In the case of the entrepreneurial market, information asymmetry leads to a “lemon” premium (Akerlof, 1970) those incentives opaque firms to prefer internal funds to any other financing instrument, reinforcing the POT according to internal fund preference.

⁶ Vaznyte and Andries (2019) conclude that the POT is influenced by factors such as industry risk at the sectorial level and entrepreneurial orientation (EO) and break-even point at the firm level.

⁷ The banking system is shown to be inefficient in screening and monitoring innovative projects. In contrast, equity investors are argued to be better able to reveal the value of an innovative project (Paul et al., 2007). Moreover, BANs have human capital that can help innovative firms (Collewaert and Manigart, 2016)

⁸ The recourse to the POT framework is empirically supported by recent research on French data by Van Hoang et al., (2018).

1.2.2 *Business Angels' activity and networks*

Measuring the influence of BANs⁹ is a challenging though necessary task due to (i) the numerous contributions angels provide throughout the firm's life (Politis, 2008) and (ii) the tax advantages conceded by governments to this class of investors (Carpentier & Suret, 2013). Angels are characterized by a wide heterogeneity (Lahti, 2011), where strong national specificities limit convergence of findings in both theoretical and empirical fields (Frid, 2009; Savignac, 2007). The heterogeneous and opaque selection processes in private equity funding further limit convergence of empirical results (Dutta & Folta, 2016).¹⁰ Unfortunately, despite the growth and employment potential of young and innovative firms there is a loss of interest on the part of the academic side because of data availability that discourages researchers and limits research developments (Landström & Sørheim, 2019).

Besides the opacity of the angels' market, the choice of unit of measurement of their contribution is also subject to debate. No ideal indicator(s) to measure the angels' network influence has been identified in the literature; the ratios proposed are determined by the nature of the research and must be taken carefully (Welch, 2011).¹¹ In this vein, we propose a set of indices resting upon the difference between *what angels have* (human capital) from *what angels are* (market certifier) following Bonini et al. (2019). We focus on *what angels are*, that is: market certifiers whose decisions send a signal on the quality of invested firms to external investors or stakeholders.

1.2.3 *Hypotheses development*

The literature presents individuals business angels and BANs as important economic players with a critical role in financing early stage firms with innovative orientation (Politis, 2008, 2016; Wirtz et al., 2015). However, their influence on financial structure still deserves investigation given the scarcity of empirical studies on this topic (Landström & Sørheim 2019).

⁹ For a definition of angels see Mason and Harrison (1999)

¹⁰ According to Riding et al. (2007), the rejection rate at the first stage in the investment decision process can go up to 90 percent of the business proposals. Their selectivity is confirmed by Croce et al. (2019) and Mason and Harrison (2015).

¹¹ The heterogeneity of indicators used is, at least, partly responsible for the contradictory results obtained (Landström & Mason, 2016). Since Angels' equity financing often goes to young and innovative companies, several papers focus on the influence of financial investment on patent filing (Kortum & Lerner, 2000; Bottazzi & Da Rin, 2002). Other scholars adopt an accounting perspective and look at the gross added value or profits to measure firm performance whereas others use alternative indicators of firm growth (Levratto et al., 2017).

When a BAN funds a firm, it sends a signal to the market indicating that the selected company has valuable innovative projects (Ko & McKelvie, 2018; Elitzur & Gaviols, 2003). Angel investment acts as a risk management mechanism that could elevate information asymmetry that weighs on financing opportunities (Vanacker & Manigart, 2010; Bonini et al., 2019). In turn, backed firms with reduced agency problems would be more likely to obtain external debt financing after funding compared to their equity-financed counterparts that can be materialized through an increase of financial debt differentials. This reasoning is summarized in the following hypothesis:

H1a: BAN-backed firms should exhibit a higher level of debt following funding compared to their equity-financed counterparts, reflecting lower financing constraint due to the angels' certification effect.

In addition to the level of debt, the financing conditions under which loans are granted influence their use (Epure & Guasch, 2015). POT stipulates that the level of information a firm is willing to disclose is strongly correlated to the financing instruments used. Prior to funding, both treated and control groups are characterized by the high information asymmetry that motivated equity financing.¹² Consequently, both groups should record similar (and high) interest charges levels (Myers & Majlouf, 1984).¹³ Following funding, BAN-backed firms benefit from angels' certification and presence on the board, allowing them to fund at better conditions or to renegotiate the terms of the contracts with banks. Hence, in years following funding, BAN-backed firms should record lower interest charges compared than their equity-financed counterparts. This aspect constitutes our second hypothesis linked to the reduction of information asymmetry by BAN and their signal effect on external finance availability.

H1b: BAN-backed firms benefit from improved financial market conditions following funding compared to their counterparts, which is reflected in interest charges reduction.

¹² Opaqueness is not necessarily suffered by firms: it can reflect the will to maintain information about products for competitive purposes, which is likely to be the case for innovative firms. Moreover, entrepreneurs' orientation may influence objectives that differ from what finance theory predicts. While some are engaged in profit maximization, others could prefer a balance between work and family and still others might prefer to maintain control rights that could hamper the development of the firm. However, we argue that entrepreneurial orientation is not a major concern, since all firms studied agreed to open capital to increase growth opportunities and, thus, profit maximization mechanisms, forcing them to adopt rational financing strategy to maximize firm value Vaznyte and Andries (2019).

¹³ The "lemon premium" (Akerlof, 1970) induced by information asymmetry problems for innovative firms operating in early stage financing increases the cost of banking debt both in absolute value and relatively to other financing sources (Vanacker & Manigart, 2010)

The scarcity of financing instruments for young and innovative firms (Bonini et al., 2018, Masiak et al., 2017) limits the capacity of firms to fund investments opportunities and ultimately weighs on the growth path (Levratto, 1996; Psillaki & Eleftheriou, 2015). Among alternative instruments, trading debt appears to be the most prominent for entrepreneurial firms¹⁴. The use of trade credit that is supported by agency and signal theories (Elliehausen & Wolken, 1993)¹⁵ has two relevant characteristics for the certification framework depicted in this chapter. First, companies operating in the high-tech sector in which intangible and specific assets are often hardly resalable make a frequent use of a trade debt instrument (Psillaki & Eleftheriou, 2015). Second, trade debt is more often used in economic systems offering a weak creditor protection, an institutional feature corresponding to civil law countries including France (La Porta et al., 1998).

The role of trade credit during and following the credit crunch received specific attention from both academics and policymakers (McGuinness & Hogan, 2016; Cabo-Valverde et al., 2016; Psillaki & Eleftheriou, 2015). Psillaki and Eleftheriou (2015) empirically test trade credit theories using French manufacturing data. They confirm the redistribution view of trade credit (Meltzer, 1960) according to which less credit constrained firms obtaining bank loans redistribute it to more constrained firms in the form of commercial debt during credit crunch periods. In contrast, García-Teruel and Martínez-Solano (2010), using European data, support the substitution views according to which bank and commercial debts are substitutes for one another. Cabo-Valverde et al., (2016) also investigate the use of trade credit following a crisis. Although not being able to discriminate between alternative views of trade credit, they stress that the use may depend on the financial situation of firms. In this chapter we go beyond the apparent contradiction between theories and, in line with Maksimovic (2001) argue that both theories may articulate into a financing continuum (Berger & Udell; 1998) according to financial situations. More precisely, at the beginning of the life cycle, more constrained firms will turn to trade credit as an alternative to bank loans (substitution effect).

¹⁴ See Cuñat & Garcia-Appendini (2012) for a review of the use of trade credit. In addition to being an important source of funding from constrained firms (Masiak et al., 2017), trade credit offers buyers the capacity to build either a credit history or fixed asset to put as collateral to ensure quality when seeking bank loans. It also allows the relationship with customers and suppliers to be improved (Cuñat & Garcia-Appendini, 2012)

¹⁵ While adverse selection and moral hazard reduction are argued to be better achievable by suppliers than banks (Cuñat & Garcia-Appendini, 2012) justifying the recourse to trading debt for credit constrained firms, the latter also and most importantly use trade debt to reduce transaction costs to fund working and fixed capital needs (Elliehausen & Wolken, 1993). Empirically, Masiak et al. (2017) provides evidence on the deep use of trade debt instruments for entrepreneurial firms.

While they accumulate credit history from suppliers and thus become less informationally opaque, firms will tend to act like financial intermediaries and redistribute bank financing to other firms in the form of short-term commercial debt (redistribution view)¹⁶. Consequently, prior to investment, backed firms should be characterized by a high level of information asymmetry that can be costly to reduce for banks limiting the use of bank loans. In addition, the reduction in information asymmetry can also be costly to acquire for other firms, resulting in expensive trade credit conditions for backed firms (Minola et al., 2013). The positive signal effect of angels' investment goes along with the reduction of agency costs that improves trade debt conditions in terms of payments, delay and late payment conditions. Moreover, beyond the positive signalling effect, BANs open the doors of their network to entrepreneurs, helping them to find better financing conditions within the angels' network (Politis, 2008; Bonini et al., 2018; Collewaert et al., 2010). Hence, backed companies should record a higher trade credit reduction, reflecting reduced information asymmetry problems associated with BANs presence on board.

H2a: Backed firms benefitting from the certification effect of angels would record a higher trade debt reduction reflecting a reduced information asymmetry issue.

However, the theoretical literature is not univocal on the signalling effect of equity investment on the use of trade debt that can depend on sectoral needs and risk, entrepreneurial orientation and strategic or personal goals pursued by entrepreneurs (Vaznyte & Andries, 2019).

Beyond the level of trade debt, the delay in payment of that commercial debt can be a sound indicator of the relationship with the stakeholders that angels are likely to improve. Regarding this last aspect, we expect that angel-backed companies benefitting from the angels' network will find more favourable conditions which materialize in longer payment delays. Indeed, as stated above, suppliers take an implicit equity stake in firms that incentivises them to adopt a conciliant contract if firms are financially constrained, leading to longer payment delays.

¹⁶ The use of trade debt grants implicit equity stakes of the supplier equal to the amount of the net present value of future profits. In the case of bankruptcy on the customers' side, trade debt suppliers come after debt suppliers which motivates a higher "lemon premium" to compensate lower creditor protection of suppliers compared to bankers. This implies that a trade creditor is more likely to be conciliant towards financing issues of the customer like liquidity shortage while banks are likely to be more prone to pursue liquidation (Cole, 2010; Huyghebaert et al., 2007).

H2b: Backed firms will tend to have longer payment delay induced by improved relationship with suppliers.

1.3 *Empirical strategy and variable operationalization*

Our empirical investigation rests upon an initial dataset of 679 firms invested in by BANs between 2009 and 2015 provided by France Angels, the national network of business angels. In addition, we have at our disposal two datasets, all provided by the French National Institute of Statistics.¹⁷ Merging BAN-backed companies to these datasets enables us to compose an unbalanced panel of BAN-backed companies to be compared to a reference group of equity-financed firms.

1.3.1 *Definition and measure of variables*

The choice of indicators to properly highlight a firm's financial structure is determined by the context, by the objectives of the users and by data availability (Barnes, 1987). When looking at angel and entrepreneurial literature, it appears that results obtained greatly depend on the indicators chosen to describe outcomes (Rauch et al., 2009; Runyan et al., 2008). Hence, to avoid partial and misleading conclusions, we consider several outcomes to capture the heterogeneous aspect of the certification effect of angels on the reduction of information asymmetry.

The first ratio we use to describe the liabilities structure is a debt ratio, noted *DebtR*, defined as the amount of financial debt scaled by total debt. Table 1-4 in the Appendix presents the definition of the explained variables used and the main descriptive statistics.

Another important aspect that concerns a firm's financial strategy is the cost of financial debt. This component of financial structure shapes the financing pattern (Kremp and Stöss, 2001), reflects companies' internal characteristic and disclosure quality (Anderson et al., 2004) and influences external finance availability (Ko & McKelvie, 2018). The cost of debt, noted *DebtCost* is defined by interest and similar charges, noted *interest*, scaled by the *gross operating profit* (GOP), which proxy for EBITDA, to control for scale effect.

¹⁷ The first dataset (FARE for Fichier Approché des Résultats d'Entreprises) contains the tax report, mainly composed of the balance sheet and the profit and loss statement of any taxable corporate company located in France. The second source (CLAP or Connaissance Locale de l'Appareil Productif) provides information on the location, the age and the legal status of the companies. The coverage and the homogeneity of datasets are ensured from 2009 (with also some limits in 2012 for some balance-sheet variables, limiting historical on pre-treatment data accumulation).

The third ratio considered is the share of trade debt which reflects the capacity of a company to rely on its suppliers to finance its operating cycle. Trading debt is also a proxy for information asymmetry that increases credit constraints (Psillaki & Eleftheriou, 2015). The weight of trade debt in total external resources is approximated by the ratio of the trade accounts payables on the total amount of debt.

The last ratio under consideration allows us to go beyond the level of trade debt that can be misinterpreted. We thus consider the days of payables outstanding that represent the average time a firm takes to pay its suppliers. Noted *DPO* this ratio allows studying in depth the multifaced character of trade debt (Cuñat & Garcia-Appendini, 2012).

1.3.2 Comparison strategy

1.3.2.1 Matching approach

Angels do not randomly invest in projects and companies but select them according to various criteria (Maxwell et al., 2011). To circumvent the risk of selection bias resulting from the comparison between invested companies and the average firm, it is necessary to neutralize the difference between backed and non-backed companies by composing comparable samples through a matching procedure.

The aim of matching literature¹⁸, initially theorized by Rubin (1973), Cochran and Rubin (1973), and Rosenbaum and Rubin (1983), is to balance the distribution of covariates of groups under research, named treated group (BAN-backed companies) and the control group (non-angel-backed companies) to estimate properly the causal effect of a treatment via a scalar, named propensity score, summarizing the covariates used in regression. The propensity score defines the probability of receiving a treatment and is used to match observations. Applying this technique makes it possible to estimate the average angels' effect on backed-firms, namely the average treatment on the treated (ATT) with a lower risk of sample bias due to selection effect. ATT is defined as:

$$ATT = \frac{1}{N} \sum_{i=1}^N (Y_i(1)|BAN = 1, X = x) - (Y_i(0)|BAN = 0, X = x) \quad (1)$$

Where N is the number of treated firms and BAN a dummy variable equal to 1 for angels-backed firms and 0 otherwise.

¹⁸ Austin (2011) and Caliendo and Kopeinig (2008) present the various propensity score matching techniques. Table 3 in the appendix recalls the main different techniques.

The matching procedure is initiated with the estimation of a logistic equation that determines the probability of receiving a treatment based on observable characteristics (step 1). The aim of the logistic equation is to compute the propensity score (step 2), a scalar that contains information relative to all covariates included and represent the probability of being funded. We then match observation by minimizing the propensity score differential between firms. Once the matching is obtained, its balancing is assessed (step 3) to ensure efficient causal treatment effect estimations (step 4).¹⁹

1.3.2.2 *Model and variable operationalization*

Beyond selection bias, other types of distortion arise. One is driven by unobservable effects resulting from angels' decision making (Jeffrey et al., 2016; Maxwell et al., 2011). Bertrand et al. (2004) introduce a procedure to reduce this bias through the settlement of the double difference estimator.²⁰ Hence, to capture angel influence on the capital structure of a backed firm over years, net of selection bias and unobservable effects, we compute outcome differentials over the timeframe of the funding year. This method enables us to control for unobservable and time invariant firm specific and business cycle effects occurring during the event window. It also allows angels' signalling effect at different stages of their relationship with entrepreneurs to be explored (Kelly & Kim, 2018), through outcome variables expressed as follows:

$$Diff_{i,x} Y = Y_{i,t+x} - Y_{i,t} \quad (2)$$

With $x = \{1, \dots, 6\}$ represents the number of years span used to calculate outcome variables. We computed outcome variables over 1 to 6 years intervals when available for both treated and control firms.

To determine the probability of getting funds from a BAN, we run the following logistic model:

$$Pr (BA_{i,t}) = \alpha + \beta X_{i,t-1} + \varepsilon_{it} \quad (3)$$

¹⁹ For further information about matching approach, see Rosenbaum and Rubin (1983) Stuart and Rubin (2008) and Stuart (2010)

²⁰ A common trend assumption is required to ensure the treatment estimates do not depend on initial conditions of the experiment. According to this assumption a common time trend in outcomes before treatment is required between treated and control units to ensure efficiency of matching.

Where Y_{it} is a dummy variable indicating angel presence, it takes the value 1 if a firm i receives an angel investment and zero otherwise. $X_{i,t}$ is the full set of desired covariates for matching and ε_{it} is a standard error term. All variables used are winsorized at 5 and 95 percent level to reduce the impact of outliers. Matching is performed on a year-by-year basis and retained control units must record equity increase on the same year as treated units to control for the demand of external finance. The literature helps determine the appropriate proxies to capture the decision-making criteria of angels, whether organised or not in networks (Mason & Stark, 2004; Croce et al., 2017, 2018). While the first generation of studies about angels' activity highlighted the heterogeneous and informal nature of investment decisions²¹, recent studies point out the professionalisation of angels' activity and decision-making process, especially within the BANs (Capizzi, 2015), which rely on more objective and comparable data between firms to reduce coordination and transaction costs (Carpentier & Suret, 2015; Croce et al., 2017). Furthermore, Brush et al., (2012) and Mason and Botelho (2016) highlight the importance of tangible and objective criteria in the initial stage of investment while Paul et al. (2007) conclude with the importance of financial ratios for investment decision making. In addition, research on early stage financing highlights the low explanatory power of personal factors on financing decision making (Cassar, 2004; Cole 2010). Based on this background and following Capizzi (2015) and Bonini et al., (2019) we select a set of comparable financial indicators on which BANs might rely to make a decision.

We introduce a profitability ratio (*ROA*) (in logarithm) measured by the EBITDA scaled by total assets that takes into account of the financial soundness of the firms. We also include the stock of intangible assets (*intangibles*) in logarithm to account for innovative orientation (Landström & Mason 2016). The stock of tangible assets (*tangibles*) expressed in logarithm is also included to capture the importance of collateral (Mason & Stark, 2004; Carpentier & Suret, 2002). To control for growth opportunities, we also include sales (*Sales*) in logarithm. Finally, the age of the firm since the foundation year (*age*) and the number of employees (*Employees*), both in logarithms, are also added to encompass the quality of the project and the capacity of firms to attract working forces. *Location* and *Industries* dummies are also included as control variables to control for local conditions (Giot & Schwiabacher, 2007) and for the preference of BANs for technological activities (Bonini et al., 2018; Politis, 2016; Van Osnabrugge, 2000).

²¹ See Croce et al., (2016) and Landstrom and Sorheim (2019) for a review of angels' decision-making studies.

1.4 Results

1.4.1 Investment process and firm characteristic

This section aims to find support to the funding decision-making process of BANs (Capizzi, 2015; Croce et al., 2017; Brush et al., 2012; Carpentier & Suret, 2015; Jeffrey et al., 2016; Maxwell et al., 2011; Riding et al., 2007).

The estimation of the probability of being financed by angels, given observable financial characteristics is achieved using a logistic model where the dependent variable is the dummy variable indicating angel investment; covariates are expressed with a lag of one period preceding funding to avoid simultaneity issues. The results are available in Table 1-1 - Probability of being invested by Angels.

The findings indicate a stable and significant positive influence of the *ROA* on angel funding suggesting that business angels are twice as likely to invest in firms with higher growth margin potential as in others. Indeed, a high *ROA* is associated to the capacity to increase margins which is, although not the only one, an interesting financial aspect of angel's decision-making (Capizzi, 2015; Mason & Bothelho, 2016). This result also finds support in Croce et al. (2017) who investigated Italian data from 2008 to 2014.

A negative relationship is found for *Sales* indicating that BAN-backed firms do not necessarily generate incomes at time of investing which is corroborated by the negative sign associated with the *Age*. Younger firms have a greater probability of being funded. Besides, higher levels of tangible assets are associated with a lower probability of being selected by a BAN as shown by the negative coefficient of the variable *tangible asset*. This finding reflects the importance of the stock of tangible assets in influencing treatment probability reflecting angels' preference for young and innovative firms. This result could also capture the lack of internal funds and assets to pledge as collateral that characterize BAN-backed companies (Lahti & Keinonen, 2016). On the contrary, we find a positive influence of *intangible assets* on the probability of being funded by BANs. Indeed, results indicate that the probability of being financed by BANs strongly increases with the stock of intangible assets, confirming angels' preference for innovative activities (Politis, 2016). As in Croce et al. (2018) the firm size, proxied by number of employees, is shown to be an important driver positively influencing the probability of being financed by a BAN. The relatively high explanatory power of our model of BAN decision making (81 percent) highlights that the decision-making process by BAN is oriented towards comparable and observable aspects of firms (Carpentier

& Suret, 2015; Croce et al., 2017) suggesting a professionalisation in the BANs decision-making process.

Table 1-1 - Probability of being invested by Angels

Variable	Odds ratio
ROA	2.06 *** (16.40)
Intangibles	1.46 *** (-3.62)
Tangibles	0.84 *** (10.75)
Sales	0.86 *** (-5.91)
Age	0.009 *** (-45.30)
Employees	1.79*** (7.37)
Intercept	37041 *** (11.07)
Fixed Effect	
Localisation	YES
Industries	YES
Observations	179142
Pseudo R ²	0.8180
Log Likelihood	-1470.90

*Notes: This table presents logistic regression of the dummy variable equal to 1 of backed firms and 0 otherwise. Variables are lagged to avoid the treatment assignment influencing covariates' level. Variables included are expressed in logarithm. * ** and *** respectively denotes 10, 5 and 1 percent significance.*

One important concern about the matching procedure is the balancing of results which ensures the comparability of the multidimensional distribution of covariates in the treated and in control groups (Stuart, 2010). Indeed, unlike regression-based methods, matching methods allow examination of the distribution of predictors and have a straightforward diagnosis resulting in an assessment of the effectiveness of a treatment. Table 1-6 in the appendix summarizes the balancing test before and after propensity score matching with replacement using 1 neighbour. The results indicate that balancing is achieved through a substantial bias reduction around 90 percent for almost all variables²². After matching, the two groups are not statistically different for almost all the dimensions of multivariate matching, ensuring a well-balanced procedure and a causal effect framework.

²² With the exception of the number of employees and the localisation of firms where matching only succeeds in reducing bias respectively by 67.3 percent and 49.3 percent

Another concern refers to event study research design related to the pre-trend assumption (PTA) according to which trends in outcome variables should not exhibit different dynamics between both groups before treatment. To ensure that the pre-treatment outcomes trends were similar between groups, we compare the mean of annual growth rates of the outcomes variables of the treated and control group. Table 1-9 in the appendix displays the results of the PTA and shows that the trends of the outcomes variables do not show different dynamics ensuring a robust treatment effect analysis.

1.4.2 Assessment of BANs influence

This section presents the results of the investigation on the impact of BANs on the capital structure of backed firms when distortions resulting from the sample composition are eliminated. Table 1-2 records the results for the hypotheses posed. Baseline matching is performed using a propensity score matching with one neighbour with replacement approach (PSM-NN(1)).

The upper part of Table 1-2 shows that BAN-backed companies record higher levels of financial debt compared to non-BAN-backed firms. Although the difference between the treated and control group hardly achieves a significant level, we can notice that the accumulation of financial debt is systematically higher for the treated group compared to the control group (regardless of the timeframe) but the differences are only significant between groups in the first and third year following funding. This result indicates that angel-backed companies accumulate a higher proportion of financial debt than control firms do, although the effect is heterogeneous along the timeframe. Consequently, we find a weak significant support for *H1a* and conclude that BANs have a marginal signalling effect towards banking institutions. The results regarding the cost of debt are less conclusive. The coefficient of the equation determining the cost of the debt for the test group is not significantly lower than that obtained for the reference group, regardless of the timeframe (Second part of Table 1-2). Hence, *H2b* is not supported. One possible explanation is that grants certification effect of the angels, reduces information asymmetry and leads to better conditions of financial debt contracts (Elitzur & Gaviious, 2003). However, this mechanism can be substantially offset by the nature of backed firms which are involved in innovative and risky activities (Edelman et al., 2017). The systemic effect is limited and underdetermined. It can depend on the prominence of angel signal effect in terms of amount invested and of quality of monitoring (Ko & McKelvie, 2018).

Overall, the results indicate a weak support for the certification effect of BAN to the financial system compared to any form of equity investment.

A similar conclusion can be transposed to the certification effect of BAN to stakeholders of the firms' environment. When comparing trade debt level differential, one can see that although significant only for the higher time frame, differential is, above all, negative. This indicates a higher reduction of trade debt for backed companies reaching up to 10 percent five years after funding. The effect may occur with a lag that demonstrating the relationship between investors and entrepreneurs may take some time before to show effects. Since trade debt is more often used by credit constrained firms (Huyghebaert et al., 2007) a higher decline of trade debt in angels-backed companies can be interpreted as a decrease in information asymmetry. Indeed, following the trade debt and agency costs literature, BAN investment would create a certification effect that would enhance firm visibility and strengthen entrepreneurs' networks making it possible to obtain more favourable financing conditions (Edelman et al., 2017). This interpretation is supported by prior studies (Politis, 2008; Ko & McKelvie, 2018) that consider BANs not only as shareholders but also as proactive stakeholder involved in the firm management (Wiltbank, 2005; Macht & Robinson, 2009).

Consequently, *H2a* is partially supported, indicating a limited certification effect on BAN compared to a certification effect of any other form of equity participation.

Regarding the DPO, we note that, unlike previous indicators, the differential does not exhibit any patterns and consequently *H2b* cannot have any empirical support. The capacity of angels to relax DPO is thus not confirmed.

The findings suggest that the certification that a BAN would grant to stakeholders benefit only marginally to financed firms with high trade debts and do not substantially change the conditions under which trade debt contracts are expressed. The findings do not show a significant difference between both groups given the proximity of treated and control firms in their financing choices and due to the heterogeneous nature of angels' value added (Collevert & Manigart, 2010), which is not covered by data at our disposal. Moreover, as suggested by Vaznyte and Andries (2019), other parameters such as entrepreneurial orientation and personal goals can influence external finance choices for entrepreneurial firms.

Finally, our results suggest a substitutability relationship between trade and financial debt. Indeed, our results indicate that the decrease in trade debt observed in backed companies goes along with an increase in the financial debt ratio. This suggests that (i) trade and financial debts are more used as substitutes than as complements for treated firms and that (ii) an information asymmetry reduction mechanism can be associated with angel financing.

Table 1-2 - Result of the ATT

Variable	Treated	Control	Difference	S. E	T-Stat	treated observations		Control observations
						Off support	On support	
Differential Financial DebtR (H1)								
1 Year differential	0.10	-0.06	0.16	0.07	2.30**	113	241	26,288
2 Years differential	0.26	-0.06	0.32	0.26	1.22	221	35	15,056
3 Years differential	0.39	-0.01	0.40	0.30	1.34	201	32	12,089
4 Years differential	0.53	-0.08	0.61	0.34	1.78*	109	28	8,921
5 Years differential	0.37	-0.07	0.44	0.35	1.25	9	29	3,869
Differential DebtCost (H2)								
1 Year differential	0.0004	0.0004	0.0001	0.0106	0.01	186	492	18,445
2 Years differential	0.0071	-0.0032	0.0103	0.0117	0.88	125	345	10,121
3 Years differential	0.0068	-0.0026	0.0094	0.0126	0.75	87	253	7,516
4 Years differential	0.0090	0.0156	-0.0066	0.0174	-0.38	25	114	4,578
5 Years differential	0.0316	0.0130	0.0186	0.0252	0.74	5	33	4,082
Differential Trading Debt (H3)								
1 Year differential	-0.02	-0.01	-0.01	0.01	-0.38	186	492	18,477
2 Years differential	-0.02	-0.02	0.00	0.02	-0.22	125	345	10,136
3 Years differential	-0.04	-0.02	-0.02	0.02	-0.85	87	253	7,524
4 Years differential	-0.03	0.00	-0.03	0.03	-0.94	25	114	4,584
5 Years differential	-0.07	0.02	-0.09	0.05	-1.73*	5	33	4,089
Differential DPO (H4)								
1 Year differential	-1.08	-9.07	7.99	7.73	1.03	186	493	19,503
2 Years differential	3.25	-6.52	9.77	11.45	0.85	125	346	10,495
3 Years differential	5.57	0.21	5.36	11.12	0.48	25	114	7,773
4 Years differential	-13.39	7.08	-20.47	18.32	-1.12	25	114	4,714
5 Years differential	9.62	13.76	-4.14	14.14	-0.29	5	33	4,179

Notes: this table present result from the outcome analysis provided by propensity score matching using 1 neighbour with replacement. S.E records the standard deviation of difference, T-Stat record the t-statistic of the equal mean test, N treated and N control represents respectively the number of treated and control observations under study. *and ** respectively represent 0.1 and 0.05 significance level.

1.5 Robustness checks

Since the theoretical literature about matching does not provide a clear guidance to empirical researchers with some rare exceptions (Stuart, 2010), we apply an alternative matching technique to test the sensitivity of our results to the approach used and run alternative specifications to check for the robustness of our results.

This sub-section presents the results of robustness checks made using an alternative matching approach, namely k -nearest-neighbours (k -NN hereafter with k the number of neighbours selected), kernel estimator and, PSM-NN(1) without replacement. The results are available in the appendix, in Table 1-7. A balancing of this alternative method can be found in the appendix, in the Table 1-8. While the Kernel approach creates control groups using every information within bandwidth and excluding any observation outside of it; NN only consider the nearest (or the k -nearest) point(s) even if far away from a treated unit in terms of propensity score. Consequently, kernel matching can produce a smoother estimation of density function of the propensity score. Matching with(out) replacement keeps bias low (high) but increases (decreases) variance since a control unit can be used to match several treated units.

Table 1-7 shows that the results obtained with alternative specifications confirm the ones obtained with the baseline approach. Outcome analysis confirms the weak influence of angel on the reduction of information asymmetry.

1.6 Conclusion and research agenda

This chapter investigates whether the financial structure of angel-backed firms differs from that of non-backed ones. The results of our empirical analysis partially support the theory according to which BANs' presence influence financial structure. This research contributes to the literature on corporate finance, shedding some light on the role played by BANs as equity investors. Our results sustain the possibility of a certification effect since BAN-backed companies are less dependent on trade-debt than non-backed ones but tend to raise find weak support of the capacity of these investors to significantly influence the perception of a bank of the backed firms' risk. The advantage BANs provide to invested companies is found to be marginal and may be heterogeneous in human capital dotation.

Indeed, the findings may be partially explained by the fact that BANs are non-professional investors, with high heterogeneous financial and human capital support. The findings also suggest that angels are less often called upon by entrepreneurs for their contacts in their role as certifiers than for their entrepreneurial capabilities.

The policy implications of our findings are potentially important. Indeed, our results provide new support for entrepreneurship policy in the informal capital market to strengthen the growth of recovery in a post-global crisis context. Whereas financial innovations tend to facilitate the entry of non-professional investors in the small firm financing market, it is important to question their capacity to radically and significantly change the firms' growth path. Shedding some light on this field, it is all the more important that we reveal a contradiction between the effectiveness of BANs and the qualities attributed to them, often presented as key partners with human and social capital skills. This central point should be kept in mind by entrepreneurs when starting a relationship with BAN; the deal should concern not only the financial support but also the non-financial aspects of the relationship.

Despite the convergent findings across matching approaches the study suffers from certain limitations that need to be addressed in future studies. First, the test group is only composed of firms funded by BANs members of the French federation of business angel networks. Even if they realize most of the deals registered in France, they are a specific group and, consequently, different from unaffiliated BANs, resulting in a possible sample bias when estimating the treatment effect. Indeed, membership in an angel network provides a higher level of information and enables individuals to share experience and know-how with other members, making them more similar to professionals. In the regard the constitution a control group based on individual angels could constitute a research avenue to isolate BAN value added compared to individual angels. Second, more qualitative information would be informative to characterise the relationship between entrepreneurs and angels since they might influence treatment effect (Tenca et al., 2018). In this vein, the study of the relationship between angel's finance and backed firms' developments should encompass the aspect related to entrepreneurial orientation and personal goals pursued by entrepreneurs. Finally, while this chapter focuses on financial structure indicators, many aspects of BANs influence remain to be investigated for the French case, including the probability of being subsequently funded by venture capitalists, or the impact on performance indicators. In this vein a mediated model

could be computed to estimate the influence on financial decision making which could in turn influence businesses developments.

1.7 References

- Anderson, R.C., Mansi, S.A., & Reeb, D.M., (2004). Board characteristics, accounting report integrity, and the cost of debt. *Journal of Accounting Economics*. 37, 315-342. <https://doi.org/10.1016/j.jacceco.2004.01.004>
- Akerlof, G. A. (1978). The market for “lemons” : Quality uncertainty and the market mechanism. In *Uncertainty in economics* (pp. 235-251). *Academic Press*.
- Austin, P. C., (2011). Optimal caliper widths for propensity-score matching when estimating differences in means and differences in proportions in observational studies. *Pharmaceutical statistics*, 10(2), 150-161.
- Barnes, P., (1987). The Analysis and Use of Financial Ratios: A Review Article. *J. Bus. Financ. Account.* 14, 449-461. <https://doi.org/10.1111/j.1468-5957.1987.tb00106.x>
- Berger, A.N., & Udell, G. F., (1998). The economics of small business finance: The roles of private equity and debt markets in the financial growth cycle. *J. Bank. Financ.* [https://doi.org/10.1016/S0378-4266\(98\)00038-7](https://doi.org/10.1016/S0378-4266(98)00038-7)
- Bertrand, M., Duflo, E., & Mullainathan, S., (2004). How much should we trust differences-in-differences estimates? *The Quarterly Journal of Economics*, 119(1), 249-275. <https://doi.org/10.1162/003355304772839588>
- Becker, S. O., & Ichino, A. (2002). Estimation of average treatment effects based on propensity scores. *The stata journal*, 2(4), 358-377.
- Bonini, S., Capizzi, V., Valletta, M., & Zocchi, P. (2018). Angel network affiliation and business angels' investment practices. *Journal of Corporate Finance*, 50, 592-608. <https://doi.org/10.1016/j.jcorpfin.2017.12.029>
- Bonini, S., Capizzi, V., & Zocchi, P. (2019). The performance of angel-backed companies. *Journal of Banking & Finance*, 100, 328-345.
- Bottazzi, L., Da Rin, M., 2002. Venture capital in Europe and the financing of innovative companies. *Economic Policy*. <https://doi.org/10.1111/1468-0327.00088>
- Brush C., G, Edelman L. F., & Manolova T., S. (2012) Ready for funding? Entrepreneurial ventures and the pursuit of angel financing. *Venture Capital: An International Journal of Entrepreneurial Finance* 14(2-3): 111-129. *424 International Small Business Journal* 35(4)
- Carbo-Valverde, S., Rodriguez-Fernandez, F., & Udell, G. F. (2016). Trade credit, the financial crisis, and SME access to finance. *Journal of Money, Credit and Banking*, 48(1), 113-143.
- Caliendo, M., & Kopeinig, S., (2008). Some practical guidance for the implementation of propensity score matching. *Journal of Economic Survey*. <https://doi.org/10.1111/j.1467-6419.2007.00527.x>
- Capizzi, V., (2015). The returns of business angel investments and their major determinants. *Venture Capital*. <https://doi.org/10.1080/13691066.2015.1092264>

- Carpenter, R. E., & Petersen, B. C. (2002). Capital market imperfections, high-tech investment, and new equity financing. *The Economic Journal*, 112(477), F54-F72.
- Carpentier, C., & Suret, J.M., (2015). Angel group members' decision process and rejection criteria: A longitudinal analysis. *Journal of Business Venturing*. <https://doi.org/10.1016/j.jbusvent.2015.04.002>
- Cassar, G. (2004). The financing of business start-ups. *Journal of Business Venturing*, 19(2), 261-283.
- Cochran, W. G., & Rubin, D. B., (1973). Controlling bias in observational studies: A review. *Sankhyā: The Indian Journal of Statistics, Series A*, 417-446.
- Collewaert, V., Manigart, S., & Aernoudt, R. (2010). Assessment of government funding of business angel networks in Flanders. *Regional Studies*, 44(1), 119-130.
- Collewaert, V., (2016). Angel-entrepreneur Relationships: Demystifying Their Conflicts. *Handbook of Research on Business Angels*, 176-198.
- Collewaert, V., & Manigart, S. (2016). Valuation of Angel-Backed companies: The role of investor human capital. *Journal of Small Business Management*, 54(1), 356-372.
- Croce, A., Tenca, F., & Ughetto, E. (2017). How business angel groups work: rejection criteria in investment evaluation. *International Small Business Journal*, 35(4), 405-426.
- Croce, A., Guerini, M., & Ughetto, E., (2018). Angel Financing and the Performance of High-Tech Start-Ups. *Journal of Small Business Management*. <https://doi.org/10.1111/jsbm.12250>
- Cuñat, V., & García-Appendini, E., (2012). Trade Credit and Its Role in Entrepreneurial Finance, in: Cumming, D. (Ed.), *The Oxford Handbook of Entrepreneurial Finance*. Oxford, pp. 526-557. <https://doi.org/10.1093/oxfordhb/9780195391244.013.0018>
- Daskalakis, N., Balios, D., & Dalla, V., (2017). The behaviour of SMEs' capital structure determinants in different macroeconomic states. *Journal of Corporate Finance*. 46, 248–260.
- Dutta, S., & Folta, T.B., (2016). A comparison of the effect of angels and venture capitalists on innovation and value creation. *Journal of Business Venturing*. <https://doi.org/10.1016/j.jbusvent.2015.08.003>
- Drover, W., Busenitz, L., Matusik, S., Townsend, D., Anglin, A., & Dushnitsky, G., (2017). A Review and Road Map of Entrepreneurial Equity Financing Research: Venture Capital, Corporate Venture Capital, Angel Investment, Crowdfunding, and Accelerators. *Journal of Management* . <https://doi.org/10.1177/0149206317690584>
- Edelman, L. F., Manolova, T. S., & Brush, C. G., (2017). Angel Investing: A Literature Review. *Foundations and Trends® in Entrepreneurship*, 13(4-5), 265–439. doi:10.1561/03000000051
- Elitzur, R., & Gaviols, A., (2003). Contracting, signaling, and moral hazard: A model of entrepreneurs, 'angels', and venture capitalists. *Journal of Business Ventur.* [https://doi.org/10.1016/S0883-9026\(03\)00027-2](https://doi.org/10.1016/S0883-9026(03)00027-2)
- Elliehausen, G. E., & Wolken, J., D. (1993). The demand for trade credit: an investigation of motives for trade credit use by small businesses. *Fed. Res. Bull.*, 79, 929.
- European Commission, (2016). Open innovation, open science, open to the world - a vision for Europe. Brussels.

- Epure, M., & Guasch, M. (2019). Debt signaling and outside investors in early stage firms. *Journal of Business Venturing*. <https://doi.org/10.1016/j.jbusvent.2019.02.002>
- Fama, E.F., & French, K.R., (2002). Testing Trade-Off and Pecking Order Predictions About Dividends and Debt. *Review of Financial Studies*, 15, 1-33. <https://doi.org/10.1093/rfs/15.1.1>
- Focarelli, D., Pozzolo, A.F., & Casolaro, L., (2008). The pricing effect of certification on syndicated loans. *Journal of Monetary Economics*, 55, 335-349. <https://doi.org/10.1016/j.jmoneco.2007.11.004>
- Frid, C.J., (2009). Acquiring financial resources to form new ventures: pecking order theory and the emerging firm. *Frontier of Entrepreneurship Research*, 29,1.
- Frank, M. Z., & Goyal, V. K. (2008). Trade-off and pecking order theories of debt. *In Handbook of empirical corporate finance* (pp. 135-202). Elsevier.
- García-Teruel, P. J., & Martínez-Solano, P. (2010). Determinants of trade credit: A comparative study of European SMEs. *International Small Business Journal*, 28(3), 215-233.
- Giot, P., & Schwienbacher, A. (2007). IPOs, trade sales and liquidations: Modelling venture capital exits using survival analysis. *Journal of Banking & Finance*, 31(3), 679-702. <https://doi.org/10.1016/j.jbankfin.2006.06.010>
- Huyghebaert, N., Van De Gucht, L., & Van Hulle, C., (2007). The choice between bank debt and trade credit in business start-ups. *Small Business Economics*, 29, 435-452. <https://doi.org/10.1007/s11187-006-9005-2>
- Hogan, T., Hutson, E., & Drnevich, P. (2017). Drivers of External Equity Funding in Small High-Tech Ventures. *Journal of Small Business Management*, 55(2), 236-253.
- Jeffrey, S. A., Lévesque, M., & Maxwell, A. L. (2016). The non-compensatory relationship between risk and return in business angel investment decision making. *Venture Capital*, 18(3), 189-209. <https://doi.org/10.1080/13691066.2016.1172748>
- Jensen, M. C., & Meckling, W. H. (1976). Theory of the firm: Managerial behavior, agency costs and ownership structure. *Journal of Financial Economics*, 3(4), 305-360.
- Kelly, R., & Kim, H. (2018). Venture capital as a catalyst for commercialization and high growth. *The Journal of Technology Transfer*, 43(6), 1466-1492. <https://doi.org/10.1007/s10961-016-9540-1>
- Ko., E.J., & McKelvie, A., (2018). Signaling for more money: The roles of founders' human capital and investor prominence in resource acquisition across different stages of firm development. *Journal of Business Venturing*. <https://doi.org/10.1016/j.jbusvent.2018.03.001>
- Kortum, S., & Lerner, J., (2000). Assessing the Contribution of Venture Capital to Innovation. *RAND Journal of Economics*. <https://doi.org/10.2307/2696354>
- Kraemer-Eis, H., Botsari, A., Gvetadze, S., Lang, F., & Torfs, W., (2018). European Small Business Finance Outlook: June 2018(No. 2018/50). *EIF Working Paper*.
- Kremp, É., Stöss, E., (2001). L'endettement des entreprises industrielles françaises et allemandes : des évolutions distinctes malgré des déterminants proches. *Economie et Statistique*. 341-342, 153-171.

- Landström, H., & Mason, C., (Eds.). (2016). Handbook of research on business angels. Edward Elgar Publishing.
- Landström, H., & Sørheim, R. (2019). The ivory tower of business angel research. *Venture Capital*, 21(1), 97-119.
- Lahti, T., (2011). Categorization of angel investments: An explorative analysis of risk reduction strategies in Finland. *Venture Capital*.
<https://doi.org/10.1080/13691066.2010.543322>
- Lahti, T., & Keinonen, H., (2016). 14 Business angel networks: a review and assessment of their value to entrepreneurship. *Handbook of Research on Business Angels*, 354.
- La Porta R., Lopez-de-Silanes F., Shleifer A. & Vishny R.W. (1998). Law and Finance, *Journal of political economy*, 106(6): 1113-1155.
- Leland, H.E., & Pyle, D.H., (1977). Informational Asymmetries, Financial Structure, and Financial Intermediation. *The Journal of Finance*, 32, 371-387.
<https://doi.org/10.2307/2326770>
- Levratto, N., (1996). Small Firms Finance in France. *Small Business Economics*, 8, 279-295.
<https://doi.org/10.1007/BF00393277>
- Levratto, N., Tessier, L., & Fontrouge, C., (2017). Business performance and angels presence: a fresh look from France 2008-2011. *Small Business Economics*, 1-18.
<https://doi.org/10.1007/s11187-016-9827-5>
- Macht, S.A., Robinson, J., (2009). Do business angels benefit their investee companies? *International Journal of Entrepreneurial Behaviour & Research*.
<https://doi.org/10.1108/13552550910944575>
- Maksimovic, V. (2001). Firms as financial intermediaries: Evidence from trade credit data. *The World Bank*.
- Masiak, C., Block, J. H., Moritz, A., Lang, F., & Kraemer-Eis, H. (2017). Financing micro firms in Europe: an empirical analysis (No. 2017/44). *EIF Working Paper*.
- Mason, C., & Botelho, T. (2016). The role of the exit in the initial screening of investment opportunities: The case of business angel syndicate gatekeepers. *International Small Business Journal*, 34(2), 157-175.
- Mason, C. M., & Harrison, R. T. (1997). Business angel networks and the development of the informal venture capital market in the UK: is there still a role for the public sector. *Small Business Economics*, 9(2), 111-123.
- Mason, C.M., & Harrison, R.T., (2004). Does investing in technology-based firms involve higher risk? An exploratory study of the performance of technology and non-technology investments by business angels. *Venture Capital*.
<https://doi.org/10.1080/1369106042000286471>
- Mason, C.M., & Harrison, R.T., (2008). Measuring business angel investment activity in the United Kingdom: A review of potential data sources. *Venture Capital*.
<https://doi.org/10.1080/13691060802380098>
- Mason, C.M., & Harrison, R.T., (2015). Business angel investment activity in the financial crisis: UK evidence and policy implications. *Environment and Planning C: Government and Policy*, 33, 43-60. <https://doi.org/10.1068/c12324b>

- Mason, C., & Stark, M. (2004). What do investors look for in a business plan? A comparison of the investment criteria of bankers, venture capitalists and business angels. *International Small Business Journal*, 22(3), 227-248.
- Maxwell, A. L., Jeffrey, S. A., & Lévesque, M. (2011). Business angel early stage decision making. *Journal of Business Venturing*, 26(2), 212-225. <https://doi.org/10.1016/j.jbusvent.2009.09.002>
- McGuinness, G., & Hogan, T. (2016). Bank credit and trade credit: Evidence from SMEs over the financial crisis. *International Small Business Journal*, 34(4), 412-445.
- Meltzer, A. H. (1960). Mercantile credit, monetary policy, and size of firms. *The Review of Economics and Statistics*, 429-437.
- Minola, T., Cassia, L., & Criaco, G. (2013). Financing patterns in new technology-based firms: An extension of the pecking order theory. *International Journal of Entrepreneurship and Small Business* 25, 19(2), 212-233.
- Mina, A., & Lahr, H. (2018). The pecking order of innovation finance.
- Myers, S. C. (1984). The capital structure puzzle. *The Journal of Finance*, 39(3), 574-592.
- Myers, S. C., & Majluf, N. S. (1984). Corporate financing and investment decisions when firms have information that investors do not have. *Journal of Financial Economics*, 13(2), 187-221.
- Myers, S. C. (2001). Capital structure. *Journal of Economic perspectives*, 15(2), 81-102. <https://doi.org/10.1257/jep.15.2.81>
- Paul, S., Whittam, G., & Wyper, J. (2007). Towards a model of the business angel investment process. *Venture Capital*, 9(2), 107-125
- Psillaki, M., & Eleftheriou, K., (2015). Trade Credit, Bank Credit, and Flight to Quality: Evidence from French SMEs, *Journal of Small Business Management*, 53(4), 1219-1240, <https://doi.org/10.1111/jsbm.12106>
- Politis, D., (2008). Business angels and value added: What do we know and where do we go? *Venture Capital*, 10(2), 127-147. <https://doi.org/10.1080/13691060801946147>
- Politis, D., (2016). Business angels as smart investors: a systematic review of the evidence. *Handbook of Research on Business Angels*, Chap 7, pp.147-175.
- Rauch, A., Wiklund, J., Lumpkin, G. T., & Frese, M. (2009). Entrepreneurial orientation and business performance: An assessment of past research and suggestions for the future. *Entrepreneurship Theory and Practice*, 33(3), 761-787.
- Riding, A.L., Madill, J.J., & Haines, G.H., (2007). Investment decision making by business angels, in: Landström, H. (Ed.), *Handbook of Research on Venture Capital*. Edward Elgar, Cheltenham, UK, pp. 332-346.
- Rosenbaum, P.R., & Rubin, D.B., (1983). The central role of the propensity score in observational studies for causal effects. *Biometrika*, 70, 41-55.
- Ross, S.A., (1977). The Determination of Financial Structure: The Incentive-Signalling Approach. *Bell Journal of Economics*. 8, 23-40. <https://doi.org/10.2307/3003485>
- Rubin, D.B., (1973). Matching to Remove Bias in Observational Studies. *Biometrics*, 29, 159-183. <https://doi.org/10.2307/2529684>

- Runyan, R., Droge, C., & Swinney, J. (2008). Entrepreneurial orientation versus small business orientation: what are their relationships to firm performance? *Journal of Small Business Management*, 46(4), 567-588.
- Savignac, F., (2007). Quel mode de financement pour les jeunes entreprises innovantes. *Revue Économique*, 58(4), 863-889. <https://doi.org/10.3917/reco.584.0863>
- Sensier, M., Bristow, G., & Healy, A., (2016). Measuring Regional Economic Resilience across Europe: Operationalizing a complex concept. *Spatial Economic Analysis*. 11(2), 128-151. <https://doi.org/10.1080/17421772.2016.1129435>
- Shyam-Sunder, L., & Myers, S. C. (1999). Testing static tradeoff against pecking order models of capital structure. *Journal of Financial Economics*, 51(2), 219-244.
- Spence, M. (2002). Signaling in retrospect and the informational structure of markets. *American Economic Review*, 92(3), 434-459.
- Stuart, E. A. (2010). Matching methods for causal inference: A review and a look forward. *Statistical science: a review journal of the Institute of Mathematical Statistics*, 25(1), 1. <https://doi.org/10.1214/09-STS313>
- Stuart, E. A., & Rubin, D. B. (2008). Best practices in quasi-experimental designs. *Best practices in quantitative methods*, 155-176.
- Tenca, F., Croce, A., & Ughetto, E. (2018). Business Angels research in entrepreneurial finance : a literature review and research agenda. *Journal of Economic Surveys*, 32(5), 1384–1413. <https://doi.org/10.1111/joes.12224>
- Tessier, L., & Ramadan, M. (2020). Sélectionner, contrôler et accompagner: Le credo du Business Angel pour réduire le risque de l'entreprise. *Revue de l'Entrepreneuriat*, 19(2), 93–120. Cairn.info. <https://doi.org/10.3917/entre1.192.0093>
- Titman, S. (1984). The effect of capital structure on a firm's liquidation decision. *Journal of Financial Economics*, 13(1), 137-151.
- Vanacker, T. R., & Manigart, S. (2010). Pecking order and debt capacity considerations for high-growth companies seeking financing. *Small Business Economics*, 35(1), 53-69.
- Van Hoang, T. H., Gurău, C., Lahiani, A., & Seran, T. L. (2018). Do crises impact capital structure? A study of French micro-enterprises. *Small Business Economics*, 50(1), 181-199.
- Van Osnabrugge, M. (2000). A comparison of business angel and venture capitalist investment procedures: an agency theory-based analysis. *Venture Capital: An international journal of entrepreneurial finance*, 2(2), 91-109. <https://doi.org/10.1080/136910600295729>
- Wallmeroth, J., Wirtz, P., & Groh, A. P. (2018). Venture capital, angel financing, and crowdfunding of entrepreneurial ventures: A literature review. *Foundations and Trends® in Entrepreneurship*, 14(1), 1-129. doi: 10.2139/ssrn.2967271.
- Welch, I., (2011). Two common problems in capital structure research: The financial-debt-to-asset ratio and issuing activity versus leverage changes. *International Review of Finance*, 11, 1-17. <https://doi.org/10.1111/j.1468-2443.2010.01125.x>
- White, B. A., & Dumay, J. (2017). Business angels: a research review and new agenda. *Venture Capital*, 19(3), 183-216. <https://doi.org/10.1080/13691066.2017.1290889>

- Wiltbank, R. (2005). Investment practices and outcomes of informal venture investors. *Venture Capital*, 7(4), 343-357. <https://doi.org/10.1080/13691060500348876>
- Wirtz, P. (2015). Entrepreneurial Finance and the Creation of Value: Agency Costs vs. Cognitive Value. In *Handbook of Research on Global Competitive Advantage through Innovation and Entrepreneurship* (pp. 552-568). IGI Global.

APPENDIX

Table 1-3 - Road map of matching methods

Methods		Bias		Variance		
NN-matching (Rubin, 1973)	Radius	(-)	(+)	(+)	(-)	
K-NN	Kernel Matching (Becker & Ichino, 2002)	(-)	(+)	(+)	(-)	
K-NN	Mahalanobis matching (<i>Stuart and Rubin 2008</i>)	(-)	(+)	(+)	(-)	
Parameters						
Number of nearest neighbours	Single	Multiple	(-)	(+)	(+)	(-)
Caliper threshold	With	Without	(-)	(+)	(+)	(-)
Replacement	With	Without	(-)	(+)	(+)	(-)
Bandwidth with KM	Small	Large	(-)	(+)	(+)	(-)

Note: This table indicates the advantages and the disadvantages of several matching methods and options. (+) increases and (-) decreases.

Table 1-4 - Definitions and descriptive statistics

Variable	Definition	Source	Sample	Obs	Mean	Std. Dev.	Min	Max
Dependent Variables								
Financial Debt ratio	$\frac{Financial\ Debts_{i,t}}{Total\ Debts_{i,t}}$	FARE	BAN	2160	0.33	0.27	0.00	0.79
		(Insee)	Non-BAN	276040	0.25	0.25	0.00	0.79
DebtCost	$\frac{Interest\ charges_{i,t}}{GOS_{i,t}}$	FARE	BAN	2153	0.0	0.1	-0.2	0.2
		(Insee)	Non-BAN	296,240	0.03	0.06	-0.04	0.18
Trading Debt	$\frac{Suppliers\ debt}{Total\ Debt_{i,t}}$	FARE	BAN	2151	0.3	0.2	0.0	0.7
		(Insee)	Non-BAN	296010	0.3	0.2	0.0	0.9
Day payable outstanding (DPO)	$\frac{Suppliers\ debt}{Total\ cost\ of\ purchase\ of\ goods\ sold_{i,t} * 365}$	FARE	BAN	1944	92.2	67.3	1.0	316.4
		(Insee)	Non-BAN	368535	55.9	48.7	1.0	224.9
Independent Variables								
Age	Year between date t and the creation of the firm.	CLAP	BAN	2160	1.8	0.6	0.7	4.1
		(Insee)	Non-BAN	536800	3.3	0.3	2.6	3.7
Effectives	Number of employees	CLAP	BAN	2159	1.6	1.0	0.0	3.3
		(Insee)	Non-BAN	531150	1.3	1.1	0.0	2.9
Return on Asset (ROA)	$\frac{GOS_{i,t}}{Total\ Assets_{i,t}}$	FARE	BAN	2153	0.8	0.3	0.3	1.3
		(Insee)	Non-BAN	296531	0.2	0.6	-17.0	19.4
Intangible Assets	Amount of intangible assets	FARE	BAN	2160	3.64	1.84	0.00	5.25
		(Insee)	Non-BAN	536799	2.4	2.0	0.0	5.3
Sales	Total Sales on a given fiscal year	FARE	BAN	2143	1.3	2.4	0.0	6.9
		(Insee)	Non-BAN	536800	2.9	3.2	0.0	7.7
Tangible	Amount of tangible assets.	FARE	BAN	2160	3.3	1.9	0.0	6.6
		(Insee)	Non-BAN	536799	4.4	1.7	0.0	6.6
Sector	Categorical variable to classify industries	CLAP	BAN					
		(Insee)	Non-BAN					
Location	Geographical categorical variable	CLAP	BAN					
		(Insee)	Non-BAN					

Table 1-5 - Correlation matrix

	(1)	(2)	(3)	(4)	(5)	(6)	(7)	(8)	(9)	(10)
ROA (1)	1									
Sales (2°)	-0.07	1.00								
Age (3)	-0.05	0.07	1.00							
Employees (4)	-0.16	0.12	-0.11	1.00						
Tangible (5)	-0.10	0.15	0.04	0.63	1.00					
Intangibles (6)	-0.14	0.27	-0.05	0.40	0.37	1.00				
Interest Charge (7)	-0.04	0.11	0.05	0.21	0.22	0.15	1.00			
Commercial Debt (8)	0.03	0.22	0.06	-0.01	-0.03	-0.01	-0.06	1.00		
DPO (9)	-0.07	-0.12	-0.04	-0.01	-0.04	0.02	0.01	0.30	1.00	
Financial Debt (10)	-0.05	0.05	-0.02	0.01	0.17	0.13	0.18	-0.43	-0.06	1.00

Table 1-6 - Smooth matching using PSM NN-1

Variable	Unmatched	Mean		Percent bias	Percent reduction bias	t-test	t	p>t
	Matched	Treated	Control					
ROA	U		0.8	0.2	182.7	54.7		0.00
	M		0.8	0.9	-7.7	95.8	-2.8	0.01
Sales	U		1.2	3.4	-75.3	-24.3		0.00
	M		1.2	1.2	1.8	97.6	0.6	0.55
Age	U		1.8	3.4	-401.4	-247.1		0.00
	M		1.8	1.8	1.9	99.5	0.4	0.71
Employees	U		1.7	1.3	41.9	14.5		0.00
	M		1.7	1.5	13.7	67.3	3.9	0.00
Tangibles	U		3.3	4.4	-65.4	-25.4		0.00
	M		3.3	3.3	2.1	96.7	0.5	.590
Intangibles	U		3.7	2.5	64.3	22.7		0.00
	M		3.7	3.6	7.7	88.0	2.1	0.04
Industry	U		58.2	50.9	45.1	17.6		0.00
	M		58.2	58.3	-0.4	99.1	-0.1	0.92
Localisation	U		42.1	50.4	-26.4	-10.1		0.00
	M		42.1	46.3	-13.4	49.3	-3.4	0.00

Notes: "U" refers to unmatched sample and "M" to matched sample. Percent bias represents the standard mean difference between both groups while "percent reduction bias" represents the reduction of bias following matching. The last two columns record respectively student statistics of equal mean test and associated decision rules.

Figure 1-1 - Smooth matching using propensity score matching (NN-1)

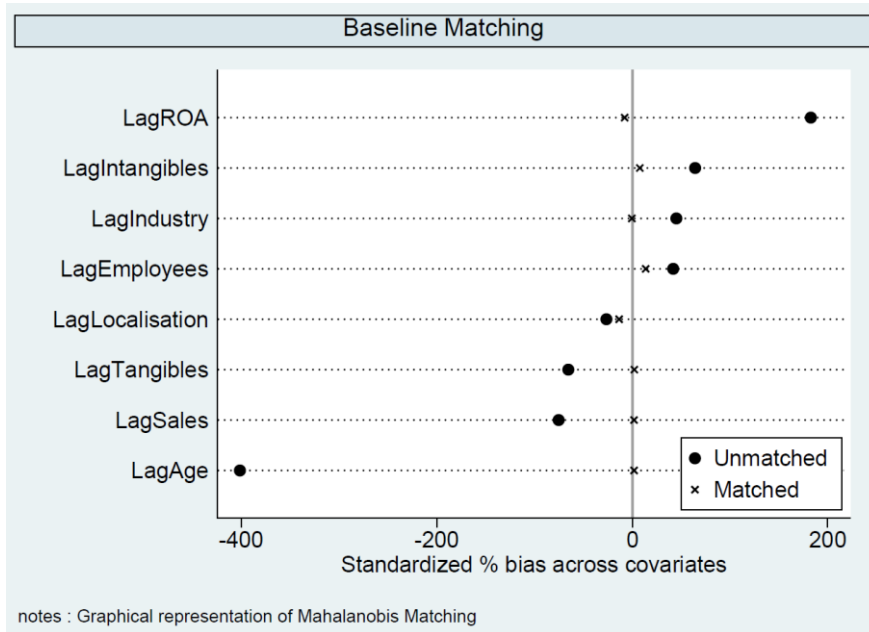

Table 1-7 - Alternative matching approaches

Technique	Time Frame	Treated	Controls	Difference	S.E.	T	Treated observations		Control observations
							Off Support	On Support	
Differential Financial Debt (H1)									
Kernel	1 Year differential	0.18	-0.02	0.19	0.18	1.07	236	116	26,288
	2 Years differential	0.26	-0.03	0.29	0.26	1.1	214	35	15,056
	3 Years differential	0.39	-0.03	0.42	0.30	1.4	201	32	12,089
	4 Years differential	0.53	0.02	0.51	0.34	1.49	109	28	8,921
	5 Years differential	0.47	-0.04	0.52	0.37	1.4	11	27	3,869
5-NN	1 Year differential	0.10	-0.02	0.12	0.07	1.62	111	241	26,288
	2 Years differential	0.26	-0.03	0.29	0.26	1.12	214	35	15,056
	3 Years differential	0.39	-0.03	0.42	0.30	1.41	201	32	12,089
	4 Years differential	0.53	0.02	0.51	0.34	1.51	109	28	8,921
	5 Years differential	0.37	-0.05	0.41	0.35	1.17	9	29	3,869
1-NN	1 Year differential	0.10	-0.03	0.12	0.12	1.04	111	241	26,288
	2 Years differential	0.26	-0.02	0.28	0.26	1.06	214	35	15,056
	3 Years differential	0.39	-0.03	0.42	0.30	1.4	201	32	12,089
	4 Years differential	0.53	0.04	0.49	0.34	1.42	109	28	8,921
	5 Years differential	0.37	-0.05	0.42	0.35	1.18	9	29	3,869
Differential DebtCost (H2)									
Kernel	1 Year differential	0.00	0.00	0.00	0.01	-0.02	180	493	18,445
	2 Years differential	0.01	-0.01	0.02	0.02	1.03	117	346	10,121
	3 Years differential	0.01	0.00	0.01	0.02	0.66	86	253	7,516
	4 Years differential	0.01	-0.01	0.02	0.02	1.11	24	114	4,578
	5 Years differential	0.03	0.00	0.03	0.03	0.85	5	33	4,082
5-NN	1 Year differential	0.00	0.00	0.00	0.01	-0.19	180	493	18,445
	2 Years differential	0.01	-0.01	0.02	0.01	1.35	117	346	10,121
	3 Years differential	0.01	0.00	0.01	0.02	0.47	86	253	7,516
	4 Years differential	0.01	-0.01	0.02	0.02	0.87	24	114	4,578
	5 Years differential	0.03	0.00	0.03	0.03	1	5	33	4,082

1-NN	1 Year differential	0.000	-0.001	0.001	0.012	0.12	180	493	18,445
	2 Years differential	0.007	-0.008	0.016	0.012	1.25	117	346	10,121
	3 Years differential	0.007	-0.005	0.011	0.018	0.62	86	253	7,516
	4 Years differential	0.009	-0.019	0.028	0.022	1.28	24	114	4,578
	5 Years differential	0.032	-0.009	0.041	0.044	0.93	5	33	4,082
Differential Trading Debt (H3)									
Kernel	1 Year differential	-0.02	0.02	-0.03	0.03	-1.19	180	492	18,477
	2 Years differential	-0.02	-0.02	0.00	0.04	-0.13	117	345	10,136
	3 Years differential	-0.04	-0.03	0.00	0.04	-0.1	86	253	7,524
	4 Years differential	-0.03	-0.07	0.04	0.04	0.88	24	114	4,584
	5 Years differential	-0.07	-0.02	-0.05	0.06	-0.86	5	33	4,089
5-NN	1 Year differential	-0.02	0.01	-0.03	0.03	-1.18	180	492	18,477
	2 Years differential	-0.02	-0.02	0.00	0.03	-0.13	117	345	10,136
	3 Years differential	-0.04	-0.03	-0.01	0.03	-0.38	86	253	7,524
	4 Years differential	-0.03	-0.07	0.03	0.04	0.89	24	114	4,584
	5 Years differential	-0.07	-0.05	-0.02	0.06	-0.39	5	33	4,089
1-NN	1 Year differential	-0.02	0.02	-0.03	0.03	-1.15	180	492	18,477
	2 Years differential	-0.02	-0.03	0.00	0.04	0.07	117	345	10,136
	3 Years differential	-0.04	-0.04	0.00	0.04	0.09	86	253	7,524
	4 Years differential	-0.03	-0.08	0.04	0.04	1.03	24	114	4,584
	5 Years differential	-0.07	-0.03	-0.04	0.07	-0.55	5	33	4,089
Differential DPO (H4)									
Kernel	1 Year differential	-1.08	2.14	-3.21	7.10	-0.45	180	493	19,503
	2 Years differential	3.25	-5.25	8.49	8.87	0.96	117	346	10,495
	3 Years differential	5.57	2.75	2.82	9.65	0.29	86	253	7,773
	4 Years differential	9.62	-2.28	11.90	11.61	1.03	24	114	4,714
	5 Years differential	-13.39	6.24	-19.63	21.86	-0.9	5	33	4,179
5-NN	1 Year differential	-1.08	-2.62	1.54	7.88	0.2	180	493	19,503
	2 Years differential	3.25	-9.56	12.81	12.32	1.04	117	346	10,495
	3 Years	5.57	5.73	-0.16	11.73	-0.01	86	253	7,773

	differential								
	4 Years	9.62	-5.63	15.25	13.20	1.15	24	114	4,714
	differential								
	5 Years	-13.39	0.99	-14.37	20.54	-0.7	5	33	4,179
	differential								
	1 Year								
	differential	-1.08	2.21	-3.29	9.67	-0.34	180	493	19,503
	2 Years								
	differential	3.25	-7.08	10.33	13.57	0.76	117	346	10,495
1-NN	3 Years								
	differential	5.57	8.85	-3.28	14.34	-0.23	86	253	7,773
	4 Years								
	differential	9.62	8.32	1.30	14.91	0.09	24	114	4,714
	5 Years								
	differential	-13.39	10.90	-24.29	24.89	-0.98	5	33	4,179

Table 1-8 - Robustness test for smooth matching using alternative methods

Methods	Variable	Unmatched Matched	Mean		Percent bias	Percent reduc- tion bias	t-test	t	p>t
			Treated	Control					
Kernel	ROA	U	0.83	0.16	186.9		56.2	0	
		M	0.83	2.05	-343.1	-83.5	-11.16	0	
N(5)		U	0.83	0.16	186.9		56.2	0	
		M	0.83	2.07	-349.8	-87.1	-11.33	0	
N(1)		U	0.83	0.16	186.9		56.2	0	
		M	0.83	1.86	-291.1	-55.7	-10.29	0	
Kernel		Sales	U	1.23	3.11	-66.4		-21.48	0
			M	1.23	1.20	0.9	98.6	0.31	0.76
N(5)			U	1.23	3.11	-66.4		-21.48	0
			M	1.23	1.14	3.2	95.2	1.05	0.295
N(1)	U		1.23	3.11	-66.4		-21.48	0	
	M		1.23	1.25	-0.6	99.1	-0.19	0.846	
Kernel	Age		U	1.81	3.38	-380.2		-212.33	0
			M	1.81	1.91	-23.3	93.9	-3.55	0
N(5)			U	1.81	3.38	-380.2		-212.33	0
			M	1.81	1.86	-11.9	96.9	-1.96	0.05
N(1)		U	1.81	3.38	-380.2		-212.33	0	
		M	1.81	1.84	-6.8	98.2	-1.14	0.255	
Kernel		Employees	U	1.68	1.29	39.6		13.69	0
			M	1.68	1.27	41.6	-5	11.2	0
N(5)			U	1.68	1.29	39.6		13.69	0
			M	1.68	1.33	35.6	10.3	9.39	0
N(1)	U		1.68	1.29	39.6		13.69	0	
	M		1.68	1.31	37.9	4.3	10.13	0	
Kernel	Tangibles		U	3.30	4.41	-64.5		-25.13	0
			M	3.30	3.06	14.1	78.2	3.38	0.001
N(5)			U	3.30	4.41	-64.5		-25.13	0
			M	3.30	3.06	14.1	78.2	3.37	0.001
N(1)		U	3.30	4.41	-64.5		-25.13	0	
		M	3.30	3.01	16.5	74.4	3.99	0	
Kernel		Intangibles	U	3.71	2.43	68.1		24.09	0
			M	3.71	2.76	50.6	25.8	12.79	0
N(5)			U	3.71	2.43	68.1		24.09	0
			M	3.71	2.84	46	32.4	11.69	0
N(1)	U		3.71	2.43	68.1		24.09	0	
	M		3.71	2.99	38.3	43.8	9.85	0	
Kernel	Industry		U	58.18	50.91	43.4		16.23	0
			M	58.21	57.73	2.9	93.4	0.74	0.46
N(5)			U	58.18	50.91	43.4		16.23	0
			M	58.21	57.77	2.6	94	0.67	0.502
N(1)		U	58.18	50.91	43.4		16.23	0	
		M	58.21	58.24	-0.2	99.5	-0.06	0.955	
Kernel		Localisation	U	42.09	50.24	-26		-10.01	0
			M	42.06	45.76	-11.8	54.7	-2.98	0.003
N(5)			U	42.09	50.24	-26		-10.01	0
			M	42.06	45.48	-10.9	58.1	-2.76	0.006
N(1)	U		42.09	50.24	-26		-10.01	0	
	M		42.06	47.39	-17	34.7	-4.23	0	

Table 1-9 - Pre-trend Assumption (PTA)

Variables	Treated		Control		Difference	T-test of equal pre-trend dynamics
	Mean	N	Mean	N	Mean	
Financial Debt	0.24 (1.43)	337	0.92 (0.13)	19560	0.68 (1.02)	0.50
DebtCost	0.16 (0.47)	190	-4,67 (10,7)	8652	-4.84 (10.47)	0.94
Trading Debt	0.23 (0.06)	385	0.84 (0.08)	24486	0.60 (0.64)	0.34
DPO	0.89 (0.38)	236	0.43 (0.018)	61870	-0.45 (0.30)	0.12

Note: This table presents results of the PTA. Outcome variables are computed in growth rates to ensure that pre-treatment dynamics are not different between treated and control group. N represents the number of observations used to compute mean tests and depends on pre-treatment data availability.

Figure 1-2 - Test of smooth matching Kernel, 5-NN matching and 1-NN matching

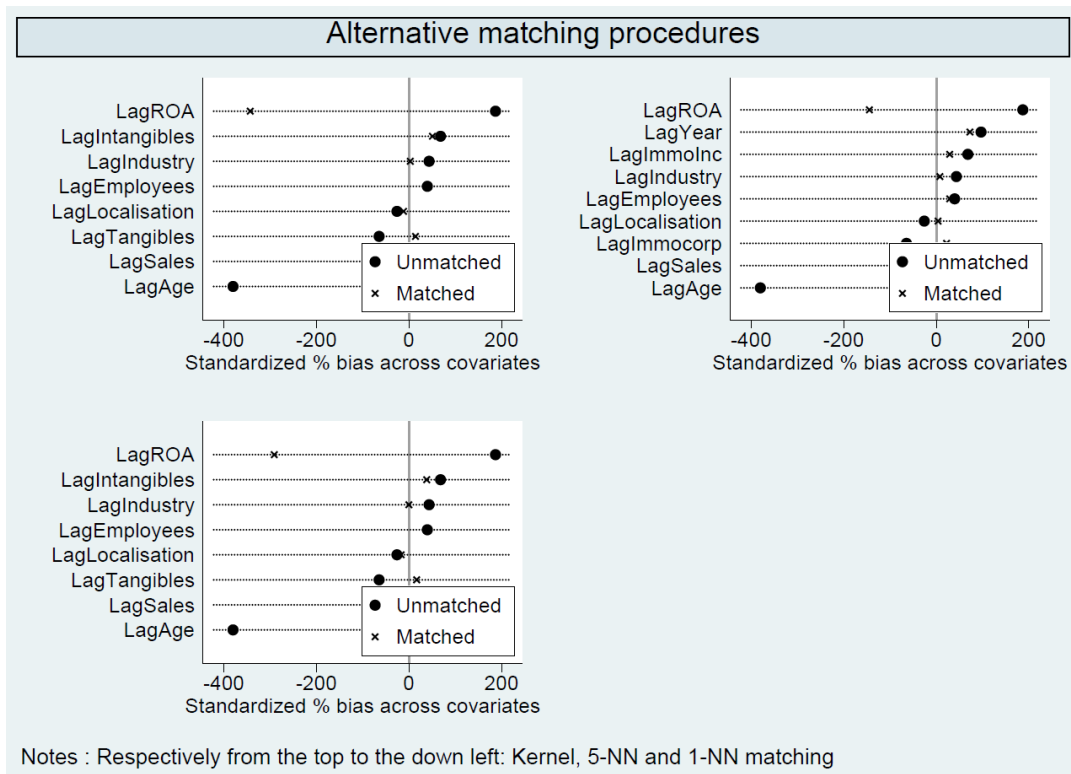

2 CHAPITRE 2

PARTICIPATIVE LOAN FOR INNOVATIVE FIRMS IN FRANCE

2.1 *Introduction*

Widely acknowledged by business operators and academic scholars, innovative young and small companies (YICs¹) face numerous difficulties regarding their development (Berger & Udell, 1998, 2006; Giraud et al., 2019). Among the constraints they encounter, financing appears to be the primary factor limiting innovative growth prospects, notably in the early stage (OECD, 2012; St-Pierre, 2019). Financing issues lead to an under-investment situation that limits growth prospects (Carpenter & Petersen, 2002). Highlighted as at least partially responsible for the issue (Mazzucato & Penna 2016) are market imperfections, including information asymmetry, agency costs, and knowledge spillovers (Hall & Lerner, 2010). Internal characteristics, such as youth, the lack of tangible assets to pledge as collateral, the involvement in innovative activities, the willingness to remain independent further contribute to the scarcity of funding these firms face (Biancalani et al., 2020; Marti & Quas, 2018; OECD, 2020). The abovementioned caveats together contribute to the high bankruptcy rate of YICs compared to other types of firms, which further reinforce the financing gap they face (Revest and Sapio, 2012; Coad, 2018). In this context, the type of firms face cumulated constraints regarding their development (Czarnistki & Delanote, 2015; Schneider & Veugelers, 2010), especially during crisis periods (Lee et al., 2015) in bank-based economies (Hernández-Cánovas & Martínez-Solano, 2010; Colombo & Grilli, 2007), which can lower their contribution to economic activity (Hölzl, 2016).

Despite being acknowledged as an efficient answer to the early-stage funding gap for YICs,² the impact of formal and informal venture capital investors (such as business angels or venture capitalists) is constrained by structural factors that relevant institutions try to address³

¹ We refer to the definition stated by Pellegrino et al. (2009), that YICs are firms engaged in product innovation and having less than 8 years of activity.

² The main advantage of business angels and other venture capitalists over banks lies in their capacity to lower information asymmetry (Sahlman, 1990). Another aspect concerns the human capital value added provided by informal investors (Politis, 2008) for the case of business angels and Cumming et al. (2017) for venture capitalists' value added).

³ The bank-based structure of the European Union is pointed out as responsible for the low recovery from the crisis compared to the recovery of the market-based system (Allard and Blavy, 2011. Grjebine et al., 2019) and for the overall low growth level in Europe in recent years (Bhatia et al. 2019). Supra-national and regional

at the national and international levels. Indeed, European market players hardly alleviate YICs' financial constraints (Giraudo et al., 2019a) which forced governments and competent authorities to implement structural innovation policies that are tailored, from architecture to application, to have an impact on the local ecosystems on which the development of YICs strongly depends (Braunerhjelm et al., 2010; Chatterji et al., 2014). In addition to facing important barriers that authorities try to reduce, the SME population under scrutiny was revealed to be important from political, social and societal viewpoints given that SMEs, particularly young and innovative ones, are responsible for an important share of employment and productivity (Grimsby, 2018, Hölzl 2016). However, the question of whether public authorities efficiently screens and monitors market imperfections remains unsolved by both empirical and theoretical studies (Keech & Munger, 2015; Tullock et al., 2002). This chapter aims to reduce this gap by exploring the impact of governmental support on YIC development.

For decades, worldwide authorities have constructed and conducted various programs to allocate public funds to innovation financing, producing extended but heterogeneous empirical literature on impact evaluations of public financial instruments for YICs⁴. On the supply side, government financing support to YICs mainly takes the form of fiscal and tax incentives for R&D, grants, loans and guarantee schemes, equity financing, and mezzanine finance. Univocal findings hardly exist for tax incentives to R&D (Czarnitzky & Delanote, 2015), so as for the government equity-based support (governmental venture capital funds) which have either positive (Colombo et al., 2016), negative (Grilli & Murtinu, 2015), or negligible effect (Grilli & Murtinu, 2014) and may depend on the period under consideration (Croce et al., 2019). Although related studies have increased in recent years, the literature on governmental mezzanine instruments is much less developed than that on other financing instruments. Recent investigations point out that, despite being widely used since the 2010s across OECD countries, only a few evaluations have been performed (Cusmano & Thompson, 2018).

measures have been undertaken to reinforce equity market and ultimately enhance the growth prospects of financed firms. Recently, in September 2020, the European Commission released an action plan to strengthen the capital market in the EU with the participation of the French financial market authority (AMF).

⁴ Table 2-3 in Appendix A summarizes the main financing instruments available for SMEs.

The goal of this chapter is to contribute to the innovation financing empirical literature and the impact evaluation literature. Specifically, this chapter investigates recent and as yet under-explored early-stage financing instruments⁵ and governmental mezzanine support granted by French national authorities. Called junior loans (JLs), this mezzanine instrument is similar to a traditional debt contract in terms of defined maturity and interest payment.⁶ However, in contrast to conventional debt, repayment is delayed and subordinate to pure debt contracts, making JLs a mezzanine financing instrument (Cusmano and Thompson, 2018). The design of such instruments is not predefined; it suits the issuing firm's needs and characteristics, making these instruments particularly suitable for entrepreneurial finance and therefore encompassing endless combinations of equity- and debt-like instruments.

Notwithstanding, despite its undeniable advantages,⁷ such financing also has disadvantages. First, from a business viewpoint, mezzanine instruments are subordinated, making them more expensive and riskier than pure debt instruments. Second, from an evaluation perspective, targeted firms usually lack financial track records, making mezzanine finance trickier to study from a global perspective than from a qualitative perspective (i.e., case studies). This chapter explores a JL programme of the French Public Investment Bank (Bpifrance) for early-stage financing called “starting loans” (*Prêt d'amorçage*). Created to overcome financing challenges and support fundraising, JLs are suited for innovative⁸ companies that are less than five years old. With amounts between 30 000 and 500 000 €, the programme includes a three-year investment deferral for a total of eight loan years. The screening process for firm selection and data cleaning led us to consider 921 firms receiving a JL between 2006 and 2014. Using the Mahalanobis matching method with replacement (King et al., 2011) augmented by a double difference estimator to control for time-invariant

⁵ The first initiatives date back to the mid-2000s in Europe (Cusmano & Thompson 2018; CNEPI, 2016). Mezzanine finance amounted to 396 million € in 2017 and 811 million € in 2018, making it the private debt financing instrument with the fastest growth, according to [France Invest and Deloitte](#) (2018).

⁶ See Appendix A,

Table 2-4 for detailed information on the mezzanine finance landscape.

⁷ From the creditor viewpoint, it allows additional incomes from successful firms that at least offset the losses from unsuccessful firms. Therefore, it can finance innovative and risky projects with higher recovery than R&D subsidies (Marti and Quas, 2018). From a debtor perspective, it avoids ownership dilution, which is an important aspect in financing innovation (Drover et al., 2017), while contributing to reinforcing the capital structure for external financing and liquidity purposes.

⁸ The innovative aspect is ensured since recipient firms already received innovation subsidies prior to receiving the PL.

characteristics, we investigate the development of backed companies compared to their non-funded counterparts. An adequate control group is constituted to explore the scenario that would have occurred without funding and address the central research question in the generic policy evaluation literature, ensuring efficient causal estimates of the treatment (Grimsby, 2018).⁹

To complete the research setting and enrich the operational strategy, we test the sensitivity of the results to loan design and, notably, to the investment timing (in years) between the innovative award and programme participation. As we can link financial and employment data,¹⁰ we notably analyse the effects of programme assignment on both input and output outcomes. Input effects are investigated through the resource accumulation hypothesis in terms of tangible and intangible assets and the certification hypothesis regarding human capital growth (employees).¹¹ Output outcomes include sales and labour productivity as production indicators.

The chapter's first contribution lies in studying a mezzanine instrument, a relatively new financing tool to be evaluated in the public support landscape (Cusmano & Thompson, 2018). Concomitantly, we enrich the scope of innovation financing studies using a unique French dataset to explore early-stage financing, different from the mainstream U.S., Canadian and U.K. datasets (Granz et al., 2020). Last, through the study of government support and in line with the rigorous public finance context, we enrich the literature devoted to the impact evaluation of public spending and the evaluation of innovation and early-stage financing in the time of recession (Srhoj et al., 2021).

The rest of the chapter is organized as follows. While the second section is dedicated to the academic literature dealing with government support for entrepreneurship, the third section develops the research design, data, and methodology. The fourth and fifth sections are devoted to the baseline results and robustness tests, respectively. The last section concludes with policy recommendations.

⁹ See the discussion about the counterfactual in section 3.1.

¹⁰ The data come from the National Institute of Statistics and Economic Studies and cover financial statements as well as data on employment.

¹¹ We do not have access to R&D data and thus use intangible assets as a proxy of the innovative aspect of firms.

2.2 Literature review: entrepreneurship's contribution to growth and its public support

Based on the foundation of the entrepreneurship and innovation literature laid by Schumpeter (1934), scholars in numerous scientific fields have tried to explain entrepreneurship and innovation processes.¹² While offering precious insights, the multidisciplinary approach of entrepreneurship and small businesses theory raises numerous and still unclear debates. Among the prominent debates are the following: (i) the comparative advantage of small organizations for innovation that can (ii) drive their contribution to growth (Hölzl, 2016) and (iii) the role of public authorities within this framework (Mazzucatto & Penna, 2016). Since YICs' innovation and growth contribution are part of the rationale behind their public support, debates on the role and importance of the public management of entrepreneurship and innovative new ventures in knowledge economics theory raise important policy implications. New insights are continuously needed to understand the heterogeneous and disruptive nature of entrepreneurship (Ratinho et al., 2020) and to fuel policy debates on the construction of *evidence-based* policies (Frese et al., 2014).

2.2.1 Does size matter: from firm size to growth

In the Schumpeterian tradition, entrepreneurs are the channel through which knowledge, and thus innovation, is linked to economic activity (Braunerhjelm et al., 2010; Landström, 2008). However, the Schumpeterian concept of innovation is not limited to entrepreneurial firms; large firms are also seen as essential innovation contributors. The innovation literature widely debates the (dis)advantages of size for innovation (Knott & Viegerr, 2020).¹³ Theoretically, large firms benefit from economies of scale that allow better diversification of stochastic R&D projects. Large firms have many financial resources to allocate to innovative activities and benefit from cost spreading in terms of output (Galbraith, 1952).¹⁴ On the other hand, small firms have lower organizational costs, which facilitate flexible decision-making (Knott & Vieregger, 2020). In addition, small firms are

¹² See Landström et al. (2012) and Landström (2020) for an exhaustive review on the development of entrepreneurship policies. Developments include notably history (Carlen 2016), sociology (Weber 1930) and psychology (Baum & Lock, 2004).

¹³ Although the related research has improved over time (Nelson, 1959 and Scherer, 1991), the theoretical developments mainly rest upon Schumpeter's insights and are heavily driven by empirical considerations (Knott & Vieregger, 2020).

¹⁴ The cost-spreading argument can have deleterious implications for social welfare. In Scherer's (1991, 1992) framework, the cost-driven consideration incentivizes projects with relatively low risk (i.e., incremental instead of radical innovation projects), which could negatively influence social welfare in the long run.

closer to customers from a market positioning viewpoint and can better adjust their production capabilities to market needs. Finally, large enterprises can dilute the perception of individuals' contribution to innovative efforts, leading to a loss of creativity and motivation. The innovation literature leads to a puzzling picture, where R&D productivity decreases with size, while R&D investment presents the opposite pattern. Recently, Knott and Vieregger (2020) provided new insight into the size-innovation relationship. They state that the apparent contradiction is driven either by the "contingent tack" or by measurement issues (the indicator traditionally used fails to account for innovation theory). While they find that size is correlated with innovation forms, they do not observe different productivity patterns, invalidating the "contingent tack" hypothesis. Instead, the results confirm the productivity measurement issue hypothesis since their indicator (R&D elasticity to investment measure) is positively correlated with size. However, as stated by the authors, the cross-sectional nature of the data could drive the depicted relationship. In addition, results obtained with U.S. data may differ widely from those obtained with continental European data.

As stated above, a critical rationale of public support for YICs lies in their contribution to growth. Theoretical developments encompass endogenous growth models. For the U.S., Lucas (1978) links firm size and the per capita income of economies with a Solow-type growth model (Solow, 1956). In Europe, Bentolila & Bertola (1990) link employment dynamics and labour policies. Their contribution provides important implications on the impact of market barriers that structurally influence firm productivity and thus firm entry/exit. They conclude that barriers distort the reallocation process, leading entrants to present higher productivity than incumbents and exiting firms¹⁵. Using endogenous growth models, the entrepreneurship literature has developed the mechanisms in the link between knowledge, innovation, and growth. At the micro level, innovative activities induce R&D spending (in terms of researchers' wages), which constitutes the first link between knowledge and economic activity (Arrow, 1971; Romer 1990; Acs et al., 2012; Audretsch et al., 2014). At the macro level, knowledge spillover state that innovative activities benefit to other actors in addition to the innovative companies themselves (Acs & Audretsch, 2010).¹⁶ Recent developments suggest that the debates around YICs' contribution to growth are mainly empirical. European investigations confirm the disproportionately high contribution to both

¹⁵ See Bartelsman et al. (2005) and Criscuolo et al. (2014) for a review.

¹⁶ However, the knowledge spillover is recognized as not being automatic (Acs et al., 2013a, b).

employment and productivity growth while acknowledging high heterogeneity across time and countries (Hölzl 2016).¹⁷

2.2.2 The role of governmental support for innovation: the case of direct support

The rationale for public intervention in the innovation market is rooted in the existence of market imperfections (Stiglitz & Weiss, 1981, Gompers & Lerner, 2000, Lerner, 1999) due to nature of innovation that is non-rival and partially non-excludable. Market frictions exacerbate transaction costs and information asymmetry issues (Myers & Majluf, 1984) and limit the growth opportunities of entrepreneurial firms (Carpenter & Petersen, 2002), especially in crisis periods (Lee et al., 2015) in bank-based economies (Hernández-Cánovas and Martínez-Solano, 2010). It also creates distortions and misalignment between agents' expectations and reduces the market internalization of innovative outcomes, leading to under-investment situations, which governments seek to reduce. In this context, government intervention is legitimized¹⁸ (Mazzucato 2016), and national authorities have developed direct and indirect instruments for innovation over the decades and across countries (Giraud et al., 2019).

Indirect instruments, intensively used across OECD countries and widely described in the literature since the surge of their use in the 1970s, are found to be idiosyncratically defined, limiting the knowledge accumulation in the field of public support (Busom et al., 2014; Larédo et al., 2016; and Spengel et al., 2015). Conversely, the case of direct support instruments, historically linked to public support, has faced a relative lack of interest during this period (Cunningham et al., 2016, Lhuillery et al., 2013).

However, the surge of societal challenges and “mission-oriented” targets (ecology, environment, gender equality) returned direct public support for innovation to the government’s agenda (Mazzucato, 2016 and Mazzucato & Penna, 2016). In addition, direct support data collection and evaluation are acknowledged more easily than generic tax credit regimes (Bozio et al., 2014; Huergo & Moreno, 2017). Figure 1 below summarizes the composition of public support across OECD countries and depicts the high recourse to

¹⁷ With U.S. data, Haltiwanger et al. (2013) find no monotonic relationship between firm size and growth, controlling for age.

¹⁸ See Schmidt (2018) or Mazzucato et al. (2016) for recent developments regarding the theoretical background of public intervention.

indirect support in France, covering approximately 75% of business expenditures for R&D.¹⁹ Direct public support instruments include government venture capital (GVC), limited partnerships (GLPs), grants and loan schemes (OCDE, 2020). Regardless of financing instruments, the research question mainly focuses on additionality (in terms of input, output and behaviours) and on the certification effect of the public asserting both the economic value and social value of firms (Dimos & Pugh, 2016; Leleux & Surlémont, 2003; Meuleman & De maeseneire, 2012). However, the wide heterogeneity of public tools favouring entrepreneurship and small business developments limits the convergence of empirical studies trying to assess the impact of public intervention. Indeed, while public support finds an theoretical support, empirical studies testing its efficiency produce mixed outcomes (Dimos & Pugh, 2016; Srhoj et al., 2019 and Zúñiga-Vicente et al., 2014).

Figure 2-1 - Direct and indirect public funds as a percentage of GDP

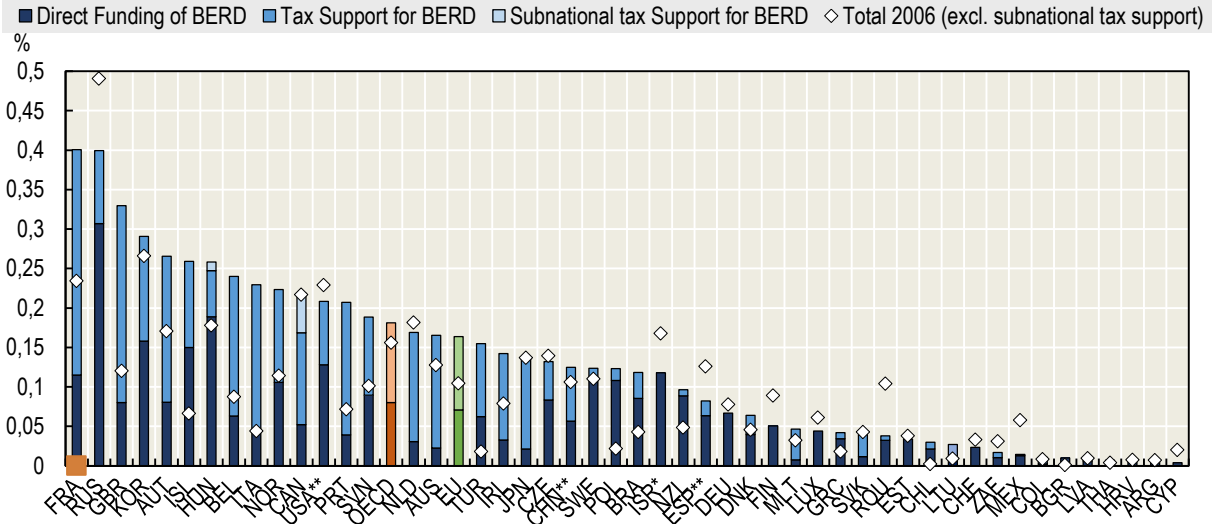

Source : OECD

2.2.2.1 R&D and non-R&D subsidies

As mentioned above and despite the extensive literature, the additionality hypothesis hardly finds univocal support (Czarnitzki & Delanote, 2015, Dimos & Pugh 2016). Recent studies globally reject the crowding-out hypothesis without accepting the crowding-in hypothesis of public innovative SMEs (Dimos & Pugh, 2016). For the U.K., Vanino et al. (2019) use propensity score matching in a double difference research design (PSM-DiD) to

¹⁹ Figure A.1 in Appendix A provides further longitudinal details for the French case.

explore the additionality of public R&D subsidies. Even if the additionality hypothesis is not rejected, its magnitude varies according to the project and firm characteristics. Belluci et al. (2019) use the same methodology to investigate R&D policies in Italy. Both Italian R&D programs²⁰ studied yield mixed results, favouring crowding-in effects yet presenting heterogeneous magnitudes.²¹ In addition to considering the crowding-in and crowding-out hypotheses, studies investigate the 3B hypothesis of public spending.²² Using a PSM-DiD research design, Autio and Ranniko (2016) study the impact of a Finnish programme on young high-growth firms on sales growth.²³ They highlight the programme's positive effect through a mechanism boosting organizational capacities, leading to a 120% increase in sales compared to the counterfactuals. In addition to additionality, the signal effect of public subsidies support is considered, notably regarding external funding availability (Meuleman & Maeseneire, 2012).²⁴ Colombo et al. (2013) also consider the certification effect through selective versus automatic Italian schemes. Their results validate the certification hypothesis for the selective programme. In the same vein, Söderblom et al. (2015) explore the certifying aspect of public spending using Swedish data for firms financed from 2002 to 2008 by a selective programme. They conclude, in line with Colombo et al. (2013), that there exists a certification effect conditioned on the financing programme's legitimacy and prestige. The result is reinforced for early-stage firms and for firms being subsequently financed or having an increasing workforce.²⁵

Reflection around the certification hypothesis allows us to investigate the nonfinancial support of public authorities and to focus on the settings of the programs (targets, application). Recent investigations also explore the public grant landscape but note that while

²⁰ One programme focuses on individual firm-level research projects, and the other programme considers collaborative projects between universities and firms.

²¹ Several studies, including Michalek et al. (2015) in Germany, also confirm the previous inconclusive results.

²² The 3B hypothesis refers to buffering, bridging and boosting. The buffering argument suggests the passive role of public spending that isolates firms from adverse market situations and thus leads to higher survival. In contrast, the bridging argument refers to the certification effect, or the legitimacy needed to obtain external finance that is granted by the programme. Finally, the boosting argument refers to the capacity of public spending to enhance growth by bringing hands-on support, for example.

²³ Eligible firms are less than six years old with at least 15% of R&D expenditure during the last three years.

²⁴ The heterogenous nature of the results is confirmed by the higher certification effect granted to more opaque firms.

²⁵ In France, R&D subsidies often take the form of a tax credit, which is not an injection a cash flow but a tax shield. We do not explore this aspect since this chapter focuses on the direct cash injection from public authorities. For the French case, interesting studies include Dugué (2004, 2010), Mulkai and Mairesse (2013) and Bozio et al., (2014). For regional R&D subsidies in France, see Bedu and Vanderstoken (2019).

many efforts are devoted to R&D grants and subsidies, few papers consider non-R&D subsidies (Shroj et al., 2020, 2021).²⁶ However, non-innovative firms represent an important proportion of SMEs and therefore could need dedicated public support to improve the extensive margins of innovation policies. The focus and rationale of public policies are subject to still unclear and intense debates (Arshed et al., 2014 and Shane, 2009).²⁷ Dvoulety et al. (2020) summarize the main recent empirical literature on grants and observe that the results suggest a positive impact on survival, employment and turnover, while equivocal results are found on productivity.²⁸

2.2.2.2 Public venture capital

Public equity intervention can be divided into direct (Leleux & Surlemont, 2003; Botazzi and Da rin, 2002), indirect (Alperovych et al., 2018; Standaert & Manignart, 2018) and syndicated interventions (Bertoni & Tykvova, 2015; Brander et al., 2015; Cumming et al., 2017 and Grilli & Murtinu 2014). Public intervention in the capital market has been driven by the importance of entrepreneurship and innovation for inclusive growth (Kortum & Lerner, 2000; Da Rin et al., 2006; OECD, 2020) in a context of high information asymmetry that limits bank financing, already reduced by regulatory constraints that have followed the financial crisis in 2008. Indeed, European Banks are reluctant to lend to opaque firms (Lee et al., 2015) and face regulatory pressures to clean balance sheets from previous bad loans (Wehinger, 2014). In France, like any other bank-based economy, private venture capital (PVC) funds and government venture capital (GVC) funds have increased since the crisis.²⁹ Recent methodological developments in the evaluation literature reduce the variability of results and globally show a positive impact of public equity intervention (Guerini & Quas, 2016 ; Croce et al., 2019).

In addition to the two main research questions depicted above, questions specific to GVC are linked to exit performance (Cumming et al., 2017) and the probability of obtaining

²⁶ The non-R&D subsidies literature is limited. Non-R&D subsidies include the purchase of equipment and tools, the development of business plan and consulting services, the training of entrepreneurs and marketing activities, etc. See OECD (2011) for further details.

²⁷ Recent literature reviews of the field were performed by Ratinho et al. (2020) and Urbano et al., (2019).

²⁸ Santos (2019) exploring a Portuguese subsidy finds a positive impact on sales and employment but a negative impact on productivity and value creation. Sissoko (2011) in France also finds negative influence of public support on labour productivity. Catozzella and Vivarelli (2016) support this view using Italian data by observing a negative impact of public subsidy and innovative productivity.

²⁹ See Harrison and Mason, (2019). Developments occurred later in bank-based economies than in market-based economies (Botazzi and Da Rin, 2002).

public support (Gompers and Lerner, 2000). Empirical investigations on the impact of GVC highlight a positive effect of mixed syndicates (Grilli and Murtinu, 2014; Brander et al., 2015) that allow the rejection of the full crowding-out hypothesis.³⁰ In contrast, GVC support is found to be either non-significant (Grilli or Murtinu, 2014) or negative compared to independent VC support (Alperovitch et al., 2015). The certification hypothesis is also debated in the case of GVC. Guerini and Quas (2016) notably find a positive effect of receiving GVC on the likelihood of receiving PVC funding for a sample of European entrepreneurial high-tech firms.

2.2.2.3 Public loan schemes

A last widely used public instrument favouring innovation is loan schemes (LSs), which are used to reduce market imperfections and boost financed firms' capacities. Competent authorities directly intervene in entrepreneurial markets, which improve public know-how, expertise and relationship lending, reducing government failure issues (Grand, 1991; Grimsby, 2018). From the firm viewpoint, the auto-selection process implied by participative loans compared to subsidies may induce a higher recipient quality, bringing back the “picking winners” debate (Autio & Ranniko, 2016; Huergo & Moreno, 2017).

In addition, participative loans are likely to improve (and eventually certificate) the financial discipline of the companies financed, a mechanism absent for most other types of direct public support to innovation. Finally, it alleviates cash flow pressure and increases equity without diluting equity, which is an important aspect for entrepreneurial and innovative new ventures. No guarantee from the firms is asked, and the loan design often encompasses a delayed payment period, which can act as an indirect subsidy. The cost of mezzanine finance is higher than the cost of traditional debt, but due to its very flexible contractual form, it can be tailored to the specific needs of innovative and young companies. Despite this instrument's relevance for national authorities and firms, it is the subject of fewer impact evaluations than previous instruments, mainly due to the limited data availability on the pre-treatment period (Cusmano & Thompson, 2018 and, Hottenrott & Richstein, 2020). Norrman & Bager-Sjögren (2010) investigate Swedish Innovation Center (SIC) programs between 1994 and 2003.

³⁰ Mixed syndicates involve both private and public venture capital funds. The rationale of partnership between the public and private sectors is rooted in the government failure theory (Legrand, 1991). This theory reconsiders the ability of government authorities to efficiently screen the market (Lerner 2012) and the political orientation of public funds (Lerner 2002) as source of inefficiency.

Despite an in-depth screening process, the authors hardly find evidence of the positive impact of SIC participative loans on employment, sales, and total assets, reflecting the government's failure in screening and monitoring firms. In northern Europe, using Norwegian panel data, Grimsby (2018) investigated innovative loan programs from 2004 to 2009. Given the importance of the control group in impact evaluation (Rosenbaum and Rubin, 1985), he built several control groups to account for unobserved heterogeneity that biases matching approaches. Compared to rejected applicants, accepted firms record either higher performance or, in worst cases, no difference (notably in terms of survival and profitability).

However, when controlling for credit demand, the results are less univocal. Compared to privately financed firms, treated companies record lower survival rates and deficits; no difference is found in sales and employee growth, and ultimately, treated firms have higher value-added formation, assets growth, and profitability. The results are even more equivocal when the author uses VC-backed firms as the control groups, highlighting the importance of counterfactual-related issues to estimate the treatment effect. Dvouléty (2017), investigating a Czech public programme, also finds mixed outcomes regarding the additionality of LSs. Marti and Quas (2018) study 488 Spanish firms funded by participative loans between 2005 and 2010 and investigate the programme's certification effect. They look at debt accumulation and postulate that, in a context of high information asymmetry, investors rely on public support to assess a project's quality. Consequently, public financing acts as a certification, improving external financing availability for backed firms. They conclude that the ENSIA loan programme's positive effect increases debt by 31.5% compared to firms that are not financed by the programme, and this effect is more substantial for more opaque firms (small, young and innovative firms). Based on Marti and Quas (2018), Bertoni et al. (2019b) using a larger dataset (512 firms covering the 2005-2011 period) investigate no more on the certification effect but employment and sales growth. Their findings support and confirm previous ones for more opaque and high-tech firms,³¹ reflecting their increased capacity to attract resources, which can be interpreted as an indicator of high-value projects (Grimsby, 2018).

The insights of previous studies surrounding the direct public support for YIC development lead us to consider the impact in terms of both input and output outcomes. While such programmes could positively impact innovative expenditures, these resources may not

³¹ The hypothesis that high-tech firms achieve higher growth is verified only for employment growth.

be used efficiently, leading to potentially no impact or even adverse effects on the output outcomes (Catozzella & Vivarelli, 2016)

2.3 *Hypotheses development*

The present chapter builds on insights from the innovation and financing literature to develop a framework where programme participation value added is expressed in both inputs and output outcomes (Czarnitski & Delanote, 2015; Söderblom et al., 2015). We define input outcomes as any outcomes used in the firms' production process to produce economic or financial payoffs, considered the output outcomes. While input outcomes give information about firms' capability to expand and develop to reach higher growth paths, output outcomes provide information about current achievements of the firm.

2.3.1 *Input effects: resource accumulation*

To explore how programme participation affects the production process, we focus our attention on the resource accumulation process. To do so in a reproducible way, we include in our analysis an employment indicator that can be considered either an input or an output outcome. YICs are acknowledged to contribute to high job creation (Huber et al., 2017 Biancalani et al., 2020), which should be reflected in their employment growth. However, using Austrian data, Huber et al. (2017) show that while young firms contribute more to net job creation, small firms contribute less than large firms, casting doubt on young and small companies' net contribution. Frequently used in the literature, employment can be considered a proxy for firms' resource attractiveness, reflecting the quality of the project and the visibility of the labour market (Grismby, 2018 and Söderblom et al., 2015). However, due to the liability of newness, hiring the workforce can be challenging (Stinchombe, 1965). In this context, an increase in the workforce following programme participation can be considered a certification effect (Söderblom et al., 2015, Marti and Quas, 2018). Therefore, we expect to observe higher employee growth for recipient companies than for their matched pairs, which is reflected by the following hypothesis:

H1: Backed companies record higher workforce accumulation than their matched pairs.

In addition to employment considerations in YICs' early-stage development, another important feature of a firm's expansion is its innovative capacities and efforts. Since the JL programme targets innovative firms, we can expect to observe higher innovation efforts in

intangible asset formation among recipient firms than among their matched counterparts, reflecting their higher involvement in innovative activities.³²

On the one hand, intangible assets' uncollateralized nature makes them more dependent on internal funds, which YICs sorely lack (Jarboe and Ellis, 2010). On the other hand, intangible assets can generate economies of scale and scope that could enhance market power and productivity, which can incentivize YICs to invest.

H2: Backed firms record higher growth in intangibles than their matched pairs.

Last, our framework regarding the input additionality of public support focuses on tangible assets. By indicating collateral capacity, tangible assets allow us to investigate the non-financial support of public authorities. Indeed, the capacity of public schemes to increase the acknowledged lack of financial discipline and know-how of entrepreneurs is often pointed out as an important aspect of public policies (Seghers et al., 2012; Fraser et al., 2015). Consequently, we expect higher collateral formation among treated firms than among their counterparts, reflecting their increased financial literacy due to programme participation.

H3: Backed firms record higher tangible growth than their matched pairs.

2.3.2 Hypotheses development: output effect

To investigate the output effect, we rely on sales as a proxy of customer satisfaction and managers' ability to commercialize a product (Norrman & Bager-Sjögren, 2010). This indicator, which is widely used in the impact evaluation literature, is used to ensure comparability between studies as much as possible (Autio & Ranniko, 2016; Bertoni et al., 2019b; Söderblom et al., 2015).

H4: Backed firms record higher sales than their matched pairs.

Finally, as stated above and yet criticized (Shane, 2009; Mazzucato, 2016) from a government failure viewpoint, YIC policies rest upon a "pick out the winner", design where selected firms pass through a rigorous selection process. This design is based on the idea that only a small fraction of firms (even among the innovative firms) have disproportionately high contributions to job creation (Haltiwanger et al., 2013 for the U.S., and Hölzl 2016 for

³² Intangible assets encompass assets related to software and database purchase, copyrights and trademark, patents. The reporting of intangibles suffers from a downward bias due to the tax-deductible feature of expenses, which incentivizes firms to register intangibles as expenses (to be deductible from earnings) instead of as intangible assets. In this regard, the conclusion must be taken carefully.

Europe) and productivity (Criscuolo et al., 2014; Hözl 2016). Thus, given their commitment to innovative activities and their will to grow, selected firms should record higher productivity per employee.

H5: Backed firms record higher productivity gains than their matched pairs.

However, the European empirical evidence of government support for productivity gains is mixed, calling for more investigations in the field (Dvoulety et al., 2020; Santos, 2019). Some papers acknowledge the job creation and productivity contribution of YICs (see Hözl, 2016), but while recognizing the net job creation contribution of YICs, Heyman et al. (2018), using Swedish data, observe that productivity gains come from large firms.

2.4 Data and methodology

2.4.1 Programme design

In France, public support for innovation mainly originated from the Public Investment Bank, Bpifrance, which launched in 2005 a mezzanine instrument for innovative start-ups aiming to provide support for creative activities through a fundraising partnership with private investors. The loan is designed for firms wishing to reduce cash flow pressures and aims to help them prepare fundraising while pursuing a business cycle. Called a "prêt d'amorçage" (PA), the loan targets innovative SMEs incorporated as companies created less than five years ago, in the seed stage. Covering eight years including three years of delayed repayments, the programme is composed of two distinct parts. The instrument provides amounts between 30k and 150k € for firms preparing a significant first round of financing and amounts between 100k and 500k € for firms in a fundraising support phase. Funded firms have to be labelled or awarded as innovative firms and registered as companies for less than eight years. The selection process includes a deep screening process of the firms' current financial situation and future cash flow and the probability of private investor funding. Priority is given to companies deemed promising in terms of value creation and future growth and for which private funding would provide fruitful leverage. No guarantee or personal deposit is required, but regional subsidiaries can guarantee the loan, which allows an increase in the amount that is limited to the equity amount at the time of the deposit. The instrument is designed to reinforce the capital structure of firms for subsequent financing rounds and complement the innovative aid already received to fund innovative projects. The programme is composed of 1607 firms from 2005 to 2015, geographically polarised around the Paris and Lyon areas and operating in computing (27%), R&D and scientific services (25%) and publishing (11%).

2.4.2 *Sample description*

To be a candidate, companies must highlight innovative features for which they have previously received innovative grants or aid. This aspect allows us to use firms that previously received innovation grants or labels as natural counterfactuals. Thus, we can control for dimensions of observable aspects (innovation) and unobservable aspects (wish to grow and team motivation), ensuring the reliability of causal estimates in our quasi-experimental framework. The firm-level database involves a first dataset provided by Bpifrance. From this dataset, we extract firms receiving aid for innovation (including treated firms), gathering information about the loan amount and date of financing and data about their credit history. The financing data of both treated and control firms from Bpifrance are then merged with financial data from the national statistical institute to complete the database.³³ The data availability, the use of lagged explanatory variables and the aim to explore at least one post-treatment period lead us to consider 921 treated firms over the 2006-2014 period. Summary statistics are displayed in Table 2.5 in the appendix below. Further information about the variables, correlation matrix and loan amount distribution is available in Table 2.6 and Table 2-77, still in Appendix A.

2.4.3 *Methodology*

Although PSM procedures are commonly used in the literature, we follow Shroj et al. (2020) and use the Mahalanobis distance as the distance metric (King et al., 2011).³⁴ For matching, we follow Bertoni et al. (2019b) and include pre-treatment variables related to sales, the number of employees, and age. In addition to sectorial and location dummies, we provide the matching process additional information related to ownership and the form and date of innovation awards obtained before programme assignment. Therefore, we control for the links between ownership and innovative activities and between innovation and external credit demand bias (Cucculelli and Peruzzi, 2020 and Grimsby, 2018).³⁵ Once matched

³³ We add data related to the governance, location and activity, also provided by the national statistical institute. The datasets included are FARE (Fichier approché du résultat d'entreprise), CLAP (connaissance local de l'appareil productif) and LIFI (liaison financière), provided by the INSEE.

³⁴ The Mahalanobis distance matching (MDM) and coarsened exact matching (CEM) approaches outperform PSM (King et al., 2011; Stuart, 2010). Mahalanobis matching appears to be more suited to our context since we used a limited number of covariates that are correlated (Zhao, 2004). In addition, CEM outperforms MDM when the number of observations is high, which is not the case in our context (King et al., 2011).

³⁵ The caveat of comparing innovative to non-innovative firms is the different growth profiles and behaviours between the treated and control groups, leading to biased estimates. In addition, when comparing firms, external financing needs can be expected to be similar between both groups, limiting both sources of bias. On the other hand, the more similar the firms are, the lower the treatment effect is due to spill-over effects in the long run.

samples are obtained, the matching adjustment quality needs to be determined (*Step (2)*). We adopt the standardized mean differences and t-statistics of the equal mean test between matched samples to ensure efficient adjustment.³⁶ Another component to be checked to ensure reliable estimates of the treatment effect is the common trend (CT) or parallel trend assumption (PTA) (*Step (3)*). The assumption states that before the treatment, both the treated and control groups record similar outcome dynamics. Formally, we use an equality test of the coefficient of the interaction terms of the treatment dummy ($D_{i,t}$) variable with temporal pre-treatment dummies (δ_t):

$$\log(Y_{i,t}) = \alpha + \sum_{t=2006}^{2014} \beta_t ([D_{i,t} * Year_t]) + \delta_t + \varepsilon_{i,t} \tag{1}$$

Studies in the impact evaluation literature frequently combine the matching and regression-based approaches given that this combination allows bias correction (Lechner, 2011). Consequently, we use a conditional difference-in-difference research design on matched samples (CMDiD) to explore the treatment effect of programme participation on firm input and output outcomes (*Step (4)*). The estimation rests upon the following equation:

$$\log(Y_{i,t}) = \alpha + \beta_1 X_{i,t-1} + \beta_2 * treated + \beta_3 * post + \beta_4 * Treated * Post + IE_{i,t-1} + \varepsilon_{i,t} \tag{2}$$

Following Bertoni et al. (2019) and Dvoulety et al. (2020), we express the dependent variable $Y_{i,t}$ as the logarithm of employees, sales, labour productivity, and tangible or intangible assets. $X_{i,t-1}$ represent lagged control variables and includes the set of dependent variables, except the one of interest, plus debt ratio (equity on total debt) and the autonomy ratio that controls for financial structure changes. IE encompasses individual effects related to the firm, location, industry, and ownership, as well as time trends.

Figure 2-2 - Empirical methodology.

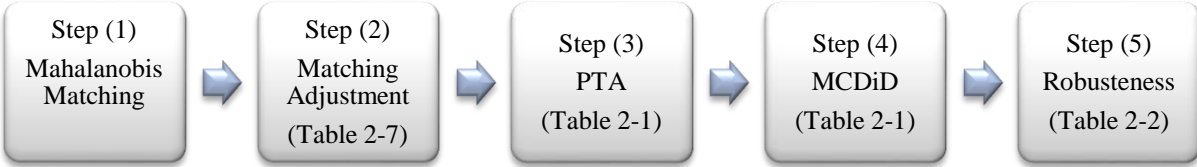

Thus, there is a trade-off between the accuracy of the counterfactual used and the magnitude of treatment effect under investigation.

³⁶ Table 2-78 in the appendix A presents the results of the adjustment quality of the matching algorithms.

Table 2-1 - MCDiD Result

Dependent	Employment	Intangibles	Tangibles	Sales	Productivity
	(1)	(2)	(3)	(4)	(5)
Treatment*Post-Grant	-0,11 *** (-2,50)	0.15 (1,58)	-0,03 (-0,53)	0,01 (0,09)	-0.08 (-0,54)
Age (i,t-1)	-0,05 (-1,42)	0.16 *** (2,42)	-0,01 (-0,11)	0,05 (0,72)	0,08 (0,64)
Leverage (i,t-1)	-0,01 (0,85)	0.05 *** (2,88)	0,01 (1,15)	0,01 (0,07)	0.01 (0,12)
Autonomy (i,t-1)	0,25 *** (8,65)	0,28 *** (4,17)	0,12*** (2,98)	0,03 (0,71)	0,61 *** (5,35)
Employees (i,t-1)		0,43 (9,77)	0,46*** (15,14)	0,10 *** (2,61)	0,42 *** (6,17)
Intangibles (i,t-1)	0,04 *** (4,72)		0,06*** (4,51)	0,03 + (1,74)	0,02 (0,71)
Tangibles (i,t-1)	0.13 *** (10,21)	0.13 *** (4,74)		0,04 (1,60)	0,01 (0,34)
Sales (i,t-1)	0,01 (0,98)	-0,01 (-0,83)	0,01 (0,18)		0,01 (0,34)
Labour Productivity (i,t-1)	0,03 *** (6,54)	0,03*** (3,25)	0,01 (1,15)	0,01 (0,27)	
Constant	2.74 *** (3,84)	6,54 *** (4,56)	6,98*** (4,35)	5,27 (4,36)	4,24 + (1,68)
Fixed Effects					
Firm	Yes	Yes	Yes	Yes	Yes
Financial historic	Yes	Yes	Yes	Yes	Yes
Time	Yes	Yes	Yes	Yes	Yes
Localisation	Yes	Yes	Yes	Yes	Yes
Industry	Yes	Yes	Yes	Yes	Yes
Ownership	Yes	Yes	Yes	Yes	Yes
N	10387	10387	10387	10387	10387
adj. R-sq	0.644	0.810	0,826	0,686	0,581
Pre-Trend F Test	0,44	0,06	0,66	0,49	0,43

Note: Estimation of the treatment effect was performed following equation (2). Regressions were performed on Mahalanobis matched samples using OLS estimators. Dependent and independent variables are expressed in logarithm ($\log 1+$) or (asinh transformation when necessary) and are winsorized at 5% to prevent outlier-dependent results. Standard errors are clustered at the firm level. *, ** and *** denote 10% 5% and 1% significance, respectively.

2.5 Results

This section presents the outcome of the empirical procedure, and the results are interpreted according to the relevant step in the research design.

Regarding step (2), the adjustment quality of Mahalanobis matching is presented in Table 2-88. We show that the bias reduction is substantial for all dimensions included in the matching process. We successfully match treated firms with innovative counterparts funded

with the same innovation aid around the same year. Regardless of the criteria under consideration to analyse the matching quality (standardized mean difference or t-statistics), the results uniformly confirm the uniform covariate distribution across groups. We cannot reject the null hypothesis of equal means for all variables and state that the bias is substantially reduced between groups following the matching procedure. Step (2) validates the use of the control group as a reliable counterfactual, thus supporting the use of the quasi-experimental research design. In addition, the bottom of Table 2-1 displays the associated joint F-statistics, whose null hypothesis supports the validity of PTA (step (3)). We notice that all outcomes present similar dynamics between the treated and control groups in the pre-treatment period. The PTA validation allows us to make a causal interpretation of the effect of programme participation on firm development with little doubt about the estimates' validity.

Turning to step (4), the results are presented in Table 2-1. In the first step, we focus on the programme's capacity to boost funded firms' attractiveness in terms of employee growth. The results show a negative treatment effect on employment growth (model (1) Table 2-1); treated firms present a lower workforce accumulation of 10.4% $((\exp(-0,11)-1)*100)$ compared to the level they would have achieved without funding. Based on this finding, H1 does not find strong support; the certification effect on resource attractiveness is not notable. We conclude that programme participation does not allow firms to gain enough visibility to acquire a larger workforce for the covered period. The mixed effect on employment finds support from Coad et al. (2017), who show that staff member growth is not the primary growth concern for YICs. Instead, firms with high growth prospects favour profit or asset growth over employment growth. They might wish to create a productive framework within which subsequent employees could become fully productive and not limited by technological or capital stock. Becker (2015) also finds a negative (although nonsignificant) impact on employment.

In addition to resource accumulation in terms of human capital, another essential component of YICs' development and of the associated justification of their support from public authorities lies in firms' innovative activities captured from the output perspective through the stock of intangible assets. From the model in Table 2-1, we observe a positive and significant impact of programme participation on innovative output formation. Quantitatively, programme participation enhances the average creative output by 17,4%. Consequently, H2 finds support from our data, and we conclude that programme participation helps funded firms improve their innovative character through the accumulation of intangible assets. Last,

from our resource accumulation framework, we investigate the programme's capacity to enhance financed firms' creditworthiness. The results for tangible assets as a proxy of firms' collateral capacity are recorded in model (3) in Table 2-1. We do not notice any significant effect of programme assignment. Tangible assets capture firms' ability to provide collateral; the result is interpreted as the programme's inability to create a collateral-generating mechanism for funded firms. In this regard, the programme does not significantly help firms acquire assets to pledge as collateral, and H3 does not find any support. The programme does not increase the financial literacy of funded firms, which leads us to conclude that mechanisms for reducing information asymmetry are absent.

On the "performance enhancing" side, we do not observe a significant treatment effect on sales. Coad et al. (2017) explore the growth process for both high-growth and non-high growth firms and find that, in contrast to the latter, the former firms follow the subsequent growth process: profit growth enhances asset growth, which in turn positively influences the growth of sales. The last link in the growth chain is that of employment. Regarding this aspect, we do not find any differences in net tangible asset dynamics, and we can argue that the growth chain is stopped. This mechanism also supports the negative influence on employment growth mentioned above. Consequently, and based on the above mechanism, we do not find support for H4. Programme participation does not significantly support the commercialization process of innovative projects. No different conclusion can be drawn from the impact on labour productivity; we find no significant differences compared to non-treated firms. Similar conclusions on possible adverse effects of programme assignment are found by Catozzella and Vivarelli (2016), Dvoulety (2017) and Köster (2010), who highlight the government failure paradigm as responsible for the lack of additionality of public funding. In addition to noting supply-side mechanisms, Catozzella and Vivarelli (2016) point out demand-side mechanisms through the non-productive detour of subsidies, which are used to finance operating cycles rather than the development of the technologies for which they were intended. Gustafsson et al. (2020) also provide insights related to demand-side mechanisms and advocate an auto-selection process, where less-productive firms are likely to apply for subsidies rather than spending their efforts on productive purposes.

2.6 *Robustness*

Each step of the research design could be the subject of sensitivity analysis.³⁷ In the second step, whose purpose is to depict adjustment quality, the t-statistics for non-normally distributed variables are controversial, and standardized mean differences are preferred (i). Related to the regression framework, we split the sample into different sub-populations to test our results' sensitivity to the research and programme design (Bertoni et al., 2019). First, we separate firms that received the innovation aid while participating in the programme from those financed with a lag between the innovation grant and the participative loan (ii). Then, we separate firms according to whether financing started during a crisis (iii). Finally, we explore the loan design by splitting firms financed with low versus high tickets (iv). These sensitivity tests are undertaken in addition to the specification validity (vi) discussed below.

For (i), we rely on both t-statistics and standardized mean difference reduction to interpret the matching adjustment quality. Regardless of the criteria used and the matching algorithms under consideration, the adjustments appear to be efficient. The robustness checks from (ii) to (iv) presented in Table 2-2 are also used to extend the main specification. We can see that despite the few patterns in this table, highlighting heterogeneous effects, the results mainly converge with the results in Table 2-1. The negative influence of programme participation on workforce accumulation is supported as a non-significant impact on tangibles, sales, and labour productivity. More precisely, the results from model (1) in Table 2-2 show that firms financed contemporaneously with the innovation aid exhibit a negative average causal effect of programme participation on employment of approximately 23% compared to their counterparts. In contrast, firms financed with a lag between the innovation award and JL funding do not show different employment dynamics than their counterparts.

Table 2-2 also shows that firms invested in during the GFC (model (3)) exhibit different dynamics than firms receiving investment before or after the crisis (model (4)). We observe a negative and significant average causal impact of 20% (coefficient of -0,26) compared to 8,6% (nonsignificant coefficient of -0,07) on workforce accumulation. Therefore, the adverse effect is reinforced during economic declines and attenuated during economic booms; the governmental financing instrument appears to have a pro-cyclical nature. Finally, models (5) and (6) depict the average causal treatment effect for firms

³⁷ The matching design itself can enable many sensitivity tests, see Stuart and Rubin (2008).

financed with relatively low tickets and those financed with high tickets, respectively. The results show a decrease of 15,6% (coefficient of -0,14) in employment for firms funded under the original framework (i.e., low tickets). In contrast, firms financed with the revised framework (i.e., higher tickets) do not record different employment dynamics than their counterparts (coefficient of 0,03). The loss of significant negative results when focusing on high amounts could suggest an increase in know-how from public business operators since higher tickets are granted in the later years of the programme.³⁸ The fact that the loan amount is limited by the capital stock indicates a correlation between the amount of the loan and the size of the firm. In this respect, the hypothesis according to which the largest firms (with larger loan amounts) are the least affected by the programme, supported in the literature, could explain the results (Bertoni et al., 2019b, Dvoulety et al., 2021; Huergo et al., 2011 and Huergo & Moreno, 2017).³⁹ Last, the (non)significant treatment effect on (large) small firms could also suggest a possible threshold effect of the instrument.

Different patterns also arise when considering intangible assets. Indeed, the results indicate a positive causal impact of programme participation on intangibles for firms financed with a lag between receiving the innovation aid and receiving the loan (+ 23,6% of intangible assets). In contrast, no significant average causal impact is found for firms receiving both aids at the same time (models (1) and (2)). We show that firms receiving investment during the economic crisis present no difference from their counterparts. Instead, firms financed outside the crisis present a positive and significant increase of approximately 16% in innovative assets. Finally, we show that low ticket-funded firms present a positive and significant impact of 30%, while high ticket-funded firms present a negative causal average effect of 34%. This result supports the previously mentioned treatment effect asymmetry relative to firm size; smaller (and more resource-constrained firms) benefit most from programme assignment (Bertoni et al., 2019b and Dvoulety et al., 2021).

³⁸ The increase in the average loan size over the studied years can be interpreted, *ceteris paribus*, as an increase in the governmental expertise in financing innovation.

³⁹ Conversely, the smallest firms (those with lower tickets) benefit the most from the treatment (in absolute terms).

Table 2-2 - Alternative specifications of the treatment effect

	Employment	Intangibles	Tangibles	Sales	Productivity
(1)	-0,21*** (-2,62)	0,01 (0,05)	-0,08 (-0,74)	0,01 (0,07)	0,03 (0,13)
N	3994	3994	3994	3994	3994
adj. R-sq	0,647	0,817	0,822	0,699	0,571
(2)	-0,02 (-0,44)	0,32*** (2,72)	-0,01 (-0,19)	0,01 (0,13)	-0,13 (-0,70)
N	6393	6393	6393	6393	6393
adj. R-sq	0,646	0,808	0,833	0,680	0,588
(3)	-0,26*** (-3,04)	0,04 (0,15)	0,06 (0,42)	-0,03 (-0,1)	-0,1 (-0,33)
N	2297	2297	2297	2297	2297
adj. R-sq	0,679	0,7933	0,815	0,7488	0,594
(4)	-0,07 (-1,36)	0,17+ (1,79)	-0,05 (-0,69)	0,02 (0,19)	-0,06 (-0,33)
N	8090	8090	8090	8090	8090
adj. R-sq	0,636	0,818	0,829	0,665	0,0578
(5)	-0,14*** (-2,80)	0,33*** (3,29)	-0,07 (-0,94)	-0,07 (-0,75)	-0,05 (-0,30)
N	8419	8419	8419	8419	8419
adj. R-sq	0,645	0,818	0,836	0,689	0,0560
(6)	0,03 (0,24)	-0,66*** (-2,64)	0,11 (0,73)	0,35** (2,05)	-0,06 (-0,19)
N	1968	1968	1968	1968	1968
adj. R-sq	0,642	0,789	0,788	0,674	0,637

Notes: This table presents the value of the coefficient of the interaction between treatment assignment and post-treatment time dummies. Models (1) to (6) are performed on equation (2) according to the sub-population of when firms are financed: concurrently with the innovation grants received (1), with a certain lag (2), during the crisis period (i.e., financing started during 2008 or 2009) (3), outside the crisis (4), with relatively low tickets (5) and relatively high tickets (6).

T-statistics are in brackets; dependent variables and independent variables are expressed in logarithm (log1+.) (asinh transformation when necessary) and are winsorized at 5% to prevent outlier-dependent results. Standard errors are clustered at the firm level.

*, ** and *** denote significance at the 10%, 5% and 1% levels, respectively.

2.7 Discussion

The above results highlight different patterns regarding programme participation's impact on a firms' resource accumulation and performance. Differences in the treatment effect highlight the necessity to investigate the evaluation framework. Indeed, the heterogeneous results linked to loan characteristics presented in Table 2 call for investigation regarding the setup and the evaluation of a programme. The evaluation literature emphasizes three main types of failure related to evaluation studies: implementation, programme theory and methodology failures (Stame, 2010). Regarding implementation failure, White (2010) points out the importance of the context; the conditions of the implementation of the programme have to be investigated to determine which interventions are effective. Programme theory failure arises when the economic mechanisms fail to be addressed. Stated

another way, the expected and estimated relationships between variables are different. This paradigm suggests that the lack of results obtained from evaluation may come from the conceptual and empirical framework built to account for the impact. Last, methodology failure arises with the (mis)use of models (quantitative or mixed methods) to ensure internal and external validity.

2.7.1 Programme theory failure

The negative average causal effect of programme participation on employment raises concern about the objective of this public financial instrument for YICs. From the firm perspective, we expected the participant firms to present higher outcomes than the counterfactuals, which would indicate that the programme design properly targeted and selected promising firms with high growth potential and ultimately helped them develop. From a local ecosystem perspective, we expected that knowledge spillovers would support the entire ecosystem of the invested firm, meaning that the counterfactuals could also indirectly benefit from a given firm's programme participation and leading to virtually no difference between treated and control units. These contradictory perspectives lead to puzzling and opposite statements based on the same evaluation⁴⁰. From the firm perspective, it would be bold, at this stage, to conclude that the programme produces a negative effect, as despite the reduced workforce accumulation, financed firms record higher innovative asset accumulation than the counterfactual sample. This reallocation of production factors does not favour short-term workforce increases but lays the foundation for innovative ecosystems from which a subsequent positive effect on employment can emerge.⁴¹ However, our analysis is at the level of the firm rather than the locality, which leads to a lack of certification mechanisms in terms of workforce attractivity (Coad et al., 2017). However, the lack of observed results may come from the irrelevance of the concept (i) or of its metric (ii). Indeed, while the dependent variables are chosen according to the empirical literature and theoretical insights, there is little ex ante theoretical justification of the use of these variables. The programme is designed to alleviate treasury pressures to improve private funding probability, making employment and innovation considerations marginal from the programme perspective but still relevant for labour and innovation policies. Despite being a clear “goal-oriented” policy, the lack of

⁴⁰ This aspect could also be considered a methodological failure.

⁴¹ The fact that the workforce dynamics are greater for non-invested firms can be interpreted as an indirect impact of ecosystem creation, which can be beneficial for firms' subsequent development. Unfortunately, these stages are not covered by our sample. Further insights are needed in this regard for data covering a longer period.

precise goals for building the evaluation framework spurs doubt according to which theoretical models and associated mechanisms to invoke when interpreting the results (Youker et al., 2016).

2.7.2 Implementation failure

The high heterogeneity in the results, robust across sensitivity tests, shows that programme design has important implications regarding the magnitude of firms' workforce accumulation. In addition to the previous discussion, the negative influence of the programme on employment raises concern about moral hazards. Financed firms do not use the loan to increase the workforce, which is one crucial rationale of YIC financing, but instead seem to increase their asset stock in terms of intangibles. Indeed, although innovative activities are not exhaustively represented in our framework⁴², a positive effect of programme participation is found for firms financed in small amounts. Different from loans in high amounts, for loans below 150K €, the funding event has not occurred yet, and we argue that the quasi-equity buffer is used to reinforce the capital structure. Indeed, this would highlight the firms' innovative aspect and ultimately improve their probability of being funded by private investors (business angels and venture capitalists). This mechanism, which indicates a reallocation process of production factors from human capital to technological capital, finds support when turning to the accumulation of tangible assets. This last aspect is essential for debt financing instruments but appears less relevant when discussing equity financing (Bernanke & Gertler, 1986). The fact that tangible asset accumulation is not different between the two groups leads us to conclude that collateral accumulation is not a critical concern compared to innovation aspects, supporting the reallocation process depicted above. The results lead us to question the rationale and objectives related to the use of mezzanine instruments. Theoretically, the use of participative loans and, more broadly, of mezzanine finance is motivated by the instrument's hybrid nature, which reinforces the capital structure while not increasing equity and thus without diluting ownership.⁴³ In addition, mezzanine instruments allow a leverage effect without requiring any collateral from the lender. Moreover, they enable a tax-deductible interest payment and adopt the most suitable form given the invested company's characteristics. However, the use of mezzanine finance is not without caveats. First, the availability of mezzanine finance is not yet widespread across firms

⁴² We lack the "Enquête R&D" in which R&D spending is recorded.

⁴³ In France, PLs are considered equity from the legislative and financial viewpoints but are considered debt from the fiscal accounting and judicial viewpoints.

of all sizes. Second, since mezzanine finance requires stringent transparency requirements for more opaque firms, the availability may be limited. Additionally, the loan is in principle unsecured and subordinated to senior debt in the case of bankruptcy. Finally, this financing form is not relevant for all business phases (firms that are restructuring or firms that are losing market position) or for all capital structures (firms with high debt-to-equity ratios).

In addition to providing an application on the theoretical use of mezzanine finance, we argue that the research framework structure allows us to investigate the screening efficiency of public agents (impact on input) and the firms' capability to use public spending (impact on output) efficiently. A positive global impact on both input and output indicators could suggest that firms are efficiently screened. A positive effect on output can be interpreted as the firm's capacity to use public money efficiently. Opposite mechanisms are found according to the monitoring aspect insofar as there is a positive impact on intangibles and a negative effect on employment dynamics. These contradictory results do not allow us to draw a clear conclusion on the effectiveness of the screening and monitoring processes. In turn, this may explain the lack of significant effects on firms' outcomes and does not allow us to investigate the firm's capability to benefit from capital buffering. Nevertheless, regarding the performance-enhancing impact of programme participation, we acknowledge that the lack of significant results may be due to both the early-stage focus of the research design and the innovative character of firms, in that it may take time to commercialize the innovative project for which they received funding (Norrman & Bager-Sjögren, 2010).

Finally, although our research design moves away from mediation models (Söderblom et al., 2015), the inclusion of lagged dependent variables to explain each other could be informative regarding treatment effect mechanisms. In this regard, we can observe that the accumulation of human capital (proxied by the number of employees) is positively associated with increased *sales*, *productivity*, and, to a greater extent, *tangible* and *intangible asset* accumulation (Söderblom et al., 2015). Interestingly, a high autonomy ratio (i.e., lower autonomy) is negatively and significantly associated with productivity growth but not significantly associated with increased sales. This finding supports the early-stage innovation financing literature that shows that opaque firms are reluctant toward ownership losses, particularly in innovative contexts (Colombo et al., 2014). The convergence of objectives from insiders and outsiders creates agency costs that could negatively affect firm performance, proxied here by labour productivity. Finally, in line with the business angel literature (Politis, 2008), we show that the presence of investors is associated with higher

resource accumulation (in terms of tangible and intangible asset accumulation), while the impact on performance is limited (in terms of sales and labour productivity).

2.7.3 Methodology failure

The results are not discussed without presenting some caveats inherent to any observational study and specific to the studied instrument. First, given the non-randomness of the treatment assignment, it may be asked whether the control group can effectively account for differences in both the observable and unobservable characteristics. In this regard, methods with higher internal validity, such as a regression discontinuity design (RDD), could have been used if firms had been ranked according to the project quality (or their credit risk rank). However, RDD offers only a local treatment effect that can be biased when moving away from the threshold.

On the limits of the counterfactual analysis, firms used as the control group can be financed by organizations other than Bpifrance, which are not covered by our data, reducing the quality of the control group's representation of the counterfactual situation. The hegemonic role of Bpifrance, capturing an important part of the innovation financing market contributes to reduce this limit.

On the scope of the chapter, further investigations are necessary both on the investment timing and on the threshold effect to disentangle the importance of the design of the PL, encompassing the age of beneficiaries (when the loan is received), the timing of investment (early or late, following innovation grants or not) and the amount of the loan (do low versus high loan amounts produce the same effects?). Last, qualitative methods could be used to disentangle the effects stakeholders expect: do the funded firms present outcomes that are well aligned with the government's stated objectives regarding the expected effects of the intervention? More technically, is the expected outcome of the treatment the same for the funders and for the recipients?

2.8 Conclusion

This chapter investigates the average causal treatment effect of a French starting loan covering 921 funded firms from 2006 to 2014. Building on insights from the entrepreneurship and public policy evaluation literature, we use a CMDiD framework to evaluate the impact of programme participation on two main aspects of a firm's development: resource accumulation and performance enhancement. The research hypotheses developed regarding resource

accumulation on tangible assets and performance enhancement, proxied by sales and labour productivity dynamics, do not find strong support.

In addition, a negative influence on human capital attractivity, proxied by the number of employees, is highlighted, which dilutes the positive impact of public certification through resource attractivity. However, treatment assignment seems to stimulate the dynamics of innovative activities, proxied by the stock of intangible assets and of sales. In addition, the research design allows exploration of the impact of the financing instrument's design on the treatment effect. Notably, we investigate the "earlier is better" hypothesis regarding investment timing, which does not find support. In line with the literature on government financing for innovation, we observe the substitutability of production factors, which may reflect the objectives of financed firms (McKenzie, 2017) and call for debates around the targeting (screening aspect) and purposes (monitoring aspect) of public financing instruments.

The enrichment of both conceptual and empirical frameworks could improve the estimation of the influence of public funding. Although our empirical framework addresses many traditional biases in quasi-experimental studies, the techniques involved only weakly meet the most rigorous natural experimental framework, thus providing only modest internal validity. Moreover, the chapter estimates only a linear relationship, while a possible threshold effect is possible regarding both the timing and amount of funding. Information on the nature of firms' innovation projects could help refine the framework and explore how the nature of innovation products (product, service, process) could influence developments. Despite this study's investigation, traditional issues regarding impact evaluation remain to be discussed to support a more reliable framework and results. By discussing the mechanisms behind the effects, this chapter can provide policy implications to improve business practices in terms of the public financing of innovative projects in early stages, notably in terms of investment timing and processes.

2.9 References:

- Acs, Z. J., & Audretsch, D. B. (1987). Innovation, Market Structure, and Firm Size. *The Review of Economics and Statistics*, 69(4), 567. <https://doi.org/10.2307/1935950>
- Acs, Z. J., & Audretsch, D. B. (1988). Innovation in Large and Small Firms: An Empirical Analysis. *The American Economic Review*, 78(4), 678–690. JSTOR.
- Acs, Z. J., & Audretsch, D. B. (2010). Knowledge Spillover Entrepreneurship. In Z. J. Acs & D. B. Audretsch (Eds.), *Handbook of Entrepreneurship Research* (pp. 273–301). Springer New York. https://doi.org/10.1007/978-1-4419-1191-9_11

- Acs, Z. J., Audretsch, D. B., Braunerhjelm, P., & Carlsson, B. (2012). Growth and entrepreneurship. *Small Business Economics*, 39(2), 289–300. <https://doi.org/10.1007/s11187-010-9307-2>
- Acs, Z. J., Audretsch, D. B., & Lehmann, E. E. (2013a). The knowledge spillover theory of entrepreneurship. *Small Business Economics*, 41(4), 757–774. <https://doi.org/10.1007/s11187-013-9505-9>
- Acs, Z. J., & Sanders, M. W. J. L. (2013b). Knowledge spillover entrepreneurship in an endogenous growth model. *Small Business Economics*, 41(4), 775–795. <https://doi.org/10.1007/s11187-013-9506-8>
- Allard, M. J., & Blavy, M. R. (2011). Market Phoenixes and Banking Ducks Are Recoveries Faster in Market-Based Financial Systems? (Issues 11–213). International Monetary Fund.
- Alperovych, Y., Hübner, G., & Lobet, F. (2015). How does governmental versus private venture capital backing affect a firm's efficiency? Evidence from Belgium. *Journal of Business Venturing*, 30(4), 508–525.
- Arrow, K. J. (1971). The economic implications of learning by doing. In *Readings in the Theory of Growth* (pp. 131–149). Springer.
- Arshed, N., Carter, S., & Mason, C. (2014). The ineffectiveness of entrepreneurship policy: is policy formulation to blame?. *Small Business Economics*, 43(3), 639–659.
- Audretsch, D. B. (2007). *The entrepreneurial society*. Oxford University Press on Demand.
- Audretsch, D. B., Coad, A., & Segarra, A. (2014). Firm growth and innovation. *Small Business Economics*, 43(4), 743–749. <https://doi.org/10.1007/s11187-014-9560-x>
- Audretsch, D. B., Falck, O., & Heblich, S. (2011). *Handbook of research on innovation and entrepreneurship*. Edward Elgar Publishing.
- Audretsch, D. B., Keilbach, M. C., & Lehmann, E. E. (2006). *Entrepreneurship and Economic Growth*. Oxford University Press. <https://doi.org/10.1093/acprof:oso/9780195183511.001.0001>
- Autio, E., & Rannikko, H. (2016). Retaining winners: Can policy boost high-growth entrepreneurship? *Research Policy*, 45(1), 42–55. <https://doi.org/10.1016/j.respol.2015.06.002>
- Baum, J. R., & Locke, E. A. (2004). The relationship of entrepreneurial traits, skill, and motivation to subsequent venture growth. *Journal of Applied Psychology*, 89(4), 587.
- Beck, T., Klapper, L. F., & Mendoza, J. C. (2008). *The typology of partial credit guarantee funds around the world*. The World Bank.
- Becker, L. (2015). Effectiveness of Public Innovation Support in Europe. Does Public Support Foster Turnover, Employment and Labour Productivity? cege Discussion Paper Number 236, Available at SSRN : <http://dx.doi.org/10.2139/ssrn.2585442>
- Bedu, N., & Vanderstocken, A. (2020). Do regional R&D subsidies foster innovative SMEs' development: Evidence from Aquitaine SMEs. *European Planning Studies*, 28(8), 1575–1598. <https://doi.org/10.1080/09654313.2019.1651828>
- Bentolila, S., & Bertola, G. (1990). Firing Costs and Labour Demand: How Bad is Euroclerosis? *The Review of Economic Studies*, 57(3), 381. <https://doi.org/10.2307/2298020>

- Berger, A. N., & Udell, G. F. (1998). The economics of small business finance: The roles of private equity and debt markets in the financial growth cycle. *Journal of Banking & Finance*, 22(6–8), 613–673.
- Berger, A. N., & Udell, G. F. (2006). A more complete conceptual framework for SME finance. *Journal of Banking & Finance*, 30(11), 2945–2966.
- Bernanke, B., & Gertler, M. (1986). *Agency Costs, Collateral, and Business Fluctuations* (No. w2015; p. w2015). National Bureau of Economic Research. <https://doi.org/10.3386/w2015>
- Bertoni, F., Colombo, M. G., & Quas, A. (2019a). The role of governmental venture capital in the venture capital ecosystem: An organizational ecology perspective. *Entrepreneurship Theory and Practice*, 43(3), 611–628.
- Bertoni, F., Martí, J., & Reverte, C. (2019b). The impact of government-supported participative loans on the growth of entrepreneurial ventures. *Research Policy*, 48(1), 371–384.
- Bertoni, F., & Tykvová, T. (2015). Does governmental venture capital spur invention and innovation? Evidence from young European biotech companies. *Research Policy*, 44(4), 925–935.
- Bhatia, A. V., Mitra, S., Weber, A., Aiyar, S., de Almeida, L. A., Cuervo, C., Santos, A. O., Gudmundsson, T., Bergthaler, W., & Garrido, J. (2019). A Capital Market Union for Europe. *IMF Staff Discussion Notes*, 19/07, Article 19/07.
- Biancalani, F., Czarnitzki, D., & Riccaboni, M. (2020). The Italian Startup Act: Empirical evidence of policy effects. *FEB Research Report MSI_2002*.
- Boschi, M., Girardi, A., & Ventura, M. (2014). Partial credit guarantees and SMEs financing. *Journal of Financial Stability*, 15, 182–194.
- Bottazzi, L., & Da Rin, M. (2002). Venture capital in Europe and the financing of innovative companies. *Economic Policy*, 17(34), 229–270.
- Bozio, A., Irac, D., & Py, L. (2014). Impact of research tax credit on R&D and innovation: Evidence from the 2008 French reform.
- Brander, J. A., Du, Q., & Hellmann, T. (2015). The effects of government-sponsored venture capital: International evidence. *Review of Finance*, 19(2), 571–618.
- Braunerhjelm, P., Acs, Z. J., Audretsch, D. B., & Carlsson, B. (2010). The Missing Link: Knowledge Diffusion and Entrepreneurship in Endogenous Growth. *Small Business Economics*, 34(2), 105–125. JSTOR.
- Brown, J. D., & Earle, J. S. (2017). Finance and growth at the firm level: Evidence from SBA loans. *The Journal of Finance*, 72(3), 1039–1080.
- Busom, I., Corchuelo, B., & Martínez-Ros, E. (2014). Tax incentives... or subsidies for business R&D?. *Small Business Economics*, 43(3), 571–596.
- Caliendo, M., & Tübbicke, S. (2020). New evidence on long-term effects of start-up subsidies: matching estimates and their robustness. *Empirical Economics*, 59(4), 1605–1631.
- Carbó-Valverde, S., Rodríguez-Fernández, F., & Udell, G. F. (2009). Bank Market Power and SME Financing Constraints*. *Review of Finance*, 13(2), 309–340. <https://doi.org/10.1093/rof/rfp003>

- Carlen, J. (2016). A brief history of entrepreneurship: The pioneers, profiteers, and racketeers who shaped our world. Columbia University Press.
- Carpenter, R. E., & Petersen, B. C. (2002). Capital market imperfections, high-tech investment, and new equity financing. *The Economic Journal*, 112(477), F54–F72.
- Catozzella, A., & Vivarelli, M. (2016). The possible adverse impact of innovation subsidies: some evidence from Italy. *International Entrepreneurship and Management Journal*, 12(2), 351–368.
- Chatterji, A., Glaeser, E., & Kerr, W. (2014). Clusters of Entrepreneurship and Innovation. *Innovation Policy and the Economy*, 14, 129–166. <https://doi.org/10.1086/674023>
- Chiappini, R., Demaria, S., Montmartin, B., & Pommet, S. (2020). *Can Direct Innovation Subsidies Relax SMEs' Credit Constraints?* Groupe de REcherche en Droit, Economie, Gestion (GREDEG CNRS),
- CNEPI. (2016). Quinze ans de politiques d'innovation en France. 116.
- Coad, A. (2018). Firm age: A survey. *Journal of Evolutionary Economics*, 28(1), 13–43.
- Coad, A., Cowling, M., & Siepel, J. (2017). Growth processes of high-growth firms as a four-dimensional chicken and egg. *Industrial and Corporate Change*, 26(4), 537–554.
- Colombo, M. G., Croce, A., & Murtinu, S. (2014). Ownership structure, horizontal agency costs and the performance of high-tech entrepreneurial firms. *Small Business Economics*, 42(2), 265–282.
- Colombo, M. G., Cumming, D. J., & Vismara, S. (2016). Governmental venture capital for innovative young firms. *The Journal of Technology Transfer*, 41(1), 10–24.
- Colombo, M. G., Giannangeli, S., & Grilli, L. (2013). Public subsidies and the employment growth of high-tech startups: Assessing the impact of selective and automatic support schemes. *Industrial and Corporate Change*, 22(5), 1273–1314.
- Colombo, M. G., & Grilli, L. (2007). Funding gaps? Access to bank loans by high-tech startups. *Small Business Economics*, 29(1–2), 25–46.
- Colombo, M. G., & Murtinu, S. (2017). Venture capital investments in Europe and portfolio firms' economic performance: Independent versus corporate investors. *Journal of Economics & Management Strategy*, 26(1), 35–66.
- Cowling, M., Ughetto, E., & Lee, N. (2018). The innovation debt penalty: Cost of debt, loan default, and the effects of a public loan guarantee on high-tech firms. *Technological Forecasting and Social Change*, 127, 166–176.
- Criscuolo, C., Gal, P. N., & Menon, C. (2014). The dynamics of employment growth: New evidence from 18 countries.
- Croce, A., Martí, J., & Reverte, C. (2019). The role of private versus governmental venture capital in fostering job creation during the crisis. *Small Business Economics*, 53(4), 879–900. <https://doi.org/10.1007/s11187-018-0108-3>
- Cucculelli, M., & Peruzzi, V. (2020). Innovation over the industry life-cycle. Does ownership matter? *Research Policy*, 49(1), 103878.
- Cumming, D. J., Grilli, L., & Murtinu, S. (2017). Governmental and independent venture capital investments in Europe: A firm-level performance analysis. *Journal of Corporate Finance*, 42, 439–459.

- Cumming, D., & Johan, S. (2019). Government venture capital research: Fake science and bad public policy. *Venture Capital*, 21(1), 121–131.
- Cunningham, P., Gök, A., & Larédo, P. (2016). The impact of direct support to R & D and innovation in firms. In *Handbook of innovation policy impact*. Edward Elgar Publishing.
- Cusmano, L. et J. Thompson (2018), « Alternative Financing Instruments for SMEs and Entrepreneurs : The Case of Mezzanine Finance », *OECD SME and Entrepreneurship Papers*, n° 2, Éditions OCDE, Paris, <https://doi.org/10.1787/3709429e-en>.
- Czarnitzki, D., & Delanote, J. (2015). R&D policies for young SMEs: Input and output effects. *Small Business Economics*, 45(3), 465–485. <https://doi.org/10.1007/s11187-015-9661-1>
- Da Rin, M., Nicodano, G., & Sembenelli, A. (2006). Public policy and the creation of active venture capital markets. *Journal of Public Economics*, 90(8–9), 1699–1723.
- de Blasio, G., De Mitri, S., D'Ignazio, A., Russo, P. F., & Stoppani, L. (2018). Public guarantees to SME borrowing. A RDD evaluation. *Journal of Banking & Finance*, 96, 73–86.
- De, D. (2017). SME policy in Europe. *The Blackwell Handbook of Entrepreneurship*, 87–106.
- Dimos, C., & Pugh, G. (2016). The effectiveness of R&D subsidies: A meta-regression analysis of the evaluation literature. *Research Policy*, 45(4), 797–815.
- Drover, W., Busenitz, L., Matusik, S., Townsend, D., Anglin, A., & Dushnitsky, G. (2017). A review and road map of entrepreneurial equity financing research: Venture capital, corporate venture capital, angel investment, crowdfunding, and accelerators. *Journal of Management*, 43(6), 1820–1853.
- Duguet, E. (2004). Are R&D subsidies a substitute or a complement to privately funded R&D?: An econometric analysis at the firm level. *Revue d'économie politique*, 114(2), 245. <https://doi.org/10.3917/redp.142.0245>
- Duguet, E. (2010). The effect of the R&D tax credit on the private funding of R&D: An econometric evaluation on French firm level data. *Available at SSRN 1592988*.
- Dvouletý, O. (2017). Effects of soft loans and credit guarantees on performance of supported firms: evidence from the Czech public programme START. *Sustainability*, 9(12), 2293.
- Dvouletý, O., Srhoj, S., & Pantea, S. (2020). Public SME grants and firm performance in European Union: A systematic review of empirical evidence. *Small Business Economics*, 1–21.
- Dvouletý, O., Blažková, I., & Potluka, O. (2021). Estimating the effects of public subsidies on the performance of supported enterprises across firm sizes. *Research Evaluation*.
- Fraser, S., Bhaumik, S. K., & Wright, M. (2015). What do we know about entrepreneurial finance and its relationship with growth?. *International Small Business Journal*, 33(1), 70-88.
- Frese, M., Rousseau, D. M., & Wiklund, J. (2014). The Emergence of Evidence-Based Entrepreneurship. *Entrepreneurship Theory and Practice*, 38(2), 209–216. <https://doi.org/10.1111/etap.12094>
- Galbraith, J. K. (1993). *American capitalism: The concept of countervailing power* (Vol. 619). Transaction Publishers.

- Giraud, E., Giudici, G., & Grilli, L. (2019). Entrepreneurship policy and the financing of young innovative companies: Evidence from the Italian Startup Act. *Research Policy*, 48(9), 103801.
- Gompers, P., & Lerner, J. (2001). The Venture Capital Revolution. *Journal of Economic Perspectives*, 15(2), 145–168. <https://doi.org/10.1257/jep.15.2.145>
- Grand, J. (1991). The theory of government failure. *British Journal of Political Science*, 423–442.
- Granz, C., Henn, M., & Lutz, E. (2020). Research on Venture Capitalists' and Business Angels' Investment Criteria: A Systematic Literature Review. In *Contemporary Developments in Entrepreneurial Finance* (pp. 105–136). Springer.
- Grilli, L., & Murtinu, S. (2014). Government, venture capital and the growth of European high-tech entrepreneurial firms. *Research Policy*, 43(9), 1523–1543.
- Grilli, L., & Murtinu, S. (2015). New technology-based firms in Europe: Market penetration, public venture capital, and timing of investment. *Industrial and Corporate Change*, 24(5), 1109–1148.
- Grilli, L., & Murtinu, S. (2018). Selective subsidies, entrepreneurial founders' human capital, and access to R&D alliances. *Research Policy*, 47(10), 1945–1963. <https://doi.org/10.1016/j.respol.2018.07.001>
- Grimsby, G. (2018). Partly risky, partly solid – Performance study of public innovation loans. *Research Policy*, 47(7), 1344–1365. <https://doi.org/10.1016/j.respol.2018.04.018>
- Grjebine, T., Szczerbowski, U., & Tripier, F. (2018). Corporate debt structure and economic recoveries. *European Economic Review*, 101, 77–100. <https://doi.org/10.1016/j.euroecorev.2017.09.013>
- Guerini, M., & Quas, A. (2016). Governmental venture capital in Europe: Screening and certification. *Journal of Business Venturing*, 31(2), 175–195.
- Gustafsson, A., Tingvall, P. G., & Halvarsson, D. (2020). Subsidy entrepreneurs: an inquiry into firms seeking public grants. *Journal of Industry, Competition and Trade*, 20(3), 439–478.
- Hall, B. H., & Lerner, J. (2010). The Financing of R&D and Innovation. In *Handbook of the Economics of Innovation* (Vol. 1, pp. 609–639). Elsevier. [https://doi.org/10.1016/S0169-7218\(10\)01014-2](https://doi.org/10.1016/S0169-7218(10)01014-2)
- Haltiwanger, J., Jarmin, R. S., & Miranda, J. (2013). Who Creates Jobs? Small versus Large versus Young. *Review of Economics and Statistics*, 95(2), 347–361. https://doi.org/10.1162/REST_a_00288
- Harrison, R. T., & Mason, C. M. (2019). Venture Capital 20 years on: Reflections on the evolution of a field. *Venture Capital*, 21(1), 1–34. <https://doi.org/10.1080/13691066.2019.1562627>
- Hernández-Cánovas, G., & Martínez-Solano, P. (2010). Relationship lending and SME financing in the continental European bank-based system. *Small Business Economics*, 34(4), 465–482.
- Heyman, F., Norbäck, P.-J., & Persson, L. (2018). Who creates jobs and who creates productivity? Small versus large versus young versus old. *Economics Letters*, 164, 50–57.

- Hölzl, W. (2016). High growth firms in Europe. European Commission, Science, Research and Innovation Performance of the E.U., 247–276.
- Hottenrott, H., & Richstein, R. (2020). Startup subsidies: Does the policy instrument matter? *Research Policy*, 49(1), 103888.
- Huber, P., Oberhofer, H., & Pfaffermayr, M. (2017). Who creates jobs? Econometric modeling and evidence for Austrian firm level data. *European Economic Review*, 91, 57–71.
- Huergo, E., & Moreno, L. (2017). Subsidies or loans? Evaluating the impact of R&D support programmes. *Research Policy*, 46(7), 1198-1214.
- Huergo, E., Trenado, M., & Ubierna, A. (2016). The impact of public support on firm propensity to engage in R&D: Spanish experience. *Technological Forecasting and Social Change*, 113, 206-219.
- Jarboe, K. P., & Ellis, I. (2010). Intangible assets: Innovative financing for innovation. *Issues in Science and Technology*, 26(2), 75–80.
- Keech, W. R., & Munger, M. C. (2015). The anatomy of government failure. *Public Choice*, 164(1), 1–42.
- Kerr, W. R., Nanda, R., & Rhodes-Kropf, M. (2014). Entrepreneurship as experimentation. *Journal of Economic Perspectives*, 28(3), 25–48.
- King, G., Nielsen, R., Coberley, C., Pope, J. E., & Wells, A. (2011). Comparative effectiveness of matching methods for causal inference. *Unpublished Manuscript*, 15(1), 41–67.
- Knott, A. M., & Vieregger, C. (2020). Reconciling the Firm Size and Innovation Puzzle. *Organization Science*, 31(2), 477–488. <https://doi.org/10.1287/orsc.2019.1310>
- Kortum, S., & Lerner, J. (2000). Assessing the Contribution of Venture Capital to Innovation, 31 RAND J. Econ, 674, 682.
- Landström, H. (2008). Entrepreneurship research: A missing link in our understanding of the knowledge economy. *Journal of Intellectual Capital*, 9(2), 301–322. <https://doi.org/10.1108/14691930810870355>
- Landström, H. (2020). The Evolution of Entrepreneurship as a Scholarly Field. *Foundations and Trends® in Entrepreneurship*, 16(2), 65–243.
- Landström, H., Harirchi, G., & Åström, F. (2012). Entrepreneurship: Exploring the knowledge base. *Research Policy*, 41(7), 1154–1181.
- Larédo, P., Köhler, C., & Rammer, C. (2016). The impact of fiscal incentives for R & D. In *Handbook of innovation policy impact*. Edward Elgar Publishing.
- Lechner, M. (2011). The estimation of causal effects by difference-in-difference methods. Now.
- Lee, N., Sameen, H., & Cowling, M. (2015). Access to finance for innovative SMEs since the financial crisis. *Research Policy*, 44(2), 370–380.
- Lelarge, C., Sraer, D., & Thesmar, D. (2010). Entrepreneurship and credit constraints: Evidence from a French loan guarantee program. In *International differences in entrepreneurship* (pp. 243–273). University of Chicago Press.
- Leleux, B., & Surlemont, B. (2003). Public versus private venture capital: Seeding or crowding out? A pan-European analysis. *Journal of Business Venturing*, 18(1), 81–104.

- Lerner, J. (2002). When bureaucrats meet entrepreneurs: The design of effective public venture capital programmes. *The Economic Journal*, 112(477), F73–F84.
- Lerner, J. (2012). *Boulevard of broken dreams: Why public efforts to boost entrepreneurship and venture capital have failed—And what to do about it*. Princeton University Press.
- Lhuillery, S., Marino, M., & Parrotta, P. (2013). Evaluation de l'Impact des Aides Directes et Indirectes à la R & D en France. *Report for the Ministry of Research, France*.
- Martí, J., & Quas, A. (2018). A beacon in the night: Government certification of SMEs towards banks. *Small Business Economics*, 50(2), 397–413.
- Mazzucato, M. (2011). The entrepreneurial state. *Soundings*, 49(49), 131–142.
- Mazzucato, M. (2016). From market fixing to market-creating: A new framework for innovation policy. *Industry and Innovation*, 23(2), 140–156.
- Mazzucato, M., & Penna, C. C. (2016). Beyond market failures: The market creating and shaping roles of state investment banks. *Journal of Economic Policy Reform*, 19(4), 305–326.
- McKenzie, D. (2017). Identifying and Spurring High-Growth Entrepreneurship: Experimental Evidence from a Business Plan Competition. *American Economic Review*, 107(8), 2278–2307. <https://doi.org/10.1257/aer.20151404>
- Meuleman, M., & De Maeseneire, W. (2012). Do R&D subsidies affect SMEs' access to external financing? *Research Policy*, 41(3), 580–591.
- Michalek, J., Ciaian, P., & Kancs, D. (2016). Investment crowding out: Firm-level evidence from northern Germany. *Regional Studies*, 50(9), 1579–1594.
- Mulkay, B., & Mairesse, J. (2013). The R&D tax credit in France: Assessment and ex ante evaluation of the 2008 reform. *Oxford Economic Papers*, 65(3), 746–766.
- Myers, S. C., & Majluf, N. S. (1984). *Corporate financing and investment decisions when firms have information that investors do not have* (No. 0898–2937; Issues 0898–2937). National Bureau of Economic Research.
- Nelson, R. R. (1959). The simple economics of basic scientific research. *Journal of Political Economy*, 67(3), 297–306.
- Norrman, C., & Bager-Sjögren, L. (2010). Entrepreneurship policy to support new innovative ventures: Is it effective? *International Small Business Journal*, 28(6), 602–619.
- OECD (2011), *Business Innovation Policies: Selected Country Comparisons*, OECD Publishing. <http://dx.doi.org/10.1787/9789264115668-en>
- OECD. (2012). *Financing SMEs and Entrepreneurs 2012: An OECD Scoreboard*. OECD. <https://doi.org/10.1787/9789264166769-en>
- OECD. (2020). *Financing SMEs and Entrepreneurs 2020: An OECD Scoreboard*. OECD. <https://doi.org/10.1787/061fe03d-en>
- Pellegrino, G., Piva, M., & Vivarelli, M. (2011). 25 How do young innovative companies innovate? *Handbook of Research on Innovation and Entrepreneurship*, 403.
- Politis, D. (2008). Business angels and value added: What do we know and where do we go? *Venture Capital*, 10(2), 127–147. <https://doi.org/10.1080/13691060801946147>
- Ratinho, T., Amezcua, A., Honig, B., & Zeng, Z. (2020). Supporting entrepreneurs: A systematic review of literature and an agenda for research. *Technological Forecasting and Social Change*, 154, 119956.

- Revest, V., & Sapio, A. (2012). Financing technology-based small firms in Europe: What do we know? *Small Business Economics*, 39(1), 179–205.
- Riding, A., Madill, J., & Haines, G. (2007). Incrementality of SME loan guarantees. *Small Business Economics*, 29(1–2), 47–61.
- Romer, P. M. (1990). Endogenous technological change. *Journal of Political Economy*, 98(5, Part 2), S71–S102.
- Rosenbaum, P. R., & Rubin, D. B. (1985). Constructing a control group using multivariate matched sampling methods that incorporate the propensity score. *The American Statistician*, 39(1), 33–38.
- Sahlman, W. A. (1990). The structure and governance of venture-capital organizations. *Journal of Financial Economics*, 27(2), 473–521.
- Santos, A. (2019). Do selected firms show higher performance? The case of Portugal's innovation subsidy. *Structural Change and Economic Dynamics*, 50, 39–50. <https://doi.org/10.1016/j.strueco.2019.04.003>
- Scherer, F. M. (1991). Changing perspectives on the firm size problem. *Innovation and Technological Change: An International Comparison*, 24–38.
- Scherer, F. M., & Ross, D. (1990). Industrial market structure and economic performance. University of Illinois at Urbana-Champaign's Academy for Entrepreneurial Leadership Historical Research Reference in Entrepreneurship.
- Schmidt, P. (2018). Market failure vs. system failure as a rationale for economic policy? A critique from an evolutionary perspective. *Journal of Evolutionary Economics*, 28(4), 785–803. <https://doi.org/10.1007/s00191-018-0564-6>
- Schneider, C., & Veugelers, R. (2010). On young highly innovative companies: Why they matter and how (not) to policy support them. *Industrial and Corporate Change*, 19(4), 969–1007.
- Schumpeter, J. (1934). *The theory of economic development* Harvard University Press. Cambridge, MA.
- Seghers, A., Manigart, S., & Vanacker, T. (2012). The impact of human and social capital on entrepreneurs' knowledge of finance alternatives. *Journal of Small Business Management*, 50(1), 63–86.
- Shane, S. (2009). Why encouraging more people to become entrepreneurs is bad public policy. *Small Business Economics*, 33(2), 141–149. <https://doi.org/10.1007/s11187-009-9215-5>
- Sissoko, A. (2011). R & D Subsidies and Firm-level Productivity: Evidence from France. UCL
- Söderblom, A., Samuelsson, M., Wiklund, J., & Sandberg, R. (2015). Inside the black box of outcome additionality: Effects of early-stage government subsidies on resource accumulation and new venture performance. *Research Policy*, 44(8), 1501–1512.
- Solow, R. M. (1956). A contribution to the theory of economic growth. *The quarterly journal of economics*, 70(1), 65–94.
- Srhoj, S., Škrinjarić, B. & Radas, S. (2021). Bidding against the odds? The impact evaluation of grants for young micro and small firms during the recession. *Small Bus Econ* 56, 83–103. <https://doi.org/10.1007/s11187-019-00200-6>

- Srhoj, S., Lapinski, M., & Walde, J. (2020). Impact evaluation of business development grants on SME performance. *Small Business Economics*, 1-17.
- Stame, N. (2010). What doesn't work? Three failures, many answers. *Evaluation*, 16(4), 371-387.
- Standaert, T., & Manigart, S. (2018). Government as fund-of-fund and V.C. fund sponsors: Effect on employment in portfolio companies. *Small Business Economics*, 50(2), 357-373.
- Stiglitz, J. E., & Weiss, A. (1981). Credit rationing in markets with imperfect information. *The American Economic Review*, 71(3), 393-410.
- Stinchcombe, A. L. (1965). Organizations and social structure. *Handbook of Organizations*, 44(2), 142-193.
- Stinchcombe, A. L. (2000). *Social structure and organizations*. Emerald Group Publishing Limited.
- Stuart, E. A. (2010). Matching methods for causal inference: A review and a look forward. *Statistical Science: A Review Journal of the Institute of Mathematical Statistics*, 25(1), 1.
- Stuart, E. A., & Rubin, D. B. (2008). Best practices in quasi-experimental designs. *Best Practices in Quantitative Methods*, 155-176.
- Tullock, G., Brady, G. L., & Seldon, A. (2002). *Government failure: A primer in public choice*. Cato Institute.
- Urbano, D., Aparicio, S., & Audretsch, D. (2019). Twenty-five years of research on institutions, entrepreneurship, and economic growth: what has been learned?. *Small Business Economics*, 53(1), 21-49.
- Vanino, E., Roper, S., & Becker, B. (2019). Knowledge to money: Assessing the business performance effects of publicly-funded R&D grants. *Research Policy*, 48(7), 1714-1737.
- White, H. (2010). A contribution to current debates in impact evaluation. *Evaluation*, 16(2), 153-164.
- Weber, M. (1930). *The Protestant ethic and the spirit of capitalism*. Scribner.
- Wehinger, G. (2014). SMEs and the credit crunch: Current financing difficulties, policy measures and a review of literature. *OECD Journal: Financial Market Trends*, 2013(2), 115-148.
- Youker, B. W., Zielinski, A., Hunter, O., & Bayer, N. (2016). Who Needs Goals? A Case Study of a Goal-Free Evaluation. *Journal of Multidisciplinary Evaluation*, 12(27), 27-43.
- Zhao, Z. (2004). Using matching to estimate treatment effects: Data requirements, matching metrics, and Monte Carlo evidence. *Review of economics and statistics*, 86(1), 91-107.
- Zúñiga-Vicente, J. Á., Alonso-Borrego, C., Forcadell, F. J., & Galán, J. I. (2014). Assessing the effect of public subsidies on firm R&D investment: A survey. *Journal of Economic Surveys*, 28(1), 36-67.

Appendix A

Figure 2-3 - Direct and Indirect public support in France

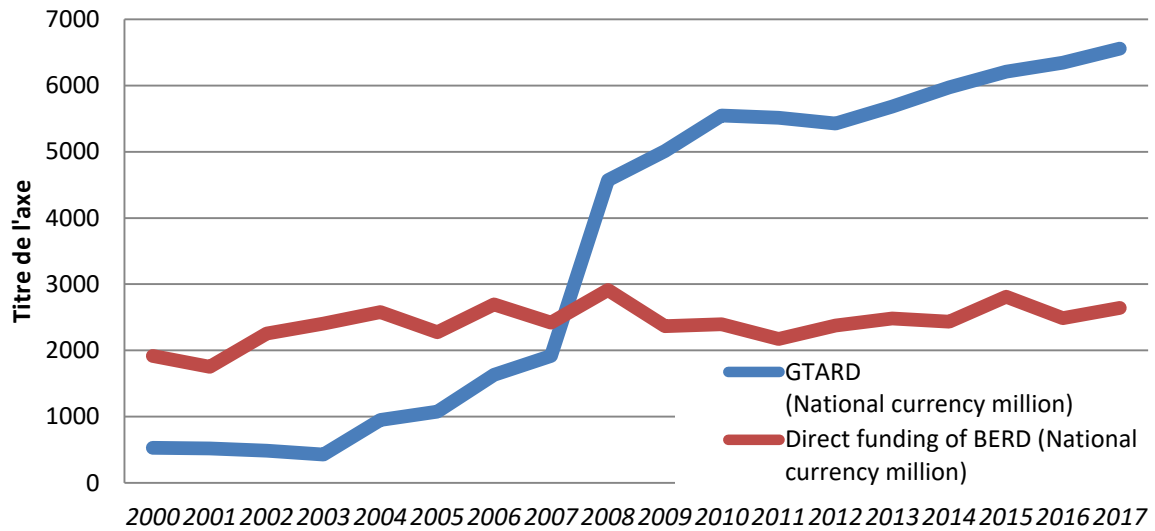

Source : OECD Science, Technology and Industry Scoreboard 2015 -

Table 2-3 - Risk/return profile of financing instruments

Low Risk/ Return		Medium Risk/Return	High Low Risk Return
Asset-Based Finance	Alternative Debt	“Hybrid” Instrument (Mezzanine Finance)s	Equity Instruments
Factoring	Corporate bonds	Subordinated Loans/Bonds	Private equity
Leasing	Secured Debt	Silent Participations	Venture capital
Purchase Order Finance		Participating Loans	Business Angels
Warehouse Receipts		Profit Participation Rights	Specialised Platforms for Public Listing of SMEs
		Bond with Warrants	Equity Derivatives

Source: Cusmano and Thompson (2018)

Table 2-4 - The Mezzanine Finance Landscape

Instrument	Description	Place in the balance sheet
1. Junior loans	Tailored loan design and repayment structure and flexibility regarding collateral requirement. Payback of principal and/or interest can take several forms (e.g., escalating or bullet loan, rolled up interests, redemption premium).	Liabilities  Stockholders' Equity
2. Royalty-based lending	Interest based payment plus royalties (payments that are dependent on the performance of the company, usually a percentage of revenue or EBIT(DA)).	
3. Convertible loans	Traditional maturity date and repayment scheme but provides an option to convert the loan into company shares. The use of the option closes the debt feature. In the same way, the conversion option is precluded once the debt payment occurs.	
4. Preferred stock	Preferred to ordinary shares, it includes a priority right in receipt of dividends and upon liquidation. Frequently associated with the annual dividend but not with a voting right, different from common stock.	
5. Redeemable equity	Like ordinary shares, but with a right to sell the shares back to the firm using a predetermined price or a formula. Does not encompass common stock issued by the firm to employees and managers, which is susceptible to be repurchased by the company according to the employment agreement.	

Table 2-5 – Descriptive statistics

	Obs	Mean	Std.	Min	Max
Panel A : Control Firms					
Age	648	0,8	0,5	0,0	1,8
Autonomy	648	0,3	0,4	-2,2	1,4
Leverage	648	-0,1	1,2	-4,0	4,1
Employees	648	1,6	0,8	0,0	4,9
Intangibles	648	3,0	2,3	0,0	8,5
Tangibles	648	3,0	1,7	0,0	7,4
Sales	648	0,9	1,8	0,0	8,8
Labour Productivity	648	2,0	3,4	-5,2	6,3
Panel B : Treated Firms					
Age	921	0,7	0,5	0,0	2,1
Autonomy	921	0,4	0,3	-1,4	1,4
Leverage	921	0,0	1,0	-3,8	4,1
Employees	921	1,5	0,8	0,0	4,9
Intangibles	921	3,5	2,3	0,0	8,5
Tangibles	921	3,0	1,6	0,0	7,9
Sales	921	0,7	1,6	0,0	10,1
Labour Productivity	921	1,3	3,3	-5,1	6,3

Note: This table presents summary statistics for the years before the loan obtention, expressed in natural logarithms.

Table 2-6 - Correlation Matrix

Variable	Measure	(1)	(2)	(3)	(4)	(5)	(6)	(7)	(8)
Age (1)	Number of years since business creation	1							
Leverage (2)	Total debt on total assets ratio	0,03	1,00						
Autonomy (3)	Equity on total asset ratio	-0,15	0,11	1,00					
Employees (4)	Number of employees at the end of the fiscal year	0,24	0,09	0,21	1,00				
Tangibles assets (5)	Stock of tangibles assets	0,31	0,20	0,11	0,36	1,00			
Intangibles assets (6)	Stock of intangibles assets	0,34	0,16	0,05	0,51	0,35	1,00		
Labour Productivity (7)	Turnover to employee ratio	0,24	0,04	-0,05	0,30	0,15	0,17	1,00	
Sales (8)	Total amount of sales	0,12	0,03	-0,02	0,15	0,08	0,17	0,09	1,00

Table 2-7 - Loan Amount Distribution

Variable	Min	1%	10%	25%	50%	75%	99%	Max
Loan Amounts in €	30 000	50 000	60 000	75 000	100 000	150 000	450 000	500 000

Table 2-8 - Step (2) Adjustment Quality

Year	Variable	Sample	Mean		Bias	% bias reduction	T-statistics	p>t
			Treated	Control				
2006	RA	U	0,43	0,29	30,40		2,14	0,03
		M	0,43	0,43	0,00	100,00	0,00	1,00
	generation	U	2005	2006	-41,30		-2,04	0,04
		M	2005	2005	-32,30	21,90	-1,88	0,06
	SUB	U	0,46	0,62	-34,00		-2,32	0,02
		M	0,46	0,46	0,00	100,00	0,00	1,00
	Age (i,t-1)	U	0,92	1,02	-24,20		-1,71	0,09
		M	0,92	0,90	6,00	75,30	0,28	0,78
	Employees (i,t-1)	U	1,70	1,64	5,10		0,29	0,78
		M	1,70	1,68	1,90	62,90	0,13	0,90
	Sales (i,t-1)	U	1,09	1,43	-15,10		-0,94	0,35
		M	1,09	1,09	0,00	99,70	0,00	1,00
2007	RA	U	0,41	0,27	30,80		2,97	0,00
		M	0,41	0,41	0,00	100,00	0,00	1,00
	generation	U	2006	2007	-40,80		-2,77	0,01
		M	2006	2007	-43,70	-7,10	-3,61	0,00
	SUB	U	0,49	0,67	-35,00		-3,31	0,00
		M	0,49	0,49	0,00	100,00	0,00	1,00
	Age (i,t-1)	U	0,78	1,00	-48,40		-4,47	0,00
		M	0,78	0,78	1,10	97,70	0,07	0,94
	Employees (i,t-1)	U	1,70	1,51	18,00		1,38	0,17
		M	1,70	1,69	0,60	96,90	0,05	0,96
	Sales (i,t-1)	U	0,96	1,41	-21,00		-1,72	0,09
		M	0,96	0,95	0,80	96,00	0,06	0,95
2008	RA	U	0,43	0,25	39,10		3,90	0,00
		M	0,42	0,42	0,00	100,00	0,00	1,00
	generation	U	2007	2008	-60,60		-4,25	0,00
		M	2007	2009	-98,20	-61,90	-5,59	0,00
	SUB	U	0,53	0,69	-33,40		-3,23	0,00
		M	0,54	0,54	0,00	100,00	0,00	1,00
	Age (i,t-1)	U	0,85	0,95	-23,10		-2,18	0,03
		M	0,87	0,84	5,20	77,40	0,36	0,72
	Employees (i,t-1)	U	1,71	1,47	23,40		1,81	0,07
		M	1,68	1,65	2,60	88,80	0,26	0,80
	Sales (i,t-1)	U	0,93	1,25	-15,00		-1,31	0,19
		M	0,59	0,59	0,00	100,00	0,00	1,00
2009	RA	U	0,6	0,22	84,2		7,04	0,00
		M	0,59	0,59	0,00	100	-0,00	1,00
	generation	U	2008	2008	-28,10		-1,67	0,09
		M	2008	2008	-14,80	47,40	-0,91	0,37
	SUB	U	0,33	0,70	-81,00		-6,38	0,00
		M	0,34	0,34	0,00	100,00	0,00	1,00
	Age (i,t-1)	U	1,11	1,15	-14,00		-1,30	0,19
		M	1,11	1,07	16,50	-17,80	0,82	0,41
	Employees (i,t-1)	U	1,66	1,47	19,30		1,28	0,20
		M	1,66	1,65	0,50	97,60	0,03	0,97
	Sales (i,t-1)	U	1,07	1,47	-19,00		-1,34	0,18
		M	1,16	1,16	-0,30	98,30	-0,02	0,99

2010	RA	U	0,45	0,24	46,00		4,67	0,00
		M	0,45	0,45	0,00	100,00	0,00	1,00
	generation	U	2009	2010	-35,60		-2,58	0,01
		M	2009	2010	-39,80	-11,80	-2,73	0,01
	SUB	U	0,46	0,68	-45,60		-4,43	0,00
		M	0,46	0,46	0,00	100,00	0,00	1,00
	Age (i,t-1)	U	0,78	0,91	-25,30		-2,46	0,01
		M	0,78	0,76	4,40	82,50	0,30	0,77
	Employees (i,t-1)	U	1,51	1,29	21,80		1,80	0,07
		M	1,51	1,52	-0,30	98,60	-0,03	0,98
Sales (i,t-1)	U	0,49	1,07	-31,90		-2,51	0,01	
	M	0,49	0,47	1,20	96,30	0,11	0,91	
2011	RA	U	0,42	0,23	42,20		4,73	0,00
		M	0,42	0,42	0,00	100,00	0,00	1,00
	generation	U	2010	2011	-34,20		-2,80	0,01
		M	2010	2011	-53,60	-56,40	-4,67	0,00
	SUB	U	0,50	0,65	-31,40		-3,34	0,00
		M	0,50	0,50	0,00	100,00	0,00	1,00
	IFL	U	0,02	0,05	-17,20		-1,52	0,13
		M	0,02	0,02	0,00	100,00	0,00	1,00
	Age (i,t-1)	U	0,67	0,81	-28,20		-2,89	0,00
		M	0,67	0,66	1,90	93,20	0,15	0,88
Employees (i,t-1)	U	1,46	1,26	20,60		1,91	0,06	
	M	1,46	1,44	1,80	91,30	0,16	0,87	
Sales (i,t-1)	U	0,80	1,04	-12,50		-1,19	0,24	
	M	0,80	0,78	0,90	92,60	0,08	0,94	
2012	R.A.	U	0,48	0,29	39,10		4,46	0,00
		M	0,47	0,47	0,00	100,00	0,00	1,00
	generation	U	2011	2007	130,60		10,23	0,00
		M	2011	2011	-18,40	85,90	-3,50	0,00
	SUB	U	0,43	0,60	-34,10		-3,73	0,00
		M	0,44	0,44	0,00	100,00	0,00	1,00
	IFL	U	0,02	0,05	-17,10		-1,55	0,12
		M	0,02	0,02	0,00	100,00	0,00	1,00
	Age (i,t-1)	U	0,53	2,22	-246,50		-22,55	0,00
		M	0,54	0,54	0,00	100,00	0,00	1,00
Employees (i,t-1)	U	1,57	2,37	-65,50		-5,77	0,00	
	M	1,56	1,56	0,50	99,20	0,06	0,95	
Sales (i,t-1)	U	0,45	2,05	-66,90		-5,61	0,00	
	M	0,45	0,45	0,30	99,60	0,04	0,97	
2013	R.A.	U	0,34	0,17	39,30		5,04	0,00
		M	0,34	0,34	0,00	100,00	0,00	1,00
	generation	U	2012	2012	16,00		1,51	0,13
		M	2012	2012	9,10	43,00	0,82	0,42
	SUB	U	0,55	0,71	-33,70		-4,05	0,00
		M	0,56	0,56	0,00	100,00	0,00	1,00
	IFL	U	0,05	0,05	-0,10		-0,01	1,00
		M	0,04	0,04	0,00	100,00	0,00	1,00
	Age (i,t-1)	U	0,59	0,74	-29,30		-3,41	0,00
		M	0,60	0,60	0,20	99,30	0,02	0,99
Employees (i,t-1)	U	1,44	1,36	8,50		0,90	0,37	
	M	1,44	1,46	-1,90	78,20	-0,18	0,85	
Sales (i,t-1)	U	0,64	0,84	-11,40		-1,21	0,23	
	M	0,64	0,60	2,60	77,50	0,25	0,81	

2014	RA	U	0,40	0,17	51,90		7,27	0,00
		M	0,40	0,40	0,00	100,00	0,00	1,00
	generation	U	2013	2012	55,20		5,72	0,00
		M	2013	2013	24,30	56,00	2,29	0,02
	SUB	U	0,50	0,73	-48,60		-6,38	0,00
		M	0,50	0,50	0,00	100,00	0,00	1,00
	IFL	U	0,05	0,04	2,40		0,30	0,76
		M	0,05	0,05	0,00	100,00	0,00	1,00
	Age (i,t-1)	U	0,61	0,78	-33,50		-4,13	0,00
		M	0,61	0,60	0,30	99,10	0,03	0,98
	Employees (i,t-1)	U	1,39	1,32	7,70		0,89	0,37
		M	1,39	1,38	0,90	87,80	0,09	0,93
	Sales (i,t-1)	U	0,50	0,74	-14,90		-1,69	0,09
		M	0,50	0,50	0,10	99,60	0,01	1,00

Notes: This table presents the adjustment of the Mahalanobis matching.

The standardized difference is defined as the difference of means normalized by the square root of the sum of estimated variances of the variables in both subsamples. RA, SUB and IFL, which refer to refundable advance, subsidy and interest-free loans, respectively, indicate the nature of the innovation aid received. Generation refers to the year the innovative aid was obtained.

3 CHAPITRE 3

THE BABEL TOWER OF PUBLIC SUPPORT FOR ENTREPRENEURSHIP AND SMALL BUSINESSES: A SYSTEMATIC LITERATURE REVIEW

3.1 Introduction

Driven by Schumpetarians' innovation, the advent of knowledge and services economies put small businesses and entrepreneurship (SBE) management at the core of industrial and development policies to ensure stable and inclusive growth (OECD, 2020). The intervention of public authorities is rooted in the traditional neoclassical perspective of market imperfection and knowledge externalities (Revest & Sapio, 2012). Market imperfections, driven by information asymmetry between firm insiders and outsiders, raise agency and coordination costs that can lower the availability of external finance to fund investments (Jensen & Meckling, 1976)⁹³. Knowledge externalities, coming from the quasi-public good nature of innovation, distort expectations of the private return of innovation, create misalignment from agents and lead to lower investment, which creates a situation in which the level of innovation is suboptimal from a social perspective (Carpenter & Petersen, 2002). The scrutiny of policy making towards SBEs lies as much in the market imperfections that constrain them more than larger organizations as in their contribution to innovation dynamics. The important contribution of SBEs to employment, value added, and productivity completes the rationale of public support for SBEs (Criscuolo et al., 2014; Hölzl, 2016) and justifies targeted policies aimed at reducing market failures or shaping markets⁹⁴ with more or less clearly stated objectives.⁹⁵

The instruments of targeted innovation policies are numerous (Edler et al., 2016; Edler & Fagerberg, 2017), and despite being widely investigated by the academic literature, the empirical convergence of findings is hardly achieved (David et al., 2000; Becker, 2015;

⁹³ Information asymmetry is exacerbated by innovation that is by nature uncertain and varies by the size of the firm (Berger & Udell, 1998, 2006)

⁹⁴ The market-shaping role of public support refers the challenge-led policies (Mazzucato et al., 2020) that are supposed to create incentives for the private sector to undertake societal and economical changes (digitalization policies, environmental policies, and gender policies)

⁹⁵ The precise characterization of policy goals is of crucial importance for evaluation and may be voluntarily fuzzy for political reasons (Georghiou, 1998; Perrin, 2002).

Dimos & Pugh, 2016; Dvouletý et al., 2020; Jugend et al., 2020; Zúñiga-Vicente et al., 2014). From an academic literature perspective, investigation of public support efficiency, effectiveness and consistency takes the form of numerous evaluation studies trying to assess the impact of public support (associated with a treatment) on SBE developments (associated with sick treated patients) in a causal way. In the public policy evaluation process, knowledge accumulation appears necessary for two reasons. The first, academic reason concerns the external validity of the studies produced. Indeed, while the use of the most rigorous statistical methods to control for traditional biases in the evaluation of innovation policies makes it possible to acquire solid internal validity (*in sample validity*), the question of external validity (*out of sample validity*) remains. Traditionally, econometric studies' external validity is achieved through the demonstration of similar results in other contexts using the same methods. The second, more operational reason focuses on public policy makers. Considered as such, knowledge accumulation, which has been made easier with the advent of computers, bibliographic databases and statistical tools, is not beneficial from a social viewpoint unless it is used to make policy recommendations and help policy makers reach objectives (Dosso et al., 2018). It provides policy makers with elements for investigation and feeds the last "i" of the "Interest, Ideology, Information" framework set out by Weiss in 1983 with the aim of formalizing the determinants of public policies. However, academic knowledge accumulation and impact evaluation on the role of public support for SBEs is often viewed by policy makers as a threat (Del Rey, 2013), limiting the use of the "information" pillar (Weiss, 1983).⁹⁶ Initiated decades ago (OECD, 1994; Sanderson, 2003) and reinforced by budgetary pressure from the supply and demand sides due to the COVID-19 crisis, the rationality of public spending is increasingly questioned, pushing policy makers towards evidence-based policy making (Dosso et al., 2018; Edler et al., 2016; Edler & Fagerberg, 2017).

The goal of this chapter, in contrast to previous chapters, is to take a side step regarding knowledge accumulation of evaluation impact studies about public support for SBEs. We notably investigate past and present trends in the related academic literature and how this knowledge accumulation can serve evidence-based decision making. We aim to study the structure and orientation of the literature, highlighting key influencers and their

⁹⁶ Evaluation processes can be divided into two main groups. The first, which prevails in France, is implemented within the government by internal administrators; the analyses are rarely published and are not part of the democratic debate. Conversely, the second takes democratic debate as a starting point and is performed to enlighten and feed the public debate; it can be conducted by the administration (the Parliament and the "Cours des comptes" in France) or by independents (universities or consulting firms) (Bozio, 2014).

works to provide implications for future academic research and ultimately guidance for evidence-based policy making. More specifically, the chapter aims to study the external validity process in the academic literature to assess the impact of public support. To do so, we perform a systematic literature review (SLR) on public support for small businesses using bibliometric and science mapping tools.

This chapter's contribution is threefold. First, from an academic perspective, we contribute to the evaluation literature by synthesizing public support for SMEs using different bibliographic databases: Scopus (SC) and Web of Science-Core Collection (WoS-CC). Second, with the use and comparison of both sources, the chapter contributes to the information science literature in social sciences from a methodological and operational perspective. Indeed, while widely used in sciences, the comparison of bibliometric databases in social science and economics in particular suffers from a lack of investigation. However, comparing the coverages and relevance of both critical knowledge sources on the topic could have important implications for academic and operational research. Last, from a policy perspective, the framework depicted and the results highlighted could have important implications for policymakers seeking to implement evidence-based policies to support SBEs.

The structure of the chapter is as follows: Section 2 reviews the methodology and framework of the study, whose results are presented in Section 3. Section 4 presents the sensitivity analysis, and Section 5 discusses the results from the previous section. Section 6 concludes by providing the limitations and policy implications of the results.

3.2 Research design and empirical setting

3.2.1 Information sciences and social sciences: Theory and practice

Information science developments, including bibliometrics, science mapping, and systemic or structured literature reviews, are based on a few theoretical developments (Kessler, 1963; Small, 1973) that have recently been challenged with the development of computer sciences (Zhao & Strotmann, 2008). The empirical literature developed appears to be strongly topic dependent, providing scarce practical guidance, especially in the social sciences (Massaro et al., 2016; Tranfield et al., 2003; Urbano et al., 2019). Medical and engineering sciences have benefitted from the increasing prevalence of evidence-based policies in public debates; the *PRISMA*⁹⁷ initiative and the *Cochrane community*⁹⁸ have

⁹⁷ <http://www.prisma-statement.org/PRISMAStatement/>

contributed to the expanding use of SLR. These collection of evaluation studies on a subject are built to inform both academics and policy makers; while it inform the former on the research front, it is a lesser use for the latter that are often unable to translate in political terms the statistic results presented within (Oliver et al., 2005). In contrast, and despite initiatives⁹⁹, social sciences still lag the field, while cross-domain application questions remain unsolved (Moher et al., 2015). Investigations in the innovation field are recent and include (Cancino et al., 2017; Landström et al., 2012; Martin, 2012; Merigó et al., 2016; Rossetto et al., 2018).

3.2.2 *Research design: The Subject-Action-Object framework*

The following section introduces the framework used in this chapter to extract relevant studies from bibliographic databases. Based on previous SLR, we build on the definition of research terms to help illustrate the frontiers of the topic (Cravo & Piza, 2019; Kersten et al., 2017). Accordingly, we resort to a *subject-action-object* triptych (SAO) that helps univocally define the research boundaries.¹⁰⁰

3.2.2.1 *Subject*

The first step of the analysis consists of defining the *subject* of the SLR. The main objective of the chapter is to study “public support”.

Public support for economic activity in knowledge economies mainly takes the form of industrial, labour, and innovation policies (Stiglitz, 1999), intermediated either directly (loans, subsidies, grants, and advice programmes) or indirectly (credit guarantee schemes and tax relief). The respective pros and cons of both instruments have been widely debated and synthesized by the academic literature; while (Dvouletý et al., 2020), using the SLR framework, summarize the public support for SMEs in Europe, (Dimos & Pugh, 2016) use a meta-analytics framework to investigate public R&D subsidies, and (Jugend et al., 2020) investigate public support for open innovation using bibliometric analysis. Despite extensive and increasing knowledge accumulation on the topic, the related conclusions are as equivocal as David et al. (2000) stated two decades ago (Becker, 2015; Dimos & Pugh, 2016; Zúñiga-Vicente et al., 2014).

⁹⁸ <https://community.cochrane.org/>

⁹⁹ The Campbell initiative launched in 1999. Initially composed of members of the Cochrane community, it aimed to provide SLR and meta-analyses of policy initiatives in the social sciences (Littell, 2018).

¹⁰⁰ Reference is also made to the list of 27 items provided by the PRISMA initiative. <http://prisma-statement.org/PRISMAStatement/Checklist>

3.2.2.2 Action

The second step consists of defining the *action* of the *subject*. Historically, the ease of implementation and the advantageous risk-cost ratio have put indirect public support (tax incentives and credit guarantees) in the spotlight of industrial and innovation policies since the 1970s (Cunningham et al. 2016; Laredo et al., 2016). Indeed, concomitantly, since the Second World War, direct support, often associated with the traditional public instrument, has fallen out of favour because of its high cost compared to indirect support. However, with the emergence of challenge-led and market-shaping policies, direct support has been revived, as it is argued to allow a more precise targeting approach for public support (Mazzucato, 2016); Lhuillery et al. 2013; and Cunningham et al. 2016). Based on these insights, the chapter focuses and explores the characterization of public support through targeted innovation policies and thus excludes tax incentives and credit guarantee schemes.

3.2.2.3 Object

Finally, to complete the framework, we define the *object* under scrutiny, which, in our context, is “small businesses and entrepreneurs”¹⁰¹. Despite worldwide institutional efforts, there is no single static definition of what SBEs are (Autio et al., 2014; Ayyagari et al., 2007; Gartner, 1990). The framework of the chapter is based on the “small businesses” definition described by Bennett (2014), encompassing entrepreneurs (i), owner-managers and self-employed (ii), and small and medium-sized enterprises (iii). The entrepreneur is defined in line with Schumpeter’s legacy (Schumpeter, 1942) and contemporaneous conceptual (Ahmad & Hoffman, 2008) and methodological (Ahmad & Seymou, 2008) developments.¹⁰² The owner-manager and self-employed category encompasses self-employed entrepreneurs of less interest in our case, as discussed in section 2.3 (Román et al., 2013). “Small and medium-sized enterprises” (SMEs) is the most frequently used vocable associated with small businesses in the policy literature. The category’s definition is fuzzier, encompassing (i) and (ii) organizations as well as organizations whose size induces a separation of ownership and management, aspects absent from (i) and (ii) (Jensen & Meckling, 1976). Multiple criteria can be considered to classify firms; while the European Commission resorts to the number of

¹⁰¹ The question of whether SMEs can be a subject of analysis is out of the scope the research; see Sabel (2009) and (Bennett, 2014) for further developments.

¹⁰² According to Ahmad and Hoffman (2008): “*Entrepreneurs are those persons (business owners) who seek to generate value, through the creation or expansion of economic activity, by identifying and exploiting new products, processes or markets*”.

employees, turnover, and the total balance sheet, the World Bank considers total assets and total annual sales in addition to the number of employees. In opposition to harmonization attempts from international institutions, national considerations claim different classifications of SMEs. In this regard, UNESCAP (2012) records 60 definitions across 65 countries.¹⁰³ The scrutiny according to the definition of SBEs in the present context is detailed in the empirical section (section 2.3).

3.2.2.4 Hypothesis development

Based on the above discussion, the main research question (MRQ) of this chapter can thus be summarized as follows: “What are the recent developments in the innovation policy evaluation literature and how can they serve evidence-based policy making?”

To build the reasoning to answer the main research question, we rely on auxiliary questions. Notably, from a methodological perspective, “What is the main relevant source of knowledge to explore public support for SBEs?”. From a policy perspective, “Is public support for innovation the same throughout Europe? How can impact studies be used reliably to formulate evidence-based policies? How to explain the low use of academic research in public debates?”¹⁰⁴ Last, from an academic perspective, “What is the intellectual structure of the topic in terms of dominant theories, authors, and documents? What are the methodologies to study public support?”

3.2.3 Empirical setting

The empirical investigation follows Jugend et al. (2020). Accordingly, we use the Scopus (Elsevier 2019) and Web of Science (Clarivate Analytics., 2019) bibliometric databases to explore literature related to the MRQ. While increasingly used to summarize the state of the art of academic fields (Archambault et al., 2009; Zhu & Liu, 2020), these databases are either used as substitutes (Tiberius et al., 2020; Urbano et al., 2019) or as complements (i.e., overlapping between both) (Dvouletý et al., 2020). However, we suggest that restricted access to databases encourages comparative studies to provide guidance to researchers seeking to find, synthesize, and analyze knowledge on a topic. In this regard, we

¹⁰³ Even within countries, definitions may vary. Japan’s sectorial classification considers manufacturing firms up to 300 employees as SMEs, while the threshold is set at 100 employees for the wholesale sector and 50 employees for the retail and services sectors.

¹⁰⁴ The last report of the French evaluation society claims that only 3% of evaluations are made by scholars’ in France (Société Française d’évaluation, 2018).

perform the same empirical procedure for both databases independently to explore their relative relevance for the literature affiliated with the MRQ. To build the bibliographic database, we have to transform the sentences reflecting research goals into code (Dvouletý et al., 2020). However, as stated above, the literature about SBEs is acknowledged to be a highly heterogeneous literature encompassing various moving definitions (Levratto, 2009). Based on a screening of previous SLRs in the field of public support (Jugend et al., 2020), Table A.1 in appendix A presents list of terms used to perform the analysis.

To comment on semantic developments of vocables used to define SBEs across authors, documents and time, we allow the numbers of employees to vary across studies. In line with the literature, we focus on 28 European Union member countries (Dvouletý et al., 2020). To capture the highest number of references related to the MRQ, we also allow the methodology of the selected studies to vary.¹⁰⁵ During this period, the literature tends to univocally consider that the last decade (i.e., 2010-2021) is sufficiently consistent to exhaustively investigate public support for SBEs (Jugend et al., 2020; Mallinguh & Zoltan, 2020; Padilla-Ospina et al., 2018).¹⁰⁶ Then, in accordance with Jugend et al. (2020) and Kersten (2017), we focus on published articles written in English.

Finally, the exclusion process ends with screenings of titles, abstracts and full texts to exclude articles outside of the scope of the research. Since the goal is to conduct quantitative research, subjective judgements about the relevance of documents are kept to a minimum to avoid influencing the research results. In this regard, we complement Kersten et al. (2017) and Padilla-Ospina et al. (2018) and allow our framework to include virtually any public support instrument and explore their relative developments in the academic literature. Accordingly, we exclude articles referring to public and innovation policies at large.¹⁰⁷ Entrepreneurship studies focusing on unemployment reduction and self-employment are removed from the

¹⁰⁵ In the chapter, we aim to depict the varying academic research landscape around public support for SBEs rather than highlighting its conceptual and methodological frontiers. In addition, from a technical viewpoint, papers that do not explicitly refer to evaluation methods in the title or abstract could be omitted from the research. For example, the paper of (Martí & Quas, 2018) does not explicitly refer to evaluation methods.

¹⁰⁶ In addition, regarding bibliometric considerations that saw an inflation of the number of articles during the last decade (Padilla-Ospina et al., 2018; Jugend et al., 2020), this threshold also corresponds to the penetration of entrepreneurship and innovation considerations into societal and political debates with, among others, the publication of Josh Lerner's book: *The boulevard of broken dreams Why Public Efforts to Boost Entrepreneurship and Venture Capital Have Failed--and What to Do about It* (Lerner 2009) and that of Mariana Mazzucato: *The entrepreneurial state* (Mazzucato 2011). In addition, relevant publications before 2000 will be included in the analysis thanks to bibliometric tools developed below.

¹⁰⁷ The exclusion criteria exclude mainly articles studying the innovation-performance relationship, and those whose findings are discussed in terms of "policy" or "policy implications".

dataset since these studies refer mainly to labour and less to industrial or innovation policies for SBEs (Dvouletý et al., 2020; Román et al., 2013). The main final dataset extracted from Scopus leads us to consider a final list of 101 connected papers. Figure 3-1 below summarizes the empirical setting and exclusion criteria.

Figure 3-1 - Research exclusion criteria

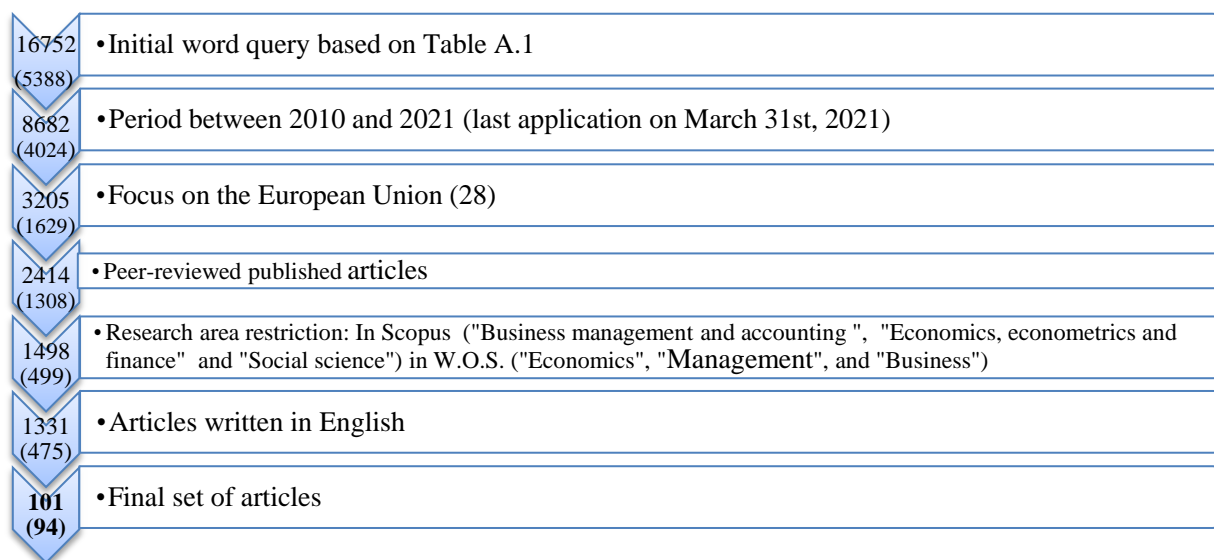

Notes: The query is performed on the Scopus database. The number of articles from the Web of Science database detailed in section 4 is given in brackets.

3.2.4 Bibliometrics

Bibliometric analyses are increasingly used to provide quantitative and comparable metrics to investigate academic developments. In this chapter, we follow previous insights and distinguish performance analysis from science mapping (Tiberius et al. 2020). While the former is used mainly to compare developments in a specific research field, the latter visually depicts a specific scientific discipline. While performance analysis enables the study of explicit knowledge, science mapping tools allow for sketches of the selected literature based on tacit, underlying knowledge embedded in reference lists (Zupic & Čater, 2015).

In this chapter, we perform science mapping using two main complementary bibliometric concepts: co-citation and bibliographic coupling. Introduced by Small (1973), co-citation provides a measure of the semantical similarity between documents in a corpus, allowing the identification of relevant literature and academic communities that may be overlooked in standard approaches to literature search. It enables us to measure the relationship between documents as perceived by the authors of the corpus. Specifically, co-citation measures the frequency of jointly cited documents, and documents A and B are co-cited if document C cites both. The more A and B are cited together by others documents, the

stronger the link between both is. Therefore, co-cited documents depict current considerations around a research field. However, co-citation analysis hardly handles niche specialties with low numbers of citations (Trujillo & Long, 2018).¹⁰⁸ Scientometric literature was dominant from the 1970s to the mid-2000s, and co-citation analysis has been challenged by bibliographic coupling but was introduced earlier (Kessler, 1963; Boyack & Klavans, 2010). In contrast to co-citation analysis, bibliographic coupling relies on the reference list of a document and is therefore a fixed, conservative concept. There is bibliographic coupling between A and B if C is cited by both. Bibliographic coupling is therefore particularly useful to depict studies whose “bets cover” the field (Zhao & Strotmann, 2008). Although bibliographic coupling presents the advantage of highlighting core and emerging documents and topics, citation behaviours may change over time, making bibliographic coupling relevant only in a limited timeframe (Glänzel & Thijs, 2012). Both co-citation analysis (CA) and bibliographic coupling analysis (BCA) are used to investigate the intellectual structure of research fields but differ in the way to do so. CA uses co-citation counts and therefore considers similarities between authors’ oeuvres¹⁰⁹ as perceived by subsequent authors. In contrast, BC uses the bibliographic coupling frequency as a unit of relatedness and therefore maps citing rather than cited authors.

Last, to complement CA and BCA analysis and to control for the time dependency of citation networks that could create an upward bias towards older contributions, we use co-word analysis (López-Fernández et al., 2016). Co-word analysis enables the investigation of keyword patterns, ignoring time dependency and therefore enabling the incorporation and consistent interpretation of newer contributions to the field and their relationship with older documents.

Science mapping is performed using Vosviewer software with a fractional counting method (van Eck & Waltman, 2010) that better handles the association of articles with several contributors. Figure 3-2 below summarizes the CA and BC of bibliometric tools.

¹⁰⁸ In this regard, despite being out of the scope of the chapter, performing a co-citation analysis in different time span could be interesting to historically follow the developments of academic research on a topic.

¹⁰⁹ Oeuvre refers to “a body of writings by a person” (White and Griffith, 1981). Insofar as bibliometric software only considers the first authors, the oeuvre is empirically defined as the list of works with the authors as the first authors and thus may vary from the overall oeuvre of that author (Zhao, 2006). In the co-citation analysis the term “author(s)” and *oeuvre* are used interchangeably.

Figure 3-2 - Co-citation and bibliographic coupling illustration

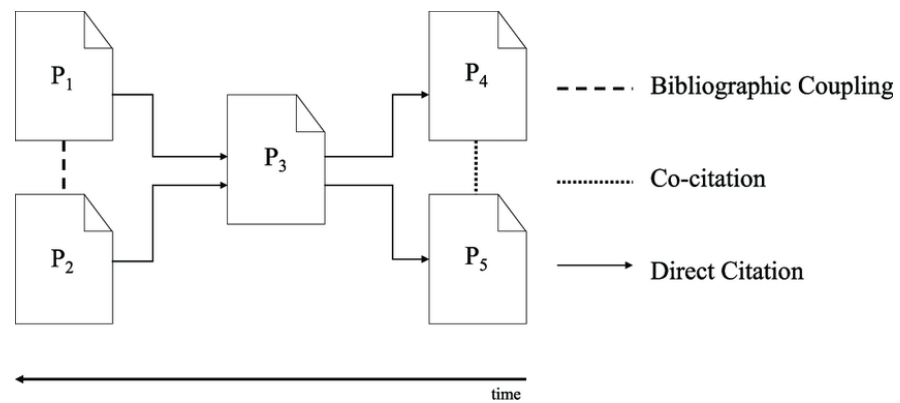

Source: Quang et al. (2019)

3.3 Results

3.3.1 Bibliometric results

• Number of publications by year

Figure 3-3 presents the number of selected documents by year. We have noticed an upward trend since the last decade, with the number of articles broadly growing over the years, highlighting increase scrutiny of public support for SBEs from academics, in line with (Padilla-Ospina et al., 2018). However, we noticed a slight drop from 2016 and 2017, in accordance with previous findings (Jugend et al., 2020). This could be methodologically interpreted as a shift in the literature towards other vocables not included in the initial code. However, the surge after 2018 indicates that the query can capture the increasing trend observed since the last decade, discarding the de facto methodological justification for the drop. Another possible explanation lies in the focus on published articles for which the publication process can be due to more sophisticated developments of datasets and methods.

Figure 3-3 - Publications by year

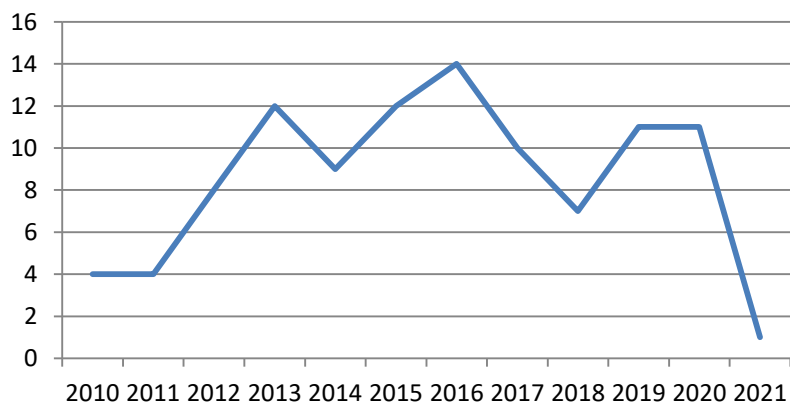

Source : Scopus.

· *Publications per country*

Figure 3-4 below breaks down the numbers of publications by country. The results show that research on public support for SBEs in Europe is dominated by scientific publications originating from Western Europe. Specifically, the main contributing countries are Italy, with 30 documents; the U.K. with 25 documents, Germany with 17 documents and Spain with 17 documents. France appears to lag in terms of the volume of peer-reviewed scientific publications, with only 5 documents captured, mainly reflecting the republican French behaviour towards evaluation considerations (Nioche 1982, Trosa, 2013, France Stratégie, 2019). Linked to the framework, there are some caveats regarding the interpretation of national contributions to the public support literature.

Although English-written academic journals account for a growing share of publications, the restriction on these journals causes us to leave out working papers and institutional publications that are, at least in France, an important source of public support evaluation (Bpifrance; CNEPI, 2016; Desrochers & Lariviere, 2016, Bono et al., 2018).¹¹⁰ The latest data from the OECD show that top-tier countries are also in the top tier of countries in terms of public spending on innovation (Table A.3 Appendix A.). Therefore, we can hypothesize that the number of publications originating from one country is correlated with the amount of public support for SBEs in that country.

Countries' contribution to the academic literature is also consistent with Padilla-Opsina et al.'s (2018) finding, excluding the U.S., that the U.K., Germany and Italy are the most prolific countries in the field. Closer to our framework, Jugend et al. (2020) also point out that in Europe, the U.K. and Spain are significant contributing countries¹¹¹. The high-country correspondence with previous reviews related to financing innovation could suggest that public support for SBEs mainly relies on financial instruments to stimulate SBE innovativeness.

¹¹⁰ The language of publication strongly influences the citation patterns of articles. Therefore, to consider homogeneous citations patterns, we focus only on English-written articles (Imbeau & Ouimet, 2013). However, major contributions published in national languages could be integrated to the framework via extracorpous analysis (section 3.2.1).

¹¹¹ The ranking suggested in the chapter is in line with Bono et al. (2018) where in Europe the U.K, Germany, and Italy are major contributors of impact evaluation.

Figure 3-4 - Publications by country

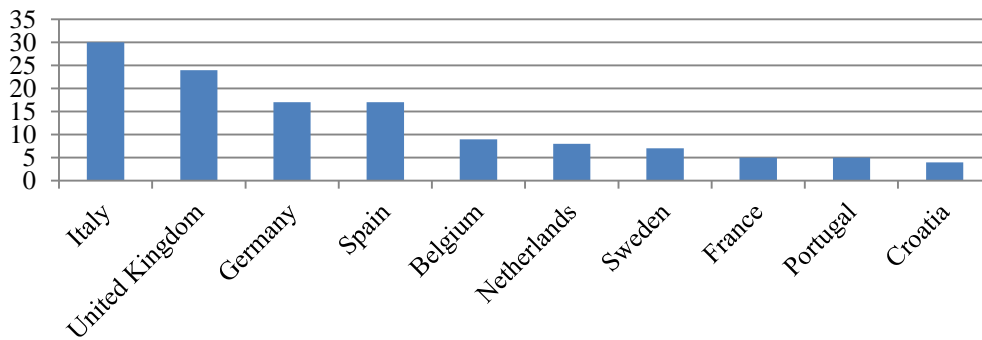

Note: (*) refers to the request date on Scopus, which was March 31, 2021, for the first ten countries in terms of the number of publications.

• Publications by author

Figure 3-5 shows that the number of publications by author is correlated with the country contribution since we show that L. Grilli (Italy), A. Hottenrott (Germany), M. Colombo (Italy) and E. Huergo (Spain) are the main contributors with 82, 141, 102 and 90 citations, respectively. We noticed that the number of contributions was not necessarily strongly correlated with the number of citations.¹¹²

Figure 3-5 - Authors' contributions

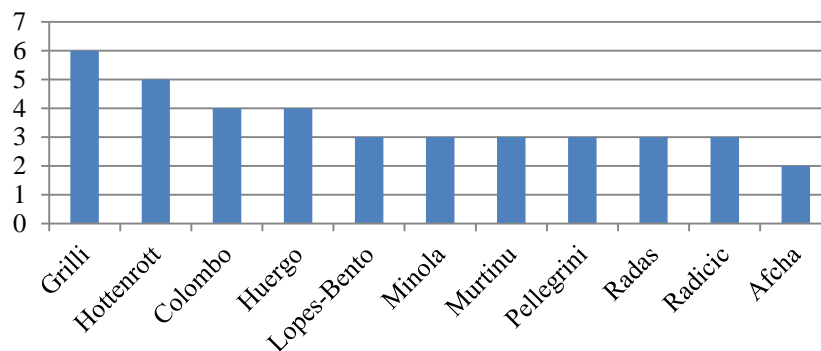

3.3.2 Cluster analysis

3.3.2.1 Co-citation analysis

Co-citation analysis (CA) is a tool widely used in quantitative studies of science. It is used to depict the underlying intellectual cluster structure and can be performed at the author

¹¹² Due to sophistication of topics, methodologies and datasets, the number of authors per paper rises regardless of the field, leading to an inflation in the number of citations (Chuang & Ho, 2014; Rossetto et al., 2018).

level (authors co-citation analysis or ACA) or at the document level (DCA) (White & Griffith, 1981); White & McCain, 1998). ACA allows connections to be drawn among researchers and fields, revealing the underlying intellectual structure of the extracorpous literature. DCA enables the exploration of documents frequently associated. To identify the authors' intellectual structure of the literature related to public support for SBEs, we perform an ACA.

Figure 3-6 presents a network visualization of the ACA. Each circle represents the *oeuvre* of an author, and the relationship between other *oeuvres* (i.e., by co-citations) is indicated by the links between the nodes. The distance between two authors on the map illustrates the relatedness of the two authors in terms of co-citations. The weight of an author in the visualization map (and thus the size of the circle) is determined by the total strength of the circles connected to that author. Since distance between authors represents the relatedness of their research, the analysis of the centre and of the external boundaries of the network representation could help us determine a label for the clusters.

We notice that the network representation enables us to consider two widely distinct clusters in a cross-checked network. Indeed, as shown in Figure 6, the boundaries of the network overlap with each other and lead to a circle-shaped representation, indicating a consistent and homogeneous research framework. In contrast, a more heterogeneous conceptual framework would imply a more dispersed, less-centred, network representation with clusters visually independent from each other.

The first cluster, in red, is centred on D. Czarnitzki and to a lesser extent on B. Hall. Both of these authors' research focuses on public support for SBEs in terms of R&D subsidies (Czarnitzki & Delanote, 2015; Czarnitzki & Lopes-Bento, 2013; Hall & Lerner, 2010; Hall & Mairesse, 1995). At the top left margins of the network, we notice J. Mairesse, T. J Klette, and Z. Griliches, among others, whose *oeuvre* is centred on the evaluation of public R&D spending (Crepon et al., 1998; Griliches & Mairesse, 1995; Hall & Mairesse, 1995; Klette et al., 2000). Linked to impact evaluations of R&D subsidies, the network representation shows that authors such as M. Lechner, PR. Rosebaum, DB. Rubin, J. Heckman, G. Imbens, M. Caliendo and, L. Georghiou, who share a strong methodological focus in their works, are included in the bottom left of the red cluster while being only marginally connected to the green cluster. The red cluster of the literature on public support for SBEs includes *oeuvres* focusing on R&D policy evaluation with a strong methodological orientation. Indeed, the authors from the red cluster seem to share a strong orientation towards methodological aspects

linked to the impact evaluation of public support for SBEs. Therefore, based on the previous discussion, the red cluster can be labelled *Methodological aspects of public R&D support evaluation*.

The second cluster, in green, is polarised around L. Grilli, M. Colombo, S. Murtinu and J. Lerner in the upper part and around M. Wright in the lower part. Additionally, the presence of E. Autio, Z. Acs and D. Audretsch and S. Shane suggests an important consideration of entrepreneurship policy, which echoes the *oeuvre* of C. Mason and R. Brown (2013). At the top are authors whose *oeuvre* is centred mainly around venture capital (B. Carpenter, R. Petersen and A. Croce) and related public support (D. Cumming, F. Bertoni). The presence of M. Colombo and L. Grilli supports the prism of the green cluster on the impact of public support on SBEs through venture capital (direct or indirect). Accordingly, the green cluster can be labelled *Entrepreneurship policies and venture capital*.

Network mapping shows M. Vivarelli and G. Pellegrini at the crossroads of the clusters; thus, they are defined as the “core” of the literature around public support for SBEs according to ACA. While M. Vivarelli is affiliated with Sacred Heart Catholic University (Italy), G. Pellegrini is affiliated with La Sapienza (Italy) and appears to be linked to the red cluster. M. Vivarelli’s *oeuvre* is diverse. He investigates employment dynamics in developing countries or developed countries (Vivarelli, 2014) and the intermediation of innovation on employment dynamics (Vivarelli & Pianta, 2000). Related to innovation, he explores conceptual boundaries of entrepreneurship research (Vivarelli, 2011; Vivarelli, 2013). He notably investigates the adverse effect of subsidies on early-stage firms (Santarelli & Vivarelli, 2002) by showing the subsidies and deadweight possible adverse effects of subsidies.¹¹³ The work of G. Pellegrini is centered around the impact of public support for SBEs through industrial and regional innovation policies in Italy (Pellegrini et al., 2013; Pellegrini & Muccigrosso, 2017). The link to the red cluster lies in the use of matching techniques to evaluate the influence of regional innovation policies in Italy (Abadie & Imbens, 2006; Rubin, 1973).

¹¹³ Substitutions may occur when less efficient firms are artificially supported. Dead weight arises when trying to reduce previous adverse effects; to avoid so-called “zombie firm” issues (Adalet McGowan et al., 2018), a “picking-winner” strategy may be used to finance firms that would have survived and been financed anyway. The nonsystematic positive effect of the public support perspective is prolonged by (Catozzella & Vivarelli, 2016) exploring the possible adverse effect of financial public support through innovation subsidies in Italy. Using a bivariate switching model to account for endogeneity, they study Italian CIS3 data to explore the output additionality of public funding and suggest a negative influence of public support on the firm’s sales-to-investment ratio.

The ACA helps to illustrate the similarities between authors that may either depend on the subject of interest or on methodological aspects linked to the evaluation of SBE support programmes. In addition, it reveals the intellectual structure by gathering groups of authors, their central or peripheral location and their proximity with other groups or other authors (White & Griffith, 1981). The network depicted thus suggests that the academic literature on public support for SBEs mainly takes the form of financial support for innovation. In addition, we observe a highly diversified literature, as suggested by the central *oeuvre* of M. Vivarelli Pellegrini. Moreover, we notice a bifaced literature that may reflect the definition of the *subject*. Indeed, the red cluster includes *oeuvres* dealing with R&D public support (mainly through tax incentives or subsidies) and that appear to be oriented towards established “small businesses”, taking firms as units of analysis. In contrast, the green cluster appears to be more oriented towards the “entrepreneurial” dimension, taking into account individual characteristics (Cowling, 2000; Lerner, 2002, 2010). However, a clear distinction between these clusters is difficult to achieve, as suggested by the *oeuvre* of Storey (Storey, 2003, 2005; Storey & Greene, 2010), which encompasses both terms and blurring the line between small business and entrepreneurship support (Ratinho et al., 2020).

Figure 3-6 - Authors' co-citation analysis using Scopus

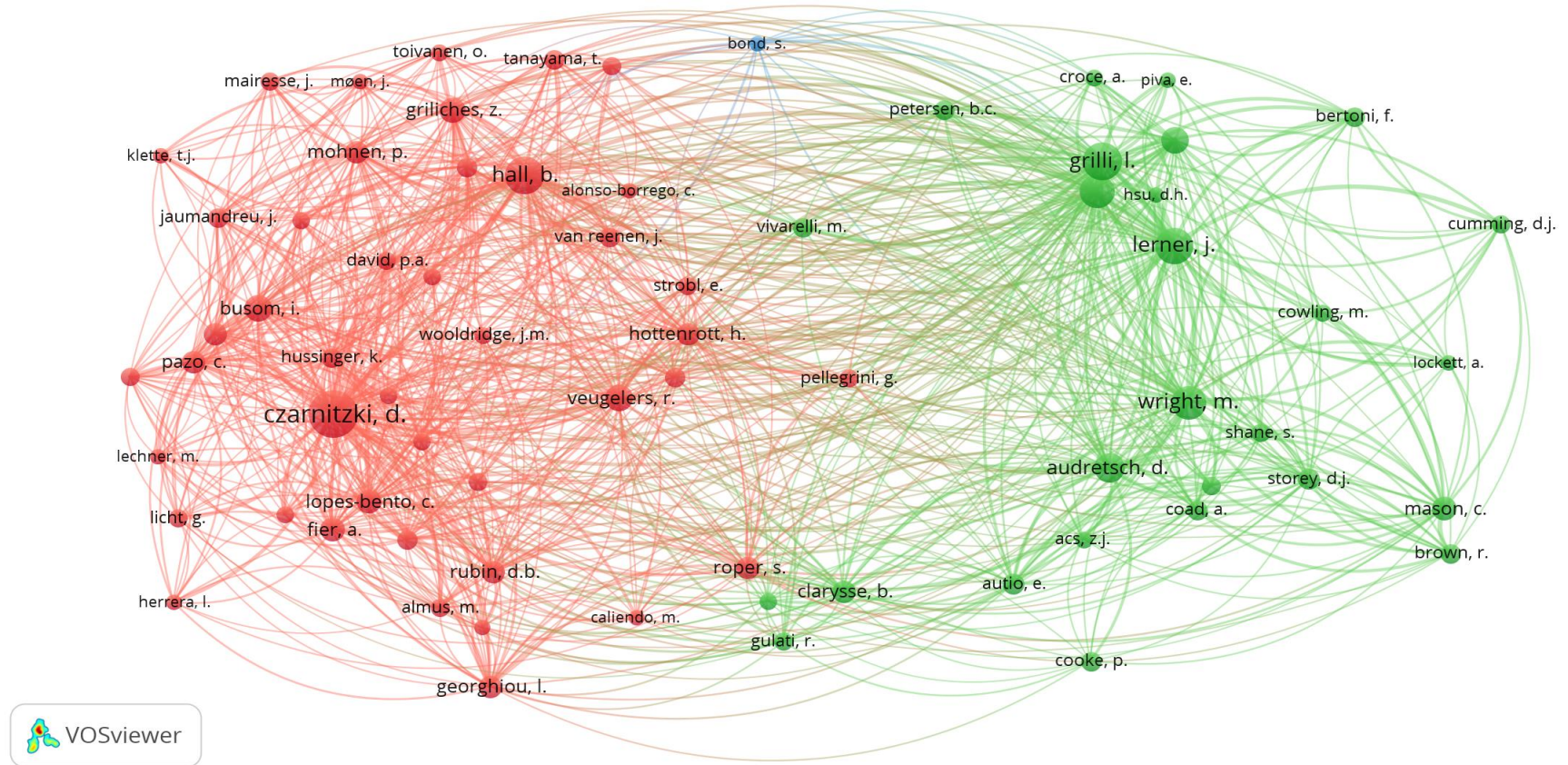

Notes: Network representation of the co-citation matrix from Vosviewer software (Van Eck and Waltman, 2010). The citation threshold, set at 20 citations, considers 72 of the 5374 authors highlighted (Tiberius et al., 2020).

3.3.2.2 Bibliographic coupling

Bibliographic coupling is a retrospective concept widely used in scientometric literature to investigate topic similarity at an authors, documents, institutions, journal or countries level helping researchers identify previous works on a topic (Kessler, 1963). While document bibliographic coupling analysis (DBCA) is traditionally used to identify the intellectual structure of a research field, authors' bibliographic coupling analysis (ABCA) aims at identifying authors' interrelationships and citing authors (Jarneving, 2005; Zhao & Strotmann, 2008). Consequently, bibliographic coupling with authors (documents) as an analytic unit enables us to consider the authors (documents) that “best cover” the field. In addition, the overlay representation enables the identification of new research fronts of public support for the SBE literature (Jarvening 2005).

· *Authors bibliographic coupling analysis (ABCA)*

The Scopus dataset leads us to consider 217 authors. To focus the visualization on the most bibliographically coupled authors, we select a threshold to keep approximately ten percent (19) of the authors (the threshold is set at 1 document and 57 citations minimum by author).¹¹⁴ Figures 3-7.a and 3-7.b show the network and overlay representation of ABCA, respectively. The network analysis considers A. Hottenrott, L. Grilli and M. Colombo at the centre of the network representation to be the authors that best cover the field of direct public support for SBEs. The network analysis also provides information about underlying co-authorship and intellectual structure. This led to the consideration of A. Hottenrott, E. Huergo, M. Colombo, and L. Grilli as core authors, as already suggested in the ACA. The overlay representation leads us to consider contemporaneously citing authors (E. Autio, H. Ranniko, L. Grilli, H. Hottenrott and E. Huergo) at the crossroads of more “traditional” citing authors (Meuleman and Demaeseniére, Colombo and Carboni) that would suggest a will for unification by contemporaneous developments.

¹¹⁴ The choice of the threshold to consider is arbitrary; thus, we follow the OECD and SCImago Research Group (2016) and select 10% threshold.

Figure 3-7 - Authors' bibliographic coupling using Scopus

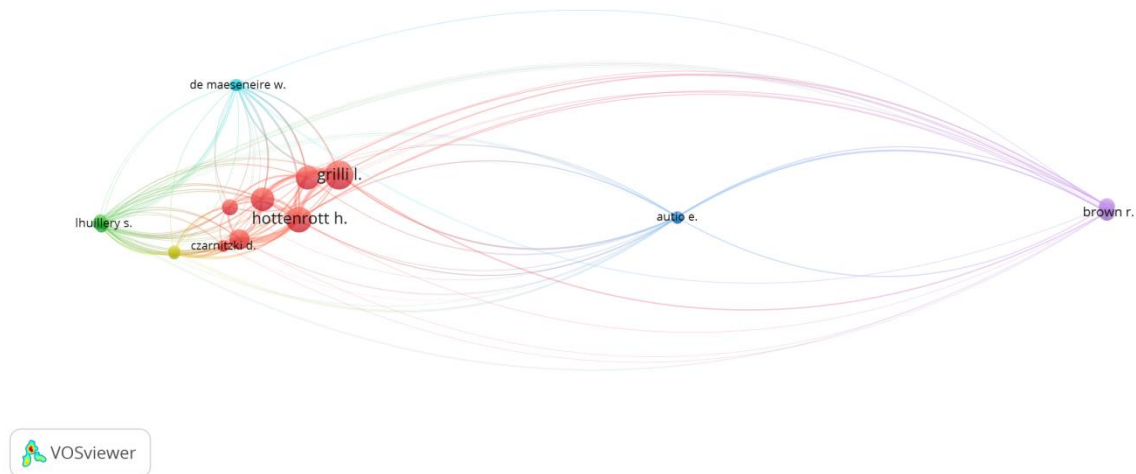

Figure 7a

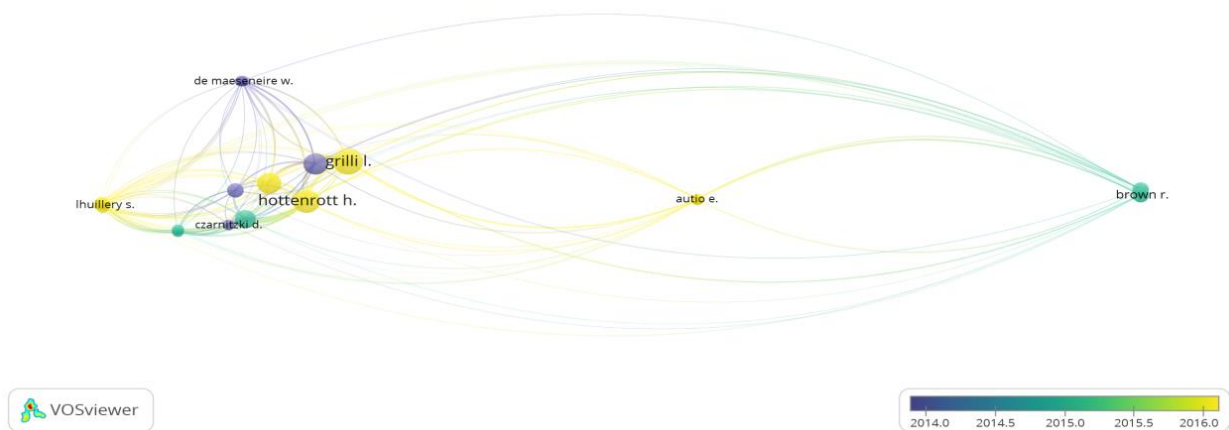

Figure 7b

Notes: Figures 7a and 7b depict network and overlay visualization of authors' bibliographic coupling using Vosviewer software (Van Eck and Waltman, 2010). The citation threshold is set to consider 10% of the total authors (1 document and 57 citations per document in the Scopus database (Tiberius et al., 2020)).

The combination of ACA and ABCA offers precious insights related to the intellectual structure of a research field that is not possible to achieve with one alone analysis (Zhao & Strotmann, 2008). In particular, comparing ACA and ABCA could offer precious insights into the self-reliance of the literature on public support for SBEs. Self-reliance is determined by the overlap between cited and citing authors or, in other words, the percentage of active authors (with high bibliographic couplings) among the most influential authors (with high co-citations) (Zhao & Strotmann, 2008). A low degree of self-reliance would indicate that the literature imports knowledge from another literature field. Both analyses lead us to consider

that A. Hottenrott, C. Lopes-Bento and E. Huergo and D. Czarnitsky, L. Grilli and M. Colombo are important contributors, therefore indicating a relative self-reliance of the literature related to public support for SBEs. Another observation that can be deduced from the comparison of both ABCA and ACA is the style of the research of a given author. While some authors have a restricted research field but have an impact on other fields, others have a broader research scope but are cited for only one particular topic. Most authors have an influence on the research field in which they publish, but few researchers have an influence on other fields in addition to the one in their speciality (Zhao & Strotmann, 2008).

The overlay visualization (Figure 7b) leads us to consider the temporal distribution of bibliographic coupling at the author level. We notice that authors at the centre of the figure (L. Grilli and H. Hottenrott), which define the core, are also contemporaneous authors, which suggests that the academic literature around public support for SBEs is a self-reliant and a recent field (Rossetto et al., 2018; Jugend et al., 2020).

• *Document bibliographic coupling analysis (DBCA)*

Figures 3-8a and 3-8b depict the network and the overlay representations of document bibliographic coupling, respectively. The analysis of intra-corpus network mapping shows that documents are grouped into five main clusters (red, green yellow, blue and purple).

The red cluster appears to include documents dealing with public support for SBEs from an impact evaluation perspective (Czarnitzki & Lopes-Bento, 2013; Hottenrott & Lopes-Bento, 2014; Hud & Hussinger, 2015; Huergo & Moreno, 2017). In contrast to the red cluster, the blue cluster includes articles related to public support for SBEs that seem to adopt a policy design perspective (Audretsch et al., 2020; Bergek & Norrman, 2015; Brown et al., 2017; Mason & Brown, 2013). Therefore, the red cluster that includes public support from a public policy management perspective could be labelled *Public R&D policy efficiency evaluation* and the blue cluster, which investigates the policy framework associated with public support for SBEs, could be called *Policy framework for SBE innovation support*.

The green cluster encompasses articles that share common features on the investigation of public support for SBE behaviour. Indeed, the blue cluster includes (Caloffi et al., 2015, 2018; Chapman et al., 2018; Chapman & Hewitt-Dundas, 2018; Grilli & Murtinu, 2018), which all investigate public support for collaborative innovation. The green cluster deals with the impact of public support on a firm's behaviour and collaboration and can be labelled *Behavioural additionality and collaboration incentives for public support*.

The yellow cluster covers articles investigating the effectiveness of instruments of public support. Indeed, the blue cluster's top burden includes (Alperovych et al., 2020; M. G. Colombo et al., 2013; Massimo G. Colombo et al., 2012, 2013; del-Palacio et al., 2012; Minola et al., 2017; Munari & Toschi, 2015). All these studies have the common feature of studying public venture capital support for innovative and entrepreneurial firms. The yellow cluster could be labelled: *Public support instruments and venture capital for SBEs*.

The purple cluster includes at its top boundaries (de Castris & Pellegrini, 2012; Di Gennaro & Pellegrini, 2019), which study regional innovation policies; thus, it could be labelled *Regional innovation policy for SBEs*.

We notice that the *Public R&D policy efficiency management* cluster is the most consistent cluster, as suggested by the closeness of nodes within it, in contrast to other clusters that appear to be more dispersed. Indeed, we also notice that the purple cluster includes documents investigating the impact of direct public support through loans or grants (Bertoni et al., 2019; Dvouletý, 2017; Dvouletý et al., 2020; (Grimsby, 2018) and appears to be interconnected to the yellow cluster. The consistent overlap suggested by Figure 6 using ACA is shown in Figure 7a using DBCA, supporting the consistent bibliometric framework used in the chapter. This also shows an interconnection between clusters; the literature on public support for SBEs, while dispersed, encompasses highly interconnected topics linked to the financing landscape of SBEs. Interestingly, the red and blue clusters are opposed in the network representation, suggesting a dichotomy between policy design and policy evaluation. This finding is supported since Figure 3-6 shows that the methodological considerations associated with the evaluation of public support schemes for SBEs are more linked to the *Methodological aspects of public R&D support evaluation* cluster (the red cluster in Figure 3-6) than to the *Entrepreneurship policies and venture capital* cluster (the green cluster in Figure 3-6).

Figure 3-8 - Documents' bibliographic coupling (DBC) using Scopus

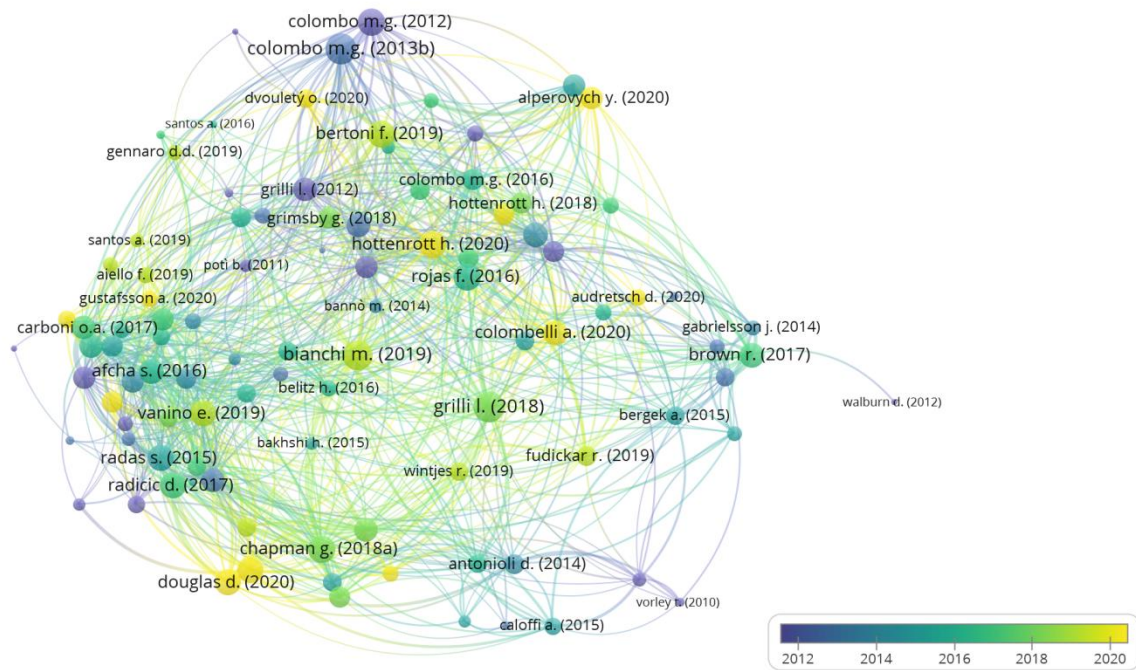
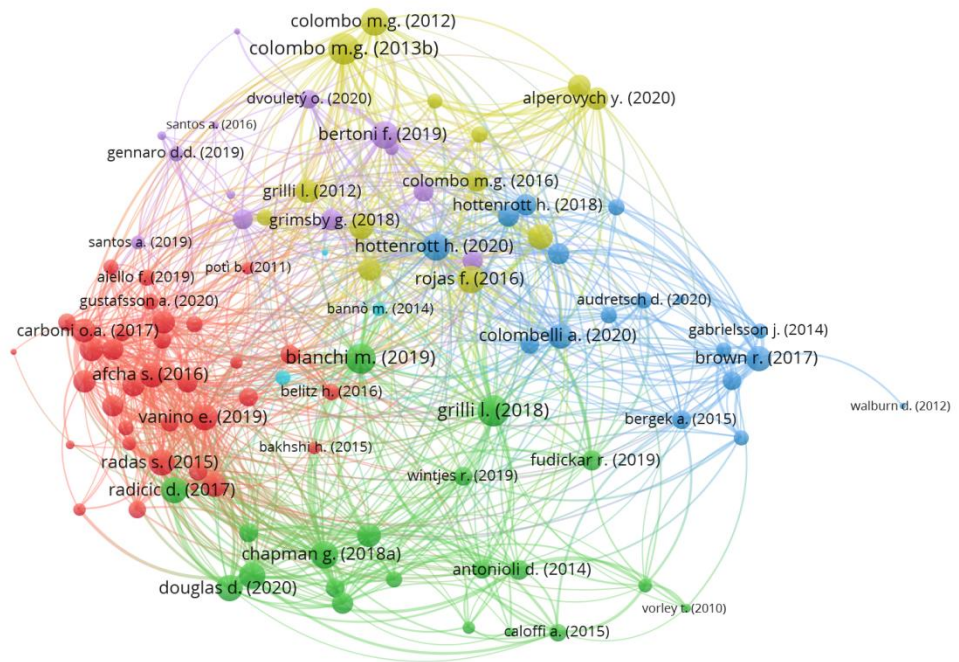

Figure 8a

Figure 8b

Notes: Figures 8a and 8b depict respectively network and overlay visualization of bibliographic couplings using Vosviewer software on the basis of the total list of 101 documents

The DBCA enables us to consider citing documents that “best” cover the field. In this regard, the analysis of the 101 documents allows the extraction of ten percent (10 documents) of the most bibliographically coupled documents from the Scopus database. Accordingly, we consider Colombo et al., (2013) (73 total link strengths (tls hereafter) and 41 citations), Grilli and Murtinu (2018) (with 70 tls and 11 citations), (Bianchi et al., 2019) (68 tls and 7 citations), (Hottenrott & Richstein, 2020) (57 tls and 7 citations), Colombo et al., (2012) (57 tls and 7 citations), Chapman et al., (2018a) (56 tls and 16 citations), Bertoni et al., (2019) (60 tls and 17 citations), Rojas and Huergo (2016) (53 tls and 7 citations), Radicic et al., (2020) (52 tls and 6 citations) and Douglas and Radicic (2020) (51 tls and 0 citations). We notice, with the exception of Colombo et al. (2012, 2013), that articles “best covering the field” are recent documents (published after 2018). This finding would indicate that the depicted literature on public support for SBEs is a research front, as already suggested by Figure 7b. Investigating financing innovation over the 2001-2016 period, Padilla-Ospina et al. (2018) also find that the articles that best represent the field have been published in the second part of the period and interpret the result as demonstrating a developing literature in accordance with Jugend et al., (2020) .

In addition, public support for SBEs does not seem to be addressed in a highly bibliographically coupled set of documents, which could suggest a dispersed literature. The overlay representation presented in Figure 8b enables us to observe intellectual shifts and the research front of the literature on public support for SBEs. We can see that contemporaneous developments are not represented by a separate cluster that could induce a shift towards a new paradigm. Instead, contemporaneous developments are at the crossroads of previous works. This would suggest that the literature on public support for SBEs is in a sophisticated phase rather than an exploration phase, and new articles based on these studies try to combine previous works with a more global framework.

3.3.3 Literature review results

The subset of documents depicted above is in accordance with previous findings pointing out the importance of authors such as L. Grilli and M. Colombo in the literature on public support for SBEs (section 3.1) but also suggests that the core literature is contemporaneous, as depicted by the publication years of the documents. Table 3-1, which summarizes the main information about articles “best covering the field”, allows several observations to be made.

While the first set of articles investigate the nature and effectiveness of public support (Colombo et al., 2013b, Colombo et al., 2012, Hottenrott and Richstein, 2020, and Bertoni et al., 2019), the second set of articles focuses on the determinants and effect of behavioural additionality induced by public support in terms of networking and collaboration breadth (Bianchi et al., 2019; Chapman et al., 2018; Douglas & Radicic, 2020; Grilli & Murtinu, 2018b; Radicic et al., 2020; Rojas & Huergo, 2016). Of the ten articles considered to best cover the field in terms of bibliographic couplings, six are from the *Research Policy* journal (multidisciplinary journal), and two come from the *Small Business Economics* journal (entrepreneurship journal), in line with the results from (Martin, 2012). Methodological developments to ensure causal treatment effect estimates (Rosembaum and Rubin 1974, Caliendo and Kopeinig, 2008) include most rigorous methologic standards in panel data (GMM estimators) and in impact evaluation literature (matching and instrumental variable framework), in line with results from (Dvouletý et al., 2020; Jugend et al., 2020).

Returning to the SAO framework, we notice that despite the *object* of reference related to public support appears to be centred on “new technology-based firms” (Grilli & murtinu, 2018, Colombo et al., 2012; Collombo et al., 2013b; Rojas and Huergo, 2016) the literature use a diversified lexical field to depict SBEs including: “SMEs”, “high tech start-ups”, “young entrepreneurial firms”, “fast growing firms”, “young entrepreneurial companies”, “young entrepreneurial ventures” or “high growth firms” (Bianchi et al., 2020; Bertoni et al., 2019; Douglas and Radicic, 2020; Hottenrott et al., 2020; Radidic et al., 2020). The *subject* is centred on the term “public support” (Douglas and Radicic, 2020; Radicic et al., 2020) but synonyms “government support” (Bertoni et al., 2019) are also used in addition to generic term “innovation policy” (Chapman et al., 2018; Hottenrott, & Richstein, 2020,). Finally, the *action* refers to behavioural additionality (Bianchi et al., 2019; Chapman et al., 2018a, Douglas and Radicic, 2020; Grilli and Murtinu, 2018; Radicic et al., 2020), input/output additionality (Bertoni et al., 2019; Colombo et al., 2012; Colombo et al., 2013b; Hottenrott et al., 2020) or public funding determinant (Rojas and Huergo, 2016).

3.3.4 Co-(Key)word analysis (CWA)

To complement investigations on contemporaneous developments presented in section presenting the document bibliographic coupling analysis, above, we investigate keyword co-occurrence. The use of keyword co-occurrence, as a content-related indicator, is another way to highlight new and core topics, and the intellectual structure of a research field and is intemporal, limiting bias leading to overweighting the oldest contributions (Liu et al., 2015).

It explores changes in research themes in a field by measuring the frequency of pairs of keywords. However, the use of keywords is not balanced, justifying the use of harmonized terms, presented in Table A.2 in the Appendix. Figures 9a and 9b show the network and overlay representation of keyword co-occurrence, respectively, where a 3 co-occurrence threshold was selected in accordance with Jugend et al. (2020). According to VOSviewer, each link has strength, represented by a positive numerical value manual. The higher this value is, the stronger the link (Van Eck and Waltman, 2010). Therefore, tfs indicates the number of publications in which two keywords occur together. With 25 occurrences and tfs of 25, the word “*innovation*” is ranked first, followed by “*SMEs*” with 16 occurrences and 16 tfs and “*research and development*” with 14 occurrences and 14 tfs. The words “*investment*” (11 occurrences and 11 tfs) and “*economics*” (9 occurrences 9 tfs) close out the top five CWA terms. We notice prims for content related to innovation, R&D and investment, suggesting that direct public support is oriented mainly towards innovation and R&D support, as suggested in the section 3.3.1 and by the Document bibliographic coupling analysis. In addition, the closeness of innovation policies and subsidies (and of public support in the green cluster) highlighted by the keyword mapping supports the hypothesis that public support for innovation in SBEs mainly takes the form of financial support.

Regarding the structure of the network representation, we find three clusters. While the yellow cluster is centered on “*innovation*” and “*SMEs*”, the green cluster is centered on “*economics*” and “*investments*” and includes “*innovation policy*”, “*public policy*” and “*public support*”. The red cluster is centered around “*R&D*”. We notice that the term “*public support*” referring to the *object* in the SAO framework is not central to the network representation and is only marginally linked to the green and blue clusters. This suggests a different semantic field associated with public support in “R&D” studies that also uses “*public spending*”, as suggested by the green cluster. Thus, the red, yellow and green clusters are labelled *innovation*, *R&D*, and *public policy*, respectively.

The keywords “*programme evaluation*” and “*performance assessment*” were more closely related to the red cluster than to the green cluster, indicating a dichotomy between the public support policy design literature and the public support evaluation literature as observed in Figures 6 and 8a.. Moreover, we notice a wide semantical difference of the use of the keyword “*SME*” on the one hand and of the keywords “*Innovative firms*” and “*new technology-based firms*” on the other, as suggested by their high distance on the network representation.

While Italy and Germany are associated with the red cluster, we notice that Spain is isolated as a blue cluster. This may highlight different semantic patterns linked to these countries that reveal idiosyncratic policies affiliated with national cultural and economic perspectives. Figure 7a has already suggested the prism for the regional innovation policy in Italy, which is confirmed by the closeness of this keyword in the mapping (“*regional policy*”). In Spain, the evaluation of European innovation programs appears to receive important considerations. Indeed, classified as a “moderate innovator” by the European innovation scoreboard in 2019¹¹⁵, Spain has historically received an important portion of EU funds (Muñoz et al., 2000). Innovation policy in Spain still relies heavily on European funds (4th beneficiary in terms of the volume of funds) that mainly explains Spain’s place in the network, close to “*program evaluation*” and “*Europe*”. Innovation policy and associated public support for SBEs in Germany rely heavily on comparative advantages in strategic industrial sectors (automotive and steel industry) and is therefore linked to “*competitiveness*”, “*industrial development*” and “*policy making*”. Both the high occurrence and cooccurrence of these countries in the intracorporus literature confirm their intellectual importance, as suggested in Table 4 (section 3.1), given their absolute contribution to the topic. Last, the network overlay representation enables us to highlight a univocal shift in the literature that initially focused on red cluster keywords and then moved to the yellow cluster to finish with the most recent keyword use in the green cluster. Indeed, Figure 9b shows the emergence of new topics, as suggested by the right boundary of the network, which shows that the keywords “*public support*”, “*innovation policy*”, and “*entrepreneurship policy*” as well as “*venture capital*”, “*innovative firms*” and “*new technology-based firms*” are new and core keywords defining the research. Interestingly, these new topics are only marginally linked to the “*innovation*” cluster. These results corroborate the findings in section 3.2 since we have shown the importance of venture capital and associated public support for SBEs in the literature (Colombo et al, 2013a,b). Table 3 summarizes the main results and interpretations according to the section to which it belongs.

¹¹⁵ <https://webgate.ec.europa.eu/dashboard/extensions/CountryProfile/CountryProfile.html?Country=Spain>

Table 3-1 - Articles best covering the fields based on bibliographic couplings (Scopus)

Authors	Title, Journal	Keywords	Sample, Period and Method	Outcome variables	Findings
Colombo, M.G., Croce, A., & Guerini, M. (2013b)	The effect of public subsidies on firms' investment-cash flow sensitivity: Transient or persistent? <i>Research Policy</i>	Public subsidies; High-tech firms; Investments; Financial constraints; Error correction model	RITA database covering 228 firms operating in manufacturing and service in Italy over 1994 to 2008 using ECM and GMM	Investment, Investment-cash flow sensitivity	Size explains constraints. Subsidies increase investment and decrease investment-cash flow sensitivity permanently, while the investment rate impact is transitory
Grilli, L., Murtinu, S.(2018)	Selective subsidies, entrepreneurial founders' human capital, and access to R&D alliances <i>Research Policy</i>	New technology-based firms; Selective public subsidies; R&D alliances; Founders; Human capital	902 manufacturing and service NTBF firms in Italy over the 1999 to 2008 period using recursive bivariate probit and IV-2SLS	Having a subsidy and obtaining an R&D alliance (binary indicators)	Selective subsidies help to establish R&D alliances Human capital has a strong moderating role
Bianchi, M., Murtinu, S., Scalera, V.G. (2019)	R&D Subsidies as Dual Signals in Technological Collaborations <i>Research Policy</i>	R&D subsidies; Signals Technological; Collaborations; Alliances; Saliency	2426 Spanish manufacturing SMEs over the 2001-2007 period using the bivariate probit model	Collaboration (dummy variables)	Do not focus on exclusively on SMEs; distinguish between pointing and activating signals to find a positive impact of public subsidies on collaboration
Hottenrott., H, and Richstein., R (2020)	Start-up subsidies: Does the policy instrument matter? <i>Research Policy</i>	Financing constraints Subsidies; R&D; High-tech start-ups; Innovation policy	IAB/ZEW database covering 1,057 manufacturing and service treated firms over the 2005-2013 period	R&D expenditures, Tangible investment ,employment and revenue growth	Positive impact on tangible investments, employment and revenues Grants, but not loans incentivize R&D: grants for R&D and loans for development External finance availability and survival unchanged
Colombo., M, Croce., A, Guerini., M, (2012)	Is the Italian Government effective in relaxing the financial constraints of high technology firms? <i>Prometheus</i>	N.A	RITA database covering 293 manufacturing and service firms over the 1994-2003 period using dynamic GMM	Tangible and intangible assets investments and investment-cash flow sensitivity	Positive impact of public finance on investment-cash flow sensitivity and investment on most credit-constrained firms
Chapman., G, Lucena., A, and Afcha., S (2018a)	R&D subsidies & external collaborative breadth: Differential gains and the role of collaboration experience <i>Research Policy</i>	External collaboration breadth; R&D subsidies; Differential effects; Collaboration experience; Innovation policy;	PITEC database covering 6371 Spanish manufacturing and service firms over the 2002-2013 period using PSM and IV-2SLS	Collaboration breadth and collaboration experience (binary indicators)	Positive impact of R&D subsidies on collaboration (one partner type on average); collaboration experience is a moderating variable increasing the benefits of

		Treatment effects			collaboration
Bertoni., F, Marti., J and Reverte., C (2019)	The impact of government-supported participative loans on the growth of entrepreneurial ventures <i>Research Policy</i>	Participative loans; Long-term financing; Government support; Entrepreneurial ventures; Employment growth	EBT program and PYME program covering 512 manufacturing and service firms in Spain over the 2005-2011 period using PSM + IV-2SLS	Employment, Sales	Positive impact of public loans on employment and sales. The effect is higher for younger and smaller firms and those benefitting from the funding during crisis periods Negative impact of experience in management Positive impact of postgraduate studies Motivation is an important moderating variable Positive role of technology transfer operators (TTOs)
Rojas., F and Huergo., E (2016)	Characteristics of entrepreneurs and public support for NTBFs <i>Small Business Economics</i>	New technology-based firms; Impact assessment; Innovation policy	NEOTEC program covering 271 firms in Spain over the 2001-2009 period using bivariate probit model	Probability of getting publicly funded	Support programmes do not promote cooperation with competitors, customers, suppliers and knowledge providers
Radicic., D, Pugh., G., and Douglas., D (2020)	Promoting cooperation in innovation ecosystems: evidence from European traditional manufacturing SMEs <i>Small Business Economics</i>	SMEs; Traditional manufacturing industry; Innovation ecosystems; Innovation policy; Cooperation for innovation; Behavioural additionality	2005-2009 PSM, Kernel and IPTW European and national innovation programmes covering 312 traditional manufacturing firms.	Propensity of SMEs to cooperate for innovation	Heterogeneous effects according to firm size; for SMEs, the policy mix has a positive impact on cooperation Regional outperformance of the national program; the policy mix is effective when initiated by national funding
Douglas., D, and Radicic., D (2020)	Network additionality and policy mix of regional and national public support for innovation <i>Economics of Innovation and New Technology</i>	Policy mix; Network additionality; Multilevel Governance; Behavioural additionality; Multilevel treatment model	Spanish national and regional fundings covering 5653 manufacturing firms (SMEs and large firms) (CIS data) over the 2010-2012 period using IPWRA	Propensity for cooperation	

Note : N.A refers to Non Available

3.4 Sensitivity analysis

In this section, we complement (Archambault et al., 2009; Zhu & Liu, 2020) on the use of Scopus and Wof-CC for information science studies in social sciences. More precisely, we perform the same empirical procedure depicted above in section 2 but use the Web of Science database instead of the Scopus database, which enables us to study the capacity of each database to cover the field and explore their relative differences in terms of coverage and intellectual structure. Therefore, we provide the internal validity of the framework and explore the overlap between both databases. Figure 10 presents the ACA network obtained from the Web of Science Core Collection database. The results from this section are analysed according to the results obtained in section 3.2. We notably analyse the results according to the network representation and the influence of *oeuvres*.

3.4.1 Authors' co-citations

Figures 3-10 presents the network of authors' co-citation analysis using the Web of Science Core Collection (WOS-CC). It consists in a curated collection of over 21,000 peer-reviewed, high-quality scholarly journals published worldwide (including Open Access journals) in over 250 science, social sciences, and humanities disciplines.

• Network representation

The red cluster is centered around D. Czarnitzki and, to a lesser extent, B. Hall. It includes Z. Griliches and I. Busom, whose work is focus on R&D subsidies. The cluster can partially share the label of the cluster identified in Figure 3-6: *R&D public support evaluation*. The blue cluster is centred on J. Lerner, M. Colombo and L. Grilli and includes authors such as F. Bertoni, D. Cumming and R. Capenter; the cluster also reflects the previous analysis depicted in Figure 6. The blue cluster therefore could have the label *Venture capital and public support instruments*. The last cluster, which encompasses D. Audretsch and D. Storey as the main cited authors, also partially reflects the analysis in Figure 3-6 according to the importance of policy design. However, the methodological niche cluster encompassing the *oeuvre* of J. Heckman, P. Rosembaum and M. Caliendo is not associated with the cluster, as presented in Figure 3-6. Instead, it appears to be more linked to the green cluster that could thus be labelled *Evaluation of SBEs policies: design and methods*.

Figure 3-10 - Authors' co-citation analysis using WOS-CC

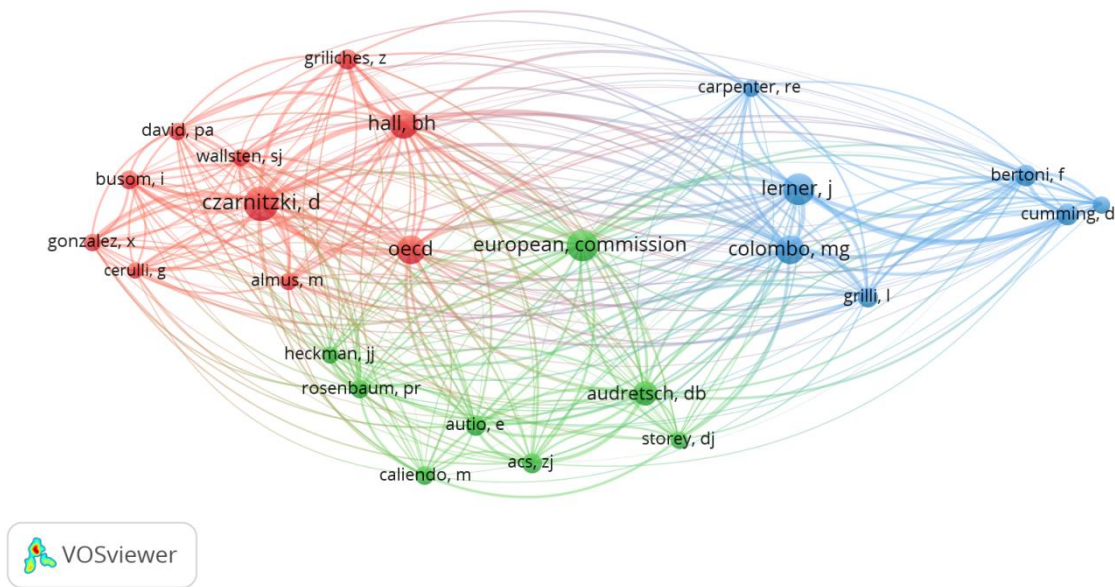

Notes: Network representation of the co-citation matrix from Vosviewer software using the Web of Science Core Collection database (Van Eck and Waltman, 2010). The citation threshold set at 20 citations considers 25 of the 3181 identified authors as an extracorpus (Tiberius et al., 2020).

Despite highlighting different associations of niche clusters, network representation leads to similar qualitative patterns, pointing out the importance of R&D subsidies and venture capital. Therefore, the hypothesis related to the importance of financial support from public authorities finds support (Paidlla-Ospina, 2018; Jugend et al., 2020)..

• Oeuvres

The institutional literature appears to have an important intellectual contribution, in contrast to what is observed Figure 6; the OECD and the European Commission play a central role that could either suggest a will to unify various conceptual frameworks from the academic literature or, conversely, a conceptual basis for subsequent developments.¹¹⁶ Although patterns are rigorously similar across databases, the represented network appears to include significantly fewer authors, as shown in Figure 6, suggesting narrower coverage from WoS-CC than from Scopus.

3.4.2 Authors' bibliographic couplings

Figure 3-11a and 3-11b respectively show network and overlay representations of ABCA using the Web of Science dataset, which leads us to consider 22 of the 224 authors in

¹¹⁶ Insofar as institutional papers are not included in the intracorpus literature, the reflection, which is outside the scope of the chapter, on the role of institutional literature in knowledge accumulation is left to future research.

the intracorporus literature (OECD and CSIC, 2016). In this section, we will focus on the citing versus cited authors and on the temporal developments.

- *Citing versus cited authors*

Despite allowing us to consider fewer authors than Figure 3-7a, Figure 3-10a shows that the main structure of citing authors is similar when using either the Web of Science or Scopus databases. Indeed, while D. Czarnitski, H. Hottenrott and C. Lopes-Bento are found together in a red cluster, D. Cumming, M. Colombo S. Murtinu and L. Grilli constitute the second main cluster of ABCA, which follows the pattern highlighted in Figure 3-7. Therefore, the suggested self-reliant aspect of the literature on public support for SBEs finds support.

- *Temporal developments*

We notice that contemporaneous citing authors notably include L. Grilli and E. Autio, in line with the results in Figure 3-7.

The comparison of ABCA and the overlap between ACA and ABCA from both databases led us to consider a similar picture regardless of the bibliometric source, suggesting a self-reliant literature where contempor aims at unifying previous frameworks.

Figure 3-11 - ABCA using WOS-CC

Figure 3-11a

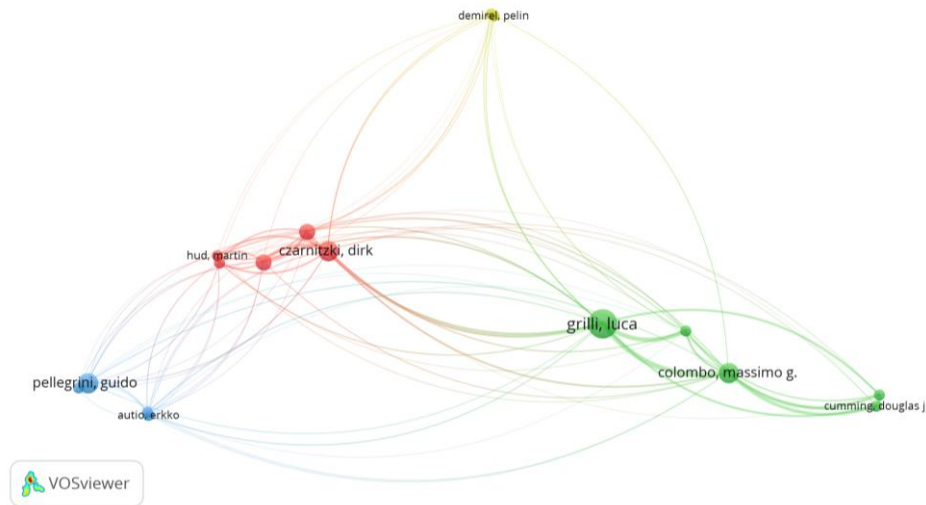
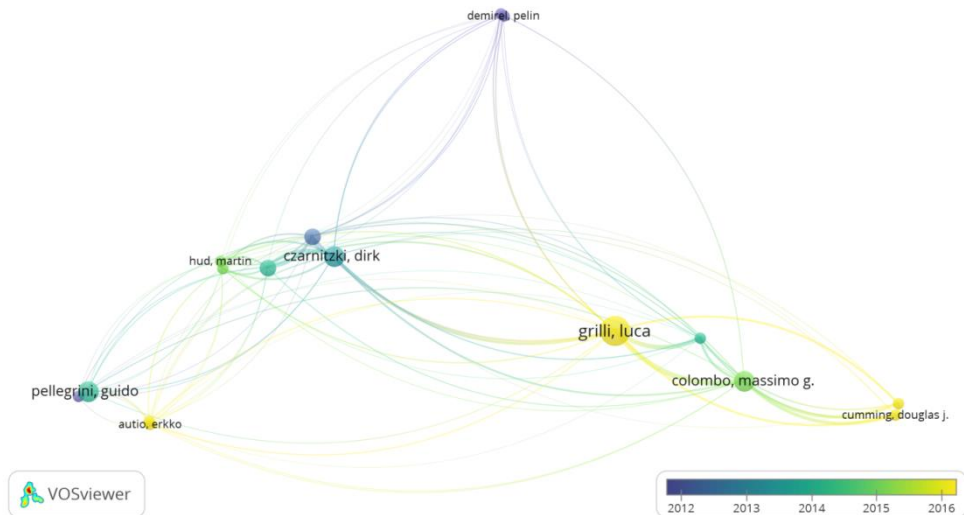

Figure 3-11b



Notes: Figures 3-11a and 3-11b show the network and overlay representations of ABCA using the WOS-CC database, respectively. The citation threshold is set to consider approximately 10% of all authors (1 document and 57 citations per document in the Web of Science database (Tiberius et al., (2020))).

3.4.3 Document bibliographic couplings

Figure 12a presents the DBCA mapping using the WoS-CC database and leads to the consideration of five main clusters while highlighting that Czarnitzki & Delanote (2015) is at the core of the network mapping.

The green cluster includes (Hottenrott & Lopes-Bento, 2014; Hud & Hussinger, 2015; Czarnitzki & Lopes-Bento, 2013) and follows the red cluster identified by the Scopus

database in Figure 8a and could therefore be identified with the same label: *Public R&D policy efficiency evaluation*.

The blue cluster follows the pattern of the yellow cluster identified in Figure 3-8a by including articles on public venture capital or public support for private venture capital at the bottom right (Alperovytych et al. 2020). We also notice, in line with Figure 3-8a, that articles dealing with soft loans (Martí & Quas, 2018 ; Bertoni et al., 2019) are included in the blue cluster. The cluster follows a pattern highlighted by the yellow cluster in Figure 8a and could therefore be labelled *Public support instruments and venture capital for SBEs*.

The red cluster from Figure 11a encompasses several topics. It includes articles related to public support for SBEs included in the blue cluster presented in Figure 8a (Bergek & Norrman, 2015). It also includes articles related to public support for internationalization (Bannò et al., 2014; Vide et al., 2010) and includes studies investigating entrepreneurship policy design and effectiveness (Audretsch, 2020). Therefore, the label *Policy framework for SBE innovation support* applies.

The yellow cluster presented in Figure 11a partially follows the green cluster identified in Figure 8 by including documents investigating behavioural additionality (Douglas & Radicic, 2020) and therefore can take the label *Behavioural additionality and collaboration incentives of public support*.

Finally, the purple cluster highlighted in Figure 11a encompasses (Bernini & Pellegrini, 2011; de Castris & Pellegrini, 2012; Di Gennaro & Pellegrini, 2019) and resembles the purple cluster identified in Figure 8a. The label can thus be *Regional innovation policy*.

The overlay representation enables us to consider qualitative patterns similar to those in Figure 8b, where new research is focused on unification of the previous framework, while older documents appear to define the boundaries of the topic, in line with the findings of (Rossetto et al., 2018).

Among the articles that “best cover” the field, the top ten are briefly summarized in Table 2 and are in line with the results obtained in Table 3-1. Indeed, the results show similar patterns, highlighted by the presence of F. Bertoni, D. Radicic and L. Grilli in both databases.

Despite depicted similarities, the relative cluster positioning in the network representation leads us to consider different associations, notably regarding the *Regional innovation policy* cluster that appears only marginally (through the *Public R&D policy efficiency evaluation cluster*) connected to the network in Figure 3-11a while being connected to both *Public support instruments and venture capital for SBEs* (yellow cluster in Figure 3-8a) and *Public R&D policy efficiency evaluation* (red cluster in Figure 8a) clusters.

3.4.4 Literature review: Sensitivity analysis

Table 3-2 reconsiders the core literature based on bibliographic couplings using WoS-CC. The results show that Orlic et al. (2019) ranks first, with 75 tls and 2 citations, followed by Grilli and Murtinu (2014) (67 tls and 105 citations), Guerini and Quas (2016) (67 tls and 34 citations), Bertoni et al. (2019) (66 tls and 14 citations) Vanino et al. (2019) (63 tls and 6 citations) Bellucci et al. (2019) (55 tls and 17 citations) Karhunen and Huovari (2015) (54 tls and 24 citations), (Grilli, 2014) (15 tls and 54 citations) Rojas and Huergo (2016) (50 tls and 7 citations) and Czarnitzki and Delanote (2015) (49 tls and 33 citations). We notice that both databases include Rojas and Huergo (2016) and Bertoni et al. (2019). While *Research Policy* appears to include most of the core literature from Scopus (Table 3-1), the leading role in the WoS database is shared between *Research Policy* and *Small Business Economics* (three and four articles, respectively, from WOS-CC).

The *subject* is oriented toward the generic denomination: “innovation policy” (Bellucci et al., 2019; Grilli, 2014; Orlic et al., 2019), “Public policy” (Grilli & Mutinu, 2014), “Industrial policy” (Karhunen & Huovari, 2015), “Regional policy” (Bellucci et al., 2019), or (Policy evaluation” (Czarnitzki & Delanote, 2015). The term “Public support” (Vanino et al., 2019) appears to be linked to recent publication, supporting previous results on the contemporaneous use of the term from our framework (Figure 9b) and from other studies (Jugend et al., 2020). The *action*, of public authorities is investigated through the effectiveness in terms of input/output additionality of public support instruments through R&D subsidies (Bellucci et al., 2019; Czarnitzki and Delanote, 2015; Karhunen & Huovari, 2015; Orlic et al., 2019, and Vanino et al., 2019), subsidized loans (Bertoni et al., 2019) or venture capital (Grilli & Murtinu, 2014; Guerini & Quas, 2016). The focus on behavioural additionality clearly appears in the Scopus database analysis but seems to be less considered in the WOS-CC database (Orlic et al., 2019). Finally, the *object* analysis confirms results presented in Table 3-1 according to the importance devoted to “NTBFs”¹¹⁷ are a major target of policy debates regarding SBE financing (Czarnitzki and Delanote, 2015; Grilli, 2014; Rojas and Huergo, 2016; Vanino et al. 2019), in line with the results in Table 3-1.

Figure 3-12 - Document bibliographic couplings using WoS-CC

¹¹⁷ Grilli and Murtin (2014) and Guerini and Quas (2016) use the term “high-tech entrepreneurial firms”.

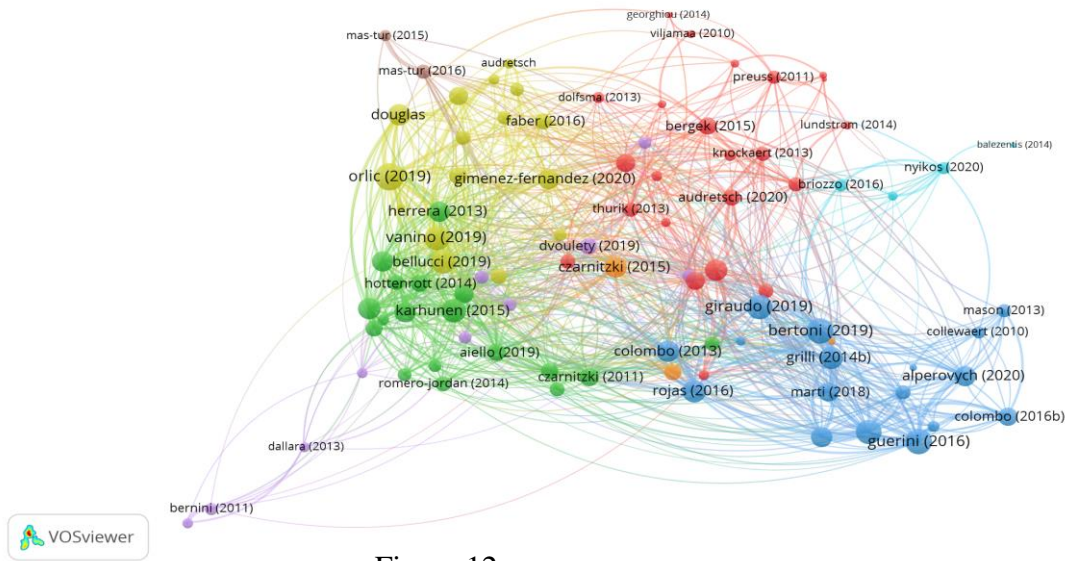

Figure 12a

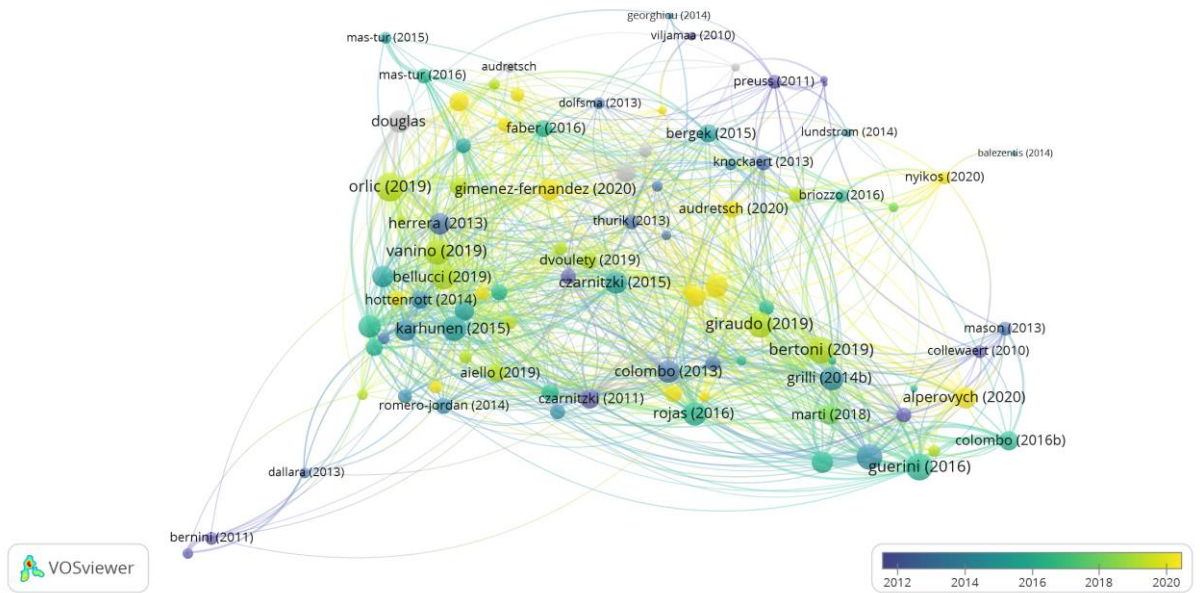

Figure 12b

Notes: Figures 12a and 12b depict bibliographic couplings using Vosviewer software on the basis of the total list of 94 documents from the WoS-CC database.

3.4.5 Keyword co-occurrence using the Web of Science Core Collection

Figure 3-13 (a and b) shows “keyword plus” cooccurrence from the WoS-CC database using 3 occurrences as the threshold (Jugend et al., 2020). The threshold enabling us to include 63 of the 295 keywords leads us to consider five main clusters. With 35 occurrences and a tls of 34, “*research-and-development*” (red cluster) is ranked first. “*Growth*,” with 31 occurrences and 31 tls (green cluster), “*innovation*” (purple cluster with 31 occurrences and 31 total link strength) and “*performance*” (purple cluster with 24 occurrences and 24 total link strength) rank next. In accordance with Figure 9b, we notice that R&D and innovation are core topics of the literature. We also observe a cluster of contemporaneous keywords at the bottom of the overlay representation, highlighting the focus of public support on entrepreneurial firms. Finally, the dispersed and heterogeneous use of terms to define SBEs suggested in Figure 8b also finds support from Figure 12a. Indeed, we observe a high dispersion of the terms used to define SBEs. While “small firms”, “SME” and “Entrepreneurship” are affiliated to the green cluster, “start-ups” is linked to the purple cluster and “Firms” to the blue cluster. This would suggest that these terms are not synonymous and refers to an idiosyncratic conceptual framework. In addition, while in the Scopus database, this contemporaneous perspective encompasses firms’ innovativeness (“*technology based firms*” and “*innovative firms*”), it considers the additionality of public support in the Web of Science database (“*firm performance*”, “*profitability*”, and “*survival*”).

Table 3-2 - Articles best covering the fields based on bibliographic couplings (Web of Science Core Collection)

Authors	Title, Journal	Keywords	Sample, Period and Method	Outcome variables	Findings
Orlic., E, Radicic., D and Balavac., M (2019)	R&D and innovation policy in the Western Balkans: Are there additional effects? <i>Science and Public Policy</i>	R&D support; SMEs; Input; Output and behavioural additionality	646 manufacturing and service SMEs in Balkan countries from 2011 to 2013 using PSM-NN and IPTW	R&D, innovative sales and behavioural additionality	No input and output additionality but behavioural additionality
Grilli., L and Murtinu., S (2014)	Government, venture capital and the growth of European high-tech entrepreneurial firms <i>Research Policy</i>	Governmental venture capital; Firm growth; High-tech entrepreneurship; Public policy; Syndication	538 IVC and 239 GVC-backed European manufacturing and service firms financed from 1984 to 2004 using PSM and Panel estimators (FE and GMM)	Employment and sales growth	GVC alone has no significant impact Syndicated investments, when led by IVC exhibit positive impact on sales growth
Guerini., M, and Quas., A (2016)	Government venture capital in Europe: Screening and certification <i>Journal of Business Venturing</i>	Venture capital; Governmental venture capital; High-tech entrepreneurial ventures; Screening; Certification	183 GVC-backed companies financed from 1994 to 2010 using PSM using mahalanobis distance and endogenous switching regression	Government venture capital support (certification effect, with IVC funding)	Positive influence of GVC investment on IVC finding probability
Bertoni., F, Marti., J and Reverte., C (2019)	The impact of government-supported participative loans on the growth of entrepreneurial ventures <i>Research Policy</i>	Participative loans; Long-term financing; Government support; Entrepreneurial ventures; Employment growth	EBT program and PYME program covering 512 manufacturing and service firms from 2005 to 2011 using PSM and IV-2SLS	Employment and sales	Positive impact of public loans on employees and sales; the effect is higher for younger and smaller firms and those benefitting of the funding during a crisis period

Vanino., E, Roper., S and Becker., B, (2019)	Knowledge to money: Assessing the business performance effects of publicly-funded R&D grants <i>Research Policy</i>	Public support; R&D; Innovation; Research council; UK	5562 manufacturing and service firms financed from 2006 to 2016 using PSM and Kernel matching	Employment and turnover growth	Positive but heterogeneous impact on backed firms' growth, depending on the sector The design of the "picking-winner" strategy is discussed
Belluci., A, Pennacchio., L, and Zazzaro., A	Public R&D subsidies: collaborative versus individual place-based programs for SMEs (2019) <i>Small Business economics</i>	Public subsidies; R&D; Impact evaluation; SMEs; Cooperation; Regional policy	Regional innovation program covering 238 Italian manufacturing and service SMEs in 2003-2012 using PSM-DiD	Input (R&D expenditures, employment and tangible investments) and output additionality (profitability and patent applications)	Positive impact individual subsidy on input and output additionality Collaborative program's input and output additionality is more limited
Karhunen., H, and Huovari., J (2015)	R&D subsidies and productivity in SMEs <i>Small Business Economics</i>	Productivity; Subsidies; R&D; SMEs; Industrial policy; Conditional difference-in-differences	1221 Finnish manufacturing and service SMEs financed from 2000 to 2007 using PMS-DiD	Labour productivity, employment, survival and human capital	Positive impact of R&D subsidies on survival but negatively impact labour productivity
Grilli., L, (2014)	High-Tech Entrepreneurship in Europe: A Heuristic Firm Growth Model and Three "(Un-)easy Pieces" for Policy-Making <i>Industry and Innovation</i>	Entrepreneurship; high-tech; Europe; Entrepreneurial ventures; Policy; Firm growth	The article depict the current situation in Europe, where the lack of innovative firms is viewed as the main constraints weighting of the achievement of the European goals stated by the Lisbon treaty regarding knowledge economy development		
Rojas., F and Huergo., E (2016)	Characteristics of entrepreneurs and public support for NTBFs <i>Small Business Economics</i>	New technology-based firms; Impact assessment; Innovation policy	NEOTEC program that covers 271 Spanish firms using the bivariate probit model	Probability of getting publicly funded	Negative impact of experience in management Positive impact of postgraduate studies Motivations is an important moderating variable Positive role of technology

transfer operators (TTOs)

Czarnitzki., D and Delanote., J (2015) R&D policies for young SMEs: input and output effects *Small Business Economics* R&D subsidies; NTBFs policy; Evaluation; Treatment effects; Patents 599 German manufacturing and service NTBFs from 1994 to 2006 using PSM-NN Input and employment (R&D expenditures, capacity and number) and Ouput additionality (patents) Highest impact on NTBFs compared to other groups with a notable increase in R&D employment intensity leading to higher R&D outputs

3.5 Discussion and limitations

3.5.1 Information science sources: Scopus and Web of Science

Information science studies, driven by data availability developments, have gained popularity to synthesize research knowledge accumulated around a research topic but tend to be underused in social science compared to medical sciences (Archambault et al., 2009; Ratinho et al., 2020; Zhu & Liu, 2020). In our context of evidence-based policy making, information science frameworks are used mainly to provide the external validity of the impact assessment of public support through systematic literature reviews or meta-analyses (BWW Center, 2017; Dimos & Pugh, 2016; Dvouletý et al., 2020).

Findings using both Scopus and WOS-CC are widely aligned (Archambault et al., 2009; Zhu & Liu, 2020). While Scopus leads to the consideration of 101 documents and 217 authors, WoS-CC enables the consideration of 94 documents with 224 authors. Qualitatively, both analyses lead to the consideration of similar intellectual structures and point out convergent patterns regarding the intellectual structure and the research front. Behavioural additionality is highlighted as the new core topic related to public support for SBEs (Orlic et al., 2019 Radicic et al., 2020) in the Scopus database. WOS-CC coverage is oriented towards the determinants and effectiveness of public support (Bertoni et al., 2019 and Rojas and Huergo, 2016). While resorting to various theoretical inspirations¹¹⁸: evolutionary economics (Mazzucato, 2016; Mazzucato & Semieniuk, 2017; Nelson, 1986), Schumpeterian economics (Baumol, 2002), and endogenous growth theory (Romer, 1994; Stiglitz & Weiss, 1981), the literature developments around public support for SBEs are driven mainly by empirical and methodological aspects (Martin, 2012; Vanino et al., 2019).

Moreover, the findings of the SAO framework used to depict the research topic are in accordance with previous bibliometric studies and systematic literature reviews on the financing of innovation highlighting, although through different aspects, a nascent self-reliant field with a high number of low-impact publications (Dvouletý et al., 2020; Jugend et al., 2020; Padilla-Ospina et al., 2018). In addition, we highlight the important role of collaboration in innovation policies for European countries (through studies on collaboration incentives and behavioural additionality) and the contemporaneous use of the terms “*public support*” and “*government support*”, in line with Jugend et al. (2020). Furthermore, we

¹¹⁸ See (Martin, 2012) for a review of theoretical developments on innovation policy frameworks.

highlight a wide variety of definitions in both outcomes and policy targeting (Dvouletý et al., 2020; Petrin, 2018) Finally, the importance of journals such as *Research Policy* and *Small Business Economics* is confirmed, as well as the contribution of authors such as D. Czarnitsky, H. Hottenrott, L. Grilli, M. Colombo and F. Bertoni, in accordance with Padilla-Ospina et al. (2018).

Mainly driven by the medical literature, the use of systematic literature reviews on a topic appears to be growing in social science to gather knowledge in order to formulate evidence-based policies (BWW Centres, 2017). Investigations around the composition and use of databases are necessary to provide relevant information science studies enabling insights on research and policy gaps (for policy makers) or on literature orientation (for academic researchers). In this regard, although both databases offer similar qualitative patterns regarding the intellectual structure and research fronts of the field, a few distinctions arise.

The first notable distinction lies in the co-citation mapping, which highlights the importance of institutional organizations (European Commission and the OECD) in the underlying literature linked to the WoS-CC database while being absent from the Scopus database. This denotes a different extracorpous basis and therefore a different literature structure. In this regard, we noticed a wider inclusion of studies from peripheral Europe in the WOS-CC database (Baležentis & Balkienė, 2014; Nyikos et al., 2020; Vide et al., 2010) compared to Scopus. This finding may reflect a “Matthew effect” on the use of the WOS-CC as a traditional bibliometric database. Researchers have traditionally used this database, which is subsequently cited and used by following researchers, leading to an increasing inflation of studies citing and using this database (Zhu and Liu, 2020). Indeed, the use of databases may depend on data source availability, data quality and coverage as well as users’ experience and habits. In addition, and linked to the historical monopoly of WOS-CC, emerging countries tend to use WOS-CC instead of Scopus (Falagas et al., 2008).

The second main distinction comes from bibliographic couplings (Figure 8a,b and Figure 11a,b, respectively, from the Scopus and WOS-CC databases) at the document level, leading to the consideration of different orientations and suggesting that the Scopus database includes more contemporaneous developments than WoS-CC (Bianchi et al., 2019; Douglas & Radicic, 2020; Hottenrott & Richstein, 2020; Radicic et al., 2020).

3.5.2 *Knowledge accumulation, external validity process and evidence-based policies*

Despite the focus depicted in the framework, we can observe that the depicted literature uses a heterogeneous set of terms for SBEs. The heterogeneous vocabulary related to the definition of the target of public support may be rooted in the legacy of macroeconomic research from the 1980s and 1990s, where interchangeably used terms designating public support are still very much present and do not allow for a stable and unambiguous semantical basis to define the associated concepts (Cunningham et al., 2016). Next, citation patterns that may follow a publication perspective (Larivière & Macaluso, 2011) induce an overuse and maybe a misuse of a particular terms to define the population studied, which could partially explain the inconclusiveness that characterizes the SLR of the role of public support for SBEs since the year 2000 (David et al., 2000; Dimos & Pugh, 2016; Dvouletý et al., 2020; Jugend et al., 2020). Indeed, the ambivalent findings stated by David et al. in 2000 were supported recently by Dimos and Pugh (2016) using a meta-regression design. The “application of sophisticated econometric techniques” launched by David et al. (2000) echoes the conclusion by Dimos and Pugh (2016) according to the over(under)estimation of the treatment effect due to the use of PSM (DiD) techniques. The methodological avenue launched in the 2000s appears to leave out the conceptual framework of public policy targets. This may cause misleading interpretations of the effectiveness of public support, as shown in previous literature reviews. In turn, the capacity of policy makers to build evidence-based policies is reduced, which may allow policy debates to be driven by ideologies or interests (Weiss, 1983).

3.5.2.1 *The case of new technology-based firms*

The advent of the concept of “new technology-based firms” in a special issue of *Research Policy* seems to support this point of view (Storey and Teher, 1998).¹¹⁹ The interest of this class of firms is not new (Bollinger et al., 1983), the authorship of the vocabulary is attributed to Little (1977) that fix the definition to include any less than 25 years old firm operating independently in a high-tech sector (Grilli et al., 2020; D. J. Storey, 2016).¹²⁰

¹¹⁹ Other terms often associated with SBEs, including “YICs”, “KIBS”, “start-ups”, “high-tech companies” and associations such as “high-tech start-ups” are not explored in this study. We rather investigate nominal groups depicting precise categories than common lexical terms such as “companies”, “ventures”, and “firms”, which are too generic to draw any conclusions about their semantic use. NTBFs are also called “technology-based new firms” (Autio, 2017; Autio & Sapienza, 2000; Yli-Renko et al., 2002).

¹²⁰ Early developments can be found in (Hart, 1968) and in the seminal work of Edward B. Roberts (Roberts, 1968, 1991)

While referring to the same concept, Table 1 and Table 2 show that the literature on NTBFs is widely heterogeneous, encompassing various and extremely different business situations. Indeed, NTBF is defined as a company less than 25 years old operating in a high-tech industry which allows a wide use of this terminology, covering entrepreneurs (Rojas and Huergo, 2016)¹²¹, start-ups (Colombo et al., 2013b, Grilli and Murtinu, 2018) and more established firms (Vavino et al., 2019, Czarnitsky and Delanote, 2015). This wide diversity of economic realities induced by the use of the same vocable raises doubts about their relevant use to ensure the external validity of the impact assessment of public support. In turn, the inconclusiveness of the results may contribute to the misconception of public policy design and may drive the inconclusiveness of subsequent evaluation studies, reinforcing a vicious loop of policy targeting definitions.

3.5.3 Limitations

In our conceptual framework, we combine quantitative bibliometric analysis and qualitative literature reviews, reducing the traditionally highlighted cognitive bias in bibliometric analysis. In addition to the use of both databases separately, we further limit the *knowledge source bias* (Tiberius et al., 2019, Mallinguh and Zoltan, 2020). However, traditional limitations concerning information science and science mapping studies remain (Cancino et al., 2017; Martin, 2012; Merigó et al., 2016; Rossetto et al., 2018).

First, the “Matthew effect”¹²² (Merton, 1968) could be a source of knowledge bias and cognitive bias that incentivizes the focus of the most visible, significant, or known nodes of the mapping, avoiding other aspects. This could lead to bias and/or narrow interpretations of the intellectual structure and fronts of the research. We argue that this bias is reduced by taking into account low-impact documents and authors that constitute most of the literature on public support for SBEs (Padilla-Ospina et al., 2018) in the empirical procedure, which enables us to observe not only high publications and authors but also small contributors and associated research topics.¹²³

¹²¹ Ratinho et al. (2020) performing a literature review on public support for “entrepreneurs” also include studies dealing with NTBFs.

¹²² The “Matthew effect” refers to a snowball effect for high-impact contributions/contributors and converse effect for low-impact contributions/contributors.

¹²³ Link to the “Matthew effect” that lead to overconsider most cited publications and fields, there might have a publication bias toward studies hihghlithing significant results, letting aside documents presenting lower statistical support . In this vein, yet out of the scope of this chapter, subsequent research perform meta-analyses on both published and unpublished document to investigate on the issue (Valentine et al., 2017)

Secondly, bibliometric software and databases consider only the first authors, which could lead to biased interpretations according to the *oeuvre* of an author, especially for authors who are often ranked second and whose contributions may thus be underestimated. The representation of the *oeuvres* of authors such as E. Autio or D. Czarnitsky is not questioned since these authors are frequently ranked first, in contrast to S. Murtinu or L. Grilli, who may be ranked second or third, according to the alphabetic rule in economics. In this regard, we can suggest that journals may require the relative contribution of authors (which is already done in natural sciences (biology, medicine, and physics) to be explicitly stated to give a different name ordering. This would help to sketch a more accurate pattern of the intellectual structure of the research topics studied.

Third, the use of an SLR framework induces a list of terms to define the subject under consideration. In this regard, authors use various sets of vocables to depict SBEs (“*new technology-based firms*” versus “*technology-based new firms*”, for example), which lead to a virtually endless set of vocables (Martin, 2012; Rossetto et al., 2018). The list of terms used in the present chapter, despite its variety, does not exhaustively cover the lexical field associated with SBEs (nor the one associated to “public support”), which may induce a bias in the depicted literature. In this regard, the intracorporus literature highlighted in this chapter complements previous studies (Dvouletý et al., 2020; Jugend et al., 2020) on the set of articles included and may provide guideline and support for subsequent research on the topic.

Finally, the possibility and relevance of interpretations can be questioned. Indeed, the algorithms behind the Vosviewer software are based on citation counts, which can differ from one base to the other. For example, Bertoni et al. (2019) (Colombo et al., (2013)) count 17 (respectively 41) citations in Scopus, 14 (resp. 24) in WoS-CC and 29 (resp. 84) in Google Scholar, which can weigh the relationships in the literature and thus limit the interpretability of intellectual structures and research fronts. In this regard, our investigations support previous studies on social sciences or on general or clinical medical sciences pointing out Scopus as the most updated database and WOs-CC as the most exhaustive database (Kulkarni, 2009; Li et al., 2010).¹²⁴ While being in accordance with previous studies on public support

¹²⁴ Additionally; although labelling clusters is a common and appealing way to interpret the results of a citation and bibliographic coupling analysis, it is rather complex, time consuming and cognitively demanding to perform and may be both conceptually and semantically misleading (Chen et al., 2010). Furthermore, citations mechanisms difficult to investigate; behavioural citations are complex to extract from scientific citations which may lead to biased intellectual structures and author relationships interpretations (Martin, 2012; Merigó et al., 2016; Rossetto et al., 2018)

for innovation (Jugend et al., 2020) and on innovation financing (Padilla-Ospina et al., 2018), the framework used does not aim at exhaustively represent the literature around public support. Instead, we aim at characterize the heterogeneity which may lead to inconclusiveness of results from previous systematic literature reviews and meta-analyses. In turn, the lack of clear guidance from the academic literature may partially explain the weak involvement of academic research in evaluation processes of public policies (BWW Centres, 2017; Bono et al., 2018; France Stratégie, 2019).

Table 3-3 - Main results according to the bibliometric tools using the Scopus database

Bibliometric tool	Result	Interpretation*
ACA (Figure 6)	<ol style="list-style-type: none"> 1. Consistent overlap (circle-shaped network) 2. Consistent representation of the <i>oeuvres</i> of core authors 3. 2 main clusters (<i>Methodological aspects of public R&D support evaluation</i> and <i>Entrepreneurship policies and venture capital</i>) 4. Central role of the <i>oeuvres</i> of G. Pellegrini and M. Vivarelli in the literature 5. Methodological considerations linked to (1) more than to (2) 	<ul style="list-style-type: none"> • Consistent conceptual framework to depict the academic literature on public support for SBEs (1) and (2) • Diversity of research topics around public support for SBEs (<i>Regional studies, Methodological papers, R&D tax and subsidies, Venture capital, Entrepreneurship policy design</i>) (1) to (5)
ABCA (Figure 7a,b)	<ol style="list-style-type: none"> 1. Self-reliance of the literature (similarity between citing and cited authors) 2. Developing literature 3. Will to unify frameworks from contemporaneous citing authors 	<ul style="list-style-type: none"> • Corroborate previous outcomes from Figure 6 depicting a wide diversity of work and previous studies (Padilla-Ospina, 2018) on the maturity level of the literature (1) to (3)
DBCA (Figure 8a,b)	<ol style="list-style-type: none"> 1. 5 main clusters (<i>Public R&D policy efficiency evaluation, Policy framework for SBE innovation support, Behavioural additionality and collaboration incentives for public support, Public support instruments and venture capital for SBEs</i> and <i>Regional innovation policy</i>) 2. Higher BCs in the red cluster compared to others 3. Consistent overlap (circle-shaped network) 4. Articles best covering the field are recent documents (published after 2018) 5. Contemporaneous studies are at the crossroads of previous documents 6. Red and blue clusters have opposite positions on the network representation 	<ul style="list-style-type: none"> • Corroborate the diversity of research topics around public support for SBEs with a high focus on R&D support schemes (1) and (2) • Consistent conceptual framework to depict the academic literature on public support for SBEs (3) • Contemporaneous will of unification (4) and (5) • Evaluation and design of public support appear opposed (6)
KWA (Figure 9a,b)	<ol style="list-style-type: none"> 1. The public support for SBEs literature is oriented towards innovation and R&D support and takes the form of financial support 2. Presence of countries in the CWA (Italy, Spain, and Germany) 3. Three different clusters (<i>Innovation, R&D, and public policy</i>) 4. “SME” “Innovative firms” and “New technology-based firms” are in different clusters 5. “Programme performance” and “Performance assessment” are more linked to the “R&D” cluster than to the “Public policy” cluster 	<ul style="list-style-type: none"> • Consistent conceptual framework to depict the academic literature on public support for SBEs in line with Padilla-Ospina (2018) and Jugend et al., (2020) (1) and (2) • Diversity of the literature and different semantical uses of vocables to define SBEs (3) and (4) • Evaluation and design of public support appear opposed (5)
Literature Review	<ol style="list-style-type: none"> 1. Convergence of methodological tools to perform evaluations 	<ul style="list-style-type: none"> • (Diffusion and standardization of the golden

(Table 1, 2)

2. Wide diversity of vocables associated with SBEs

standard of impact evaluation) (Storey, 2017)

- Semantical diversity of the literature according to the use of vocables to define SBEs (2)

Note () Numbers in brackets indicate the result (in the Results column) used for the interpretation.*

3.6 *Concluding remarks*

This chapter explores the literature related to public support for small businesses in Europe using an information science framework to provide new insights into the intellectual structure and research fronts related to the topic and to investigate knowledge accumulation for evidence-based policy making. The systematic literature review and the science mapping tools used to scan the related literature during the last decade enable us to find conclusions about the present and implications of future academic research related to public support for SBEs. Notably, from a methodological perspective we bring insights on the use of Scopus and Web of Science Core Collection databases. First, we notice Scopus and Web of Science Core Collection databases leads us to consider similar quantitative and qualitative coverage of the literature around public support for SBEs. Second, despite high quantitative and qualitative convergence, the Scopus database appears to contain more updated citations of documents, challenging the traditional use of Web of Science CC database. The use of Scopus allows drawing more reliable and relevant mapping about the intellectual structure and research fronts.

Furthermore, we characterize the form of public support in European countries. In line with previous research in the field, we find that public support mainly takes the form of financial instruments (Bennett, 2014; Jugend et al., 2020; Padilla-Ospina et al., 2018). The analysis of research front shows that while input and output additionality of public support appears to be a major concern in the literature during the last decade, recent developments appear to focus more on qualitative and subjective aspects related to behavioural additionality. Behavioural additionality, while not new in the literature (OECD, 2006), is a fuzzy concept broad enough to encompass both input and output additionality in a unified attempt at linking the concepts and theories in the literature (Kubera, 2021). The research front suggest that while input, output, and behavioural additionality are investigated, future research could more deeply investigate the mechanisms, of the “black box of additionality” (Södderblom et al., 2015).

Finally, we bring insights to the literature on public support that appears to be based on various definitions of SBEs. We argue that the fuzzy definition make more difficult the construction and the analysis of results from systematic literature reviews which limits the scope of the recommendations and finally impede their use to fuel policy debates and policy decision-making. This aspect may partially explain the lack of clear academic guidance to build evidence-based policies (Oliver et al., 2005; Valentine et al., 2017). Indeed, following the research avenue suggested by David et al. (2000) on the importance of methodological

aspects linked to the impact assessment of public support, important considerations have been and are still devoted to the use of most rigorous methodologies to ensure causal treatment effect estimates, giving little consideration to the definitions of conceptual tools used to characterize small businesses and entrepreneurs. However, pressures regarding the rationality of public spending, reinforced by the COVID-19 public health crisis, catalyze financial constraints from both the supply and demand sides, encouraging evidence-based policy making with precise targets in terms of the type of *action* and *object*. The chapter investigating the heterogeneity in terms and associated concepts suggests that harmonization attempts may constitute an avenue for future research. In this regard, the construction of a database gathering the list of terms used in previous systematic reviews on the public support to stimulate SBEs' innovation could also be considered for subsequent research. This would provide researcher tools and practical guidance to perform adequate systematic reviews to be used to fuel evidence-based policy making.

Another avenue for future research lies the conceptual side of the framework with the inclusion of a narrower set of studies related each financing instrument to depict more homogenous literature. This would allow investigating more deeply in the terms and their influence on the knowledge accumulation process. A last research opening concerns the technical side. While we use co-citation, bibliographic coupling and keywords analyses other metric can be used like direct citation or co-authorship. In this vein, while we perform that analyses at authors and documents level, future research could conduct a deeper network analysis, including other units, such as journals, countries, and institutions.

3.7 References

- Abadie, A., & Imbens, G. W. (2006). Large Sample Properties of Matching Estimators for Average Treatment Effects. *Econometrica*, 74(1), 235–267. <https://doi.org/10.1111/j.1468-0262.2006.00655.x>
- Adalet McGowan, M., Andrews, D., & Millot, V. (2018). The walking dead? Zombie firms and productivity performance in OECD countries. *Economic Policy*, 33(96), 685–736. <https://doi.org/10.1093/epolic/eiy012>
- Ahmad, N., & Hoffman, A. (2008). *A Framework for Addressing and Measuring Entrepreneurship* (OECD Statistics Working Papers No. 2008/02; OECD Statistics Working Papers, Vol. 2008/02). <https://doi.org/10.1787/243160627270>
- Ahmad, N., & Seymou, R. (2008). *Defining Entrepreneurial Activity: Definitions Supporting Frameworks for Data Collection* (OECD Statistics Working Papers No. 2008/01; OECD Statistics Working Papers, Vol. 2008/01). <https://doi.org/10.1787/243164686763>
- Alperovych, Y., Groh, A., & Quas, A. (2020). Bridging the equity gap for young innovative companies: The design of effective government venture capital fund programs. *Research Policy*, 49(10), 104051. <https://doi.org/10.1016/j.respol.2020.104051>
- Archambault, É., Campbell, D., Gingras, Y., & Larivière, V. (2009). Comparing bibliometric statistics obtained from the Web of Science and Scopus. *Journal of the American Society for Information Science and Technology*, 60(7), 1320–1326. <https://doi.org/10.1002/asi.21062>
- Audretsch, D., Colombelli, A., Grilli, L., Minola, T., & Rasmussen, E. (2020). Innovative start-ups and policy initiatives. *Research Policy*, 49(10), 104027. <https://doi.org/10.1016/j.respol.2020.104027>
- Autio, E. (2017). Growth of Technology-based New Firms. *The Blackwell Handbook of Entrepreneurship*, 329–347.
- Autio, E., Kenney, M., Mustar, P., Siegel, D., & Wright, M. (2014). Entrepreneurial innovation: The importance of context. *Research Policy*, 43(7), 1097–1108. <https://doi.org/10.1016/j.respol.2014.01.015>
- Autio, E., & Sapienza, H. J. (2000). Comparing process and born global perspectives in the international growth of technology-based new firms. *Frontiers of Entrepreneurship Research*, 413.
- Ayyagari, M., Beck, T., & Demirguc-Kunt, A. (2007). Small and Medium Enterprises Across the Globe. *Small Business Economics*, 29(4), 415–434. <https://doi.org/10.1007/s11187-006-9002-5>
- Baležentis, A., & Balkienė, K. (2014). Innovation policy measurement: Analysis of Lithuania's case. *Economic Research-Ekonomska Istraživanja*, 27(1), 1–14. <https://doi.org/10.1080/1331677X.2014.947103>
- Bannò, M., Piscitello, L., & Amorim Varum, C. (2014). The Impact of Public Support on SMEs' Outward FDI: Evidence from Italy: Journal of Small Business Management. *Journal of Small Business Management*, 52(1), 22–38. <https://doi.org/10.1111/jsbm.12029>
- Baumol, W. J. (2002). Entrepreneurship, innovation and growth: The David-Goliath symbiosis. *Journal of Entrepreneurial Finance, JEF*, 7(2), 1–10.
- Becker, B. (2015). Public R&D policies and private R&D investment: A survey of the empirical evidence. *Journal of Economic Surveys*, 29(5), 917–942.

- Bellucci, A., Pennacchio, L., & Zazzaro, A. (2019). Public R&D subsidies: Collaborative versus individual place-based programs for SMEs. *Small Business Economics*, 52(1), 213–240. <https://doi.org/10.1007/s11187-018-0017-5>
- Bennett, R. J. (2014). *Entrepreneurship, small business and public policy: Evolution and revolution*. Routledge.
- Berisha, G., & Pula, J. S. (2015). Defining Small and Medium Enterprises: a critical review. *Academic Journal of Business, Administration, Law and Social Sciences*, 1(1), 17-28.
- Bergek, A., & Norrman, C. (2015). Integrating the supply and demand sides of public support to new technology-based firms. *Science and Public Policy*, 42(4), 514–529.
- Berger, A. N., & Udell, G. F. (1998). The economics of small business finance: The roles of private equity and debt markets in the financial growth cycle. *Journal of Banking & Finance*, 22(6–8), 613–673.
- Berger, A. N., & Udell, G. F. (2006). A more complete conceptual framework for SME finance. *Journal of Banking & Finance*, 30(11), 2945–2966.
- Bernini, C., & Pellegrini, G. (2011). How are growth and productivity in private firms affected by public subsidy? Evidence from a regional policy. *Regional Science and Urban Economics*, 41(3), 253–265. <https://doi.org/10.1016/j.regsciurbeco.2011.01.005>
- Bertoni, F., Martí, J., & Reverte, C. (2019). The impact of government-supported participative loans on the growth of entrepreneurial ventures. *Research Policy*, 48(1), 371–384.
- Bianchi, M., Murtinu, S., & Scalera, V. G. (2019). R&D Subsidies as Dual Signals in Technological Collaborations. *Research Policy*, 48(9), 103821. <https://doi.org/10.1016/j.respol.2019.103821>
- Bollinger, L., Hope, K., & Utterback, J. M. (1983). A review of literature and hypotheses on new technology-based firms. *Research Policy*, 12(1), 1–14. [https://doi.org/10.1016/0048-7333\(83\)90023-9](https://doi.org/10.1016/0048-7333(83)90023-9)
- Bono, P. H., Debu, S., Desplatz, R., Hayet, M., Lacouette-Fougère, C., & Trannoy, A. (2018). Vingt ans d'évaluations d'impact en France et à l'étranger. Analyse quantitative de la production scientifique. *Document de travail*, (2018-06).
- Boyack, K. W., & Klavans, R. (2010). Co-citation analysis, bibliographic coupling, and direct citation: Which citation approach represents the research front most accurately? *Journal of the American Society for Information Science and Technology*, 61(12), 2389–2404. <https://doi.org/10.1002/asi.21419>
- Bozio, A. (2014). L'évaluation des politiques publiques: Enjeux, méthodes et institutions. *Revue française d'économie*, XXIX(4), 59–85. Cairn.info. <https://doi.org/10.3917/rfe.144.0059>
- Brown, R., Mawson, S., & Mason, C. (2017). Myth-busting and entrepreneurship policy: The case of high growth firms. *Entrepreneurship & Regional Development*, 29(5–6), 414–443. <https://doi.org/10.1080/08985626.2017.1291762>
- Caloffi, A., Mariani, M., Rossi, F., & Russo, M. (2018). A comparative evaluation of regional subsidies for collaborative and individual R&D in small and medium-sized enterprises. *Research Policy*, 47(8), 1437–1447. <https://doi.org/10.1016/j.respol.2018.04.022>
- Caloffi, A., Rossi, F., & Russo, M. (2015). What Makes SMEs more Likely to Collaborate? Analysing the Role of Regional Innovation Policy. *European Planning Studies*, 23(7), 1245–1264. <https://doi.org/10.1080/09654313.2014.919250>

- Cancino, C. A., Merigo, J. M., & Coronado, F. C. (2017). Big Names in Innovation Research: A Bibliometric Overview. *Current Science*, *113*(08), 1507. <https://doi.org/10.18520/cs/v113/i08/1507-1518>
- Carpenter, R. E., & Petersen, B. C. (2002). Capital market imperfections, high-tech investment, and new equity financing. *The Economic Journal*, *112*(477), F54–F72.
- Catozzella, A., & Vivarelli, M. (2016). The possible adverse impact of innovation subsidies: Some evidence from Italy. *International Entrepreneurship and Management Journal*, *12*(2), 351–368. <https://doi.org/10.1007/s11365-014-0342-3>
- Chapman, G., & Hewitt-Dundas, N. (2018). The effect of public support on senior manager attitudes to innovation. *Technovation*, *69*, 28–39. <https://doi.org/10.1016/j.technovation.2017.10.004>
- Chapman, G., Lucena, A., & Afcha, S. (2018). R&D subsidies & external collaborative breadth: Differential gains and the role of collaboration experience. *Research Policy*, *47*(3), 623–636. <https://doi.org/10.1016/j.respol.2018.01.009>
- Chen, C., Ibekwe-SanJuan, F., & Hou, J. (2010). The structure and dynamics of cocitation clusters: A multiple-perspective cocitation analysis. *Journal of the American Society for Information Science and Technology*, *61*(7), 1386–1409.
- Chuang, K.-Y., & Ho, Y.-S. (2014). Bibliometric profile of top-cited single-author articles in the Science Citation Index Expanded. *Journal of Informetrics*, *8*(4), 951–962. <https://doi.org/10.1016/j.joi.2014.09.008>
- Clarivate Analytics. (2019). Web of Science Database. from <https://www.webofknowledge.com/>
- CNEPI. (2016). *Quinze ans de politiques d'innovation en France*. 116.
- Collewaert, V., Manigart, S., & Aernoudt, R. (2010). Assessment of Government Funding of Business Angel Networks in Flanders. *Regional Studies*, *44*(1), 119–130. <https://doi.org/10.1080/00343400802070860>
- Colombo, M. G., Giannangeli, S., & Grilli, L. (2013). Public subsidies and the employment growth of high-tech start-ups: Assessing the impact of selective and automatic support schemes. *Industrial and Corporate Change*, *22*(5), 1273–1314. <https://doi.org/10.1093/icc/dts037>
- Colombo, Massimo G., Croce, A., & Guerini, M. (2012). Is the Italian Government effective in relaxing the financial constraints of high technology firms? *Prometheus*, *30*(1), 73–96. <https://doi.org/10.1080/08109028.2012.673757>
- Colombo, Massimo G., Croce, A., & Guerini, M. (2013). The effect of public subsidies on firms' investment–cash flow sensitivity: Transient or persistent? *Research Policy*, *42*(9), 1605–1623. <https://doi.org/10.1016/j.respol.2013.07.003>
- Cowling, M. (2000). Are entrepreneurs different across countries? *Applied Economics Letters*, *7*(12), 785–789. <https://doi.org/10.1080/135048500444804>
- Cravo, T. A., & Piza, C. (2019). The impact of business-support services on firm performance: A meta-analysis. *Small Business Economics*, *53*(3), 753–770. <https://doi.org/10.1007/s11187-018-0065-x>
- Crepon, B., Duguet, E., & Mairessec, J. (1998). Research, Innovation And Productivity: An Econometric Analysis At The Firm Level. *Economics of Innovation and New Technology*, *7*(2), 115–158. <https://doi.org/10.1080/10438599800000031>

- Criscuolo, C., Gal, P. N., & Menon, C. (2014). *The dynamics of employment growth: New evidence from 18 countries*.
- Cunningham, P., Gök, A., & Larédo, P. (2016). The impact of direct support to R & D and innovation in firms. In *Handbook of innovation policy impact*. Edward Elgar Publishing.
- Czarnitzki, D., & Delanote, J. (2015). R&D policies for young SMEs: Input and output effects. *Small Business Economics*, 45(3), 465–485. <https://doi.org/10.1007/s11187-015-9661-1>
- Czarnitzki, D., & Lopes-Bento, C. (2013). Value for money? New microeconomic evidence on public R&D grants in Flanders. *Research Policy*, 42(1), 76–89. <https://doi.org/10.1016/j.respol.2012.04.008>
- David, P. A., Hall, B. H., & Toole, A. A. (2000). Is public R&D a complement or substitute for private R&D? A review of the econometric evidence. *Research Policy*, 29(4–5), 497–529. [https://doi.org/10.1016/S0048-7333\(99\)00087-6](https://doi.org/10.1016/S0048-7333(99)00087-6)
- de Castris, M., & Pellegrini, G. (2012). Evaluation of Spatial Effects of Capital Subsidies in the South of Italy. *Regional Studies*, 46(4), 525–538. <https://doi.org/10.1080/00343404.2010.509130>
- del-Palacio, I., Zhang, X. T., & Sole, F. (2012). The capital gap for small technology companies: Public venture capital to the rescue? *Small Business Economics*, 38(3), 283–301. <https://doi.org/10.1007/s11187-010-9275-6>
- Del Rey, A. (2013). *La tyrannie de l'évaluation*. La Découverte.
- Di Gennaro & Pellegrini. (2019). Are Regional Policies Effective? An Empirical Evaluation on the Diffusion of the Effects of R&D Incentives. *Politica economica*, 1, 3–26. <https://doi.org/10.1429/93305>
- Dimos, C., & Pugh, G. (2016). The effectiveness of R&D subsidies: A meta-regression analysis of the evaluation literature. *Research Policy*, 45(4), 797–815. <https://doi.org/10.1016/j.respol.2016.01.002>
- Dosso, M., Martin, B. R., & Moncada-Paternò-Castello, P. (2018). Towards evidence-based industrial research and innovation policy†. *Science and Public Policy*, 45(2), 143–150. <https://doi.org/10.1093/scipol/scx073>
- Douglas, D., & Radicic, D. (2020). Network additionality and policy mix of regional and national public support for innovation. *Economics of Innovation and New Technology*, 1–25. <https://doi.org/10.1080/10438599.2020.1789277>
- Dvoutely, O. (2017). Effects of Soft Loans and Credit Guarantees on Performance of Supported Firms: Evidence from the Czech Public Programme START. *Sustainability*, 9(12), 2293. <https://doi.org/10.3390/su9122293>
- Dvoutely, O., Srhoj, S., & Pantea, S. (2020). Public SME grants and firm performance in European Union: A systematic review of empirical evidence. *Small Business Economics*. <https://doi.org/10.1007/s11187-019-00306-x>
- Edler, J., Cunningham, P., & Gök, A. (2016). *Handbook of innovation policy impact*. Edward Elgar Publishing.
- Edler, J., & Fagerberg, J. (2017). Innovation policy: What, why, and how. *Oxford Review of Economic Policy*, 33(1), 2–23.
- Elsevier. (2019). Scopus database., from <https://www.scopus.com/search/form.uri?display=basic>

- Falagas, M. E., Pitsouni, E. I., Malietzis, G. A., & Pappas, G. (2008). Comparison of PubMed, Scopus, web of science, and Google scholar: Strengths and weaknesses. *The FASEB Journal*, 22(2), 338–342.
- Fotopoulos, G., & Storey, D. J. (2019). Public policies to enhance regional entrepreneurship: Another programme failing to deliver? *Small Business Economics*, 53(1), 189–209. <https://doi.org/10.1007/s11187-018-0021-9>
- France Stratégie. (2019), L'évaluation des politiques publiques en France, Document de travail n° 2019-13
- Gartner, W. B. (1990). What are we talking about when we talk about entrepreneurship? *Journal of Business Venturing*, 5(1), 15–28. [https://doi.org/10.1016/0883-9026\(90\)90023-M](https://doi.org/10.1016/0883-9026(90)90023-M)
- Georghiou, L. (1998). Issues in the evaluation of innovation and technology policy. *Evaluation*, 4(1), 37–51.
- Glänzel, W., & Thijs, B. (2012). Using ‘core documents’ for detecting and labelling new emerging topics. *Scientometrics*, 91(2), 399–416. <https://doi.org/10.1007/s11192-011-0591-7>
- Griliches, Z., & Mairesse, J. (1995). Production functions: the search for identification. *NBER working paper*, (w5067).
- Grilli, L., Jensen, P. H., Murtinu, S., & Park, H. D. (2020). A close look at the contingencies of founders’ effect on venture performance. *Industrial and Corporate Change*, 29(4), 997–1020.
- Grilli, L., & Murtinu, S. (2014). Government, venture capital and the growth of European high-tech entrepreneurial firms. *Research Policy*, 43(9), 1523–1543. <https://doi.org/10.1016/j.respol.2014.04.002>
- Grilli, L., & Murtinu, S. (2018a). Selective subsidies, entrepreneurial founders’ human capital, and access to R&D alliances. *Research Policy*, 47(10), 1945–1963. <https://doi.org/10.1016/j.respol.2018.07.001>
- Grilli, L., & Murtinu, S. (2018b). Selective subsidies, entrepreneurial founders’ human capital, and access to R&D alliances. *Research Policy*, 47(10), 1945–1963. <https://doi.org/10.1016/j.respol.2018.07.001>
- Grimsby, G. (2018). Partly risky, partly solid – Performance study of public innovation loans. *Research Policy*, 47(7), 1344–1365. <https://doi.org/10.1016/j.respol.2018.04.018>
- Guerini, M., & Quas, A. (2016). Governmental venture capital in Europe: Screening and certification. *Journal of Business Venturing*, 31(2), 175–195.
- Hall, B. H., & Lerner, J. (2010). The financing of R&D and innovation. In *Handbook of the Economics of Innovation* (Vol. 1, pp. 609–639). Elsevier.
- Hall, B. H., & Mairesse, J. (1995). Exploring the relationship between R&D and productivity in French manufacturing firms. *Journal of Econometrics*, 65(1), 263–293. [https://doi.org/10.1016/0304-4076\(94\)01604-X](https://doi.org/10.1016/0304-4076(94)01604-X)
- Hart, P. A. (1968). The New Industrial Revolution. *Wash. & Lee L. Rev.*, 25, 187.
- Hölzl, W. (2016). High growth firms in Europe. *European Commission, Science, Research and Innovation Performance of the EU*, 247–276.
- Hottenrott, H., & Lopes-Bento, C. (2014). (International) R&D collaboration and SMEs: The effectiveness of targeted public R&D support schemes. *Research Policy*, 43(6), 1055–1066.
- Hottenrott, H., & Richstein, R. (2020). Start-up subsidies: Does the policy instrument matter? *Research Policy*, 49(1), 103888. <https://doi.org/10.1016/j.respol.2019.103888>

- Hud, M., & Hussinger, K. (2015). The impact of R&D subsidies during the crisis. *Research Policy*, 44(10), 1844–1855.
- Huergo, E., & Moreno, L. (2017). Subsidies or loans? Evaluating the impact of R&D support programmes. *Research Policy*, 46(7), 1198–1214. <https://doi.org/10.1016/j.respol.2017.05.006>
- Imbeau, L. M., & Ouimet, M. (2013). Langue de publication et performance en recherche: Publier en français a-t-il un impact sur les performances bibliométriques des chercheurs francophones en science politique ? *Politique et Sociétés*, 31(3), 39–65. <https://doi.org/10.7202/1014959ar>
- Jarneving, B. (2005). A comparison of two bibliometric methods for mapping of the research front. *Scientometrics*, 65(2), 245–263. <https://doi.org/10.1007/s11192-005-0270-7>
- Jensen, M. C., & Meckling, W. H. (1976). Theory of the firm: Managerial behavior, agency costs and ownership structure. *Journal of Financial Economics*, 3(4), 305–360. [https://doi.org/10.1016/0304-405X\(76\)90026-X](https://doi.org/10.1016/0304-405X(76)90026-X)
- Jugend, D., Fiorini, P. D. C., Armellini, F., & Ferrari, A. G. (2020). Public support for innovation: A systematic review of the literature and implications for open innovation. *Technological Forecasting and Social Change*, 156, 119985. <https://doi.org/10.1016/j.techfore.2020.119985>
- Karhunen, H., & Huovari, J. (2015). R&D subsidies and productivity in SMEs. *Small Business Economics*, 45(4), 805–823. <https://doi.org/10.1007/s11187-015-9658-9>
- Kersten, R., Harms, J., Liket, K., & Maas, K. (2017). Small Firms, large Impact? A systematic review of the SME Finance Literature. *World Development*, 97, 330–348. <https://doi.org/10.1016/j.worlddev.2017.04.012>
- Kessler, M. M. (1963). Bibliographic coupling between scientific papers. *American Documentation*, 14(1), 10–25.
- Klette, T. J., Møen, J., & Griliches, Z. (2000). Do subsidies to commercial R&D reduce market failures? Microeconomic evaluation studies. *Research Policy*, 29(4–5), 471–495. [https://doi.org/10.1016/S0048-7333\(99\)00086-4](https://doi.org/10.1016/S0048-7333(99)00086-4)
- Kubera, P. (2021). *The Challenges in the Evaluation of Behavioural Additionality of Innovation Policy*.
- Kulkarni, A. V. (2009). Comparisons of Citations in Web of Science, Scopus, and Google Scholar for Articles Published in General Medical Journals. *JAMA*, 302(10), 1092. <https://doi.org/10.1001/jama.2009.1307>
- Larédo, P., Köhler, C., & Rammer, C. (2016). The impact of fiscal incentives for R & D. In Handbook of innovation policy impact. Edward Elgar Publishing.
- Larivière, V., & Macaluso, B. (2011). Improving the coverage of social science and humanities researchers' output: The case of the Érudit journal platform. *Journal of the American Society for Information Science and Technology*, 62(12), 2437–2442. <https://doi.org/10.1002/asi.21632>
- Lerner, J. (2002). When Bureaucrats Meet Entrepreneurs: The Design of Effective 'Public Venture Capital' Programmes. *The Economic Journal*, 112(477), F73–F84. <https://doi.org/10.1111/1468-0297.00684>
- Lerner, J. (2009). *Boulevard of broken dreams: why public efforts to boost entrepreneurship and venture capital have failed--and what to do about it*. Princeton University Press.

- Lerner, J. (2010). The future of public efforts to boost entrepreneurship and venture capital. *Small Business Economics*, 35(3), 255–264. <https://doi.org/10.1007/s11187-010-9298-z>
- Levratto, N. (2009). *Les PME: définition, rôle économique et politiques publiques*. De Boeck Supérieur.
- Lhuillery, S., Marino, M., & Parrotta, P. (2013). Evaluation de l'Impact des Aides Directes et Indirectes à la R & D en France. Report for the Ministry of Research, France.
- Li, J., Burnham, J. F., Lemley, T., & Britton, R. M. (2010). Citation Analysis: Comparison of Web of Science®, Scopus™, SciFinder®, and Google Scholar. *Journal of Electronic Resources in Medical Libraries*, 7(3), 196–217. <https://doi.org/10.1080/15424065.2010.505518>
- Littell, J. H. (2018). Conceptual and practical classification of research reviews and other evidence synthesis products. *Campbell Systematic Reviews*, 14(1), 1–21. <https://doi.org/10.4073/cmdp.2018.1>
- Little, A. D. (1977). *New technology-based firms in the United Kingdom and the Federal Republic of Germany*.
- Liu, Z., Yin, Y., Liu, W., & Dunford, M. (2015). Visualizing the intellectual structure and evolution of innovation systems research: A bibliometric analysis. *Scientometrics*, 103(1), 135–158.
- López-Fernández, M. C., Serrano-Bedia, A. M., & Pérez-Pérez, M. (2016). Entrepreneurship and Family Firm Research: A Bibliometric Analysis of An Emerging Field. *Journal of Small Business Management*, 54(2), 622–639. <https://doi.org/10.1111/jsbm.12161>
- Mallinguh, E., & Zoltan, Z. (2020). Map of the existing research on business innovation, funding, and policy framework. *Journal of Entrepreneurship, Management and Innovation*, 16(2), 161–202. <https://doi.org/10.7341/20201626>
- Martí, J., & Quas, A. (2018). A beacon in the night: Government certification of SMEs towards banks. *Small Business Economics*, 50(2), 397–413. <https://doi.org/10.1007/s11187-016-9828-4>
- Martin, B. R. (2012). The evolution of science policy and innovation studies. *Research Policy*, 41(7), 1219–1239. <https://doi.org/10.1016/j.respol.2012.03.012>
- Mason, C., & Brown, R. (2013). Creating good public policy to support high-growth firms. *Small Business Economics*, 40(2), 211–225.
- Massaro, M., Dumay, J., & Guthrie, J. (2016). On the shoulders of giants: Undertaking a structured literature review in accounting. *Accounting, Auditing & Accountability Journal*.
- Mazzucato, M. (2011). The entrepreneurial state. *Soundings*, 49(49), 131-142.
- Mazzucato, M. (2016). From market fixing to market-creating: A new framework for innovation policy. *Industry and Innovation*, 23(2), 140–156. <https://doi.org/10.1080/13662716.2016.1146124>
- Mazzucato, M., Kattel, R., & Ryan-Collins, J. (2020). Challenge-driven innovation policy: Towards a new policy toolkit. *Journal of Industry, Competition and Trade*, 20(2), 421–437.
- Mazzucato, M., & Semieniuk, G. (2017). Public financing of innovation: New questions. *Oxford Review of Economic Policy*, 33(1), 24–48.
- Merigó, J. M., Cancino, C. A., Coronado, F., & Urbano, D. (2016). Academic research in innovation: A country analysis. *Scientometrics*, 108(2), 559–593. <https://doi.org/10.1007/s11192-016-1984-4>

- Minola, T., Vismara, S., & Hahn, D. (2017). Screening model for the support of governmental venture capital. *The Journal of Technology Transfer*, 42(1), 59–77. <https://doi.org/10.1007/s10961-015-9461-4>
- Moher, D., Shamseer, L., Clarke, M., Ghersi, D., Liberati, A., Petticrew, M., Shekelle, P., & Stewart, L. A. (2015). Preferred reporting items for systematic review and meta-analysis protocols (PRISMA-P) 2015 statement. *Systematic Reviews*, 4(1), 1. <https://doi.org/10.1186/2046-4053-4-1>
- Munari, F., & Toschi, L. (2015). Assessing the impact of public venture capital programmes in the United Kingdom: Do regional characteristics matter? *Journal of Business Venturing*, 30(2), 205–226. <https://doi.org/10.1016/j.jbusvent.2014.07.009>
- Nelson, R. R. (1986). Institutions supporting technical advance in industry. *The American Economic Review*, 76(2), 186–189.
- Nyikos, G., Béres, A., Laposa, T., & Závecz, G. (2020). Do financial instruments or grants have a bigger effect on SMEs' access to finance? Evidence from Hungary. *Journal of Entrepreneurship in Emerging Economies*, 12(5), 667–685. <https://doi.org/10.1108/JEEE-09-2019-0139>
- OECD and SCImago Research Group (CSIC) (2016), Compendium of Bibliometric Science Indicators. OECD, Paris. Accessed from <http://oe.cd/scientometrics>.
- OECD. (2020). *Financing SMEs and Entrepreneurs 2020: An OECD Scoreboard*. OECD. <https://doi.org/10.1787/061fe03d-en>
- Oliver, S., Harden, A., Rees, R., Shepherd, J., Brunton, G., Garcia, J., & Oakley, A. (2005). An emerging framework for including different types of evidence in systematic reviews for public policy. *Evaluation*, 11(4), 428–446.
- Orlic, E., Radicic, D., & Balavac, M. (2019). R&D and innovation policy in the Western Balkans: Are there additional effects? *Science and Public Policy*, 46(6), 876–894. <https://doi.org/10.1093/scipol/scz036>
- Padilla-Ospina, A. M., Medina-Vásquez, J. E., & Rivera-Godoy, J. A. (2018). Financing innovation: A bibliometric analysis of the field. *Journal of Business & Finance Librarianship*, 23(1), 63–102. <https://doi.org/10.1080/08963568.2018.1448678>
- Pellegrini, G., & Muccigrosso, T. (2017). Do subsidized new firms survive longer? Evidence from a counterfactual approach. *Regional Studies*, 51(10), 1483–1493. <https://doi.org/10.1080/00343404.2016.1190814>
- Pellegrini, G., Terribile, F., Tarola, O., Muccigrosso, T., & Busillo, F. (2013). Measuring the effects of European Regional Policy on economic growth: A regression discontinuity approach: Does EU Regional Policy enhance growth? *Papers in Regional Science*, 92(1), 217–233. <https://doi.org/10.1111/j.1435-5957.2012.00459.x>
- Perrin, B. (2002). How to—And how not to—Evaluate innovation. *Evaluation*, 8(1), 13–28.
- Petrin, T. (2018). *A literature review on the impact and effectiveness of government support for R&D and innovation*. ISIGrowth.
- Quang, Minh Nguyen; Rogers, Tim; Hofman, Jan; Lanham, Ana B. (2019): Difference between bibliographic coupling and co-citation.. PLOS ONE. Figure. <https://doi.org/10.1371/journal.pone.0216126.g001>

- Radicić, D., Pugh, G., & Douglas, D. (2020). Promoting cooperation in innovation ecosystems: Evidence from European traditional manufacturing SMEs. *Small Business Economics*, 54(1), 257–283. <https://doi.org/10.1007/s11187-018-0088-3>
- Ratinho, T., Amezcua, A., Honig, B., & Zeng, Z. (2020). Supporting entrepreneurs: A systematic review of literature and an agenda for research. *Technological Forecasting and Social Change*, 154, 119956. <https://doi.org/10.1016/j.techfore.2020.119956>
- Revest, V., & Sapio, A. (2012). Financing technology-based small firms in Europe: What do we know? *Small Business Economics*, 39(1), 179–205. <https://doi.org/10.1007/s11187-010-9291-6>
- Roberts, E. B. (1968). Entrepreneurship and technology: A basic study of innovators; how to keep and capitalize on their talents. *Research Management*, 11(4), 249–266.
- Roberts, E. B. (1991). *Entrepreneurs in high technology: Lessons from MIT and beyond*. Oxford University Press.
- Rojas, F., & Huergo, E. (2016). Characteristics of entrepreneurs and public support for NTBFs. *Small Business Economics*, 47(2), 363–382.
- Román, C., Congregado, E., & Millán, J. M. (2013). Start-up incentives: Entrepreneurship policy or active labour market programme? *Journal of Business Venturing*, 28(1), 151–175. <https://doi.org/10.1016/j.jbusvent.2012.01.004>
- Romer, P. M. (1994). The origins of endogenous growth. *Journal of Economic Perspectives*, 8(1), 3–22.
- Rossetto, D. E., Bernardes, R. C., Borini, F. M., & Gattaz, C. C. (2018). Structure and evolution of innovation research in the last 60 years: Review and future trends in the field of business through the citations and co-citations analysis. *Scientometrics*, 115(3), 1329–1363. <https://doi.org/10.1007/s11192-018-2709-7>
- Rubin, D. B. (1973). The Use of Matched Sampling and Regression Adjustment to Remove Bias in Observational Studies. *Biometrics*, 29(1), 185. <https://doi.org/10.2307/2529685>
- Sabel, C. (2009). Is the Small Firm Still a Category of Analysis?. The Role of SMEs and Entrepreneurship in a Globalised Economy, 116.
- Sanderson, I. (2003). Is it ‘what works’ that matters? Evaluation and evidence-based policy-making. *Research Papers in Education*, 18(4), 331–345. <https://doi.org/10.1080/0267152032000176846>
- Santarelli, E., & Vivarelli, M. (2002). Is subsidizing entry an optimal policy? *Industrial and Corporate Change*, 11(1), 39–52. <https://doi.org/10.1093/icc/11.1.39>
- Santarelli, Enrico, & Vivarelli, M. (2007). Entrepreneurship and the process of firms’ entry, survival and growth. *Industrial and Corporate Change*, 16(3), 455–488.
- Small, H. (1973). Co-citation in the scientific literature: A new measure of the relationship between two documents. *Journal of the American Society for Information Science*, 24(4), 265–269.
- Société Française d'évaluation (2018), Baromètre 2018 de l'évaluation des politiques publiques en France.
- Stiglitz, J. E., & Weiss, A. (1981). Credit rationing in markets with imperfect information. *The American Economic Review*, 71(3), 393–410.

- Storey, D. (2017). Six Steps to Heaven: Evaluating the Impact of Public Policies to Support Small Businesses in Developed Economies. In D. L. Sexton & H. Landström (Eds.), *The Blackwell Handbook Of Entrepreneurship* (pp. 176–193). Blackwell Publishing Ltd. <https://doi.org/10.1002/9781405164214.ch9>
- Storey, D. J. (2003). Entrepreneurship, small and medium sized enterprises and public policies. In *Handbook of entrepreneurship research* (pp. 473–511). Springer.
- Storey, D. J. (2005). Entrepreneurship, Small and Medium Sized Enterprises and Public Policies. In Z. J. Acs & D. B. Audretsch (Eds.), *Handbook of Entrepreneurship Research* (Vol. 1, pp. 473–511). Springer-Verlag. https://doi.org/10.1007/0-387-24519-7_18
- Storey, D. J. (2016). *Entrepreneurship and New Firm: Theory and Policy*. Routledge.
- Storey, D. J., & Greene, F. J. (2010). *Small business and entrepreneurship*. Financial Times Prentice Hall.
- Tiberius, V., Rietz, M., & Bouncken, R. B. (2020). Performance Analysis and Science Mapping of Institutional Entrepreneurship Research. *Administrative Sciences*, 10(3), 69. <https://doi.org/10.3390/admsci10030069>
- Tranfield, D., Denyer, D., & Smart, P. (2003). Towards a methodology for developing evidence-informed management knowledge by means of systematic review. *British Journal of Management*, 14(3), 207–222.
- Trujillo, C. M., & Long, T. M. (2018). Document co-citation analysis to enhance transdisciplinary research. *Science Advances*, 4(1), e1701130. <https://doi.org/10.1126/sciadv.1701130>
- UNESCAP (2012). Policy guidebook for SME Development in Asia and the Pacific. Bangkok, United Nation Economic and Social Commission for Asia and the Pacific.
- Urbano, D., Aparicio, S., & Audretsch, D. (2019). Twenty-five years of research on institutions, entrepreneurship, and economic growth: What has been learned? *Small Business Economics*, 53(1), 21–49. <https://doi.org/10.1007/s11187-018-0038-0>
- Valentine, J. C., Wilson, S. J., Rindskopf, D., Lau, T. S., Tanner-Smith, E. E., Yeide, M., LaSota, R., & Foster, L. (2017). Synthesizing evidence in public policy contexts: The challenge of synthesis when there are only a few studies. *Evaluation Review*, 41(1), 3–26.
- van Eck, N. J., & Waltman, L. (2010). Software survey: VOSviewer, a computer program for bibliometric mapping. *Scientometrics*, 84(2), 523–538. <https://doi.org/10.1007/s11192-009-0146-3>
- van Stel, A., Storey, D. J., & Thurik, A. R. (2007). The Effect of Business Regulations on Nascent and Young Business Entrepreneurship. *Small Business Economics*, 28, 171–186. <https://doi.org/10.1007/s11187-006-9014-1>
- Vanino, E., Roper, S., & Becker, B. (2019). Knowledge to money: Assessing the business performance effects of publicly-funded R&D grants. *Research Policy*, 48(7), 1714–1737.
- Vide, R. K., Bobek, V., Cancer, V., Perko, I., & Hauptman, L. (2010). The efficiency of entrepreneurship policy support for the internationalisation of SMEs: The case of Slovenia. *European Journal of International Management*, 4(6), 644–664.
- Vivarelli, M. (2013). Is entrepreneurship necessarily good? Microeconomic evidence from developed and developing countries. *Industrial and Corporate Change*, 22(6), 1453–1495. <https://doi.org/10.1093/icc/dtt005>

- Vivarelli, Marco. (2011). Baumol, W.J.: The microtheory of innovative entrepreneurship: XIV, 246 pp. Princeton University Press, Princeton and Oxford, 2010. Hardback \$ 39.50. *Journal of Economics*, 103(2), 199–202. <https://doi.org/10.1007/s00712-011-0195-y>
- Vivarelli, Marco. (2014). Innovation, Employment and Skills in Advanced and Developing Countries: A Survey of Economic Literature. *Journal of Economic Issues*, 48(1), 123–154. <https://doi.org/10.2753/JEI0021-3624480106>
- Vivarelli, Marco, & Pianta, M. (Eds.). (2000). *The employment impact of innovation: Evidence and policy*. Routledge.
- Weiss, C. H. (1983). Ideology, Interests, and Information. In D. Callahan & B. Jennings (Eds.), *Ethics, The Social Sciences, and Policy Analysis* (pp. 213–245). Springer US. https://doi.org/10.1007/978-1-4684-7015-4_9
- White, H. D., & Griffith, B. C. (1981). Author cocitation: A literature measure of intellectual structure. *Journal of the American Society for Information Science*, 32(3), 163–171. <https://doi.org/10.1002/asi.4630320302>
- Yli-Renko, H., Autio, E., & Tontti, V. (2002). Social capital, knowledge, and the international growth of technology-based new firms. *International Business Review*, 11(3), 279–304.
- Zhao, D. (2006). Towards all-author co-citation analysis. *Information Processing & Management*, 42(6), 1578–1591. <https://doi.org/10.1016/j.ipm.2006.03.022>
- Zhao, D., & Strotmann, A. (2008). Evolution of research activities and intellectual influences in information science 1996–2005: Introducing author bibliographic-coupling analysis. *Journal of the American Society for Information Science and Technology*, 59(13), 2070–2086.
- Zhu, J., & Liu, W. (2020). A tale of two databases: The use of Web of Science and Scopus in academic papers. *Scientometrics*, 123(1), 321–335. <https://doi.org/10.1007/s11192-020-03387-8>
- Zúñiga-Vicente, J. Á., Alonso-Borrego, C., Forcadell, F. J., & Galán, J. I. (2014). Assessing the effect of public subsidies on firm R&D investment: A survey. *Journal of Economic Surveys*, 28(1), 36–67.
- Zupic, I., & Čater, T. (2015). Bibliometric Methods in Management and Organization. *Organizational Research Methods*, 18(3), 429–472. <https://doi.org/10.1177/1094428114562629>

Appendix A
Table A.1 Research keywords

Subject	Object	
	What they are	What they have
“public support*”	“*SME*”	“Recipients”
“government support*”	“*start-up*”	“treated firm*”
“public direct support*”	“small firm*”	“participating firm*”
“government direct support*”	“innovative firm*”	“subsidized firm*”
“public sponsorship”	“NTBF*”	“granted firm*”
“government sponsorship”	“YIC*”	“supported firm*”
“innovation polic*”	“financially-constrained SME*”	
“public polic*”		
“Entrepreneurship polic*”		
“high-growth entrepreneurship*”		
“High-growth polic*”		

“publicly-funded”
 “publicly funded”

Notes: “*” indicates that any nominal group including the word under consideration (“public support*” includes “public support for innovation” and any other association including the word. However, as the vocable “firms” is too generic, we impose some restrictions by requiring nominal groups to include “firms”.

Table A.2 Keyword harmonization

Label	Replace by
innovation policies	innovation policy
r&d	research and development
small and medium-sized enterprise	smes
entrepreneurship policies	entrepreneurship policy
r and d	research and development
public policies	public policy
public support policies	public policy
public interventions management	public interventions
new technology-based firms	new technology based firms

Table A.3. Public spending on innovation policies

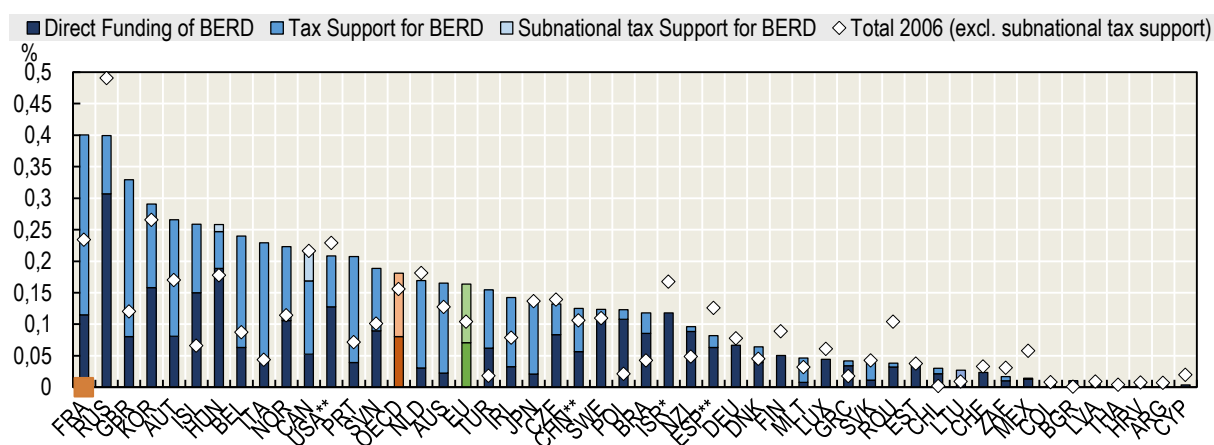

Source OECD, 2020, <http://www.oecd.org/sti/rd-tax-stats.htm>

*Data on tax support not available; ** Data on subnational tax support not available; BERD refers to business expenditures for research and development

Table A.4 List of acronyms

Accronym	Definition
2SLS	Two-stage least squares

ABCA	Authors' bibliographic couplings
ACA	Authors' co-citation analysis
CWA	Co-(Key)word analysis
DBCA	Documents' bibliographic coupling
DiD	Difference in differences
ECM	Error correction models
EM	Exact matching
FE	Fied effect
GMM	Generalized method of moments
IPWRA	Inverse probability weighting regression adjustment
IV	Instrumental variables
MRQ	Main research question
NTBFs	New technology-based firms
NN	Nearest neighbours
PMS	Propensity score matching
SBEs	Small businesses and entrepreneurs
SLR	Systematic literature review
SMEs	Small and medium-sized enterprises

List of selected articles using Scopus database :

- Afcha, S., & Garcíá-Quevedo, J. (2016). The impact of R & D subsidies on R & D employment composition. *Industrial and Corporate Change*, 25(6), 955-975. doi:10.1093/icc/dtw008
- Aiello, F. (2013). The effectiveness of R&D support in italy. some evidence from matching methods. *Risk Governance and Control: Financial Markets and Institutions*, 3(4), 7-15. doi:10.22495/rgecv3i4art1
- Aiello, F., Albanese, G., & Piselli, P. (2019). Good value for public money? the case of R&D policy. *Journal of Policy Modeling*, 41(6), 1057-1076. doi:10.1016/j.jpolmod.2019.02.006
- Alecke, B., Mitze, T., Reinkowski, J., & Untiedt, G. (2012). Does firm size make a difference? analysing the effectiveness of R&D subsidies in east germany. *German Economic Review*, 13(2), 174-195. doi:10.1111/j.1468-0475.2011.00546.x
- Alperovych, Y., Groh, A., & Quas, A. (2020). Bridging the equity gap for young innovative companies: The design of effective government venture capital fund programs. *Research Policy*, 49(10) doi:10.1016/j.respol.2020.104051
- Antonelli, C. (2020). Knowledge exhaustibility public support to business R&D and the additionality constraint. *Journal of Technology Transfer*, 45(3), 649-663. doi:10.1007/s10961-019-09727-y
- Antonioli, D., Marzucchi, A., & Montresor, S. (2014). Regional innovation policy and innovative behaviour: Looking for additional effects. *European Planning Studies*, 22(1), 64-83. doi:10.1080/09654313.2012.722977
- Aschhoff, B. (2010). Who gets the money? the dynamics of R&D project subsidies in germany. *Jahrbucher Fur Nationalokonomie Und Statistik*, 230(5), 522-546.
- Audretsch, D., Colombelli, A., Grilli, L., Minola, T., & Rasmussen, E. (2020). Innovative start-ups and policy initiatives. *Research Policy*, doi:10.1016/j.respol.2020.104027
- Autio, E., & Rannikko, H. (2016). Retaining winners: Can policy boost high-growth entrepreneurship? *Research Policy*, 45(1), 42-55. doi:10.1016/j.respol.2015.06.002
- Bakhshi, H., Edwards, J. S., Roper, S., Scully, J., Shaw, D., Morley, L., & Rathbone, N. (2015). Assessing an experimental approach to industrial policy evaluation: Applying RCT+ to the case of creative credits. *Research Policy*, 44(8), 1462-1472. doi:10.1016/j.respol.2015.04.004
- Bannò, M., Morandi, V., & Varum, C. A. (2013). Public policy for innovation and internationalization: Are they worth it? *Applied Economics Letters*, 20(10), 927-930. doi:10.1080/13504851.2013.765535
- Bannò, M., Piscitello, L., & Amorim Varum, C. (2014). The impact of public support on SMEs' outward FDI: Evidence from italy. *Journal of Small Business Management*, 52(1), 22-38. doi:10.1111/jsbm.12029

- Barajas, A., Huergo, E., & Moreno, L. (2016). SME performance and public support for international RJVs*. *Journal of Small Business Management*, 54(4), 1206-1228. doi:10.1111/jsbm.12221
- Basit, S. A., Kuhn, T., & Ahmed, M. (2018). The effect of government subsidy on non-technological innovation and firm performance in the service sector: Evidence from germany. *Business Systems Research*, 9(1), 118-137. doi:10.2478/bsrj-2018-0010
- Belitz, H., & Lejpras, A. (2016). Financing patterns of R&D in small and medium-sized enterprises and the perception of innovation barriers in germany. *Science and Public Policy*, 43(2), 245-261. doi:10.1093/scipol/scv027
- Bergek, A., & Norrman, C. (2015). Integrating the supply and demand sides of public support to new technology-based firms. *Science and Public Policy*, 42(4), 514-529. doi:10.1093/scipol/scu072
- Bertoni, F., Martí, J., & Reverte, C. (2019). The impact of government-supported participative loans on the growth of entrepreneurial ventures. *Research Policy*, 48(1), 371-384. doi:10.1016/j.respol.2018.09.006
- Bianchi, M., Murtinu, S., & Scalerà, V. G. (2019). R&D subsidies as dual signals in technological collaborations. *Research Policy*, 48(9) doi:10.1016/j.respol.2019.103821
- Bloch, C., Sørensen, M. P., Graversen, E. K., Schneider, J. W., Schmidt, E. K., Aagaard, K., & Mejlgaard, N. (2014). Developing a methodology to assess the impact of research grant funding: A mixed methods approach. *Evaluation and Program Planning*, 43, 105-117. doi:10.1016/j.evalprogplan.2013.12.005
- Bodas Freitas, I. M. (2020). Mapping variety of innovation strategies sponsored by the policy-mix: An analytical framework and an empirical exploration. *Journal of Evolutionary Economics*, 30(3), 741-771. doi:10.1007/s00191-020-00660-0
- Boldrini, J. -, Schieb-Bienfait, N., & Chéné, E. (2011). Improving SMEs' guidance within public innovation supports. *European Planning Studies*, 19(5), 775-793. doi:10.1080/09654313.2011.561036
- Briozzo, A., & Cardone-Riportella, C. (2016). Spanish SMEs' subsidized and guaranteed credit during economic crisis: A regional perspective. *Regional Studies*, 50(3), 496-512. doi:10.1080/00343404.2014.926318
- Brown, R., Mawson, S., & Mason, C. (2017). Myth-busting and entrepreneurship policy: The case of high growth firms. *Entrepreneurship and Regional Development*, 29(5-6), 414-443. doi:10.1080/08985626.2017.1291762
- Buchmann, T., & Pyka, A. (2015). The evolution of innovation networks: The case of a publicly funded german automotive network. *Economics of Innovation and New Technology*, 24(1-2), 114-139. doi:10.1080/10438599.2014.897860
- Busom, I., Corchuelo, B., & Martínez-Ros, E. (2014). Tax incentives... or subsidies for business r&d? *Small Business Economics*, 43(3), 571-596. doi:10.1007/s11187-014-9569-1
- BWW Centres (2017). what lessons for evidence-based policy in France. *British What Works Centres-Alliance for Useful Evidence*.
- Caloffi, A., Mariani, M., Rossi, F., & Russo, M. (2018). A comparative evaluation of regional subsidies for collaborative and individual R&D in small and medium-sized enterprises. *Research Policy*, 47(8), 1437-1447. doi:10.1016/j.respol.2018.04.022
- Caloffi, A., Rossi, F., & Russo, M. (2015). What makes SMEs more likely to collaborate? analysing the role of regional innovation policy. *European Planning Studies*, 23(7), 1245-1264. doi:10.1080/09654313.2014.919250
- Cansino, J. M., Lopez-Melendo, J., Pablo-Romero, M. D. P., & Sánchez-Braza, A. (2013). An economic evaluation of public programs for internationalization: The case of the diagnostic program in spain. *Evaluation and Program Planning*, 41, 38-46. doi:10.1016/j.evalprogplan.2013.07.002
- Carboni, O. A. (2011). R&D subsidies and private R&D expenditures: Evidence from italian manufacturing data. *International Review of Applied Economics*, 25(4), 419-439. doi:10.1080/02692171.2010.529427
- Carboni, O. A. (2017). The effect of public support on investment and R&D: An empirical evaluation on european manufacturing firms. *Technological Forecasting and Social Change*, 117, 282-295. doi:10.1016/j.techfore.2016.11.017
- Catozzella, A., & Vivarelli, M. (2016). The possible adverse impact of innovation subsidies: Some evidence from italy. *International Entrepreneurship and Management Journal*, 12(2), 351-368. doi:10.1007/s11365-014-0342-3
- Cerqua, A., & Pellegrini, G. (2017). Industrial policy evaluation in the presence of spillovers. *Small Business Economics*, 49(3), 671-686. doi:10.1007/s11187-017-9855-9
- Chapman, G., & Hewitt-Dundas, N. (2018). The effect of public support on senior manager attitudes to innovation. *Technovation*, 69, 28-39. doi:10.1016/j.technovation.2017.10.004
- Chapman, G., Lucena, A., & Afcha, S. (2018). R&D subsidies & external collaborative breadth: Differential gains and the role of collaboration experience. *Research Policy*, 47(3), 623-636. doi:10.1016/j.respol.2018.01.009

- Clifton, N., Huggins, R., Morgan, B., & Thompson, P. (2015). An appropriate tool for entrepreneurial learning in SMEs? the case of the 20Twenty leadership programme. *Local Economy*, 30(5), 534-556. doi:10.1177/0269094215589310
- Colombelli, A., Grilli, L., Minola, T., & Mrkajic, B. (2020). To what extent do young innovative companies take advantage of policy support to enact innovation appropriation mechanisms? *Research Policy*, 49(10) doi:10.1016/j.respol.2019.05.006
- Colombo, M. G., Croce, A., & Guerini, M. (2012). Is the italian government effective in relaxing the financial constraints of high technology firms? *Prometheus (United Kingdom)*, 30(1), 73-96. doi:10.1080/08109028.2012.673757
- Colombo, M. G., Croce, A., & Guerini, M. (2013b). The effect of public subsidies on firms' investment-cash flow sensitivity: Transient or persistent? *Research Policy*, 42(9), 1605-1623. doi:10.1016/j.respol.2013.07.003
- Colombo, M. G., D'Adda, D., & Pirelli, L. H. (2016). The participation of new technology-based firms in EU-funded R&D partnerships: The role of venture capital. *Research Policy*, 45(2), 361-375. doi:10.1016/j.respol.2015.10.011
- Colombo, M. G., Giannangeli, S., & Grilli, L. (2013a). Public subsidies and the employment growth of high-tech start-ups: Assessing the impact of selective and automatic support schemes. *Industrial and Corporate Change*, 22(5), 1273-1314. doi:10.1093/icc/dts037
- Czarnitzki, D., & Lopes-Bento, C. (2014). Innovation subsidies: Does the funding source matter for innovation intensity and performance? empirical evidence from germany. *Industry and Innovation*, 21(5), 380-409. doi:10.1080/13662716.2014.973246
- de Castris, M., & Pellegrini, G. (2012). Evaluation of spatial effects of capital subsidies in the south of italy. *Regional Studies*, 46(4), 525-538. doi:10.1080/00343404.2010.509130
- de Mello-Sampayo, F., de Sousa-Vale, S., Camões, F., & Gomes, O. (2012). Protectionism under R&D policy: Innovation rate and welfare. *Journal of Economic Studies*, 39(1), 106-124. doi:10.1108/01443581211192134
- del-Palacio, I., Zhang, X. T., & Sole, F. (2012). The capital gap for small technology companies: Public venture capital to the rescue? *Small Business Economics*, 38(3), 283-301. doi:10.1007/s11187-010-9275-6
- Douglas, D., & Radicic, D. (2020). Network additionality and policy mix of regional and national public support for innovation. *Economics of Innovation and New Technology*, , 1-25. doi:10.1080/10438599.2020.1789277
- Dvouletý, O. (2017). Effects of soft loans and credit guarantees on performance of supported firms: Evidence from the czech public programme START. *Sustainability (Switzerland)*, 9(12) doi:10.3390/su9122293
- Dvouletý, O., Srhoj, S., & Pantea, S. (2020). Public SME grants and firm performance in european union: A systematic review of empirical evidence. *Small Business Economics*, doi:10.1007/s11187-019-00306-x
- Ebersberger, B., & Herstad, S. J. (2013). The relationship between international innovation collaboration, intramural R&D and SMEs' innovation performance: A quantile regression approach. *Applied Economics Letters*, 20(7), 626-630. doi:10.1080/13504851.2012.724158
- Faber, J., van Dijk, J., & van Rijnsoever, F. (2016). Incentives and barriers for R & D-based SMEs to participate in european research programs: An empirical assessment for the netherlands. *Science and Public Policy*, 43(3), 414-428. doi:10.1093/scipol/scv050
- Freel, M., Liu, R., & Rammer, C. (2019). The export additionality of innovation policy. *Industrial and Corporate Change*, 28(5), 1257-1277. doi:10.1093/icc/dty059
- Fudickar, R., & Hottenrott, H. (2019). Public research and the innovation performance of new technology based firms. *Journal of Technology Transfer*, 44(2), 326-358. doi:10.1007/s10961-018-9695-z
- Gabrielsson, J., Dahlstrand, A. L., & Politis, D. (2014). Sustainable high-growth entrepreneurship: A study of rapidly growing firms in the scania region. *International Journal of Entrepreneurship and Innovation*, 15(1), 29-40. doi:10.5367/ijei.2014.0138
- Gennaro, D. D., & Pellegrini, G. (2019). Are regional policies effective? an empirical evaluation on the diffusion of the effects of R&D incentives. *Politica Economica*, 35(1), 10.1016/j.respol.2019.103821
- Grilli, L. (2014). High-tech entrepreneurship in europe: A heuristic firm growth model and three "(un-)easy pieces" for policy-making. *Industry and Innovation*, 21(4), 267-284. doi:10.1080/13662716.2014.939850
- Grilli, L., & Murtinu, S. (2012). Do public subsidies affect the performance of new technologybased firms? the importance of evaluation schemes and agency goals. *Prometheus (United Kingdom)*, 30(1), 97-111. doi:10.1080/08109028.2012.676836
- Grilli, L., & Murtinu, S. (2018). Selective subsidies, entrepreneurial founders' human capital, and access to R&D alliances. *Research Policy*, 47(10), 1945-1963. doi:10.1016/j.respol.2018.07.001
- Grimsby, G. (2018). Partly risky, partly solid – performance study of public innovation loans. *Research Policy*, 47(7), 1344-1365. doi:10.1016/j.respol.2018.04.018

- Gustafsson, A., Stephan, A., Hallman, A., & Karlsson, N. (2016). The “sugar rush” from innovation subsidies: A robust political economy perspective. *Empirica*, 43(4), 729-756. doi:10.1007/s10663-016-9350-6
- Gustafsson, A., Tingvall, P. G., & Halvarsson, D. (2020). Subsidy entrepreneurs: An inquiry into firms seeking public grants. *Journal of Industry, Competition and Trade*, 20(3), 439-478. doi:10.1007/s10842-019-00317-0
- Herrera, L., & Bravo Ibarra, E. R. (2010). Distribution and effect of R&D subsidies: A comparative analysis according to firm size. *Intangible Capital*, 6(2), 272-299. doi:10.3926/ic.2010.v6n2.272-299
- Herrera, L., & Sánchez-González, G. (2013). Firm size and innovation policy. *International Small Business Journal*, 31(2), 137-155. doi:10.1177/0266242611405553
- Hottenrott, H., Lins, E., & Lutz, E. (2018). Public subsidies and new ventures’ use of bank loans. *Economics of Innovation and New Technology*, 27(8), 808-830. doi:10.1080/10438599.2017.1408200
- Hottenrott, H., & Lopes-Bento, C. (2014). (International) R&D collaboration and SMEs: The effectiveness of targeted public R&D support schemes. *Research Policy*, 43(6), 1055-1066. doi:10.1016/j.respol.2014.01.004
- Hottenrott, H., Lopes-Bento, C., & Veugelers, R. (2017). Direct and cross scheme effects in a research and development. *Research Policy*, 46(6), 1118-1132. doi:10.1016/j.respol.2017.04.004
- Hottenrott, H., & Richstein, R. (2020). Start-up subsidies: Does the policy instrument matter? *Research Policy*, 49(1) doi:10.1016/j.respol.2019.103888
- Hud, M., & Hussinger, K. (2015). The impact of R&D subsidies during the crisis. *Research Policy*, 44(10), 1844-1855. doi:10.1016/j.respol.2015.06.003
- Huergo, E., & Moreno, L. (2017). Subsidies or loans? evaluating the impact of R&D support programmes. *Research Policy*, 46(7), 1198-1214. doi:10.1016/j.respol.2017.05.006
- Huergo, E., Trenado, M., & Ubierna, A. (2016). The impact of public support on firm propensity to engage in R&D: Spanish experience. *Technological Forecasting and Social Change*, 113, 206-219. doi:10.1016/j.techfore.2015.05.011
- Kösters, S. (2010). Subsidizing start-ups: Policy targeting and policy effectiveness. *Journal of Industry, Competition and Trade*, 10(3), 199-225. doi:10.1007/s10842-010-0083-0
- López-Fernández, M. C., Serrano-Bedia, A. M., & Pérez-Pérez, M. (2016). Entrepreneurship and family firm research: A bibliometric analysis of an emerging field. *Journal of Small Business Management*, 54(2), 622-639.
- Månsson, J., & Delander, L. (2011). Gender differences in active labour market policy: The swedish self-employment programme. *Equality, Diversity and Inclusion*, 30(4), 278-296. doi:10.1108/02610151111135741
- Marino, M., Lhuillery, S., Parrotta, P., & Sala, D. (2016). Additionality or crowding-out? an overall evaluation of public R&D subsidy on private R&D expenditure. *Research Policy*, 45(9), 1715-1730. doi:10.1016/j.respol.2016.04.009
- Mason, C., & Brown, R. (2013). Creating good public policy to support high-growth firms. *Small Business Economics*, 40(2), 211-225. doi:10.1007/s11187-011-9369-9
- Mas-Tur, A., & Simón Moya, V. (2015). Young innovative companies (YICs) and entrepreneurship policy. *Journal of Business Research*, 68(7), 1432-1435. doi:10.1016/j.jbusres.2015.01.028
- Meuleman, M., & De Maeseneire, W. (2012). Do R&D subsidies affect SMEs' access to external financing? *Research Policy*, 41(3), 580-591. doi:10.1016/j.respol.2012.01.001
- Mina, A., Minin, A. D., Martelli, I., Testa, G., & Santoleri, P. (2021). Public funding of innovation: Exploring applications and allocations of the european SME instrument. *Research Policy*, 50(1) doi:10.1016/j.respol.2020.104131
- Minola, T., Vismara, S., & Hahn, D. (2017). Screening model for the support of governmental venture capital. *Journal of Technology Transfer*, 42(1), 59-77. doi:10.1007/s10961-015-9461-4
- Møen, J. (2019). Corporate returns to subsidised R&D projects: Direct grants vs. tax credit financing. *International Journal of Technology Management*, 79(1), 84-101. doi:10.1504/IJBCRM.2018.096550
- Munari, F., & Toschi, L. (2015). Assessing the impact of public venture capital programmes in the united kingdom: Do regional characteristics matter? *Journal of Business Venturing*, 30(2), 205-226. doi:10.1016/j.jbusvent.2014.07.009
- Novero, S. (2011). Impact analysis of public policies supporting SMEs' technological innovation: An italian case. *International Journal of Technology, Policy and Management*, 11(1), 34-56. doi:10.1504/IJTPM.2011.040300
- Pickernell, D., Senyard, J., Jones, P., Packham, G., & Ramsey, E. (2013). New and young firms: Entrepreneurship policy and the role of government - evidence from the federation of small businesses survey. *Journal of Small Business and Enterprise Development*, 20(2), 358-382. doi:10.1108/14626001311326770

- Pierrakis, Y., & Saridakis, G. (2017). Do publicly backed venture capital investments promote innovation? differences between privately and publicly backed funds in the UK venture capital market. *Journal of Business Venturing Insights*, 7, 55-64. doi:10.1016/j.jbvi.2017.02.002
- Potì, B., & Cerulli, G. (2011). Evaluation of firm R&D and innovation support: New indicators and the ex-ante prediction of ex-post additionality. *Research Evaluation*, 20(1), 19-29. doi:10.3152/095820211X12941371876427
- Radas, S., & Anić, I. -. (2013). Evaluating additionality of an innovation subsidy program targeted at SMEs: An exploratory study. *Croatian Economic Survey*, 15(1), 61-88. Retrieved from www.scopus.com
- Radas, S., Anić, I. -. , Tafro, A., & Wagner, V. (2015). The effects of public support schemes on small and medium enterprises. *Technovation*, 38, 15-30. doi:10.1016/j.technovation.2014.08.002
- Radas, S., Mervar, A., & Škrinjarić, B. (2020). Regional perspective on R&D policies for SMEs: Does success breed success? *Sustainability (Switzerland)*, 12(9) doi:10.3390/su12093846
- Radicić, D., & Pugh, G. (2017). R&D programmes, policy mix, and the 'european paradox': Evidence from european SMEs. *Science and Public Policy*, 44(4), 497-512. doi:10.1093/scipol/scw077
- Radicić, D., Pugh, G., & Douglas, D. (2020). Promoting cooperation in innovation ecosystems: Evidence from european traditional manufacturing SMEs. *Small Business Economics*, 54(1), 257-283. doi:10.1007/s11187-018-0088-3
- Ramaciotti, L., Muscio, A., & Rizzo, U. (2017). The impact of hard and soft policy measures on new technology-based firms. *Regional Studies*, 51(4), 629-642. doi:10.1080/00343404.2016.1255319
- Rojas, F., & Huergo, E. (2016). Characteristics of entrepreneurs and public support for NTBFs. *Small Business Economics*, 47(2), 363-382. doi:10.1007/s11187-016-9718-9
- Santos, A. (2019). Do selected firms show higher performance? the case of portugal's innovation subsidy. *Structural Change and Economic Dynamics*, 50, 39-50. doi:10.1016/j.strueco.2019.04.003
- Santos, A., Neto, P., & Serrano, M. M. (2016). A long-term mortality analysis of subsidized firms in rural areas: An empirical study in the portuguese alentejo region. *Eurasian Economic Review*, 6(1), 125-151. doi:10.1007/s40822-015-0035-4
- Segarra-Blasco, A., & Teruel, M. (2016). Application and success of R&D subsidies: What is the role of firm age? *Industry and Innovation*, 23(8), 713-733. doi:10.1080/13662716.2016.1201649
- Söderblom, A., Samuelsson, M., Wiklund, J., & Sandberg, R. (2015). Inside the black box of outcome additionality: Effects of early-stage government subsidies on resource accumulation and new venture performance. *Research Policy*, 44(8), 1501-1512. doi:10.1016/j.respol.2015.05.009
- Spanos, Y. E., Vonortas, N. S., & Voudouris, I. (2015). Antecedents of innovation impacts in publicly funded collaborative R&D projects. *Technovation*, 36, 53-64. doi:10.1016/j.technovation.2014.07.010
- Svensson, R. (2013). Publicly-funded R&D programs and survival of patents. *Applied Economics*, 45(10), 1343-1358. doi:10.1080/00036846.2011.617700
- Vanino, E., Roper, S., & Becker, B. (2019). Knowledge to money: Assessing the business performance effects of publicly-funded R&D grants. *Research Policy*, 48(7), 1714-1737. doi:10.1016/j.respol.2019.04.001
- Vorley, T., & Nelles, J. (2010). Innovation policy as industrial policy: Some lessons from hamburg's regional innovation system. *Local Economy*, 25(8), 631-649. doi:10.1080/02690942.2010.533422
- Walburn, D. (2012). Public policy and high growth firms. *Local Economy*, 27(4), 329-331. doi:10.1177/0269094212441446
- Wintjes, R., & Hollanders, H. (2019). Promoting innovation, capabilities and impact for smes in traditional industries calls for variety in innovation support. *Industria*, 40(1), 45-74. doi:10.1430/94059

4 CONCLUSION GENERALE

Pour conclure ce travail doctoral, nous proposons de revenir sur les résultats et les contributions de chacun des trois chapitres à la littérature sur le financement de l'innovation en phase d'amorçage, ainsi que sur leurs principales limites. Nous compléterons la discussion en ouvrant la réflexion sur des pistes de recherches futures et des recommandations en matière de soutien public à l'innovation que peuvent inspirer ces travaux.

4.1 Principaux résultats et contributions

L'économie de la connaissance, paradigme dominant des économies développées depuis les années 1980, met l'innovation au cœur du processus de croissance. Les décideurs publics, soucieux de stimuler cette dernière ont mis en place des politiques visant à réduire les failles de marchés et orienter l'économie vers les principaux défis du siècle (pollution et changement climatique, croissance inclusive). Devant l'accumulation des travaux académiques sur le rôle des PME dans l'activité économique ces politiques se sont concentrées sur leur soutien et, plus particulièrement, leur financement, unanimement considéré comme la contrainte principale pesant sur le développement de ces entreprises. Les travaux académiques sur le financement de l'innovation ont alimenté ces démarches en mettant en évidence le rôle du financement d'amorçage comme facteur structurant du développement des entreprises. Devant le constat de l'importance du financement d'amorçage de l'innovation deux principales réflexions émergent : Quels sont les acteurs de l'amorçage en France ? Quels sont leurs rôles et leurs impacts ?

Au-delà de la caractérisation et de l'évaluation de l'influence des acteurs de l'amorçage en France, cette thèse aborde également la question de la définition et de la mise en place de politiques publiques visant à stimuler les efforts d'innovation. Elle revient notamment sur le processus d'accumulation de connaissances sous-jacent à la conception et à la décision des politiques publiques fondées sur la preuve scientifique nous conduisant ainsi à étudier les questions suivantes : Comment se structure et se développe la littérature académique relative à l'évaluation des politiques publiques ? Comment cette littérature peut-elle servir à la prise de décision dans un contexte de rationalisation des dépenses publiques renforcé par la crise sanitaire du COVID-19 ?

Sur la base de ces questionnements, cette thèse a cherché à apporter une réflexion nouvelle concernant les politiques publiques de soutien à l'innovation en phase d'amorçage.

4.1.1 Le financement d'amorçage de l'innovation par capital risque

Le premier chapitre a étudié le marché du capital risque en France et son impact sur les entreprises à travers le financement par les business-angels, acteurs reconnus du secteur souvent organisés en réseaux afin d'augmenter leur impact et réduire leurs coûts. Malgré les avantages attribués à ces investisseurs providentiels, les résultats empiriques académiques sont très hétérogènes et ne parviennent pas à conclure à l'efficacité de ces acteurs et à leur rôle dynamisant en tant qu'accompagnateurs des entreprises.

Ce chapitre qui repose sur une analyse empirique appliquée à une base de données inédite sur le financement par les réseaux de business-angels en France entre 2001 et 2014 débouche sur plusieurs résultats. Il a permis de caractériser le rôle des réseaux de business-angels dans le financement des entreprises et leur impact sur la structure du capital des entreprises soutenues. Aspect relativement peu considéré dans les recherches sur le capital-risque, la gestion de la structure du capital est pourtant un élément essentiel pour le développement des entreprises innovantes. Une autre contribution de ce chapitre réside dans la prise en compte des différents niveaux d'action des business-angels. En analysant la relation entre l'intervention des business-angels et différents indicateurs de la structure du capital, nous avons pu mettre en évidence un effet de certification auprès des partenaires commerciaux et bancaires.

Cependant, si ce mécanisme de certification s'est révélé significatif, nous avons également montré qu'il était peu robuste, confirmant ainsi les conclusions des précédentes études mettant en évidence l'effet hétérogène du soutien par business-angels. Cette analyse nous a donc amené à conclure que le financement des business-angels ne différencie pas radicalement les entreprises adossées à ces investisseurs des autres. Il conduit, à une modeste baisse de la dette commerciale, indicateur de l'asymétrie d'information avec les partenaires commerciaux, et à une croissance de la dette financière dans l'année qui suit l'intervention des business-angels. En revanche, aucune variable de croissance ou de performance n'est significativement améliorée par la présence de ces investisseurs.

Les implications en termes de politiques publiques concernent l'importance de la mise en place d'un système d'information rigoureux permettant d'obtenir des données, qui, tant sur le plan quantitatif que qualitatif pourraient permettre d'approfondir les recherches concernant les business-angels en France et leur impact sur les entreprises financées.

Principales limites du chapitre 1.

Le chapitre rencontre plusieurs limites que de futures recherches pourraient s'attacher à dépasser. D'un point de vue statistique, l'analyse souffre d'un biais fréquent sur le marché d'amorçage concernant le manque de données disponibles. Ce déficit d'information explique que l'hétérogénéité de l'apport en capital humain et le caractère multiforme de l'action des business-angels soient des thèmes de recherche ayant rarement fait l'objet d'analyses empiriques systématiques en France. Ensuite, d'un point de vue méthodologique, l'analyse se concentre sur des données de bilan alors que l'intervention des business-angels dépasse le seul financement. La prise en considération d'aspects relatifs à la nature de la gouvernance ou aux caractéristiques des entrepreneurs pourrait permettre d'enrichir la démarche. Enfin, le recours à un modèle de médiation pourrait permettre de vérifier l'impact des business-angels sur la structure du capital et d'étudier les conséquences induites par ces choix de financement sur le développement des firmes

4.1.2 Banque de développement et développement des entreprises innovantes en France

Le deuxième chapitre a mis l'accent sur le rôle des banques publiques de développement dans le financement de l'innovation en évaluant l'impact d'un prêt participatif sur des jeunes entreprises à caractère innovant entre 2006 et 2014. Le ciblage sur ce dispositif s'explique par la capacité de la finance mezzanine, regroupant des modalités de financement situées entre le haut et le bas de bilan, à répondre aux contraintes financières subies par les entreprises innovantes en début du cycle de vie. En France, cet instrument a été utilisé à partir des années 2000 et n'a fait que rarement l'objet d'évaluations, contrairement aux autres formes de financement de l'innovation (incitations fiscales, garanties de crédit, subventions) pour lesquelles une abondante littérature est disponible.

Ce chapitre a cherché à combler ce vide. En accord avec la littérature, nous avons testé l'additionnalité des dépenses publiques à travers l'impact du prêt considéré sur l'emploi et l'accumulation d'actifs matériels et immatériels. Pour compléter le cadre d'étude nous avons également analysé l'impact du financement sur le chiffre d'affaires et la productivité du travail. Enfin, la démarche retenue nous a permis d'enrichir l'analyse de l'effet estimé du traitement en étudiant la médiation de certains aspects relatifs à la mise en place du produit dont la temporalité de l'investissement, du financement durant la crise financière de 2008 et du montant du prêt. L'originalité de ce chapitre tient également dans l'identification d'un groupe de contrôle composé d'entreprises ayant reçu une aide sélective pour leurs activités d'innovation mais n'ayant pas bénéficié d'un prêt participatif de Bpifrance. Cela nous a

permis de contrôler le biais de motivation et le biais de demande de financement externe dans la mesure où les entreprises traitées, comme les entreprises témoin, ont demandé et reçu une aide à l'innovation.

Les résultats obtenus ont montré un effet négatif du programme sur l'emploi ainsi qu'un effet positif, mais conditionnel au design du prêt, sur l'accumulation d'actifs immatériels ainsi que sur le chiffre d'affaires. L'analyse souligne également l'influence de la conception et de l'implémentation du programme, de la temporalité entre l'aide à l'innovation et le prêt participatif, du contexte macroéconomique ainsi que du montant du prêt sur l'emploi.

En termes d'implication pour les politiques publiques, ce chapitre montre l'importance de la définition des objectifs suivis par le programme dans le cadre d'une évaluation d'impact. Il met également en évidence l'importance du ciblage des entreprises à soutenir ou du moment de l'attribution du prêt (contemporain ou postérieur à l'aide à l'innovation), éléments qu'il est alors nécessaire d'intégrer à l'évaluation du dispositif. Il révèle également que les stratégies de croissance des firmes à fort potentiel peuvent différer de celles d'autres classes d'entreprises (Siepel & Dejardin, 2020). A ce double titre le chapitre interroge sur la conception et la conceptualisation d'une politique publique, allant de ses effets attendus (conception et évaluation *ex ante*) à ses effets estimés (implémentation et évaluation *ex post*).

Principales limites du chapitre 2

Ce chapitre présente quelques limites, notamment méthodologiques, qu'il convient à ce stade de mentionner. D'abord, bien que la méthode d'appariement suivie d'une estimation en double différence permette de réduire les biais de sélection concernant l'hétérogénéité observable et inobservable, le biais de « sélection des vainqueurs » peut remettre en question les effets obtenus. Ensuite, les possibles financements ultérieurs des entreprises du groupe de contrôle peuvent également induire un biais de sélection qui pèse sur la pertinence des résultats obtenus. Ce dernier biais ne devrait pas être de grande ampleur dans la mesure où l'action de Bpifrance sur le marché du financement est quasi monopolistique, ce qui réduit la probabilité d'accès d'une entreprise à une autre forme de financement.

Des limites plus conceptuelles peuvent également être mentionnées. En effet, l'analyse ici conduite s'est exclusivement concentrée sur des données de bilan, laissant de côté les caractéristiques des entrepreneurs (âge, genre, passé entrepreneurial, niveau d'étude, etc.)

dont l'importance a été soulignée par la littérature. L'inclusion de variables de profil individuel pourrait ainsi constituer un prolongement de l'étude.

Nous pouvons également noter, en ce qui concerne l'analyse des résultats, que le chapitre reprend des indicateurs usuels dans l'évaluation des politiques publiques en matière d'innovation. Or, les stratégies de développement des entreprises à fort potentiel de croissance peuvent être très différentes de celles des autres entreprises innovantes, cette particularité risquant de remettre en cause la pertinence des indicateurs étudiés et conduire à préconiser l'emploi d'autres indicateurs. Enfin, les résultats exploratoires sur l'importance des conditions de mise en place du prêt pourraient faire l'objet d'investigations plus poussées à travers une étude des mécanismes d'attribution permettant alors de contribuer à une mise en place efficace du programme (Söderblom et al., 2015).

4.1.3 Les politiques publiques basées sur la preuve, un processus complexe

Le dernier chapitre de cette thèse revient sur le processus de validité externe avancé par la littérature sur l'évaluation à travers une revue de littérature systématique concernant le soutien public aux petites entreprises et entrepreneurs (PE&Es) en Europe entre 2010 et 2021. Ce chapitre a été construit sous la forme d'un raisonnement à rebours qui part du constat, relativement admis dans la littérature sur l'évaluation, de la faible utilisation des travaux académiques dans les débats politiques (Weiss, 1983). Ce déficit d'appropriation par les décideurs publics n'a pas empêché la publication d'un nombre élevé et croissant d'études d'impact relatives aux dépenses publiques en matière d'innovation (Jugend et al., 2020), ce qui pourrait sembler paradoxal. Le paradoxe se révèle d'autant plus important que le paradigme de rationalisation des dépenses publiques qui caractérisent les économies développées (Lane, 2002) a favorisé le recours à des travaux académiques pour rendre compte de l'(in)efficacité des dispositifs d'action publique. Il s'est alors agi d'expliquer pourquoi, en dépit du besoin croissant d'évaluation et d'analyses toujours plus nombreuses sur l'évaluation d'outils d'aide à l'innovation des PE&E, ces dernières sont demeurées circonscrites à la sphère académique.

Nous avons étudié cette situation en prenant comme point de départ l'accumulation de connaissances, à travers des revues de littérature systématiques ou des méta-analyses. Ces revues de littératures servent d'ancrage aux débats scientifiques et politiques concernant l'efficacité des programmes publics et contribuent à la mise en place de politique publiques basées sur la preuve scientifique (Oliver et al., 2005; Valentine et al., 2017). Pourtant, malgré le développement de ces recherches, les constats d'aujourd'hui ressemblent à ceux d'hier ; les

effets observés sont ambigus et d'autres études demeurent nécessaires pour comprendre la nature hétérogène des résultats (David et al., 2000; Dimos & Pugh, 2016; Dvouletý et al., 2020).

Notre troisième chapitre a montré que l'ambiguïté qui caractérise les revues de littérature et empêche l'utilisation du savoir académique dans le cadre des débats sur la mise en place de politiques basées sur la preuve pourrait provenir du champ lexical utilisé pour désigner l'objet du soutien public. En effet, alors qu'un axe de recherche essentiel s'est construit autour de l'importance des méthodologies causales, la caractérisation du sujet s'est souvent révélée insuffisamment précise, conduisant les recueils d'évaluation d'impact à inclure des études utilisant un vocable homogène mais renvoyant parfois à des réalités économiques très divergentes. Ce phénomène pourrait prendre racine dans les pressions à la publication qui forcent l'utilisation d'un champ lexical particulier afin de convenir aux exigences des revues académiques. Le cas des « new technology-based firms » s'est montré particulièrement révélateur de ce type de situation.

Ce chapitre contribue à la littérature sur le soutien public à l'innovation en Europe à travers la mise en place d'une étude bibliométrique synthétisant la structure intellectuelle et le développement de la recherche de la dernière décennie sur le sujet. Il contribue également à la recherche sur les sciences de l'information en sciences sociales en comparant la couverture et les orientations que peuvent avoir les bases de données bibliométriques. Cet aspect pourtant structurant dans le processus d'accumulation de connaissance reste à développer en sciences sociales.

Principales limites du chapitre 3

Les recherches bibliométriques contiennent un certain nombre de biais, endogènes à leur construction, qu'il convient de mettre en évidence afin d'améliorer les conclusions et faciliter la prise de décision éclairée en termes de politiques publiques de soutien à l'innovation.

D'abord, la couverture des bases de données n'est pas exhaustive et peut comporter des vides relatifs à certains auteurs ou certains travaux. Ensuite, les outils bibliométriques ramènent les contributions aux premiers auteurs dans l'analyse des réseaux. Enfin les bases de données ne sont pas forcément à jour concernant les citations, ce qui nuit à la pertinence de la représentation graphique des réseaux de chercheurs ou de documents, et limite par conséquent la portée des interprétations.

Au-delà de ces limites inhérentes à toute étude bibliométrique, une autre réserve spécifique à ce chapitre pourrait déboucher sur un axe majeur d'amélioration dans le cadre de futures recherches. Elle concerne l'utilisation d'un champ lexical, défini à la discrétion de(s) auteur(e)(s) des revues systématiques, lequel se révèle souvent biaisé ou incomplet. A ce titre, une certaine harmonisation, sans toutefois passer sous silence les spécificités de chacune des catégories de firmes identifiées, serait souhaitable afin de faciliter les recherches bibliométriques et, *in fine* d'améliorer l'impact des revues systématiques dans les débats académiques et politiques.

4.2 *Agenda de recherche*

Cette thèse se situe à l'intersection de plusieurs champs de recherche. Le premier et deuxième chapitre ont emprunté à la littérature sur l'innovation et à celle sur la finance entrepreneuriale, les deuxième et troisième chapitres ont été inspirés par la littérature sur l'évaluation de l'impact des politiques publiques en matière d'innovation, tandis que le troisième chapitre a pris racine dans la littérature sur les sciences de l'information appliquées aux sciences sociales.

Les prolongements de la recherche concernant le premier champ sont relatifs à la possibilité de mise en place de questionnaires qualitatifs et, plus largement, d'un système d'information permettant d'étudier les relations entre entrepreneurs et financeurs. Cette connaissance qualitative permettrait de contribuer à mieux définir les soutiens publics à l'offre de financement à travers les incitations fiscales dont bénéficie l'investissement productif et la demande de financement. En effet, les difficultés posées par le « brouillard informationnel » qui caractérise le marché du capital-risque limitent la mise en place d'études quantitatives ayant un pouvoir statistique satisfaisant et nuit finalement leur utilisation dans les débats publics.

La continuation des travaux au croisement de la littérature sur la finance entrepreneuriale et l'innovation pourrait passer par la réalisation d'une recherche combinant le financement par capital risque et le financement par Bpifrance qui permettrait de tester l'effet de la combinaison d'efforts public et privés en matière de financement de l'innovation. A ce jour, l'insuffisance de données disponibles ne permet pas de mener une telle analyse. Un autre prolongement pourrait provenir de l'utilisation des statistiques bayésiennes pour renverser la charge de la preuve liée à la validité externe. Au lieu d'être réalisée à la fin du processus d'évaluation pour assurer la crédibilité du processus de validité interne (robustesse), mais

l'évaluation pourrait être effectuée en amont afin de calibrer le modèle en fonction des résultats d'études précédentes. Cette démarche pourrait s'inspirer de récentes recherches mettant en évidence la flexibilité de l'approche bayésienne par rapport à l'approche fréquentiste dans la formulation des hypothèses et dans l'expression des recommandations en termes de politique publique (Chandler et al., 2020; Oliver et al., 2005; Valentine et al., 2017).

La prise en compte de la connaissance accumulée en amont du processus d'évaluation débouche sur des possibilités de prolongement dans le domaine de la littérature sur les sciences de l'information appliquée aux sciences sociales. Une première extension pourrait consister dans la mise en place d'une revue systématique se concentrant sur un terme particulier pour étudier la variété des réalités économiques auxquelles il renvoie. Un second prolongement pourrait être de rassembler dans une base de données disponible publiquement, l'ensemble des termes utilisés dans la littérature pour caractériser, d'un côté, le vocable associé au soutien public et, de l'autre, le vocable associé aux petites entreprises innovantes et aux entrepreneurs. Ce travail pourrait alors servir de base pour de futures revues de littérature en vue d'améliorer leur utilisation dans le débat public.

4.3 References

- Chandler, J. J., Martinez, I., Finucane, M. M., Terziev, J. G., & Resch, A. M. (2020). Speaking on data's behalf: What researchers say and how audiences choose. *Evaluation Review*, 44(4), 325–353.
- David, P. A., Hall, B. H., & Toole, A. A. (2000). Is public R&D a complement or substitute for private R&D? A review of the econometric evidence. *Research Policy*, 29(4–5), 497–529. [https://doi.org/10.1016/S0048-7333\(99\)00087-6](https://doi.org/10.1016/S0048-7333(99)00087-6)
- Dimos, C., & Pugh, G. (2016). The effectiveness of R&D subsidies: A meta-regression analysis of the evaluation literature. *Research Policy*, 45(4), 797–815. <https://doi.org/10.1016/j.respol.2016.01.002>
- Dvouletý, O., Srhoj, S., & Pantea, S. (2020). Public SME grants and firm performance in European Union: A systematic review of empirical evidence. *Small Business Economics*. <https://doi.org/10.1007/s11187-019-00306-x>
- Jugend, D., Fiorini, P. D. C., Armellini, F., & Ferrari, A. G. (2020). Public support for innovation: A systematic review of the literature and implications for open innovation. *Technological Forecasting and Social Change*, 156, 119985. <https://doi.org/10.1016/j.techfore.2020.119985>
- Lane, J.-E. (2002). *New public management: An introduction*. Routledge.
- Oliver, S., Harden, A., Rees, R., Shepherd, J., Brunton, G., Garcia, J., & Oakley, A. (2005). An emerging framework for including different types of evidence in systematic reviews for public policy. *Evaluation*, 11(4), 428–446.

- Siepel, J., & Dejardin, M. (2020). How do we measure firm performance? A review of issues facing entrepreneurship researchers. *Handbook of Quantitative Research Methods in Entrepreneurship*.
- Söderblom, A., Samuelsson, M., Wiklund, J., & Sandberg, R. (2015). Inside the black box of outcome additionality: Effects of early-stage government subsidies on resource accumulation and new venture performance. *Research Policy*, *44*(8), 1501–1512. <https://doi.org/10.1016/j.respol.2015.05.009>
- Valentine, J. C., Wilson, S. J., Rindskopf, D., Lau, T. S., Tanner-Smith, E. E., Yeide, M., LaSota, R., & Foster, L. (2017). Synthesizing evidence in public policy contexts: The challenge of synthesis when there are only a few studies. *Evaluation Review*, *41*(1), 3–26.
- Weiss, C. H. (1983). Ideology, Interests, and Information. In D. Callahan & B. Jennings (Eds.), *Ethics, The Social Sciences, and Policy Analysis* (pp. 213–245). Springer US. https://doi.org/10.1007/978-1-4684-7015-4_9
- Zúñiga-Vicente, J. Á., Alonso-Borrego, C., Forcadell, F. J., & Galán, J. I. (2014). Assessing the effect of public subsidies on firm R&D investment: A survey. *Journal of Economic Surveys*, *28*(1), 36–67. <https://doi.org/10.1111/j.1467-6419.2012.00738.x>